

Proceedings



of the I·R·E

A Journal of Communications and Electronic Engineering

(Including the WAVES AND ELECTRONS Section)

S. Prevost

July, 1947

Volume 35

Number 7

PROCEEDINGS OF THE I.R.E.

Frequency Modulation and Control
by Electron Beams

25-Watt 4000-Mc. F-M Magnetron

1-Kilowatt 900-Mc. F-M
Magnetron

Propagation Studies on 45.1, 474,
and 2800 Mc.

Multitone Amplitude and
Frequency Modulation

Waves and Electrons
Section

Electronics in Submarine Warfare

Radar Beacons

Antenna Focal Devices for
Parabolic Mirrors

Microwave Impedance-Plotting
Device

Abstracts and References

TABLE OF CONTENTS PAGE FOLLOWS PAGE 32A



General Electric Company

RADIO LABORATORIES "TAKE TO THE ROAD"

Trailers, equipped with radio and electronic testing and repair apparatus suitable for study of radio communication systems, will be available in most of the United States. Government and industrial services will benefit from prompt availability of transportable laboratory facilities. In the upper left-hand illustration are shown: Nat Gade (A'46), C. A. Priest (A'24-M'38-SM'43-F'47), and C. M. Heiden (S'40).

The Institute of Radio Engineers

THE OPERATION

BROADCASTING that earns the approval of station managers and listeners alike under any and all local conditions for reliability, efficiency and economy.

THE EQUIPMENT

COLLINS 21A 5Kw Air Cooled BROADCAST TRANSMITTER made by **COLLINS RADIO COMPANY**, 11 West 42nd Street, New York 18, N. Y.

The new Collins 21A has been the choice of keen executives for close to a score of installations in recent months. Knowledge and experience gained by Collins engineers during war time are reflected in improved design, longer life, higher safety factors and unusual standards of trouble free operation.

THE AMPEREX tubes THAT DO THE JOB!



AMPEREX experience in communication goes back a quarter of a century. The same record of performance, long life and economy marks Amperex tubes for industrial, rectification, electro medical and special purpose use. As tube specialists concerned with all electronic developments Amperex engineers are in a position to give detached counsel and information

Write Application Engineering Department.

POWER TUBE SPECIALISTS SINCE 1925

COMMUNICATION
RECTIFICATION
INDUSTRIAL
ELECTRO-MEDICAL
SPECIAL PURPOSE

AMPEREX

ELECTRONIC CORPORATION

25 WASHINGTON STREET, BROOKLYN 1, N. Y. CABLES: "ARLAB"

In Canada and Newfoundland: ROGERS MAJESTIC LIMITED, 622 Fleet Street West, Toronto 28, Canada



NEW IMPROVED HY75A

**25% MORE
POWER OUTPUT**

**INCREASED
FREQUENCY RANGE**

	Max Ratings
2-meter band	100%
1 1/4-meter band	85%
3/4-meter band	60%

SAME LOW PRICE \$3.95

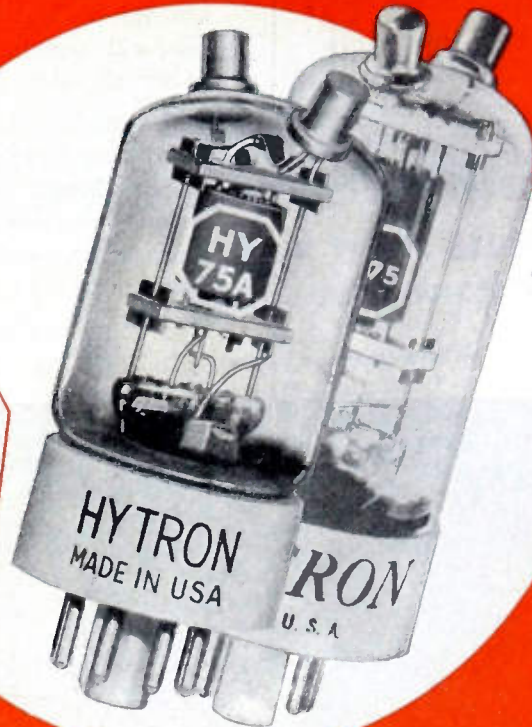

COMPARISON HY75A AND HY75 VHF POWER OSCILLATOR/AMPLIFIERS

GENERAL CHARACTERISTICS

	HY75	HY75A	
Type of filament	Thor.	Thor.	
Filament potential	6.3	6.3	v
Filament current	2.6	2.6	amp
Amplification factor	8	9.6	
Transconductance	1700	2400	μmhos
Grid-to-plate capacitance	3.8	2.6	μmf
Grid-to-filament capacitance	1.8	1.8	μmf
Plate-to-filament capacitance	1.	1.	μmf
Max overall length	3 7/8	3 1/2	in.
Max diameter	1 7/16	1 7/16	in.
Bulb	T-11	T-11	
Base	Octal	Octal	

ABSOLUTE MAXIMUM CCS RATINGS

D-c plate potential	450	450	v
D-c plate current	80	90	ma
D-c plate input	36	40.5	w
D-c grid potential	-150	-150	v
D-c grid current	25	25	ma
Plate dissipation	15	15	w

USEFUL POWER OUTPUT (CCS)—TYPICAL OPERATION*

Class C unmod.—144 mc#	13	17	w
Class C mod.—144 mc#	11	14	w

CCS = continuous commercial service. *Useful power output to the load is determined by subtracting grid, circuit, and direct radiation losses from total plate power output. #Actual values using tubes in Hytron HY-Q 75 transmitter are shown.

To improve upon the HY75 was not easy. But the new HY75A does the trick. Useful power output as a class C oscillator is up 25%. Maximum plate current is increased to 90 ma. Grid-to-plate capacitance is sharply reduced to 2.6 μmf. Lead inductance is minimized. Proof of the pudding: an HY75A substituted for an HY75 in a 144-mc quarter-wave line oscillator raises the resonant frequency by 20–30 mc.

How was this accomplished? By a shorter mount, smaller elements, special high-voltage processing of the lava insulators, redesigned vertical bar grid, and zirconium-coated graphite anode. All at no extra-cost to you.

When replacing the HY75, the HY75A requires only readjustment of the tank circuit and a higher value of grid resistor. For example, the HY75A can be used in the Hytron HY-Q 75 transmitter merely by retuning the shorting bar and installing a 7000-ohm grid resistor. For replacement or new vhf equipment, the rugged, instant-heating HY75A is your logical choice.

SPECIALISTS IN RADIO RECEIVING TUBES SINCE 1921

HYTRON

RADIO AND ELECTRONICS CORP.



MAIN OFFICE: SALEM, MASSACHUSETTS

PROCEEDINGS OF THE I.R.E., July, 1947, Vol. 35, No. 7. Published monthly in two sections by The Institute of Radio Engineers, Inc., at 1 East 79 Street, New York 21, N.Y. Price \$1.50 per copy. Subscriptions: United States and Canada, \$12.00 a year; foreign countries \$13.00 a year. Entered as second class matter, October 26, 1927, at the post office at Menasha, Wisconsin, under the act of March 3, 1879. Acceptance for mailing at a special rate of postage is provided for in the act of February 28, 1925, embodied in Paragraph 4, Section 412, P. L. and R., authorized October 26, 1927.

Table of contents will be found following page 32A

It tells when
you will
telephone

"It" is an icosahedron—a solid with twenty regular faces. The laws of probability say that if you roll a hundred icosahedrons on a table, eleven or more will come to rest with side "A" on top only once in a hundred throws.

Identical laws of probability rule the calls coming into your local Bell Telephone exchange. Suppose you are one of a group of a hundred telephone subscribers whose practice is to make one three-minute call each during the busiest hour of the day. The chance that

eleven or more of you will be talking at once is also only one in a hundred. Thus it would be wasteful for the Bell System to supply your group with a hundred trunk circuits. Eleven trunks will suffice to give you good service.

Telephone traffic conditions vary. But you can be sure, wherever you live, that Bell Telephone Laboratories research, which pioneered in applying probability theory to telephone traffic, is everywhere helping to make the most use of costly equipment.

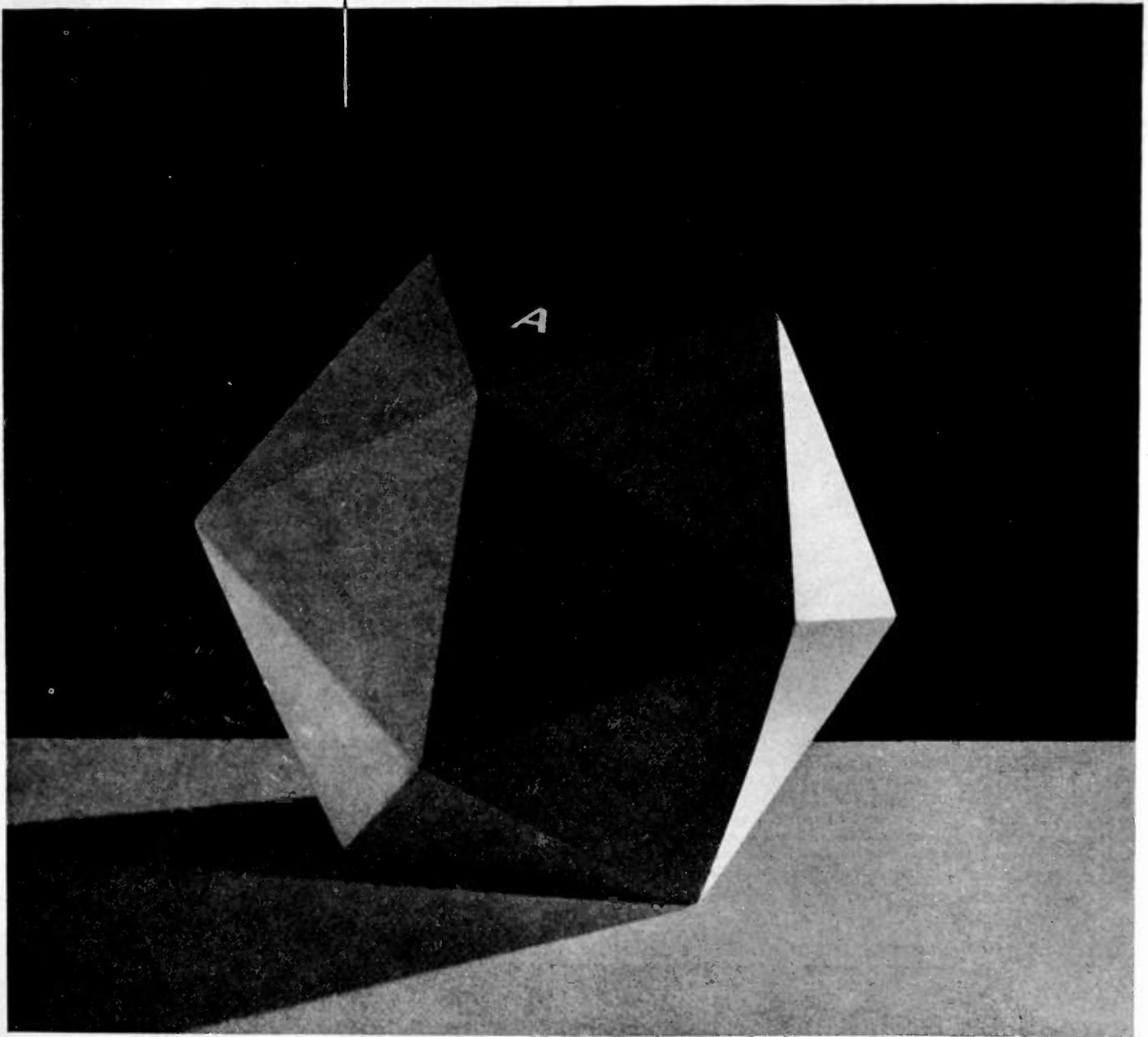

BELL TELEPHONE LABORATORIES



EXPLORING AND INVENTING, DEVISING AND PERFECTING, FOR CONTINUED IMPROVEMENTS AND ECONOMIES IN TELEPHONE SERVICE

MEASURE TOTAL DISTORTION
Between 20 cps and 20 kc



330B DISTORTION ANALYZER



CHECK THESE SEVEN IMPORTANT FUNCTIONS:

1. Measures total audio distortion.
2. Checks distortion of modulated r-f carrier.
3. Determines voltage level, power output.
4. Measures amplifier gain and response.
5. Directly measures audio noise and hum.
6. Determines unknown audio frequencies.
7. Serves as high-gain, wide-band stabilized amplifier.

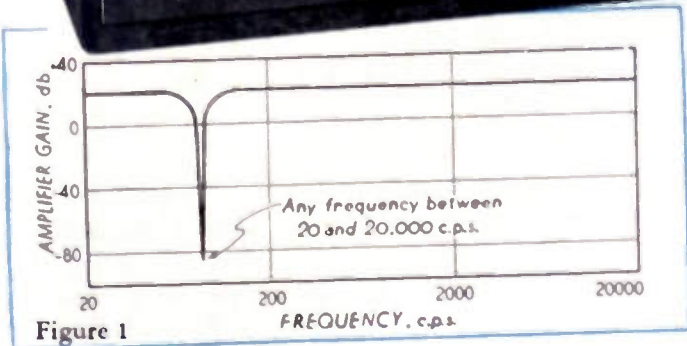

Figure 1

This fast, versatile *-hp-* 330B Analyzer measures distortion at *any* frequency from 20 cps to 20 kc. Measurements are made by eliminating the fundamental and comparing the ratio of the original wave with the total of remaining harmonic components. This comparison is made with a built-in vacuum tube voltmeter.

The unique *-hp-* resistance-tuned circuit used in this instrument is adapted from the famous *-hp-* 200 series oscillators. It provides almost infinite attenuation at one chosen frequency. All other frequencies are passed at the normal 20 db gain of the amplifier. Figure 1 shows how attenuation of approximately 80 db is achieved at any pre-selected point between 20 cps and 20 kc. Rejection is so sharp that second and higher harmonics are attenuated less than 10%.

Full-Fledged Voltmeter

As a high-impedance, wide-range, high-sensitivity vacuum tube voltmeter, this *-hp-* 330B gives precision response flat at any frequency from 10 cps to 100 kc. Nine full-scale

ranges are provided: .03, .1, .3, 1.0, 3.0, 10, 30, 100 and 300. Calibration from +2 to -12 db is provided, and ranges are related in 10 db steps.

The amplifier of the instrument can be used in cascade with the vacuum tube voltmeter to increase its sensitivity 100 times for noise and hum measurements.

Accuracy throughout is approximately $\pm 3\%$ and is unaffected by changing of tubes or line voltage variations. Output of the voltmeter has terminals for connection to an oscilloscope, to permit visual presentation of wave under measurement.

Measures Direct From R-F Carrier

The *-hp-* 330B incorporates a linear r-f detector to rectify the transmitted carrier, and input circuits are continuously variable from 500 kc to 60 mc in 6 bands.

Ease of operation, universal applicability, great stability and light weight of this unique *-hp-* 330B Analyzer make it ideal for almost any audio measurement in laboratory, broadcast or production line work. Full details are immediately available. Write or wire for them—today Hewlett-Packard Company, 1437D Page Mill Road, Palo Alto, Calif.

hp laboratory instruments
FOR SPEED AND ACCURACY

Noise and Distortion Analyzers	Wave Analyzers	Frequency Meters
Audio Frequency Oscillators	Audio Signal Generators	Vacuum Tube Voltmeters
Amplifiers	Power Supplies	Attenuators
Square Wave Generators	UHF Signal Generators	Electronic Tachometers
	Frequency Standards	

ARNOLD

PERMANENT MAGNETS

*Depend on them
for Uniformly
High Quality
in every
PHYSICAL, MAGNETIC
and METALLURGICAL
Characteristic*

You would find it hard to set a requirement on Arnold magnets that is not already exceeded in our regular production procedure.

All Arnold products are made on a basis of 100% quality-control at every step of manufacture. These rigidly maintained standards cover all physical, magnetic and metallurgical characteristics. . . you can place complete confidence in the uniformity and dependability of Arnold Permanent Magnets, and their resultant performance in your assemblies.

Remember, too, that Arnold's service covers all types of permanent magnet materials, any size or shape of unit, and any field of application. Our engineers are at your command—write us direct or ask any Allegheny Ludlum representative.

WAD 1098

THE ARNOLD ENGINEERING COMPANY



Subsidiary of

ALLEGHENY LUDLUM STEEL CORPORATION

147 East Ontario Street, Chicago, Illinois

Specialists and Leaders in the Design, Engineering and Manufacture of PERMANENT MAGNETS

Reasons why...

The Trend is Toward ERIE "GP" CERAMICONS for By-Pass and Coupling Applications

ECONOMICAL

REQUIRE
LESS SPACE

EXCELLENT
ELECTRICAL
PROPERTIES

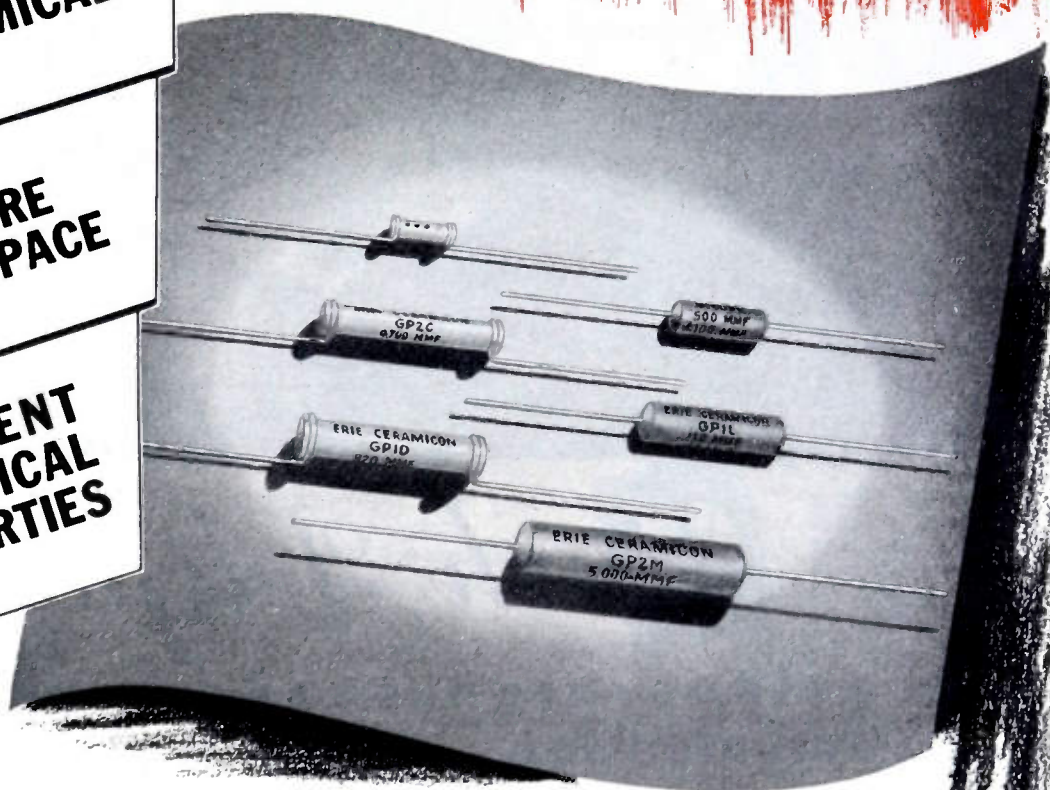

*M*ASS production methods in the manufacture of ERIE "GP" Ceramicons make possible mass production prices. Available in popular capacities, quantity production, with strict adherence to quality standards, bring new price economies in ceramic condensers for practically all applications in which the condenser is not directly frequency determining.

High capacities are available in extremely compact sizes. Because they are tubular in shape, they require less area than many types of rectangular shaped condensers of

equal capacities. Their physical characteristics make them easy to handle in the assembly line.

Because of their basic, simple construction ERIE "GP" Ceramicons have higher resonant frequencies. This factor is increasingly important as the higher frequencies used in FM & Television are reached.

The trend is toward ERIE "GP" Ceramicons. They are made in insulated styles in popular capacity values up to 5000 MMF, and in non-insulated styles up to 10,000 MMF. Write for full details and samples.



Electronics Division

ERIE RESISTOR CORP., ERIE, PA.

LONDON, ENGLAND • • TORONTO, CANADA

finch facsimile



Finch Telefax

**provides high-speed, accurate
communication . . . by wire or radio**

Finch Telefax Duplex Unit transmits or receives exact facsimiles of written or printed messages, drawings, photographs, signatures, etc. Leased wire rates are authorized under A.T.&T. tariff, F.C.C. No. 135, effective May 4, 1946.

Also Make:

**FACSIMILE BROADCAST TRANSMITTING EQUIPMENT
FACSIMILE HOME RECORDERS
MOBILE FACSIMILE RECORDERS
FACSIMILE DUPLICATING MACHINES
FINCH ANTENNAS FOR FM STATIONS**

FINCH TELECOMMUNICATIONS, INC.

Address all inquiries to Sales Office

10 EAST 40th STREET • NEW YORK 16, N. Y.

THREE GREAT AIR LINES



USE FEDERAL'S MULTI-CHANNEL TRANSMITTERS

Interchangeable-unit Construction gives a new high in versatility for ground-to-air and point-to-point communication

THE BIG AIRLINES, like TWA, United and American, know how important it is to meet the fast-changing needs of modern airport communication service, without obsolescence of costly equipment. And they've solved this problem with Federal's multi-channel ground station transmitters, 184A, 185A and 186A. For interchangeable RF units, power supplies and modulators make them adaptable to an almost unlimited combination of operating characteristics — for present needs and those of the future!

In one transmitter, you can now combine single or multi-channel CW and phone service in all three bands—HF, VHF, and LF. Unit-type construction simplifies maintenance and inspection, minimizes service interruptions and holds down operating costs. And, as always, Federal offers you the last word in modern engineering, top quality and precise workmanship—backed by 38 years of research and experience.

THIS NEW BOOKLET GIVES YOU ALL THE FACTS



A request on your company letterhead will bring your copy by return mail, without obligation. Write Dept. A537.

INTERCHANGEABLE COMPONENTS permit wide selection of ratings and characteristics

Transmitter	RF Units	Power Supplies	Audio Amplifiers
184-A	1 to 4	1 or 2	1 or 2
185-A	1 to 6	1	1
186-A	1 or 2	1	1
RF Units*	HF, 2-20 Mc.—500 Watts, CW or Phone VHF, 108-140 Mc.—200 Watts, Phone LF, 200-540 Kc.—400 Watts, CW or Phone		
Power Supply 125-A	Provides power for simultaneous operation of 2 RF units on CW or 1 RF Unit on CW and 1 RF Unit on Phone		
Audio Amplifier 136-A	Provides voice modulation of any one RF unit at full rated output		

*Each RF unit is independent of all others—HF, VHF, and LF can be used in the same transmitter if desired.

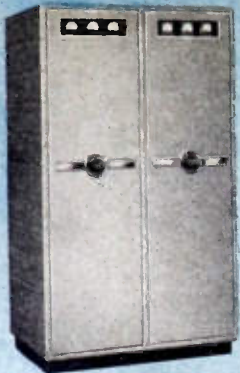

RADIO TRANSMITTER 184-A. Provides maximum operation on 2 phone channels and 2 CW channels simultaneously, or 4 CW channels simultaneously, with choice of up to 4 different frequencies.

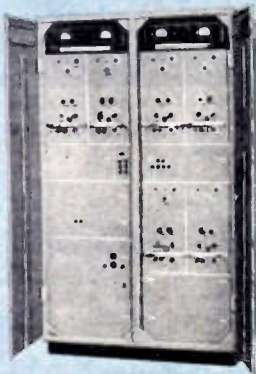

RADIO TRANSMITTER 185-A. Provides maximum operation on 1 phone channel and 1 CW channel simultaneously, or 2 CW channels simultaneously with choice of up to 6 different frequencies.



RADIO TRANSMITTER 186-A. Provides maximum operation on 1 phone channel and 1 CW channel simultaneously, or 2 CW channels simultaneously, with choice of 2 frequencies.

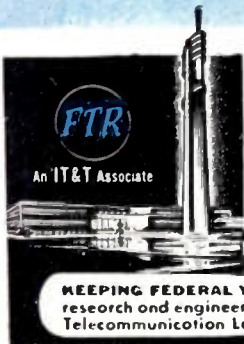

Federal Telephone and Radio Corporation

100 KINGSLAND ROAD, CLIFTON, NEW JERSEY

In Canada: — Federal Electric Manufacturing Company, Ltd., Montreal.
Export Distributors: — International Standard Electric Corp., 67 Broad St., N. Y. C.

KEEPING FEDERAL YEARS AHEAD... is IT&T's world-wide research and engineering organization, of which the Federal Telecommunication Laboratories, Nutley, N. J., is a unit.

WORKHORSE for INDUSTRY



HIGH EFFICIENCY AND HIGH POWER WITH LOW VOLTAGE

HERE'S AN EIMAC TRIODE . . . THE 3X2500F3 . . . specially designed to deliver 5 kw into industrial loads with a plate voltage of only 3500 volts. This low plate voltage contributes to safety as well as reliability of equipment. The tube operates at efficiencies as high as 80 per cent, not only in induction heating service at 200-500 kc, but also in dielectric heating service at 1.5-40 Mc. Operation at 5000 plate volts gives an output of 7.5 kw.

Physically the 3X2500F3 bears the following specific advantages for industrial application:

- COOLER** Unusually efficient..only 74 cfm of air at ambient temperature of 25 C and static pressure of 1 in. of water required to keep cooler core at rated 150° C.
- TERMINALS** Flexible leads..convenience and economy of mounting and connection. Rugged design for rough service.
- FILAMENT** Thoriated tungsten gives required electron emission with minimum power consumption and long useful life. Operates at 7.5 volts, 48 amp.

PRICE \$165 each

Further details on this useful new triode, the 3X 2500F3, are yours for the asking. Write:

EITEL-McCULLOUGH, INC.
1723 San Mateo Ave., San Bruno, California

EXPORT AGENCY: FRAZAR & HANSEN
301 Clay St., San Francisco 11, California, U.S.A.

EIMAC 3X2500F3 POWER TRIODE ELECTRICAL CHARACTERISTICS	
Filament: Thoriated tungsten	
Voltage	7.5 volts
Current	48 amp.
Maximum starting current	100 amp.
Amplification Factor (Average)	20
Direct Interelectrode Capacitances (Average)	
Grid-Plate	20 uuf
Grid-Filament	48 uuf
Plate-Filament	1.2 uuf
Transconductance (i_p : 830 ma, E_p : 3000 v)	20,000 umho
RATINGS AND OPERATION	
Class-C Grounded-Filament R-F Oscillator or Power Amplifier	
Maximum Ratings Below 40 Mc	
D-C Plate Voltage	5000 volts
D-C Plate Current	2 amp
Plate Dissipation	2500 watts
Grid Dissipation	150 watts
Typical Operation Below 40 Mc, per tube	
D-C Plate Voltage	3500 4000 5000 volts
D-C Plate Current	1.8 1.6 2.0 amp
D-C Grid Voltage	-420 -360 -400 volts
D-C Grid Current	0.5 0.4 0.5 amp
Peak R-F Grid Input Voltage	735 630 710 volts
Driving Power (Approximate)	325 237 337 watts
Grid Dissipation	120 88 148 watts
Plate Input	6.3 6.4 10 kw
Plate Dissipation	1.3 1.4 2.5 kw
Plate Power Output	5 5 7.5 kw

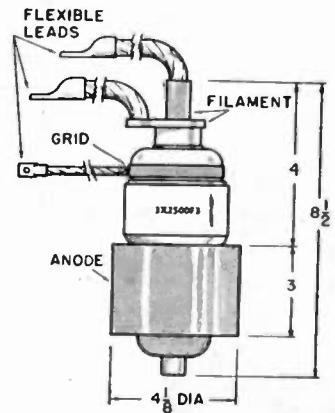

Follow the Leaders to



The Power of Industry

PROCEEDINGS OF THE I.R.E. July, 1947



for LINE VOLTAGE CONTROL

STEPDOWN • ADJUSTMENT • ISOLATION

STEPDOWN AUTO TRANSFORMERS

To reduce line voltage of 200-240 volts, 50-60 cycles, to 100-120 volts 50-60 cycles for operating radios, amplifiers, appliances, etc. Will safely handle any device consuming wattage up to the ratings shown. With six foot cord and female receptacle.

Type No	Application	Wgt. Lbs.	List Price
R-41	85 watt capacity	4	\$7.50
R-42	125 watt capacity	5	8.50
R-43	175 watt capacity	5½	9.50
R-44	250 watt capacity	6½	12.50
R-45	500 watt capacity	12	20.00
R-46	1200 watt capacity	18	35.00
R-64	2500 watts (no cord)	30	70.00

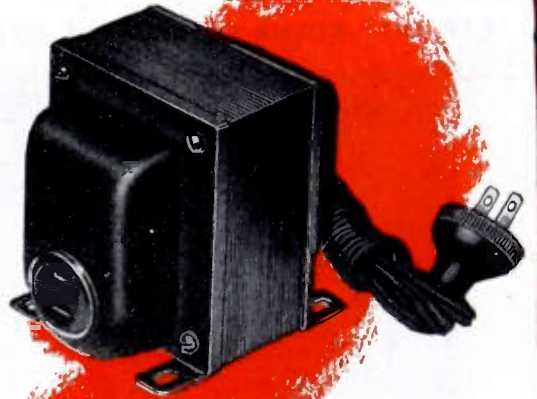

LINE VOLTAGE ADJUSTERS

with meter

The perfect answer to abnormal or fluctuating line voltage. Adjust switch so that meter reads at red line and you know that your equipment is working at correct voltage.

These units combine a tapped auto-transformer with a switch and meter in a compact, rugged assembly.

The nine tap switch provides for line voltages of 60 to 140 volts on 115 volt output models and 160 to 240 volts on 230 volt output models. All units are designed for 50/60 cycle service and come complete with 6 foot input cord and plug and outlet receptacle.

Type No.	Primary Voltages	Sec. Volts	Watts	Wgt. Lbs.	List Price
R-78	60,70,80,90,100,110,120,130,140	115	150	6	\$18.00
R-79	60,70,80,90,100,110,120,130,140	115	300	9	22.00
R-80	60,70,80,90,100,110,120,130,140	115	600	13	30.00
R-81	60,70,80,90,100,110,120,130,140	115	1200	21	60.00
R-83	160,170,180,190,200,210,220,230,240	230	150	6	18.00
R-84	160,170,180,190,200,210,220,230,240	230	300	9	22.00
R-85	160,170,180,190,200,210,220,230,240	230	600	13	30.00
R-86	160,170,180,190,200,210,220,230,240	230	1200	21	60.00

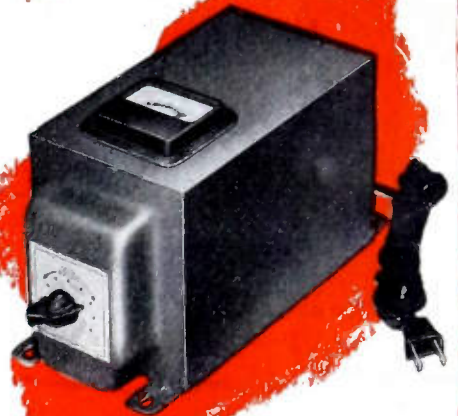

ISOLATION TRANSFORMERS

Ideal for isolating line noise, test equipment, AC-DC sets, etc. Excellent electrostatic shielding. 2000 volt breakdown test. With six foot cord and female receptacle. Primary 110-120 volts, 50/60 cycles—Secondary 110-120 volts.

Type No.	Rating	Wgt. Lbs.	List Price
R-73	100 watts	6	\$13.00
R-74	250 watts	12	24.00
R-75	600 watts	20	35.00
R-76	1200 watts	30	55.00
R-77	2500 watts (no cord)	70	95.00



United Transformer Corp.
 150 VARICK STREET NEW YORK 13, N. Y.

EXPORT DIVISION: 13 EAST 40th STREET, NEW YORK 16, N. Y.,

CABLES: "ARLAB"

A New Du Mont instrument for peak-to-peak voltage measurements! Measures any waveform! Can be used with any oscillograph!

DU MONT TYPE 264-A Voltage Calibrator

PLACE IT RIGHT ON TOP OF YOUR OSCILLOGRAPH!

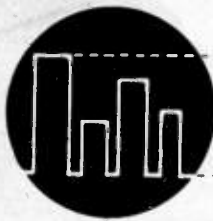
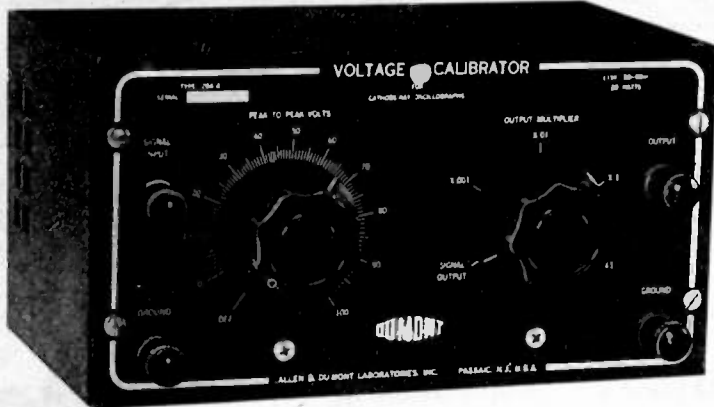

Example: Typical complex signal; peak-to-peak voltages unknown.

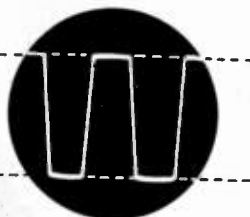

Adjust amplitude of this calibrating signal to match desired peaks of unknown signal. Read voltage from dial settings of calibrator.

HIGHLIGHTS...

- Independent of line-voltage variations.
- Direct-reading.
- Convenient to use.
- Low-priced.
- Small and compact.
- Overall accuracy of $\pm 5\%$. Better than requirements of most electronic circuit tolerances.

SPECIFICATIONS...

- RANGE:** 0-0.1; 0-1.0; 0-10; 0-100 volts.
- ACCURACY:** $\pm 5\%$ of full scale on each range, with variations in line voltage as great as $\pm 10\%$.
- INPUT IMPEDANCE:** 20 uuf (signal connected through calibrator).
- FUSE:** $\frac{1}{2}$ amp.; 115 volts, 50-60 cps., 20 watts.
- SIZE:** $4\frac{1}{2}$ " x 8" x $5\frac{3}{4}$ ".
- WEIGHT:** 5 lbs.

◆ The Du Mont Type 264-A Voltage Calibrator is designed to measure the peak-to-peak voltage of any signal being viewed on a cathode-ray oscillograph. Small, low-priced, convenient, it may be used with any commercial cathode-ray oscillograph. The output is essentially a square wave the amplitude of which is continuously variable from 0 to 100

volts. By merely throwing the selector switch, either the unknown signal or any of four ranges of calibrating voltage may be applied to the input of the oscillograph. There is no need for switching leads between signal and calibrating voltage. Unlike a voltmeter, measurements may be made of any part of a complex, composite waveform with Type 264-A.

◆ Descriptive bulletin sent on request.

© ALLEN B. DU MONT LABORATORIES, INC.

DUMONT Precision Electronics & Television

ALLEN B. DUMONT LABORATORIES, INC., PASSAIC, NEW JERSEY • CABLE ADDRESS: ALBEEDU, PASSAIC, N. J., U. S. A.

EL-MENCO

GOOD PRODUCTS BUILD GOOD NAMES

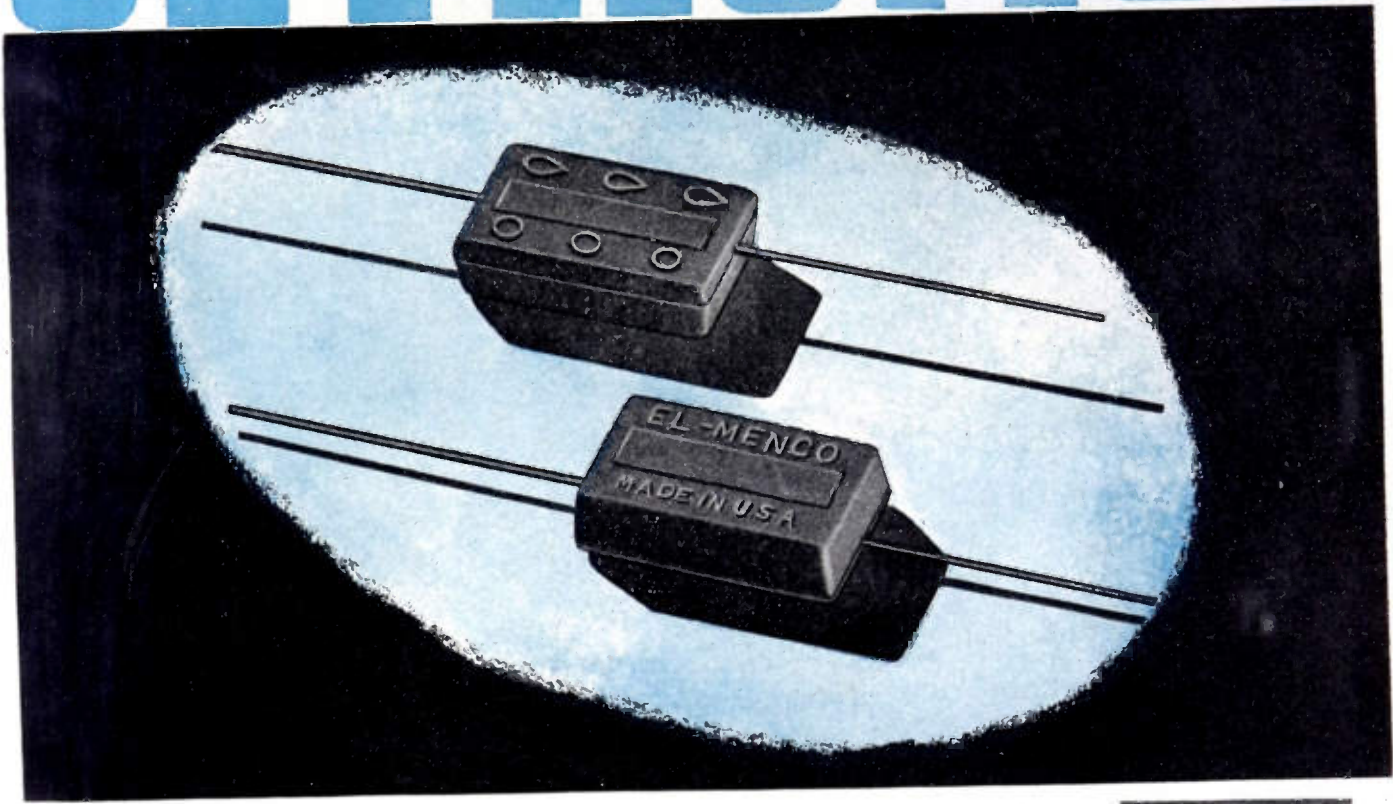

Because the makers of EL-MENCO Capacitors have always insisted on quality at any cost, the name EL-MENCO is now recognized as the identification mark of leadership.

EL-MENCO Capacitors—Molded Mica—Mica Trimmer. We are bending every effort to satisfy all manufacturers who want these quality products. Send us your specifications and we will do our level best to supply you.

THE ELECTRO MOTIVE MFG. CO., Inc. Willimantic, Conn.

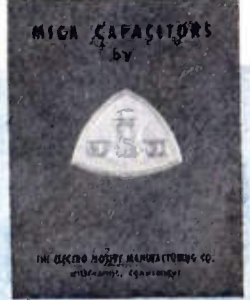

Our new catalogue for manufacturers and engineers is now available . . . send for your copy.



MOLDED MICA

EL-MENCO CAPACITORS

MICA TRIMMER

Foreign Radio and Electronic Manufacturers communicate direct with our Export Department at Willimantic, Conn. for information.

SPRAGUE

PIONEERS OF ELECTRIC & ELECTRONIC PROGRESS

*

MIDGET

CAPACITORS

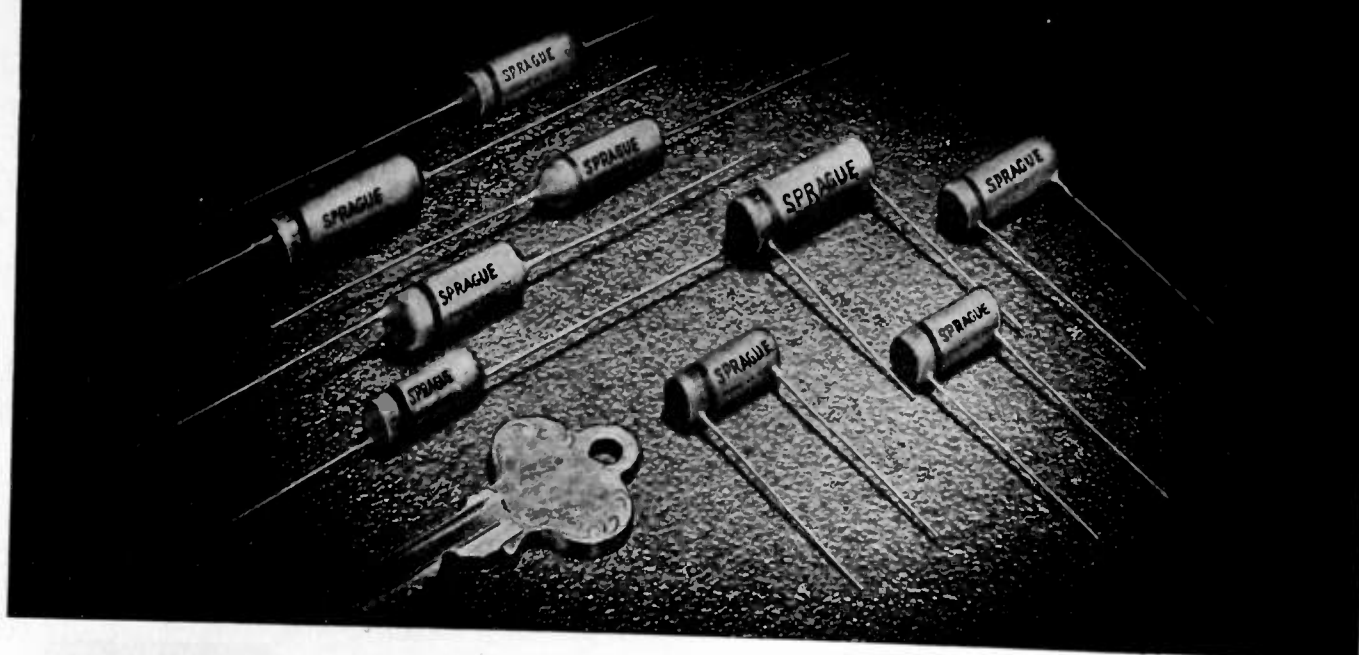

... that operate at high temperature
... that are really moisture resistant

Sprague Types 68P and 69P MIDGET Paper Dielectric Capacitors are the first small-size tubulars to operate at 85°C, and to have adequate humidity protection. They are moderately priced to meet the needs of small radio receivers, "personal" radios and other electronic instruments where high component quality in minimum space is essential.

The usual practice in producing small capacitors is simply to "whittle down" conventional types. Dielectrics are made thinner. End seals are reduced in depth. Protective wrappers are eliminated—and troubles have invariably cropped up in direct relation to this sacrifice of normal safety factors.

Write for Sprague Engineering Data Bulletin 202

SPRAGUE ELECTRIC COMPANY, NORTH ADAMS, MASS.

*Trademark Reg. U. S. Pat. Office

12A

Sprague Types 68P and 69P Midgets, however, prove that really small capacitors can be fully dependable. Made by new processes and with new materials, they are a direct adaptation of Sprague experience in engineering reliable, humidity resistant capacitors for the proximity fuse and other small electronic assemblies for war equipment. They operate satisfactorily at high temperatures. They meet the proposed RMA humidity specifications. So eminently satisfactory have these little capacitors proved that they are already replacing the larger-size Sprague Type AG Paper Tubular Capacitors in many applications.

PROCEEDINGS OF THE I.R.E.

July, 1947



CHECK THESE OUTSTANDING FEATURES

Frequency response of Tuners is flat within ± 2 db from 30 to 15,000 cycles! Bass control provides 10 db boost at 40 cycles; treble control varies response from +12 db to -14 db at 10,000 cycles. Volume control has automatic bass compensation circuit to match the bass characteristic of the human ear.

Sensitivity of the Tuners is less than 10 microvolts. Selectivity for AM signals may be made either "broad" or "sharp". Output of the Tuners is 8 volts at the high-impedance terminals and .75 volts at the 500 ohm terminals. Hum level is 60 db below output. Phonograph input terminals are provided so that Tuner and its amplifier may be used with a record player. Any antenna with single lead-in wire can be used for AM signals. FM section designed for an antenna having a balanced 300 ohm transmission line.

AM-FM Tuner Tube complement; 9003 R. F. Amplifier; 6BE6 oscillator converter; 2-9003 I. F. Amplifiers; (456 kc); 6AL5 detector for AM section. For the FM section; 6AG5 R. F. Amplifier; 6C4 oscillator; 6AG5 converter; 3-6AG5 I. F. Amplifiers (10.7 mc.) 2-9001 limiters and 6AL5 detector. Two 6C4's are used for audio amplifiers, a 6U5/6G5 for tuning indicator and 5Y3GT/G for rectifier.

AM Tuner Tube complement; 6BA6; 6BE6; 2-6BA6; 6AL5; 2-6C4; 5Y3GT/G and 6U5/6G5.

available now . . .
MEISSNER
AM and AM-FM TUNERS

For
Superlative Reception

Designed for use wherever exceptionally high fidelity reception is desired, the new postwar Meissner AM and AM-FM Tuners are now available for your most exacting requirements. Both of these new precision designed components cover the broadcast band from 527 to 1620 kc. and the AM-FM Tuner also covers the FM band from 88 to 108 mc. At 105-125 volts, 50-60 cycles, power consumption is 80 watts for the AM-FM Tuner and 60 watts for the AM Tuner. See these quality units at your jobbers today or write for complete specifications to the address below;

Meissner

**ELECTRONIC DISTRIBUTOR AND
INDUSTRIAL SALES DEPARTMENT**

MAGUIRE INDUSTRIES, INC.

936 N. MICHIGAN AVE., CHICAGO 11, ILLINOIS

EXPORT ADDRESS: SCHEEL INTERNATIONAL
4237 N. LINCOLN AVE., CHICAGO 18, ILL. CABLE—HARSHEEL

STACKPOLE



SIDE-MOLDED

... for maximum stability of permeability with respect to length.



IRON SLEEVE

Paving the way to highly efficient tuning in units of smaller size and with smaller cans.

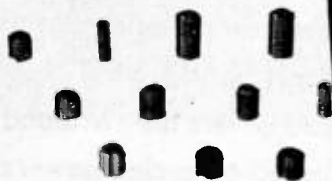

SCREW TYPE

Brass screws are eliminated from the coil field, thus greatly increasing efficiency and reducing size in many applications.

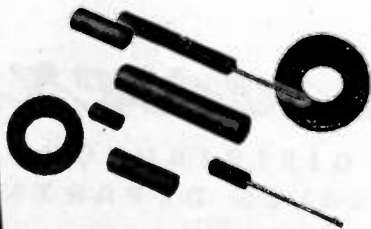

STANDARD and HIGH FREQUENCY TYPES

... Available in sizes, shapes and ranges for practically any requirement. Engineered to specific needs.

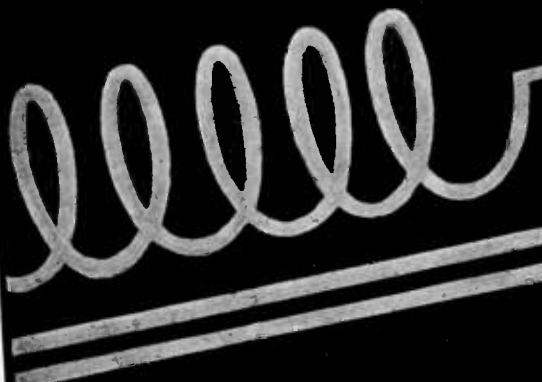

LOSSES BALANCED WITH CORRECT, EFFECTIVE PERMEABILITY

Optimum iron core efficiency calls for full consideration of all loss factors, then balancing these carefully against correct effective permeability.

To achieve this end, Stackpole offers several unique iron core types in addition to its standard lines. Frequently, these have paved the way to combining a low loss factor with engineering short cuts of proved economy and dependability—not only in the cores themselves, but likewise in the way in which they can be utilized in a circuit.

Based on an extremely broad background of practical application experience, Stackpole welcomes the opportunity to engineer iron cores for specific applications.

Write for Stackpole Electronic Components Catalog RC6

ELECTRONIC COMPONENTS DIVISION
STACKPOLE CARBON COMPANY, St. Marys, Pa.

RESISTORS • IRON CORES • SWITCHES

Viewed from any angle
... KARP builds finer metal cabinets

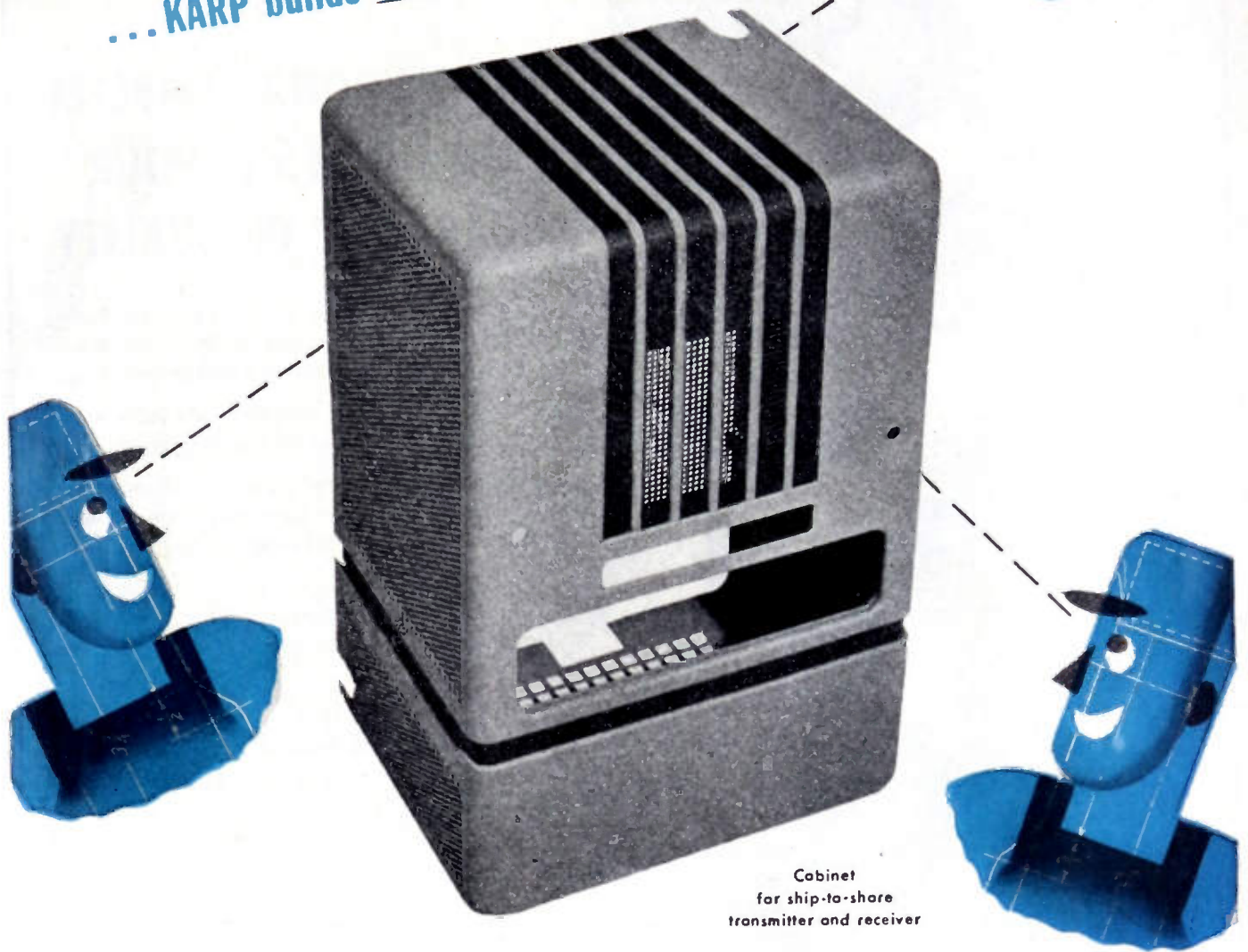

Cabinet
for ship-to-shore
transmitter and receiver

No matter how you look at it, you'll find many reasons why Karp-built cabinets, housings and enclosures will add value to completed equipment assemblies.

We will follow your designs with fidelity, or our design specialists can suggest design ideas which will enhance appearance, achieve ruggedness, save space or weight. Our work insures uniformity and accuracy—which mean production economy both in the fabrication and in your own assembling operations.

At your service is our staff's combined "know-how" gained in 22 years of specialization. Our tool and die

department is so complete that we often save customers special die costs. We make our own dies and do all our own finishing. We do all kinds of welding—including spot-welding of aluminum with electronic timing controls.

It's the hard-to-do type of craftsmanship that brings out the best in our trained minds and skilled hands. We invite your inquiries on any sheet metal fabrication.

**Any Metal • Any Gauge • Any Size
Any Quantity • Any Finish**

KARP METAL PRODUCTS CO., INC.

117 - 30th STREET, BROOKLYN 32, NEW YORK

Custom Craftsmen in Sheet Metal



THE NATIONAL EMBLEM ON PARTS IS YOUR GUARANTEE OF QUALITY

For over 25 years, hams, engineers and radio technicians have agreed that National parts were thoroughly reliable in manufacture and performance.

That reputation is your guarantee of quality when ordering National parts for new equipment.

If you need parts that will fit as they're supposed to, that will give you long hard service, then National's your best bet — as any radio veteran can tell you.

Send today for your copy of the new 1947 National catalog, containing over 600 parts.

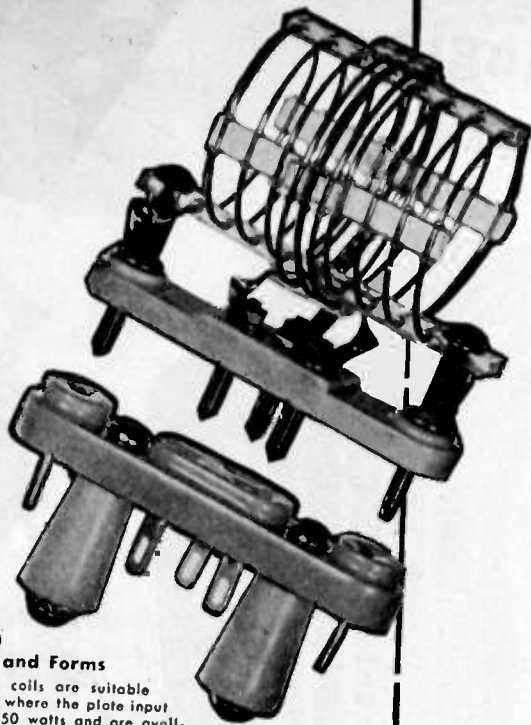

Type AR-16 (Air-Spaced) Exciter Coils and Forms

These air-spaced coils are suitable for use in stages where the plate input does not exceed 50 watts and are available for the 6, 10, 20, 40 and 80 meter bands. All have separate link coupling coils and all include the PB-16 plug, which fits the XB-16 Socket.

AR-16 Coils, End Link, Center Link or Swinging Link.
Net price.....\$1.15 (Include PB-16 Plug)
PB-16, Plug In Base Only.....Net price...\$.27
XB-16, Plug-in Socket Only.....Net price...\$.33

The HRT is a new plastic tuning knob with a chrome plated appearance circle. The HRT knob fits a 1/8" diameter shaft and is 2 1/8" in diameter. Available in Black or Gray.

HRT Knob....Net price...\$.75

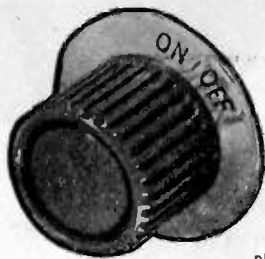

The HRS Knobs are a new series of plastic knobs with a 1 3/8" diameter chrome-plated skirt. They all fit 1/8" diameter shafts. Three types are available in Black or Gray.

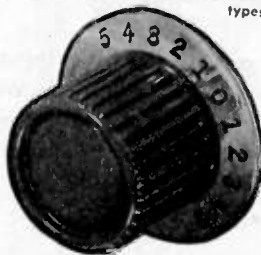

HRS-1 Knob...ON-OFF through 30° rotation.....Net price.....\$.51
HRS-2 Knob...5-0-5 through 180° rotation.....Net price.....\$.51
HRS-3 Knob...0-10 through 300° rotation.....Net price.....\$.51



National Company, Inc. Malden, Mass.

Please write to Department 17
National Company, for further information.

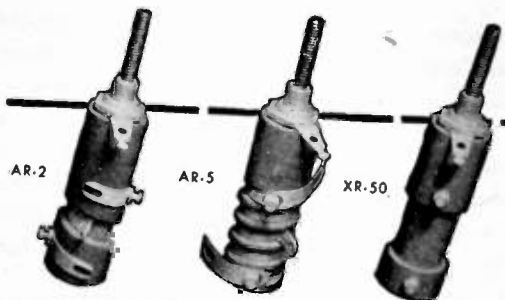

The AR-2 and AR-5 coils are high Q permeability tuned RF coils. The AR-2 coil tunes from 75 mc to 220 mc and the AR-5 coil tunes from 37 mc to 110 mc with suitable capacitors.

XR-50 coil forms may be wound as desired to provide a permeability tuned coil. The form winding length is 11 1/16" and the form winding diameter is 1/2". The iron slug is 3/8" diameter by 1/2" long.

AR-2 High Frequency Coil.....Net price.....\$1.71
AR-5 High Frequency Coil.....Net price.....\$1.46
XR-50.....Net price.....\$1.01

MAKERS OF LIFETIME RADIO EQUIPMENT



ALSiMAG TRADE MARK **in** **Heavy duty** **resistors**

Too often, the resistor is the weakest part of an assembly . . . and the insulator the weakest part of the resistor. To overcome that difficulty many resistors are being re-designed around ALSiMag custom made insulators.

One of the most important factors of ALSiMag resistor insulation is its uniformity. It does not vary. All production is carefully checked and held to strict standards of characteristics and dimensions. For example: ALSiMag's coefficient of expansion is always uniform. This advantage is readily understood by any manufacturer who has tried to work with less uniform material.

Since ALSiMag is custom made, the design can often facilitate heat dissipation. Some designs provide minimum contact area between element and core and free air circula-

tion around core. Cruciforms and edge wound strips answer some design problems. ALSiMag has a major advantage in its ability to withstand repeated heating and cooling. It has good resistance to heat shock. It is strong, permanently rigid, cannot char. Its insulating qualities are in the top bracket of materials used in resistors.

In many instances, the fact that ALSiMag insulators are uniform and are made to close tolerances will more than offset their higher first cost. This cost is picked up through faster assembly, fewer rejects . . . and by far longer life, more dependable operation, the reduction of equipment failures and the elimination of wasteful shut-downs.

● The American Lava Corporation does not make resistors. It is the custom maker of ALSiMag insulation which is sold only to manufacturers.

PROPERTY CHART covering the more frequently used ALSiMag compositions sent FREE ON REQUEST

46TH YEAR OF CERAMIC LEADERSHIP
AMERICAN LAVA CORPORATION
CHATTANOOGA 5, TENNESSEE

SALES OFFICES: ST. LOUIS, MO., 1123 Washington Ave., Tel: Garfield 4959 • CAMBRIDGE, MASS., 38-B Brattle St., Tel: Kirkland 4498 • PHILADELPHIA, 1649 N. Broad St., Tel: Stevenson 4-2823
NEWARK, N. J., 671 Broad St., Tel: Mitchell 2-8159 • CHICAGO, 9 S. Clinton St., Tel: Central 1721 • SAN FRANCISCO, 163 2nd. St., Tel: Douglas 2464 • LOS ANGELES, 324 N. San Pedro St., Tel: Mutual 9076



July, 1947

New Regulator Tube

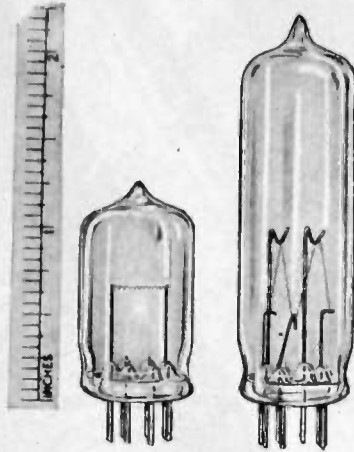

The Amperite Company, 561 Broadway, New York 12, N. Y. now offers the miniature T5 $\frac{1}{2}$ regulator tube for currents from 60 milliamperes to 1 ampere, with a claimed maximum wattage dissipation of 3 watts for the longer tube and 2 watts for the shorter tube, designed for compactness and ruggedness.

It is stated that with a 10% change in current through the tube the voltage drop across it will increase 200%, and that the regulator will withstand 25B and is not affected by ambient changes of minus 40 to plus or minus 70° Centigrade. Being hermetically sealed it is not affected by altitude or climatic conditions. A miniature octal base is used.

Low-Cost Direction Indicator Potentiometer



To provide a simple, low-cost method of indicating the position of a rotary-beam antenna, wind vane, or other rotating device, Ohmite Manufacturing Company, 4855 Flournoy Street, Chicago 44, Ill., has developed the Model RB-2 Direction-Indicator Potentiometer.

For use as a rotary-beam-antenna direction indicator, the shaft of the RB-2 potentiometer is coupled to the rotary-

These manufacturers have invited PROCEEDINGS readers to write for literature and further technical information. Please mention your I.R.E. affiliation.

beam antenna so that the shaft of the potentiometer rotates with the antenna. The potentiometer is then connected, by means of a simple circuit, to a 6-volt battery and an ordinary 0-5, 0-1.5 or 0-2 milliamperes direct-current meter with specially marked scale, which will then indicate the position of the antenna.

Oscillograph for Television Waveform Studies

Intricate television waveforms even to those in a single scanning line and to a fraction of that line are claimed to be picked out, expanded either vertically or horizontally, and be recorded when desired by means of the new Du Mont Type 280 Oscillograph presented by Allen B. Du Mont Laboratories, Inc., of Passaic, N. J. This instrument is designed to provide means for accurately determining (a) the duration and shape of various waveforms contained in the composite television signal, and (b) the character of the picture-signal video in conjunction with transmitter operation according to Federal Communication Commission standards and practices.

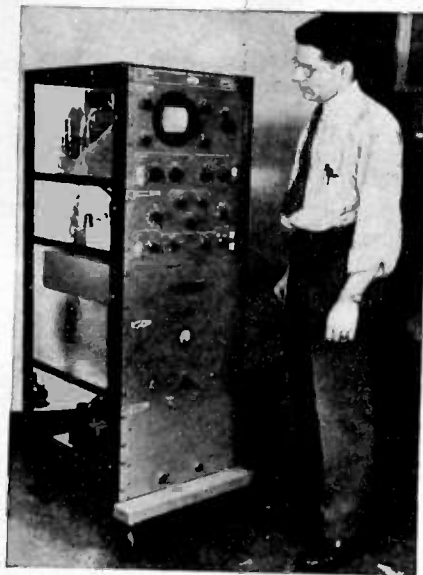

The illustration shows that the Type 280 cathode-ray oscillograph is made up of four units, each mounted on a standard relay-rack panel and chassis, and racked together with casters for mobility. Side and rear panels are removable. The indicator is the Type 5RP-A cathode-ray tube with three post-deflection intensifier electrodes. Type 280 operates on the usual 115 volt 50-60 cycle alternating current supply, and consumes 690 watts.

Sprague Miniature Capacitors

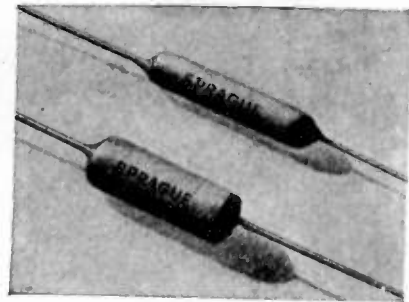

A new line of miniature capacitors particularly useful for hearing devices, and designed to maintain high insulation resistance under adverse humidity conditions, is announced by the Sprague Electric Company, North Adams, Mass. Based on research development of the VT fuse, these new capacitors are known as the 63P and 64P and are manufactured in both round and flat types, ranging from 0.00025 to 1.0 microfarads.

It is claimed that insulation resistance at 25° Centigrade after a 2-minute charge at 180 volts D.C. is such that the product of capacitance expressed in microfarads and insulation resistance in megohms is not less than 1,000, except that the insulation resistance of any capacitor need not exceed 10,000 megohms. Fuller details are given in a technical data bulletin.

High Voltage Capacitors for Television Receivers

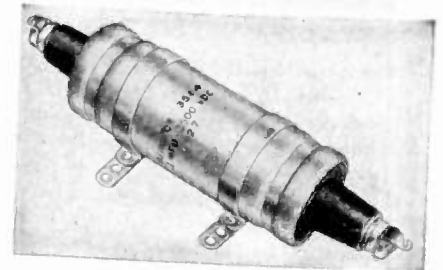

Series "84" tubular paper capacitors are now being produced with ratings up to 10,000 working volts D.C. for use in television receivers, by Aerovox Corporation, New Bedford, Mass. The midget-can Series "89" and the round-can Series "12" and "14" are available in extended voltage ratings from 3500 to 7500. Offered are both paper and oil-filled capacitors. Illustrated is the Series "14" in double ended design with two adjustable ring mountings.

WANTED:



**Experienced Senior Project Engineers
for Responsible Positions in
the Development of . . .**

OSCILLOSCOPES, TELEVISION *and* UHF EQUIPMENT

If you are an electronic engineer with an outstanding background—academic and practical—one of these jobs may be the opportunity you have been waiting for.

This progressive, medium-sized organization needs men with superior ability, fully experienced in the development of oscilloscopes, television and ultra high frequency equipment.

Applications are invited from top men to carry on projects under their own direction in modern, fully-equipped plant situated in attractive south-east New Jersey within one hour's ride of New York City.

If you can qualify, send us a resume of your education, experience, age and salary requirements. Or, if you prefer, telephone us for an appointment at Matawan 1-1049.

Larvie Laboratories

RADIO ENGINEERS AND MANUFACTURERS
MORGANVILLE, N. J.

Specialists in the Development and Manufacture of LF and HF Equipment

ISOLATION

...from extraneous radio interference...
for test rooms in laboratory or factory

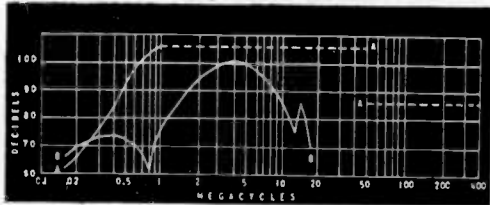
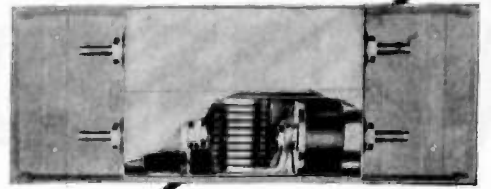
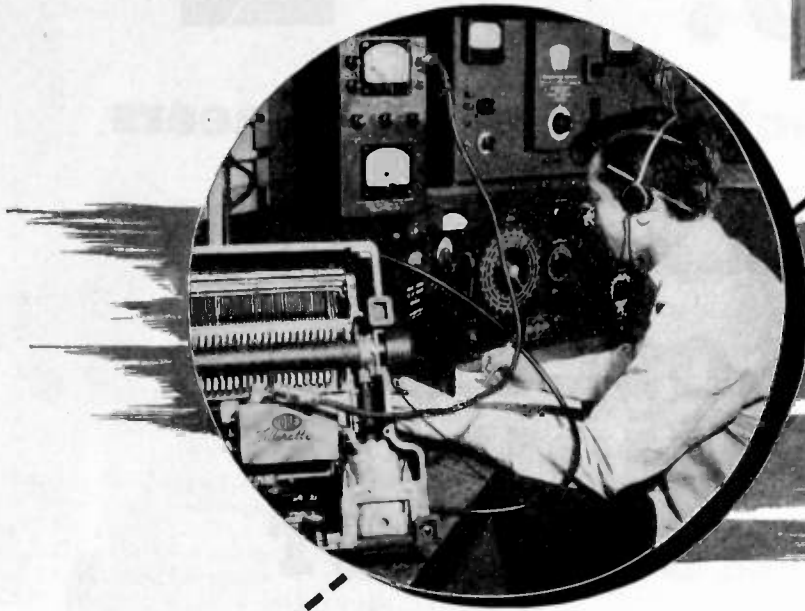

Curve A—Heavy-duty filters; dotted line indicates attenuation beyond range of available measuring equipment.

Curve B—Medium-duty filters.

Installed where the electric power service passes through the screen, these Filterettes provide high attenuation from 150 kc to 400 mc, thus permitting operation of sensitive high-frequency test apparatus in close proximity to electric production equipment, welding generators, repulsion motors, and high-frequency induction heating equipment.

SPECIFICATIONS

Mechanical design and assembly conform to practical electrical installation requirements. Outer housings are of welded steel; knockouts at each end accommodate electrical conduits; heavy, threaded studs facilitate attachment of cable lugs.



Screen Booth Filters

These units employ non-inductive, mineral-oil impregnated capacitors; the inductors, of large cross-section, have low series resistance, hence voltage drop is negligible. Overload ratings are: 150% of ampere rating for one hour; 200% of voltage rating for one minute. Since the filters have no saturable characteristics, performance is uniform for all loads up to maximum ratings.

HEAVY DUTY FILTERS					
Type	Amperes	Volts	Volt. Drop	Freq. Range	Weight
No. 1179-A Two Wire	100	500 a-c/d-c	.2 volts per circuit	0.15 to 400 megacycles	40 lbs.
No. 1182-A Three Wire	100	500 a-c/d-c	.2 volts per circuit	0.15 to 400 megacycles	65 lbs.
MEDIUM DUTY FILTERS (Two Wire)					
No. 1137	20	110/220 a-c 500 d-c	.5 volts per circuit	0.15 to 20 megacycles	17 lbs.
No. 1116	50	110/220 a-c 500 d-c	.5 volts per circuit	0.15 to 20 megacycles	17 lbs.



TOBE DEUTSCHMANN Corporation CANTON, MASSACHUSETTS

SCA SYMBOL OF durability

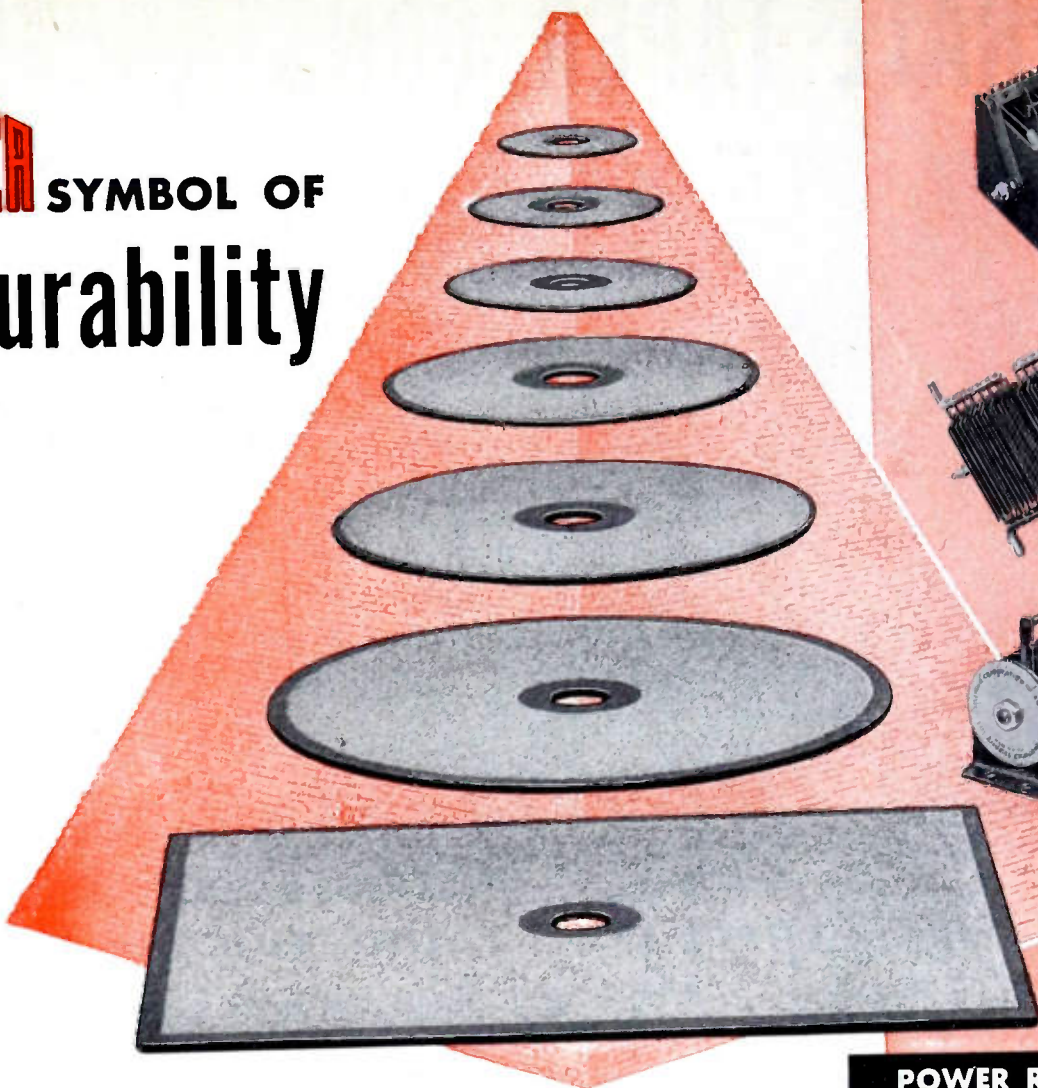

SCA Selenium Pyramid reflects all the durability of the ancient Egyptian pyramids. Selenium Rectifiers are ENGINEERED FOR ENGINEERS. Improved performance at lower costs through ENGINEERED adaptability. Selenium Corporation of America meets exacting specifications of modern electronic developments. Manufacturers of a broad line of Selenium Power and Instrument Rectifiers, Self generating Photo-Electric Cells and allied scientific products.

Selenium Rectifiers are rapidly becoming standard in industry for all rectifier applications. Selenium Corporation of America's engineering experience can be called upon for the development and production of special rectifiers for any application.



SELENIUM CORPORATION OF AMERICA

Affiliate of **VICKERS** Incorporated
2160 East Imperial Highway
El Segundo, Calif.

CHECK THESE OUTSTANDING FEATURES

- ✓ Permanent characteristics
- ✓ Adaptability to all types of circuits and loads
- ✓ Unlimited life—no moving parts
- ✓ Immunity to atmospheric changes
- ✓ High efficiency per unit weight
- ✓ From 1 volt to 50,000 volts rms.
- ✓ From 10 micro-amperes to 10,000 amperes
- ✓ Economical—simple to install—no maintenance cost
- ✓ Hermetically sealed units available

POWER RECTIFIERS



INSTRUMENT RECTIFIERS



PHOTO-ELECTRIC CELLS

ACCURATE TAPER CONSTRUCTION

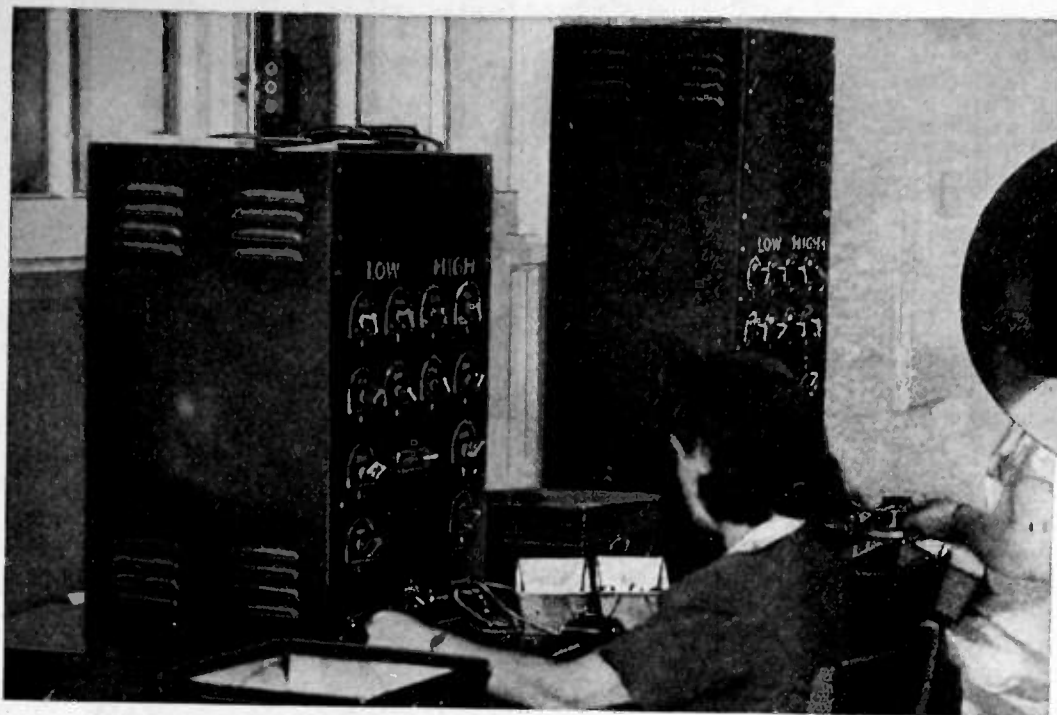

Mallory operators testing electrical characteristics of taper shown above.

... you expect it ... and you get it in
Mallory Carbon Controls

Mallory carbon controls have long been famous for their taper construction—construction so accurate that it literally duplicates the most rigid laboratory standards in quantity production. How Mallory achieves this mathematical precision is a closely-guarded secret. But the results are clearly apparent in the smooth feathering-out of the tapers themselves—in the *noiseless* operation which they make possible.

Mallory methods of manufacture provide *accuracy over the entire taper*—and that's one reason, though not the only one, why you expect more and get more from Mallory carbon controls. Check the other reasons listed below. Then, contact our district sales office or write us direct. Feel free to call on us for special engineering help too.

Only Mallory Carbon Controls Offer All These Features: Low "Hop-Off" Resistance . . . Minimum Short-Out Resistance . . . Smooth-Operating Mallory Alloy Contactor . . . Highly Humidity Resistant . . . Low Noise Level . . . Extremely Accurate Taper Construction . . . Non-Distorting, Non-Loosening Assembly Construction . . . Spring Pressure Terminals, Smooth Bearing Surfaces, Mallory Spring Alloy Contact Arms, Self-Lubricating Elements—all contributing to longer life.

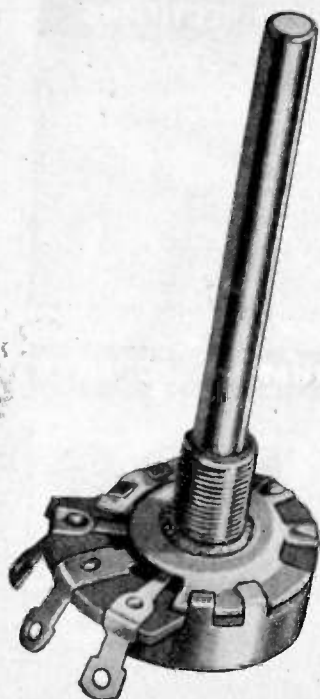

NEW DATA FOLDER AND SPECIFICATION SHEETS. Send for new Engineering Data Folder containing complete specifications on all Mallory variable resistors, including both carbon and wire-wound types. Specification Sheets also available.

P. R. MALLORY & CO., Inc.
MALLORY RESISTORS
(FIXED AND VARIABLE)

P. R. MALLORY & CO., Inc., INDIANAPOLIS 6, INDIANA

Now BRIGHTER PICTURES with far greater contrast

ALSO
NO ION SPOT
●
NO CATHODE
GLOW



TYPE 10FP4

CHARACTERISTICS

Max bulb diameter	10½ inches
Min useful screen diameter	9 inches
Heater voltage	6.3 v
Heater current	0.6 amp
Focusing method	magnetic
Deflecting method	magnetic
Max deflecting angle	50 degrees
Screen fluorescent color	white
Over-all length	18 inches (max)
Bulb contact	recessed small-cavity cap
Base	small-shell 7-pin duodecal

Maximum Ratings (design-center values)

Anode voltage	10,000 v
Grid No. 2 accelerating electrode, voltage	410 v
Grid No. 1 control electrode, voltage	-125 v

Typical Operating Conditions

Anode voltage	9,000 v
Grid No. 2, voltage	250 v
Grid No. 1, voltage for cut-off	-45 v
Focusing coil current, d-c, approx	100 ma

● General Electric's extensive line of cathode-ray tubes is complete as to types and sizes, including:

- Television types for all applications, such as the popular 5TP4, 7GP4 and 10BP4 for home receivers.
- Oscilloscope types . . . a full range, including Types GL-3BP1-A, GL-5CP1-A, etc.
- Radar types from 5 inches to 12 inches in screen diameter, of both electrostatic and magnetic designs.

—with General Electric's great new 10FP4 television tube featuring an aluminized screen!

AN important G-E development, the aluminum-backed direct-view screen used on Type 10FP4 has greater brilliancy of image, increased clarity, and sharper definition. Here is the cathode-ray tube that is helping television "come into its own"!

The aluminum backing is a film of microscopic thickness, which not only permits free passage of the electrons to the screen, but by its reflective qualities increases their light-giving effect. At the same time, there is no ion penetra-

tion. Therefore, no ion spot can develop on the screen, and no ion-trap magnet is required. Cathode glow is invisible because it is intercepted by the aluminum film.

Widen the market for your television receivers—increase their popular appeal—by installing 10FP4's! General Electric tube engineers will be glad to work closely with you, to help you profit by applying this new *bright-image* tube. Write *Electronics Department, General Electric Company, Schenectady 5, New York.*

GENERAL ELECTRIC

178.F-4-8880

FIRST AND GREATEST NAME IN ELECTRONICS



Let Trouble be our Introduction

THERE'S nothing like trouble to bring people together. That's how some of Revere's closest friends were gained—through a mutual struggle against difficulties, troubles such as occasionally beset any business.

Take the case of an important electronic product, originally developed for war use, since the war finding increasing applications in peacetime services. When manufacture began, rejections ran extremely high, over 40%, costs were skyrocketing, and badly-needed production was being lost. The maker asked if we would care to collaborate in solving the problem. Of course we would! After studying the subject in detail (and also under conditions of the greatest secrecy), we suggested a radical change in the properties of a non-ferrous product used in the manufacture of the vital part with which so much trouble was being experienced. New processes of manufacture were developed, and in a short time test runs of the recommended material proved successful. Rejections of finished units dropped to less than 1%. Thus an expensive and vexing bottleneck was broken, and we gained a new customer and a firm friend.

This success story demonstrates that Revere has an open mind as well as an informed one, and is always ready to question the customary, find new answers to new problems, or to old ones, for that matter. If something is worrying you in your employment of non-ferrous metals in electronics, get in touch with Revere, not for ready-made answers, but for wholehearted cooperation, a joint search for better results. This help is given freely, without obligation, through the Revere Technical Advisory Service, which has at its command the knowledge and facilities of our laboratories, and the accumulated experience of the entire Revere organization.

REVERE
COPPER AND BRASS INCORPORATED
Founded by Paul Revere in 1801

230 Park Avenue, New York 17, New York

Mills: Baltimore, Md.; Chicago, Ill.; Detroit, Mich.; New Bedford, Mass.; Rome, N. Y.—Sales Offices in Principal Cities, Distributors Everywhere.

When a little means a lot



Whenever and wherever space is at a premium . . . in shavers, hearing aids, pocket radios, guided missiles and other radio, electrical or electronic devices . . . you can use one or more of these four miniature products IRC makes-by-the-million. For complete information, including dimensions, ratings, materials, construction, tolerances, write for comprehensive catalog bulletins, stating products in which you are interested.



MPM Resistors

$\frac{1}{4}$ watt for UHF. Resistance film permanently bonded to solid ceramic rod. Length only $\frac{3}{16}$ ". Diameter $\frac{1}{16}$ ". Available resistance values 30 ohms to 1.0 megohms.



BTR Resistors

$\frac{1}{8}$ watt—insulated composition. Length only $\frac{1}{2}$ ". Diameter $\frac{3}{32}$ ". Resistance range 470 ohms to 22 megohms (higher on special orders).



TYPE H Fingertip Control

Composition volume or tone control. Its $\frac{13}{16}$ " diameter and $\frac{1}{2}$ " overall depth include knob and bushing.



TYPE SH Fingertip Switch

Similar to TYPE H Control (left) in appearance. $\frac{13}{16}$ " diameter. OFF and 3 operating positions.

ILLUSTRATIONS

ACTUAL

SIZE

$$I = \frac{E}{IRC}$$

INTERNATIONAL RESISTANCE COMPANY

401 N. BROAD STREET PHILADELPHIA 8, PENNSYLVANIA

IN CANADA: INTERNATIONAL RESISTANCE COMPANY, LTD., TORONTO, LICENSEE

Copyright, 1947, International Resistance Company

SYLVANIA NEWS

CIRCUIT ENGINEERING EDITION

JULY

Prepared by SYLVANIA ELECTRIC PRODUCTS INC., Emporium, Pa.

1947

NEW SYLVANIA TECHNICAL MANUAL AVAILABLE NOW— FULL OF ESSENTIAL RADIO TUBE DATA

Handy Volume Describes Over 450 Tubes—
Contains Valuable Information for Circuit Designers



Now
378
pages!

The bigger, better-than-ever new Sylvania Technical Manual is available now.

The large number of tube types listed (old and new)—over 450—has been made available as a result of extensive and careful study of radio tube characteristics and applications.

IMPORTANT INFORMATION

Contents of this descriptive manual include: Fundamental Properties of Vacuum Tubes; Characteristic Curves; General Tube and Circuit Information; Resistance Coupled Amplifier Data—and many more—all of great interest to circuit designers and equipment manufacturers.

AVAILABLE NOW

We urge you to get a copy right away—because we know you'll find this volume chock-full of invaluable information.

Available from your Sylvania Tube Distributor or directly from Radio Tube Division, Emporium, Pa.

SYLVANIA ELECTRIC

MAKERS OF RADIO TUBES; CATHODE RAY TUBES; ELECTRONIC DEVICES; FLUORESCENT LAMPS, FIXTURES, WIRING DEVICES; ELECTRIC LIGHT BULBS

PROCEEDINGS OF THE I.R.E. July, 1947

Collins 496E Autotune

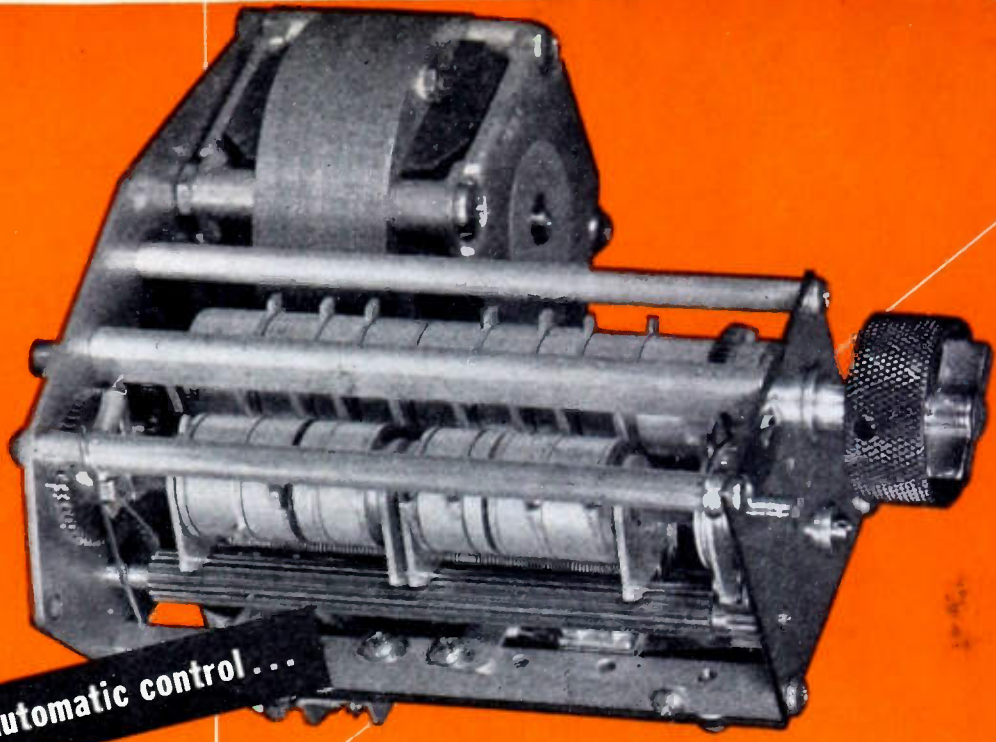

reliable, precise, automatic control . . .

FOR HOME RECEIVERS AND INDUSTRIAL EQUIPMENT

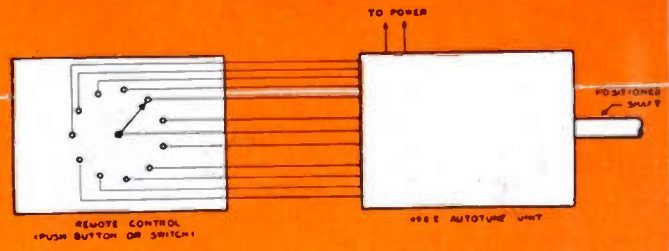

Automatic Tuning. The Collins Type 496E Autotune is an automatic repositioning mechanism designed specifically for tuning quality-built home radio receivers and for control of industrial equipment. Its guaranteed accuracy is one part in 36,000. Age, use, wear, and normal changes in operating conditions do not affect its precision or reliability.

The 496E is a commercial adaptation of the Collins Autotune system originated and patented more than a decade ago. The Autotune reached a high state of development during the war years and was a major contribution to the reliability of thousands of military radio communication equipments designed and built by Collins.

Remote Control. The 496E provides ten automatically reset positions and one position for unlimited manual adjustment of a rotating shaft. Each reset position is independently adjustable to any setting within the full range of ten revolutions of the shaft. Initial settings and desired changes can be

performed by unskilled personnel. No tools are required. Control is by means of push-buttons or a tap switch located either at the unit or at any remote position. Only electrical connections are necessary between the 496E and its control unit.

Easy to Use. The operating time is a maximum of six seconds. Reset accuracy is 0.1 degree. This Autotune can be built for operation from any a-c or d-c source. Power consumption is very low. Installation is simple, requiring a single shaft coupler for connecting the Autotune to the positioned shaft.

We will be pleased to furnish engineering services to aid you in applying the Autotune to your needs. Engineering models of special designs are available at reasonable cost. Write us for further information.

BETTER INDUSTRIAL CONTROLS BY . . .

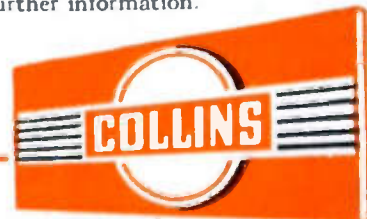

COLLINS RADIO COMPANY, Cedar Rapids, Iowa

11 West 42nd Street, New York 18, N. Y.

458 South Spring Street, Los Angeles 13, California

IF IT'S 1000 WATTS YOU WANT

... STUDY THIS NEW, ADVANCED RAYTHEON AM TRANSMITTER

"It's a beauty,"
says the visitor . . .

"It's a star performer,"
says the station engineer . . .

"It's an excellent investment,"
says the station-owner.

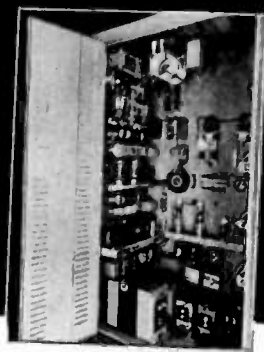

HERE'S WHAT RAYTHEON OFFERS

Study these RAYTHEON features before you choose any transmitter, for replacement or new installation.

- 1 Simplified, More Efficient Circuits**—A high level modulation system eliminates necessity of complicated and critical adjustment of linear amplifiers and minimizes harmonic distortion. Tube cost low, power consumption considerably lower.
- 2 Greater Dependability**—Modern components, operated at well below their maximum ratings, and simplified circuit design reduce failures to minimum. Designed to withstand overloads—fully resistant to excessive temperatures, high humidity. Performance not impaired by ordinary line voltage fluctuation.
- 3 High Fidelity Signal**—Moderate triode type tubes used in all audio stages have an inherently lower distortion level. Specially designed audio transformers reduce distortion still further. The feedback circuit also improves signal quality but is not essential in this simplified circuit.
- 4 Push-Pull Final Amplifier**—A Push-Pull R F final amplifier materially decreases harmonic distortion. Parasitic oscillation in this stage is eliminated and suppressors are not needed.
- 5 Easy to Operate**—Only two stages, the R F Drive Amplifier and Power Amplifier, have to be tuned. A Video type amplifier eliminates complicated tuning of the Buffer stage.
- 6 Fast, Accurate Tuning**—All operational controls are centralized on the front panel; every circuit is completely metered and instantly checked. Low speed motor tuning gives positive micrometer adjustment of the two-tuned stages.
- 7 Easy to Service**—Vertical chassis construction and symmetrical mechanical layout make servicing easy. Hinged side panels give access to all cabling and meters. Full height double rear doors give maximum access to wiring and components.
- 8 Easily Meets All F.C.C. Requirements**—Flat frequency response from 30 to 10,000 cycles per second. Noise level —60 db below 100% modulation. Less than 2½% RMS for 95% modulation.

AGAIN RAYTHEON presents an item of broadcast equipment that scores a hit with all who see it. Following on the heels of Raytheon's highly successful 250 Watt design, this new 1000 Watt AM transmitter provides the same excellent performance, the same inherent superiorities for higher-powered stations . . . and at surprisingly low cost.

It's an outstanding design . . . perfected after months of careful engineering. Simpler circuits give the all-important *dependability* that Raytheon transmitters are becoming widely noted for. Exceptional signal quality is achieved through triode type tubes and audio transformers better than were ever before available. Its striking modern beauty catches the eye of visitors—makes it a show-piece.

This Raytheon transmitter commands attention of 1000 Watt station owners and engineers. Before *you* decide on a transmitter, write or wire for our fully illustrated specification bulletin. *Prompt deliveries can be made.*

RAYTHEON

Excellence in Electronics

RAYTHEON MANUFACTURING COMPANY

COMMERCIAL PRODUCTS DIVISION, WALTHAM, 54, MASSACHUSETTS

Industrial and Commercial Electronic Equipment, Broadcast Equipment, Tubes and Accessories

Sales offices: Boston, Chattanooga, Chicago, Dallas, Los Angeles, New York, Seattle

DEVOTED TO RESEARCH AND MANUFACTURE FOR THE BROADCASTING INDUSTRY

FIVE NEW

OHMITE Products

for the Radio and Electronic Industry

1. NEW 2-WATT MOLDED COMPOSITION POTENTIOMETER

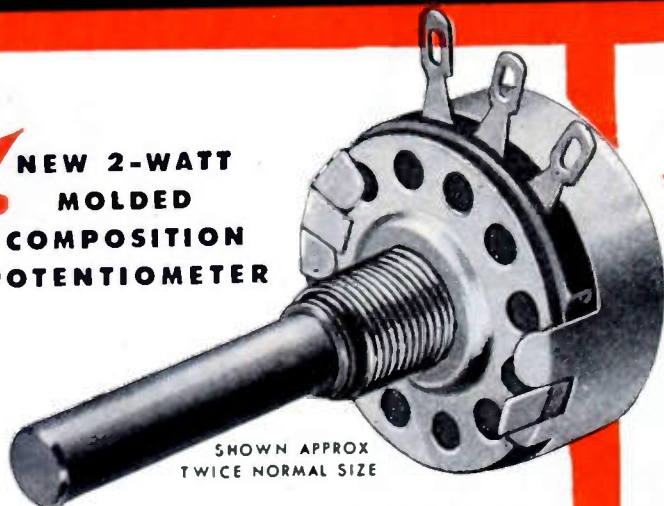

SHOWN APPROX
TWICE NORMAL SIZE

Now—a 2-watt unit with a good margin of safety, for industrial use. The resistance element is a thick, solid-molded ring, heat treated under pressure—not a film. It is unaffected by heat, cold, moisture, or length of service. *Sold only through Ohmite jobbers.*

4. NEW RB-2 DIRECTION INDICATOR POTENTIOMETER



A compact, low-cost unit used in a simple potentiometer circuit as a transmitting element to indicate, remotely, the position of a rotary beam antenna, wind vane, or other rotating device. Used with a six-volt battery and a simple 0.1 milliammeter.

5. NEW R. F. PLATE CHOKES

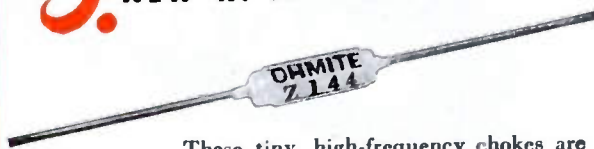

These tiny, high-frequency chokes are single-layer wound on low power factor bakelite cores, covered with a moisture-proof coating. Four stock sizes for all frequencies from 50 mc. to 460 mc. Rated 1000 ma. or more.

2. NEW $\pm 5\%$ TOLERANCE LITTLE DEVIL COMPOSITION RESISTORS

These popular resistors are now available in $\frac{1}{2}$ and 1-watt sizes in tolerances of $\pm 5\%$, in addition to the standard $\pm 10\%$. The resistance and wattage are clearly marked on every unit. *Sold only through Ohmite jobbers.*



3. NEW 5-WATT BROWN DEVIL WIRE-WOUND RESISTORS



A rugged, new Ohmite wire-wound, vitreous-enameled resistor of unusual compactness. Easily mounted by its $\frac{1}{2}$ -inch tinned copper-wire leads. Tolerance $\pm 10\%$.

WRITE FOR
INFORMATION

OHMITE MFG. CO.

4860 Flournoy Street

Chicago, Ill.



Be Right with

OHMITE

RHEOSTATS • RESISTORS • TAP SWITCHES • CHOKES • ATTENUATORS



ELECTRICAL

★
EQUIPMENT

Save

MILLIONS of dollars' worth of top-quality electrical equipment are now being offered by your Government at a fraction of their cost. Most materials are *unused* and afford a real money-saving opportunity for alert users, commercial buyers and exporters. Inventories of various types of equipment are held by all War Assets Administration Regional Offices. Some items are now being sold on a fixed price basis while others will be offered on competitive sealed bid sales. Visit your Customer Service Center or write the Regional Office holding the inventories to place your name on the mailing list for this type equipment.

EXPORTERS! Your business is solicited. Much material which is surplus in the United States is urgently needed or is readily salable in other countries. Watch for our offerings; many of them may be of interest to your clients.

On Surplus

LIGHTING PANEL BOARDS — DISTRIBUTION PANEL BOARDS. There are wall and column types—both large and small capacity. Some have interlocked doors for added safety. In many cases, their construction permits alteration without disturbing wiring connections. This equipment will be offered on sealed bid basis. Largest inventories are held by: Boston, New York, Cincinnati, San Francisco, Seattle, Birmingham, Spokane, Los Angeles and Portland. Other regions have smaller stocks.

★ ★ ★

FLOOR BOXES AND COVERS — SCREWED CONDUIT FITTINGS — JUNCTION, SWITCH AND OUTLET BOXES AND BOX COVERS. Some standard, some explosion-proof, *all* of these units are of high quality and proved dependability. There are many types and sizes available to meet your needs. Some items are being sold on a fixed price basis, others on competitive sealed bid. Large inventories are held by the following Regional Offices: Boston, Chicago, Little Rock, Los Angeles, New York, San Francisco, Seattle and Spokane. Other regions have smaller stocks.

★ ★ ★

CIRCUIT BREAKERS — OIL CIRCUIT BREAKERS — AIRBREAK SWITCHES — SWITCHBOARDS — ASSORTED ELECTRICAL SWITCHGEAR. Both oil and air types of circuit breakers are offered in this great sale. Many types and sizes of panels and electrical switchgear are available and *all* are of high quality. This equipment will be offered on both Fixed Price and Sealed Bid Sales. Regions holding largest inventories: New York, Philadelphia, Denver, Chicago, Richmond, Atlanta and Detroit. Other regions have smaller quantities.

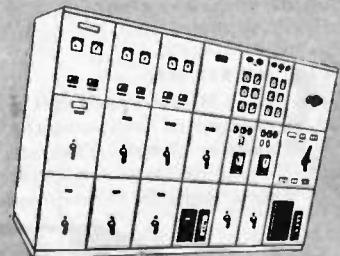
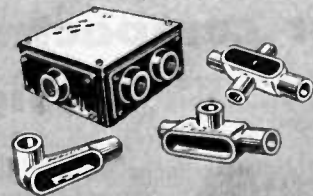
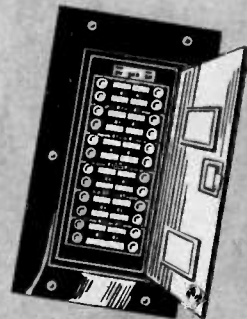

OFFICE OF GENERAL DISPOSAL

★
WAR ASSETS ADMINISTRATION



Offices located at: Atlanta • Birmingham • Boston • Charlotte • Chicago
Cincinnati • Cleveland • Denver • Detroit • Grand Prairie, Tex. • Helena
Houston • Jacksonville • Kansas City, Mo. • Los Angeles • Louisville • Minneapolis
Nashville • New Orleans • New York • Omaha • Philadelphia • Portland, Ore. • Richmond
St. Louis • Salt Lake City • San Antonio • San Francisco • Seattle • Spokane • Tulsa

1153



RECTIFIERS, Vacuum Types

Half-Wave 35W4, 45Z3, 117Z3, 1654, 6X4

Full-Wave 1A3, 9006, 6AL5

DIODE DETECTORS

Single Unit 6C4, 614, 9002

Twin Unit 3A5, 6J6, 12AU7

TRIODE AMPLIFIERS

Single Unit 6AQ6, 6AT6, 12AT6

Twin Unit 6BF6, 26C6

DIODE-TRIODE AMPLIFIERS

High-Mu 11A, 155, 1U4, 6AG5, 6AK5

Medium-Mu 6AU6, 12AU6, 12AW6, 9001

Sharp-Cutoff 6AU6, 12AU6, 11T4, 6BA6, 12BA6

Remote-Cutoff 26A6, 9003

Beam Power Amplifiers 1S4, 3A4, 3Q4

Power Amplifiers 35A, 3V4, 6AK6

Beam Power Amplifiers 6AQ5, 35B5, 50B5

Power Amplifiers 1R5, 6BE6

Beam Power Amplifiers 12BE6, 26D6

Beam Power Amplifiers 2D21

Beam Power Amplifiers 0A2

Beam Power Amplifiers 0A2

Beam Power Amplifiers 0A2

Beam Power Amplifiers 0A2

For compactness **PLUS** maximum performance... design around **RCA Miniatures**

RCA Miniatures offer the engineer a wider latitude in equipment designs for all services where light weight and compactness are necessary or desirable features. And RCA has complements for virtually all applications.



MIDGET SETS

RCA Miniatures permit closer spacing of components on a smaller chassis. They are the equal of larger, comparable tube types in performance.

AUTO SETS

RCA Miniatures make feasible the design of small two-unit receivers for dashboard mounting with greater installation flexibility. Audio outputs up to 10 watts can be obtained.



TELEVISION SETS

RCA Miniatures have already accounted for a reduction of 60 per cent in chassis area, thus permitting the design of more compact models.

FM SETS

For the FM bands, RCA Miniatures have the additional advantage of providing performance superior to metal and glass types because of their lower inter-electrode capacitances, reduced lead inductance, and low-loss, button-stem bases.



COMMERCIAL AND BUSINESS EQUIPMENT

The compactness gained by using RCA

Miniatures is accompanied by a proportionate reduction in weight... a matter of considerable importance in the design of business machines and mobile communications equipment.

RCA TUBE APPLICATION ENGINEERS will be pleased to consult with you on the utilization of RCA Miniatures in designs you now have under consideration. For further information write RCA, Commercial Engineering, Section R-52G, Harrison, New Jersey.



RCA Laboratories, Princeton, N. J.

THE FOUNTAINHEAD OF MODERN TUBE DEVELOPMENT IS RCA



TUBE DEPARTMENT

RADIO CORPORATION of AMERICA

HARRISON, N. J.

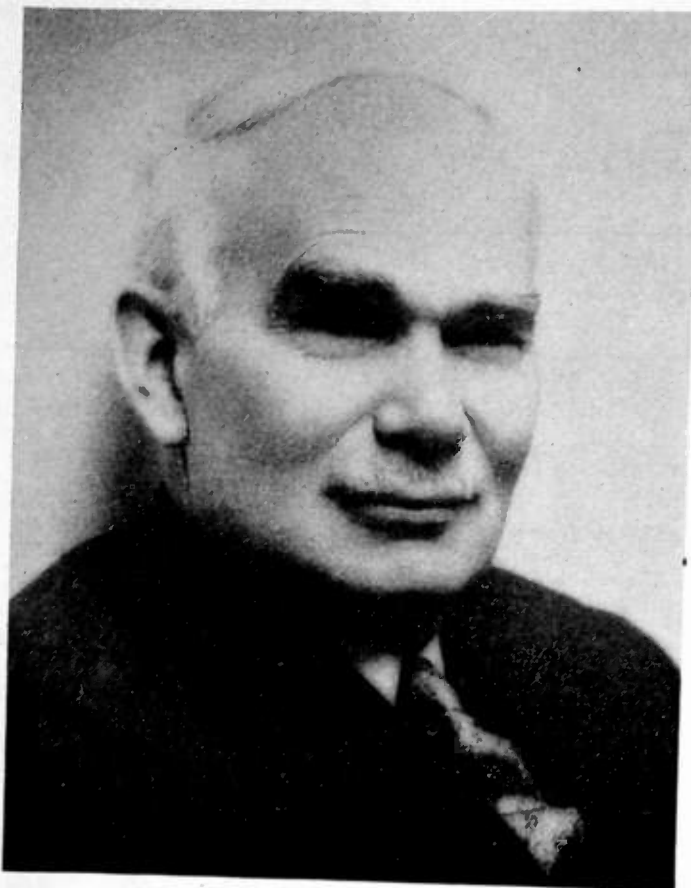

Lee de Forest

Pioneer and Benefactor of Radio

Dr. Lee de Forest has been identified with the development of radio communication since 1901. He is best known for his invention of the Audion, the three-element grid radio tube whose inception forty years ago was the birth of modern radio. This vital contribution formed the basis of electronics, the capabilities of which have opened up a new era in human progress with amazing potentialities. From radio's many branches of activity, it has reached out through industry and medicine to affect the work, health, and pleasure of all. Revolutionizing communication, it was supremely important in war and is fundamental in peace.

Born at Council Bluffs, Iowa, on August 26, 1873, Dr. de Forest became interested in the electromagnetic wave theory while studying at Yale University. He received the B.S. degree from the Sheffield Scientific School of Yale University in 1896; the Ph.D. in 1899 and the D.Sc. in 1926, from Yale

University; the D.Sc. from Syracuse University in 1919; and the D.Eng. from Lewis Institute in 1937.

He has continued to work with the applications of the vacuum tube in its various uses, often under many difficulties; he holds over 300 patents in the United States and foreign countries, and is the author of numerous scientific papers. Dr. de Forest is chairman of the board of Lee de Forest, Inc.; and dean of engineering, American Television Laboratories.

Among the many honors he has received are the Cross of the Legion of Honor from France; the Prix La Tour of the Institute of France; the Elliott Cresson Medal from the Franklin Institute; the John Scott Medal from the City of Philadelphia; the Gold Medal of the St. Louis World's Fair in 1904 for work in wireless telegraphy; the Gold Medal of the Panama Pacific Exposition in San Francisco in 1915 for his work in radio-

telephony; the Medal of Honor from The Institute of Radio Engineers in 1922 for his "major contributions to the communications arts and sciences, as particularly exemplified by his invention of that outstandingly significant device: the three-electrode vacuum tube, and his work in the fields of radio-telephonic transmission and reception"; the Scroll of Achievement, Society of Motion Pictures, July 10, 1946; and the 1946 Edison Medal "in recognition of his many valuable contributions to the electrical art of communication, and primarily for his creation of the Audion."

Dr. de Forest, a Fellow of The Institute of Radio Engineers, was one of its founders, and was its President in 1930. He is a Fellow of the American Institute of Electrical Engineers; a member of the Society of Motion Picture Engineers, Yale Engineering Society, Sigma Xi, Tau Beta Pi, and the Aurelian Honor Society of Yale.

Through long experience, and devoted and skilled attention to the problems involved in determining the appropriate I.R.E. grade of membership for applicants, the writer of the following guest editorial, who is himself a member of the Board of Directors and of the Executive Committee of the Institute, and an editor of the journal *Electronics*, has presented material of major value to applicants for membership, to their sponsors, and to the Administrative Staff of the Institute.—*The Editor.*

Twelve Good Men and True

KEITH HENNEY

Early in the morning on December 19, 1946, twelve members of the Institute convened at 1 East 79 Street where, in the elegance of the new home, they sat as a jury to determine which of the 125 applicants for admission to higher grades of membership had the proper qualifications. Later in the morning this group was joined by F. B. Llewellyn, President of the Institute, and the writer, representing the Executive Committee of the Board of Directors.

By the end of the session, 1 P.M., it had been determined that 100 candidates had the qualifications necessary for Member or Senior Member. At times the going was easy and fast—where the candidate fulfilled the requirements without any doubt and where he, with his references, had fully documented his application. Often—much too often—there was no forward action at all, progress ceasing for the simple reason that the candidate had furnished data which were too scant or too indefinite or which, if apparently of the right sort, were not backed up by his references. Because routine work of the office staff was interrupted by moving to new quarters, the 125 applications scrutinized on this 19th of December represented a day's job considerably below the average of the past year when the Institute has been growing so rapidly. Some days as many as 16 Admissions Committee members took part in this work under the Chairmanship of George Royden; more than 200 applications have been stacked up before the Committee for action at several meetings.

At the end of the session, action on 6 per cent of the applications for Member and Senior Member grade was deferred; favorable recommendation was not given to 14 per cent more.

This number is always too high, disappointing not only to the applicants but to the Committee as well. Aside from the disappointment to be suffered by the applicant, the following facts have an important bearing on this situation. All rejections and deferments recommended by the Admissions Committee are reviewed by the Executive Committee, and the actions of this committee are passed upon by the Board of Directors. In this way the Institute insures its members that those admitted to the higher grades of membership fulfill the Constitutional requirements.

All of this represents much time and effort on the part of many busy people; time and effort that might well be spent in other ways to the advantage of the Institute.

A very great deal of the disappointments stored up each month by the batch of unacceptable applications and much of the work and time spent on these applications could be saved if the applicants and sponsors carried out their part of this process more carefully.

First, the applicant should be thoroughly familiar with the requirements for the grades of Member and Senior Member. He should be in no doubt about his ability to qualify. His references should be men who are familiar with his work and who, therefore, will be able to verify the applicant's claims regarding his experience. Next, he should document his application with facts.

Where did the applicant work? How long? Who was his boss? Just what did he do? What was his responsibility? What was his title? Was the work in the nature of research, design, production, installation, maintenance, operation, administration? If he is a teacher, what courses does he teach, and for how long? What is his teaching title? Is he responsible for the course or does he instruct in a course which someone else constructs? If the applicant has written technical papers, where were they published? When? What was the title? If he has made inventions, what were they? When? Were patents issued? All of these facts are of tremendous value to the Admissions Committee. An application made out with proper recognition of the importance of such questions will save untold hours of the Committee's time.

References who fill out papers for the Admissions Committee to pore over should try to answer the above questions too. Their real job is to verify what the applicant claims. It is of no value to the Admissions Committee for the reference member to state that the candidate is a "fine fellow and merits Membership." The Admissions Committee expects the applicant to be an honest and otherwise decent citizen, but it expects the references will give facts concerning the applicant's technical accomplishments. The Institute of Radio Engineers is a professional organization, not a social club. Its Members and Senior Members are "professional" men; they are "responsible" men; they are the top engineers and scientists in the radio and electronics industry.

Of the monthly list of those whose applications are rejected, some 10 per cent or 15 per cent simply do not have the necessary qualifications. No applicant should put himself in the embarrassing position of being told this hard fact by the Institute. Applications are deferred for the simple reason that neither applicant nor reference supplied the proper amount of the right kind of data. This eventuality, too, is entirely unnecessary. If the candidate fulfills the requirements, he should have no difficulty in sending the committee the data to authenticate it.

It is of the utmost importance that the higher grades be composed of members of the proper professional experience and that these grades, particularly Senior Members, not be diluted by men who have not yet attained adequate experience of a professional engineering level. It is equally important that all members take their rightful place in the Institute.

Working together, the applicants, their references, the Admissions Committee, and the Board of Directors can make these two desirable ideals come to pass.

Frequency Modulation and Control by Electron Beams*

LLOYD P. SMITH† AND CARL I. SHULMAN†, SENIOR MEMBER, I.R.E.

Summary—General formulas for the effect of electron beams on resonant systems in terms of frequency shift and change in Q are derived from the point of view of lumped circuits and from a general electromagnetic field standpoint. A way of introducing the electrons has been found which materially enhances their effectiveness in producing a shift of frequency in a resonant system. Measurements of the frequency shift produced by such an electron beam in a typical geometry were made which check well with values calculated from the general theory. Possible amplitude and phase distortions are calculated when such a beam is used to frequency-modulate a system, and these are found to be negligibly small, even for very high modulating frequencies.

It is shown that this method of frequency control is ideally suited for frequency modulation or automatic frequency stabilization of continuous-wave magnetron oscillators using negative-grid-controlled electron beams for controlling the frequency of oscillations.

I. INTRODUCTION

MANY occasions arise when it is desirable to control the frequency of a high-frequency oscillating system so rapidly that only electronic means can be used. The theory of reactive electron beams and the computation of the change in frequency and loading they produce in an oscillating system is presented here from two points of view; the first of which is a treatment essentially based on lumped-constant concepts, and the second is a general field-theory approach especially applicable to cavity systems or systems with distributed constants. The change of frequency and loading can be finally expressed in terms of rather simple formulas.

A part of the problem of obtaining the largest frequency shift possible for a given number of electrons entering the oscillating electromagnetic field region per second is that of introducing the electrons into that combination of oscillating electromagnetic field and steady electric and magnetic fields for which the largest reactive current is produced. For many applications it is necessary to obtain this maximum reactive current consistent with the auxiliary condition that there be no resistive component. A complete answer to this problem is not attempted here, but a particular combination of fields has been found which yields a much larger reactive current than many other usual field combinations. It also has the advantage that the loading can be made negligibly small.

II. LUMPED-CIRCUIT TREATMENT

When free electrons are introduced into a rapidly oscillating electromagnetic field, there is in general an

exchange of energy between the electrons and the field. The electrons oscillate and induce oscillating image currents on the surfaces of the field boundaries. These surface currents are proportional to the field amplitude and in general are not in phase with the oscillating field. Since these currents are proportional to the field, a linear admittance function relating the currents to the field can be written. This electronic admittance can be handled as a conventional circuit element in conjunction with a proper equivalent circuit to represent the over-all system. The real part of the electronic admittance represents an energy transfer between the oscillating electrons and the electromagnetic field, and the imaginary part represents a change in the resonant frequency of the system.

The first section of the paper treats the problems of estimating the change in admittance across a pair of parallel-plane electrodes due to the introduction of an electron beam moving between the parallel planes and in the direction of a constant magnetic field. From this change in electronic admittance one can calculate the change in the resonant frequency of the oscillating system coupled to the parallel-plane electrodes.

Calculation of Electronic Admittance

L. Malter¹ has studied certain phases of the problem, but his results are not readily applicable to the problem considered here.

Consider a pair of parallel plates a distance d apart, infinitely long in the y direction, and of length L in the z direction, as indicated in Fig. 1. In the z direction is a constant magnetic field H . Let a rectangular electron beam enter the region between the plates at $z=x=0$,

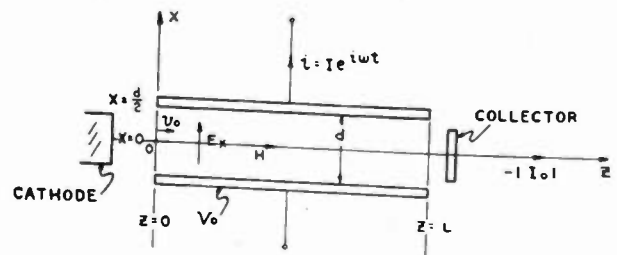

Fig. 1—Schematic diagram of beam and electrode arrangement.

with velocity v_0 in the z direction. Between the plates is an oscillating electric field E_x in the x direction which is constant over the length and width of the plates.

* Decimal classification: R138X R355.912.1. Original manuscript received by the Institute, April 26, 1946; revised manuscript received, October 16, 1946. Presented, 1947 I.R.E. National Convention, March 4, 1947, New York, N. Y.

† RCA Laboratories, Princeton, N. J.

¹ L. Malter, "Deflection and impedance of electron beams at high frequencies in the presence of a magnetic field," *RCA, Rev.*, vol. 5, pp. 439-454; April, 1941.

(Assume no fringe field. This point is considered in the Appendix.) The equations of motion for the electrons in the space between the plates are

$$m\ddot{x} = -E_x |e| - H |e| \dot{y} \tag{1}$$

$$m\ddot{y} = +H |e| \dot{x} \tag{2}$$

$$m\ddot{z} = 0 \tag{3}$$

where $|e|$ is the absolute value of the electronic charge.

For a field $E_x = E_0 e^{i\omega t}$, the solution of these equations for the x component of velocity v_x , subject to the initial conditions at $t = t_0$

$$x = z = 0, \quad \dot{x} = v_x = \dot{y} = 0, \quad \dot{z} = v_0, \tag{4}$$

is

$$v_x = -E_0 \frac{|e|}{m} \frac{i\omega}{\omega^2 - \omega_c^2} \left\{ \left(\frac{\omega_c + \omega}{2\omega_c} \right) e^{i(\omega_c - \omega)(t - t_0)} + \left(\frac{\omega_c - \omega}{2\omega_c} \right) e^{-i(\omega + \omega_c)(t - t_0)} - 1 \right\} e^{i\omega t} \tag{5}$$

where t_0 is the time at which an electron enters the electric field and $\omega_c = He/m$. If we restrict our interest to the region where $\omega \simeq \omega_c$ or $(|\omega_c - \omega|/\omega) \ll 1$, the second term in (5), in addition to being rapidly oscillating with respect to the first term, becomes very small. In almost all cases of interest the second term can be neglected, in which case (5) becomes

$$v_x = \frac{-E_0 |e|}{2} \frac{i}{m(\omega - \omega_c)} [e^{i(\omega_c - \omega)(t - t_0)} - 1] e^{i\omega t} \tag{6}$$

The current to the parallel-plane electrodes due to an oscillating charge dq between them is

$$dI e^{i\omega t} = \frac{dq}{d} v_x = \frac{-|I_0|}{v_0} \frac{v_x}{d} dz \tag{7}$$

which on substitution of v_x becomes

$$dI = E_0 \frac{|e|}{2m} \frac{|I_0|}{v_0 d} \frac{i}{\omega - \omega_c} [e^{i(\omega_c - \omega)z/v_0} - 1] dz \tag{8}$$

for

$$t = t_0 + \frac{z}{v_0}$$

The total current at any instant is the sum of the image currents for each differential element of charge from $z = 0$ to $z = L$, so that

$$I = \frac{E_0 |e|}{2d} \frac{|I_0|}{m} \frac{i}{v_0(\omega - \omega_c)} \int_0^L (e^{i(\omega_c - \omega)z/v_0} - 1) dz$$

On evaluating the integral, one obtains

$$I = E_0 \frac{|e|}{m} \frac{|I_0|}{2d} \tau^2 \left\{ \frac{1 - \cos \theta}{\theta^2} + i \frac{\theta - \sin \theta}{\theta^2} \right\} \tag{9}$$

where

$$\tau = \frac{L}{v_0} \text{ and } \theta = (\omega_c - \omega)\tau$$

Letting

$$E_0 d = V_{ac} = \frac{I}{Y_e}$$

then

$$Y_e = \frac{L^2}{4d^2} \frac{I_0}{V_0} \left\{ \frac{1 - \cos \theta}{\theta^2} + i \frac{\theta - \sin \theta}{\theta^2} \right\} = G_e + iB_e \tag{10}$$

where Y_e is an electron admittance and

$$V_0 = \frac{1}{2} \frac{m}{|e|} v_0^2$$

Y_e versus θ is shown in Fig. 2.

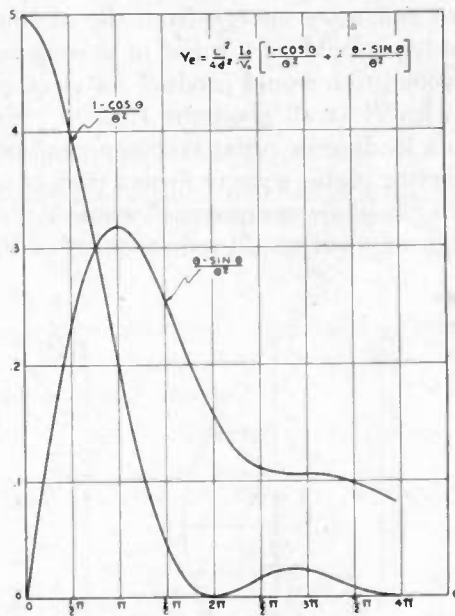

Fig. 2—Electronic admittance as a function of θ .

It is apparent from (10) that the electronic admittance can be made purely reactive when θ is 2π or -2π . This can be clearly understood physically by considering an electron's contribution to the total current at various points of its trajectory between the parallel plates. Mathematically, of course, this contribution is proportional to the current differential given by (8). The physical situation is as follows: When an electron has a velocity in a direction at right angles to a uniform magnetic field H , it will describe a circular path. The time T required to traverse a complete circle is $T = 2\pi m/H|e|$ where m is the mass of the electron, $|e|$ is its charge, and H is the magnetic field intensity. This period of rotation is independent of the electron's velocity or the radius of its circular path. The angular frequency of rotation is then

$$\omega_c = \frac{2\pi}{T} = \frac{H|e|}{m}$$

Consider a pair of parallel plates across which an alternating potential difference is applied, resulting in an electric field of amplitude E and angular frequency ω between the capacitor plates shown in Fig. 3(a). The uniform magnetic field is in the direction shown. An electron is projected into the field between the plates along the line ab parallel to the magnetic field. Its velocity in this direction will remain constant so that at time $t=0$ the electron will be at position 1, and at time Δt seconds later it will be at position 2, etc. At position 1 the electron has no velocity in the direction of E , but on encountering the electric field E between positions 1 and 2, it will be accelerated in this instantaneous direction. If the frequency of the oscillating electric field ω were equal to the frequency ω_e , the electron would remain in phase with the electric field and would be continuously accelerated so that it would receive more and more energy from the oscillating field and its motion would be a spiral of ever-increasing radius. This condition would produce an electron current in phase with E at all positions 1, 2, ... and would constitute a loading or resistive component of current. If the capacitor plates were to form a part of a resonant circuit, this "in-phase component" would have no effect on the frequency but would reduce the Q of the circuit.

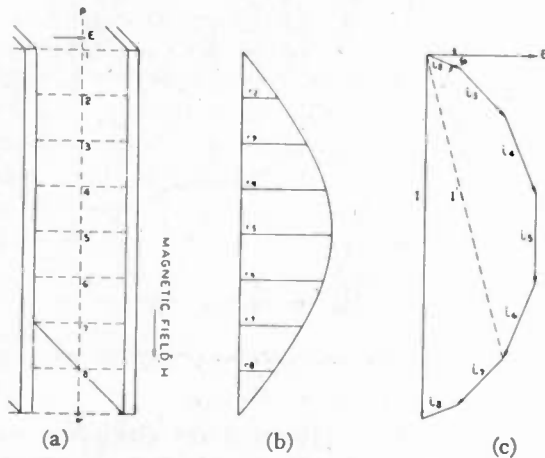

Fig. 3—Vector representation of electron current between parallel plates.

The transit time of the electron through the capacitor plates and the relative values of ω and ω_e can be chosen so that the net electron current is not in the direction of E but in quadrature with E , so that it constitutes a purely reactive current. To see how this comes about, let ω_e be somewhat less than ω . In this circumstance the electron will not complete one revolution during one complete cycle of the oscillating field. Consequently it will lag behind E by a certain phase angle $\Delta\phi$, so that as time goes on the electron lags more and more behind E . It will, however, continue to be accelerated until it lags behind E by 90 degrees. The electron then still increases its lagging phase angle by $\Delta\phi$ for each revolution, but the electron now is retarded by the oscillating field and loses energy. It is evident that, for a given value

of $\omega - \omega_e$, the time of flight of the electron between the capacitor plates can be adjusted so that the energy acquired in the time interval during which acceleration took place is given back to the field during the interval of retardation, and the net energy transfer from field to electron is zero. This situation is illustrated in Figs. 3(a), (b) and (c). When an electron enters the plates at position 1 in Fig. 3(a), it has no displacement from the median plane between the plates. The displacement for various positions is shown in Fig. 3(b). Also the transverse current at position 1 is zero, as is shown in Fig. 3(c). At position 2, Fig. 3(a), the electron has acquired some circular motion and its amplitude of oscillation about the median plane is shown by the vector r_2 in Fig. 3(b). Since $\omega_e < \omega$, the electron lags behind E by the phase angle ϕ when it reaches position 2. The transverse electron current in magnitude and phase relative to E is shown by the vector i_2 in Fig. 3(c). When the electron has reached position 3, its amplitude of oscillation is given by r_3 and the transverse current by i_3 . Because of the electron's increased velocity, it is evident that at position 3 the magnitude of the current i_3 is greater, as also is the lagging phase angle. At position 5 the electron has acquired its maximum displacement and the current due to it is 90 degrees out of phase with E and is purely reactive. From this point on, the electron is retarded and the current produced by it has a negative resistive component (a component opposite to E). When electrons enter the capacitor plates at all times, as in a continuous beam, there will be electrons at all positions from 1 to 9 simultaneously, and the total effective current will be the vector sum of the current at each position. This vector sum is shown by I in Fig. 3(c). Thus the total effective current lags behind the field E by 90 degrees. Thus E and I are related in phase exactly the same as the potential difference across an inductance and the current through it. If the capacitor plates as shown were in parallel with an inductance to form a resonant circuit with resonant frequency ω , the passage of the beam of electrons through the capacitor plates would increase the resonant frequency.

On the other hand, if $\omega_e > \omega$, then the currents i_2 , i_3 , etc., would lead E and the total current would lead E by 90 degrees, giving rise to a decrease in the resonant frequency of the parallel circuit.

If the electrons had emerged from the plates at position 6, then the total current would be I' as shown by the dashed vector in Fig. 3(c). In this case, the total current will have a resistive and reactive component as indicated by (9).

Calculation of Frequency Change

If a beam of electrons is to be used in the manner described above to control the resonant frequency of an oscillating system, the frequency of the over-all system can be estimated by applying the Y_e calculated above to the equivalent circuit for the system, and calculating the frequency from conventional circuit theory. Let the

L_0C circuit shown in Fig. 4 represent the equivalent circuit of the system before the beam is introduced.

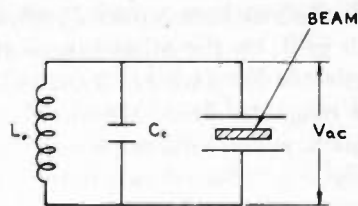

Fig. 4—Equivalent lumped circuit of resonant system.

C_0 is defined as the total equivalent capacitance of the system, or more exactly,

$$C_0 V_{ac}^2 = \mathcal{E} \int_v E^2 dv$$

where \mathcal{E} is the dielectric constant of the space, V_{ac} is the radio-frequency voltage across the parallel planes between which the beam moves, and the integral is taken over the entire volume of the oscillating system. C_0 is then determined by the stored energy of the system and the point at which the beam is introduced, for V_{ac} depends, in general, on the geometry of the system.

To calculate the resonant frequency, write

$$B_c + B_e = 0 \tag{11}$$

where

$$B_e = \text{electronic susceptance}$$

and

$$B_c = \text{circuit susceptance} = \frac{C_0}{\omega} (\omega^2 - \omega_0^2) \tag{12}$$

where $\omega_0^2 = 1/L_0C_0 =$ resonant frequency of the system before the electron beam is introduced. Let $\omega = \omega_0 + \Delta\omega$ where $\Delta\omega$ is the small change in frequency due to the introduction of the beam. If

$$\Delta\omega \ll \omega_0 \text{ so that } \frac{\omega_0 + \omega}{\omega} \simeq 2, \text{ and } B_c \simeq 2C_0\Delta\omega,$$

(11) becomes

$$2C_0\Delta\omega + \frac{L^2}{4d^2} \frac{|I_0|}{V_0} \frac{(\omega_c - \omega_0 - \Delta\omega)\tau - \sin(\omega_c - \omega_0 - \Delta\omega)\tau}{(\omega_c - \omega_0 - \Delta\omega)^2 \tau^2} = 0. \tag{13}$$

For most cases of interest we may take $\Delta\omega \ll (\omega_c - \omega_0)$. Then $(\omega_c - \omega)\tau = (\omega_c - \omega_0)\tau = \theta$, so that

$$\Delta\omega(\theta) = \frac{L^2}{8d^2} \frac{|I_0|}{V_c} \frac{1}{C_0} \frac{\sin \theta - \theta}{\theta^2}. \tag{14}$$

The electronic conductance introduced by the beam is

$$G_e(\theta) = \frac{L^2}{4d^2} \frac{|I_0|}{V_0} \frac{1 - \cos \theta}{\theta^2}. \tag{15}$$

Fig. 5(a) shows $\Delta\omega$ and G_e versus ω_c/ω_0 . Note that the conductance is a maximum at $\omega_c = \omega_0$. This means that the electrons rotate in phase with the electric field, absorbing energy continuously. There are no reactive currents, so that $\Delta\omega = 0$. At $(\omega_c - \omega_0)\tau = 2\pi$, $G_e = 0$. The electrons gain and lose energy during transit and come out with no net exchange, as inferred from Figs. 3(a),

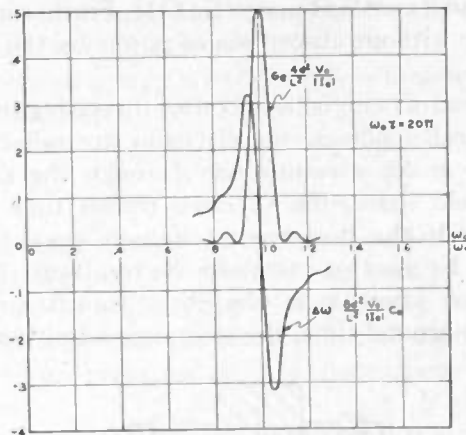

Fig. 5(a)—Theoretical frequency shift and electronic loading as a function of magnetic field strength.

(b), and (c). However, there are reactive currents and the frequency does change. For a given value of τ , $\Delta\omega(\theta)$ is a maximum at $(\omega_c - \omega_0)\tau = \pm \pi$.

$$\Delta\omega(\pm \pi) = \pm \frac{L^2}{8d^2} \frac{|I_0|}{V_0} \frac{1}{\pi C_0} \tag{14a}$$

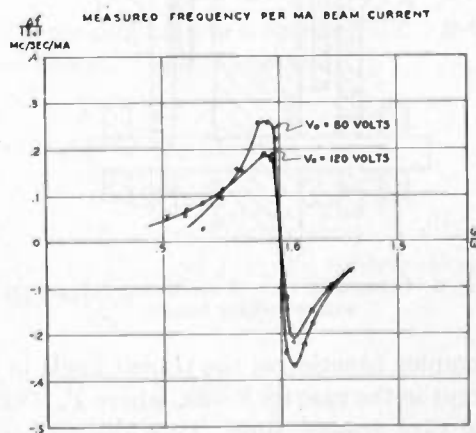

Fig. 5(b)—Measured frequency shift as a function of magnetic field strength.

and

$$G_e(\pm \pi) = \frac{L^2}{2d^2} \frac{|I_0|}{V_0} \frac{1}{\pi^2}, \tag{15a}$$

while

$$\Delta\omega(\pm 2\pi) = \pm \frac{L^2}{8d^2} \frac{|I_0|}{V_0} \frac{1}{2\pi C_0} = \frac{1}{2} \Delta\omega(\pm \pi) \quad (14b)$$

$$G_e(\pm 2\pi) = 0. \quad (15b)$$

It is clear from the above that it is possible to frequency-modulate an oscillating system by introducing into the resonant circuit an electron beam moving in the direction of a constant magnetic field. Furthermore, this is possible without absorption of power by the electron beam.

If, instead of being collected after traversing the length of the parallel planes, the electrons are reflected and caused to make a return trip through the radio-frequency field space, the effective transit time may be increased. If the turn-around time is zero, (14) and (15) may be used to calculate the resultant electronic admittance where τ is the total transit time. For finite turn-around time, the electronic admittance Y_e is

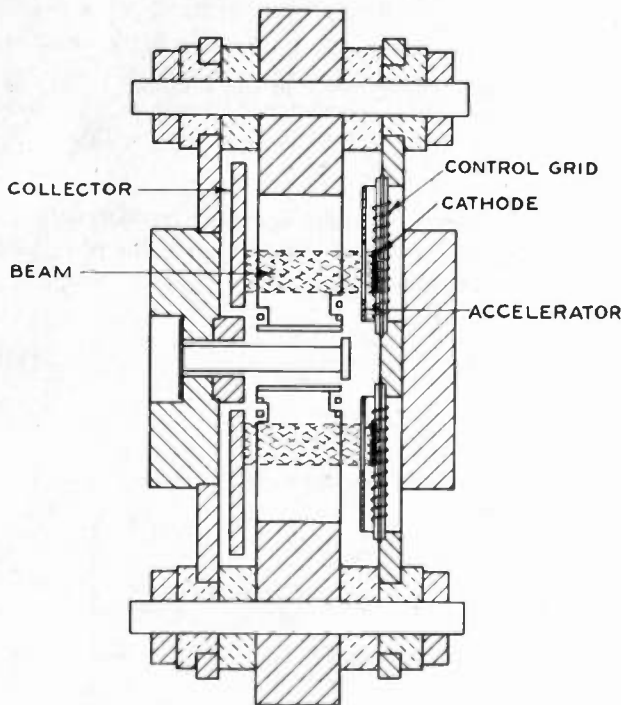

Fig. 6—Schematic view of multivane magnetron with auxiliary beams.

a fairly complex function of the transit angle in the end space, except in the case for $\theta = 2\pi$, where Y_e is independent of the turn-around time. This follows because at $\theta = 2\pi$ the electrons emerge from the active space with zero transverse velocity and, of course, re-enter with zero transverse velocity, in which case Y_e is independent of the entrance time.

Some Experimental Results

An experimental check of (14) was carried out at 4000 megacycles using a twelve-vane magnetron oscillator shown schematically in Figs. 6 and 7, which

show a multivane magnetron with two rectangular beams introduced between the vane structures. On one side of the resonant cavity block is the beam gun structure, which includes a cathode, control grid, and acceleration aperture or grid; on the other side of the block is a collector (or reflector for multiple transit). The beam is focused by the magnetic field. Measured values of the change in frequency per milliampere of beam current are shown in Fig. 5(b) plotted as a function of ω_c/ω_0 for two different transit times. These curves have the same form as the theoretical curves shown in Fig. 5(a). The L/d ratio for the cavity was 3, and the effective capacitance C_0 was estimated to be about 2×10^{-12} farads. At a beam voltage of 80 volts, (14) gives for this cavity a maximum frequency change of 0.36 megacycle per milliampere of beam current. The measured value at 80 volts was about 0.25 megacycle per milliampere. Since the estimate of C_0 was rather rough, the check is considered good. Magnetrons of the type shown in

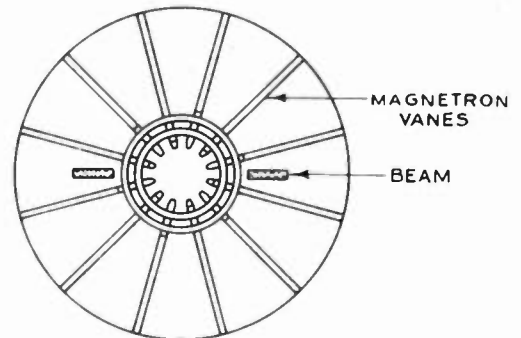

Fig. 7—Cross-sectional view of multivane magnetron with auxiliary beams.

Figs. 6 and 7 were built and successfully modulated at these laboratories under U. S. Navy Contract No. NXsa-35042 during the past two years.

Design Considerations

It would appear from the foregoing analysis that the effect of the electron beam is independent of the electric field intensity. This is indeed true if none of the electrons strike the electrodes. It is clear from (10) that $\Delta\omega$ increases with τ^2/d^2 . Integration of (6) shows that the maximum amplitude of oscillation about the median plane increases with τ . Hence, $\Delta\omega$ increases with x_{\max}^2/d^2 and is obviously a maximum at grazing incidence. In order to obtain the maximum frequency shift consistent with electron orbits just grazing the plates, it is necessary to look at the displacement of the spiraling electron which does depend on the electric field intensity.

Integration of (6) gives

$$x = -E_0 \frac{|e|}{m} \frac{e^{i\omega t}}{2(\omega - \omega_c)\omega} [e^{i(\omega_c - \omega)\tau(t/L)} - 1] \quad (16)$$

$$|x|_{\max} = \frac{E_0 |e|}{m} \frac{\tau}{\omega_c \theta}, \quad (\omega \neq \omega_c). \quad (17)$$

As long as $|x|_{\max} \leq (d/2)$, $\Delta\omega$ and G_e are independent of the field intensity.

It is of interest to estimate, in a rough way, the largest possible frequency change consistent with space-charge limitations and grazing incidence that can be effected with the introduction of a resonant beam of the type herein described. Consider a beam of thickness t and width W moving between a pair of parallel-plane electrodes also of width W , of length L , and a distance d apart. We shall assume that all the stored energy in the system is contained between the parallel-plane electrodes and select a case of particular interest, namely $(\omega_c - \omega_0)\tau = 2\pi$ (no loading). From (14b),

$$\Delta\omega = \frac{L^2}{8d^2} \frac{|I_0|}{V_0} \frac{1}{2\pi C_0} \quad (18)$$

The maximum current that can be established between parallel planes is²

$$|I_0|_{\max} = \frac{4}{9\pi} \sqrt{\frac{2e}{m}} \frac{W}{d} V_0^{3/2} F \quad (19)$$

where F is a function of t/d , the ratio of beam thickness to plate separation, varying between 2 at $t/d=1$ and 0.87 at $t/d=0$, and W is the beam width. Since all the stored energy is assumed to be between the plane electrodes, the effective capacitance C_0 is

$$C_0 = \frac{1}{4\pi} \frac{WL}{d} \quad (20)$$

The $\Delta\omega$, where I_0 has been maximized, would then be (combining (18), (19), and (20))

$$\Delta\omega = \frac{F}{9\pi d^2} \frac{L^2}{\tau} \quad (21)$$

It is clear from (21) that $\Delta\omega$ may be increased further by reducing d . However, d may not be reduced beyond the point where electrons are caught by the electrodes. The

$$dI_m = iE_0 \frac{|e|}{m} \frac{|I_0|}{2(\omega - \omega_c)v_0 d} (1 + p \cos \omega_m t_0) [e^{i(\omega_c - \omega)t/v_0} - 1] dz \quad (26)$$

minimum d is determined by the requirement that the maximum orbit diameter be just equal to $d/2$ for a beam of negligible thickness, or

$$I_2 = i \frac{E_0}{d} \frac{|e|}{m} p \frac{|I_0|}{2(\omega - \omega_c)v_0} \int_0^L \cos \omega_m t_0 [e^{i(\omega_c - \omega)t/v_0} - 1] dz \quad (27)$$

$$|x|_{\max} = E_0 \frac{|e|}{m} \frac{\tau}{\omega_c 2\pi} = \frac{d}{2}$$

Recalling that $V_{ac} = E_0 d$, we have

$$\frac{d^2}{2} = \frac{V_{ac}}{2\pi\omega_c} \frac{|e|}{m} \tau \quad (22)$$

² A. V. Haefl, "Space-charge effects in electron beams," PROC. I.R.E., vol. 27, pp. 586-602; September, 1939.

Combining (21) and (22),

$$\left(\frac{\Delta\omega}{\omega_c}\right)_{\max} = \frac{2F}{9} \frac{V_0}{V_{ac}}$$

Since $\omega_c \approx \omega_0$, write

$$\left(\frac{\Delta\omega}{\omega_0}\right)_{\max} = \frac{2F}{9} \frac{V_0}{V_{ac}} \quad (23)$$

Equation (23) gives the maximum fractional frequency change for a given beam voltage and radio-frequency voltage across the electrodes.

If the stored energy is not entirely contained between the parallel planes, then

$$\left(\frac{\Delta\omega}{\omega_0}\right)_{\max} = \frac{2F}{9} \frac{V_0}{V_{ac}} \frac{C}{C_0} \quad (24)$$

where C_0 is the total effective capacitance of the system, and C is the capacitance between the parallel planes.

It should be pointed out that (24) may be expected to furnish somewhat too low a value for $\Delta\omega$ because all electrons were presumed to have space-charge-free transit times.

The limitations described in this section apply also to multiple-transit conditions, for the total current that can be maintained in the vane space is the sum of the magnitudes of the current away from and toward the cathode.

Effect of Modulation Rate on Electronic Admittance

If a resonant beam of the type herein described is to be used to modulate or control oscillating systems, it is important to know how the electronic admittance Y_e depends on the modulation rate. Assume, for instance, that the beam current $|I_0|$ is not constant but is of the form

$$|I_0| (1 + p \cos \omega_m t_0) \quad (25)$$

where ω_m is the modulation frequency and p is the modulation coefficient. Then (8) becomes

Let $I_m = I_1 + I_2$ where I_1 is the solution with no modulation given by (9), and I_2 is the contribution from the modulation terms.

Let $\omega_m \tau = \phi$ and recall that $(\omega_c - \omega)\tau = \theta$ where $\tau = L/v_0$. Integration of (27) gives

$$I_2 = \frac{E_0}{d} \frac{|e|}{m} \frac{|I_0|}{4} \frac{\tau^2}{\theta} p \left\{ e^{i\omega_m t} \left[\frac{1 - e^{i(\theta - \phi)}}{\theta - \phi} + \frac{1 - e^{-i\phi}}{\phi} \right] + e^{i\omega_m t} \left[\frac{1 - e^{i(\theta + \phi)}}{\theta + \phi} - \frac{1 - e^{i\phi}}{\phi} \right] \right\} \quad (28)$$

Combining I_1 and I_2 , one can write the over-all modulated admittance Y_{em} in expanded trigonometric terms as follows:

$$Y_{em} = \frac{L^2}{4d^2} \frac{|I_0|}{V_0} \left\{ \frac{1 - \cos \theta}{\theta^2} [1 + p S_1(\theta, \phi) \cos(\omega_m t + \beta(\theta, \phi))] + i \frac{\theta - \sin \theta}{\theta^2} [1 + p S_2(\theta, \phi) \cos(\omega_m t + \alpha(\theta, \phi))] \right\} \quad (29)$$

$$Y_{em}(2\pi, \phi) = i \frac{L^2}{4d^2} \frac{|I_0|}{V_0} \frac{1}{2\pi} \left[1 + p \frac{\sqrt{2}}{\phi} \sqrt{1 - \cos \phi} \cos \omega_m \left(t + \frac{\tau}{2} \right) \right] \quad (41)$$

$$\Delta\omega(2\pi, \phi) = \frac{-L^2}{16\pi d^2} \frac{|I_0|}{V_0} \frac{1}{C_0} \left[1 + p \frac{\sqrt{2}}{\phi} \sqrt{1 - \cos \phi} \cos \omega_m \left(t + \frac{\tau}{2} \right) \right] \quad (42)$$

where

$$S_1^2(\theta, \phi) = \frac{\theta^2}{4(1 - \cos \theta)^2} \left\{ \left[\frac{1 - \cos(\theta - \phi)}{\theta - \phi} + \frac{1 - \cos(\theta + \phi)}{\theta + \phi} \right]^2 + \left[\frac{\sin(\theta - \phi)}{\theta - \phi} - \frac{\sin(\theta + \phi)}{\theta + \phi} \right]^2 \right\} \quad (30)$$

$$S_2^2(\theta, \phi) = \frac{\theta^2}{4(\theta - \sin \theta)^2} \left\{ \left[2 \frac{\sin \phi}{\phi} \frac{\sin(\theta - \phi)}{\theta - \phi} \frac{\sin(\theta + \phi)}{\theta + \phi} \right]^2 + \left[\frac{1 - \cos(\theta - \phi)}{\theta - \phi} - \frac{1 - \cos(\theta + \phi)}{\theta + \phi} + 2 \frac{1 - \cos \phi}{\phi} \right]^2 \right\} \quad (31)$$

$$\tan \beta(\theta, \phi) = \frac{\frac{\sin(\theta + \phi)}{\theta + \phi} - \frac{\sin(\theta - \phi)}{\theta - \phi}}{\frac{1 - \cos(\theta - \phi)}{\theta - \phi} + \frac{1 - \cos(\theta + \phi)}{\theta + \phi}} \quad (32)$$

$$\tan \alpha(\theta, \phi) = \frac{\frac{1 - \cos(\theta + \phi)}{\theta + \phi} - \frac{1 - \cos(\theta - \phi)}{\theta - \phi} - 2 \frac{1 - \cos \phi}{\phi}}{2 \frac{\sin \phi}{\phi} \frac{\sin(\theta - \phi)}{\theta - \phi} \frac{\sin(\theta + \phi)}{\theta + \phi}} \quad (33)$$

For low modulating frequencies where $\theta \gg \phi$, ϕ can be

$$Y_{em}(\pi, \phi) = \frac{L^2}{4d^2} \frac{|I_0|}{V_0} \left\{ \frac{2}{\pi^2} \left[1 + p \frac{\pi^2}{2(\pi^2 - \phi^2)} \sqrt{2(1 + \cos \phi)} \cos \omega_m \left(t - \frac{\tau}{2} \right) \right] + i \frac{1}{\pi} \left[1 + p \frac{\sqrt{2}}{(\pi^2 - \phi^2)\phi} \sqrt{\pi^2(\pi^2 - 2\phi^2)(1 - \cos \phi) + 2\phi^4} \cos(\omega_m t + \alpha) \right] \right\} \quad (47)$$

neglected with respect to θ . Then

$$S_1(\theta, \phi) = 1 \quad \theta \gg \phi \quad (34)$$

$$\beta(\theta, \phi) = 0 \quad \theta \gg \phi \quad (35)$$

$$S_2(\theta, \phi) = \frac{\theta}{\theta - \sin \theta} \sqrt{\left(\frac{\sin \phi}{\phi} - \frac{\sin \theta}{\theta} \right)^2 + \left(\frac{1 - \cos \phi}{\phi} \right)^2} \quad (36)$$

$$\tan \alpha(\theta, \phi) = \frac{\frac{1 - \cos \phi}{\phi}}{\frac{\sin \phi}{\phi} - \frac{\sin \theta}{\theta}} \quad (37)$$

It is of interest to look at the case where $\theta = 2\pi \gg \phi$:

$$S_2(2\pi, \phi) = \frac{\sqrt{2}}{\phi} \sqrt{1 - \cos \phi} \quad \theta \gg \phi \quad (38)$$

and

$$\alpha(2\pi, \phi) = \frac{\phi}{2} \quad \theta \gg \phi \quad (39)$$

$$S_1(2\pi, \phi) = 1 \quad \theta \gg \phi \quad (40)$$

So that, when $\theta = 2\pi \gg \phi$,

Note that, for $\theta \gg \phi$, distortion terms appear only in the reactive component of the modulated admittance, and appear in the form of both amplitude and phase distortion. For $\theta = 2\pi \gg \phi$, the loading term becomes zero and the phase distortion in the reactive component disappears. Equation (42) is of great practical interest in the design of electronic reactance control devices.

When θ and ϕ are of the same order of magnitude, Y_{em} is given by (29) and is rather involved. Two cases of interest are $\theta = \pi$ and 2π .

$$\theta = \pi \quad S_1(\pi, \phi) = \frac{\pi^2}{2(\pi^2 + \phi^2)} \sqrt{2(1 + \cos \phi)} \quad (43)$$

$$\beta(\pi, \phi) = -\frac{\phi}{2} \quad (44)$$

$$S_2(\pi, \phi) = \frac{\sqrt{2}}{(\pi^2 - \phi^2)\phi} \sqrt{\pi^2(\pi^2 - 2\phi^2)(1 - \cos \phi) + 2\phi^4} \quad (45)$$

$$\alpha(\pi, \phi) = \tan^{-1} \frac{(\pi^2 - 2\phi^2) \cos \phi - \pi^2}{(\pi^2 - 2\phi^2) \sin \phi} \quad (46)$$

so that

Fig. 8 shows S_1 , S_2 , and α versus ϕ for $\theta = \pi$. It is interesting to note that there is only amplitude distortion in the loading term, while there is both amplitude and phase distortion in the reactance term.

$\theta = 2\pi$: ($\cos \theta = 1$) Although in this case $S_1(2\pi, \phi)$ becomes infinite,

$$\frac{1 - \cos \theta}{\theta^2} S_1(2\pi, \phi) \text{ remains finite.}$$

$$\frac{(1 - \cos \theta)}{\theta^2} S_1(2\pi, \phi) = \frac{1}{4\pi^2 - \phi^2} \sqrt{2(1 - \cos \phi)} \quad (48)$$

$$\beta(2\pi, \phi) = \frac{\pi}{2} - \frac{\phi}{2} \tag{49}$$

$$S_2(2\pi, \phi) = \frac{4\pi^2}{4\pi^2 - \phi^2} \frac{\sqrt{2(1 - \cos \phi)}}{\phi} \tag{50}$$

$$\alpha(2\pi, \phi) = -\frac{\phi}{2} \tag{51}$$

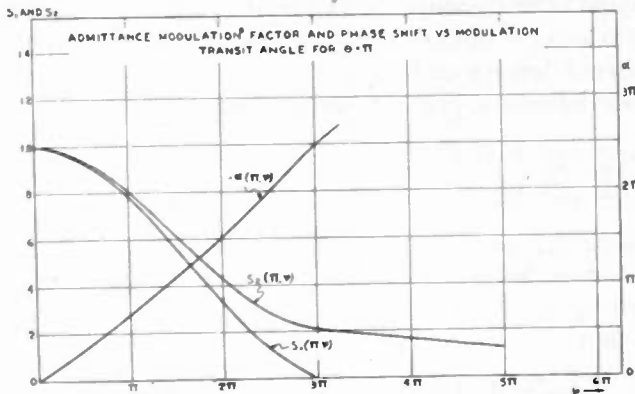

Fig. 8—Admittance modulation factor and phase shift versus modulation transit angle for $\theta = \pi$.

so that

$$Y_{em}(2\pi, \phi) = \frac{L^2}{4d^2} \frac{|I_0|}{V_0} \left\{ p \frac{1}{4\pi^2 - \phi^2} \sqrt{2(1 - \cos \phi)} \cos \left[\omega_m \left(t - \frac{\tau}{2} \right) + \frac{\pi}{2} \right] + i \frac{1}{2\pi} \left[1 + p \frac{4\pi^2}{4\pi^2 - \phi^2} \frac{\sqrt{2(1 - \cos \phi)}}{\phi} \cos \omega_m \left(t - \frac{\tau}{2} \right) \right] \right\} \tag{52}$$

No phase distortion appears in either the loading or the reactive term. Fig. 9 shows $(1 - \cos \theta/\theta^2)S_1$ and S_2 versus

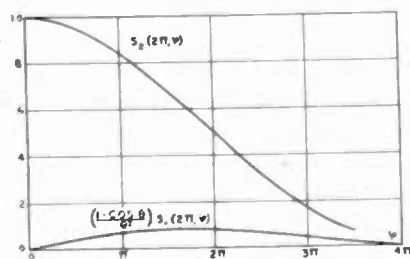

Fig. 9—Admittance modulation factor versus modulation transit angle for $\theta = \pi$.

ϕ for $\theta = 2\pi$. There is no average loading, but there is instantaneous loading with a maximum near $\phi = 2\pi$.

$$\Delta\omega_m(2\pi, \phi) = \frac{L^2}{16\pi d^2} \frac{|I_0|}{V_0} \frac{1}{C_0} p G_2(2\pi, \phi) \cos \omega_m \left(t - \frac{\tau}{2} \right) \tag{53}$$

ϕ may be as large as $3\pi/2$ before $S_2(\theta = 2\pi)$ is reduced to half its value at $\phi = 0$. For example, if

$$\omega_0 = 2\pi \times 4000 \times 10^6 \text{ and } \frac{\omega_0}{\omega_0} = 1.1$$

$$\phi_m = \frac{3\pi}{2} \text{ corresponds to } \omega_m$$

$$= 2\pi \times 300 \times 10^6 \text{ radians per second.}$$

III. GENERAL FIELD-THEORY TREATMENT

When electrons are injected into cavities or systems with distributed constants, it is convenient to be able to calculate the resulting changes in frequency in terms of the electromagnetic field quantities and the forced electron convection current, rather than in terms of currents induced in a circuit containing lumped constants as was done in Section I. This can be done quite simply with adequate accuracy by means of a perturbation method.

The electromagnetic field in a region of space entirely enclosed by a perfectly conducting surface will be given by a solution of Maxwell's equations for which the tangential component of electric field at the surface vanishes. When the field quantities are expressed in the meter-kilogram-second³ system of units, these equations are:

$$\text{Curl } H = J + \epsilon \dot{E} \tag{54a}$$

$$\text{Div } H = 0 \tag{54b}$$

$$\text{Curl } E = -\mu \dot{H} \tag{54c}$$

$$\text{Div } E = \rho/\epsilon. \tag{54d}$$

In obtaining solutions of (54), it is convenient to reduce the number of equations by expressing E and H in

terms of the scalar potential ϕ and the vector potential A by means of the relations

$$E = -\dot{A} - \text{grad } \phi \tag{55a}$$

$$\mu H = \text{Curl } A \tag{55b}$$

where

$$A = \frac{\partial A}{\partial t}$$

When so expressed, E and H automatically satisfy (54b) and (54c) and we are left with the problem of solving the equations

$$\nabla \cdot \nabla A - \epsilon \mu \ddot{A} = -\mu J + \mu \epsilon \text{grad } \dot{\phi} + \text{grad div } A$$

$$\nabla^2 \phi + \text{div } A = -\rho/\epsilon.$$

For the interpretation of $\nabla \cdot \nabla A$, see footnote reference 3, page 49. Since A is not uniquely defined by (55b), we are free to impose the additional condition that $\text{div } A = 0$, whereafter the above equations reduce to

$$\nabla \cdot \nabla A - \epsilon \mu \ddot{A} = -\mu J + \mu \epsilon \text{grad } \dot{\phi} \tag{56a}$$

$$\nabla^2 \phi = -\rho/\epsilon. \tag{56b}$$

When there is no charge or current in the enclosed space, ϕ may be taken to be identically zero, and only one

³ J. D. Stratton, "Electromagnetic Theory," p. 16, McGraw-Hill Book Co., New York, N. Y., 1941.

equation remains, namely,

$$\nabla \cdot \nabla A - \epsilon \mu \ddot{A} = 0. \quad (57)$$

This means that both the electric and magnetic fields are derivable from the vector potential.

The general procedure in computing the change in resonant frequencies of a cavity produced by the injection of a stream of electrons is as follows. Before the electrons are injected, the field in the cavity must satisfy (57), since there is no charge or current in the interior. Solutions of this equation, which are harmonic in the time and which satisfy the boundary conditions already mentioned, exist only for discrete frequencies. Such particular solutions can be written in the form

$$A(r, t) = A_{0n}(r)e^{i\omega_{0n}t} \quad (58)$$

where

$$\nabla \cdot \nabla A_{0n} + \epsilon \mu \omega_{0n}^2 A_{0n} = 0. \quad (59)$$

The solutions of the last equation give the special distribution of field for the characteristic modes of oscillation of the cavity and for every geometry of cavity it is, in principle, possible to compute the corresponding resonant frequency ω_{0n} . This will be done later for special cases.

When electrons are injected into the cavity, the electromagnetic field changes, and the resonant frequency may also change. The new field will be given by solutions of (56a) and (56b). The field in the cavity will act on the electrons, and so the current will not remain uniform but will vary with time and position in the cavity. This modified current in turn modifies the field, and so on until a steady state is reached. If the injected current is not too large it is convenient to adopt a method of successive approximations for arriving at the steady-state condition. To this end we shall assume that before electrons are introduced the field in the cavity is given in terms of the vector potential of the n th mode, i.e., A_{0n} , corresponding to the frequency ω_{0n} . If a uniform beam of electrons is introduced into the cavity, then we may calculate a first approximation to the current inside the cavity by calculating the electron trajectories that would be produced by the unperturbed or zeroth-order field existing before the electrons were introduced. Let the first-order approximation to the current density inside the cavity be denoted by $\delta J_1(r, t)$. δ is a parameter introduced to indicate the order of smallness of the current. The corresponding first approximation to the charge distribution in the cavity can be denoted by $\delta \rho_1(r, t)$. The first-order current and charge can be substituted in (56a) and (56b) and these equations solved to obtain a first approximation for the vector and scalar potentials which may be denoted by A_{1n} and ϕ_{1n} . In principle this procedure can be repeated and would be expected to yield a convergent series (when J_1 is not too large) which would give a solution of the problem with any desired accuracy.

Carrying out this procedure, the first-order approximation for the vector and scalar potentials will be found

by solving the following equations:

$$\begin{aligned} \nabla \cdot \nabla A_{1n}(r, t) - \epsilon \mu \ddot{A}_{1n}(r, t) \\ = -\mu \delta J_{1n}(r, t) + \mu \epsilon \text{grad } \phi_{1n}(r, t) \end{aligned} \quad (60)$$

$$\nabla^2 \phi_{1n}(r, t) = \frac{\delta \rho_{1n}(r, t)}{\epsilon}. \quad (61)$$

It is to be understood that J_1 and ρ_1 are to be determined from the unperturbed field distribution $A_{0n}(r)e^{i\omega t}$ with ω as yet unknown. When this is done, the first-order current density and charge can be expressed in terms of their harmonic components as follows:

$$J_{1n} = J_{1n}^0 + J_{1n}^{(1)}(r)e^{i\omega t} + J_{1n}^{(2)}(r)e^{2i\omega t} + \dots \quad (62)$$

$$\rho_{1n} = \rho_{1n}^0 + \rho_{1n}^{(1)}(r)e^{i\omega t} + \rho_{1n}^{(2)}(r)e^{2i\omega t} + \dots$$

where J_{1n}^0 and ρ_{1n}^0 are the steady current and charge densities. Solutions of (60) and (61) are facilitated by writing the potentials in terms of harmonic components, so that

$$\begin{aligned} A_{1n} = A_{1n}^0 + A_{1n}^{(1)}e^{i\omega t} + A_{1n}^{(2)}e^{2i\omega t} + \dots \\ \phi_{1n} = \phi_{1n}^0 + \phi_{1n}^{(1)}e^{i\omega t} + \phi_{1n}^{(2)}e^{2i\omega t} + \dots \end{aligned} \quad (63)$$

Equations (62) and (63) can now be substituted in (60) and (61) and coefficients of the linearly independent time functions $e^{i\omega t}$, $e^{2i\omega t}$, etc., equated. This gives the following infinite set of equations:

$$\nabla \cdot \nabla A_{1n}^0 = -\mu \delta J_{1n}^0 \quad (64a)$$

$$\nabla \cdot \nabla A_{1n}^{(1)} + \epsilon \mu \omega^2 A_{1n}^{(1)} = -\mu \delta J_{1n}^{(1)} + i\mu \epsilon \omega \text{grad } \phi_{1n}^{(1)} \quad (64b)$$

$$\nabla^2 \phi_{1n}^0 = \frac{\delta \rho_{1n}^0}{\epsilon} \quad (65a)$$

$$\nabla^2 \phi_{1n}^{(1)} = \frac{\delta \rho_{1n}^{(1)}}{\epsilon}. \quad (65b)$$

Equations (64a) and (65a) have no bearing on the problem of determining the resonant frequencies, since the quantities involved are independent of the time.

Since $\delta J_{1n}^{(1)}$ is small, we may make use of a standard perturbation method for determining A_{1n} and ω . To do this we write

$$A_{1n}^{(1)} = A_{0n} + \delta B_{1n}^{(1)} + \delta^2 C_{1n}^{(1)} \dots \quad (66)$$

$$\omega = \omega_{0n} + \delta \omega_{0n}' + \delta^2 \omega_{0n}'' \dots \quad (67)$$

$$\phi_{1n}^{(1)} = \delta \psi_{1n}' + \delta^2 \psi_{1n}'' \dots \quad (68)$$

$J_{1n}^{(1)}$ will in general depend on the frequency ω assumed by the system. When it does, the perturbation method can be kept consistent by expanding $J_{1n}^{(1)}$ in a power series in $\omega - \omega_0$. Then

$$\begin{aligned} J_{1n}^{(1)}(\omega, r) &= J_{1n}^{(1)}(\omega_{0n}, r) \\ &+ \left\{ \frac{d}{d\omega} J_{1n}^{(1)}(\omega, r) \right\}_{\omega_{0n}} (\omega - \omega_{0n}) + \dots \\ &= J_{1n}^{(1)}(\omega_{0n}, r) \\ &+ \left\{ \frac{d}{d\omega} J_{1n}^{(1)}(\omega, r) \right\}_{\omega_{0n}} \delta \omega_{0n}' + \dots \end{aligned}$$

When these equations are used in (64b) and coefficients of like powers of δ are equated, we have

$$\nabla \cdot \nabla A_{0n} + \epsilon \mu \omega_{0n}^2 A_{0n} = 0 \tag{69}$$

$$\nabla \cdot \nabla B_{1n}^{(1)} + \epsilon \mu [2\omega_{0n}\omega_{0n}' A_{0n} + \omega_{0n}^2 B_{1n}^{(1)}] = -\mu J_{1n}^{(1)}(\omega_{0n}) + i\mu \epsilon \omega_{0n} \text{grad } \psi_{1n}' \tag{70}$$

Equation (69) is already satisfied by A_{0n} . Since it is known that the vector potentials form an orthogonal set of functions, i.e.,

$$\int A_{0m} \cdot A_{0n}^* d\tau = \begin{matrix} 0, & m \neq n \\ \text{constant}, & m = n \end{matrix} \tag{71}$$

where A_{0n}^* is the complex conjugate of A_{0n} and the integral is taken over the volume of the cavity, we may expand $B_{1n}^{(1)}$ in terms of the functions A_{0k} . Thus

$$B_{1n}^{(1)} = \sum_{k=1}^{\infty} C_{1nk}^{(1)} A_{0k} \tag{72}$$

Substituting this into (70) and rearranging and making use of (69), we obtain

$$\sum_k \epsilon \mu [\omega_{0n}^2 - \omega_{0k}^2] C_{1nk}^{(1)} A_{0k} = -2\epsilon \mu \omega_{0n} \omega_{0n}' A_{0n} - \mu J_{1n}^{(1)}(\omega_{0n}) + i\mu \epsilon \omega_{0n} \text{grad } \psi_{1n}' \tag{73}$$

If we multiply this equation by A_{0n}^* scalarly and integrate the result over the volume of the cavity, we have the result

$$2\epsilon \mu \omega_{0n} \omega_{0n}' \int A_{0n}' \cdot A_{0n}^* d\tau + \mu \int \{ J_{1n}^{(1)}(\omega_{0n}) + i\mu \epsilon \omega_{0n} \text{grad } \psi_{1n}' \} \cdot A_{0n}^* d\tau = 0.$$

The orthogonality property of the A_{0n} 's has been used. If the potential $\phi_{1n}^{(1)}$ and consequently ψ_{1n}' is made zero on the boundary of the cavity, then it can be shown that

$$\int \text{grad } \psi_{1n}' \cdot A_{0n}^* d\tau = 0$$

so that

$$\omega_{0n}' = - \frac{\int J_{1n}^{(1)}(\omega_{0n}) \cdot A_{0n}^* d\tau}{2\epsilon \omega_{0n} \int A_{0n} \cdot A_{0n}^* d\tau} \tag{74}$$

Since $J_{1n}^{(1)}$ is calculated from the unperturbed field distribution, the above formula shows that the first-order frequency change is determined from the unperturbed vector potential, so that it is not necessary to calculate the field as modified by the electrons in order to determine the change in frequency caused by the electron stream, provided the change is small.

The quantity ω_{0n}' computed from (74) will, in general, be complex, so that the frequency change is actually the real part of (74), the imaginary terms giving rise to a net energy transfer from field to electrons. If the electrons gain energy and the wall losses in the cavity are small, this loss of energy to the electrons determines the

Q of the cavity, so that (74) furnishes the basis for the following two formulas:

$$\Delta\omega = -Rp \frac{\int J_{1n}^{(1)}(\omega_{0n}) \cdot A_{0n}^* d\tau}{2\epsilon \omega_{0n} \int |A_{0n}|^2 d\tau} \tag{75}$$

$$\frac{\omega_{0n}}{2Q_{0n}} = -Im \frac{\int J_{1n}^{(1)}(\omega_{0n}) \cdot A_{0n}^* d\tau}{2\epsilon \omega_{0n} \int |A_{0n}|^2 d\tau} \tag{76}$$

where $\Delta\omega$ is the change in frequency, Q_{0n} is the Q of the cavity with injected electrons, and the cavity is oscillating in the n th mode.

Before calculating the electron currents in some special cases, it will be of interest to discuss the implications of (75) and (76) with regard to the nature of the currents necessary to produce optimum frequency shifts, etc. If the unperturbed electric field in the cavity is represented by

$$E_n(\mathbf{r})e^{i\omega_{0n}t},$$

then from the relation (55) the vector potential may be written as

$$A_{0n}(\mathbf{r})e^{i\omega_{0n}t} = \frac{i}{\omega_{0n}} E_n(\mathbf{r})e^{i\omega_{0n}t} = \frac{E_n(\mathbf{r})}{\omega_{0n}} e^{i\pi/2} e^{i\omega_{0n}t} \tag{77}$$

Consequently the vector potential leads the electric field intensity in time phase by 90 degrees. The vector

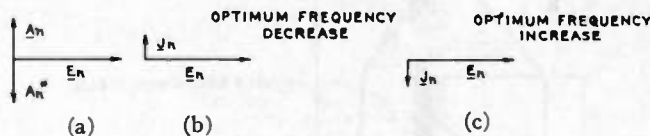

Fig. 10—Phase diagrams for A , E , and J .

diagram in Fig. 10(a) shows the time-phase relationship of E_{0n} , A_{0n} , and A_{0n}^* taking the phase angle of E_n as zero.

Since the denominators of (75) and (76) are real, the real and imaginary parts are determined by the scalar product

$$J_{1n}^{(1)}(\mathbf{r}) \cdot A_n^*(\mathbf{r})$$

in the integrals in the numerators. This scalar product, expressed in terms of $E_n(\mathbf{r})$, which is real, is

$$J_{0n}^{(1)}(\omega_{0n}, \mathbf{r}) \cdot A_n^*(\mathbf{r}) = J_{0n}^{(1)}(\omega_{0n}, \mathbf{r}) \cdot \frac{E_n(\mathbf{r})}{\omega_{0n}} e^{-i\pi/2} \tag{78}$$

Consequently, for the optimum real part of this expression and therefore the optimum frequency shift, the electron current should lead or lag the electric field intensity by 90 degrees. For maximum decrease in frequency (75) shows that the electron current must lead E_n by 90 degrees, while for maximum increase in frequency the electron current should lag E_n by 90 degrees. This is analogous to the situation in circuit theory. The vector diagrams for these two cases are shown in Figs. 10(b) and 10(c), respectively.

Formulas (76) and (78) show that optimum loading takes place when the current is in phase with E_n . This

is the case when energy is transferred from the electromagnetic field to the electrons. If the current were 180 degrees out of phase with E_n , energy would be transferred from the electrons to the field. In this case one would have a generator and a negative Q .

If the time phase of the current is a function of position in the cavity, as it usually will be, the net frequency shift is, of course, given by the integral.

In addition to the optimum time-phase relationships, (75) and (76) show that the greatest frequency change or loading for a given current occurs when that current is parallel to the electric field and located in that region of the cavity where the electric field is the largest. This is the region of largest interaction of field and electrons.

Calculation of Current

The frequency shift and loading will be computed for a rectangular cavity for a special way of introducing the electrons. We shall assume that before the electrons are introduced the mode of oscillation is such that the elec-

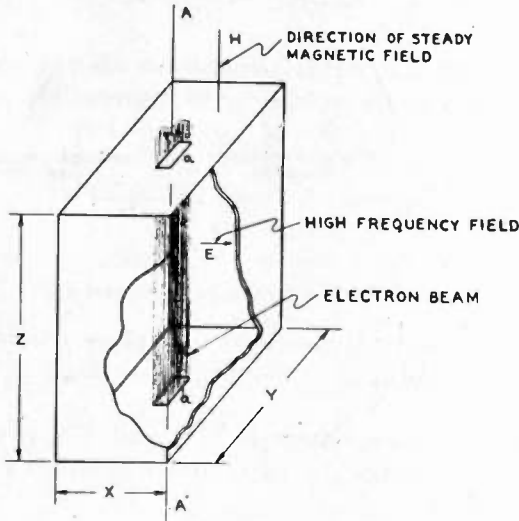

Fig. 11—Schematic diagram showing beam in rectangular resonant cavity.

tric field is parallel to the x direction only, as shown in Fig. 11. The electric field for this mode is given by

$$E_x(r, t) = E_0 \sin \frac{\pi y}{Y} \sin \frac{\pi z}{Z} e^{i\omega_0 t} \quad (79)$$

and the frequency by

$$\omega_{0n} = \omega_0 = \pi C \sqrt{\frac{1}{Y^2} + \frac{1}{Z^2}} \quad (80)$$

The x component of the vector potential corresponding to this mode is

$$A_x(r, t) = \frac{i}{\omega_0} E_0 \sin \frac{\pi y}{Y} \sin \frac{\pi z}{Z} e^{i\omega_0 t} \quad (81)$$

We shall assume that the electron stream traverses

the cavity in a direction parallel to the z axis, in which direction a uniform magnetic field H is assumed to be present. The determination of the first-order current $J_{1n}(\omega_0)$ for this case (see (62)) requires the calculation of the electron trajectories through the cavity under the influence of the unperturbed field given in (79). For definiteness we shall take the electron beam to be of rectangular cross section with center at $x=X/2$ and $y=Y/2$, all electrons entering the cavity at $z=0$ with a velocity v_0 .

Taking the initial conditions at $t=t_0$, the time of entrance, to be

$$x = \frac{X}{2}; \quad y = \frac{Y}{2}; \quad z = 0$$

$$\dot{x} = \dot{y} = 0 \quad \text{and} \quad \dot{z} = v_0,$$

the solutions of the equations of motion, (1), (2), (3), for the x component of velocity, \dot{x} , with the above applied field, is

$$\dot{x} = - \frac{|e| E_0}{m} F(z) e^{i\omega_0 t_0} \quad (82)$$

where

$$F(z) = \int_0^{z/v_0} \cos \omega_c(\eta - z/v_0) \sin \frac{\pi v_0}{Z} \eta e^{i\omega_0 \eta} d\eta \quad (83)$$

The charge entering the cavity per unit area of the beam between t_0 and $t_0 + dt_0$ will be

$$dq = - |J_0| dt_0$$

where J_0 is the current density in the beam before entering the cavity. The current density J in the x direction in the beam between z and $z+dz$ at time t is

$$J dz = - |J_0| \frac{dz}{v_0} \dot{x} = \frac{|e|}{m} \frac{|J_0|}{v_0} E_0 F(z) e^{i\omega_0 t_0} dz \quad (84)$$

$$J = \frac{|e|}{m} \frac{|J_0|}{v_0} E_0 F(z) e^{i\omega_0(t-z/v_0)}$$

The amplitude of the current density entering (75) and (76), namely, $J_{1n}^{(1)}$, is just the time-independent part of the above expression; hence,

$$J_{1n}^{(1)}(\omega_0) = \frac{|e|}{m} \frac{|J_0|}{v_0} E_0 F(z) e^{-i\omega_0 z/v_0} \quad (85)$$

This completes the calculation of the first-order approximation for the current.

Calculation of the Frequency Shift

The integral in the denominators of (75) and (76) is easy to compute. The result is

$$\int_0^Z \int_0^Y \int_0^X |A_{0n}|^2 dx dy dz = \frac{E_0^2}{\omega_0^2} \frac{X Y Z}{4} \quad (86)$$

In the numerator of the same formulas, we require the value of

$$\int_0^Z \int_0^Y \int_0^X J_{1nz}^{(1)}(r) A_z^*(r) dx dy dz$$

$$= \frac{-i|e|}{m} \frac{E_0^2}{v_0} \int_0^Z \int_0^Y \int_0^X |J_0| F(z) e^{i\omega_0 z/v_0} \sin \frac{\pi y}{Y} \sin \frac{\pi z}{Z} dx dy dz.$$

The results (85) and (81) have been used. On the right side $|J_0|$ is different from zero only within the beam, so that, neglecting the variation in $\sin \pi y/Y$ over the beam width as before, the integrals over x and y can be evaluated at once since $\iint |J_0| dx dy = |I_0|$ where $|I_0|$ is the total beam current. Then

$$\iiint J_{1nz}^{(1)}(r) A_z^*(r) dx dy dz = |I_0| \frac{|e|}{m} \frac{E_0^2}{v_0 \omega_0} K \quad (87)$$

where

$$K = -i \int_0^Z F(z) e^{-i\omega_0 z/v_0} \sin \frac{\pi z}{Z} dz. \quad (88)$$

K can be evaluated and for the real part we find

$$R\{K\} = \frac{Z}{4\pi} \left[\pi \left\{ \frac{(\omega_0 + \omega_c)}{\left(\frac{\pi v_0}{Z}\right)^2 - (\omega_0 + \omega_c)^2} + \frac{\omega_0 - \omega_c}{\left(\frac{\pi v_0}{Z}\right)^2 - (\omega_0 - \omega_c)^2} \right\} - 2 \left(\frac{\pi v_0}{Z}\right)^3 \left\{ \frac{\sin(\omega_0 + \omega_c)z/v_0}{\left[\left(\frac{\pi v_0}{Z}\right)^2 - (\omega_0 + \omega_c)^2\right]^2} + \frac{\sin(\omega_0 - \omega_c)z/v_0}{\left[\left(\frac{\pi v_0}{Z}\right)^2 - (\omega_0 - \omega_c)^2\right]^2} \right\} \right] \quad (89)$$

The final formula for the frequency shift can be materially simplified by adopting new variables, namely,

$$u = (1 + k)\alpha \quad \text{and} \quad w = (1 - k)\alpha \quad (90)$$

where

$$k = \frac{\omega_c}{\omega_0} \quad \text{and} \quad \alpha = \frac{Z\omega_0}{v_0} = \text{transit angle}. \quad (91)$$

When the above formulas are substituted in (75), we have the expression for the frequency shift. This is

$$\Delta\omega = -\frac{|I_0||e|\alpha^2}{2emXYZ\omega_0^2} [f(u) + f(w)] \quad (92)$$

where

$$f(u) = \frac{u(\pi^2 - u^2) - 2\pi^2 \sin u}{(\pi^2 - u^2)^2} \quad (93)$$

A graphical representation of $f(u)$ is shown in Fig. 12.

The main characteristics of this method of changing the frequency are that the frequency is proportional to the total beam current and inversely proportional to the energy stored in the electromagnetic field within the

cavity. A further examination of (92) and (93) shows that when the transit angle α is not too small, the maximum frequency shift $\Delta\omega_{max}$ occurs when

$$(1 - k)\alpha \approx 4 \quad (94)$$

and that $\Delta\omega_{max}$ is proportional to α^2 . The above condi-

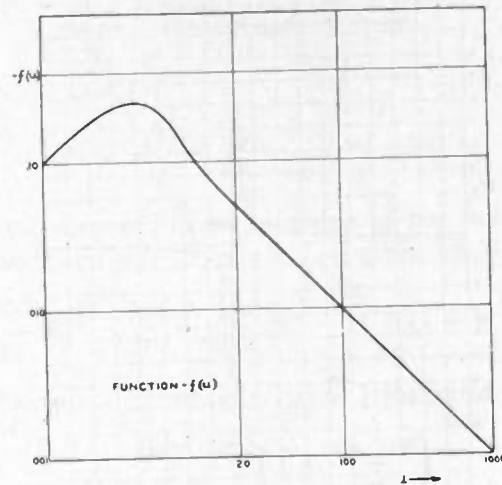

Fig. 12— $f(u)$ versus u .

tion for maximum frequency shift is not quite the same as that found for electrons moving between parallel plates.

In order to indicate the magnitude of the frequency change and its behavior as a function of the magnetic field, a curve is shown in Fig. 13 which gives $\Delta\omega$ as a function of k for a rectangular cavity where $Y=Z=5.3$ centimeters, $X=0.2$ centimeter, and $\omega_0=4000$ megacycles, and the transit angle corresponds to that of electrons having been accelerated through 100 volts. One may readily verify that the maximum of $\Delta\omega$ occurs when the condition (94) is satisfied. The curve shows the greatly increased frequency shift that can be obtained by adjusting the magnetic field so that the electron is nearly resonant with the oscillating electric field over that which would result for zero magnetic field.

When $k < 1$, the electron current is inductive, i.e., lags behind the electric field producing it, and gives rise to an increase in resonant frequency of the system. When $k > 1$ the electron current is capacitive, i.e., leads the electric field, and produces a decrease in resonant frequency.

It should be noted that the above behavior applies to

cases where the beam is not limited by space-charge effects and the orbits of the electrons are not large enough to strike the walls of the cavity. An estimate of the effects of these factors can be made for any special case.

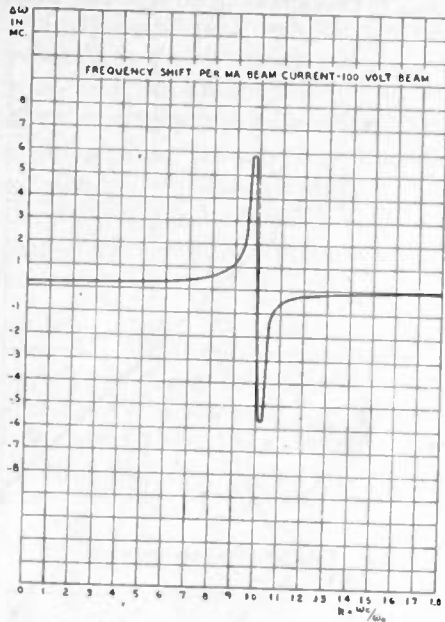

Fig. 13—Frequency shift versus magnetic field for the rectangular cavity structure.

Electron Loading

In order to calculate the electronic loading, we note from (76) that the imaginary part of K given by (88) is required. Thus

$$\frac{\omega_0}{2Q_0} = \frac{2 |I_0| |e|}{\epsilon m v_0 X Y Z} \text{Im} K. \tag{95}$$

The value of the $\text{Im} K$ is

$$\text{Im} K = v_0 \left[\frac{\left(\frac{\pi v_0}{Z}\right)^2 \cos^2(\omega_0 - \omega_c) \frac{Z}{2v_0}}{\left\{\left(\frac{\pi v_0}{Z}\right)^2 - (\omega_0 - \omega_c)^2\right\}^2} + \frac{\left(\frac{\pi v_0}{Z}\right)^2 \cos^2(\omega_0 + \omega_c) \frac{Z}{2v_0}}{\left\{\left(\frac{\pi v_0}{Z}\right)^2 - (\omega_0 + \omega_c)^2\right\}^2} \right] \tag{96}$$

Using the variable u and w given in (90) and (91), the above expressions can be combined and rearranged so that

$$\frac{\omega_0}{2Q_0} = \frac{I_0 |e| \alpha^2}{2\epsilon m X Y Z \omega_0^2} [T(w) + T(u)] \tag{97}$$

where

$$T(w) = \frac{4\pi^2 \cos^2 w}{[\pi^2 - w^2]^2} \tag{98}$$

A graph of $T(w)$ is shown in Fig. 14.

Just as in the case of the frequency shift, the loading is proportional to the total beam current and inversely proportional to the cavity volume and the square of the resonant frequency. The maximum loading occurs when $w = (1 - k)\alpha = 0$. For a transit angle different from zero this occurs at $k = 1$, i.e., $\omega_c = \omega_0$, which means that the electron circular motion is exactly in resonance with the electric field. As seen from Fig. 13, $\Delta\omega$ is zero at this

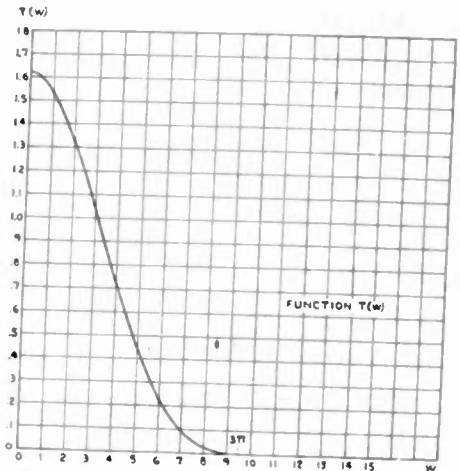

Fig. 14— $T(w)$ versus w .

point, so that the electron current is entirely a resistive component.

When the transit angle is not too small the loading is essentially zero at

$$w = (1 - k)\alpha = 3\pi \tag{99}$$

since $T(w)$ is zero at this point and $T(u)$ is very small. In this case we find that minimum loading occurs at $(1 - k)\alpha = 3\pi$, instead of 2π as it was for electrons moving in a uniform oscillating field between parallel plates.

If we compare Figs. 12 and 13, we find that for a given transit time (not too short) when $(1 - k)\alpha$ is adjusted

for no loading, the frequency shift is about four-tenths of the maximum frequency shift, i.e.,

$$\Delta\omega_{\text{no loading}} \approx 0.4\Delta\omega_{\text{max}}. \tag{100}$$

Again this is a somewhat different ratio from the case of electrons moving between parallel planes.

**APPENDIX
FRINGE-FIELD EFFECT**

In general, the problem of estimating the effect of the fringe field depends on the geometry of the specific

system. If, however, the transit time in the fringe field is small, the effects can be approximated as follows.¹

Consider a charge q emerging from between a pair of parallel-plane electrodes, and let the charge be displaced a distance x from the median plane. The induced charge on one plane is

$$-\frac{q}{d}\left(x + \frac{d}{2}\right)$$

and that on the other is

$$-\frac{q}{d}\left(-x + \frac{d}{2}\right).$$

The difference between the charge on the two planes is $-q(2x/d)$. After the electron has traversed the fringe field in the exit space, this difference of charge must have disappeared, so that during the transit time in the fringe field a charge $-q(x/d)$ must have moved from one electrode to the other through the external circuit.

If a beam of current $-|I_0|$ is moving between the plates at a velocity v_0 , the charge at the exit point is

$$q = \frac{-|I_0|}{v_0} dz$$

and the charge

$$+\frac{|I_0|}{dv_0} x dz = \int i_f dt$$

is the charge moved from one electrode to the other during transit through the fringe field. i_f is the current in the external circuit due to this rearrangement of charge.

$$i_f = + \frac{|I_0|}{dv_0} x \frac{dz}{dt} = + \frac{|I_0|}{d} x. \quad (101)$$

The fringe effects on *entering* the space between the parallel planes are negligible, for the electrons are assumed to enter at $x=0$. From integration of (6)

$$x = + E_0 \frac{|e|}{m} \frac{\tau}{2\omega_c \theta} (e^{i\theta} - 1) e^{i\omega t}. \quad (102)$$

If

$$i_f = I_f e^{i\omega t}$$

$$I_f = \frac{|I_0|}{2d} E_0 \frac{|e|}{m} \frac{\tau}{\omega_c \theta} (e^{i\theta} - 1).$$

The total current can be regarded as the sum of two parts, so that $I = I_1 + I_f$ where I_1 is given by (9).

$$I = \frac{|I_0|}{2d} E_0 \frac{|e|}{m} \frac{\tau^2}{\theta^2} \left[\frac{\omega_c - \omega}{\omega_c} (e^{i\theta} - 1) + (1 + i\theta - e^{i\theta}) \right]$$

Y_{ef} = over-all admittance including fringe-field effects.

$$Y_{ef} = \frac{L^2}{4d^2} \frac{|I_0|}{V_0} \left\{ \frac{1 - \cos \theta}{\theta^2} \left(1 - \frac{\omega_c - \omega}{\omega_c} \right) \right. \\ \left. \theta - (\sin \theta) \left(1 - \frac{\omega_c - \omega}{\omega_c} \right) \right\} + i \frac{\theta - (\sin \theta) \left(1 - \frac{\omega_c - \omega}{\omega_c} \right)}{\theta^2}. \quad (103)$$

It is clear from the above that, for small transit times through the fringe field, the contribution to the image currents from the fringe electrons is of the same order of magnitude of terms already neglected in this theory and should be neglected here.

A Frequency-Modulated Magnetron for Super-High Frequencies*

G. R. KILGORE†, SENIOR MEMBER, I.R.E., CARL I. SHULMAN†, SENIOR MEMBER, I.R.E., AND
J. KURSHAN†, MEMBER, I.R.E.

Summary—This paper is based on a wartime requirement for a 25-watt, 4000-megacycle continuous-wave oscillator capable of electronic frequency modulation with a deviation of at least 2.5 megacycles. A satisfactory solution was found in the addition of frequency control to a continuous-wave magnetron by the introduction of electron beams into the magnetron cavities in a manner described by Smith and Shulman.¹ This method is referred to as "spiral-beam" control.

* Decimal classification: R355.912.1. Original manuscript received by the Institute, July 2, 1946; revised manuscript received, September 16, 1946. Presented, 1947 I.R.E. National Convention, New York, N. Y., March 4, 1947. This paper is based to a large extent on work done for the United States Navy under Contract No. NXsa-35042.

† Radio Corporation of America, RCA Laboratories Division, Princeton, N. J.

¹ Lloyd P. Smith and Carl I. Shulman, "Frequency modulation and control by electron beams," *Proc. I.R.E.*, vol. 35, pp. 644-657; July, 1947.

A brief account is given of the method of designing a continuous-wave magnetron for the specified power and frequency. The problem of adding spiral-beam frequency control to this magnetron is considered in detail, and a procedure is presented for obtaining the optimum design consistent with negligible amplitude modulation and reasonable cathode-current densities. The unusual features of construction of this magnetron are described, including a method of mechanical tuning and the method of adding grid-controlled beams for frequency modulation.

Performance data on the continuous-wave magnetron over a wide range of operating conditions indicate that the required 25 watts output can be attained at 850 volts with 50 per cent efficiency. Experimental results on "spiral-beam" frequency control demonstrate that the required 2.5-megacycle frequency deviation with no amplitude modulation can be achieved by electron beams introduced into two out of twelve cavities. A deviation of 4 megacycles is attained under conditions allowing some amplitude modulation. Still greater deviation is predicted by using more beams.

I. INTRODUCTION

DURING the war it was one of the assignments of these Laboratories to explore the possibilities of frequency-modulation radar.¹ In one of the more advanced phases of this work a continuous-wave oscillator was required which would deliver 25 watts output at 4000 megacycles and be capable of electronic frequency modulation with a deviation of at least 2.5 megacycles.

A survey of possible types of oscillators indicated that the magnetron offered the best possibility of obtaining the required power at high efficiency and at low voltage. The design of a continuous-wave magnetron for the required power and frequency was readily evolved from early continuous-wave magnetron experience and from design information obtained from work on pulse magnetrons.

The method of electronic frequency control considered most promising was one suggested by L. P. Smith¹ wherein an electron beam moving in the direction of a constant magnetic field is introduced into a resonant cavity at right angles to the radio-frequency electric field. In an arrangement of this kind electrons travel in spiral paths through the cavity inducing reactive currents. For convenience this method will be referred to as "spiral-beam" control.

The modulating beam may be introduced directly into a magnetron cavity or into an external cavity. The problem at hand was solved by introducing the spiral-beam control into a continuous-wave magnetron already designed to meet the above requirements. It is with this problem that the present paper is mainly concerned, but for completeness a brief account is given of the design of the continuous-wave magnetron and a description of some of its unusual features of construction, including a mechanical tuning arrangement added for a later application.

II. DESIGN OF THE CONTINUOUS-WAVE MAGNETRON

With earlier experience on continuous-wave magnetrons, and with design data gained from pulse magnetrons, the problem of designing a 25-watt, 4000-megacycle tube was fairly straightforward, and the power requirement did not appear difficult to attain. Further requirements to be met were that the plate voltage be less than 1000 volts and that the magnet weight be kept small.

Instead of attempting to design a tube by scaling from a particular known magnetron, a first approach to a design was made on the basis of general experience on a variety of magnetrons of both continuous-wave and pulsed types.

In order to obtain the desired power output of 25 watts, a value of 800 volts was chosen for the anode potential. This was used in calculating the other tube parameters which are connected by the semiempirical

relations of J. C. Slater:²

$$\frac{V\lambda^2}{r_a^2} = \frac{30,200}{(N+4)^2} \left(\lambda H - \frac{21,200}{N} \right) \quad (1)$$

$$\frac{r_c}{r_a} = \frac{N-4}{N+4} \quad (2)$$

where operation in the π mode is assumed, V =anode voltage, r_a =anode radius in centimeters, λ =wavelength in centimeters, H =magnetic field in gauss, and N =number of anode segments.

The value $N=12$ was chosen as a compromise between low cathode-current density (N large) and ease of construction (N small). This value of N also allowed an adequate margin between the minimum magnetic field and the field required for spiral-beam modulation.³ A value of $\lambda H=12,000$ was chosen on the basis of experience on other twelve-segment magnetrons.

For a plate voltage of 800 volts, wavelength of 7.5 centimeters, and for $\lambda H=12,000$, the tube dimensions computed from the above equations are:

$$\begin{aligned} \text{anode diameter} &= 0.155 \text{ inch} \\ \text{cathode diameter} &= 0.0775 \text{ inch} \\ \text{anode length} &= 0.240 \text{ inch.} \end{aligned}$$

The plate current required for 25 watts output at 800 volts, assuming 50 per cent efficiency, is 0.062 ampere. The corresponding cathode-current density for a cathode the full length of the anode is 0.165 ampere per square centimeter. This value is considerably higher than common in commercial tube practice but was not considered excessive for the particular application at hand.

III. ADDITION OF SPIRAL-BEAM FREQUENCY MODULATION

A continuous-wave magnetron having been designed to meet specified power, voltage, and frequency requirements, there remained the problem of introducing proper electronic frequency control. The frequency-modulation requirements were as follows: (1) electronic frequency control with an over-all frequency swing of at least 5 megacycles with small amplitude modulation; (2) frequency deviation to be independent of load changes; (3) the control element to be an integral part of the tube. It was further recognized that a linear relationship between the frequency and the control variable would be a desirable feature.

Several schemes for electronic frequency control were considered. Spiral-beam modulation with grid control was decided upon because large frequency deviation could be obtained with no electronic loading, and the effect of output load changes could be minimized. The problem was then to examine the limiting factors in

² Unpublished work of J. C. Slater.

³ The minimum allowable λH varies inversely as N is found by combining the direct-current cutoff relation with equation (1).

applying spiral-beam modulation to the given magnetron in order to determine the optimum beam dimensions and operating conditions to obtain the required frequency deviation with no electronic loading.

A geometry for spiral-beam control which immediately suggested itself is shown in Fig. 1, where an electron beam of rectangular cross section, moving in the direction of the axial magnetic field, is introduced into the magnetron vane space beyond the outer strapping ring. Proceeding on this choice of geometry, the design problem became one of finding the beam voltage, beam current, and beam cross section that would give maximum frequency deviation consistent with no loading. The maximum frequency deviation is determined by two factors: (1) the maximum beam current limited by space charge in the vane space; and (2) the spiral size limited by the condition of grazing incidence at the vane walls.

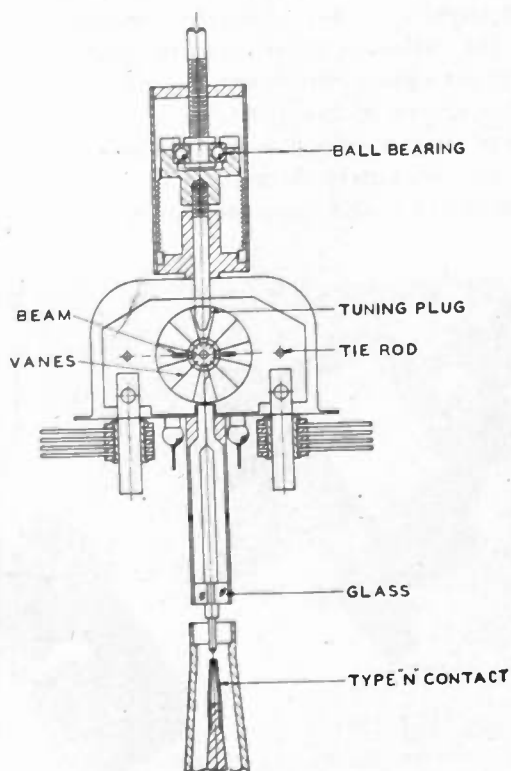

Fig. 1—Longitudinal cross section.

In the case of parallel planes, this maximum obtainable frequency change has already been calculated. By a judicious application of the parallel-plane results, it is possible to estimate the maximum frequency deviation obtainable with the magnetron shown in Fig. 1. The maximum obtainable frequency swing per beam for the equivalent parallel-plane geometry is given approximately by the expression¹

$$\left(\frac{\Delta f}{f}\right)_{\max} = \frac{2F}{9} \frac{V_0}{V_{ac}} \frac{C}{C_0} \quad (3)$$

where

V_0 = the beam voltage

V_{ac} = the peak radio-frequency voltage which determines the spiral size of the grazing electron (the voltage across the vanes at the point which is closest to the beam)

C/C_0 = the ratio of the capacitance subtended by the beam to the total effective capacitance of the oscillating system, or the ratio of the stored energy at the beam to the total stored energy in the system

F = a parameter depending on t/d , the ratio of beam thickness to the effective parallel-plate separation, varying between 2 at $t/d=1$ and 0.87 at $t/d=0$.

It is clear that, in order to design the frequency-modulation structure, an accurate knowledge of the radio-frequency field magnitude and distribution is essential. The peak radio-frequency voltage across the vane tips was computed from bandwidth measurements and an estimate of the total effective capacitance of the oscillating system. At a power output level of 25 watts, this peak radio-frequency voltage was about 350 volts. With the beam placed beyond the outer strapping rings as shown in Fig. 1, the best possible value of C/C_0 was estimated to be about 0.02.⁴ This value was obtained from a theoretical calculation of the field distribution in the cavities, and its smallness is attributable to the rapid decrease in radio-frequency field strength with distance from the center.

Since the parameter F is a slowly varying function in the vicinity of unity, it was set equal to unity for a first approximation. The maximum attainable frequency deviation per beam at a frequency of 4000 megacycles and power output level of 25 watts was given approximately as

$$\begin{aligned} (\Delta f)_{\max} &= \frac{2}{9} \frac{V_0(0.02)}{350\alpha(r)} \times 4000 \\ &= \frac{0.05V_0}{\alpha(r)} \text{ megacycles per beam} \end{aligned} \quad (4)$$

where $\alpha(r)$ is a geometrical factor relating the radio-frequency field which determines the spiral size of the grazing electron to the radio-frequency field at the vane tips. In this application $\alpha(r)$ was approximately 0.8.

$$\text{Total } (\Delta f)_{\max} = 0.06V_0n \text{ megacycles} \quad (5)$$

where n is the number of beams.

The beam currents necessary to obtain the required frequency deviation with no loading was computed from the equation relating frequency deviation to beam

⁴ In order to evaluate C/C_0 , a beam width must be chosen. In this application the beam width was arbitrarily taken as 3 millimeters, for it would be pointless to run the beam all the way to the back of the cavities where the radio-frequency field strength falls off rapidly with distance from the center.

current and voltage, developed on the basis of a parallel-plane structure.¹ This expression takes the form

$$\Delta f(\theta) = \frac{n}{16\pi} \frac{L^2 I_0}{d^2 V_0 C_0} \frac{10^{-6} \sin \theta - \theta}{\theta^2} \text{ megacycles, } (6)$$

while a measure of the electronic loading is given by the expression for conductance

$$G_e = n \frac{L^2 I_0 (1 - \cos \theta)}{4d^2 V_0 \theta^2} \text{ mhos } (7)$$

where

- L = axial length of the magnetron
- d = effective spacing between vanes
- I_0 = current per beam in amperes
- V_0 = beam voltage in volts
- C_0 = total effective capacitance of the system in farads
- $\theta = (\omega_c - \omega_0)\tau$

$$\omega_c = \frac{He}{m}, \quad \tau = \frac{L}{\sqrt{2V_0} \frac{e}{m}}$$

ω_0 = angular velocity corresponding to the tube frequency before the beam is introduced.

For this application $L/d=3$ and $C_0=2$ micromicrofarads.

Since it was required that the tube operate with no amplitude modulation, G_e had to be zero, which meant that the tube should be operated at $\theta=2\pi$. Hence,

$$\Delta f(2\pi) = 1.5 \frac{I_0}{V_0} n \times 10^4 \text{ megacycles. } (8)$$

Equations (6), (7), and (8) are not complete in that space-charge effects have not been included. However, it is necessary only to add that I_0 cannot exceed the maximum value which the vane space will support at a particular value of V_0 . Since (5) was derived on the basis of space-charge limitation of beam current and no loading, the space-charge condition may be included by merely requiring that $(I_0)_{\max}$ be that value of beam current for which

$$\Delta f(2\pi) = (\Delta f)_{\max}$$

or

$$\begin{aligned} n 1.5 \frac{(I_0)_{\max}}{V_0} \times 10^4 &= 0.06 V_0 n \\ (I_0)_{\max} &= 4 \times 10^{-6} V_0^2 \\ (I_0)_{\max} &= 1.1 \times 10^{-3} \frac{(\Delta f)_{\max}^2}{n^2} \end{aligned} \quad (9)$$

where

$(\Delta f)_{\max}$ is in megacycles.

Thus, to obtain the required 5-megacycle frequency

change with one beam, a beam current of 28 milliamperes at 100 volts would be needed.

The only remaining factors to be determined were the beam thickness and location. In the case of the tapered cavity, moving the beam toward the vane tips increases the effectiveness of the electrons but causes the electrons to be more readily captured by the vane walls. Reducing beam width tends to avoid capture but increases current density. A compromise of these factors led to the choice of a 0.025-inch beam width and 0.025-inch separation between the beam edge and outer strapping ring. The cathode area for the beam was then 0.02 square centimeters.

For one beam, where it was shown that 28 milliamperes would be necessary to obtain the required deviation, the cathode-current density would have to be 1.4 amperes per square centimeter, a value much higher than considered practical. Referring to (9) it is seen that, for a given deviation, the current density decreases rapidly with the number of beams. For two beams the cathode-current density would be only 0.35 amperes per square centimeter, a more reasonable value. With the choice of two beams, the required frequency change of 5 megacycles may be obtained at a beam voltage of approximately 50 volts and a beam current of approximately 7 milliamperes (14 milliamperes total).

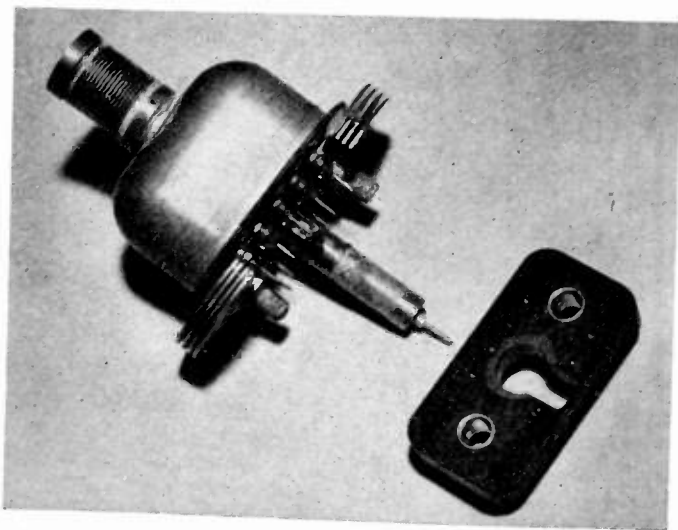

Fig. 2—Magnetron and socket. The external tuning mechanism has been removed.

In all the considerations so far it has been required that there be no amplitude modulation. However, in cases where amplitude-modulation requirements are not severe it is possible to obtain much larger frequency deviation than in the case for no loading. In fact, it appears that Δf at $\theta=\pi$ is twice Δf at $\theta=2\pi$, and might be an attractive condition of operation. However, if the design were adjusted so that no electrons were caught by the vane walls at $\theta=2\pi$, operation at $\theta=\pi$ would result in some being caught, and $\Delta f(\pi)$ would be not quite

$2\Delta f(2\pi)$ but nevertheless would be greater than $\Delta f(2\pi)$, and could be used as a practical condition of operation.

IV. CONSTRUCTION

Fig. 1 is a longitudinal cross-section drawing of the tube and the coaxial circuit into which it plugs. This should be compared with Fig. 2, which is a photograph of the tube and its special socket. Fig. 3 is a horizontal cross section through the axis of the cathode.

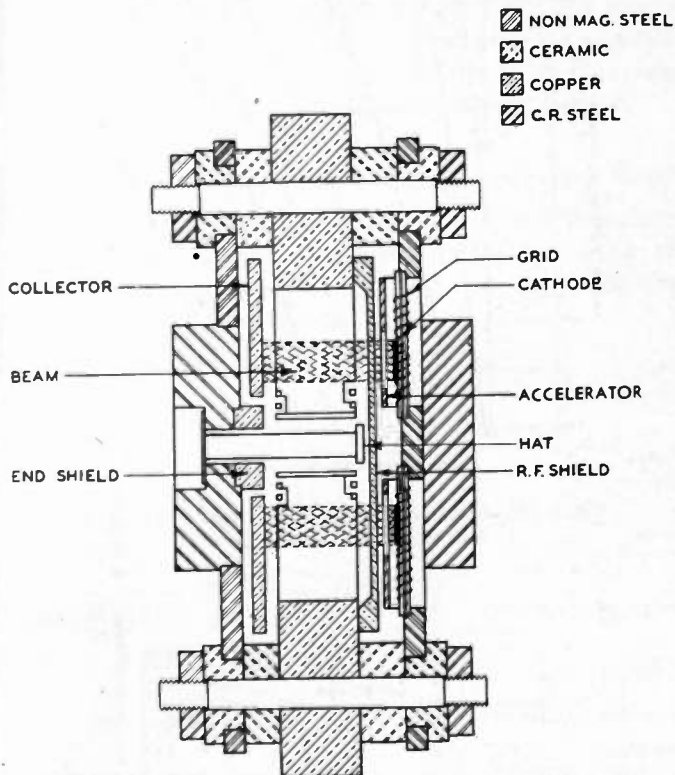

Fig. 3—Cross section through the cathode and parallel to the header. The main header is not shown. It is a double helix wound non-inductively to prevent modulation by its alternating magnetic field.

The Header Assembly

Header construction is used on this tube; that is, the leads and support posts are all located on one plate (the header) and, as a final operation, the envelope is slipped over the assembled structure and sealed to the header. This type of construction differs from conventional magnetron practice wherein the cathode (and tuner, if any) are ordinarily supported by the magnetic inserts which become part of the vacuum envelope. In the present design there is maximum accessibility to all parts until the envelope is sealed on. The tube can be cut open and rewelded several times. This is important in experimental apparatus since it allows repairs and changes to be made with a minimum of delay and waste. Monel is used for the header and the envelope. Although monel is slightly magnetic, its effect on the field in the interaction space is insignificant. This metal is relatively easy to work; it provides a good vacuum envelope, and, most

important, it can be brazed in a line-hydrogen furnace.

To simplify the problem of connections, the tube plugs into a nine-contact socket. The anode is grounded to the envelope which provides another connection. It will be noticed that the inner conductor of the output coaxial line is undercut at the point of glassing so as to preserve a uniform characteristic impedance. The external circuit is designed for a smooth fit onto this line and uses a standard type-N contact on its inner conductor. The copper posts which hold the anode block are also used to conduct heat to the copper cooling fins. Forced air cooling is used on these. The main seal between the header and the flange of the "bathtub" envelope is made by atomic-hydrogen welding.⁶

The Frequency-Modulation Gun Assembly

This magnetron mounts two electron guns for frequency modulation (Fig. 4). Construction of the guns

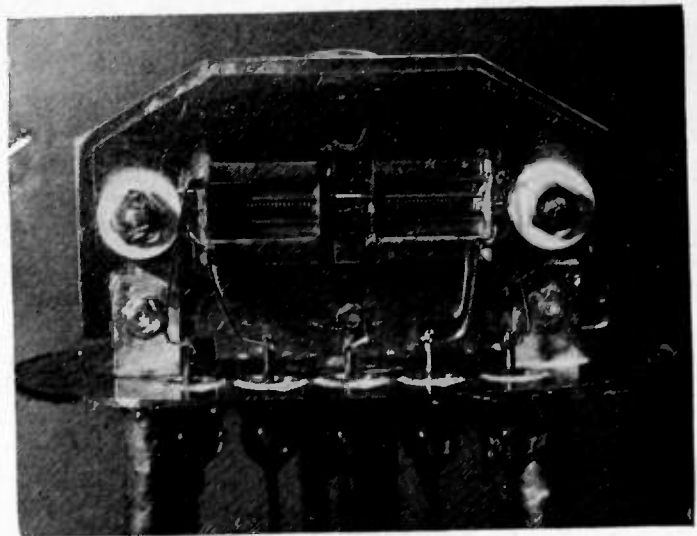

Fig. 4—Electron-gun side of the magnetron with envelope and magnetic button removed.

follows standard receiver-tube techniques and the parts were modified from the 6AK5, a close-spaced pentode. Instead of the conventional triode plate there is an accelerator with a rectangular aperture which permits passage of the beam to the anode cavity. To reduce the useless current going directly to the accelerator, the gun cathodes are sprayed over an area smaller than the apertures. After going through a cavity, the electrons hit the collector. A radio-frequency shield, necessary to keep radio frequency off the gun elements, completely covers the gun side of the anode except for two apertures through which the electrons are beamed.

The magnetic buttons shorten the effective gap between the poles of the external magnet. In addition, they shape the magnetic field in the electron interaction

⁶ Earlier applications of the header-bathtub construction to magnetrons were in the 2J41 and its predecessors, developed in these Laboratories.

spaces, insuring its direction and uniformity independent of small variations in the location of the magnet. Because of the requirements of the electron beams, the magnetic field must extend over a much larger area than the unmodulated magnetron would require. Moreover, one is restrained from shaping the magnetic field by tapering the magnetic buttons.

The Tuner

It was desired to add a 2 per cent tuning range to the original untuned magnetron. This is accomplished by moving a copper plug in and out of the topmost cavity. A screw and ball-bearing device vary the plug position and this motion is transmitted through the vacuum envelope with the help of a metal bellows. In Fig. 2 some of the gear has been removed to show the bellows.

V. PERFORMANCE

Continuous-Wave Magnetron Performance

A typical performance chart is shown in Fig. 5. It is seen that the efficiency reaches a maximum of 50 per cent in the vicinity of 850 volts and 120 milliamperes and that as much as 50 watts output is obtainable. Typical operating values are 850 volts, 80 milliamperes, at which the efficiency is still very high. The magnetic fields are the values that would be measured inside the tube.

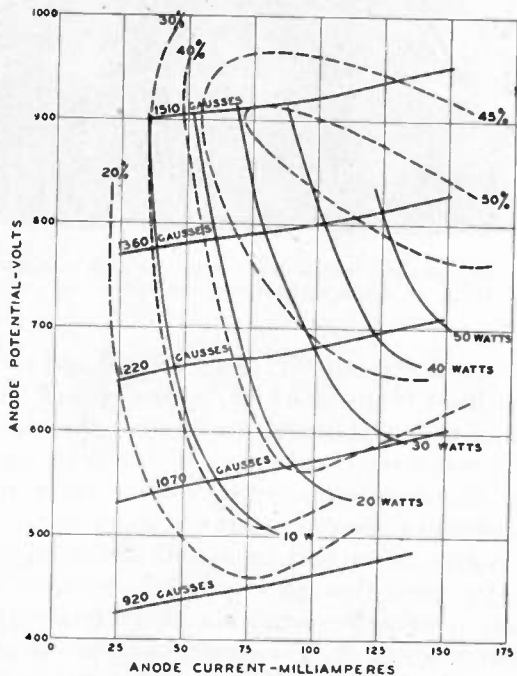

Fig. 5—Performance chart taken at matched load and showing contours of constant magnetic field, power output, and efficiency.

When the problem of frequency modulation first arose, it was hoped that plate-current modulation would furnish a simple solution, but preliminary measurements indicated that this method is unsatisfactory. The “pushing” (change in frequency per unit change in plate current)

depends on the load impedance, and even for a constant, matched load, there is considerable variation from tube to tube. Pushing characteristics for a particular tube are plotted in Fig. 6. This family of curves shows that the modulation would be very nonlinear. Taking 0.1 mega-

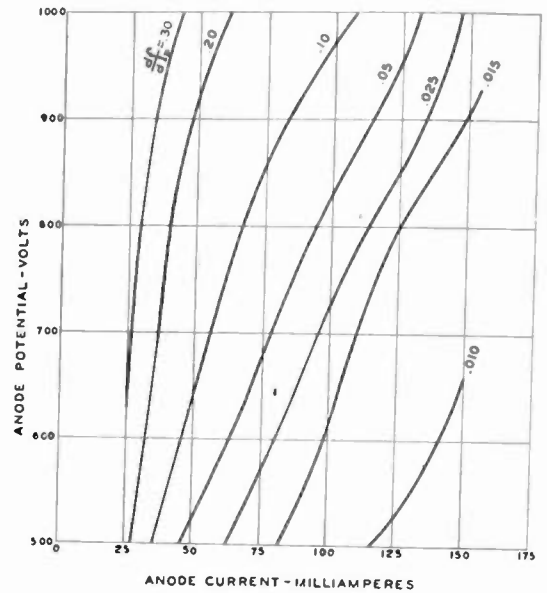

Fig. 6—Pushing curve at matched load. df/dI_p is in megacycles per milliampere.

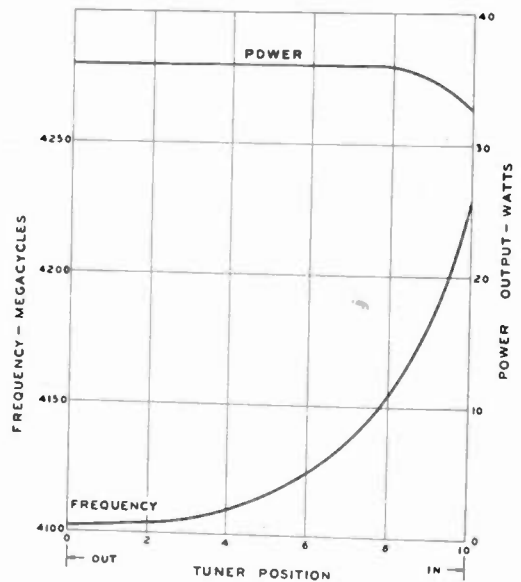

Fig. 7—Tuning curves taken at matched load. “Out” and “in” refer to position of tuning plug in the cavity.

cycle per milliampere as a mean value for df/dI_p , a variation from 50 to 100 milliamperes in plate current would yield a total frequency shift of 5 megacycles. However, Fig. 5 shows that this would be accompanied by a power output change of about 3 to 1. Another latent

difficulty lies in the large plate-current swing required. While instabilities in general were not a source of trouble, any given tube is liable to have isolated regions of unstable operation. There is a good chance of sweeping through one of these when the plate current is varied 100 per cent.

The "pulling" figure (frequency change when the phase of the load impedance is varied with its voltage standing-wave ratio kept at 1.5) averages to 10 megacycles for a number of tubes.

Fig. 7 shows the tuning characteristics of the magnetron. The total frequency range obtainable varies among tubes, but a 2 per cent tuning range is about average, with less than 2 per cent change in power output.

Experimental Results on Spiral-Beam Frequency Control

Measurements on the frequency-modulation performance of the two-beam magnetrons described in this paper are summarized in Figs. 8, 9, and 10, which show

difference between measured and calculated values is easily attributable to errors in estimating the total equivalent capacitance of the system. For values of ω_c/ω_0 where the loading is not zero, larger frequency

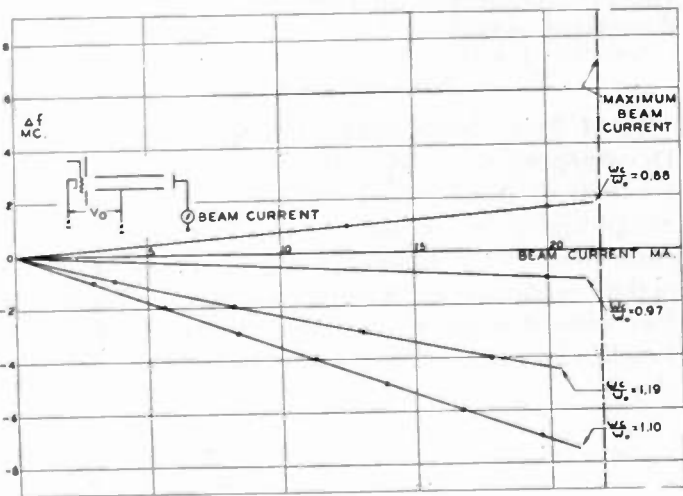

Fig. 8—Frequency shift versus beam current for various values of $\omega_c/\omega_0 = He/m\omega_0$. Beam current is varied by grid voltage.

typical behavior of the tubes tested. Few tubes departed materially from the characteristics shown. All the curves were taken at a beam voltage of 80 volts and at a power output level of 25 watts into an approximately matched load. Changes in load had little effect on frequency-modulation performance when the voltage-standing-wave ratio was kept less than 1.5.

Fig. 8 shows frequency shift plotted as a function of beam current for various values of ω_c/ω_0 , the ratio of the cyclotron angular frequency, He/m , to the tube angular frequency, while Fig. 9 shows power output as a function of beam current for various values of the same parameter ω_c/ω_0 . Fig. 10 summarizes the effect of the variation of the parameter ω_c/ω_0 on frequency shift and power output. It is seen that a beam voltage of 80 volts, instead of the calculated 50 volts, was necessary to obtain the required deviation with no loading. This

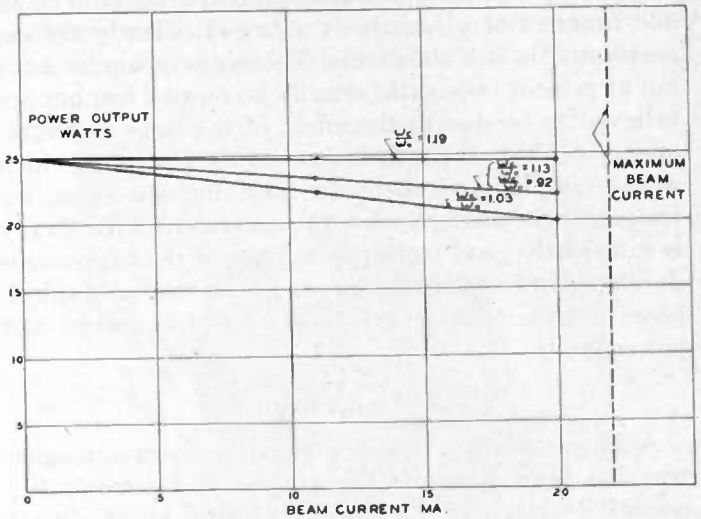

Fig. 9—Power output versus beam current for various values of ω_c/ω_0 where $\omega_c = (e/m)H$.

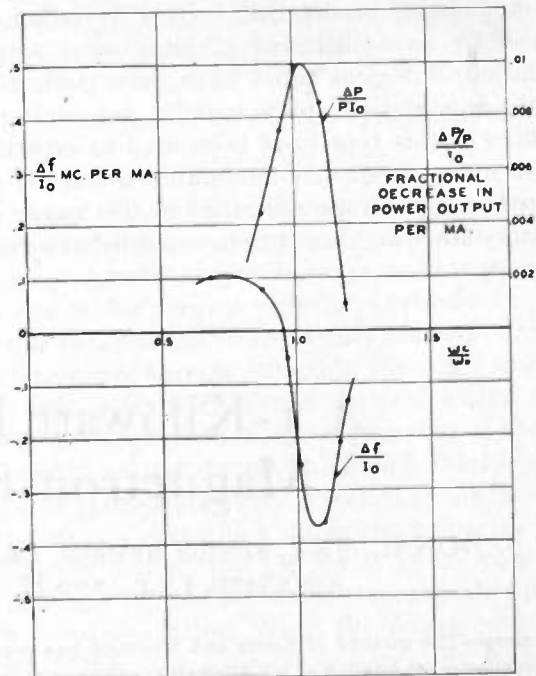

Fig. 10—Frequency shift and fractional change in power output per milliamper of beam current versus $He/m\omega_0$.

deviations were obtained with a maximum frequency change of 8 megacycles with 20 per cent loading ($\Delta P/P = 0.2$). It is interesting to note that the frequency deviation is fairly linear with beam current over a range of operating conditions.

Although the general over-all performance of the frequency-modulation system compares qualitatively with theory, anomalous dissymmetries, which did not show

up in earlier low-level measurements, have appeared. Maximum loading and zero frequency deviation should both occur at $\omega_c/\omega_0 = 1$, that is, when the tube frequency is equal to the cyclotron frequency of rotation of the electrons. Furthermore, from theory, the frequency deviation per milliampere of beam current should be an odd function of ω_c/ω_0 about $\omega_c/\omega_0 = 1$. Clearly the experiments do not show this. These discrepancies have not at present been satisfactorily accounted for, but are believed to be due to the effect of the large radio-frequency fields on the transit times of the electrons, which would not, in general, be an odd function of ω_c/ω_0 . Despite these discrepancies, the agreement with theory is sufficiently good to justify the use of the expressions developed in Section III for preliminary design of spiral-beam modulated magnetrons at other frequencies and power levels.

VI. CONCLUSIONS

A 25-watt, 4000-megacycle continuous-wave magnetron has been developed capable of an electronic frequency deviation of 2.5 megacycles with no amplitude modulation. Frequency modulation is accomplished by using electron beams in two out of twelve magnetron cavities. Greater deviation can be expected by using more modulating beams. Still further deviation can be obtained by an adjustment allowing some amplitude modulation. Sufficient tubes have been made to show that the modulation characteristics are reproducible, and tubes of this type have been used in experimental tests, including frequency-modulation radar. It should be noted that the tube described in this paper is in a laboratory stage and is not to be regarded as a commercial design.

At higher frequencies the mechanical difficulties in putting a beam through the magnetron cavities increase. At some point it may be more desirable to utilize spiral-beam modulation in a separate cavity coupled to the magnetron cavities.

Probably a more important result of this work than the actual tube is the clear demonstration that magnetron oscillators can be satisfactorily frequency-modulated. For a number of years the magnetron has been recognized as the most efficient generator of power at super-high frequencies, but so far its application has been severely restricted because of modulation difficulties. The wartime use of the magnetron as a pulse-modulated oscillator has made the magnetron more popular, but it is still generally regarded as a device of very limited use. Now, with the addition of frequency modulation, the magnetron should find other fields of application such as frequency-modulation radio relay, television transmission, and the like. The frequency-modulated magnetron makes possible the use of super-high-frequency systems requiring power levels of the order of one hundred times that obtainable from other present-day frequency-modulated oscillators.

ACKNOWLEDGMENTS

K. M. McLaughlin and his associates of the Harrison Development Shop, RCA Victor Division, Radio Corporation of America, contributed to the mechanical design and construction of the frequency-modulation guns. Margaret S. Heagy, of these Laboratories, aided in the mechanical design and measurements. The writers also wish to acknowledge the contributions of Rohn Truell, who was associated with this project in its earlier phases.

A 1-Kilowatt Frequency-Modulated Magnetron for 900 Megacycles*

J. S. DONAL, JR.†, SENIOR MEMBER, I.R.E., R. R. BUSH†, ASSOCIATE, I.R.E., C. L. CUCCIA†, ASSOCIATE, I.R.E., AND H. R. HEGBAR†, SENIOR MEMBER, I.R.E.

Summary—The method of Smith and Shulman has been used for the frequency modulation of a 1-kilowatt continuous-wave magnetron. This tube is of the "vane" type, having twelve resonant cavities, and it is mechanically tunable over a range from about 720 to 900 megacycles by a cylindrical element which varies the interstrap capacitance. At the applied magnetic field required for frequency modulation without change in amplitude, 1 kilowatt output at 900

megacycles is obtained with an anode voltage of 2.5 kilovolts and an efficiency of about 55 per cent; the efficiency rises with decreasing frequency or with increasing magnetic field.

At 900 megacycles, electron beams in nine of the magnetron resonant cavities give a frequency deviation of 3.5 megacycles (a total frequency swing of 7 megacycles) at an output of 1 kilowatt, rising to 4 megacycles at an output of 750 watts. The frequency deviation is reduced when the tube is tuned to lower frequencies. The modulator power required would be very low, since the grid-cathode capacitance of the frequency-modulation guns is small and the grids draw no current.

It would be practicable to increase the frequency deviation of this tube by about 15 per cent through an increase in beam current, and by an additional 20 per cent through the use of eleven beams. A change in the type of beam cathode would effect an even greater deviation.

* Decimal classification: R355.912.1×R583.6. Original manuscript received by the Institute, July 21, 1946; revised manuscript received, September 9, 1946. Presented, 1947 I.R.E. National Convention, March 4, 1947, New York, N. Y.

† This paper is based in part on work done for the Office of Scientific Research and Development under sub-Contract No. DIC-183677 of OSRD prime Contract No. OEMsr-262 with the Massachusetts Institute of Technology.

† RCA Laboratories Division, Radio Corporation of America, Princeton, N. J.

I. MAGNETRON DESIGN

SMITH and Shulman¹ have described a means for electronic frequency modulation and control. The method has been applied by Kilgore, Shulman, and Kurshan² to the frequency modulation of a magnetron oscillator. This paper describes a 900-megacycle magnetron of 1 kilowatt output for experimental use in the transmission of high-definition, frequency-modulated television pictures. A frequency deviation of at least 4.5 megacycles was desired.

It is known from the general theory of frequency modulation that the magnetic field required at 900 megacycles is limited to about 400 gauss for reasonable values of electron-transit time. A magnetic field H of 400 gauss corresponds to values of λH in the neighborhood of 14,000 (for the frequency range from 840 to 900 megacycles) and experience indicates that twelve-cavity tubes operate with satisfactory efficiency under this condition. Cavities bounded by vanes were chosen for this tube. Considering the smaller total tube capacitance of the vane-type structure, it was estimated that the frequency modulation would be at least 75 per cent of that obtainable with any other type of cavity with comparable strapping.

A twelve-cavity vane-type structure having been chosen, the tube was scaled from a 9400-megacycle pulsed magnetron developed in these Laboratories. Assuming a magnetic field of 400 gauss and an output of 1 kilowatt at 50 per cent efficiency, the scaling procedure³ yielded the dimensions and values of current and voltage given in Table I. The cathode diameter of the

TABLE I

DIMENSIONS, CURRENT, AND VOLTAGE OF THE SCALED 900-MEGACYCLE MAGNETRON MODIFIED BY STRUCTURAL AND OPERATIONAL REQUIREMENTS

Anode diameter	1.25 inches
Anode length	2.00 inches
Vane thickness	3/16 inch
Vane height (axial direction)	2 inches
Vane length (radial direction)	1.84 inches
Height of strapping rings	7/32 inch
Thickness of strapping rings	0.020 inch
Cathode diameter	0.625 inch
Coated cathode length	1.33 inches
Cathode area (oxide coated)	17 square centimeters
Predicted current density	0.040 ampere per square centimeter
Total current, approximate	0.65 ampere
Anode voltage	3000 volts

900-megacycle tube was made equal to half of the anode diameter in order to satisfy the relation⁴

$$\frac{\text{cathode diameter}}{\text{anode diameter}} = \frac{(1 - 4/N)}{(1 + 4/N)}$$

where N is the number of cavities.

The basic anode-envelope structure is shown in Fig. 1. Since the tube was to be tuned by a change in strap capacitance, strapping was at one end only, in order to afford the maximum capacitance variation by a single

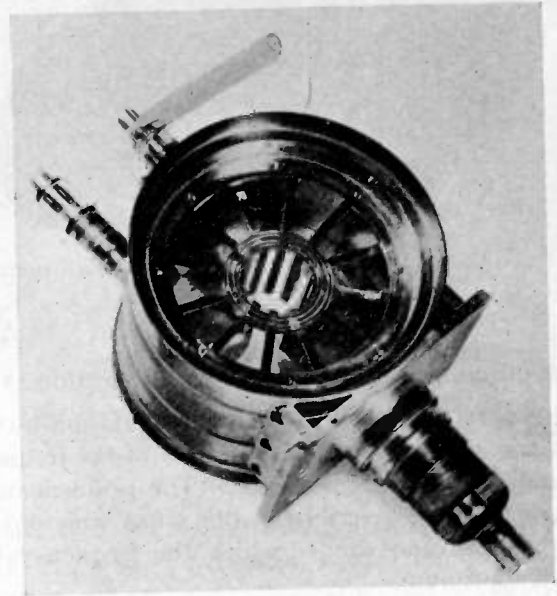

Fig. 1—Anode-envelope assembly after attachment of seals.

tuning element. To increase further the capacitance variation, each of the two ring straps was subdivided into two rings soldered to the same vanes, so that the tuning member could be divided into three cylinders entering the spaces between the straps simultaneously. Channels for cooling water were machined in the outer surface of the envelope. They were covered with cylindrical bands, visible in the illustration. Rings for support of the cathode assembly and of the plates bearing the frequency-modulation components were attached to the inner wall of the envelope about $\frac{1}{4}$ inch above and below the vanes.

The heater power was 150 watts at 25 volts for a cathode temperature of 800 degrees centigrade when the tube was not oscillating. When the power output was 1 kilowatt, the same cathode temperature was maintained when the heater power was reduced to about 75 watts. The tube could be placed in oscillation at the latter value without damage.

The triple cylinder shown in Fig. 2 was introduced between the divided straps (Fig. 1) with clearances of 0.020 inch. This cylindrical tuner was made movable, from outside the tube, by mounting it on a stud extending through a diaphragm in the lid. A large gear (see Fig. 2) was attached to the rotating assembly to permit slow movement of the tuner by a crank and worm gear mounted on the envelope. The tube frequency was approximately 900 megacycles with the tuning element

¹ L. P. Smith and C. I. Shulman, "Frequency modulation and control by electron beams," *Proc. I.R.E.*, vol. 35, pp. 644-657; July, 1946.

² G. R. Kilgore, C. I. Shulman, and J. Kurshan, "A frequency-modulated magnetron for super-high frequencies," *Proc. I.R.E.*, vol. 35, pp. 657-664; July, 1946.

³ S. T. Martin, unpublished work, April, 1942.

⁴ J. C. Slater, unpublished work.

withdrawn a short distance outside the straps. The frequency change was proportional to the motion of the cylinder, with the minimum frequency 720 megacycles or lower.

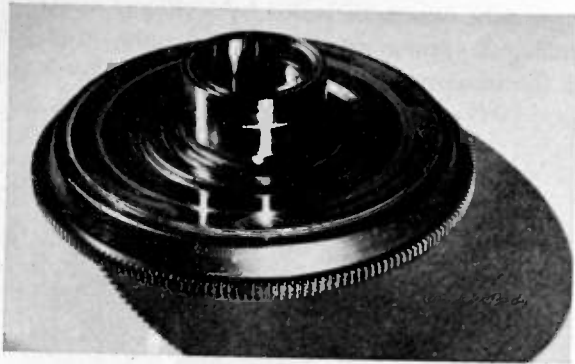

Fig. 2—Triple-cylinder tuning element mounted on a diaphragm forming a portion of the tube lid.

II. FREQUENCY-MODULATION DESIGN CONSIDERATIONS

The general theory of frequency modulation by electron beams permits the determination of the frequency shift under particular conditions. The problem in the design of the tube described in this paper was to determine the conditions under which the frequency shift would be optimum.

In the case of parallel planes, the equations for frequency shift, spiral deflection, space-charge-limited current, etc., are known,¹ but the derivation of these equations assumes that the radio-frequency voltage between the plates is constant along their length. When applied to a magnetron cavity in which the separation of the plates as well as the radio-frequency voltage vary, the equations for the parallel-plane case will clearly give only a rather rough approximation. However, since an exact solution of the problem of a tapered cavity is extremely complicated, the parallel-plane equations were used, with average values of the variable parameters substituted for the constant values.

The frequency swing is given by¹

$$\Delta f = \frac{e}{m} \frac{J_0}{2L} \left(\frac{C}{C_0} \right) \left(\frac{t}{d} \right)^2 \frac{\sin \theta - \theta}{\theta^2}, \quad (1)$$

where (in centimeter-gram-second electrostatic units) J_0 is the cathode-current density, L is the length of the plates in the direction of the magnetic field, C is the interplate capacitance in the region of the beam, C_0 is the total effective tube capacitance, t is the cathode width, d is the separation of the plates, τ is the transit time of the beam, and θ is defined by

$$\theta = \left(H \frac{e}{m} - \omega_0 \right) \tau \quad (2)$$

in which H is the magnetic field strength and ω_0 is the

angular velocity corresponding to the tube frequency before the beam is introduced.

In choosing the parameter θ , not only frequency shift but loading, also, must be considered. It was shown¹ that when $\theta = 2\pi$ the theoretical loading is zero, and since calculations indicated that the loading would be excessive for values of θ much different from 2π , that value was chosen in the design of the present tube.

The current density J_0 is limited by cathode life, and C/C_0 is determined primarily by the geometry, but the quantities τ , t/d , and L in (1) may be chosen such that Δf will be a maximum.

In order for there to be no loading, the maximum spiral deflection must be such that the electrons are not captured by the walls. This limits the transit time τ , as may be seen by equating the maximum spiral deflection¹ to the distance between the edge of the cathode and the cavity walls:

$$|x|_{\max} = \frac{V_{ac}\tau^2}{H\theta d} = \frac{1}{2}(d-t), \quad (3)$$

where V_{ac} is the radio-frequency voltage between the plates.

The magnetic field is a function of τ , from (2). Solving (2) for H gives

$$H = \frac{2\pi}{e/m} \left(\frac{1}{\tau} + f \right) \quad (2a)$$

for the case when $\theta = 2\pi$. It is seen that for large τ , desired to increase Δf in (1), H is determined largely by the tube frequency f . If H is considered to be independent of τ , the maximum τ is determined by (3). When (3) is solved for τ and the result is inserted in (1), we have

$$\Delta f = \frac{e}{m} \frac{J_0 H^2 \theta^2}{8V_{ac}^2 L} \left(\frac{C}{C_0} \right) \frac{\sin \theta - \theta}{\theta^2} d^4 [(1-t/d)^2 t/d]. \quad (4)$$

The expression in brackets has a maximum value of $4/27$ for $t/d = 1/3$. Substituting $t/d = 1/3$ (and $\theta = 2\pi$) in (4) gives, for the maximum value of Δf with respect to t/d ,

$$\Delta f = \frac{\pi}{27} \frac{e}{m} \frac{J_0 H^2}{V_{ac}^2 L} \left(\frac{C}{C_0} \right) d^4. \quad (4a)$$

The value of d was determined within narrow limits by the shape of the cavities, already chosen, and the values of V_{ac} by the magnetron power and loaded Q . The value of L also was determined, since the transit time was limited by (3), and the beam voltage by the space-charge relation^{1,5}

$$(J_0)_{\max} = \frac{4}{9\pi} \sqrt{2} \frac{e}{m} \frac{V_0^{3/2}}{d^2} \frac{F_{\max}}{t/d} \quad (5)$$

which must be satisfied if the beam-current density is to be equal to maximum cathode-current density.

⁵ A. V. Haefl, "Space-charge effects in electron beams," *Proc. I.R.E.*, vol. 27, pp. 586-602; September, 1939.

As a result the design was completely determined, except for the shape and position of the beam which would affect the ratio C/C_0 . From an exact solution of the problem, an optimum shape of cathode, probably a trapezoidal one with increasing width in the back of the cavity, could have been determined such that Δf would have been a maximum. It is obvious that a cathode which extends from the vane tips to the back wall of the cavity would produce a greater Δf than one which does not extend to the back wall. However, since the spacing d becomes large in the back of the cavity, it is seen from (5) that the current density becomes small at a beam voltage low enough to keep the current from the front portion of the cathode within safe limits. This consideration, along with the fact that the capacitance C per unit length in (1) and (4) becomes small, results in a rapid decrease in the additional Δf obtained by extending the cathode farther back. The capacitance is greatest near the vane tips, however, and the beam should be extended to a point as near that end of the cavity as possible. It was felt that any advantage in using a trapezoidal cathode rather than a rectangular one did not justify the mechanical complexities involved. Clearly, the choice of cathode size and shape was a compromise between frequency shift on the one hand and economy and ease of construction on the other.

In the tube herein described, a rectangular cathode of 0.59-inch length was used. The width t was made 0.125 inch, which is about one-third of the average d along the cathode length. Because of life considerations for oxide-coated cathodes a maximum current density of 300 milliamperes per square centimeter was used, giving a current of 150 milliamperes per beam. Using the average d , the beam voltage V_0 was then calculated from (5) to be about 500 volts. After the radio-frequency voltage V_{oc} was calculated for the power and loaded Q of the magnetron, (2) and (3) permitted a calculation of H and τ , and thus of L since the beam voltage was known. The result was 400 gauss for H and about 2 inches for the vane height L .

Using the above values, the expected Δf was calculated from (1) and (3), giving about 1.0 megacycle per beam. The use of eight or ten beams was then expected to give the desired frequency swing of 9.0 megacycles.

The design of the electron guns for the beams followed the procedure used in the design of conventional receiving tubes, the magnetic field providing a portion of the focusing. A grid-cathode spacing of 0.005 inch and an amplification factor of 32 were used. At zero grid voltage the guns supplied the maximum current of 150 milliamperes; a bias of about -30 volts produced cutoff. A screen grid aligned with the control grid was used to prevent excessive currents to the sides of the aperture.

The plate shown in Fig. 3 supporting the guns, as well as the collector plate at the other end of the resonant cavities, were both placed about one-eighth inch from the ends of the vanes so that space-charge limitation would not exist in that region. Care was taken to

shield the various frequency-modulation components from the magnetron cavities. Since considerable heat was developed in both plates, they were rigidly attached to the shell of the tube in order to provide cooling. This

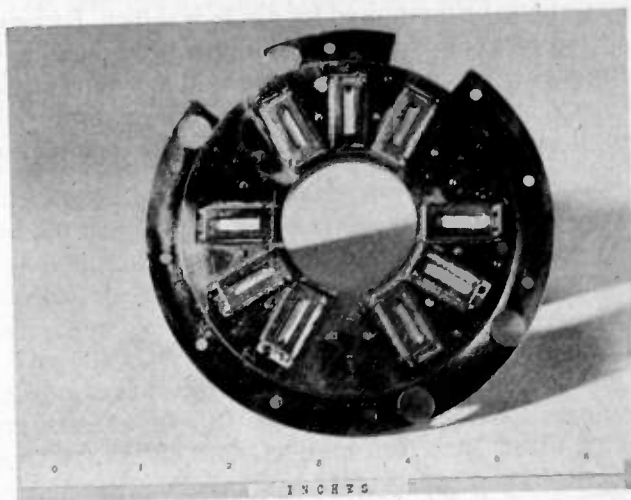

Fig. 3—View of the frequency-modulation guns, from the side facing the resonant cavities, after installation in their supporting plate.

required that the collector and accelerating electrodes be held at ground (magnetron-anode) potential, with the frequency-modulation cathodes held at a negative potential.

III. RESULTS

A typical performance chart, taken at 840 megacycles with a voltage-standing-wave ratio less than 1.05 in the 52-ohm line, is shown in Fig. 4. The "pushing"

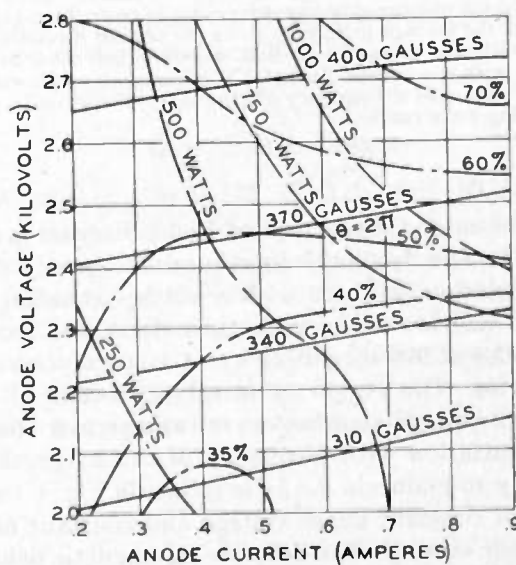

Fig. 4—Typical performance chart, taken at 840 megacycles, showing the power output and efficiency as functions of the anode current and voltage.

(frequency change with variation in anode current) was approximately 1 megacycle per 0.1 ampere at currents

above 0.3 ampere. As the tube was tuned over the range of about 180 megacycles, the general character of the performance chart maintained; i.e., at currents from about 0.5 ampere to at least 1 ampere, the efficiency, at constant magnetic field, rose with increasing current. The magnetic field required for $\theta = 2\pi$ is shown. By using a tapered magnetic field it would have been possible to realize higher magnetron magnetic field and thus higher efficiency, while still maintaining the correct field strength in the region of the frequency-modulation beams.

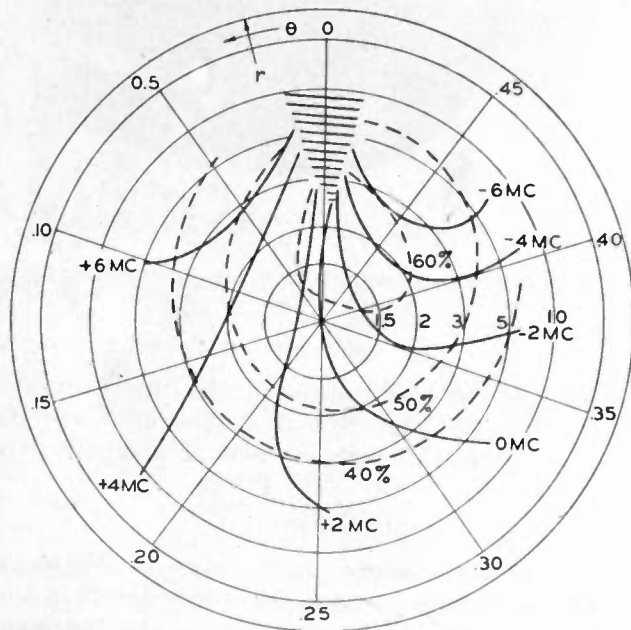

Fig. 5—Rieke diagram showing the frequency and efficiency as functions of the voltage-standing-wave ratio (r co-ordinate) and position of the voltage minimum along the coaxial transmission line (θ co-ordinate measured in half wavelengths). The data were taken with a magnetic field of 370 gauss, an anode current of 0.4 ampere, and a frequency of 840 megacycles at unity voltage-standing-wave ratio.

For the same tube, a typical Rieke diagram is shown in Fig. 5. The "pulling" (maximum frequency change for a variation in phase with a voltage-standing-wave ratio of 1.5) of the average tube decreased from 6.5 megacycles at 900 megacycles to 4.5 megacycles at 720 megacycles. The region of instability occurred in all cases at a voltage-standing-wave ratio greater than 2.5.

The variation with frequency of the magnetic field necessary to maintain $\theta = 2\pi$ is shown in Fig. 6 for conditions of constant beam voltage and constant magnetron anode current. The decrease in magnetic field with frequency resulted in a proportionate decrease in magnetron anode voltage. However, because of an increase in efficiency with decreasing frequency, the power output remained substantially constant for constant current. This variation of efficiency was not surprising, since, from (2a), λH is a linear function of λ for constant

θ , and a slight increase of efficiency with increasing λH was to be expected.

All of the tubes constructed and tested operated with a stable single-line spectrum above about 0.2 ampere in the range of voltage shown in Fig. 4, and over the entire

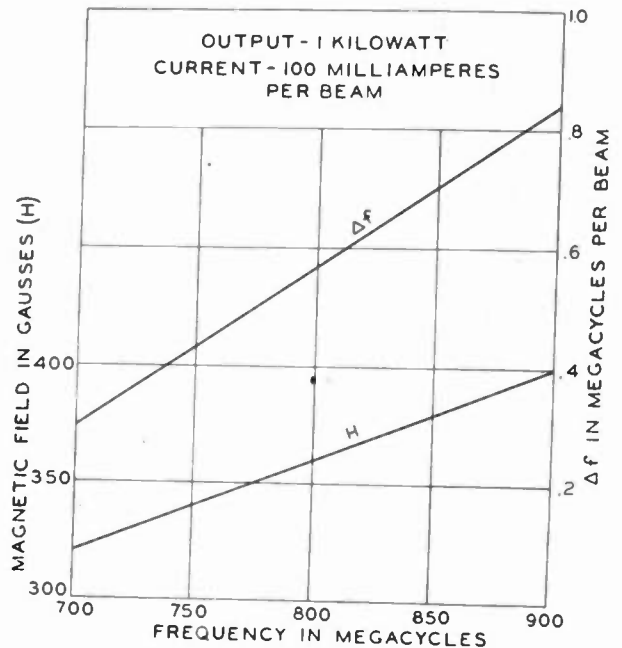

Fig. 6—Variation, at $\theta = 2\pi$, of the frequency deviation per beam and of the magnetic field, with changes in tube frequency.

tuning range of the tube. In one tube a "mode boundary" (a discontinuity in frequency and power) was observed at the low-frequency end of the tuning range when the voltage was very low.

In testing and operating the tubes, it was important to be able to set the magnetic field to the value required for a θ of 2π . This was accomplished as follows: a 5- to 10-kilocycle signal and a negative bias were applied to the grids of the frequency-modulation guns and the beam voltage was held at a constant value. The output of the tube was observed on a spectrum analyzer which provided a plot of amplitude versus frequency. The magnetic field was first adjusted for zero frequency modulation, denoting $\theta = 0$, and then for maximum frequency modulation, denoting $\theta = \pi$. An extrapolation from these two points then permitted determination of the magnetic field for $\theta = 2\pi$. As was expected, the frequency deviation at this point was about half of the deviation at $\theta = \pi$ and the loading was zero or very small.

At a beam current of 100 milliamperes and a beam voltage of 300 volts the frequency deviation was about 0.4 megacycle per beam for a power output of 1 kilowatt at frequencies between 850 and 900 megacycles. Two tubes, each with nine beams, gave deviations of about 3.5 megacycles under these conditions. At reduced power the frequency deviation was increased slightly. Thus, at an output of 750 watts the deviation

for the tubes with nine beams was 4 megacycles, corresponding to a swing of 8 megacycles.

As the tube was tuned to lower frequencies the frequency deviation decreased as shown in Fig. 6. The decrease in Δf with increasing power and with decreasing frequency was explained by the fact that the spiral deflection increased under either or both conditions, as may be seen from (3). This resulted in electrons being captured by the vanes, as was confirmed by the observation that the loading increased slightly. In the case of decreasing tube frequency, Δf was decreased, in addition, because the tube capacitance C_0 , which appears in the denominators of (1) and (4) increased. The decrease in Δf with tube frequency was not serious as regards the tuning requirement originally placed upon the tube, which was for a range of only 60 megacycles.

The necessity of maintaining $\theta = 2\pi$ as the tube is tuned requires a variable magnetic field. By using "trimming" coils on a permanent magnet or by using an electromagnet, this may be accomplished easily. A change of about 60 gauss over a 170-megacycle range is required. For a small tuning range, such as 30 megacycles, a constant H would result in a change of θ of only about $\pm 0.1\pi$, which would not produce appreciable loading, but Δf would be expected to vary by about 20 per cent. However, Δf could be maintained nearly constant and at the same time θ could be held at 2π by varying the beam voltage over about a 100-volt range, with the higher beam voltage at the lower frequency. Over an appreciably wider tuning range, variation of the beam voltage would not be feasible, since either the cathode-current density would be excessive at the low-frequency end of the range or the resulting Δf would be greatly reduced below the maximum obtainable at the high-frequency end.

With a negative bias of 15 volts, a grid swing of ± 15 volts peak was required to modulate the frequency-modulation beams. There was no grid current arising from secondary-emission effects. The variation of Δf with grid voltage was nearly linear in the tubes tested and the input capacitance of the tubes with beams in nine cavities was 80 micromicrofarads. If this capacitance were made part of a simple parallel tuned circuit in the output of a video modulator, a shunt resistance of 200 ohms would be required for a bandwidth of 10 megacycles. For the above grid swing the power absorbed would be less than 0.6 watt.

Two of the tubes were sine-wave modulated at frequencies from 1 to 10 megacycles. The observed spectra

were qualitatively in accordance with those predicted by theory.¹

IV. DISCUSSION

The maximum number of beams employed in the tubes constructed was nine, giving, in the 850- to 900-megacycle range, a total frequency deviation of about 3.5 megacycles at 1 kilowatt output and about 4.0 megacycles at 750 watts output. Since the deviation is proportional to the number of guns, the use of eleven guns would have increased the deviations to about 4.25 and 5.0 megacycles, respectively, at the above powers.

If simultaneous amplitude modulation had been permissible, the above deviations would have been approximately doubled.

These deviations were measured for currents of 100 milliamperes per beam, instead of the rated 150 milliamperes, to provide an additional factor of safety as regards cathode life. Operation at rated beam current would have increased the deviations about 15 per cent. With the use of a type of cathode and gun permitting substantially higher current densities it would be entirely practical to double, and possibly triple, the obtainable frequency deviations by increasing the beam voltage. The increase in magnetic field necessary to maintain $\theta = 2\pi$ would improve magnetron efficiency, in addition. For a given increase in cathode current density, the deviation would be increased still further by a change in the shape of the cavities.

For a moderate increase in frequency of the tube, to 1500 megacycles, as an example, it should be feasible to keep C/C_0 constant by maintaining the same relative capacitance in the region of the beams. For the same power output from the scaled tube, (24) of footnote reference 1 shows that the deviation would increase in proportion to the tube frequency.

V. ACKNOWLEDGMENTS

K. M. McLaughlin and W. C. Dale of the RCA Victor Division, Radio Corporation of America, were responsible for both the mechanical design and the construction of the frequency-modulation guns. Acknowledgment is made to G. B. Collins and L. F. Moose, formerly with the Radiation Laboratory at the Massachusetts Institute of Technology, for their co-operation in making many items of equipment available and in making possible independent tests of the tube.



Propagation Studies on 45.1, 474, and 2800 Megacycles Within and Beyond the Horizon*

GILBERT S. WICKIZER†, SENIOR MEMBER, I.R.E., AND ARTHUR M. BRAATEN†, SENIOR MEMBER, I.R.E.

Summary—Continuous recordings of field strength on 474 and 2800 megacycles, over a period of 13 months, revealed maximum values three to four times the free-space field at distances of 42.5 and 70.1 miles from the transmitting site atop the Empire State Building, New York City. Recordings on 45.1 megacycles during the same period, on a reduced schedule, did not exhibit the large variation found on the higher frequencies. Refraction was found to be greater in the summertime, the strongest periods occurring at night or in the early morning. Refraction greater than normal was not evident when the average wind velocity was above 13 miles per hour. A study of weather conditions during the periods of strongest refraction indicated that roughly 60 per cent of the gradients were of the frontal type, involving different air masses, and approximately 60 per cent of the gradients were higher than 100 feet above the earth's surface.

INTRODUCTION

PROPAGATION studies in the very-high-frequency region (30 to 300 megacycles) have been reported by a number of investigators. The effects of reflection, diffraction, and refraction were outlined in an early paper by Schelleng, Burrows, and Ferrell.¹ As the laws governing propagation within the horizon became better known, more interest was focussed on the subject of variations observed at greater distances. Burrows, Decino, and Hunt have reported on the stability and fading characteristics of 150 megacycles over a nonoptical path.² Analysis on a statistical basis and correlation with atmospheric conditions require continuous observations for extended periods to attain worth-while results. The relatively early work of Hull on this subject was a valuable contribution in explaining the nature of refraction and revealing the magnitude of its effects.³⁻⁵ Englund, Crawford, and Mumford suggested that seasonal variation in refraction was due to corresponding changes in water-vapor content of the air, and they were able to verify the existence of dielectric-constant gradients through frequency-

sweep methods.^{6,7} MacLean and Wickizer demonstrated that fading was random and increased with distance.⁸

The rapid extension of the frequency spectrum in the centimeter region as a result of wartime research opened up a new field for propagation studies. The application of new techniques permitted construction and operation of equipment at frequencies far above the range of previous propagation studies. Thus a need was suddenly created for information on the propagation of signals in the ultra- and super-high-frequency bands (300 to 30,000 megacycles). The present paper describes the re-

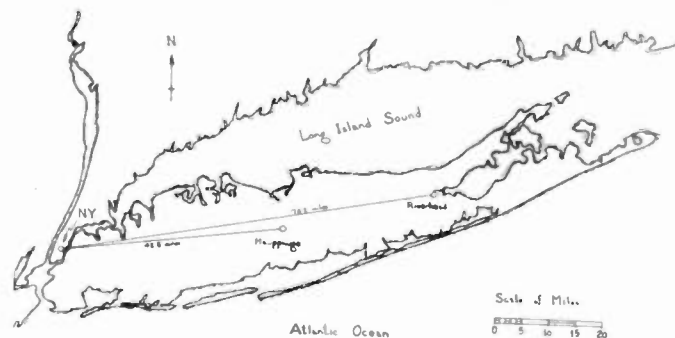

Fig. 1.—Map of Long Island, showing locale of measurements. Transmission paths from Empire State Building to receiving sites at Hauppauge and Riverhead are indicated.

sults of simultaneous field-strength measurements on 45.1, 474, and 2800 megacycles at two distant points, one of which was beyond the horizon. The more important meteorological factors influencing refraction in the lower atmosphere were studied.

PROPAGATION PATHS AND EQUIPMENT

Transmission Paths

The transmitters were located in the tower of the Empire State Building, New York City, and the receiving locations were at Hauppauge and Riverhead, Long Island, New York, 42.5 and 70.1 miles distant, respectively. The transmission paths are shown on the map in Fig. 1. The difference in azimuth between the

* Decimal classification: R113.501. Original manuscript received by the Institute, September 12, 1946. This paper is based on work done for the Office of Scientific Research and Development under Contract No. OEMsr-691. Presented, joint I.R.E.-U.R.S.I. meeting, Washington, D. C., May 2, 1946.

† Radio Corporation of America, RCA Laboratories, Riverhead, L. I., New York.

¹ J. C. Schelleng, C. R. Burrows, and E. B. Ferrell, "Ultra-short-wave propagation," *Proc. I.R.E.*, vol. 21, pp. 427-463; March, 1933.

² C. R. Burrows, A. Decino, and L. E. Hunt, "Stability of two-meter waves," *Proc. I.R.E.*, vol. 26, pp. 516-528; May, 1938.

³ R. A. Hull, "Air-mass conditions and the bending of ultra-high-frequency waves," *QST*, vol. 19, pp. 13-18; June, 1935.

⁴ R. A. Hull, "Air-wave bending of ultra-high-frequency waves," *QST*, vol. 21, pp. 16-18, 76-82; May, 1937.

⁵ A. W. Friend, "A summary and interpretation of ultra-high-frequency wave-propagation data collected by the late Ross A. Hull," *Proc. I.R.E.*, vol. 33, pp. 358-373; June, 1945.

⁶ C. R. Englund, A. B. Crawford, and W. W. Mumford, "Further studies of ultra-short-wave transmission phenomena," *Bell Sys. Tech. Jour.*, vol. 14, pp. 369-387; July, 1935.

⁷ C. R. Englund, A. B. Crawford, and W. W. Mumford, "Ultra-short-wave transmission and atmospheric irregularities," *Bell Sys. Tech. Jour.*, vol. 17, pp. 489-519; October, 1938.

⁸ K. G. MacLean and G. S. Wickizer, "Notes on the random fading of 50-megacycle signals over nonoptical paths," *Proc. I.R.E.*, vol. 27, pp. 501-505; August, 1939.

two paths is 3 degrees. Although transmission was over land, the presence of large bodies of water on both sides no doubt influenced propagation conditions to some extent.

The profiles along the two transmission paths are depicted in Figs. 2 and 3. Elevations above sea level are

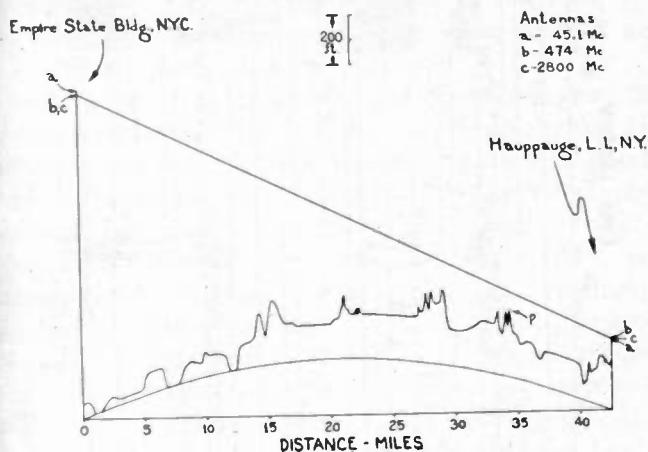

Fig. 2.—Profile along optical path between New York and Hauppauge. Earth radius of $4/3$ assumed, for condition of standard refraction. Observe elevated location of transmitters as compared with that of the receivers, and absence of unobstructed reflecting regions.

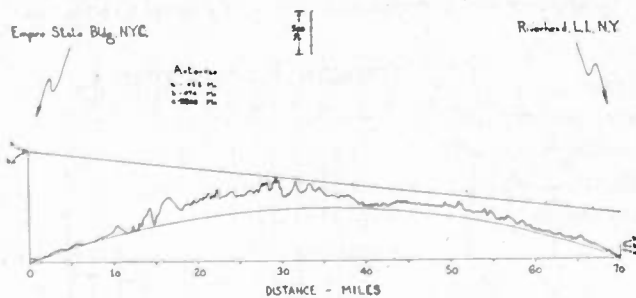

Fig. 3.—Profile along nonoptical path between New York and Riverhead, based on $4/3$ earth radius. Note presence of relatively high ground near center of path.

plotted vertically, while distances along the earth's surface are plotted horizontally. The datum line corresponding to sea level is in the form of a parabola, elevation falling with distance from the mid-point of the path according to the relation

$$h = \frac{d^2}{2} \quad (1)$$

where h is in feet and d in statute miles. This relation is based on an earth's radius of $4/3$ to correct for standard atmospheric refraction.

The foregoing method of representing transmission-path profiles is simple and convenient. Because of the radically different scale factors for height and distance which must be employed to show a useful amount of

detail, curved lines and angles will become distorted; but all straight lines, such as the paths taken by direct and reflected rays, remain straight. The accuracy with which elevations and distances can be read from such a profile is limited only by the respective scales chosen for plotting.

The transmission path from the Empire State Building to the receiving site at Hauppauge was "optical" on a $4/3$ -earth's-radius profile. The clearance between the direct ray and ground level at a distance of 34.3 miles from the transmitter was 70 feet. This point is indicated by p in Fig. 2.

The transmission path to Riverhead was beyond the horizon; the receiving antennas were roughly 450 feet below line-of-sight on a $4/3$ -earth's-radius profile. The earth's-radius factor had to be greater than 2.3 to provide an "optical" path to the two lower-frequency antennas, and the path to the 2800-megacycle antenna became "optical" when the radius factor was greater than 3.

Transmitting Equipment

The regular transmissions of W2XWG, the frequency-modulated transmitter of the National Broadcasting Company, were used for the propagation study on 45.1 megacycles. The radiated power from this transmitter was equivalent to 750 watts in a horizontal half-wave doublet. The transmission schedule was from 2 to 10 P.M., Eastern Standard Time, daily, except Thursdays and Fridays. The power output was maintained within 0.5 decibel.

The transmitter on 474 megacycles was of the master-oscillator power-amplifier type, with a high degree of frequency stability. The transmitter output was 17.6 watts at the beginning of the test and 4.1 watts at the end of the test, a decrease of 6.3 decibels. The antenna was a special horn having a total aperture of 7 square feet. The width of the radiated pattern at half-power points was 44 degrees in the horizontal plane and 27 degrees in the vertical plane. The equivalent radiated power was not measured directly, but was expressed as the resulting free-space field E_0 . This was obtained from local measurements using the same receiving antenna as was used in the final installation. The voltage delivered by the receiving antenna and transmission line was measured under conditions of free-space propagation, at distances of 30 to 100 feet. The measured values were then extrapolated to distances of 42.5 and 70.1 miles to serve as the values of free-space received voltage at the distant receiving points. The output of a thermocouple monitor pickup in the transmitter horn was recorded continuously to provide a record of transmitter output. Vertical polarization was used on this frequency.

The 2800-megacycle transmitter contained a Westinghouse WL-410 klystron. The transmitter output decreased from 4.2 watts at the beginning of the test to 0.7 watt at the end of the test, a change of 7.8 decibels.

The transmitter output was fed through a wave guide to a small horn having an aperture of 1.66 square feet. The width of the radiated pattern at half-power points was 14 degrees in the horizontal plane and 17 degrees in the vertical plane. The antenna was equipped with a thermocouple monitor similar to that in the 474-megacycle horn. Transmissions were vertically polarized on this frequency.

Receiving Equipment

The receiving equipment at Hauppauge was installed in a temperature-controlled room and all supply voltages were regulated. Only the 474-megacycle receiver was equipped with automatic frequency control. The diode outputs of the three receivers were recorded individually on an Engelhard four-color recorder, which operated at a chart speed of $\frac{3}{4}$ inch per hour. Calibrations of receiver gains were checked with standard-signal generators three times weekly. A summary of the antenna systems used at Hauppauge is given in Table I.

TABLE I
HAUPPAUGE ANTENNAS

Frequency, (megacycles)	Antenna		Transmission Line		Loss (decibels)
	Type	Height, feet		Type	
		Above ground	Above sea level		
45.1	$\lambda/2$ doublet	82	280	Twisted pair	4.8
474	Parabolic reflector, area 12.5 square feet	100	298	Coaxial	4.6
2800	Horn, area 5.6 square feet	90	288	Wave guide	1.3

The antenna facilities and receiving equipment at Riverhead were essentially duplicates of the Hauppauge installation. The receiving equipment was installed in two separate buildings which were temperature controlled. A small building housed the 45.1- and 474-megacycle receivers, while the 2800-megacycle receiver was located in one of the laboratory spaces where it could be watched more conveniently. An Engelhard two-color recorder was used on 45.1 and 474 megacycles, and a Bristol moving-pen recorder was used on 2800 megacycles. The chart speed on the latter was 1 inch per hour. The antenna heights at Riverhead are listed in Table II.

TABLE II
RIVERHEAD ANTENNA HEIGHTS

Antenna frequency (megacycles)	Height, feet	
	Above ground	Above sea level
45.1	132	154
474	124	145
2800	68	87

DISCUSSION OF RESULTS

General Observations

The signal recordings from the three charts were analyzed, and plotted to show hourly ranges of signal strength on all frequencies at both receiving locations. The received fields were compared to their free-space

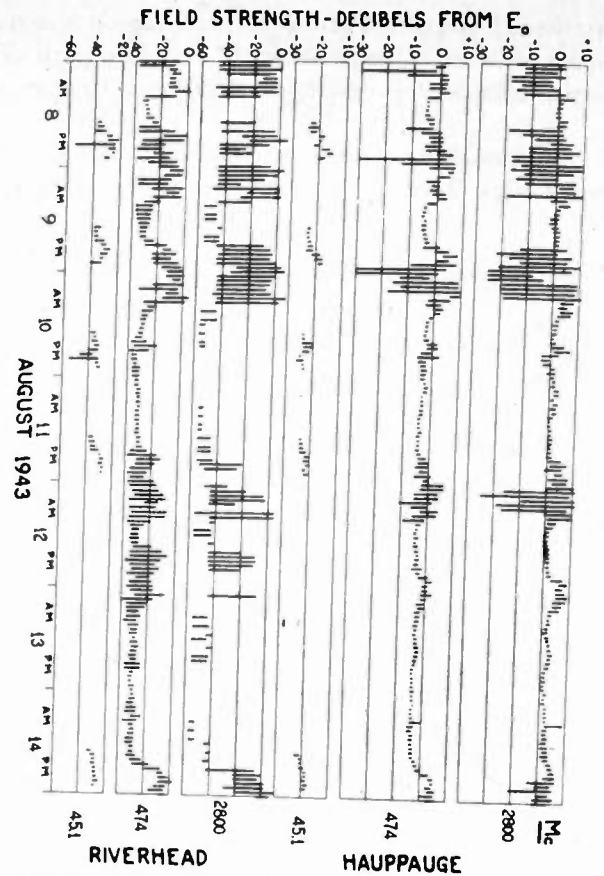

Fig. 4—Hourly ranges of field intensity, on three frequencies, at Hauppauge and Riverhead for period of August 8 to 14, 1943.

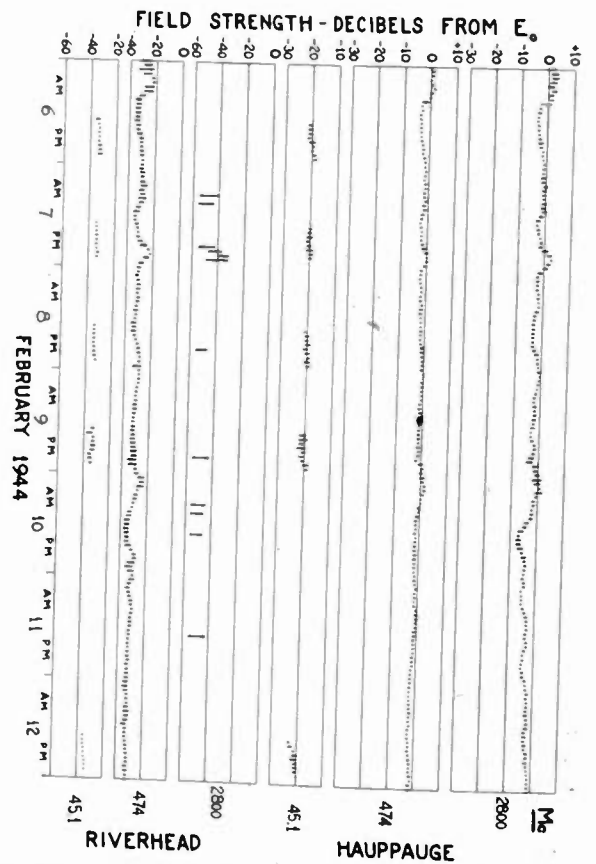

Fig. 5—Same as Fig. 4, but for period of February 6 to 12, 1944.

values E_0 , and the comparison expressed in decibels. This method of expressing field strength provides comparative measurements on the transmission path only, since equipment factors such as transmitter power, antenna gain, and transmission-line loss are measured and removed from the result. Thus, the quality of the transmission path may be quickly recognized. Sample plots illustrating the general performance of the three frequencies at Hauppauge and Riverhead, in summer and winter, are found in Figs. 4 and 5.

Continuous recordings of signal strength near the horizon usually exhibit a diurnal pattern in which the record is disturbed during the night and is relatively smooth during the daylight hours. The least disturbed period occurs in the early afternoon, usually about 2 P.M., local standard time. At this time of day, any atmospheric stratification which may have formed during the previous night has been broken up by convection, and transmission is through a turbulent medium. The amount of refraction at such times will be referred to here as "normal refraction," and the corresponding signal strength will be called the "undisturbed level." Usually, this level is easily recognized on the two higher frequencies, and is a convenient reference level to use as a basis for fading analyses.

Transmission Within the Horizon

As would be expected, reception within the horizon was marked by strong signals, with some fading present. Signal-strength variations were larger on the two higher frequencies, especially in the case of fading minimums. A summary of the measurements at Hauppauge is complicated somewhat by slight seasonal variations in the undisturbed levels. Values for the undisturbed levels contained in Table III are average values obtained over the period of the recording.

TABLE III
HAUPPAUGE SIGNAL-STRENGTH SUMMARY
(All compared to E_0 , in decibels)

Frequency (megacycles)	Undisturbed Level	Highest Maximum	Lowest Minimum
45.1	-21	-13	-29
474	-4	+10.5	Below -30
2800	-2	+12	Below -25

Attempts at determining the field strengths to be expected at Hauppauge on a theoretical basis, on the three widely separated frequencies, brought to light several interesting points. It will be evident, by referring to Fig. 2, that regular reflections of the Empire State transmissions reaching the receiving antennas would be expected to originate in a region some eight miles short of Hauppauge. As can be seen, the profile in the vicinity of this point is quite irregular and is not an ideal reflecting surface. The terrain consists of several areas of reasonably flat ground a few miles in extent, separated from each other by small ranges of hills rising to about 100 feet above the surrounding ground. At 45.1 megacycles these hills represent roughness in the reflecting surface

of 4 to 5 wavelengths in height. Theoretically, such roughness should not impair reflection at angles near grazing, provided the roughness is fairly well distributed. Such does not appear to be the case here, as an examination of the profile will reveal. Nevertheless, reflection apparently is not seriously affected. The undisturbed level of 21 decibels below free space received on 45.1 megacycles at Hauppauge would be realized with a reflection coefficient of 0.9, with the reflection taking place on a plane coinciding with the top of the ridge designated by p in Fig. 2. Any diffraction effect occurring on this frequency would appear to be masked by the relatively greater reflection effect.

At 474 and 2800 megacycles, the hills at p represent roughness of approximately 50 and 300 wavelengths, respectively, and these orders of roughness are theoretically too large to allow regular reflections. Calculated fields on the basis of reflection theory on these frequencies were not in as good agreement with measured values as they were on 45.1 megacycles. Evidently, on the higher frequencies, with obstructions of this size, the effects of diffraction predominate, and it was found that calculations on the basis of diffraction theory produced values which agreed well with measured values of undisturbed levels.

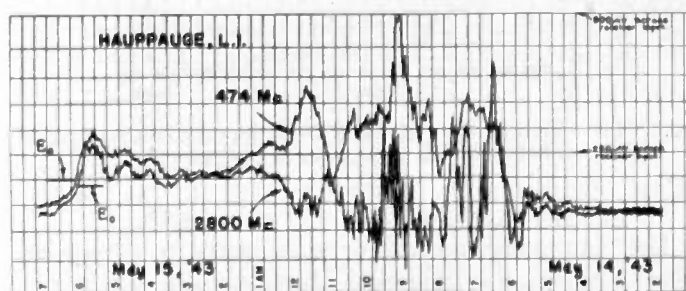

Fig. 6—Example of synchronous fading of opposite phase over an optical path, transcribed from record taken at Hauppauge.

Signal traces on the two higher frequencies were observed to move in opposite directions during many of the disturbed periods. This opposite fading usually took the form of an increase in strength on 474 megacycles, and a slight increase, followed by a decrease, on 2800 megacycles. In many cases the 474-megacycle signal passed through a maximum at the same time that the 2800-megacycle signal was near its minimum level. This condition is not easily explained on the basis of the same transmission path for both frequencies, since the path difference to produce the first maximum on 474 megacycles would be 31.6 centimeters, while the path difference to produce the first minimum on 2800 megacycles would be 10.6 centimeters. An interesting section of chart, illustrating opposite fading within the horizon, is found in Fig. 6. Two distinct types of signal-strength variation are present, one in which the two frequencies vary in opposite directions, and the other in

which both frequencies move together. This suggests that, in this case, a distinct change in propagation conditions took place between midnight and 1 A.M. The weather instruments at Hauppauge indicated a steep surface gradient in dielectric constant from midnight to 6 A.M., and the weather map taken at 1:30 A.M. showed the presence of relatively dry air at the surface, with overlying maritime tropical air, so it is quite possible that the opposite fading in the early evening was due to refraction at higher altitudes, and the smooth fading after midnight was due to the surface gradient.

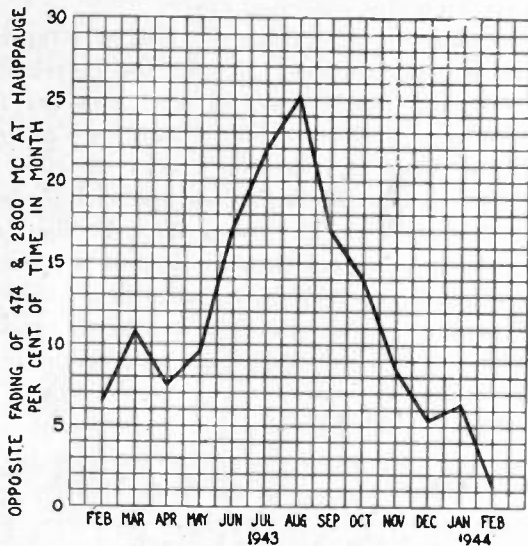

Fig. 7—Per cent of time in months in which opposite fading occurred on 474 and 2800 megacycles at Hauppauge.

The Hauppauge records were inspected to determine what proportion of the time that opposite fading occurred. Each month was analyzed separately, on an hourly basis, and the result plotted in Fig. 7. Since opposite fading on this particular path was found to be an

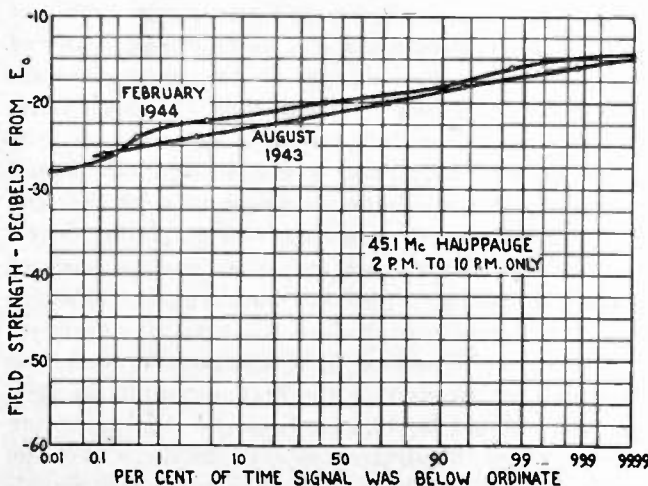

Fig. 8—Per cent of time per month that received field at Hauppauge on 45.1 megacycles was less than indicated level, referred to free space. Summer and winter conditions.

indication of strong refraction, it appears from this graph that conditions were most disturbed during August, and least disturbed during February, 1944.

A statistical analysis of the field-strength variation at Hauppauge is found in Figs. 8, 9, and 10. Due to lack of time, it was not possible to analyze the 474- and 2800-megacycle signals with respect to E_0 . Referring to Fig. 8, the performance of 45.1 megacycles within the horizon exhibits a resemblance to a normal probability distribution, especially the data for the month of August. The relatively sharp drop at the low end of the February curve was due to a single deep fade which

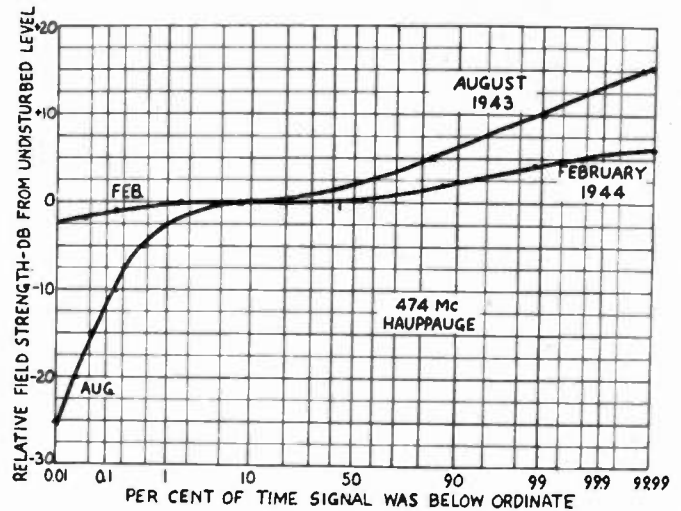

Fig. 9—Same as Fig. 8, but for frequency of 474 megacycles. Note that field here is compared to undisturbed level, rather than free space.

may not have been representative, since there were three fades below -26 decibels during August, which were not as long nor as deep. It is of interest to note that the field strength was generally greater in the winter, by a measurable amount. The average normal-refraction

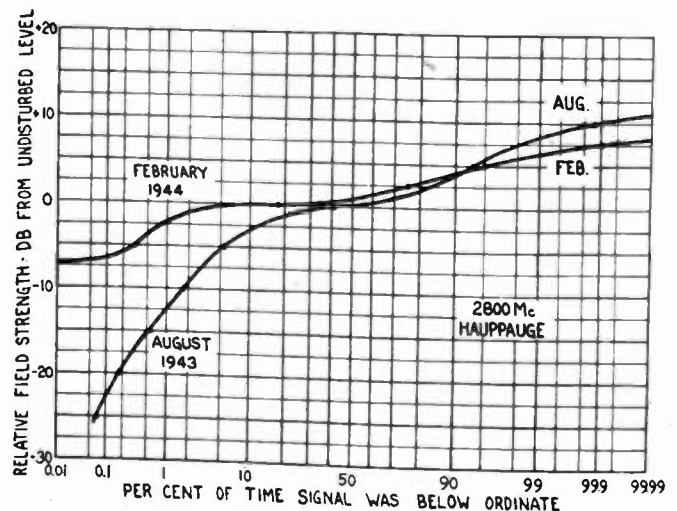

Fig. 10—Same as Fig. 9, but for 2800 megacycles.

level in February was found to be 2.5 decibels higher than in August. It is possible that the reduction in field

strength during the summer was due to improved reflection from vegetation, thus reducing the resultant of the direct and reflected rays. The normal-refraction level during August was 22.7 decibels below E_0 , and during February, 20.2 decibels below E_0 . Note that these curves are for the daily period of 2 P.M. to 10 P.M. Eastern Standard Time, only.

The greater signal-strength variation on 474 megacycles is evident in Fig. 9, as is the difference in performance during summer and winter. In February, 474 megacycles showed less over-all variation than 45.1 megacycles, but more variation was present in the summer, especially below the undisturbed or normal-refraction level. On this frequency, the undisturbed level was also higher in February, by 3.3 decibels. The normal-refraction level in August was 5.8 decibels below E_0 , and in February, 2.5 decibels below E_0 .

Signal-strength variation on 2800 megacycles was greater than that on 474 megacycles, as indicated by Fig. 10. Points of interest are the large proportion of the time that the higher frequency was below the undisturbed level in August, and the low minimum values of field strength recorded. During the summer, 2800 megacycles, within the horizon, was below the normal-refraction level for roughly ten times the length of time that 474 megacycles was. Comparison of the normal-refraction level in winter and summer on 2800 megacycles reversed the condition observed on the lower frequencies. The normal-refraction level in August was 0.8 decibel above E_0 , and in February, 3.3 decibels below E_0 , a difference of 4.1 decibels.

Transmission Beyond the Horizon

Performance beyond the horizon was marked by lower signal levels and greater variations than within the horizon. Comparing normal-refraction fields within and beyond the horizon, the highest frequency was attenuated most in passing over the horizon, and

the lowest frequency was attenuated the least. Variations generally took the form of an increase in field strength, with the highest frequency showing the largest increase.

Curves showing the performance of 45.1 megacycles at Riverhead are found in Fig. 11. The field strength was more variable in the summer, so at times there was no undisturbed level, or it was not clearly defined. From the available data, the undisturbed level appeared to be about 35 decibels below E_0 , both summer and winter.

The signal on 474 megacycles was more variable than that on 45.1 megacycles, as shown in Fig. 12. The curves are approximate below -5 decibels (from the undisturbed level) in August, and below 0 decibels in February, due to the low signal levels received on this frequency beyond the horizon. The undisturbed level on this frequency was about 3 microvolts delivered to the

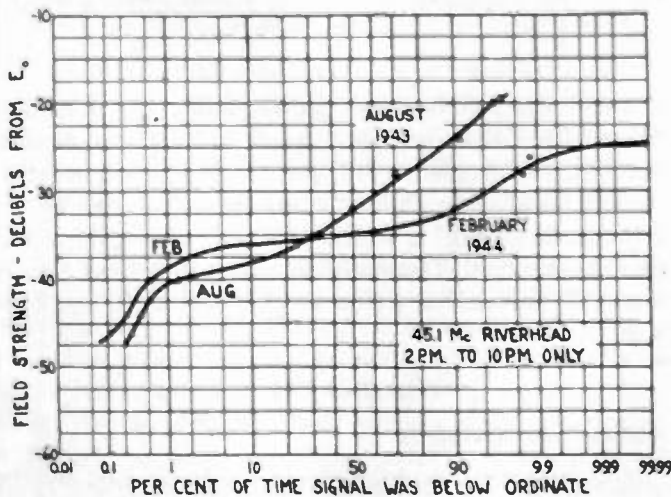

Fig. 11—Per cent of time per month that received field at Riverhead on 45.1 megacycles was less than indicated level, referred to free space. Summer and winter conditions.

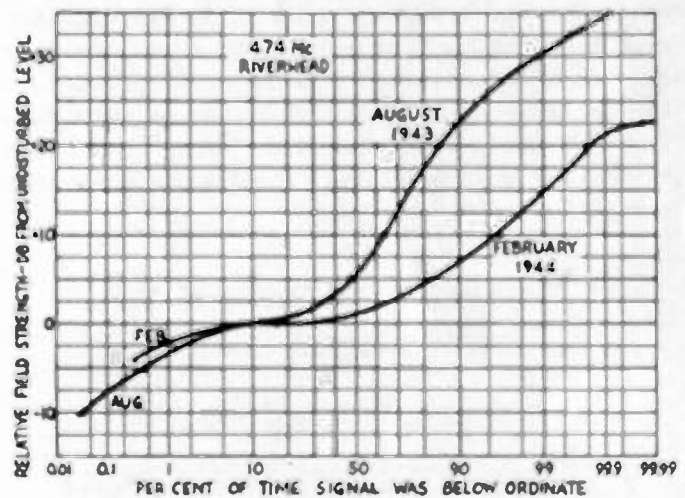

Fig. 12—Same as Fig. 11, but for frequency of 474 megacycles. Note that field here is compared to undisturbed level.

receiver input terminals. It is interesting to note that 474 megacycles beyond the horizon attained signal levels

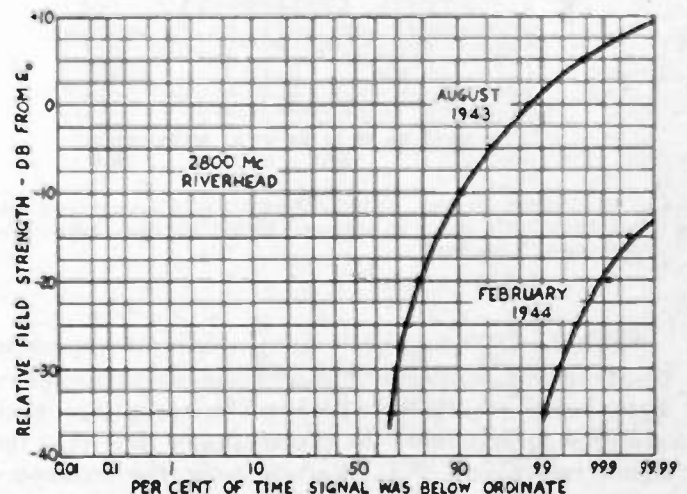

Fig. 13—Same as Fig. 11, but for 2800 megacycles.

more than 35 decibels above the normal-refraction level. The maximum recorded on this frequency was 10.5 decibels above E_0 . The normal-refraction level was slightly higher in the summer, being 31.5 decibels below E_0 in August and 33 decibels below E_0 in February, a difference of 1.5 decibels.

The normal-refraction level on 2800 megacycles at Riverhead was 50 to 60 decibels below the free-space value, and was too weak to measure quantitatively. For this reason, the field-strength recordings were compared to E_0 , as shown in Fig. 13. The seasonal variation is quite striking, as are the slopes of the curves. The maximum signal received was 13 decibels above E_0 , and the minimum could not be discerned, so it is quite likely that the signal level was zero at times. In general, field-strength levels were appreciably higher on this frequency in the summer. In August, the signal could be heard through the daylight hours, with an average strength about 50 decibels below E_0 . In February, however, the signal could be heard at 2 P.M. only about one day out of ten, at a level from 50 to 55 decibels below the free-space value. In general, the signal levels on 474 and 2800 megacycles followed the same broad pattern beyond the horizon, although the 474-megacycle signal showed less over-all variation.

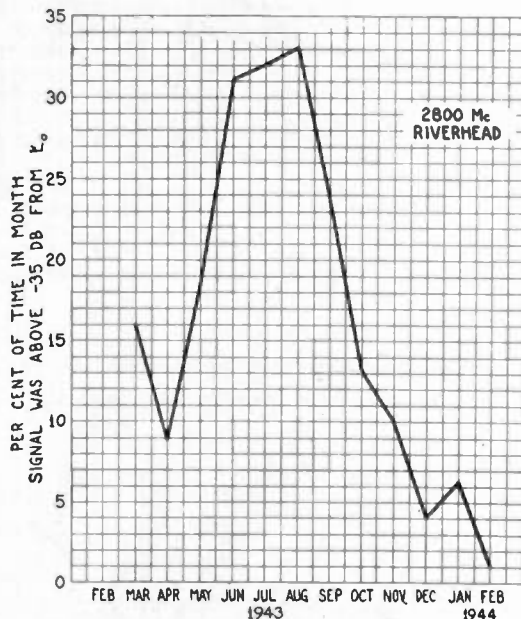

Fig. 14—Per cent of time, by months, that the 2800-megacycle field was sufficiently strong to produce a recordable signal beyond the horizon at Riverhead.

Since the 2800-megacycle signal was most responsive to changes in propagation conditions, its performance was chosen for further study. The recordings were analyzed to determine the proportion of time that the signal was above -35 decibels from the free-space value. A graph showing this characteristic by months is shown in Fig. 14. This graph is very similar to Fig. 7, showing opposite fading at Hauppauge, especially dur-

ing the winter months. While there appears to be, over a long period of time, a general correlation between opposite fading at Hauppauge and reception of 2800 megacycles at Riverhead, comparisons over shorter periods than a month do not show as good correlation. Under conditions of opposite fading at Hauppauge, the 2800-megacycle signal was usually received at Riverhead, but the converse did not hold. The seasonal nature of abnormal refraction is clearly demonstrated by this graph, with the most consistent strong refraction occurring in the three summer months of June, July, and August.

The days and hours during which the 2800-megacycle signal exceeded 6 decibels above the free-space value at Riverhead were tabulated, and the corresponding weather conditions were analyzed. It was found that the signal exceeded the above level in 65 hourly periods, distributed over 37 days. Fig. 15 shows the distribution of these conditions by months. The days with unusually strong refraction were rather uniformly distributed

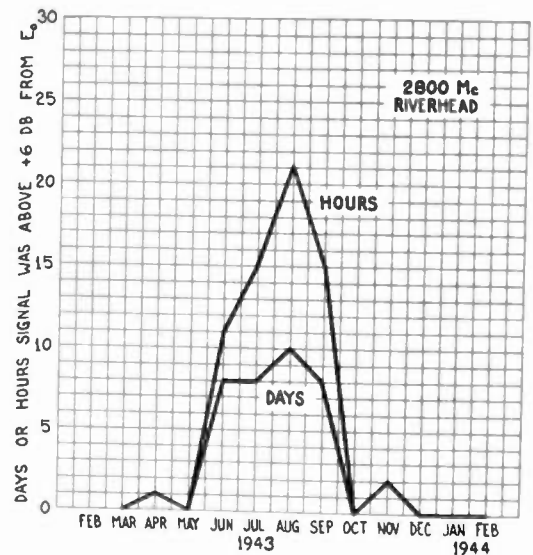

Fig. 15—Number of days and hours, by months, during which 2800 megacycles at Riverhead exceeded twice the free-space value.

through the summer months, including the month of September. Although this graph indicates a definite maximum in August, 1943, the vagaries of the weather could conceivably shift the maximum to one of the other three months in which unusually strong refraction periods occurred. Diurnally, the most prevalent time of unusually strong refraction was between 5:30 and 6:30 A.M.

WEATHER STUDIES

Atmospheric Gradients

The exceptionally high signal levels reached by the 2800-megacycle signal at Riverhead could not fail to arouse an interest in knowing more about the weather conditions which produced such strong refraction. Although very little time could be devoted to such a broad

field, it was hoped that some information could be obtained with the limited facilities available.

Two hair-type hygrothermographs loaned by the Radiation Laboratory of the Massachusetts Institute of Technology were installed at Hauppauge to record temperature and relative humidity of the air at two heights above the ground. From measurements of temperature, pressure, and relative humidity, the dielectric constant of the air may be calculated from the following formula:

$$(\epsilon - 1)10^6 = \frac{157.5}{T} \left[p + \frac{4800e_m}{T} (R.H.) \right] \quad (2)$$

where ϵ = dielectric constant of the atmosphere
 T = absolute temperature in degrees Kelvin
 p = total atmospheric pressure in millibars
 e_m = maximum water vapor pressure in millibars
 $R.H.$ = relative humidity (e/e_m), in terms of pressure.

Knowing the value of the dielectric constant at two heights above ground establishes the dielectric-constant gradient, $d\epsilon/dh$. The labor of calculating the dielectric constant for continuous recording was shortened appreciably by neglecting the variations in atmospheric pressure, leaving only the constant pressure difference due to height, and by the construction of special nomograms which were much more accurate than the recording instruments. From the dielectric-constant gradient, the earth's-radius factor k was obtained from the relation

$$k = \frac{1}{1 + 10.4 \frac{d\epsilon}{dh} \times 10^6} \quad (3)$$

where $d\epsilon/dh$ = dielectric-constant gradient.

Two plots comparing reception of signals at Riverhead with the equivalent earth's-radius factor measured at Hauppauge are found in Figs. 16 and 17. There appears to be some correlation between the surface refraction at Hauppauge and reception of signals at Riverhead in the month of April, but refraction, in terms of k , in July is negative (i.e., bending greater than earth's curvature) most of the time. It might be pointed out that, under the circumstances, good agreement should not be expected. The concept of the factor k as a measure of refraction presupposes a homogeneous atmosphere in which uniform bending of the ray takes place throughout the path. For the Riverhead path, such a condition, over an extended period of time, would be rarely encountered; atmospheric conditions, in general, would not be uniform either horizontally or vertically. A sample of the atmosphere taken at a single point along the path, and near the surface, would obviously not be representative of conditions along the path as a whole. Furthermore, it is quite likely that instrument errors were responsible for some of the extreme values of k in Fig. 17.

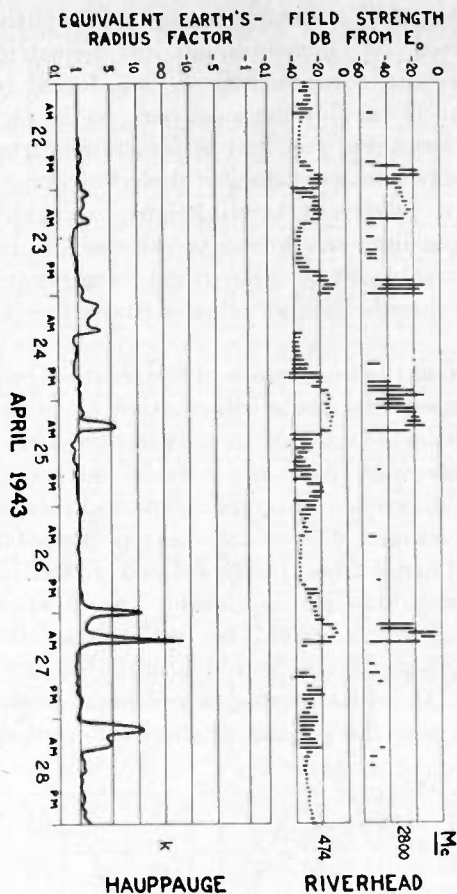

Fig. 16—Comparison of received fields on 474 and 2800 megacycles at Riverhead to surface refraction near center of path at Hauppauge, in April in terms of equivalent earth's radius.

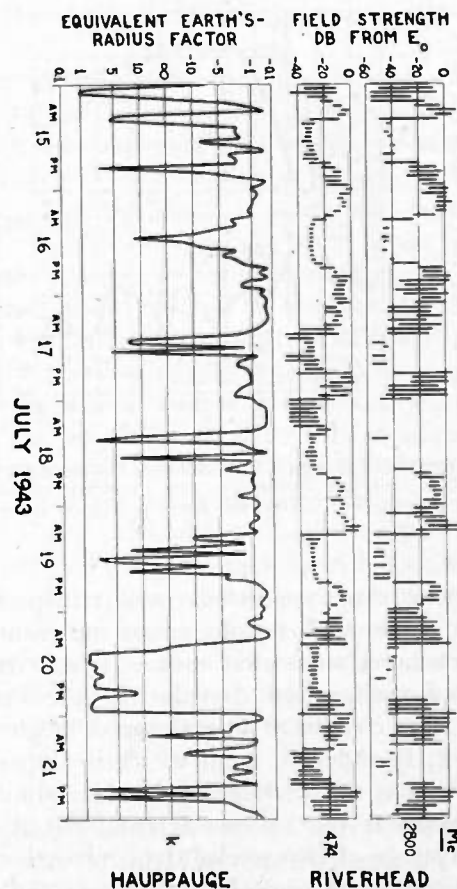

Fig. 17—Same as Fig. 16, but for month of July. Note sustained periods of strong refraction.

The degree of accuracy required in weather instruments used for measurement of dielectric-constant gradients (and consequently k) was found to be very great. This is due, for the most part, to the fact that the dielectric-constant gradient is determined from the difference between two values of dielectric constant measured in a relatively small height interval. Working with height intervals in the vicinity of 100 feet, it was found desirable to be able to read temperature to 0.1 degree Fahrenheit, and relative humidity to 0.5 per cent.

In spite of the limitations of the weather instruments, it was hoped that some information of value could be derived from a study of records obtained with various height intervals, near the earth's surface. If hourly values of difference in temperature and relative humidity are averaged over a sufficient period of time, any existing diurnal trend in the related dielectric-constant gradient should become apparent. The effects of random instrument errors would be minimized, although, of course, constant errors would be unaffected.

In Fig. 18 will be found a comparison of gradients measured near the ground, at three different spacings in

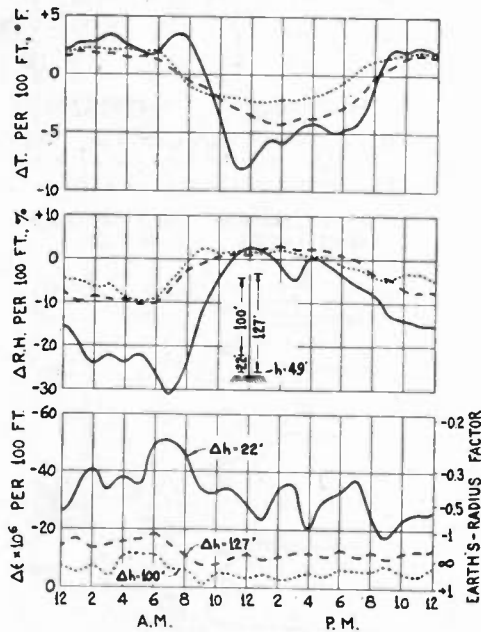

Fig. 18—Atmospheric gradient conditions at Hauppauge. Changes in temperature, relative humidity, and dielectric constant (for a constant height interval of 100 feet) for three layers near the earth's surface.

height. These three conditions permit inspection of a "thin" and a "thick" layer of air near the ground, and a fairly thick layer somewhat removed from the direct influence of the ground. In plotting the curves, all gradients were converted to a common height interval of 100 feet, in order to compare their slopes. Unfortunately, it was not possible to conduct simultaneous measurements at the various heights, but it was felt that the average of two weeks' data for each condition should be significant, especially if interpreted with the

help of other weather information. Inspection of available weather records indicated that the general weather conditions were practically the same for the three measurement periods, which covered the interval from July 14 to August 28, 1943.

The curves of temperature and relative-humidity gradients (Fig. 18) show, as might be expected, a temperature inversion and higher relative humidity at the surface during the night. However, the curves of the derived dielectric-constant gradients do not exhibit the definite trends of the corresponding temperature and relative-humidity gradients. In the diurnal heating and cooling of the same air mass, the relationship of the temperature and relative humidity is such as to result in a compensating effect on the value of the dielectric constant as calculated from (2). Thus it is possible to have definite changes in temperature and relative humidity, with little change in corresponding dielectric constant. Close inspection reveals a fairly definite increase of gradient about two hours after sunrise; this agrees with the early-morning increase in signal strength observed many times on the records at Riverhead.

From Fig. 18, it is apparent that the steepest dielectric-constant gradients were in the 22-foot layer nearest the ground, followed by the 127-foot layer, with the smallest gradients in the 100-foot layer which was above the ground. This apparent irregularity is explicable as follows. The 100-foot layer was well above ground, and thus did not embrace gradients near the surface; the 127-foot layer included this surface region. Thus, the three curves are in agreement, and indicate that the largest dielectric-constant gradients are found nearest the earth's surface.

The general weather conditions prevailing during the periods of unusually strong refraction (Fig. 15) were studied in an attempt to divide the types of gradient into three classes: (1) the frontal type, involving different air masses; (2) the radiation type, in which the lower layers of the same air mass are modified by the influence of the earth's temperature; and (3) a combination of the two types. Weather information was obtained from the daily weather maps, temperature and humidity recordings at two heights above ground at Hauppauge, and local observations at Riverhead. The Weather Bureau co-operated by furnishing radiosonde data on days of especial interest. As a rule, the weather conditions to produce unusually strong refraction were definite enough to permit the type of gradient to be classified. The analysis indicated that frontal gradients accounted for 62 per cent of the total number of hourly periods of unusually strong refraction; radiation gradients, 23 per cent; and a combination of the two, 15 per cent. Analysis of the temperature and relative-humidity recordings at Hauppauge revealed that a steep surface gradient of dielectric constant was present in 39 per cent of the hourly periods of unusually strong refraction, and no appreciable gradient was indicated in the remaining 61 per cent. Although these

figures appear to duplicate those already given, there were cases of local movements of different air masses which were measured in a height difference of 100 feet, and there were other typical examples of radiation-type gradient in which both instruments indicated a high value of dielectric constant. Under the latter condition, the gradient producing the refraction was evidently above the weather instruments. From the above discussion, it may be concluded that the controlling gradient is more than 100 feet above the ground in about 60 per cent of the cases when unusually strong signals are received beyond the horizon on this particular transmission path.

Wind Effects

Since strong refraction is dependent on more or less stratified layers of air, the effect of wind would be to break up this stratification, especially near the surface of the earth. An anemometer was installed about 70 feet above the ground at Riverhead, to record the average wind velocity. Results of a study of the effect of surface wind velocity on the reception of 2800 megacycles at Riverhead are found in Fig. 19. The curves represent the

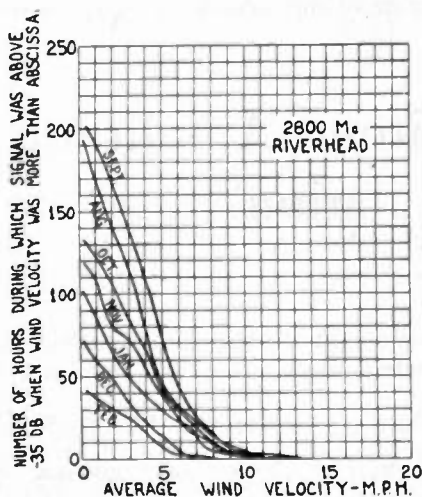

Fig. 19—Comparison, by months, of 2800-megacycle reception and surface wind velocity at Riverhead.

number of hours during which the signal was above the receiver threshold when the average wind velocity was greater than indicated. The "number of hours" was obtained from the analyzed data for convenience, and does not represent true integrated time; the figure for wind velocity was an hourly average. The curves indicate a fairly definite upper limit to the surface wind velocity which would permit strong refraction on this radio circuit. This value was slightly over 13 miles per hour. The slopes of the separate curves are relatively constant at low velocities, suggesting that strong refraction was independent of surface wind velocity below 6 to 8 miles per hour. The gradual change in the slope of the curves for the individual months as the weather became colder is also of interest. The curve for August represents only 19 days; September was the first full month of wind-velocity recording.

Fig. 20 contains direct plots of the average wind velocity at Riverhead during the months of September,

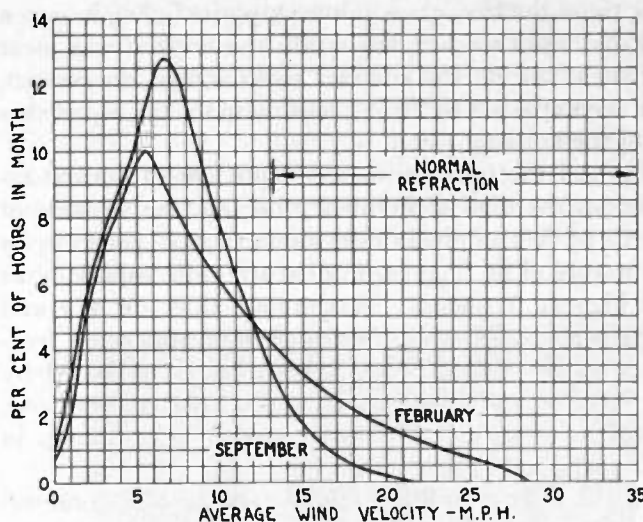

Fig. 20—Comparison of surface wind velocities for months of September and February. Normal refraction usually obtained for wind velocities above 13 miles per hour.

1943, and February, 1944. The comparison indicates the more active circulation of air in the winter, which prevented the formation of gradients. Another point of interest is that, although the wind performance below 5 miles per hour was practically the same for September and February, the slopes of the curves for these months in Fig. 19 are quite different, a direct indication that factors other than wind velocity were controlling refraction.

The weather records during the periods of unusually strong refraction shown in Fig. 15 were chosen for further study. The average wind velocity, during the period of wind-velocity recording at Riverhead, was found to be 3.3 miles per hour, a value well down on the curves of Fig. 19. The average water-vapor content of the air, as measured by the specific humidity, was 11.6 grams per kilogram of air. This corresponds to air at 70 degrees Fahrenheit, 74 per cent relative humidity, and 1000 millibars pressure, typical of summer conditions on Long Island. Since refraction is dependent on both temperature and water-vapor content, these cannot be discussed separately. In general, strong refraction was more frequent when the water-vapor content was high, as indicated above. Although refraction greater than normal was evident on rare occasions with specific humidities one-tenth the above value, such quantities of water vapor require severe temperature inversions to produce strong refraction, a condition seldom experienced on Long Island due to the stabilizing influence of the Atlantic Ocean and Long Island Sound.

CONCLUSIONS

Within the horizon, the normal-refraction signal level tended to approach the free-space value as the frequency increased. Variations in field strength also increased

with frequency, usually taking the form of a reduction in field strength at the highest frequency. Maximum levels observed on the higher frequencies were three to four times the free-space value. Opposite fading between 474 and 2800 megacycles within the horizon was most prevalent during the summer months, and, in general, was accompanied by strong refraction for the signals beyond the horizon.

Beyond the horizon, under conditions of normal refraction, the highest frequency became the weakest of the three. Variations in field strength were generally in the nature of an increase in field strength, especially at the highest frequency. Maximum values on 474 and 2800 megacycles were three and four times the free-space value, respectively. Refraction, as indicated by the reception of 2800 megacycles beyond the horizon, was at a maximum in August, and at a minimum in February.

In the field of weather studies, strong refraction did not take place when the surface wind velocity was greater than about 13 miles per hour. In studying gradients of dielectric constant near the earth's surface, the steepest gradients were found nearest the earth. Periods of unusually strong refraction beyond the

horizon occurred most frequently in the summer, with the boundaries between different air masses predominating in the formation of gradients, usually at heights more than 100 feet above the surface of the earth.

ACKNOWLEDGMENT

The project yielding the data upon which the material in this article is based was carried on under the sponsorship of the National Defense Research Committee of the Office of Scientific Research and Development. Many groups and individuals were instrumental in contributing to the success of the investigations. In particular, valuable assistance was given by the Propagation Group of the Radiation Laboratory of the Massachusetts Institute of Technology. The Empire State Building staff of the National Broadcasting Company rendered aid in operating the transmitting equipment. The Rocky Point group of RCA Laboratories designed and built the 474-megacycle transmitter used in the tests. Of those of the Riverhead group of RCA Laboratories who assisted in the work, particular credit is due E. N. Brown, who prepared the original nomograms used in the weather studies, and who did most of the analyzing of the recorded signal intensities.

Generalized Theory of Multitone Amplitude and Frequency Modulation*

L. J. GIACOLETTO†, MEMBER, I.R.E.

Summary—The frequency spectrum produced by single-tone, two-tone, and multitone modulating signals in the case of amplitude modulation, frequency modulation, and combined amplitude and frequency modulation are studied in turn. Amplitude, symmetry, and energy of sidebands for the different cases are considered. Extensive computations are made of frequency spectrums, and these are compared with actual frequency spectrums observed by means of a spectrum analyzer. The agreement between computed and measured frequency spectrums is very close.

INTRODUCTION

MODULATION of a radio-frequency signal occurs whenever the character of the signal is varied as a function of the instantaneous value of another wave.¹ Modulation is necessary in order to transmit messages by radio. This paper will discuss three types of modulation: (1) amplitude modulation, (2) frequency modulation, and (3) combined amplitude

and frequency modulation; together with generalization of each to include modulation by a multitone signal.

PART I—AMPLITUDE MODULATION

The mathematical theory of multitone amplitude modulation has been completely discussed by Carson.² The only purpose in discussing amplitude modulation in this paper is for completeness.

The radio-frequency signal can be represented mathematically as

$$a = A \begin{Bmatrix} \sin \\ \cos \end{Bmatrix} \phi, \quad (1)$$

where both sine and cosine functions are considered for generality. The amplitude of the signal is A and the angular velocity of the signal is defined as

$$\omega = \frac{d\phi}{dt}. \quad (2)$$

For amplitude modulation the angular velocity is made a constant, say, ω_0 , and the amplitude is made to vary about a mean amplitude A_0 so as to contain the message

² John R. Carson, "Notes on the theory of modulation," Proc. I.R.E., vol. 10, pp. 57-64; February, 1922.

* Decimal classification: R148.1×R148.2. Original manuscript received by the Institute, August 2, 1945; revised manuscript received, November 8, 1946. Manuscript begun at University of Michigan, Ann Arbor, Michigan, and completed at Evans Signal Laboratories, Belmar, New Jersey.

† Radio Corporation of America, RCA Laboratories, Princeton, N. J.

¹ "American Standard Definitions of Electrical Terms", published by American Institute of Electrical Engineers"; Modulation, (65.10.300), p. 202.

to be transmitted. The message can be expressed as a summation of individual sinusoidal terms

$$f(t) = a_0 + \sum_{j=1}^l (a_j \cos \Omega_j t + b_j \sin \Omega_j t) \\ = c_0 + \sum_{j=1}^l c_j \cos (\Omega_j t + \Theta_j) \quad (3)$$

where

$$\left. \begin{aligned} c_0 &= a_0 \\ c_j &= \sqrt{a_j^2 + b_j^2} \\ \Theta_j &= \tan^{-1} \left(-\frac{b_j}{a_j} \right) \end{aligned} \right\} \quad j = 1, 2, \dots, l. \quad (4)$$

It is to be noted that no restrictions are placed on the value of Ω_j , so that both recurrent and nonrecurrent modulating signals are included in the expansion indicated by (3). Using (3), the amplitude of the radio frequency is

$$A = A_0 \left[1 + \frac{f(t)}{A_0} \right] = A_0 + c_0 + \sum_{j=1}^l c_j \cos (\Omega_j t + \Theta_j) \\ = A_0 \left[1 + m_0 + \sum_{j=1}^l m_j \cos (\Omega_j t + \Theta_j) \right] \quad (5)$$

where

$$m_j = \frac{c_j}{A_0} \quad j = 0, 1, 2, \dots, l. \quad (6)$$

The complete expression for the multitone amplitude-modulated radio-frequency signal is

$$a = A_0 \left[1 + m_0 + \sum_{j=1}^l m_j \cos (\Omega_j t + \Theta_j) \right] \begin{cases} \sin \\ \cos \end{cases} \omega_0 t. \quad (7)$$

For many purposes the expansion of the above expression into carrier and side-frequency terms is desired. This can be accomplished by using well-known trigonometric identities. The result is

$$a = A_0 \left[(1 + m_0) \begin{cases} \sin \\ \cos \end{cases} \omega_0 t + \sum_{j=1}^l \frac{m_j}{2} \left(\begin{cases} \sin \\ \cos \end{cases} [(\omega_0 + \Omega_j)t + \Theta_j] + \begin{cases} \sin \\ \cos \end{cases} [(\omega_0 - \Omega_j)t - \Theta_j] \right) \right] \quad (8)$$

Equation (8) indicates that amplitude modulation with a signal which contains l individual modulating frequencies will produce $(2l+1)$ individual radio-frequency signals. This multitone amplitude-modulation spectrum is symmetrical both as to amplitude and frequency location about the original radio-frequency carrier signal of frequency ω_0 . The signal frequencies

lying above ω_0 form the upper sideband, and the signal frequencies lying below ω_0 form the lower sideband. Each modulating signal of frequency Ω_j produces an upper side signal of frequency $\omega_0 + \Omega_j$ and a lower side signal of frequency $\omega_0 - \Omega_j$. The phase angles Θ_j of the modulating signal do not alter the amplitudes of the sidebands but merely change their initial phase.

The frequency spectrum for a single-tone amplitude-modulated signal is shown in Fig. 1. For this case the modulating signal is a 5-kilocycle sinusoidal signal whose amplitude is chosen so that 100 per cent amplitude modulation results ($m_1 = 1.00$).

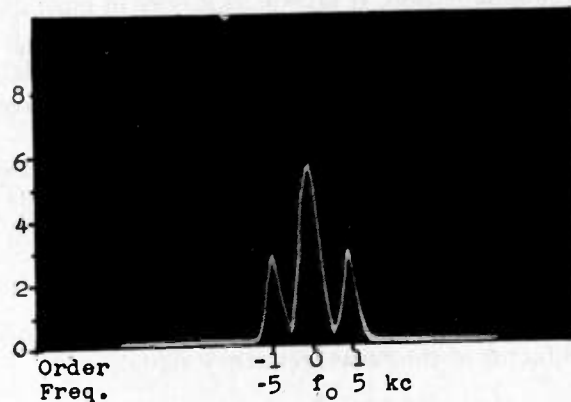

Fig. 1—Oscillogram picture of single-tone amplitude-modulated signal.

Fig. 2 is for a multitone amplitude-modulated signal. The modulating signal is a series of equally spaced dots whose amplitude is chosen so that 100 per cent amplitude modulation results. Since an infinite number of

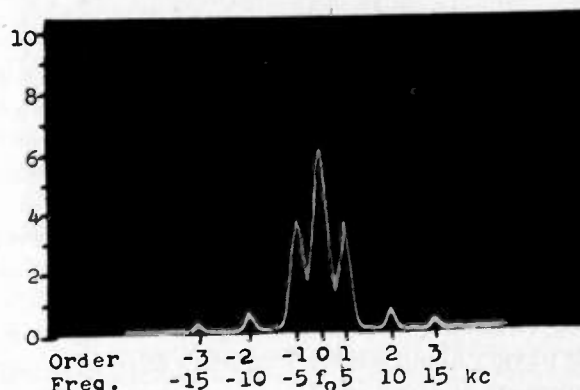

Fig. 2—Oscillogram picture of multitone amplitude-modulated signal.

terms in (3) are required to express accurately the series of dots, the corresponding radio-frequency spectrum theoretically will have an infinite number of upper and lower side signals. Practically, the upper and lower side signals soon evanesce, so that the multitone amplitude-modulation spectrum can be placed in a bounded frequency band.

The energy present in the signal of (8) is proportional to the squares of the amplitudes of the individual signals. Strictly speaking, this is true only if the Ω_j 's are harmonically related, although it will still be

³ Throughout the balance of this paper, frequency will be used synonymously with angular velocity for the sake of simplicity.

approximately true even if this is not the case. Then, after modulation, the energy W_a is

$$W_a \sim A_0^2 \left[(1 + m_0)^2 + \sum_{j=1}^l \frac{m_j^2}{2} \right]. \quad (9)$$

Since, before modulation, the energy W_b is

$$W_b \sim A_0^2, \quad (10)$$

there must have been energy added in the amount

$$W_a - W_b \sim A_0^2 \left[(1 + m_0)^2 - 1 + \sum_{j=1}^l \frac{m_j^2}{2} \right] \quad (11)$$

by the modulation. If $m_0 = 0$, as it does in most cases, it is seen that the energy added through modulation is the energy that is present in the upper and lower sidebands. Indeed, this added energy is divided equally between the upper and lower sidebands.

Before beginning the discussion of frequency modulation, it seems advisable to mention that the value of m_j must be restricted by the inequality

$$m_j \leq 1 + m_0 \quad (12)$$

as otherwise (5) no longer correctly expresses the amplitude factor of the radio-frequency signal.

PART II—FREQUENCY MODULATION

The mathematical theory of a signal frequency modulated by a single sinusoidal wave has been adequately discussed by Roder⁴ and Carson and Fry.⁵ The past work on the multitone frequency-modulated signal can be summarized briefly. Carson and Fry⁵ mentioned, in passing, a few aspects of the multitone case. Crosby⁶ derived the expansion for the two-tone case, and from this made certain predictions as to the multitone case, but the development and some of the conclusions in this article are incorrect. More recently a thorough mathematical treatment of different aspects of modulation, together with the multitone frequency-modulated signal, has been presented.⁷

Equations (1) and (2) are again the starting point for the development of the multitone frequency-modulated signal. For frequency modulation, the amplitude is assumed to remain constant as A_0 and the frequency is made to vary about a mean frequency ω_0 so as to contain the message as given in (3):

$$\begin{aligned} \omega &= \omega_0 [1 + f(t)] \\ &= \omega_0 \left[1 + a_0 + \sum_{i=1}^k (a_i \cos \omega_i t + b_i \sin \omega_i t) \right] \\ &= \omega_0 \left[1 + c_0 + \sum_{i=1}^k c_i \cos (\omega_i t + \theta_i) \right] \end{aligned} \quad (13)$$

and, therefore,

$$\begin{aligned} \phi &= \int \omega dt = \omega_0 \left[t + \int f(t) dt \right] \\ &= \omega_0 (1 + c_0) t + \sum_{i=1}^k \frac{c_i \omega_0}{\omega_i} \sin (\omega_i t + \theta_i). \end{aligned} \quad (14)$$

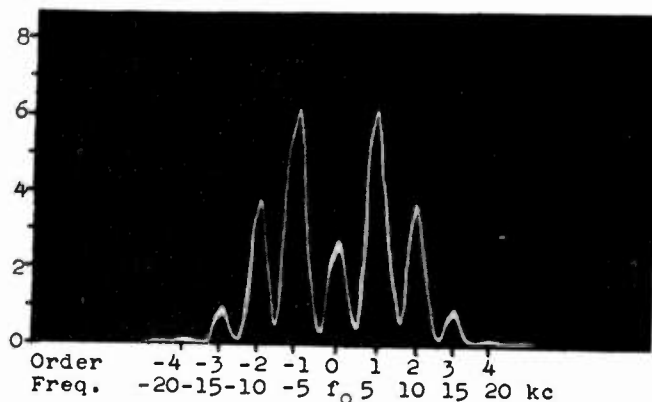

Fig. 3—Oscilloscope picture of single-tone frequency-modulated signal (5-kilocycle modulation—10-kilocycle deviation).

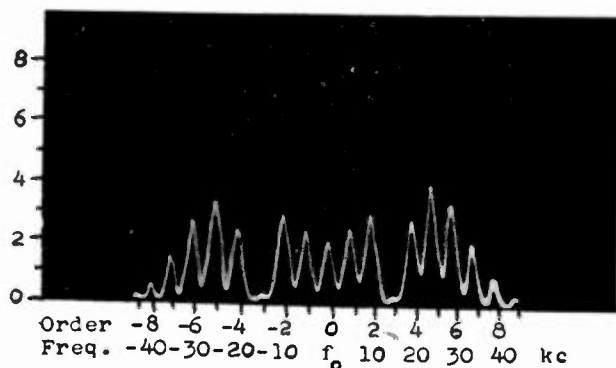

Fig. 4—Oscilloscope picture of single-tone frequency-modulated signal (5-kilocycle modulation—30-kilocycle deviation).

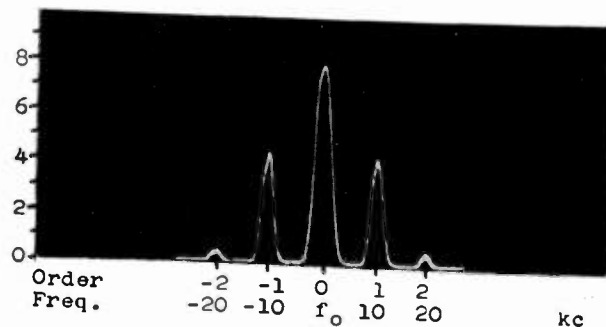

Fig. 5—Oscilloscope picture of single-tone frequency-modulated signal (10-kilocycle modulation—10-kilocycle deviation).

In these equations, Ω_j and Θ_j in the modulating signal have been replaced by ω_i and θ_i so as to avoid confusion

⁴ Hans Roder, "Amplitude, phase, and frequency modulation," Proc. I.R.E., vol. 19, pp. 2145-2176; December, 1931.

⁵ J. R. Carson and T. C. Fry, "Variable frequency electric circuit theory with application to the theory of frequency modulation," Bell Sys. Tech. Jour., vol. 16, pp. 513-540; October, 1937.

⁶ M. G. Crosby, "Carrier and side-frequency relations with multi-tone frequency or phase modulation," RCA Rev., vol. 3, pp. 103-106; July, 1938.

⁷ A. Bloch, "Modulation theory," Jour. I.E.E. (London), vol. 91, pp. 31-42; March, 1944. The material contained in the present paper was first developed by the author during the early part of 1940 and was shortly thereafter presented at a seminar in applied mathematics, conducted by Ruel V. Churchill of the University of Michigan mathematics department. A preliminary draft of the present paper, including the complete mathematical development, was prepared in November, 1940, and presented to the electrical engineering department of the University of Michigan.

in Case III for combined amplitude and frequency modulation. Also, an arbitrary constant of integration has been omitted as irrelevant.

Using the substitution

$$z_i = \frac{c_i \omega_0}{\omega_i} = \frac{c_i f_0}{f_i} = \frac{\sqrt{a_i^2 + b_i^2} f_0}{f_i} \quad i = 1, 2, \dots, k \quad (15)$$

and placing (14) into (1),

$$a = A_0 \frac{\sin}{\cos} \left[\omega_0(1 + c_0)t + \sum_{i=1}^k z_i \sin(\omega_i t + \theta_i) \right]. \quad (16)$$

In (15) the factor c_i may be a function of f_i , giving rise to various types of frequency modulation. Thus, if c_i is in turn a product of a constant by f_i , there results the type of frequency modulation commonly referred to as phase modulation.⁸⁻¹² For pure frequency modulation c_i is a constant. There will be derived the expansion for (16) in terms of carrier and side frequencies. In order to obtain this expansion, other relationships and expansions must first be derived.

Assuming that $i=1$, then (16) is,

$$a = A_0 \frac{\sin}{\cos} [\omega_0(1 + c_0)t + z_1 \sin(\omega_1 t + \theta_1)]. \quad (17)$$

Expanding (17) trigonometrically,

$$a = A_0 \left[\frac{\sin}{\cos} \{ \omega_0(1 + c_0)t \} \frac{\cos}{\cos} \{ z_1 \sin(\omega_1 t + \theta_1) \} + \cos \{ \omega_0(1 + c_0)t \} \frac{\sin}{\sin} \{ z_1 \sin(\omega_1 t + \theta_1) \} \right]. \quad (18)$$

In order to expand (18) and similar expressions further, four Bessel function identities¹² will be needed. These are:

$$\sin(y \sin x) = \sum_{n=-\infty}^{\infty} J_{2n-1}(y) \sin(2n-1)x, \quad (19)$$

$$\sin(y \cos x) = \sum_{n=-\infty}^{\infty} (-1)^{n-1} J_{2n-1}(y) \cos(2n-1)x, \quad (20)$$

$$\cos(y \sin x) = \sum_{n=-\infty}^{\infty} J_{2n}(y) \cos 2nx, \quad \text{and} \quad (21)$$

⁸ The author prefers to consider frequency modulation as a generic class including all types of modulation which leave the amplitude constant and have the instantaneous frequency a function of time as in (13). Depending upon what function of time is chosen, different types of frequency modulation are produced. Similarly, amplitude modulation may be used as a generic term and different types of amplitude modulation are produced depending on what function of time is chosen in (5). The views expressed here were first advanced by L. N. Holland, J. B. Wiesner, and the author in an interdepartmental article entitled, "A consideration of basic frequency-modulation principles," January, 1940, and a letter from the author to H. A. Moench, Rose Polytechnic Institute, dated November 4, 1940.

⁹ H. Stockman and G. Hok, "A note on frequency-modulation terminology," *Proc. I.R.E.*, vol. 32, pp. 181-183; March, 1944.

¹⁰ David G. C. Luck, "Discussion on 'amplitude, phase, and frequency modulation'," *Proc. I.R.E.*, vol. 20, pp. 884-887; May, 1932.

¹¹ W. L. Everitt, "Frequency modulation," *Trans. A.I.E.E. (Elec. Eng. November, 1940)*, vol. 59, pp. 613-625; November, 1940.

¹² N. W. McLachlan, "Bessel Functions for Engineers," The Clarendon Press, Oxford, 1934.

$$\cos(y \cos x) = \sum_{n=-\infty}^{\infty} (-1)^n J_{2n}(y) \cos 2nx. \quad (22)$$

Substituting (19) and (21) into (18) yields

$$a = A_0 \left[\frac{\sin}{\cos} \{ \omega_0(1 + c_0)t \} \sum_{n=-\infty}^{\infty} J_{2n}(z_1) \cos 2n(\omega_1 t + \theta_1) + \cos \{ \omega_0(1 + c_0)t \} \sum_{n=-\infty}^{\infty} J_{2n-1}(z_1) \sin(2n-1)(\omega_1 t + \theta_1) \right]. \quad (23)$$

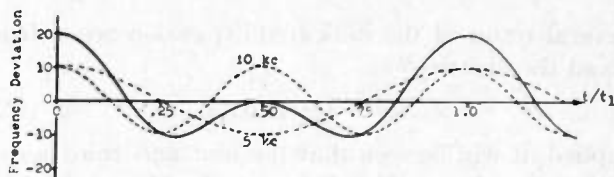

(a)

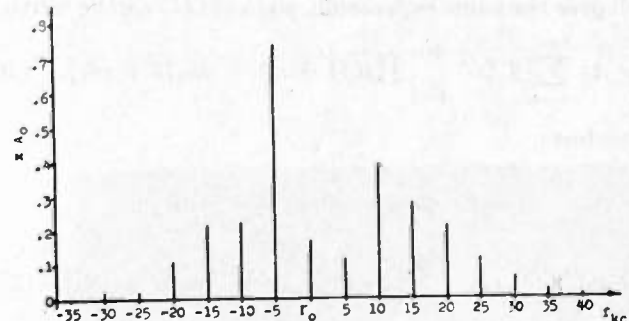

(b)

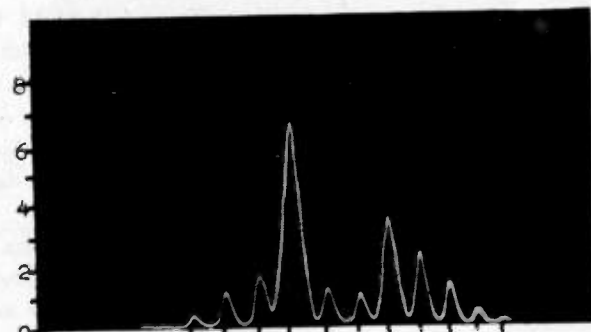

(c)

Fig. 6—Two-tone frequency-modulated signal (5-kilocycle modulation—10-kilocycle deviation, and 10-kilocycle modulation—10-kilocycle deviation).

(a) Modulating signal:

$$f = f_0 + 10 \cos 2\pi f_1 t + 10 \cos 2\pi f_2 t$$

$$\theta_1 = 0, \quad f_1 = 5 \text{ kilocycles}, \quad \theta_2 = 0, \quad f_2 = 10 \text{ kilocycles}.$$

(b) Frequency spectrum after frequency modulation:

$$a = A_0 \sin [\omega_0 t + z_1 \sin 2\pi f_1 t + z_2 \sin 2\pi f_2 t]$$

$$= A_0 \sum_{n_1=-\infty}^{\infty} \sum_{n_2=-\infty}^{\infty} J_{n_1}(z_1) J_{n_2}(z_2) \sin [2\pi(f_0 + n_1 f_1 + n_2 f_2)t]$$

$$\theta_1 = 0, \quad f_1 = 5 \text{ kilocycles}, \quad c_1 f_0 = 10 \text{ kilocycles}, \quad z_1 = \frac{c_1 f_0}{f_1} = 2.0$$

$$\theta_2 = 0, \quad f_2 = 10 \text{ kilocycles}, \quad c_2 f_0 = 10 \text{ kilocycles}, \quad z_2 = \frac{c_2 f_0}{f_2} = 1.0.$$

(c) Oscillogram picture of frequency spectrum.

Using trigonometric identities in (23) gives

$$a = \frac{A_0}{2} \sum_{n=-\infty}^{\infty} \left[J_{2n}(z_1) \left\{ \frac{\sin [\omega_0(1+c_0)t + 2n(\omega_1 t + \theta_1)]}{\cos} + \frac{\sin [\omega_0(1+c_0)t - 2n(\omega_1 t + \theta_1)]}{\cos} \right\} + J_{2n-1}(z_1) \left\{ \frac{\sin [\omega_0(1+c_0)t + (2n-1)(\omega_1 t + \theta_1)]}{\cos} - \frac{\sin [\omega_0(1+c_0)t - (2n-1)(\omega_1 t + \theta_1)]}{\cos} \right\} \right]. \quad (24)$$

If several terms of the indicated expansion are written out and the identity¹²

$$J_{-n}(z) = (-1)^n J_n(z) \quad (25)$$

is applied, it will be seen that the first and third terms and the second and fourth terms of (24) combine to each give the same expression, so that (24) can be written

$$a = A_0 \sum_{n=-\infty}^{\infty} J_n(z_1) \frac{\sin [\{\omega_0(1+c_0) + n\omega_1\}t + n\theta_1]}{\cos}. \quad (26)$$

Therefore,

$$a = A_0 \frac{\sin [\omega_0(1+c_0)t + z_1 \sin (\omega_1 t + \theta_1)]}{\cos} = A_0 \sum_{n=-\infty}^{\infty} J_n(z_1) \frac{\sin [\{\omega_0(1+c_0) + n\omega_1\}t + n\theta_1]}{\cos}. \quad (27)$$

Equation (27) is the general mathematical expression for a signal frequency modulated by a single pure tone. If $b_1=0$ in (13), so that $\theta_1=0$, (27) would yield the customary expansion for a single-tone frequency-modulated signal. If $a_1=0$ in (13), so that $\theta_1 = -(\pi/2)$, the expansion of (27) is that of a not so well-known form of a single-tone frequency-modulated signal. The four possible trigonometric forms of a single-tone frequency-modulated signal are included in (27).

If $c_0=0$, as it does in most cases, (27) indicates that a signal frequency modulated by a single tone is composed of a double infinity of side frequencies. The upper side frequencies are given by $\omega_0 + n\omega_1$, as n goes from 1 to ∞ , and the lower side frequencies are given by $\omega_0 - n\omega_1$, as n goes through the same gamut. Here again, as in the case of the square-wave amplitude-modulated signal, the amplitude of the higher-order side frequencies began to decrease so that, practically speaking, the complete spectrum can be placed in a bounded frequency band. For a single-tone case the upper sideband is symmetrical with the lower sideband in amplitude and frequency location but not as to phase, as indicated by (25) and by the presence of $n\theta_1$ in (26).

The energy present in a single-tone frequency-modulated signal remains constant during modulation. This can be demonstrated by forming the square of the amplitudes of the individual signals and summing them by means of a Bessel identity:¹³

¹³ G. N. Watson, "Theory of Bessel Functions," Cambridge University Press, Cambridge, 1922, p. 31.

$$\sum_{n=-\infty}^{\infty} J_n^2(x) = 1. \quad (28)$$

Thus

$$W_a \sim A_0^2 \sum_{n=-\infty}^{\infty} J_n^2(z_1) = A_0^2 \sim W_b. \quad (29)$$

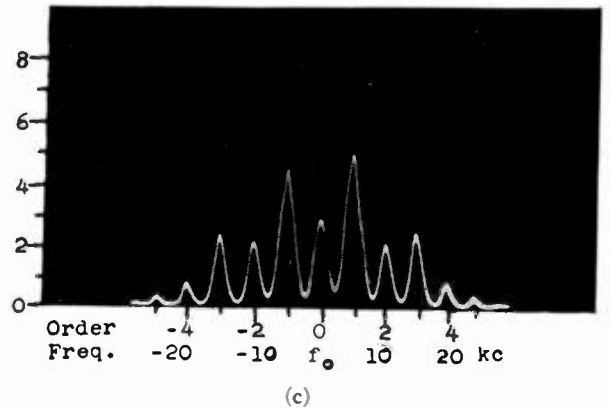
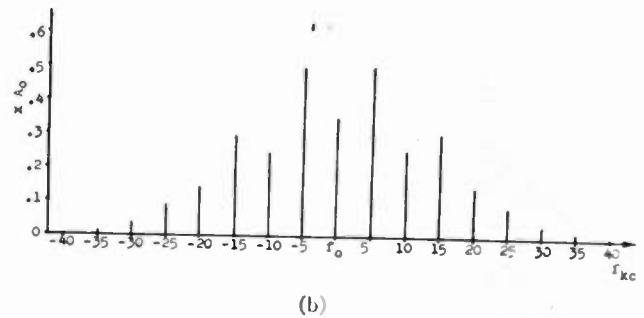
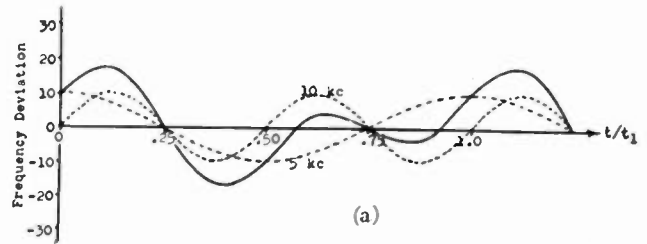

Fig. 7—Two-tone frequency-modulated signal (5-kilocycle modulation—10-kilocycle deviation, and 10-kilocycle modulation—10-kilocycle deviation.)

(a) Modulating signal:

$$f = f_0 + 10 \cos 2\pi f_1 t + 10 \sin 2\pi f_2 t$$

$$\theta_1 = 0, \quad f_1 = 5 \text{ kilocycles}, \quad \theta_2 = -\frac{\pi}{2}, \quad f_2 = 10 \text{ kilocycles}$$

(b) Frequency spectrum after frequency modulation:

$$c = A_0 \sin [\omega_0 t + z_1 \sin 2\pi f_1 t + z_2 \cos 2\pi f_2 t] = A_0 \sum_{n_1=-\infty}^{\infty} \sum_{n_2=-\infty}^{\infty} J_{n_1}(z_1) J_{n_2}(z_2) \sin [2\pi(f_0 + n_1 f_1 + n_2 f_2)t - n_2 \frac{\pi}{2}].$$

$$\theta_1 = 0, \quad f_1 = 5 \text{ kilocycles}, \quad c_1 f_0 = 10 \text{ kilocycles}, \quad z_1 = \frac{c_1 f_0}{f_1} = 2.0$$

$$\theta_2 = -\frac{\pi}{2}, \quad f_2 = 10 \text{ kilocycles}, \quad c_2 f_0 = 10 \text{ kilocycles}, \quad z_2 = \frac{c_2 f_0}{f_2} = 1.0.$$

(c) Oscillogram picture of frequency spectrum.

Single-tone frequency-modulated-signal frequency spectrums are illustrated in Figs. 3, 4, and 5. Additional

By a development similar to that used for a single-tone frequency-modulated signal, the expansion of a

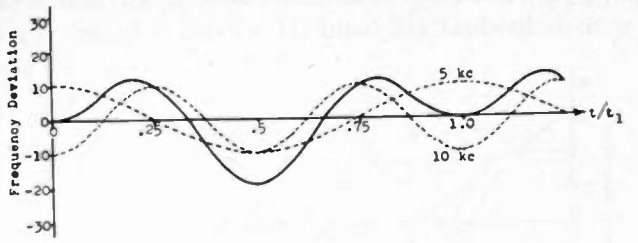

(a)

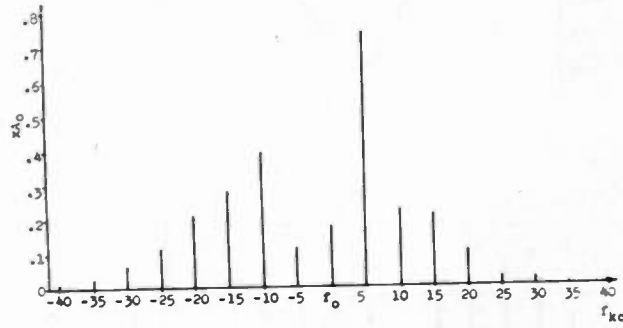

(b)

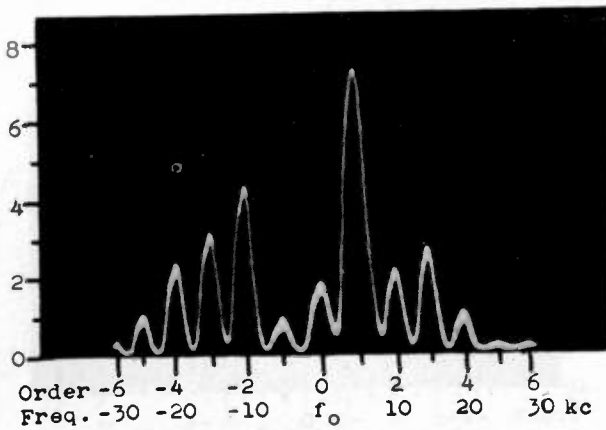

(c)

Fig. 8—Two-tone frequency-modulated signal (5-kilocycle modulation—10-kilocycle deviation and 10-kilocycle modulation—10-kilocycle deviation.)

(a) Modulating signal:

$$f = f_0 + 10 \cos 2\pi f_1 t - 10 \cos 2\pi f_2 t$$

$$\theta_1 = 0, f_1 = 5 \text{ kilocycles}, \theta_2 = -\pi, f_2 = 10 \text{ kilocycles.}$$

(b) Frequency spectrum after frequency modulation:

$$a = A_0 \sin [\omega_0 - z_1 \sin 2\pi f_1 t - z_2 \sin 2\pi f_2 t]$$

$$= A_0 \sum_{n_1=-\infty}^{\infty} \sum_{n_2=-\infty}^{\infty} J_{n_1}(z_1) J_{n_2}(z_2) \sin [2\pi(f_0 + n_1 f_1 + n_2 f_2)t - n_2 \pi].$$

$$\theta_1 = 0, f_1 = 5 \text{ kilocycles}, c_1 f_0 = 10 \text{ kilocycles}, z_1 = \frac{c_1 f_0}{f_1} = 2.0$$

$$\theta_2 = -\pi, f_2 = 10 \text{ kilocycles}, c_2 f_0 = 10 \text{ kilocycles}, z_2 = \frac{c_2 f_0}{f_2} = 1.0$$

(c) Oscilloscope picture of frequency spectrum.

oscilloscope pictures of single-tone frequency-modulated-signal frequency spectrums are given in a paper by R. J. Pieracci.¹⁴

¹⁴ R. J. Pieracci, "A frequency-modulation monitoring system," Proc. I.R.E., vol. 28, pp. 374-378; August, 1940.

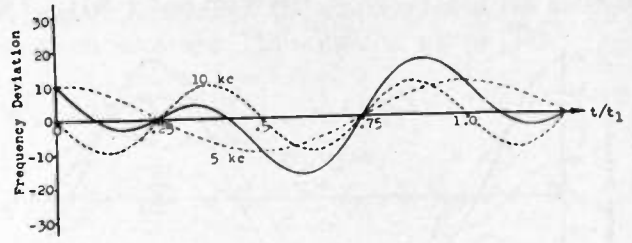

(a)

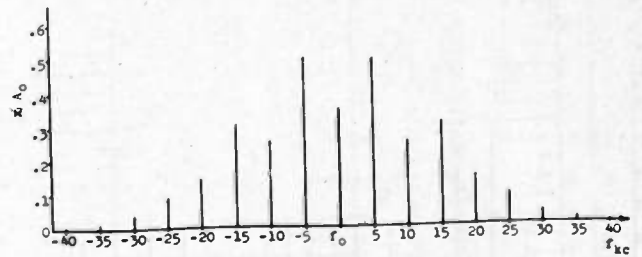

(b)

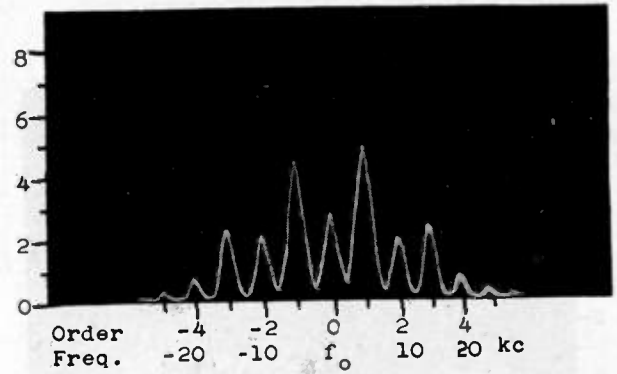

(c)

Fig. 9—Two-tone frequency-modulated signal (5-kilocycle modulation—10-kilocycle deviation, and 10-kilocycle modulation—10-kilocycle deviation.)

(a) Modulating signal:

$$= f_0 + 10 \cos 2\pi f_1 t - 10 \sin 2\pi f_2 t$$

$$\theta_1 = 0, f_1 = 5 \text{ kilocycles}, \theta_2 = -\frac{3}{2}\pi, f_2 = 10 \text{ kilocycles.}$$

(b) Frequency spectrum after frequency modulation:

$$a = A_0 \sin [\omega_0 t + z_1 \sin 2\pi f_1 t + z_2 \cos 2\pi f_2 t]$$

$$= A_0 \sum_{n_1=-\infty}^{\infty} \sum_{n_2=-\infty}^{\infty} J_{n_1}(z_1) J_{n_2}(z_2) \sin [2\pi(f_0 + n_1 f_1 + n_2 f_2)t - n_2 \frac{3}{2}\pi].$$

$$\theta_1 = 0, f_1 = 5 \text{ kilocycles}, c_1 f_0 = 10 \text{ kilocycles}, z_1 = \frac{c_1 f_0}{f_1} = 2.0$$

$$\theta_2 = -\frac{3}{2}\pi, f_2 = 10 \text{ kilocycles}, c_2 f_0 = 10 \text{ kilocycles}, z_2 = \frac{c_2 f_0}{f_2} = 1.0.$$

(c) Oscilloscope picture of frequency spectrum.

two-tone frequency-modulated signal can be shown as

$$a = A_0 \sum_{n_1=-\infty}^{\infty} \sum_{n_2=-\infty}^{\infty} J_{n_1}(z_1) J_{n_2}(z_2) \frac{\sin}{\cos} [\{\omega_0(1 + c_0) + n_1\omega_1 + n_2\omega_2\}t + n_1\theta_1 + n_2\theta_2]$$

$$= A_0 \frac{\sin}{\cos} [\omega_0(1 + c_0)t + z_1 \sin(\omega_1 t + \theta_1) + z_2 \sin(\omega_2 t + \theta_2)]. \quad (30)$$

included in (30). It is seen that the signal, in terms of the sidebands, is given by a double infinite summation. If f_1 and f_2 are not commensurable, there is only one term to each individual sideband. However, if f_1 and f_2 are

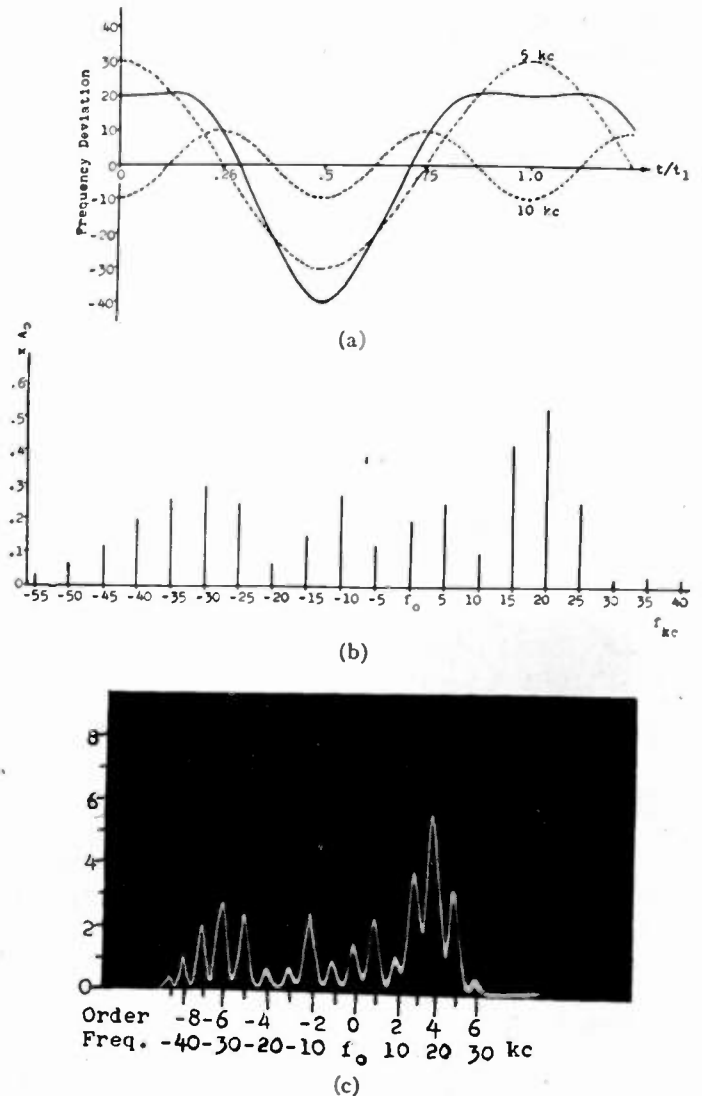
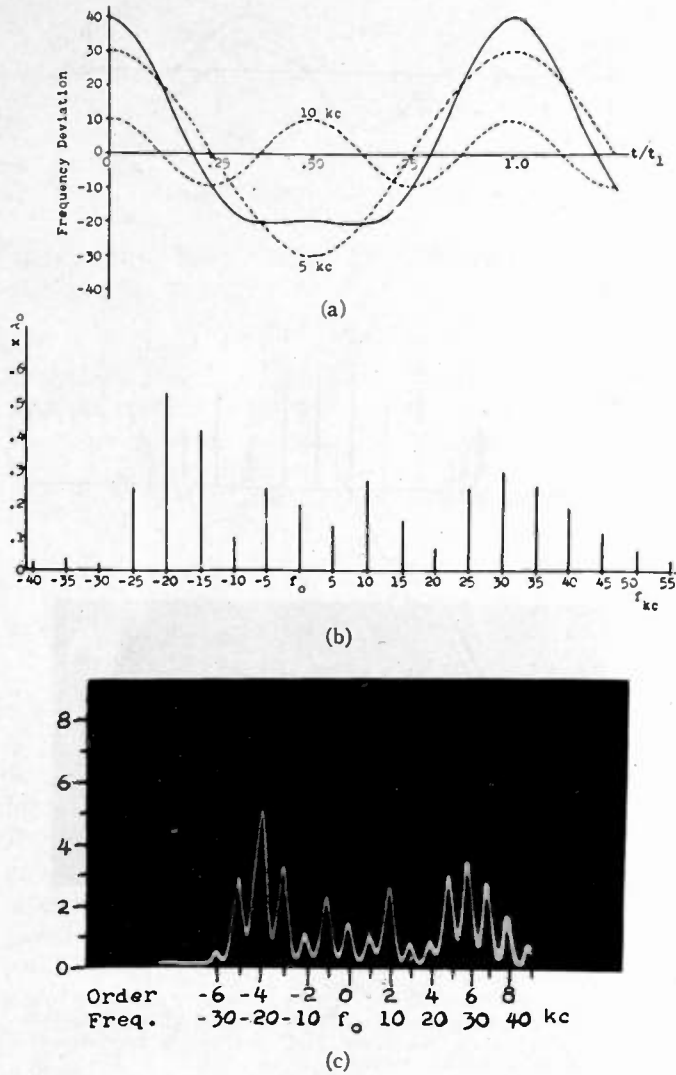

Fig. 10—Two-tone frequency-modulated signal (5-kilocycle modulation—30-kilocycle deviation, and 10-kilocycle modulation—10-kilocycle deviation).

Fig. 11—Two-tone frequency-modulated signal (5-kilocycle modulation—30-kilocycle deviation, and 10-kilocycle modulation—10-kilocycle deviation).

(a) Modulating signal:

$$f = f_0 + 30 \cos 2\pi f_1 t + 10 \cos 2\pi f_2 t$$

$$\theta_1 = 0, f_1 = 5 \text{ kilocycles}, \theta_2 = 0, f_2 = 10 \text{ kilocycles}.$$

(b) Frequency spectrum after frequency modulation:

$$a = A_0 \sin [\omega_0 t + z_1 \sin 2\pi f_1 t + z_2 \sin 2\pi f_2 t]$$

$$= A_0 \sum_{n_1=-\infty}^{\infty} \sum_{n_2=-\infty}^{\infty} J_{n_1}(z_1) J_{n_2}(z_2) \sin [2\pi(f_0 + n_1 f_1 + n_2 f_2)t].$$

$$\theta_1 = 0, f_1 = 5 \text{ kilocycles}, c_1 f_0 = 30 \text{ kilocycles}, z_1 = \frac{c_1 f_0}{f_1} = 6.0$$

$$\theta_2 = 0, f_2 = 10 \text{ kilocycles}, c_2 f_0 = 10 \text{ kilocycles}, z_2 = \frac{c_2 f_0}{f_2} = 1.0.$$

(c) Oscillogram picture of frequency spectrum.

Equation (30) is the general mathematical expression for a signal frequency modulated by any signal composed of two pure sinusoidal terms. All trigonometric forms for a two-tone frequency-modulated signal are

(a) Modulating signal:

$$f = f_0 + 30 \cos 2\pi f_1 t - 10 \cos 2\pi f_2 t$$

$$\theta_1 = 0, f_1 = 5 \text{ kilocycles}, \theta_2 = -\pi, f_2 = 10 \text{ kilocycles}.$$

(b) Frequency spectrum after frequency modulation:

$$a = A_0 \sin [\omega_0 t + z_1 \sin 2\pi f_1 t - z_2 \sin 2\pi f_2 t]$$

$$= A_0 \sum_{n_1=-\infty}^{\infty} \sum_{n_2=-\infty}^{\infty} J_{n_1}(z_1) J_{n_2}(z_2) \sin [2\pi(f_0 + n_1 f_1 + n_2 f_2)t - n_2 \pi].$$

$$\theta_1 = 0, f_1 = 5 \text{ kilocycles}, c_1 f_0 = 30 \text{ kilocycles}, z_1 = \frac{c_1 f_0}{f_1} = 6.0$$

$$\theta_2 = -\pi, f_2 = 10 \text{ kilocycles}, c_2 f_0 = 10 \text{ kilocycles}, z_2 = \frac{c_2 f_0}{f_2} = 1.0.$$

(c) Oscillogram picture of frequency spectrum.

commensurable, each individual sideband is made up of a vector summation of an infinite number of individual terms. The individual terms in this case are all those terms corresponding to n_1 and n_2 for which $n_1 f_1 + n_2 f_2$

= constant. If $b_1 = b_2 = 0$ in (13), so that $\theta_1 = \theta_2 = 0$, the expression (30) for a two-tone frequency-modulated signal is somewhat simplified.

It is of interest to prove that the energy present in a two-tone frequency-modulated signal remains constant during modulation. This can be demonstrated by again forming the squares of the amplitudes of the sideband terms and summing. Thus, making use of (28),

$$W_a \sim A_0^2 \sum_{n_1=-\infty}^{\infty} \sum_{n_2=-\infty}^{\infty} J_{n_1}^2(z_1) J_{n_2}^2(z_2) = A_0^2 \sum_{n_1=-\infty}^{\infty} J_{n_1}^2(z_1) \sum_{n_2=-\infty}^{\infty} J_{n_2}^2(z_2) = A_0^2 \sim W_b. \quad (31)$$

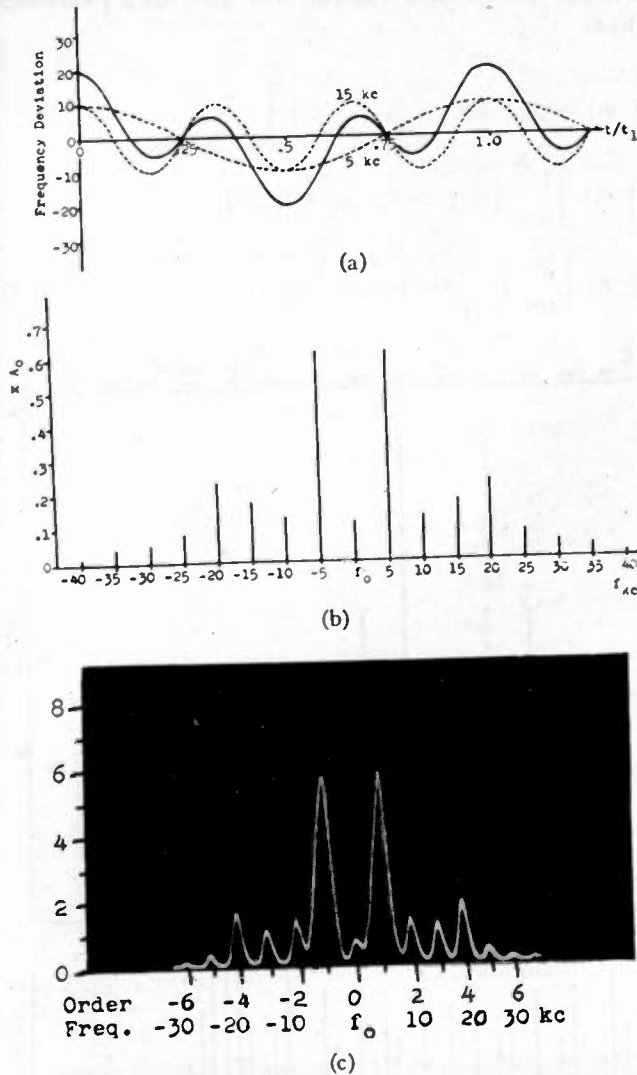

Fig. 12—Two-tone frequency-modulated signal (5-kilocycle modulation—10-kilocycle deviation, and 15-kilocycle modulation—10-kilocycle deviation).

(a) Modulating signal:

$$f = f_0 + 10 \cos 2\pi f_1 t + 10 \cos 2\pi f_2 t$$

$\theta_1 = 0, f_1 = 5$ kilocycles. $\theta_2 = 0, f_2 = 15$ kilocycles.

(b) Frequency spectrum after frequency modulation:

$$a = A_0 \sin [\omega_0 t + z_1 \sin 2\pi f_1 t + z_2 \sin 2\pi f_2 t]$$

$$= A_0 \sum_{n_1=-\infty}^{\infty} \sum_{n_2=-\infty}^{\infty} J_{n_1}(z_1) J_{n_2}(z_2) \sin [2\pi(f_0 + n_1 f_1 + n_2 f_2) t].$$

$\theta_1 = 0, f_1 = 5$ kilocycles. $c_1 f_0 = 10$ kilocycles: $z_1 = \frac{c_1 f_0}{f_1} = 2.0$

$\theta_2 = 0, f_2 = 15$ kilocycles. $c_2 f_0 = 10$ kilocycles: $z_2 = \frac{c_2 f_0}{f_2} = 2/3.$

(c) Oscilloscope picture of frequency spectrum.

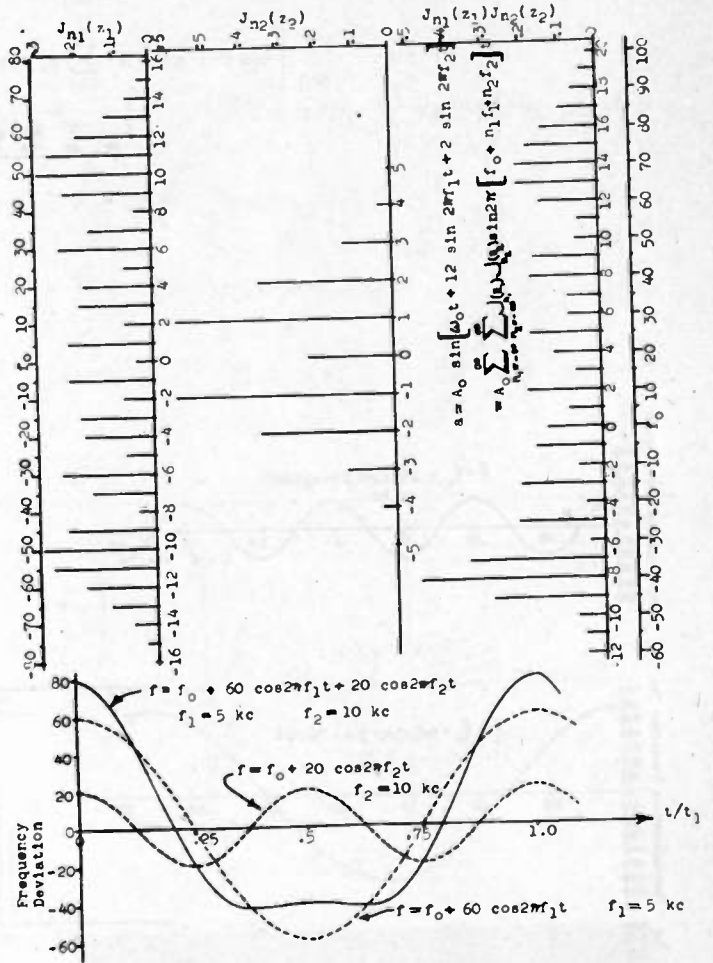

Fig. 13—Single- and two-tone frequency-modulated signal (5-kilocycle modulation—60-kilocycle deviation, and 10-kilocycle modulation—20-kilocycle deviation).

Two-tone frequency-modulated signal spectrums are illustrated in Figs. 6 through 14. Oscilloscope pictures are given to correspond to calculated spectrums.

The expansion for the k -tone frequency-modulated signal will be derived. From the results obtained for the single-tone (27) and the two-tone (30) frequency-modulated signal, it might be deduced that the expression for a k -tone frequency-modulated signal (16) would be

$$a = A_0 \frac{\sin \left[\omega_0(1 + c_0)t + \sum_{i=1}^k z_i \sin(\omega_i t + \theta_i) \right]}{\cos \left[\left\{ \omega_0(1 + c_0) + \sum_{i=1}^k n_i \omega_i \right\} t + \sum_{i=1}^k n_i \theta_i \right]} \prod_{n_i=-\infty}^{\infty} J_{n_i}(z_i) \quad (32)$$

where z_i and θ_i are defined by (4) and (15). The method of mathematical deduction will be used to prove that (32) is correct. This method consists of assuming that (32) is correct for $i=1, 2, 3, \dots, k$ and proving that it holds for $i=k+1$ also. Then, since (32) has already been

proved correct for $i=1$ (27), it must necessarily follow that (32) is correct for all values of i from $i=1$ to $i=k$.

To prove that (32) holds for $i=k+1$, let the $k+1$ term be added and expand the resulting expression. Thus,

$$\begin{aligned}
 a &= A_0 \frac{\sin \left[\omega_0(1+c_0)t + \sum_{i=1}^k z_i \sin(\omega_i t + \theta_i) + z_{k+1} \sin(\omega_{k+1} t + \theta_{k+1}) \right]}{\cos \left[\omega_0(1+c_0)t + \sum_{i=1}^k z_i \sin(\omega_i t + \theta_i) \right]} \frac{\cos \left[z_{k+1} \sin(\omega_{k+1} t + \theta_{k+1}) \right]}{\cos \left[\omega_0(1+c_0)t + \sum_{i=1}^k z_i \sin(\omega_i t + \theta_i) \right]} \\
 &= A_0 \left\{ \frac{\sin \left[\omega_0(1+c_0)t + \sum_{i=1}^k z_i \sin(\omega_i t + \theta_i) \right]}{\cos \left[\omega_0(1+c_0)t + \sum_{i=1}^k z_i \sin(\omega_i t + \theta_i) \right]} \frac{\cos \left[z_{k+1} \sin(\omega_{k+1} t + \theta_{k+1}) \right]}{\cos \left[\omega_0(1+c_0)t + \sum_{i=1}^k z_i \sin(\omega_i t + \theta_i) \right]} \right. \\
 &\quad \left. + \frac{\cos \left[\omega_0(1+c_0)t + \sum_{i=1}^k z_i \sin(\omega_i t + \theta_i) \right]}{\sin \left[\omega_0(1+c_0)t + \sum_{i=1}^k z_i \sin(\omega_i t + \theta_i) \right]} \frac{\sin \left[z_{k+1} \sin(\omega_{k+1} t + \theta_{k+1}) \right]}{\sin \left[\omega_0(1+c_0)t + \sum_{i=1}^k z_i \sin(\omega_i t + \theta_i) \right]} \right\} \quad (33)
 \end{aligned}$$

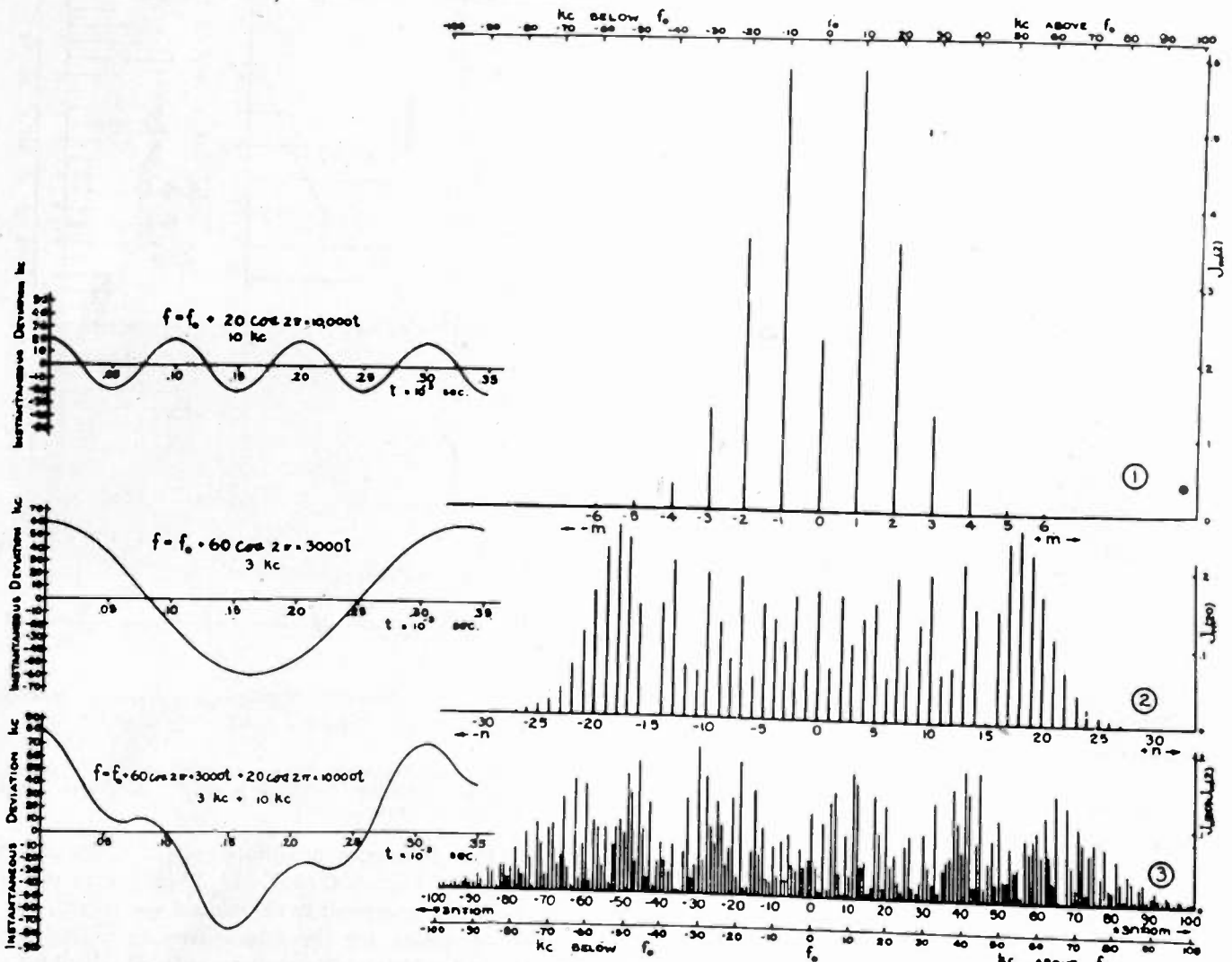

Fig. 14—Single- and two-tone frequency-modulated signal (3-kilocycle modulation—20-kilocycle deviation, and 10-kilocycle modulation—20-kilocycle deviation).

$$\begin{aligned}
 (1) \quad a &= A_0 \sin [\omega_0 t + 2 \sin 2\pi \times 10,000t] \\
 &= A_0 \sum_{m=-\infty}^{\infty} J_m(2) \sin 2\pi [f_0 + m \times 10,000]t. \\
 (2) \quad a &= A_0 \sin [\omega_0 t + 20 \sin 2\pi \times 3000t] \\
 &= A_0 \sum_{n=-\infty}^{\infty} J_n(20) \sin 2\pi [f_0 + n \times 3000]t. \\
 (3) \quad a &= A_0 \sin [\omega_0 t + 20 \sin 2\pi \times 3000t + 2 \sin 2\pi \times 10,000t] \\
 &= A_0 \sum_{n=-\infty}^{\infty} \sum_{m=-\infty}^{\infty} J_n(20) J_m(2) \sin 2\pi [f_0 + n \times 3000 + m \times 10,000]t.
 \end{aligned}$$

Substituting (19), (21), and (32) into (33),

provided use is made of (25) in the latter combination.

$$\begin{aligned}
 a = A_0 \left\{ \sum_{n_1=-\infty}^{\infty} \sum_{n_2=-\infty}^{\infty} \cdots \sum_{n_k=-\infty}^{\infty} J_{n_1}(z_1) J_{n_2}(z_2) \cdots J_{n_k}(z_k) \frac{\sin \left[\left\{ \omega_0(1+c_0) + \sum_{i=1}^k n_i \omega_i \right\} t \right. \right. \\
 \left. \left. + \sum_{i=1}^k n_i \theta_i \right] \right\} \sum_{n_{k+1}=-\infty}^{\infty} J_{2n_{k+1}}(z_{k+1}) \frac{\cos [2n_{k+1}(\omega_{k+1}t + \theta_{k+1})]}{\cos} + \sum_{n_1=-\infty}^{\infty} \sum_{n_2=-\infty}^{\infty} \cdots \sum_{n_k=-\infty}^{\infty} J_{n_1}(z_1) J_{n_2}(z_2) \cdots J_{n_k}(z_k) \\
 \left. \left\{ \begin{aligned} &[+] \cos \left[\left\{ \omega_0(1+c_0) + \sum_{i=1}^k n_i \omega_i \right\} t + \sum_{i=1}^k n_i \theta_i \right] \sum_{n_{k+1}=-\infty}^{\infty} J_{2n_{k+1}-1}(z_{k+1}) \frac{\sin}{\sin} [(2n_{k+1}-1)(\omega_{k+1}t + \theta_{k+1})] \\ &[-] \sin \left[\left\{ \omega_0(1+c_0) + \sum_{i=1}^k n_i \omega_i \right\} t + \sum_{i=1}^k n_i \theta_i \right] \sum_{n_{k+1}=-\infty}^{\infty} J_{2n_{k+1}+1}(z_{k+1}) \frac{\sin}{\sin} [(2n_{k+1}+1)(\omega_{k+1}t + \theta_{k+1})] \end{aligned} \right\} \cdot \quad (34)
 \end{aligned}$$

Using trigonometric identities, (34) may be written

$$\begin{aligned}
 a = \frac{A_0}{2} \sum_{n_1=-\infty}^{\infty} \sum_{n_2=-\infty}^{\infty} \cdots \sum_{n_k=-\infty}^{\infty} \sum_{n_{k+1}=-\infty}^{\infty} \left[J_{n_1}(z_1) J_{n_2}(z_2) \cdots J_{n_k}(z_k) J_{2n_{k+1}}(z_{k+1}) \left\{ \frac{\sin \left[\left\{ \omega_0(1+c_0) + \sum_{i=1}^k n_i \omega_i + 2n_{k+1} \omega_{k+1} \right\} t \right. \right. \right. \\
 \left. \left. + \sum_{i=1}^k n_i \theta_i + 2n_{k+1} \theta_{k+1} \right] \right\} + \frac{\sin \left[\left\{ \omega_0(1+c_0) + \sum_{i=1}^k n_i \omega_i - 2n_{k+1} \omega_{k+1} \right\} t + \sum_{i=1}^k n_i \theta_i - 2n_{k+1} \theta_{k+1} \right]}{\cos} \right] \\
 + J_{n_1}(z_1) J_{n_2}(z_2) \cdots J_{n_k}(z_k) J_{2n_{k+1}-1}(z_{k+1}) \left\{ \frac{\sin \left[\left\{ \omega_0(1+c_0) + \sum_{i=1}^k n_i \omega_i + (2n_{k+1}-1) \omega_{k+1} \right\} t \right. \right. \\
 \left. \left. + \sum_{i=1}^k n_i \theta_i + (2n_{k+1}-1) \theta_{k+1} \right] \right\} - \frac{\sin \left[\left\{ \omega_0(1+c_0) + \sum_{i=1}^k n_i \omega_i - (2n_{k+1}-1) \omega_{k+1} \right\} t \right. \\
 \left. \left. + \sum_{i=1}^k n_i \theta_i - (2n_{k+1}-1) \theta_{k+1} \right] \right\} \cdot \quad (35)
 \end{aligned}$$

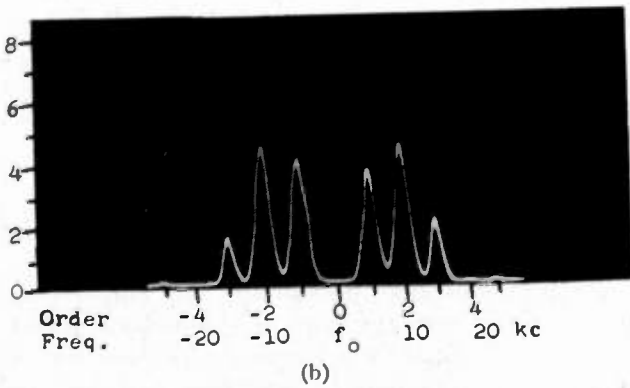
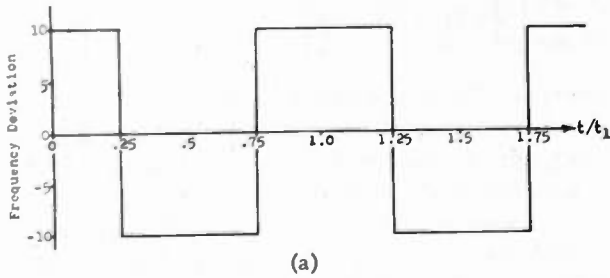

Fig. 15—Multitone frequency-modulated signal (5-kilocycle square-wave modulation—10-kilocycle deviation.)

(a) Modulating signal:

$$f = f_0 + 10 \left(\frac{4}{\pi} \right) \sum_{n=1}^{\infty} \frac{\cos 2(2n+1)\pi f_1 t}{(2n+1)}$$

$$\theta_n = 0, \quad f_1 = 5 \text{ kilocycles.}$$

(b) Frequency spectrum after frequency modulation.

By careful examination of (35) it is seen that the first and third terms in (35) add to give an expression identical with the combination of the second and fourth terms

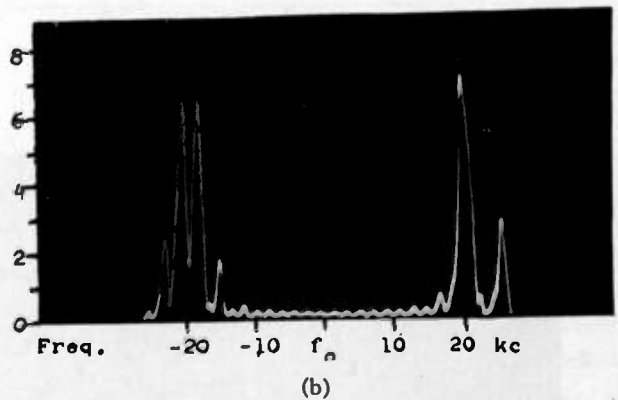
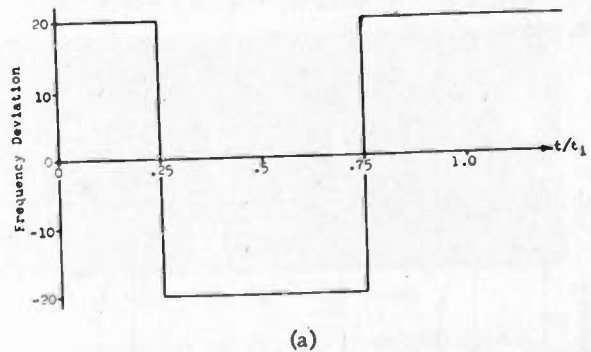

Fig. 16—Multitone frequency-modulated signal (500-cycle square-wave modulation—20-kilocycle deviation.)

(a) Modulating signal:

$$= f_0 + 20 \left(\frac{4}{\pi} \right) \sum_{n=1}^{\infty} \frac{\cos 2(2n+1)\pi f_1 t}{(2n+1)}$$

$$\theta_n = 0, \quad f_1 = 500 \text{ cycles.}$$

(b) Frequency spectrum after frequency modulation.

Thus (35) may be written

$$a = A_0 \sum_{n_1=-\infty}^{\infty} \sum_{n_2=-\infty}^{\infty} \cdots \sum_{n_k=-\infty}^{\infty} \sum_{n_{k+1}=-\infty}^{\infty} J_{n_1}(z_1) J_{n_2}(z_2) \cdots J_{n_k}(z_k) J_{n_{k+1}}(z_{k+1}) \frac{\sin \left[\left\{ \omega_0(1 + c_0) + \sum_{i=1}^{k-1} n_i \omega_i \right\} t + \sum_{i=1}^{k-1} n_i \theta_i \right]}{\cos \left[\left\{ \omega_0(1 + c_0) + \sum_{i=1}^{k-1} n_i \omega_i \right\} t + \sum_{i=1}^{k-1} n_i \theta_i \right]} \quad (36)$$

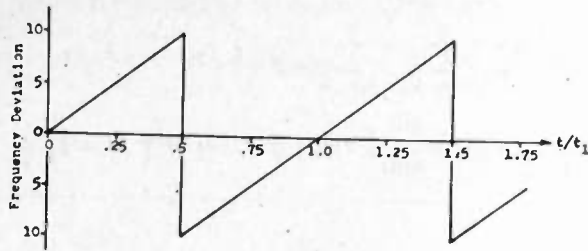

(a)

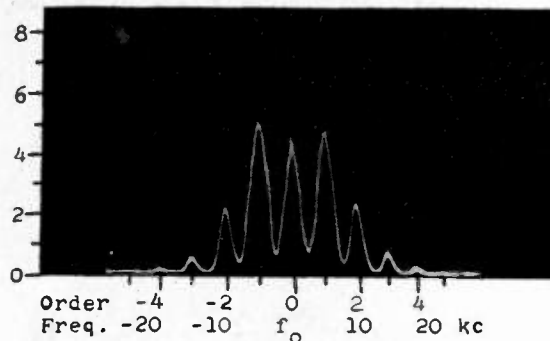

(b)

Fig. 17—Multitone frequency-modulated signal (5-kilocycle sawtooth-wave modulation—10-kilocycle deviation).

(a) Modulating signal:

$$f = f_0 + 10 \left(\frac{1}{\pi} \right) \sum_{n=1}^{\infty} \frac{(-1)^{n-1}}{n} \sin 2n\pi f_1 t$$

$$\theta_n = -\frac{\pi}{2}, \quad f_1 = 5 \text{ kilocycles.}$$

(b) Frequency spectrum after frequency modulation.

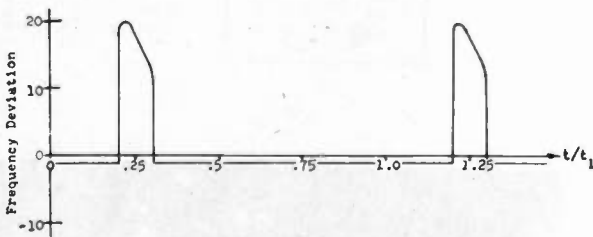

(a)

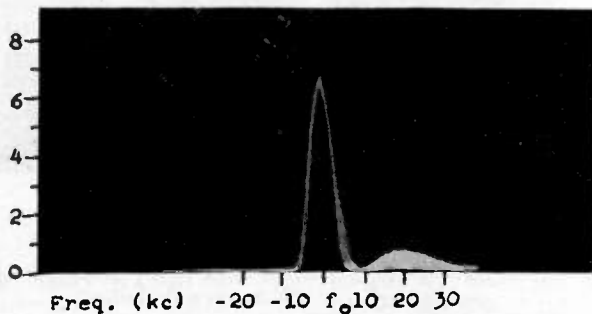

(b)

Fig. 18—Multitone frequency-modulated signal (400-pulse-per-second modulation—20-kilocycle positive deviation.)

(a) Modulating signal: $f_1 = 400$ pulses per second.
 (b) Frequency spectrum after frequency modulation.

It is seen that (36) is identical to (32) with the exception that the range of summation has been extended to $k+1$. By mathematical induction, as indicated above, it follows that (32) is valid for $i=1, 2, 3, \dots, k$. If the series of terms in (32) can be shown to converge, the range of i can be extended to $k = \infty$. Convergence follows immediately from the inequality^{15,16}

$$|J_{n_i}(z_i)| \leq \frac{z_i^2}{n_i^2 - 1} \quad n_i = 2, 3, \dots, \quad (37)$$

so that

$$L \lim_{n_i \rightarrow \infty} |J_{n_i}(z_i)| = L \lim_{n_i \rightarrow \infty} \frac{z_i^2}{n_i^2 - 1} = 0. \quad (38)$$

Equation (32) extended to ∞ may be written in a compact manner as

$$a = A_0 \frac{\sin \left[\omega_0(1 + c_0)t + \sum_{i=1}^{\infty} z_i \sin(\omega_i t + \theta_i) \right]}{\cos \left[\omega_0(1 + c_0)t + \sum_{i=1}^{\infty} z_i \sin(\omega_i t + \theta_i) \right]}$$

$$= A_0 \prod_{i=1}^{\infty} \left[\sum_{n_i=-\infty}^{\infty} J_{n_i}(z_i) \right]$$

$$\frac{\sin \left[\left\{ \omega_0(1 + c_0) + \sum_{i=1}^{\infty} n_i \omega_i \right\} t + \sum_{i=1}^{\infty} n_i \theta_i \right]}{\cos \left[\left\{ \omega_0(1 + c_0) + \sum_{i=1}^{\infty} n_i \omega_i \right\} t + \sum_{i=1}^{\infty} n_i \theta_i \right]} \quad (39)$$

Equation (39) is the general mathematical expression for a signal frequency modulated by a signal composed of an infinite number of sinusoidal components. The frequency-modulated signal has been expressed in terms of an infinite number of discrete side-frequency terms.

It can be shown that the energy present in a multitone frequency-modulated signal remains constant during modulation in the same manner that was shown to be true for the two-tone frequency-modulated signal (31). Thus, from (39) and making use of (28),

$$W_a \sim A_0^2 \prod_{i=1}^{\infty} \left[\sum_{n_i=-\infty}^{\infty} J_{n_i}^2(z_i) \right] = A_0^2 \sim W_b. \quad (40)$$

Multitone frequency-modulated spectrums are shown in Figs. 15 through 18.

As was indicated previously, the single-tone frequency-modulated spectrum is symmetrical about the carrier in amplitude and frequency location, but not in phase. For a two-tone or multitone frequency-modulated signal, symmetry is no longer present, although it may be present in special cases. Sideband unsymmetry has been indicated by other authors¹⁷ who have pointed

¹⁵ From the author's personal notes on a course on "Partial differential equations," given by I. E. Ward, State University of Iowa, 1939.

¹⁶ R. V. Churchill, "Fourier Series and Boundary Value Problems," McGraw-Hill Book Co., New York, N. Y., 1941, p. 152.

¹⁷ F. H. Kroger, Bertram Trevor, and J. E. Smith, "A 500-megacycle radio-relay distribution system for television," *RCA Rev.*, vol. 5, pp. 31-50; July, 1940.

ut that sideband symmetry about the carrier occurs in frequency modulation only when the polarities of the modulating wave have symmetrical waveshapes. That

3:

Symmetrical modulating signals produce symmetrical frequency-modulated signal spectrums, while unsymmetrical modulating signals produce unsymmetrical spectrums.

This statement is clearly demonstrated in Figs. 6 through 9, which give frequency spectrums for two-tone frequency-modulated signals with the second harmonic term added in different phases to give unsymmetrical sidebands (Figs. 6 and 8) or symmetrical sidebands (Figs. 7 and 9). Because of a slight degree of unsymmetry of the modulating square wave, the frequency spectrum in Fig. 15 does not possess perfect symmetry. Unsymmetry in Fig. 16 is largely caused by the small frequency of the modulating square wave. Apparent sidebands in Fig. 16 as well as in Fig. 19 are caused by interaction between the modulating frequency and the sweep frequency of the spectrum analyzer.

From the statements made above, it appears permissible to associate the upper sideband with the positive side of the modulating wave (assuming that the frequency is deviated upward by the positive side of the modulating wave) and the lower sideband with the negative side of the modulating wave. This leads to the statement:

The energy in the sidebands tends to distribute itself in accordance with the shape of the modulating wave.

Thus, for a sine-wave modulating signal the carrier is momentarily stationary at the inflection points at the two ends so that sideband energy tends to bunch up at these points (Fig. 4). The bunching of the sideband energy is more noticeable, as might be expected, for square-wave modulating signals (see Figs. 15 and 16) and for sine-wave modulating signals when the modulation index, $c f_0 / f_i$, is large (Fig. 19). As a matter of fact, the grouping of sideband energy under the latter condition is sufficiently pronounced that it affords an excellent means of measuring frequency deviation under dynamic conditions (Fig. 19). It is only necessary that the spectrum analyzer be calibrated in frequency; this can be done by modulating with a high enough frequency so that the sidebands may be noted and the analyzer oscilloscope calibrated. Calibration is necessary because, when the modulating signal is small, the sidebands are usually too close together for resolution.

The statement given above on the distribution of sideband energy indicates that it is impossible to make a concise statement as to how the effective bandwidth of a frequency-modulated signal spectrum changes with the introduction of harmonics of the modulating signal. Generally, it can be stated that the effective bandwidth

is increased or decreased depending on whether the harmonics add in such phase as to either increase or decrease the peak deviation of the resulting signal. Thus the presence of a third harmonic of the modulating signal will increase the peak deviation if added in cosine phase as indicated in Fig. 12, or will decrease the peak deviation if added in sine phase.

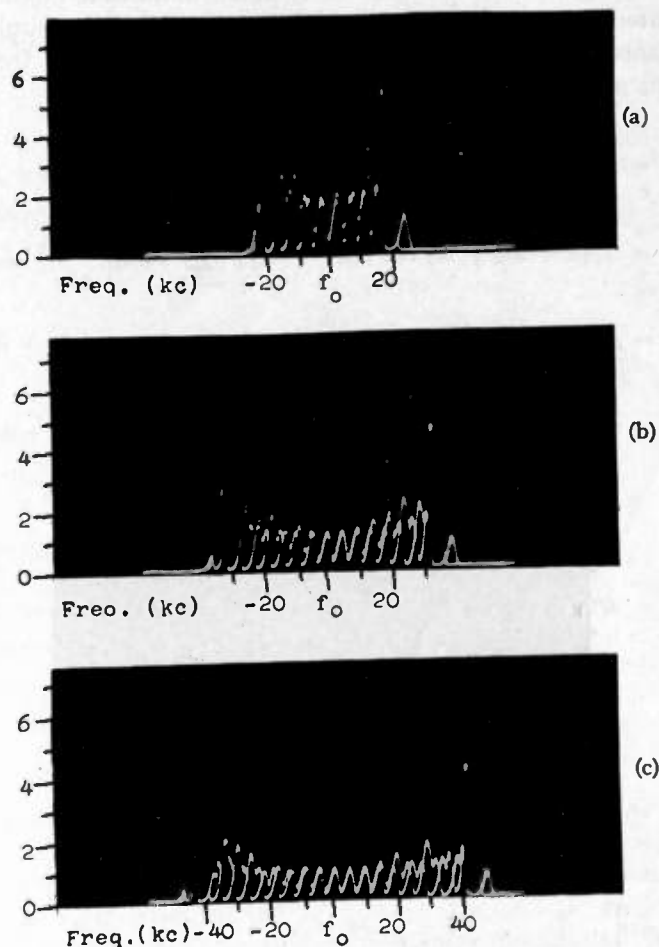

Fig. 19—Single-tone frequency-modulated signals.
(a) 500-cycle-per-second modulation—20-kilocycle deviation.
(b) 500-cycle-per-second modulation—30-kilocycle deviation.
(c) 500-cycle-per-second modulation—40-kilocycle deviation.

PART III—COMBINED AMPLITUDE AND FREQUENCY MODULATION

The sideband resolution of a signal simultaneously modulated in amplitude and frequency with the same modulating signal has been carried out by several authors.¹⁸⁻²¹ The general case of combined amplitude and frequency modulation, where the modulating signal causing amplitude modulation may be different from the modulating signal causing frequency modulation,

¹⁸ Hans Roder, "Amplitude, phase, and frequency modulation," *Proc. I.R.E.*, vol. 19, pp. 2145-2176; December, 1931.

¹⁹ August Hund, "High-Frequency Measurements," McGraw-Hill Book Co., New York, N. Y.; 1933, p. 376.

²⁰ August Hund, "Frequency Modulation," McGraw-Hill Book Co., New York, N. Y.; 1942, p. 55.

²¹ W. L. Barrow, "A new electrical method of frequency analysis and its application to frequency modulation," *Proc. I.R.E.*, vol. 20, pp. 1626-1639; October, 1932.

Thus (35) may be written

$$a = A_0 \sum_{n_1=-\infty}^{\infty} \sum_{n_2=-\infty}^{\infty} \cdots \sum_{n_k=-\infty}^{\infty} \sum_{n_{k+1}=-\infty}^{\infty} J_{n_1}(z_1) J_{n_2}(z_2) \cdots J_{n_k}(z_k) J_{n_{k+1}}(z_{k+1}) \frac{\sin \left[\left\{ \omega_0(1 + c_0) + \sum_{i=1}^{k-1} n_i \omega_i \right\} t + \sum_{i=1}^{k-1} n_i \theta_i \right]}{\cos \left[\left\{ \omega_0(1 + c_0) + \sum_{i=1}^{k-1} n_i \omega_i \right\} t + \sum_{i=1}^{k-1} n_i \theta_i \right]} \quad (36)$$

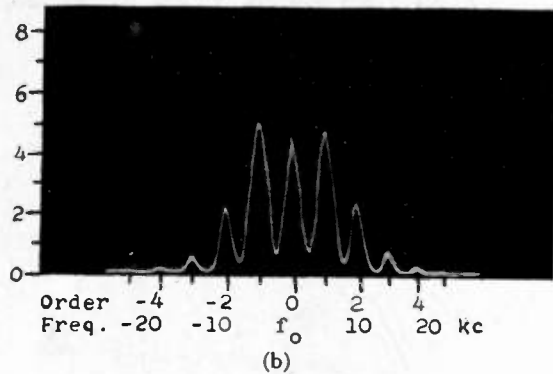
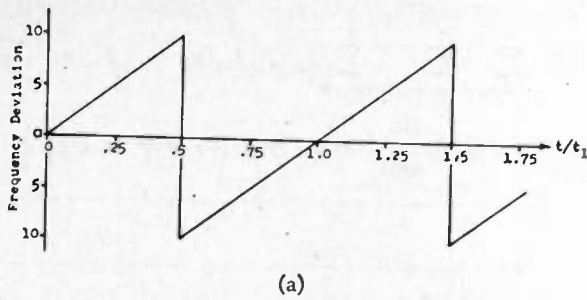

Fig. 17—Multitone frequency-modulated signal (5-kilocycle sawtooth-wave modulation—10-kilocycle deviation).

(a) Modulating signal:

$$f = f_0 + 10 \left(\frac{1}{\pi} \right) \sum_{n=1}^{\infty} \frac{(-1)^{n-1}}{n} \sin 2n\pi f_1 t$$

$$\theta_n = -\frac{\pi}{2}, \quad f_1 = 5 \text{ kilocycles.}$$

(b) Frequency spectrum after frequency modulation.

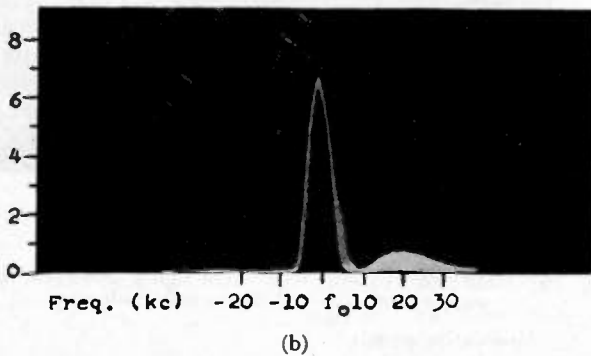
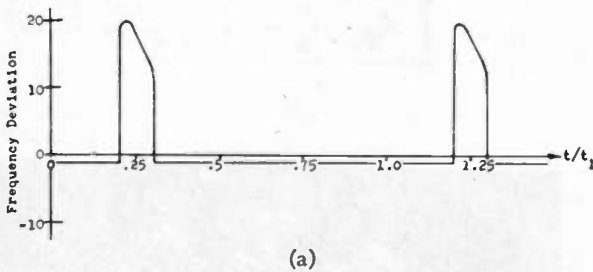

Fig. 18—Multitone frequency-modulated signal (400-pulse-per-second modulation—20-kilocycle positive deviation.)

(a) Modulating signal: $f_1 = 400$ pulses per second.
 (b) Frequency spectrum after frequency modulation.

It is seen that (36) is identical to (32) with the exception that the range of summation has been extended to $k+1$. By mathematical induction, as indicated above, it follows that (32) is valid for $i=1, 2, 3, \dots, k$. If the series of terms in (32) can be shown to converge, the range of i can be extended to $k = \infty$. Convergence follows immediately from the inequality^{15,16}

$$|J_{n_i}(z_i)| \leq \frac{z_i^2}{n_i^2 - 1} \quad n_i = 2, 3, \dots, \quad (37)$$

so that

$$L_{n_i \rightarrow \infty} |J_{n_i}(z_i)| = L_{n_i \rightarrow \infty} \frac{z_i^2}{n_i^2 - 1} = 0. \quad (38)$$

Equation (32) extended to ∞ may be written in a compact manner as

$$a = A_0 \frac{\sin \left[\omega_0(1 + c_0)t + \sum_{i=1}^{\infty} z_i \sin(\omega_i t + \theta_i) \right]}{\cos \left[\omega_0(1 + c_0)t + \sum_{i=1}^{\infty} z_i \sin(\omega_i t + \theta_i) \right]}$$

$$= A_0 \prod_{i=1}^{\infty} \left[\sum_{n_i=-\infty}^{\infty} J_{n_i}(z_i) \right]$$

$$\frac{\sin \left[\left\{ \omega_0(1 + c_0) + \sum_{i=1}^{\infty} n_i \omega_i \right\} t + \sum_{i=1}^{\infty} n_i \theta_i \right]}{\cos \left[\left\{ \omega_0(1 + c_0) + \sum_{i=1}^{\infty} n_i \omega_i \right\} t + \sum_{i=1}^{\infty} n_i \theta_i \right]} \quad (39)$$

Equation (39) is the general mathematical expression for a signal frequency modulated by a signal composed of an infinite number of sinusoidal components. The frequency-modulated signal has been expressed in terms of an infinite number of discrete side-frequency terms.

It can be shown that the energy present in a multitone frequency-modulated signal remains constant during modulation in the same manner that was shown to be true for the two-tone frequency-modulated signal (31). Thus, from (39) and making use of (28),

$$W_a \sim A_0^2 \prod_{i=1}^{\infty} \left[\sum_{n_i=-\infty}^{\infty} J_{n_i}^2(z_i) \right] = A_0^2 \sim W_b. \quad (40)$$

Multitone frequency-modulated spectrums are shown in Figs. 15 through 18.

As was indicated previously, the single-tone frequency-modulated spectrum is symmetrical about the carrier in amplitude and frequency location, but not in phase. For a two-tone or multitone frequency-modulated signal, symmetry is no longer present, although it may be present in special cases. Sideband unsymmetry has been indicated by other authors¹⁷ who have pointed

¹⁵ From the author's personal notes on a course on "Partial differential equations," given by I. E. Ward, State University of Iowa, 1939.

¹⁶ R. V. Churchill, "Fourier Series and Boundary Value Problems," McGraw-Hill Book Co., New York, N. Y., 1941, p. 152.

¹⁷ F. H. Kroger, Bertram Trevor, and J. E. Smith, "A 500-megacycle radio-relay distribution system for television," *RCA Rev.*, vol. 5, pp. 31-50; July, 1940.

but that sideband symmetry about the carrier occurs in frequency modulation only when the polarities of the modulating wave have symmetrical waveshapes. That is:

Symmetrical modulating signals produce symmetrical frequency-modulated signal spectrums, while unsymmetrical modulating signals produce unsymmetrical spectrums.

This statement is clearly demonstrated in Figs. 6 through 9, which give frequency spectrums for two-tone frequency-modulated signals with the second harmonic term added in different phases to give unsymmetrical sidebands (Figs. 6 and 8) or symmetrical sidebands (Figs. 7 and 9). Because of a slight degree of unsymmetry of the modulating square wave, the frequency spectrum in Fig. 15 does not possess perfect symmetry. Unsymmetry in Fig. 16 is largely caused by the small frequency of the modulating square wave. Apparent sidebands in Fig. 16 as well as in Fig. 19 are caused by interaction between the modulating frequency and the sweep frequency of the spectrum analyzer.

From the statements made above, it appears permissible to associate the upper sideband with the positive side of the modulating wave (assuming that the frequency is deviated upward by the positive side of the modulating wave) and the lower sideband with the negative side of the modulating wave. This leads to the statement:

The energy in the sidebands tends to distribute itself in accordance with the shape of the modulating wave.

Thus, for a sine-wave modulating signal the carrier is momentarily stationary at the inflection points at the two ends so that sideband energy tends to bunch up at these points (Fig. 4). The bunching of the sideband energy is more noticeable, as might be expected, for square-wave modulating signals (see Figs. 15 and 16) and for sine-wave modulating signals when the modulation index, $c f_0 / f_i$, is large (Fig. 19). As a matter of fact, the grouping of sideband energy under the latter condition is sufficiently pronounced that it affords an excellent means of measuring frequency deviation under dynamic conditions (Fig. 19). It is only necessary that the spectrum analyzer be calibrated in frequency; this can be done by modulating with a high enough frequency so that the sidebands may be noted and the analyzer oscilloscope calibrated. Calibration is necessary because, when the modulating signal is small, the sidebands are usually too close together for resolution.

The statement given above on the distribution of sideband energy indicates that it is impossible to make a concise statement as to how the effective bandwidth of a frequency-modulated signal spectrum changes with the introduction of harmonics of the modulating signal. Generally, it can be stated that the effective bandwidth

is increased or decreased depending on whether the harmonics add in such phase as to either increase or decrease the peak deviation of the resulting signal. Thus the presence of a third harmonic of the modulating signal will increase the peak deviation if added in cosine phase as indicated in Fig. 12, or will decrease the peak deviation if added in sine phase.

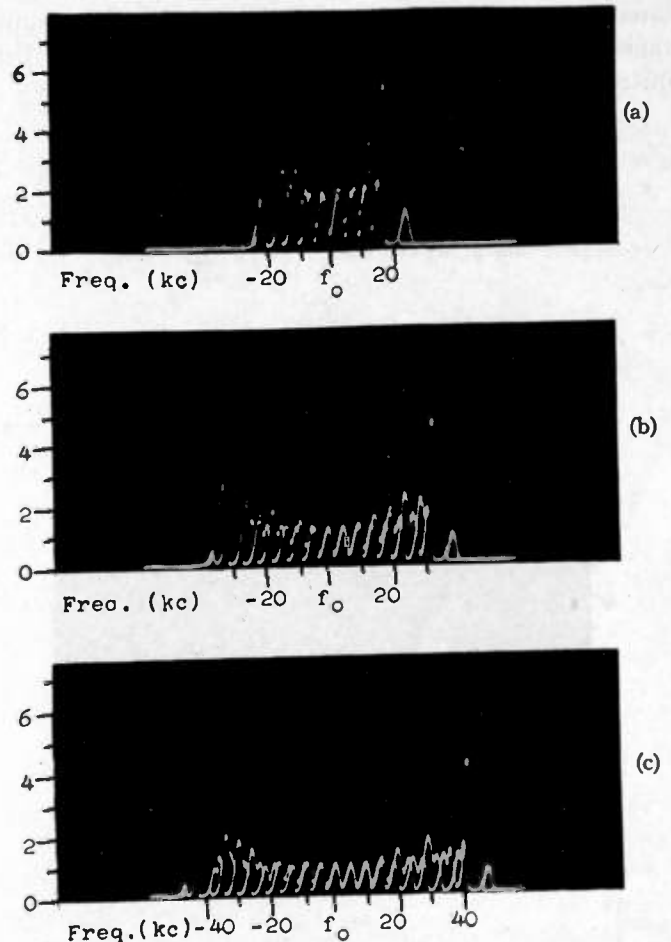

Fig. 19—Single-tone frequency-modulated signals.
 (a) 500-cycle-per-second modulation—20-kilocycle deviation.
 (b) 500-cycle-per-second modulation—30-kilocycle deviation.
 (c) 500-cycle-per-second modulation—40-kilocycle deviation.

PART III—COMBINED AMPLITUDE AND FREQUENCY MODULATION

The sideband resolution of a signal simultaneously modulated in amplitude and frequency with the same modulating signal has been carried out by several authors.¹⁸⁻²¹ The general case of combined amplitude and frequency modulation, where the modulating signal causing amplitude modulation may be different from the modulating signal causing frequency modulation,

¹⁸ Hans Roder, "Amplitude, phase, and frequency modulation," *Proc. I.R.E.*, vol. 19, pp. 2145-2176; December, 1931.

¹⁹ August Hund, "High-Frequency Measurements," McGraw-Hill Book Co., New York, N. Y.; 1933, p. 376.

²⁰ August Hund, "Frequency Modulation," McGraw-Hill Book Co., New York, N. Y.; 1942, p. 55.

²¹ W. L. Barrow, "A new electrical method of frequency analysis and its application to frequency modulation," *Proc. I.R.E.*, vol. 20, pp. 1626-1639; October, 1932.

Thus (35) may be written

$$a = A_0 \sum_{n_1=-\infty}^{\infty} \sum_{n_2=-\infty}^{\infty} \cdots \sum_{n_k=-\infty}^{\infty} \sum_{n_{k+1}=-\infty}^{\infty} J_{n_1}(z_1) J_{n_2}(z_2) \cdots J_{n_k}(z_k) J_{n_{k+1}}(z_{k+1}) \frac{\sin \left[\left\{ \omega_0(1 + c_0) + \sum_{i=1}^{k-1} n_i \omega_i \right\} t + \sum_{i=1}^{k-1} n_i \theta_i \right]}{\cos \left[\left\{ \omega_0(1 + c_0) + \sum_{i=1}^{k-1} n_i \omega_i \right\} t + \sum_{i=1}^{k-1} n_i \theta_i \right]} \quad (36)$$

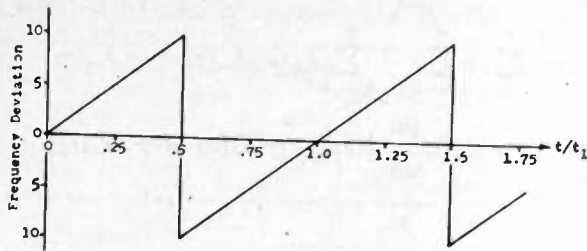

(a)

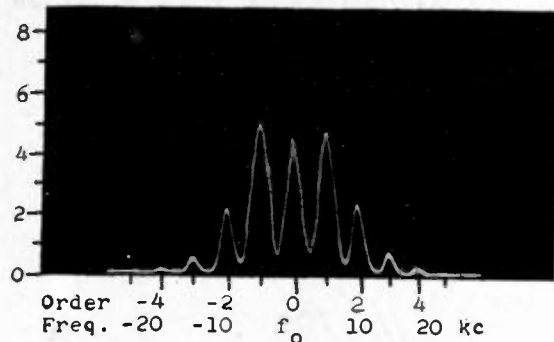

(b)

Fig. 17—Multitone frequency-modulated signal (5-kilocycle sawtooth-wave modulation—10-kilocycle deviation).

(a) Modulating signal:

$$f = f_0 + 10 \left(\frac{1}{\pi} \right) \sum_{n=1}^{\infty} \frac{(-1)^{n-1}}{n} \sin 2n\pi f_1 t$$

$$\theta_n = -\frac{\pi}{2}, \quad f_1 = 5 \text{ kilocycles.}$$

(b) Frequency spectrum after frequency modulation.

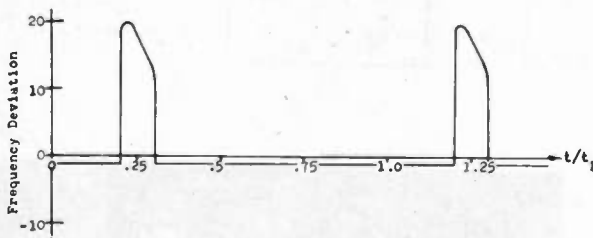

(a)

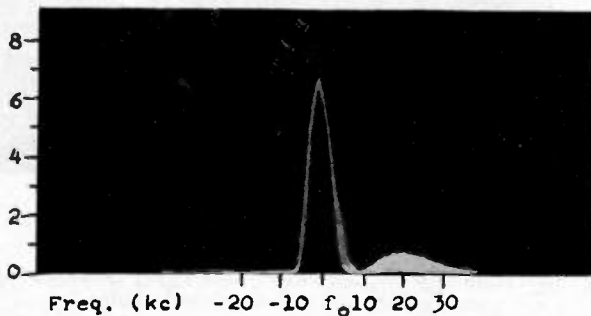

(b)

Fig. 18—Multitone frequency-modulated signal (400-pulse-per-second modulation—20-kilocycle positive deviation.)

(a) Modulating signal: $f_1 = 400$ pulses per second.
 (b) Frequency spectrum after frequency modulation.

It is seen that (36) is identical to (32) with the exception that the range of summation has been extended to $k+1$. By mathematical induction, as indicated above, it follows that (32) is valid for $i=1, 2, 3, \dots, k$. If the series of terms in (32) can be shown to converge, the range of i can be extended to $k = \infty$. Convergence follows immediately from the inequality^{16,16}

$$|J_{n_i}(z_i)| \leq \frac{z_i^2}{n_i^2 - 1} \quad n_i = 2, 3, \dots, \quad (37)$$

so that

$$L \lim_{n_i \rightarrow \infty} |J_{n_i}(z_i)| = L \lim_{n_i \rightarrow \infty} \frac{z_i^2}{n_i^2 - 1} = 0. \quad (38)$$

Equation (32) extended to ∞ may be written in a compact manner as

$$a = A_0 \frac{\sin \left[\omega_0(1 + c_0)t + \sum_{i=1}^{\infty} z_i \sin(\omega_i t + \theta_i) \right]}{\cos \left[\omega_0(1 + c_0)t + \sum_{i=1}^{\infty} z_i \sin(\omega_i t + \theta_i) \right]}$$

$$= A_0 \prod_{i=1}^{\infty} \left[\sum_{n_i=-\infty}^{\infty} J_{n_i}(z_i) \right]$$

$$\frac{\sin \left[\left\{ \omega_0(1 + c_0) + \sum_{i=1}^{\infty} n_i \omega_i \right\} t + \sum_{i=1}^{\infty} n_i \theta_i \right]}{\cos \left[\left\{ \omega_0(1 + c_0) + \sum_{i=1}^{\infty} n_i \omega_i \right\} t + \sum_{i=1}^{\infty} n_i \theta_i \right]} \quad (39)$$

Equation (39) is the general mathematical expression for a signal frequency modulated by a signal composed of an infinite number of sinusoidal components. The frequency-modulated signal has been expressed in terms of an infinite number of discrete side-frequency terms.

It can be shown that the energy present in a multi-tone frequency-modulated signal remains constant during modulation in the same manner that was shown to be true for the two-tone frequency-modulated signal (31). Thus, from (39) and making use of (28),

$$W_a \sim A_0^2 \prod_{i=1}^{\infty} \left[\sum_{n_i=-\infty}^{\infty} J_{n_i}^2(z_i) \right] = A_0^2 \sim W_b. \quad (40)$$

Multitone frequency-modulated spectrums are shown in Figs. 15 through 18.

As was indicated previously, the single-tone frequency-modulated spectrum is symmetrical about the carrier in amplitude and frequency location, but not in phase. For a two-tone or multi-tone frequency-modulated signal, symmetry is no longer present, although it may be present in special cases. Sideband unsymmetry has been indicated by other authors¹⁷ who have pointed

¹⁵ From the author's personal notes on a course on "Partial differential equations," given by I. E. Ward, State University of Iowa, 1939.

¹⁶ R. V. Churchill, "Fourier Series and Boundary Value Problems," McGraw-Hill Book Co., New York, N. Y., 1941, p. 152.

¹⁷ F. H. Kroger, Bertram Trevor, and J. E. Smith, "A 500-megacycle radio-relay distribution system for television," *RCA Rev.*, vol. 5, pp. 31-50; July, 1940.

but that sideband symmetry about the carrier occurs in frequency modulation only when the polarities of the modulating wave have symmetrical waveshapes. That is:

Symmetrical modulating signals produce symmetrical frequency-modulated signal spectrums, while unsymmetrical modulating signals produce unsymmetrical spectrums.

This statement is clearly demonstrated in Figs. 6 through 9, which give frequency spectrums for two-tone frequency-modulated signals with the second harmonic term added in different phases to give unsymmetrical sidebands (Figs. 6 and 8) or symmetrical sidebands (Figs. 7 and 9). Because of a slight degree of unsymmetry of the modulating square wave, the frequency spectrum in Fig. 15 does not possess perfect symmetry. Unsymmetry in Fig. 16 is largely caused by the small frequency of the modulating square wave. Apparent sidebands in Fig. 16 as well as in Fig. 19 are caused by interaction between the modulating frequency and the sweep frequency of the spectrum analyzer.

From the statements made above, it appears permissible to associate the upper sideband with the positive side of the modulating wave (assuming that the frequency is deviated upward by the positive side of the modulating wave) and the lower sideband with the negative side of the modulating wave. This leads to the statement:

The energy in the sidebands tends to distribute itself in accordance with the shape of the modulating wave.

Thus, for a sine-wave modulating signal the carrier is momentarily stationary at the inflection points at the two ends so that sideband energy tends to bunch up at these points (Fig. 4). The bunching of the sideband energy is more noticeable, as might be expected, for square-wave modulating signals (see Figs. 15 and 16) and for sine-wave modulating signals when the modulation index, $c_f f_0 / f_i$, is large (Fig. 19). As a matter of fact, the grouping of sideband energy under the latter condition is sufficiently pronounced that it affords an excellent means of measuring frequency deviation under dynamic conditions (Fig. 19). It is only necessary that the spectrum analyzer be calibrated in frequency; this can be done by modulating with a high enough frequency so that the sidebands may be noted and the analyzer oscilloscope calibrated. Calibration is necessary because, when the modulating signal is small, the sidebands are usually too close together for resolution.

The statement given above on the distribution of sideband energy indicates that it is impossible to make a concise statement as to how the effective bandwidth of a frequency-modulated signal spectrum changes with the introduction of harmonics of the modulating signal. Generally, it can be stated that the effective bandwidth

is increased or decreased depending on whether the harmonics add in such phase as to either increase or decrease the peak deviation of the resulting signal. Thus the presence of a third harmonic of the modulating signal will increase the peak deviation if added in cosine phase as indicated in Fig. 12, or will decrease the peak deviation if added in sine phase.

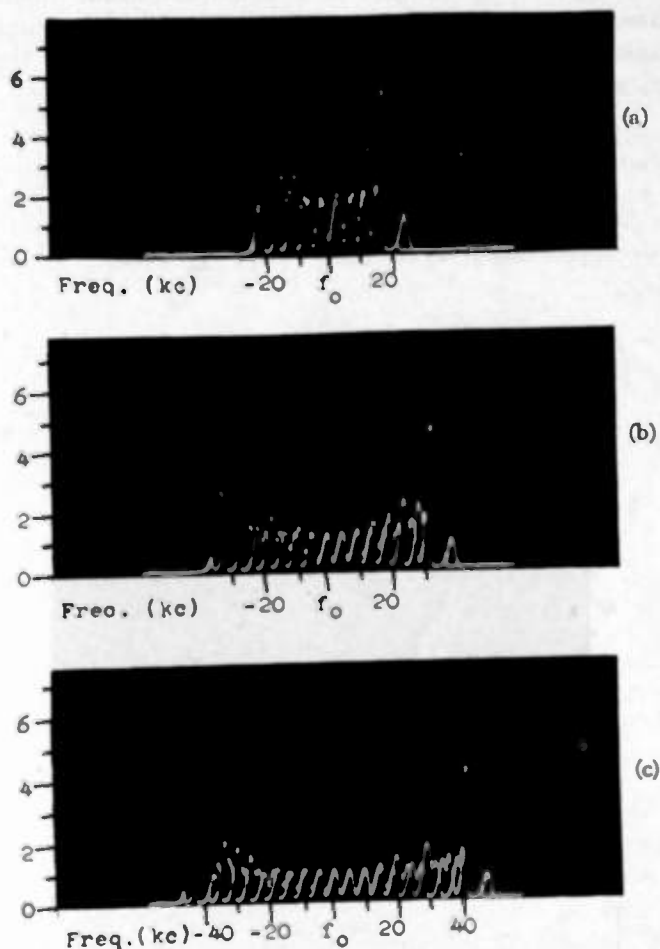

Fig. 19—Single-tone frequency-modulated signals,
(a) 500-cycle-per-second modulation—20-kilocycle deviation.
(b) 500-cycle-per-second modulation—30-kilocycle deviation.
(c) 500-cycle-per-second modulation—40-kilocycle deviation.

PART III—COMBINED AMPLITUDE AND FREQUENCY MODULATION

The sideband resolution of a signal simultaneously modulated in amplitude and frequency with the same modulating signal has been carried out by several authors.¹⁸⁻²¹ The general case of combined amplitude and frequency modulation, where the modulating signal causing amplitude modulation may be different from the modulating signal causing frequency modulation,

¹⁸ Hans Roder, "Amplitude, phase, and frequency modulation," *PROC. I.R.E.*, vol. 19, pp. 2145-2176; December, 1931.

¹⁹ August Hund, "High-Frequency Measurements," McGraw-Hill Book Co., New York, N. Y.; 1933, p. 376.

²⁰ August Hund, "Frequency Modulation," McGraw-Hill Book Co., New York, N. Y.; 1942, p. 55.

²¹ W. L. Barrow, "A new electrical method of frequency analysis and its application to frequency modulation," *PROC. I.R.E.*, vol. 20, pp. 1626-1639; October, 1932.

appears not to have been treated in the literature.

The former case can be treated easily. Possibly the most direct approach is merely to differentiate, with respect to time, a frequency-modulated signal such as (27) producing an amplitude- and frequency-modulated signal. The latter case is no more difficult but somewhat more tedious.

Consider first the case of a signal amplitude-modulated with a signal of frequency Ω_1 (7) and simultaneously frequency-modulated with a signal of frequency ω_1 (27). The result is

$$\begin{aligned}
 a &= A_0 [1 + m_0 + m_1 \cos(\Omega_1 t + \Theta_1)] \frac{\sin}{\cos} [\omega_0(1 + c_0)t + z_1 \sin(\omega_1 t + \theta_1)] \\
 &= A_0 [1 + m_0 + m_1 \cos(\Omega_1 t + \Theta_1)] \sum_{n=-\infty}^{\infty} J_n(z_1) \frac{\sin}{\cos} [\{\omega_0(1 + c_0) + n\omega_1\}t + n\theta_1] \\
 &= A_0 [1 + m_0] \sum_{n=-\infty}^{\infty} J_n(z_1) \frac{\sin}{\cos} [\{\omega_0(1 + c_0) + n\omega_1\}t + n\theta_1] \\
 &\quad + \frac{m_1 A_0}{2} \sum_{n=-\infty}^{\infty} J_n(z_1) \left\{ \frac{\sin}{\cos} [\{\omega_0(1 + c_0) + n\omega_1 + \Omega_1\}t + n\theta_1 + \Theta_1] + \frac{\sin}{\cos} [\{\omega_0(1 + c_0) + n\omega_1 - \Omega_1\}t + n\theta_1 - \Theta_1] \right\}. \quad (41)
 \end{aligned}$$

ward in frequency by Ω_1 ; and the upper spectrum is the frequency-modulated signal spectrum decreased in size by $(m_1/2)$ and shifted upward in frequency by Ω_1 . For the case when $m_0 = 0$ the same result is achieved by considering the individual sidebands of the center frequency-modulated signal spectrum to be amplitude-modulated to an extent corresponding to m_1 . Each sideband then has its own upper and lower sideband. If Ω_1 is an integer multiple of ω_1 , some of the resulting sidebands overlap. In this case the resultant sideband is a vector summation of the individual sidebands with

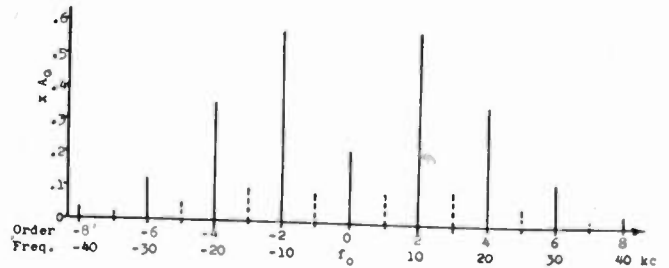
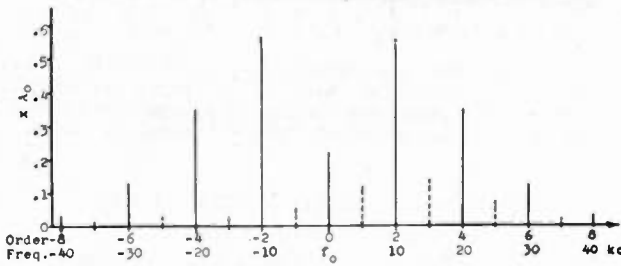
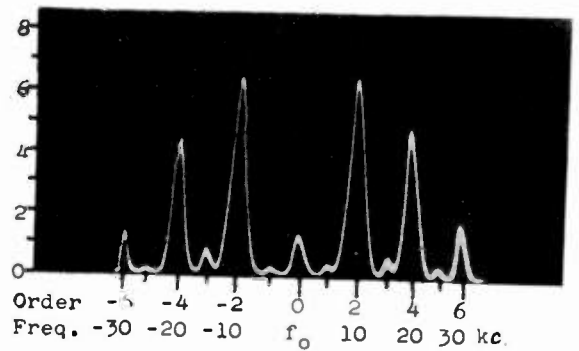
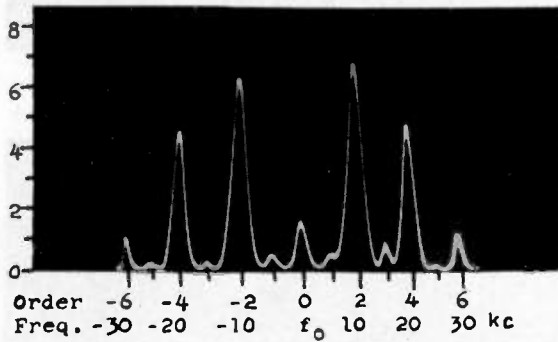

Fig. 20—Single-tone combined amplitude- and frequency-modulated signal. Frequency spectrum after combined modulation:

$$\begin{aligned}
 a &= A_0 [1 + 0.30 \cos 2\pi F_1 t] \sin [\omega_0 t + z_1 \sin 2\pi f_1 t] \\
 \Theta_1 &= 0, \quad F_1 = 5 \text{ kilocycles}, \quad \theta_1 = 0, \quad f_1 = 10 \text{ kilocycles}, \\
 c_1 f_0 &= 20 \text{ kilocycles}, \quad z_1 = 2.0.
 \end{aligned}$$

Fig. 21—Single-tone combined amplitude- and frequency-modulated signal. Frequency spectrum after combined modulation:

$$\begin{aligned}
 a &= A_0 \left[1 + 0.30 \cos \left(2\pi F_1 t + \frac{\pi}{4} \right) \right] \sin [\omega_0 t + z_1 \sin 2\pi f_1 t] \\
 \Theta_1 &= 0, \quad F_1 = 5 \text{ kilocycles}, \quad \theta_1 = 0, \quad f_1 = 10 \text{ kilocycles}, \\
 c_1 f_0 &= 20 \text{ kilocycles}, \quad z_1 = \frac{c_1 f_0}{f_1} = 2.0.
 \end{aligned}$$

Equation (41) indicates that an amplitude- and frequency-modulated signal spectrum consists of a composition of three individual spectrums: the center spectrum is the spectrum associated with the frequency-modulated signal increased in amplitude by $(1+m_0)$; the lower spectrum is the frequency-modulated signal spectrum decreased in size by $(m_1/2)$ and shifted down-

ward regard to θ_1 and Θ_1 . Frequency spectrums of a signal simultaneously modulated in amplitude and frequency are illustrated in Figs. 20 and 21.

The extension of (41) to the multitone combined amplitude- and frequency-modulation case is immediately evident. The results for a two-tone and multitone case are:

$$\begin{aligned}
a &= A_0 [1 + m_0 + m_1 \cos(\Omega_1 t + \Theta_1) + m_2 \cos(\Omega_2 t + \Theta_2)] \frac{\sin}{\cos} [\omega_0(1+c_0)t + z_1 \sin(\omega_1 t + \theta_1) + z_2 \sin(\omega_2 t + \theta_2)] \\
&= A_0 [1 + m_0 + m_1 \cos(\Omega_1 t + \Theta_1) + m_2 \cos(\Omega_2 t + \Theta_2)] \sum_{n_1=-\infty}^{\infty} \sum_{n_2=-\infty}^{\infty} J_{n_1}(z_1) J_{n_2}(z_2) \frac{\sin}{\cos} [\{\omega_0(1+c_0) + n_1\omega_1 + n_2\omega_2\}t + n_1\theta_1 + n_2\theta_2] \\
&= A_0 [1 + m_0] \sum_{n_1=-\infty}^{\infty} \sum_{n_2=-\infty}^{\infty} J_{n_1}(z_1) J_{n_2}(z_2) \frac{\sin}{\cos} [\{\omega_0(1+c_0) + n_1\omega_1 + n_2\omega_2\}t + n_1\theta_1 + n_2\theta_2] \\
&\quad + \frac{m_1 A_0}{2} \sum_{n_1=-\infty}^{\infty} \sum_{n_2=-\infty}^{\infty} J_{n_1}(z_1) J_{n_2}(z_2) \left\{ \frac{\sin}{\cos} [\{\omega_0(1+c_0) + n_1\omega_1 + n_2\omega_2 + \Omega_1\}t + n_1\theta_1 + n_2\theta_2 + \Theta_1] \right. \\
&\quad \left. + \frac{\sin}{\cos} [\{\omega_0(1+c_0) + n_1\omega_1 + n_2\omega_2 - \Omega_1\}t + n_1\theta_1 + n_2\theta_2 - \Theta_1] \right\} \\
&\quad + \frac{m_2 A_0}{2} \sum_{n_1=-\infty}^{\infty} \sum_{n_2=-\infty}^{\infty} J_{n_1}(z_1) J_{n_2}(z_2) \left\{ \frac{\sin}{\cos} [\{\omega_0(1+c_0) + n_1\omega_1 + n_2\omega_2 + \Omega_2\}t + n_1\theta_1 + n_2\theta_2 + \Theta_2] \right. \\
&\quad \left. + \frac{\sin}{\cos} [\{\omega_0(1+c_0) + n_1\omega_1 + n_2\omega_2 - \Omega_2\}t + n_1\theta_1 + n_2\theta_2 - \Theta_2] \right\} \tag{42}
\end{aligned}$$

$$\begin{aligned}
a &= A_0 \left[1 + m_0 + \sum_{j=1}^l m_j \cos(\Omega_j t + \Theta_j) \right] \frac{\sin}{\cos} \left[\omega_0(1+c_0)t + \sum_{i=1}^k z_i \sin(\omega_i t + \theta_i) \right] \\
&= A_0 \left[1 + m_0 + \sum_{j=1}^l m_j \cos(\Omega_j t + \Theta_j) \right] \prod_{i=1}^k \left[\sum_{n_i=-\infty}^{\infty} J_{n_i}(z_i) \right] \frac{\sin}{\cos} \left[\left\{ \omega_0(1+c_0) + \sum_{i=1}^k n_i \omega_i \right\} t + \sum_{i=1}^k n_i \theta_i \right] \\
&= A_0 [1 + m_0] \prod_{i=1}^k \left[\sum_{n_i=-\infty}^{\infty} J_{n_i}(z_i) \right] \frac{\sin}{\cos} \left[\left\{ \omega_0(1+c_0) + \sum_{i=1}^k n_i \omega_i \right\} t + \sum_{i=1}^k n_i \theta_i \right] \\
&\quad + \frac{A_0}{2} \sum_{j=1}^l \prod_{i=1}^k \left[\sum_{n_i=-\infty}^{\infty} m_j J_{n_i}(z_i) \right] \left\{ \frac{\sin}{\cos} \left[\left\{ \omega_0(1+c_0) + \sum_{i=1}^k n_i \omega_i + \Omega_j \right\} t + \sum_{i=1}^k n_i \theta_i + \Theta_j \right] \right. \\
&\quad \left. + \frac{\sin}{\cos} \left[\left\{ \omega_0(1+c_0) + \sum_{i=1}^k n_i \omega_i - \Omega_j \right\} t + \sum_{i=1}^k n_i \theta_i - \Theta_j \right] \right\} \tag{43}
\end{aligned}$$

The energy during modulation for the multitone case (43) is not constant but is given by (9). The energy added through modulation is given by (11).

CONCLUSIONS

Equation (8) for multitone amplitude modulation; (27), (30), and (32) for single-tone, two-tone, and multitone frequency modulation, respectively; and (41), (42), and (43) for single-tone, two-tone, and multitone combined amplitude and frequency modulation, respectively, represent the result of mathematical investigation of the resolution of the respective modulation cases into discrete sidebands. These equations have been verified by comparison with certain typical cases of modulation by resolving sidebands with a spectrum analyzer. The agreement between calculated and measured sideband amplitudes (after suitable corrections have been made) is usually within limits of experimental

error. Any remaining discrepancy is probably due to difficulty in accurately setting the desired modulation index, or the presence of small amounts of distortion in the modulating signal.

For the case of multitone frequency modulation, it is found that the distribution of sidebands is intimately associated with the wave shape of the modulating signal and, therefore, on the phase angles between the various sinusoidal components. Likewise, symmetry of the frequency spectrum depends on symmetry of the modulating wave.

The introduction of amplitude modulation in combination with frequency modulation produces an extra set of amplitude-modulation sidebands for each frequency-modulation sideband, whose amplitudes may depend, among other things, upon the phase angles between the amplitude-modulating signal and the frequency-modulating signal.



Correction

A. E. Hastings has called to the attention of the editors the following corrections to Figs. 5 and 6 in his paper, "Analysis of a Resistance-Capacitance Parallel-*T* Network and Applications," which appeared on pages 126P-129P of the March, 1946, issue of the PROCEED-

INGS OF THE I.R.E. AND WAVES AND ELECTRONS.

1. On page 128P, Fig. 5, the expression e at the right should read e' .

2. On page 129P, Fig. 6, the expression $(\mu\Delta R/R, 0)$ should read $(\mu\Delta R/4R, 0)$.

Correspondence

Cathode-Follower Circuit

February 11, 1947*

I have read with interest the paper, "The Cathode follower driven by a rectangular voltage wave," by M. S. McIlroy.¹ Although the author has reached some excellent conclusions on the basis of his approximate method, I wish to point out that an accurate graphical solution (subject to the same initial assumptions as the author's) is possible with very little work involved.

In a recent article in another periodical,² I presented a graphical solution for the cathode-follower circuit and indicated that the method could also be employed for the type of circuit which McIlroy has discussed. By this method either the cathode-ground or plate-ground voltages may be found readily.

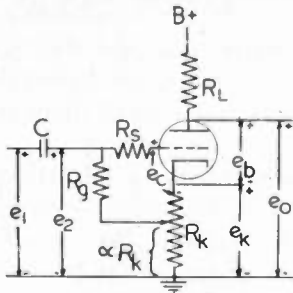

Fig. 1

In order to obtain a solution for the circuit of Fig. 1, the graphical solution proceeds as outlined for the cathode follower,³ except that the load line is drawn for $R_L + R_K$ and the cathode-voltage scale is computed from $e_K = i_b R_K$ (see Fig. 2). A typical calculation for a 6J5 tube with $R_L = 30,000$ ohms, $R_K = 10,000$ ohms, and $E_{cb} = 400$ volts is illustrated in Fig. 2, using McIlroy's symbols where they differ from those of Krauss. From the e_K scale shown, the value of e_K at each in-

tersection of the load line and tube characteristics is easily obtained. The value of e_2 at each of these intersections (in the negative-grid region) may then be computed from the formula $e_2 = e_K + e_c$, obtained from Fig. 1. The value of e_2 is given at each intersection in Fig. 2.

Now suppose that the "average operating point"⁴ for the circuit is arbitrarily chosen where $e_c = -8$, giving $e_{Kavg} = 46$ and $e_{2avg} = 38$. The value of α required to make the circuit operate about this point is

$$\alpha = \frac{e_{2avg}}{e_{Kavg}} = \frac{38}{46} = 0.825.$$

The maximum signal swings which will sat-

isfy McIlroy's condition 1 are:

216 + 46 = 262 volts. Other points may be found by a similar procedure. In order to compare the approximate and graphical solutions, the values of e_{Kavg} , e_{2avg} , Δe^+ , and Δe^- were calculated by McIlroy's method from the values of E_{cb} , R_L , R_K , and α given previously, and using $\mu = 20$, $r_p = 10,000$ ohms for the 6J5 tube. From Fig. 2, $E_{cb} \approx 25$ volts. Using (2),⁵ $A = 0.8$ which agrees with the value obtained graphically. Equation (1) gives $E_{cb} = (400 - 25)/20 = 18.8$ volts as compared to the true value of 24 volts. Now using (7) and (4),

$$e_{Kavg} = \frac{0.8(18.8)}{1 - 0.825(.8)} = 44 \text{ volts,}$$

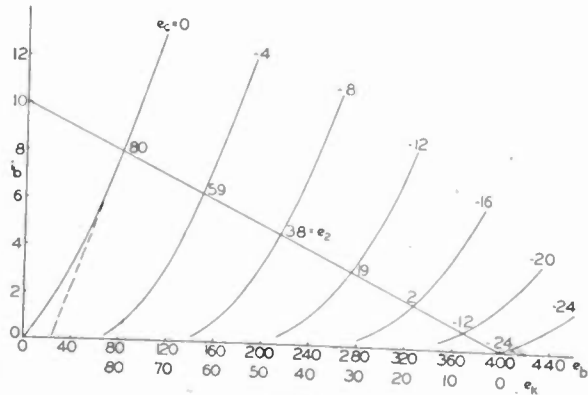

Fig. 2

isfy McIlroy's condition 1 are:

$$\Delta e^+ = 80 - 38 = 42$$

$$\Delta e^- = 38 - (-24) = 62.$$

Obviously, if the deviations Δe^+ and Δe^- from the average value of a given rectangular-pulse input signal are known, the allowable range of values of e_{Kavg} is readily determined from a graph such as Fig. 2. The permissible range for α is then easily computed.

In case the output voltage is obtained from the plate of the tube in Fig. 1, the instantaneous plate-to-ground voltage e_o may be determined by adding the tube drop e_o to e_K , ($e_o = e_b + e_K$). Thus in Fig. 2, at the point where $e_K = 46$ and $e_2 = 38$, $e_b = 216$ and $e_o =$

and $e_{2avg} = 0.825(44) = 36$ volts. These values are quite close to the correct ones given previously. Finally, (11) and (15) are used to obtain

$$\Delta e^- = 36 + 18.8 \approx 55 \text{ volts}$$

$$\Delta e^+ = \frac{0.8(18.8)}{0.2} - 36 \approx 39 \text{ volts.}$$

The errors in these values are around 10 percent, which would generally be close enough when the variations in individual vacuum tubes are considered.

HERBERT L. KRAUSS
School of Engineering
Yale University
New Haven, Connecticut

* Equation numbers refer to McIlroy's paper.

* Received by the Institute, February 13, 1947.
¹ M. S. McIlroy, "The cathode-follower driven by a rectangular voltage wave," vol. 34, pp. 848-852; November, 1946.

² H. L. Krauss, "Graphical solutions for cathode followers," *Electronics*, vol. 20, pp. 116-121; January, 1947.

³ See Fig. 3 and page 117 in footnote reference 1.

⁴ This is not the same as the quiescent operating point unless $\Delta e^+ \cdot T_u = \Delta e^- \cdot T_L$.

Proposed Constitutional Amendments

May 19, 1947*

The proposed revision of the Constitution introduces several fundamental changes in the basic rules by which the Institute is governed. Some of these changes are undoubtedly good and should be adopted. Some may not be, as will be discussed later, but the important point is that, whether good or bad, the membership has had no opportunity to discuss and weigh them and is given no choice as to which features it wishes to adopt and which it wishes to reject.

The lumping of various proposals together and asking for their passage in toto is a parliamentary procedure often used to obtain passage of some unfavorable along with good. Although, in this case, there is no doubt of the sincerity of the Board of Directors, nevertheless the practice is so questionable that the proposal should be rejected in order that the method taken for its adoption may be repudiated.

The proposed Constitution creates a new grade of member—Special Member—open to persons having no technical background. This grade of membership carries full voting privileges, and the only protection against its abuse is the integrity of the Board of Directors. We have great confidence in the present Board, but do not feel that this protection is sufficient, especially since under the new Constitution a future Board may elect someone with no technical background as a Special Member and then place him on the Board as an Appointed Director. If this form of membership is adopted may not some future Director find himself subject to undue pressure from his employer who wishes to become a Special Member when only qualified for the Associate grade? If we must have Special Members, and we see no need for this grade, should we not provide that they have no voting power, can hold no office, and are limited in number to say $\frac{1}{2}$ of 1 per cent of the total membership. This question deserves more discussion. Therefore, if the new Constitution is adopted, we request the Board to refrain from electing any Special Members until the status of this grade can be discussed and decided by the membership entirely apart from any other changes.

The proposed Constitution transfers to the By-Laws, and, therefore, to the control of the Board, many details of the Membership requirements. Perhaps some latitude in this matter is desirable, although the Board has given no clear picture of the need, but certainly for protection of the members and to insure uniformity, the qualifications of the various grades should be more closely defined in the Constitution than is done, for example, for Member grade in the proposed Constitution. Certainly any new Constitution should contain the equivalent of sections 7 and 8, Article III, of the present Constitution, since these clauses specifically state how long a member may be delinquent in dues before being dropped, and guarantee fair treatment before a member can be expelled from the Institute. Future Boards may be relieved from undue pressure from substandard "radio schools" if the definition

of a "school of recognized standing" is included in the Constitution, rather than being transferred to the By-Laws as is proposed.

Many minor changes are proposed in the new Constitution, some of which are undoubtedly desirable and some of which may not be. For example, members of the smaller sections may well wish to retain the right to nominate officers with a petition bearing only 35 names, as at present, rather than 100 signatures as is proposed.

As for the question of dues, which are only one part and not the whole of this question, almost everyone recognizes that some increase will be necessary before long. But many members would like to know if it is to be a \$2, a \$5 or a \$10 increase before signing this blank check. The Board has given no information on the new dues structure. The only information we have been able to obtain is the personal opinion of two Board members; one, that the dues should be about the same as those of the A.I.E.E., and the other that a \$2 increase will be sufficient. While the Board does need some latitude in changing the dues, should not the members retain some control or veto power and should not the Board consult the members as to whether they desire an increase in dues or a decrease in services?

We hear arguments that the financial situation is such that this new Constitution must be adopted whether it contains serious flaws or not. The dues of a large portion of the members become due on January 1 and

members of the Board agree no change in dues is necessary before that date. The present Constitution will allow such a change if the membership votes favorably on an amendment submitted not later than October 1. Keeping this date in mind, why, if the proposed Constitution is defeated, can not a proposal dealing with dues alone be submitted to the members in time for the change to be made on next January 1?

In conclusion, it should be pointed out that, in an organization such as The Institute of Radio Engineers, it is necessary that certain powers be delegated to a body such as the present Board of Directors. The Constitution then becomes the sole guarantee to the membership that no particular future Board, no matter whether because of incompetence or intent, can do the organization harm. We believe that the proposed Constitution to a large extent removes that guarantee and should therefore be defeated.

Again we wish to emphasize that we in no way question the sincerity of the present Board, but only lament their too ardent desire to remove what to them must at times appear as just so much "red tape."

KARL G. JANSKY, FELLOW I.R.E.

FRANK R. STANSEL, SENIOR MEMBER I.R.E.

Engineering Education

February 6, 1947*

I have noted with very great interest the "Report on Professional Standing of the Canadian Council of The Institute of Radio Engineers!" and can testify as to the accuracy of its findings and the soundness of its conclusions, in so far as they relate to the problems of the educator.

It is perhaps true that the development of engineering curricula for the communication field has progressed further in colleges and universities in the United States than this report would imply has been the case in Canadian institutions, but there is still a very great uncertainty in many quarters on just what should be done with the old "power" curricula to adapt them to the modern needs of electrical communication. Should we, for example, broaden our electrical engineering curricula so that a graduate would be reasonably well trained to enter the field of either electric power or electric communication, or should we recognize the distinctly different specialized needs of these two groups and make a definite split in our training program to achieve more specific objectives?

Diversity of aims among our educational institutions is certainly the existing rule; and quite likely this is a fortunate thing, for it would seem to be a mistake to pour all fluid talent into a common mold and find it solidifying into a standardized form admitting of no variation. This is the sure way to discourage individual initiative and impede invention. Nevertheless, for the various plans pursued, it is not out of place certainly to question how the chosen objectives may be best achieved, and a pool of our experience to date will be helpful in this respect.

After 25 years of teaching experience, I can approach this subject with very great

* Received by the Institute, February 10, 1947.

1 "Report on professional standing to the Canadian Council of The Institute of Radio Engineers," *Proc. I.R.E.* vol. 35, pp. 61-65; January, 1947.

Reprints and Preprints

In most cases, The Institute of Radio Engineers does *not* have available reprints or preprints of papers published in the PROCEEDINGS, papers presented at Conventions, or papers presented at Section meetings. Reprints *can* be obtained *only* if ordered in advance of publication and in quantities of fifty or more copies. However, the following three papers *are* available in reprint form and may be obtained by writing to the Institute.

"Radar," by Edwin G. Schneider. Published in the August, 1945, issue of the PROCEEDINGS OF THE I.R.E. AND WAVES AND ELECTRONS. Price, \$.50.

"The Presentation of Technical Developments Before Professional Societies," by William L. Everitt. Published in the July, 1945, issue of the PROCEEDINGS OF THE I.R.E. Obtainable on request without charge.

"Preparation and Publication of I.R.E. Papers," by Helen M. Stote. Published in the January, 1946, issue of the PROCEEDINGS OF THE I.R.E. AND WAVES AND ELECTRONS. Obtainable on request without charge.

Please address your inquiries to The Institute of Radio Engineers, Inc. 1 East 79 Street New York 21, New York

It would be appreciated if a stamped, self-addressed envelope accompanied each request.

* Received by the Institute, May 20, 1947.

humility, for I know that formal university training is far from being the all-determining factor in an engineer's success; but still I have an inner conviction that we educators should be alert to new technical trends, and exercise every bit of ingenuity we possess in an attempt to meet the needs of our technical world by offering a program which shall utilize to the fullest the time allotted to us for real professional training of our young engineers.

I should like to comment first on a "combined curriculum," one supposed to satisfy the requirements of either the power or communication student. I have had much experience with this sort of thing at the University of Maine, where for the last ten years our program has approximated that recommended by the Montreal Section of The Institute of Radio Engineers, while at the same time retaining much of the traditional power curriculum. It has been possible to follow such a plan by the wide use of optional courses during the Senior year as indicated by the tabulation given below.

SENIOR-YEAR OPTIONS

First Semester

Illumination Engineering
Direct-Current Machine Design
Electric-Power Systems
Communication Engineering (Networks)
Radio Engineering
Radio Laboratory
Electroacoustics
Thesis

Second Semester

Alternating-Current Machine Design
Electric Motive Power
Advanced Electric Power Laboratory
Communication Engineering (Transmission Lines)
Radio Engineering (includes Frequency Modulation)

Radio Laboratory Ultra-High-Frequency Systems Thesis

This program offers a solution to the problem of covering two fields which is practical for small institutions, although it does make for small (and therefore expensive) classes in the optional work. It is, however, coming to have grave limitations if constricted within the traditional four-year training period, because of the expansion of electronic applications and new communication techniques. Many topics of instruction which, in the past, were briefly treated as merely interesting fundamentals, without the mention of specific uses, now must be followed through various applications; and a host of new topics, hitherto not regarded as important fundamentals, have now assumed that role. It is becoming increasingly difficult to carry on this combined program satisfactorily without resort to a five- or six-year curriculum; and a decision must soon be reached in regard to this expansion in time.

The other alternative would seem to be a complete division in the Junior and Senior years of a four-year program between the courses pursued by the "power" and "communication" engineering students. The curriculum for the communication group proposed in the Montreal Section of The Institute of Radio Engineers seems an admirable one. But some power courses must be retained, their scope lying perhaps midway between the present major power courses and those traditionally offered to nonelectrical students. Oral seminars should be employed freely in order to avoid the wholly textbook style of instruction and keep the students up to date on current progress. Students should be encouraged to undertake experimental theses on small unit problems with the view to acquiring research techniques.

Finally, a good course in general psychol-

ogy should be a requirement. This course should in particular emphasize the physiological and psychological bases of vision and audition. The purely utilitarian aspects of such a course should be evident when the communication engineer's concern with television and sound systems is considered. Aside from this, it would seem an absurdity for a student to receive a diploma from any institution where mental processes are supposed to be the sum and substance of four years of concentrated effort, and yet fail to obtain any fundamental knowledge of how the mind receives the communication signals which the senses provide, how it classifies and interprets them, and how it can initiate the responses characteristic of *homo sapiens*, or even perhaps those of an educated man.

In conclusion, I should like to recommend for the consideration of the Institute membership the excellent article by Dean Langsdorf,² which points out the currently wasteful methods of arriving at our educational objectives, which clears the educational atmosphere of the foggy notion that culture can be attained by the acquisition of a certain number of semester hours of college credit, and which emphasizes the point that there can be no compromise with rigorous technical training if the engineering profession is to be adequately served.

It would seem an opportune time for our membership to give careful consideration to the problems of engineering education, not indeed with the idea of issuing blunt directives of what must be done, but rather with the idea of establishing a forum where we may discuss problems pertaining to our mutual welfare.

W. J. CREAMER

Professor of Communication Engineering
University of Maine
Orono, Maine

² A.S. Langsdorf, "Realism in engineering education," *Elec. Eng.*, vol. 65, pp 251-255; June, 1946.

Contributors to the Proceedings of the I.R.E.



ARTHUR M. BRAATEN

Arthur M. Braaten (A'27-M'38-SM'43) was born on November 30, 1901, at St. Paul, Minnesota. He has been an amateur radio experimenter and operator since 1916. He received the B.E.E. degree from the University of Minnesota in 1928, and upon graduation became a student engineer with the Radio Corporation of America. Since 1929 he has been an engineer in the communications research and development laboratory at Riverhead, L. I., formerly under RCA Communications, Inc., and now under RCA Laboratories. He has been engaged chiefly in the development of precision frequency standards and methods of frequency measurement, and in investigations of propagation phenomena on the high and ultra-high frequencies.

Mr. Braaten held a commission in the Signal Corps Reserve, U. S. Army, from



R. R. BUSH

Contributors to the Proceedings of the I.R.E.



C. LOUIS CUCCIA

❖

1928 to 1938. He is a member of Tau Beta Pi, Eta Kappa Nu, the American Radio Relay League, and the Radio Society of Great Britain.

❖

R. R. Bush (A'43) was born in Albion, Michigan, on July 20, 1920. He received the B.S. degree in electrical engineering from Michigan State College in 1942. From 1942 until 1946 he was a research engineer, working on ultra-high-frequency electronics, at RCA Laboratories, Princeton, New Jersey.

Mr. Bush is now a graduate student in physics and is associated with the department of physics of Princeton University. He is a member of Sigma Xi, Tau Beta Pi, Phi Kappa Phi, Pi Mu Epsilon, and the American Physical Society.

❖

C. Louis Cuccia (S'40-A'44) was born in Bedford Hills, New York, on April 8, 1918. He received the B.S. degree in electrical

❖



J. S. DONAL, JR.

engineering in 1941 and the M.S. degree in 1942 from the University of Michigan. From 1941 to 1942 he was affiliated with the department of engineering research of the University of Michigan for the Fisher Body Department of the General Motors Corporation as a research engineer. In June, 1942, he joined the research department of the RCA Manufacturing Company in Harrison, New Jersey, to do research work on high-power ultra-high-frequency transmitting tubes. In November, 1942, he transferred to the research staff of the RCA Laboratories in Princeton, New Jersey, where he has continued with this work and associated modulation problems.

In 1944 and 1945, Mr. Cuccia was a member of the ESMWT faculty of Rutgers University, where he taught evening courses in advanced mathematics and electrical engineering. He is a member of Sigma Xi.

❖

J. S. Donal, Jr. (M'40-SM'43) was born on June 19, 1905, at Philadelphia, Pennsylvania. He received the A.B. degree from Swarthmore College in 1926 and the Ph.D. degree in physics from the University of Michigan in 1930. From 1930 to 1936, Dr. Donal was associated with the Johnson Foundation for Research in Medical Physics and with the department of pharmacology of the University of Pennsylvania. In 1936, he joined the research laboratories of the RCA Manufacturing Company, Inc., and is now located in the RCA Laboratories at Princeton, New Jersey. He is a member of Sigma Xi and of the American Physical Society.

❖

L. J. Giacoletto (S'37-A'42-M'44) was born in Clinton, Indiana, November 14, 1916. He received the B.S. degree in electrical engineering from Rose Polytechnic Institute, Terre Haute, Indiana, in 1938; and the M.S. degree in physics from the State University of Iowa in 1939, while holding an appointment as research assistant there. From 1939 to 1941, while a Teaching Fellow in the department of electrical engineering at the University of Michigan, he engaged in frequency-modulation research.

Mr. Giacoletto was associated with the Collins Radio Company during the summers of 1937 and 1938, and with the Bell Telephone Laboratories in 1940. From 1941 to 1945 he served with the Signal Corps in various laboratory assignments concerned with development activities in the field of radio, navigational, and meteorological direction-finding equipments. While on overseas duty during 1945 and 1946, he spent some time in Japan engaged in technical intelligence work on Japanese radio and electronic equipment. He returned to inactive status as a major in the Signal Corps Reserve in May, 1946. Since June, 1946, he has been serving as a research engineer with



L. J. GIACOLETTO

the Radio Corporation of America, RCA Laboratories Division, Princeton, New Jersey.

Mr. Giacoletto is a member of the American Association for the Advancement of Science, Tau Beta Pi, Gamma Alpha, Iota Alpha, Phi Kappa Phi, and Sigma Xi.

❖

Howard R. Hegbar (S'41-SM'46) was born in Valley City, North Dakota, on February 22, 1915. He received the B.S. degree in electrical engineering from North Dakota State College in 1937. He attended the University of Wisconsin as a Wisconsin Alumni Research Scholar, Fellow, and Research Assistant, receiving the M.S. degree in electrical engineering in 1938, and the Ph.D. degree in electrical engineering in 1941.

In 1941 Dr. Hegbar joined the research department of the RCA Manufacturing Company at Harrison, New Jersey. Since 1942 he has been a research engineer working on vacuum-tube electronics problems with the RCA Laboratories at Princeton, New Jersey. He is a member of Sigma Xi, Tau Beta Pi, Phi Kappa Phi, and Gamma Alpha.



HOWARD R. HEGBAR

Contributors to the Proceedings of the I.R.E.



JEROME KURSHAN

Jerome Kurshan (M'46) was born in 1919 at Brooklyn, New York. He received the B.A. degree from Columbia University in 1939 and was an assistant in physics there during that year. From 1939 to 1943 he was an assistant in physics at Cornell University, where he received the Ph.D. degree in 1943. Since then he has been with the RCA Laboratories at Princeton. He is a member of Phi Beta Kappa, Sigma Xi, and the American Physical Society.



G. Ross Kilgore (A'30-M'40-SM'43) was born at Fremont, Nebraska on January 31, 1907. He received the B.S. degree in electrical engineering in 1928 from the University of Nebraska and the M.Sc. in electrical engineering in 1931 from the University of Pittsburgh. He entered the employ of the Westinghouse Electric Corporation in East Pittsburgh as a student engineer in 1928, and joined the Westinghouse Research Laboratories in 1929. From 1930 to 1934 he was engaged in magnetron research and in early microwave radio-detection experiments. In 1934 he joined the electrical research section of the RCA Radiotron Company in Harrison, N. J., continuing to work on research and develop-



G. ROSS KILGORE

ment of ultra-high-frequency and super-high-frequency transmitting and receiving tubes. From 1942 through 1946 he was at the RCA Laboratories in Princeton, N. J. Recently he joined the Evans Signal Laboratory in Belmar, N. J., where he is assistant chief of the thermionics branch and chief of the vacuum-tube development section. He is a member of Sigma Tau, Sigma Xi, and Pi Mu Epsilon.



Carl I. Shulman (S'39-A'41-SM'46) was born in Chelsea, Massachusetts, on January 12, 1917. He received the B.S. and M.S. degrees in electrical engineering in 1938 and 1939 from the Massachusetts Institute of Technology. From June, 1939, to December, 1940, he was employed by the Submarine Signal Company of Boston, and from December, 1940 to date has been with RCA Laboratories, at Princeton, N. J., working on ultra-high-frequency tube problems. Mr. Shulman is now a half-time graduate student in the Physics Department of Princeton University. He is a member of Sigma Xi.



CARL I. SHULMAN



Lloyd P. Smith was born on November 6, 1903, at Reno, Nevada. He received the degree of B.S. in electrical engineering with honors from the University of Nevada in 1925. In 1926 he received the Coffin Fellowship for graduate work in physics at Cornell University. He received the Ph.D. degree from Cornell in 1930. That same year he was awarded a National Research Council Fellowship to do research in theoretical physics at California Institute of Technology and in 1931 received an International Fellowship to do research at the University of Munich, Germany, and later at the University of Utrecht, Holland. In 1932 he became an assistant professor at Cornell University and was promoted to full professor in 1936.

In 1939, during a Sabbatic leave, he became temporary research physicist with the RCA Manufacturing Company at Harrison, N. J. In 1941 he obtained almost full-time leave from Cornell University to act as consultant on war research for RCA Labo-



Photo by Bachrach

LLOYD P. SMITH

ratories. From 1943 to 1945 he assisted the research director of RCA Laboratories in supervising a section of the research staff on war projects. In 1945 he was appointed associate research director of RCA Laboratories at Princeton, N. J. In July, 1946 Dr. Smith was appointed chairman of the department of physics, Cornell University, and director of their new department of engineering physics. Since March, 1946, he has been serving as consultant on research at the RCA Laboratories, Princeton, N. J.

Dr. Smith is a member of the American Physical Society, the American Association of Physics Teachers, and the New York State Section of the American Physical Society.



Gilbert S. Wickizer (A'28-SM'46) was born on August 20, 1904, at Warren, Pennsylvania. He received the B.S. degree in electrical engineering from the Pennsylvania State College in 1926, and after graduation he was employed by the Radio Corporation of America, in the operating division. Since 1927 he has been at Riverhead, N. Y., engaged in communications research for RCA, RCA Communications, Inc., and, at the present time, with RCA Laboratories.



GILBERT S. WICKIZER

Institute News and Radio Notes

NOMINATIONS—1948

At its May 7, 1947, meeting, the Board of Directors received the recommendations of the Nominations Committee, and the reports of the Regional Committees, for officers and directors for 1948. They are as follows:

For President:

B. E. Shackelford

For Vice-President:

R. L. Smith-Rose

Two Directors-at-Large, 1948-1950:

B. deF. Bayly J. E. Shepherd
A. B. Chamberlain J. A. Stratton
H. B. Richmond (later declined)

Regional Director (1 per Region):

1948 only

Region 2, the North Central Atlantic Region:

F. A. Polkinghorn
H. P. Westman

Region 4, the East Central Region:

W. A. Dickinson
P. L. Hoover

J. A. Hutcheson

Region 6, the Southern Region:

Ben Akerman

Region 8, the Canadian Region:

F. S. Howes
F. H. R. Pounsett

1948-1949

Region 1, the North Atlantic Region:

L. E. Packard
H. J. Reich

Region 3, the Central Atlantic Region:

J. B. Coleman

Region 5, the Central Region:

T. A. Hunter
W. O. Swinyard

Region 7, the Pacific Region:

F. E. Terman

According to Article VII, Section 1, of the Constitution, nominations by petition for any of the above offices may be made by letter to the Board of Directors setting forth the name of the proposed candidate and the office for which it is desired he be nominated. For acceptance, a letter of petition must reach the executive office before twelve o'clock noon on August 14, 1947, and shall be signed by at least thirty-five voting members qualified to vote for the office of the candidate nominated.

I.R.E. AT INTERNATIONAL TELECOMMUNICATIONS CONFERENCE

In attendance at the opening plenary session of the International Telecommunications Conference at Atlantic City on May 16, 1947, were Haraden Pratt, secretary of The Institute of Radio Engineers, Dr. F. B. Llewellyn, past-president and member of the I.R.E. Board of Directors, and G. W. Bailey, executive secretary of the Institute.

Minutes of Technical Committee Meetings

The following brief abstracts of I.R.E. technical committee minutes are intended to keep the membership informed as to the activities of such groups. Members having views or proposals of interest to the committees, or desiring possibly available information from them, should write directly to the chairman of the particular committee, sending a copy of the letter to Mr. Laurence G. Cumming, Technical Secretary, The Institute of Radio Engineers, 1 East 79 Street, New York 21, N. Y.—*The Editor*.

ELECTRON TUBES

Date.....April 15, 1947
Place.....I.R.E. Headquarters,
New York, N. Y.
Chairman.....R. S. Burnap

Present

R. S. Burnap, *Chairman*

L. G. Cumming	I. E. Mouromtseff
C. B. DeSoto	L. S. Nergaard
J. E. Gorham	G. D. O'Neill
J. W. Greer	I. M. Price
E. G. Homer	H. D. Reich
S. B. Ingram	A. C. Rockwood
J. A. Morton	J. R. Steen
C. M. Wheeler	

Mr. O'Neill stated that the 1948 Electron-Tube Conference would be held at Cornell University and that Professor Smith of that institution would supervise the arrangements. No dates have been set. Mr. D. E. Marshall was appointed as liaison between the I.R.E. Technical Committee on Electron Tubes and the A.I.E.E. Electronic Power Converter Subcommittee. A review was made of material ready for publication covering Methods of Testing, and Definitions.

SUBCOMMITTEES

ELECTRON-TUBE CONFERENCE

Date.....April 18, 1947
Place.....I.R.E. Headquarters,
New York, N. Y.
Chairman.....G. D. O'Neill

Present

G. D. O'Neill, *Chairman*

R. A. Galbraith	I. E. Mouromtseff
E. D. McArthur	L. S. Nergaard
J. A. Morton	H. W. Parker

It was suggested that Mr. McArthur be authorized to approach Dr. Baker with an inquiry as to whether the latter intends to address the Conference in a short talk. Professor Galbraith submitted a detailed outline of the entire program of the Conference

and an estimate of the actual cost and organization of registration, rooms, and meals. Mr. McArthur transmitted General Electric Company's invitation to visit Electronics Park near Syracuse.

TECHNICAL PROGRAM OF THE ELECTRON-TUBE CONFERENCE

Date.....April 18, 1947
Place.....I.R.E. Headquarters,
New York, N. Y.
Chairman.....J. A. Morton

Present

J. A. Morton, *Chairman*

A. G. Hill	E. D. McArthur
G. R. Kilgore	I. E. Mouromtseff
L. Malter	G. D. O'Neill

The list of invitees was reviewed, with the result that fifteen additional individuals are to be invited. After considerable discussion, a motion of E. D. McArthur, outlining the working basis for the Conference schedule, was passed. An "organizer" for each scheduled session was selected to see to it that a well-organized session is arranged. A list of possible subject "introducers" and "discussers" was prepared. It will be part of the agenda of the next meeting to draft the final printed program.

BOOKS AND PERIODICALS FOR WORLD RECOVERY

The desperate and continued need for American publications to serve as tools of physical and intellectual reconstruction abroad has been made vividly apparent by appeals from scholars in many lands. The American Book Center for War Devastated Libraries has been urged to continue meeting this need at least through 1947. The Book Center is therefore making a renewed appeal for American books and periodicals—for technical and scholarly books and periodicals in all fields and particularly for publications of the past ten years. It will welcome complete or incomplete files of the PROCEEDINGS OF THE I.R.E.

The generous support which has been given to the Book Center has made it possible to ship more than 700,000 volumes abroad in the past year. It is hoped to double this amount before the Book Center closes. The books and periodicals which individuals as well as institutional libraries can spare are urgently needed and will help in the reconstruction which must preface world understanding and peace.

Ship your contributions to the American Book Center, c/o The Library of Congress, Washington 25, D. C., freight prepaid, or write to the Center for further information.

WEST COAST I.R.E. CONVENTION

The West Coast Institute of Radio Engineers Convention will be held September 24, 25, and 26, 1947, under the sponsorship of the San Francisco Section, I.R.E.

The program will begin with registration on Wednesday morning, September 24. Technical sessions will be held during the first afternoon and there will be a cocktail party that evening as a get-together for those attending the convention. Thursday will be devoted to technical sessions with a luncheon at noon; the evening will be kept open. There will be technical sessions again on Friday; and in the afternoon several inspection trips will be arranged to points of interest in the San Francisco Bay Area, including such places as the University of California, Stanford University, and probably military and naval installations.

The West Coast Electronic Manufacturers Association is holding a Trade Show in San Francisco on September 26, 27, and 28, at which the various radio and electronic products manufactured on the West Coast will be exhibited. Arrangements will be made so that I.R.E. members who wish to attend these exhibits may do so on the afternoon of September 26, or they may remain over and attend the exhibits on Saturday and Sunday, as they desire. The various activities of the Show will be made available to those attending the West Coast I.R.E. Convention.

The San Francisco Section officers and committees in charge of activities at the Convention are as follows:

SAN FRANCISCO SECTION OFFICERS

Chairman W. J. Barklay
Vice Chairman L. E. Reukema
Secretary-Treasurer and
Convention Vice Chairman F. R. Brace

GENERAL CONVENTION CHAIRMAN

Karl Spangenberg

TECHNICAL PROGRAM

W. R. Hewlett, *Chairman*
F. E. Terman L. J. Black

ARRANGEMENTS

(Registration, Printing, Tickets, Meeting
Rooms, Ladies' Program)

W. G. Wagener, *Chairman*
J. R. Grace R. J. Smith
N. E. Porter

HOTEL FUNCTIONS

(Reservations, Luncheon, Cocktail Party,
Banquet)

J. H. Landells, *Chairman*
F. P. Barnes R. H. Schuler
R. A. Iseberg E. Whitehead

ANNOUNCEMENTS AND PUBLICITY

Herman Held, *Chairman*
Al Towne

EXHIBITS REPRESENTATIVE

Bert Cole, *Chairman*

CONVENTION TREASURER

Jack Kaufman, *Chairman*

SECTION ACTIVITIES

Carl Penther, *Chairman*

INSPECTION TRIPS

David Packard, *Chairman*

JOINT URSI-IRE MEETING

The joint meeting of the International Scientific Radio Union, American Section, and The Institute of Radio Engineers, held in Washington, D. C., May 5, 6, and 7, 1947, proved to be the largest such gathering in the history of these meetings, both as to number of papers and attendance. The variety of subject matter and the scope of the ninety-odd papers presented at the sessions provided further evidence of the expanding horizon of the radio art in the postwar world.

Of the 600 registered guests at the meeting, approximately 150 came from outside the Washington area. The program included papers delivered by engineers from eleven states, as well as Canada and Sweden.

Dr. J. H. Dellinger, chairman of the American Section of U.R.S.I. and past president of I.R.E., made the introductory remarks at the opening session. There followed four sessions of papers at the National Academy of Sciences and six at the New Interior Department Auditorium. For the first time at these meetings, it was necessary to schedule four pairs of simultaneous sessions.

Ten papers were delivered under the general classification of "Communications Systems, Modulation, and Radar"; eleven under "Navigation, Control, and Telemetry"; ten under "Ionospheric Propagation"; seven under "Measurements Methods—I"; eight under "Measurements Methods—II"; twelve under "Geophysical and Cosmic Phenomena"; ten under "Circuits"; ten under "Microwave Propagation"; ten under "Theory Calculations and Vacuum Tubes"; and ten under "Antennas." It is hoped that some of these papers will be published in the PROCEEDINGS OF THE I.R.E. in future issues.

One evening in a lighter vein was devoted to a demonstration of electric eels and the showing of a German colored motion-picture film illustrating an advanced stage of color-photographic technique.

The local committee in charge of the meeting consisted of Newbern Smith, T. J. Carroll, and R. S. Ould.

FRANKLIN INSTITUTE RECEIVES
NEW RCA ELECTRON MICROSCOPE

A new model of the Radio Corporation of America's electron microscope was recently presented to the Franklin Institute, Philadelphia, Pennsylvania. The instrument was installed in the Franklin Institute Museum for a public demonstration, and then placed in service for scientific studies in the Franklin Institute Laboratories for Research and Development.

Employing a beam of electrons in place of light to provide useful magnifications up to 100,000 diameters, this new electron microscope makes it possible for scientists to see and photograph for the first time sub-microscopic particles of matter and disease-causing organisms.



HEAD TABLE AT RMA ANNUAL SPRING MEETING DINNER, HOTEL SYRACUSE, SYRACUSE, N. Y.

Left to right: S. P. Taylor, Western Electric Company, chairman of RMA's transmitter section; F. R. Lack, vice president and manager of Western Electric's radio division and principal speaker at the dinner; Dr. W. R. G. Baker, president of I.R.E., director of engineering for RMA, vice-president of General Electric Company, and toastmaster for the dinner; George W. Bailey, executive secretary of I.R.E.; and J. J. Farrell, of General Electric's electronics department.

Broadcast Engineers Conference

ATLANTA, GEORGIA, APRIL 14-18, 1947

The Broadcast Engineers Conference, sponsored jointly by the Georgia School of Technology, the Atlanta Section of The Institute of Radio Engineers, and the Georgia Association of Broadcasters, was held at the Biltmore Hotel, with exhibits in the Naval Armory on the Georgia Tech campus, for the five-day period from April 14 to 18 inclusive. This conference, the first of its kind to be held in the South, was the direct result of discussions with Dr. W. L. Everitt during his visit to the Atlanta Section in 1945.

Over 150 persons registered for the technical sessions, in addition to many graduate students, instructors, and research personnel from Georgia Tech. Colonel Blake R. Van Leer, president of the Georgia School of Technology, welcomed the conference at the opening session.

Features of the exhibits were frequency-modulation transmitters and antennas, speech input equipment, limiting amplifiers, and recording equipment and supplies. This was the first opportunity for most of the 1000 registered visitors to the exhibits to see postwar radio broadcasting equipment.

A total of twenty-four technical papers in the field of radio broadcasting were presented. Many of these papers were presented for the first time at the conference. The closing banquet was high-lighted by a talk by Lewis F. Gordon entitled, "Beyond All Else—People," and by the presentation of certificates by Colonel Van Leer.

The success of the conference was due

largely to the members of the Atlanta Section of The Institute of Radio Engineers and its executive committee: P. H. Herndon, Jr., Dr. W. A. Edson, M. S. Alexander, and Dr. G. A. Rosselot. The chairmen of the committees which made the conference arrangements were: Honorary Chairman, Colonel Blake R. Van Leer; General Chairman, M. A. Honnell; Program Chairman, Ben Akerman; Exhibit Chairman, C. F. Daugherty; Arrangement Chairman, G. A. Rosselot; Registration Chairman, R. S. Howell; Housing Chairman, M. R. McClure; Promotion Chairman, L. F. Zsuffa; and Ladies Chairman, Mrs. F. C. Bragg.

The technical papers presented were "Performance of Limiting Amplifiers," by W. W. Dean and L. M. Leeds (presented by L. M. Leeds), General Electric Co. "Cross Talk in Audio Systems," by Ben Akerman, Radio Station WGST.

"Safety Precautions for Radio Stations," by William N. Cox, Jr., Georgia Tech.

"Studio Design," by George Nixon, Assistant Director of Technical Development, National Broadcasting Company.

"Design of Studios for Small Stations," by A. F. Henry, Acoustic Engineering Co.

"Antennas for Standard Broadcast Stations," by R. F. Holtz, Radio Corporation of America.

"Symposium on Recording," by Ivan Miles, Radio Station WGST; Frank Parkins, Radio Station WSB; and Henry White, Radio Station WSB.

"FM Systems," by W. H. Doherty, Bell Telephone Laboratories; Nils Oman, Radio Corporation of America; J. M. Comer, General Electric Company; and D. C. Abbott, Westinghouse Electric Company.

"FM Antennas and Transmission Lines," by A. G. Kandoian, Federal Telephone and Radio Corporation, and Robert F. Holtz, Radio Corporation of America.

"FM Transmitter Measurements," by John L. Johnson, Westinghouse Electric Company; and H. P. Thomas and L. M. Leeds (presented by L. M. Leeds), General Electric Company.

"Program Transmission Circuits for FM," by R. H. Daugherty, American Telephone and Telegraph Company.

"Status of FM Broadcasting," by W. R. David, General Electric Company.

"Design Problems of a Modern Home Receiver," by Z. Bennin, Research Department, Zenith Corporation.

"Questions and Answers," conducted by John A. Willoughby, Assistant Chief Engineer, Broadcasting Branch, Federal Communications Commission.

"Television Equipment Layouts," by P. G. Caldwell, General Electric Company.

"High-Frequency Tubes," by T. A. Elder, General Electric Company.

"Stratovision," by C. E. Noble, Westinghouse Electric Company.

"FM Propagation in the Atlanta Area," by M. A. Honnell, Georgia Tech, and A. W. Shropshire, Radio Station WSB.



Left to right: T. A. Elder, General Electric Company; Dr. W. A. Edson, Georgia Tech Electrical Engineering Department; E. S. Lammers, Westinghouse Electric Corporation, Atlanta, Georgia; Professor M. A. Honnell, Georgia Tech Electrical Engineering Department, Conference General Chairman; C. F. Daugherty, Chief Engineer, WSB, and Conference Exhibit Chairman; and L. M. Leeds, General Electric Company, Syracuse, N. Y.



Left to right: Colonel Blake Ragsdale Van Leer, President, Georgia School of Technology; John A. Willoughby, Assistant Chief Engineer, Broadcasting Branch, FCC; Allan Woodall, President, WDAK, and Vice President of the Georgia Association of Broadcasters; Lewis M. Gordon, vice president, Citizens and Southern National Bank, Atlanta; and Paul H. Herndon, Inspector in Charge, FCC, Atlanta Office, and Chairman, Atlanta Section, I.R.E.



Left to right: W. R. David, General Electric Company; John A. Willoughby, Assistant Chief Engineer, Broadcasting Branch, Federal Communications Commission, leader of a question-and-answer session on FCC; Paul H. Herndon, Inspector in Charge, Federal Communications Commission, Atlanta Office, and Chairman of Atlanta Section, Institute of Radio Engineers; and A. W. Shropshire, Assistant Chief Engineer, The Atlanta Journal Station WSB.



Left to right: E. S. Lammers, Westinghouse Electric Corporation, Atlanta, Georgia; C. E. Noble, Westinghouse Electric Corporation; P. G. Caldwell, General Electric Company; and Dr. G. A. Rosselot, Director of Georgia Tech Engineering Experiment Station, and Conference Arrangements Chairman.



Left to right: C. F. Daugherty, Chief Engineer, WSB, and Conference Exhibit Chairman; George Nixon, Assistant Director of Technical Development, NBC; W. L. Fattig, General Electric Company; Duane F. McConnell, WRUF; and Phil C. Bangs, Acoustic Equipment Company.



Left to right: J. M. Comer, General Electric Company, and W. H. Doherty, Bell Telephone Laboratories; Ben Akerman, Chief Engineer, Station WGST, Atlanta, Georgia, and Conference Program Chairman; Nils Oman, General Electric Company, and D. C. Abbott, Westinghouse Electric Corporation.

Institute Committees—1947

EXECUTIVE

W. R. G. Baker, *Chairman*
 R. F. Guy, *Treasurer and Vice-Chairman*
 Haraden Pratt, *Secretary*
 A. N. Goldsmith, *Editor*
 S. L. Bailey, *Keith Henney*
 F. R. Lack

BOARD OF EDITORS

A. N. Goldsmith, *Chairman*
 F. W. Albertson
 J. S. Allen
 W. L. Barrow
 R. R. Batcher
 A. E. Bowen
 Ralph Bown
 R. S. Burnap
 O. H. Caldwell
 C. W. Carnahan
 L. W. Chubb
 L. M. Clement
 J. D. Cobine
 M. G. Crosby
 R. B. Dome
 W. G. Dow
 E. W. Engstrom
 W. L. Everitt
 W. G. H. Finch
 D. G. Fink
 H. C. Forbes
 I. A. Getting
 G. W. Gilman
 P. C. Goldmark
 A. W. Graf
 F. W. Grover
 L. B. Headrick
 E. W. Herold
 J. A. Hutcheson
 C. M. Jansky, Jr.
 J. K. Johnson
 L. F. Jones
 H. S. Knowles
 J. D. Kraus
 J. B. H. Kuper
 J. T. Lawson
 D. G. Little
 F. B. Llewellyn
 V. K. Zworykin
 S. S. Mackeown
 Nathan Marchand
 E. D. McArthur
 Knox McIlwain
 J. W. McRae
 L. A. Meacham
 G. F. Metcalf
 E. L. Nelson
 D. O. North
 H. F. Olson
 R. M. Page
 H. O. Peterson
 G. W. Pickard
 Haraden Pratt
 C. A. Priest
 J. R. Ragazzini
 Simon Ramo
 H. J. Reich
 J. D. Reid
 F. X. Rettenmeyer
 P. C. Sandretto
 S. W. Seeley
 V. W. Sherman
 L. C. Smeby
 C. E. Smith
 J. A. Stratton
 W. C. Tinus
 K. S. Van Dyke
 E. K. Van Tassel
 E. C. Wente
 H. A. Wheeler
 J. R. Whinnery
 W. C. White
 L. E. Whittlemore
 G. W. Willard
 William Wilson
 I. G. Wolff
 V. K. Zworykin

AWARDS

F. B. Llewellyn, *Chairman*
 E. W. Engstrom
 D. G. Fink
 V. M. Graham
 H. A. Hackbusch
 D. D. Israel
 I. J. Kaar

EDUCATION

William H. Radford, *Chairman*
 W. E. Arcand
 R. E. Beam
 A. B. Bronwell
 Melville Eastham
 G. H. Fett
 A. W. Graf
 E. A. Guillemin
 Alan Hazeltine
 G. B. Hoadley
 L. N. Holland
 A. H. Howell
 H. H. Newell
 R. G. Porter
 H. J. Reich
 E. H. Schulz
 W. J. Seeley
 F. R. Stansel
 W. O. Swinyard
 G. R. Town
 Ernst Weber
 A. H. Wing, Jr.

PAPERS PROCUREMENT

Dorman D. Israel, *Chairman*
 Andrew Alford
 B. B. Bauer
 R. M. Bowie
 A. B. Bronwell
 J. W. Butterworth
 I. F. Byrnes
 T. J. Carroll
 Madison Cawein
 K. A. Chittick
 B. J. Chromy
 J. T. Cimorelli
 Harry Diamond
 E. Dietze
 G. V. Eltgroth
 M. K. Goldstein
 H. Grossman
 R. C. Guthrie
 D. E. Harnett
 J. R. Harrison
 J. V. L. Hogan
 F. V. Hunt
 T. A. Hunter
 D. D. Israel
 Hans Jaffe
 J. J. Jakosky
 Martin Katzin
 C. E. Kilgour
 I. G. Maloff
 H. B. Marvin
 W. P. Mason
 Pierre Mertz
 B. J. Miller
 A. F. Murray
 I. E. Mourontseff
 J. R. Nelson
 L. L. Nettleton
 G. M. Nixon
 D. E. Noble
 T. M. Odarenko
 H. F. Olson
 W. E. Reichle
 J. D. Reid
 F. X. Rettenmeyer
 H. W. G. Salinger
 Robert E. Shelby
 W. P. Short
 P. L. Smith
 J. Q. Stansfield
 G. R. Town
 L. G. Trolese
 H. J. Tyzzer
 K. S. Van Dyke
 W. L. Webb
 J. R. Whinnery
 W. C. White
 G. S. Wickizer
 R. J. Wise
 C. J. Young

PAPERS REVIEW

Murray G. Crosby, *Chairman*
 H. A. Affel
 E. W. Allen
 C. F. Baldwin
 B. de F. Bayly
 F. J. Bingley
 H. S. Black
 F. T. Bowditch
 H. A. Chinn
 J. K. Clapp
 I. S. Coggeshall
 S. B. Cohn
 J. M. Constable
 F. W. Cunningham
 H. D. Doolittle
 O. S. Duffendack
 R. D. Duncan, Jr.
 I. E. Fair
 E. H. Felix
 V. H. Fraenckel
 R. L. Freeman
 Stanford Goldman
 W. M. Goodall
 W. C. Hahn
 G. L. Haller
 O. B. Hanson
 A. E. Harrison
 J. R. Harrison
 T. J. Henry
 C. N. Hoyler
 F. V. Hunt
 Harley Iams
 D. L. Jaffe
 Hans Jaffe
 W. R. Jones
 D. C. Kallbelf
 A. G. Kandoian
 J. G. Kreer, Jr.
 Emil Labin
 H. C. Leuteritz
 C. V. Litton
 V. D. Landon
 H. R. Lubcke
 Louis Malter
 W. P. Mason
 R. E. Mathes
 H. F. Mayer
 H. R. Mimno
 R. E. Moe
 R. M. Morris
 F. L. Mosely
 I. E. Mourontseff
 G. G. Muller
 A. F. Murray
 J. R. Nelson
 K. A. Norton
 L. J. Peters
 A. P. G. Peterson
 W. H. Pickering
 A. F. Pomeroy
 S. O. Rice
 T. H. Rogers
 H. E. Roys
 M. W. Scheldorf
 Samuel Seely
 Harner Selvidge
 C. M. Slack
 J. E. Smith
 L. P. Smith
 P. L. Smith
 E. E. Spitzer
 E. K. Stodola
 H. P. Thomas
 Bertram Trevor
 Dayton Ulrey
 A. P. Upton
 G. L. Usselman
 L. Vierh
 S. N. Van Voorhies
 R. M. Wilmotte
 J. W. Wright
 H. R. Zeamans

CONSTITUTION AND LAWS

B. E. Shackelford, *Chairman*
 G. W. Bailey
 A. B. Chamberlain
 I. S. Coggeshall
 R. F. Guy
 R. A. Heising
 F. R. Llewellyn
 F. E. Terman
 H. R. Zeamans

ADMISSIONS

G. T. Royden, *Chairman*
 F. A. Polkinghorn, *Vice-Chairman*
 R. D. Avery
 H. H. Beverage
 R. M. Bowie
 J. T. Brothers
 J. L. Callahan
 H. A. Chinn
 J. D. Cobine
 E. D. Cook (W. A. Ford, alternate)
 O. M. Dunning
 Lloyd Espenschied
 T. T. Goldsmith, Jr.
 A. R. Hodges
 A. R. Morton
 C. E. Scholz
 S. W. Seeley
 R. F. Shea
 M. E. Strieby
 J. C. Stroebel
 W. L. Webb
 F. D. Webster
 G. S. Wickizer
 R. C. G. Williams

MEMBERSHIP

Beverly Dudley, *Chairman*
 A. L. Albert
 R. E. Beam
 E. D. Cook
 A. V. Eastman
 D. G. Fink
 R. P. Glover
 George Grammer
 R. F. Guy
 J. W. Horton
 P. B. Laeser
 I. E. Mourontseff
 W. H. Radford
 Donald Sinclair
 J. A. Stratton
 K. S. Van Dyke
 Ernst Weber
 W. C. White
 P. D. Zottu

PUBLIC RELATIONS

Virgil M. Graham, *Chairman*
 G. W. Bailey
 E. L. Bragdon
 W. C. Copp
 C. B. DeSoto
 O. E. Dunlap
 W. C. Evans
 H. C. Forbes
 Charles Fry
 R. A. Hackbusch
 Keith Henney
 George Lewis
 R. H. Manson
 E. A. Nicholas
 R. C. Poulter
 H. B. Richmond
 E. L. Robinson
 Crump Smith
 D. B. Smith
 Will Whitmore

SECTIONS

W. O. Swinyard, *Chairman*
 S. L. Bailey
 E. D. Cook
 A. W. Graf
 J. A. Green
 R. A. Heising
 G. B. Hoadley
 Earl Kent
 P. B. Laeser
 L. E. Packard
 J. E. Shepherd
 (Section Chairmen *Ex Officio*)

NOMINATIONS

Haraden Pratt, *Chairman*
 S. L. Bailey
 J. E. Brown
 E. W. Engstrom
 J. J. Farrell
 L. C. F. Horle
 F. B. Llewellyn

TELLERS

H. A. Chinn, *Chairman*
 W. A. Cobb
 J. E. Shepherd

Technical Committees—May 1, 1947—May 1, 1948

ANNUAL REVIEW

L. E. Whittemore, *Chairman*

W. Bode	D. G. Fink
P. Bosomworth	Keith Henney
George Brown	J. V. L. Hogan
S. Burnap	E. A. Laport
V. G. Cady	P. J. Larsen
S. Carter	W. B. Lodge
B. Chamberlain	E. W. Schafer
S. Coggeshall	S. A. Schelkunoff
M. G. Crosby	W. O. Swinyard
Eginhard Dietze	F. E. Terman
S. Ellefson	H. A. Wheeler

ANTENNAS

P. S. Carter, *Chairman*

Andrew Alford	R. B. Jacques
W. L. Barrow (W. W. Miehler, alternate)	E. C. Jordan
F. M. Bloomer	W. E. Kock
G. H. Brown	K. A. MacKinnon
Harry Diamond	D. C. Ports
W. S. Duttera	M. W. Scheldorf
J. E. Eaton	S. A. Schelkunoff
Sidney Frankel	J. C. Schelleng
George Grammer	George Sinclair
R. F. Guy	P. H. Smith
R. F. Holtz	L. C. Van Atta
	J. W. Wright

CIRCUITS

H. W. Bode, *Chairman*

J. G. Brainerd	E. A. Guillemin
Cledo Brunetti	H. L. Krauss
C. R. Burrows	E. E. Overmier
F. C. Everett	E. H. Perkins
W. L. Everitt	J. B. Russell, Jr.
R. M. Foster	S. W. Seeley
S. G. Goldman	W. M. Smith
	W. N. Tuttle

ELECTROACOUSTICS

Eginhard Dietze, *Chairman*

P. N. Arnold	F. L. Hopper
B. B. Bauer	F. V. Hunt
S. J. Begun	G. S. Knowles
R. H. Bolt	H. M. Nixon
R. K. Cook	Benjamin Olney
M. J. Di Toro	H. F. Olson
W. D. Goodale, Jr.	R. A. Schlegel
E. C. Gregg	E. S. Seeley
	Lincoln Thompson

ELECTRON TUBES

R. S. Burnap, *Chairman*

A. Y. Bentley	Louis Malter
K. C. De Walt	D. E. Marshall
W. G. Dow	J. A. Morton
A. M. Glover	I. E. Mourontseff
J. E. Gorham	L. S. Nergaard
George Grammer	G. D. O'Neill
J. W. Greer	L. M. Price
L. B. Headrick	H. J. Reich
E. C. Homer	A. C. Rockwood
D. R. Hull	A. L. Samuel
S. B. Ingram	J. R. Steen
H. L. Krauss	C. M. Wheeler

FACSIMILE

J. V. L. Hogan, *Chairman*

J. C. Barnes	Pierre Mertz
Henry Burkhard	H. C. Ressler
J. J. Callahan	Arthur Rustad
A. G. Cooley	W. E. Stewart
R. E. Mathes	E. F. Watson
	R. J. Wise

HANDBOOK

H. A. Wheeler, *Chairman*

C. T. Burke	Sidney Frankel
R. S. Burnap	Knox McIlwain
J. D. Crawford	Frank Massa
C. B. De Soto	F. E. Terman
R. L. Dietzold	B. F. Wheeler
D. G. Fink	J. R. Whinnery
	R. M. Wilmotte

INDUSTRIAL ELECTRONICS

G. P. Bosomworth, *Chairman*

W. B. R. Agnew	H. W. Parker
J. E. Brown	H. O. Peterson
R. D. Campbell	Walther Richter
C. A. Ellert	W. C. Rudd
C. W. Frick	P. C. Sandretto
Merle Gander	V. W. Sherman
H. C. Gillespie	D. E. Watts
Otto Glasser	Julius Weinberger
A. C. Holt	R. M. Wilmotte
Eugene Mittelman	T. L. Wilson
	P. D. Zottu

MODULATION SYSTEMS

M. G. Crosby, *Chairman*

H. S. Black	D. M. Hill
J. E. Brown	V. D. Landon
F. L. Burroughs	B. D. Loughlin
C. C. Chambers	C. T. McCoy
F. M. Doolittle	C. R. Miner
C. W. Finnigan	G. W. Olive
W. F. Goetter	E. M. Ostlund
A. C. Goodnow	Dale Pollack
George Grammer	S. W. Seeley
D. D. Grieg	Bertram Trevor
R. F. Guy	W. G. Tuller
	J. W. Wright

NAVIGATION AIDS

D. G. Fink, *Chairman*

H. G. Busignies	H. R. Mimno
P. A. D'Orio	H. K. Morgan
F. C. Dyer (C. R. Banks, alternate)	Marcus O'Day
R. C. Ferrar	G. H. Phelps
N. L. Harvey	J. A. Pierce
C. J. Hirsch	J. A. Rankin
A. B. Hunt	P. C. Sandretto
W. E. Jackson	Ben Thompson
	R. R. Welsh

PIEZOELECTRIC CRYSTALS

W. G. Cady, *Chairman*

C. F. Baldwin	W. P. Mason
W. L. Bond	P. L. Smith
J. K. Clapp	R. A. Sykes
Clifford Frondel	K. S. Van Dyke
Hans Jaffe	J. M. Wolfskill

RAILROAD AND VEHICULAR COMMUNICATION

G. M. Brown, *Chairman*

F. T. Budelman	D. E. Noble
W. T. Cooke	G. H. Phelps
W. S. Halstead	W. W. Salisbury
W. A. Harris	David Talley
C. N. Kimball, Jr.	F. W. Walker
	W. R. Young

RESEARCH

F. E. Terman, *Chairman*

W. L. Barrow	D. G. Fink
F. T. Bowditch	H. T. Friis
R. M. Bowie	L. C. Van Atta
E. W. Engstrom	A. F. Van Dyck
W. L. Everitt	Julius Weinberger

RADIO RECEIVERS

W. O. Swinyard, *Chairman*

G. L. Beers	C. R. Miner
J. E. Brown	Garrard Mountjoy
W. F. Cotter	H. O. Peterson
W. L. Dunn	J. M. Pettit
H. C. Forbes	Dale Pollack
D. E. Foster	F. H. R. Pounsett
C. J. Franks	J. D. Reid
A. R. Hodges	R. F. Shea
K. W. Jarvis	H. L. Shortt
J. K. Johnson	R. M. Wilmotte
	C. F. Wolcott

RADIO TRANSMITTERS

E. A. Laport, *Chairman*

L. T. Bird	L. A. Looney
M. R. Briggs	C. H. Meyer
Cledo Brunetti	J. C. R. Punched
H. R. Butler	R. L. Robbins
George Grammer	J. C. Schelleng
A. E. Kerwien	Robert Serrell
J. B. Knox	I. R. Weir

RADIO WAVE PROPAGATION AND UTILIZATION

S. A. Schelkunoff, *Chairman*

S. L. Bailey	K. A. Norton
C. R. Burrows	H. O. Peterson
T. J. Carroll	J. A. Pierce
A. E. Cullum	George Sinclair
W. S. Duttera	R. L. Smith-Rose
A. G. Fox	J. A. Stratton
M. C. Gray	H. W. Wells
D. E. Kerr	J. W. Wright

STANDARDS

A. B. Chamberlain, *Chairman*

L. G. Cumming, *Vice Chairman*

H. W. Bode	J. V. L. Hogan
G. P. Bosomworth	L. C. F. Horle
G. M. Brown	E. A. Laport
R. S. Burnap	P. J. Larsen
W. G. Cady	A. V. Loughren
P. S. Carter	E. W. Schafer
M. G. Crosby	S. A. Schelkunoff
Eginhard Dietze	W. O. Swinyard
D. G. Fink	H. M. Turner
V. M. Graham	H. A. Wheeler
Keith Henney	L. E. Whittemore

SYMBOLS

E. W. Schafer, *Chairman*

A. E. Anderson	E. T. Dickey
R. R. Batcher	H. S. Knowles
M. R. Briggs	O. T. Laube
R. S. Burnap	C. A. Nietzert
C. R. Burrows	A. F. Pomeroy
H. F. Dart	A. L. Samuel
J. H. Dellinger	J. R. Steen
	H. M. Turner

TELEVISION

P. J. Larsen, *Chairman*

W. F. Bailey	R. D. Kell
J. E. Brown	J. B. Minter
K. A. Chittick	Garrard Mountjoy
D. G. Fink	J. A. Ouimet
P. C. Goldmark	D. W. Pugsley
R. N. Harmon	R. E. Shelby
A. G. Jensen	D. B. Smith
I. J. Kaar	M. E. Strieby

Special Committees

BUILDING FUND ADMINISTRATORS

Melville Eastham E. A. Nicholas
Haraden Pratt

CONVENTION POLICY

J. E. Shepherd, *Chairman*
Austin Bailey E. J. Content
G. W. Bailey B. E. Shackelford

EDITORIAL ADMINISTRATIVE

A. N. Goldsmith, Editor—*Chairman*
R. S. Burnap F. B. Llewellyn
M. G. Crosby Donald McNicol
E. W. Herold Haraden Pratt
L. E. Whittemore

FOUNDERS

R. F. Guy, *Chairman*

FISCAL

Haraden Pratt, *Chairman*
A. N. Goldsmith F. R. Lack
R. F. Guy F. B. Llewellyn

INTERNATIONAL LIAISON

Ralph Bown, *Chairman*
F. S. Barton E. M. Deloraine
F. B. Llewellyn

OFFICE QUARTERS

R. A. Heising, *Chairman*
G. W. Bailey F. B. Llewellyn
A. N. Goldsmith Haraden Pratt

PLANNING

R. A. Heising, *Chairman*
S. L. Bailey Keith Henney
A. N. Goldsmith D. B. Sinclair
B. E. Shackelford

PROFESSIONAL RECOGNITION

W. C. White, *Chairman*
E. F. Carter J. V. L. Hogan
C. C. Chambers H. A. Wheeler
H. R. Zeamans

SPECIAL PUBLICATION FUND

F. R. Lack, *Chairman*
S. L. Bailey J. R. Miller
J. E. Brown B. E. Shackelford
R. V. Howard D. B. Sinclair
D. B. Smith

RMA-I.R.E. CO-ORDINATING

V. M. Graham, *Chairman*
L. G. Cumming D. D. Israel
J. J. Farrell Keith Henney
L. C. F. Horle

Institute Representatives in Colleges—1947

Alabama Polytechnic Institute: Appointment Later
Alberta, University of: J. W. Porteous
Arkansas, University of: Appointment Later

British Columbia, University of: H. J. MacLeod
Brooklyn, Polytechnical Institute of: G. B. Hoadley

California Institute of Technology: S. S. Mackeown
California, University of: L. J. Black
Carleton College: Appointment Later
Carnegie Institute of Technology: E. M. Williams
Case School of Applied Science: P. L. Hoover
Cincinnati, University of: A. B. Bereskin
Colorado, University of: Appointment Later
Columbia University: J. R. Raggazzini
Connecticut, University of: F. P. Fischer
Cooper Union: J. B. Sherman
Cornell University: True McLean

Detroit, University of: Appointment Later
Drexel Institute of Technology: Appointment Later
Duke University: W. J. Seeley

Florida, University of: F. H. Pumphrey

Georgia School of Technology: M. A. Honnell

Harvard University: E. L. Chaffee

Idaho, University of: P. K. Hudson
Illinois Institute of Technology: Appointment Later
Illinois, University of: E. C. Jordan
Iowa, State University of: L. A. Ware
Iowa State College: W. L. Cassell

Johns Hopkins University: Ferdinand Hamburger, Jr.

Kansas State College: K. Martin
Kansas, University of: G. A. Richardson

Lawrence Institute of Technology: H. L. Byerlay
Lehigh University: D. E. Mode
Louisiana State University: W. E. Owen

Maine, University of: W. J. Creamer, Jr.
Manhattan College: E. N. Lurch
Maryland, University of: G. L. Davis
Massachusetts Institute of Technology: E. A. Guillemin
and W. H. Radford
McGill University: F. S. Howes
Michigan State: J. A. Strelzoff
Michigan, University of: L. N. Holland
Minnesota, University of: O. A. Becklund
Missouri, University of: D. L. Weidelich

Nebraska, University of: F. W. Norris
Newark College of Engineering: Solomon Fishman
New Hampshire, University of: W. B. Nulsen
New Mexico, University of: H. L. Jones
New York, College of the City of: Harold Wolf
New York University: Philip Greenstein
North Carolina State College: W. S. Carley
North Dakota, University of: Appointment Later
Northeastern University: G. E. Pihl
Northwestern University: R. E. Beam
Notre Dame, University of: H. E. Ellithorn

Ohio State University: E. M. Boone
Oklahoma Agriculture and Mechanical College: H. T. Fristoe
Oregon State College: A. I. Albert

Pennsylvania State College: G. L. Crossley
Pennsylvania, University of: C. C. Chambers
Pittsburgh, University of: Appointment Later
Princeton University: J. G. Barry
Purdue University: R. P. Siskind

Queen's University: H. H. Stewart

Rensselaer Polytechnic Institute: H. D. Harris
Rice Institute: M. V. McNany
Rose Polytechnic Institute: H. A. Moench
Rutgers University: J. L. Potter

Southern Methodist University: H. J. Smith
Stanford University: Karl Spangenberg
Stevens Institute of Technology: Carl Neitzert
Syracuse University: C. S. Roys

Texas, University of: E. W. Hamlin
Toronto, University of: R. G. Anthes
Tufts College: A. H. Howell

Union College: F. W. Grover
United States Military Academy: L. E. Johnson
United States Naval Academy: G. R. Giet
Utah, University of: O. C. Haycock

Virginia, University of: L. R. Quarles
Virginia Polytechnic Institute: R. R. Wright

Washington, University of: A. V. Eastman
Washington University: S. H. Van Wambeck
Wayne University: G. W. Carter
Western Ontario, University of: G. W. Wootton
West Virginia University: R. C. Colwell
Wisconsin, University of: Glenn Koehler
Worcester Polytechnic Institute: H. H. Newell

Yale University: H. M. Turner

Sections

Chairman		Secretary		Chairman		Secretary	
P. H. Herndon 3/0 Dept. in charge of Federal Communication #11 Federal Annex Atlanta, Ga.	ATLANTA	M. S. Alexander 2289 Memorial Dr., S.E. Atlanta, Ga.		L. W. Butler 3019 N. 90 St. Milwaukee 13, Wis.	MILWAUKEE	E. T. Sherwood 9157 N. Tennyson Dr. Milwaukee, Wis.	
H. L. Spencer Associated Consultants 18 E. Lexington Baltimore 2, Md.	BALTIMORE	G. P. Houston, 3rd 3000 Manhattan Ave. Baltimore 15, Md.		R. R. Desnaultiers Canadian Marconi Co. 211 St. Sacrement St. Montreal P.Q., Canada	MONTREAL, QUEBEC	R. Matthews Federal Mfg. Co. 9600 St. Lawrence Blvd. Montreal 14, P.Q., Can- ada	
W. S. Radford Massachusetts Institute of Technology Cambridge, Mass.	BOSTON	A. G. Bousquet General Radio Co. 275 Massachusetts Ave. Cambridge 39, Mass.		J. T. Cimorelli RCA Victor Division 415 S. Fifth St. Harrison, N. J.	NEW YORK	J. R. Ragazzini Columbia University New York 27, N. Y.	
A. T. Consentino San Martin 379 Buenos Aires, Argentina	BUENOS AIRES	N. C. Cutler San Martin 379 Buenos Aires, Argentina		L. R. Quarles University of Virginia Charlottesville, Va.	NORTH CAROLINA- VIRGINIA	J. T. Orth 4101 Fort Ave. Lynchburg, Va.	
H. W. Staderman 264 Loring Ave. Buffalo, N. Y.	BUFFALO-NIAGARA	J. F. Myers Colonial Radio Corp. 1280 Main St. Buffalo 9, N. Y.		K. A. Mackinnon Box 542 Ottawa, Ont. Canada	OTTAWA, ONTARIO	D. A. G. Waldock National Defense Headquarters New Army Building Ottawa, Ont., Canada	
J. A. Green Collins Radio Co. Cedar Rapids, Iowa	CEDAR RAPIDS	Arthur Wulfsburg Collins Radio Co. Cedar Rapids, Iowa		P. M. Craig 342 Hewitt Rd. Wyncote, Pa.	PHILADELPHIA	J. T. Brothers Philco Radio and Tele- vision Tioga and C Sts. Philadelphia 34, Pa.	
Karl Kramer Jensen Radio Mfg. Co. 6601 S. Laramie St. Chicago 38, Ill.	CHICAGO	D. G. Haines Hytron Radio and Elec- tronics Corp. 4000 W. North Ave. Chicago 39, Ill.		W. E. Shoupp 911 S. Braddock Ave. Wilkinsburg, Pa.	PITTSBURGH	C. W. Gilbert 52 Hathaway Ct. Pittsburgh 21, Pa.	
J. D. Reid Box 67 Cincinnati 31, Ohio	CINCINNATI	C. K. Gieringer 303 W. Third St. Cincinnati 2, Ohio		Francis McCann 4415 N.E. 81 St. Portland 13, Ore.	PORTLAND	A. E. Richmond Box 441 Portland 7, Ore.	
W. G. Hutton R.R. 3 Breckeville, Ohio	CLEVELAND	H. D. Seilstad U. S. Coast Guard Office Kieth Building Cleveland 15, Ohio		A. E. Newlon Stromberg-Carlson Co. Rochester 3, N. Y.	ROCHESTER	J. A. Rodgers Huntington Hills Rochester, N. Y.	
E. M. Boone Ohio State University Columbus, Ohio	COLUMBUS Aug. 8	C. J. Emmons 158 E. Como Ave. Columbus 2, Ohio		E. S. Naschke 1073-57 St. Sacramento 16, Calif.	SACRAMENTO	G. W. Barnes 1333 Weller Ave. Sacramento, Calif.	
Dale Pollack 352 Pequot Ave. New London, Conn.	CONNECTICUT VALLEY	R. F. Blackburn 62 Salem Rd. Manchester, Conn.		R. L. Coe Radio Station KSD Post Dispatch Bldg. St. Louis 1, Mo.	ST. LOUIS	N. J. Zehr Radio Station KWK Hotel Chase St. Louis 8, Mo.	
Robert Broding 2921 Kingston Dallas, Texas	DALLAS-Ft. WORTH	A. S. LeVelle 308 S. Akard St. Dallas 2, Texas		Rawson Bennett U. S. Navy Electronics Laboratory San Diego 52, Calif.	SAN DIEGO Aug. 5	C. N. Tirrell U. S. Navy Electronics Laboratory San Diego 52, Calif.	
S. L. Adams Miami Valley Broadcast- ing Corp. Dayton 3, Ohio	DAYTON	George Rappaport 132 E. Court Harshman Homes Dayton 3, Ohio		W. J. Barclay 955 N. California Ave. Palo Alto, Calif.	SAN FRANCISCO	F. R. Brace 955 Jones San Francisco 9, Calif.	
P. O. Frincke 219 S. Kenwood St. Royal Oak, Mich.	DETROIT June 20	Charles Kocher 17186 Sioux Rd. Detroit 24, Mich.		J. F. Johnson 2626 Second Ave. Seattle 1, Wash.	SEATTLE Aug. 14	J. M. Patterson 7200-28 N. W. Seattle 7, Wash.	
N. J. Reitz Sylvania Electric Prod- ucts, Inc. Emporium, Pa.	EMPORIUM	A. W. Peterson Sylvania Electric Prod- ucts, Inc. Emporium, Pa.	Prod-	C. A. Priest 314 Hurlburt Rd. Syracuse, N. Y.	SYRACUSE	R. E. Moe General Electric Co. Syracuse, N. Y.	
F. M. Austin 3103 Amherst St. Houston, Texas	HOUSTON	C. V. Clarke, Jr. Box 957 Paradise, Texas		H. S. Dawson Canadian Association of Broadcasters 80 Richmond St., W. Toronto, Ont., Canada	TORONTO, ONTARIO	C. J. Bridgland Canadian National Tele- graph 347 Bay St. Toronto, Ont., Canada	
H. I. Metz Civil Aeronautics Admin- istration 84 Marietta St., NW Atlanta, Ga.	INDIANAPOLIS	M. G. Beier 3930 Guilford Ave. Indianapolis 5, Ind.		M. E. Knox 43-44 Ave., S. Minneapolis, Minn.	TWIN CITIES	Paul Thompson 4602 S. Nicollet Minneapolis, Minn.	
C. L. Omer Midwest Eng. Devel. Co. Inc. 3543 Broadway Kansas City 2, Mo.	KANSAS CITY	Mrs. G. L. Curtis 6003 El Monte Mission, Kansas		L. C. Smeby 820-13 St. N. W. Washington 5, D. C.	WASHINGTON	T. J. Carroll National Bureau of Standards Washington, D. C.	
R. C. Dearle Dept. of Physics University of Western Ontario London, Ont., Canada	LONDON, ONTARIO	E. H. Tull 14 Erie Ave. London, Ont., Canada		L. N. Persio Radio Station WRAK Williamsport 1, Pa.	WILLIAMSPORT	R. G. Petts Sylvania Electric Prod- ucts, Inc. 1004 Cherry St. Montoursville, Pa.	
C. W. Mason 141 N. Vermont Ave. Los Angeles 4, Calif.	LOS ANGELES July 15	Bernard Walley RCA Victor Division 420 S. San Pedro St. Los Angeles 13, Calif.					

Sections

SUBSECTIONS

Chairman		Secretary		Chairman		Secretary	
J. D. Schantz Farnsworth Television and Radio Company 3700 E. Pontiac St. Fort Wayne, Ind.	FORT WAYNE (Chicago Subsection)	S. J. Harris Farnsworth Television and Radio Co. 3702 E. Pontiac Fort Wayne 1, Ind.		N. W. Mather Princeton University Princeton, N. J.	PRINCETON (Philadelphia Subsection)	A. E. Harrison Princeton University Princeton, N. J.	
F. A. O. Banks 81 Troy St. Kitchener, Ont., Canada	HAMILTON (Toronto Subsection)	E. Ruse 195 Ferguson Ave., S. Hamilton, Ont., Canada		A. R. Kahn Electro-Voice, Inc. Buchanan, Mich.	SOUTH BEND (Chicago Subsection)	A. M. Wiggins Electro-Voice, Inc. Buchanan, Mich.	
K. G. Jansky Bell Telephone Laboratories Box 107 Red Bank, N. J.	MONMOUTH (New York Subsection)	L. E. Hunt Bell Telephone Labora- tories Deal, N. J.		W. A. Cole 323 Broadway Ave. Winnipeg, Manit., Can- ada	WINNIPEG (Toronto Subsection)	C. E. Trembley Canadian Marconi Co. Main Street Winnipeg, Manit., Can- ada	

Books

Television Receiving Equipment, by W. T. Cocking

Published (1947—Second Edition) by Iliffe & Sons, Ltd., Dorset House, London S.E. 1, England. 339 pages+3-page index +6-page appendix+26 advertising pages. 217 figures and illustrations. $4\frac{1}{2} \times 7$ inches. Price, 12s, 6d.

This is the second edition of an excellent practical book on British television receiver practice. The new edition contains 48 additional pages, including new appendices on integrators, differentiators, and direct-current restoration circuits. The book is written from first-hand knowledge of the field, in a nonmathematical style. It includes chapters on cathode-ray tubes and power supplies, deflection systems, radio-frequency, intermediate-frequency, and video amplifiers, converters, video detectors, synchronizing circuits, sound systems, antennas, and servicing problems. A chapter of particular current interest to American designers is that on superheterodyne interference problems. A complete receiver, suitable for experimental construction, is described, complete with circuit values.

The value of the book to American readers is somewhat lessened by the differences between United States and British standards (particularly the British use of amplitude modulation for sound, double-sideband transmission, positive modulation, 405 lines, 25 frames). Moreover, there are no references to several postwar developments now appearing in commercial receivers in this country, such as automatic-frequency-control synchronizing circuits, voltage-doubler and tripler power supplies (although there is a brief mention of the fly-back type of power supply), stagger tuning of intermediate-frequency amplifiers, Schmidt optics for projection, and multichannel radio-frequency switching (the latter not being necessary in British designs in any event). But these are minor omissions compared with the wealth of material on the basic circuits of direct-vision equipment. British designers, as well as American engineers concerned with the

export market, will find the book a most valuable index to British needs and practices.

DONALD G. FINK
McGraw-Hill Publishing Co.
330 West 42 St., New York 18, N. Y.

Directional Antennas, by Carl E. Smith

Published (1946) by Cleveland Institute of Radio Electronics, Terminal Tower, Cleveland 3, Ohio. 298 pages+xiii pages. 39 figures, 15,160 patterns. $8\frac{1}{2} \times 11$ inches. Price, \$15.00, two for \$25.00.

This book will be of particular interest to those concerned with the design of vertical-tower directional antennas for broadcast stations. A thorough, systematic engineering treatment of the problem of broadcast-antenna design is presented. To facilitate the work, consideration is given to Federal Communications Commission standards and field intensities are stated in terms of the value at 1 mile from an antenna with 1 kilowatt input. More than 15,000 antenna patterns are included and these should, in many cases, greatly reduce or eliminate the labor of pattern calculation. Although the book is designed primarily for the needs of the broadcast-antenna designer, the wealth of formulas, charts, and patterns make it of value also as a general reference.

The book is divided into three parts. The first part of 58 pages treats the general problem of pattern calculation. The radiation characteristics of simple reference antennas and of arrays of several vertical elements are analyzed in detail. Both horizontal- and vertical-plane patterns are considered. Sinusoidal-current distributions and a perfectly conducting earth are assumed in the calculations.

The second part of 10 pages is a systematized tabulation of 568 electromechanically calculated polar plots of horizontal-plane patterns of antennas of two towers. Patterns are presented as a function of spacing and phasing in steps of 15 degrees for spacings up to 1 wavelength and in steps of 45 degrees

for spacings up to 4 wavelengths. The third part of 228 pages is a systematized tabulation of 14,592 polar plots of horizontal-plane patterns of antennas of three towers. Patterns are presented for three-tower antennas arranged in 228 different configurations with 64 different phasings for each configuration.

JOHN D. KRAUS
Department of Electrical Engineering
Ohio State University
Columbus 10, Ohio

Photoelectric Cells, by A. Sommer

Published (1947) by Chemical Publishing Company, Inc., 26 Court Street, Brooklyn 2, N. Y. 99 pages+2-page index+2-page bibliography+xviii pages. 27 figures. $5\frac{1}{2} \times 8\frac{1}{2}$ inches. Price, \$2.75.

This short monograph deals with the principles, preparation, and properties of phototubes and outlines the fields of application of the different types of photoemissive surfaces. It expressly does not cover either photoconductive or photovoltaic cells, nor does it discuss phototube circuits and other auxiliary equipment.

The presentation has several minor omissions and inaccuracies which may be attributed to the effort to keep the account plain and nonmathematical. The illustrative material, in the form of line drawings, is held to the minimum required to explain the text.

Since the book is written in Britain, it covers very little of the United States practice in this field.

In general, the book may prove a useful and up-to-date guide to the student or engineer unfamiliar with general characteristics of phototubes, who wishes to acquire a survey knowledge of this important subject. However, it would be of no use to anyone interested in using phototubes for practical purposes.

V. K. ZWORYKIN
RCA Laboratories Division
Princeton, New Jersey

The Theory of Mathematical Machines, by Francis J. Murray

Published (1947) by King's Crown Press, Columbia University Press, 2960 Broadway, New York 27, N. Y. 114 pages + 2-page bibliography + viii pages. 229 figures. 8½ × 11 inches. Price, \$3.00.

With the growing mathematical complexity of modern engineering problems, the use of machines for their solution has grown in recent years; Professor Murray has assembled under one cover material which gives the theoretical basis as well as practical realization of many types of mathematical machines. He starts with a discussion of digital-type machines such as counters, digital adders, multipliers, and punch-card devices. He then describes continuous operators such as adders, multipliers, integrators, and differentiators. In this section, both mechanical, electrical, and electronic devices are covered. Examples are then given to demonstrate the synthesis of devices to solve problems. Analogue computers and adjuster-type devices are described. Finally, mathematical instruments such as planimeters, harmonic analyzers, and integrometers are covered.

The author has covered the field completely. However, the material is not in as much detail as would be desirable for a reader who is new to the field. Had it been, the book would have had double the number of pages. In addition, some of the terminology and circuit concepts reflect the fact that the author is a mathematician. The book is very well documented with reference material and the illustrations are complete and neat.

Engineers who are interested in the field of automatic computation and in some instances control of systems or processes will find this book valuable, and it is to them that it is most recommended.

JOHN R. RAGAZZINI
Electrical Engineering Department
Columbia University
New York 27, N. Y.

Fundamentals of Industrial Electronic Circuits, by Walter Richter

Published (1947) by McGraw-Hill Book Company, 330 W. 42nd St., New York 18, N. Y. 556 pages + 13-page index + xviii pages. 405 figures. 6 × 9 inches. Price, \$4.50.

Without including the preface, the casual reader of Richter's Industrial Electronic Circuits would logically conclude that here is just another electronics textbook, the addition of which "might seem to represent an unnecessary effort." The author's objective (achieved in this first printing to a reasonable degree of fulfillment) was to provide a text of "middle-road" caliber for use in evening-school classes which are usually "attended by people with widely varying educational backgrounds." "While no instructor will probably ever find a text entirely to his liking," this publication provides another choice when an instructor is scanning the field, either in picking the class "standard," or in listing reference reading. In the latter

classification the book is a good catalog of contemporary reading, because each chapter ends with up to a score of "References" and "Suggested Additional Reading" items.

Each chapter likewise includes an appropriate list of questions (without answers) for the ambitious reader's benefit or for classroom assignments.

The 550 odd pages contain 27 chapters beginning with the usual Direct-Current and Alternating-Current Fundamentals, and working into Nonlinear Conductors; Space Charges; Rectifier Fundamentals; Triode and Amplifier Principles; Compensation and Bridge Circuits; Multigrid Tubes and Multistage Amplifiers; Cathode Followers; Phase-Inversion and Degenerative Circuits; Electronic-Metering Equipment; Tuned Circuits and Oscillators; Multivibrators; Gaseous and Photocell Tubes; Optical Systems; and Cathode-Ray Tubes with the auxiliaries therefor.

The general layout of the material gives evidence of thought in preparation, and the text shows careful sentence structure and therefore reads easily. The progress is logical and reasonably complete for a book of its scope, and the style of presentation proves that the author has gained experience as an instructor.

While this edition falls within the "general" classification of electronics texts, as planned—falling between the "popular" and the "classical"—the reviewer believes that, had the author made a greater effort to include more typical examples of the industrial electronic applications now so extensively used in the field (in applying the principles he has covered), the book would possess greater reader interest and student appeal. It is inherently a book of principles (of which there are many) with little stress on "any specific application" (quoting from the preface). The latter type of publication is admittedly referenced profusely but humans are still of phlegmatic temperaments. The acquisition of knowledge comes less painfully and automatically becomes more complete when a minimum of effort need be expended in procuring relevant information.

A. P. UPTON
Minneapolis-Honeywell Regulator Co.
Minneapolis 8, Minnesota

The Radio Amateur's Handbook (Twenty-fourth Edition—1947), by The Headquarters Staff of the American Radio Relay League

Published (1947) by The American Radio Relay League, West Hartford 7, Conn. 470 pages + 10-page index + advertising. 618 illustrations, many charts and tables. 6½ × 9½ inches. Price, \$1.25 in U.S.A. proper, \$2.00 elsewhere.

Written for the radio amateur by his own organization, this annual has attained a high standing also among engineers who are confronted with practical problems within its scope. The soundness of its principles and the accuracy of its information are recognized by the profession.

The two main divisions of this volume are devoted to "Principles and Design" and

"Equipment Construction." The former is carried over from the previous edition, while the latter is largely revised to include receivers and transmitters of more recent design, all of which have been built and proved in actual operation during the preceding year or two. The principal enlargement is the added information on the mechanical construction of antennas.

About 80 per cent of the material is carried over from the 1946 edition, while the remaining 20 per cent is new with this edition. Therefore the new edition should be well received not only by those who do not have a fairly recent edition, but also by those who are most anxious to keep abreast of amateur progress.

HAROLD A. WHEELER
Consulting Radio Physicist
Great Neck, N. Y.

The Engineer in Society, by John Mills

Published (1946) by D. Van Nostrand Co., Inc., 250 Fourth Avenue, New York 13, N. Y. 196 pages + xix pages. 5½ × 8½ inches. Price, \$2.50.

John Mills is an interesting conversationalist whether you meet him face to face or through the pages of one of his books. This book gives you the feeling that you are conversing with him. He is best when discussing the philosophy of engineers and engineering, and here he outlines his observations on the nature of engineers and their relation to industry. The book is autobiographical in character and draws its conclusions from the wide experience of the author, who has been successively a teacher, a practicing engineer, a personnel man, and an editor. During the majority of this time he has served in the Bell Telephone Laboratories and hence his illustrations are replete with personalities and experiences in that organization.

The conversational manner of the book leads him to cover five groups of topics which, while integrated in themselves, are connected somewhat loosely as the author passes from one train of thought to another. The five group headings are: What Manner of Men, Scientists Gone Executive, Salary Curves, A Course for Action, Exposition for Engineers. The first group discusses how men may be classified and fitted to the right type of work. The second discusses the problem met in the industrial research laboratory when producing scientists must be transformed into executives. Thirdly, he discusses the problems of adequate remuneration. In the fourth group, he discourses upon the general problem of the engineer in society, and lastly, he enters a plea for improvement on the part of the engineer in his ability to use the written and spoken word. The interest of the author in each of these groups of problems can be traced to a particular period in his career, so emphasizing the autobiographical as well as the philosophical features of the book.

The book as a whole is stimulating and thought-provoking and well worth the attention of all engineers.

W. L. EVERITT
University of Illinois
Urbana, Illinois

Electronics for Industry, by Waldemar I. Bendz (Assisted by Charles A. Scarlott)

Published (1947) by John Wiley and Sons, Inc., 440 Fourth Avenue, New York 16, N. Y. 488 pages+7-page index+6-page appendix+x pages. 244 illustrations. $5\frac{1}{2}\times 8\frac{1}{2}$ inches. Price, \$5.00.

The author states that this book is addressed to the "engineer already familiar with the fundamentals of electrical devices." It is the reviewer's impression that such a definition of the term "fundamental" is a bit archaic, since most of the material of the first twelve chapters has been included in all balanced courses in electrical engineering for the last fifteen to twenty years. The first half of the book is really addressed to those engineers whose formal training preceded about 1925 or to those whose subsequent experience might require a thoroughgoing review of electronic fundamentals before tackling the later chapters. There are so many excellent works on electronics which cover this material that the effort devoted to these chapters seems misdirected.

The last half of the book contains very worthwhile material on high-frequency heating, electronic control circuits, and a brief treatment of carrier transmission. Expansion of this latter material would have been a definite contribution to the rapidly expanding literature on industrial electronics.

The English system of units is employed by the author with but a few exceptions found in the earliest chapters. The centimeter and the centigrade degree do not appear throughout the work, yet the angstrom and the micron are introduced with little apology; the ratio of charge to mass for the electron is given in coulombs per kilogram to introduce a modernistic note.

The text employs the American Standards Association 1946 revision of the "Graphical Symbols for Electric Power and Control" as, it is hoped, will all other new texts in the field. The box alternate symbol for resistance however is not well adapted for use in illustrating a multiple voltage divider.

The author warms to his subject in the latter chapters of his book, and for these it should find ready acceptance in industrial laboratories and engineering sections.

ALAN M. GLOVER
Radio Corporation of America
Lancaster, Pennsylvania

Servomechanism Fundamentals, by Henri Lauer, Robert Lesnick, and Leslie E. Matson—All of the Engineering Department, RCA Victor Division, Radio Corporation of America

Published (1947) by McGraw-Hill Book Company, Inc., 330 W. 42nd St., New York 17, N. Y. 274 pages+3-page index+xi pages. 166 figures. $6\frac{1}{2}\times 9\frac{1}{2}$ inches. Price \$3.50.

The authors of this excellent little book have attempted to cover a limited field, that

is, to teach the reader how to design a position control mechanism of one of the three simpler types: a servo with viscous output damping, with or without error-rate damping, and integral control. They have covered this field with remarkable clarity and thoroughness. They assume nothing from the reader but a certain familiarity with the standard engineering mathematics, and supply him with all other necessary information, mechanical and electrical. Their discussion of the solutions of the differential equation of the system, when the input position angle either is given a sudden constant angular velocity, or is a harmonic function of time, is very clearly presented with emphasis on the parameters, derived from the primary data, which directly describe the response of the system. Moreover, the solutions of a considerable number of numerical design problems, both direct-current and alternating-current, are completely developed, and often include specific remarks which excellently supplement the main text. This approach, which may be called classical, is extended in the last two chapters to include an introduction to transfer function analysis and a generalization to control devices other than positioning; but the treatment here is rather cursory.

This book should be extremely valuable to the great number of engineers who wish to build for their own plant some type of regulator or distant control or repeater and do not demand precision of antiaircraft quality. Their problem is essentially solved by the presence on the market of small motors and generators of the selsyn, or similar, types, and this book will tell them precisely how to incorporate these follow-up devices in a well-organized system. From a theoretical point of view, the differential equation approach may be considered much narrower than transfer function analysis; but it is probably true that the three cases which are so well treated here will take care of the majority of practical peacetime problems.

P. LE CORBEILLER
Harvard University
Cruft Laboratory
Cambridge 38, Mass.

The Decibel Notation, by V. V. L. Rao

Published (1946) by The Chemical Publishing Company, Inc., 26 Court St., Brooklyn 2, N. Y. 171 pages+xvi pages+3-page index+4-page bibliography. 52 figures. $5\frac{1}{2}\times 8\frac{1}{2}$ inches. Price, \$3.75.

The author is to be commended on his efforts to correlate and summarize the field of decibel notation and usages. Expressing measurements or computations in logarithmic units is old, but the adoption of the designation for a particular logarithmic ratio—the decibel—gave rise to a range of usages, probably far beyond the ideas of its original proponents.

Because of the convenience of the unit, these uses have grown somewhat haphazardly and, in many cases, without the advantages of concerted action or standard-

ization. A common difficulty has also resulted from the fact that while, in fact, the decibel is merely a nondimensional ratio, it is frequently employed to express absolute values of power or intensity, without a proper mention or understanding of the zero base level to which the measurement is referred.

Mr. Rao's book is an effort to clarify this situation and, despite the fact that the author is somewhat removed from the centers of communication interest and therefore lacks an intimate touch with the decibel-conscious world, he has succeeded reasonably well. However, the book lacks up-to-dateness and accuracy in many details.

For example, on page 6 it is stated that the decibel is "in general use in all countries now. This is known as the 'Transmission Unit' in the U. S. A." It is a fact that the transmission unit had a brief usage about twenty years ago, but is certainly not commonly known in the United States at the present time.

On page 13 it is stated that the 6-milliwatt "zero power level" is in general use in the United States, barring RCA, which expresses the gain or loss of its products with respect to a zero power of 12.5 milliwatts only. This is not correct.

On pages 14 and 18 the author makes reference to the "VU" as a unit of volume measurement in circuits carrying speech. However, he ignores the justification for the "VU," whose adoption resulted from a deliberate effort to clarify one aspect of the decibel situation, because he fails to note that "VU's" are only measurable on a meter of specified dynamic characteristics and by a particular measuring technique. In fact, he goes out of his way to make the situation more difficult by stating, "This is the same as the decibel referred to already." It is true that "VU's" have decibel intervals. It is also true that the decibel meter is calibrated on 1 milliwatt, but it is not true that the "VU" is the same measurement as determined by an ordinary so-called decibel meter.

There are curious omissions in a historical sense, such as the failure to bring out the fact that the neper is the unit which results naturally from the computation of the attenuation of a uniform line by theoretical formulas. It is also interesting that the author seemingly ignores the fact that the decibel unit in fact developed initially more as a result of line-attenuation applications rather than as a useful measure of the subjective response of the human senses. These latter applications have, of course, become important also.

In the section of the book on "Applications of the Decibel Notation to Radio Engineering and Acoustics," there is much useful information on measuring techniques, such as audio amplifiers, radio receivers, microphones, loudspeakers, transmission lines, equalizers, and others. These, while only indirectly related to the subject of the book, will be of considerable value to the reader.

HERMAN A. AFFEL
Bell Telephone Laboratories
New York 14, N. Y.

NOTE: For a review of the Indian edition of this book, see R. V. L. Hartleys' report on page 903 of the December, 1945, issue of the PROCEEDINGS.

I.R.E. People

ROYAL V. HOWARD

Royal V. Howard (M'41-SM'43) was recently appointed director of engineering to supervise technical activities of the National Association of Broadcasters.

Born in Rosenberg, Oregon, in 1905, Mr. Howard received his B.Sc. degree from the Polytechnic College of Engineering, and has been active in the radio field for the past twenty-seven years. He was a pioneer in the development of short wave and point-to-point communication and a research engineer in the development of high-frequency radio aids for aerial navigation.

Mr. Howard is director of the Universal Research Laboratories, engineering consultants. For the last fourteen years he has been with Associated Broadcasters, Inc., where he was vice-president in charge of engineering for KSFO, KWID, KWIX and KPAS. During World War II he was sent to Europe by the Army as director of a headquarters analyst staff for the Office of Scientific Research and Development.



ROYAL V. HOWARD

An officer of the San Francisco Section of The Institute of Radio Engineers for four years, Mr. Howard was chairman in 1946; he is also a member of the American Institute of Electrical Engineers. Other activities include membership on the International Committee, Board of War Communications; Radio Technical Planning Board, Committee 8 on International Broadcasting; and Committee 4 on Standard Broadcasting, Radio Manufacturers Association Standardization Committee. He has also served as a member of the Engineering Executive Committee of the National Association of Broadcasters.



NEW RCA SECTION MANAGERS

Virgil E. Trouant (A'26-M'38-SM'43), Robert R. Welsh (A'30-SM'47), William J. Morlock (A'43-SM'46), Clarence A. Gunther (A'27), and Horace R. Dyson (A'26), have been appointed section managers of Radio Corporation of America's engineering products department.

Mr. Trouant, manager of the broadcast and industrial section, joined RCA in 1933,

having been previously associated with Westinghouse Electric and Manufacturing Company in its automotive engineering and radio development departments. He designed RCA's first 50-kilowatt broadcast transmitter and its first high-frequency power generator for the industrial heating application. He graduated from the University of Maine with a B.S. in electrical engineering, and is a member of Tau Beta Pi.

Mr. Welsh, communications and specialty section manager, started with RCA in 1930 as a receiver design engineer, and later was appointed chief engineer of the Canadian plant, a position he held for four years. During the war, he headed a group working on airborne projects for the armed forces. When the aviation equipment engineering section was formed by the company, he was placed in charge of its activities. Recently he was sent to London as technical adviser to the State Department at the Provisional International Conference on Aeronautics Organization. Mr. Welsh received his degree in electrical engineering from the University of Maryland.

Mr. Morlock, manager of the distributed products section, became associated with RCA in 1930 and was assigned to testing activities on photophone equipment. Transferred to the development and design of government sound equipment, he was later placed in charge of government sound equipment at RCA Victor's Indianapolis manufacturing plant. During the war he acted in an advisory capacity to the Office of Scientific Research and Development. In 1945, he was transferred to Camden as manager of the sound and electronics section. He received his electrical engineering degree from Ohio State University.

Mr. Gunther, assistant chief engineer and in charge of the government equipment section, also joined RCA in 1930, after four years of communications engineering with the General Electric Company. He was appointed leader of the company's receiver and direction-finder group, and later was made manager of the television engineering section. During the war, Mr. Gunther served as civilian adviser on air warning to the Office of the Secretary of War. He received his degree in electrical engineering from Princeton University, and is a member of the American Society of Naval Engineers.

Mr. Dyson, government radiation section manager, started in radio in 1918 as an amateur. He founded the Springfield (Massachusetts) Radio Association. In 1921, he was made chief engineer of WBZ in Springfield. After graduation from the Massachusetts Institute of Technology as a communications engineer, he headed a transmitter design section at the Westinghouse plant in Chicopee Falls, Massachusetts. He joined RCA in 1931 and was the company's first transmitter design engineer for government equipment. Mr. Dyson recently was sent as an official State Department adviser to the International Conference on Radio Aids to Marine Navigation, meeting in London. He is a member of the Army Signal Association, and a commissioned member of the Institute of Naval Engineers.



EUGENE MITTELMANN

EUGENE MITTELMANN

Eugene Mittelmann (A'38-SM'44) has resigned his position as director of Electronic Research and Development of the Illinois Tool Works, Chicago, to open his own offices and laboratory at 549 West Washington Boulevard, Chicago. His work will be devoted primarily to the applications of high-frequency heating in industry, and industrial applications of physics and mathematics in industry. Dr. Mittelmann is a member of the Committee on Industrial Electronics of The Institute of Radio Engineers and of Panel 12 of the Radio Technical Planning Board. He is a Fellow of the American Association for the Advancement of Science; a member of the Physical Society of America, and of the Western Society of Engineers.



DONALD M. MILLER

Donald M. Miller (A'37-M'46) was recently elected a vice-president of Airborne Instruments Laboratory, Inc., Mineola, New York. Associated with A.I.L. since April, 1942, he was, until his election, assistant secretary of the organization and director of engineering services for the Laboratory. Before the war he was a partner in the Twin Cities firm of Skifter and Miller, consulting engineers.



DONALD M. MILLER



Alois W. Graf

Chairman, Chicago Section May, 1946 to May, 1947

Alois W. Graf was born on March 20, 1901, at Mankato, Minnesota. He received the B.S. degree in electrical engineering from the University of Minnesota in 1926, and the L.L.B. degree from the National Law University in 1931.

From 1930 to 1938 Mr. Graf served as a member of the patent department of General Electric Company, handling various electronic devices, including radio transmitters and receivers, television circuits and apparatus, and power applications of vacuum tubes. In 1939 and 1940 he was patent lawyer for Productive Inventions, Inc., handling all phases of patent law. For the next three years he had a private patent-law practice, and was associated part time with two Chicago law firms, dealing primarily with electronic equipment. From 1943 to 1946 he was associated with the law firm of Moore, Olson, and Trexler of Chicago, specializing in radio, radar, electronic and electrical systems, and me-

chanical apparatus. In October, 1946, he established his own practice in Chicago, dealing in patent and trademark causes.

Mr. Graf has been actively associated with various engineering organizations for a number of years, and has served on numerous committees of The Institute of Radio Engineers. Joining the Institute as an Associate in 1926, he transferred to Member in 1944, and became a Senior Member in 1945. He is on the executive committee of the Illinois Engineering Council, which sponsored the enactment of the Illinois professional engineer registration law, and is active in the Chicago Technical Societies Council and the National Electronics Conference. He is a member of the American Bar Association, Chicago Law Institute, Illinois Society of Professional Engineers, the American Arbitration Association, Chicago Patent Law Association, and the Radio Engineer's Club of Chicago.

It is the privilege of the PROCEEDINGS OF THE I.R.E. to serve the membership by bringing them scientific and engineering advances in the communications and electronic field, as well as news on the activities of their Institute and its membership. The publication of the PROCEEDINGS is regarded as one of the major functions of the Institute.

There is, however, no complete and adequate substitute for another major function of the Institute, namely, to provide a group of scientific forums where members directly interchange their viewpoints in the stimulating atmosphere of face-to-face presentations of papers and discussions.

The membership will accordingly gain marked benefits by carrying out, where applicable, the proposals made in the following guest editorial by the Acting Dean of the Department of Engineering at the University of Virginia, who is, as well, Chairman of the North Carolina-Virginia Section of the Institute.—*The Editor.*

The Problem of a Scattered Membership

LAWRENCE R. QUARLES

The real value of a professional society is realized by its members only if they can participate actively in its work. I say this with full realization that the interchange of information through the journals is a very valuable function of the societies, but this answers only part of the problem. Much more benefit can be derived from a discussion of such information by groups of members. In addition, the society itself, as a corporate body, gains a great deal when its members are able to attend meetings. Such meetings are the healthy stimulant needed to provide essential growth.

It was with these thoughts that several members of the Institute in North Carolina and Virginia undertook the solution of a problem presented by the geographical separation of many members in these states. The two states had a membership of approximately one hundred and fifty, but with no one city having a group large enough to sponsor a Section. Virginia was formerly in the Washington Section, and North Carolina in the Atlanta Section. With a large concentration of membership in the two cities, meetings naturally were held there, and the distant members had little chance or incentive to attend.

As a result of a membership poll in the two states during the summer of 1946, a North Carolina-Virginia Section was formed to include all of North Carolina and all of Virginia except the region within approximately fifty miles of Washington, D. C. The by-laws provide for a chairmanship alternating yearly between the two states, for equal membership from each State on the standing committees, and for meetings to be held at major cities in each State. In carrying out the intent of the organizers, the membership of committees has been spread over as many cities as possible, thus giving each small group an active voice in formulating and executing the Section policies.

The roving meeting place brings at least one meeting a year within easy traveling distance for each member. This policy has already produced an unexpected dividend. Not only are members actively supporting the meetings in their area, but they feel that the Institute is now *their* organization, rather than an intangible thing in some far-away place. As a result of this new interest, all meetings of the new Section have been attended by several engineers who have traveled over two hundred miles to be present.

This same lively interest by the members has produced a boom in membership applications, as the members "talk it up" among their associates. There has also been a healthy stream of applications for transfer to higher grades since the Section was formed last summer.

We strongly commend the plan used in the North Carolina-Virginia Section to other scattered groups who may feel they are too far from Institute activities.

Long hours of quiet work in the laboratory, followed by days of arduous test and study of equipment under field conditions, constitute major portions of the tasks of the communications and electronic engineers. Once their work is completed, the equipment which they have conceived and brought into production disappears from their ken. Its successful operation, its limitations, its contributions to the use of the Armed Forces (when it is destined for wartime purposes), are largely unknown to the individual engineer. In effect, he is an actor upon a stage without a visible audience. It is accordingly doubly gratifying and stimulating to the members of the Institute to read the following graphic and authoritative account of the contributions to victory which were made by the equipment designed and produced by them, and which was so skillfully and bravely used by members of the Submarine Service of the United States Navy.—*The Editor.*

Electronics in Submarine Warfare*

VICE ADMIRAL CHARLES A. LOCKWOOD†

I FEEL much honored—and a little abashed—to address a group whose roster reads like “Who’s Who” in the electronics world. However, it is my good fortune that I am not here to talk about the technicalities of the myriad electronic devices. Instead, it is my privilege to tell you something of the employment of some of these devices by our submarines in World War II.

Volumes have been written, or could be written, about the tremendous part which electronic equipment played in the air, land, and surface battles of the last war, but, due to considerations of security made necessary by the very nature of their assignments, only meager details have been made public regarding the use in our submarines of the amazingly clever electronic gear which you conceived and supplied.

When the Japanese struck on that fateful December day at Pearl Harbor and Cavite, as we now know, a very considerable portion of our strength in surface vessels and aircraft was destroyed. However, only one of our submarines was sunk. This unlucky sub was the *Sealion*, which had been immobilized for repairs at Cavite. The Jap planes attacking Pearl Harbor apparently paid no attention to our fine submarine base there, and that was a serious mistake on their part, since that base was our main dependence for many months to come. Most of the 51 submarines which we had in the Pacific on December 7, 1941, were on patrol at sea as part of the “defensive dispositions” which had been ordered for the Fleet, and that fortunate fact later proved to be a major factor in our war of attrition against the Japanese while new ships were being rushed off the ways and the damaged ones were being repaired. As history will relate, our surface and air forces, sufficiently fit for combat in those trying days of 1942 and early 1943, were badly out-numbered and had to fight an enemy flushed with early success in many desperate engagements before experience, training, and improved radar and fire control had their opportunity to swing the tide of battle. It was during those dark days in the early stages of the war that our submarines, few as they were, wrote glowing

chapters of heroism, daring, and skill while destroying hundreds of the Mikado’s finest ships. Nor did these valiant deeds cease after our surface forces had been strengthened to a parity with the enemy, nor even when the brains, ability, and productive genius of our country had far surpassed the Japanese in both quality and quantity of arms.

On the contrary, reports of still more and greater achievements continued to pour in from our submarines which were taking the fight to Japan’s very front yard. Several factors entered into this picture; first, as in all types of warfare, were the many daring and skilled officers and men who manned these killers of the deep; second, the great strides in design and construction of hull, machinery, and weapons; and third, the introduction and rapid development of many types of electronic equipment suited to submarine warfare. On December 7, 1941, and for many months thereafter, very few surface ships and even fewer submarines were equipped with such electronic devices as air-warning and surface-search radar, fire-control radar, identification-of-friend-or-foe, etc. Thus during these early months of the war our submarines operated under severe handicaps as compared to later operations when the boats were equipped with the latest in electronic equipment, manned by personnel trained in their use.

The advent of radar, identification-friend-or-foe, ultra-high-frequency, and very-high-frequency communication techniques, when added to the latest in echo-ranging and sound equipment, soon began to create even greater gaps in the enemy’s shipping. These advancements not only gave our undersea marauders a greater advantage offensively but enabled them to take more efficient evasive tactics, thus materially decreasing our own losses in submarines and personnel. This upswing in efficiency of attack, with consequent increase in Japanese losses, also spared us the loss of many thousands of American lads in the amphibious forces by destroying much-needed supplies and reinforcements destined for the Sons of Nippon in their far-flung, embattled bases.

It is impossible for me to describe all of the incidents wherein electronic equipment materially aided in detecting, tracking, ranging on, and ultimately destroying ship after ship of the enemy merchant and naval forces.

Nor is it feasible to describe the many instances in which modern communication techniques were employed in recognition signals and in making battle reports. I will have to content myself with saying that these techniques were invaluable in the co-ordination of attacks of submarines with other surface and air units, and in co-ordination between submarines when operating as “wolf packs.” Numerous engagements between our submarines and those of the enemy were highlighted by the efficiency of our echo-ranging and listening devices in making approaches, taking bearings, and attacking, which resulted, many times, in the ultimate destruction of enemy submarines. This type of engagement, submarine versus submarine, is one of the most difficult in undersea warfare, which made these victories all the more remarkable and demonstrates the tremendous advantage our fighting men and ships had been afforded by your splendid electronic equipment and by their smart use of the same.

To illustrate the skillful use of these electronics as well as the determination, resourcefulness, and daring of our submarine personnel, I would like to describe briefly a few of the battles in which we came out victorious. These are picked as typical examples with the hope that they will better acquaint you with the technique of undersea warfare when full use was made of many advantages afforded our Navy by men and women such as yourselves in the electronics field.

Just after noon on October 18, 1944, the U.S.S. *Raton*, under the command of Commander Mike Shea, was patrolling south and west of Manila when contact was made visually with a convoy of nine big ships and three escorts proceeding south. The *Raton* immediately started to stalk the enemy ships. Shortly after the initial contact, she was forced to dive by an escorting enemy aircraft. Upon resurfacing she found herself in a torrential downpour with visibility practically zero. Under similar conditions only a year or two previously she would probably have lost contact with the enemy, but our submarines were now equipped to meet and overcome such obstacles. She regained contact by radar and tracked the convoy through the use of both radar and under-water-sound devices until the rain lifted about an hour later.

* Declassification: R565. Original manuscript received by the Institute, March 4, 1947. Presented, 1947 I.R.E. National Convention, March 3, 1947, New York, N. Y.

† Navy Department, Washington, D. C.

When night closed down the sky was completely overcast, with no moon. However, brilliant and incessant flashes of lightning illuminated the northern and western skies. Consequently, Shea elected to attack from the east side of the convoy so as to take advantage of the dark background and to silhouette his targets against the lightning in the west.

The *Raton* tried repeatedly to contact another submarine which was in the area, in order to give her a chance to get in on the kill, but the electrical disturbances resulting from the thunderstorm made it impossible to raise the other ship. The convoy was his alone. By 8:30 P.M., the weather was approaching typhoon proportions with rain driving in sheets, making visibility absolutely zero. Shea again was forced to resort to radar for keeping track and range on the enemy, and with this substituting for his eyes he reached his attack position on the port bow of the convoy at about 9:30 and headed into the teeth of the storm, with wind, rain, and spray driving into his face as he clung to the bridge. He passed 800 yards astern of the leading ship without being able to sight her visually, passed two more ships at 600 yards or less, and ended up in excellent firing position, in the center of the convoy. During all this maneuvering, the *Raton* remained on the surface and relied entirely on radar for making the approach.

He commenced firing his bow torpedo tubes at 10:00 P.M., but after firing three torpedoes, he had to order full right rudder to avoid ramming a ship ahead and to keep clear of one on his quarter. He continued firing as he swung until all six bow torpedoes were fired. It is worthy of note that all of this firing was done using electronic devices such as radar and underwater-sound equipment, plus the trusty old torpedo data computer. As he steadied down to fire his stern tubes, Shea saw huge flashes with accompanying explosions which marked five hits on three different targets. He then fired his stern tubes, obtaining two more hits, and hauled out to reload. In clearing the formation, which was now scattering wildly, he missed ramming one big ship practically by inches. When well clear, and breathing a little more easily, he took stock of the situation by radar from a distance of 8000 yards. His screen then showed the enemy convoy scattered, with three echoes or "pips" missing, indicating that three of the original twelve had gone down. One ship, with an escort, was stopped astern of the convoy, and another ship was heading off to the eastward. While chasing this would-be escapee, a terrific explosion was heard from the bearing of the stopped ship, whose echo then vanished immediately from the radar screen. One more enemy had gone down. Shea continued the chase of the fleeing ship in weather that was growing worse and worse. The waves were from 20 to 40 feet high, heavy seas with overhanging crests breaking continuously and with spume blown along with the wind. It was into that stinging, rolling, pitching, turmoil that Commander Shea pressed home his attacks.

The target was zigzagging radically, staggering with the storm as the *Raton* ap-

proached to 1500 yards and fired four torpedoes. All missed the ship, primarily because of the extremely rough seas which tossed the running torpedoes about. However, about three minutes after firing, a torpedo explosion was seen and heard on the far side of the ship, followed by six quick depth charges. One of the torpedoes that had evidently missed the larger ship had struck the escort which had just come up from the sunken straggler to rejoin the convoy. As the escort vessel sank, her depth charges had exploded.

With five ships down, and in the middle of a howling typhoon, no one would have reproached Commander Shea if he had broken off the attack at this point. But "Mike" and his crew were made of sterner stuff. He reloaded his bow tubes, crossed astern of the remainder of the convoy, cleared the bridge of all but himself and the officer of the deck in order to get them out of the way of gun fire and also to reduce chances of losing a man overboard in the raging sea.

The visibility was still zero and the sea was too rough for anything like reliable torpedo performance, but he just couldn't bear to see those remaining targets get away; so, once more, relying entirely on his radar, he stood in to close range and fired six torpedoes. This time he got only one hit on each of two targets and so decided to break off the attack and wait for better weather. However, he had a good bag of five down and two damaged (which may have sunk in the storm), all due to his excellent radar—plus a lot of determination and daring on his part.

Another similar example of the excellent tactical use of radar and the plan-position-indicator 'scope is furnished by the *Sailfish*, which, about midnight of December 3, 1944, picked up four radar pips, evidently on a northwesterly course, while patrolling some 300 miles southeast of Tokyo Bay.

In this attack, also, the weather was of typhoon caliber, 40 to 50 knots of wind with mountainous seas, a driving rain, and very low visibility. Lieutenant Commander Bob Ward, the skipper of the *Sailfish*, considered this all in his favor in spite of the chance of poor torpedo performance in heavy seas. His SJ radar had recently been installed, his crew had been trained in the technique of radar attacks, and he was eager to try out this new equipment.

Difficulty was encountered in reaching attack position because he could not make much speed against the heavy seas. However, just after midnight he reached a position on the port bow of one of the larger pips with a destroyer 400 yards from him and signaling with a searchlight in his direction, probably demanding a recognition signal. He thereupon carried out beautifully the procedure for radar attack by submerging to 40 feet, where his radar antenna was just out of water, and fired entirely on radar range and bearing. From his first four shots he got two hits on the still unseen target, and then went deep to avoid the expected pounding with depth charges. However, the destroyers were probably having their troubles in locating him in the

heavy seas, added to which was Ward's smart maneuver in crossing close astern of the target. Hence, at 2 A.M. he was able to surface and found his target to be circling. She finally steadied on a course at about four knots, whereupon he again bored in, this time on surface, fired three bow tubes, and observed two hits.

The Japanese then "started a Fourth of July celebration," as Ward expressed it, and, since daylight was approaching and tracers beginning to come his way, he submerged and reloaded preparatory to another attack, convinced that his target was now a "dead duck."

At about 0745, the *Sailfish* stood in, submerged, and at last was able to see her victim—a carrier, dead in the water, with a destroyer dashing madly about. She was badly listed and her flight deck was covered with personnel and planes, which, from time to time, slid over the side. Ward made an inspection of her and sketched her profile in order to make sure of her identity. Then he let her have three more torpedoes, two of which hit and finished her career.

This battle, which took from midnight until 9:40 in the morning, was fought with skill and dogged determination seldom surpassed during the war, and it scratched one flat-top at a most opportune time. It is of interest to note that the commander of the Japanese submarine force tried to *inspire his own submarines* by citing *Sailfish's* attack as an example of daring and determination which should be emulated.

Not until the end of the war did we learn to our sorrow that this flat-top, the *Chuyo*, had on board 21 prisoners from the *Sculpin*, which had been sunk two weeks before, and 20 of whom went down with the *Chuyo*.

Examples of this type are almost endless, but I would like to tell the story of an attack by the *Tang* (Commander Dick O'Kane) at the conclusion of a patrol in which she sank about 110,000 tons, which is the highest sinking score on a single patrol of any submarine in the war.

About midnight of October 23, 1944, the *Tang* was patrolling in the north end of Formosa Straits, and I will give you in Commander O'Kane's own words his report of a night attack on an important enemy convoy:

"We had had some trouble with our SJ radar, but I was fortunate in having a very expert radar technician and he very rapidly found the trouble and corrected it. On the first trial of the radar after its repairs the operator reported land at 14,000 yards, where no land ought to be. I commenced tracking and immediately discovered a small pip moving out in our direction. We put him astern and bent on speed. He evidently lost his original contact on us, for he changed course and commenced a wide sweep about the convoy which was now also in sight. A submariner's dream quickly developed as we were able to assume the original position of this destroyer just ahead of the convoy while he went on a 20-mile inspection tour. The convoy was composed of three large modern tankers in column, a transport on the starboard hand, a freighter on the port hand, flanked by destroyer escorts or

destroyers on both beams and quarters. After zigging with the convoy while in position 3000 yards ahead, we dropped back between the tankers and the freighter. On the next zig I stopped and turned right for straight bow shots at the tankers as they came by, firing two torpedoes under the stack and engine room of the nearest tanker, a single torpedo into the overlapping stern of the middle tanker, and two torpedoes under the stack and engine room of the far tanker. The minimum range was 300 yards and the maximum 800 yards. Torpedoes were exploding before the firing was completed and *all* hit as aimed. It was a terrible sight to see three blazing, sinking tankers, but there was only time for just a glance, for the freighter was in fine position crossing our stern. We completed the setup and I was about to fire at this vessel when Leibold, my boatswain's mate, whom I've used for an extra set of eyes on all patrols, properly diagnosed the maneuvers of the starboard transport, which was coming in like a destroyer, attempting to ram. We were boxed in by the sinking tankers, the transport was so close that we couldn't dive, so we had to cross his bow. It was really a 'thriller-diller,' with the *Tang* barely getting on the inside of his turning circle and saving our stern with full left rudder in the last few seconds. The transport commenced firing with large and small caliber stuff, so I cleared the bridge before I realized that it was all above our heads. A quick glance aft, however, showed the tables were again turned, for the transport was forced to continue her swing in an attempt to avoid colliding with the freighter which had also been coming in to ram. The freighter struck the transport's starboard quarter shortly after we commenced firing four stern torpedoes spread along their double length. At a range of 400 yards the crash, coupled with the four torpedo explosions, was terrific, and the freighter sank nose down, almost instantly, while the transport hung with a 30-degree up angle.

"The destroyer was now coming in on our starboard quarter at 1300 yards with the smaller escorts on our port bow and beam. We headed for the destroyer escort on our bow, so as to get the destroyer astern, and gratefully watched the destroyer escort turn away—he apparently having seen enough. Our destroyer still hadn't lighted off another boiler, and it was possible to open the range slowly, avoiding the last interested escort vessel. When the radar range to the destroyer was 4500 yards he gave up the chase and returned to the vicinity of the sunken transport. We moved back also, as the transport's bow disappeared both from sight and from the radar screen. Its disappearance was accompanied by a series of explosions which set off a gun duel among the destroyer and escort vessels which fired at random, apparently sometimes at each other and sometimes just out into the night. Their confusion was truly complete. It looked like a good place to leave, so we cleared the area at full speed until dawn.

"Our attack log showed that only 10 minutes had elapsed from the time of firing

our first torpedo until that final explosion when the transport's bow went down."

On the following night the *Tang* again encountered an enemy convoy, and I give you her patrol-record account of the affray.

"On surfacing at dark, headed for Turnabout Island off the China Coast, feeling that the Japs would now scarcely run traffic other than in the shallow protected waters. On approaching the islands at a range of 35,000 yards, so many pips appeared on the radar screen that at tracking ranges the SJ radar was absolutely saturated.

"The Leyte Campaign was still in progress and the ships of this convoy, as in the one of the 23rd, were all heavily loaded. The tankers all carried planes on deck, and even the bows and sterns of the transports were piled high with apparent plane crates.

"The convoy was tracked on courses which followed the ragged China Coast at 12 knots. The enemy escorts evidently became suspicious during our initial approach, and two escorts commenced to run on opposite course to the long column, firing bursts of 40-millimeter and 5-inch salvos. As we continued to close the leading ships, the escort commander obligingly illuminated the column with a large searchlight which he was using to signal with. It gave us a perfect view of our first selected target—a three-deck, two-stack transport; of the second target—a three-deck, one-stacker; and of the third—a large modern tanker. With ranges from 1400 yards on the first transport to 900 yards on the tanker, I fired two Mark 18 torpedoes each in deliberate salvos to pass under the foremast and mainmast of the first two vessels and under the middle and stack of the tanker. In spite of the apparent early warning and the sporadic shooting which was evidently designed to scare us, no evasive tactics were employed by any of the ships. The torpedoes commenced hitting as we paralleled the convoy to search out our next two targets.

"Our love for Mark 18 electric torpedoes, after the disappointing cruiser experience a few days before, was again restored, as all torpedoes hit nicely. We passed the next ship—a medium freighter—abeam at 600 yards and then turned for a stern-tube shot at another tanker and transport astern of her. Fired a single stern torpedo under the tanker's stack, then one at the foremast and one at the mainmast of the transport. The ranges were between 600 and 700 yards. Things were anything but calm and peaceful now, for the escorts had stopped their warning tactics and were directing good salvos at us and at the blotches of smoke we left behind on going to full power to pull clear of the melee. Just after firing at the transport, a full-ledged destroyer charged under her stern and headed for us. Just exactly what took place in the following seconds will never be determined, but the tanker was hit and blew up—apparently a gasoline loaded job. At least one torpedo was observed to hit the transport and an instant later the destroyer blew up, either intercepting our third torpedo or possibly running into the 40-millimeter fire from the two destroyer escorts which were bearing down on our beam. In any case, the result

was the same, and only the transport remained afloat—and she, apparently, stopped.

"We were as yet untouched, all gunfire having either cleared over our heads or being directed at the several blurps of smoke we emitted when making full speed. At 10,000 yards from the transport we were all in the clear, so stopped to look over the situation and recheck our last two torpedoes which had been loaded forward during our stern tube attack.

"A half hour was spent with each torpedo, withdrawing it from the tube, ventilating the battery, and checking the rudders and gyros. With everything in readiness we started cautiously back in to get our cripple. The two destroyer escorts were patrolling on his seaward side, so we made a wide sweep in toward the coast and came in very slow in order not to be detected, even by sound. The cripple was lower in the water but not definitely sinking. Fired our 23rd torpedo from 900 yards, aimed just forward of her mainmast. Observed the phosphorescent wake heading, as aimed, at our crippled target; fired our 24th and last torpedo at her foremast. Almost instantly I rang up emergency full speed as this last torpedo broached and curved sharply to the left. Completed part of a fishtail maneuver in a futile attempt to clear the turning circle of this erratic, circular run. The torpedo was clearly observed through about 180 degrees of its turn due to the phosphorescence of its wake. It struck the *Tang* abreast the after torpedo room with a violent explosion about 20 seconds after it had been fired. The tops were blown off the after ballast tanks and the three after compartments flooded instantly. The *Tang* sank by the stern so rapidly that there was insufficient time even to carry out the last order to close the hatch. One consolation for those of us who were washed off the bridge into the water was the explosion of our 23rd torpedo against our last target, which immediately settled by the stern. Those who escaped from the forward torpedo room in the morning were greeted by the transport's bow sticking straight out of the water a thousand yards or so away."

Thus perished a gallant ship and all but nine of her crew.

One of the most thrilling victories of our submarine campaign was achieved by the U.S.S. *Sealion* under Commander Eli Reich on November 21, 1944, in the East China Sea. At about 1220 A.M. the *Sealion* made radar contact with three large echoes on the radar screen at a range of 44,000 yards. The sea was calm and there was only a light air stirring. Commander Reich rang up full speed and headed for his targets. The sky was overcast, with no moon, and visibility was limited to about 1500 yards. As the range decreased to 35,000 yards it became apparent that the enemy group consisted of two large echoes and two smaller ones. The two large echoes were estimated to be battleships and the two smaller ones, large cruisers. The four ships were in column, with a cruiser ahead and astern of the two battleships. They were not zig-zagging but running a steady course at a speed of 16 knots. At about 20,000 yards

three smaller echoes became visible, indicating three escort vessels, probably destroyers.

By expert maneuvering, the *Sealion* placed herself ahead of the task force and slowed for the attack, keeping her bow pointed at the nearest destroyer so as to present the smallest possible target to the enemy. Reich selected as his first target the leading battleship, and kept the *Sealion* swinging with her bow pointed directly at the destroyer until the range was right for firing. Six torpedoes were fired at the battleship, from 3000 yards. Immediately after firing her bow tubes, the *Sealion* swung and fired three torpedoes from her stern tubes at the second battleship, with a range of 3100 yards.

You can imagine the thrill of that moment to Commander Reich and his lads. Japanese battleships for targets! This was the moment they had lived for!

The two minutes required for the torpedoes to make the distance seemed hours to them, but suddenly the first target was blasted by three explosions accompanied by several small mushrooms of explosion on the ship's side. Very shortly thereafter one hit was observed on the second target that produced a large explosion with a sudden rise of flames along the side which, however, quickly subsided. The *Sealion* pulled out rapidly to about 8000 yards from the target area, commenced to reload all tubes, and paralleled the enemy's course. At this point the commanding officer was both puzzled and chagrined to discover that the enemy was still making 16 knots and remaining on the same course. However, very soon after, the enemy formation started breaking up into two groups, one group dropping astern while the other continued on. The plan-position-indicator on the radar showed the group dropping astern to consist of a battleship with two destroyers as escorts.

Commander Reich decided to attack the second group because this battleship was the one that had been hit with the three torpedoes on the first attack. The speed of this second group was determined to be only 11 knots as plotted from the radar screen. As Commander Reich continued observations on this group, the radar operator reported the echo from the battleship appeared to be getting smaller. At 5:24 A.M., a tremendous explosion was observed from the direction of the target group astern, which was so bright that it looked like a sunset in the middle of the night. Excited reports from the radar operator indicated the battleship echo now rapidly diminishing in size, and eventually it disappeared from the screen, leaving only the two smaller echoes from the destroyers. These two echoes were milling around madly in the vicinity where the battleship echo was last seen. Results—one battleship, the *Kongo*, sunk—and another rising sun set.

The most remarkable example of our success in sinking enemy submarines and of the value of the APR countermeasures equipment was provided by the U.S.S. *Batfish*, commanded by commander J. K. Fyfe, of Seneca Falls, New York.

The *Batfish* was on a station north of Luzon at the time when General MacArthur was squeezing the Japs northward. Since the sea and air communication of the enemy had been cut off, we rightly expected night reinforcement activity or evacuation of important personnel, by submarine, similar to the operations which took place at Guadalcanal and Leyte. We therefore put three submarines in position to counter any such moves. The *Batfish* was nearest Luzon and on the normal traffic route between Luzon and the port of Takao in Formosa.

On her first night on this station she picked up indications of an enemy radar north bound which she followed until eventually she sighted a dark shape which was identified as a Japanese submarine. I may say, at this point, that the silhouette of our submarines differs greatly from those of the Japanese and the Germans; therefore identification is comparatively easy. Commander Fyfe approached this target to a range of 1850 yards and fired four torpedoes, but missed. All four torpedoes exploded at the end of their runs, some distance beyond the Japanese, but he evidently paid no attention, maintaining his same course and speed.

The *Batfish* then opened the range to about 5000 yards, increased speed, and gained position ahead of the enemy once more. The night was very dark, with no moon, and partially overcast, so the range was closed to 900 yards without the target giving any indication that it was aware of the presence of our submarine. Commander Fyfe fired three torpedoes, one of which struck the Japanese ship which sank immediately to the accompaniment of loud breaking-up noises. The *Batfish* closed the spot where the submarine had gone down and turned on her searchlight in an attempt to pick up a prisoner or two; however, nothing could be seen except a heavy oil slick with the very distinctive smell of Diesel oil.

The next morning the *Batfish* was forced down by a plane which evidently fired a torpedo at her, as its propellers were distinctly heard to pass overhead. That night, a few miles north of the spot where he encountered the first submarine, Commander Fyfe again picked up enemy radar emanations on the APR equipment and closed in on his target. At a range of 1300 yards a submarine identified as enemy was plainly visible, but dived just as the *Batfish* was preparing to fire torpedoes. Somewhat discouraged and feeling that he had muffed this attack, Commander Fyfe hauled off in order to avoid enemy torpedoes if any should be fired. Whether the target had heard them or merely made a routine dive, we will never know, but the fact remains that about one-half hour later the *Batfish* sound operator reported, "Captain, I can hear someone blowing ballast tanks," and in a few moments the enemy radar indications reappeared. The *Batfish* immediately dived and started closing in. At 800 yards from his target Commander Fyfe fired four torpedoes. The first torpedo hit and literally blew the target to pieces.

The next two torpedoes apparently struck debris in the water, for they also exploded. As the victim sank, two more loud explosions occurred which were believed to be her own warheads detonating.

The next night, at 2:30 A.M., the *Batfish*, in approximately the same position, again picked up the now familiar enemy radar indications. This time the approach wasn't so simple, for the Japanese, for no apparent reason, dived while the *Batfish* was still 7000 yards distant. Commander Fyfe, undaunted, plotted the Japanese along on his estimated course and speed and kept well ahead of him. At the end of half an hour his patience was rewarded by his receiving enemy radar indications. He immediately dived and closed in toward his victim. The Japanese came buzzing merrily along and the *Batfish* blew him to pieces with one hit. On surfacing, to search for survivors, the *Batfish* found nothing but a large amount of debris among which was a midshipman's navigation log book which, however, indicated this particular midshipman could not have been a very enthusiastic navigator, since the last entry had been made some two months before. Thus, in the space of about 76 hours, with the aid of electronic equipment intelligently and efficiently used the *Batfish* had bagged three enemy submarines and undoubtedly a goodly store of supplies desperately needed by the Japanese in Luzon.

These few incidents which I have been proud to relate are only a small part of an offensive which mounted steadily in tempo, skill, daring, and relentless fury by our submarines in the capable hands of highly trained officers and men. Every effort was made to take advantage of the modern implements of war which men of science, such as yourselves, placed at the disposal of our underseas warriors. Without such weapons as radar, underwater-sound equipment, identification-friend-or-foe, countermeasures equipment, and efficient communication equipment, many of these kills would not have been possible, which would have had the effect of prolonging the war and thereby causing more losses and more sorrow to the wives and families of our service men all over the world.

There can be no doubt that, from the research, inventive genius, and skill of such far-thinking men and women as yourselves, many more great scientific developments will be forthcoming to aid materially in keeping the peace that we have fought so desperately to win, and to help mankind in numberless ways. We of the armed forces, and I feel sure every thinking American, salute you and offer our most sincere thanks for the many amazing electronic devices which you produced during the war as weapons of destruction for the defense of your country in order to shorten the conflict and to save American lives.

The secrets incorporated into nearly all of these weapons and equipment are now available for civilian use, and it is my earnest hope that they will be put to work in the economic, medical, and scientific fields for the advancement and happiness of mankind instead of for its destruction.

hereby. The superregenerative circuit has certain inherent defects, however, such as susceptibility to jamming by continuous-wave interference, continuous hash radiation, and a tendency to exhibit unstable characteristics. For this reason, receivers of the crystal-video or superheterodyne types are usually preferred where their use is otherwise feasible. The simplicity of the crystal-video receiver renders it very attractive for use in many applications, particularly in the field of microwave radar beaconry. The superheterodyne-type receiver is probably the most satisfactory receiver electrically. Where its size and complexity can be tolerated, and where the operating frequency is such that satisfactory local oscillators can be fabricated readily, its use is recommended. For application to microwave beacons, the superheterodyne receiver requires very careful design.

3. Discriminator

This unit is included in many beacons, particularly those of the larger and higher-powered types, to eliminate responses to all interrogating pulses except those having a duration within certain specified limits. For example, the discriminator may be adjusted to pass pulses having between 2 and 5 microseconds duration. Shorter or longer pulses will be rejected and will not actuate the beacon. The discriminator is sometimes used in a simplified form in which only pulses narrower than a certain specified value are rejected. At some beacon locations reflections of primary radar signals from objects near the beacon may follow the main pulse, on arrival at the beacon, by an amount just sufficient to increase the length of the pulse as it appears at the discriminator input. Under these reflection conditions the beacon may be triggered by radar pulses which are actually much shorter than the lower setting of the discriminator. This effect may be minimized by proper siting of the beacon. Ideally, the beacon antenna should be mounted on a tall structure or hill so that it is above all surrounding objects or buildings. The effect also may be minimized in the design of the beacon by taking advantage of the fact that the direct radar pulse will, normally, be of a much greater amplitude than the trailing reflected pulses. By making use of a fast-acting automatic-volume-control circuit the beacon receiver can be so designed that its sensitivity will be reduced, for a short interval immediately following the reception of the relatively strong radar pulse, by an amount sufficient to prevent reception of the trailing reflected pulses. Such an arrangement makes the operation of the discriminator more effective, and may be desirable for permanently installed ground beacons where the effect cannot be satisfactorily eliminated by proper siting.

Where a beacon and interrogator-responder equipment are located in close proximity, spurious triggering of the beacon by the local interrogator may be prevented by blocking or suppressing the beacon during the interval when the transmitted energy from the interrogator is impressed on the beacon receiver.

4. Blanking Gate

The blanking gate is provided to render the beacon inoperative for a specified interval, usually on the order of 200 microseconds, following the transmission of a signal. This feature serves to eliminate the retransmission by the beacon of a portion of its own transmitted energy which might be reflected from near-by objects.

5. Coder

The fundamental purpose of coding is to provide identification or segregation of a particular beacon. The coding may be any one, or a combination, of several types and may be introduced in either the interrogating or reply channels of the system. Interrogation coding is possible by means of various devices which may be used to actuate the receiver during a specified interval, or as a result of a special interrogation-pulse sequence. Beacons may also be identified by means of their assigned operating frequencies, though this means of identification is subject to certain obvious limitations as regards available frequency spectrum, mutual interference, and operational flexibility. The most generally used form of coding is "reply" coding, which may be one or a combination of the following types: (a) gap or "keyed" type; (b) pulse-width type; and (c) range type.

(a) Gap coding is accomplished by keying the circuit somewhere in the chain between receiver and transmitter at a rate corresponding to some combination of Morse characters which can be used to identify the beacon. It is probably the simplest of all codes, but has the disadvantage that the beacon is inoperative during the gaps of transmission and, therefore, cannot be observed as reliably as a beacon which is operating continuously. Also, this type of code cannot readily be applied to a narrow-beam scanning radar.

(b) Pulse-width coding is accomplished by keying the transmitted pulse width at a rate corresponding to the identifying Morse character combination. This type of coding is superior to gap coding in that the beacon is on continuously while the pulse width is keyed. Pulse-width coding cannot, however, be readily applied to a scanning radar. Also, pulse-width coding is not generally applicable to magnetron types of oscillators.

(c) Range coding is a type whereby a series of pulses is transmitted for every pulse received. Such a series of pulses may be generated by several single-cycle multivibrators or similar devices operating in tandem. The first multivibrator of the series is triggered by the received pulse and the remaining pulses are generated in a sequence determined by the time constants of the successive multivibrators. The beacon is identified by the number and relative spacing of the transmitted pulses. This type of coding requires greater circuit complication and a higher transmitter duty cycle than either types (a) or (b). The code is, however, instantaneously identifiable to a scanning radar, since the beacon reply is transmitted continuously. For this reason, range coding is preferred in any system utilizing a plan-position indicator or B-type display.

6. Modulator-Driver

The driver for the modulator must deliver the pulse shape and power required to insure proper operation of the modulator. The unit generally consists of a blocking oscillator or similar type of device operating in conjunction with suitable pulse-forming networks. The modulator-driver normally receives its excitation directly from the coder unit. An alternative design, which is sometimes used, consists of having a separate blocking oscillator, gas-switch-tube modulator, and pulse-forming network for each pulse in the range-coding sequence. The combined output of several units is then used to drive the transmitter.

7. Modulator

If the transmitter tube is a standard multielectrode tube, such as a triode, two basic types of modulation are possible, i.e., (a) grid-circuit modulation and (b) plate-circuit modulation. (If the transmitter tube is a magnetron, only plate-circuit modulation is feasible.) In general, plate modulation is to be preferred. Grid modulation requires little power from the modulator and less exacting modulator designs, but is likely to be less stable in operation than plate-circuit modulation because of the erratic grid-circuit characteristic encountered in many tubes. Also, the high plate voltage is applied to the oscillator tube continuously in the case of grid modulation, whereas it may be applied only for the duration of the pulse in the case of plate modulation. If the plate-modulation pulse transformer is so designed that a step-up in voltage is achieved between the modulator output and oscillator plate input, then the direct-current power source may be designed to provide a correspondingly lower direct voltage than would be otherwise required. This step-up in pulse voltage through the modulation transformer is usually quite feasible in the case of triode oscillators, but is considerably more difficult in the case of magnetron oscillators because of the relatively low impedance of the magnetron oscillator. In either case it is extremely important to provide low-impedance modulators when plate-circuit modulation is used. For this reason gaseous-type modulator tubes are customarily provided when plate circuit modulation is to be used.

8. Transmitter

The transmitter generates and delivers to an output load circuit or antenna energy at a specified frequency and power output, modulated as indicated in the above section describing modulators. The transmitter tuned circuits or cavity must be so designed that the required transmitter frequency stability and power output will be maintained under various specified conditions of ambient temperature, humidity, and pressure. Also, the maximum power capability and duty cycle of the transmitter and associated power supply must be such that the beacon will reply simultaneously to the maximum number of aircraft that system considerations indicate

will simultaneously interrogate the beacon. These factors will be considered later, in greater detail, during the discussion of complete beacon systems.

9. Stabilizing Tuner

This device is used principally in connection with magnetron transmitters and takes the form of a tuned cavity coupled to the antenna transmission line, or a stub tuner connected as a part of the magnetron "plumbing." The device also acts as an impedance-matching unit between the magnetron-output and antenna-input circuits. The impedance of the cavity or stubs, reflected into the magnetron, tunes or "pulls" the magnetron to the desired frequency. If the frequency of the magnetron varies under operating conditions the impedance presented by the stabilizer cavity changes in a direction to maintain the desired frequency. Temperature-frequency compensation of one type of stabilizer was obtained by using a steel cavity, an invar bracket supporting the control, and aluminum or duralumin adjusting screws and tuning vanes.

10. Antennas

Beacon antennas may be classified as to polarization and function. The polarization is dictated by system considerations and may be vertical, horizontal, or elliptical.

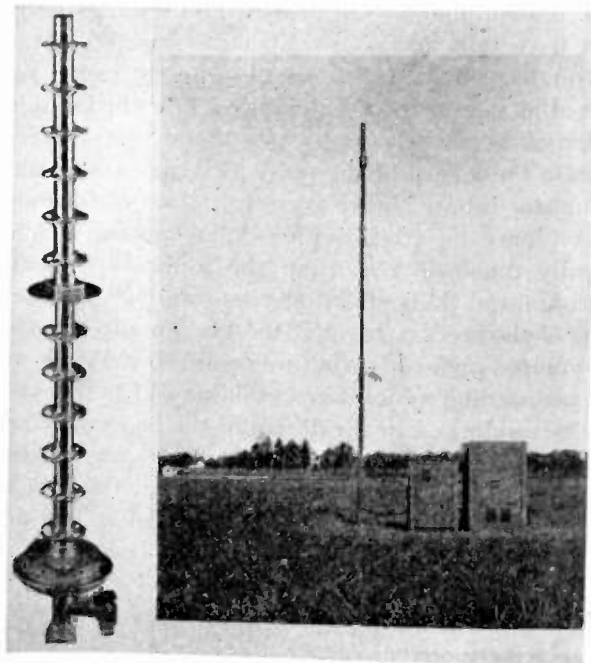

Fig. 2—3000-megacycle beacon and antenna in operating position with inset showing details of antenna assembly.

Functionally, separate receiving and transmitting antennas may be provided as shown in Fig. 1, or a common antenna may be utilized for both transmitting and receiving. When both transmitting and receiving frequencies are the same, common transmission and reception may be accomplished by effectively switching the antenna from transmitter to receiver at the end

of the transmitted pulse and by switching the antenna back to the transmitter at the beginning of the following transmitted pulse. Keying tubes connected into suitable coupling circuits are utilized for this purpose. As in almost all radar equipment, the transmit-receive tube is actuated for the duration of the transmitted pulse and acts to shunt out the receiver input for this period. It is obvious that some loss will be incurred in any common transmitting and receiving antenna system. These losses can be made small by proper design but must nevertheless be given due consideration in deciding whether separate transmitting and receiving antennas or a common antenna should be utilized. Where the antennas can be made small, as at operating frequencies on the order of several thousand megacycles, it is usually better to provide separate antennas. Such an antenna assembly designed for operation at approximately 3000 megacycles is shown in Fig. 2. The particular field-pattern shape required of any beacon antenna will be dictated by system considerations. However, for most ground or airborne beacon installations an omniazimuth coverage is required. In aircraft installations maximum energy should be concentrated within an angle of approximately plus or minus 20 degrees of the horizontal plane through the aircraft. At the average ground beacon installation, maximum energy should be concentrated within an angle of approximately 10 degrees of the horizon.

11. Beacon Monitor

Provisions must be made for monitoring the operation of beacon installations to insure satisfactory continuous operation. Such monitoring facilities are preferably made a permanent part of mobile or fixed ground-beacon installations. Facilities are provided for conveniently connecting suitable external monitoring equipment in the case of airborne beacon installations. Monitoring may be accomplished visually or aurally. Aural monitoring provides a fairly reliable check on the over-all operation of the beacon, but is of little value in localizing trouble.

12. Special Types of Beacons

Though the block diagram of Fig. 1 may be considered representative of radar beacons in general, certain specific types of beacons, while containing functionally many of the components shown in Fig. 1, may differ appreciably in basic circuit arrangements. For example, Fig. 3 (a) illustrates the block diagram of a superregenerative type of transponder. Continuous oscillation or feedback is prevented by the video time constants of the rectifier-pulse-amplifier-pulse-shaper channel. Also, the receiver-transmitter unit may have the time constant of the cathode circuit so adjusted that, because of the relatively slow rate of discharge of the cathode capacitor, the receiver-transmitter tube is maintained in an insensitive condition for a sufficient length of time at the conclusion of the transmitted pulse

to accomplish the purpose of the blanking gate as described in connection with Fig. 1. The circuit of Fig. 3 (a) has the disadvantage that it tends to be unstable; that is, the mode of operation of the receiver-transmitter tube is sensitive to changes of plate and bias voltages and to variations in antenna impedance. While initially the operating point may be correctly adjusted by means of a manually set bias control, such adjustment is not likely to hold over an extended period of time. To overcome this difficulty the arrangement shown in Fig. 3 (b) may be used. Here an automatic-sensitivity-control amplifier and direct-current amplifier are connected to the circuit in such a manner as to maintain the operating mode of the receiver-transmitter tube at the correct point. The time constant and other operating characteristics of the automatic-gain-control circuit can be so adjusted that it will follow relatively rapid fluctuations in supply voltages or reflected antenna impedances. Such a circuit is quite stable in operation and no manual adjustments are required.

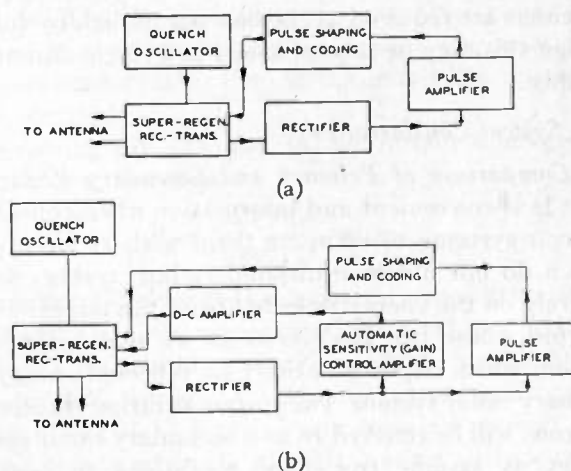

Fig. 3—Block diagrams of superregenerative transponder.

A transponder of the type illustrated diagrammatically in Fig. 3 is particularly applicable to certain identification of friend or foe (IFF) systems where it is desired to have the transponder operating frequency sweep through a band of frequencies in a specified manner. The tuned circuit in the transponders of Fig. 3 is common to both transmitter and receiver, and for this reason no tracking is required to sweep both transmitter and receiver operating frequencies in an identical manner. When such a transponder is used, the interrogator-responder units operating in conjunction with the transponder do not have to be precisely adjusted as to operating frequency, so long as this frequency is within the band swept by the transponder.

Another type of beacon which should receive special mention is the cross-band beacon. The cross-band beacon is usually understood to refer to a beacon which receives signals on one frequency and retransmits them on a widely different frequency; though, strictly speaking, any beacon which receives on one frequency and

transmits on a frequency several megacycles different may be considered a cross-band beacon. The cross-band beacon may, for example, be designed to receive signals at 10,000 megacycles where relatively simple receivers may be designed and built but where the transmission of relatively large amounts of power is impractical without the use of large (high-voltage) power supplies and associated components such as magnetrons. The cross-band beacon obviates this transmitter-design difficulty by transmitting its reply at a relatively low frequency (200 megacycles, for example) where the transmitter components are much smaller and the power supply requirements may be met with lighter units. Such an equipment is particularly applicable to special airborne or ultraportable ground-beacon applications where light weight and extreme portability are basic requirements. The directivity of the 10,000-megacycle interrogator antenna may be realized in such a system, though a special 200-megacycle antenna and receiver (responder) will be required to receive the 200-megacycle transmission from the beacon. Also, functionally, two separate antennas are required at the beacon, though by suitable design this may be accomplished in a single antenna assembly.

13. System Considerations

A. Comparison of Primary and Secondary Radar System: It is convenient and informative when considering beacon systems to compare them with radar systems which do not utilize transponders but, rather, depend entirely on the energy reflected from the target. To distinguish these two basic systems we shall refer to the system which depends entirely on reflected energy as a primary radar system. The system utilizing transponder beacons will be referred to as a secondary radar system.

Let us assume free-space conditions to exist and the energy density from the radar transmitter, or interrogator, to be S_i watts/meter² at a given target location.

The amount of this energy which will be reflected in the direction of the radar set will depend on the effective cross-section area of the target and its coefficient of reflection; which factors are, in turn, dependent on the shape, texture, and material characteristics of the target. All of these factors may be grouped together in a factor σ , termed the scattering factor or echo area of the target. Assuming this factor to have been determined empirically, we may consider the target a source of effective energy in the direction of the radar set of σS_i watts. (Note that σ has the dimensions "meters²".)

If we locate a radar beacon at the target considered above and equip it with a receiving antenna which has an effective absorption cross section A_b in the direction of the interrogator-responder equipment, the energy available for actuating the beacon receiver is $A_b S_i$ watts. Beacon sensitivity may be defined as the power at the input to the beacon receiver required to produce at the receiver output terminals a signal sufficiently strong to fire the beacon transmitter. This minimum signal is re-

ferred to as a "tangential" signal and has been determined experimentally to be approximately equal to three times the ambient noise level of the system, or $3N$, where the noise factor is limiting. Let us assume $A_b S_i = 3N$, then a power of $P_b G_b$ watts will be radiated from the beacon (target), where P_b is the peak power output of the beacon transmitter and G_b is the power gain of the beacon antenna.

The power density at the radar set or interrogator-responder location as a result of the reflected energy from the target is, therefore, $\sigma S_i / 4\pi r^2$ watts/meter² where r is the distance in meters from the target to the interrogator-responder equipment. The comparative power density as a result of the energy radiated by the transponder beacon is $P_b G_b / 4\pi r^2$ watts/meter².

The minimum power required to give a usable signal at the output of the responder, or radar-set receiver, is a function of the ambient noise level of the system (N). We shall assume that a signal having a power level of $2N$ is usable, though the exact value is somewhat dependent on the skill of the observer and other psychological and physiological factors which often are very difficult to evaluate. Fundamentally, then, to a close approximation, we can write the following as a requirement for the primary system to be usable:

$$\sigma S_i A_0 / 4\pi r^2 = 2N \text{ watts/meter}^2. \quad (1a)$$

Similarly, the following is a fundamental requirement for the secondary system to be usable:

$$P_b G_b A_0 / 4\pi r^2 = 2N \text{ watts/meter}^2 \quad (1b)$$

where A_0 is the effective absorption cross section of the responder antenna.

It is of interest, now, to consider the operating ranges possible with a given interrogator-responder equipment having an antenna gain G_0 , and an effective absorption cross section of A_0 , operating, first, as a primary system and, second, as a secondary system. The power density at the target S_i is $G_0 P_i / 4\pi r^2$ watts/meter² where P_i is the peak-power output of the interrogator. Substituting for S_i in (1a) we find that the maximum reliable operating range for the primary system is

$$r_p = \frac{1}{2} \left(\frac{\sigma G_0 A_0 P_i}{2N\pi^2} \right)^{1/4} \text{ meters.} \quad (2)$$

In the case of the secondary system, we must determine the maximum range at which a tangential signal will occur at the beacon receiver; i.e., the maximum range at which the relation $A_b S_i = 3N$ will hold true. Substituting for S_i and solving for r_s , we obtain as the maximum range of the secondary system

$$r_s = \frac{1}{2} \left(\frac{A_b G_0 P_i}{3\pi N} \right)^{1/2} \text{ meters.} \quad (3)$$

Dividing (3) by (2) we obtain the ratio between the usable operating ranges obtainable with a given interrogator-responder and antenna equipment operating as

a secondary system and as a primary system when the inherent ambient noise level of the system is the limiting factor. This ratio is

$$\frac{r_s}{r_p} = \left(\frac{A_b}{3}\right)^{1/2} \left(\frac{2G_0 P_t}{A_0 N \sigma}\right)^{1/4} \quad (4)$$

It was assumed in deriving (4) that the limiting range was the range at which the radar beacon could be triggered. Actually, of course, a further requirement is that the beacon transmit sufficient power to the responder to be usable in the presence of the ambient noise level (N) inherent in the system. The beacon transmitter power required to do this may be obtained from (1b) by remembering that $A_b S_t = 3N$ for a tangential signal. Also, it may be shown analytically¹ that the average absorption cross section of resonant dipoles oriented at random is given by the expression $\lambda^2/4\pi$, which is the area of a circle whose circumference is λ . It follows, therefore, that the total effective absorption cross section A_b of the beacon antenna system is related to the effective gain G_b of the beacon antenna, over that of an isotropic radiator, by the following expression:

$$A_b = 2\lambda G_b/4\pi \text{ meters}^2. \quad (5)$$

Substituting for A_b and S_t in the expression for the tangential signal, we have

$$G_b = 3N(4\pi r)^2/\lambda^2 G_0 P_t.$$

Also, it follows that

$$A_0/G_0 = \lambda^2/4\pi.$$

Substituting these values in (1b), it may be shown that

$$P_b = (2/3)P_t. \quad (6)$$

That is, for a theoretically perfect balanced system, operating at the maximum range possible with the ambient noise level inherent in the system, the peak transmitted power output of the beacon should be 2/3 that of the interrogator under the assumed conditions.

It will be recalled that we assumed the tangential signal at the beacon to be $3N$; whereas, the minimum usable signal at the responder was assumed to be $2N$. This difference in required signal levels accounts for the factor of 2/3 in the above expression and follows from the fact that for maximum system reliability and traffic-handling capacity the beacon must not be fired by noise impulses to any appreciable extent. It has been found experimentally that to satisfactorily approach this objective the beacon modulator bias must be set to establish tangential firing at approximately $3N$. On the other hand, a signal having an amplitude $2N$ is usually readable at the responder output under favorable conditions. A greater incidence of noise impulses can be tolerated at the responder output, since such impulses do not tend to saturate the system to the same extent as

spurious firing of the beacon. Actually, N can only be taken to represent the noise level not exceeded in, say, 97 per cent of the time. Since noise is a random phenomenon, noise peaks exceeding any specified value are likely to occur if one waits long enough for the occurrence.

Also, the value of N depends on several system design parameters such as receiver bandwidth and type of mixer or detector used. In the general case we should write (6) in the form $P_b = f_0(N)P_t$, where, $f_0(N) = f_r(N)/f_b(N)$. Here, instead of $2N$, $f_r(N)$ is the usable responder sensitivity, in watts, expressed as a function of the minimum noise level of the system. $f_b(N)$ is the tangential signal, in watts, at the beacon receiver, rather than $3N$. $f_r(N)$ and $f_b(N)$ require empirical determination for any particular system. Rather than introduce these general expressions at this point, however, we shall later, when we consider (8) and (9), introduce means, in the form of factors K_i and K_r , for evaluating variations in usable receiver sensitivities. It may be noted that when $P_b = [f_r(N)/f_b(N)]P_t$ the system is balanced. That is, the values of transmitter power output and receiver sensitivity are correctly proportioned with respect to each other at the maximum operating range specified.

Combining (3), (5), and (6) we obtain a more convenient form, as follows:

$$P_b = \frac{32\pi^2 r_s^2 N}{\lambda^2 G_b G_0} \text{ watts}. \quad (7)$$

Equation (7) gives the peak beacon transmitter power required for a given operating range r_s , where the limiting factor on usable receiver sensitivity is an ambient noise level N . Assume: $r_s = 366,000$ meters (corresponding to line-of-sight transmission from an aircraft to a ground beacon when the aircraft is at an altitude of approximately 27,000 feet); $N = 2 \times 10^{-12}$ watts; $\lambda = 10$ centimeters; $G_b = 3$; $G_0 = 700$; then, $P_b = 4.03$ watts. $P_t = (3/2) \times 4.03 = 6.05$ watts. Beacon receiver sensitivity $= 3N = 3 \times 2 \times 10^{-12}$ watts $= 6 \times 10^{-12}$ watts for reliable firing of the beacon. Responder-receiver sensitivity $= 2N = 4 \times 10^{-12}$ watts under the assumed conditions. We have thus completely defined the system required to provide the specified operating range under the assumed conditions. We have, however, failed to take into consideration the various losses in system. These losses must be estimated and the calculated values of P_b and P_t increased sufficiently to provide the required power for operation of the system with the losses included.

It is convenient to consider the two operating legs of the system separately. The interrogating leg we define as the leg from the interrogator to the beacon receiver. The reply leg we define as the leg from the beacon transmitter to the responder.

Losses in the interrogating leg include principally those losses in the transmission lines or plumbing, both between the interrogator antenna proper and the interrogator transmitting tube, and also between the beacon

¹ J. C. Slater, "Microwave Transmission," McGraw-Hill Book Co., New York, N. Y., 1942, p. 244.

receiving antenna and the receiver input termination. These losses are conveniently expressed in decibels. The total interrogator power required may then be obtained from the relation:

$$P_{i0} = K_i P_i \text{ watts} \quad (8)$$

where

$$K_i = 10^x; \quad x = \text{decibel loss}/10.$$

Where the system design is such that light-weight beacon receiver construction is required with a loss in resulting receiver sensitivity, it will be necessary to increase P_{i0} by the amount in decibels that the receiver sensitivity is below the maximum value dictated by the point in the system at which N was measured. This loss factor may also be included in K_i . Where a radar system is designed for operation as a primary system and is used incidentally as a secondary system there is usually an ample factor of safety on the interrogating leg, as is indicated by (4). Under these conditions a simple type of beacon receiver may often be used to advantage. Where the system is to be used only as a secondary system, however, the factor K_i must be carefully evaluated.

The losses in the reply leg are more difficult to evaluate than the losses in the interrogating leg for the reason that the losses in the reply leg must be considered from the standpoint of the particular type of display used to view the beacon reply and are, therefore, complicated by psychological and physiological factors often difficult to evaluate. In addition, the plumbing and receiver losses must also be considered on this leg. Reply-leg losses have been carefully considered, defined, and evaluated by the Radiation Laboratory, Massachusetts Institute of Technology, in Report 627, particularly as they apply to the reception of beacon signals in an aircraft in flight, the most unfavorable condition. This report defines and evaluates these losses essentially as follows:

(1) Antenna scanning losses—Scanning losses are defined as the difference between the minimum detectable A- or B-scope signal measured while searchlighting the beacon by the airborne radar beam and the same signal measured while scanning. It is concluded that, for scanning rates higher than 6 per minute, this loss is given approximately by the square root of the ratio of the radar antenna beamwidth to the total scanning angle. For a typical airborne radar set this loss is approximately 7 decibels.

(2) Observation loss—This loss depends on the ambient light intensity and what a particular observer believes is a reliable signal. It is estimated, from experimental data, at approximately 3 to 4 decibels.

(3) Long-sweep loss—This is the loss in signal readability or sensitivity which occurs on switching from, say, the 15-mile range on the radar indicator to the 100-mile range. It is estimated at 5 decibels.

(4) Noise level in flight—This loss is dependent entirely on the aircraft installation and in properly shielded and bonded installations will be negligible.

(5) TR-ATR Loss—This loss occurs when the beacon reply frequency is different to the primary radar operating frequency and results from the fact that the TR-ATR circuits are adjusted to the primary radar operating frequency. This loss may be as high as 20 decibels. However, where the TR-ATR circuits may be tuned to the beacon reply frequency this loss may be reduced to a very small value. For the reply leg we may, then, write the total required beacon transmitter power as

$$P_{b0} = K_r P_b \text{ watts} \quad (9)$$

where

$$K_r = 10^y; \quad y = \text{decibel loss}/10.$$

Let us now further consider the secondary system we had set up in connection with (7). We determine the total loss in the interrogating leg to be 20 decibels. This includes 4 decibels in the interrogator antenna plumbing and 4 decibels in beacon receiver-antenna plumbing. In addition, because of a relatively high ambient noise level at the beacon receiver and a requirement for a relatively wide beacon-receiver acceptance bandwidth, the effective sensitivity of the beacon receiver is reduced by 12 decibels. Therefore, $x = 2.0$ and $K_i = 100$. It follows that: $P_{i0} = 6.05 \times 100 = 605$ watts.

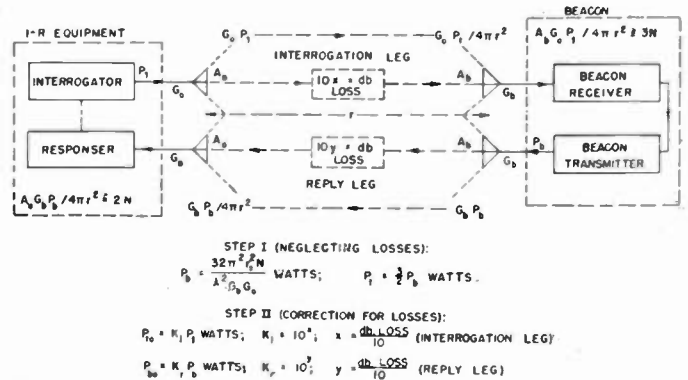

Fig. 4—Summary of secondary-system design considerations.

The losses in the reply leg are determined to be 22 decibels, divided as follows: scanning losses, 7 decibels; observation loss, four decibels; long-sweep loss, 5 decibels; losses in plumbing, 6 decibels. We assume no TR-ATR loss since the system is designed for beacon operation only. Thus, $y = 2.2$ and $K_r = 159$. $P_{b0} = 159 \times 4.03 = 640$ watts.

It is seen, therefore, that (7) may be used as a basis for the complete design of secondary radar systems. The data obtained must, however, be modified to account for the various losses in the system as outlined above. The resulting system will be balanced. That is, the interrogator-transmitter power output is just adequate to fire the beacon transmitter at the specified operating distance when the beacon receiver is operating at its maximum practicable sensitivity consistent with the ambient noise level. Also, the beacon-transmitter power

output is just adequate to provide reliable reading of the beacon-reply signal, as it appears at the responder output, at the specified operating conditions, and with the responder receiver operating at its maximum practicable sensitivity consistent with the ambient noise level.

Fig. 4 depicts a summarization of the system design considerations we have evolved. Step I: the system is designed on a purely theoretical (free-space) basis established from a certain minimum ambient noise level (N) which is assumed constant throughout the system. Step II: using Step I as a basis, the losses in the interrogation and reply legs are evaluated and the design parameters corrected accordingly.

B. Delay in the Beacon: In making precise range measurements with a secondary radar system it is important to accurately evaluate the delay in the beacon; i.e., the elapsed time between the beginning of the rise of the received signal and the beginning of the rise of the transmitter radio-frequency envelope. For typical beacon designs this delay is usually between 2 and 5 microseconds. For any particular beacon system it should be possible to maintain a fixed delay to within plus or minus 0.3 microseconds.

C. Factors Governing Choice of Beacon Transmitter and Receiver Frequencies: Choice of beacon transmitter and receiver frequencies is usually dictated by the operating frequency of the radar interrogator-responder equipment with which the beacon is required to operate. The operating frequency of the radar interrogator-responder equipment is, in turn, determined by the required definition and the size of directive antenna assembly which can be tolerated to achieve the required definition. The propagation characteristics of the frequency band selected must be suitable.

When the beacon is operated in conjunction with a primary radar system it is usually desirable to adjust the beacon-reply frequency to a value displaced from the scatter band of radar transmitter operating frequencies of an amount somewhat greater than one-half the responder (radar-receiver) acceptance bandwidth. The radar receiver is then tuned to the beacon-reply frequency when beacon operation is desired. In this way all primary-type radar replies are eliminated and the beacon reply is displayed with a minimum of interference. When operating with primary interrogator-responder equipments it is important that the acceptance bandwidth of the beacon receiver be at least as wide as the scatter band of all the radar transmitters with which the beacon is expected to operate. That is, the beacon receiver must be broad enough to receive all radar-transmitter operating frequencies within the band included between the extreme upper and lower operating frequencies which are known to exist. This requirement for a wide-acceptance bandwidth seriously limits the maximum receiver sensitivity obtainable with microwave beacons required to operate in such a system. The

responder, or radar receiver, can be more precisely adjusted and "trimmed" in operation, and for this reason a narrower acceptance bandwidth can be utilized. The above considerations often make it practicable to design responders with from 12 to 20 decibels greater sensitivity than is feasible with the corresponding beacon receivers. However, most of this increased sensitivity is lost in the TR-ATR circuits, when the responder is adjusted for beacon reception, unless provision is made for also retuning the TR-ATR circuits to the beacon transmitter frequency.

For the reasons previously mentioned, cross-band beacon operation is often advantageous when, for example, it is required that a beacon operate in conjunction with a 10,000-megacycle primary radar transmitter. The beacon will only be triggered when a tangential, or greater, signal is received from the radar interrogator, which means that at all operating ranges greater than a certain minimum value the azimuth discrimination of the radar antenna will be realized. The azimuth definition of say, a 200-megacycle reply leg is, of course, not comparable to the azimuth definition attainable on the 10,000-megacycle interrogation leg, for a given size antenna. The disadvantage of this loss in azimuth definition, together with the necessity for providing a special low-frequency responder for receiving the reply from the cross-band beacon, must be weighed against the saving in size and weight provided by this type of beacon before a decision can be made as to whether the cross-band beacon should be used in preference to the single-band beacon.

D. System Accuracy: When using beacons for purposes of navigation or identification two factors must be precisely measured; they are (1) azimuth and (2) distance or range. The definition in azimuth which can be realized is a function of the size of reflector or "dish" which can be used in connection with the interrogator-responder antenna and, also, of the operating frequency. Where it is necessary to keep the antenna assembly as small as practicable, as in aircraft installations, for example, it is desirable to use as high an operating frequency as feasible. This follows from the fact that the higher the operating frequency the greater the azimuth definition will be with a given size interrogator-response antenna assembly. The angular width of the beam over which the cross-band or single-band beacon is interrogated is the angle between the two directions in which the energy received by the beacon provides a tangential signal. Thus the angular spread or arc for interrogation is a function of range, varying from almost zero degrees at maximum range to a full circle for a beacon close to the interrogating transmitter. For airborne beacons being flown high enough so that horizon effects are not involved, the arc for interrogation will be very little greater than the one-half power beamwidth of the interrogator antenna from maximum range to a point one-half to one-third of that value. At distances

less than approximately one-tenth maximum range the interrogation arc rapidly increases to a full circle, often referred to as the "circle of confusion." The minimum range at which the circle of confusion occurs can be adjusted by (1) the application of a sweep-time sensitivity control to the responder receiver, and (2) by reducing the transmitted power output of the interrogator when interrogating beacons at less than one-third maximum range. Item (1) may be made automatic. That is, the sensitivity of the responder can be made a specified function of sweep voltage so that the sensitivity is a maximum at extreme operating ranges and is a minimum at ranges less than one-tenth maximum. Item (2) may be accomplished manually. The same effects can be obtained by adjusting the receiver sensitivity and power output of the beacon. This is not usually desirable, however, since such variations in operating characteristics of the beacon will prevent its simultaneously responding satisfactorily to other interrogator-responder equipments at greater ranges.

The range or distance-measuring accuracy attainable in a beacon system is determined by the stability of the fixed delay in the beacon, the stability of the sweep or range-measuring circuits in the responder indicator, and by the interrogator and beacon-reply pulse widths. With suitable design the delay in the beacon can be held constant to within plus or minus 0.3 microsecond over extreme operating conditions. Present techniques make it possible to provide distance-measuring circuits which are sufficiently precise to render any error, inherent therein, negligible in comparison with instability of delay in the beacon.

E. Duty Cycle and Traffic-Handling Capacity: The duty cycle D of a beacon may be defined as the fraction of a period that the transmitter operates or as the ratio of average transmitter power P_a to peak pulse power P_p . That is,

$$D = WN/T_{pr} = P_a/P_p = WNf_{pr} \quad (10)$$

where W = pulse width in seconds; f_{pr} = pulse-repetition-rate, in pulses per second, based on a single-pulse reply; N = the number of pulses in each reply group when range coding is used; $T_{pr} = 1/f_{pr}$ = the period, in seconds, between transmitted pulses or the beginning of code groups. The traffic-handling capacity of a beacon is determined by the number of reply pulses the beacon can transmit per period without overload; which is, in turn, a function of the maximum allowable duty cycle of the modulator and transmitter, and the setting of the blanking gate. The setting of the blanking gate limits the rate at which the beacon can respond, for if the blanking gate is set for a time T_b seconds the beacon cannot respond 100 per cent to a pulse repetition rate greater than $1/T_b$ pulses per second. That is, if the blanking gate is set for 200 microseconds, the upper limit at which the beacon can transmit a pulse for every pulse received is $10^6/200 = 5000$ pulses per second. If this rate of interrogation is exceeded, the beacon will "count down," or transmit fewer pulses than are re-

ceived. When the beacon is "counting down" the replies are shared statistically, so that each interrogator-responder equipment always receives some replies. It should be noted, in this connection, that the repetition rate used for beacon interrogation should be as low as practicable to minimize system overloads.

F. Siting and Range of Microwave Beacons: Microwave energy is propagated along essentially straight lines and for this reason many problems pertaining to the propagation of microwaves may be worked out geometrically using straight lines. Beacon sites may, for example, be surveyed with satisfactory accuracy using a surveyors transit. Mount the transit at the proposed beacon site and at the same height as the beacon antenna. Level the instrument and swing around the horizon taking readings of the skyline (positive and negative) elevation angles A at a sufficient number of points to plot the irregularities of the skyline. Note that negative elevation angles are advantageous. From these data a skyline survey such as is shown in Fig. 5 can be plotted

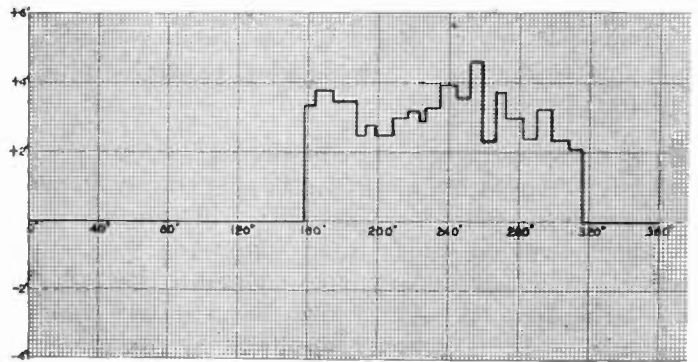

Fig. 5—Skyline survey for beacon with antenna height of 20 feet.

Such survey graphs can also be plotted from accurate topographical maps. The graph of Fig. 5 was plotted for a beacon antenna height of 20 feet. Such a graph gives the minimum positive or negative elevation angle A , as measured from the horizon, at which line-of-sight operation from an aircraft is possible at any given azimuth. These data, by the application of certain geometrical considerations, permit us to plot a range altitude chart as shown in Fig. 6.

The maximum line-of-sight range to the aircraft for various total elevation angles A_t , as determined by the skyline survey, may be calculated from the relation

$$R_s = \frac{1.22\sqrt{h_a}(\sqrt{h_a} + \sqrt{h_b})}{5000 \sin A_t + \sqrt{h_a} \cos A_t} \quad (11a)$$

where R_s = maximum line-of-sight range to the aircraft in nautical miles; h_a is the altitude in feet of the aircraft above the datum plane; h_b is the altitude in feet of the beacon antenna above the datum plane. It will be noted that, when $A_t = 0$, (11a) becomes

$$R_s = 1.22(\sqrt{h_a} + \sqrt{h_b}) \quad (11b)$$

which is the generally accepted expression for the horizontal line-of-sight radar range and which also

defines the reference from which A_i is measured. Equation (11a) is not exact since the multiplying factor, 5000, was determined empirically and is actually a function of A_i . The form of (11a) is convenient to use, however, and will give values of R_i which are accurate to within approximately 15 per cent for elevation angles (A_i) of less than 20 degrees. This accuracy is sufficient for most practical applications. Fig. 6 is plotted from Fig. 5 by means of (11a) and provides a means of predicting the

identify hostile radar targets. This problem is especially acute when dealing with targets such as single aircraft in flight or single or widely spaced ships at sea where the echo is sufficiently discrete to permit accurate offensive action to be taken against the target by radar means alone. Since there is no direct method of obtaining identification of hostile targets, it becomes necessary to identify by indirect means. The indirect method is accomplished by providing all friendly radar targets with

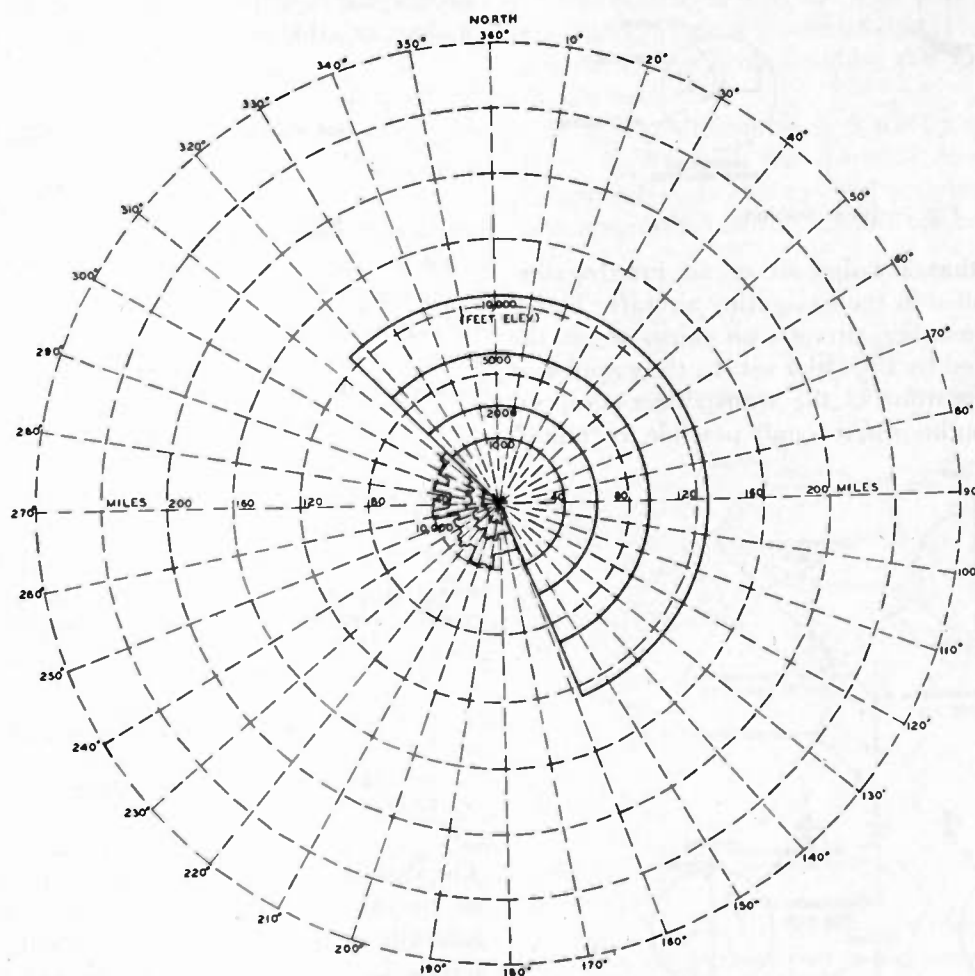

Fig. 6—Plotted range-altitude chart for beacon of Fig. 5. Average beacon maximum range in nautical miles for plane at elevations shown.

maximum operating ranges that can be obtained by aircraft operating at various directions and altitudes with respect to the beacon site. Such a chart, therefore, provides a means of evaluating proposed sites for microwave beacons or for ground-based interrogator-responder equipments operating against airborne beacons. In general, proposed sites can be evaluated by a survey, as outlined above, more accurately than they can be evaluated experimentally unless many hundreds of carefully controlled flights are conducted for each proposed site.

PART II—APPLICATIONS

1. Identification

One of the basic problems in the development of military tactics using radar systems is that of being able to

transponders and assuming that any nonidentified target is hostile. This indirect method has some inherent disadvantages, but is entirely workable provided that the transponder is extremely reliable in operation and is well maintained. The basic elements of the system are shown in Fig. 7.

2. Aids to Air Navigation

For purposes of discussion, the applications of radar beacons as aids to air navigation will be divided into three categories, namely, general navigation, precision navigation, and collision warning.

A. General Navigation: This field may be further subdivided into air-controlled and ground-controlled navigation.

Air-controlled navigation may be defined as that method of navigation wherein the data are observed from the aircraft requiring the navigational information. This

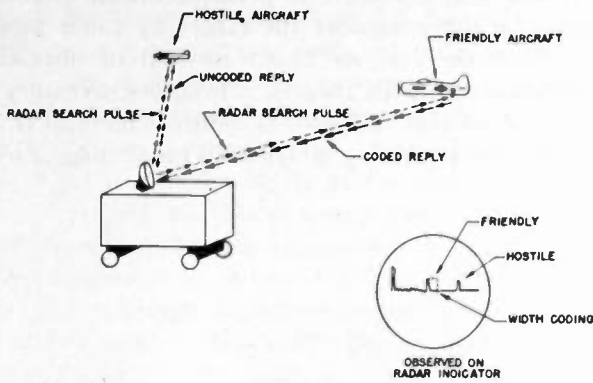

Fig. 7—Identification.

system requires that a radar set or an interrogator-responder be installed in the navigating aircraft. Transponders located in other aircraft, on ships, or on the ground are observed by the radar set. In the event that the geographical position of the transponder-equipped ship or aircraft is unknown, it is only possible to "home"

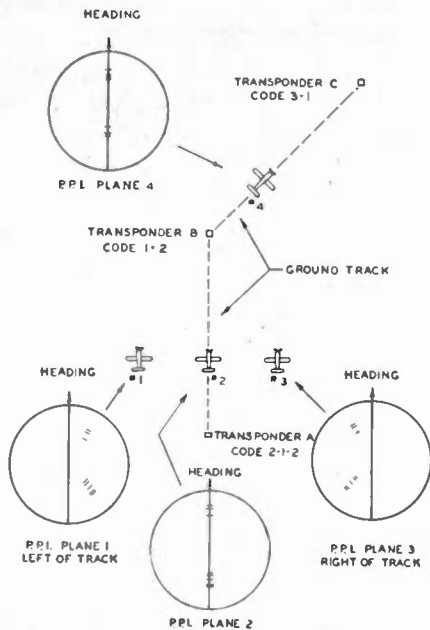

Fig. 8—"Radar range" system.

on the transponder involved. "Homing" is accomplished by using the azimuth resolution of the radar to obtain the correct heading to the transponder, then using the range information from the radar to determine when the navigating aircraft is at the rendezvous point. The coding of the transponders permits selection by the navigation aircraft of the ship or aircraft desired.

The technique of "homing" led to the development of the "radar range," which is substantially a radio-range type of system. Aircraft depart from a transponder-equipped location and "home" on a transponder at the terminus, or check point, if the flight is a long one.

By observing the relative positions of the two transponders, the position of the aircraft with respect to the ground track between the transponders is determined. The "radar range" system is illustrated in Fig. 8.

In the event that the geographical position of the transponder is known, it is possible to obtain a rough "fix." This method is based upon the assignment of a specific and unique code for each transponder location. Thus, when a transponder is "seen" by the radar set, its geographic co-ordinates are determined by referring to a chart or table giving transponder codes and locations.

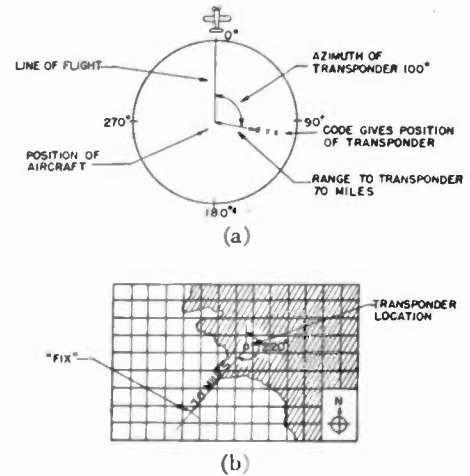

Fig. 9.—Obtaining a "fix."

- (a) Data observed on plan-position indicator:
- | | |
|---|--------------|
| Aircraft magnetic heading (from compass) | 300 degrees |
| Transponder azimuth (from PPI) | +100 degrees |
| | 400 degrees |
| | -360 degrees |
| Magnetic bearing, aircraft to transponder | 40 degrees |
| | +180 degrees |
| Magnetic bearing, transponder to aircraft | 220 degrees |
- (b) Plotting the "fix."

The distance and azimuth of the transponder relative to the aircraft line of flight are observed, and the azimuth is converted into a magnetic bearing by referring it to the magnetic heading of the aircraft. The "fix" is plotted by laying off a line from the transponder location along a reciprocal of the magnetic bearing from the aircraft of the transponder, then plotting the distance from the aircraft to the transponder. This procedure is illustrated in Fig. 9.

Ground-controlled navigation may be defined as that method of navigation wherein the data are observed by a radar set on the ground and the navigational information is supplied to the aircraft via communications channels. In this case the "fix" is recorded from a known location (i.e., that of the observing radar set). The data are observed in the same manner as outlined in Fig. 9, but the plotting is done directly by laying off the observed magnetic azimuth and range on a map. The "fix" obtained is more accurate than obtained by an aircraft because the magnetic azimuth error is reduced.

Ground-controlled navigation may be applied to general surveillance or to specific navigational problems,

such as traffic control. The advantage of the transponder for these applications is that it provides identification and range extension. By using a transponder we may extend the range at which a given radar set can "see" a small fighter aircraft by a factor which may be evaluated from (4).

Surveillance involves monitoring or "policing" the air around the radar set to maintain the flow of air traffic without danger of collision. In the event that a particular transponder-equipped aircraft is causing, or about to enter, a condition of potential collision, the surveillance radar operator calls the attention of the aircraft to the situation, and orders it out of danger.

B. Precision Navigation: Precision navigation may be defined as navigation that gives position within plus or minus 100 yards of the true position.

Existing radar sets have antenna beamwidths of the order of several degrees. The width of the radar antenna pattern, its symmetry, and the accuracy of the magnetic compass limit the accuracy of azimuth measurement; consequently the information obtained from the radar set alone may not be sufficiently accurate for precision navigation.

The basic principle underlying transponder-type precision navigation systems is that of accurate measurement of distance to or from two fixed points of known geographic location. The accuracy of distance measurement of present radar sets is considerably greater than the accuracy of their azimuth measurement, being on the order of one part in one hundred thousand for distance.

We may divide precision navigation systems of the transponder type into air-controlled and ground-controlled, as in the case of general navigation above.

Air-controlled precision navigation may be defined in the same manner as air-controlled general navigation, i.e., that method wherein the data are observed by the navigating aircraft. This system requires that a radar set or an interrogator-responder be installed in the aircraft, and that two transponders or radar beacons be installed at known points on the ground. The transponder locations are identified by the coding of the transponders. Shoran (short-range navigation) and the "H" type of system are examples of air-controlled precision navigational systems and the following general remarks are applicable to all systems of this type.

"Fixes" are obtained by measurement of distance from the aircraft of the two ground transponders. The transponder locations are plotted on a map and locus circles corresponding to the observed distances from the aircraft to the transponders are drawn upon the map. The ambiguity as to which of the two circle intersections is the true "fix" is resolved by determining the approximate azimuth from the aircraft to the transponders. One of the intersections is assumed to be the true "fix," and the relative positions of the transponders with respect to this "fix" are determined. If the relative posi-

tions are opposite from the observed position, then the "fix" is false, and the other intersection is the true "fix." This procedure is illustrated in Fig. 10.

Precision navigation usually requires more than precision fixes. It requires in addition that a precision course or heading be followed. It is possible to use the method described above to fly certain precision courses, and to cross selected points with precision. There are two types of courses that may be followed, namely, circular and hyperbolic.

A circular course is flown by maintaining one of the transponders at a constant distance. Position on the circular course is obtained by the "fixing" method outlined above.

A hyperbolic course is flown by maintaining a constant *difference* in the distance measured to the two transponders. In this method of flying a course, "fixing" is accomplished in the manner already outlined.

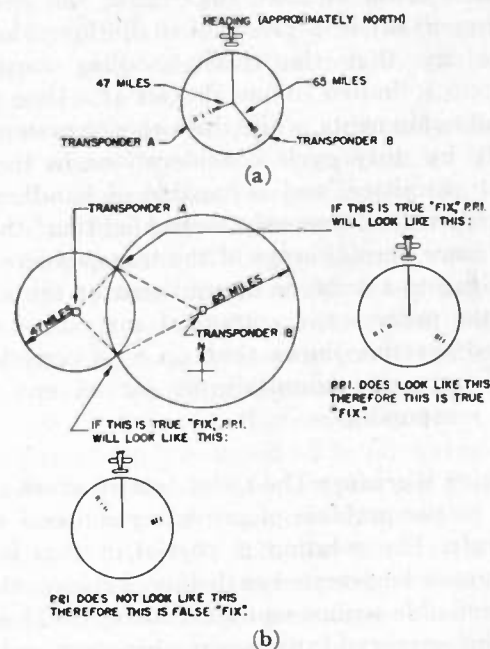

Fig. 10—Obtaining a precision "fix."

(a) Data observed on plan-position-indicator.
(b) Plotting the "fix."

Neither course method will provide for crossing any point in the area covered on any desired heading, but both courses provide that any point in the area covered may be approached on a total of six known headings. Four headings are provided by the circular method. Either transponder may be used as a center of the orbit, and each circle may be flown either in a clockwise or in a counter-clockwise direction. Two additional headings are provided by the hyperbolic method. One of the headings is the reciprocal of the other. If it is desired that a particular track be followed, or that a particular point be crossed on a particular heading, the transponders can be suitably sited to accomplish this. However, in this case it is not possible to simultaneously provide other specified tracks or headings without a special airborne computer.

A number of factors in system design are important. Among these are the stability of delay in the transponders, the accuracy of the maps and of the location of the transponders on the maps, and the effects of the curvature of the earth and the slant height upon the map distances measured.

Ground-controlled precision navigation is similar to the systems described above, except that the number of courses available without computing devices is reduced to four. The ground control is exercised by two radar sets, and the navigating aircraft is equipped with a transponder. Utilizing ground-to-air communications channels, the operator of one radar set guides the aircraft along a circular course and the operator of the second radar set informs the aircraft of its position on the course.

The advantage of ground-controlled navigation is that the accuracy of the measurements is greater than those made in the aircraft, since space and weight are not as important in a ground installation. The disadvantages are that the traffic-handling capacity of this system is limited to one aircraft at a time per pair of ground equipments, while the airborne system is limited only by duty cycle considerations in the transponder transmitter, and is capable of handling 10 or more aircraft simultaneously "searchlighting" the transponder. Since normal usage of the transponders by any one navigating aircraft is intermittent at the scanning rate of the radar set, a statistical analysis of the air-controlled systems shows that up to several hundred aircraft can make simultaneous use of one pair of ground transponders.

C. Collision Warning: The radar beacon offers a partial solution to the problem of providing collision warning for aircraft. The solution is partial in that inert obstacles cannot be detected at distances comparable with those obtainable against equipped obstacles. Thus, when using a low-powered interrogator-responder, only those aircraft and obstacles equipped with transponders will give warning of their presence.

Three possible solutions to the problem of marking obstacles are discussed herein. They involve marking each obstacle with either a passive transponder, a normal transponder, or with a "ring-around" transponder.

Passive transponders are really not transponders, but merely resonant dipoles or "corner reflectors." These devices reinforce the reflection from the obstacles that they mark, and do not as a general rule provide any coding for identification.

Normal radar beacon obstacle markers have been discussed under air-controlled navigation above. In that discussion the transponder is used for navigational purposes, but it is evident that collision warning is merely a special case of that navigational problem.

"Ring-around" transponders form a system which is really not a true pulse radar system. The basic principle of this system is that two transponders receiving and transmitting on the same frequency will tend to "ring

around," or continuously interrogate each other at a repetition rate which is a function of the distance between them. Means must be provided to cause the "ring around" to start promptly. A transponder will tend to "fire" randomly due to internal and external bursts of noise, but, because of the random occurrence, this cannot be relied on for collision warning. It is preferable to cause the transponder to transmit continuously at a low rate. The "blanking" of each transponder must be such that it will not "ring around" with itself.

The technique of "ring around" gives information as to the presence of and the distance to an equipped obstacle. In order to provide azimuth and elevation information, a directional antenna system must be used.

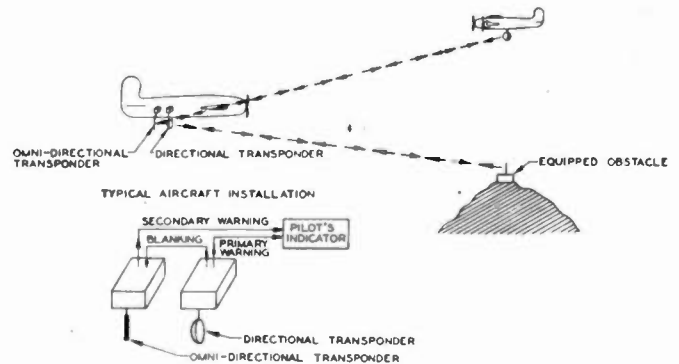

Fig. 11—Typical "ring-around" system.

Since each equipped aircraft must be capable of being detected at any time independently of its ability to detect obstacles, the transponder must have continuous omnidirectional antenna coverage. If azimuth and elevation resolution are desired, they must be added without affecting the omnidirectional coverage. One of the simplest methods of obtaining this resolution is to use a second transponder employing a directional antenna system.

While no "ring-around" system has yet been developed and put into use, a proposed system is outlined below. The elements of the system are illustrated in Fig. 11.

Each aircraft carries two transponders. One transponder has a directional antenna and is used to interrogate equipped obstacles. It transmits at, say, two cycles per second. When an obstacle comes within range, the transponder starts to "ring," giving warning to the pilot of the presence, distance, and azimuth of the obstacle. The second transponder has an omnidirectional antenna and is used to reply to the interrogations from other transponders. A blanking connection is made between the directional and the nondirectional transponders in the same aircraft to prevent them from "ringing" with each other. A safety or secondary warning feature of the omnidirectional transponder is that its output may also be connected to the pilot's indicator. Thus, if the directional transponder is presenting range and azimuth to one obstacle, and an equipped aircraft comes into range at a different azimuth, the

omnidirectional transponder will give warning to the pilot of the presence of the second obstacle.

It is usually desirable to limit the maximum warning range in order to prevent the pilot from worrying about aircraft beyond the edges of his air space. This leads to the establishment of a minimum "ring" frequency which will actuate the warning circuits. The expression for determining this frequency is

$$F_1 = 5 \times 10^5 / (5.38R_1 + D), \quad (12)$$

where

- F_1 = lower "ring" frequency limit, cycles per second
- R_1 = maximum warning distance, statute miles
- D = delay time in transponder, microseconds (assumed to be the same for all transponders).

Under certain conditions it is not possible to obtain "ring around" when the distance between the transponders is below a certain value. To sustain oscillation

$$R_2 \geq (M - D) / 10.76, \quad (13)$$

where

- R_2 = minimum "ring" distance, statute miles
- M = transponder blanking time, microseconds
- D = transponder delay time, microseconds.²

The traffic-handling capacity of the omnidirectional transponder must be as large as possible in order to minimize "counting down," or "ringing" at a frequency lower than that corresponding to the actual distance. This phenomenon occurs when two or more directional transponders are within range of the same omnidirectional transponder. Unless the omnidirectional transponder can "ring" freely with the directional transponders, one or both will "ring" at a lower frequency, giving apparent ranges which are greater than true ranges. The "counting down" can be reduced by using low frequencies for range measurement, and by the use of an automatic-gain-control circuit for the receiver of the transponder. Low-frequency range measurement (involving large values of D) is also advantageous because it means low transmitter duty cycle. Automatic gain control may be used to reduce the receiver sensitivity, thus discriminating against more distant obstacles in favor of ones close at hand.

3. Special Applications

The transponder has certain special applications other than for identification and aids to air navigation. Among these are emergency rescue, field-strength measurement, and aids to airport-approach control.

A. Emergency Rescue: Several transponder-type equipments have been developed to assist in emergency rescue of air crews forced down on water. These are the "corner reflector," the "squegging" or self-pulsing transmitter, and the true transponder.

The "corner-reflector" type of transponder is actually a radar target having a very high reflection factor (σ). (For a discussion of σ , see Part I, Section 13.) It is con-

structed of a series of mutually perpendicular reflecting planes. The intersection of any three planes resembles the corner of a room, hence the name "corner reflector." By using three mutually perpendicular planes, the "corner reflector" gives first-, second-, and third-order reflections of the incoming radar signals. This improves σ to such an extent that it becomes possible for a radar set to distinguish the signal of a "corner reflector" from the normal sea return signal. Experimental data have shown that a "corner" $3 \times 3 \times 3$ feet has the same effective reflection as an 80-foot crash boat.

The "squegging" transmitter is a continuously radiating pulse-type beacon. This device is a self-blocking pulse transmitter operating at a constant, high repetition rate. The azimuth resolution of the radar set or interrogator is used to "home" on the transmissions. No ranging information is provided, so that it is possible to fly a reciprocal course; i.e., away from the transmitter instead of toward it. It is usually possible to resolve this ambiguity by observing the variation of signal strength as the receiver moves.

The true transponder offers a third solution to the emergency rescue problem. By simplification of the circuits of the superregenerative transponder, a small, compact unit has been developed. It consists of two packages weighing a total of approximately four pounds. One package contains the batteries, a hearing-aid type headphone for monitoring, a power switch, and a key for width coding the transponder replies. The second package contains a collapsible mast, the two-tube transponder, and the antenna. Ranges up to 80 miles have been obtained with this device. The advantages of the transponder over the two devices discussed above are that the maximum useful range is considerably greater, that coding is provided, and that the replies provide range information to the interrogating radar. The disadvantage is that the life of the equipment is limited by the batteries, as is the case with the "squegging" transmitter.

B. Field-Strength Measurement: A proposed application of the radar beacon is in connection with a system for automatically recording the data required for plotting microwave field-strength contours. The beacon for this application is so designed that its sensitivity is well stabilized in value over extended periods of operation. The power output is made high enough to cover reliably the area over which it is desired to conduct the survey.

The field-strength recorder consists of an interrogator-responder adjusted to transmit on the beacon receiver frequency, which is also the frequency at which the survey is to be made. The responder is adjusted to the frequency of the beacon transmitter, which may be any convenient value. The output of the responder operates a servomechanism which controls the transmitter or interrogator power output in such a manner that the power output is increased until the interrogator just begins to trigger the transponder as manifest by the reception of beacon signals by the responder. At this point

² The above expression is based on blanking being applied at the beacon receiver. If blanking is applied at the modulator or transmitter, this expression becomes $R_2 \geq (M - 2D) / (10.76)$.

the operation is stabilized. Since this point is determined by the amount of power required to trigger the transponder, the interrogator power adjustment may be calibrated to read the field strength at the location of the interrogator-responder which would result from a transmitter of a given power output located at the transponder location. The servomechanism may, therefore, be connected to a suitable recorder and calibrated to record relative field strength directly.

The reply pulse at the interrogator-responder may be "gated" and the amplitude of the range-gate control voltage calibrated to record range directly.

A servomechanism tie-in with the interrogator-responder antenna array can be used to record azimuth information directly.

By causing the recordings described above to be made simultaneously on a strip which is driven by a clock mechanism, we have all the data required for plotting field-strength contours around any location under consideration.

C. Aids to Airport-Approach Control: The radar beacon has been applied to the problem of guiding an aircraft through low overcast to the point where the pilot can make a landing by visual means.

One method of providing an azimuth track for the aircraft to follow in making an approach is substantially a specific application of the "radar range" system discussed previously. Two beacons are sited on the center line of the runway, one at the up-wind end, and the second at the down-wind end. The up-wind beacon is coded and the down-wind beacon provides a single pulse reply. This difference in coding permits the aircraft to determine the wind direction by noting the relative positions of the beacon codes. Microwaves are employed in order to permit the aircraft to extrapolate accurately the center line of the runway from the observed positions of the beacons. This system has the advantage that a highly skilled operator is required to interpret the responses from the two beacons, and that a separate aid must be used to define a glide path.

A more accurate and complete approach system may be provided by measurement of time or distance differences, as discussed in the section on precision navigation. The simplest form of this system provides a hyperbolic glide path. If the locus of points representing a constant difference in distance to two beacons is plotted in three dimensions, a hyperboloid of revolution, bisected by the ground plane, will be described. One half of such a surface is illustrated in Fig. 12. A section taken through the axis of revolution and perpendicular to the ground plane will provide a hyperbola. If the axis of revolution is made to coincide with the center line of the runway, the hyperbola of intersection will be in line with the runway. Suitable selection of the fixed delay in and spacing of the beacons will make that portion of the intersection which is down-wind from the runway essentially a straight line. This, when applied in conjunc-

tion with the method of providing an azimuth track described above, provides a straight-line glide path which is usable up to the point where the aircraft is directly over the down-wind beacon.

A combination of localizer and glide path requiring only measurement of differential distance may be provided by a slight modification of the hyperbolic system described above. In this proposed system two beacons giving different reply codes are placed symmetrically about the center line of the up-wind end of the runway and one beacon is placed on the center line of the runway at the down-wind end. Each up-wind beacon, paired with the down-wind beacon, will define a hyperboloid of revolution as described above. The intersection of the two surfaces will be a hyperbola which now defines a line of approach, both as regards azimuth and descent, determined entirely by measurements of time differences.

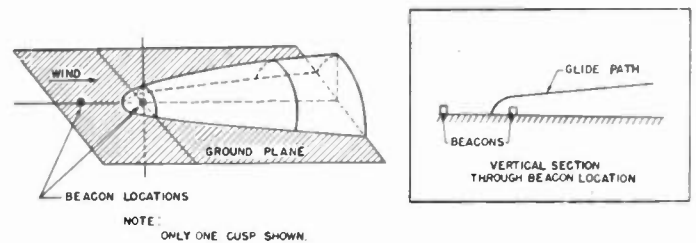

Fig. 12—Hyperbolic glide path.

A mathematical analysis of the above hyperbolic approach system shows that it is necessary to distinguish between extremely small differences in time or distance. For example, when the distance between the up-wind and down-wind beacons is 2 miles and the angle of approach is 2 to 4 degrees, differential time intervals on the order of 0.0015 microsecond must be discernible. That is, a 0.0015-microsecond change in the relative position of the reply pulses from one pair of beacons must be perceptible to the operator. As a corollary to the above it follows that the over-all delay in each beacon must be constant to well within 0.0015 microsecond—say on the order of 0.0005 microsecond.

The above requirements are not fulfilled by any beacon system now in use. There does not appear to be any fundamental reason, however, why a system complying with these requirements could not be developed, providing the advantages to be gained by its use were worthy of the required effort.

The proposed system has one basic limitation. In the instance described above, the glide path is, for all practical purposes, a straight line until a point approximately one-half mile from the down-wind beacon is reached. Here the altitude is approximately 400 feet and the glide path bends sharply toward the ground plane. It is possible, however, that a satisfactory landing could be accomplished by utilizing artificial means for maintaining a constant rate of descent from this point, until the touch-down point is reached.

Antenna Focal Devices for Parabolic Mirrors*

GROTE REBER†, SENIOR MEMBER, I.R.E.

Summary—The purpose and general nature of the receiving pattern are discussed. The results of calculations for the resistance and reactance of wide-angle cone antennas in free space are given. Several cone antennas in hemispherical enclosures have been measured and the impedance and phase-angle curves are shown. These results indicate that cylinders are more desirable than cones; therefore, two cylindrical antennas in hemispheres are tested. The results of investigation show that by making the antenna more slender and providing fine tips: (a) the radiation resistance is increased, (b) the rate of change of phase angle at resonance is increased, and (c) the resonant frequency is lowered.

INTRODUCTION

EXPERIMENTS on cosmic static^{1,2} have been conducted at Wheaton, Illinois, for several years. A large parabolic mirror is used to collect this radiant energy from the sky. The mirror transforms the

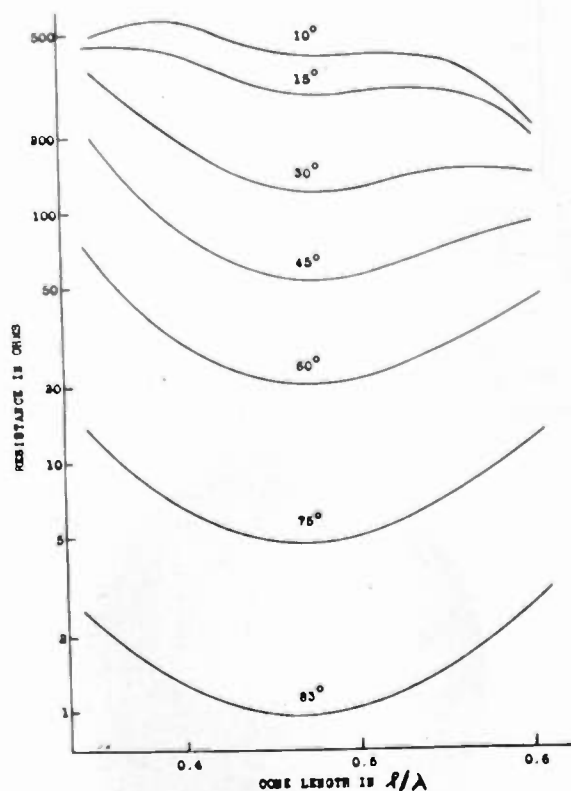

Fig. 1—Computed values of radiation resistance for cones in free space versus cone length. Cone revolution angles, 10 to 83 degrees.

plane wave front arriving from space to a spherical wave front centered on the focal point of the mirror. The antenna device at the focal point must intercept this spherical wave front freely from the solid angle sub-

* Decimal classification: R120×R221. Original manuscript received by the Institute, October 24, 1945; revised manuscript received, September 27, 1946.

† 212 Seminary Avenue, Wheaton, Illinois.

¹ Grote Reber, "Cosmic static," *PROC. I.R.E.*, vol. 30, pp. 367-378; August, 1942.

² Grote Reber, "Cosmic static," *Astrophys. Jour.*, vol. 100, pp. 279-287; November, 1944.

tended by the mirror and be shielded from all extraneous radiation arriving from other directions.

Schelkunoff³ has discussed cone antennas quite thoroughly. Such devices readily receive spherical wave fronts. Apparently all that is necessary is to keep the axis of the cones in the focal plane of the paraboloid of

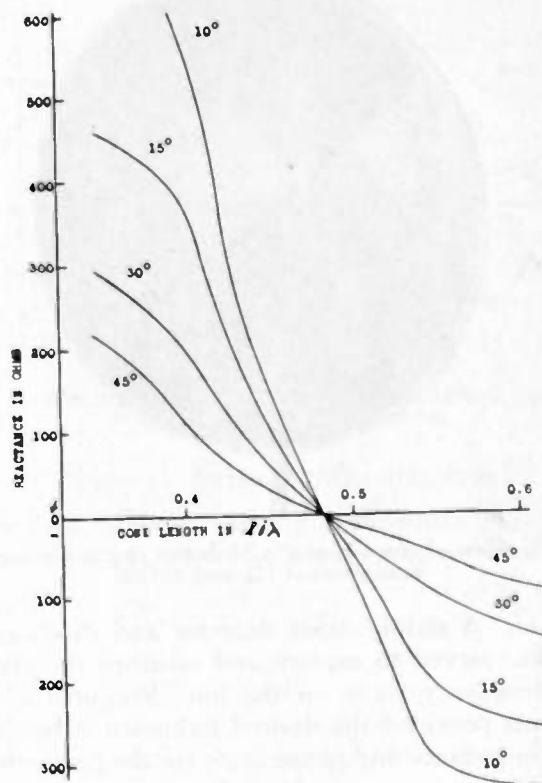

Fig. 2—Computed values of reactance for cones in free space versus cone length. Cone revolution angles, 10 to 45 degrees.

revolution, and to make the apices of the cones coincident with the focal point of the mirror.

To prevent the antennas from accepting energy from undesired directions, it appears that a hemispherical metal shield could be placed around the antennas. Such a part-spherical shell should have its center also coincide with that of the cone apices.

Schelkunoff displays curves of the resistance and reactance of various cone antennas for K values from 450 to 1200. These correspond to angles of revolution from 2.7 degrees to 18 seconds of arc. Such fine cones are not suitable mechanically in practice, and give very high values of radiation resistance which are difficult to handle electrically. Further, it can be observed from his data that the rate of change of reactance in relation to resistance decreases somewhat for the larger cone angles of revolution. This is a desirable circumstance and aids

³ S. A. Schelkunoff, "Theory of antennas," *PROC. I.R.E.*, vol. 29, pp. 493-521; September, 1941.

in the construction of antenna couplers where an appreciable frequency bandwidth is to be passed.

Accordingly, more data were calculated using his (22) and (26) for a variety of cone revolution angles from 10 to 83 degrees. The results are shown in Figs. 1 and 2.

CONE-ANTENNA MEASUREMENTS

In all cases the cones were terminated in a concentric transmission line which was coupled at the far end to an

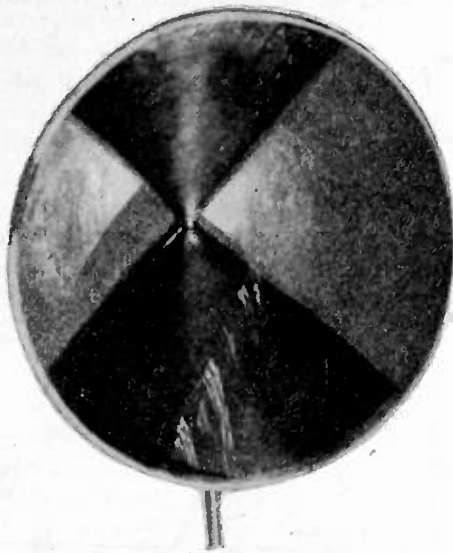

Fig. 3—View of cones having a 45-degree revolution angle in hemisphere of 12½-inch radius.

oscillator. A sliding diode detector and direct-current amplifier served to explore and measure the standing radio-frequency wave on the line. Recourse to circle diagrams provided the desired unknown values of antenna impedance and phase angle for the particular set-up and frequency.

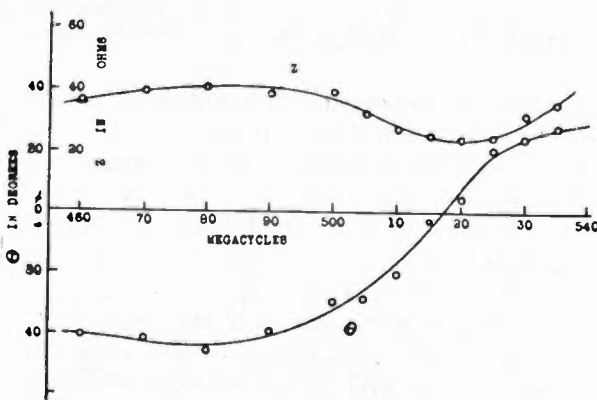

Fig. 4—Electrical characteristic of cones having a 45-degree revolution angle in hemisphere of 12½-inch radius.

The first antenna tested is shown in Fig. 3. It had a 45-degree angle of revolution and was in a hemisphere of 12½-inch radius. The results of electrical measurements appear in Fig. 4. Curiously enough, the measured radiation resistance was about half the computed value for open cones in free space; see Fig. 1.

The second antenna tested had a 15-degree angle of revolution and was in a hemisphere of 13½-inch radius. Two sets of data were taken using coaxial transmission lines respectively 1½ inches and 9/16 inch in diameter. This allowed the use of relatively blunt and sharper tips

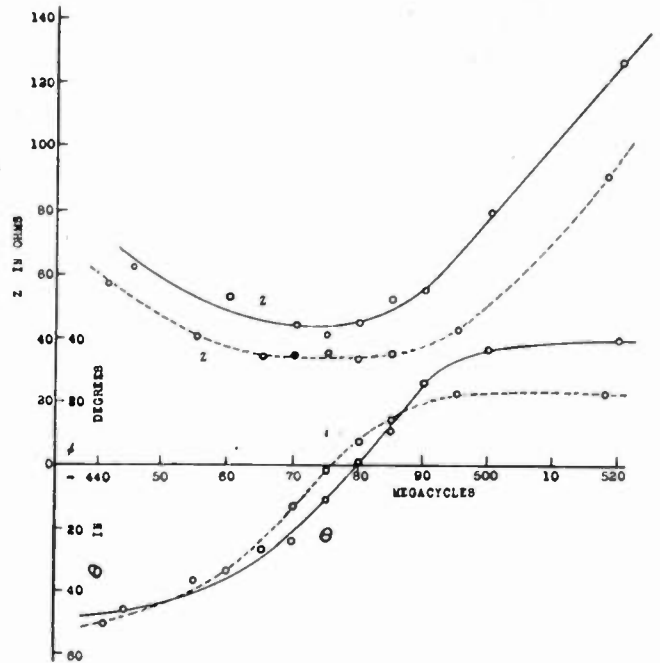

Fig. 5—Electrical characteristic of cones having a 15-degree revolution angle in hemisphere of 13½-inch radius. Solid line: fine tips; dotted line: blunt tips (see text).

at the apices of cones. The resultant electrical characteristics are shown in Fig. 5.

The third antenna tested had an angle of revolution of 5 degrees and was in a hemisphere of 13-inch radius.

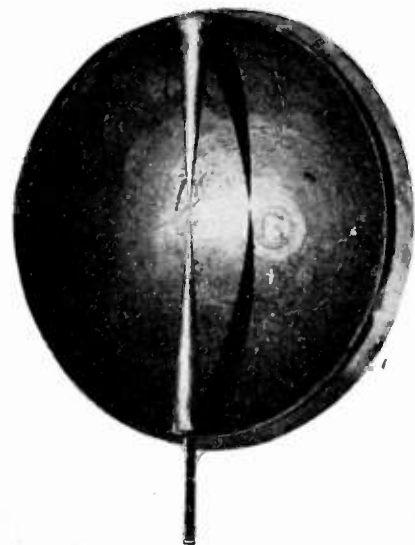

Fig. 6—View of cones having a 5-degree revolution angle in a hemisphere of 13-inch radius.

The antenna is shown in Fig. 6 and the electrical characteristics in Fig. 7.

From the above tests it was concluded that, by reducing the angle of revolution of cones and sharpening the

cone tips, (a) the radiation resistance is increased somewhat but far less than predicted from the theory of cones

thick cross section. In other words, not cones at all should be chosen, but rather cylinders.

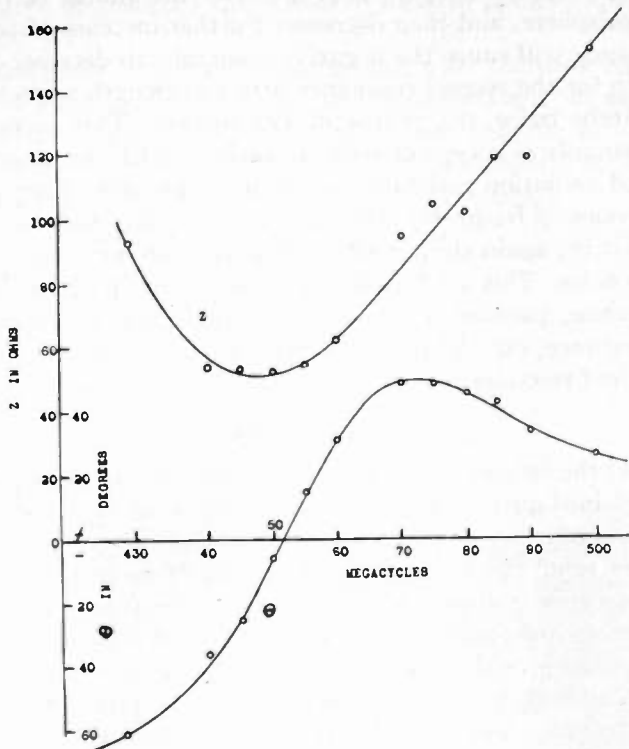

Fig. 7—Electrical characteristic of cones having a 5-degree revolution angle in a hemisphere of 13-inch radius.

in free space; and (b) the rate of change of phase angle with frequency and the extremes through which the phase angle passes both increase.

For ease of handling of the associated electrical equipment, it will be desirable to secure values of radiation

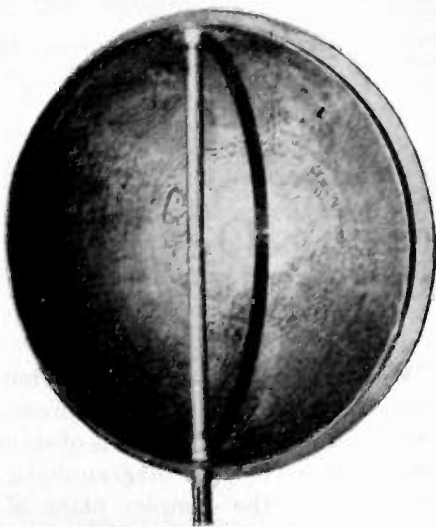

Fig. 8—View of cylinder antennas of 1 1/8-inch diameter in a hemisphere of 13-inch radius.

resistance substantially greater than was found in the above tests; also, the rate of change of phase angle with frequency should be as small as possible. This seems to point to structures with small angles of revolution and

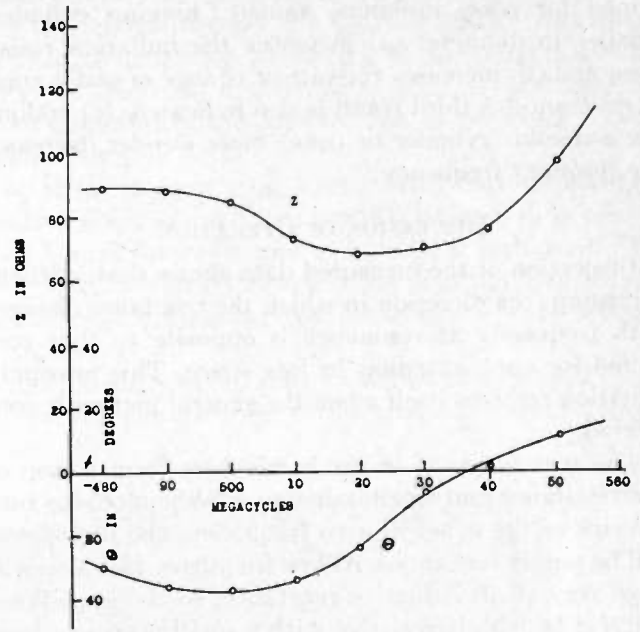

Fig. 9—Electrical characteristic of cylinders 1 1/8-inch diameter in a hemisphere of 13-inch radius.

CYLINDER-ANTENNA MEASUREMENTS

The first cylinder antenna is shown in Fig. 8. The cylinders are 1 1/8 inches in diameter and are in a hemi-

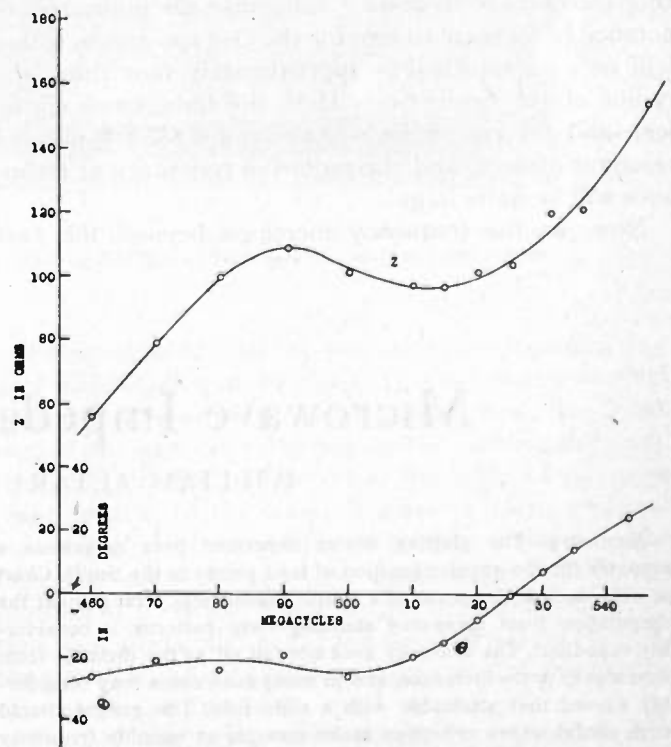

Fig. 10—Electrical characteristic of cylinders of 9/16-inch diameter in a hemisphere of 13-inch radius.

phere of 13-inch radius. The electrical characteristics appear in Fig. 9.

The second antenna was in the same hemisphere but

the cylinders were reduced to 9/16-inch diameter. The results of electrical tests are shown in Fig. 10.

These results are in agreement with the data obtained for cone antennas, namely: making cylinders smaller in diameter (a) increases the radiation resistance and (b) increases the rate of change of phase angle at resonance. A third result is also indicated: (c) making the antenna (cylinder or cone) more slender decreases the resonant frequency.

DISCUSSION OF OPERATION

Inspection of the measured data shows that, without exception, the direction in which the reactance changes with frequency at resonance is opposite to that predicted for cone antennas in free space. This unseemly situation resolves itself when the general picture is considered.

The two antennas in the hemisphere form a loop of low resistance and small inductance. When looking into the tips of the cones at zero frequency, the impedance will be purely resistance. At low frequency this loop will have very small inductive reactance, so the impedance still will be mainly resistive with a small positive reactance. As the frequency increases, the inductive reactance becomes larger and assumes the major part of the impedance. Finally it reaches a maximum and begins to decrease. This maximum inductive reactance will be at a frequency corresponding to a wavelength approximately eight times the radius of the hemisphere. Further increases of frequency will cause the inductive reactance to decrease to zero for the first resonance, which will be at a wavelength approximately four times the radius of the hemisphere. Here the inductance of the loop and the capacitance of the cones form a parallel resonant system, and the radiation resistance at resonance will be quite large.

Now, as the frequency increases beyond the first

resonance, the reactance becomes negative. This capacitive reactance will increase to a maximum at a wavelength approximately eight-thirds of the radius of the hemisphere, and then decrease. Further increase of frequency will cause the negative reactance to decrease to zero for the second resonance at a wavelength approximately twice the radius of hemisphere. This second resonance is a type of series resonance, with the associated radiation resistance small in magnitude. Further increase of frequency will cause the reactance to become positive, again similar to the situation at very low frequencies. This cycle will repeat in order: positive reactance, parallel resonance, negative reactance, series resonance, etc. All of the present work has been on the second resonance.

ANTENNA PICKUP

At the second resonance the phenomenon of pickup is explained quite well by McPherson^{4,5} as outlined above. Obviously the device will accept radiation only from its open side. The correctness of this fact was tested in a qualitative manner using the antenna for the radiation of energy instead of for the reception of electromagnetic waves. A sensitive wavemeter was used to probe around the antenna-hemisphere assembly at a distance of four to six wavelengths. The position of maximum field strength was located as very closely in line with and over center of the hemisphere opening. The field died out more rapidly in the direction along the axis of the antenna than in the direction perpendicular to the axis of the antenna. Several interference fringes could be located away from the maximum in all directions. A considerable number of these probably were caused by nearby surrounding objects.

⁴ W. L. McPherson, "Micro ray communication," *Elec. Commun.*, vol. 14, p. 340; April, 1936.

⁵ Grote Reber, "Reflector efficiency," *Electronics Ind.*, vol. 3, p. 101; July, 1944.

Microwave Impedance-Plotting Device*

WILLIAM ALTAR† AND J. W. COLTMAN†

Summary—The plotting device described here serves as a computer for the angular position of load points in the Smith Chart for microwaves. By means of a simple mechanical arrangement the computation from measured standing-wave patterns is considerably expedited. The accuracy does not fall off as the distance from generator to probe increases, and in many such cases may considerably exceed that attainable with a slide rule. The gadget should prove useful where reflection measurements at variable frequency are repeatedly required as, for instance, in Q-circle and other resonance measurements.

* Decimal classification: R078×R244.3. Original manuscript received by the Institute, April 19, 1946; revised manuscript received, August 26, 1946.

† Westinghouse Research Laboratories, East Pittsburgh, Pa.

THE WELL-KNOWN impedance chart^{1,2} is extensively used in microwave measurement and design work for plotting the results of standing-wave measurements. The chart is a diagrammatic presentation of load points in the complex plane of reflection coefficients. Commonly the chart (right half of Fig. 1) provides a set of superposed co-ordinates by means of which the measured data may be translated into impedance values. The plotting device described here was

¹ P. H. Smith, "Transmission line calculator," *Electronics*, vol. 12, pp. 29-31; January, 1939.

² P. S. Carter, "Charts for transmission-line measurements and computations," *RCA Rev.*, vol. 3, pp. 355-368; January, 1939.

developed in order to shorten the somewhat laborious routine of reducing the observed data to points on the chart.

As is well known, the readings taken are the standing-wave ratio K , the position x of the probe when the galvanometer reading is at its minimum, and the wave-meter reading. From these, the polar co-ordinates of the load point on the chart, r and θ , are obtained by

$$r = \frac{K - 1}{K + 1} \quad (1)$$

and

$$\theta = \frac{4\pi x}{\lambda_0} \quad (2)$$

quantities, particularly where the chosen reference point is well outside the range of the standing-wave detector. The chief advantage of the plotting device described here lies in the manner in which it circumvents this difficulty. In addition, a convenient scale is provided to make unnecessary the computation of the guide wavelength from (3).

In effect, a very long x scale with correspondingly good accuracy is provided; but it is broken up in pieces of half-wave intervals, and at no time is it necessary to move the indicator through more than one-half wavelength range when going from an arbitrary probe setting to another.

The x -scale readings refer to distances measured from the guide reference point to the minimum, and increase

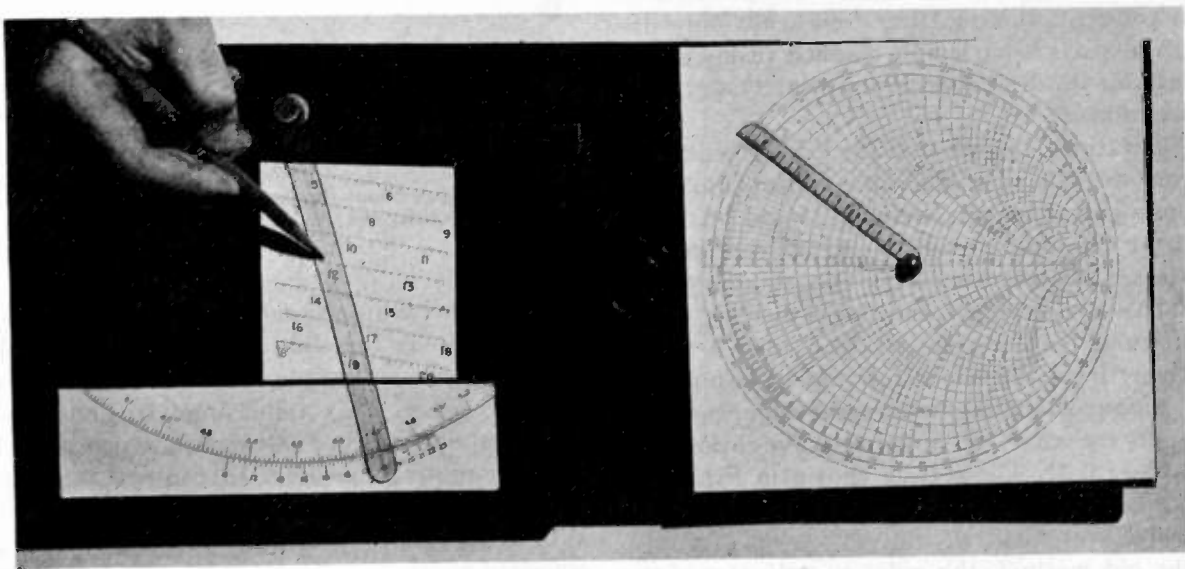

Fig. 1—Photograph of plotting device in use. Setting corresponds to illustrative example of the text ($\lambda = 4.7$ centimeters, $x = 12.0$ centimeters.) This machine was built to plot directly the conjugates of reflection coefficients or impedances.

In microwave standing-wave detectors the probe response is commonly fed to an indicator with a quadratic characteristic, such as a crystal, in which case the standing-wave ratio K is the square root of the ratio of maximum to minimum galvanometer reading.

λ_0 is the wavelength along the transmission line used, and in the case of a wave guide is determined from

$$\lambda_0 = \frac{\lambda_0}{\sqrt{1 - (\lambda_0/\lambda_{\text{cut-off}})^2}} \quad (3)$$

where λ_0 is the free-space wavelength for the frequency employed and $\lambda_{\text{cut-off}}$ is characteristic of the guide used. The determination of θ from (2) usually requires four-figure accuracy in order to get the angular position to within 3 degrees. A considerable loss in accuracy is incurred because only that part of θ in excess of a multiple of 360 degrees is relevant for the position of the load point on the chart; thus the computed angle is found as the relatively small difference between two much bigger

in the direction toward the generator corresponding to a clockwise rotation in the chart. This would at first seem to be at variance with the printed instruction, "clockwise toward the generator," given on the published charts. However, this instruction refers to a shift of reference point relative to the standing-wave pattern, while we are interested in the minimum position relative to the reference point. (Actually, the machine was built for the plotting of Q circles³ requiring the conjugates of reflection coefficients, and thus gave the reversed rotation, as the reader will verify from an inspection of the mechanism shown in Fig. 2.)

The plotting device is shown in Figs. 1 and 2. The x scale is mounted on a movable carriage a which is linked to the rotating scale h by means of the rack and pinion l and m . This scale h is calibrated in standing-wave ratios K ; that is, the ratio of maximum to minimum

³ W. Altar, "Q circles—a means of analysis of resonant microwave systems," *Proc. I.R.E.*, Part I, vol. 35, pp. 355-361; April, 1947; Part II, vol. 35, pp. 478-484; May, 1947.

electric field strength along the transmission line. To operate the device, first set the straight edge b to its wavelength setting on the scale c . Move the carriage a until the straight edge intersects with the desired probe position x . The scale h is then automatically in its correct position, and the impedance (or admittance) may be read directly from the chart or mapped on it at the K point for further use.

Thus laboratory data are fed directly to the device with but one simple calculation—the K value.

The merit of this plotting device can be estimated from the following facts: An accuracy of 0.1 millimeter at the X band in reading the probe position is necessary for an accuracy of about 3 degrees on the chart. This necessitates a computational accuracy of better than four figures. Such computations are not possible on the slide rule and must be performed on computing machines. In contrast, this plotting device not only dispenses with all except one simple division (using a slide rule) but attains the desired accuracy directly and without complications.

As an illustration, suppose that the load impedance is desired from the following laboratory data. Maximum and minimum galvanometer readings: 10 and 2.5; probe position x at minimum readings: 12.00 centimeters; wavelength λ_g : 4.700 centimeters. The standing-wave ratio is 2.0 ($K = \sqrt{\max/\min}$), and this is the only necessary calculation. Now set the straight edge b to the wavelength setting 4.700; move the carriage a until the point 12.00 intersects with the straight edge; read the impedance on the chart at standing-wave-ratio point 2.0: $Z = 0.54 - j 0.24$. The setting shown in Fig. 1 for these data gives the conjugate value of Z , in accordance with a previous statement.

Using the old method, the polar co-ordinates of the points r and θ had to be determined:

$$r = \frac{K - 1}{K + 1} = \frac{2 - 1}{2 + 1} = \frac{1}{3}$$

$$\theta = \frac{4\pi x}{\lambda_g} = 2\pi \left(\frac{2x}{\lambda_g} \right)$$

$$= (360^\circ) \left[\frac{(12.00)(2)}{4.700} \right]$$

$$= (360^\circ)(5.106).$$

Since θ is listed in fractional wavelengths instead of degrees on conventional charts, with 360 degrees on the chart corresponding to half a wavelength,

$$\theta = (0.500)(5.106).$$

However, since integral multiples of half a wavelength merely revolve the scale about the chart, only the fractional part in excess of half wavelengths is needed:

$$\theta = (0.500)(0.106)$$

$$= 0.053.$$

The point on the chart is thus determined by going out

1/3 length of the radius at the angle 0.053 (wavelengths toward generator), and the impedance may be read as before:

$$Z = 0.54 - j0.24.$$

It is apparent from the sample computation that, for an accuracy of 1.8 degrees on the chart, the value of θ must be computed within 0.025. In other words, (2) must be

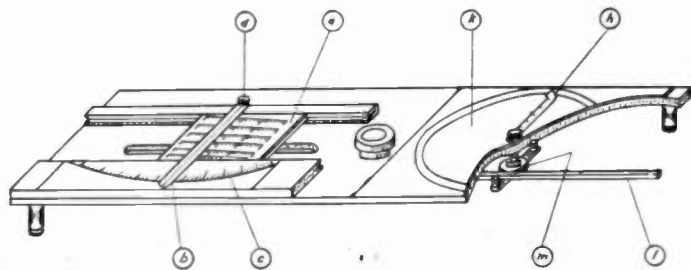

Fig. 2—Sketch of impedance plotting device. The lettered parts are: (a) carriage with probe position indications; (b) straight-edge pivoted at (d) and used to align a probe position with the proper wavelength on scale (c); the knob in the center controls the movement of the carriage (a) and the standing-wave-ratio scale (h), which rotates about the impedance chart (k), through rack and pinion wheel (l) and (m).

calculated with an accuracy of 0.1 per cent, which cannot be done on the slide rule with certainty. Furthermore, the guide wavelength λ_g has to be given with the same accuracy. This value must be determined from (3), involving another calculation which must be done on a computing machine. In contrast, scale c on the impedance-plotting device can be calibrated in terms of λ_0 or of wavemeter readings, as long as a wave guide of standard width is used; and this calculation is not necessary.

Frequently one is interested not in the impedance or admittance when measuring the reflection coefficient, but in other characteristic circuit quantities. For example, the determination of the Q of resonant cavities is made possible by plotting reflection coefficients on the chart for a number of frequencies throughout the resonance range (Fig. 3). The device is of great help for this purpose in view of the many points which must be plotted. The construction, which is not described here, requires no impedance contours; so they have been omitted in Fig. 3, which shows 9 points plotted for as many frequencies, and the so-called Q circle which is the locus of all such points. These data suffice to determine the loaded Q of the resonator for matched load, as well as for any applied load.

PRINCIPLE OF THE IMPEDANCE-PLOTTING DEVICE

The device can best be understood in terms of an auxiliary sketch. In a co-ordinate system for the variables x (probe position) and θ (angular position of the K scale) as shown in Fig. 4, let the straight line g represent the relation between the two variables for an arbitrary

guide wavelength λ_{g0} , preferably chosen in the middle of the contemplated working range. Its slope is

$$\theta/x = -4\pi/\lambda_{g0}. \tag{4}$$

Now let line g be displaced up or down without change in slope until its intersection with line f comes at the abscissa x representing the instantaneous probe position. If line f starts from the origin a of the reference frame and has a slope variable with wavelength,

$$\theta/x = 4\pi(1/\lambda_g - 1/\lambda_{g0}), \tag{5}$$

then inspection of Fig. 4 shows that line g intersects the θ axis at a point B such that the distance AB represents the angle $\theta = 4\pi x/\lambda_{g0}$, which is the exact angle to which the scale must be rotated on the chart when plotting the measured minimum position.

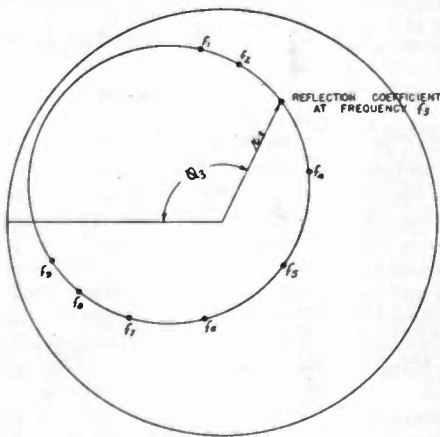

Fig. 3—The outer circle represents the rim of the impedance chart. The inner circle is the so-called Q circle and is determined by the 9 points taken at 9 frequencies. From these data, the Q of the resonator for any applied load may be determined.

A mechanism could be based literally on Fig. 4 employing obvious kinematical means, and the motion of the point B could be used to generate the correct rotation of the K scale. Such an arrangement, however, would not be convenient, owing to the unnecessarily large range of θ values on the ordinate axis of Fig. 4. Actually, these values repeat in intervals of 2π as the K scale goes through one revolution after another. For this reason a more compact arrangement is obtained by repeating line g at these intervals, as shown by the dotted lines in Fig. 4, and restricting the plot to one period of the ordinate axis. This gives the mechanism as shown in Fig. 2.

Referring to Fig. 2, a represents a carriage which slides parallel to the θ axis and on which are marked the lines $g, g',$ and $g'' \dots$ of slope $4\pi/\lambda_{g0}$ in accordance with (2) and displaced from each other by amounts $\Delta\theta = 2\pi$. These lines are evenly divided to indicate probe positions, each line g' continuing the x scale of

the preceding line g'' . Clearly, each section g'' , say, covers a probe position interval equal to one-half of the reference guide wavelength λ_{g0} . A straight edge b is pivoted to the base c at a point d representing the reference point $x=0$, so that it can be turned by amounts in accordance with (2). (If the reference point $x=0$ is not always the same with respect to the scale on which probe positions are read, one may provide an adjustment whereby the pivoted point d in Fig. 2 may be placed anywhere along a slot parallel to the x direction. This is not shown in Fig. 2.) Scale c is preferably calibrated in guide wavelengths, wavelengths, or wavemeter readings—the last two provided that the same guide width and the same wavemeter are constantly employed. The scale is preferably placed beyond the carriage, so as to give larger divisions. The motion of the

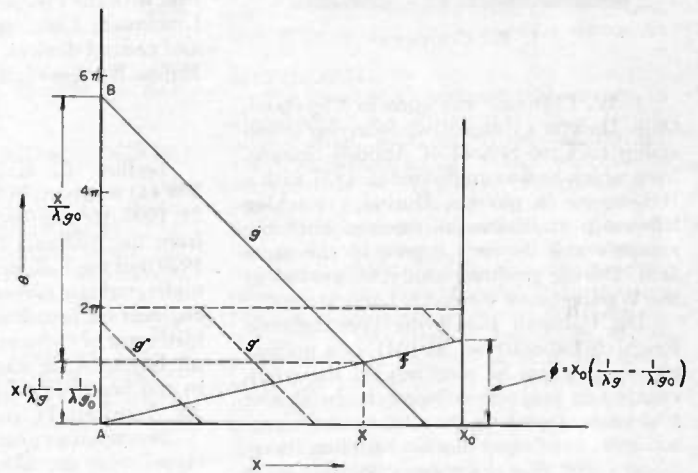

Fig. 4—This auxiliary sketch shows the relation of probe position (x), angular position of the standing-wave ratio scale (θ), and guide wavelength (λ_{g0}). The lines $g', g'' \dots$ supplement g in order to reduce the range of θ values.

carriage, is used to generate a rotation of the K scale h relative to the chart k by means of a rack and pinion wheel, l and m .

It is obvious that only the relative motion between carriage and base is relevant and that some kinematical modifications of the arrangement are possible. It is also possible to mechanize the procedure still further by building the device into the standing-wave detector in a manner such that the probe carriage of the standing-wave detector and the carriage of this device must always move through equal (or proportional) distances. Furthermore, mechanical links can be devised to couple the displacements of the straight edge attending a change of wavelength directly to one of the movable members of the wavemeter. While such an arrangement requires great care in design and execution, it will effect a further saving in time and will, in particular, relieve the observer of the most tiring operation—i.e., the precise measurement of probe positions.

Contributors to Waves and Electrons Section



J. W. COLTMAN

J. W. Coltman was born in Cleveland, Ohio. He won a competitive four-year scholarship to Case School of Applied Science, from which he was graduated in 1937 with a B.S. degree in physics. During a teaching fellowship at Illinois he received both the master's and doctor's degree in the same field. During graduate study he worked at the Westinghouse Research Laboratories.

Dr. Coltman joined the Westinghouse Research Laboratories in 1941 as a nuclear physicist, where he soon headed the group engaged in magnetron research. In almost four years of work on the tube, he and his associates contributed much to tripling its efficiency and raising its power output some fifteen times.

Dr. Coltman now heads the section dealing with X-ray research and development, a three-objective program designed to add to the basic knowledge of X rays, develop new apparatus, and perform important X-ray tasks at the Laboratories. He supervised a group of Westinghouse research men who devised the air-pressure and water-pressure instrumentation for the Bikini tests.



LUDLOW B. HALLMAN, JR.

Ralph D. Hultgren (M'46) was born on February 5, 1920, in Chicago, Illinois. He received the B.S. degree in electrical engineering from Purdue University in 1941. From 1941 to the middle of 1942 he was employed by the Procter and Gamble Company. In 1942, he entered on active duty in the Signal Corps and was sent to England for radar training by the Royal Air Force. He returned to the United States in 1943 and was assigned to the Radar Branch, Aircraft Radio Laboratory, Wright Field, where he was made officer-in-charge of microwave radar beacon development, and engaged in research, development, and co-ordination of various radar beacon activities.

Mr. Hultgren is now an electrical engineer with the Procter and Gamble Company, Cincinnati, Ohio, specializing in electronic and control devices. He is a member of Eta Kappa Nu Association.



'RALPH D. HULTGREN

Ludlow B. Hallman, Jr. (J'27-A'29-SM'44) was born in Sneads, Florida, on July 21, 1907. He received the B.S. in E.E. degree from the Alabama Polytechnic Institute in 1929 and the E.E. degree in 1934. During his undergraduate career he served part-time as engineer for broadcast station WAPI and as instructor of radio at the Alabama Polytechnic Institute. He was elected to membership in the honorary fraternities of Eta Kappa Nu, Tau Beta Pi, and Phi Kappa Phi.

Shortly after graduation he became associated with the Montgomery Broadcasting Company at Montgomery, Alabama, as chief engineer, and supervised the installation and subsequent operation of broadcast station WSFA. Mr. Hallman continued his work in the field of broadcast station engineering until 1936, when he accepted a position in the Aircraft Radio Laboratories at Wright Field, Ohio. Since 1936 he has been associated with various projects involving the development, procurement, and testing of special electronic equipment for the U. S. Army Air Forces. At present, he is chief engineer of the communications and navigation laboratory of the Electronic Subdivision, at Wright Field.

Mr. Hallman served as chairman of the Dayton I.R.E. Section during 1945. He was recently the recipient of a War Department Commendation for Meritorious Civilian Service.

Charles A. Lockwood was born in Midland, Virginia, on May 6, 1890, and attended Werntz Preparatory School at Annapolis, Maryland, before his appointment to the United States Naval Academy from Missouri, in 1908. He was graduated and commissioned an ensign in June, 1912, and received subsequent promotions until October, 1943, when he was made vice admiral. For citations awarded Admiral Lockwood, see page 49 of the January, 1947, issue of the PROCEEDINGS OF THE I.R.E.



GROTE REBER

Grote Reber (A'33-SM'44) was born on December 22, 1911. He received the B.S. degree from Armour Institute of Technology in 1933. He was a radio engineer for General Household Utilities in 1933 and 1934 and was with the Stewart-Warner Corporation from 1935 to 1937. Mr. Reber attended the University of Chicago during 1938, and in 1939 he was associated with the Research Foundation of Armour Institute of Technology. He returned to Stewart-Warner in 1941 to aid the war program. During 1946, he joined the Belmont Radio Corporation as a radio engineer.

He is an associate member of the American Rocket Society, the Chicago Astronomical Society, and the American Institute of Electrical Engineers.

For a photograph and biography of WILLIAM ALTAR, see page 379 of the April, 1947, issue of the PROCEEDINGS OF THE I.R.E.

Abstracts and References

Prepared by the National Physical Laboratory, Teddington, England, Published by Arrangement with the Department of Scientific and Industrial Research, England, and *Wireless Engineer*, London, England

NOTE: The Institute of Radio Engineers does not have available copies of the publications mentioned in these pages, nor does it have reprints of the articles abstracted. Correspondence regarding these articles and requests for their procurement should be addressed to the individual publications and not to the I.R.E.

Acoustics and Audio Frequencies.....	739
Aerials and Transmission Lines.....	739
Circuits and Circuit Elements.....	740
General Physics.....	742
Geophysical and Extraterrestrial Phenomena.....	743
Location and Aids to Navigation.....	744
Materials and Subsidiary Techniques.....	746
Mathematics.....	747
Measurements and Test Gear.....	747
Propagation of Waves.....	750
Stations and Communication Systems.....	751
Subsidiary Apparatus.....	751
Television and Phototelegraphy.....	752
Vacuum Tube and Thermionics.....	752
Miscellaneous.....	752

The number in heavy type at the upper left of each Abstract is its Universal Decimal Classification number and is not to be confused with the Decimal Classification used by the United States National Bureau of Standards. The number in heavy type at the top right is the serial number of the Abstract.

The Annual Index to these Abstracts and References, covering those published from January, 1946, through December, 1946, may be obtained for 2s. 8d., postage included, from the *Wireless Engineer*, Dorset House, Stamford St., London S. E., England.

Band Acoustic Measurements—Hull. (See 1702.)

621.395.625.3 1661
Magnetic Tape Recorder—(See 1832.)

621.396.645.029.3 1662
High-Impedance Input Circuits for A.-F. Service—Parry. (See 1715.)

AERIALS AND TRANSMISSION LINES

621.315.2.029.5:621.317.333.4 1663
New Methods for Locating Cable Faults, Particularly on High-Frequency Cables—F. F. Roberts. (*Jour. I.E.E.* (London), part I, vol. 94, pp. 61–63; January, 1947.) Summary of 1002 of May.

621.315.212 1664
Determination of the Optimum Ratio of Conductor Diameters in Coaxial Cables—K. O. Schmidt. (*Elektrotech. Zeit.*, vol. 65, pp. 170–173; May 4, 1944.) Methods in common use require too much copper. Expressions are derived which permit accurate calculation of the diameter ratio. Sets of curves show the correctness of the formulas used and enable the optimum ratio to be found for particular cables when the attenuation per kilometer is given. The saving in copper, as compared with the usual methods, may be of the order of 20 to 30 per cent.

621.315.212.2:621.317.336 1665
New Method of Measuring the Impedance Errors of Concentric Pairs—Fuchs. (See 1848.)

621.392.029.64+534.213.4 1666
Acoustic and Electromagnetic Wave Guides of Complicated Shape—P. Krasnooshkin. (*Jour. Phys.* (U.S.S.R.), vol. 10, no. 5, pp. 434–445; 1946.) Waves in hollow pipes of rectangular section and complicated shape are discussed. An equivalence theorem is established relating a pipe of complicated shape to a straight cylindrical pipe filled with a nonuniform medium. Pipes having parabolic, elliptic and toroidal forms are discussed and reference is made to tunnel effect, band-pass effect, and 'clinging phenomenon.'

621.392.029.64 1667
The Effect of the Curvature of a Wave Guide on Propagation—M. Jouguet. (*Compt. Rend. Acad. Sci.* (Paris), vol. 223, pp. 380–381; August 26, 1946.) To a first approximation the curvature of a wave guide does not affect the phase velocity. For relatively great curvatures, an expression is here derived for the change of propagation constant in the case of $H_{n,0}$ waves in a rectangular curved guide and from this the change of phase velocity, group velocity, and wavelength are at once obtained. The expression has no meaning if the frequency is equal to the cut-off frequency of the guide for

zero curvature. Formulas for the field components and cut-off frequency are given which should be used near the cut-off frequency, in place of those previously given for the general case. See also 1320 of June and back references.

621.392.029.64 1668
The Effect of a Curvature Discontinuity on Propagation in Waveguides—M. Jouget. (*Compt. Rend. Acad. Sci.* (Paris), vol. 223, pp. 474–475; September 23, 1946.) The case is considered of an $H_{p,0}$ wave propagated in a guide of rectangular cross section whose axis is curved in a plane perpendicular to the electric field. At a point where the curvature changes suddenly, parasitic waves and oscillations, all of the form $H_{n,0}$ occur in the two portions of the guide. Formulas are given for the ratio of the complex amplitudes of the perturbations in the two parts of the guide (a) for the general case of any frequency, and (b) where the frequency is very near the cut-off frequency of the wave $H_{q,0}$, ($q+p$) being odd. A loss factor, the ratio between the energy of the parasitic waves and that of the wave $H_{p,0}$, can be calculated. Owing to the abnormal excitation of the parasitic waves near the cut-off frequency, the loss factor shows a sharp rise. See also 1667 above.

621.392.029.64 1669
Rectangular Waveguide Systems—N. Elson. (*Wireless Eng.*, vol. 24, pp. 44–54; February, 1947.) The mismatch at a discontinuity in a wave guide (expressed in terms of the percentage amplitude reflection coefficient) is determined for a chopped-off corner of various angles in the E and H planes at wavelengths of 10.8 centimeters, and an optimum design is deduced. Curves for the standing-wave ratios of various bends at wavelengths of 3.2 ± 0.1 centimeters are given. An analysis of the equivalent circuit of T - and Y -junctions is given and the results presented graphically. An appendix treats theoretically the location of the plane of minimum transverse current in a curved wave guide to determine the best position for a cut.

621.392.029.64 1670
Some Applications of the Principle of Variation of Wavelength in Wave Guides by the Internal Movement of Dielectric Sections—G. E. Bacon and J. C. Duckworth. (*Jour. I.E.E.* (London), part IIIA, vol. 93, no. 1, p. 56; 1946.) Summary of 1321 of June.

621.392.029.64:538.3 1671
Quasi-Stationary Field Theory and Its Application to Diaphragms and Junctions in Transmission Lines and Wave Guides—G. G. Macfarlane. (*Jour. I.E.E.* (London), part IIIA, vol. 93, no. 1, pp. 63–64; 1946.) Summary of 1323 of June.

621.395.625:621.396.611.1:621.396.619 1660
Resonant Circuit Modulator for Broad-

- 621.392.029.64:621.318.572 1672
The Rhumbatron Wave-Guide Switch—A. Macleese and J. Ashmead. (*Jour. I.E.E.* (London), part IIIA, vol. 93, no. 1, p. 65; 1946.) Summary of 1325 of June.
- 621.392.029.64:621.396.662.3 1673
Filtering of Guided Waves—J. Ortusi. (*Bull. Soc. Franç. Élec.*, vol. 6, pp. 589-596; November, 1946.) A theoretical treatment is given of simple cavity resonators and of the effect in a wave guide of an obstacle formed by a conducting plate with a window. Two such windows in a wave guide constitute the simplest band-pass filter; a band-stop filter is obtained by means of a resonator coupled to the guide through an aperture in the wall. Band-pass filters are usually formed by a number of elementary cells with suitable coupling. Examples are given of the results obtained when four or more windows are used, with a description of the apparatus used to verify the theory.
- 621.392.029.64.091 1674
Calculation of Attenuation in Wave Guides—S. Kuhn. (*Jour. I.E.E.* (London), part IIIA, vol. 93, no. 1, pp. 61-63; 1946.) Summary of 1328 of June.
- 621.396.67.029.62 1675
A Stacked Array for 6 and 10 [Meters]—E. P. Tilton. (*QST*, vol. 31, pp. 38-41, 130; February, 1947.) Structural details and tuning procedure are given for a three-element array for 10 meters, matched by means of a T section, and for a four-element 6-meter array using a folded dipole, both being fed by 300-ohm lines.
- 621.396.671:621.396.611.33 1676
Matching Ranges [Plages d'Adaptation] of Transmitters—Glazer and Familier. (See 1958.)
- 621.396.677 1677
Slotted-Cylinder Antenna—E. C. Jordan and W. E. Miller. (*Electronics*, vol. 20, pp. 90-93; February, 1947.) A discussion of the properties with polar diagram and impedance data.
- 621.396.677 1678
Rhombic Aerials and Matching Circuits for Reception—T. S. Rangachari, B. H. Parantpye, and G. S. Deshpande. (*Electrotech.*, no. 19, pp. 19-31; December, 1946.) The practical design of these aerials to meet various common requirements and restrictions is discussed. The construction of a noninductive weatherproof terminating resistor and of a matching transformer is described, with the transformer adjustment procedure required to eliminate reflection.
- 621.396.677:621.317.7 1679
Radio-Frequency Measurements on Rhombic Antennae—Christiansen, Jenvey, and Carman. (See 1857.)
- 621.396.677.029.58 1680
The Double Triplex Beam—J. A. Biggs. (*CQ*, vol. 3, pp. 27-30; January, 1947.) Constructional details and performance of a directive array for use on long range amateur radio telephony in the 20-meter wavelength band.
- 621.396.677.029.63 1681
A Switched-Beam Directive Aerial on 600 Mc/s—R. V. Alred. (*Jour. I.E.E.* (London), part IIIA, vol. 93, no. 2, pp. 411-422; 1946.) The aerial has a cylindrical, parabolic reflector fed by a line of dipoles parallel to its axis. Particular problems in design for horizontal polarization, ease of production, and installation aboard ships are discussed. A phasing system and mechanism for rapid switching of the direction of the beam are described with an electrical method for correcting mechanical and electrical variations in production. A summary of this paper is given in part IIIA, vol. 93, no. 1, pp. 322-323; 1946.
- 621.396.677.029.64 1682
A Dielectric-Lens Aerial for Wide-Angle Beam Scanning—F. G. Friedlander. (*Jour. I.E.E.* (London), part IIIA, vol. 93, no. 1, pp. 53-54; 1946.) Summary of 1358 of June.
- 621.396.677.029.64 1683
A Detailed Experimental Study of the Factors Influencing the Polar Diagram of a Dipole in a Parabolic Mirror—E. G. Brewitt-Taylor. (*Jour. I.E.E.* (London), part IIIA, vol. 93, no. 1, p. 57; 1946.) Summary of 1357 of June.
- 621.396.677.029.64:621.392.029.64 1684
Directive Couplers in Wave Guides—M. Surdin. (*Jour. I.E.E.* (London), part IIIA, vol. 93, no. 1, p. 66; 1946.) Summary of 1359 of June.
- 621.396.677.029.64:621.392.029.64 1685
Resonant Slots—W. H. Watson. (*Jour. I.E.E.* (London), part IIIA, vol. 93, no. 1, p. 67; 1946.) Summary of 1360 of June.
- 621.396.679.4:621.315.24 1686
A Six-Wire Transmission Line Application—J. C. Wadsworth. (*Proc. I.R.E.* (Australia), vol. 7, pp. 7-11; December, 1946.) The required characteristics for feeding radio-frequency energy to a vertical aerial are obtained by a six-wire unbalanced transmission line, which has also the advantages of a concentric line.
- 621.396.96:621.396.82 1687
Radar Reflections from Long Conductors—F. Bloch, M. Hamermesh, and M. Phillips. (*Jour. Appl. Phys.*, vol. 17, no. 12, pp. 1015-1020; December, 1946.) When rolls of metalized strip are to be released by aircraft to give rise to strong backscattering, the effective cross section is of importance. The reflection pattern of a straight cylindrical conductor, of great length and small diameter compared to wavelengths, has a sharp lobe perpendicular to its length. In practice a rope-like conductor deviates from this ideal condition and the effective cross section becomes nearly independent of the instantaneous shape and orientation of the rope. Cross sections have been derived assuming the shape to be a series of (a) helical turns, and (b) straight sections whose parameters are such that the scattering adds incoherently. The two assumptions give similar results.
- The cross section of a thin, twisted ribbon conductor whose width d exceeds 0.75 wavelength is almost the same for both parallel and transverse polarization. As d is decreased below 0.75 wavelength, the cross section for transverse polarization passes through a small maximum at $d=0.5$ wavelength and then falls away rapidly.

CIRCUITS AND CIRCUIT ELEMENTS

- 621.314.2.029.3 1688
Response of Audio-Frequency Transformers at High Frequencies—E. K. Webb. (*Proc. I.R.E.* (Australia), vol. 5, pp. 3-12; January, 1944.) The response of loaded and unloaded audio-frequency transformers at high-audio frequencies is analyzed and nomograms for numerical calculations are given. Constructional characteristics and the causes and effects of losses present are examined. Measurements for an interstage transformer show the order of accuracy to be expected in practice.
- 621.314.3 1689
Hum in High-Gain Amplifiers—P. J. Baxandall. (*Wireless World*, vol. 53, pp. 57-61; February, 1947.) The hum level in an alternating-current mains-operated audio amplifier can be made negligible in comparison with the Johnson noise, for an input grid circuit having an impedance of the order of 50 kilohms. Causes of hum and practical means of eliminating it are discussed.
- 621.316.726.078.3:621.396.615.14 1690
Electronic Frequency Stabilization of

Microwave Oscillators—R. V. Pound. (*Rev. Sci. Instr.*, vol. 17, pp. 490-505; November, 1946.) Frequency control is achieved by feeding back to the oscillator a control voltage derived from an external cavity resonator coupled to the circuit by 'Magic-Tee' waveguide sections to form a frequency discriminator; the cavity has a frequency-dependent reflection coefficient going through zero at resonance. Two particular control circuits of this type are described: the first uses two 'Magic-Tee' sections and the reflected wave controls the relative outputs from two crystals, one in each section; the outputs are applied to the oscillator via a suitable low-pass amplifier. The second circuit uses a single 'Magic-Tee' in which the reflected wave from the cavity goes to a crystal having an applied intermediate-frequency voltage. This crystal reflects amplitude-modulated sidebands with intermediate-frequency spacing on either side of the signal frequency. These mix with the signal frequency in a second crystal, using the intermediate-frequency oscillator as reference, and give a voltage which is amplified and applied to the microwave oscillator.

- 621.317.727 1691
Potentiometers—L. A. Nettleton and F. E. Dole. (*Rev. Sci. Instr.*, vol. 17, pp. 356-363; October, 1946.) Discusses methods used to improve performance, including the use of 'Paliney' (an alloy of Pt, Pd, Au, Ag, Cu, and Zn) wire for the contactor.
- 621.318.323.2.042.15 1692
Permeability of Dust Cores—G. W. O. H. (*Wireless Eng.*, vol. 24, pp. 33-34; February, 1947.) The high effective permeability of dense dust cores can be attributed to the alignment of nonspherical particles in the direction of the magnetic field, though the cause of this alignment is obscure.
- 621.318.323.2.042.15 1693
Permeability of Dust Cores—P. R. Bardell. (*Wireless Eng.*, vol. 24, p. 63; February, 1947.) Measured permeabilities can be explained by assuming that the particles are uniformly coated rectangular slabs (dimension ratio 10 to 2 to 1) of permeability 1000 and oriented with the long axis parallel to the magnetic field.
- 621.318.371.011.2/4 1694
H.F. Resistance and Self-Capacitance of Single-Layer Solenoids—R. G. Medhurst. (*Wireless Eng.*, vol. 24, pp. 35-43 and 80-92; February and March, 1947.) Results of measurements on 40 coils wound with copper wire on grooved distrene formers. The resistances agree well with the values given by Butterworth's theory for widely spaced turns but are considerably lower for closely spaced turns. The magnification of a coil of mean radius R at frequency f can be represented by $Q=0.15 R\psi\sqrt{f}$, where ψ is a tabulated function of the length to diameter and spacing ratios. The self-capacitance is given by $C=HD$ micromicrofarads where D is the mean coil diameter and H is a tabulated function of the length to diameter ratio.
- 621.318.4.042.15 1695
Dust Ring-Core Coils and Their Possible Applications—E. Ganz. (*Brown Boveri Mitt.*, vol. 33, pp. 219-221; August, 1946.) Describes some of the stock sizes of Brown Boveri dust rings and pots and discusses their use for frequencies up to 2 or 3 megacycles.
- 621.392.52+537.228.1 1696
Progress in the Construction of Crystal Filters—B. Bieffer, H. Keller, and B. Matthias. (*Brown Boveri Mitt.*, vol. 33, pp. 214-218; August, 1946.) The temperature coefficient of crystals of potassium and ammonium phosphate limits their application, but mixed crystals obtained by replacing ammonium by rubidium or thallium have a much lower tem-

perature coefficient at room temperature. Methods of using length, thickness, and bending vibrations for various frequency ranges are described and the properties of bridge-type filters illustrated. The simultaneous use in such filters of potassium and ammonium phosphate crystals gives very wide pass bands with sharp cut-off.

621.392.52 1697

Insertion Characteristics of Filters—J. B. Rudd. (*A.W.A. Tech. Rev.*, vol. 7, pp. 145-176; December, 1946.) Expressions are obtained for the insertion loss L and phase shift B of multi-sectioned low-, high- and band-pass filters of 'constant- k ' form, terminated in the design resistance. The 'unit-current' method is used, and it is shown that with proper choice of the frequency variable, K , the expressions for L and B are functions of K identical for all three types of filter. The values of L and B at cut-off frequencies are given and the general behavior of these quantities with respect to K is tabulated. Values of L are plotted as a function of K for filters containing up to five sections and compared with an experimental curve for a five-section low-pass filter. Phase-shift curves for one-, two- and four-section filters are also shown. Two methods of examining the effects of dissipation in the filter are considered. The preferred method assumes that all inductor and capacitor elements have equal dissipation factors, and gives the dissipation at any frequency at which the slope of the phase-shift characteristic is known.

621.392.52.094 1698

Distortion of Frequency-Modulated Signals by Band-Pass Filters—P. Güttinger. (*Brown Boveri Mitt.*, vol. 33, pp. 185-187; August, 1946.) Quasi-stationary methods are applied to the calculation of the distortion due to passage through two-stage band-pass filters. A practical formula is given for the noise factor.

621.394.652:621.394.141 1699

The Electroplex—a New Automatic Key—J. T. Dixon. (*Radio News*, vol. 37, pp. 38-39, 151; January, 1947.) A system comprising a timing circuit, control circuit, audio-frequency monitoring oscillator, and power supply enabling dots and dashes of a given length to be formed automatically for radiotelegraphy.

621.396.611.1+534.112 1700

Self-Maintenance of Several Oscillations on the Same Wire—Jouty and Rocard. (*See* 1728.)

621.396.611.1 1701

Duality of the Mechanisms of Self-Oscillation—Y. Rocard. (*Compt. Rend. Acad. Sci. (Paris)*, vol. 214, pp. 601-603; March 23, 1942.) The introduction of a negative resistance into an oscillatory circuit is not the only means of producing self-oscillation. An alternative process is termed "confusion of the two natural frequencies." An example is that of two resonating circuits coupled by mutual induction. The voltage at the terminals of the second circuit capacitor feeds an amplifier which, through a very small resistance, supplies in the first circuit an electromotive force in proportion but in opposition. Self-oscillation is obtained in this case by adjustment of the amplifier gain.

621.396.611.1:621.396.619:621.395.625 1702

Resonant Circuit Modulator for Broad Band Acoustic Measurements—G. F. Hull, Jr. (*Jour. Appl. Phys.*, vol. 17, pp. 1066-1075; December, 1946.) The theory is outlined and an experimental recorder described having a uniform response between 0.5 and 1000 cycles. Apart from a 5-decibel resonance peak at 7500 cycles, the response between 0.025 and 10,000 cycles is constant to within ± 3 decibels of the uniform section.

621.396.611.1.013.62 1703

On Self-Excitation of Electric Systems with Distributed Parameters—S. Gvosdover. (*Jour. Phys. (U.S.S.R.)*, vol. 10, no. 5, pp. 481-488; 1946.) Formulas are derived for determining the conditions for self-excitation and the amplitude and frequency of the steady-state oscillations in terms of the constants of the system.

621.396.611.21:621.396.615.029.5 1704

Crystal-V.F.O. Mixing—W. A. Sparks. (*Short Wave Mag.*, vol. 4, pp. 554-555; November, 1946.) Details of a circuit for mixing the output of a 6040-kilocycle crystal oscillator with that of a variable-frequency oscillator covering the range 1000 to 1500 kilocycles to obtain a variable frequency in the range 7040 to 7540 kilocycles.

621.396.611.21:621.396.62 1705

Receiver with Automatic Tuning and Quartz Control—Martin. (*See* 1912.)

621.396.611.4 1706

Resonant Frequencies of the Nosed-In Cavity—E. Mayer. (*Jour. Appl. Phys.*, vol. 17, pp. 1046-1055; December, 1946.) The resonant frequency of a cylindrical cavity with a smaller coaxial re-entrant cavity at one end is studied theoretically using the Ritz variational method. Results on an experimental model differed from theoretical values by about 2.5 per cent, because a slight departure from the theoretical shape was necessary for tuning purposes. Results for several sets of parameters are shown graphically.

621.396.611.4:535.214 1707

Perturbations and Radiation Pressure in Electromagnetic Cavities—T. Kahan. (*Compt. Rend. Acad. Sci. (Paris)*, vol. 223, pp. 785-786; November 13, 1946.) From the formulas previously given (2521 of 1946) the perturbed natural frequency of a circular cylindrical cavity is calculated. The general expression is used to find the effect of inserting axially a small metal piston and also the radiation pressure exerted on a small metal diaphragm placed coaxially at the center of the cavity.

621.396.611.4:621.384.6 1708

The Study of a Certain Type of Resonant Cavity and Its Application to a Charged Particle Accelerator—E. S. Akeley. (*Jour. Appl. Phys.*, vol. 17, pp. 1056-1060; December, 1946.) A linear accelerator consisting of a number of cavity resonators placed end to end, with the inside end plates removed, is discussed. To determine possible shapes for each cavity, the stationary TM_{01} modes between two parallel plates are found. When only one mode is excited, the radius of the cavity becomes infinite at the plates when the phase velocity is less than that of light. By exciting simultaneously two modes having suitable relative amplitudes, the radius can be made finite everywhere.

621.396.615.029.5 1709

H.F. Beat-Frequency Oscillator—R. Lemas. (*Radio en France*, no. 1, pp. 4-8; 1947.) An oscillator on a fixed frequency F_1 , which may be modulated either in amplitude or frequency, is coupled to the grid g_1 of a mixer and a second cathode-wave oscillator, of variable frequency F_2 , is coupled to the grid g_2 of the mixer. The difference frequency $F_2 - F_1$ is selected and its voltage measured by a tube voltmeter. The amplitude of the output is directly proportional to the amplitude applied to g_1 , which is controlled by an attenuator. Details of a five-range instrument are given.

621.396.615.17:621.317.39:531.76 1710

Some Precision Circuit Techniques Used in Wave-Form Generation and Time Measurement—B. Chance. (*Rev. Sci. Instr.*, vol. 17, pp. 396-415; October, 1946.) An outline of the

characteristics and uses of nonlinear circuit elements in systems developed for distance measurement, computation, and timing in radar circuits. The generation of sinusoidal and other waveforms is described, with diagrams of the circuits employed, and the development of electronic switch circuits for modulation and demodulation of rapidly varying waveforms is discussed.

621.396.615.17:621.317.755 1711

A Linear Time Base of Wide Range—D. F. Gibbs and W. A. H. Rushton. (*Jour. Sci. Instr.*, vol. 23, pp. 270-271; November, 1946.) Circuit details for an oscillograph time-base having sweep times from 0.6 millisecond to 60 seconds and delivering a sweep voltage of 350 volts. The time base can also be set for single sweeps.

621.396.619.13 1712

Frequency Modulator—Bruck. (*See* 1960.)

621.396.645 1713

A Stabilized 813 Amplifier—R. M. Smith. (*QST*, vol. 31, pp. 23-27, 128; February, 1947.) Uses an 813 beam tetrode with neutralization. Readjustment of the neutralizing capacitor is not necessary when changing frequency bands.

621.396.645:535.215 1714

Amplification of Very Feeble Photoelectric Currents—A. Blanc-Lapierre. (*Compt. Rend. Acad. Sci. (Paris)*, vol. 214, pp. 660-662; March 30, 1942.) A brief discussion of various methods.

621.396.645.029.3 1715

High-Impedance Input Circuits for A-F Service—C. A. Parry. (*Proc. I.R.E. (Australia)*, vol. 4, pp. 73-75; December, 1940.) The effects of an unbypassed cathode resistor on the input impedance of a resistance-capacitance amplifier are analyzed and formulas derived. Noise voltages developed in the resistor and methods of neutralizing hum pickup are discussed.

621.396.645.36 1716

150 Watts Push-Pull—L. H. Thomas. (*Short Wave Mag.*, vol. 4, pp. 598-602; December, 1946.) Construction and operational details of a power amplifier of simple design, using pentode tubes, for the 14- and 28-megacycle amateur bands.

621.396.645.37.012.3 1717

Three Feedback Amplifier Charts—J. S. Wells. (*Proc. I.R.E. (Australia)*, vol. 7, pp. 4-7; November, 1946.) These give the gain, phase shift, and improvement in gain stability with feedback, as functions of A for various values of θ , A being the magnitude and θ the phase angle of the gain from the input to the feedback terminals.

621.396.662.21.076.2 1718

Coaxial Coils for F.M. Permeability Tuners—W. J. Polydoroff. (*Radio*, vol. 31, pp. 9-10, 32; January, 1947.) Requirements of coil design and windings for adaptation of permeability tuning to the new frequency-modulation band.

621.396.662.3:621.392.029.64 1719

Filtering of Guided Waves—Ortusl. (*See* 1673.)

621.396.662.34 1720

On the Extension of Band-Pass Effect at High Frequencies—Miss Rajeswari and S. P. Chakravarti. (*Electrotech.*, no. 19, pp. 52-63; December, 1946.) For high-frequency wave filters terminated in thermionic negative impedances. See also 1721 below.

621.396.662.34:621.396.611.21 1721

On Calculations Relating to Band-Pass Effect in Crystal Resonator Associated with Thermionic Negative Impedance Element—

S. P. Chakravarti and Miss Rajeswari. (*Electrotech.*, no. 19, pp. 32-40; December, 1946.) The series and parallel connections of crystal and thermionic element in both the tuned and the detuned conditions are considered theoretically. Previous experimental results are confirmed (1032 and 3267 of 1941 and back references, and 1720 above).

621.396.665+518.4 1722
A.V.C. Calculations: Graphical Methods of Estimating the Performance of Circuits—S. W. Amos. (*Wireless World*, vol. 53, pp. 46-50; February, 1947.)

621.396.69+621.396.621 1723
New Methods of Radio Production—Sargrove. (*See* 1913.)

621.396.69 1724
Midget Electronic Equipment—F. R. (*Electronics*, vol. 20, pp. 84-89; February, 1947.) Design data, available types of components, and possible applications are given for equipment small enough to be carried in a suit pocket.

621.392.52+[548.0:538.3 1725
Wave Propagation in Periodic Structures: Electric Filters and Crystal Lattices [Book Review]—Brillouin. (*See* 1907.)

621.396.611.4.029.62 1726
Der Frequenzstabile Schwingtopf-Generator [Thesis]—A. Braun. Verlag A. G. Gebr. Leemann, Zürich, 79 pp., 7.50 Swiss francs. (*Wireless Eng.*, vol. 24, p. 64; February, 1947.) "It deals with the use of a cavity resonator as the oscillatory circuit of a tube oscillator at frequencies of about 200 megacycles, with special reference to the constancy of frequency and to the optimum design of the cavity resonator."

GENERAL PHYSICS

531.18:531.15 1727
Is Rotation Relative or Absolute?—P. M. C. Lacey (*Wireless Eng.*, vol. 24, p. 63; February, 1947.) Further correspondence on 3564 of January (G.W.O.H.). See also 390 of March.

534.112+621.396.611.1 1728
Self-Maintenance of Several Oscillations on the Same Wire—R. Jouty and Y. Rocard. (*Rev. Sci.* (Paris), vol. 84, pp. 283-285; September 15, 1946.) A steel wire can be made to oscillate at several widely different frequencies simultaneously by means of an electromagnet whose coil is connected to an amplifier, the output from which passes through the wire. Frequency ratios of about 1 to 10 can be obtained, the higher frequency not being an exact harmonic of the lower. This result differs from van der Pol's for two coupled tuned circuits made self-oscillating by a triode, in which case gradual transfer from one natural frequency to the other was possible, but not simultaneous excitation of both.

534.756+621.39 1729
Theory of Communication—D. Gabor. (*Jour. I.E.E.* (London), part 1, vol. 94, p. 58; January, 1947.) Summary of 1057 of May.

535.23.08+621.317.794 1730
The Production of Film Type Bolometers with Rapid Response—C. B. Aiken, W. H. Carter, Jr., and F. S. Phillips. (*Rev. Sci. Instr.*, vol. 17, pp. 377-385; October, 1946.) The construction is described of small, rapid-response bolometers consisting basically of a thin gold strip and blackening material deposited successively by evaporation on a cellulose nitrate film. Methods of testing during construction for noise and sensitivity are explained and it is shown that results are improved by the use of metal back plates and a gas pressure of 20 millimeters of nitrogen.

535.338 1731
The Molecular Beam Magnetic Resonance Method. The Radiofrequency Spectra of Atoms and Molecules—J. B. M. Kellogg and S. Millman. (*Rev. Mod. Phys.*, vol. 18, pp. 323-352; July, 1946.)

535.343.4:538.56.029.64 1732
Rotational Spectra of Some Linear Molecules near 1-cm Wave-Length—C. H. Townes, A. N. Holden, and F. R. Merritt. (*Phys. Rev.*, vol. 71, p. 64; January 1, 1947.) A technique is used similar to that noted in 1399 of June for ammonia. Measured frequencies and intensities of lines are tabulated for BrCN, ClCN, and OCS, and moments of inertia and nuclear bond distances are computed. The structure of these molecules is discussed in the light of the results obtained.

537+538].081 1733
Dimensions and Units of Electromagnetic Quantities—G. J. Baker. (*Geophys.*, vol. 11, pp. 373-384; July, 1946.) A historical discussion, with a conversion table for various systems. The adoption of the meter-kilocycle-second system of electromagnetic units by physicists and engineers is urged.

537.122 1734
The Characteristics of the Electron—H. Ebrall. (*Proc. I.R.E.* (Australia), vol. 5, pp. 3-11; April, 1944.) A historical survey including brief reviews of quantum theory, work function, photoelectric and thermionic emission, shot effect, and filament materials.

537.122:530.12 1735
The Motional Mass of the Electron—C. A. Boddie. (*Elec. Eng.*, vol. 66, pp. 45-60; January, 1947.) The interaction of a moving electron and a deflecting electric field is reconsidered *ab initio*. An electric field is shown to have lateral inertia and elasticity as well as the well-known longitudinal tension and lateral pressure; a velocity of propagation identical with the velocity of light is deduced. The observed change in the ratio of electron charge to mass, previously attributed to change in mass, is shown to be due to a motional effect of the electron in the deflecting electric field; electron mass is independent of velocity. The kinetic energy acquired by an electron accelerated in an electric field is very much less than the product of charge and potential, owing to the reduction in pull on an accelerated electron with increase in velocity. No practical advantage is to be gained by using potentials over 2 millivolts for electron acceleration.

537.133:[546.217+546.621 1736
Theoretical Range-Energy Values for Protons in Air and Aluminum—J. H. Smith. (*Phys. Rev.*, vol. 71, pp. 32-33; January 1, 1947.) Range-energy values are tabulated for energies up to 10⁶ electron volts. For the theoretical derivation of the formula used see for example 1303 of 1943 (Rossi and Greisen): restrictions on its validity and computational procedure are discussed.

537.311.31+537.311.33 1737
Thermomagnetic Nernst Effect in Semiconductors and Metals—Pisarenko. (*See* 1815.)

537.311.33 1738
Mechanism of Luminescence of Alkali-Halogen Phosphors—Antonov-Romanovskij. (*See* 1817.)

537.311.37:537.525 1739
Conductivity of Gases Excited by H.F. Discharges—P. Mesnage. (*Compt. Rend. Acad. Sci.* (Paris), vol. 214, pp. 702-704; April 8, 1942.) Measurements at about 25 megacycles give conductivities of 0.03 to 0.3 mho per centimeter for hydrogen, 0.2 to 0.4 mho per centimeter or more for neon, and still higher values for a mixture of argon and cadmium vapour,

the pressures being a few tenths of 1 millimeter Hg. The volt-ampere characteristics are of the descending type, as with arcs.

537.523.4 1740
Influence of Electric Fields on the Extinction of Electric Sparks—O. Yadoff. (*Compt. Rend. Acad. Sci.* (Paris), vol. 223, pp. 74-75; July 8, 1946.) Application of a radial electric field between a cylinder and the axial path of sparks maintained between two platinum-iridium points has the effect of progressively reducing the brightness of the sparks as the field intensity is increased, until finally the sparks are completely extinguished. For sparks 10 centimeters long maintained by 51 kilovolts the critical extinction voltage for the cylinder was 264 kilovolts. Reduction of the air pressure increased the extinction voltage. Application is envisaged to high-voltage circuit breakers.

537.533:537.311.31 1741
Cold Emission from Plane Metallic Surfaces—F. Berstein. (*Compt. Rend. Acad. Sci.* (Paris), vol. 223, pp. 475-478; September 23, 1946.) Comparison of the cold emission current I from a nearly plane surface S with I_0 , that from the geometrically plane surface obtained by projecting S on to its mean plane, shows that there may be a considerable discrepancy, so that determination of the characteristic constant A , in Fowler and Nordheim's formula, from the curve relating I and the applied voltage, gives results which are too high. This does not apply to the constant B , which is found from the slope of the curve, which is practically the same for I and I_0 . The case of microscopically rough surfaces is also discussed.

537.535.75 1742
Absorption of Secondary Electrons by Thin Screens—A. Saulnier. (*Compt. Rend. Acad. Sci.* (Paris), vol. 222, pp. 876-878; April 8, 1946.) Secondary X rays from a sheet of lead 0.2 millimeter thick are used with a graded series of foils of aluminium and cellophane to obtain photometrically a set of curves connecting foil thickness, photographic density, and primary X-ray voltage.

538.12 1743
Note on Magnetic Energy—G. H. Livens. (*Phys. Rev.*, vol. 71, pp. 58-63; January 1, 1947.) Reply to a recent article by E. A. Guggenheim (1227 of 1946) referring to the author's earlier work (2825 of 1945) and continuing the discussion of the correct formulation of the Lagrangian and Hamiltonian functions for a system of linear currents and permanent magnetization.

538.23 1744
Calculation of the Coercive Field from the Theories of Becker and of Kersten—L. Néel. (*Compt. Rend. Acad. Sci.* (Paris), vol. 223, pp. 141-142; July 17, 1946.)

538.323 1745
The Force Exerted by a Rectilinear Current on a Parallel Current—É. Brylinski. (*Compt. Rend. Acad. Sci.* (Paris), vol. 223, pp. 453-455; September 16, 1946.) A supplement to 1747 below. The force between two parallel conductors carrying current is calculated rigorously, including the effects of the finite cross section of the conductors and their internal permeability. The formulas provide a solid foundation for an absolute definition of the ampere in the meter-kilocycle-second system.

538.23 1746
Mathematical Representation of Hysteresis Cycles—P. Bricout. (*Rev. Gén. Elec.*, vol. 54 pp. 183-191; June, 1945.) A mathematical relation between the magnetizing field and the induction is derived by means of an 'indicator curve' whose abscissas are inductions and whose ordinates are the logarithms of the slopes of the tangents to the cyclic curve. From the

shape of the 'indicator curve' a representative function can be derived easily, which contains in general a hyperbolic term, an exponential term, and an added constant. The errors due to the use of this function are within those of experimental measurement.

538.31 1747

The Force Exerted by a Magnetic Field on an Element of Current—É. Brylinski. (*Compt. Rend. Acad. Sci. (Paris)*, vol. 223, pp. 378-380; August 26, 1946.) A demonstration, by a new argument, that the permeability which figures in the classical formula for the force exerted by a magnetic induction field on a current element is that of the medium and not that of the conductor. See also 1745 above.

548.0:547.476.3-162 1748

Structure and Thermal Properties Associated with Some Hydrogen Bonds in Crystals: Part 7—Behaviour of KH_2PO_4 and KH_2AsO_4 on Cooling—A. R. Ubbelohde and I. Woodward. (*Proc. Roy. Soc. A*, vol. 188, pp. 358-371; February 11, 1947.) Part 6 was noted in 3256 of 1946.

537.53:535.42 1749

The Diffraction of X-Rays and Electrons by Free Molecules [Book Review]—M. H. Pirenne. Cambridge University Press, 1946, 160 pp., 12s. 6d. (*Nature (London)*, vol. 159, pp. 45-46; January 11, 1947.)

GEOPHYSICAL AND EXTRA-TERRESTRIAL PHENOMENA

523.16 1750

Induction of Fast Charged Particles Currents by Rotating Magnetized Cosmic Bodies—J. Terletsky. (*Jour. Phys. (U.S.S.R.)*, vol. 10, no. 4, pp. 377-382; 1946.) Computation of the motion of charged particles in the electromagnetic field of a rotating magnetized cosmic body whose magnetic and geographic poles do not coincide. The energy up to which the particles can be accelerated in such a field is calculated.

523.165+550.37+550.38+551.510.535]:061.6 1751

Summary of the Year's Work, to June 30, 1946, Department of Terrestrial Magnetism, Carnegie Institution of Washington—J. A. Fleming. (*Terr. Mag. Atmo. Elec.*, vol. 51, pp. 517-529; December, 1946.) An account of investigations completed or in progress, with S. Chapman's comments on the program. Items are described under the following headings: geomagnetic investigations, cosmic relations, terrestrial electricity, ionosphere, nuclear physics, and observatory and field work. A review of war applications is given and the more important achievements of the various service departments are listed.

523.5:621.396.82 1752

Radar Detection of Meteor Trails—E. V. Appleton and R. Naismith. (*Nature (London)*, vol. 158, pp. 936-938; December 28, 1946.) The diurnal and seasonal variation of transient radio echoes from the upper atmosphere have been observed since 1932, and have been ascribed to the incidence of sporadic meteors. Normally, a few tens of these echoes are observed in the evening, rising to a hundred or more in the early morning. On the night of October 9 to 10, 1946, their number rose sharply to about 1500 for a short period at the time of the Giacobinid meteor shower. Though visual observation was impossible on this occasion, the shape of the curve giving rate of echo occurrence agrees remarkably well with that obtained visually by F. G. Watson during the last Giacobinid shower in 1933. It is concluded that the meteoric origin of these transient radio echoes is established.

523.5:621.396.82 1753
Meeting of the Royal Astronomical Society:

Observations of the Giacobinids, 1946—(*Observatory*, vol. 67, pp. 1-8; February, 1947.) The minutes of a meeting of the Society held on December 13, 1946, which included the description and discussion of visual observations of the 1946 Giacobinid shower by J. P. M. Prentice and radio observations by A. C. B. Lovell and J. S. Hey. The ionization density and velocity of the meteor trails were deduced by radar methods. The values obtained—particle radii 0.01 to 0.03 centimeter and average velocity 22.9 kilometers—are in good agreement with other evidence.

523.7+550.385] "1946" 1754

Magnetic Storms and Solar Activity 1946—H. W. Newton. (*Observatory*, vol. 67, pp. 37-39; February, 1947.) Outstanding solar phenomena in 1946 were the largest and second largest sunspots ever recorded at Greenwich (in February and July) with associated brilliant flares and the highest prominence ever observed. The correlation of this activity with radio fade-out and magnetic storms is demonstrated.

523.7+550.385] "1946.07/.09" 1755

Solar and Magnetic Data, July to September, 1946, Mount Wilson Observatory—S. B. Nicholson and E. S. Mulders. (*Terr. Mag. Atmo. Elec.*, vol. 51, pp. 561-562; December, 1946.)

523.7 1756

On the Distribution of the Solar General Magnetic Field and Remarks Concerning the Geomagnetism and the Solar Rotation—C. Walén. (*Ark. Mat. Estr. Fys.*, vol. 33, part 3, section A, 63 pp; February 6, 1947. In English.) A general mathematical paper. The convective motions in the core are studied in section 2 without any regard to magnetism. Although certain 'convective convulsions' are shown to exist, only a qualitative demonstration of convection within the core is given. The magnetic field in the core is studied in section 3. Calculations are difficult but the conclusion that the general field in the core is reproduced by the convection is, at any rate, certain. The rotation of the sun is discussed in section 4 together with the elastic torsional vibrations resulting from the recurrent 'convulsions.' The conditions at the solar surface (nonuniform rotation, sunspots and the corona) are tentatively discussed. Concluding sections of the paper deal with the general magnetic field in the radiative envelope and with the electric drift current in the granulated layer.

523.72+537.591]:621.396.822.029.5 1757

Radio-Frequency Investigations of Astronomical Interest—G. Reber and J. L. Greenstein. (*Observatory*, vol. 67, pp. 15-26; February, 1947.) Critical survey of the experimental and theoretical work on cosmic and solar radiations at radio frequency. The dependence of cosmic noise intensity on frequency and on galactic co-ordinates and the mechanism of its production are discussed, but on present evidence it cannot be decided whether interstellar particles or the stars themselves are the radiant sources. The abnormally intense solar radiation at wavelength > 1 meter originates in the corona and the frequency dependence is determined by the variation of absorption and temperature with height. The marked increase (1000 times) of intensity during periods of sunspot activity may be related to gyromagnetic effects caused by the field of the sunspot.

523.72:621.396.822 1758

On Radio-Frequency Emission from the Sun—J. V. Garwick. (*Compt. Rend. Acad. Sci. (Paris)*, vol. 224, pp. 551-553; February 24, 1947.) Discussion based on the gyromagnetic theory of solar radio-frequency emission shows that for the observed radiation the Doppler effect is of little importance. The radiation intensity was previously found to be proportional to $H^{\frac{1}{2}}$. A revised value of the index is 0.9.

523.72:621.396.822.029.62 1759

Study of the Conditions of Emission of Metre Radio Waves by the Solar Atmosphere—J. Denisse. (*Rev. Sci. (Paris)*, vol. 84, pp. 259-262; September 15, 1946.) The possible emission of short waves by electrons moving in the magnetic field of a sunspot is considered. As the waves are absorbed by the very medium which produces them, it is suggested that a layer of thickness z_0 is solely responsible for the emission. In the lower corona z_0 is of the order of several kilometers for a magnetic field of 1000 gauss, corresponding to a wavelength of 10 centimeters. Such waves could only emerge if there is a considerable gradient of the magnetic field in the layer of thickness z_0 : during the growth of a sunspot, high field gradients appear to be possible. The waves could be transmitted through the corona if generated in its lowest layers, where there is strong emission and feeble absorption. At the surface of the earth it is calculated that a radiation of about 10^{-10} watt per square centimeter per megacycle of bandwidth should be obtained for wavelengths from several centimeters to several meters.

523.72:621.396.822.029.63 1760

Solar Radiation at 480 Mc/s—G. Reber. (*Nature (London)*, vol. 158, p. 945; December 28, 1946.) Discussion of results of daily automatic recording at Wheaton, Illinois. During a partial eclipse the intensity decreased and variable activity was observed during a radio storm.

523.746:538.12 1761

Magnetic Field of Sunspots: Part 1—L. Gurevich and A. Lebedinsky. (*Jour. Phys. (U.S.S.R.)*, vol. 10, no. 4, pp. 327-332; 1946.) The magnetic field of sunspots is explained in terms of a self-excitation process related to the hydrodynamic circulation inside a sunspot. Calculations on this hypothesis give fields of several thousand gauss in the outer layers of sunspots and also show that the magnetic fields in the components of bipolar groups of sunspots are oppositely directed.

523.746 "1946.07/.09" 1762

Provisional Sunspot-Numbers for July to September, 1946—M. Waldmeier. (*Terr. Mag. Atmo. Elec.*, vol. 51, p. 500; December, 1946.)

537.591+523.165 1763

Measurements of the Absorption of Cosmic Rays at an Altitude of 3050 m above Sea Level—A. Alichanian and A. Weissenberg. (*Jour. Phys. (U.S.S.R.)*, vol. 10, no. 3, pp. 293-294; 1946.) Continuation of work described in 73 of 1946 (Alichanow and Alichanian.) Of two drops observed in the absorption curve one is attributed to the probable presence of protons in the soft component; the other is as yet unexplained. See also 1423 of June.

537.591+523.165 1764

On Narrow Showers—A. Alichanian and A. Alexandrian. (*Jour. Phys. (U.S.S.R.)*, vol. 10, no. 3, pp. 296-297; 1946.) From an investigation of cosmic-ray showers at heights of 960 and 3250 meters it is concluded that there exist: (a) Auger showers of radius about 100 meters, (b) narrow showers of radius about 50 centimeters, the radius decreasing with increase of altitude, and (c) dense penetrating showers of undetermined radius.

537.591 1765

Highly Ionizing Particles in the Cosmic Radiation—W. Wechsler, N. Dobrotin, and V. Khvoles. (*Zh. Eksp. Teor. Fiz.*, vol. 16, no. 7, pp. 553-556; 1946. In Russian, with English summary.) At an altitude of 3860 meters the number of particles with ionizing power 3 to 4 times that of fast mesotrons was found to be less than 0.5 per cent of the total of penetrating particles. For English version see *Jour. Phys. (U.S.S.R.)*, vol. 9, p. 277; 1945.

- 537.591 1766
On the Space Correlation of Particles in Cosmic Rays: Part 2—Correlation Between Electrons and Protons—V. Berestetzky. (*Zh. Eksp. Teor. Fiz.* vol. 16, no. 8, pp. 665-671; 1946.) English version noted in 1435 of June.
- 537.591.15 1767
Ionization Bursts created by Mesotrons—S. Belenky. (*Zh. Eksp. Teor. Fiz.*, vol. 16, no. 6, pp. 465-473; 1946. In Russian, with English summary.) "Bursts created by δ -electrons due to mesotrons are considered. The spectrum of mesotrons is taken into account. The expression obtained in this way for the number of bursts differs considerably from that given by other authors." English version in *Jour. Phys.* (U.S.S.R.), vol. 10, no. 2, pp. 144-150; 1946.
- 537.591.5 1768
Variation with Altitude of the Cosmic Ray Showers. Photons in the Showers—S. Gorodetzky, P. Chanson and H. Denamur. (*Compt. Rend. Acad. Sci.* (Paris), vol. 214, pp. 310-312; February 16, 1942.)
- 550.38 "1946.01/.03" 1769
Five International Quiet and Disturbed Days for January to March, 1946—W. E. Scott. (*Terr. Mag. Atmo. Elec.*, vol. 51, p. 560; December, 1946.)
- 550.38 "1946.07/.09" 1770
American Magnetic Character-Figure, CA, Three-Hour-Range Indices, K, and Mean K-Indices, KA, for July to September, 1946—W. E. Scott. (*Terr. Mag. Atmo. Elec.*, vol. 51, pp. 505-508; December, 1946.)
- 550.384 1771
Periodicity of Geomagnetic Activity—A. Ogg. (*Terr. Mag. Atmo. Elec.*, vol. 51, pp. 543-546; December, 1946.) The results are given of a harmonic analysis of three-hour-range magnetic indexes at Hermanus from 1940 to 1946. Periods of magnetic activity which were one half and one-third of the solar rotation period were found, in addition to the full period of 26.875 days.
- 550.385 "1946.09" 1772
Geomagnetic Disturbance of September 16-23 [1946]—(*Nature* (London), vol. 158, pp. 477-478; October 5, 1946.) A description of the geomagnetic and associated phenomena of the disturbance, which coincided with marked sunspot activity. At Abinger the extreme ranges were 2 degrees 16 inches in D, 925 γ in H and, 450 γ in V. A short radio fade-out was reported during the storm and during this fade-out a small solar flare was observed at Greenwich. Reprinted in *Terr. Mag. Atmo. Elec.*, vol. 51, pp. 577-578; December, 1946.)
- 551.508.1:621.396.9 1773
The British Radio-Sonde—P. A. Sheppard. (*Quart. Jour. Ray. Met. Soc.*, vol. 72, pp. 169-173; April-July 1946.) A description is given of the apparatus and procedure used, and the magnitude of errors in measurement is discussed. Report of a discussion of a Royal Meteorological Society meeting. For the original account of the apparatus see 4263 of 1938 (Thomas).
- 551.510.535+621.396.812 1774
Echoes on Short Waves at Low Altitude—R. Jouaust. (*Compt. Rend. Acad. Sci.* (Paris), vol. 214, pp. 309-310; February 16, 1942.) During the daily ionosphere measurements carried out in Paris about midday in 1938 and 1939, echoes were observed at altitudes lower than that of the E layer. Comparison with records of abnormal long-wave (11,000 meters) propagation between Paris and Casablanca and Tunis, shows that on three occasions when the short-wave echoes were sharpest, almost simultaneous strengthening of the 11,000-meter signals occurred. The observed heights of the reflecting layer were of the order of 70 to 100 kilometers.
- 551.510.535 1775
Early History of the Ionosphere—A. L. Green. (*A.W.A. Tech. Rev.*, vol. 7, pp. 177-228; December, 1946.) A detailed survey, with extensive bibliography, of early work on the ionosphere.
- 551.510.535 1776
The Origins of the E Layer of the Ionosphere—R. Jouaust. (*Compt. Rend. Acad. Sci.* (Paris), vol. 214, pp. 441-442; March 2, 1942.) Ionization in the E layer is shown to be due not to normal atoms, but to atoms excited to a metastable state. Study of the light from the night sky leads to the conclusion that certain metastable atoms should exist at a height of about 100 kilometers and these can be excited by radiation of wavelength 1323 angstroms. The mechanism proposed by Cabannes and Arynard to explain the production of these atoms also explains the low altitude of the E layer.
- 551.510.535:523.78(485) "1945.07" 1777
Chalmers Solar Eclipse Ionospheric Expedition 1945—O. E. H. Rydbeck. (*Chalmers Tekn. Högsk. Handl.*, no. 53, 44 pp., 1946. In English.) Observations were made for a month, centered on July 9, 1945, the day of the eclipse, near Umeå in northern Sweden. Effects in the E and F₁ layers were regular and symmetrical: apparent recombination coefficients were $\alpha_g = 1.1 \times 10^{-8}$ for the E layer and $\alpha_{F_1} = 0.6 \times 10^{-8}$ for the F₁ layer. The electron-density versus time curves for the E and F₁ layers during the eclipse period had practically the same shape and gave a ratio of recombination coefficients equal to 1.8. Calculations on the basis of constant α values indicate that the ionizing radiation from the corona cannot be neglected. The results of the observations agree with those of previous workers and add further proof to the theory that the primary ionizing force of the E and F₁ layers is ultraviolet light from the sun.
- F₂-layer results were more complex. The recombination coefficient α_{F_2} was of the order 3×10^{-9} ; there was a definite ultraviolet light eclipse effect, and there may be an eclipse temperature effect resulting in a contraction of the layer. No definite indications of a corpuscular eclipse were noticed. High latitude F₂ eclipse effects seem to show a definite character which differs from that observed in equatorial regions; this may be due to geomagnetic control.
- The paper includes a general theoretical discussion of eclipse effects upon the time-variation of ionospheric electron densities. Simple formulas have been obtained for the calculation of E and F₁ minimum solar eclipse electron densities; these formulas can be used for rapid determination of the recombination coefficient.
- The influence of horizontal diffusion upon the F₂ eclipse electron density variation is also discussed theoretically and is shown to be unimportant even in regions of high electron temperature.
- 551.510.535:523.78 (485) "1945.07.09" 1778
Records of the Ionosphere During the Total Eclipse in the North of Sweden on July 9, 1945—W. Stoffregen. (*Terr. Mag. Atmo. Elec.*, vol. 51, pp. 495-499; December, 1946.) Measurements made with a portable automatic recorder showed variations of ionization nearly symmetrical with respect to the eclipse, and agreeing with earlier observations. The F₂ region showed a marked increase in height, while towards the end of the eclipse the abnormal-E ionization disappeared.
- 551.510.535:621.396.812 1779
Radio Waves and the Ionosphere—G. W. O. Howe. (*Jour. Brit. I.R.E.*, vol. 7, pp. 36-42; January-February, 1947.) A short historical survey is followed by a discussion of the mechanism which causes radio waves entering the ionosphere to return to the earth. Reference is made to experimental results by Appleton and others.
- 551.594:546.212-14/-16 1780
Electrical Effects Associated with a Change of State of Water—J. E. Dinger and R. Gunn. (*Terr. Mag. Atmo. Elec.*, vol. 51, pp. 477-494; December, 1946.) A laboratory investigation shows that freezing and melting give rise to changes in contact potential at the air-water interface. The results are of interest in explaining the charges on atmospheric precipitation and the separation of electricity in clouds.
- 551.594.11(65) 1781
A Year's Records of the Atmospheric Electric Potential Gradient at Tamanrasset (Hoggar)—J. Lacaze. (*Rev. Sci.* (Paris), vol. 84, pp. 286-289; September 15, 1946.)
- 551.594.12 1782
The Ionisation in the Lowest Regions of the Atmosphere—J. A. Chalmers. (*Quart. Jour. Roy. Met. Soc.* vol. 72, pp. 199-205; April-July, 1946.) Assuming the rate of ionization at the earth's surface to be 5 times that at a height of 1 meter, it is possible to obtain a variation of conductivity in general agreement with Hogg's results without requiring a space charge large enough to alter the field appreciably.
- 551.594.21 1783
A Theory of the Fundamental Phenomena of Atmospheric Electricity—J. Frenkel. (*Bull. Acad. Sci.* (U.R.S.S.), sér. géogr. géophys., vol. 8, no. 5, pp. 244-272; 1944. In Russian, with English summary.) The principles of colloidal electrochemistry are applied to the thundercloud. In the dispersive medium formed by the weakly ionized air, negative electrification of the water drops or ice crystals is deduced.
- 551.594.221:621.396.821 1784
The Nature and Variation of Atmospherics Caused by Lightning Discharges—H. Norinder and W. Stoffregen. (*Ark. Mat. Astr. Fys.*, vol. 33, part 3, section A, 44 pp.; February 6, 1947. In English.) Preliminary report of research in progress. The electric field changes associated with atmospherics and the variation of wave form with distance from the source are examined. Wave forms are photographically recorded by various oscillographic techniques and preliminary discharges have been observed up to 0.5 second before the main discharge in addition to the usual "leader" strokes. Further measurements will be made by taking simultaneous recordings at various distances from the source.
- 551.594.52(481) "1911/44" 1785
Frequency of 12,330 Measured Heights of Aurora from Southern Norway in the Years 1911-1944—C. Stormer. (*Terr. Mag. Atmo. Elec.*, vol. 51, pp. 501-504; December, 1946.)

LOCATION AND AIDS TO NAVIGATION

- 621.396.9:551.594.6 1786
Atmospherics and Their Location—C. Clarke. (*Jour. I.E.E.* (London), part I, vol. 94, pp. 54-55; January, 1947.) The nature of the discharge process associated with a lightning flash is briefly considered. A direction-finder used for locating lightning flashes must have a selective-tuned receiver for an operating band of about 10 to 30 kilocycles, a linear output for a wide range of input voltages, and a higher over-all gain than would be necessary for cathode-wave signals of similar field strength. A cathode-ray tube with a persistent screen must be used. Brilliance modulation has marked advantages. Atmospherics are located by simultaneous observation of their direction of arrival

at two well-separated stations. The main source of inaccuracy is polarization error. Summary of an Institution of Electrical Engineers. Students' section paper.

621.396.932 1787
Decca Navigator—(*Wireless World*, vol. 53, p. 67; February, 1947.) Now approved by the Ministry of Transport for general marine navigation, after extensive trials.

621.396.932/.933.24 1788
Consol—(*Wireless World*, vol. 53, p. 67; February, 1947.) The first consol direction-finding station, situated at Bush Mills, Co. Antrim, Northern Ireland, now provides a 24-hour service for civil aircraft. For a description of the system, see 2912 of 1946 (Clegg).

621.396.933 1789
Gee: A Radio Navigational Aid—R. J. Dippy. (*Jour. I.E.E.* (London), part IIIA, vol. 93, no. 2, pp. 468-480; 1946.) A 'master' station transmits 6-microsecond pulses at a repetition frequency of 500 per second; two 'slave' stations also transmit 6-microsecond pulses at a repetition frequency of 250 per second, and are locked to the 'master' so that the interval between 'master' and 'slave' pulses remains constant. The signals are displayed on the airborne receiver so that the path difference from the aircraft to the 'master' and each 'slave' station can be read directly. Charts are provided with a system of hyperbolas of constant path difference plotted for the 'master' and each 'slave' station: the aircraft's position is then determined as an intersection of a hyperbola of each system.

The airborne and ground-station equipments are described in detail. A later development was the introduction of a third slave station to give all-round coverage, and the design of light transportable ground stations. Future possibilities of the system are briefly discussed. A summary of this paper is given in part IIIA, vol. 93, no. 1, pp. 344-345; 1946.

621.396.933 1790
Oboe: A Precision Ground-Controlled Blind-Bombing System—F. E. Jones. (*Jour. I.E.E.* (London), part IIIA, vol. 93, no. 2, pp. 496-511; 1946.) Aircraft flying at 30,000 feet could be controlled from two ground stations up to a range of nearly 300 miles. Bombs were released automatically by a signal sent from one of the ground stations; the radial bombing error was of the order of 100 yards, varying with aircraft height, range, and speed. The two ground stations transmit pulses on the same carrier frequency but different pulse recurrence frequencies. The tracking station guides the pilot on to a circular track passing over the target while the releasing station determines the ground speed of the aircraft along this track and hence the bomb release point. The airborne and ground station equipments are described in detail. Possible future applications are mentioned. A summary of this paper is given in part IIIA, vol. 93, no. 1, pp. 345-346; 1946.

621.396.933 1791
200-Mc/s Radar Interrogator-Beacon Systems—K. A. Wood. (*Jour. I.E.E.* (London), part IIIA, vol. 93, no. 2, pp. 481-495; 1946.) Extensive wartime use of radar beacon systems, is described. Particular problems encountered in developing both ground and airborne equipment are discussed. The development of the identification-friend-or-foe system is outlined with the modifications which later made possible its use as a simple navigational aid. The series of equipments known as 'Rebecca-Fureka,' enabled aircraft not fitted with radar search equipment to use the beacon system. Aircraft approach and landing by the beam-approach system are considered. Special developments of the beacon system to meet operational requirements of all three services are

outlined and trends in development for future use are reviewed. A summary of this paper is given in part IIIA, vol. 93, no. 1, pp. 347-348; 1946.

621.396.933.23 1792
The C.A.A. Instrument Landing System—C. E. Planck. (*Inter-Avia*, vol. 1, pp. 63-66; November-December, 1946.) The system introduced by the United States Civil Aeronautics Administration consists of a runway localizer (110 megacycles), a straight-line glide path (330 megacycles) and marker beacons (75 megacycles). These elements are briefly described, and details and photographs of the ground and airborne equipments are given. Advantages over the ground-control-approach radar system are claimed in cheapness and in automatic devices for instrument landing and control-tower monitoring.

621.396.96 1793
H₂S: An Airborne Radar Navigation and Bombing Aid—C. J. Carter. (*Jour. I.E.E.* (London), part IIIA, vol. 93, no. 2, pp. 449-467; 1946.) A radar device giving a visual plan of the terrain beneath so that accurate navigation and bombing become possible from above clouds. Development of the system since 1939 is traced, and its operational use by the Royal Air Force is briefly considered. The functions of the various units which make up the complete equipment are outlined; particular attention is paid to the correction of slant-range distortion to give a true plan position indication, and to problems of display and aerial design peculiar to this equipment. A summary of this paper is given in part IIIA, vol. 93, no. 1, pp. 343-344; 1946.

621.396.96 1794
Principles and Applications of Radar—L. Bouthillon. (*Bull. Soc. Franç. Élec.*, vol. 6, pp. 563-578; November, 1946.) An outline of the basic principles of radar and of the technique of determining direction and range, together with some military applications.

621.396.96 1795
Questions Concerning Different Radar Systems—G. Guanella. (*Inter-Avia*, vol. 1, pp. 48-54; November-December, 1946.) Comparison of the short-pulse method and the beat method, in which the transmitter frequency is changed uniformly during a pulse of relatively long duration, shows that theoretically the two methods are comparable in accuracy. The detection of moving objects by Doppler techniques is discussed and the practical embodiment of the various systems is described.

621.396.96(44) 1796
French Contributions to Radar—M. Ponte. (*Bull. Soc. Franç. Élec.*, vol. 6, pp. 579-588; November, 1946.) A general description of experimental work on the detection of obstacles by ultra-short waves, carried out in France between 1934 and 1942. See also 1099 of May and back reference.

621.396.96:371.3:534.321.9 1797
H₂S Trainer—G. W. A. Dummer. (*Wireless World*, vol. 53, pp. 65-66; February, 1947.) Ultrasonic waves propagated through water on to submerged relief maps enabled H₂S operational conditions to be reproduced on a scale of 1 to 200,000.

621.396.96:531.55 1798
Naval Fire-Control Radar—J. F. Coales, H. C. Calpine, and D. S. Watson. (*Jour. I.E.E.* (London), part IIIA, vol. 93, no. 2, pp. 349-379; 1946.) Development is reviewed from the beginning as a simple range finder to the present accurate and complex form. Aerial arrays are described with polar diagrams, and the installation of the equipment aboard ships is shown diagrammatically.

Methods of display and the problem of dia-

criminating between targets are discussed. Such narrow beam widths are required and the actual size of the equipment is so limited by the available space, that very-high frequencies are used. The development of equipment in the 600-, 3000-, and 10,000-megacycle bands is described and methods of using radar to locate shell splashes to correct gun laying are explained. A summary of this paper is given in part IIIA, vol. 93, no. 1, pp. 323-325; 1946.

621.396.96:531.55 1799
Precision Ranging Systems for Close-Range Weapons—H. W. Pout. (*Jour. I.E.E.* (London), part IIIA, vol. 93, no. 2, pp. 380-394; 1946.) The development of close-range sets is described and also the reasons for the successive changes. The prediction of aircraft future position is discussed, including analysis of "rate aiding" as a method of rate determination. Two sets are described, with block diagrams. The first of these, type 282, did not give the required accuracy. The second, type 285, incorporating panel L22, is described in detail and the problems associated with the use of panel L22 in conjunction with the auto-barrage unit are discussed. An account is given of a completely self-contained automatic set including auto-ranging and auto-aiming of the guns. The limitations of such a system are outlined. A summary of this paper is given in part IIIA, vol. 93, no. 1, pp. 326-327; 1946.

621.396.96:531.55 1800
The Application and Design of Medium-Precision Ranging Equipment—H. A. Prime. (*Jour. I.E.E.* (London), part IIIA, vol. 93, no. 2, pp. 395-410; 1946.) A description of ranging outfit R.T.A. for use on small vessels with diagrams of parts of the circuit. The modified version (outfit R.T.C.) of this set, used for control of short-range antisubmarine weapons is also described.

The design of medium-precision ranging equipment for use with plan-position-indicator display is discussed, reference being made to ranging outfit R.T.D., display outfit J.P., and the applications of such equipment to torpedo control, navigation and shore bombardment.

The limitations of this type of display led to the development of equipment known as ranging outfit R.T.B. which combines a sector display with R.T.A. A summary of this paper is given in part IIIA, vol. 93, no. 1, pp. 327-328; 1946.

621.396.96:531.55 1801
Engineering Design of Ship-Borne Gunnery Radar Panels—T. C. Finnimore and W. D. Mallinson. (*Jour. I.E.E.* (London), part IIIA, vol. 93, no. 2, pp. 441-447; 1946.) The design of radar equipment to operate under the conditions experienced aboard ship is described with particular reference to two types developed during the war. A note on future trends in design is added. A summary of this paper is given in part IIIA, vol. 93, no. 1, pp. 329-330; 1946.

621.396.96:531.55 1802
Naval Gunnery Radar—(*Jour. I.E.E.* (London), part IIIA, vol. 93, no. 2, pp. 447-448; 1946.) A discussion led by Commander C. G. Mayer, United States Naval Reserve, on 1798 to 1801 above, and 1803 and 1804 below.

621.396.96:531.55 1803
Checking the Angular Accuracy of Precision Fire-Control Radar—G. H. Beeching. (*Jour. I.E.E.* (London), part IIIA, vol. 93, no. 2, pp. 519-526; 1946.) The principal sources of error are incorrect alignment of the mechanical axis of the aerial system and of the electrical axis of the radar equipment, and incorrect installation with respect to predictor, guns, etc. Methods are described for checking and correcting these errors in typical army equipment.

621.396.96:531.55:621.396.611.21 1804

A Precision-Ranging Equipment Using a Crystal Oscillator as a Timing Standard—C. A. Laws. (*Jour. I.E.E.* (London), part IIIA, vol. 93, no. 2, pp. 423-440; 1946.) A detailed account, with practical difficulties experienced, of the development of a system for naval armament fire control. One period of the crystal is equal to a radar range of 1000 yards and the intervals are continuously subdivided by a phase-shifting transformer in the oscillator output, one revolution giving a linear phase change of 360 degrees so that it can be calibrated in terms of radar range. The form of display of the radar and timing signals on a cathode-ray tube gives a very-high measurement accuracy.

Recent applications of the system are described, with an appendix on the factors governing the phase-shifting transforming accuracy. A summary of this paper is given in part IIIA, vol. 93, no. 1, pp. 325-326; 1946.

621.396.96.004.11 1805

Airborne Radar Specifications—(*Electronics*, vol. 20, no. 2, p. 132; February, 1947.) Brief technical details of various United States Army radar equipments recently declassified. Further information can be obtained from the Superintendent of Documents, Government Printing Office, Washington, D. C.

621.396.96.088.2 1806

The Measurement of the Zero Error of Range in Radar Equipments—H. I. S. Allwood, J. G. Bartlett, and G. T. Davies. (*Jour. I.E.E.* (London), part IIIA, vol. 93, no. 2, pp. 513-518; 1946.) A brief description of the precautions necessary for eliminating errors and details of the measurement of the zero error by means of an electronic calibrator employing an artificial target. Ranges can usually be determined to within ten yards of the true value. A summary of this paper is given in part IIIA, vol. 93, no. 1, p. 127; 1946.

MATERIALS AND SUBSIDIARY TECHNIQUES

535.215.6:546.281.26 1807

A New Spectral Effect and a Method for Determining the Long Wavelength Limit of the Rectifier Photoeffect in Carborundum Monocrystals—O. V. Losev. (*Bull. Acad. Sci. (U.R.S.S.)*, sér. phys., vol. 5, nos. 4-5, pp. 494-498; 1941. In Russian with English summary.) In the 'active layer' of carborundum monocrystals a special component of the rectifier photoeffect may be observed when an accelerating voltage is applied. The ratio of this component to the short-circuit photocurrent increases steadily if the wavelength of the monochromatic light is decreased. This fact is used for the determination of the long wavelength limit of the rectifier photoeffect.

535.37 1808

Luminescence of (Zn, Be)₂SiO₄:Mn and Other Manganese Activated Phosphors—J. H. Schulman. (*Jour. Appl. Phys.*, vol. 17, pp. 902-908; November, 1946.)

535.37 1809

Luminescence Extinction in Complex Molecules—L. A. Tumerman. (*Bull. Acad. Sci. (U.R.S.S.)*, sér. phys., vol. 9, nos. 4-5, p. 328; 1945. In Russian.) Discusses the effect of temperature and the existence of a 'dark pause.'

535.37:537.311.33 1810

Contemporary Investigations of the Mechanism of Luminescence of Semiconductors—V. L. Levsin [W. L. Lewschin]. (*Bull. Acad. Sci. (U.R.S.S.)*, sér. phys., vol. 5, nos. 4-5, pp. 510-522; 1941. In Russian with English summary.) Luminescent solid phosphors can be divided into three groups. The first are activated by complex organic molecules; their absorption and emission spectra are closely connected. Emission consists of a momentary

process lasting approximately 5×10^{-9} seconds together with an exponential process lasting about 1 second due to metastable levels of the activator molecules. The second group includes luminescent pure inorganic substances and isomorphous crystals, for which absorption and emission spectra are also closely connected. Luminescence consists essentially of an exponential process lasting about 0.01 second. The third group includes crystalline phosphors activated by impurities of heavy metals. Emission consists of a momentary process lasting less than 10^{-8} second, a short exponential process lasting about 0.01 second, and a prolonged hyperbolic recombination process. The momentary process provides a fraction of the total radiation negligible at low intensity, and increasing with intensity. Curves obtained by using a phosphoroscope with a rotating mirror are given, illustrating these processes for ZnS.Mn- and ZnS.Cu-phosphors. Investigation of isotherms of decay shows that the character of the process changes little with temperature in the range 90 to 670 degrees Kelvin; increase in recombination probability with temperature is compensated by a decrease in the number of excited electrons present when excitation ceases. The character of isotherms taken when the number of electrons remains approximately constant is very sensitive to temperature changes, as are also the light sums accumulated during excitation. From the relationship between light sum and temperature, the energy required to liberate a localized electron can be deduced.

535.37:546.65 1811

Luminescence of Solutions of Salts of the Rare Earths—A. N. Zaidel. (*Bull. Acad. Sci. (U.R.S.S.)*, sér. phys., vol. 9, nos. 4-5, pp. 329-334; 1945.) In Russian.

535.37:548.0 1812

The Luminescence of Crystalline Substances—V. L. Levshin. (*Bull. Acad. Sci. (U.R.S.S.)*, sér. phys., vol. 9, nos. 4-5, pp. 355-368; 1945. In Russian.) A new scheme to explain the mechanism. Main features are the assumption of three types of discontinuous radiation, and an explanation of the nature of adhesion levels.

535.37:666.1 1813

Luminescence of Glasses—V. V. Vargin and T. I. Weinberg. (*Bull. Acad. Sci. (U.R.S.S.)*, sér. phys., vol. 9, nos. 4-5, pp. 563-574; 1945. In Russian.) Critical survey of existing knowledge.

535.371 1814

Some Problems of the Synthesis of Zinc-Sulphide Phosphors with Long Afterglow—V. M. Gougel. (*Bull. Acad. Sci. (U.R.S.S.)*, sér. phys., vol. 9, nos. 4-5, pp. 539-542; 1945. In Russian.) Discusses the effect of impurities on the intensity and color of the luminescence.

537.311.31+537.311.33 1815

Thermomagnetic Nernst Effect in Semiconductors and Metals—N. L. Pisarenko. (*Bull. Acad. Sci. (U.R.S.S.)*, sér. phys., vol. 5, nos. 4-5, pp. 417-421; 1941. In Russian with English summary.) The magnitude as well as the sign of this effect may be explained by the mode of dependence of the time of the electron free path on the velocity, and by the fact that in semiconductors in which the conductivity is of a complex nature both types of charge carriers are present.

537.311.33+621.315.59 1816

Experimental Investigation of the Metal-Semiconductor Contact—V. I. Ljašenko, G. A. Fedorus, and S. P. Felvašnikova. (*Bull. Acad. Sci. (U.R.S.S.)*, sér. phys., vol. 5, nos. 4-5, pp. 434-441; 1941. In Russian with English summary.) An investigation for cuprous oxide and selenium of the relation between metal-semiconductor contact potential difference; and

field strength, current density, and conductivity. The potential difference at first increases almost linearly with current density, then attains a maximum, and finally falls to zero. The smaller the conductivity of the specimen, the larger the potential difference.

The explanation suggested is that the flow of current reduces the 'holes' concentration in the layer of chemically uniform semiconductor near a contact. The experimental data agree fairly well with S. I. Pekar's theoretical results (1819 below).

537.311.33 1817

Mechanism of Luminescence of Alkali-Halogen Phosphors—V. V. Antonov-Romanovskij. (*Bull. Acad. Sci. (U.R.S.S.)*, sér. phys., vol. 5, nos. 4-5, pp. 523-531; 1941. In Russian with English summary.) Discussion of decay phenomena leads to the conclusion that the Bloch-Wilson representation of semiconductors, if applied to phosphorescence, must take account of the interaction between the electron and the ionized center, long before their recombination, and also of the fact that the average displacement of the thermal electron, in the time interval between captures, is relatively small.

537.311.33 1818

Electrical Conductivity of Semiconductors in Strong Electric Fields—B. I. Davydov and I. M. Šmuškevič. (*Bull. Acad. Sci. (U.R.S.S.)*, sér. phys., vol. 5, nos. 4-5, pp. 399-408; 1941. In Russian with English summary.) Different mechanisms which may increase the conductivity of semiconductors in strong fields are considered. The magnitude of the field at which these mechanisms become significant is evaluated. The deviations from Ohm's law in the case of a semiconductor with an ionic lattice in a strong field are examined in detail. When solving the kinetic equation, not only the interaction of electrons with the optical vibrations of the lattice, but also inelastic collisions, i.e., the ionization, must necessarily be taken into account. In contrast to the semiconductor with an atomic lattice, the mobility of electrons in that with an ionic lattice increases in strong fields. The dependence of the mobility on the field and the temperature has different forms according to whether kT is greater or less than $h\nu_0$, ω_0 being the limiting frequency of optical vibrations of the crystal. The mobility of electrons, the number of ionizing collisions and the resulting concentration of free electrons are found for both limiting cases; the intermediate case may be interpolated.

537.311.33 1819

The Metal-Semiconductor Contact and the Contact Potential Drop—S. I. Pekar. (*Bull. Acad. Sci. (U.R.S.S.)*, sér. phys., vol. 5, nos. 4-5, pp. 422-433; 1941. In Russian with English summary.) A theory of the metal-semiconductor contact is considered which differs from those previously given by Mott and Johnson by taking into account the redistribution of the concentration of conducting electrons in a semiconductor caused by the passage of the current. Contact potential differences and their dependence on current density could thus be calculated. The experimental data of Ljašenko, Fedorus, and Felvašnikova (1816 above) confirm the theory.

537.311.33:546.281.26 1820

On the Mechanism of the Electric Conductivity of Silicon Carbide—G. Busch and H. Labhart. (*Helv. Phys. Acta.*, vol. 19, pp. 463-492; December 18, 1946. In German.)

537.323:546.817.221 1821

The Thermoelectric Effect in Lead Sulphide—E. D. Devjatková, J. P. Maslakovec, and M. S. Sominskij. (*Bull. Acad. Sci. (U.R.S.S.)*, sér. phys., vol. 5, nos. 4-5, pp. 409-416; 1941. In Russian with English summary.) Theoretical expressions are given for the dependence of

thermoelectric force on the concentration of carriers of electricity. The temperature variations of electrical and thermal conductivities and of thermoelectric force are investigated in lead sulphide having electronic as well as 'hole' conductivity. The results obtained show that in lead sulphide the concentration of carriers of electricity equals 10^{18} to 10^{19} . The electrical conductivity is determined mainly by the temperature variation of the mobility of the carriers.

538.22: [669.155+669.245.5] 1822
Magnetic Properties and Chemical Nature of Solid Solutions of Weak Magnetic Elements in Nickel and Iron—J. Dorfman. (*Zh. Eksp. Teor. Fiz.*, vol. 16, no. 4, pp. 349-360; 1946. In Russian, with English summary.) The nature of the elementary nickel magnet can be understood if numerical results of gyromagnetic investigations are taken into account as well as experimental magnetic data.

The magnetic properties, above the Curie point, of solid solutions of different metals in nickel (at low concentrations of the alloying metal) are determined not only by the valency of the foreign atoms, but also by the individual chemical peculiarities of the elements. The theory of zones is not fully applicable to nickel *d*-electrons.

There is a close analogy between the magnetic properties of nickel and iron alloys, but the peculiar structure and filling of *d*-levels of metallic iron explains some magnetic properties of iron alloys.

The difference between the chemical bonds of 'included atoms' and 'replacement atoms' explains why carbon behaves differently from other elements when dissolved in iron.

538.221 1823
Time Effects in Materials Containing Iron Under the Influence of Mechanical and Magnetic Forces—J. L. Snoek. (*Schweiz. Arch. Angew. Wiss. Tech.*, vol. 13, pp. 9-14; January, 1947.) A discussion of dispersion and relaxation phenomena, both elastic and magnetic, based on Bloch's theory of magnetism. Long- and short-time after effects are found, the first concerned with the diffusion of material particles, while the second is as yet unexplained, though possibly connected with the *s*- and *d*-electrons.

546.28+621.383.4 1824
A New Bridge Photo-Cell Employing a Photo-Conductive Effect in Silicon. Some Properties of High Purity Silicon—Teal, Fisher, and Treptow. (See 1961.)

549.514.51 1825
Growing Quartz Crystals—(*Radio*, vol. 31, p. 30; January, 1947.) An abstract of "Report of Investigations in European Theater; PB-28897" describing a German method in which a seed crystal of quartz is suspended in a mixture of finely ground glass and water and is heated in an autoclave to 375 degrees centigrade.

620.197(213):621.396.6 1826
Deterioration of Radio Equipment in Damp Tropical Climates and Some Measures of Prevention—C. P. Healy. (*A.W.A. Tech. Rev.*, vol. 7, pp. 103-129; December, 1946.) Reprint of 3502 of 1946.

621.3.011.5.029.5/.6]:631.437 1827
Dielectric Properties of Indian Soils at High and Medium Radio-Frequencies—Khastgir, Ray, and Banerjee. (See 1900.)

621.315.59 1828
Papers on Semiconductors—(*Bull. Acad. Sci.* (U.R.S.S.), sér. phys., vol. 5, nos. 4-5, pp. 546-554; 1941.) Summaries in English and Russian of the following papers are given: "A Complex Investigation of the Mechanism of Semi-Conductor's Electrical Conductivity," by V. A. Davidenko; "A New Method of Investi-

gating the Electrical Conductivity of Semiconductors and Results of Application of this Method to the Investigation of Conductivity of Alundum," by A. R. Šulman; "Concentration Phenomena in Semi-Conductors," by B. I. Davydov; "Galvanomagnetic Effects in Semi-Conductors," by I. D. Rožanskij; "A Contact Between a Semi-Conductor and a Metal," by A. V. Ioffe and A. F. Ioffe; "Solid Rectifiers," by P. V. Šaravskij; "The Investigation of Sulphide Rectifiers," by J. A. Dunajev and B. V. Kurčatov; "Inner Photoelectric Effect in Sulphur and Electronic Energy Levels," by P. S. Tartakovskiy and G. I. Rekalova; "On the Photoelectrically Inactive Absorption of Light by Some Semi-Conductors," by F. F. Volkenštein; and "Spectral Distribution of Rectifier and Inner Photoeffect in Selenium," by D. I. Arkadiev.

621.315.6+[621.39:371.31] 1829
The War-Time Education and Training of Radio Personnel and Recent Developments in Dielectric Materials—Jackson. (See 1973.)

621.315.616:621.317.33.011.5 1830
Dielectric Investigations on Polymeric Fluids—R. Goldschmidt. (*Schweiz. Arch. Angew. Wiss. Tech.*, vol. 13, pp. 21-27; January, 1947.) Describes the method of measurement of the permittivity, loss angle, insulation resistance, viscosity, and expansion coefficient of oils and various mixtures. The results are given graphically. Photographs show the development during cooling of pseudo-crystalline patterns in mixtures of ozocerite and resin.

621.357.8 1831
Electropolishing—C. L. Faust. (*Metal. Ind.* (London), vol. 69, pp. 512-513; December 20, 1946.) Discusses the status of electropolishing as a metal finishing process.

621.395.625.3 1832
Magnetic Tape Recorder—(*Radio*, vol. 31, p. 7; January, 1947.) Uses a paper tape $\frac{1}{4}$ -inch wide coated with a new metallic paint having magnetic properties that are claimed to approach those of Alnico III.

621.775.7:669.3 1833
Copper-Base Powder Metallurgy Parts—H. Chase. (*Materials and Methods*, vol. 24, pp. 1439-1444; December, 1946.)

669.14:621.396.69 1834
A New Radar Transformer Steel—G. H. Cole and R. S. Burns. (*Materials and Methods*, vol. 24, pp. 1457-1460; December, 1946.) A steel, containing 3 to 3.5 per cent silicon, capable of being rolled to a thickness of 0.002 inch, and suitable for radar pulse-transformer laminations.

679.5:621.3 1835
Plastics in Electrical Industry—T. J. Fielding. (*Electrician*, vol. 137, pp. 1196-1199, 1281-1285, and 1370-1374; November 1-15, 1946.) A general account of the properties of various bakelite materials, in laminated forms, as antitracking materials, and as resins, varnishes, and cements, together with their electrical applications.

679.5:[621.315.616+539.4] 1836
Standard Tests for Thermosetting Plastics. (See 1865.)

678.02 1837
Advances in Colloid Science, Vol. 2 [Book Review]—H. Mark and G. S. Whitby (editors). Interscience Publishers, Inc., New York, N. Y. 1946, 453 pp., \$7.00 (*Nature* (London), vol. 158, pp. 924-926; December 28, 1946.) A much-needed co-ordination of recent developments in rubber science.

MATHEMATICS

517.941.9:53 1838
A New Method of Solution of Certain

Boundary Problems for Equations of Mathematical Physics Permitting of a Separation of Variables—G. Grünberg. (*Jour. Phys.* (U.S.S.R.), vol. 10, no. 4, pp. 301-320; 1946.)

518.5 1839
Concerning "Computer for Solving Linear Simultaneous Equations"—C. C. Eaglesfield; C. E. Berry. (*Jour. Appl. Phys.*, vol. 17, p. 1125; December, 1946.) Suggested modifications to the design described in 1927 of 1946 to make it easier and quicker to use, and Berry's reply, stating that the same mathematical method had been suggested several months previously by W. M. Bleakney.

519.283:621.318.572 1840
On the Distribution of Counts in a Counting Apparatus—Hole. (See 1877.)

530.162:621.394/.397].822 1841
Study of Fluctuations Produced by the Shot Effect in Amplifiers—A. Blanc-Lapierre. (*Rev. Sci.* (Paris), vol. 84, pp. 75-94; June-July, 1946.) A review of the analytical methods used for calculating the influence of linear amplifiers and of nonlinear detectors on a random voltage. The properties of the correlation function of a random variable are related to its spectral density; for Bernamont's earlier work on this subject see 1715 of 1937 and back references. The relations between the characteristic function, the probability distribution and moments of a variable are established. In practice the Laplace-Gauss (normal) distribution is valid since the number of elementary events occurring within the time constant of the apparatus is very large, and its general formulation for *K* variables is derived. The results are applied to the case of detectors having the law $y=x^{2p}$ and to a linear detector (single- or full-wave). The significance of departures from the normal distribution is discussed and it is shown that if an arbitrary fluctuation voltage is applied to an amplifier of large time constant, the small fluctuations appearing at the output depend only on the amplifier and have a normal distribution. Cf., similar work by Franz (3026 and 3027 of 1941, 2124 of 1943, and 443 of 1944). An abbreviated version of this paper appears in *Bull. Soc. Franc. Elec.*, vol. 5, pp. 343-351; November, 1945.

518.3:621.3.012.3.081.4 1842
DB Gain-Loss Calculator—L. A. Lohr. (*Electronics*, vol. 20, p. 134; February, 1947.) An abac for converting ratios to decibels.

MEASUREMENTS AND TEST GEAR

538.569.4+621.396.812].029.64:551.51 1843
Atmospheric Absorption Measurements with a Microwave Radiometer—R. H. Dicke, R. Beringer, R. L. Kyhl, and A. B. Vane. (*Phys. Rev.*, vol. 70, pp. 340-348; September 1-15, 1946.) The absorption of microwave radiation in traversing the earth's atmosphere has been measured at wavelengths of 1.0, 1.25, and 1.50 centimeters in the neighborhood of a water vapour rotational absorption line. A sensitive radiometer was used to detect thermal radiation from the absorbing atmosphere at these wavelengths. From the measured absorption, together with data from humidity soundings of the atmosphere, absorption coefficients under standard conditions (293 degrees Kelvin and 1015 millibars) can be calculated. These are 0.011, 0.026, and 0.014 decibel per kilometer for 1 gram of water vapour per cubic meter, at wavelengths of 1.00, 1.25, and 1.50 centimeters, respectively.

620.179.1 1844
Non-Destructive Testing—(*Elec. Times*, vol. 111, pp. 147-148; January 30, 1947.) Summary and discussion of an Institution of Electrical Engineers paper by H. C. Turner and E. M. Tomlin. Special instruments described include (a) a magnetic sorting bridge using the

change of the hysteresis loop with variations of heat treatment, hardness or depth of carburization, (b) a vibration analyzer with crystal pickup, (c) a crystal resonance apparatus for thickness measurement from one side only, and (d) a development of (c) for the detection of flaws in sheet material.

621.317.31.014.33 1845

The Measurement of Current Transients in a Low Voltage Circuit—B. T. Barnes, R. Q. Adams, and D. D. Hinman. (*Rev. Sci. Instr.*, vol. 17, pp. 426–427; October, 1946.) Measurement of current transients of the order of 1 ampere per microsecond, using an oscillograph, is discussed. The construction of a special coaxial type of oscillograph shunt, which has the very low inductance necessary, is described.

621.317.33.011.5:621.315.616 1846

Dielectric Investigations on Polymeric Fluids—Goldschmidt. (See 1830.)

621.317.333.4:621.315.2.029.5 1847

New Methods for Locating Cable Faults, Particularly on High-Frequency Cables—Roberts. (See 1663.)

621.317.336:621.315.212.2 1848

New Method of Measuring the Impedance Errors of Concentric Pairs—G. Fuchs. (*Rev. Gén. Élec.*, vol. 55, pp. 109–117; March, 1946.) A differential method for measuring the asymmetry of quadrupoles is applied to the determination of impedance errors arising from dimensional and material irregularities in the construction of concentric cables. Comparison between this differential method and that of Kaden at the resonant frequencies shows good agreement, though both methods fail when similar irregularities are symmetrically located with respect to the midpoint of the cable. Tests carried out at the transmission laboratory of the Société Anonyme de Télécommunications show good agreement between experimental and theoretical values for cables with artificial impedance errors.

621.317.336:621.317.372 1849

On the Measurement of Negative Impedances with a Q-Meter—B. N. Prakash. (*Electrotech.*, no. 19, pp. 69–73; December, 1946.) Measurements on a Q-meter are made (a) with a suitable coil connected to the Q-meter coil terminals and (b) with a tuned circuit, shunted by the impedance, connected to the Q-meter capacitor terminals the impedance being (1) passive, and (2) active, i.e., with battery supplies connected. The value of the impedance can then be calculated.

621.317.372+621.396.615+621.317.75 1850

Service Station Measurement Apparatus: Part 1—Beat-Frequency Oscillator; Part 2—A New Q-Meter; Part 3—Frequency Spectrum Analyser—R. Aschen. (*TSP Pour Tous*, vol. 22, pp. 171–173, 195–197, and 219–222; September–November, 1946.) In the beat-frequency oscillator a variable voltage at a fixed frequency F_0 is applied to the control grid of a frequency changer and beats with a second signal of constant voltage but variable frequency F_1 to give an output of variable frequency F_2 whose voltage can be varied from zero up to about 0.05 volts. By modulating F_1 either by audio or frequency, F_2 is similarly modulated. For Q measurements, the circuit is loosely coupled by a small capacitor to the generator, the resonance frequency F_0 determined and the voltage V measured by a tube voltmeter. F_2 is then varied by a known amount ΔF to give a 30 per cent reduction of V , when $Q = F_0/2\Delta F$. Modification of this simple method gives a direct reading instrument. The frequency analyzer, whose circuit diagram is given, displays the components of a signal on the 50 by 50 centimeter screen of a separate cathode-ray oscilloscope, the horizontal scale giving the fre-

quency and the vertical, the voltage of the various components.

621.317.372 1851

A New Q-Meter—L. Liot. (*Télev. Franç.*, no. 20, supplement *Électronique*, pp. 6–7; December, 1946.) Describes the principles and operation of the Aschen meter. For the original account see 1850 above.

621.317.39:531.76 1852

The Measurement of Small Time Intervals by Electrical Bridge Methods—L. U. Hibbard. (*Proc. I.R.E.* (Australia), vol. 7, pp. 18–19; December, 1946.) Abstract of a paper read before the Physics section of the 25th Congress of the Australian and New Zealand Association for the Advancement of Science. Wartime developments for radar equipments included a coarse and fine potentiometer with an accurately exponential law and a balanced amplifier for the bridge circuit output.

621.317.431 1853

B-H Meter for Samples of Small Cross-Sectional Area—E. C. Crittenden, Jr., C. S. Smith, Jr., and L. O. Olsen. (*Rev. Sci. Instr.*, vol. 17, pp. 372–374; October, 1946.) Displays on a cathode-ray oscilloscope the hysteresis loop of samples with cross sections of the order of 10^{-8} square centimeters.

621.317.6:621.396.619 1854

Direct-Reading Modulation Meter—D. W. Atchley, Jr. and R. E. Fricks. (*QST*, vol. 31, pp. 55–57, 146; February, 1947.) The meter makes use of the 1N34 germanium crystal diode, thus avoiding the necessity of power supplies and eliminating the triode amplifier stage. Uniformity of these crystal diodes renders individual calibration unnecessary.

621.317.6:621.396.619.11 1855

On an Amplitude Modulation Meter for Receiving Stations—S. M. Dasgupta. (*Electrotech.*, no. 19, pp. 64–68; December, 1946.)

621.317.7 1856

Trend and Development in Meters and Instruments—L. J. Matthews. (*Jour. I.E.E.* (London), part I, vol. 94, pp. 39–44; January, 1947.) Summary of the inaugural address by the chairman of the Institution of Electrical Engineers' Measurements section. Several types of instrument for measurement or control are included, though the main subject is electricity supply meters. For other accounts see *Electrician*, vol. 137, pp. 1225–1226; November, 1946; and *Engineer* (London), vol. 182, pp. 414–415; November 8, 1946.

621.317.7:621.396.677 1857

Radio-Frequency Measurements on Rhombic Antennae—W. N. Christiansen, W. W. Jenvey, and R. D. Carman. *A.W.A. Tech. Rev.*, vol. 7, pp. 131–144; December, 1946.) Two instruments are described for investigating performance. One is an impedance meter and the other is for measuring the radio-frequency current flowing in an elevated horizontal conductor. The use of these instruments is described and some typical results given.

621.317.71[:72]:621.396.694.015.33 1858

Pulse-Type Tester for High-Power Tubes—E. C. Easton and E. L. Chaffee. (*Electronics*, vol. 20, pp. 97–99; February, 1947.) For measuring simultaneously peak voltage and current for both plate and grid of a triode, when the grid current consists of very short pulses.

621.317.72.027.7 1859

Meter for High Voltage Measurement—H. Alfén and S. Eklund. (*Rev. Sci. Instr.*, vol. 17, pp. 353–356; October, 1946.) An instrument covering the range 2 to 100 kilovolts and using a capacitance voltage divider combined with a special automatic earthing device.

621.317.725 1860

Measuring Complex Components of Voltage—G. E. Pihl. (*Electronics*, vol. 20, pp. 128–131; February, 1947.) To the unknown voltage, assumed of sinusoidal wave form and reasonably good frequency stability, a relatively large reference voltage is added and the resultant is measured by an audio-frequency tube voltmeter arranged so that the component of the unknown voltage in phase with the reference voltage is measured directly. The phase of the reference voltage is then advanced by 90 degrees and the imaginary component is measured similarly. Circuit details and operation are described. Full scale range can be 1, 5, 10, or 50 volts, while the frequency range is 20 to 20,000 cycles.

621.317.725 1861

Super-Sensitive Voltmeter [WV-73A]—(*Radio*, vol. 31, pp. 28–29; January, 1947.) A Radio Corporation of America instrument combining a high-gain audio amplifier and diode rectifier in the meter circuit.

621.317.73.029.63 1862

Precision Impedance Measurement Apparatus for Decimetre Waves—H. Klausner. (*Brown Boveri Mitt.*, vol. 33, p. 223; August, 1946.) An accurately constructed Lecher-wire system with sliding bridge is used for the measurement of the reflection coefficient, from which the unknown impedance is easily calculated.

621.317.794.029.6 1863

Apparatus for Radiation Measurements on Metre and Decametre Waves—F. Carbenay. (*Compt. Rend. Acad. Sci.* (Paris), vol. 223, pp. 143–144; July 17, 1946.) A local generator produces a current equal in value to that in the receiving aerial, coil, or dipole to be measured; by means of a coupling circuit using toroidal coils. The wavelength of the coupling circuit is small compared with that of the wave to be measured, so that the mutual inductance between coupling circuit and aerial is effectively constant up to high frequencies. This mutual inductance is measured when the apparatus is calibrated. The coupling circuit includes a thermoelectric couple for current measurement. Operational details are discussed.

621.396.619.15.083 1864

Keying Monitors—W. A. Roberts. (*Wireless World*, vol. 53, p. 73; February, 1947.) Circuit diagram and description of a keying monitor which is in effect an audio-frequency oscillator with the high voltage "obtained by self-rectification of the signals radiated from the transmitting aerial and picked up by the monitor."

679.5:[621.315.616+539.4 1865

Thermosetting Plastics—(*Schweiz. Arch. Angew. Wiss. Tech.*, vol. 10, pp. 323–330; October, 1944.) Test methods standardized by the Swiss Society of Machine Constructors for measuring dielectric breakdown strength, dielectric constant and loss factor, coefficient of linear expansion, density, and modulus of elasticity.

537.533.72 1866

The Study of Very Small Structures with the Electron Microscope—L. de Broglie. (*Compt. Rend. Acad. Sci.* (Paris), vol. 223, pp. 490–493; September 30, 1946.) Further discussion of the effect of the impact of particles from the source on the object (see 1545 of June) shows that when the particles are sufficiently rapid to enable details of atomic structure to be discerned, they are liable to detach the atom from the parent body and even to modify its internal structure by withdrawing electrons. It would therefore appear that, even with microscopes using very-high-voltage protons, it will be impossible to see the structure of atoms.

537.533.73 1867

Measurements of the Relative Intensity in

- Electronic Debye-Scherrer Diagrams—S. v. Friesen and S. Lenander. (*Ark. Mat. Astr. Fys.*, vol. 33, part 4, section A, 16 pp., February 11, 1947. In English.) Measured intensity distribution differs widely from theoretical predictions; the difference is in the same direction as that found by Ornstein.
- 538.691:539.163.2 1868
An Inhomogeneous Ring-Shaped Magnetic Field for Two-Directional Focusing of Electrons and Its Application to β -Spectroscopy—N. Svartholm and K. Siegbahn. (*Ark. Mat. Astr. Fys.*, vol. 33, part 4, section A, 28 pp.; February 11, 1947. In English.) Dispersion and resolving power are included in a detailed account of the theory. Constructional details are given of a β -ray spectrograph using this focusing system.
- 539.16.08 1869
Types of Geiger-Müller Counters [Zählrohr und Spitzenzähler]—C. Brinkmann. (*Zeit. Instrum. Kde.*, vol. 64, pp. 46-64; January-March, 1944.)
- 539.16.08 1870
The Geiger-Müller Counter with a Hollow Anode—T. Mikhaleva. (*Jour. Phys. (U.S.S.R.)*, vol. 10, no. 3, p. 296; 1946.)
- 539.16.08 1871
Geiger-Müller Counter Characteristics in the Neher-Harper Circuit—K. Siegbahn. (*Ark. Mat. Astr. Fys.*, vol. 33, part 3, section B, 5 pp.; February 6, 1947. In English.) The marked effect of the pentode grid potential upon the characteristics of tube counters is shown graphically, and must be examined whenever a new size and type of Geiger-Müller counter is introduced into the circuit.
- 539.16.08 1872
The Theory of Misses in an Electromagnetic Numerator at the Output of a Dividing Scheme with a Geiger-Müller Counter—E. Berlovich. (*Zh. Eksp. Teor. Fiz.*, vol. 16, no. 6, pp. 547-552; 1946. In Russian, with English summary.)
- 539.16.08 1873
Statistics of Misses in Geiger-Müller Counters—E. Berlovich. (*Zh. Eksp. Teor. Fiz.*, vol. 16, no. 6, pp. 543-546; 1946. In Russian, with English summary.) A new formula for correcting for misses is derived, and existing theories are criticized.
- 550.83:621.317.49 1874
The Airborne Magnetometer—G. Muffly. (*Geophys.*, vol. 11, pp. 321-334; July, 1946.) A discussion of the problem of magnetic exploration for oil from an aircraft, with a detailed description of apparatus using an automatically-stabilized total-field magnetometer for continuous recording.
- 621.317.39:531.7 1875
Electric Amplification in Metrology—J. Villet. (*Rev. Sci. (Paris)*, vol. 83, pp. 114-117; February, 1945.)
- 621.318.572 1876
Measurement of High-Intensities with the Geiger-Müller Counter—C. O. Muelhouse and H. Friedman. (*Rev. Sci. Instr.*, vol. 17, pp. 506-510; November, 1946.) The maximum counting rate of a typical Geiger-Mueller counter may be extended to 100,000 per second by providing high pulse amplification. If a single large counter is replaced by a parallel combination of several small counters the limit of resolving power is set by the speed of the electronic counter.
- 621.318.572:519.283 1877
On the Distribution of Counts in a Counting Apparatus—N. Hole. (*Ark. Mat. Astr. Fys.*, vol. 33, part 3, section B, 8 pp.; February 6, 1947. In English.) Continuation of 3336 of 1946, giving further calculations on the statistical problems arising in connection with a counting apparatus receiving impulses with a known distribution of intervals.
- 621.318.572.015.33 1878
Final Stage of an Electronic Pulse Counter Registering Once for Any Number of Received Pulses—T. Kahan and A. Kwartiroff. (*Compt. Rend. Acad. Sci. (Paris)*, vol. 223, pp. 988-989; December, 1946.) Circuit arrangements with practical details are described whereby the received pulses, whatever their nature, are transformed into a series of identical pulses. An accumulation stage is then used to obtain a scale of the required order.
- 621.365 1879
Industrial Applications of High Frequency—H. Baumgartner. (*Brown Boveri Mitt.*, vol. 33, pp. 204-210; August, 1946.) Curves show the changes in permittivity and loss factor of several rubbers during high-frequency vulcanization, and of whitewood during high-frequency drying. Methods of case-hardening gear teeth are described and the results illustrated.
- 621.365.92 1880
Radio-Frequency Heating, with Special Reference to Dielectric Heating—J. H. Suker. (*Jour. I.E.E. (London)*, part I; vol. 94, pp. 55-56; January, 1947.) A general survey of the principles and methods of radio-frequency heating at present in use, and of the design of electronic radio-frequency power generators. Summary of an Institution of Electrical Engineers students' section paper.
- 621.38:6 1881
Electronics in Industry—H. A. Thomas. (*Elec. Rev. (London)*, vol. 140, p. 154; January 24, 1947.) Summary of an Institution of Electrical Engineers paper. For another account see 1531 of June.
- 621.38:621.317.7 1882
Electronics in Measurements—R. J. Kryter. (*Elec. Eng.*, vol. 66, pp. 31-35; January, 1947.) The advantages and limitations of electronic methods are discussed and some typical applications to measurements not otherwise possible are described.
- 621.38.001.8:667.64 1883
Electrostatic Painting—V. Zeluff. (*Sci. Amer.*, vol. 175, pp. 252-254; December, 1946.) Equipment and technique using electrostatic fields to control paint particles and so prevent waste and excess deposits on objects being sprayed.
- 621.384.6 1884
20-Million-Volt Betatron—(*Mech. Eng.*, vol. 69, pp. 34-35; January, 1947.) The first betatron to be used for industrial radiographic inspection has recently been installed at the Picatinny Arsenal, Dover, New York.
- 621.384.6 1885
Largest Cyclotron Ready for Service—(*Mech. Eng.*, vol. 69, p. 84; January, 1947.) The 184-inch University of California cyclotron is now ready for service and is expected to produce protons with an energy of 3.5×10^8 electron volts, and α particles of 4×10^8 e. v.
- 621.384.6:621.317.311 1886
A Cyclotron Beam Current Integrator and Recorder—E. A. Hamacher. (*Rev. Sci. Instr.*, vol. 17, pp. 364-368; October, 1946.)
- 621.384.6:621.396.611.4 1887
The Study of a Certain Type of Resonant Cavity and Its Application to a Charged Particle Accelerator—Akeley. (*See* 1708.)
- 621.385.83.032.29 1888
High Current Electron Guns—Field. (*See* 1967.)
- 621.385.833 1889
Report of the Electron Microscope Society of America's Committee on Resolution—W. G. Kinsinger, J. Hillier, R. G. Picard, and H. W. Zieler. (*Jour. Appl. Phys.*, vol. 17, pp. 989-995; December, 1946.)
- 621.386 1890
A Survey of Engineering Radiography—V. E. Pullin. (*Engineer (London)*, vol. 183, pp. 40-42; January 10, 1947.) A general account of the application of X rays to the inspection of light alloy castings, steel castings, fuses, welds, and complex assemblies.
- 621.392.029.63:535.33 1891
Microwave Spectroscopy—(*Radio*, vol. 31, p. 26; January, 1947.) For spectrochemical analysis of vapours, using wavelengths from 1.2 to 1.6 centimeters. The vapour under test is sealed in a wave guide excited by an oscillator swept in synchronism with the horizontal sweep of a cathode-ray oscilloscope. The output of the crystal detector gives vertical deflections for the various characteristic absorption bands.
- 621.396:539.172.4 1892
Electronics—Workhorse at Bikini—(*Elec. Eng.*, vol. 66, pp. 6-10; January, 1947.) Description of instrumental work associated with the Bikini atom bomb tests. In order to discover the causes as well as the effects of damage to standard military equipment, arrangements were made for (a) direct observation by television of the blast and its effects, including wave heights; (b) telemetering of air and water pressures and radio activity; (c) study of electromagnetic wave effects including radio and radar monitoring; and (d) precise measurement of the relative timing of explosion phenomena. Drone boats were guided into the contaminated area by remote control. Summary of papers presented by D. G. Fink and T. D. Hanscome at a joint meeting of the American Institute of Electrical Engineers (New York section), the New York section of The Institute of Radio Engineers, and the Radio Club of America.
- 621.396.615.029.58:545.38 1893
Use of High-Frequency Oscillators in Titrations and Analyses—F. W. Jensen and A. L. Parrack. (*Ind. and Eng. Chem. (Analytical Edition)*, vol. 18, pp. 595-599; October, 1946.) Changes of the ionic or dipole content in ionized or unionized solutions are observed by means of the changes in anode current of a 15-megacycle oscillator with tuned anode and tuned grid, the liquid being in a container placed inside the anode coil. The method gives sharp indication and has the advantage that no electrodes are inserted in the liquid.
- 621.396.96:371.3:534.321.9 1894
 H_2S Trainer—Dummer. (*See* 1797.)
- 621.398:621.396.933 1895
Electronic Communication for Telemetering—L. L. Rauch. (*Electronics*, vol. 20, pp. 114-120; February, 1947.) A method of time-division multiplexing wherein short samples of the various instrument or gauge readings are converted into pulse signals and transmitted in cyclic serial order over a frequency-modulation radio link. 18 channels can each be sampled 952 times per second. A master pulse generator controls broken-ring trigger stages. The main application is to flight tests of new or pilotless aircraft.
- 621.791.76 1896
Conversion of Energy into Heat During the Transient Stage in Resonant Circuits. Application to Electric Welding—D. Genkin. (*Compt. Rend. Acad. Sci. (Paris)*, vol. 223, pp. 140-141; July 17, 1946.) If the circuit has only resistance and inductance the quantity of heat released at a point weld in the first 3 to 5 cycles depends on the phase of the electromotive force at the instant of closing, so that some welds are burned while others are insufficiently welded. With a capacitor connected in series and tuned to

resonance with the supply frequency the heat developed increases regularly with the time whatever the phase of the electromotive force and hence much better control of spot welding is possible.

537.533.72+621.385.833 1897

The Electron Microscope [Book Review]—E. F. Burton and W. H. Kohl, Reinhold Publishing Corp., New York, N. Y., second edition, 1946, 325 pp., \$4.00 (*Rev. Sci. Instr.*, vol. 17, pp. 441-442; October, 1946.) The second edition, with the text rearranged and many parts rewritten to produce a greatly improved volume. The book is addressed essentially to the nontechnical reader.

621.386:620.11 1898

Engineering Radiography [Book Review]—Emmott and Co., Manchester, 57 pp., 2s 6d. (*Electrician*, vol. 138, p. 134; January 10, 1947. "Mechanical World" Monograph No. 26.) An introduction to the application of X rays and gamma rays to analysis and inspection.

PROPAGATION OF WAVES

538.569.4.+621.396.812].029.64:551.51 1899

Atmospheric Absorption Measurements with a Microwave Radiometer—Dicke, Beringer, Kyhl, and Vane. (*See* 1843.)

621.3.011.5.029.5/.6]:631.437 1900

Dielectric Properties of Indian Soils at High and Medium Radio-Frequencies—S. R. Khastgir, J. N. Ray, and A. Banerjee. (*Indian Jour. Phys.*, vol. 20, pp. 119-147; August, 1946.) Dielectric properties of various soils and their variation with packing, moisture content, and frequency of alternating field are examined by differential transformer and oscillographic methods. Theory and experimental procedure are given. The constants of soils from various parts of India are compared.

621.396.11 1901

Solution of the Problem of Propagation of Electromagnetic Waves along the Earth's Surface by the Method of Parabolic Equation—M. Leontovich and V. Fock. (*Zh. Eksp. Teor. Fiz.*, vol. 16, no. 7, pp. 557-573; 1946.) Application of Leontovich's parabolic equation method to a plane earth leads to the well known Weyl-van der Pol formula; applied to a spherical surface it gives the formula Fock obtained by infinite summation of a more rigorous solution.

621.396.11 1902

On the Propagation of Radio Waves Along an Imperfect Surface—E. Fienberg. (*Jour. Phys. (U.S.S.R.)*, vol. 10, no. 5, pp. 410-418; 1946.) Formulas are derived for the field perturbation and change of direction of propagation produced by a surface composed of sea, a linear shore slope, and land of finite conductivity. A term representing the effect of the transition zone must be added to equations previously used in the treatment of coastal refraction. Experiments are discussed. For parts 1, 2, and 3 see 2529 of 1945 and 1962 of 1946.

621.396.81.029.64 1903

Millimetre Wave Propagation—H. R. L. Lamont and A. G. D. Watson. (*Nature (London)*, vol. 158, pp. 943-944; December 28, 1946.) Propagation tests over sea at wavelengths of 5.81 and 6.35 millimeters are described and received signal versus distance curves given. At wavelengths of 5.81 millimeters, the results indicate an atmospheric absorption of about 1.5 decibels per kilometer. At wavelengths of 6.35 millimeters the mean level closely follows the expected inverse distance law. From laboratory experiments at 8.7 millimeters, the reflection coefficient of a plane sea surface for grazing angles is between 0.88 and 0.97. See also 3396 of 1946.

621.396.812:551.510.535 1904

Radio Waves and the Ionosphere—Howe. (*See* 1779.)

621.396.812+551.510.535 1905

Echoes on Short Waves at Low Altitude—Jouaust. (*See* 1776.)

621.396.812.4:551.510.535 1906

The Validity of Ionospheric Forecasts—T. W. Bennington. (*B.B.C. Quart.*, vol. 1, 9 pp., reprint. October, 1946.) A general article on the prediction and use of optimum working frequencies (O.W.F.), assessed as 15 per cent below the maximum usable frequency (MUF). MUF predictions are based on normal ionospheric and solar variations, and are plotted as ionospheric contour charts on a Mercator projection, the surface of the earth being covered in three zones. Increased knowledge of the effects of sporadic-E ionization may lead to the provision of sporadic-E contour charts for use in conjunction with ionospheric contour charts. Sudden ionospheric storms are described, and the difficulty of forecasting them is pointed out.

621.392.52+[548.0:538.3 1907

Wave Propagation in Periodic Structures—Electric Filters and Crystal Lattices [Book Review]—L. Brillouin. McGraw Hill Book Co., New York and London, 1946, 247 pp., 20s. (*Nature (London)*, vol. 158, p. 926; December 28, 1946.) The propagation of waves in two- and three-dimensional lattices and the filtering properties of such systems are discussed. The application of the same mathematical treatment to problems of pure physics is also explained.

621.385.3+621.396.694]:621.396.645 1908

Grounded-Grid Technique—Knowles. (*See* 1965.)

621.394/.397].822:530.162 1909

Study of Fluctuations Produced by the Shot Effect in Amplifiers—Blanc-Lapierre. (*See* 1841.)

621.396.6 1910

A Quiet Break-In System—C. L. Robinson. (*QST*, vol. 31, pp. 33-35, February, 1947.) A description of a smooth receiver-silencing system.

621.396.61/.62 1911

Operating the BC-645 on 420 Mc—Ralph and Wood. (*See* 1957.)

621.396.62:621.396.611.21 1912

Receiver with Automatic Tuning and Quartz Control—A. V. J. Martin. (*Radio en France*, no. 1, pp. 17-18; 1947.) A receiver circuit is described, with detailed diagram, using quartz control of the local-oscillator frequency. The input circuit is tuned to different stations by means of pre-set capacitors.

621.396.621+621.396.69 1913

New Methods of Radio Production—J. A. Sargrove. (*Jour. Brit. I.R.E.*, vol. 7, pp. 2-33; January-February, 1947.) Insulating plates are moulded into such a structural form that, when fully processed without manual aid, they contain the inductors, capacitors, resistors, potentiometer tracks, switch, and other terminations, together with conductor paths, in an interrelated and interconnected manner, the plate material forming the dielectric of the capacitors. Full details are given of the methods adopted for making connections through the plates for larger capacitors and inductances, fitting tube sockets, using the inside walls of the moulded cabinet for the larger resistors, etc. The manufacturing process is completely automatic. The plates, after infrared drying, sand blasting and cleaning to remove grit, are metallized on both sides by spraying and then surface-milled to remove all projections, leaving the metal only in the grooves and depressions. The resistors are added by graphite spraying

through stencils. Automatic timing ensures the accuracy of resistor values. Successive machines remove unwanted plastic, metal or graphite from holes, slots, etc., and insert metal sockets for tubes, electrolytic capacitors, loudspeakers, etc. The sockets are fixed permanently by a combined riveting, welding, and soldering operation. After electrical overload tests and thermal aging the plates are lacquered, dried and passed to a conveyor belt where other parts are added, some manually. Automatic testing is applied at every stage of the process. Failure of any stage shuts down all previous ones. After a final radio signals test, the completed sets are automatically packed and sealed. The complete outfit is known as **Electronic Circuit-Making Equipment** and has obviously wide applications to the speedy production of cheap, light-weight, and uniform communication apparatus of many types.

621.396.621 1914

Ekco Model A28—(*Wireless World*, vol. 53, pp. 54-56; February, 1947.) Test report on a table model receiver for alternating-current mains.

621.396.621.5:537.312.62 1915

Demodulation by Superconductivity—D. H. Andrews and C. W. Clark. (*Nature (London)*, vol. 158, pp. 945-946; December 28, 1946.) Demodulation of broadcast waves can be effected with superconducting bolometers of columbium nitride operated within certain temperature limits. Quality is comparable with that of good standard radio reception.

621.396.621.54 1916

Home-Constructed Communications Superhet—A. B. Wright. (*Short Wave Mag.*, vol. 4, pp. 470-478 and 546-551; October and November, 1946.) Constructional details for a receiver of conventional design suitable for amateur use.

621.396.621.54 1917

"Single-Span," a 4-Valve Single Range Superhet for A.C. Mains—V. Stuzzi. (*Radio Welt*, vol. 1, pp. 69-74; December, 1946.) The range is 200 to 2000 meters, without switching. Constructional and circuit details are given.

621.396.662:621.396.62 1918

Tuning Devices for Broadcast Radio Receivers—R. C. G. Williams. (*Jour. I.E.E. (London)*, part I, vol. 94, pp. 59-61; January, 1947.) Summary of 1194 of May.

621.396.8.015.33:621.396.82 1919

A Theoretical Comparison of the Visual, Aural, and Meter Reception of Pulsed Signals in the Presence of Noise—J. H. Van Vleck and D. Middleton. (*Jour. Appl. Phys.*, vol. 17, pp. 940-971; November, 1946.) The paper gives detailed theoretical studies of the dependence of the sensitivity of the three methods on various parameters including the width and shape of the intermediate-frequency response, the pulse length, the pulse-recurrence frequency and, in aural or meter reception, the duration of the gate, the width of the audio filter, and the time constant of the meter.

621.396.812.3 1920

Diversity Reception—Z. Jelonek, E. Fitch, and J. H. H. Chalk. (*Wireless Eng.*, vol. 24, pp. 54-62; February, 1947.) The diversity gain is a measure of the permitted reduction of signal level for a given fractional time loss of signal when more than one signal is used. This is evaluated for two- and three-signal systems, assuming independent fading with a Rayleigh or a square-law probability-integral function. The bivariate Gaussian distribution is used to study the case of correlated two-signal fading. Experimental data on fading are given for ionospheric waves and for centimeter wave propagation over long paths.

- 621.396.82:523.5 1921
Radar Detection of Meteor Trails—Appleton and Naismith. (See 1752.)
- 621.396.821:551.594.221 1922
The Nature and Variation of Atmospheric Discharges Caused by Lightning—Norinder and Stoffregen. (See 1784.)
- 621.396.822.029.63:523.72 1923
Solar Radiation at 480 Mc/s—Reber. (See 1760.)
- 621.396.828:061.3 1924
Radio Interference—(Wireless World, vol. 53, p. 67; February, 1947.) Brief note of an international conference in London called by the British Standards Institution to consider radio interference suppression.
- 621.396.828:551.508 1925
Reduction of Radio Interference from Meteorological Installations—R. L. Ives. (Bull. Amer. Met. Soc., vol. 27, pp. 59–61; February, 1946.) Interference is of three types, stray magnetic fields, low-frequency oscillations and radio-frequency oscillations. Methods for its reduction are given.
- 621.396.828:621.396.645.029.3 1926
Hum in High-Gain Amplifiers—Baxandall. (See 1689.)
- STATIONS AND COMMUNICATION SYSTEM**
- 621.39+534.756 1927
Theory of Communication—D. Gabor. (Jour. I.E.E. (London), part I, vol. 94, p. 58; January, 1947.) Summary of 1057 of May.
- 621.396.215 1928
Transmitter-Receiver Broadcasting System with Two Channels on a Single Carrier Wave—J. Donnay. (Radio en France, no. 4, pp. 3–5, 1945; and no. 1, p. 18; 1946.) A rectangular signal with frequency of the order of 10 to 40 kilocycles is applied to the transmitter; the positive and negative half-cycles cut out the audio modulation for the first and second channels, respectively. At the same time the amplitude of the crests of the rectangular signal is modulated by the audio frequency to be transmitted on each channel. A signal of complex modulation is thus obtained which can be used for the transmission of two programs. A suitable discriminating system in the receiver allows program selection. In practice it is found preferable to separate the positive and negative crests by short quiescent periods.
- 621.396.24.029.63/.64 1929
Problems of Intelligence [Speech or Music] Transmission on Microwaves—H. J. v. Baeyer. (Brown Boveri Mill., vol. 33, pp. 198–203; August, 1946.) A general discussion, with special treatment of the problems of generation, transmission and reception of wavelengths between 2 and 20 centimeters. Comparison is made between single channel audio and frequency modulation, multichannel methods using frequency transposition for each channel, and pulse modulation systems. The latter are particularly suitable when the number of channels is large.
- 621.396.44 1930
Development and Present Position of Multichannel Directional Technique—E. Huber. (Brown Boveri Mill., vol. 33, pp. 182–185; August, 1946.) From a discussion of possible systems it is concluded that for a small number of channels (up to about 12) an adaptation of cable carrier-frequency technique gives the best results. A short description is given of two equipments, one providing two telephone and two telegraph channels (a modification of the military equipment described in 1937 below) and the other six telephone channels, frequency modulation being used in both sets.
- 621.396.61/.62/.029.64 1931
Dishing Out the Milli-watts on 10 kMc—J. A. McGregor. (QST, vol. 31, pp. 58–61, 148; February, 1947.) The transmitter uses a type 723A/B valve and gives about 35 milli-watts. With a 30-inch parabolic reflector and dipole aerial, very strong signals were obtained at a range of 2 miles, using a Hallicrafter S-29 portable receiver.
- 621.396.619.16 1932
The Application of Pulse Technique to Broadcasting—H. L. Kirke. (B.B.C. Quart., vol. 1, 6 pp., reprint, October, 1946.) If the pulse amplitude in the receiver is limited, the signal-to-noise ratio is proportional to the steepness of the sides of the pulse provided the bandwidth passes the pulse without distortion. The pulse duration determines the ratio of the pulse-recurrence frequency to the highest audio frequency transmitted. A comparison with other systems shows that for a high-fidelity, low-noise service, pulse modulation is inferior to frequency modulation. The apparatus for a single-transmitter, multichannel system is simple but a greater bandwidth is required than for a frequency modulation system with separate transmitter. There is also a danger of cross talk in the pulse-modulation system due to multipath transmission.
- 621.396.619.16 1933
Pulse Time Modulation—P. Güttinger. (Brown Boveri Mill., vol. 33, pp. 188–192; August, 1946.) The general principles of pulse modulation, and particularly of pulse time modulation, are explained. Broad frequency bands are required if this method is to be used to the greatest advantage, so that its main application is to microwaves. It also enables interference effects to be reduced considerably, as with frequency modulation. A special feature of the system described gives a linear relation between the pulse lengths and the modulation values at fixed and equal time intervals which do not depend on the modulation process.
- 621.396.712:621.396.81 1934
Site Selection and Field Intensity Surveys for Broadcasting Stations—R. Gill. (Proc. I.R.E. (Australia), vol. 7, pp. 7–21; November, 1946.) The basic coverage requirements of a medium-wave broadcasting station are outlined and the factors governing the service area of such a station are examined. Survey procedure is described, with typical examples. The requirements for the siting of transmitters for frequency modulation very-high-frequency operation are discussed and details given of a survey in the Sydney area using a mobile very-high-frequency transmitter.
- 621.396.72.029.62 1935
First Steps on Five [Metres]—J. Hum. (Short Wave Mag., vol. 4, pp. 541–545; November, 1946.) Reconstruction of existing equipment to obtain a superheterodyne converter, a beam aerial, and a transmitter for 58-megacycle amateur use.
- 621.396.72.029.63 1936
Simple Decimetre Directional Equipment—R. Schüpbach. (Brown Boveri Mill., vol. 33, pp. 181–182; August, 1946.) The set comprises transmitter, receiver, and supply units; works on a fixed frequency in the range 300 to 330 megacycles and with a transmitter power of 1 to 2 watts has a working range up to 10 kilometers.
- 621.396.73.029.63 1937
Portable Decimetre Equipment for Military Directional Links—R. Schüpbach. (Brown Boveri Mill., vol. 33, pp. 178–181; August, 1946.) The transmitter and receiver are of unit construction and operate in the range 330 to 355 megacycles with a transmitter frequency modulation of ± 75 kilocycles. With relay sta-
- tions good communication is achieved at distances of several hundred kilometers.
- 621.396.75 1938
Directional Communication System—H. Köhler. (Radio Welt, vol. 1, pp. 64–69; December, 1946.) A general account of basic principles, aerial systems, transmitting and receiving equipment.
- 621.396.9.029.63 1939
Interesting Applications of Decimetre Waves in the Communications and Remote Supervisory Control Fields—R. Schüpbach. (Brown Boveri Rev., vol. 32, pp. 453–456; December, 1945.) A survey of many possible uses of equipment at wavelengths in the region 0.8 to 1.5 meters, which have definite advantages, particularly for beam transmission.
- 621.396.932 1940
Naval Radio Gear—G. M. Bennett. (Wireless World, vol. 53, pp. 62–64; February, 1947.) Details of British naval communication systems used in large warships.
- 621.396.96:621.396.82 1941
Radar Reflections from Long Conductors—Bloch, Hamermesh, and Phillips. (See 1687.)
- 621.396.97(54) 1942
Ultra Short Waves to Replace Medium Waves for Regional Broadcasting in India—S. P. Chakravarti. (Electrotech., no. 19, pp. 5–18; December, 1946.) A review of the broadcasting policy of India, and a comparison between medium and ultra-short waves is made. The problems of ultra-high-frequency regional broadcasting are discussed and the advantages of ultra-short waves for dual program transmission are stated. Finally, a scheme for India using 70 stations each of $\frac{3}{4}$ kilowatt power working in the frequency range 60 to 150 megacycles is suggested.
- 621.396.97.029.6:621.396.619 1943
Broadcasting at V.H.F.—T. Roddam. (Wireless World, vol. 53, pp. 70–71; February, 1947.) The relative merits of audio, frequency, and pulse modulation for very-high-frequency broadcasting are considered. In the present state of knowledge, no one of these systems should be adopted to the exclusion of the others.
- SUBSIDIARY APPARATUS**
- 621.3.032.53:621.51/.52 1944
Hermetic Seals and Bushes—United Insulator Co. (Jour. Sci. Instr., vol. 23, pp. 272–273; November, 1946.) Ceramic bushes are metallized both round a shoulder, to allow soft-soldering to a metal container, and on one end, for soldering a lead-in wire or metal insert. They will withstand vacuum and pressures over 30 pounds per square inch and have high flash-over voltage and insulation resistance.
- 621.314.5 1945
Development of 150 Watts D.C.-A.C. Vibro-Converter of 50 Cycles per Second Fundamental Frequency—R. N. Dewan. (Electrotech., no. 19, pp. 81–88; December, 1946.) To convert 110/220 volts direct-current mains to 110/220 volts single-phase alternating current of square-topped waveform having a fundamental frequency of 50 cycles. Extends work previously noted in 754 of 1946.
- 621.314.6+621.319.4+621.383]:669.018 1946
Light Alloys in Metal Rectifiers, Photocells, and Condensers—Continuing the series in light metals mentioned in 1593 of June and back references.
(xxii) Vol. 9, pp. 372–378; July, 1946. Finishing processes in the manufacture of fixed paper capacitors, and certain more recent developments in dielectric and impregnating media.
(xxlii) Vol. 9, pp. 408–413; August, 1946.

Aluminum and pigmented cellulose lacquers and enamels, with special reference to corrosion resistance and durability tests.

(xxiv) Vol. 9, pp. 517-524; October, 1946. Methods of identification marking of fixed paper capacitors, and inspection systems and testing techniques before dispatch.

(xxv) Vol. 9, pp. 637-642; December, 1946. The use of plastic film in place of paper and mica in the construction of fixed capacitors.

621.316.93 1947
Lightning Protection—R. C. Cuffe. (*Elec. Rev.* (London), vol. 139, p. 1011; December 20, 1946.) Abstract of a paper presented at a meeting of the transmission section of the Institution of Electrical Engineers.

621.317.755 1948
A Universal Oscillograph—G. L. Hamburger. (*Electronic Eng.*, vol. 19, pp. 7-10, 22 and 51-57; January and February, 1947.) A full account of the design of a laboratory instrument of great versatility, with complete circuit diagram, table of components, and constructional details. A direct sweep with 5 to 30 per cent flyback and a repetition rate of 0.5 to 275,000 cycles is used and an elliptical time base is also incorporated. Voltage calibration of the trace is direct-reading from 100 millivolts to 200 volts for both alternating and direct current. The operator can calibrate adjustable audio frequencies up to about 10 kilocycles in terms of mains frequency. Mechanical features include a retractable terminal panel and division of the instrument into two main chassis, connected by a hinge, so that all parts are easily accessible.

621.385.832 1949
Origin of Trapezoidal Distortion in Cathode-Ray Oscillographs—A. Cazalas. (*Compt. Rend. Acad. Sci.* (Paris), vol. 223, pp. 27-28; July 1, 1946.) Experiments show that the distortion is due more particularly to stray lines of force from the ends of the plates which are located furthest from the source. Correction of the effect has been achieved by (a) making these plates circular, the center of the circle being on the axis around which the beam of electrons turns when it is deflected by the other plates; and (b) introducing between the two pairs of plates a cylindrical screen, concentric with the above circle, maintained at the final anode potential and having a window to allow passage of the beam.

621.394.652 1950
Telegraph Key Design—(*Wireless World*, vol. 53, p. 61; February, 1947.) Abstract of article previously noted in 1232 of May.

621.396.682:621.316.722.078.3.029.6 1951
Power Supply for Microwave Equipment—O. Hoag. (*Electronics*, vol. 20, pp. 110-113; February, 1947.) An electronically controlled servo motor adjusts an auto-transformer. Voltage can be varied between 300 and 5000 volts with less than 3 millivolts ripple in the direct current output.

TELEVISION AND PHOTOTELEGRAPHY

621.397.5:621.385.83.032.29 1952
Electron Guns for Television Application—Morton. (*See* 1968.)

621.397.62 1953
Television Receiver Construction (Part 2)—(*Wireless World*, vol. 53, pp. 40-42; February, 1947.) Construction and winding data for line deflector coils. For part 1 see 1245 of May.

621.397.621 1954
Image Quality and Definition—P. Hémandinquer. (*Télev. Franç.*, no. 10, pp. 17-18, 22; February, 1946.) Discusses the optimum results to be expected from a 450-line system. Comparison is made with photographic reproduction.

621.394.652 1955
Telegraph Key Design—(*See* 1950.)

621.394.652:621.394.141 1956
The Electroplex—a New Automatic Key—Dixon. (*See* 1699.)

621.396.61/62 1957
Operating the BC-645 on 420 Mc/s—J. T. Ralph and H. M. Wood. (*QST*, vol. 31, pp. 15-21; February, 1947.)

621.396.611.33:621.396.671 1958
Matching Ranges [Plages d'Adaptation] of Transmitters—D. Glazer and V. Familier. (*Onde Élec.*, vol. 26, pp. 430-437; November, 1946.) A transmitter is to be matched to an aerial of resistance R and reactance jX . For a particular frequency f , the possible pairs of values of R and X form an aggregate which is called the matching range (plage d'adaptation). In the general case where f , R , and X all vary, the matching range will be a skew surface when the coupling system has only one degree of freedom, and a volume when it has two degrees of freedom. A method is given, with numerical examples, for determining this matching volume for direct inductive coupling.

621.396.619.13 1959
Frequency Modulator—G. G. Bruck. (*Electronics*, vol. 20, pp. 166-170; January, 1947.) Reactance tubes, double diode demodulator, and inverse feedback loop for linearity and midfrequency control are here combined into a single unit.

621.396.645.36 1960
150 Watts Push-Pull—Thomas. (*See* 1716.)

VACUUM TUBE AND THERMIONICS

621.383.4+546.28 1961
A New Bridge Photo-Cell Employing a Photo-Conductive Effect in Silicon. Some Properties of High Purity Silicon—G. K. Teal, J. R. Fisher, and A. W. Treptow. (*Jour. Appl. Phys.*, vol. 17, pp. 879-886; November, 1946.) A method is described for making bridge-type photocells by reaction of silicon tetrachloride and hydrogen gases at ceramic or quartz surfaces at high temperatures. The maximum photo-sensitivity occurs at 8400 to 8600 angstroms. The sensitivity is about equivalent to that of the selenium bridge; the silicon cell is far more stable and rapid in response. From measurements of the electronic conductivity of silicon as a function of temperature, it is concluded that the same electron bands are concerned in the photoelectric, optical, and thermal processes. The low values of specific conductances found (1.8×10^8 mho per centimeter) are ascribed to high purity of the silicon, not polycrystalline structure.

621.383.5.032.21:537.533 1962
The Emission of Electrons by Active Semi-Conducting Cathodes—N. D. Morgulis. (*Bull. Acad. Sci.* (U.R.S.S.), sér. phys., vol. 5, nos. 4-5, pp. 536-545; 1941. In Russian with English summary.) Survey of fundamental data concerning various properties of cathodes, used as thermoemitters, photoemitters, and secondary-electron emitters.

621.385:519.283 1963
Electron Tube Quality Control—J. R. Steen. (*Radio*, vol. 31, pp. 16-19; January, 1947.) A survey of modern methods of control by sample testing.

621.385:621.317.723 1964
Improvements in the Stability of the FP-54 [Pliotron] Electrometer Tube—J. M. Lafferty and K. H. Kingdon. Full paper, a summary of which was abstracted in 583 of March.

621.385.3+621.396.694:621.396.645 1965
Grounded-Grid Technique—R. Knowles. (*Short Wave Mag.*, vol. 4, pp. 536-540 and 603-

608; November and December, 1946.) The uses of the grounded-grid triode as a radio frequency or power amplifier, as an oscillator, or in audio-frequency amplifiers are discussed. Stage gain, matching, and circuit and constructional details are considered practically. Circuit values are given for a 58-megacycle radio-frequency receiver amplifier. Characteristics of commercial tubes suitable for grounded-grid working are tabulated.

621.385.3:621.396.694.012.8 1966
The Equivalent Diode—W. E. Benham. (*Wireless Eng.*, vol. 24, p. 62; February, 1947.) Comment on 949 of April.

621.385.83.032.29 1967
High Current Electron Guns—L. M. Field. (*Rev. Mod. Phys.*, vol. 18, pp. 353-361; July, 1946.) The limitations in high-current electron-gun design include a maximum permissible current density, thermal velocities of emission, cathode poisoning, ion bombardment, and anode heating. Single and multiple electrostatic guns, and combined electrostatic and magnetic field guns are described, with their relative advantages and limitations.

621.385.83.032.29:621.397.5 1968
Electron Guns for Television Application—G. A. Morton. (*Rev. Mod. Phys.*, vol. 18, pp. 362-378; July, 1946.) A description of the iconoscope, orthicon, image orthicon, and the various electron guns used. A two-lens system is used in the iconoscope, and a low-velocity magnetically-focused beam in the orthicon systems. Diagrams are given for several types of commercial electron guns.

621.396.615.1:537.58 1969
Effect of Space Charge on the Frequency of Oscillation in Positive-Grid Oscillators—C. Yeh. (*Chin. Jour. Phys.*, vol. 6, pp. 79-84; July, 1946.) The effect of the nonuniformity of the interelectrode field in a planar Barkhausen-Kurz tube due to space charge results in a frequency about 10 to 20 per cent lower than in the absence of a space charge.

MISCELLANEOUS

001.4 1970
The Use of Standard Terms and Symbols—G. W. O. H. (*Wireless Eng.* vol. 24, p. 34; February, 1947.) Several examples of confusion caused by slipshod use of symbols are given. See also 960 of April.

519.283:621.385 1971
Electron Tube Quality Control—Steen. (*See* 1963.)

621.3.016.25 1972
The Sign of Reactive Power—E. W. Kimbark, H. K. Sels, R. H. Lindsay, G. A. Irland, W. V. Lyon. (*Elec. Eng.*, vol. 66, pp. 107-110; January, 1947.) Further comment on 971 of April; see also 1289 of May. Agreement is expressed with the recommendation that the previously adopted sign of reactive power should be changed, but comment is made on some of the definitions suggested.

621.39:371.3]+621.315.6 1973
The War-Time Education and Training of Radio Personnel and Recent Developments in Dielectric Materials—W. Jackson. (*Jour. I.E.E.* (London), part I, vol. 94, pp. 26-34; January, 1947; and part III, vol. 94, pp. 2-10; January, 1947.) Details are given of the courses organized by the Wireless Personnel Committee for radio and wireless mechanics, radio officers, and of a post-graduate course in high vacua and electronics.

The structure of carbon, silicon, and titanium compounds, and its relation to their dielectric properties, is considered in detail. Summaries of this paper were noted in 314 of February.

Let's get together

YOU have the

WE have the spring materials

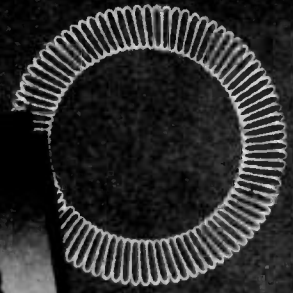

Whatever combination of conditions your springs must fight...

CORROSION • RUST • HEAT • COLD • HIGH STRESS • FATIGUE

Whatever type of spring you need...

COMPRESSION • EXTENSION • TORSION • SPIRAL • FLAT • CLIP • RETAINER • GARTER • BANANA

Consider these alloys first...

MONEL* • "K" MONEL* • INCONEL* • "Z" NICKEL* • NICKEL

There is no need to put up any longer with repeated troubles that can be avoided by using INCO Nickel Alloy springs for corrosive conditions and elevated or sub-zero temperatures.

Now, rustless, high-strength springs can be made of five different INCO Nickel Alloys to withstand corrosive attack and temperatures up to 750°F. or even higher.

And they cost so much less than special alloy springs that it is practical to use them for any application where heat, corrosion or fatigue are causing you trouble with ordinary spring parts.

* Reg. U.S. Pat. Office

NICKEL  **ALLOYS**



HERE'S A CHANCE TO GET RID OF THE SPRING PROBLEM THAT HAS BEEN BOTHERING YOU

Send for "ANALYZING THE SPRING PROBLEM." When you get this simplified worksheet, jot down the data about your spring problem and what you want in a spring. The information you supply, plus our service records and test data, will enable us to judge which material can be recommended for your particular service. Then, we will cooperate with your spring manufacturer to work out the answer to your problem. That is all you need to do. Write today for "ANALYZING THE SPRING PROBLEM."

THE INTERNATIONAL NICKEL COMPANY INC. 37 WALL STREET, NEW YORK

AM-FM-TV

*...the ideal mike
for all 3*



Broadcasters keep on buying more and more of these popular Western Electric Cardioids. That's because they deliver quality performance, are attractive in appearance, and offer six pick-up patterns . . . omni-directional, bi-directional, true cardioid and three modified cardioid patterns . . . which enable you to master 'most any pick-up assignment in AM, FM, or Television broadcasting. For all-around *quality* of pick-up—there's *nothing better than a 639B Cardioid*. For full information, get in touch with your local Graybar Broadcast Representative or write Graybar Electric Co., 420 Lexington Avenue, New York 17, N. Y.

Western Electric 639B CARDIOID

*Performance... Appearance
...Versatility*

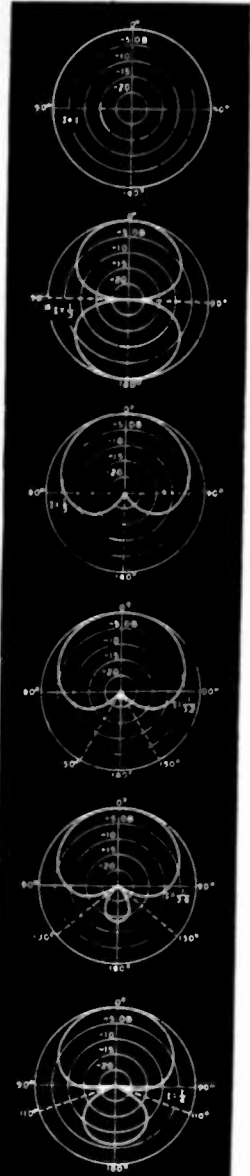

These six pick-up patterns are available with the 639B Microphone.



— Quality Counts —

SECTION MEETINGS

CLEVELAND

"Cosmic Noise," by J. W. Herbstreit, National Bureau of Standards; February 27, 1947.

"Underwater Sound Developments in World War II," by H. C. Williams, Ohio Bell Telephone Company; March 27, 1947.

"Applications of Electronic Generators," by G. P. Bosomworth and F. H. Mason, Firestone Tire and Rubber Company; April 24, 1947.

"Errors in Thermal Meters," by Messrs. Burger, Davies, and Glass of Christie Laboratories, Hickok Electrical Instrument Company, and National Carbon Company, respectively; May 8, 1947.

DALLAS-Ft. WORTH

"Duties and Functions of the Federal Communications Commission District Office No. 10," by J. H. Homsy, Engineer in Charge, District No. 10; April 29, 1947.

"RCA Television Demonstration," by T. Shipferling, RCA Field Television Project; May 2, 1947

NORTH CAROLINA-VIRGINIA

"The Westinghouse System of Frequency Modulation," by J. R. Boykin, Westinghouse Electric Company; May 9, 1947.

PHILADELPHIA

"Discussion and Demonstration of Projected Natural Color Television," by R. D. Kell and D. W. Epstein, Radio Corporation of America, RCA Laboratories Division; May 1, 1947.

Election of Officers; May 1, 1947.

PORTLAND

"The Civil Aeronautics Administration Instrument Landing System," by W. H. Curry, Civil Aeronautics Administration; May 8, 1947.

St. Louis

"Teleran, A System of Air Navigation and Traffic Control," by L. F. Jones, Research and Development Projects, Radio Corporation of America; April 24, 1947.

SUBSECTIONS

HAMILTON

"Hi-Quality' Sound Reproduction," by A. R. Leary, Northern Electric Company; May 5, 1947. Election of Officers; May 5, 1947.

WINNIPEG

Tour of Radio Station CKRC-Transmitting Plant conducted by B. Hooper, Chief engineer, CKRC; April 25, 1947.

MEMBERSHIP

The following transfers and admissions were approved on May 22, 1947, to be effective as of July 1, 1947:

Transfer to Senior Member

Anderson, H. W., 422 Charles St., Scotia 2, N. Y.
 Beegle, D. H., 2711 Lake Ave., Cheverly, Md.
 Bousky, S., 3725 Menlo Rd., Cleveland 20, Ohio
 Brown, B., F. A., Australian Military Mission, L2054 Navy Bldg., Washington 25, D. C.
 Burroughs, F. L., 70 Wilton St., New Hyde Park, L. I., N. Y.
 Campbell, V. H., Sylvania Electric Products, Inc., Emporium, Pa.

(Continued on page 36A)

ANDREW UHF ANTENNAS

assure maximum signal strength

Each of these six Andrew Antennas offers a balanced blend of: gain, impedance matching, bandwidth, directional properties and mechanical design as needed for a specific application. As is typical of the complete Andrew line, they do not concentrate on one feature to the exclusion of others. Backed by the experience of the pioneer specialists in antenna manufacture, these models assure maximum signal strength. Write today for complete details.



This is a Dielectric Antenna, with special directional properties for radar.



A "Yagi" array, highly directional with excellent impedance matching & bandwidth.

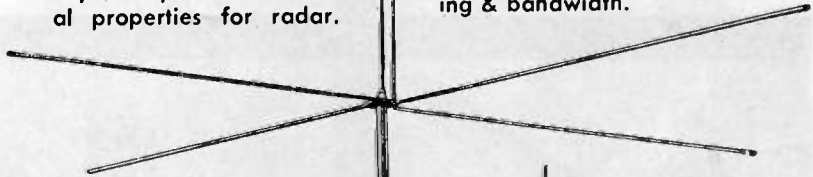

The Andrew Folded Unipole Antenna, ideal for transmitting or receiving, in the frequency range 30 to 174 MC.



A Coaxial Antenna for the amateur 2 meter band.

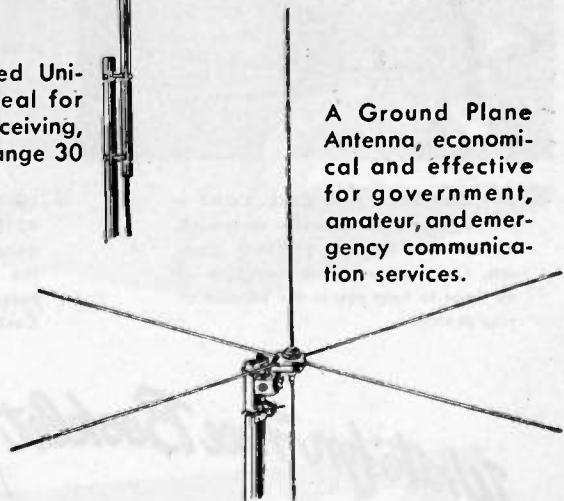

A Ground Plane Antenna, economical and effective for government, amateur, and emergency communication services.

The new Andrew Di-Fan Broad Band Antenna, for improved FM and TV reception.

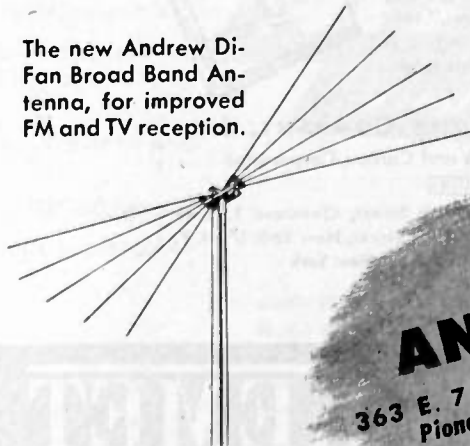

ANDREW
ANDREW CO.
 363 E. 75th St. • Chicago 19, Illinois
 Pioneer Specialists in the Manufacture
 of a Complete Line of Antenna
 Equipment

4 REASONS why you should specify "KIC" GETTERS



(Continued from page 35A)

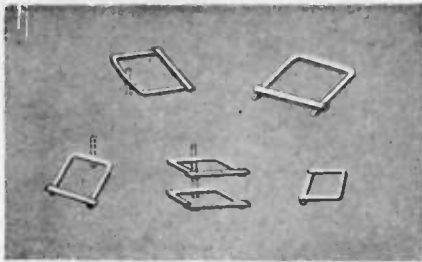

1. 50 ASSEMBLY TYPES. Kemet makes getter assemblies of barium, and of barium alloyed with magnesium, or with aluminum, or with both. These getter assemblies are produced in a variety of sizes and shapes designed to meet your specific requirements.

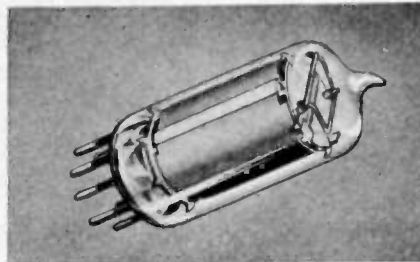

2. BETTER GAS CLEANUP. To adsorb residual gases most effectively, Kemet has designed the KIC getter assembly. This consists of a barium core protected by an iron sheath which promotes efficient dispersion of vaporized barium upon flashing.



3. AT YOUR BECK AND CALL. Kemet is always prepared to render on-the-job assistance to the user of KEMET products. Our engineers are available at all times to help you in the solution of your problems.



4. LOWERED TUBE COSTS THROUGH RESEARCH. In the search for superior gettering methods Kemet draws upon the experience and metallurgical research facilities of Units of Union Carbide and Carbon Corporation.

Write for Free Booklet

The 28-page booklet Z-1, "Getters and Gettering Methods for Electronic Tubes," tells how to overcome difficulties in gettering. It is recommended for designers of electronic tubes.

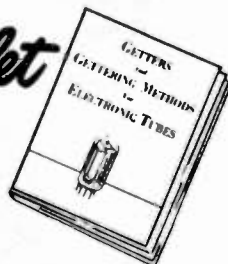

KEMET LABORATORIES COMPANY, INC.
Unit of Union Carbide and Carbon Corporation



Madison Avenue and West 117th Street, Cleveland 1, Ohio
Foreign Department—30 East 42nd Street, New York 17, N. Y.
Cable Address: Kemetlab, New York

KEMET and KIC are trade-marks of Kemet Laboratories Company, Inc.

KIC BARIUM GETTERS KEMET

- Cutrona, L. J., 576 Marcellus Rd., Williston Park, L. I., N. Y.
Dean, W. W. H., RCA Victor Company, Ltd., Montreal, P. Q., Canada
Griffing, B., 555 St. Paul Ave., Dayton Ohio (June 1 Election)
Kranz, H. E., 3893 Yorkshire Ave., Detroit 24, Mich.

Admission to Senior Member

- Allison, J. L., 418 Central Park West, New York 25, N. Y.
Barden, W. S., 105 Hillcrest Terr., Grasmere, S. I., N. Y.
Barstow, J. M., Bell Telephone Laboratories, Inc., 463 West St., New York 14, N. Y.
Beyer, J. W., Bell Telephone Laboratories, Inc., 463 West St., New York 14, N. Y.
Bhatt, N. B., Indian Institute of Science, Bangalore, India
Depp, W. A., Bell Telephone Laboratories, Inc., 463 West St., New York 14, N. Y.
DeTar, D. R., 19 Bogart Ave., White Plains, N. Y.
Dodge, S. W., 53 Cedar Lane, Princeton, N. J.
Doremus, J. A., 4949 Ainslie St., Chicago 30, Ill.
Edwards, P. G., Bell Telephone Laboratories, Inc., 180 Varick St., New York 14, N. Y.
Foster, R. F., 90 Eaton St., Stratford, Conn.
Galbraith, R. A., Electrical Engineering Department, Syracuse University, Syracuse, N. Y.
Hagey, W. C., 136 Dover Ave., LaGrange, Ill.
Hanchett, G. D., Jr., 14 Duncan St., Milburn, N. J.
Jones, A. B., 801 S. Royal St., Alexandria, Va.
Lewis, H. A., Bell Telephone Laboratories, Inc., 463 West St., New York 14, N. Y.
Lovoff, A., 1020—19 St., N.W., Washington 6, D. C.
Lynn, L. H., 351 Mildred Ave., Syracuse, N. Y.
Maxfield, J. P., Bell Telephone Laboratories, Inc., Murray Hill, N. J.
Metcalfe, D., 36 Trinity Place, Hewlett, N. Y.
Miller, W. J., 81 Market St., Annapolis, Md.
Minks, F. A., Bellemead, N. J.
Noyes, A. J., 23 Fernwood Place, Mountain Lakes, N. J.
Pande, A., RCA Laboratories, Princeton, N. J.
Richardson, W. M., 3514 Northampton St., N.W., Washington 15, D. C.
Ryan, A. H., U. S. Naval Research Laboratory, Anacostia Station, Washington, D. C.
Schooley, C. E., Room 2106, 32 Sixth Ave., New York 13, N. Y.
Smith C. A., 180 Varick St., New York 14, N. Y.
Smith, K. D., 871 Dorian Rd., Westfield, N. J.
Thatcher, E. W., 2661 Poinsettia Dr., San Diego 6, Calif.
Wedin, A. G., 1518 Phyllis Ave., Dayton 3, Ohio

Transfer to Member

- Appel, J. H., Jr., Chateau Rochambeau, Scarsdale, N. Y.
Ax, L. S., 411 E. Maumer, Angola, Ind.
Cohen, A. A., Engineering Research Association, 1902 W. Minnehaha Ave., St. Paul, Minn.
Davis, R. E., 4320 Nichols Ave., S.W., Washington, D. C.
Foster, J. C., 4001 N.E. 77 Ave., Portland, Ore.
Garretson, T. A., 105 State St., Perth Amboy, N. J.
Grayson, E. L., Engineering Products Department, RCA Victor Division, Camden, N. J.
Gresham, W. S., Jr., Station WISH, Indianapolis, Ind.
Harmon, W. R., 4079 Minnesota Ave., N. E., Washington, D. C.
Hastings, L. E., c/o Federal Communications Commission, Box 150, Miami, Fla.

(Continued on page 38A)

NOW

One INSTRUMENT FOR ELECTRONIC MEASUREMENTS

WESTON ELECTRONIC ANALYZER

Incorporating:

1. A conventional Volt-Ohm-Milliammeter with self-contained power source.
2. A high impedance electronic Volt-Ohmmeter using 115 volt, 60 cycle power.
3. A stable, probe-type, Vacuum Tube Voltmeter, for use to 300 megacycles.



Model 769

Accurate a-c measurements .25 volt to 120 volts, 50 cycles to 300 megacycles.

Extremely small R.F. Probe ($3\frac{1}{2}$ " x $\frac{3}{4}$ " dia.). Probe constants, 5 megohms paralleled by 5 mmfd., approx.

New unity gain d-c amplifier provides absolute stability with line voltage variations from 105 to 130 volts.

D-C Electronic amplifier ranges 3 to 1200 volts at 15 megohms, resistance ranges 3000 ohms to 3000 megohms.

Conventional 10,000 ohm per volt d-c ranges 3 to 1200 volts, 1000 ohm per volt a-c rectifier ranges 3 to 1200 volts.

Resistance ranges 3000 to 300,000 ohms where a-c power is not available.

Entire Model 769 protected from external RF influences.

Uses standard commercial types of tubes replaceable without recalibration.

Size only 10" x 13" x $6\frac{1}{8}$ ".

Full details from your local WESTON representative. Literature available... Weston Electrical Instrument Corporation, 589 Frelinghuysen Avenue, Newark 5, N. J.

WESTON

Instruments

ALBANY · ATLANTA · BOSTON · BUFFALO · CHARLOTTE · CHICAGO · CINCINNATI · CLEVELAND
DALLAS · DENVER · DETROIT · JACKSONVILLE · KNOXVILLE · LITTLE ROCK · LOS ANGELES
MERIDEN · MINNEAPOLIS · NEWARK · NEW ORLEANS · NEW YORK · PHILADELPHIA
PHOENIX · PITTSBURGH · ROCHESTER · SAN FRANCISCO · SEATTLE · ST. LOUIS
SYRACUSE · IN CANADA, NORTHERN ELECTRIC CO., LTD., POWERLITE DEVICES, LTD.

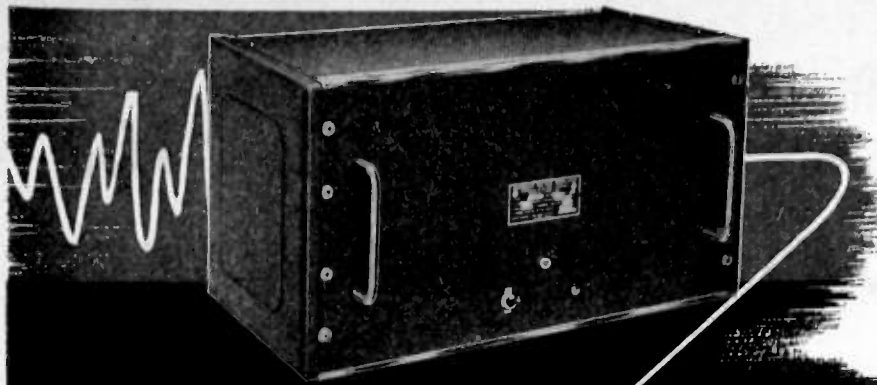

FLUCTUATING LINE VOLTAGES

held to within
± 0.1 Volts

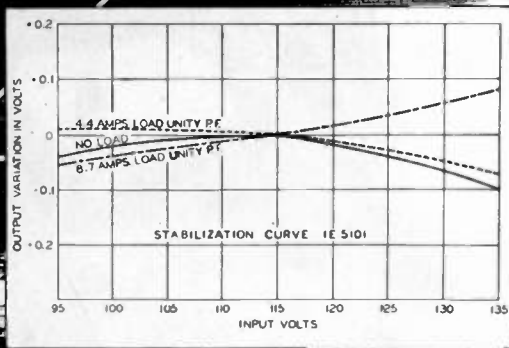

STABILINE *Instantaneous Electronic* VOLTAGE REGULATOR

With a STABILINE type IE Voltage Regulator in the power line, electrical apparatus is assured of constant voltage. Regardless of line changes — rapid fluctuations or slow variations — the delivered voltage is held to within ± 0.1 volts of the preset value. Typical are the performance curves of type IE5101. Although the input line voltage may vary from 95 to 135 volts, the preset output voltage is stabilized to well within ± 0.1 volts.

Fluctuating line voltage is just one problem of many in maintaining constant voltage. Others are varying frequencies, loads, power factors together with waveform distortion. An investigation of the STABILINE type IE will show, in addition to stabilization of ± 0.1 volts, such characteristics as . . . waveform distortion never exceeding 3 percent . . . regulation to within ± 0.15 volts for any load current change or load power factor change from lagging .5 to leading .9.

Write Superior Electric, 907 Laurel Street,
For Information and Literature

THE SUPERIOR ELECTRIC CO.
BRISTOL, CONNECTICUT



Powerstat Variable Transformers • Voltbox A C Power Supply • Stabiline Voltage Regulators.



(Continued from page 36A)

- Hedrick, P. F., 2472 Maplewood Ave., Winston-Salem, N. C.
Hess, H. M., Wayne University, 4841 Cass Ave., Detroit, Mich.
Hinojosa, J. A., Instituto Politecnico Hinojosa, Avenida Aniceto Arce 658, Cohabamba, Bolivia, South America
Knubbe, H. H., 755 Beverly Park, Jackson, Mich.
Mackenzie, D. G., Latamore, Rookery Rd., Staines, Middlesex, England
McLaren, J. P., c/o E. K. Cole, Ltd., Malmesbury, Wilts., England
Meneley, C. A., 131 Monroe Ave., Cuyahoga Falls, Ohio
Morgan, A. H., 4609 Eighth Rd., S., Arlington, Va.
Sastry, S. S., Domchanch, Dodarma, E. 1, Ry., Bihar, India
Spencer, S. W., 29 W. Third St., Williamsport, Pa.

Admission to Member

- Arlin, M. N., 65 Dana St., Cambridge 38, Mass.
Aske, V. H., Box 42, Kew Gardens, N. Y.
Attewell, T. H. D., 9, Elmgrove Rd., Redland, Bristol 6, England
Berman, R., 1146 E. Ninth St., Brooklyn 30, N. Y.
Beyer, G. L., Jr., 3311 Wheeler Rd., Washington 20, D. C.
Biggs, J. A., 725—19 St., S.E., Cedar Rapids, Iowa
Birnbaum, I., 156 Allen St., New York 2, N. Y.
Brand, J. J., 200 Crest Rd., Glen Ellyn, Ill.
Byer, D. L., 939 Longfellow St., N.W., Washington 11, D. C.
Cardwell, L. R., Arlington Naval Radio Station, Washington, D. C.
Chandler, C. H., 67 S. Stanworth Dr., Princeton, N. J.
Chertock, M., 1591 W. Sixth St., Brooklyn 5, N. Y.
Cook, F. D., 2100 Dempster, Evanston, Ill.
Cooper, B. F., Radio Branch, National Research Council, Sussex St., Ottawa, Ont., Canada
Cox, L. H., 302 E. Elm St., Watseka, Ill.
Curry, R. O. L., 518 W. Packard Ave., Fort Wayne 6, Ind.
DeConnick, L. G., 801 Bellows Ave., Columbus 8, Ohio
Diamond, H., 733 Chislett, Pittsburgh 6, Pa.
Dickson, J. F. R. F. D. 2, Box 191, Neptune, N. J.
Dixon, L. G., 75 Carman Ave., Lynbrook, N. Y.
Eberhart, E. K., Bell Telephone Laboratories, Inc., 180 Varick St., New York 14, N. Y.
Ellis, R. M., c/o Howard W. Sams & Co., Inc., 2924 E. Washington St., Indianapolis 6, Ind.
Ewert, A. C., 72 North Stoughton St., Bergenfield, N. J.
Fellers, R. G., 144 Ivanhoe St., S.W., Washington 20, D. C.
Felton, N. F., 64, St. Margaret's Road, Twickenham, Middlesex, England
Florence, V. H., 6632 N. Broad St., Philadelphia, Pa.
Foote, W. S., 718 W. Springfield Road, Springfield, Pa.
Free, A. L., 214 East Durham St., Philadelphia, Pa.
Freehafer, J. E., 310 Rugby Ave., Rochester 11, N. Y.
Goddard, W. R., Jr., 3475 Valemont St., San Diego 6, Calif.
Grant, J. P., 89 Mayfield St., Rochester 9, N. Y.
Gunderson, R. W., 980 Waring Ave., New York 67, N. Y.
Gutmann, F., 7 Wentworth St., Point Piper, Sydney, NSW, Australia
Hafemeister, E. F., 400 E. 56 St., New York 22, N. Y.
Hawkins, D. W., 218 Alexander Ave., Scotia 2, N. Y.
Hill, M. A., 341 Orchard Dr., Dayton 9, Ohio

(Continued on page 42A)

PROFESSIONAL PERFORMANCE—that keeps the original sound alive!

**Stop
'WOW'!**



—with a positive drive at 33.3 and 78 rpm—



Remember this: When a listener becomes dissatisfied with the quality of your programs, he simply twists a dial. And in doing so, he also tunes out his pocketbook. So why jeopardize what is probably your best source of revenue—*your recorded programs!*

Professional recording and playback should be, and can be, 'WOW'-free. How? With the time-tested Fairchild direct-from-the-center turntable drive, shown above. It eliminates all variations in turntable speed. Evenness of speed is obtained by a carefully calculated loading of the drive mechanism to keep the motor pulling constantly; by careful precision control of all drive alignments that might cause intermittent grab and release; by carefully maintained .0002" tolerances in all critical moving parts.

Further aid to 'WOW'-free performance is provided by a perfectly balanced turntable with extra weight in the rim and a turntable clutch that permits smooth starting, stopping and shifting from 33.3 to 78 rpm in operation.

Fairchild's 'WOW'-free performance is available on professional Transcription Turntables, Studio Recorders and Portable Recorders. For complete information—and prompt delivery—address: 88-06 Van Wyck Blvd., Jamaica 1, New York.



Transcription Turntables
Studio Recorders
Magnetic Cutterheads
Portable Recorders
Lateral Dynamic Pickups
Unitized Amplifier Systems



Fairchild

CAMERA

AND INSTRUMENT CORPORATION



If you're designing a Wire Recorder

Brush Plated Wire

- ✓ Constant plating thickness assures uniform signal
- ✓ Correct balance of magnetic properties assures good frequency response and high level
- ✓ Excellent surface finish assures low noise and minimum wear
- ✓ Corrosion resistant
- ✓ Easy to handle—ductile—can be knotted

consider

Brush Wire Recording Heads

Of principal interest are their excellent electrical characteristics, extreme simplicity of design to avoid trouble, and the "hum-bucking" characteristics, which reduce the effect of extraneous magnetic fields. When required, the head cartridge alone (pole piece and coil unit) may be supplied for incorporation into manufacturers' own head structure.

consider

Hysteresis loop of
Brush plated wire.

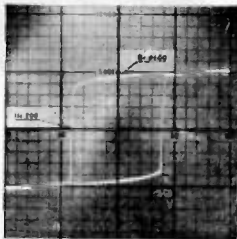

Cross section of
Brush plated wire.



The new Brush wire
recording head.



These latest developments in magnetic recording equipment can now be obtained for radio combinations and other uses. Brush engineers are ready to assist you in your particular use of magnetic recording components.

The Brush Development Co.

3405 Perkins Avenue • Cleveland 14, Ohio

SURPLUS Equipment

General Radio Precision Wavemeter, Type 724-A, range 16 kilocycles to 50 megacycles, V.T.V.M. resonance indicator, complete with accessories and carrying case, new, packed for export \$200.00

RCA 5" Cathode Ray Scope model 160B, new, packed for export \$135.00

RCA Voltohmst model 165, new packed for export \$50.00

RCA Beat Frequency Audio Signal Generator model 154, new \$60.00

Radio Set AN/TRC-7, 16 tube, portable, low power Receiver-Transmitter two preset channels in the range of 100-156 megacycles, new \$50.00

General Radio Signal Generator model 804 C, 7.5-330 megacycles, 1-20.000 microvolts output, good working order \$275.00

Tuning Unit TN 54/APR-4, range 2150-4000 megacycles, for search receiver APR-4, consists of mixer and oscillator stage \$35.00

Tuning Unit TN 19/APR-4, range 1000-2150 megacycles \$35.00

Antenna Cavity Tuner, part of tuning unit TN54/APR-4, range 2150-4000 megacycles, with diode crystal mounting \$5.00

Butterfly Tuners, range 80-300 or 300-1000 megacycles, silver plated, either range \$3.00

W. E. 704-A High Frequency Diode, plate to cathode capacity 0.55 mmfd, 1" x 3/8" \$2.00

Pulse Input Transformer, permalloy core, 50-4000 kc, impedance ratio 120 to 2350 ohms, W.E. D161310 \$2.80

Sprague Vitamin Q Oil filled Capacitor, 2 x 0.75 mfd, 8000 WVDC \$3.00

High voltage transformer, 115 volt 60 cps to 6250 volts, 80 ma \$12.00

SD-3 Radar Equipment, complete with all accessories, operates on 115 volts 60 cps, new.

SA-1 Radar Transmitter in good working order, 115 volts 60 cps

SA-2 Radar Transmitter in good working order, 115 volts 60 cps.

Mast Equipment AB 26 CR, for 6" diam. 72 ft. Mast, consisting of steel base plate, mast section coupling units, Guy cables with insulators, anchor screws, etc.

ELECTRO IMPULSE LABORATORY

Box 250 Red Bank, N.J.
Red Bank 6-4247

YOUR REPORT

RST=5-9-9X



with the

FOUR-20

TRANSMITTER

● You can be on the air with the Four-20

Transmitter five minutes after it is unpacked. All you need is a crystal and a key and you are all set to go with a full 20 watts output at the antenna terminals.

Stability is assured by an improved oscillator circuit that allows less than five milliamperes of R.F. current to pass through the crystal. A special resistor network keeps the load on the transmitter constant with the key up or down.

And in the Four-20 the matching problem is solved by the special output coil which will match any transmission line from 50 to 600 ohms.

You will be amazed when those reports come in—**RST=599X**.



Write for Descriptive Booklet

For phone operation use the **FOUR-11**
Modulator, companion unit to the **FOUR-20**



HAMMARLUND

THE HAMMARLUND MFG. CO., INC., 460 W. 34TH ST., NEW YORK 1, N. Y.
MANUFACTURERS OF PRECISION COMMUNICATIONS EQUIPMENT

It's Better Because It's Bendix!

Now Available!

Aviation Standard
Bendix DYNAMOTORS

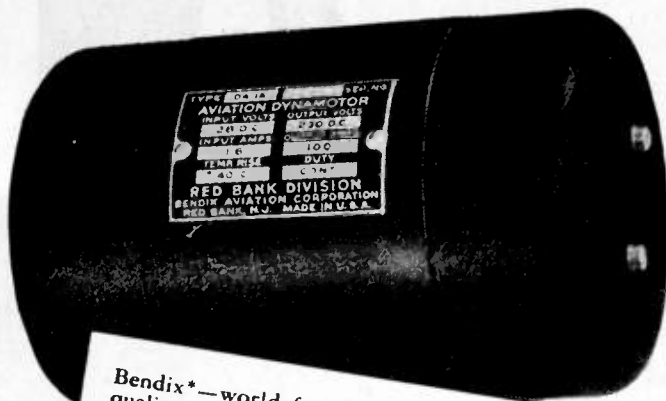

Bendix*—world famous for top-flight aviation quality—now makes available to the radio industry these low-cost D.C. Transformers.

- Specially designed for long life, light weight, and low ripple.
- Standard diameters run 2¾, 3⅞, 4, 4½, 5 and 5¼ inches.
- From 12 to 1100 volts and from 15 to 500 watts output.
- Continuous duty—enclosed.
- Intermittent duty—ventilated.
- Single, dual, and triple output.
- Regulated and unregulated.

Write to the address below for detailed information on these and other Bendix Dynamotors to meet your power requirements.

*REG. U.S. PAT. OFF.

STANDARD RATINGS					
Model	Frame Size	Input Volts	Output Volts	Output Watts	Approx. Weight
DA58A	2¾"	14	250	15	2 lb. 12 oz.
DA1A	3⅞"	14	230	23	5 lb.
DA77A	4"	5.5	600	104	9 lb. 12 oz.
DA1F	4½"	25	540	243	11 lb. 8 oz.
DA7A	5¼"	26.5	1050	420	26 lb. 10 oz.

RED BANK DIVISION of
Red Bank, New Jersey



(Continued from page 38A)

- Hollingsworth, R. L., 340 Hempstead Ave., West Hempstead, N. Y.
- Hunter, W. C., 31 Valley View Rd., Rockaway, N. J.
- Jacobs, B. S., 16 Ripley St., Waltham 54, Mass.
- Jira, J. W., 13900 Lorain Ave., Cleveland 11, Ohio
- Johanson, A. E., Bell Telephone Laboratories, Inc., Murray Hill, N. J.
- Johnston, T. F., 26 Melbourne Ave., Silver Springs, Md.
- Klichli, J. A., 244 Avenue C, Billings, Mont.
- Knox, L. A., 400 Summit St., Bridgeport 6, Conn.
- Macdonald, W. S., Williams Rd., Concord, Mass.
- Malsbary, J. S., 280 Edwin Ave., Glendale 22, Mo.
- Mandl, G. P., 21 Ardmore St., Rochester 11, N. Y.
- Marks, R. L., 18 Old Short Hills Rd., Millburn, N. J.
- Marsh, D. R., 7 Cardinal Court, Audubon Park, N. J.
- Mathieu, R. E., 11 So. Beechfield Ave., Baltimore 29, Md.
- Maxon, J. S., 126 E. Kibler St., Bluffton, Ohio
- Milazzo, S., 28 Bay 13 St., Brooklyn 14, N. Y.
- Miller, C. W., 101 Park Dr., Catonsville 28, Md.
- Mock, W. C., Jr., The Radiart Corp., 3571 W. 62 St., Cleveland 2, Ohio
- Moore, C. E., Radiomarine Corporation of America, 75 Varick St., New York 13, N. Y.
- Morris, J. S., 1931 Piedmont Rd., Atlanta, Ga.
- Muckenhirn, O. W., Department of Electrical Engineering, University of Minnesota, Minneapolis 14, Minn.
- Nelson, R. E., RCA International Division, 745 Fifth Ave., New York 22, N. Y.
- Oliner, A. A., Microwave Research Institute, 55 Johnson St., Brooklyn 1, N. Y.
- Ozsvath, D., 170 So. Clinton St., East Orange, N. J.
- Parsons, J. H., 304 Firestone Rd., Oak Ridge, Tenn.
- Porter, N. E., 395 Page Mill Rd., Palo Alto, Calif.
- Prather, A. W., 4741—36 St., San Diego 4, Calif.
- Probst, M. C., 161 Yellow Springs Court, Dayton 3, Ohio
- Quinn, Q. Q., 51 Hinsdale Ave., Waterbury, Conn.
- Rasmussen, H. E., 1015 Garfield St., Winnipeg, Man., Canada
- Ridgeway, F. B., c/o Frank H. McIntosh, 710—14 St., N.W., Washington, D. C.
- Root, L. W., 356 W. Stewart St., Dayton 8, Ohio
- Rothschild, J. B., Box 281, Wharton, N. J.
- Schunemann, C. F., 13507 Gainsboro Ave., East Cleveland, Ohio
- Short, C. D., 4533 Ocean Blvd., San Diego 9, Cal.
- Showen, L., 21 South St., Fairfield, Ohio
- Smee, P. G., 503 Oakwood Ave., Syracuse 5, N. Y.
- Smith, W. H., 97 Mabon St., Brookville, Pa.
- Spannuth, W. H., 1205 E. Armour, Kansas City 3, Mo.
- Straiton, A. W., Department of Electrical Engineering, University of Texas, Austin, Texas
- Stump, A. M., Jr., 311 Marathon Ave., Dayton 6, Ohio
- Swanson, B. E., 7425 Normal Ave., Chicago 21, Ill.
- Taylor, E. B., General Electric Company, Suite 1123, The Merchandise Mart, Chicago 54, Ill.
- Thomas, B. J., 13 Clinton St., Morristown, N. J.
- Thrift, S. R., 1821—18 St., S.E., Washington, D. C.
- Tipple, H. L., Canadian National Carbon Company Ltd., 805 Davenport Road, Toronto 4, Ont., Canada
- Vadersen, C. W., Bell Telephone Laboratories, Inc., 463 West St., New York 14, N. Y.
- Walker, E. A., Ordnance Research Laboratory, Box 30, State College, Pa.
- Ward, C. E., 1826 Beuer Ave., S.E., Cedar Rapids, Iowa
- Warder, J. C., 613 Gorsvenor St., London, Ont., Canada

(Continued on page 44A)



**FOR COMBINATION
AM-FM BROADCASTING**

This recent installation shows a Blaw-Knox 280 ft. self-supporting insulated Vertical Radiator for AM, topped by an FM antenna.

With Blaw-Knox experience in tower construction dating back to the birth of commercial radio, the broadcasting station had full confidence in the ability of Blaw-Knox to design, build and erect this new type of structure.

**BLAW-KNOX DIVISION
OF BLAW-KNOX COMPANY**

2037 Farmers Bank Building
Pittsburgh, Pa.

BLAW-KNOX ANTENNA TOWERS

IT HAD TO COME!

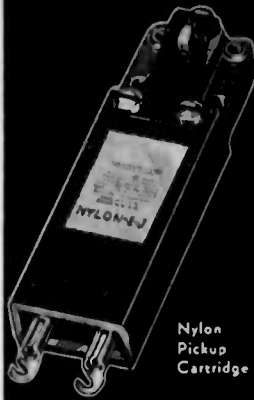

Nylon Pickup Cartridge



Nylon Jewel Tipped Needle



Nylon Precious Metal Tipped Needle

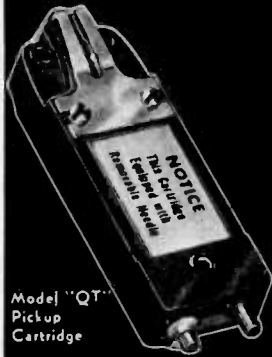

Model "QT" Pickup Cartridge



"QT" Jewel Tipped Needle



"QT" Precious Metal Tipped Needle

Special Literature Available on Request

● No modern engineering achievement has contributed more to improvement in the quality of phonograph reproduction than Astatic's recent development of two new pickup cartridges employing **MATCHED, REPLACEABLE NEEDLES**. It had to come! In no other way can equipment manufacturers or ultimate users be sure of the maintenance of quality phonograph reproduction.

● Too many Needle Replacements have been and are still being made with Needles possessing characteristics entirely unsuitable to the cartridges in which they are used. Results, naturally, have been disappointing.

● Astatic engineers, pioneering again, have found a logical answer to this problem with the development of two new Crystal Cartridges, the "Nylon" and Model "QT," both of which employ **MATCHED, REPLACEABLE** needles. These Needles are engineered to match the characteristics of the "Nylon" and "QT" Cartridges and are the only needles that can be used in them.

● The result is, at long last, that quality reproduction can be maintained through the life of the instrument. Many of the new record players now appearing on the market employ these new matched reproducer units. They had to come.

THE Astatic CORPORATION
 CONNEAUT, OHIO
IN CANADA: CANADIAN ASTATIC LTD. TORONTO, ONTARIO
 Astatic Crystal Devices Manufactured under Brush Development Co. patents.



(Continued from page 42A)

- White, C. E., Box 137, New London, Conn.
- Wolff, H. G., 1253 N. Fairfax Ave., Los Angeles 46, Calif.
- Woodward, J. E., 160 Old Country Road, Mineola, L. I., N. Y.
- Wright, D. F., 344-40 Ave., Lachine, Que., Canada
- Yard, E. M., 2 Whittlesey Rd., Trenton 8, N. J.
- Yellin, H., 18 Plymouth Ave., Norwalk, Conn.

The following admissions to Associate were approved on June 3, 1947, to be effective as of July 1, 1947:

Admission to Associate

- Ban, G. R., 3706 W. 57 Pl., Chicago 29, Ill.
- Barrett, G. D., 1036 W. 20 St., Los Angeles 7, Calif.
- Bell, H. J., 2655 Lalla St., Beaumont, Texas
- Beller, E. H., 3939a Folsom, St. Louis 10, Mo.
- Berge, R. P., 8-23 Astoria Ave., Astoria, L. I., N. Y.
- Bianco, J. F., 110 College Ave., Medford 55, Mass.
- Bishop, M. J., 455 Sheridan Rd., Winnetka, Ill.
- Block, K. A., 3567 Ray St., San Diego 4, Calif.
- Bobian, G. M., 1306 W. Farwell Ave., Chicago, 26, Ill.
- Burgoyne, C. L., 53 Hartsford St., Dorchester 25, Mass.
- Carmody, T. P., 2603 N. Lamon, Chicago 39, Ill.
- Castle, C., 25 E. Delaware Pl., Apt. 15B, Chicago, Ill.
- Christensen, R. L., 1725 Wilson Ave., Chicago, Ill.
- Churchill, H. J., 430 E. High St., Philadelphia, Pa.
- Cihak, W. E., 2100 S. Highland Ave., Berwyn, Ill.
- Conley, W. H., Route 4, Van Wert, Ohio
- Cox, L. V., 8 Findon St., East Malvern, Melbourne, S.E. 5, Victoria, Australia
- Crane, G. B., 1313 W. 95 Street, Los Angeles, Calif.
- Cunningham, R. E., Box 3225, Beaumont, Texas
- Cupp, E. W., 2025 E. Main St., Decatur, Ill.
- Currier, R. A., 5307 Ellis Ave., Chicago 15, Ill.
- Davis, H. P., 2835 Park Dr., Silver Lake, Cuyahoga Falls, Ohio
- DeBusman, D. J., 4518 Sheridan Rd., Chicago 40, Ill.
- DesLauriers, E. L., 1402 Summit Ave., Baltimore, Md.
- Devereux, J. G. F., 112 N. Oratun Parkway, East Orange, N. J.
- Downey, R. F., 229 Winthrop Rd., Syracuse 6, N. Y.
- Dillon, S. K., 1687 Park Pl., Brooklyn 33, N. Y.
- Evans, H., 4026 Lansing St., Philadelphia 36, Pa.
- Evans, L. L., 520 Bettewood Ave., Collingswood, N. J.
- Fink, F. G., 1500 Wilson Ave., Chicago 40, Ill.
- Frank, E., Sr., Freehold R.F.D. 2, Freehold, N. J.
- Fueo, P. J., 106-03-79 St., Ozone Park, L. I., N. Y.
- Funderburg, P. E., 40 S. Jefferson, Huntington, Ind.
- Gehr, G. A., 415 Hague, El Paso, Texas.
- Geisel, F. J., Box 163, Groves, Texas
- Gibbs, D. R., 2791 Powell Ave., Columbus, Ohio
- Gibbs, L. C., 1651 W. 204, Torrance, Calif.
- Golub, B., 1619 E. 10 St., Brooklyn 23, N. Y.
- Goodwin, C. E., PAA, 147th AACSS Squadron, Det 33, A.P.O. 184, c/o Postmaster, San Francisco, Calif.
- Guichard, R. S., 505 South Superior St., Angola, Ind.
- Hancock, C. T., 26 Reginald Rd., E. Southsea, Hants, England
- Hanson, N. L., 19 Orange Terr., West Haven, Conn.
- Henning, P. A., 1 Tilton St., No. Randolph, Mass.
- Hill, W. B., 1185 Clark Ave., Apt. 400, Detroit 9, Mich.
- Hintz, H. F., 237 Elgin Ave., Forest Park, Ill.
- Hulme, H. Box 49, Nassau, Bahamas
- Hurt, R. E., 474 Johnson St., Gary, Ind.
- Jackson, E. W., 93 Mechanic St., Foxboro, Mass.

(Continued on page 46A)

STRAIGHT-LINE FEED

... Low Residual Inductance

... Higher Resonant Frequency

AEROVOX SERIES 1690

Mica Capacitors

● The brand new Aerovox Series 1690 molded-in-bakelite mica capacitor is intended specifically for circuits where inductance must be kept at a minimum. It is designed for least possible residual inductance, low r.f. losses and lower r.f. resistance and impedance. What's more, it provides increased KVA ratings for given capacitor sizes.

Such units can be advantageously applied as blocking capacitors in transmission lines; as tank capacitors for high-frequency oscillators; as by-pass capacitors for ultra-high-frequency currents; and as coupling or by-pass capacitors in induction-heating circuits.

Exceptional compactness for given KVA ratings; exceptionally-low-loss operation; ability to withstand constant duty and heavy overloads—for these and other reasons this latest Aerovox development marks a new performance standard for severe-service capacitors.



ACTUAL
SIZE

Featuring...

● Rounded hardware—round nuts tightened by spanner wrench supplied; round washers; spherical lock nuts. Elimination of sharp edges and corners that might cause corona loss.

● Body of XM or yellow low-loss bakelite molded about mica section for thorough sealing and extreme ruggedness.

● Mica section of carefully selected mica and foil. Designed for straight-line path for ultra-high-frequency currents.

● Several times the size of the well-known Series 1650 bakelite-molded transmitting capacitors. Dimensions: 2 $\frac{3}{8}$ " w. x 2 $\frac{1}{8}$ " d. x 1 $\frac{3}{8}$ " h., and 4 $\frac{3}{4}$ " overall between rounded terminal tips.

● Available in ratings up to 20,000 volts D.C. Test, or 10,000 volts operating. Capacitance values up to .001 mfd. at the highest voltage rating.

● Fine threads for terminal studs, insuring maximum contact and minimum resistance.

● Silver plating for all conducting members, minimizing skin resistance.

● Interested? Write for detailed information. Meanwhile, submit that capacitor problem for our engineering collaboration.

FOR RADIO-ELECTRONIC AND INDUSTRIAL APPLICATIONS

AEROVOX CORPORATION, NEW BEDFORD, MASS., U.S.A.

SALES OFFICES IN ALL PRINCIPAL CITIES • Export: 13 E. 40th St., New York 16; N. Y.

Cable: 'ABLAB' • In Canada: AEROVOX CANADA LTD., HAMILTON, ONT.



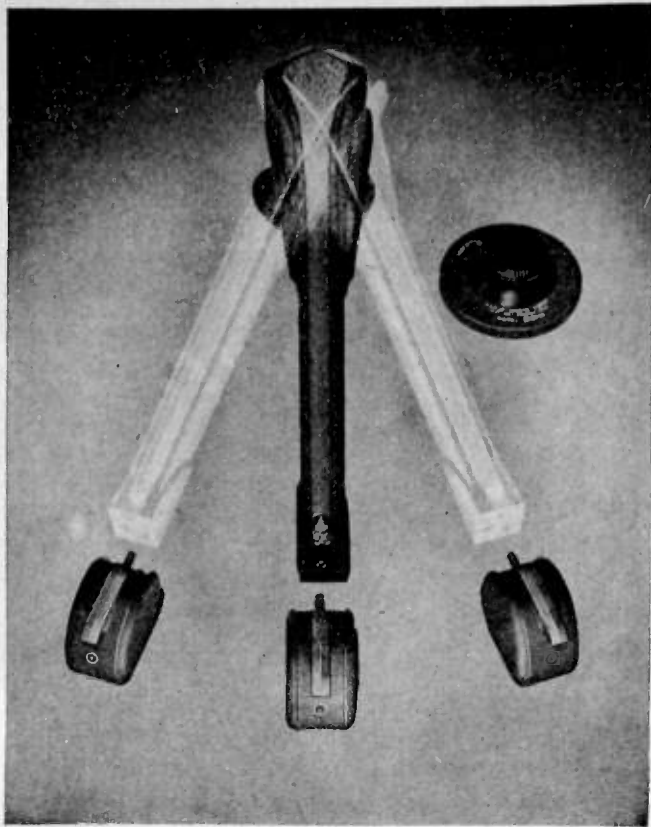

PARA-FLUX REPRODUCERS

with **INTERCHANGEABLE HEADS**

Universal . . . Lateral Only . . . Vertical Only



Universal
Reproducer



Lateral
Only
Reproducer



Vertical
Only
Reproducer

All three types are interchangeable with only one Model A-16 ARM and new Model EL-2 EQUALIZER. Each head can be removed and replaced quickly by simple plug connection.

Reproducer arm is of die-cast aluminum; sturdily built. Swings by means of unique friction-free bearings that minimize side-of-groove wear, and requires no oiling, cleaning nor adjusting. Convenient finger lift prevents slipping.

Model EL-2 Equalizer is effective with all three of the PARA-FLUX heads. All possess the same impedance matching to the Equalizer. High output level affords an important advantage in broadcasting as to value of signal level to background noise.

Each head is fitted with a selected, hard African diamond stylus, polished and finished to tolerance of 1/10,000 of an inch. Hairline indicator on head plus precision stylus construction make accurate cuing possible. Allows "back-tracking" without damage to record or reproducer.

*Available immediately through Authorized Jobbers
Bulletin PR51, yours for the asking*

RADIO-MUSIC CORP.
EAST PORT CHESTER, CONN.



(Continued from page 44A)

- Jenny, D. A., RCA Laboratories, Princeton, N. J.
Jeziak, S' F., 2126 W. Thomas, Chicago 22, Ill.
Jones, W. C., Box 8, NAL, NAS, Banana River, Fla.
Kasdorf, G. R., 6094 N. Nassau Ave., Chicago 31, Ill.
Katchky, M., 186 Gladstone Ave., Ottawa, Ont., Canada
Kay, A. P., Jr., 2985 Terrell St., Beaumont, Texas
Kay, L. E., 2985 Terrell St., Beaumont, Texas
Kidwell, W. M., 203 Security Bldg., Phoenix, Ariz.
King, L. C., 1041 Martin St., Winston-Salem 7, N. C.
Kinzie, M. M., General Electric Company, Syracuse, N. Y.
Knaul, J. E., 324 E. 41 St., New York 17, N. Y.
Koerner, F. A., Allerton Hotel, 701 No. Michigan Ave., Chicago 11, Ill.
Larson, R. G., 2647 Scottwood Ave., Toledo 10, Ohio
Laschever, N. L., 753 Brown St., Dayton 9, Ohio
Lipp, J. P., 9 Russel Ave., Fort Monmouth, N. J.
Maeder, M., Radio-Suisse, S.A., Prangins, Switzerland
Masek, J. R., 3901 Montrose Ave., Chicago 18, Ill.
Maze, R. O., 2 Twin Maple Ave., Riderwood, Md.
McDonald, J. A., 2016 N. Bissell St., Chicago, Ill.
McGovern, M. C. 2 High St., Balbriggan, Co. Dublin, Eire
McKinley, W. H., 744 East Pine St., Altadena, Calif.
McNamara, J. E., Sulphur, La.
Messerschmidt, W. T., 35 Windsor Rd., Clifton-Allwood, N. J.
Moore, W. T., R.F.D. 1, Box 460, Fort Lauderdale, Fla.
Morrow, J. C., Jr., Route 2, Box 104-D, Port Arthur, Texas
Moss, J. A., 263 Penn St., Brooklyn 11, N. Y.
Mullan, L. A., Radio Station KTRH, Rice Hotel, Houston 2, Texas
Murphy, J. F., 47 West Court, Holyoke, Mass.
Nitchals, J. L., 7524 S. Shore Dr., Chicago 49, Ill.
Novak, C. W., 6619 S. Stewart Ave., Chicago 21, Ill.
O'Connor, J. F., 211 Base Workshop, R.C.E.M.E., National Defence Bldg., Regina, Sask., Canada
Orosco, E. M., 307 W. 20 St., New York 11, N. Y.
Ottum, R. W., Box 20, McFarland, Wis.
Palm, K. E., 235—First Ave., Haddon Heights, N. J.
Palmer, R. P., 303 N. Washington St., Valparaiso, Ind.
Parkhill, D. F., 89 Orchard View Blvd., Toronto, Ont., Canada
Peters, J. G., 570A—19 St., Brooklyn 18, N. Y.
Poirier, J. H., 312 Olivewood Terr., San Diego 2, Calif.
Porrazzo, R. J., Box 552, Eatontown, N. J.
Radke, W. F., 454 Stella, Elgin, Ill.
Reeves, H. J., 1432 Newton St., N.W., Washington, D. C.
Robb, E. J., R.F.D. 1, Rockville, Conn.
Rogers, K. S., 3 Grafton St., Charlottetown, P.E.I., Canada
Schaefer, R. K., Carnegie, Okla.
Scrievers, B. J., 1946—44 Ave., San Francisco 16, Calif.
Seandrett, E. D., 1548—Eighth Ave., S.E., Cedar Rapids, Iowa
Sheese, O. C., 2816½ South Lafayette St., Fort Wayne, Ind.
Shepard, E. S., 126 Water St., Saxonville, Mass.
Sherburne, F. B., Box 601, 94 Maple Ave., Red Bank, N. J.
Simmons, A. J., 21 Maplewood St., Watertown, Mass.
Sloker, G. H., 705 Lorette Ave., Winnipeg, Man., Canada

(Continued on page 60A)

SHERRON offers you an *All-Inclusive* ELECTRONICS SERVICE

RESEARCH

DESIGN

DEVELOPMENT

ENGINEERING

MANUFACTURING

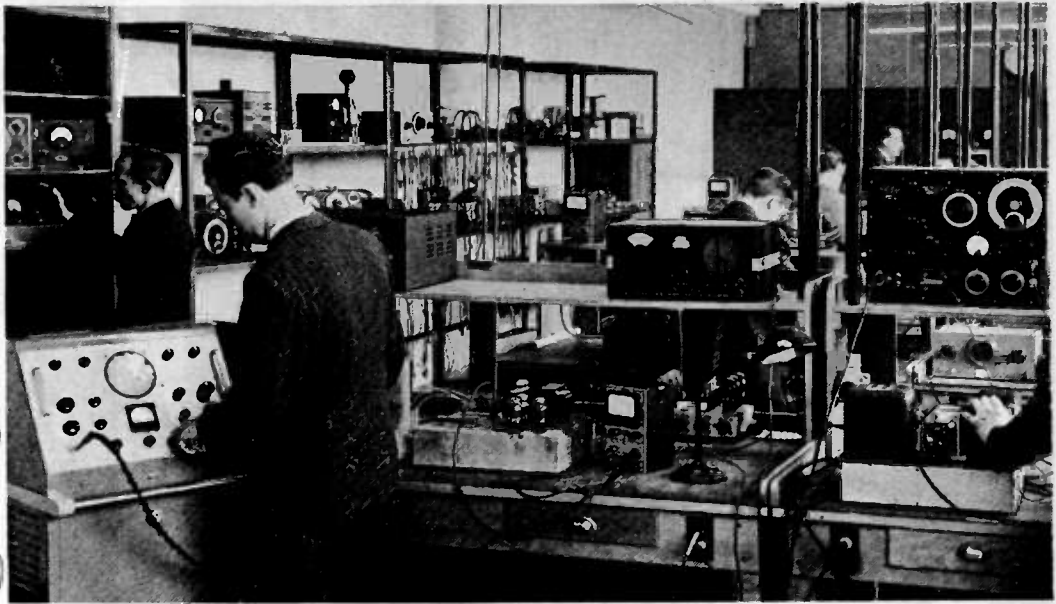

For Efficient, Economical Production

Are your present manufacturing processes proving too costly? Are outmoded methods exacting a heavy toll in waste time, manpower, materials? You'll find Sherron's all-inclusive electronics service worth looking into.

There's the Sherron laboratory. A full-fledged service in itself, noteworthy for research and development facilities. No mere auxiliary department, but a vital function in the integrated Sherron operation.

A full complement of seasoned electronics en-

gineers and physicists are on hand to initiate your project. Practical, realistic, their job is to explore new ideas, track down new applications to make the tool of electronics do a better job for industry.

Their creative and fact-finding talents, meshed with the skills and resources of Sherron's manufacturing staff, can benefit you in many ways. Why not arrange for a talk with the Sherron management? You will find it worth-while and revealing.

TYPES OF CUSTOM BUILT SHERRON TEST EQUIPMENT

GENERAL TEST EQUIPMENT:

(A) Vacuum Tube Test Equipment—Automatic Production Tube Test Equipment, Electronic Reject circuits provide only positive rejects. Eliminates meters, places quality control in hands of quality control men. (B) Other characteristic test sets for receiving, small transmitting and power tubes, cathode-ray and kinescope tubes. Basic characteristic tests—dynamic and static—and bridge measurements are incorporated. Designed and manufactured to individual needs on custom built basis.

TELEVISION TEST EQUIPMENT:

(A) Television Signal Synthesizer. Includes gen-

erating, viewing and transmitting test equipment. Sync generators, monoscopes, shapers, timers, wide band oscilloscopes, air monitors, measuring devices and field survey equipment.

COMPONENT TEST EQUIPMENT:

(A) Focusing and deflection coils. (B) Resistor and condenser testing. (C) Wire and insulation test equipment. (D) Relays, transformers, chokes and other iron components.

All the above available on custom built basis. Designed, developed and manufactured to customers' specs and needs.

INSTRUMENTATION AND MEASURING DEVICES:

(A) A.C. Bridge Measuring; Radio frequency

Cathode-ray Null Detector—1 mc operation. Cathode-ray Null Detector—1000 cycle measurements. (B) D.C. Vacuum Tube Voltmeters and Ammeters: Measurements of minute voltages and currents necessary for laboratory research. (C) Multi-Wave Shape Generator: Source of several wave shapes, including negative and positive pulses and a trigger pulse; used in testing amplifiers at audio and video frequencies. (D) Computers and Calculators: Summing amplifiers—impedance matching networks. (E) Control of Measurements: Flow indicators—sorting, counting, etc.—Measurement of chemical titrations—electronic measurement of surface strains, stresses, films, non-linear surfaces.

All the above designed and manufactured to customers' requirements and specs on custom built basis.



SHERRON ELECTRONICS CO.

Division of Sherron Metallic Corporation

1201 FLUSHING AVENUE • BROOKLYN 6, NEW YORK

CURRENTLY

FROM
SORENSEN
AT
STAMFORD

SORENSEN & COMPANY, INC.
Manufacturers of
VOLTAGE REGULATORS, NOBATRONS & ELECTRONIC APPARATUS



POWERFUL NEWS! SORENSEN SYSTEM NOW APPLIED TO DC VOLTAGE REGULATION

The Sorensen system of AC electronic voltage regulation provides quick, accurate response to even the smallest voltage change with a minimum wave distortion and a regulation accuracy of 1/2 of 1%.

Arrange now to receive your personal copy of the Sorensen electronics journal "Currently", published bi-monthly.

This same electronic regulation system has been incorporated into the Nobatron, providing a source of regulated DC voltage at currents and stabilities that, in the

past, was available only with batteries.

This new source of stabilized DC voltage is obtainable in six standard models operating on a 95-125 AC source of 50 to 60 cycles.

Among the more important uses for Nobatrons are DC ammeter calibration in experimental and quality control laboratories, testing of components in the automotive and aircraft industries in battery-operated relays and in other applications where it is desirable to replace a battery to guarantee continuous regulated power supply.

GENERAL AC REGULATOR SPECIFICATIONS

Input Voltage Range	(-1 model) .. 95-125
	(-2 model) .. 190-250
Output Voltage Range	(-1 model) .. 110-120
	(-2 model) .. 220-240
Load Range 25-30,000 V. A.
Regulation Accuracy 1/2 of 1%
Harmonic Distortion 5% Max. (12% in "5" Models)
Input Frequency Range 50-70 cycles
Inductive Power Factor Range Down to 0.7 P.F.

For standard voltage regulation, Sorensen Model 500 is a proven leader in its field—compact, accurate and dependable. This model typifies the Sorensen line of AC and Nobatron all-purpose voltage regulators. Let a Sorensen engineer help you with your next voltage regulation problem.

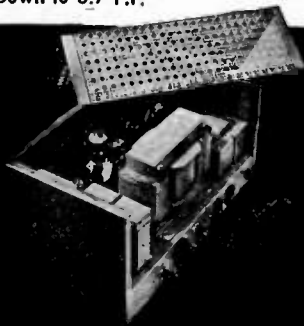

SORENSEN & COMPANY, INC.
375 FAIRFIELD AVENUE • STAMFORD, CONNECTICUT

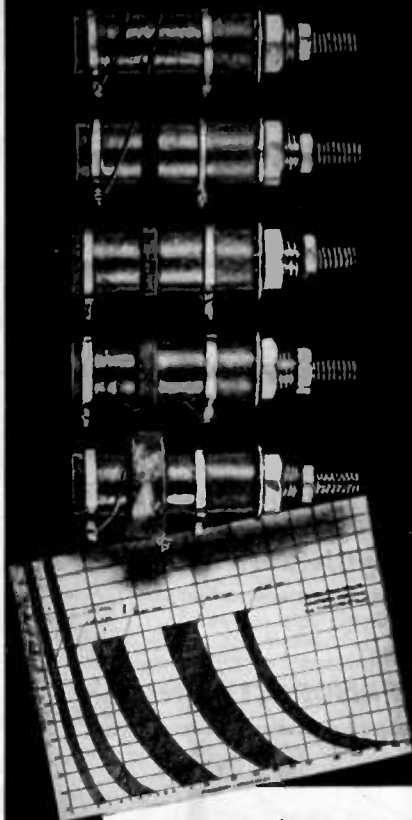

This graph shows frequency ranges covered by each unit. Write us for your full-size copy.

-  Turret Lug
-  Split Lug
-  Double-end Lug
-  Swager
-  Terminal Board
-  HPB Crystal

Five Standard Slug-Tuned LS3 Coils Cover 1/2 to 184 mc

For strip amplifier work, the compact (1 1/4" high when mounted) LS3 Coil is ideal. Also for Filters, Oscillators, Wave-Traps or any purpose where an adjustable inductance is desired.

Five Standard Windings—1, 5, 10, 30 and 60 megacycle coils cover inductance ranges between 750 and 0.065 microhenries.

CTC LS3 Coils are easy to assemble, one 1/4" hole is all you need. Each unit is durably varnished and supplied with required mounting hardware.

SPECIAL COILS

CTC will custom-engineer and produce coils of almost any size and style of winding... to the most particular manufacturer's specifications.

Consult CTC for
Three-Way
Component Service

Custom Engineering... Standardized Designs...
Guaranteed Materials and Workmanship
CAMBRIDGE THERMIONIC CORPORATION
436 Concord Avenue, Cambridge 38, Mass.

Going places
(AGAIN)

hallicrafters

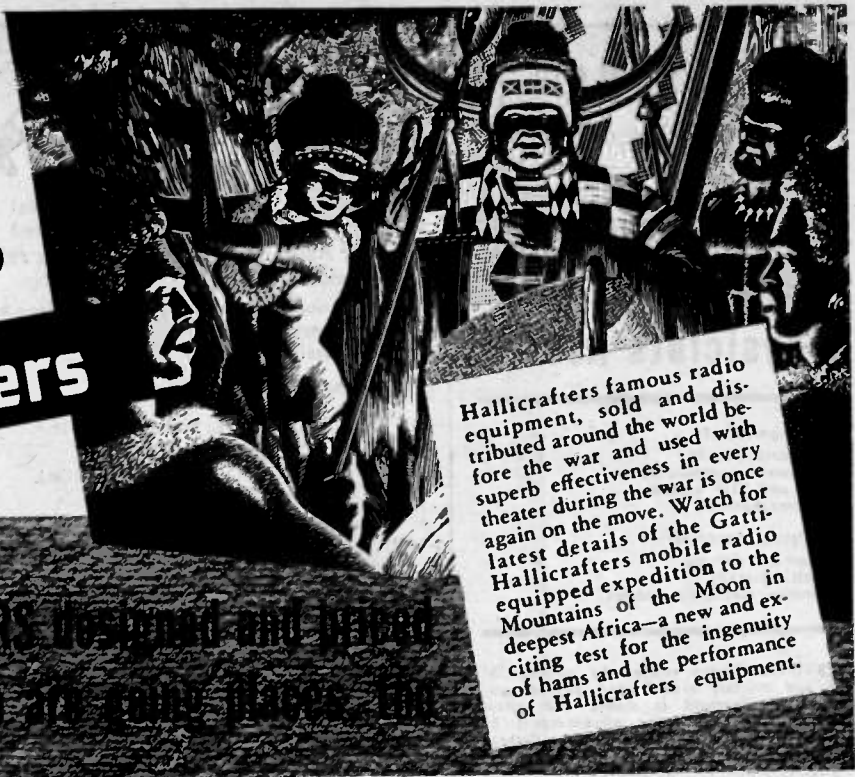

Hallicrafters famous radio equipment, sold and distributed around the world before the war and used with superb effectiveness in every theater during the war is once again on the move. Watch for latest details of the Gatti-Hallicrafters mobile radio equipped expedition to the Mountains of the Moon in deepest Africa—a new and exciting test for the ingenuity of hams and the performance of Hallicrafters equipment.

3

GREAT RECEIVERS DESIGNED AND BUILT FOR HAMS WHO GO ANYWHERE FOR



Model SX-42 Described by hams who have operated it as "the first real postwar receiver." One of the finest CW receivers yet developed. Greatest continuous frequency coverage of any communications receiver—from 540 kc to 110 Mc, in six bands. FM-AM-CW. 15 tubes. Matching speakers available. **\$27500**



Model S-40A Function, beauty, unusual radio performance and reasonable price are all combined in this fine receiver. Overall frequency range from 540 kc to 43 Mc, in four bands. Nine tubes. Built-in dynamic speaker. Many circuit refinements never before available in medium price class. **\$8950**



Model S-38 Overall frequency range from 540 kc to 32 Mc, in four bands. Self contained speaker. Compact and rugged, high performance at a low price. Makes an ideal standby receiver for hams. CW pitch control is adjustable from front panel. Automatic noise limiter. **\$4750**

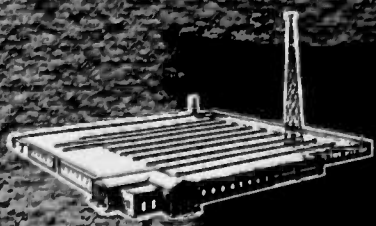

hallicrafters RADIO

THE HALLICTRAFTERS CO., MANUFACTURERS OF RADIO AND ELECTRONIC EQUIPMENT, CHICAGO 16, U. S. A.
Sole Hallicrafters Representatives in Canada: Rogers Majestic Limited, Toronto-Montreal

BOEING

AIRCRAFT COMPANY

Highly Qualified Engineers and Physicists Needed

Development of:
Electronic circuits
Microwave components
UHF and VHF antennas
Servomechanisms

Analytical Study of:
Dynamical systems
Electric circuits
Complex electronic systems

PROBLEMS are related to commercial and military aircraft and guided missiles. Employment is stable and offers ample opportunity for advancement to those able to assume responsibility. Present staff includes highly qualified physicists, engineers and mathematicians and ensures a stimulating professional environment. Liberal patent and publication policy.

Apply to:
Personnel Manager
Boeing Aircraft Company
Seattle 14, Washington

WANTED PHYSICISTS ENGINEERS

Engineering laboratory of precision instrument manufacturer has interesting opportunities for graduate engineers with research, design and/or development experience on radio communications systems, electronic & mechanical aeronautical navigation instruments and ultra-high frequency & microwave technique.

WRITE FULL DETAILS
TO
EMPLOYMENT SECTION
**SPERRY
GYROSCOPE
COMPANY, INC.**

Marcus Ave. & Lakeville Rd.
Lake Success, L.I.



The following positions of interest to I.R.E. members have been reported as open. Apply in writing, addressing reply to company mentioned or to Box No. . . .

The Institute reserves the right to refuse any announcement without giving a reason for the refusal.

PROCEEDINGS of the I.R.E. 1 East 79th St., New York 21, N.Y.

INSTRUCTORS IN ELECTRICAL ENGINEERING

Instructors and professors to teach electrical engineering at prominent, university in metropolitan area. Undergraduate and graduate courses in all fields and excellent research facilities. Professors must have advanced degrees. Salaries \$3,000 to \$7,500 depending on qualifications. Write to Box 459 with full details of education and experience.

INSTRUCTOR IN ELECTRICAL ENGINEERING

Electrical graduate with Master's degree and some teaching experience, to teach undergraduate courses in circuits and machinery. Opportunity to do graduate work. Salary \$3,000 for nine months. Location, midwest. Box 465.

ASSISTANT PROFESSOR OF ELECTRICAL ENGINEERING

Electrical graduate with Master's degree and several years teaching experience; to teach AC and DC circuits, AC and DC machinery, and other power courses. Opportunity to do graduate work. Salary \$3,600 for nine months. Location, mid-west. Box 466.

PHYSICISTS AND ELECTRICAL ENGINEERS

For vacuum tube research. Apply by letter stating qualifications to Director of Research, National Union Radio Corporation, 350 Scotland Road, Orange, New Jersey.

ELECTRICAL ENGINEERING TEACHERS

Instructors, assistant and associate professors to teach electrical engineering at state university in the southeast. Salaries \$2,800 to \$4,500 for nine months depending upon qualifications. Write full details of education and experience. Box 467.

RF-IF—TRANSFORMER ENGINEER

Radio engineer with theoretical and practical knowledge and experience in design of RF-IF transformers. Familiar with modern practice and requirements in FM and television receivers. Excellent opportunity with established growing company. Write giving full details. Box 468.

ENGINEER

A mid-western manufacturer has an opening for a graduate engineer with a broad background in electronic circuit design and instrumentation. Experience with pulse technique, servo-systems or telemetering procedure is particularly desirable. Unlimited opportunity in a specialized and highly interesting field is offered. A complete resume should be submitted. Box 469.

(Continued on page 52A)

ENGINEERS

Experienced senior electrical and mechanical project engineers needed for responsible positions in development and production of A.M., F.M., television receivers and components. Opportunity for advancement.

State qualifications in application to:

**Employment Manager
North American
Philips Co., Inc.
145 Palisade Street
Dobbs Ferry, New York**

3 Positions Now Open

—Location—Long Island

**PhD—Theoretical Physicist
MSEE—Electronic Project
Engineer
MSME—Electro-Mechanical
Design Engineer**

Have you considered the advantages of a smaller company?

1. Closer relationship with management.
YOUR abilities more quickly recognized!
2. Diversity of responsibilities.
YOUR job has greater interest!
3. Closer functioning with all departments.
YOU get greater breadth!
4. Expanding process is dynamic.
YOU get more opportunities at the top!
5. No complex wage structure.
YOUR salary determined by ability!

If you are alert to progress, we would be glad to receive your résumé of qualifications.

Box 475

The Institute of Radio Engineers
1 East 79th St. New York 21



All recessed head screws and bolts have definite advantages over the older slotted head, but the REED & PRINCE type Recessed Head is the ONLY one which can be fitted and driven throughout the entire size range with a SINGLE DRIVER.



THE POINT IS ALWAYS THE SAME . . . BUY

REED & PRINCE



CHICAGO, ILL.



WORCESTER, MASS.



(Continued from page 50A)

ELECTRONICS ENGINEER

Electronics Engineer wanted for responsible position in development of instruments for radiation measurement. Degree and several years experience plus initiative and ability to follow through are desired. Background in instrumentation, electronics associated with nuclear physics is advantageous. Box 470.

CHIEF ENGINEER

Chief engineer and works manager wanted by first company to deliver projection television. Heavy experience Ultra High frequency circuit characteristics and mechanical layout in engineering required. Mechanical layout of radio chassis, production and testing techniques. Resourcefulness, initiative, foresight, sound judgment, willingness to assume responsibility for own decisions. Ability to enforce discipline, to locate and eliminate unnecessary overhead. Salary high—only heavy weights need apply. United States Television Manufacturing Corporation, 3 West 61st Street, New York 23, N.Y.

ENGINEERS—PHYSICISTS

Engineers experienced with the operation and maintenance of the SCR-584 radar. Also graduate physicists experienced with optical instruments and electronics timing. Unusually attractive advantages. For application forms write to P. O. Box 661, Ventura, California.

ELECTRONICS ENGINEER

A large research and manufacturing company has openings for men with B.S. or M.S. in physics or engineering. Ages between 28 and 35 years. Must have 2 years experience on the development of electronic measuring instruments; experience in the design of radar circuits or in servo-mechanism techniques. Box 471.

RADIO COMPONENT ENGINEER

Experienced in design of RF and IF components and FM circuits essential. Excellent opportunity for qualified man. Please send a complete resume. Automatic Manufacturing Corporation, 900 Passaic Ave., East Newark, New Jersey.

ENGINEERS—PHYSICISTS

Graduate engineer or physicist for design and development of electronic instruments is required by a large research laboratory. At least three years' experience in the field, familiarity with pulse technique and broad band amplifier design is essential. Living accommodation arranged. Address: National Research Council, Chalk River, Ontario.

ELECTRONIC ENGINEER

Electronic engineer capable of designing and supervising construction of oscillator circuits from 15 kilocycles to 500 megacycles for use in quartz crystal networks and testing equipment. College graduate preferred. Mid-western university town. Salary open. Send full details of education and experience. Write Box 473.

(Continued on page 54A)

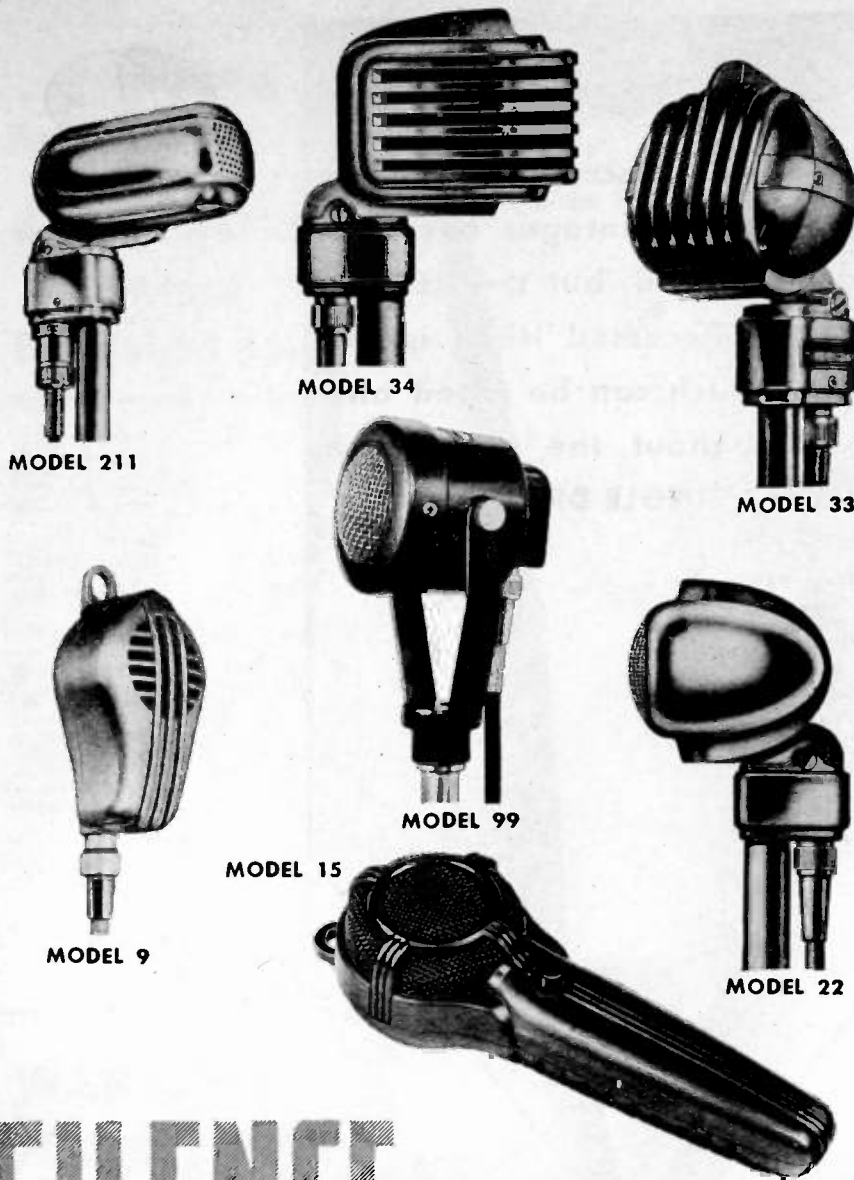

SILENCE IS GOLDEN

WITH MICROPHONES BY TURNER

The smooth performance and rugged dependability of Turner Microphones are the result of sound engineering, highest quality materials, and faultless workmanship.

For voice and music, for voice alone, or for any special sound application rely on Turner for greater satisfaction. Turner engineers will be glad to make impartial suggestions as to the right type microphone for your particular job.

ASK YOUR DEALER OR WRITE

THE TURNER COMPANY
909 17th Street N. E. • Cedar Rapids, Iowa

TURN TO TURNER—THE PASSWORD TO SOUND PERFORMANCE

LICENSED UNDER U. S. PATENTS OF THE AMERICAN TELEPHONE AND TELEGRAPH COMPANY, AND WESTERN ELECTRIC COMPANY, INCORPORATED. CRYSTALS LICENSED UNDER PATENTS OF THE BRUSH DEVELOPMENT CO.





MEMORANDUM

TO: *Engineering*
 FROM: *Purchasing*

*Here is the New Ceramic Socket
 for those Lock-in Tubes.*
Tfc

✓ **FORGET HUMIDITY!**

*Steatite Insulation with
 Baked Silicone Varnish
 Coating*

✓ **NO FUMBLING!
 NO DAMAGED TUBES!**

*Tubes Are Easily Removable
 Yet Effectively Locked
 In Sockets*

✓ Write on your letterhead for Catalog describing our other component parts, such as Snap-slide Fasteners, Steatite-Insulated Connectors, Steatite-Insulated Miniature Relays, Miniature Pin-Plugs, and "Music-Box"-Type Selector Switches.

The main holding pressures are contributed by the 8 FLOATING contact springs. The locking spring action is merely sufficient to prevent the tube from starting to work out.

The socket mounts in the standard 1 1/64" diameter hole having one or two keys, using a specially designed spring retainer-ring. The 8 keyways on the socket permit choice of 8 mounting positions.

AIRCRAFT RADIO CORPORATION

DEPENDABLE ELECTRONIC EQUIPMENT SINCE 1928

Boonton, N. J.



THE *Project Engineer* TELLS WHY **S.S. WHITE FLEXIBLE SHAFTS** ARE USED IN THIS F-M TRANSMITTER

In high frequency radio transmitting equipment, various variable elements must be strategically located for premium electrical performance. In most cases, the resultant mechanical placement of these various elements do not readily adapt themselves to a symmetrical front panel placement of control knobs. Various methods of pulley and chain drive arrangements result in stiff operation with intolerable back-lash. For these reasons we have selected S.S. White flexible control shafts to allow us complete freedom in our mechanical and electrical design.

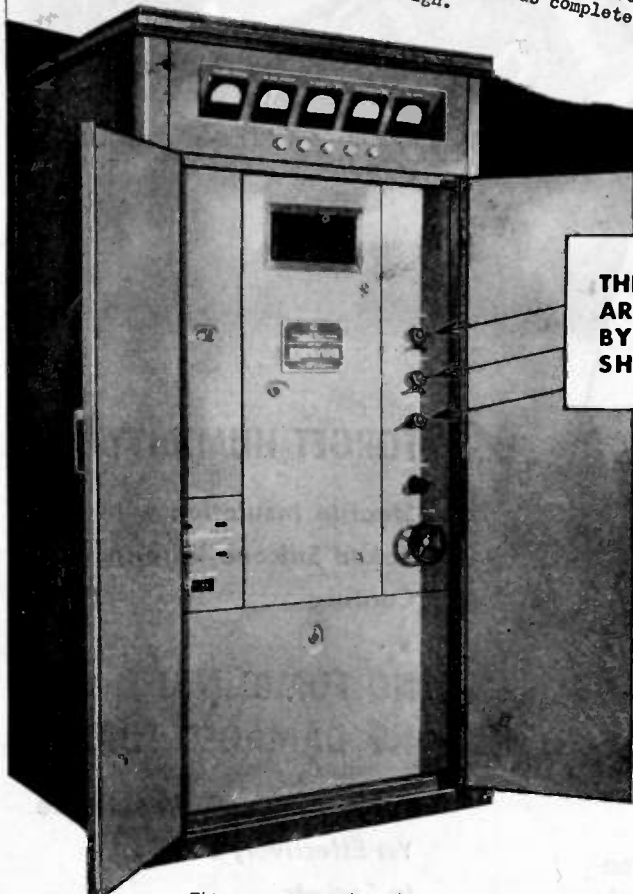

**THESE 3 CONTROLS
ARE OPERATED
BY FLEXIBLE
SHAFTS**

Photo courtesy of
Radio Engineering
Laboratories, Inc.
Long Island City, N. Y.

✿ This statement by the project engineer of Radio Engineering Laboratories, Inc. hits the nail on the head. The use of S. S. White remote control flexible shafts to couple variable units to their control knobs, eliminates all problems of knob and unit placement. Furthermore, these shafts when properly applied, give a quality of control that is as smooth and sensitive as a direct connection. Full details of these shafts and their application are given in the 260-page FLEXIBLE SHAFT HANDBOOK. A request direct to us on your business letterhead, indicating your position, will bring you a free copy. Write for it today.



S.S. WHITE INDUSTRIAL DIVISION
THE S. S. WHITE DENTAL MFG. CO. DEPT. G 10 EAST 40TH ST., NEW YORK 16, N. Y.



FLEXIBLE SHAFTS • FLEXIBLE SHAFT TOOLS • AIRCRAFT ACCESSORIES
SMALL CUTTING AND GRINDING TOOLS • SPECIAL FORMULA RUBBERS
MOLDED RESISTORS • PLASTIC SPECIALTIES • CONTRACT PLASTICS MOLDING

One of America's AAAA Industrial Enterprises



(Continued from page 52A)

ENGINEERS—PHYSICISTS

Highly qualified engineers and physicists needed in the development of electronic circuits, microwave components, UHF and VHF antenna, and servomechanisms. Highly qualified talent is also needed for analytical study of dynamical systems, complex electric circuits, and complex electronic systems. Opportunities are unlimited for the right men who are capable of assuming responsibilities. Write to Personnel Manager, Boeing Aircraft Company, Seattle 14, Washington.

COMMUNICATIONS ENGINEER OR PHYSICIST

The National Geophysical Company, Inc. has an opening on its engineering staff for a communications engineer, or physicist with electronic training, who is interested in research and development work. Projects cover all phases of geophysical work. This position is permanent. Salary open. Write National Geophysical Company, Inc. Research Laboratory, 8806 Lemmon Avenue, Dallas, Texas.

ENGINEERS—PHYSICISTS

Eastern tube manufacturer has openings for experienced men for electronic tube and circuit research and development work. Box 474.



Positions Wanted By Armed Forces Veterans

In order to give a reasonably equal opportunity to all applicants, and to avoid overcrowding of the corresponding column, the following rules have been adopted:

The Institute publishes free of charge notices of positions wanted by I.R.E. members who are now in the Service or have received an honorable discharge within a period of one year. Such notices should not have more than five lines. They may be inserted only after a lapse of one month or more following a previous insertion, and the maximum number of insertions is three per year. The Institute necessarily reserves the right to decline any announcement without assignment of reason.

JUNIOR ENGINEER

B.E.E., Cooper Union, Tau Beta Pi. Age 27. Three and one-half years ship power plant design, two years Army experience on aircraft instruments. Theoretical work completed for M.S. with thesis. Prefer New York City. Box 73. W.

ELECTRONICS PATENT ENGINEER

B.E.E. Graduate study. Age 28. Three years high voltage and dielectric research, four years patent experience, frequency modulation, television and radar. Formerly supervisory patent officer at M.I.T. Radiation Laboratory. Two years in Navy. Box 74 W.

(Continued on page 56A)

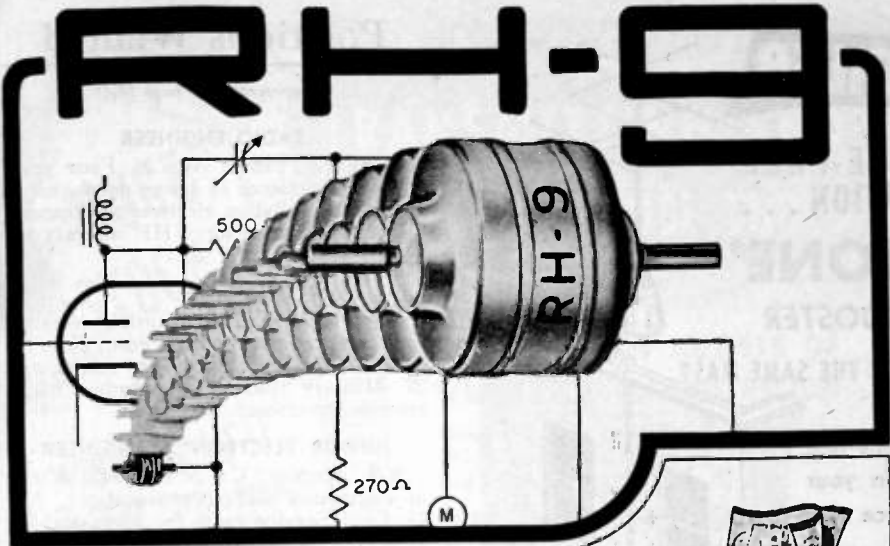

THE LATEST IN VHF HARMONIC MODE CRYSTAL UNITS

With RH-9 in a simple one tube oscillator circuit output X-tal frequencies from 12 to 75 mc. while operating in the 3rd, 5th, or 7th mechanical mode, can be generated. These frequencies can be multiplied to higher frequencies as desired.

- .005% maximum frequency drift from -55°C to +90°C
- Capacity between pins approximately 1 mmds
- Shock and vibration tested (ideal for mobile equipment)
- For transmitting, receiving, and filtering circuits
- For FM and TV
- Higher frequencies on special order



For Specifications of Crystal Unit RH-9 write for Catalog RHC-2



REEVES-HOFFMAN CORPORATION

SALES OFFICE: 215 EAST 91 STREET, NEW YORK 28, N. Y.
PLANT: 321 CHERRY STREET, CARLISLE, PA.



SPECIFICATIONS

- Direct reading accuracy: 1% ± 1/2 dial division
- Convenient bar type knob

PRECISION VARIABLE RESISTOR Type RVL-3

Primarily for use in the experimental laboratory as a convenient DIRECT READING variable resistor of moderately high accuracy.

- Binding posts with non-removable heads for ease in connecting
- Ranges:
0 to 100-200-500 ohms
0 to 1000-2000-5000 ohms
0 to 10000-20000-50000-100000 ohms

OUTSTANDING FEATURES

Adjustable rotor stop . . . 360 degree rotation . . . easy maintenance . . . precious metal contacts . . . reliable rotor take-off assembly . . . low temperature co-efficient . . . ganging simplicity . . . dustproof. Other models available. Write us regarding your requirements.

ENGINEERING REPRESENTATIVES:

CHICAGO: 1024 Superior Street, Oak Park 37, Illinois, Phone Village 9245
HOLLYWOOD: 623 Guaranty Building, Hollywood 28, California, Phone: HOLLYWOOD 5111



TECHNOLOGY INSTRUMENT CORP.
WALTHAM 54, MASSACHUSETTS



PULSE CABLE ASSEMBLIES incorporating inserts molded directly on the cable to meet higher dielectric strength and corona-free requirements.

H. H. BUGGIE & CO.
TOLEDO 1, OHIO

Cable Assemblies
Pressurized AN Connectors
Coax Connectors • Wiring Harnesses

MR. RADIO RETAILER

A MUST for NOISE-FREE
STORE DEMONSTRATION . . .



PURATONE*

SIGNAL BOOSTER

CARRIES AM, FM and TV ANTENNAS ALL ON THE SAME MAST

Increase your radio sales by bringing home-like reception to any AM, FM and TV set in your showroom . . . eliminating all interference and bothersome noises.

HERE'S HOW: The Puratone Signal Booster System is easily installed on the roof of your building. A shielded coaxial cable runs directly from the mast to the concealed amplifier on the display floor.

From the amplifier a radiating wire is placed inconspicuously around the display space. No direct wire connection to radio sets required. One system serves any number of floor models. Dual wave traps in the video-type AM-FM amplifier bring in all stations at an average tone-level. 30-40 DB gain on FM; 40-60 DB gain on AM. Effective for any radio department layout.

Write for illustrated circular.

L.S. BRACH MFG. CORP.
200 CENTRAL AVE. NEWARK, N. J.

WORLD'S OLDEST AND LARGEST MANUFACTURERS OF RADIO ANTENNAES AND ACCESSORIES

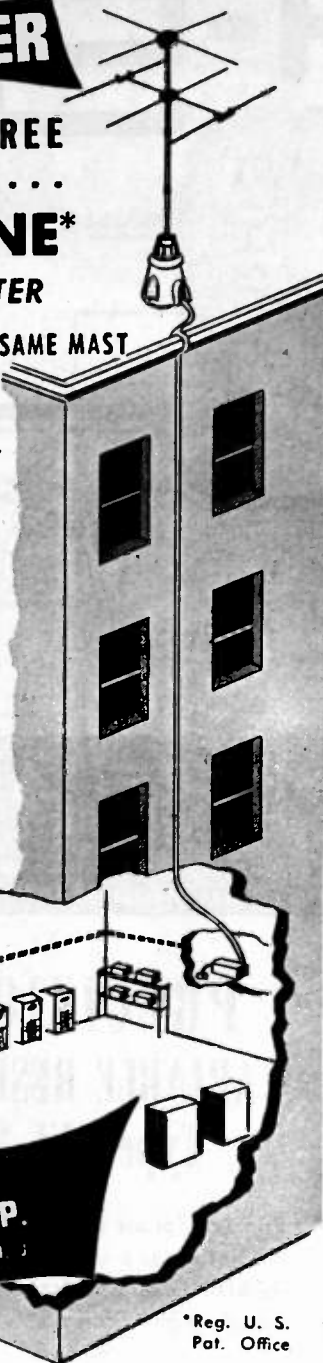

*Reg. U. S.
Pat. Office

Positions Wanted

(Continued from page 54A)

RADIO ENGINEER

B.S.E.E. Purdue. Age 26. Four years civilian experience in design development, test and installation electronic equipment. Currently developing VHF aircraft receiver. Box 75 W.

ENGINEER

B.A., M.A., E.E. Stanford University; first class radiotelephone license; Harvard —M.I.T. Officers' Electronics school. Age 27. Military research, supply and maintenance experience. Box 76 W.

JUNIOR ELECTRONICS ENGINEER

B.S. Physics, C.C.N.Y., 1947. Minor in electronics and communications. Age 23. Civil Service radio mechanic and instructor, one year. Signal Corps radar mechanic and instructor, three years. First class telephone operator's license. Prefers Metropolitan area. Box 77 W.

SALES—ADMINISTRATIVE

Experience includes three years with large radio distributor, electronic research, advertising and sales. War years —Navy, ending as Force Radio Material Officer. Interested in good opportunity utilizing technical and administrative ability. Box 78 W.

ENGINEER

B.S.E.E., sea duty as electrical officer in Navy. Age 21. Single. Desires position in Providence or Boston area. Box 79 W.

PATENT ENGINEER

M.S.E.E., Worcester Polytechnic Institute. Navy electronics training at Bowdoin, M.I.T. Patent solicitor at M.I.T. Radiation Laboratory. Prefers position as patent engineer. Location immaterial. Age 26. Available June 30, 1947. Box 80 W.

TELEVISION ENGINEER

B.E.E.E. (Commun.) RPI 1½ years test engineer G.E.; 1½ years development engineer Naval Research Laboratory; 2½ years naval radar officer M.I.T. radar laboratory project; 1 year development engineer television. Minimum salary \$5,000. West coast preferred. Box 91 W.

PRODUCT DESIGN ENGINEER

Creative executive engineer seeks permanent affiliation with firm or financial facilities backer to bring out many obviously useful and popularly priced new radio-electronic products for wide civilian use. Box 92 W.

ENGINEER—LAWYER

L.L.B. and B.S. in engineering (electrical); 3½ years experience in U.S. Army Signal Corps, including: radio, microwave communications, training and administration; 2½ years experience in banking, including accounting and investments. Desires position offering opportunity to enter field of engineering administration. Box 93 W.

RADIO OR SALES ENGINEER

Harvard, M.I.T., radio material Navy electronics training; 6 years radio material officer in charge at advanced base laboratory R.C.A.; Institutes, some college; 1st radio telephone, 2nd radio telegraph, class A amateur licenses, laboratory and maintenance experience. Box 94 W.

(Continued on page 58A)



The "fly-weight" Model
2A 0.45 (450 MA hr. cap.)
Actual Size Illustrated

RECHARGEABLE • NON-SPILL

VITAMITE

1 OZ. BATTERIES

(Smaller Than 2 Pen-Lights)

IDEAL FOR USE WITH

Miniature And Sub-Miniature Filament Type Tubes
for HEARING AIDS, POCKET RADIOS, ETC.

Other Miniature Models weighing from 1 oz. to 1 lb. also
manufactured. All models obtainable in Multi-Units from 2
volts to 120 volts. CHARGERS for all models available.

Write for Data and Literature on Letterhead

THE VITAMITE COMPANY

227 West 64th Street

New York 23, N.Y.

HUGE STOCKS!

TRANSMITTING AND SPECIAL PURPOSE TUBES

WRITE FOR NEWARK'S LIST OF TUBES

Make Newark your source, too, for all needed radio and electronic parts. Brisk, competent service assures quick delivery.

NEWARK NOW AGENTS OF WAR ASSETS ADMINISTRATION

Newark has been appointed agents of the War Assets Administration for transmitting and special purpose electronic tubes.

HUGE STOCKS! WIDE SELECTION!

This means that you can now get prompt Newark service on the previously hard-to-get tubes, priced at a fraction of their original cost. Make Newark your headquarters for tubes — whether it's for experimental work or production runs.

ACTING AS AGENTS FOR WAR ASSETS ADMINISTRATION UNDER CONTRACT WAS(p) 7-167

NEW YORK
Offices & Warehouse
242 W. 55th St., N.Y. 19

NEWARK
ELECTRIC COMPANY INC

TELEPHONE
Circle 6-4060

• MAIL AND PHONE ORDERS FILLED PROMPTLY

• WRITE: 242-N WEST 55th STREET, NEW YORK CITY

New York City Stores: 115-17 W. 45th St. & 212 Fulton St.



applications of COSMALITE*

A SPIRALLY LAMINATED PAPER BASE PHENOLIC TUBE

For coil forms in all standard broadcast receiving sets, specify #96 Cosmalite.

For permeability tuners, specify SLF Cosmalite.

LOWER COSTS . . . Quick deliveries

Ask about our spirally wound kraft and fish paper Coil Forms and Condenser Tubes.

*Trade Mark Registered.

•
for experienced cooperation
"call Cleveland"
•



The **CLEVELAND CONTAINER Co.**
6201 BARBERTON AVENUE CLEVELAND 2, OHIO

PRODUCTION PLANTS also at Plymouth, Wisc., Ogdensburg, N. Y., Chicago, Ill., Detroit, Mich., Jamesburg, N. J.
PLASTICS DIVISIONS at Plymouth, Wisc., Ogdensburg, N. Y. • ABRASIVE DIVISION at Cleveland, Ohio
New York Sales Office—1186 Broadway, Room 223

IN CANADA—The Cleveland Container Canada Ltd., Prescott, Ontario

**SO
DEPENDABLE**



PILOT LIGHT ASSEMBLIES!

They do the job better and more economically

DRAKE Socket and Jewel Light Assemblies are built to highest standards, yet cost no more than ordinary types. There is a COMPLETE selection of standard types, special types, "Underwriters Approved" Types, Bayonet, Screw and Bracket Types, Neon, Jewel Types . . . and hundreds of others. Or we can custom-build an Assembly for your special requirements.

→ ENGINEERS

Drake Assemblies are designed with a safety factor adequate to meet varying conditions. Materials and workmanship are highest grade. Our engineers will cooperate with you on your Pilot Light problems . . . no obligation.

→ MANUFACTURERS

Drake will supply your Pilot Light needs faster, better, more economically. Get the benefit of our patented features, of high speed precision methods and machinery developed thru 15 years of specializing in making Socket and Jewel Light Assemblies.

→ PRODUCT DESIGNERS

Add a DRAKE Light Assembly to your specifications. They often mean that "extra something" that clinches a sale. Use Drake Light Assemblies for on or off signals, for illumination, for warning signals. Be sure to "SPECIFY DRAKE", for the finest.

ASK FOR FREE CATALOG

**DRAKE
MANUFACTURING CO.**
1713 W. HUBBARD ST., CHICAGO 22



WOLLASTON PROCESS WIRE

drawn as small as .000010";

Made to your specifications

for diameter and resistance

WRITE for list of products.



Positions Wanted

(Continued from page 56A)

ELECTRONIC ENGINEER

B.S.E.E. by June 1947. Age 29. Experience: Troubleshooter on proximity fuses; engineering assistant on pilot line; assistant to chief propagation engineer of large short wave broadcasting station and assistant in laboratory doing research work on A.C. motor electronic speed controls. Member Eta Kappa Nu. Commercial and amateur radio licenses. Will consider foreign service. Box 95 W.

JUNIOR ELECTRICAL ENGINEER

B.E.E. 1946. Cooper Union. Age 22. Single. Majored in electronics—communications. Excellent college record. Desires position in New York or within commuting distance in communications or VHF field. Box 96 W.

ELECTRICAL ENGINEER

B.S.E.E. Worcester Tech. 1942. Age 27. Married. Three years production and design engineer at radio tube plant. Varied electronic experience for two years as Naval officer. Has held amateur radio license for 11 years. Desires responsible position with progressive concern in Metropolitan area. Detailed resume on request. Box 97 W.

ELECTRONIC ENGINEER

B.E.E. 1943, College of the City of New York, graduate work. Age 25. Married. 2 years Army Signal Corps radar technician on pulse position modulated radar link communications equipment. 1 year microwave research experience. Desires electronics development work vicinity New York City. Box 98 W.

TELEVISION ENGINEER

B.S.E.E., Cooper Union. Age 24. Single. Desires position in radar or television development. New York City vicinity or Northeast. 2½ years industrial experience in development and design of U. S. Navy Airborne I.F.F. and airborne television receivers; also civilian television receivers. Maintenance and operation of ground radar sets in Army for 10 months. Box 99 W.

ELECTRONIC ENGINEER

B.E.E. Age 27. Married. Graduate RCA Institutes. Signal Corps radar officer, trained M.I.T. Civilian electronics and army radar development experience. Prefer electronics development. Box 100 W.

ELECTRICAL ENGINEER

B.S. from M.I.T. in 1942. M.A. Stanford University in 1946. Two years television experience with General Electric Co. Four years Navy radar officer. Age 29. Interested in research and design of radio and television equipment. Box 102 W.

ENGINEER

B. S. Chemistry, Rutgers 1941. Age 28. Married. Naval radar and year graduate work physical chemistry M.I.T. Experience includes photochemical research, instruction in electronics, electronic maintenance officer and vacuum tube manufacturing. Special training and experience in microwave spectroscopy. Seek research and/or teaching position. Box 111 W.

JUNIOR ENGINEER

B.E.E. New York University 1947. Age 23. Single. Desires work in radio electronics, or industrial electronics in Metropolitan area. Details on request. Box 112 W.

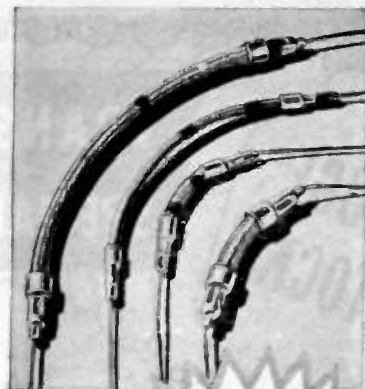

★ Exclusively Clarostat! These flexible glass-insulated wire-wound resistors spell tougher components for tighter spots. Fibre-glass core and fibre-glass braided covering. Nothing to char or burn. Self-supporting when soldered in place. Especially handy for point-to-point wiring. Ideal for attenuators or step-by-step controls. Truly midget power resistors. Also used as miniature heating elements in longer lengths.

GLASOHMS

Ex two ratings: Series FXG, 1 watt per winding inch; Series FYG, 2 watt.

Maximum resistance per winding inch: Series FXG, 750 ohms; FYG, 1500 ohms.

Minimum resistance per winding inch: Series FXG, ¼ ohm; Series FYG, ½ ohm.

Both types supplied to any reasonable length especially for heating-element applications.

Patented "Clinch-Grip" ferrules and 2" pigtail, standard.

★ Write for Bulletin . . .

Engineering Bulletin No. 105 gives complete specifications. Copy on request. Meanwhile, submit your resistor, control or resistance-device problems for our engineering aid.



CLAROSTAT MFG. CO., Inc. • 285 7 N. 6th St., Brooklyn, N. Y.

MANUFACTURERS

JOBBERS

WHOLESALEERS

Valuable, hard-to-get, electronic materials and equipment can be obtained through *your* WAA Approved Distributor.

Huge inventories, declared surplus by the Armed Forces, have been allocated to these Approved Distributors for efficient disposal.

The names and addresses of our distributors are listed below. They are equipped to serve your needs and will know what is immediately available.

BOSTON, MASS.
Automatic Radio Mfg. Co., Inc.
122 Braakline Ave.
Technical Apparatus Co.
165 Washington St.

BUCHANAN, MICH.
Electro-Voice, Inc.
Carral I & Cecil Sts.

CANTON, MASS.
Tabe Deutschmann Corp.
863 Washington St.

CHICAGO, ILL.
American Condenser Co.
4410 N. Ravenswood Ave.
Belmont Radio Corp.
3633 S. Racine Ave.

EMPORIUM, PENNA.
Sylvania Electric Products, Inc.

FORT WAYNE, IND.
Essex Wire Corp.
1601 Wall St.

HOUSTON, TEXAS
Navigation Instrument Co., Inc.
P.O. Box 7001, Heights Station

LOS ANGELES, CALIF.
Cole Instrument Co.
1320 S. Grand Ave.
Haffman Radio Corp.
3761 S. Hill St.

NEWARK, N. J.
National Union Radio Corp.
57 Sloat St.
Standard Arcturus Corp.
99 Sussex Ave.
Tung-Sol Lamp Works, Inc.
95-8th Ave.

NEW ORLEANS, LA.
Southern Electronic Co.
512 St. Charles St.

NEW YORK, N. Y.
Carr Industries, Inc.
1269 Atlantic Ave., B'klyn.
Communication Measurements
Laboratory
120 Greenwich St.
Electronic Corp. of America
353 W. 48th St.
Emerson Radio & Phonograph
Corp.
76-9th Ave.
General Electronics, Inc.
1819 Broadway
Hammarlund Mfg. Co., Inc.
460 W. 34th St.

Johanns & Keegan Co., Inc.
62 Pearl St.
Newark Electric Co., Inc.
242 W. 55th St.
Smith-Meeker Engineering Co.
125 Barclay St.

NORFOLK, VA.
Radio Parts Distributing Co.
128 W. Olney Road

ROCHESTER, N. Y.
W. & H. Aviation Corp.
Municipal Airport

SALEM, MASS.
Hytron Radio & Electronics Corp.
76 LaFayette St.

SCHENECTADY, N. Y.
General Electric Co.
Bldg. 267, 1 River Road

WASECA, MINN.
E. F. Jahnsan Co.
206-2nd Ave., S. W.

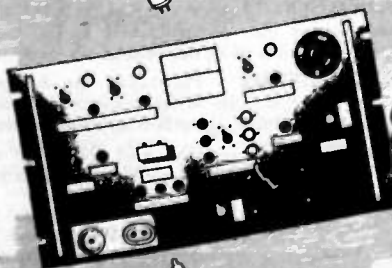

OFFICE OF AIRCRAFT AND ELECTRONICS DISPOSAL

WAR ASSETS ADMINISTRATION



Offices located at: Atlanta • Birmingham • Boston • Charlotte • Chicago
Cincinnati • Cleveland • Denver • Detroit • Grand Prairie, Tex. • Helena • Houston
Jacksonville • Kansas City, Mo. • Little Rock, Ark. • Los Angeles • Louisville • Minneapolis
Nashville • New Orleans • New York • Omaha • Philadelphia • Portland, Ore. • Richmond
St. Louis • Salt Lake City • San Antonio • San Francisco • Seattle • Spokane • Tulsa

NEW 5-WAY BINDING POST

SERVES
ALL



Offering complete insulation . . .
current capacity of 30 amperes
. . . working voltage of 1000
volts; the new Superior Binding
Post type DF30 meets the need
for a multi-purpose electrical
connector.

Features Five Connections

1. Permanent clamping of wire up to #12 through the center hole.
2. Looping of wire around the center shaft and clamping.
3. Plug-in of standard 3/4" banana plug.
4. Clip-lead by removing the hexagonal shaped phenolic head.
5. Spode lug connection.

DESCRIPTIVE LITERATURE ON REQUEST



NEW Engineering DATA BOOK

Just released . . . Bulletin 547 complete with ratings, detail drawings, performance and engineering data on POWERSTAT variable transformers and STABILINE Voltage Regulators. Get your copy.

Write



The SUPERIOR ELECTRIC Co.
907 LAUREL STREET
BRISTOL, CONN.



(Continued from page 46A)

- Sokolki, E. A., 300 Riverside Dr., New York 25, N. Y.
Spokus, P. P., Jr., 65 River St., Haverhill, Mass.
Stanphill, J. R., Box 150, c/o Federal Communications Commission, Miami, Fla.
Stone, A. J., 5824 W. Jackson Blvd., Chicago 44, Ill.
Sugg, L. M., WSJS, Winston-Salem, N. C.
Swan, L. L., 8207 Champlain Ave., Chicago 19, Ill.
Tanrath, E. G., 3151 W. Monroe St., Chicago 12, Ill.
Taylor, H. O., 1520 Pennsylvania, Beaumont, Texas
Thomas, C. W., Jr., 801 Caplin, Houston, 9, Texas
Ulleweit, O., 918 Oakwood Ave., Wilmette, Ill.
Varga, M. J., Jr., 20 E. Dayton Dr., Osborn, Ohio
Watson, C. B., Radio Station WSTP, Salisbury, N. C.
Weaver, R. J., 220 Pickett, Plainfield, Ind.
Webster, R. H., 148 Warren Terr., Longmeadow 6, Mass.
West, J. L., 720 Riverside Dr., New York 31, N. Y.
Wilcox, G. A., 155 Benson St., Vallejo, Calif.
Wolstenholme, E. V., Jr., 3110 W. Grace St., Richmond, Va.
Woods, A. R., 3 Cambridge Mansions, Milnerton, Capetown, South Africa
Yaeger, E., 3151 W. Monroe St., Chicago 12, Ill.
Young, J. S., 141 Danbury St., S.W., Washington, D. C.
Yount, T. L., 6503 Buffalo Ave., Niagara Falls, N. Y.
Zalewski, W. J., 2126 W. Thomas, Chicago 22, Ill.
Zurbruggen, J. H., 2109 E. Fair, St. Louis 7, Mo.

Specify

MYCALEX

LOW LOSS INSULATION

Where high mechanical and electrical specifications must be met.

MYCALEX 410

(MOLDED MYCALEX)

makes a positive seal with metals
. . . resists arcing, moisture and high temperatures.

27 years of leadership
in solving the most
exacting high frequency
insulating problems.

MYCALEX CORPORATION OF AMERICA

"Owners of 'MYCALEX' Patents"
Plant and General Offices: Clifton, N.J.
Executive Offices: 30 Rockefeller Plaza
New York 20, N.Y.

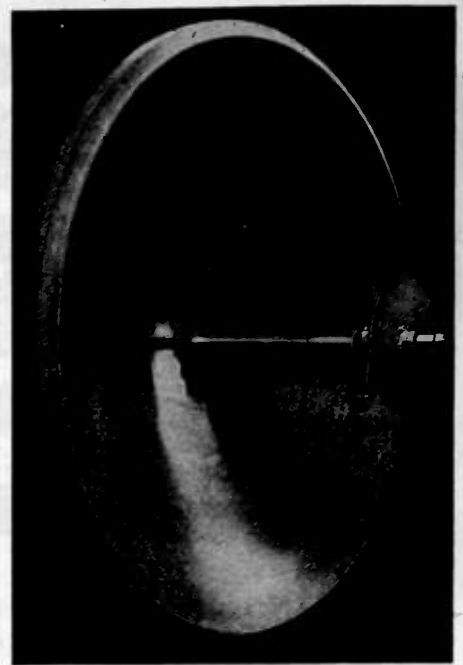

PARABOLIC ANTENNAS

FOR

- FM and AM Studio-to-Transmitter Link
- Television and Facsimile Relay Work
- Multi-channel Point-to-Point Relay
- Research and Development Laboratories

The Workshop can supply parabolic antennas in a wide range of types, sizes and focal lengths, plus a complete production and engineering service on this type of antenna.

Workshop test equipment and measurements for the determination of antenna characteristics is outstanding in the industry. These facilities, coupled with the wartime experience of its engineers on high frequency antennas, assure exceptional performance.

PARABOLAS— Precision-formed aluminum reflectors. Can be supplied separately, if desired.

MOUNTINGS— Various types of aluminum reinforced mountings can be supplied with all antennas.

R. F. COMPONENTS— Precisions machined and heavily silver plated. Critical elements protected by low-loss plastic radome.

PATTERN AND IMPEDANCE DATA— A series of elaborate measurements of both pattern and impedance are made to adjust the settings for optimum performance. Pattern and impedance data is supplied with each antenna.

POLARIZATION— Either vertical or horizontal polarization can be obtained easily by a simple adjustment at the rear of the reflector.

SPECIAL ANTENNAS— Parabolas can be perforated to eliminate wind resistance or sectioned to produce a specified antenna pattern.

OTHER ANTENNAS— FM and television receiving antennas. A complete line of amateur antenna equipment.

Prices on Request

The Workshop invites your inquiry on any type of high frequency antenna problem—no obligation. Write, or phone Boston, BIGelow 3330.

The WORKSHOP ASSOCIATES, Inc.

66 NEEDHAM STREET
Newton Highlands, Massachusetts





FROM
MICROPHONE
TO **LINE**

TYPE
116-A

TYPE
117-A

● **YOU NEED**

Only two types of PLUG-IN amplifiers... Type 116-A as a pre-amplifier or booster... Type 117-A as a program amplifier, monitor, or booster.

Only two types of tubes, 1620's and 6V6GT's.

● **YOU SAVE**

By conserving rack space.
By simplified maintenance...
Just PLUG-IN a spare amplifier should trouble occur.

● **YOU HAVE QUALITY**

These amplifiers are built to the Langevin standard of high quality performance... They exceed the FCC specifications for FM.

The complete story of "PLUG-IN Amplifiers by Langevin" is ready for you now in booklet form... write for it today.



The Langevin Company

INCORPORATED
SOUND REINFORCEMENT AND REPRODUCTION ENGINEERING
NEW YORK 39 W 65 St 23 • SAN FRANCISCO 1050 Howard St 3
LOS ANGELES 1000 N Seward St 38

**UNIVERSAL PLATE
SUPPLY TRANSFORMERS**

Professional
Series

CUSTOM BUILT—ECONOMICAL

- "Electroseal" Construction ▶
- High Overload Capacity ▶
- Extreme Compactness ▶
- Complete Reliability ▶
- Unlimited Life ▶
- Fully Guaranteed ▶

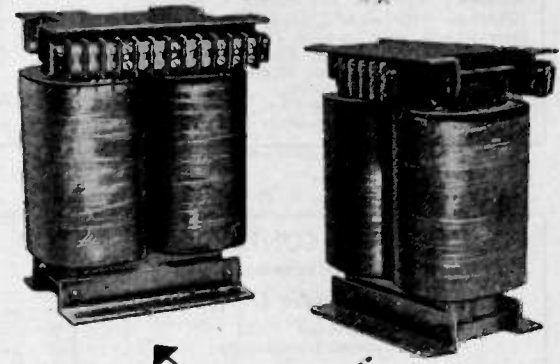

ELECTRO Transformers embody the distinctive "Electro" construction and are designed* to combine maximum performance with reduced weight and size. They are adaptable to a wide variety of uses and offer efficient, economical performance. Quality materials, excellent workmanship and twenty years of research are combined to give you the particular transformer for your specific job.

* We will be glad to quote to "quantity users" on modifications of our designs to meet special requirements.



ELECTRO ENGINEERING WORKS

6021 College Avenue, Oakland 11, California

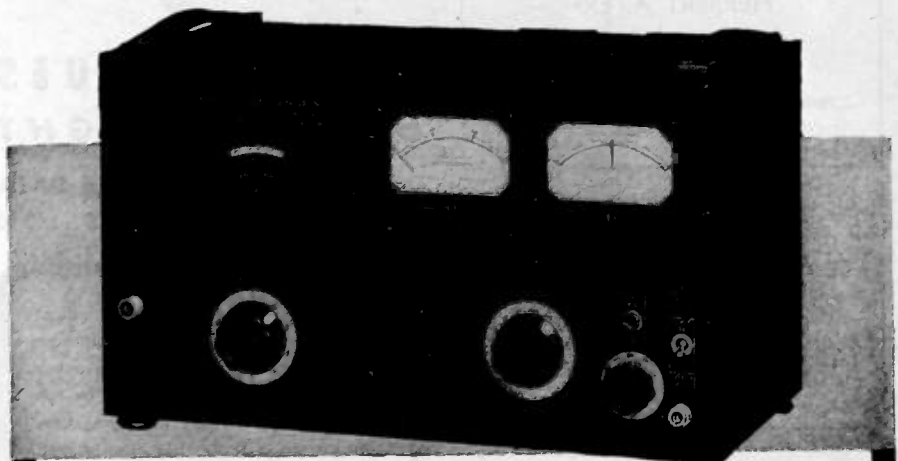

STANDARD SIGNAL GENERATOR Model 80

- CARRIER FREQUENCY RANGE: 2 to 400 megacycles.
- OUTPUT: 0.1 to 100,000 microvolts.
50 ohms output impedance.
- MODULATION: A M 0 to 30% at 400 or 1000 cycles internal.
Jack for external audio modulation.
Video modulation jack for connection of external pulse generator.
- POWER SUPPLY: 117 volts, 50-60 cycles.
- DIMENSIONS: Width 19", Height 10 1/4", Depth 9 1/2".
- WEIGHT: Approximately 35 lbs.
Suitable connection cables and matching pads can be supplied on order.

- MANUFACTURERS OF**
- Standard Signal Generators
 - Pulse Generators
 - FM Signal Generators
 - Square Wave Generators
 - Vacuum Tube Voltmeters
 - UHF Radio Noise & Field Strength Meters
 - Capacity Bridges
 - Megohm Meters
 - Phase Sequence Indicators
 - Television and FM Test Equipment

MEASUREMENTS CORPORATION

BOONTON  NEW JERSEY

PROFESSIONAL CARDS

W. J. BROWN

Electronic & Radio Engineering Consultant
Electronic Industrial Applications, Commercial and Broadcasting Transmitter and Receiver Design, Test Equipment, etc.
23 years experience in electronic development
P.O. Box 5106, Cleveland, Ohio
Telephone, Yellowstone 7771

EDWARD J. CONTENT

Acoustical Consultant
Functional Studio Design

FM - Television - AM
Audio Systems Engineering
Roxbury Road Stamford 3-7459
Stamford, Conn.

STANLEY D. EILENBERGER

Consulting Engineer
INDUSTRIAL ELECTRONICS

Design—Development—Models
Complete Laboratory and Shop Facilities
6309-13—27th Ave.
Kenosha, Wis. Telephone 2-4213

HERBERT A. ERF

Architectural Acoustics
Consultant

STUDIO DESIGN
Standard Broadcast—FM—Television
Cleveland 15, Ohio
3868 Carnegie Avenue Express 1616

DAVID C. KALBFELL, Ph.D.

Engineer — Physicist

Complete laboratory facilities
Industrial instrumentation and control
Broadcast engineering and measurements
1076 Morena Boulevard Jackson 1939
San Diego 10, California

FAirmount 5105 Express 7766

FRANK MASSA

Electro-Acoustic Consultant

3393 Dellwood Road 3868 Carnegie Avenue
CLEVELAND, OHIO

ROBERT E. McCOY

Consulting Engineer

Antennas, Antenna-Coupling Systems,
Direction Finders and Beacons.
Electronic Circuits for Special Purposes:
Measurement, Computation and Control.
301-302 Concord Bldg., Portland 4, Oregon

EUGENE MITTELMANN, E.E., Ph.D.

Consulting Engineer & Physicist

**HIGH FREQUENCY HEATING
INDUSTRIAL ELECTRONICS
APPLIED PHYSICS &
MATHEMATICS**

549 W. Washington Blvd. Chicago 6, Ill.
Phone: State 8021

ARTHUR J. SANIAL

Consulting Engineer

Loudspeaker Design; Development; Mfg.
Processes. High Quality Audio Systems.
Announcing Systems. Test and Measuring
Equipment Design.

168-14 32 Ave. Flushing, N.Y.
FLushing 9-3574

Paul D. Zottu

Consulting Engineer
Industrial Electronics

High Frequency Dielectric and Induction
Heating Applications, Equipment Selection,
Equipment and Component Design, Development, Models.

272 Centre St., Newton, Mass. BIG-9240

MICROTORQUES by AUTOFLIGHT

FOR REMOTE DATA
TRANSMISSION

Solve remote control and remote indicating problems by adopting Microtorque Potentiometers to your particular needs. Microtorque Potentiometers can be connected directly to your present gages and indicators by a simple yoke adaptation to the instrument pointer, and used to operate directly recorder controllers, oscillographs, telemetering circuits, etc.

Input torque less than
.003 oz. in. Size
1" x 1/4" Weight less
than 3/4 oz.



Write for detailed
information.



**AUTOFLIGHT
INSTRUMENTS**

A Division of G. M. Giannini & Co., Inc.
285 WEST COLORADO ST.
PASADENA 1, CALIFORNIA

INDEX

Section Meetings	35A
Membership	35A
Positions Open	50A
Positions Wanted	54A
News—New Products	18A

DISPLAY ADVERTISERS

Aerovox Corp.	45A
Aircraft Radio Corporation	53A
American Lava Corp.	17A
Amperex Electronic Corp.	Cover II
Andrew Co.	35A
Arnold Engineering Co.	4A
Astatic Corp.	44A
Bell Telephone Laboratories	2A, 34A
Bendix Aviation Corp. (Red Bank Div.)	42A
Blaw-Knox Co.	43A
Boeing Aircraft Co.	50A
L. S. Brach Mfg. Co.	50A
W. J. Brown	62A
Brush Development Co.	40A
H. H. Buggie & Co.	55A
Cambridge Thermionic Corp.	48A
Clarostat Mfg. Co.	58A
Cleveland Container Co.	57A
Sigmund Cohn & Co.	58A
Collins Radio Co.	27A
E. J. Content	62A
Cornell-Dubilier Electric Corp.	Cover III
Tobe Deutschmann Corp.	20A
Drake Mfg. Co.	57A
Allen B. DuMont Labs., Inc.	10A
Stanley D. Eilenberger	62A
Eitel-McCullough, Inc.	8A
Electro Engineering Works	61A
Electro Impulse Laboratories	40A
Electro-Motive Mfg. Co., Inc.	11A
H. A. Erf	62A
Erie Resistor Corp.	5A
Fairchild Camera & Instrument Corp.	39A
Federal Telephone & Radio Corp.	7A
Finch Telecommunications	6A
General Electric Company	23A
General Radio Co.	Cover IV
G. M. Giannini Co., Inc.	62A
Hallcrafters Company	49A
Hammarlund Mfg. Co.	41A
Hewlett-Packard Co.	3A
Hytron Radio & Electronics Corp.	1A
Insulation Manufacturers Corp.	63A
International Nickel Co.	33A
International Resistance Co.	25A
International Tel. & Tel. Corp.	7A
David C. Kalbfell	62A
Karp Metal Products Co., Inc.	15A
Kemet Laboratories Company, Inc.	36A
Langevin Co.	61A
Lavoie Laboratories	19A
Maguire Industries, Inc.	13A
P. R. Mallory & Co., Inc.	22A
Frank Massa	62A
Robert E. McCoy	62A
Measurements Corp.	61A
Eugene Mittelmann	62A
Mycalex Corp. of America	60A
National Co.	16A
Newark Electric Co.	57A
North American Phillips Co., Inc.	50A
Ohmite Mfg. Co.	29A
Radio Corp. of America	32A, 64A
Radio-Music Corp.	46A
Raytheon Mfg. Co.	28A
Reed & Prince Mfg. Co.	51A
Reeves-Hoffman Corp.	55A
Revere Copper & Brass, Inc.	24A
A. J. Sanial	62A
Selenium Corp. of America	21A
Sherron Electronics Co.	47A
Sorensen & Company, Inc.	48A
Sperry Gyroscope Co., Inc.	50A
Sprague Electric Company	12A
Stackpole Carbon Co.	14A
Superior Electric Co.	38A, 60A
Sylvania Electric Products Inc.	26A
Technology Instrument Corp.	55A
Turner Co.	52A
United Transformer Corp.	9A
Union Carbide & Carbon Corporation	36A
Vitamite Co.	56A
War Assets Administration	30A & 31A, 59A
Western Electric Company	34A
Weston Electrical Inst. Corp.	37A
S. S. White Dental Mfg. Co.	54A
Workshop Associates, Inc.	60A
Paul D. Zottu	62A

The IMC Engineer



ON YOUR *STAFF* but not on your payroll

HELPS YOU SELECT INSULATION TO SOLVE YOUR PROBLEMS

Whatever your problem on application of electrical insulation, it is likely that the IMC Engineer carries the answer with him. He represents most of the recognized leading manufacturers of electrical insulation—each specializing in his own particular product. With this background of information behind him, your IMC Engineer is a specialist in the business of helping you.

The practical experience of the IMC Engineer in the application of these materials provides him with a valuable fund of information for you. He and the IMC organization behind him are qualified to . . .

1. Assist you in the selection of the best insulating materials for the job.
2. Familiarize you with their proper application.
3. Suggest ways to eliminate waste.
4. Help you increase your production.

DIFFLEX FIBERGLAS INMANCO MACALLEN MANNING
NAT'L FIBRE PEDIGREE PERMACEL SILICONES VARTEX

INSULATION

MANUFACTURERS CORPORATION

*CHICAGO 6
565 W. Washington
Boulevard

MILWAUKEE 2
312 East Wisconsin
Avenue



*Local Stocks Available

*CLEVELAND 14
1231 Superior
Ave., N. E.

DAYTON 2
1315 Mutual Home
Building

Representatives in: DETROIT 2; 11341 Woodward Avenue
MINNEAPOLIS 3; 1208 Harmon Place PEORIA 5; 101 Heinz Court

IMC PRODUCTS:—Macallen Mica Products—Vartex Varnished Cloth and Tapes—Varslot Combination Slot Insulation—Varnished Silk and Paper—Fiberglas Electrical Insulation—Manning Insulating Papers and Pressboards—Dow Corning Silicones—Dieflex Varnished Tubings and Saturated Sleeveings of Cotton and Fiberglas—National Hard Fibre and Fishpaper—Phenolite Bakelite—Permacel Adhesive Tapes—Asbestos Woven Tapes and Sleeveings—Cotton Tapes, Webbing and Sleeveings—Pedigree Insulating Varnishes—Wedgie Brand Wood Wedges.



RCA Miniature Tubes enhance the tonal brilliance of RCA Victor Globe Trotter portable radios.

She shall have music wherever she goes!

Wherever you go with an RCA Victor Globe Trotter portable radio you'll enjoy richness and clarity of tone—volume enough for outdoor dancing—made possible through tiny tubes.

Miniature tubes save valuable space in small radios—space that can be used for larger and better loudspeakers and for longer lasting, radio-engineered RCA batteries.

These miniature tubes were developed by RCA Laboratories—a world center of radio and electronic research—and long a leader in development of electron tubes for all purposes.

At RCA Laboratories, the same research, experimentation and advancement that resulted in these improved tubes, keep all RCA products and services at the top in their particular fields.

When you buy a product bearing the name RCA or RCA Victor—a radio set, television receiver, Victrola radio-phonograph, a radio tube or phonograph record—you get one of the finest products of its kind that science has yet achieved.

"Victrola" T.M. Reg. U. S. Pat. Off.

Radio Corporation of America, RCA Building, Radio City, New York 20. Listen to the RCA Victor Show, Sundays, 2:00 P.M., Eastern Daylight Saving Time, over NBC.

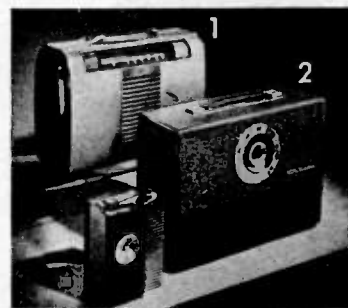

Ideal traveling companions. (1) RCA Victor "Globe Trotter" portable radio—operates on AC, DC, or batteries. (2) RCA Victor "Escort"—has a battery you can recharge from any ordinary AC electric outlet. (3) RCA Victor "Solitaire"—less than 6¼ inches tall!



RADIO CORPORATION of AMERICA

your Noise Problems, too can be Solved Better with C-D Quietones



Just because Mom wants to bake a cake is no reason why she shouldn't hear her pet soap opera. And sooner or later she's bound to find out that *some* mixers *don't* cause radio interference. Mixers equipped with C-D Capacitors, for example.

C-D's experience in designing and building noise suppressors is unequalled in the capacitor industry. We are now manufacturing hundreds of types of noise filters for electrical appliances and equipment. It's possible, of course,

that the exact unit for solving *your* noise problem is not included. In that case, our engineers are ready and anxious to design and build the suppressor best suited to your specific requirements—*better, faster, more economically. Consult with them.*

Catalog of standard types will be mailed on request. Cornell-Dubilier Electric Corporation, Dept. M7, South Plainfield, New Jersey. Other large plants in New Bedford, Brookline and Worcester, Mass., and Providence, R. I.

MICA • DYKANOL • PAPER • ELECTROLYTIC

CORNELL-DUBILIER
world's largest manufacturer of
CAPACITORS

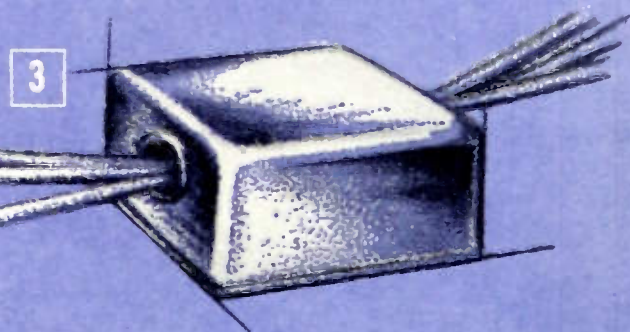
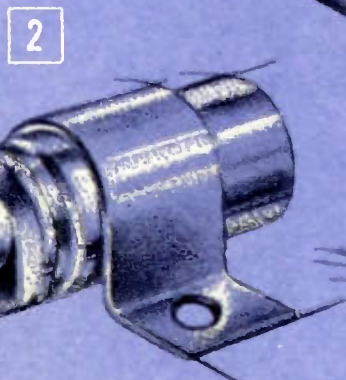

TYPICAL NOISE SUPPRESSORS

CAPACITORS #1 AND #2

Two of the Type MC Filter Capacitors designed for heavy duty service on buses, trucks, etc. for spark and noise suppression. Mechanically rugged, oil filled and impregnated and hermetically sealed.

CAPACITOR #3

A general purpose filter—effectively controls radio noise energy created by fluorescent lamps. This capacitive—inductive type filter is compact and can be quickly installed in a variety of positions. Convenient leads simplify installation.

for
**VOLTAGE
MEASUREMENTS**
to
1,000 Mc!

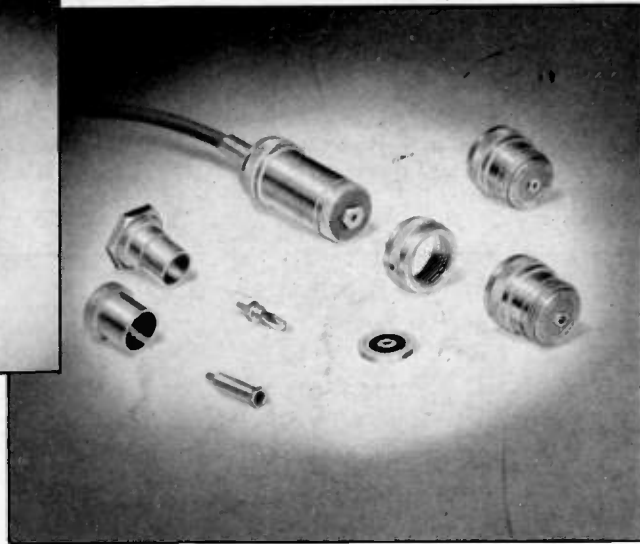

The Type 1802-A Crystal Galvanometer (a "galvanometer" rather than a "voltmeter" because it does not have the high accuracy of most other G-R instruments) measures voltages from 30 to 1,000 Mc, and is useful up to 4,000 Mc. It is direct-reading from 0.1 volt to 100 volts and is finding considerable utility in u-h-f measurements.

Essentially it is very simple — a 1N21B crystal and a d-c amplifier. To obtain the high upper-frequency limit, however, several mechanical and electrical design problems are involved. The crystal rectifier extends the frequency range far above that obtained with the usual tube diode; however, the uniformity of commercially available crystals is below that of the v-t diodes and limits the instruments accuracy to $\pm 5\%$.

The upper frequency limit is dependent upon the design of the pick-up probe. The probe assembly has been designed to minimize inductance by using cylindrical blocking and by-pass condensers. The probe design and the crystal itself result in an average probe resonant frequency of about 1800 Mc. Individual crystals modify this resonant frequency.

The amplifier uses a degenerative cathode-follower circuit arranged as a bridge system. The sensitivity of the meter is essentially independent of zero setting.

Two capacitance voltage dividers are supplied as multipliers extending the voltage ranges to 10 and 100 volts. Fittings for plugging into coaxial connectors are furnished.

TYPE 1802-A Crystal Galvanometer . . . \$210.00

WE HAVE A FEW IN STOCK — Order Now for Probable Immediate Shipment



GENERAL RADIO COMPANY

Cambridge 39,
Massachusetts

90 West St., New York 6

920 S. Michigan Ave., Chicago 5

950 N. Highland Ave., Los Angeles 38