

PROCEEDINGS OF THE I.R.E.



AND



WAVES AND ELECTRONS

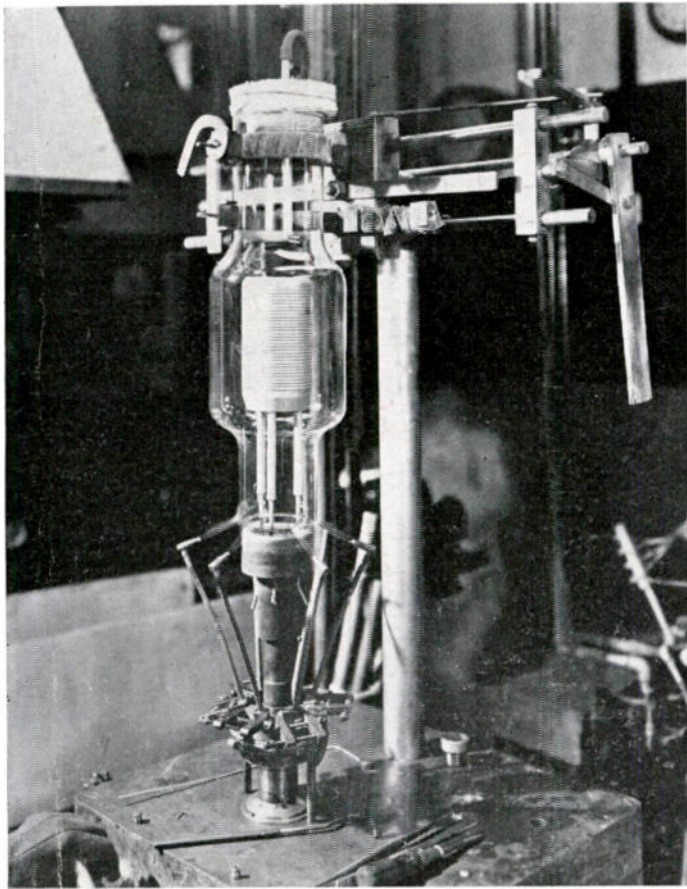

Amperex

The Complicated Art of Transmitting-Tube Assembly in a vertical lathe for sealing the anode assembly, with a three-column vibration-reducing support, inert gas is introduced to maintain cleanliness.

July, 1946

Volume 34

Number 7

PROCEEDINGS
OF THE I.R.E.

Image Orthicon
5RP-Multiband Tube
Unbalanced Dipole Radiation Field
Effect of Grid Wires
Frequency-Selective Parallel-T R-C
Networks

Waves and Electrons
Section

Electrical Engineers Trained During
the War
Disk-Seal-Tube Amplifiers
H-F Heating Equipment Design
Amplifier-Gain Formulas and Meas-
urements
Abstracts and References

The Institute of Radio Engineers

New Vacuum Condenser Cuts Frequency Drift

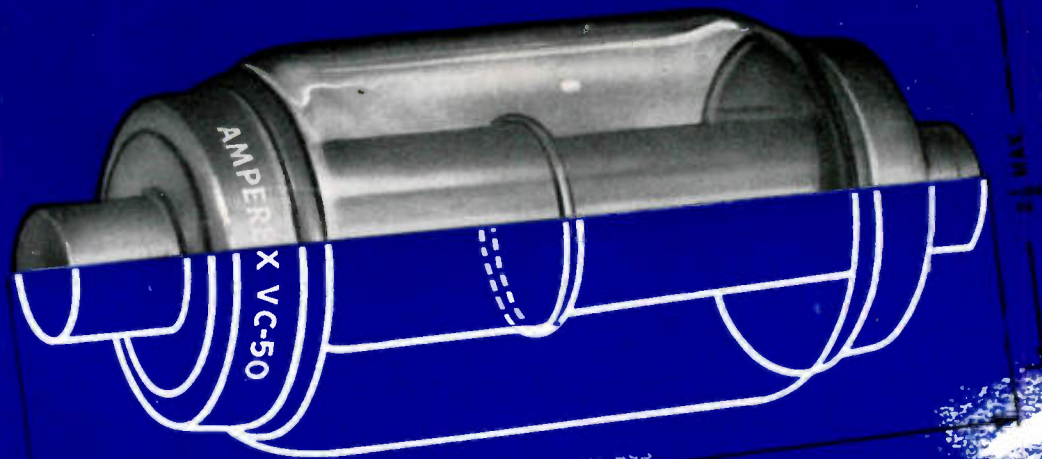

GENERAL CHARACTERISTICS —

Capacitance...50 uuf $\pm 2\%$ • Maximum Peak Voltage...30,000
Maximum RMS Current...65 Amps at 10 Mc. • 40 Amps at 60 Mc.

Higher current handling ability and lower I^2R losses in reduced space simplify equipment design — meets new FCC frequency stability regulations for industrial and electro-medical oscillators using Amperex-developed circuits

Design and manufacturing techniques evolved for high power copper anode tubes were successfully brought to bear in developing the unusual qualities of the Amperex VC50 Vacuum Condenser. This unique all-copper construction with large area seals, no welds and increased mechanical ruggedness insures efficient and economical operation.

READY FOR YOU: Detailed technical rating and data sheets.

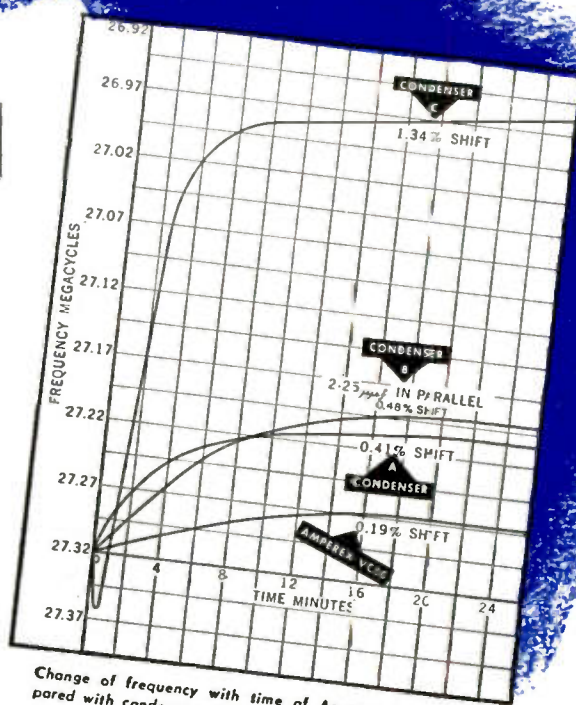

Change of frequency with time of Amperex VC50 compared with condensers of three other leading manufacturers in a typical piece of industrial equipment operating at 27.32 MC with a 50 uuf vacuum tank condenser and 2000 V.D.C. plate supply under no-load conditions.

POWER TUBE SPECIALISTS SINCE 1925

COMMUNICATION
RECTIFICATION
INDUSTRIAL
ELECTRO-MEDICAL
SPECIAL PURPOSE

AMPEREX

ELECTRONIC CORPORATION



25 WASHINGTON STREET, BROOKLYN 1, N. Y. CABLE: "ARLAS"

In Canada and Newfoundland: ROGERS MAJESTIC LIMITED, 622 Fleet Street West, Toronto 28, Canada

ANSWERING THE DEMAND FOR **"Something Better"**



PRESTO

MODEL "L"



A better portable playback—compact, easy to carry, simple to set up. The remarkably clear, wide range of reproduction—far superior to what is ordinarily expected of a portable playback—makes it a favorite with broadcasting stations and advertising agencies who demand top performance in demonstrating recorded programs to prospective clients.

Model L plays 6 to 16" records, 78 or 33 $\frac{1}{3}$ R.P.M., on a 12" rim-driven turntable. Standard equipment includes high quality 16" pickup on a swivel mounting which folds into a case when not in use, four stage amplifier, 8" loudspeaker with 20' extension cable, and a Presto Transcriptone semi-permanent playing needle. For use on 110 volts AC only.

The complete equipment, in an attractive grey carrying case, weighs only 46 lbs.



RECORDING CORPORATION
242 West 55th Street, New York 19, N. Y.
WALTER P. DOWNS, LTD., in Canada

WORLD'S LARGEST MANUFACTURER OF INSTANTANEOUS SOUND RECORDING EQUIPMENT

PROCEEDINGS OF THE I.R.E. AND WAVES AND ELECTRONS, July, 1946, Vol. 34, No. 7. Published monthly in two sections by The Institute of Radio Engineers, Inc., at 450 Alhnaip St., Menasha, Wis., or 330 West 42nd Street, New York 18, N.Y. Price \$1.00 per copy. Subscriptions: United States and Canada, \$10.00 a year; foreign countries, \$11.00 a year. Entered as second-class matter, October 26, 1927, at the post office at Menasha, Wisconsin, under the act of March 3, 1879. Acceptance for mailing at a special rate of postage is provided for in the act of February 28, 1925, embodied in Paragraph 4, Section 412, P. L. and R., authorized October 26, 1927.

Table of contents will be found following page 32A



Centralab

**CERAMIC
TUBULAR CAPACITORS**

... from the ceramic which houses the capacitor to the silver paint and copper plating, every part of these capacitors is completely fabricated by CENTRALAB.

... no wonder that all Centralab Tubular capacitors hold such fine tolerances.

Always Specify Centralab.

CRL

Centralab

Division of GLOBE-UNION INC., Milwaukee

PRODUCERS OF



Ceramic Trimmers
Bulletin 695



Variable Resistors
Bulletin 697

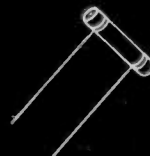

Tubular Ceramic
Capacitors
Bulletins 630 and 586



Selector Switches
Bulletin 722



Ceramic High Voltage Capacitors
Bulletin 814

DEPENDABLE AIR-TO-GROUND RECEPTION

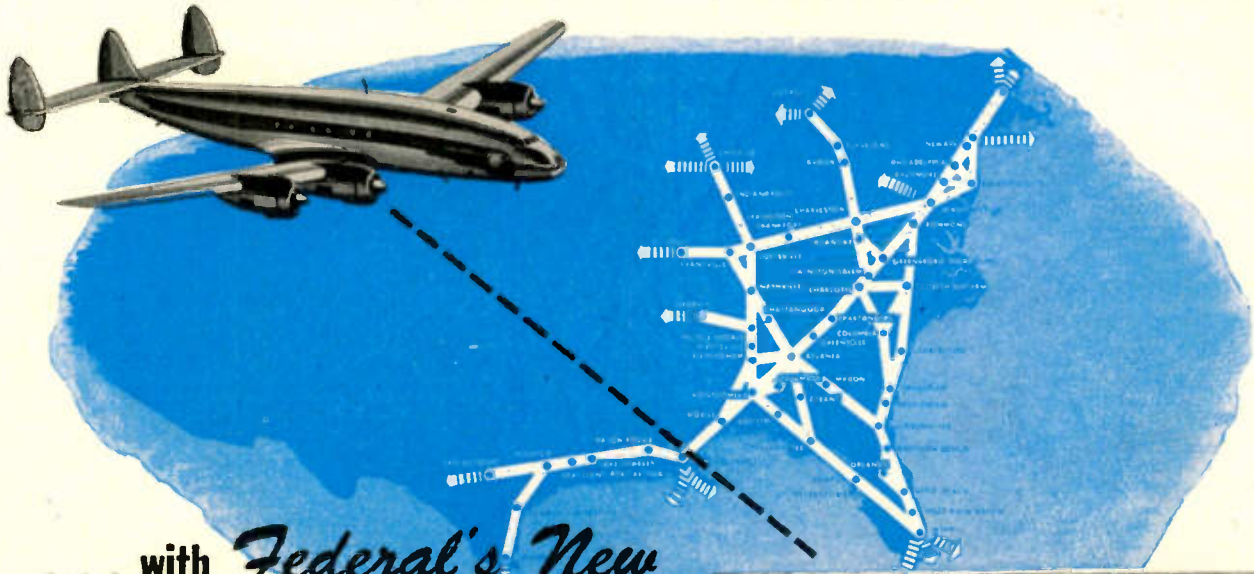

... with *Federal's New*
VHF RADIO RECEIVER 139A

Ordered in Quantity by Eastern Airlines

FEDERAL'S NEW single channel ground station receiver 139A is especially designed for post-war commercial aviation service, in the band from 108 to 132 Mc; this range covers the recently assigned band for air-to-ground communication. This receiver offers many time- and trouble-saving features, with emphasis on reliability and simplicity of operation and maintenance.

This compact unit permits clear, dependable AM voice reception for airport control towers or remote unattended stations. Airlines and airport owners will find it a valuable means of safeguarding their vital communication systems. Eastern Airlines has already ordered a quantity of these units.

Design Features of the FTR-139A

1. Designed for compact mounting in standard 19-inch relay rack
2. Front panel is hinged at bottom, giving unobstructed access to wiring for checking or maintenance
3. Designed for expected 100 KC channel separation
4. Crystal-controlled superhet circuit gives high performance
5. Either heated or unheated crystal holder can be used
6. Has carrier-operated noise-suppression circuit with adjustable threshold control
7. Includes provision for remote rf gain control
8. Amplified AVC



Front view, showing panel in operating position. Hinged at the bottom, this panel, when open, allows voltage measurements and inspection of all components to be made while set is operating, without removing it from the rack.

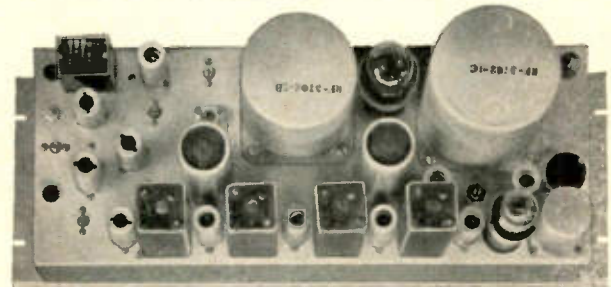

Rear view, showing transformers and tubes horizontally mounted on back, for free ventilation and ready accessibility.

DATA

Power Output Max. undistorted, 750 MW
 Max. output, 1000 MW
 Frequency Range 108 to 132 Megacycles
 Power Input
 70 Watts, 105-125 Volts, 50 to 60 Cycles
 Dimensions 19" long by 7" high by 9" deep
 Write today for complete information and performance data.

Federal Telephone and Radio Corporation

In Canada:—Federal Electric Manufacturing Company, Ltd., Montreal
 Export Distributor:—International Standard Electric Corporation

Newark 1, New Jersey



Raytheon ANNOUNCES



JUST OFF THE PRESS!

The most complete, most carefully-indexed, most usable and informative catalog of war surplus electronic equipment yet offered! Describes more than 5000 items, with specifications and PRICES. . . .

**SEND FOR
CATALOG
TODAY!**

...A READY SUPPLY OF ELECTRONIC EQUIPMENT and COMPONENT PARTS

available for immediate delivery
to wholesalers, retailers and manufacturers

Here is merchandise you need. Electronic merchandise you can sell at a profit, with or without further processing. And there's plenty of it! Enough to "plug the gap" until your normal sources of supply can replenish your shelves and stockrooms.



Excellence in Electronics

find immediate use for. It's all in the catalog—carefully described—priced—easy to find and easy to order. And of course it's all top-quality equipment, made to Government specifications by America's finest electronic manufacturers.

It's Army and Navy gear—now being returned to the regular channels of trade by the War Assets Administrator. Acting as agent, Raytheon has a plentiful supply for you—together with a carefully indexed, easy-to-choose-from catalog that's literally bursting with news about the kind of goods you *want, need, and can obtain* right away. *Send for this catalog*—it means business for you. Good business, ready business, profitable business.

Most of the equipment is in the communications field—but there are large supplies of components too, electrical and electronic parts that you and your customers can

You'll be missing a bet if you don't take immediate advantage of this opportunity to *sell merchandise at a profit*. The market is hungry for this equipment. The business is there. Get your share of it.

Sending for the Raytheon catalog is the first step. Do that at once. Then get in touch with Raytheon for technical advice and merchandising plans for speedy action.

RAYTHEON MANUFACTURING COMPANY

Acting as Agent of the
War Assets Administrator under Contract No. 51A-3-46
60 East 42nd Street, New York
West Coast Office: 2802 N. Figueroa St., Los Angeles 31, Cal.

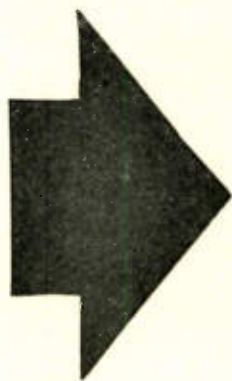

RAYTHEON MANUFACTURING COMPANY

60 East 42nd Street, New York 17, N. Y. PIRE 7

GENTLEMEN: Send your new Catalog of salable and immediately-available items of war surplus electronic equipment to

Name

Firm Name

Street Address

City State

• PIONEERS OF ELECTRIC AND ELECTRONIC PROGRESS •

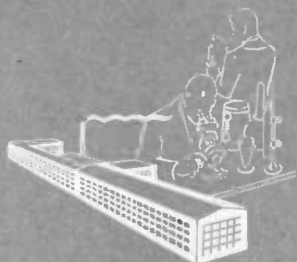

THE MAJOR CAPACITOR
AND WIRE-WOUND RESISTOR
DEVELOPMENTS OF THE PAST 5
YEARS HAVE BEEN ENGINEERED

by

SPRAGUE

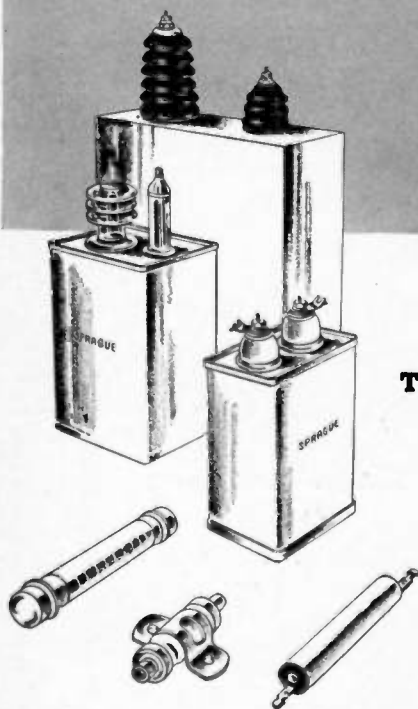

THEY INCLUDE:

• ***VITAMIN Q** impregnated capacitors for higher voltages, higher temperatures and higher insulation resistance.

• ***HYPASS 3-TERMINAL NETWORKS** that set new standards of performance in solving anti-resonant frequency problems at frequencies as high as 150 megacycles or more.

• **GLASS-TO-METAL** hermetically-sealed capacitors fully proofed against leakage, moisture, fungus, corrosion and shock.

• **ENERGY STORAGE** capacitors of greatly increased capacity in smaller physical sizes.

• **MEGOMAX** high-resistance, high-voltage resistors. Megohms of resistance operated at thousands of volts.

• **SPRAGUE *KOOLOHM RESISTORS** with glazed ceramic coating and new type end seals in one standard type for use under any climatic condition.

• *Catalog of any type on request*

• **Trademarks Reg. U. S. Pat. Off.*

SPRAGUE ELECTRIC CO., NORTH ADAMS, MASS.



SYMBOL OF FIDELITY...

Fidelity to the world's most critical employer . . . the international press . . . **Fidelity** to the task of engineering, developing and fabricating communication equipment and systems to stand the gaff of delivering tens of thousands of words of vital, high speed, radio communications traffic each day as demanded by the press of the world.

Back of this Press Wireless Symbol of Fidelity is an organization of men who for years have been charged with the responsibility of planning, installing and operating the vast array of equipment which makes up the Press Wireless international radio press circuits.

The communication equipment, designed and fabricated to serve the international press, is now available to all who require dependable radio communication equipment and systems.



PRESS WIRELESS MANUFACTURING
C O R P O R A T I O N

Executive Offices: 38-01 35th AVENUE, LONG ISLAND CITY 1, NEW YORK

A collection of various custom-made metal parts, including springs, rods, and brackets, arranged on a dark surface. The parts are made of a light-colored metal, possibly aluminum or steel, and show a variety of shapes and sizes. Some parts have holes, some have threads, and some have specific shapes like a butterfly-shaped hole in a circular piece. The background is a dark, textured surface.

ALSIMAG

TRADE MARK REGISTERED U.S. PATENT OFFICE

CUSTOM MADE

TECHNICAL CERAMICS

- PRECISION MADE TO YOUR BLUE PRINT FROM THE ALSIMAG COMPOSITION HAVING EXACTLY THE PHYSICAL CHARACTERISTICS REQUIRED FOR YOUR APPLICATION
- CHART OF PHYSICAL CHARACTERISTICS FREE ON REQUEST



Original Award July 27, 1942 Second Award February 13, 1943
Third Award September 25, 1943 Fourth Award May 27, 1944
Fifth Award December 2, 1944

AMERICAN LAVA CORPORATION

CHATTANOOGA 5, TENNESSEE
43RD YEAR OF CERAMIC LEADERSHIP

ENGINEERING SERVICE OFFICES

ST. LOUIS, Mo., 1123 Washington Ave., Tel: Carfield 4959 • NEWARK, N. J., 67 Broad Street, Tel. Mitchell 2-6159
CAMBRIDGE, Mass., 38-B Brattle St., Tel: Kirkland 4498 • CHICAGO, 9 S. Clinton St., Tel: Central 1721
SAN FRANCISCO, 143 Second St., Tel: Douglas 2464 • LOS ANGELES 224 N. San Pedro St., Tel: Mutual 9076

MOISTURE PROOF

LESS MAINTENANCE

HERMETICALLY
SEALED

LESS
AIR DRAG

NEW ADF LOOP FOR HIGH SPEED PLANES

Developed by Bendix engineers to increase aerodynamic efficiency, the type MN-60A Iron-Core Loop reduces air drag to only 2.57 pounds at 300 mph. Use of the iron core permits reduction in size, while retaining the signal pickup efficiency of larger loops.

All moving parts are hermetically sealed in dry nitrogen, eliminating oxidation and minimizing maintenance problems. The Type MN-60A loop assures thousands of hours of trouble-free operation.

A low-inertia a-c induction motor rotates the loop. A combined quadrantal error corrector and "Autosyn" transmits corrected bearings accurately to a remote indicator.

A streamlined phenolic-impregnated anti-static housing is available for belly or top mounting.

Write for new brochure, "Toward Automatic Flight."

BENDIX RADIO DIVISION, BALTIMORE 4, MD.

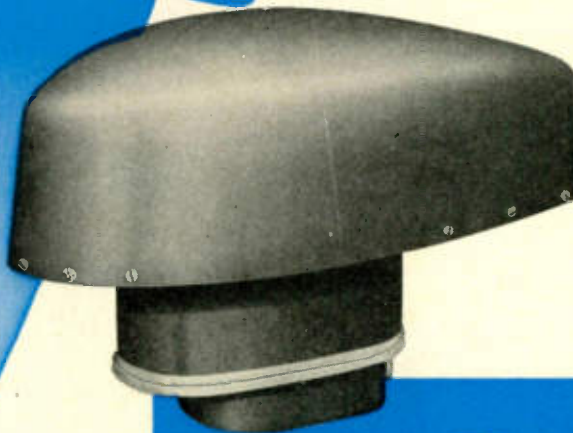

MN-60A
IRON CORE LOOP

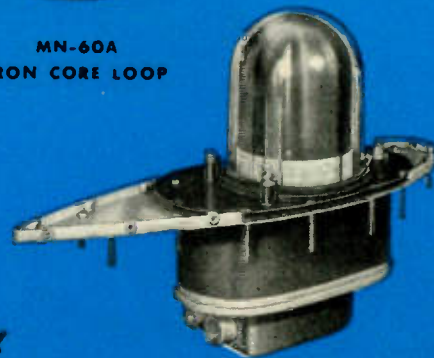

STANDARD FOR THE AVIATION INDUSTRY

Specify C-D MICABOND

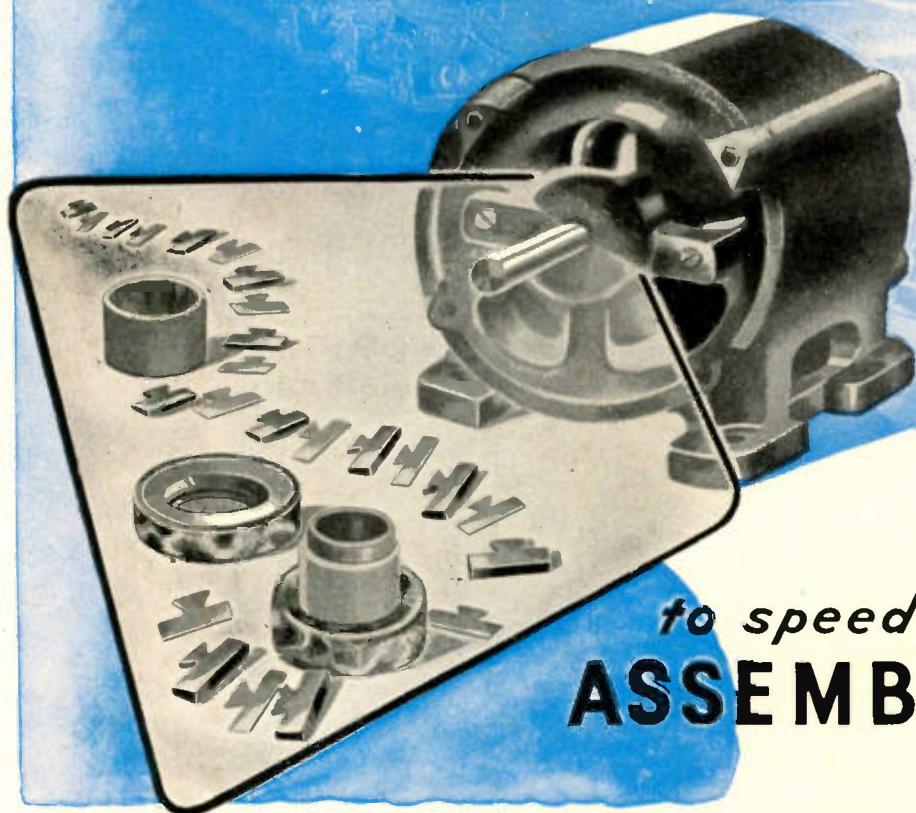

to speed-up
ASSEMBLY

ARMATURE assemblies fit when C-D MICA-BOND insulating rings and segments are used. They fit because C-D manufacturing standards assure close tolerance production of MICA-BOND materials and parts. The consistent quality and accuracy of C-D MICABOND products justify the confidence C-D MICABOND en-

joys from the many manufacturers of armatures who specify C-D MICABOND. When your electrical insulating problem dictates "mica insulation," C-D engineers will be glad to help you to design to use mica to the best possible advantage—and in its most usable form—C-D MICABOND.

C-D PRODUCTS

The Plastics

DILECTO—Thermosetting Laminates.

CELORON—A Molded Phenolic.

DILECTENE—A Pure Resin Plastic Especially Suited to U-H-F Insulation.

HAVEG—Plastic Chemical Equipment, Pipe, Valves and Fittings.

The NON-Metallics

DIAMOND Vulcanized FIBRE

VULCOID—Resin Impregnated Vulcanized Fibre.

MICABOND—Built-Up Mica Electrical Insulation.

Standard and Special Forms

Available in Standard Sheets, Rods and Tubes; and Parts Fabricated, Formed or Molded to Specifications.

Descriptive Literature

Bulletin GF gives Comprehensive Data on all C-D Products. Individual Catalogs are also Available.

Continental-Diamond
C-D
Engineered Dielectrics

KYC-46

BRANCH OFFICES

NEW YORK 17 • CLEVELAND 14 • CHICAGO 11 • SPARTANBURG, S. C. • SALES OFFICES IN PRINCIPAL CITIES

WEST COAST REPRESENTATIVES: MARWOOD LTD., SAN FRANCISCO 3

IN CANADA: DIAMOND STATE FIBRE CO. OF CANADA, LTD., TORONTO 8

SEE OUR CATALOG IN SWEET'S

Continental - Diamond FIBRE COMPANY

Established 1895...Manufacturers of Laminated Plastics since 1911—NEWARK 48 • DELAWARE

FOR INDUCTION HEATING COILS **REVERE DRYSEAL TUBE**

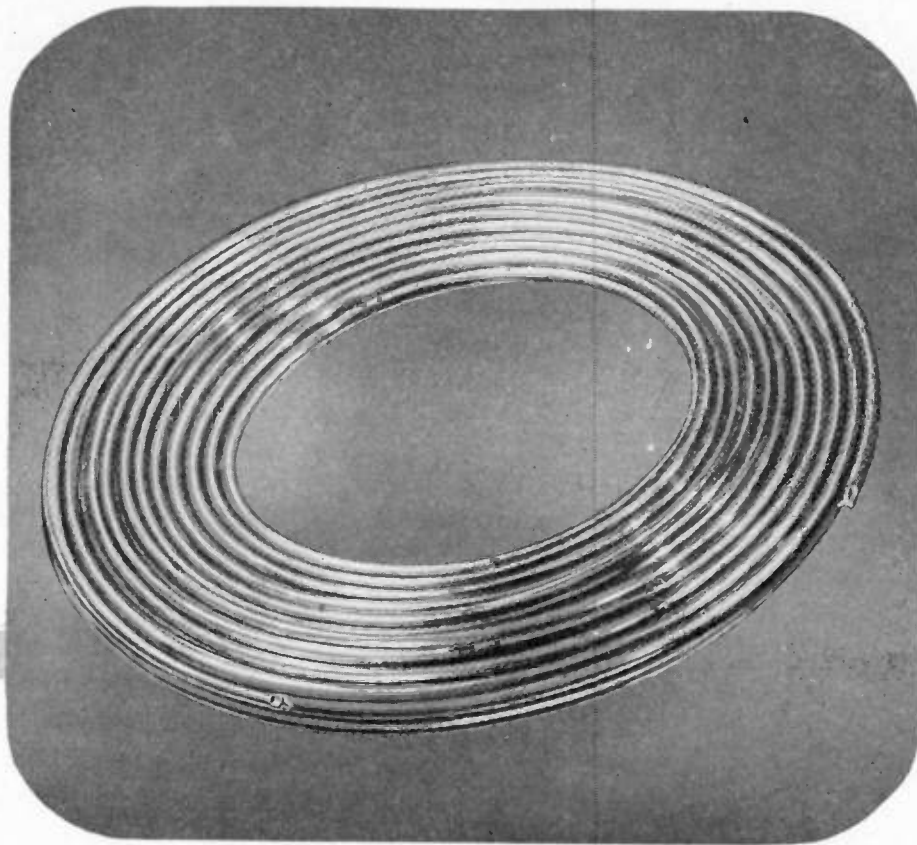

Revere Dryseal Copper Tube is ideal for fabricating coils for induction heating applications. It is pure copper, seamless, high in both electrical and heat conductivity. Temper, dead soft, so it can be easily formed into a coil

by hand or machine. Sizes from $\frac{1}{8}$ " to $\frac{3}{4}$ ", with .035" wall. Supplied in standard 50-foot coils, dehydrated and sealed at both ends. Sold by Revere Distributors in all parts of the country.

REVERE

COPPER AND BRASS INCORPORATED

Founded by Paul Revere in 1801

230 Park Avenue, New York 17, N. Y.

*Mills: Baltimore, Md.; Chicago, Ill.; Detroit, Mich.; New Bedford, Mass.; Rome, N. Y.
Sales Offices in Principal Cities, Distributors Everywhere.*

Listen to *Exploring the Unknown* on the Mutual Network every Sunday evening, 9 to 9:30 p.m., EDST.



ON THE STRAIGHT AND NARROW

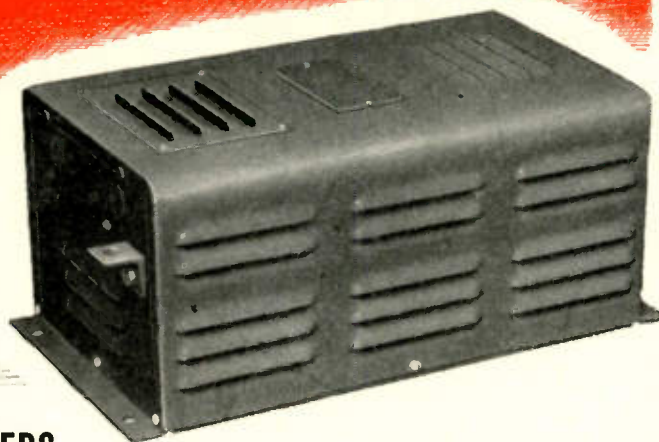

Here's Why
G-E AUTOMATIC VOLTAGE STABILIZERS
Safeguard your Equipment

- ✓ Less than $\pm 1\%$ variation on all applications!
- ✓ Practically instantaneous voltage correction!
- ✓ No moving parts; no adjustments!
- ✓ Will operate continuously at open or short circuit without excessive damage!

This General Electric voltage stabilizer is excellent for use where it is necessary to keep a-c output voltage right where it belongs. It provides a constant, precise output of 115 volts from any a-c source that may vary from 95 to 130 volts.

The G-E voltage stabilizer protects costly laboratory and other equipment from sudden over-voltages, speeds production line testing. It gives longer life to testing apparatus, radio transmitting tubes, x-ray filament

circuits, motion-picture equipment. Here are some of its more outstanding characteristics which qualify it as a precision voltage stabilizer:

- *Maintains voltage regulation* for fixed loads to within ± 1 per cent. Maintains regulation to within 2 per cent on heavy variations occurring between no load and full load.
- *Automatic action* eliminates moving parts, adjustments, etc.
- *Instantaneous action* provides voltage correction in less than three cycles time.
- *Limits current* at short circuit to approximately 180 per cent of full load.
- *Low harmonic content*, negligible variation over wide load range.

For complete details on this stabilizer's unusual possibilities, write for Bulletin GEA-3634, *Apparatus Dept.*, General Electric Company, Schenectady 5, N. Y.



Turn the Knob and Set the Voltage

For giving the right voltage when you want it, this variable-voltage autotransformer is an asset to any laboratory or shop bench. By merely turning the con-

trol knob, you can have any voltage from zero to 135 volts from a 115-volt a-c input, zero to 270 volts on a 220-volt a-c input. For complete description, ask for Bulletin GEA-3635A.

GENERAL  ELECTRIC

403-89-5207



more efficient
... in miniature

With the aid of a little hand microphone, the ship's officer, speaking in a normal voice, can be heard by any vessel in the fleet. Contrast this to the ineffectual hellowings through the huge megaphone of yesterday. The trend of science has been to develop greater efficiency in miniature. It was true of the megaphone, it is true of the electron tube.

TUNG-SOL Miniatures offer many advantages, especially in high-frequency currents. They are more impervious to shock and vibrations. The glass bases have better dielectric properties. They offer

lower lead inductance, lower inter-element capacitance and higher mutual inductance.

TUNG-SOL engineers will be glad to help you interpret your tube requirements in terms of Miniatures. TUNG-SOL is a tube manufacturer, not a set builder. The disclosures of your plans you make in consultation will be held in strictest confidence.



ACTUAL SIZE

TUNG-SOL

vibration-tested

ELECTRONIC TUBES

TUNG-SOL LAMP WORKS, INC., NEWARK 4, NEW JERSEY

Sales Offices: Atlanta • Chicago • Dallas • Denver • Detroit • Los Angeles • New York
Also Manufacturers of Miniature Incandescent Lamps, All-Glass Sealed Beam Headlight Lamps and Current Intermittors

PACKAGED R. F. RADAR ASSEMBLY ELIMINATES DESIGN HEADACHES

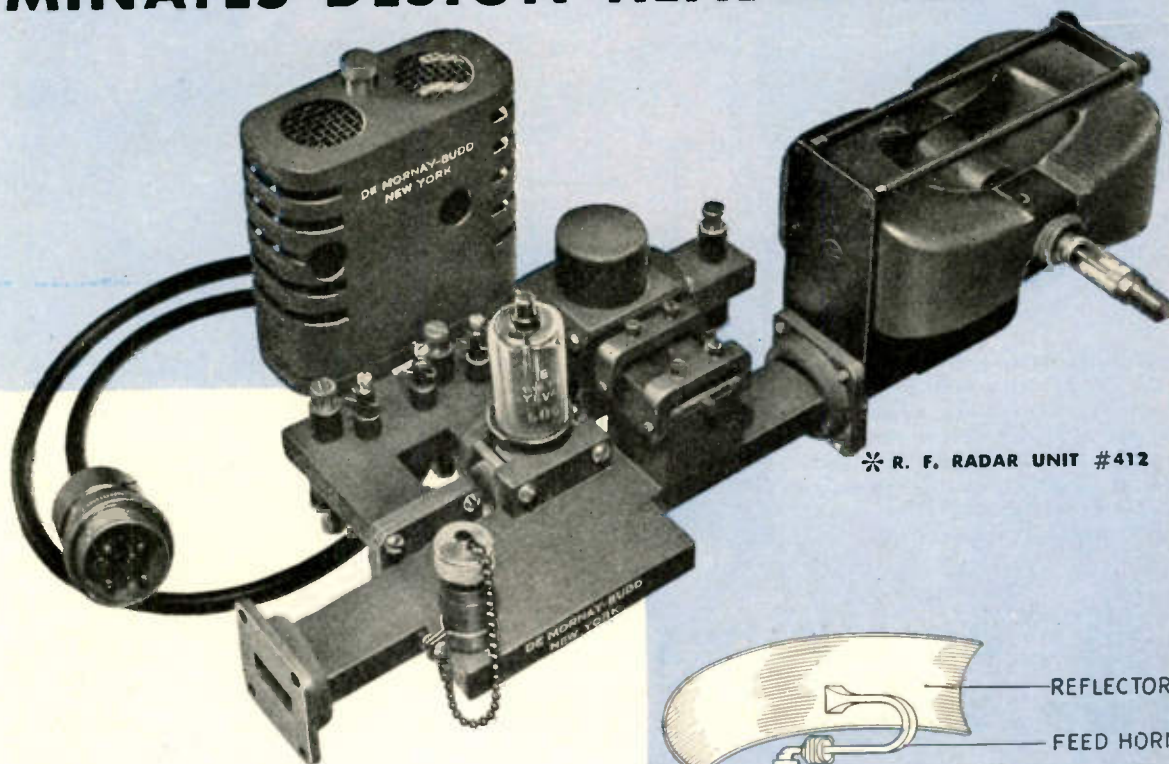

* R. F. RADAR UNIT #412

The DeMornay-Budd packaged R. F. Unit provides a complete R. F. assembly for microwave radar. It is now possible to obtain as standard items all the microwave R. F. components necessary in the fabrication of a complete radar—DeMornay-Budd Standard Transmission Line Components plus packaged R. F. Unit.

The R. F. Radar Unit is delivered complete and ready to operate. It is wired and contains all the necessary tubes and crystals. The unit uses a packaged magnetron capable of delivering 20 kw., peak power, at 9375 mc. Two type 2K25 local oscillator tubes are provided, one for receiver and A.F.C. and the other for beacon operation. A type 1B35 A-T-R tube, a type 1B24 T-R tube and the necessary type 1N21 crystals are included in the assembly. A 20 db. directional coupler permits accurate measurements to be made at any time with a maximum of convenience and safety.

Since the use of radar beacons is contemplated in the near future, the unit has been designed with a beacon cavity and crystal mount. The unit can be supplied without the beacon cavity and crystal mount and beacon local oscillator, and a termination supplied in their place so that it becomes a simple matter to convert to beacon operation when necessary.

We offer complete laboratory research facilities and have available such production test equipment as: Standing Wave Detectors, Calibrated Attenuators, Slug Tuners, Power Supplies, Square Wave Modulators, in addition to transmission line components shown in diagram above. Write for information or catalog.

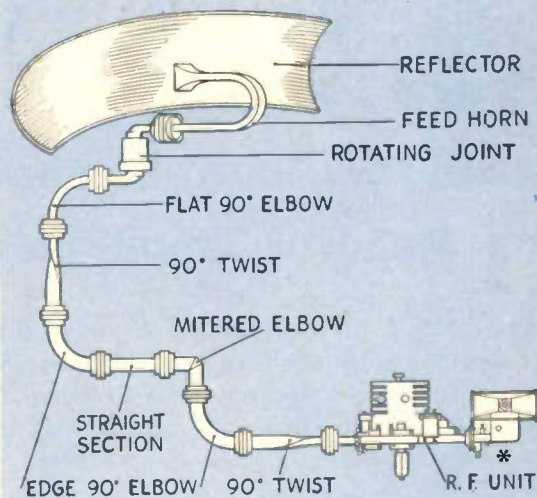

R. F. Radar unit #412 (indicated by asterisk) used in conjunction with standard DeMornay-Budd transmission line components.

**DE MORNAY
BUDD**

EQUIPMENT
FOR
97% OF ALL
RADAR SETS

DE MORNAY-BUDD, INC.
475 GRAND CONCOURSE, NEW YORK, N. Y.

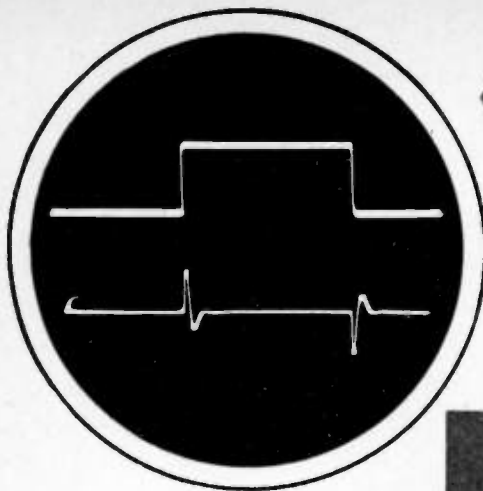

You can get this

with this

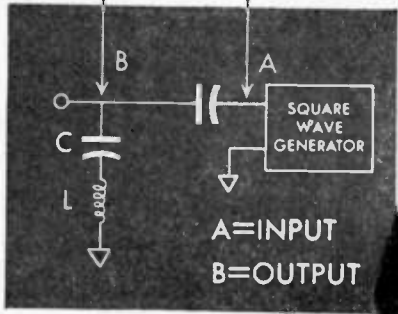

A typical application showing how the type 5SP may be used to examine both the input signal to a circuit and the resultant output signal. Here, a square wave has been applied to an L-C network. Both input and output signals appear simultaneously on the face of the Type 5SP. Either signal may be expanded for detailed study.

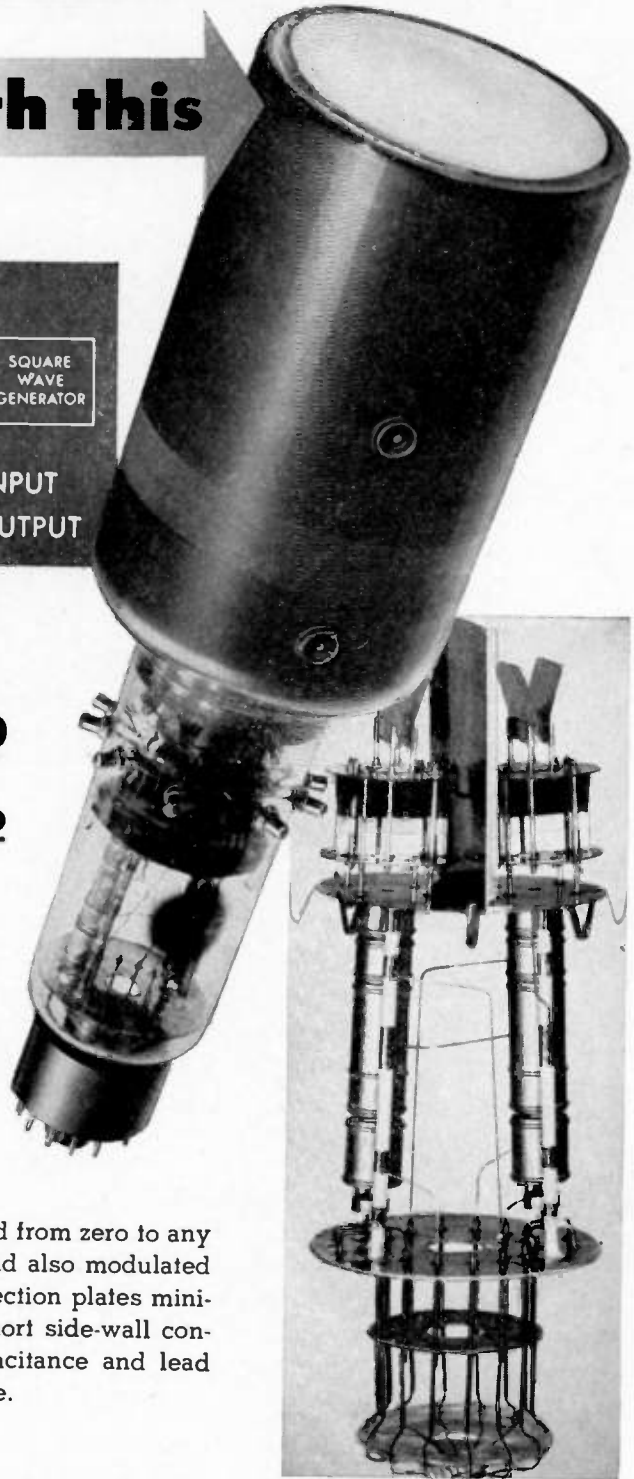

DU MONT'S Two-GUN TYPE 5SP Cathode-Ray Tube Shows Two Patterns Simultaneously

► NOW—a superior method for viewing two independent signals *simultaneously*. Not subject to the frequency limitations encountered when using the electronic switch. More convenient than using two oscillographs side by side.

Du Mont's Type 5SP tube contains *two complete electron guns* in a 5-inch flat-faced envelope. The X, Y and Z axes of each electron gun can be independently controlled, thus permitting two traces to be spaced from zero to any value desired within limitations of the tube diameter, and also modulated as desired. Adequate shielding between guns and deflection plates minimizes "cross-talk" particularly at higher frequencies. Short side-wall connections to deflection plates minimize shunt-input capacitance and lead inductance. Army-Navy approved diheptal 12-inch base.

Further Details on Request

© ALLEN B. DU MONT LABORATORIES, INC.

DUMONT
Precision Electronics & Television

ALLEN B. DUMONT LABORATORIES, INC., PASSAIC, NEW JERSEY • CABLE ADDRESS: ALBEEDU, PASSAIC, N. J., U. S. A.

ENGINEERING



DEVELOPMENT

Since its inception, the designs of the UTC Engineering Department have set the standard for the transformer field.



Hum Balanced Coil Structure: Used by UTC in practically all high fidelity designs. . . . Hum balanced transformers are now accepted as standard practice in the transformer field.

1
9
3
3



Ultra-Compact Audio Units: A complete series of light weight audio and power components for aircraft and portable applications. Ultra-Compact Audio units are hum balanced . . . weigh approximately six ounces . . . high fidelity response.

1
9
3
5



Ounce Audio Units: Extremely compact audio units for portable application were a problem until the development of the UTC Ounce series. Fifteen types for practically all applications . . . range 40 to 15,000 cycles.

1
9
3
7

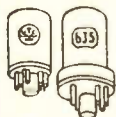

Plug-In Audio Units: These units are a modification of our Ounce series, incorporating a simple octal base structure. Fifteen standard items cover all applications.

1
9
3
9



Light Weight Aircraft Filters: RRF-5 Radio Range Filters and other special filters for light weight applications embody unique size and weight saving features. A typical unit, made by another source with 32 lb. weight, weighed 1 1/4 lbs. after UTC design.

1
9
4
1

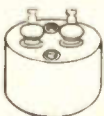

Toroidal Wound High Q Coils: UTC type HQA and HQB Coils afford a maximum in Q . . . stability . . . and dependability with a minimum of hum pickup. Standardized types available for all audio requirements.

1
9
4
3



Sub-Audio and Supersonic Transformers: Embody new design and constructional principles, for special frequency ranges. 1/2 to 60 cycles for geophysical, brain wave applications . . . 8 to 50,000 cycles for laboratory service, 200 to 200,000 cycles for supersonic applications.

1
9
4
5

1
9
3
4

Linear Standard Audio Units: Flat from 30 to 20,000 cycles . . . A goal for others to shoot at.

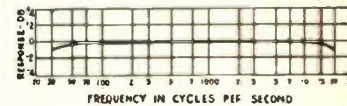

1
9
3
6

Tri-Alloy Shielding: The combination of Linear Standard frequency response and internal tri-alloy magnetic shielding is a difficult one to approach. Used by G. E., RCA, Western Electric, Westinghouse, M G M, Walt Disney NBC, etc.

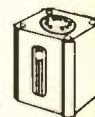

1
9
3
8

Universal Equalizers: The UTC Universal Equalizers, Attenuators, and Sound Effects Filters fill a specific need of the broadcast and recording field. Almost any type of audio equipment can be equalized to high fidelity standards.

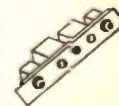

1
9
4
0

Sub-Ounce Units: A series of 1/3 ounce miniature units with non-corrosive—long life construction for hearing aid, miniature radio, and similar applications. Five types cover practically all miniature requirements.



1
9
4
2

Hermetic Seal Pioneering: Realizing the essentiality of hermetic sealing for many applications, UTC pioneered a large number of the terminals and structures for hermetic transformers . . . now available for commercial use.

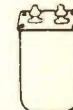

1
9
4
4

Standardized Filters: UTC type HPI, LPI, and BPI (low pass, high pass, and band pass) Filters are standardized to effect minimum cost and good delivery time. Available for frequencies throughout the entire audio range.

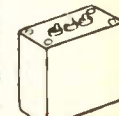

1
9
4
6

New Items: The UTC Research Laboratory is developing new items and improving standard designs in 1946. While some of these developments will be described in our advertisements, many are applied to customers' problems.

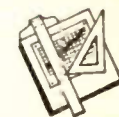

MAY WE COOPERATE WITH YOU ON YOUR PROBLEM?

United Transformer Corp.

150 VARICK STREET

NEW YORK 13, N. Y.

EXPORT DIVISION: 13 EAST 40th STREET, NEW YORK 16, N. Y.,

CABLES: "ARLAB"

The Rauland **VISITRON** R-6025



The Rauland Visitron R-6025 is a 10-inch, virtually flat face, direct-viewing Cathode Ray Tube especially suitable to television. The electromagnetically focusing and deflection method employed allows the screen to be excited by a relatively high beam current, insuring good contrast with excellent focus.

**Virtually
Flat Face**

Direct-Viewing

Specifications of the Rauland Visitron R-6025

Heater Voltage	6.3 A. C. or D. C.
Heater Current	0.6 amp.
Focusing Method	Electromagnetic
Deflection	Electromagnetic
Deflection Angle	50 degrees
Screen	Phosphor P4
Bulb Diameter (Max.)	10 $\frac{3}{8}$ " at screen end
Length (Max.)	17 $\frac{3}{8}$ " \pm $\frac{3}{8}$ "
Base	Small Shell Duodecal 7 Pin
Anode Volts (Max.)	11,000
Anode Volts (Operating)	8,000

electrical pipe-line →



Microwaves make their journey from apparatus to antenna not by wire, cable, or coaxial — but by waveguide.

Long before the war, Bell Laboratories by theory and experiment had proved that a metal tube could serve as a pipe-line for the transmission of electric waves, even over great distances.

War came, and with it the sudden need for a conveyor of the powerful microwave pulses of radar. The metal waveguide was the answer. Simple,

rugged, containing no insulation, it would operate unchanged in heat or cold. In the radar shown above, which kept track of enemy and friendly planes, a waveguide conveyed microwave pulses between reflector and the radar apparatus in the pedestal. Bell Laboratories' engineers freely shared their waveguide discoveries with war industry.

Now, by the use of special shapes and strategic angles, by putting rods

across the inside and varying the diameter, waveguides can be made to separate waves of different lengths. They can slow up waves, hurry them along, reflect them, or send them into space and funnel them back. Bell Laboratories are now developing waveguides to conduct microwave energy in new radio relay systems, capable of carrying hundreds of telephone conversations simultaneously with television and music programs.

EXPLORING AND INVENTING, DEVISING AND PERFECTING FOR CONTINUED IMPROVEMENTS AND ECONOMIES IN TELEPHONE SERVICE



BELL TELEPHONE LABORATORIES

3 cm. RADAR PLUMBING

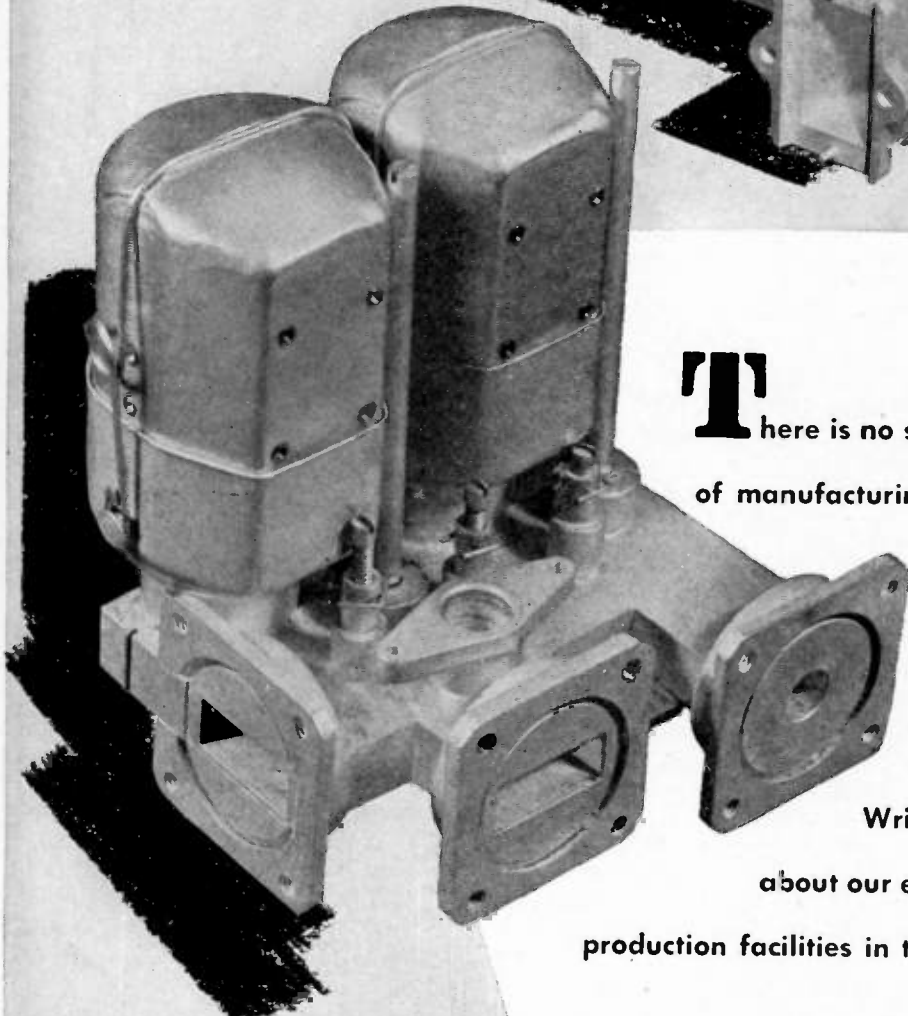
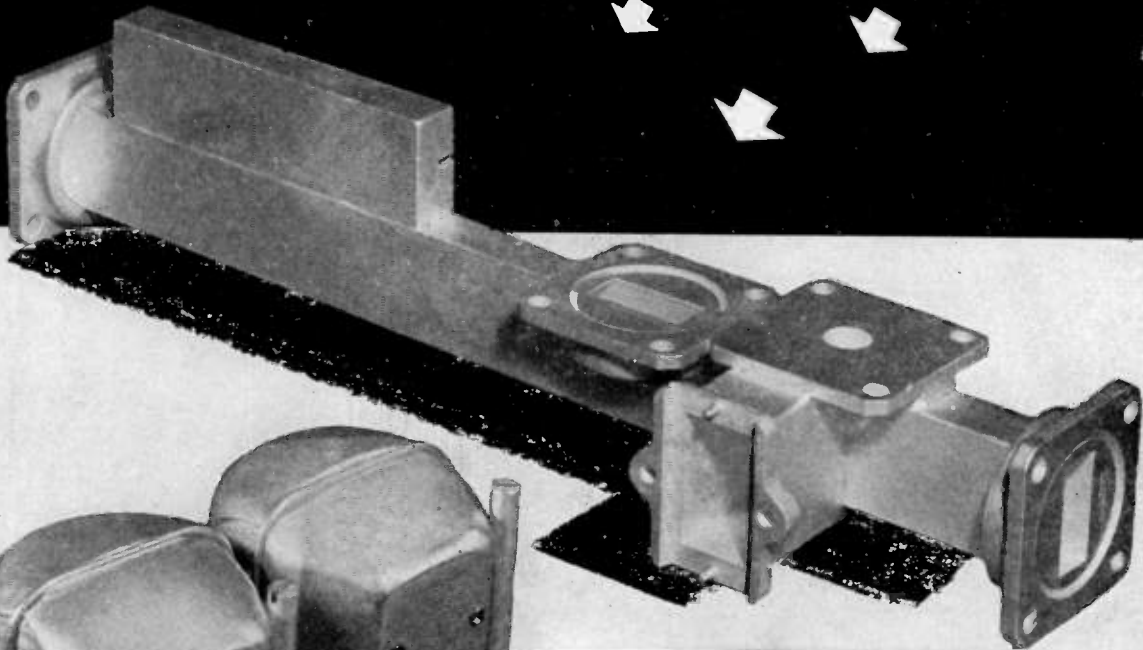

There is no substitute for 35 years of manufacturing skill and experience when it comes to building 3 cm. RADAR plumbing equipment.

Write for full information about our engineering and production facilities in this new field.



HAMMARLUND

THE HAMMARLUND MFG. CO., INC., 460 W. 34TH ST., NEW YORK 1, N. Y.
MANUFACTURERS OF PRECISION COMMUNICATIONS EQUIPMENT

MAKING TUBES IS EASY...

If YOU KNOW HOW!

HOW-HYTRON CATHODE COATINGS ARE MADE

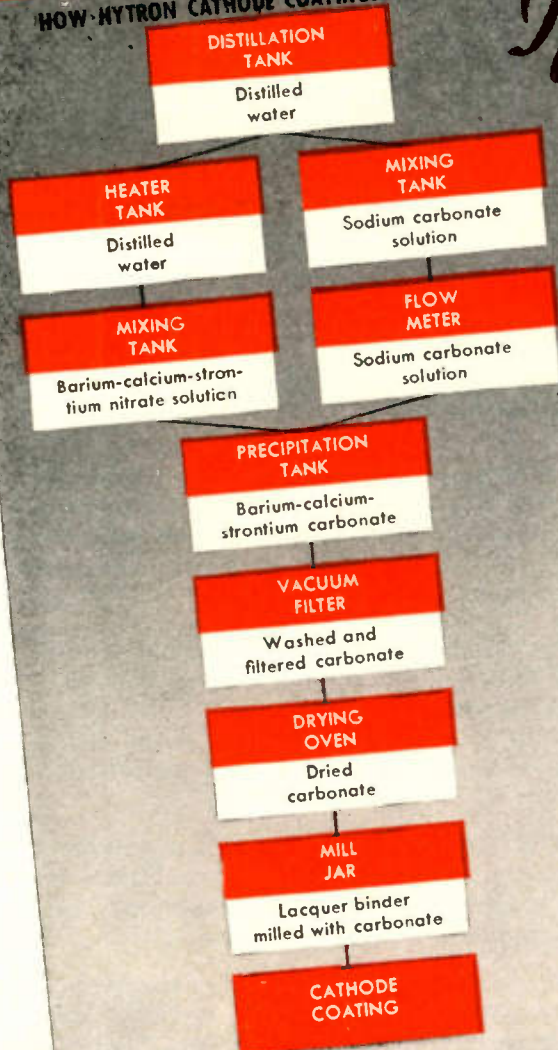

First floor of Hytron chemical precipitation system. Note the flow meter, precipitation tanks, and ceramic vacuum filters. Spotless cleanliness is vital to avoid contamination of carbonates precipitated for cathode coatings.

AGAIN HYTRON KNOW-HOW WORKS FOR YOU...

THIS photograph and flow chart may look strange in an advertisement on radio tubes. Chemistry and metallurgy, however, are a vital part of Hytron engineering. The picture illustrates the first of three floors used by Hytron's chemical system which precipitates the carbonates for cathode coatings.

Prewar, Hytron purchased such carbonates—as did most other tube manufacturers. Wartime mass production demanded much better quality control than suppliers offered. By doing the job itself, Hytron gained extra know-how which serves you in peacetime.

For these carbonates, absolute control is required of formulation, crystal size and shape, density, purity, and

viscosity. Most cathode coatings are prepared from carbonates compounded of barium, calcium, and strontium. The percentage of each of these elements affects the performance of different types of tubes. Crystal size and shape, density, freedom from impurities, all determine the degree of electronic emission. Variations in viscosity must be minimized to assure uniform application of coating on the cathode.

There is still much "black magic" in obtaining proper cathode emission. But Hytron makes easier the problems involved by accurate chemical and metallurgical controls. No research is too tough or too unrelated, if it leads to know-how which will give better performance of the Hytron tubes you buy.

OLDEST MANUFACTURER SPECIALIZING IN RADIO RECEIVING TUBES



HYTRON

RADIO AND ELECTRONICS CORP.

MAIN OFFICE: SALEM, MASSACHUSETTS



BRENTWOOD, N. Y.

Key Station of **MACKAY
RADIO & TEL. CO., INC.**

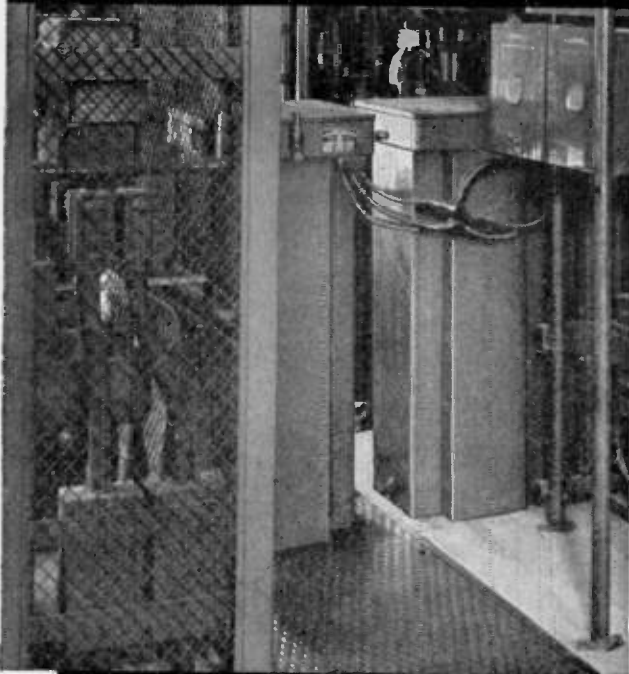

AmerTran voltage-regulating transformers—132 KW mercury vapor rectifier. Filament Transformers visible at left.

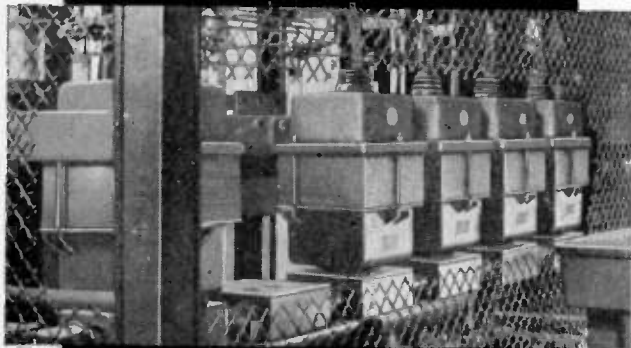

Closeup view of AmerTran Dry Type Filament Transformers. Rated 1.64 KW, 460—32/16 V.

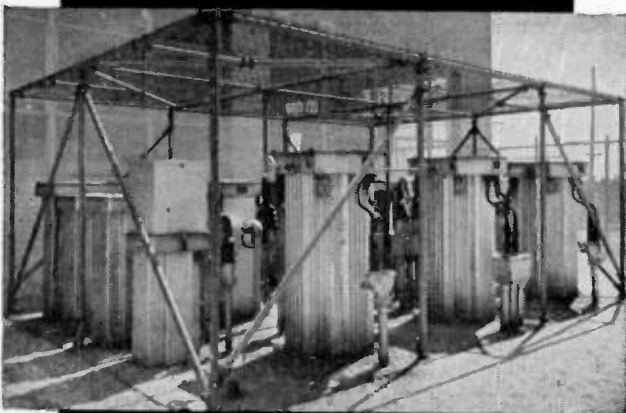

Group of AmerTran Plate Transformers, outdoor installation. Supply 132 KW Transmitter. 18,600 V. secondaries.

is "alive" with **AMERTRAN TRANSFORMERS**

ALIVE in every respect! Brentwood, one of the busiest of commercial radio stations, handles large volumes of traffic over a complex array of transmitters and frequencies. Station equipment is kept excited for long periods of continuous duty.

There are literally dozens of AmerTran Transformers, Retard Coils, and Reactors, indoors and out, feeding controlled voltages to various transmitter units in this station. Some of these, in the rectifier circuits of a 132 KW transmitter, are shown here.

The 1.64 KW Filament Transformers, at left, have been on the job for 15 consecutive years. This is the kind of consistent performance engineered into every AmerTran.

AmerTran Transformers are "built-in" components in the best-known communications and industrial-electronic assemblies now in operation. They are designed by authorities in electronic energy transformation, and are built in a plant devoted exclusively to the production of transformers and allied products. You may feel free to use the entire facilities of the AmerTran organization.

AMERICAN TRANSFORMER COMPANY
178 EMMET ST. NEWARK 5, N. J.

We'll be glad to send you a copy of the new Bulletin "G", showing the wide scope of AmerTran Products.

Pioneer Manufacturers of Transformers, Reactors and Rectifiers for Electronics and Power Transmission



AMERTRAN

REG. U. S. PAT. OFF.
MANUFACTURING SINCE 1901 AT NEWARK, N. J.



Type TS2A Ceramic Trimmer
1.5-7 MMF 3-13 MMF 4-30 MMF
3-12 MMF 5-20 MMF 7-45 MMF



Feed-Thru Ceramics
3 MMF—1,000 MMF



Insulated Hi-K Ceramics
271 MMF—5,000 MMF
Non-Insulated Hi-K Ceramics
271 MMF—15,000 MMF



High Voltage Double Cup Ceramics
20 MMF—600 MMF



Type 554 Ceramic Trimmer
5-12 MMF 5-30 MMF
5-25 MMF 8-50 MMF

*A Directory of
Electronic Components*
by **ERIE RESISTOR**

ERIE RESISTOR has developed and manufactured a complete line of Ceramic Condensers for receiver and transmitter applications; Silver-Mica and Foil-Mica Button Condensers; Carbon Resistors and Suppressors; Custom Injection Molded Plastic Knobs, Dials, Bezels, Nameplates and Coil Forms. Complete technical information will be sent on request.



Cinch-Erie Plexicon Tube Sockets with 1,000 MMF built in by-pass condensers



Stand-Off Ceramics
1 MMF—2,500 MMF



Type 680A High Voltage, High KVA Multiple Plate Transmitting Ceramics
120 MMF—1,800 MMF



Types 504B, 1/2 Watt—518B, 1 Watt Resistors
10 ohms—22 megohms



Disc Ceramics
51 MMF—7,500 MMF

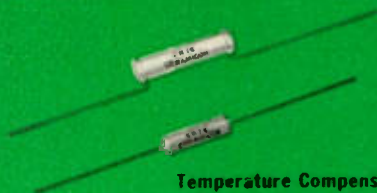

Temperature Compensating Insulated Ceramics
0.5 MMF—360 MMF
Temperature Compensating Non-Insulated Ceramics
0.5 MMF—1,100 MMF



Button Mica Condensers
15 MMF—6,000 MMF

Custom Injection Molded Plastic Knobs, Dials, Bezels, name plates, coil forms, etc.

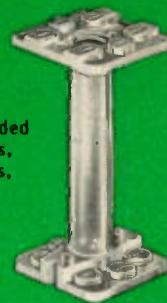

Types L-4, L-7, S-5 Suppressors for Spark Plugs and Distributors



ERIE RESISTOR CORP.

ERIE, PENNSYLVANIA

LONDON, ENGLAND...TORONTO, CANADA

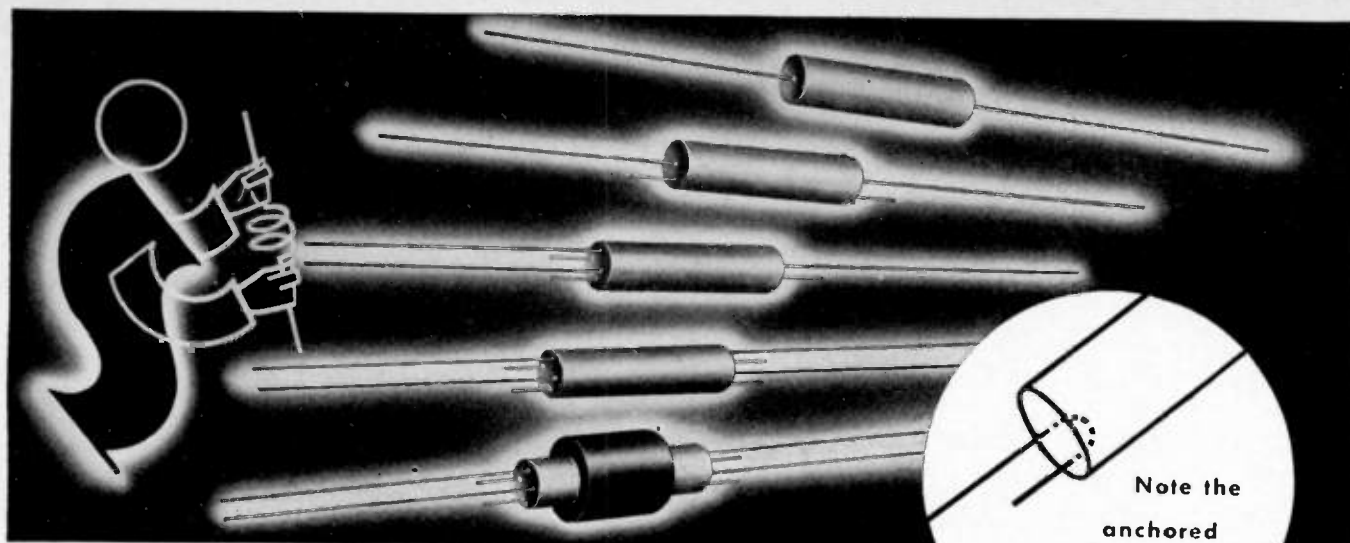

Note the anchored hairpin leads

MOLDED COIL FORMS

THE MODERN ANSWER TO INEXPENSIVE MECHANICAL SUPPORTS FOR WINDINGS

<p>COAXIAL LEADS each end Type DR-1750" x .220" Type DR-2875" x .280"</p>
<p>SINGLE HAIRPIN lead each end Type DR-3875" x .280"</p>
<p>SINGLE HAIRPIN lead one end DOUBLE HAIRPIN lead other end Type DR-4875" x .280"</p>
<p>DOUBLE HAIRPIN lead each end Type DR-5875" x .280"</p>
<p>Typical use of molded coil form with Stackpole W-1976 iron sleeve core attached</p>

Reduced space factor . . . simplicity of assembly . . . point-to-point wiring . . . one third fewer soldered connections . . . extreme flexibility of application . . . absolute minimum cost

These proved advantages mean wide use for Stackpole molded bakelite coil forms in a variety of applications. Hairpin anchored leads mean that the soldered core wires are not disturbed or strained when leads are flexed or moved. The forms being smooth, coils may be wound on separate tubes and slipped over the forms—or windings may be wound directly on the forms. Where required, forms may be provided with Stackpole molded iron sleeve cores, thereby increasing Q materially, decreasing the amount of wire for a given inductance and reducing stray magnetic fields. Write for details or samples to meet your requirements.

STACKPOLE CARBON CO., ST. MARYS, PA.
Electronic Components Division

Typical Stackpole Molded Coil Form Applications

UNIVERSAL WINDING

SOLENOID WINDING BENT AT 90

TAPPED UNIVERSAL WINDING

ANTENNA OR COUPLED WINDINGS

IRON CORED UNIVERSAL WINDING

IRON CORED I-F TRANSFORMER OR COUPLED COILS

STACKPOLE

FIXED AND VARIABLE RESISTORS • IRON CORES • SWITCHES

THE IMC ENGINEER IS

ON YOUR STAFF—

But Not on Your Payroll



ASK HIM TO . . .

1. Assist you in the selection of the best insulating material for the job.
2. Familiarize you with their proper application.
3. Suggest ways to eliminate waste.
4. Increase your production.

The IMC engineer makes his recommendations on the basis of his knowledge and experience—not of one or a few electrical insulating materials but of many, each made by a leader in his particular product field. He is a specialist in electrical insulation. He knows which product is best suited for each application. He and the IMC organization are at your service to give technical assistance as well as to see you get what you need when you need it.

IMC PRODUCTS

Macallen Mica Products—Vartex Varnished Cloths and Tapes—
Varslot Combination Slot Insulation—Fiberglas Electrical
Insulation—Manning Insulating Papers and Pressboards—Dow Corning
Silicones—Dieflex Varnished Tubings and Saturated Sleeveings—National Hard
Fibre and Fishpaper—Phenolite Bakelite—Permacel Adhesive
Tapes—Asbestos Woven Tapes and Sleeveings—
Inmanco Cotton Tapes, Webbing, and Sleeveings—Pedigree
Insulating Varnishes—Wedgie Brand Wood Wedges.

INSULATION MANUFACTURERS CORPORATION

•CHICAGO 6
565 W. Washing-
ton Blvd.



•CLEVELAND 14
1005 Leader Bldg.

Representatives in MILWAUKEE 2, 312 East Wisconsin Avenue;
DETROIT 2, 11341 Woodward Avenue; MINNEAPOLIS 3, 1208
Harmon Place; PEORIA 5, 101 Heinz Court; and other cities

In ratings from 1000 volts to 10,000 volts test . . .

Molded-in-Bakelite

MICA CAPACITORS

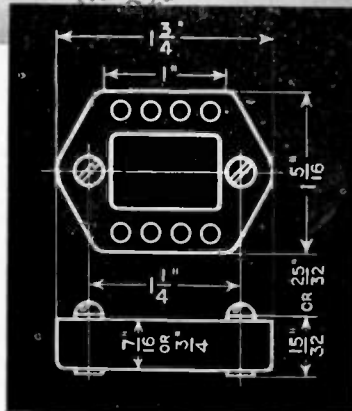

● The 1650 Series is the most rugged of the heavy-duty molded-in-bakelite mica capacitors of the extensive Aerovox line. These high-voltage units are intended for the most critical service of low-powered transmitting circuits, buffer stages, power amplifiers, laboratory equipment, etc. Also recommended for use in ultra-high-frequency circuits, and accordingly their r.f. current ratings are given in the Aerovox Capacitor Catalog.

The extra-generous use of high-grade dielectric material provides that greater factor of safety for longer service under severest operating conditions.

Standard units with tapped holes take 6/32 screws which serve for terminals. Also available with clearance holes through which screws or rods may be slipped, so that two or more units can be stack-mounted. Low-loss ceramic mounting insulators are available for mounting on metal surfaces. Standard units molded in brown bakelite. Also available in low-loss (yellow) XM bakelite.

In 1000, 2500, 5000, 7500 and 10,000 volts D.C. test. Capacitance ratings from .00005 mfd. to .06 mfd. in Type 1650 at 1000 v. D.C. test; .00005 mfd. to .001 mfd. in Type 1654L at 10,000 v. D.C. test.

● Literature on request . . .



FOR RADIO-ELECTRONIC AND INDUSTRIAL APPLICATIONS

AEROVOX CORPORATION, NEW BEDFORD, MASS., U.S.A.

SALES OFFICES IN ALL PRINCIPAL CITIES • Export: 13 E. 40th St., NEW YORK 16, N. Y.

Cable: 'ARLAB' • In Canada: AEROVOX CANADA LTD., HAMILTON, ONT.

from every angle...
IT'S A HONEY!

Western Electric 25B speech input console

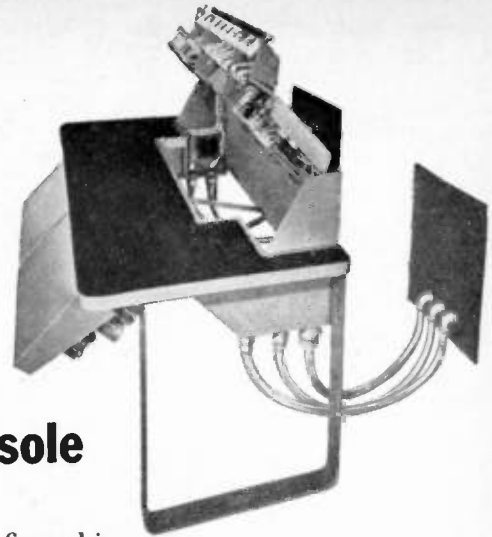

It's got sparkling eye-appeal — that's the first thing you'll like about this new audio unit designed by Bell Laboratories. When you see how completely it opens up for inspection and maintenance—almost as easily as turning the pages of a book—you'll like that too. And when you study the list of operating advantages it gives you at moderate cost, you'll agree *it really is a honey!* Ask your nearest Graybar Broadcast Equipment Representative for *all the the* facts about this pacesetter 25B.



Look at these features:

- Neat modern styling.
- Complete unit design—including table and NEW plug-in cables.
- Uniform, noise-free, distortionless operation over a 15,000 cycle range.
- 8 low level microphone channels and 3 line level channels. Any 4 microphone channels and three line level channels—7 in all—can be used simultaneously.
- 2 high quality main amplifier channels that handle 2 programs simultaneously—plus separate monitor and cueing channel.
- 7 remote line input circuits—3 normal

- through for program transmission or sending or receiving cue.
- All controls arranged and coordinated for maximum operating flexibility and convenience.
- Compact—only 36" high, 55 1/4" wide, 28 1/4" deep.
- Designed for maximum ease of installation—junction boxes supplied.
- Completely wired for easy plug-in connection.
- All parts readily accessible for inspection and maintenance.



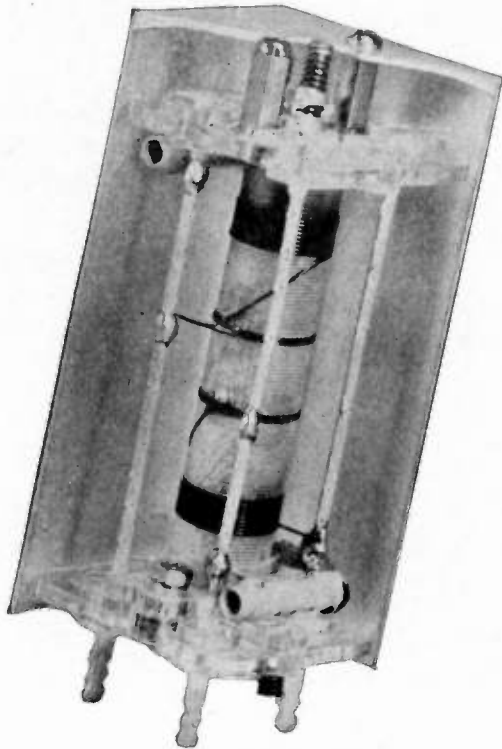

NEW IF TRANSFORMERS

These new IF transformers are designed to meet the highest standards of performance in high frequency FM and AM. All operate at 10.7 MC., making them ideal for the new FM band. Iron core tuning is employed and the tuning does not affect the bandwidth of 100 Kc. for the IFN or 150 Kc. for the IFM.

The discriminator output is linear over the full 150 Kc. output and remains symmetrical regardless of the position of the tuning cores.

Insulation is polystyrene for low losses. Mechanical construction is simple, compact and rugged. The transformer is $1\frac{7}{8}$ inches square and stands $3\frac{1}{8}$ inches above the chassis.



NATIONAL COMPANY, INC., MALDEN, MASS.

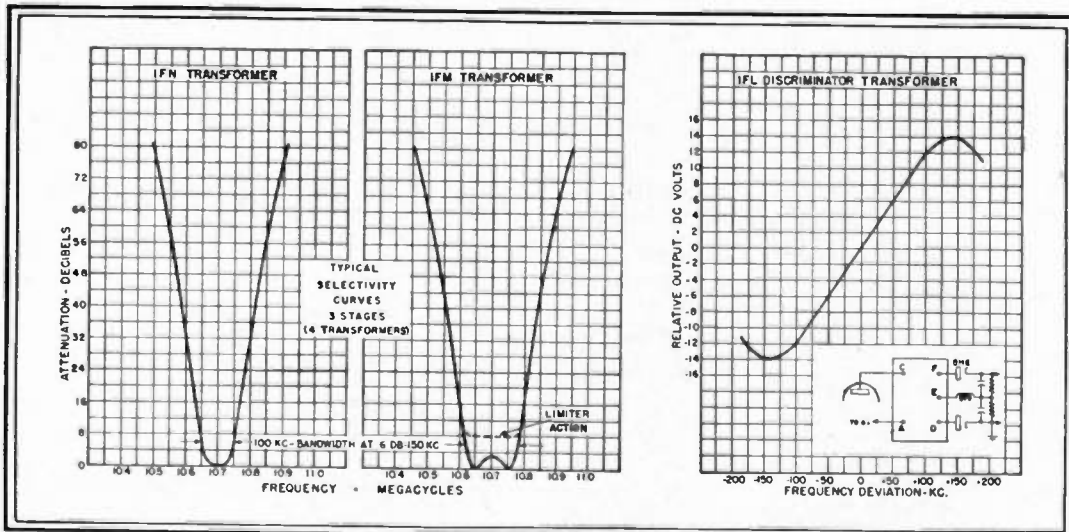

FOOLPROOF MEASUREMENTS

are now possible with **Daven Totalizing**
and
Calculating Instruments



TOTALIZING
RESISTANCE DECADE



TOTALIZING ATTENUATION
NETWORK



CALCULATING BRIDGE

In the operation of multi-dial test equipment, the greatest single source of error has been the incorrect addition or interpretation of dial settings. To eliminate such errors, the Daven Company has developed a line of test equipment having calculating and totalizing indicators*.

**ELIMINATE
ERROR**

These new devices automatically totalize the various dial settings at one point on the face of the units, where the total can be seen quickly and without eye-strain. Another feature of these calculators is that on bridges, the decimal point is automatically set in the right place, without any mental calculations.

**NO MORE
CALCULATION**

In order to insure the serviceability of the calculating indicator, life tests were conducted on this new feature. These tests proved conclusively that perfect functional results will be obtained after millions of operations. As a time saving device, the calculating indicator will speed up measurements in some cases as much as 100%.

SAVE TIME

These totalizing and calculating devices will be available shortly on a wide variety of equipment including bridges, resistance decades, voltage dividers, attenuation networks, etc. For further information write to our Engineering Department.

**WIDE
APPLICATION**

*Patent Applied For

THE **DAVEN** COMPANY
191 CENTRAL AVENUE
NEWARK 4, NEW JERSEY

SYLVANIA NEWS

CIRCUIT ENGINEERING EDITION

JULY

Prepared by SYLVANIA ELECTRIC PRODUCTS INC., Emporium, Pa.

1946

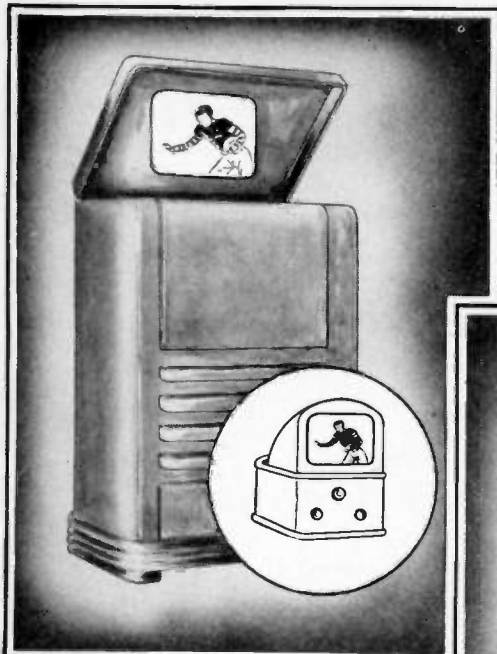

More compact television receivers will be made possible by the T-3.

Much Smaller Sets Possible

Radical reductions in the size and weight of many types of electronic equipment are seen as a distinct possibility arising from Sylvania Electric's development of the extremely small T-3 tube. The T-3 is the commercial version of the peanut-sized electronic tube of proximity fuze fame.

Tiny as it is, the T-3 tube is characterized by exceptional ruggedness. It has a life of hundreds of hours, and is ideally suited for operation at high frequencies.

Savings in Space and Weight

The small size of the T-3 contributed directly to compactness and lightness in the design of radio and television receivers and other types of electronic equipment. Other fea-

RUGGED ELECTRONIC TUBE TINY ENOUGH TO REVOLUTIONIZE DESIGN OF RADIO RECEIVERS AND OTHER EQUIPMENT

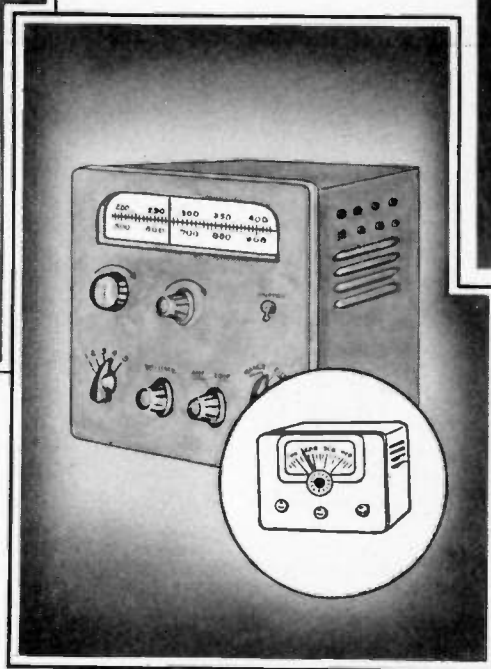

Weight-saving features of the T-3 will be of special value in air-borne equipment.

tures of the tube make possible still further reductions in space and weight.

Range of Applications

The design possibilities opened by the T-3 are naturally of greatest interest in the case of portable and air-borne equipment. However, its potentialities are not limited to these fields. Write Sylvania Electric Products Inc., Emporium, Pa.

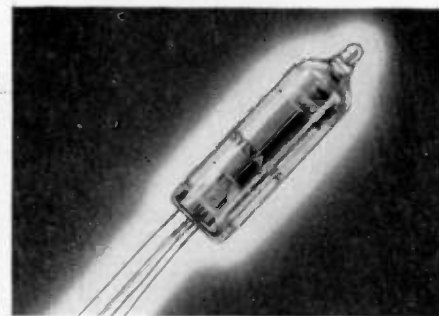

The T-3 tube is shown here in its actual size.

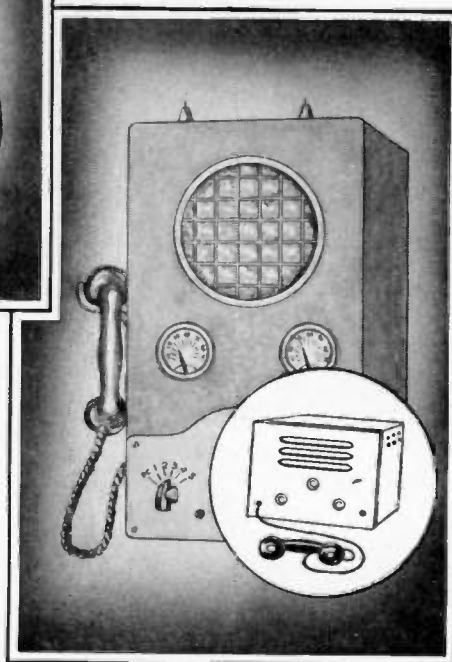

Equipment for motor boats and yachts can be made smaller and lighter.

SYLVANIA ELECTRIC

Emporium, Pa.

MAKERS OF RADIO TUBES; CATHODE RAY TUBES; ELECTRONIC DEVICES; FLUORESCENT LAMPS, FIXTURES, WIRING DEVICES; ELECTRIC LIGHT BULBS

WMCA WQXR CBS MBS DIC NEWS REELS TELEV. NBC ABC BBC CBC WHN
 WLIB WNYC ↓ ↓ ↓ ↓ ↓ ↓ ↓ ↓ ↓ ↓ ↓
 ↓ ↓ ↓ ↓ ↓ ↓ ↓ ↓ ↓ ↓ ↓



Security Council Chamber, United Nations, Hunter College, New York. Robert Glenn, Inc., Builders, N.Y.C.

As The World Listens...

... to the United Nations Security Council in session, whether by radio, by television, or by newsreel, it is listening through the latest in audio facilities. The entire system in the Security Council Chamber, which feeds all services, is Langevin engineered, designed and manufactured, with the exception of the microphones which are Western Electric.

The Langevin Company

INCORPORATED

SOUND REINFORCEMENT AND REPRODUCTION ENGINEERING

NEW YORK, 37 W. 65 St., 23 • SAN FRANCISCO, 1050 Howard St., 3 • LOS ANGELES, 1000 N. Seward St., 38

For dependability when the heat is on...

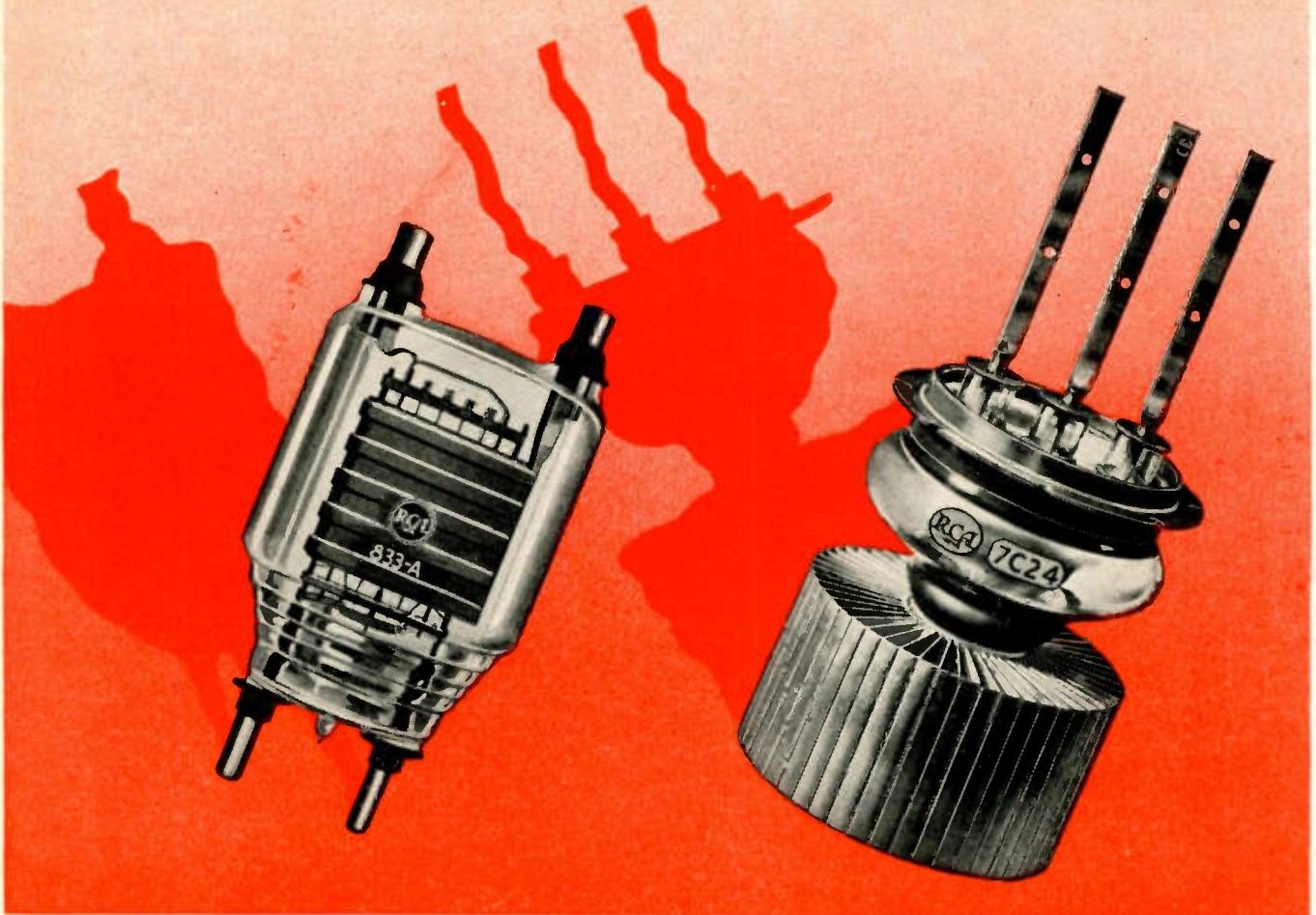

Two outstanding RCA power triodes for electronic heaters of 1 to 8 kw

THE RCA-833-A and 7C24 power triodes offer the manufacturer of dielectric or induction heating equipment considerable latitude in designs involving outputs ranging from 1 to 8 kw.

Both triodes provide good stability under changing load, with moderate excitation requirements, because they are in the medium- μ class. Being air-cooled, they permit simplified designs of apparatus having complete mobility.

The RCA-833-A delivers 1.0 kw to the load with natural air-cooling—

1.4 kw under forced-air-cooled conditions. It operates at full ratings up to 30 Mc., and as high as 75 Mc. at reduced ratings.

The RCA-7C24 forced-air-cooled triode is a high-perveance tube of rugged construction having a large efficient copper radiator. It delivers 4.0 kw to the load and operates at full ratings up to 110 Mc.

Higher outputs are readily obtained by using these tubes in push-pull.

The steady and increasing demand for these tubes assures you of unfailing quality and uniformity.

RCA tube application engineers will be glad to cooperate with you in the adaptation of these or other RCA tube types to your equipment designs. Just write RCA, Commercial Engineering Department, Section D-18G, Harrison, New Jersey.

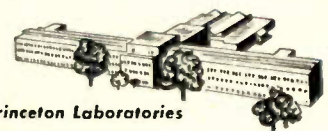

Princeton Laboratories
THE FOUNTAINHEAD OF
MODERN TUBE DEVELOPMENT IS RCA



TUBE DEPARTMENT

RADIO CORPORATION of AMERICA

HARRISON, N. J.

PROCEEDINGS OF THE I.R.E.

AND

WAVES AND ELECTRONS

Published Monthly by

The Institute of Radio Engineers, Inc.

BOARD OF DIRECTORS, 1946

Frederick B. Llewellyn
President

Edmond M. Deloraine
Vice-President

William C. White
Treasurer

Haraden Pratt
Secretary

Alfred N. Goldsmith
Editor

Hubert M. Turner
Senior Past President

William L. Everitt
Junior Past President

1944-1946

Raymond F. Guy
Lawrence C. F. Horle

1945-1947

Stuart L. Bailey
Keith Henney
Benjamin E. Shackelford

1946-1948

Walter R. G. Baker
Virgil M. Graham
Donald B. Sinclair

1946

Ralph A. Hackbusch
Frederick R. Lack
George T. Royden
William O. Swinyard
Wilbur L. Webb
Edward M. Webster



Harold R. Zeamans
General Counsel



George W. Bailey
Executive Secretary
William H. Crew
Assistant Secretary
Robert B. Jacques
Technical Secretary



BOARD OF EDITORS

Alfred N. Goldsmith
Chairman



PAPERS REVIEW COMMITTEE

Murray G. Crosby
Chairman



PAPERS PROCUREMENT COMMITTEE

Dorman D. Israel
General Chairman
Edward T. Dickey
Vice General Chairman



VOLUME 34

July, 1946

NUMBER 7

PROCEEDINGS OF THE I.R.E.

Subsections in the I.R.E. Program.....	Harold E. Ellithorn	422
W. Cullen Moore, Chairman, Chicago Section, 1946.....		423
The Image Orthicon—A Sensitive Television Pickup Tube.....	Albert Rose, Paul K. Weimer, and Harold B. Law	424
The 5RP Multiband Tube: An Intensifier-Type Cathode-Ray Tube for High-Voltage Operation.....	Irving E. Lempert and Rudolf Feldt	432
The Radiation Field of an Unbalanced Dipole.....	William Kelvin	440
The Effect of Grid-Support Wires on Focusing Cathode Emission.....	Chai Yeh	444
Theory and Application of Parallel-T Resistance-Capacitance Frequency-Selective Networks.....	Leonard Stanton	447
Discussion on "A New Type of Automatic Radio Direction Finder," by C. C. Pine.....	H. Busignies and C. C. Pine	457
Correspondence:		
"Simplified Frequency Modulation".....	George G. Bruck	458
"Phase Inverter".....	E. F. Good	458
Contributors to PROCEEDINGS OF THE I.R.E.....		459

INSTITUTE NEWS AND RADIO NOTES

Report of the Secretary—1945.....		461
Browder J. Thompson Memorial Prize for 1946.....		466
Joint IRE-IEE Meeting Held by Radiotelephone.....		467
I.R.E. People.....		469
Books:		
"Currents in Aerials and High-Frequency Networks," by F. B. Pidduck.....	Reviewed by John D. Kraus	473
"A Theoretical Survey of the Possibilities of Determining the Distribution of the Free Electrons in the Upper Atmosphere," by Olof E. H. Rydbeck.....	Reviewed by Newbern Smith	473
"Electrical Coils and Conductors," by Herbert Bristol Dwight.....	Reviewed by E. L. Hall	473
"Electronics for Engineers," Edited by John Markus and Vin Zeluff.....	Reviewed by Russell A. Berg	473
Sections.....		474
Technical Committees, I.R.E.....		474

WAVES AND ELECTRONS

SECTION

Professional Institutions and the Technical Press.....	Hugh S. Pocock	479
J. Griffiths Barry, Secretary-Treasurer, Princeton Subsection, 1946.....		480
A Note on Electrical Engineers Trained During the War.....	G. H. Fett	481
Power Amplifiers with Disk-Seal Tubes.....	H. W. Jamieson and J. R. Whinnery	483
Problems in the Design of High-Frequency Heating Equipment.....	Wesley M. Roberds	489
Amplifier-Gain Formulas and Measurements.....	Sylvester J. Haefner	500
Contributors to WAVES AND ELECTRONS Section.....		506
Abstracts and References.....		507
Section Meetings.....	34A	Positions Open..... 50A
Membership.....	40A	Positions Wanted..... 52A
Advertising Index.....		70A

EDITORIAL DEPARTMENT

Alfred N. Goldsmith
Editor

Helen M. Stote
Publications Manager

Clinton B. DeSoto
Technical Editor

William C. Copp
Advertising Manager

Lillian Petranek
Assistant Advertising Manager

Responsibility for the contents of papers published in the PROCEEDINGS OF THE I.R.E. AND WAVES AND ELECTRONS rests upon the authors. Statements made in papers are not binding on the Institute or its members.

Changes of address (with advance notice of fifteen days) and communications regarding subscriptions and payments should be mailed to the Secretary of the Institute, at 450 Ahnaip St., Menasha, Wisconsin, or 330 West 42nd Street, New York 18, N. Y. All rights of republication, including translation into foreign languages, are reserved by the Institute. Abstracts of papers, with mention of their source, may be printed. Requests for republication privileges should be addressed to The Institute of Radio Engineers.



One of the major functions of a scientific and professional engineering society is to bring about close intellectual contact and interchange of helpful information between the members of the organization. The promotion of these desirable aims is greatly furthered by the organization and effective operation of Subsections of the Institute, as is pointed out in a particularly illuminating guest editorial written by the chairman of the South Bend, Indiana, Subsection of the Institute. As a member of the department of electrical engineering of the University of Notre Dame, he is in a favorable position to judge the tutorial and technical advantages of the Subsection activities. *The Editor.*

Subsections in the I. R. E. Program

HAROLD E. ELLITHORN

I want to outline briefly the advantages of the Subsection program to the members of the Institute and the importance of the Subsection in the development of The Institute of Radio Engineers.

The need of Subsections is made evident by the fact that, when engineers, who are located in small cities, are approached to join the I.R.E., they reply that membership in the I.R.E. is the same as subscribing to the I.R.E. PROCEEDINGS. This reply results from the fact that the engineer feels that he cannot devote the required time for travel to and from the nearest Section meetings. For these men, the Subsection performs an invaluable service by bringing speakers, on subjects of special interest, to the Subsection meetings. The difficulty of time used in travel is hard for the Section to overcome no matter what the nature of its program may be.

The contact with fellow members and the privilege of hearing speakers of national repute means much to the I.R.E. member and creates the feeling of being an integral part of the Institute. Moreover, the Subsection allows those engineers who are interested in the freedom and variety of engineering work, associated with being a member of the engineering staff of a small company, to avail themselves of these advantages and still receive all the benefits associated with I.R.E. membership.

The Institute is benefited by the Subsection program because of increased membership in the areas of the Subsection. There is also an increased interest in Institute affairs and policies because of the discussion group provided by the Subsection. As a result of discussion, the membership may vote more intelligently upon national I.R.E. issues. Also, there is a greater incentive for officers and members of the Subsection to attend and participate in national conventions. The Subsection also provides training in Institute affairs and policies for more men who may later hold office in a Section or on national committees.

The Subsection program must be integrated with a strong Section program because the sponsoring Section can schedule nationally known speakers for the Subsection or provide it with speakers from the Section membership. The latter possibility provides a source of papers which may later be published in the PROCEEDINGS, but in any event there is a greater interchange of information between I.R.E. members. The Subsection officers will be guided, to a large extent, by the Section executive committee, where Institute procedure and policies are concerned.

To promote an active Subsection program, there are definite questions which must be answered; namely, is it worth the speaker's time to address a group of twenty-five or thirty? How is the Subsection to be financed? How are Subsections to be originated? The answer to the first, from experience, is definitely yes. The smaller group enters into discussions with a greater freedom and pointed questions are asked. The Section question cannot be answered by the Subsections themselves, but must await Section and national action. The third question will be answered by small groups when they recognize that the Subsection program is encouraged by the national organization and that the Sections are willing to aid the group in organizing.



W. Cullen Moore
Chairman, Chicago Section, 1946

W. Cullen Moore was born on November 17, 1912, in Portland, Oregon. He received the B.A. degree in physics from Reed College in 1936. Prior to graduation he did field observation and research for the United States Forestry Service on the characteristics of electrical storms and lightning discharges. Following graduation he collaborated in the design and installation of a photoelectric remote control for foghorns for the United States Lighthouse Bureau. During 1937 and 1938, Mr. Moore was with the communications laboratory of United Air Lines, where he was engaged in the design of equipment for typetesting aircraft radio and research on the characteristics of the disturbances radiated by the discharge of static electricity and their control.

Since 1938, Mr. Moore has been employed in the engineering department of the Galvin Manufacturing Corporation ("Motorola" Radio). His prewar work was on frequency-modulation receiver design and the construction of television-picture signal-generating equipment. His wartime activities included: project engineer

in charge of the development of the SCR-511 "Cavalry Set" and the redesign of the SCR-536 "Handie-Talkie," systems for the remote control of aircraft radio, and design work on very-high-frequency pack and aircraft radio equipment. Out of his activities as a licensed private pilot he developed for the Navy a flight computer used with radar. Currently he is a project engineer on microwaves in the television division at Galvin.

Graduate work consists of study at Armour Institute and the Northwestern Technological Institute. He also has taught elementary radio and electronics.

In 1937, Mr. Moore became an Associate Member in the Institute of Radio Engineers, transferring to Senior Member grade in 1944. He served simultaneously as chairman of the Meetings and Papers Committee of the Chicago Section and as Program chairman of the Radio Engineers Club of Chicago, and as vice-chairman and vice-president of both organizations. At present he is a member of the Board of Directors of the National Electronics Conference and chairman of the Chicago Section of the Institute of Radio Engineers for 1945-1946.

The Image Orthicon—A Sensitive Television Pickup Tube*

ALBERT ROSE†, SENIOR MEMBER, I.R.E., PAUL K. WEIMER‡, ASSOCIATE, I.R.E., AND HAROLD B. LAW†

Summary—The image orthicon is a television pickup tube incorporating the principles of low-velocity-electron-beam scanning, electron image multiplication, and signal multiplication. It closely approaches the theoretical limit of pickup tube sensitivity and is actually 100 to 1000 times as sensitive as the iconoscope (1850) or orthicon (1840). It can transmit pictures with a limiting resolution of over 500 lines and, if properly processed, is relatively free from spurious signals. At low lights, the signal output increases linearly with light input; at high lights, the signal output is substantially independent of light input. The tube is completely stable at all light levels. The signal output is sufficiently high to make the operation of the tube insensitive to many of the preamplifier characteristics that are normally considered significant. The construction, operation, electron optics, and performance of the tube are discussed.

I. INTRODUCTION

THE IMPORTANCE of sensitive pickup tubes to the success of a well-rounded television service needs little emphasis. One has only to be reminded that, insofar as the television pickup tube is called upon to replace the human observer, the sensitivity of the pickup tube should match that of the human eye. The demands on a television service are often more stringent than on news photography, for example. The latter can, within wider limits, select the times and conditions under which it will record pictures. The pickup tube, once committed to transmitting an event, such as a football game, must steadily transmit pictures under the whole gamut of lighting conditions. It is, accordingly, highly desirable to have a pickup tube which can transmit pictures both at very low and at very high light levels.

The iconoscope¹ has transmitted excellent pictures at high light levels; the orthicon² has operated best at medium light levels. The image orthicon extends the range still further toward lower illuminations by a factor of approximately 100. At the same time, the image orthicon can operate *stably* at medium and high light levels. Unlike the orthicon, it is not subject to transient loss of operation caused by sudden bursts of illumination. The use of the image orthicon in the higher light ranges is not, however, emphasized relative to the iconoscope or orthicon. The additional complexity of the tube needed to provide its increased sensitivity has not yet permitted pictures whose quality equals the

best that the iconoscope or orthicon can transmit.

The present paper describes the construction, operation, and performance of the image orthicon. It is hoped to treat some of the electron-optical and constructional problems in more detail in separate papers.

II. GENERAL DESCRIPTION OF THE IMAGE ORTHICON

The usual storage type of pickup tube (Fig. 1) has an electron gun, a photosensitive insulated surface, referred to as the target, and a means for deflecting the electron-

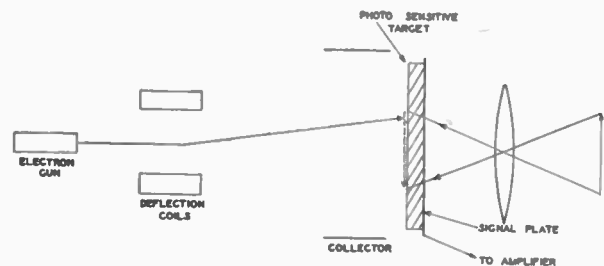

Fig. 1—Typical parts of storage type of pickup tube.

scanning beam. The scene to be transmitted is focused on the target on which it builds up by photoemission a charge pattern corresponding to the light and shade in the original scene. The beam of electrons, generated by the electron gun, is made to scan the charge image in a series of parallel lines. While a constant stream of electrons approaches the target, the stream which leaves is modulated by the charge pattern. A signal plate located close to the target surface picks up the modulation by capacitance and feeds it into the grid of the first amplifier tube. The same video signal, however, appears in the modulated stream of electrons leaving the target, and if these electrons could be collected on a single electrode, the signal could be fed through it into an amplifier.

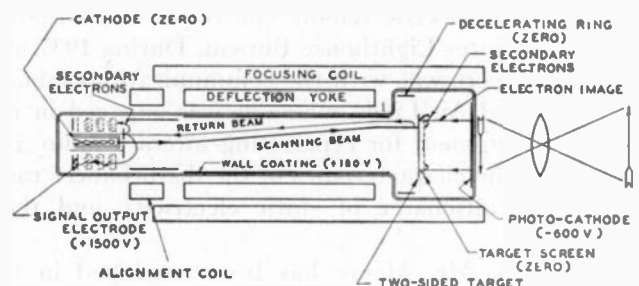

Fig. 2—Diagram of the image orthicon.

The image orthicon (Figs. 2 and 3) has, in addition to the usual gun, deflection means, and target, three parts that contribute to its sensitivity and stability. An

* Decimal classification: R 583.6. Original manuscript received by the Institute, February 12, 1946. Presented, 1946 Winter Technical Meeting, New York, N. Y., January 24, 1946.

† R.C.A. Laboratories, Princeton, New Jersey.

¹ V. K. Zworykin, G. A. Morton, and L. E. Flory, "Theory and performance of the iconoscope," *Proc. I.R.E.*, vol. 25, pp. 1071-1092; August, 1937.

² A. Rose and H. A. Iams, "The orthicon," *RCA Rev.*, vol. 4, pp. 186-199; October, 1939.

electron multiplier, built into the tube near the gun, multiplies the modulated stream of electrons returning from the target before it is fed into an amplifier. Sensitivity gains of 10 to 100 are thereby made possible. The charge pattern on the target, instead of being generated by photoemission, is formed by secondary emission from an electron image focused on the target. The electron image is released by light from the scene to be transmitted falling on a conducting semitransparent photocathode and is focused on the target by a uniform magnetic field. The combination of the higher photosensitivities that can be obtained for a conducting surface than for an insulated surface, together with the secondary-emission gain of the electron image at the target, provides another factor of about fivefold increase in sensitivity. The use of a separate conducting photocathode is made possible by a two-sided target in place of the usual one-sided target. The two-sided target allows the charge pattern to be formed on one side and the scanning to take place on the opposite side. Further, it permits the tube to operate stably over a large range of scene brightnesses.

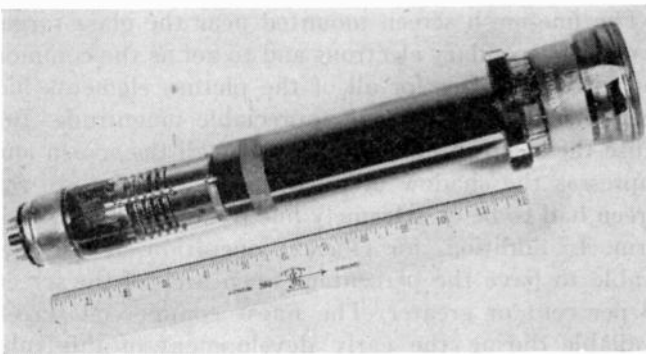

Fig. 3—The image orthicon.

The electron multiplier, two-sided target, and electron-image section will be recognized as elements whose virtues and incorporation into a pickup tube have been discussed frequently in the literature.^{1,3-6} The image orthicon represents one way of including all three elements in a useful, sensitive, and stable pickup tube.

V III. TYPICAL OPERATING CYCLE

The scene to be transmitted is focused on the semitransparent photocathode (Fig. 2). Photoelectrons are released in direct proportion to the brightnesses of the various parts of the scene. The photoelectrons are accelerated from the photocathode toward the target by a uniform electric field and are focused on the target by a uniform magnetic field parallel to the axis of the tube.

¹ H. A. Iams and A. Rose, "Television pickup tubes with cathode-ray beam scanning," *Proc. I.R.E.*, vol. 25, pp. 1048-1070; August, 1937.

³ H. A. Iams, G. A. Morton, and V. K. Zworykin, "The image iconoscope," *Proc. I.R.E.*, vol. 27, pp. 541-547; September, 1939.

⁴ A. Rose, "The relative sensitivities of television pickup tubes, photographic film, and the human eye," *Proc. I.R.E.*, vol. 29, pp. 293-300; June, 1942.

⁶ P. T. Farnsworth, "Television by electron image scanning," *Jour. Frank. Inst.*, vol. 218, pp. 411-444; October, 1934.

The paths of the electrons from photocathode to target are, except for emission velocities, substantially straight lines parallel to the axis. The electron image, accordingly, has unity magnification.

The photoelectrons strike the target at about 300 volts, at which potential the secondary-emission ratio is greater than unity. Because more secondary electrons are emitted than there are incident photoelectrons, a positive charge pattern is formed on the target, the high lights corresponding to the more positive areas. The secondary electrons are collected by the fine-mesh target screen.

At the same time that a charge pattern is being formed on one side of the target, a beam of electrons scans the opposite side. The scanning beam is of the low-velocity type already described for the orthicon.² It starts at the thermionic cathode of the electron gun at zero potential and is accelerated by the gun to about 100 volts. From the gun to the target the beam is in an approximately uniform magnetic focusing field. As the beam electrons approach the target they are decelerated again to zero volts. If there is no positive charge on the target, all the electrons are reflected and start to return toward the gun along their initial paths. If there is a positive charge pattern on the target, the beam electrons are deposited in sufficient numbers to neutralize the positive charges. The remaining electrons are reflected. In this way a stream of electrons, amplitude-modulated by the charge pattern, is started on its way toward the gun.

The return beam not only starts back toward the gun, but it actually arrives at the gun very near the defining aperture through which it emerged. An electron beam will follow closely the lines of a magnetic field under the following conditions: (1) that the beam is initially directed along the magnetic lines; (2) that the beam velocity in volts does not greatly exceed the magnetic field strength in gauss; (3) that electric fields transverse to the magnetic field are small or absent; and (4) that the magnetic lines do not bend sharply. These conditions are approximately fulfilled in the image orthicon. The beam is shot into the magnetic field parallel to its lines. The beam velocity in volts and magnetic field strength in gauss are each in the neighborhood of 100. The only prominent electric field is near the target and parallel to the magnetic field. The bends in the magnetic field caused by the transverse fields of the deflecting coils are well tapered.

The return beam accordingly strikes the gun in an area around the defining aperture which is small compared with the defining aperture disk, but large compared with the defining aperture itself. Also, the return beam strikes this surface at about 200 volts and generates a larger number of secondary electrons than there were incident primary electrons. In short, the defining aperture disk is also the first stage of an electron multiplier. Succeeding stages of the multiplier are arranged symmetrically around and back of the first

stage. More will be said of the multiplier in a following section. Meantime, the secondary electrons are drawn from the first stage by suitable electric fields into the succeeding stages. The number of stages, as will be explained, need not be large to exhaust the useful gain of the multiplier. In its present form, the image orthicon uses five stages of electron multiplication.

The output current from the final stage of the multiplier is fed into a wide-band television amplifier in the usual manner. Because this output current is already at a high level, the required gain of the amplifier is small compared with that for an iconoscope or orthicon. The high-level output has other advantages. The performance of the tube, for example, is not critically dependent upon the noise characteristics and input-circuit parameters of the preamplifier, as is the case for the iconoscope and orthicon.

The above operating cycle, while somewhat elaborate, is nevertheless easily traceable. On the other hand, the detailed operation of the parts of the tube does include some interesting and less obvious problems. These will be discussed below.

IV. ELECTRON-IMAGE SECTION

The semitransparent conducting photocathode is a well-known structure for getting photoemission from the side opposite to that from which the light enters. Photosensitivities several times higher than those for insulating mosaic surfaces can be obtained.

The use of a uniform magnetic field to focus the electron image is not only well known but is also one of the simplest methods of electron-image formation. Unity magnification, erect image, and good definition at low anode voltage are its characteristics.

V. CONSTRUCTION OF THE TWO-SIDED TARGET

The two-sided target is perhaps one of the oldest and most frequently proposed structures for improving the sensitivity of a television pickup tube. It makes possible the separation of charging and discharging processes so that the sensitizing procedures and electric fields appropriate to each may be incorporated in the tube without mutual interference. The two-sided target must conduct charges *between* its two surfaces but *not along* either surface. It should have a conducting element nearby to act as the common capacitor plate for the separate picture elements.

Most of the attempts to fabricate two-sided targets have centered on a structure which had discrete conducting elements or "plugs" embedded in an insulating medium. These have been satisfactory for testing the properties of a two-sided target but have failed thus far to provide the uniformity necessary for a commercial tube.

The two-sided target used in the image orthicon is exceedingly simple and capable of a high degree of uniformity. It is a thin sheet of low-resistivity glass. The

resistivity is chosen low enough so that charges deposited on opposite sides of the glass are neutralized by conduction in a frame time (1/30 second). It is chosen thin enough so that these same charges do not spread laterally in a frame time sufficiently to impair the resolution of the charge pattern. Thicknesses of five to ten wavelengths of light have been found to be satisfactory.

The thin sheet of glass, about $1\frac{1}{2}$ inches in diameter, is mounted flat to within a few thousandths of an inch and spaced about two thousandths of an inch from a similarly flat fine-mesh screen. The mounting techniques to achieve these tolerances have been the subject of a considerable amount of work. The problem is especially accentuated when it is realized that the assembled structure must go through a standard bake-out schedule at about 400 degrees centigrade. Satisfactory assemblies were obtained only after the glass and screen were each mounted under tension on flat metal rings. The metal ring for the glass had to be carefully chosen so that the 400-degree-centigrade bake-out did not cause the glass either to break or to wrinkle on cooling.

The fine-mesh screen mounted near the glass target to collect secondary electrons and to act as the common capacitive member for all of the picture elements has been, itself, a problem of appreciable magnitude. Because the electron image passes through the screen and impresses the shadow of its wires on the picture, the screen had to be of extremely fine mesh and highly uniform. In addition, for efficient operation, it was desirable to have the percentage open area of the screen 50 per cent or greater. The finest commercial screen available during the early development of this tube which had even reasonable uniformity was a 230-mesh per linear inch, woven-wire, stainless-steel screen. It had 47 per cent open area and could be etched to about 60 per cent open area. The 230-mesh screen was, however, readily resolved in the transmitted picture and limited the resolution objectionably.

In contrast to this screen, a technique was developed for making fine-mesh screens with 500 to 1000 meshes per linear inch, an open area of 50 to 75 per cent, and an accuracy of spacing comparable with that of a ruled optical grating. These screens have made possible the transmission of pictures with high definition and substantial freedom from spurious signals.

VI. OPERATION OF THE TWO-SIDED TARGET

Fig. 4 shows the potentials⁷ of the two sides of the glass target during a typical charge-discharge cycle. In Fig. 4(a) the tube has been in the dark. The scanned side of the target has been brought to zero volts by the

⁷ For simplicity, the emission velocities of the thermionic and secondary electrons are taken to be zero and the contact potentials of all surfaces are taken to be the same. Including finite emission velocities and contact potential differences would merely shift the values of the potentials shown in Fig. 4 without affecting the argument.

scanning beam. The picture side also is at zero volts as a result of leakage to the scanned side. The fine-mesh screen for collecting secondary electrons is held at +1 volts. Fig. 4(b) shows the target potentials after exposure

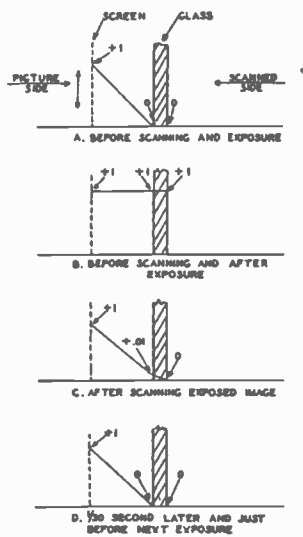

Fig. 4—Target potentials during a typical scanning cycle.

to light for a frame time. The picture side of the glass has been charged to +1 volt by the electron image. The scanned side of the target also has been brought up to +1 volt by capacitive coupling to the picture side. In Fig. 4(c), the beam has just scanned the target, bringing the scanned side down to zero volts and the picture side down *almost* to zero volts by its capacitive coupling to the scanned side. The "*almost*" results from the fact that there is a positive charge on one side of the glass and a negative charge on the other, constituting a charged capacitor. If, therefore, the scanned side is brought to zero volts, the picture side must be positive by an amount equal to the picture charge divided by the capacitance between the two sides of the glass. This turns out to be small compared with the +1 volt to which the target as a whole had been charged. In particular, it is shown to be 0.01 volts in the illustration chosen. During the next frame time the charges on the two sides of the glass unite by conduction to wipe out the potential difference between the two sides. Fig. 4(d) shows the potentials at this time, and by comparison with Fig. 4(a) the target has returned to its initial state ready for another cycle.

In the above cycle, the charging by the picture, discharging by the beam, and leakage between the two sides of the glass were described as events in series. Actually, of course, all three events occur simultaneously and steadily.

It may be remarked, in passing, that the choice of a glass with too high a resistivity (that is, a leakage time constant greater than a frame time) tends to allow charge to accumulate on the picture side. For sufficiently high resistivities, an objectionable loss of signal, as well as spurious after-images, are encountered.

VII. AN ELECTRON-OPTICAL PROBLEM

It has been found that, for good operation over a large range of scene brightnesses, the fine-mesh screen potential should be kept low, about +1 volt. This means that the glass target potential can swing only between the narrow limits of zero volts, to which the scanning beam charges it, and +1 volt, to which the picture can charge it as limited by the potential of the fine-mesh screen. The maximum signal output is proportional to the maximum potential swing of the target (e.g., +1 volt as above). It is important, therefore, in order to insure uniform signal output at all points on the target, to have the limits constant over the target. The upper limit, +1 volt, as set by the fine-mesh screen, is obviously the same at all points on the target. The lower limit, however, is set by the lowest potential to which the beam can charge the target. If the beam approached the target at all points with normal incidence, the lower limit would be constant over the target and equal to zero volts.⁸ The attainment of this "if" is not, in general, a simple task. The ease with which the beam can depart from normal incidence is, perhaps, more suggestive. A few possibilities will be mentioned.

When the beam is shot into the magnetic field by the short electron gun, it is usually not quite parallel with the magnetic lines. The component of the beam's velocity transverse to the magnetic field lines goes into helical motion of the beam. The energy of this helical motion is subtracted from the energy of the beam directed along the magnetic lines. The latter energy, however, determines the potential to which the beam can charge the target. Thus if $\frac{1}{2}$ volt of energy is absorbed in helical motion, the beam can charge the target to only $+\frac{1}{2}$ volt instead of to zero volts. This permits the target to swing only between the limits of $+\frac{1}{2}$ volt and +1 volt. In other words, the maximum signal output is reduced by half.

Another contribution to the helical motion of the beam may come from the deflection fields. The electron beam, in the process of negotiating a bend in the magnetic field lines, redistributes some of its energy into helical motion.⁹ The amount of this energy increases in general for larger angles of deflection, weaker magnetic fields, and higher beam voltages. Here one expects, and finds, the helical energy, and correspondingly the loss of signal, increasing from the center of the picture out to the edges.

Helical motion introduced into the beam is fortunately a removable defect. One has only to introduce a second source of helical motion of equal amplitude and opposite phase. To correct for helical motion resulting from misalignment of gun and magnetic field, an adjustable, small (in magnitude and physical extent) transverse magnetic field is introduced at the exit end

⁸ Again for simplicity, the thermionic-emission energies of the beam electrons are taken to be zero.

⁹ A. Rose, "Electron optics of cylindrical electric and magnetic fields," *Proc. I.R.E.*, vol. 28, pp. 30-39; January, 1940.

of the gun. To correct for helical motion resulting from the deflection fields, a second source, whose contribution also increases from the center of the picture to the edges, is introduced near the target. This source is the component of the electric field of the decelerating ring transverse to the axis of the tube. The relative phases of the helical motions resulting from the deflection coil and decelerating ring can be adjusted for cancellation by sliding the coil along the axis of the tube. In practice, once a design of the tube and coil has been decided upon, this can be fixed.

What is of particular interest in this problem is the delicacy of adjustment necessary for good performance. A 100-volt beam must be generated, deflected, and corrected in such manner that it approaches all points on the target with not more than a tenth of a volt energy "squandered" in helical motion.

VIII. ELECTRON MULTIPLIER

In spite of the variety of electron multipliers offered by the literature, it was thought desirable to add still another to the list—one which was more nearly suited to the requirements of the image orthicon. A brief consideration of the diffuse spray of secondary electrons emerging from the first multiplier stage (defining-aperture disk) suggests immediately the difficulties of getting all of them to enter the relatively narrow mouth of the more conventional electron multipliers. This is particularly true because it was desirable, for other reasons, to retain the axial symmetry of the electric field in front of the first stage. To focus the secondary electrons into a narrow-mouth multiplier might very well require objectionably strong asymmetric electric fields. Once committed to the symmetry of fields, one is also committed to a relatively large entrance opening for the second stage of the multiplier because the secondary electrons spray out symmetrically or "fountain-wise" from the first stage.

It was found to be relatively easy to arrange for substantially all of the secondary electrons from the first stage to strike the large annular-disk second stage shown in Fig. 2. The arrangement consisted of surrounding the first stage with electrodes all at lower potential than the first stage, with the one exception of the second stage. In this way the electrons were offered two alternatives: to return to their place of origin, the first stage, or to land on the second stage.¹⁰ Energetically the electrons could return to the first stage, since they were emitted from it with a few volts of spare energy. But to return to the first stage, the electrons must approach it at nearly normal incidence or, more accurately, with all but their emission energy directed normal to the surface. The brief excursion of the electrons into the strong dispersing field provided by the more positive second stage makes the probability of such return small. The secondary electrons from the

first stage accordingly quickly find their way to the second stage.

Here the problem is to multiply the electrons again and send them on to a third stage, and so on through a number of stages to the final collector. The use of a series of parallel-screen multipliers is well suited geometrically to the problem, but the efficiency of the screen-type multiplier is low. That is, for a secondary-emission ratio of four, the gain per stage is only about two. The "pinwheel" type of multiplier shown schematically in Fig. 2, on the other hand, has an efficiency of 80 to 90 per cent. By inspection it is evident that the electrons incident on a "pinwheel" see an almost opaque surface. There are no holes, as there are in the screen-type multiplier, through which electrons are lost. The secondary electrons, however, readily pass through the blades toward the succeeding stage. They are helped in their path by the coarse-mesh guard screen which shields them from the suppressing action of the negative potential of the preceding stage. Succeeding stages have their blades opposed to accentuate their opacity. The operation of the multiplier was found to be uncritical to electrical adjustment and mechanical alignment. Both these features are highly desirable to simplify the construction and operation of an otherwise complex tube.

Total gains of 200 to 500 are readily obtained for the five-stage multiplier. These gains are usually more than sufficient to exhaust the sensitivity possibilities of electron multiplication. The "useful" gain obtainable with electron multiplication is discussed in the following section.

IX. SENSITIVITY AND SIGNAL-TO-NOISE RATIO

It was pointed out in the introduction that the image orthicon derives its increased sensitivity over the iconoscope and orthicon from (1) the higher photosensitivity of a conducting photocathode relative to that of an insulating mosaic; (2) the multiplication by secondary emission of the electron image at the target; and (3) the use of an electron multiplier for the signal current. The gain from (1) and (2) is about a factor of five. It must be remembered that this factor reflects more the state of the art of making photosensitive surfaces than any intrinsic limitations. The gain from (3) is a function of the signal-to-noise ratio in the transmitted picture. The term "noise" as used here refers to the more or less fundamental current fluctuations associated with amplifiers or generated in the pickup tube. These fluctuations give rise to a masking effect, often referred to as "snow," in the transmitted picture. The video signal current must exceed the noise current before a picture can be seen. The noise currents, therefore, set the threshold scene brightness that a pickup tube can transmit; they also define the scene brightness required for the transmission of good pictures, that is, pictures with high signal-to-noise ratios.

The performance of the iconoscope and orthicon is limited by the noise currents in the first tube of the

¹⁰ The third possibility, that of retaining their freedom in space, is usually of negligibly short duration.

television preamplifier. The performance of the image orthicon is limited by the much smaller noise in the scanning beam. The multiplier, accordingly, provides a useful gain in sensitivity up to the point at which the shot noise in the scanning beam is made equal to, or slightly greater than, the noise current in the preamplifier. The usual preamplifier noise current¹¹ is 2×10^{-9} ampere for a 5-megacycle bandwidth. The shot noise in the scanning beam is $(2eI\Delta f)^{1/2} = I^{1/2} \times 10^{-6}$ ampere for the same bandwidth, where I is the scanning-beam current in amperes. The "useful" multiplier gain is, therefore,

$$\frac{2 \times 10^{-9}}{I^{1/2} \times 10^{-6}} = \frac{2 \times 10^{-3}}{I^{1/2}}$$

A more convenient way of expressing this gain is to make use of the relation between the scanning-beam current and the maximum signal-to-noise ratio that can be obtained when the beam is fully modulated. Under these conditions, the maximum signal is the beam current itself; the noise associated with this signal is the shot noise in the beam; and the signal-to-noise ratio R is given by

$$R = \frac{I}{I^{1/2} \times 10^{-6}} = I^{1/2} \times 10^6.$$

With this relation, the useful gain of the multiplier may be written as $2000/R$. Some comments and caution are needed in the application of this gain expression.

The useful gain was computed for 100 per cent modulation of the scanning beam. In practice, for medium- and high-light pictures, modulations in the neighborhood of 50 per cent are realized. The lowered modulation results, for the most part, from the fact that all of the electrons that strike the target do not stick—some are reflected or scattered back. Further, for low-light pictures, near threshold, the modulation is still lower because the potential swing of the target is smaller than the emission velocities of the electrons in the scanning beam—only the higher-velocity electrons can land. Whatever the source of lower modulation, the useful gain is reduced in proportion to the modulation.

With the above limitations, the useful gain of the multiplier is of the order of 20 for a high-light picture and of the order of 200 for a low-light picture. The combined gain of the electron-image section and the multiplier make the image orthicon from 100 to 1000 times as sensitive as the iconoscope or orthicon.

The sensitivity of the image orthicon is high enough to make comparisons with the performance of the eye both significant and interesting. The image orthicon has approximately the same intrinsic sensitivity⁵ as the eye. This means that, for scene brightnesses *near the threshold for the tube*, both tube and eye can transmit the same pictures. On the other hand, the greater flexibility of the eye relative to a television system enables it still to

"see" scenes whose brightness is as little as one thousandth of the threshold scene brightness for the pickup tube. The eye attains this low threshold by sacrificing resolution for operating sensitivity.

X. SIGNAL VERSUS LIGHT CHARACTERISTICS

A representative curve for the video signal as a function of light is shown in Fig. 5. Three equivalent abscissa scales are shown for convenience in referring to scene brightness, image brightness, or photocathode current. Also, the video signal is given in microamperes of modulated signal at the target. It is this current which

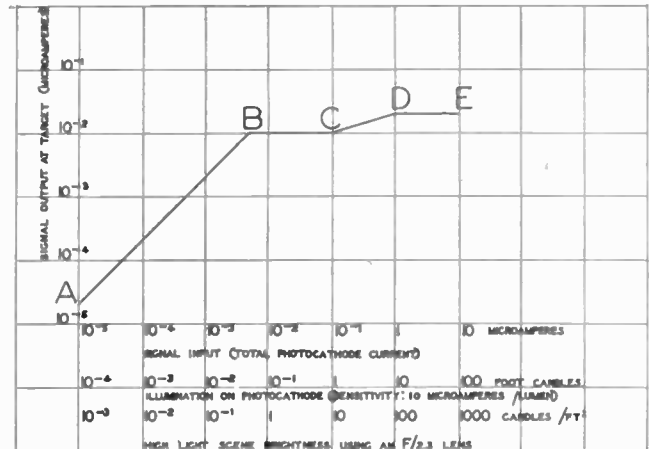

Fig. 5—Signal versus light characteristic.

determines the signal-to-noise ratio. The final output signal is the product of the video signal at the target and the gain of the electron multiplier, usually several hundred. The multiplier is an almost noiseless device.

The curve is divided, for purposes of discussion, into four parts by the letters *A*, *B*, *C*, *D*, and *E*. These will be considered in order, starting from the left.

The low-light range *A-B* is particularly simple. Here the signal out is proportional to the light in, just as it is for the orthicon. At the lowest point on the curve, the video signal is equal to the shot noise in the scanning beam. The beam current is adjusted in this range just to discharge the picture. As point *B* is approached, higher signals and signal-to-noise ratios are obtained. At *B*, the light is just sufficient to cause the target to be fully charged (i.e., to the potential of the fine-mesh screen) in a frame time of $1/30$ of a second. One would ordinarily expect that increasing the light level beyond *B* would tend to saturate the transmitted picture. The high lights would remain constant in amplitude in this range; the low lights would continue to increase and tend to make the entire picture white. This is what one ordinarily would interpret from Fig. 3. Actually, pictures transmitted by the image orthicon in the range *B-C* have, except for large black areas, the same or improved contrast. The explanation follows.

Fig. 6(a) shows the transmitted picture of a single spot of light whose brightness is located at *B*. The picture is normal. Fig. 6(b) shows the transmitted picture of the same spot illuminated to ten times the previous

¹¹ H. B. DeVore and H. A. Iams, "Some factors affecting the choice of lenses for television cameras," *PROC. I.R.E.*, vol. 28, pp. 369-374; August, 1940.

brightness. One sees in this figure that the signal output did not change for a tenfold increase in original picture brightness, that the contrast of the spot is maintained in the immediate neighborhood of its boundaries, and that the rest of the background, supposedly black in the original, has begun to lighten up. The black halo surrounding the light spot in Fig. 6(b) is the key to the

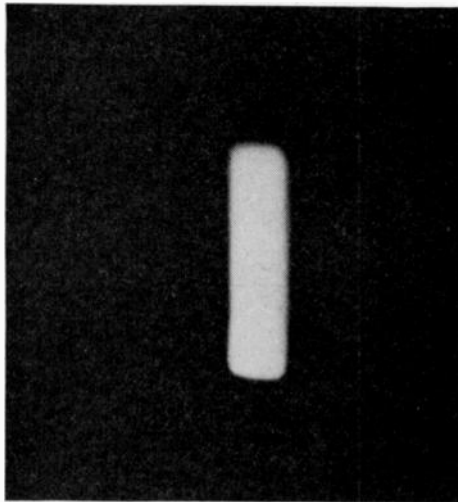

(a)

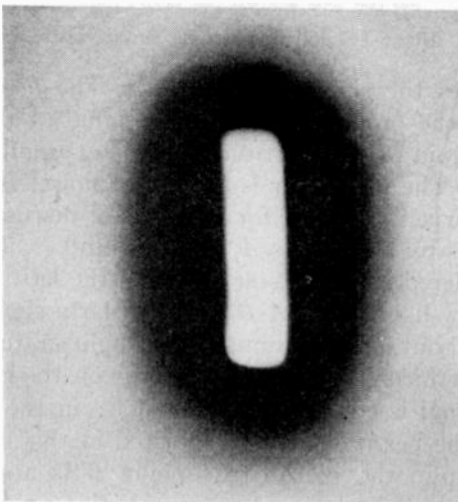

(b)

Fig. 6—Transmitted picture of light spot at low and at high spot brightness.

preservation of good picture contrast in the *B-C* range. This halo is formed by low-velocity secondary electrons originating in the light spot and scattered into the immediate neighborhood of the light spot. Where they land, they tend to keep the target charged negatively and to counteract the effect of stray light, tending to wash out the picture. In brief, the brighter areas in the *B-C* range tend to maintain their potential higher than neighboring less-bright areas by spraying the less-bright areas with more low-velocity secondary electrons than they get in return. While the "halo" effect is unnatural in Fig. 6(b), it is not visible, as such, in the usual fine-

detail half-tone picture (see Fig. 8), and serves only to maintain picture contrast.

The "halo" has another useful function. If the spot of light in Fig. 6(b) is moved rapidly across the field of view, the transmitted picture is not a continuous white streak as one would expect from an orthicon or from an image orthicon in the low-light range *A-B*. The transmitted picture is a series of relatively sharp tilted images of the spot separated by 1/30-second intervals. In effect, the sharp tilted image is not unlike what one obtains from a focal-plane shutter in a photographic camera. The mechanism for generating the effect is the discharging action of the halo electrons. When the spot of light is displaced from an initial position, the halo electrons erase, by discharging, the initial charge pattern. The brighter the light, the more rapid the erasing action and the more sharply resolved are pictures in motion.

The second rise in video signal, namely, the range *C-D*, has an interesting origin. An outline of the argument for its existence will be given here. The signals in both the ranges *B-C* and *C-D* are determined by the charge accumulated on a picture element just prior to being scanned by the electron beam. In the range *B-C*, this charge is equal to the total charge that the *entire target*, considered as a parallel-plate capacitor, can accumulate divided by the number of picture elements. In the range *C-D*, the picture-element charge is the total charge that an *element* can accumulate as determined by the capacitance of that element, alone, to the signal plate. If the spacing between target glass and fine-mesh screen is small compared with the diameter of a picture element, these two charges are equal and there is no "second rise" in the *C-D* range. As the spacing between glass and screen is increased, the capacitance of the target as a whole decreases linearly with the reciprocal spacing, while the capacitance of a picture element alone levels off to a constant value, independent of spacing and equal to the capacitance of a disk, the size of a picture element, in free space. The usual spacing is such that the capacitance of a picture element alone is two or three times the capacitance that would be computed for the picture element by dividing the number of picture elements into the total target capacitance.

Thus far, a basis has been established for the separate picture elements having more capacitance and being able to store more charge than is possible when these picture elements act together as a complete target. It turns out, however, that the additional storage capacity does not become effective until the light is sufficiently intense to charge the target as a whole in a small fraction of a frame time. Hence, the flat plateau *B-C* before the "second rise" *C-D* sets in. The end of the second rise, point *D*, should and does occur when the light is sufficiently intense to charge the target as a whole in a line time.

Beyond *D* the signal output curve again levels off and

the transmitted picture does not change with changes in scene brightness.

To summarize: in the low light range, the image orthicon acts like an orthicon; in the high light range, the transmitted picture is substantially independent of scene brightness, the contrast and half-tone scale being maintained by redistributed secondary electrons on the picture side of the target. These redistributed electrons have also the property of tending to keep moving images in sharp focus.

XI. RESOLUTION

Starting at one end of the tube with a well-focused image on the photocathode, the picture undergoes three transformations before emerging from the multiplier at the other end in the form of a modulated signal current. The transformations are, in order: optical image to electron image, electron image to charge pattern on the target, charge pattern to modulated stream of electrons in the scanning beam. Each transformation has been capable separately of resolving over 1000 lines per inch; the combination has resolved well over 500 lines per inch.

The resolution of the electron image is limited by the emission velocities of the photoelectrons. The resolution of the charge pattern on the target is limited, at high lights, in part by the fine-mesh screen, and at low lights, in part by the leakage along the glass target. The ability of the scanning beam to resolve the charge pattern is controlled by a number of factors, among which are defining aperture diameter, thermionic-emission velocities, angle of approach to the target, and magnitude of the potential differences in the charge pattern. The magnetic field strength, once adjusted for focus, has no first-order effect on the resolution of either the scanning beam or the electron image. On the other hand, the resolution of both the scanning beam and the electron image improves with increasing electric field strength on the scanned side of the target and in front of the photocathode, respectively.

An expression has been derived¹² for the limiting current density that may be focused by an electron gun into a spot on a target. This current density is proportional to the target potential and to the \sin^2 of the angle of convergence of the electrons approaching the target. Experience with oscilloscopes and kinescopes has led to high anode potentials, kilovolts and tens of kilovolts, for the purpose of getting small spots. It may, accordingly, appear surprising to find even smaller spot sizes attained in the image orthicon at a target potential of approximately zero volts. The smaller beam-current densities used in the pickup tube are only part of the explanation. The larger part is the difference in the convergence angles of the electrons approaching the pickup tube target and kinescope screen. For the orthicon type of pickup tube the \sin^2 of this angle is near unity, while

¹² D. B. Langmuir, "Theoretical limitations of cathode-ray tubes," *Proc. I.R.E.*, vol. 25, pp. 977-991; August, 1937.

for the kinescope it is usually 10^{-3} to 10^{-4} . Thus the low-velocity scanning beam makes up for its low velocity by its large convergence angle.

XII. PERFORMANCE

Representative pictures transmitted by the image orthicon are shown in Figs. 7, 8, and 10. Figs. 7 and 8 are

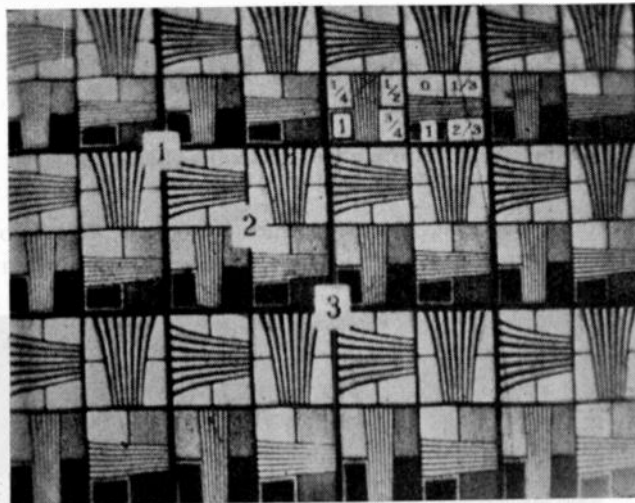

Fig. 7—Test pattern transmitted by image orthicon.



Fig. 8—Half tone transmitted by image orthicon.

the transmitted pictures of slides projected on the photocathode. Fig. 10 shows the results of a test in which a direct comparison was made between the operating sensitivity of an image orthicon and of a 35-millimeter camera using Super-XX film. The experimental setup for the comparison is shown in Fig. 9. The original subject was illuminated with an ordinary 40-watt bulb attenuated with neutral filters. The television camera was focused on the subject alone and its picture was reproduced on a receiver located alongside the subject. The 35-millimeter camera photographed simultaneously the original and reproduced pictures. Both cameras used $f/2$ lenses and an exposure time of $1/30$ second. It will be

seen from Fig. 10 that only in the first exposure, at 2-foot-lamberts brightness of the subject, do both original and reproduced pictures appear. At 0.2 foot-lam-

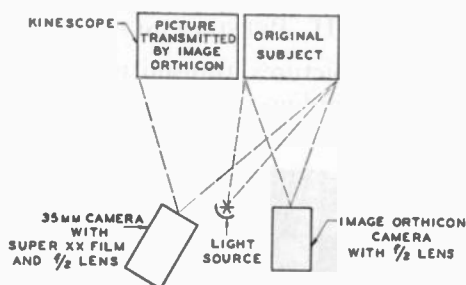

Fig. 9—Setup for comparing the sensitivities of image orthicon and photographic film.

bert only the picture reproduced by the television camera is present. And, in fact, the television camera



Fig. 10—Comparison of sensitivities of image orthicon and 35-millimeter Super XX film. (Incandescent light source.)
 (a) 2 foot-lamberts (b) 0.2 foot-lambert (c) 0.07 foot-lambert (d) 0.02 foot-lambert

continues to transmit a picture even at 0.02 foot-lambert, which is the brightness of a white surface in full moonlight.

ACKNOWLEDGMENT

The work on the image orthicon has had an extended

course. Throughout, it has profited from the experience and helpful criticism of many of the writers' associates both in these Laboratories and in other divisions of The Radio Corporation of America. Much of the work was made possible by an immediate background of pickup-tube research, largely as yet unpublished, and contributed by a number of individuals. Among these are H. B. DeVore,¹³ L. E. Flory,¹⁴ R. B. Janes,¹⁵ H. A. Iams,¹⁴ G. L. Krieger,¹⁴ G. A. Morton,¹⁴ P. A. Richards,¹⁵ J. E. Ruedy,¹⁴ and O. H. Schade.¹⁶ The writers would particularly like to acknowledge the encouraging direction of B. J. Thompson (now deceased) and V. K. Zworykin, and the valuable contributions of S. V. Forgue,¹⁴ J. Gallup,¹⁶ and R. R. Goodrich.¹⁴

The groundwork for the image orthicon had already been laid prior to the war. Early in the war, effort was directed under an Office of Scientific Research and De-

velopment contract toward developing the image orthicon in a form suitable for military purposes.

- ¹³ Formerly, RCA Laboratories.
- ¹⁴ RCA Laboratories.
- ¹⁵ RCA Victor Division, Lancaster, Pa.
- ¹⁶ RCA Victor Division, Harrison, N. J.

The 5RP Multiband Tube: An Intensifier-Type Cathode-Ray Tube for High-Voltage Operation*

IRVING E. LEMPert†, MEMBER, I.R.E., AND
 RUDOLF FELDT†

Summary—It is pointed out that, at the medium voltages employed in conventional cathode-ray oscillographs (3 to 4 kilovolts), full advantage cannot be taken of high-frequency circuit performance either by photographic recording or visual observation, due to insufficient trace intensity. A new tube, the multiband tube, is described which is essentially a high-voltage intensifier-type cathode-ray tube. Its cylindrical shape and the subdivision of the intensifier electrode into several bands (multiband) reduce intensifier distortion to such an extent that the tube may be operated with good results at intensifier-to-second-anode voltage ratios of 10:1. A low-capacitance deflection system, with leads brought through the tube neck, makes it particularly useful for high-frequency applications, and its nearly flat face simplifies the lens problem for photographic recording and

projection. The tube can be used as a replacement for 5CP tubes on standard equipment with little change, except the addition of an external intensifier voltage supply. Typical operation is at $E_{b_2} = 1500$ volts, $E_{b_3} = 15,000$ volts. Results are given and particular applications and modifications (projection, ultra-high-frequency tubes) are described.

INTRODUCTION AND FORMULATION OF REQUIREMENTS

IN RECENT years considerable progress has been made in the design of cathode-ray oscillographs and tubes. The performance of cathode-ray tubes has been improved by the use of more efficient guns, more efficient screen materials, and the reduction of distortions and aberrations. Cathode-ray oscillographs of recent design are equipped with elaborate circuits for automatic beam control, with wide-band amplifiers, and

* Decimal classification: R138.31. Original manuscript received by the Institute, October 8, 1945; revised manuscript received, March 19, 1946. Presented, New York Section, New York, N. Y., January 2, 1946.

† Allen B. DuMont Laboratories, Inc., Passaic, N. J.

with high-speed sweep circuits. These developments have been accompanied by only minor changes in the accelerating voltages used for the operation of the cathode-ray tube, and so, in modern cathode-ray oscillographs, the total accelerating voltage seldom exceeds 3000 or 4000 volts. While this operating voltage is perfectly satisfactory for repetitive phenomena which take a substantial part of the repetitive period to occur, or for transient phenomena of moderate speed, the light output becomes insufficient for observing or recording very-high-speed transients, or repetitive high-speed phenomena which occur in a very small fraction of the repetition period. From data obtained on maximum photographic writing rates for photographic recording¹ and visual observation,² Table I has been compiled, showing

make the use of higher accelerating voltage desirable, such as the cathode-ray projection oscillograph, the electrostatic television tube, and the ultra-high-frequency oscillographic cathode-ray tube. The use of long-persistence screens for visual observation of high-speed and even moderately high-speed transients also requires much higher accelerating voltages, in order to make the brightness of the persistent light sufficient for observation.

There are several factors which, up to the present time, have limited accelerating voltages to low or medium values. In the case of tubes in which all of the accelerating voltage is applied prior to deflection, increase of the accelerating voltage decreases the deflection sensitivity to an extent which makes the deflection

TABLE I
WRITING-RATE LIMITS FOR 5CP TUBES

A. Maximum visual writing rates v_{\max} for single transients (conditions: observation in darkness with dark-adapted eye, automatic beam control).

Tube Type	E_{b2}/E_{b3} voltage	Specified light output—foot-lumens (See footnote 8)	$v_{\max} = a2\pi f_{\max}$	Corresponding f_{\max} (2-centimeter amplitude, peak to peak)
5CP1	1500/3000	7.5	150 kilometers per second = 6 inches per microsecond	2.4 megacycles per second
5CP11	1500/3000	3.5	40 kilometers per second = 1.6 inches per microsecond	640 kilocycles per second

B. Maximum photographic writing rates, v_{\max} rates for single transients.

Tube Type	E_{b2}/E_{b3} voltage		$v_{\max} = a2\pi f_{\max}^{***}$	Corresponding f_{\max} (2-centimeter amplitude, peak to peak)
5CP1	1500/3000	7.5*	6 kilometers per second = 0.24 inch per microsecond	90 kilocycles per second
5CP11	1500/3000	3.5**	25 kilometers per second = 1 inch per microsecond	400 kilocycles per second

* Measured with Weston Type 3 cell corrected for eye sensitivity.

** Measured with uncorrected Weston Type 3 cell.

*** For lens $F=1$, object-to-image ratio $M=1:1$, high-speed orthochromatic film, high-contrast development, automatic beam control. For other values of F and M , the values have to be corrected according to the following formula:

$$V = \frac{4v_{\max}}{F^2 \left(1 + \frac{1}{M}\right)^2}$$

the limiting writing rates for the type 5CP cathode-ray tube operated³ at $E_{b2}=1500$ volts, $E_{b3}=3000$ volts. It is of interest to translate this data into terms of frequency and amplitude of single sinusoidal transients having equivalent maximum writing rates. For photographic recording of a 2-centimeter peak-to-peak trace, the data then shows that the maximum frequencies that can be recorded are 90 kilocycles for a 5CP1 tube, and 400 kilocycles for a 5CP11 tube. Visual observation of single transients under the same conditions is limited to 2.4 megacycles for a 5CP1 tube, and to 640 kilocycles for a 5CP11 tube. This data shows eloquently that an accelerating voltage of 3000 volts is inadequate to take advantage of circuit performance of high-frequency oscillographs. There are additional applications which

amplifier problem extremely difficult. In addition, since it is desirable to have the deflecting plates at ground potential, the cathode must be operated at a high negative potential with respect to ground, and the insulation requirements of the heater transformer become excessive. An even more serious disadvantage is the increasing size, with its attendant large stray capacitance of the grid-coupling capacitor when dynamic grid control is used. The use of standard intensifier-type cathode-ray tubes (such as the 5CP type) permits some increase in accelerating voltage, but these tubes cannot be operated at voltages of 20 or 30 kilovolts since increasing the intensifier ratio⁴ above about 2.3 increases distortion very quickly and limits the useful screen area to a small

⁴ Ratio of intensifier potential to second-anode potential, all potentials being measured with respect to cathode. The second anode is the accelerating electrode of the gun, which is at the same direct-current potential as the deflecting-plate structure and which provides the acceleration of the electrons in the beam prior to deflection. The intensifier electrode or electrodes, sometimes called post-accelerating electrodes, provide acceleration after deflection.

¹ Rudolph Feldt, "Photographing patterns on cathode-ray tubes," *Electronics*, vol. 17, pp. 130-138; February, 1944.

² Unpublished.

³ All potentials referred to in this paper are with respect to the cathode of the cathode-ray tube, unless otherwise indicated.

barrel-shaped fraction, as shown in Fig. 1, for the case of a Type 5CP tube operated at a 10:1 ratio.

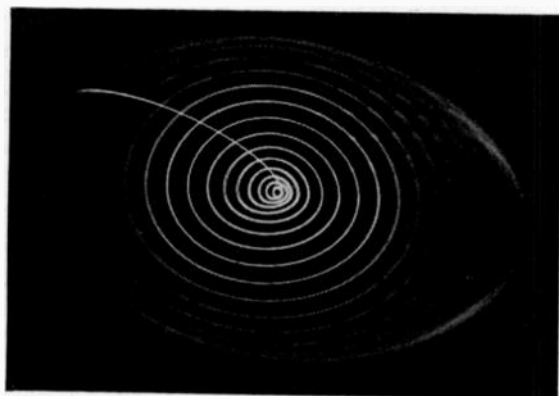

Fig. 1—Pattern distortion and limitation of useful screen area of a type 5CP cathode-ray tube at 10:1 intensifier ratio.

It should be mentioned in this connection that equally as important as deflection sensitivity is what Pierce⁵ has called deflection sensibility; that is, the reciprocal of the deflecting voltage required to move the spot one spot diameter on the screen. Deflection sensibility is a measure of the resolving sensitivity of the cathode-ray tube. Since the spot diameter of intensifier-type tubes decreases with increasing intensifier voltage to a greater extent than the deflection sensitivity, the deflection sensibility increases. This is an important property of the intensifier tube, because it means that, with increasing voltage and with the same operating conditions of the electron gun, the intensifier tube resolves as many details of a pattern with a given amount of deflecting voltage as at low accelerating voltage, or even more, but with a somewhat reduced size of the oscillogram. The absolute value of the pattern size, within reasonable limits, is of secondary importance for most of the applications for which the multiband tube is intended, since it can be compensated by optical enlargement of the recorded or projected picture. The size of the spot is further reduced if, with the additional intensifier potential, it is possible to reduce the beam current delivered by the gun. Another factor which has discouraged the use of high accelerating voltages is the widespread belief that, with increased voltage, the danger of screen burning augments. It will be shown later that this fear is not justified.

With these considerations in mind, the design of a new tube was undertaken to meet the following basic specifications:

1. Light output to be sufficient for use as a projection tube and for visual and photographic recording of high-frequency transients (total accelerating voltage to be greater than 10 kilovolts).

2. Accelerating voltage prior to deflection to be low, so as to have sufficient deflection sensitivity to avoid the circuit problems outlined above, and to afford the pos-

sibility of using the tube with existing equipment.

3. Tube to be of intensifier type and capable of operating at intensifier ratios as high as 10:1, in order to satisfy requirements 1 and 2, above.

4. Deflection sensibility not to decrease as intensifier voltage is increased, and preferably to increase.

5. Deflecting-plate capacitances and inductances to be minimized, in order to facilitate high-frequency operation, by the use of direct deflecting-plate connections through the neck.

6. For high-frequency operation where transit time is a limiting factor, or for cases where extremely high brightness is desired, second-anode voltages up to about 3.5 kilovolts to be applicable.

7. A flat or nearly flat screen to be provided in order to increase the accuracy of reading and to minimize the lens problem for photographic recording and projection.

8. Danger of screen burning not to be unduly high.

9. Dimensions to conform with existing tube types insofar as possible in order to facilitate its use in existing equipment.

10. Design to be such that the tube can be manufactured readily and utilized conveniently, so as to make it a valuable tool.

DESIGN CONSIDERATIONS

Intensifier Distortions

In the past, operation of intensifier-type cathode-ray tubes with ratios of intensifier potential to second-anode potential much in excess of 2:1 has not been feasible. As the ratio increases much above this value, distortions occur as discussed in the following paragraphs.

- (1) When the intensifier field extends into the region of the deflecting-plate structure, its symmetry is disturbed and astigmatism results (Fig. 2). Distortion of the shape of the deflection pattern under this condition has also been reported.⁶ For a given tube structure this distortion becomes worse with increasing intensifier potential, since the intensifier field penetrates further into the deflecting-plate region. This type of distortion is avoided in the new tube by beginning the first intensifier gap at a sufficient distance from the end of the deflecting plates, by shaping the bulb so as to shield the deflecting plates from the intensifier field, and by applying the intensifier potential gradually over the length of the bulb body.

- (2) Because the intensifier field has a convergent lens action, a deflected beam is bent toward the axis as it passes through. Therefore, in order to obtain a given amount of deflection at the screen, more deflection of the beam must be produced by the deflecting plates than would be the case if there were no intensifier. Since distortion of the spot always occurs as a result of deflection, and becomes increasingly worse as the deflection is increased, it follows that the presence of the intensifier causes additional distortion. This distortion is minimized

⁵ J. R. Pierce, "After-acceleration and deflection," Proc. I.R.E., vol. 29, pp. 28-32; January, 1941.

⁶ J. deGier, "A cathode-ray tube with post-acceleration," Philips Tech. Jour., vol. 5, pp. 245-252; September, 1940.

by suitable design of the deflecting-plate structure, by keeping the electron-beam diameter to a minimum, and by designing the intensifier-electrode arrangement to minimize its lens action.

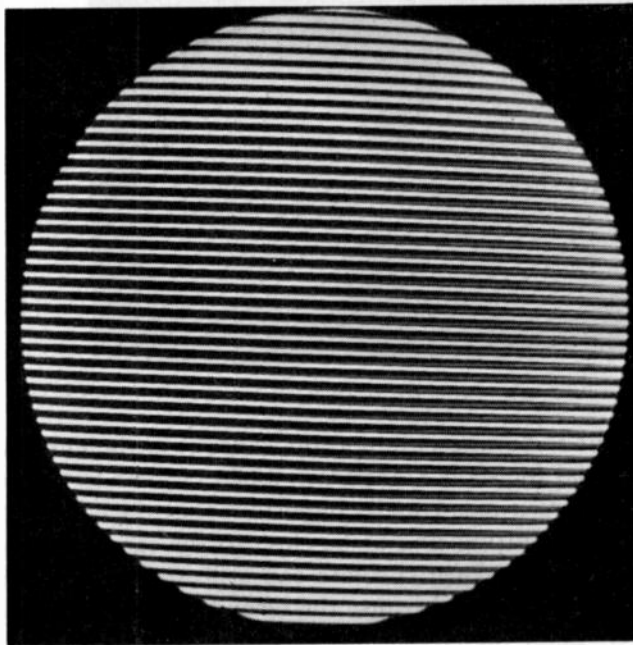

(a) Pattern on which lines were focused.

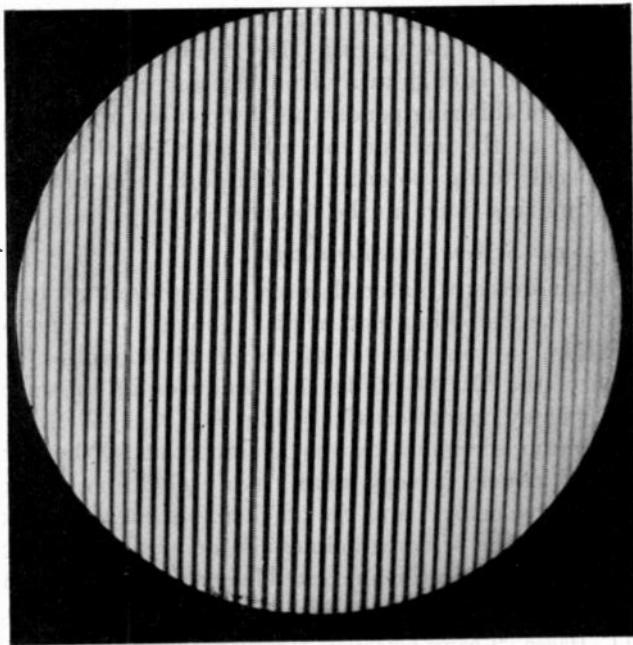

(b) Deflecting-plate connections reversed.

Fig. 2—Astigmatism due to deflecting plates impairing symmetry of intensifier field.

(3) A third type of distortion results from nonuniform strength of the intensifier-lens action for different amounts of deflection. This condition usually becomes very bad if the beam is deflected into the strongly curved fields close to the bulb wall at the intensifier gap or gaps. It may become so excessive as to prevent deflection beyond a certain amplitude on the screen, and even to

bend the beam back toward the center of the screen as a result of further deflecting voltage. This condition is illustrated by Fig. 1. This type of distortion is avoided by keeping the beam at a maximum distance from the edges of the intensifier fields, and by gradual application of the intensifier voltage. For this reason, a cylindrically shaped bulb body is used in the new tube.

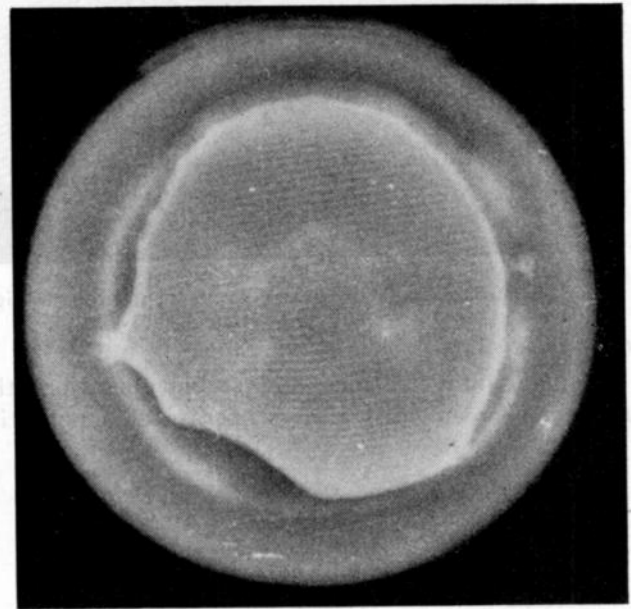

Fig. 3—Pattern distortion due to intensifier contact protruding into the interior of the cathode-ray tube.

(4) In high-voltage tubes, distortions occur very readily as a result of unsymmetrical shapes in the intensifier region and uncontrolled and haphazard charge distributions on the tube walls, if preventive precautions are not taken. As an example, the result of a contact lead extending into an intensifier field is illustrated by Fig. 3.

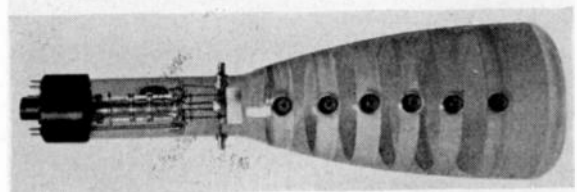

Fig. 4—Developmental high-voltage intensifier-type tube with five intensifier steps.

Prevention of Distortions in the Multiband Tube

The first step taken toward eliminating these difficulties was to divide the intensifier into several steps (see Fig. 4). It was found that approximately equal voltage steps gave best results, and that the useful pattern size for large intensifier-voltage ratios was substantially increased, as compared to a standard 5CP type tube (see Fig. 5). Further application of the principles outlined above resulted in the final type 5RP tube with cylindrically shaped body, as shown in Fig. 6.

Fig. 7 shows a pattern obtained with the tube of Fig. 6 operating at a 10:1 intensifier-to-second-anode voltage

ratio. The improvement over the standard 5CP tube, operating at approximately this ratio (see Fig. 1) is apparent.

through the glass by bringing the end of the final accelerating ring as close as possible to the screen, or even into contact with it. The potential of the screen, when no

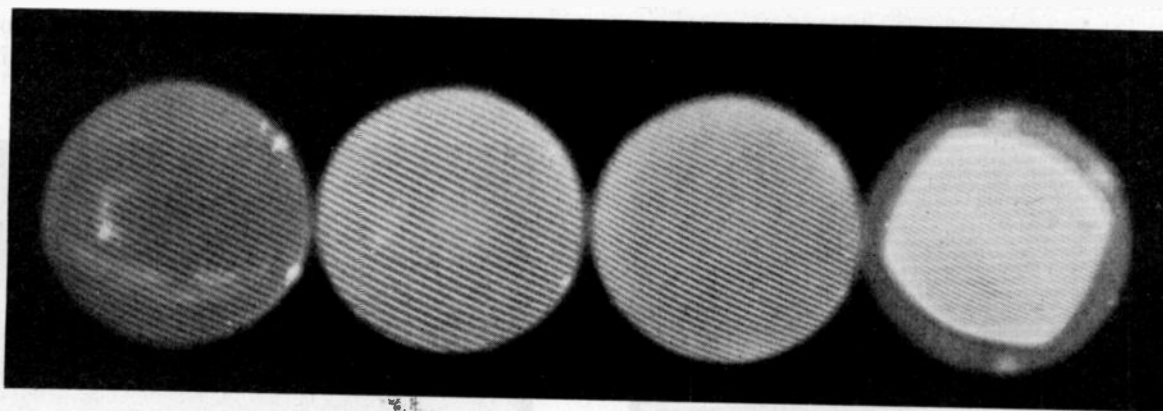

Fig. 5—Patterns obtained with the developmental tube of Fig. 4 at intensifier ratios (from left to right) of 1:1, 3:1, 5:1, and 11:1.

Design of the Final Accelerating Ring

For maximum efficiency and stable operation, the fluorescent screen must always operate at a potential

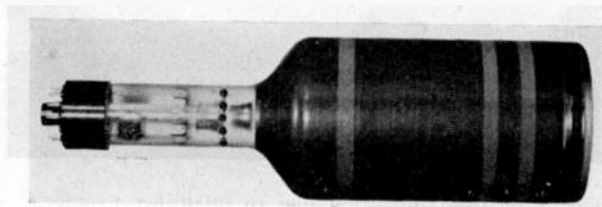

Fig. 6—Type 5RP multiband tube.

close to the final applied accelerating potential. When no current is flowing to the screen, the screen arrives at an equilibrium potential as a result of electrical conduction.

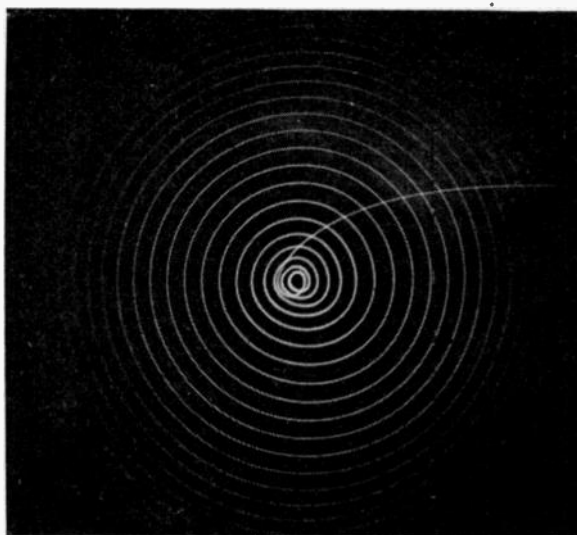

Fig. 7—Pattern obtained with a type 5RP tube operated at 10:1 intensifier ratio.

When current is flowing to the screen, the screen potential is determined primarily by the potential to which the electrons of the beam are brought before striking it, and by the secondary emissive properties of the screen. In the first case, it is important to minimize the effects of extraneous leakage over the outside surface and

current is flowing is important, since it is the effective potential for short transients. When current is flowing to the screen it is equally important that the end of the final accelerating ring be as close to the screen as possible, since leakage currents can still upset the screen potential and also because the secondary-emission characteristic of the screen may be improved, under certain conditions, by the proximity of the final accelerating electrode.⁷

On the other hand, it is important that the beginning of the final accelerating ring (the edge farthest from the screen) be far enough away from the screen so that the influence of this ring penetrates sufficiently to bring the potential at the axis of the tube substantially to the final accelerating potential. Therefore, the final accelerating ring must not be too narrow.

Fluorescent Screen Considerations

The fluorescent materials used in high-voltage tubes must have "sticking potentials" above the range of operation, in this case in excess of 25 kilovolts. The screen of the 5RP11 fulfills this condition as shown by the efficiency characteristic⁸ of Fig. 8.

Optimum screen thickness is important. When the screen thickness is very small, many electrons do not hit an active center, and the efficiency is low. If, on the other hand, the screen thickness is too great, too much light is absorbed in the unexcited layer of the screen, and the efficiency again is low. Between these two conditions

⁷ C. Hagen, "Charge potentials, secondary emission, and fatigue effects of electron bombarded metals and luminescent materials," *Phys. Zeits.*, vol. 40, pp. 621-640; October, 1939.

⁸ The standard RMA method of measurement of the visual efficiency of cathode-ray-tube screens is to measure the visual brightness of a 2-by-2-inch raster. The problem of evaluating and specifying photographic efficiency of a cathode-ray-tube screen in a universal and practical manner is more difficult. The ideal method would be to measure the energy radiated with a photocell having the same spectral response as the film to be used. Standardization on such a method obviously requires that a standard film spectral response be assumed; but unfortunately the films in use have widely different spectral characteristics. A compromise method is in use at the present time which has been found to give a reasonably good correlation with actual photographic efficiency for orthochromatic films. This method is to use a photocell having the spectral response of a standard Weston Type 3 cell, without visual sensitivity correction, and calibrated in foot candles with a light source having a color temperature of 2700 degrees kelvin.

an optimum exists. As the voltage is increased, the electrons penetrate farther into the interior of the screen (the penetration increases with the square of the accelerating voltage⁹), and the optimum screen thickness increases accordingly.

Considerable work has been done by one of the authors to determine the best screen material for visual observation and photographic recording of high-speed transients.¹ For visual observation over the ordinary range of writing rates, the P1 screen is most efficient. At speeds where the excitation time of each screen element is only a fraction of 1 microsecond, the efficiency of a screen material depends upon how fast and to what level it builds up and how slowly it decays. There is some evidence to indicate that at extremely high writing rates the blue P11 screen becomes more efficient visually than the P1. This question is under investigation at the present time.

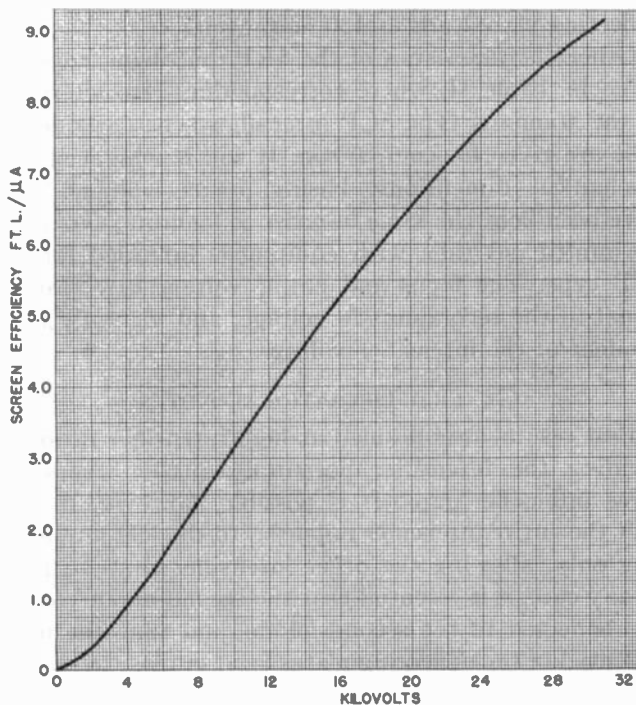

Fig. 8—Efficiency of P11 screen versus voltage at 10 microamperes screen current.

Numerous measurements carried out in the Allen B. DuMont Laboratories show that, for any pulse duration and repetition rate, the blue sulphide screens (now designated as P11) are very much more efficient photographically than the blue tungstate screens (designated as P5). For the most recently developed sulphides the difference is as much as 10:1. On the other hand, sulphide screens have a slightly longer decay than tungstate screens. This is of importance for recording with high-speed, continuous-motion cameras. Most recent tests show that no objectionable blurring occurs for recording of frequencies up to 200 kilocycles per second with the sulphide screens.

Very little has been published about "screen burning."

⁹ H. W. Leverenz, "Problems concerning the production of cathode-ray-tube screens," *Jour. Opt. Soc. Amer.*, vol. 27, pp. 25-35; January, 1937.

Essentially, two forms of burning by electron bombardment exist. One is characterized by blackening of the screen material and occurs at medium energy levels. The other takes place at high energy concentrations, and the screen material simply disintegrates and vaporizes. The two phenomena will be referred to as "screen burning" and "screen disintegration," respectively. The opacity increase due to electron bombardment (screen burning) is generally explained as resulting from the elimination of metal atoms from the crystal lattice and their deposit on the screen surface, forming thereby a metallic opaque layer. In the second case, the heat developed by bombardment becomes so high that the screen material vaporizes.

Since the energy of the electrons increases with accelerating voltage, increased danger of screen burning might be expected at high voltages. Numerous measurements and observations carried out in this laboratory have shown that the contrary is true. While at anode voltages of 1000 volts and below screen burning occurs nearly immediately, no burn, or only one of less intensity, is observed when the screen is bombarded at the same current density but at an anode voltage of 10 or 20 kilovolts. This may be explained by the greater depth of penetration of the electrons, which increases with the square of the acceleration voltage, while for constant current the energy of the electrons is directly proportional to the accelerating voltage. Consequently, with constant current and increasing voltage, the energy per unit volume of screen material decreases. It is also likely that the temperature increase in the interior of the screen material favors an effect of regeneration by recombination and migration of the metal atoms.

In certain cases, darkening has been observed under high-voltage, high-intensity bombardment. In these cases it was found that the change was in the transparency of the glass rather than in the screen material.

Additional Design Considerations

To simplify the lens problems for photographic recording and projection, and to increase accuracy of measurements, a flat face is desirable and has been provided. It is also a well-known fact that a flat face increases contrast.

It was found that, when cathode-ray tubes were operated at voltages of the order of 10 kilovolts, much trouble was experienced with leakage across the outside surface of the glass. This condition was eliminated by the application of a special nonhygroscopic matte varnish over the outside body of the tube.

To minimize circuit problems for high-frequency deflection, the deflecting-plate leads are brought directly through the neck, rather than through the base. The necessity of crossing leads in equipment is avoided by locating the two terminals of each deflecting-plate pair adjacent to each other. The second-anode connection is brought to a terminal between the two pairs of deflecting-plate terminals, so as to provide a short high-frequency ground connection and to improve insulation (see Fig. 6).

OTHER CHARACTERISTICS OF THE MULTIBAND TUBE

Deflection sensitivity is inversely proportional to the second-anode potential (or to the intensifier potential) so long as the ratios of potentials applied to the second anode and to all the intensifier electrodes are kept constant. The curves of Fig. 9 show how the deflection

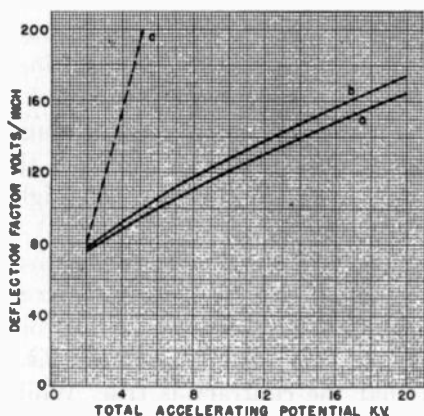

Fig. 9—Deflection factor versus total accelerating potential (a) for deflection-plate pair of 5RP tube nearer gun with $E_{s2} = 2000$ volts and E_{s3} varied; (b) for deflection-plate pair of 5RP tube nearer screen with $E_{s2} = 2000$ volts and E_{s3} varied; (c) for similar nonintensifier-type tube with E_{s2} varied.

factor (reciprocal of sensitivity) varies with intensifier-potential ratio, for the condition of equal division of potential across the three intensifier gaps.

Also shown for comparison is the variation in deflection factor which would occur in a tube similar to the multiband tube, with the same variation in over-all accelerating potential, if it were applied to the second anode instead of to intensifier electrodes.

The effect of added intensifier potential on spot size has been studied by many observations and photographs. The fact that the spot of a conventional type of cathode-ray-tube gun is not sharply defined makes reliable evaluation of spot size very difficult. However, it can be said that visual and photographic observations definitely confirm the analytically derived conclusions that the decrease in spot size as intensifier potential is increased may be expected to be greater than the decrease in deflection sensitivity.⁵ This means that the resolution sensitivity of the tube, which is determined by the ratio

of deflection sensitivity to spot size, is actually improved by the addition of intensifier voltage, rather than being reduced.

The maximum frequencies at which the 5RP can be used will be determined primarily by transit-time limitations and resonance effects in leads to the deflecting plates. At a second-anode voltage of 3500 volts, the first zero-deflection frequency is computed to be of the order of 2000 megacycles, and the deflection will be reduced 10 per cent at about 500 megacycles. Transit time between deflecting-plate pairs, which causes a phase difference between presentations of signals applied to the two deflecting-plate pairs, is about 0.7×10^{-9} second, which will cause a 10 per cent phase shift at a frequency of about 140 megacycles. When the terminals of a deflecting-plate pair are short-circuited by the shortest possible heavy braid connection, the resonance of the circuit formed occurs at 500 megacycles. A 5 per cent voltage drop occurs across the inductance of the deflecting-plate leads at 130 megacycles.

Other characteristics of the 5RP multiband tube are given in Table II, where corresponding characteristics of the standard type 5CP intensifier-type cathode-ray tube are given for comparison. It will be observed that mechanical dimensions, basing, focus, voltage, etc., have been kept the same in order to facilitate the use of the multiband tube with equipment intended for the 5CP type. The focus and cutoff voltages are proportional to the second-anode voltage, and virtually independent of the intensifier voltage.

GENERAL OPERATIONAL NOTES

Best results are obtained at high intensifier ratios by dividing the intensifier potential equally across the three intensifier gaps. It is possible, however, to connect the entire intensifier potential to the last intensifier ring only, allowing the other intensifier rings to float. In any case, it is essential that the second-anode coating be connected to the second anode, and that the mean potential of the deflecting plates be at or close to second-anode potential.

In order to prevent leakage through the glass from depressing the potential in the intensifier and screen region, the tube should preferably be held by a support

TABLE II
Mechanical and Operating Characteristics of the 5RP Cathode-Ray Tube and Comparison with 5CP Cathode-Ray Tube

	5RP		5CP
Heater	6.3 volts, 0.6 ampere		6.3 volts, 0.6 ampere
Over-all length	16 3/4 inches		16 3/4 inches
Body diameter	5 1/4 inches		5 1/4 inches
Basing	Diheptal base, same RMA basing as 5CP cathode-ray tube except deflecting-plate and second-anode connections omitted.		14B
<i>Typical Operation*</i>			
Anode No. 3 voltage (E_{s3})	10,000 volts	20,000	4000 volts
Anode No. 2 voltage (E_{s2})	2000 volts	2000	2000 volts
Anode No. 1 voltage (E_{s1})	575 volts	575	575 volts
Grid cutoff voltage (E_{co})	-60 volts	-60 volts	-60 volts
Deflection sensitivity			
D_1D_2	0.20 millimeter per direct-current volt	0.15 millimeter per direct-current volt	0.28 millimeter per direct-current volt
D_2D_3	0.20 millimeter per direct-current volt	0.15 millimeter per direct-current volt	0.32 millimeter per direct-current volt

* Experience has shown that it is possible to operate the tubes at much higher voltages than those given here.

near the face which is at the final-intensifier potential, and the face and body of the tube should not come into contact with grounded parts. Careful protective insulation and grounding is, of course, essential.

For both photographic recording and visual observation of transients, it is essential that beam control be used, so that the beam is turned off except during the period in which the transient occurs. Otherwise, stray illumination will fog the negative or reduce the sensitivity of the eye.

The spot must never be allowed to remain stationary on the screen when operating the tube at high intensities, since the large energy in the beam will disintegrate the screen.

In addition to the obvious need for precautions to avoid contact with high voltages, it must also be kept in mind that there may be x-ray radiation at voltages of 20,000 volts and higher, and that most of the cathode-ray-tube screens radiate a very considerable amount of ultraviolet energy. Persons viewing cathode-ray tubes operating at the high intensities possible with the multiband tube for any appreciable length of time should use suitable goggles to protect the eyes against ultraviolet radiation, and when tubes are used at voltages over 20,000 volts protection against X-rays should be provided.

~ APPLICATIONS

Projection Oscillograph

The usefulness of enlarging and projecting the oscillographic pattern for lectures in classrooms and larger auditoriums is obvious.

An attempt was made in this direction by Allgemeine Elektrizitäts-Gesellschaft in Germany, which provided an oscillograph and projection adaptor operating at an accelerating potential of about 6000 volts. The higher practicable operating voltages of the new multiband tube greatly extend the possibilities of this type of device.

The intensifier voltage required for projection depends on the size of the auditorium. It has been found that, with 1500 volts on the second anode and 15,000 volts on the intensifier (operation in DuMont Type 247 oscillograph with auxiliary high-voltage power supply), the brightness is sufficient even for fairly large auditoriums. (It is important to note that, despite the high final accelerating voltage, the deflection sensitivity is sufficient for use with a standard oscillograph.) The P1 screen is the most suitable for projection. The high-voltage intensifier supply should deliver a total current of about 200 microamperes (including the voltage divider). Rectified radio-frequency power supplies similar to those described by Schade¹⁰ are very satisfactory and economical.

Relatively simple and moderately corrected projection lenses of high light transmission should be used in order to obtain maximum screen brightness. For the

¹⁰ O. H. Schade, "Radio-frequency-operated high-voltage supplies for cathode-ray tubes," *Proc. I.R.E.*, vol. 31, pp. 158-163; April, 1943.

same reason, directive projection screens (beaded screens) should be used whenever possible.

Observation and Recording of High Speed Transients

The most important application of the multiband tube is visual observation and photographic recording of transient phenomena beyond the range covered by standard low-voltage tubes (see Table I). Successful recording of single transients of high writing rates (100

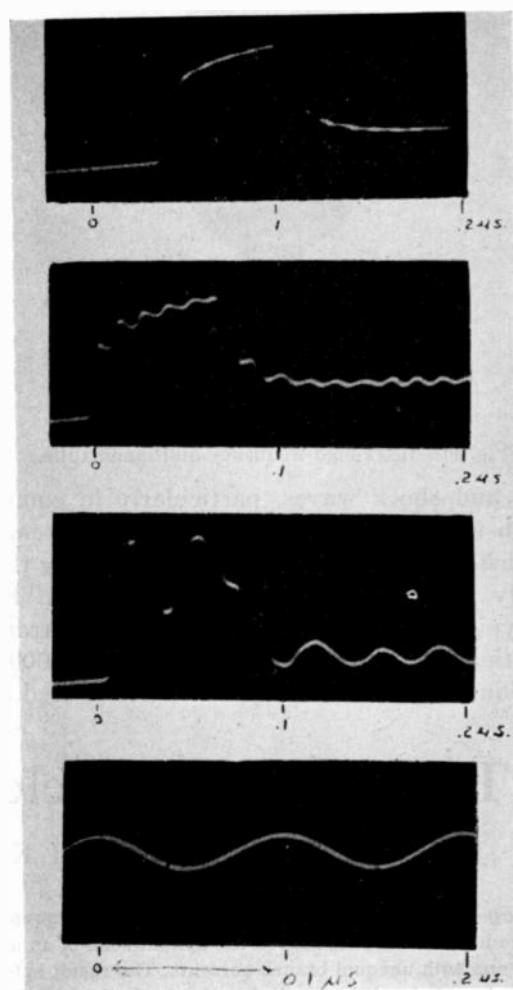

Fig. 10—Typical high-speed single transient recordings with 5RP11 tube at 18,000 volts. (Courtesy of Professor M. Newman, Institute of Technology, University of Minnesota.)

inches per microsecond or more) requires some photographic skill and careful selection of all the components.¹

Excellent photographic results have been obtained with the 5RP11 tube. For instance, with a total accelerating voltage of 25 kilovolts, an $f/1$ lens, and an image reduction of 5:1, a maximum photographic writing rate of 400 inches per microsecond, or 10,000 kilometers per second, has been recorded. This is particularly interesting since it is equivalent to, or better than, the results published for recent continuously pumped, cold-cathode oscillographs which operate at higher voltage (50 kilovolts) and require a much greater complement of accessories than a sealed-off tube. It also shows that, because of the development of very efficient screen materials, better results are now obtained by external photography than by direct electron bombardment of the

photographic emulsion in vacuum. The results obtained with the 5RP11 tube make it possible to use the hot-cathode, sealed-off cathode-ray tube in the field of surge



Fig. 11—Ultra-high-frequency multiband tube.

voltages and shock waves, particularly in connection with high-voltage lines and power-plant maintenance, a field which heretofore was primarily served by the continuously pumped, cold-cathode oscillograph. Fig. 10 shows typical high-speed recordings of single transients made with a total accelerating potential of 18,000 volts. A 35-millimeter camera with $f/1.5$ lens was used. These

photographs were made by Professor M. Newman at the University of Minnesota.

Visual Observation

Very-high-speed transients can be observed visually; for instance, writing rates of 100 inches per microsecond (2500 kilometers per second) for single transients could be observed with a 5RP11 tube and 15-kilovolt total accelerating voltage. For phenomena of lower speed, better light output will be obtained with 5RP1 tubes. In the case of long-persistent screens, considerable increase of persistence and light output is obtained by the use of 5RP2 and 5RP7 tubes.

Ultra-High-Frequency Cathode-Ray Tube

It is indicated that the frequency limit for useful operation of the 5RP tube is around 100 megacycles. Since the 5RP tube is able to produce light output sufficient for the recording and observation of frequencies above this limit, the application of the multiband principle to the design of ultra-high-frequency cathode-ray tubes is suggested. Special multiband tubes have been designed with a deflection system built for operation at 1000 megacycles using coaxial connections to the deflecting plates (see Fig. 11).

Additional References

- (1) E. Schwartz, "On the post-acceleration problem in cathode-ray tubes," *Fernseh. Mitt.*, vol. 1, pp. 19-23; December, 1938.
- (2) A. Bigalke, "Quadruple-beam cathode-ray tube of high recording speed," *Arch. für Elek.*, vol. 33, pp. 107-117; February, 1939.
- (3) W. Rogowski and H. Thielen, "On post-acceleration in cathode-ray tubes," *Arch. für. Elek.* vol. 33, p. 441; June, 1939.
- (4) P. S. Christaldi, "Cathode-ray tubes and their applications," *Proc. I.R.E.*, vol. 33, pp. 373-381; June, 1945.

The Radiation Field of an Unbalanced Dipole*

WILLIAM KELVIN†, ASSOCIATE, I.R.E.

Summary—A method is described for obtaining the expression for the magnitude of the electric field in the distant zone of an ordinary dipole antenna with unequal branch currents. The result is found to involve two functions of the vertical angle, both of which have appeared separately in previous literature.

Useful plots of each of these functions in terms of a parameter h are included. Curves for the magnitude of the distant-zone electric field are plotted in terms of two parameters h and k . Illustrative field patterns are obtained experimentally and are plotted for common dipole lengths.

INTRODUCTION

IN AN earlier paper,¹ Harrison and King describe the distant electric field for the symmetrical dipole with equal branch currents. In this investigation of the distant electric-field patterns for the case of un-

equal branch currents in a symmetrical dipole, the method of the above-mentioned reference paper is followed.

By separation of the steps of integration over the two halves of the antenna, one arrives at an expression for the distant field in the unbalanced case. One now has a family of curves, with magnitude of the electric field plotted against the vertical angle, for each curve plotted in the reference paper. These families are formed by the presence of the additional parameter k , which is herein defined as the ratio of the magnitudes of the branch currents at the driving point.

The experimental curves of Fig. 10 were run with a klystron generating a frequency of 3000 megacycles. A combination coaxial and parallel-wire feeder was used to drive moderately thin dipoles, cut to integral multiples of a quarter wavelength. Effective antenna lengths differed somewhat from these nominal values.²

* Decimal classification: R121. Original manuscript received by the Institute June 7, 1945; revised manuscript received, March 1, 1946.

† Federal Telecommunication Laboratories, Inc., New York, N. Y. Work covered in this paper comprises a portion of the graduate research of the author while at Cruft Laboratory, Harvard University Graduate School of Engineering.

¹ Charles W. Harrison, Jr., and Ronald King, "The radiation field of a symmetrical center-driven antenna of finite cross section," *Proc. I.R.E.*, vol. 31, pp. 694-697; December, 1943.

² Ronald King, "The approximate representation of the distant field of linear radiators," *Proc. I.R.E.*, vol. 29, pp. 461-462; August, 1941.

THE DISTANT ELECTRIC FIELD

For the symmetrical center-driven antenna, the distant electric field is calculated using the relation

$$E_{\theta r} = \frac{j\omega I_0 e^{-i\beta R_0}}{4\pi R_0} \int I_{z'} e^{i\beta z' \cos\theta} \sin\theta dz' \quad (1)$$

Integration is carried out over the length of the antenna, making use of the following notation:

$E_{\theta r}$ = the electric field in the distant or radiation zone of the antenna, in volts per meter.

$\omega = 2\pi$ multiplied by the frequency.

Π = the magnetic constant of space given numerically by $\Pi = 4\pi \times 10^{-7}$ henry per meter.

β = the propagation constant in radians per meter, and equals $2\pi/\lambda$, where λ is the wavelength.

R_0 = the distance from the point of field calculation in the distant zone to a convenient reference origin O at the center of a center-driven antenna or at the base of a vertical base-driven antenna over a perfectly conducting half space.

$I_{z'}$ = the complex current amplitude in amperes flowing in the element dz' .

z' = the distance from the reference origin at the center of the antenna to the element dz' .

R_0 , θ and ϕ form a set of spherical co-ordinates with origin at O . ϕ does not appear in (1) because rotational symmetry obtains.

h = the half length of the antenna of total length $2h$.

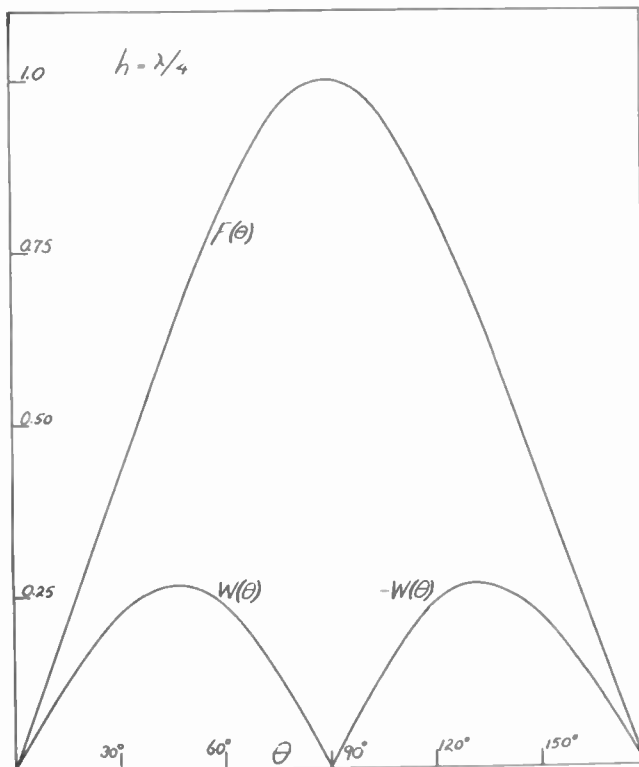

FIG. 1

Π , in radians, is numerically equal to the product βh .

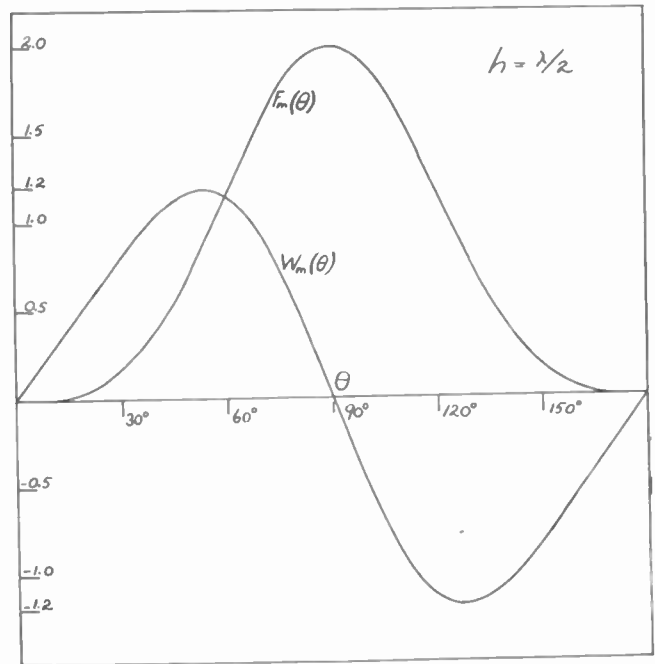

FIG. 2

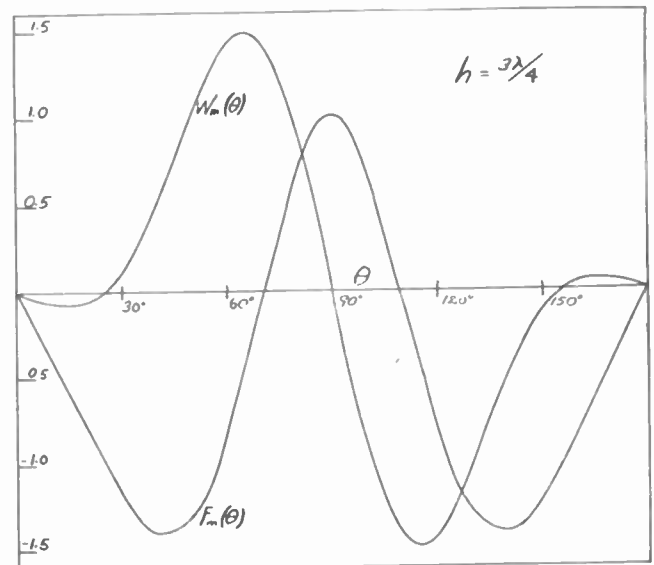

FIG. 3

The current distribution may be assumed to be of the following form:

$$I_{z'} = I_m \sin \beta(h - |z'|) \quad \text{for } -h \leq z' \leq h \quad (2)$$

and where

$$I_m = \frac{I_0}{\sin H}$$

Thus the expression for $E_{\theta r}$ becomes

$$E_{\theta r} = \frac{j\omega I_0 e^{-i\beta R_0}}{4\pi R_0} I_m \sin\theta \int_{-h}^h \sin \beta(h - |z'|) e^{i\beta z' \cos\theta} dz' \quad (3)$$

As the origin is approached, let the currents in the two branches be I_{01} and I_{02} , respectively. Noting that $|z'| = z'$ for $0 \leq z' \leq h$, and that $|z'| = -z'$ for $-h \leq z' \leq 0$, the electric field is evaluated

$$E_{\theta} = \left[j30 \frac{e^{-j\beta R_0}}{R_0} \right] \left[(I_{01} + I_{02}) \left(\frac{\cos(H \cos \theta) - \cos H}{\sin H \sin \theta} \right) \right.$$

$$\left. + j(I_{01} - I_{02}) \left(\frac{\sin(H \cos \theta) - \sin H \cos \theta}{\sin H \sin \theta} \right) \right]. \quad (4)$$

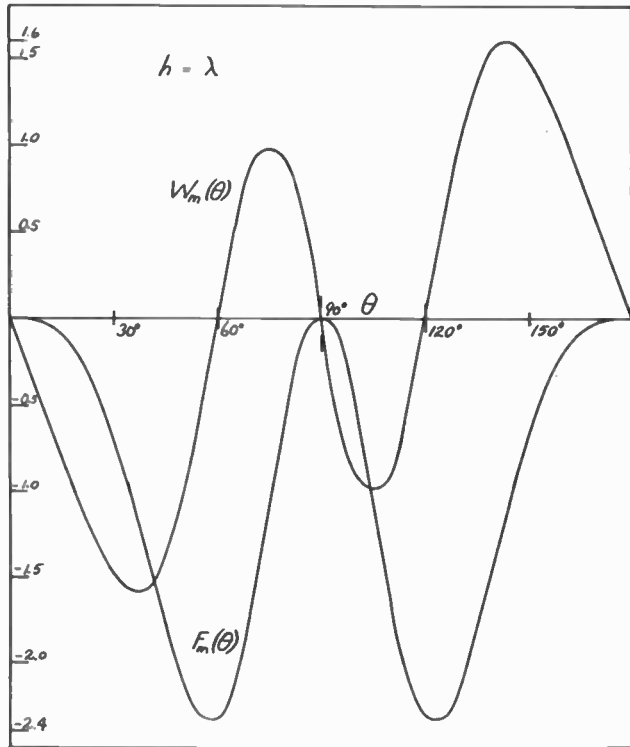

FIG. 4

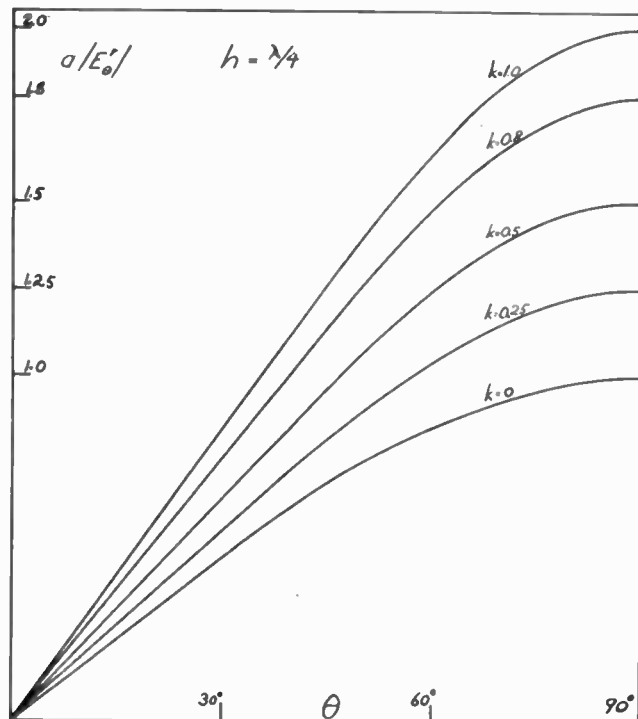

FIG. 5

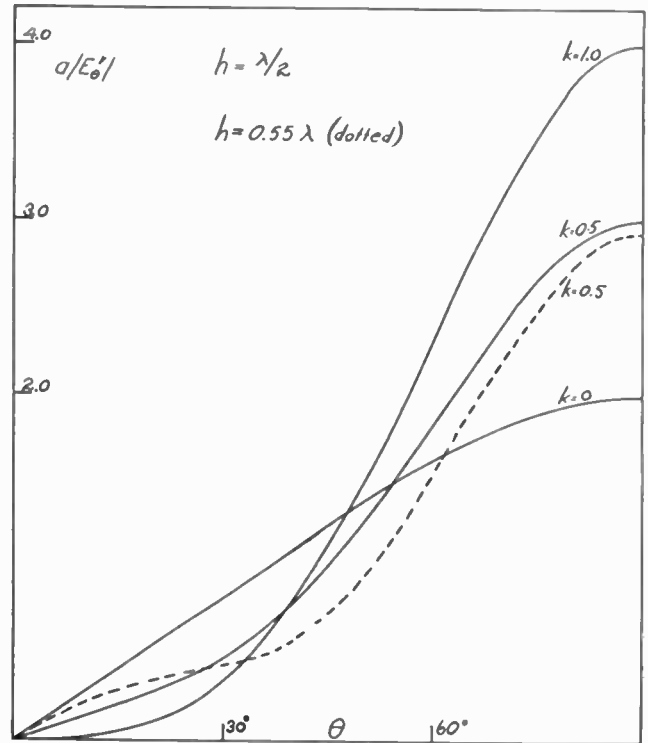

FIG. 6

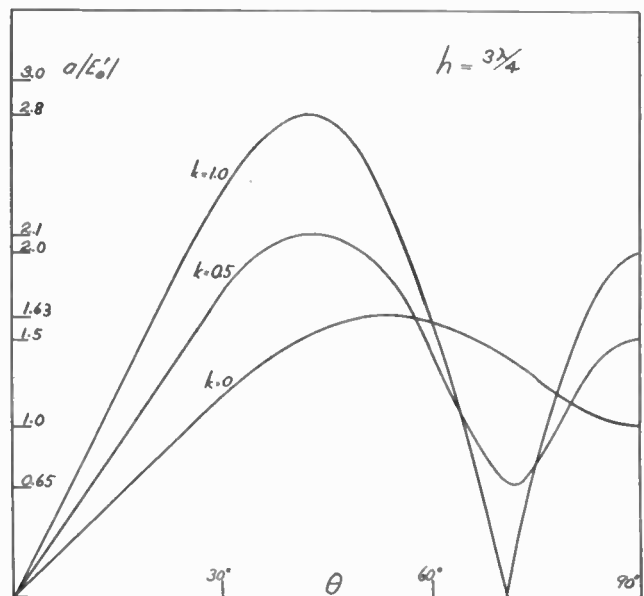

FIG. 7

Here we have two functions of θ :

$$F_0(\theta) = \frac{\cos(H \cos \theta) - \cos H}{\sin \theta \sin H}$$

$$W_0(\theta) = \frac{\sin(H \cos \theta) - \sin H \cos \theta}{\sin \theta \sin H}$$

so that

$$E_{\theta}^r = \left[j30 \frac{e^{-j\beta R_0}}{R_0} \right] [I_{01}(F_0(\theta) + jW_0(\theta)) + I_{02}(F_0(\theta) - jW_0(\theta))]. \quad (5)$$

Let $k = I_{02}/I_{01}$, and, writing simply I_0 for I_{01} , we have

$$E_{\theta}^r = AI_0 [F_0(\theta)(1 + k) + jW_0(\theta)(1 - k)] \quad (6)$$

where $A = j30(e^{-j\beta R_0}/R_0)$, and $0 \leq k \leq 1$.

In terms of magnitude, we have

$$|E_{\theta}^r| = AI_0 \sqrt{\{F(\theta)(1 + k)\}^2 + \{W(\theta)(1 - k)\}^2} \quad (7)$$

THE CURVES

Figs. 1, 2, 3, and 4 are useful plots of the functions $F(\theta)$ and $W(\theta)$. Reference is made to the maximum branch current I_m for $h > \lambda/4$.

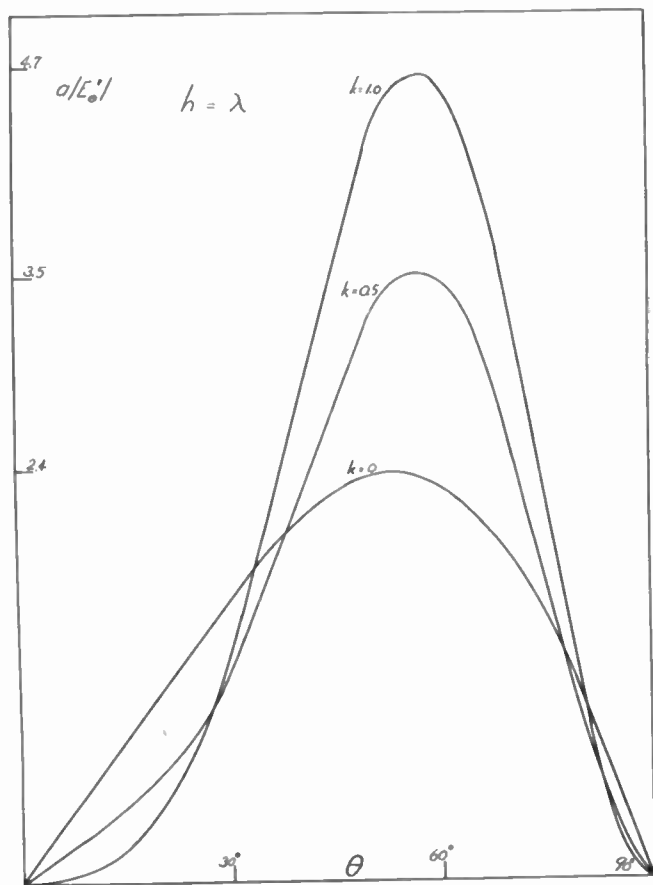

FIG. 8

Figs. 5, 6, 7, 8, and 9 are plots of the quantity

$$\sqrt{\{F(\theta)(1 + k)\}^2 + \{W(\theta)(1 - k)\}^2} = a |E_{\theta}^r|$$

where a is a constant of proportionality. $k = 1$ yields the curve for the symmetrically fed antenna, investigated previously¹ and repeated here for comparison.

The curves of Fig. 10 are plots of detector current versus vertical angle, θ , for the indicated length of transmitting antenna, with the parameter k not found.

A receiving symmetrical dipole of length $h < \lambda/4$ was used, in combination with a crystal detector, to measure field strength in the distant zone. The receiving an-

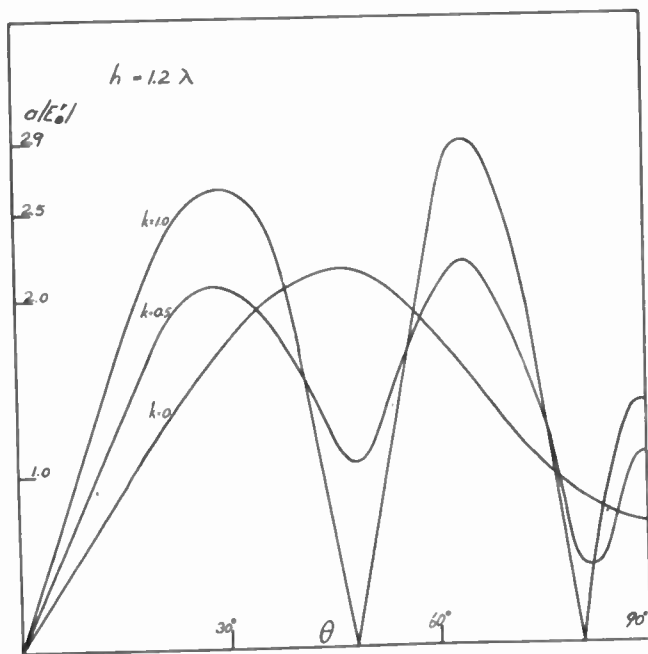

FIG. 9

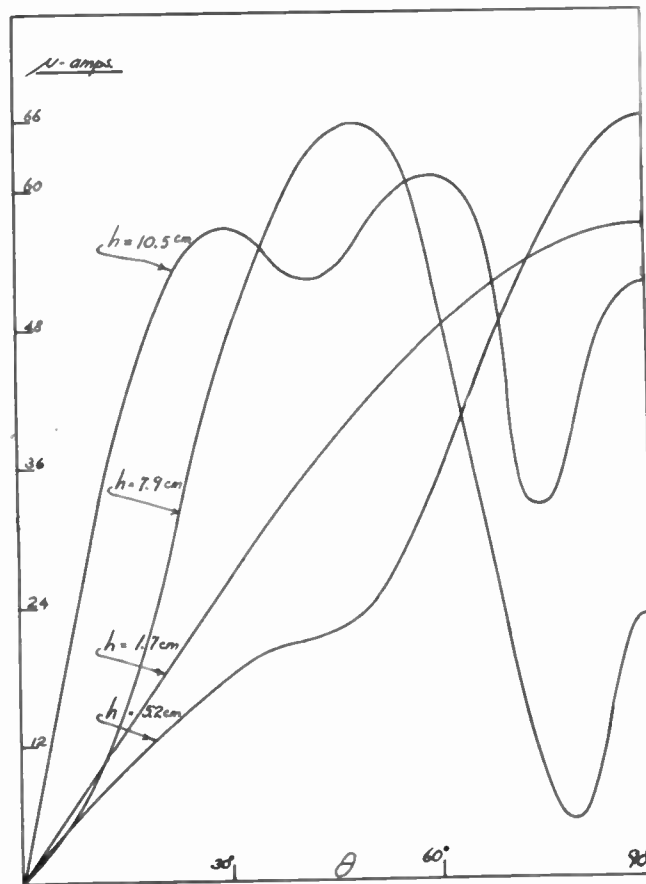

FIG. 10

tenna being in a plane parallel to that of the rotating transmitter, the detector current (corrected according

to a calibration curve for the particular crystal used) will be proportional³ to $|E_{\theta}|$.

CONCLUSIONS

Need for a knowledge of the distortion in the far-zone field pattern, as introduced by the unbalance of branch currents, is widely recognized. At the extremely short wavelengths, current symmetry is a condition obtained only with great effort and patience.

It is shown here that branch-current inequality affects the magnitude of the distant field strength for all lengths of transmitting antenna, and that, for half-lengths greater than a quarter wavelength, the shape of the field pattern also is appreciably altered.

Note that the case of $h=\lambda$, $k=0$ does not correspond to the case of $h=\lambda/2$, $k=1$. This is so because, for the former case, current distribution in the active branch is

³ Ronold King and Charles W. Harrison, Jr., "The receiving antenna," *Proc. I.R.E.*, vol. 32, pp. 18-34; January, 1944.

a true sine curve over an angle of 2π , while in the latter case the currents in each branch have the same sign.

For the experimental data, care was taken to detune the antenna feeders according to the method described in another paper.⁴ Despite this, inequality of branch currents is apparent. An accurate measurement of the parameter k was not practicable for the data plotted in Fig. 10. Therefore, these curves may not be compared directly with the calculated curves.

ACKNOWLEDGMENT

The material of this paper constitutes a portion of the graduate research work performed by the author under the supervision of Professor Ronold W. P. King, of Harvard University. Indebtedness is also acknowledged to earlier material on the subject of antenna theory, completed by Dr. King, and presented by him in published papers and in lectures.

⁴ Ronold King, "Coupled antennas and transmission lines," *Proc. I.R.E.*, vol. 31, pp. 638-640; November, 1943.

The Effect of Grid-Support Wires on Focusing Cathode Emission*

CHAI YEH†

Summary—In an earlier paper, Thompson¹ has shown experimentally that sharp electron beams can be obtained if the relative electrode potentials on the anode and the grid of a vacuum tube are properly adjusted. However, theoretical interpretation of this effect was lacking. In the present paper the effects of the grid-support wires and of the various tube dimensions on the angle of electron emission are investigated theoretically. The investigation indicates that Thompson's interpretations are in the right direction. Quantitative check with the experimental results cannot be expected, because the theoretical computations are based upon pure electrostatic considerations at the cathode surface, while in actual experiments the angle of beam current at the anode is measured. Thus, the focusing and defocusing effects of the field distribution in space and the space charge existing near the cathode will cause a wide deviation between the angle of electron emission at the cathode and that of the beam current at the anode.

I. THEORY

THE PRESENT analysis makes use of a special tube. It consists of a cylindrical cathode of radius r_c and a coaxial cylindrical anode of radius r_p . Between these two cylinders, two grid wires, each of radius R , are placed on diametrically opposite sides of the cathode and at a distance r_g from it (see Fig. 1(a)). This arrangement resembles somewhat the practical construction of a beam tube with the screen grid, the

beam-forming plates, and the spiral grid wires dismantled. The only portions of the grid structure remaining are the two grid-support wires. It is intended to demonstrate the importance of the contribution of these grid-support wires to the formation of an electron beam in beam tubes.

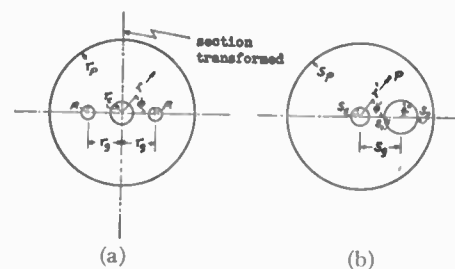

Fig. 1—Original and transformed cross section of the special tube under investigation.

It is also assumed that the effect of space charge is negligible, so that the problem is studied from a pure electrostatic point of view. In a complicated two-dimensional electrostatic problem of this type we usually make use of the "conformal transformation." In this transformation, the actual co-ordinate system is transformed into an equivalent one which makes the analysis of apparently complicated electric fields easily determinable by comparing with familiar geometry. If x and y are the co-ordinates of the original field which satisfy the two-dimensional differential equation $\partial^2 V/\partial x^2$

* Decimal classification: R138.312. Original manuscript received by the Institute, May 31, 1945; revised manuscript received, February 13, 1946.

† Radio Research Institute, National Tsing Hua University, Kunming, China.

¹ H. C. Thompson, "Electron beams and their applications in low-voltage devices," *Proc. I.R.E.*, vol. 24, pp. 1276-1298; October, 1936.

$+\partial^2 V/\partial y^2=0$, this field can be transformed into a new system having x' and y' as co-ordinates and satisfying a similar differential equation $\partial^2 V/\partial x'^2+\partial^2 V/\partial y'^2=0$. This is to say that the Laplacian equation must be satisfied in both the actual and equivalent systems for a space-charge-free condition. The potential difference between electrodes, the capacitances, and the total charges of the original system are carried over to the new system without change, while the potential gradient and charge density may have been modified to a considerable extent.

Let us now transform half of the original section of the tube shown in Fig. 1(a) into a whole section, using the transformation

$$Z' = f(Z) \tag{1}$$

where $Z' = r'e^{i\phi'}$, $z = re^{i\phi}$. For two grid wires, the transformation formulas are

$$Z' = (Z/r_g)^2 \quad \text{or} \quad \begin{aligned} \phi' &= 2\phi \\ \ln r' &= 2 \ln (r/r_g). \end{aligned} \tag{2}$$

The r_g that appears in the denominator of the above equation is introduced to make the grid distance the unit of measurement for the tube dimensions. The transformed or Z' -plane view is shown in Fig. 1(b), with the following new dimensions:

$$\left. \begin{aligned} \text{The cathode radius } S_c &= (r_c/r_g)^2. \text{ The plate radius } \\ S_p &= (r_p/r_g)^2. \text{ The inner and outer extremes of} \\ \text{the grid wire occur at } S_1 &= (1-R/r_g)^2 \text{ and} \\ S_2 &= (1+R/r_g)^2, \text{ respectively. The grid radius} \\ R' &= S_2 - S_1/2 \text{ and its distance away from the} \\ \text{center of cathode } S_g &= 1/2(S_1 + S_2). \end{aligned} \right\} \tag{3}$$

It is seen that, after transformation, the cathode radius is reduced, while the grid-wire and the anode radii are both expanded. From a pure electrostatic point of view, we may calculate the potential at any point $P(r', \phi')$ in space within the anode cylinder by considering the charges on grid, cathode, and anode, respectively. (See Fig. 2.) Let $-\lambda_1$ be the line charge located at the center

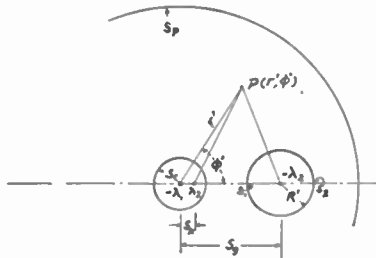

Fig. 2—Location of charges for the evaluation of the space potential at $P(r', \phi')$.

of the cathode due to charges on the anode and $-\lambda_2$ be that of the grid located at its center. Then the total charge on cathode cylinder is $-\lambda_1 + \lambda_2$, where λ_2 is the image of $-\lambda_2$ on the cathode in order to make the latter an equipotential surface. The location s_k of the image charge λ_2 satisfies the equation $s_k s_g = s_c^2$.

The potential in space is then given by

$$V = \lambda_1 \ln r'^2 - \lambda_2 \ln (r'^2 + s_k^2 - 2r's_k \cos \phi') + \lambda_2 \ln (r'^2 + s_g^2 - 2r's_g \cos \phi') + c. \tag{4}$$

Equation (4) must satisfy the proper boundary conditions on the anode, the grid, and the cathode, respectively. Thus, at the anode, the proper boundary conditions are $r' = s_p$, $V = V_p$; at the cathode, they are $r' = s_c$, $V = V_c$; and using the approximations $s_p^2 \gg s_g^2$, and $s_p^2 \gg s_c^2$, (4) becomes

$$V_p - V_c = \lambda_1 \ln (s_p/s_c)^2 - \lambda_2 \ln (s_g/s_c)^2 = 2K_1\lambda_1 - 2K_p\lambda_2 \tag{5}$$

where

$$K_1 = \ln s_p/s_c \tag{6}$$

and

$$K_p = \ln s_g/s_c. \tag{7}$$

The grid surface is now no more an equipotential one. But if R is small, we may calculate the effect of the grid potential on the cathode by taking the potential at some point on the grid surface, say at a point $\phi' = 0$, $s = s_2 = (1 + R/r_g)^2$. Then

$$\begin{aligned} V_g - V_c &= \lambda_1 \ln \left(\frac{s_2}{s_c}\right)^2 - \lambda_2 \ln \frac{(s_g/s_c)^2 s_2^2 + s_c^2 - 2s_g s_2 \cos \phi'}{s_2^2 + s_g^2 - 2s_g s_2 \cos \phi'} \\ &= 2K_2\lambda_1 - 2K_g\lambda_2 \end{aligned} \tag{8}$$

where

$$K_2 = \ln (s_2/s_c) \tag{9}$$

and

$$K_g = \ln (s_g s_2 - s_c^2)/s_c R'. \tag{10}$$

From (5) and (8), we obtain the ratio of the charges

$$\lambda_2/\lambda_1 = (K_2\alpha - K_1)/(K_g\alpha - K_p) \tag{11}$$

where

$$\alpha = (V_p - V_c)/(V_g - V_c).$$

It is assumed that on the cathode surface, if the initial velocity of the electrons is negligible, the emitted electrons are able to get out of the surface only when the field at the surface is positive. That is to say, if the field at the cathode is zero, emission is cut off. The cutoff field at cathode is found by differentiating (4) with respect to r' and letting $r' = s_c$; then

$$\begin{aligned} \left(\frac{\partial V}{\partial r'}\right)_{s_c} &= 2\lambda_1/s_c - 2\lambda_2/s_c \\ &\cdot \frac{s_g^2 - s_c^2}{s_c^2 + s_g^2 - 2s_c s_g \cos \phi'_0} = 0. \end{aligned} \tag{12}$$

Solve for $\cos \phi'_0$, the cosine of the cutoff angle ϕ'_0 ; thus

$$\cos \phi'_0 = \left[(s_c^2 + s_g^2) - \frac{\lambda_2}{\lambda_1} (s_g^2 - s_c^2) \right] / 2s_c s_g \tag{13}$$

or the cutoff angle is

$$\phi_0' = \cos^{-1} \frac{1}{2} \left[\left(\frac{s_c}{s_g} + \frac{s_g}{s_c} \right) - \frac{\lambda_2}{\lambda_1} \left(\frac{s_g}{s_c} - \frac{s_c}{s_g} \right) \right] \quad (14)$$

and the angle of electron emission is

$$\phi_e = 180 - \phi_0'. \quad (15)$$

II. INTERPRETATIONS OF THE THEORETICAL EQUATIONS

From (14) and (15) it is seen that, for a definite tube structure, all the terms except α are constant, while α can be varied by adjusting the electrode potentials. Therefrom, we may deduce the following simple principles which may serve as a valuable basis for the design of beam devices:

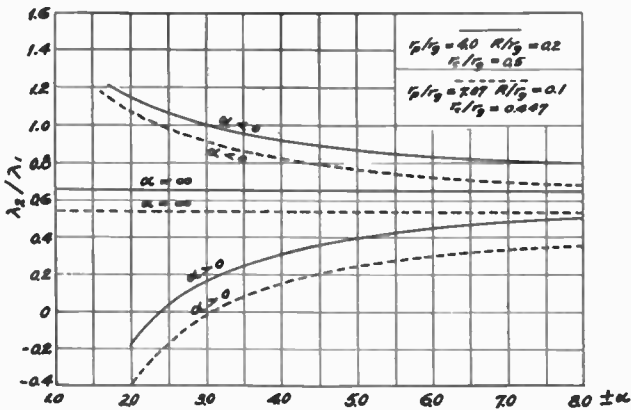

Fig. 3—Examples of the calculated ratio of charges λ_2/λ_1 for various values of $\pm\alpha$.

(1) If α , the ratio of anode to grid potentials, is kept constant, the angle of emission will be substantially constant. This is in agreement with the mathematical generalization on electron paths where initial electron

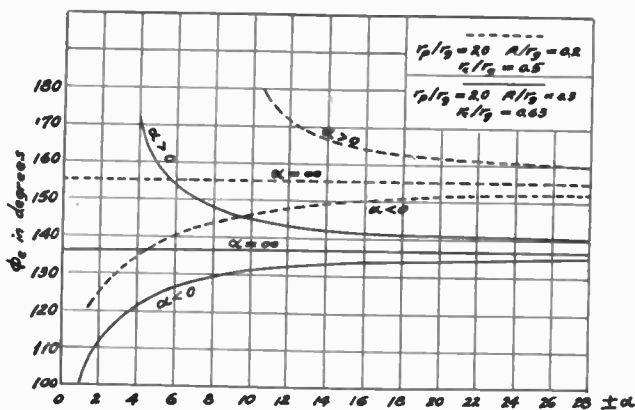

Fig. 4—Examples of the calculated angle of electron emission at cathode surface.

velocities are zero, as expressed by Langmuir and Compton.² Thompson's experiment indicated that for $\alpha = -3$ the beam angle measured at different anode currents is practically constant.

(2) If the grid potential is zero, then $\alpha = \infty$. Equa-

tions (14) and (15) give a constant value of emission angle for various values of the anode potentials, or

$$(\phi_e)_{\alpha=\infty} = 180 - \cos^{-1} \frac{1}{2} \left[\left(\frac{s_c}{s_g} - \frac{s_g}{s_c} \right) - \frac{K_2}{K_1} \left(\frac{s_g}{s_c} - \frac{s_c}{s_g} \right) \right] = \text{constant}. \quad (16)$$

This interpretation is also in agreement with Thompson's experiment. (See Fig. 6 of his original paper.¹)

(3) For negative values of the grid potential, i.e., $\alpha < 0$, it is seen from (11) or the plot on Fig. 3 that

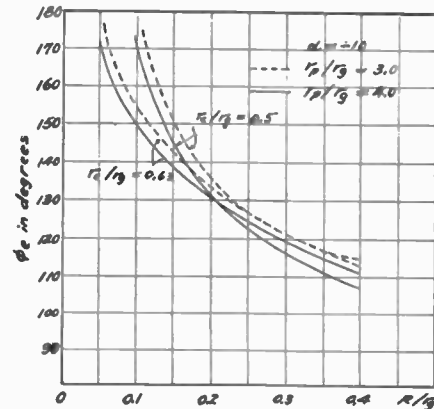

Fig. 5—Effect of varying R/r_g and r_p/r_g upon the angle of electron emission at cathode surface for $\alpha = -10$.

λ_2/λ_1 is always positive. And as the anode potential increases, keeping the grid potential unchanged, λ_2/λ_1 decreases slowly with it. Then from (14) and (15), the emission angle should increase with increasing anode potential.

For positive values of the grid potential, i.e., $\alpha > 0$, it is seen that from the plot, λ_2/λ_1 increases slowly with increasing α ; the emission angle is expected to decrease with it.

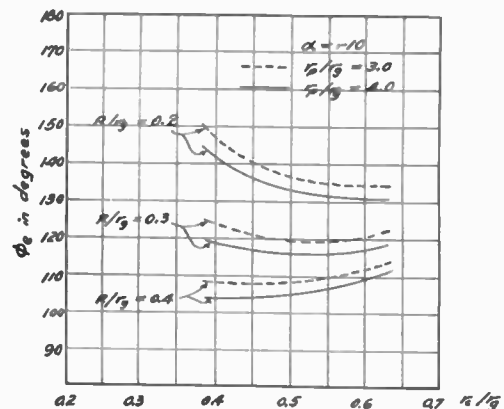

Fig. 6—Effect of varying r_c/r_g and r_p/r_g upon the angle of electron emission at cathode surface for $\alpha = -10$.

By the use of (14) and (15), the angles of emission for specific tube dimensions, at various anode-to-grid potential ratios, are calculated and plotted on Fig. 4. The upper and lower curves stand for the positive and negative potentials, respectively. The middle curve is for zero grid potential. Due to lack of data it is not possible

² I. Langmuir and K. T. Compton, "Electrical discharges in gases—Part II," *Rev. Mod. Phys.*, vol. 3; April, 1931.

to make a quantitative check with Thompson's results, but qualitatively they agree with each other. The theoretical results and the experimental data can not be expected to give a better check. This is because of the fact that the angle of electron emission calculated from the theoretical formulas is based upon zero off-cathode field, while in practice it is hardly possible to measure the angle of emission right at the cathode surface. What Thompson observes on the fluorescent screen is the angle of current arriving at the anode. The latter will be modified considerably by the field distribution between the electrodes. Thus, if the grid potential is negative, the equipotential lines in the neighborhood of the grid and cathode surface are of such distribution and shape as to cause the electrons to converge toward the anode. The observed angle of emission (the beam angle), therefore, will be much smaller than that calculated. If the grid potential is positive, the reverse is true.

III. THE EFFECTS OF VARYING TUBE DIMENSIONS

The various factors involved in the equations determining the angles of electron emission are the anode radius r_p , the grid radius R , the cathode radius r_c , and the distance r_o between centers of the grid wire and the cathode. For the tube dimensions expressed in terms of r_o , the number of variables are reduced to three. The ratio R/r_o may be interpreted either as varying R with constant r_o or varying r_o with constant R . The same is true for r_c/r_o and r_p/r_o . To find the effect of the tube dimensions on the angle of electron emission, it is first necessary to calculate the constants K_1 , K_2 , K_p , and K_o in (5) and (8) for various values of r_c/r_o , r_p/r_o , and R/r_o , respectively. With values of these constants, the

corresponding values of λ_2/λ_1 are evaluated, and thus the angle of electron emission is calculated. Figs. 5 and 6 show the effect of these variations.

In Fig. 5, it is seen that, for smaller grid radius or larger r_o , i.e., for smaller R/r_o ratio, the effect of the grid potential is small. The angle of emission is practically determined by the anode potential and thus gives nearly complete emission from the periphery of the cathode surface. The effect of the grid potential becomes increasingly important for larger grid radius and smaller r_o , and the angle of electron emission decreases rapidly (for negative grid potentials) with increasing ratio R/r_o . The two solid-line curves are calculated for two different cathode ratios r_c/r_o , using the same r_p/r_o . The dotted-line curves are for the respective cathode ratio while using a different r_p/r_o ratio. It is seen that changing the anode ratio r_p/r_o from three to four affects the angle of emission only slightly. (See Fig. 5.)

The effect of the cathode radius on the angle of electron emission is shown in Fig. 6. If the cathode radius is small, and when it is used in combination with small R/r_o ratio, the effect of the grid potential is very small. The angle of electron emission is seen to be large. But if the cathode surface is too large, it is exposed to the influence of the anode potential to a larger extent than that of the grid potential; thus the angle of electron emission will increase with increasing cathode surface. Somewhere between these values the influence of the grid potential reaches a maximum, and the angle of electron emission is smallest (for $-\alpha$). The effect of varying r_p/r_o is also shown as dotted-line curves in this figure. Here, again, its effect on the angle of emission is rather small.

Theory and Application of Parallel-T Resistance-Capacitance Frequency-Selective Networks*

LEONARD STANTON†

Summary—This paper deals with the theory and application of the parallel-T resistance-capacitance network, and gives a more general treatment of this network than that found in earlier papers. Using wye-delta conversion methods, the parallel-T resistance-capacitance network is represented by a single equivalent pi circuit. By introducing symbols corresponding to frequency and component values, simple expressions are derived for the impedance of the pi arms, as well as the network transmission, at any frequency. Since no arbitrary relationships are assumed between component values, the derived expressions are general.

The practical application of the network is also considered. Three versatile circuit embodiments are described, and the effects of deviating from specified component values investigated. A calculation is made to illustrate the application of the network to a negative-feedback circuit using a single stage of voltage amplification.

* Decimal classification: R143. Original manuscript received by the Institute, July 6, 1945; revised manuscript received, January 16, 1946.

† Brown Instrument Company, Philadelphia, Pa.

INTRODUCTION

FREQUENCY-SELECTIVE networks comprising inductance and capacitance elements have been extensively discussed in the literature, and an impressive list of references is available on their theory and application. However, networks comprising resistance and capacitance elements have received less consideration, while parallel-T resistance-capacitance circuits are described, to the author's knowledge, in only two papers, by Tuttle¹ and Scott.² Tuttle discusses the resonant conditions of bridged-T and parallel-T

¹ W. N. Tuttle, "Bridged-T and parallel-T null circuits for measurements at radio frequencies," *PROC. I.R.E.*, vol. 28, pp. 23-29; January, 1940.

² H. H. Scott, "A new type of selective circuit and some applications," *PROC. I.R.E.*, vol. 26, pp. 226-235; February, 1938.

networks in general, and considers the symmetrical parallel-T resistance-capacitance network as a single case. Scott applies the same network to feedback circuits for harmonic analyzers and oscillators. However, the following additional design considerations are of interest:

1. The degree of circuit loading caused by this network, at a given frequency.
2. The transmission versus frequency characteristic of the network, and its phase-shift characteristic.
3. The characteristics of networks having impedance-branch values which do not bear simple integral relationships to each other.
4. The deviation from ideal characteristics produced by component tolerances.
5. The advantages and limitations of this type of network.

The object of this paper is to discuss these topics. The paper is divided as follows: Part I—General Application; Part II—Theory; Part III—Design Considerations.

PART I—GENERAL APPLICATION OF PARALLEL-T RESISTANCE-CAPACITANCE NETWORKS

The behavior of this network resembles that of an antiresonant wave trap. At its resonant frequency, its transfer impedance becomes large and its transmission is a minimum. Unlike an inductance-capacitance filter, however, it can be made to pass virtually no current at resonance, even at low resonant frequencies. For example, compact resistance-capacitance circuits have been readily designed and used to detect the harmonics in a commercial power line by means of an oscilloscope, with virtually no vestige of the 60-cycle signal remaining. It is estimated that this corresponds to less than 0.1 per cent transmission of the resonant frequency, when the network feeds into a two-megohm load. The network-resonant-transfer impedance is thus more than 2000 megohms. High attenuation near resonance is one of the major advantages of this type of circuit. Another advantage is that it can be made compact for low-frequency applications. Using three small capacitors and two resistors, and two small potentiometers, highly selective networks can be made for frequencies as low as ten cycles per second. A corresponding inductance-capacitance filter would be expensive, bulky, less selective, and susceptible to magnetic pickup.

Scott² has applied the selective behavior of parallel-T resistance-capacitance networks to feedback amplifiers for emphasizing a given frequency. He describes a harmonic analyzer and oscillator which uses a three-stage direct-coupled amplifier, with a feedback loop including a parallel-T resistance-capacitance selective network. It has also been found that a single-stage feedback amplifier yields a 20-decibel or greater rejection of all frequencies below two thirds the resonant frequency, and above one-and-one-half times the resonant frequency.

There are, however, important limitations to parallel-T resistance-capacitance networks. These may be summarized as follows:

1. Unlike antiresonant inductance-capacitance wave traps, parallel-T resistance-capacitance networks add a parallel load to the circuit into which they are inserted, at both their input and output terminals. This is true even at resonance.

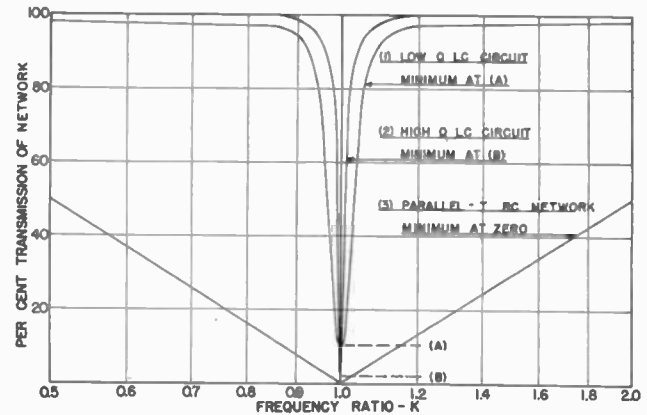

Fig. 1—Transmission versus frequency ratio for three networks.

2. They are generally less satisfactory for filtering direct-current power supplies than conventional "brute-force" multisection resistance-capacitance networks of comparable cost and component magnitudes. This results from the fact that it is usually desired to attenuate a number of harmonic frequencies in power supplies, and parallel-T resistance-capacitance networks attenuate primarily a single frequency.

3. Off resonance, parallel-T resistance-capacitance networks have relatively low transmission. Fig. 1 compares the transmission of a high- Q inductance-capacitance antiresonant wave trap at higher frequency, a low- Q inductance-capacitance wave trap at low audio frequency, and a representative parallel-T resistance-capacitance network. Transmission is plotted against frequency ratio, which is defined as the ratio of the actual to the resonant frequency.

At intermediate and radio frequencies, where high- Q circuits are easily made, the use of a parallel-T resistance-capacitance network offers no theoretical advantage. At low frequencies, where high- Q coils are difficult and expensive to make, resistance-capacitance networks can serve a very useful, even essential purpose.

PART II—THEORY OF THE PARALLEL-T RESISTANCE-CAPACITANCE NETWORK

This section discusses the basic nature of the parallel-T resistance-capacitance network, as shown in Fig. 2. This network consists of two "tee" or "wye" networks in parallel, wye (A) and wye (B).

A. Representation of the Parallel-T as a Single Pi or Delta Network

This is accomplished by first converting the wyes into

equivalent deltas. Then, since the deltas terminate in common points, they are easily converted into a single equivalent delta or pi network.

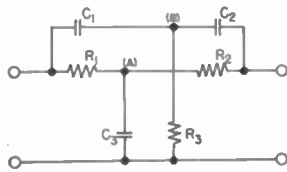

Fig. 2—The parallel-T resistance-capacitance network.

Figs. 3(a) and 3(b) show wye (A) and its equivalent delta (A) respectively. Substituting the wye-arm im-

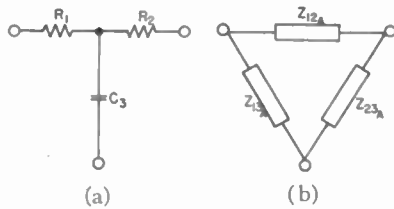

Fig. 3—Wye (A) and its equivalent delta (A).
(a) Wye (A)
(b) Delta (A)

pedances in conventional formulas gives the delta (A) arm impedances as follows:

$$Z_{13A} = R_1 - jx_3 \frac{R_1 + R_2}{R_2} \tag{1}$$

$$Z_{23A} = R_2 - jx_3 \frac{R_1 + R_2}{R_1} \tag{2}$$

$$Z_{12A} = (R_1 + R_2) + j \frac{R_1 R_2}{x_3} \tag{3}$$

Figs. 4(a) and 4(b) show wye (B) and its equivalent delta (B) respectively. Substituting the wye-arm im-

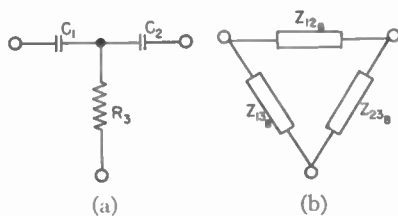

Fig. 4—Wye (B) and its equivalent delta (B).
(a) Wye (B)
(b) Delta (B)

pedances in conventional formulas gives the delta (B) arm impedances as follows:

$$Z_{13B} = R_3 \frac{x_1 + x_2}{x_2} - jx_1 \tag{4}$$

$$Z_{23B} = R_3 \frac{x_1 + x_2}{x_1} - jx_2 \tag{5}$$

$$Z_{12B} = - \frac{x_1 x_2}{R_3} - j(x_1 + x_2). \tag{6}$$

Fig. 5 shows a single delta network, equivalent to the

parallel-T resistance-capacitance network of Fig. 2, with the following branch-arm impedances:

$$Z_{13} = \frac{Z_{13A} Z_{13B}}{Z_{13A} + Z_{13B}}; \quad Z_{23} = \frac{Z_{23A} Z_{23B}}{Z_{23A} + Z_{23B}};$$

$$Z_{12} = \frac{Z_{12A} Z_{12B}}{Z_{12A} + Z_{12B}}.$$

Substituting (1) to (6) in the above expressions yields the following combined pi branch-arm impedances, ex-

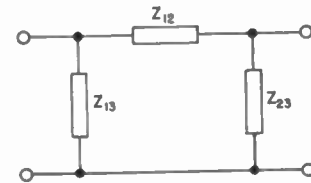

Fig. 5—Single delta network equivalent to parallel-T resistance-capacitance network.

pressed in terms of the components of the parallel-T resistance-capacitance network of Fig. 2:

$$Z_{13} = \frac{\left[R_1 - jx_3 \frac{R_1 + R_2}{R_2} \right] \left[R_3 \frac{x_1 + x_2}{x_2} - jx_1 \right]}{\left[R_1 + R_3 \frac{x_1 + x_2}{x_2} \right] - j \left[x_1 + x_3 \frac{R_1 + R_2}{R_2} \right]} \tag{7}$$

$$Z_{23} = \frac{\left[R_2 - jx_3 \frac{R_1 + R_2}{R_1} \right] \left[R_3 \frac{x_1 + x_2}{x_1} - jx_2 \right]}{\left[R_2 + R_3 \frac{x_1 + x_2}{x_1} \right] - j \left[x_2 + x_3 \frac{R_1 + R_2}{R_1} \right]} \tag{8}$$

$$Z_{12} = \frac{\left[R_1 + R_2 + j \frac{R_1 R_2}{x_3} \right] \left[- \frac{x_1 x_2}{R_3} - j(x_1 + x_2) \right]}{\left[R_1 + R_2 - \frac{x_1 x_2}{R_3} \right] - j \left[x_1 + x_2 - \frac{R_1 R_2}{x_3} \right]} \tag{9}$$

B. Conditions for Zero Network Transmission

The network transmission is here defined as the vector ratio of the output-to-input network voltages under conditions of no load. For zero network transmission to occur, it therefore follows from Fig. 5 that the expression $Z_{23}/(Z_{12} + Z_{23})$ must vanish. This requires either that Z_{23} vanish, which is impossible under the assumption of finite components, or that Z_{12} become infinite. The latter condition is met only when both real and imaginary components of the denominator in (9) vanish, a condition requiring that

$$x_1 x_2 = (R_1 + R_2) R_3 \tag{10}$$

$$R_1 R_2 = (x_1 + x_2) x_3. \tag{11}$$

These equations reduce to those of Scott² and Tuttle¹ when $R_1 = R_2$ and $X_1 = X_2$.

Examination of (10) and (11) shows the following:

(1) If the resistances are small, $(x_1 x_2)$ and x_3 must be small, according to (10) and (11) respectively. Hence,

for given resonant frequencies, small resistances require large capacitances, and vice versa.

(2) The conditions of Tuttle¹ and Scott² are a special case of the more general relationships (10) and (11).

(3) From (11), it follows that the resonant frequency is given when C_1 , C_2 , C_3 , R_1 , and R_2 are specified. However, unless R_3 satisfies (10), the transmission will merely pass through a minimum value at resonance, rather than reduce to zero. Therefore (11), containing all the reactances, may be considered to be the frequency-determining equation, while (10) is the zeroing equation.

(4) If the capacitance values and the desired frequency are specified, R_1 and R_2 need only be varied in relative value to obtain vernier tuning, while R_3 can be varied to secure a reduction to zero transmission at resonance.

(5) Ganged tuning can readily be accomplished. It is shown in Part III that if R_1 , R_2 , and R_3 all increase in magnitude by a factor ρ , the zero transmission conditions (10) and (11) are still met when the frequency is reduced by the same factor. Thus, three potentiometers of similar tapers can be ganged to select zero-transmission frequencies in a parallel-T resistance-capacitance network. The harmonic analyzer and oscillator described by Scott² uses this principle, always maintaining the relationship $R_1 = R_2 = 2R_3$. In general, however, no arbitrary relationship between the resistances is needed.

C. Simplification of the Expressions for the Pi Branches

Equations (7), (8), and (9) are very difficult to manipulate. To simplify these equations, it is now assumed that the network is capable of zero transmission at some finite frequency f_0 , at which x_1 , x_2 , and x_3 become the resonant values X_1 , X_2 , and X_3 , respectively. Additional symbols are introduced as follows:

$$R = R_1 + R_2 \quad K = \frac{f}{f_0} = \frac{\text{actual frequency}}{\text{resonant frequency}}$$

$$a = \frac{R_1}{R_1 + R_2} \quad b = \frac{X_1}{X_1 + X_2}$$

$$\alpha = \frac{R_2}{R_1 + R_2} \quad \beta = \frac{X_2}{X_1 + X_2}$$

$$q = \frac{X_1 + X_2}{R_1 + R_2}$$

It will be noted that q and K can assume any finite positive values; while a , α , b , and β are always positive and less than unity. R is a quantity determining whether a high- or a low-impedance network is obtained, q determines the phase angle of the network input impedance, and a and b are symmetry factors of wye (A) and wye (B), respectively.

Solving for the resistance and capacitive-reactance values of a network capable of zero transmission (using

(10) and (11)), and recalling that $x = X/K$ always, it is readily shown that the general wye (A) and wye (B) component impedance values of Fig. 2 become

$$R_1 = aR \quad x_1 = \frac{bq}{K} R$$

$$R_2 = \alpha R \quad x_2 = \frac{\beta q}{K} R$$

$$R_3 = b\beta q^2 R \quad x_3 = \frac{a\alpha}{Kq} R$$

Substituting the above expressions in (7), (8), and (9) yields, upon simplification, the following equations for the branch-arm impedances of Fig. 5:

$$Z_{13} = \frac{abq^2}{a + bq^2} (1 - j/qK)R \quad (12)$$

$$Z_{23} = \frac{\alpha\beta q^2}{\alpha + \beta q^2} (1 - j/qK)R \quad (13)$$

$$Z_{12} = \frac{1}{1 - K^2} (1 + jqK)R. \quad (14)$$

These equations show the following interesting characteristics of a parallel-T resistance-capacitance network capable of zero transmission:

1. The expressions for Z_{13} and Z_{23} , the input- and output-branch impedances, are identical in form. When $a = \alpha$ and $b = \beta$, as in Scott's and Tuttle's networks, $Z_{13} = Z_{23}$. It will be noted that the network always loads both its input source and output load circuits, as Z_{13} and Z_{23} can never grow infinite.

2. Z_{12} is entirely independent of the network symmetry factors a and b , but does contain frequency, magnitude, and phase terms (K , R , and q , respectively).

3. Z_{13} and Z_{23} are always partially capacitive in nature. Z_{12} is inductive for frequencies below resonance, capacitive for frequencies above resonance. At resonance, $K = 1$, and Z_{12} becomes infinite.

D. The Network Transmission Expression

Now that simpler expressions have been derived for Z_{13} , Z_{23} , and Z_{12} it is not difficult to compute T , the "no-load" network transmission. This has been defined above as the vector ratio of network output-to-input voltage at a given frequency, for no load across the output terminals.³

$$T = \frac{Z_{23}}{Z_{12} + Z_{23}} = \frac{1}{1 + Z_{12}/Z_{23}}$$

$$Z_{12}/Z_{23} = \left[\frac{\alpha + \beta q^2}{\alpha\beta q} \right] \left[\frac{K}{1 - K^2} \right] j$$

³ Detailed consideration of the effect of loading a parallel-T resistance-capacitance network is a problem properly left to the specific circuit application, and is hence beyond the scope of this paper. It is, however, very briefly considered in Part III.

Therefore

$$T = \frac{1}{1 + j \left[\frac{K}{1 - K^2} \right] \left[\frac{\alpha + \beta q^2}{\alpha \beta q} \right]} \quad (15)$$

Study of (15) shows the following:

1. The frequency term $K/(1-K^2)$ and the component value term $(\alpha+\beta q^2)/\alpha\beta q$ are independent of each other, since α , β , and q are independent of K .
2. Fig. 6 shows the general nature of the phase shift suffered by a signal in passing through the network as a function of the frequency ratio K . At frequencies very

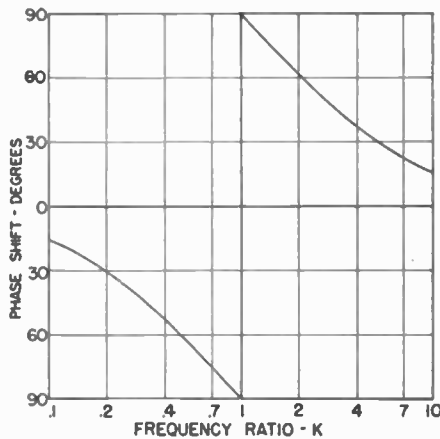

Fig. 6—Typical phase-shift characteristic of parallel-T resistance-capacitance network.

close to resonance, the phase shift approaches plus or minus ninety degrees, and diminishes with increasing departure from resonance.

3. It will be noted that R does not enter the expression for T . This follows from the restricted definition of T , which assumes the load impedance Z_L infinite. Where Z_L is finite, the over-all system transmission involves R/Z_L terms.

4. α , β , and q are the only component terms appearing in (15). These quantities explicitly determine R_1 and R_2 , by definition. However, they also implicitly determine R_3 and X_3 by the resonance conditions. Thus, when α , β , and q are varied to vary the transmission response, R_3 and X_3 can also be adjusted to reproduce the zero-transmission conditions.

5. Maximum transmission at a given frequency also corresponds to minimum phase shift.

6. The T versus $\log K$ curve is symmetrical about $K=1$. It is hence convenient to plot T versus K curves semilogarithmically.

In applying this circuit it is generally desired to have as high a degree of transmission and as small a phase shift off resonance as possible. This implies that the quantity $(\alpha+\beta q^2)/\alpha\beta q$ must be a minimum. This expression becomes a minimum, for given values of α and β , when $q=q_m$ where

$$q_m = \sqrt{\frac{\alpha}{\beta}} \quad (16)$$

Substituting q_m in the component-value term, $(\alpha+\beta q^2)/\alpha\beta q$ yields a minimum value of the term as follows:

$$\left[\frac{\alpha + \beta q^2}{\alpha \beta q} \right]_{\min} = \frac{2}{\sqrt{\alpha \beta}} \quad (16a)$$

Substituting (16a) in (15) yields T_{\max} , which has the maximum absolute value of T for given values of α and β .

$$T_{\max} = \frac{1}{1 + j \left(\frac{K}{1 - K^2} \right) \frac{2}{\sqrt{\alpha \beta}}} \quad (17)$$

It will be noted from (16) that maximum transmission does not necessitate that q equal unity. However, this

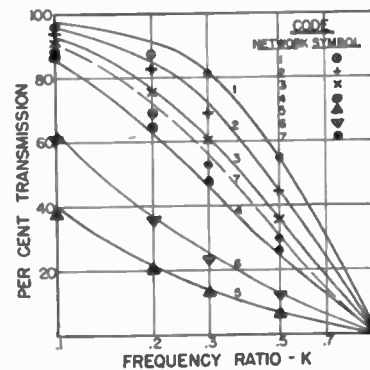

Fig. 7—Transmission versus frequency ratio (κ) for seven networks.

is a desirable condition, as the choice of component values becomes somewhat simpler when $\alpha=\beta$, and $q=1$. For this special case, where $\alpha=\beta=\beta_0$,

$$T_{\max} = \frac{1}{1 + j \left[\frac{K}{1 - K^2} \right] \frac{2}{\beta_0}} \quad (17a)$$

An indication of the accuracy of (15) in predicting transmission performance is shown in Fig. 7. In this figure only the curves to the left of $K=1$ are shown, since these curves are symmetrical about $K=1$ when plotted on a semilogarithmic scale. The curves show

TABLE I

Filter Number	α	β	R	q	C_1	C_2	C_3	Resonant Frequency	
								Predicted	Actual
1	10/11	10/11	55×10^6 ohms	1	0.05	0.005	0.05	600	635
2	2/3	2/3	45	1	0.02	0.01	0.03	530	470
3	1/2	1/2	50	1	0.01	0.01	0.02	600	540
4	1/3	1/3	45	1	0.01	0.02	0.03	530	470
5	1/11	1/11	55	1	0.005	0.05	0.05	600	635
6	10/11	1/11	55	1	0.005	0.05	0.05	600	635
7	10/11	10/11	55	4	0.01	0.001	0.20	720	715

predicted transmission, while experimental points are plotted with appropriate code symbols. Prediction was made on the basis of nominal component values (standard 10 per cent tolerances). For completeness, Table I is given below, showing the approximate values used experimentally.

E. Input Impedance

As mentioned above, the parallel-T resistance-capacitance network adds a parallel load to the circuit into which it is inserted, at both the network input and output terminals. The magnitude of this load depends

can be predicted with sufficient accuracy for most design purposes.

Table II shows the agreement between predicted and measured values of $|Z_i|$ for all seven networks of Table I, at three K values.

TABLE II
AGREEMENT BETWEEN PREDICTED AND MEASURED VALUES OF INPUT IMPEDANCE

Filter No.	$K=0.3$			$K=1.0$			$K=3\frac{1}{2}$		
	Predicted	Measured	Per Cent Deviation	Predicted	Measured	Per Cent Deviation	Predicted	Measured	Per Cent Deviation
1	8.2K Ω	8.4K Ω	+ 3.0	3.4K Ω	3.8K Ω	+10.0	2.45K Ω	2.9K Ω	+18.0
2	21.8	19.8	- 9.1	10.6	10.7	+ 0.9	5.6	6.5	+16.5
3	30.6	27.5	-10.1	17.7	16.5	- 6.8	10.5	9.0	-14.3
4	32.2	29.2	- 9.3	21.2	18.9	-10.8	10.8	9.45	-12.8
5	46.3	45.0	- 2.8	35.4	32.9	- 7.0	14.5	14.75	+ 1.7
6	16.4	14.0	-14.3	6.4	6.5	+ 1.1	4.4	4.2	- 4.0
7	5.8	6.9	+18.1	4.1	4.7	+13.5	4.29	4.32	+ 0.5

on the network design. In general, it is simple to compute Z_{i0} , the input impedance at the resonant frequency, since $Z_{i0}=Z_{13}$. On occasion it may be of considerable interest to know how the network input impedance Z_i varies for different networks. In this connection, two relationships are of most general interest: $|Z_{i0}|=f(a)$, for $q=1$, $\alpha=\beta$, and $|Z_i/Z_{i0}|=g(K)$ for $q=1$, $\alpha=\beta$. These expressions specify $|Z_i|$ of any design and at any frequency, for networks characterized by $q=1$, $\alpha=\beta$. These relationships will now be discussed.

1. When $K=1$, $q=1$, and $\alpha=\beta$, then

$$|Z_{i0}| = \frac{1-\alpha}{\sqrt{2}} R = \frac{a}{\sqrt{2}} R,$$

from (12). Or,

$$|Z_{i0}/R| = \frac{a}{\sqrt{2}} = \frac{1-\alpha}{\sqrt{2}}. \quad (18)$$

This is a surprisingly simple relationship.

2. When the frequency departs from resonance, networks perform as shown in Fig. 8. Here are shown how

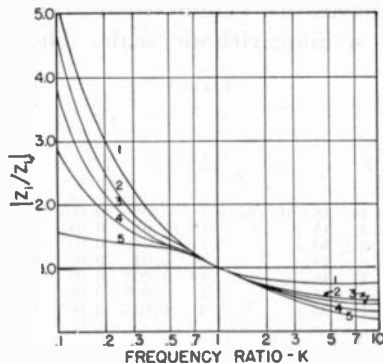

Fig. 8— $|Z_i/Z_{i0}|$ for five networks for which $q=1$ and $\alpha=\beta$.

$|Z_i/Z_{i0}|$ varies with K for the five networks specified in Table I where $q=1$ and $\alpha=\beta$.

With the aid of (18) and Fig. 8, the input-impedance characteristics of a network for which $q=1$ and $\alpha=\beta$

This table shows a maximum deviation of experimental from predicted input impedance of ± 18 per cent. This represents reasonable agreement, as components were taken at random from capacitor and resistor stocks of commercial tolerances (± 10 per cent).

The above graphical procedure is sufficient for most applications. However, if $\alpha \neq \beta$ or $q \neq 1$, or if accuracy and generality are desired, the following formulas for Z_i may be employed:

$$Z_{i1} = V \left[1 - j \frac{Q}{M} \right] PR \quad (19a)$$

$$Z_{i2} = V \left[1 - j \frac{P}{M} \right] QR. \quad (19b)$$

Where

Z_{i1} =impedance across input terminals looking into the network

Z_{i2} =impedance across output terminals looking into the network

$$P = \frac{abq}{a + bq^2}$$

$$Q = \frac{\alpha\beta q}{\alpha + \beta q^2}$$

$$M = K/(1 - K^2)$$

$$V = \frac{q - j/K}{1 - j \left(\frac{P + Q}{M} \right)}$$

R is as defined previously.

PART III—DESIGN CONSIDERATIONS IN APPLYING PARALLEL-T RESISTANCE-CAPACITANCE NETWORKS

A. The Effect of Loading the Network

Since a network is always used with a load impedance, it is necessary to devote some attention to the behavior of the network and load combination. Any load tends to lower the network transmission by shunting Z_{23}

(Fig. 5). Even an inductive load produces only a minor peak in the transmission curve, because the large resistance component of Z_{23} makes secondary-resonance effects negligible.

At lower frequencies, the magnitudes of Z_{13} and Z_{23} increase, and as a result loading effects are then considerably greater than at higher frequencies. Hence, the symmetry of the transmission versus $\log K$ curve is destroyed by loading.

Table III illustrates the effect of resistive loading. It compares the computed transmission before and after loading, at different frequency ratios K , for a resistance-loaded network for which $q=1$, and $\alpha=\beta$. The load resistor R_L is equal to $3R$, and is about five times as great as $|Z_{23}|$.

TABLE III
EFFECT OF RESISTIVE LOADING ON A NETWORK

K	Transmission		Drop in Transmission with Loading
	No Load	With Load	
	<i>Per Cent</i>	<i>Per Cent</i>	<i>Per Cent</i>
0.1	99.97	73.2	26.8
0.3	77.2	60.4	16.8
0.5	51.5	42.8	8.7
0.7	28.0	23.0	5.0
1.0	0	0	0
1 $\frac{1}{3}$	28.0	25.4	2.6
2	51.5	47.9	3.6
3 $\frac{1}{3}$	77.2	73.6	3.6
10	99.97	96.4	3.6

Networks for which $q=1$ and $\alpha=\beta$ allow satisfactory transmission for most designs when the magnitude of the load impedance $|Z_L|$ is equal to or greater than $3R$, at frequencies near resonance and above.

For this particular type of network, the impedance seen by a source connected thereto is not seriously reduced by the termination of the network in a load, as long as the load-impedance magnitude is at least three times as great as R .

B. Component Tolerances

Departures from specified component values due to manufacturing tolerances of commercial parts affect the following network characteristics:

1. Actual resonant frequency
2. Transmission at desired resonant frequency
3. Off-resonant transmission
4. Input and output impedance.

A few per cent deviation from predicted values is not serious in off-resonant transmission and input and output impedance. However, to obtain maximum rejection of a particular frequency, only a slight deviation of the network resonant frequency from that particular frequency can be tolerated, and the network transmission at the particular frequency must be made to approach zero. In view of the importance of this problem, it is considered in some detail. From (10), it may be shown that the network resonant frequency is given by

$$f_0 = \frac{1}{2\pi\sqrt{R_1R_2[C_1C_2/(C_1 + C_2)]C_3}} \quad (20)$$

In the most unfavorable case, where small percentage errors ϵ are additive, the total deviation in f_0 is about minus 2ϵ . Each component therefore contributes about minus $\frac{1}{2}$ per cent shift in f_0 for each 1 per cent increase from its specified value. It should be noted, however, that, to return to the proper resonant frequency, the adjustment in a single corrective component should permit a variation in either direction of more than four times the tolerance of each component.

Equations (7), (8), (9), (10), and (11) can be used to establish an important relationship. At a network resonant frequency f_0 , its deviation factors θ and ϕ are defined, along with ϵ_θ and ϵ_ϕ , as follows:

$$\theta = 1 + \epsilon_\theta = \frac{X_1X_2}{(R_1 + R_2)R_3};$$

$$\phi = 1 + \epsilon_\phi = \frac{R_1R_2}{(X_1 + X_2)X_3}.$$

The magnitude of the minimum network transmission when θ and ϕ are approximately unity is then given by the expression

$$|T| \leq \left| \frac{1}{1 + 2 \left[\frac{(1-\theta) + (1-\phi)}{(1-\theta)^2 + (1-\phi)^2} + j \frac{\theta - \phi}{(1-\theta)^2 + (1-\phi)^2} \right]} \right| \quad (21)$$

The following undesired finite values of network transmission are then obtained:

$$\begin{aligned} |T| &< \epsilon_\theta/2 \quad \text{for } \theta = \phi \quad (\epsilon_\theta = \epsilon_\phi) \\ |T| &< \epsilon_\phi/2 \quad \text{for } \theta = 1 \quad (\epsilon_\theta = 0) \\ |T| &< \epsilon_\theta/2 \quad \text{for } \phi = 1 \quad (\epsilon_\phi = 0). \end{aligned}$$

This result is important as it indicates the relative ease with which the network may be adjusted to zero transmission at its resonant frequency.

C. Practical Network Design

The design of parallel-T resistance-capacitance networks is governed by the following two principal considerations:

1. R should be relatively large to prevent excessive loading of the source. However, it should be less than one third of the terminating impedance of the network; otherwise, the network transmission is seriously reduced.

2. α and β values are preferably chosen to be 0.5 and higher, to maintain off-resonance transmission. The choice of values depends on the ratio of source internal resistance to load resistance.

The problem of network adjustment includes both tuning to a desired frequency and obtaining zero transmission at that frequency. This is best solved by first specifying relatively close tolerances (at least ± 5 per cent for best performance), and using variable resistors

to obtain proper adjustment. As the network is usually applied to lower frequencies, resistance vernier adjustment appears preferable. Three practical network embodiments are given below.

1. The network shown in Fig. 9 is adjusted by means of two rheostats r_1 and R_3 . Both (R_1+R_2) and (R_1R_2)

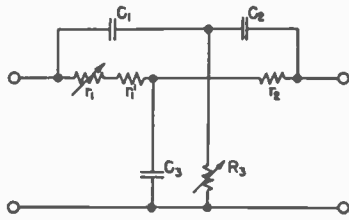

Fig. 9—Network adjusted by means of two rheostats.

change when r_1 is varied for tuning, while R_3 is varied to secure zero transmission at resonance. This network is useful where off-resonance transmission and input impedance are not critical, and broad component tolerances are desired. No simple ganged combination of r_1 and R_3 exists for adjustment.

2. The network shown in Fig. 10 is adjusted by means of a rheostat r_3 and a potentiometer r . This system re-

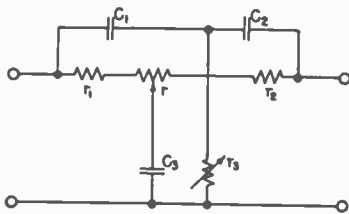

Fig. 10—Network adjusted by means of one potentiometer and one rheostat.

quires rather careful selection of components to assure tuning to a required resonant frequency. For 5 per cent tolerances on components, r should be more than one-fifth R . There is no simple ganged combination of r and r_3 for this type of network, either.

3. The network shown in Fig. 11 is adjusted by means of three rheostats R_1 , R_2 , and R_3 and capacitor selectors S_1 , S_2 , and S_3 . This arrangement provides for switching

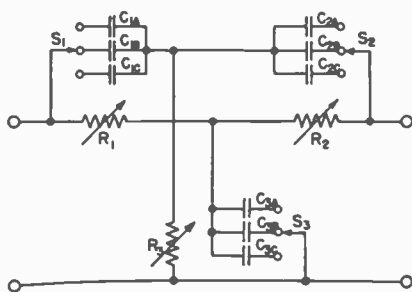

Fig. 11—Network adjusted by means of three rheostats and three capacitor selectors.

capacitors to change the frequency tuning range, while R_1 , R_2 , and R_3 are similarly tapered rheostats ganged together for fine adjustment. This type of network is employed by Scott² in an harmonic analyzer where $R_1 = R_2 = 2R_3$, $C_1 = C_2 = C_3/2$, for all settings of frequency.

It will now be shown that the zero-transmission frequency of any parallel-T resistance-capacitance network is inversely proportional to ρ and χ , where ρ and χ are the factors by which the resistance and capacitance values, respectively, change from initial values. This is true regardless of network symmetry.

A necessary condition that a new resonant frequency be λ times the initial one is that (10) still be satisfied when the reactance and resistance values corresponding to the changed conditions (indicated by primes below) are substituted.

$$\begin{aligned} X_1' &= X_1/\chi\lambda & R_1' &= \rho R_1 \\ X_2' &= X_2/\chi\lambda & R_2' &= \rho R_2 \\ X_3' &= X_3/\chi\lambda & R_3' &= \rho R_3. \end{aligned}$$

Substituting these new symbols in (10) yields $X_1'X_2'(R_1'+R_2')R_3'=1/\rho^2\lambda^2\chi^2$ and the prerequisite is therefore

$$f_0'/f_0 = \lambda = 1/\rho\chi. \tag{22}$$

To assure that this prerequisite alone is sufficient, the tuning conditions of (11) must also be satisfied, when prime terms and (22) are substituted in (11). This substitution yields $R_1'R_2'/(X_1'+X_2')X_3'=1$, which proves that the zero-transmission frequency is inversely proportional to ρ and χ .

D. Applications

The parallel-T resistance-capacitance network can be used to discriminate against or to emphasize a single frequency. The first application involves relatively straightforward use of principles already discussed. The second application is more complicated, however, since it involves a negative-feedback system.

Multistage feedback amplifiers have been comprehensively discussed in many other papers, and therefore the scope of this paper is restricted to the design of a single-stage feedback amplifier. The design of such an amplifier involves the following special considerations:

1. Loading of the output circuit of the tube operating into the network by the network input impedance.
2. Maintenance of sufficiently large network output off resonance to make the feedback effective.
3. Loading of the input circuit of the amplifier tube by the output impedance of the network.
4. Loading of the network output by the input circuit of the amplifier tube.

Fig. 12(a) is a schematic representation of a triode feedback circuit; while Fig. 12(b) shows its equivalent circuit. The first and second of the above considerations call for operation of the tube at points of low plate resistance and high amplification factor, and the use of a network for which $q=1$ and α and β are large and equal. The third and fourth, however, require a compromise. If r_1 is inserted to provide a higher degree of feedback, the initial signal is attenuated, while the use of r_2 attenuates the feedback signal. In most applications of this circuit,

maximum rejection of undesired frequencies is required. Hence, the feedback signal must be maintained, even at the sacrifice of the over-all voltage gain of the system in which the network is employed. Consequently, r_1 is

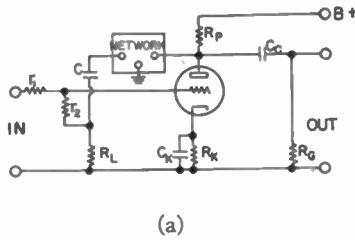

(a)

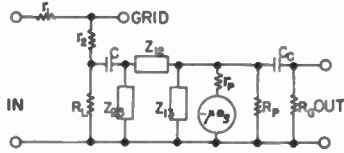

(b)

Fig. 12—The general feedback circuit.
(a) Schematic diagram.
(b) Equivalent circuit.

usually made large, and r_2 small by comparison. A particular circuit for this type of application, used for audio frequencies, is shown in Fig. 13. Particular values of

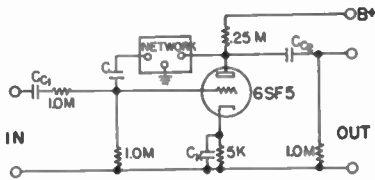

Fig. 13—Feedback circuit using 6SF5 tube.

capacitances are chosen on the basis of the frequency desired. The voltage gain of this amplifier is about 45 times at the resonant frequency (audio range).

In order to illustrate the frequency response which may be expected from this circuit, a computation has been made and the response curve of the feedback system plotted in Fig. 14. A symmetrical network is assumed in this computation, for simplicity of arithmetic. Equally good or better results can be obtained with unsymmetrical networks. The following components were employed:

$$R_1 = R_2 = 150,000 \text{ ohms; } R_3 = 75,000 \text{ ohms}$$

$$X_1 = X_2 = 150,000 \text{ ohms; } X_3 = 75,000 \text{ ohms.}$$

Using the formula $G = G_0 / (1 - G_0 T)$ (where G is the vector ratio of the tube plate to grid signal voltages, G_0 is the value of G at resonance, and T is the transmission of the network under load), Fig. 14 is obtained as a reasonable approximation to actual performance. It will be noted

that, at frequencies less than two thirds and more than three halves the resonant frequency, a rejection ratio of

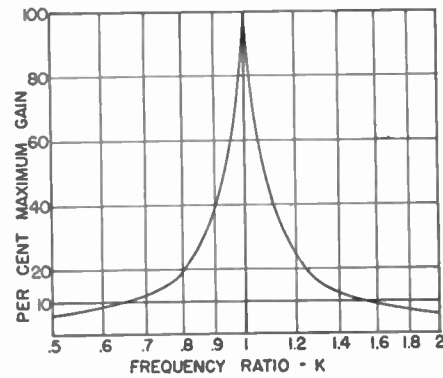

Fig. 14—Frequency-response curve of circuit shown in Fig. 13.

more than 20 decibels is attained. This is characteristic of the observed performance of this type of circuit.

APPENDIX I

GENERALIZED PARALLEL-T RESISTANCE-CAPACITANCE NETWORK TRANSMISSION EXPRESSION

Previously in this paper, the transmission versus frequency expression (15) of a parallel-T resistance-capacitance network capable of zero transmission was derived. In this derivation, (10) and (11) were assumed to apply. However, the characteristics of this type of network are expressed more generally by the following equations:

$$A^2 X_1 X_2 = (R_1 + R_2) R_3 \tag{10'}$$

$$B^2 R_1 R_2 = (X_1 + X_2) X_3 \tag{11'}$$

where A^2 and B^2 are not necessarily unity.

When (10') and (11') are substituted in (7), (8), and (9), and the additional symbols given in Section C of Part II are employed, the most general equations for the branch-arm impedances of Fig. 5 are obtained as follows:

$$Z_{13} = \frac{abqR}{jK} \frac{[B^2 + jqK][1 + jqKA^2]}{[aB^2 + bq^2] + jqK[a + bq^2A^2]} \tag{12'}$$

$$Z_{23} = \frac{\alpha\beta qR}{jK} \frac{[B^2 + jqK][1 + jqKA^2]}{[\alpha B^2 + \beta q^2] + jqK[\alpha + \beta q^2A^2]} \tag{13'}$$

$$Z_{12} = [-R] \frac{[B^2 + jqK][1 + jqKA^2]}{B^2[K^2A^2 - 1] - jqKA^2[B^2 - K^2]} \tag{14'}$$

From (12'), (13'), and (14'), the following transmission expression is derived:

$$T = \frac{Z_{23}}{Z_{12} + Z_{23}}$$

$$T = \frac{\alpha\beta[B^2(K^2A^2 - 1) - jqKA^2(B^2 - K^2)]}{\{K^2[(\alpha + \beta q^2A^2) + \alpha\beta A^2 B^2] - \alpha\beta B^2\} - j\alpha\beta KqA^2 \left\{ \left[\frac{\alpha B^2 + \beta q^2}{\alpha\beta q^2 A^2} \right] + (B^2 - K^2) \right\}} \tag{23a}$$

This expression does not yield readily to analysis, except in the case where $A^2B^2=1$, for which the transmission expression reduces to

$$T = \frac{1}{1 + j \left[\frac{K}{B^2 - K^2} \right] \left[\frac{\alpha B^2 + \beta q^2}{\alpha \beta q} \right]} \quad (23b)$$

Equation (15) follows directly from (23b) when $B^2=1$. Hence, the criterion for zero-transmission capability of a parallel- T resistance-capacitance network is that $A^2B^2=1$ in (10') and (11'). This criterion may also be demonstrated as follows. A frequency ratio $K=K'$ can always be found for which $(K')^2=B^2$. In this case, one obtains

$$\frac{(R_1 + R_2)R_3}{X_1'X_2'} = (K')^2A^2 \quad (24)$$

$$\frac{(X_1' + X_2')X_3'}{R_1R_2} = \frac{B^2}{(K')^2} \quad (25)$$

In (24) and (25), X_1' , X_2' , and X_3' are values of X_1 , X_2 and X_3 , respectively, where $K=K'$.

If $(K')^2=B^2$, (25) is of the form of (11); moreover, if $A^2B^2=1$ also, (24) is of the form of (10). Hence, when $K^2=(K')^2=B^2$ the network exhibits zero transmission.

APPENDIX II

REPRESENTATION OF PARALLEL-T RESISTANCE-CAPACITANCE NETWORK BY A SINGLE PI OR TEE NETWORK CONSISTING OF PURE RESISTANCES AND REACTANCES

The form of (15) and (23b) indicates that simple equivalent pi or tee networks can be found, when $A^2B^2=1$, comprising only pure resistances and reactances, all multiplied by a single vector. However, no such networks exist, unless $A^2B^2=1$, since the ratio z_{12}/z_{23} is not otherwise a pure imaginary. The branch components of these pi and tee networks will now be evaluated.

The pi network components follow directly from (12'), (13'), and (14'), by substituting $A^2=1/B^2$ in these equations. The branch-arm impedances may then be written as follows:

$$\begin{aligned} Z_{13} &= \left[\frac{abq}{\alpha B^2 + \beta q^2} \right] \left(q - j \frac{B^2}{K} \right) R \\ &= P \left(q - j \frac{B^2}{K} \right) R \end{aligned} \quad (26)$$

$$\begin{aligned} Z_{23} &= \left[\frac{\alpha \beta q}{\alpha B^2 + \beta q^2} \right] \left(q - j \frac{B^2}{K} \right) R \\ &= Q \left(q - j \frac{B^2}{K} \right) R \end{aligned} \quad (27)$$

$$\begin{aligned} Z_{12} &= j \left[\frac{K}{B^2 - K^2} \right] \left(q - j \frac{B^2}{K} \right) R \\ &= jM \left(q - j \frac{B^2}{K} \right) R. \end{aligned} \quad (28)$$

It will be observed that P , Q , and M are all scalar quantities, and that M alone is a function of frequency. The quantity $(q - jB^2/k)$ is common to all the impedances, and introduces no relative phase difference between Z_{13} , Z_{23} , and Z_{12} .

Hence, a parallel- T resistance-capacitance network for which $A^2B^2=1$ may be considered, from a transmission point of view, to be a pi network consisting of two resistors

$$\frac{abq}{\alpha B^2 + \beta q^2} R \quad \text{and} \quad \frac{\alpha \beta q}{\alpha B^2 + \beta q^2} R$$

as input and output shunt-impedance branches respectively, coupled by a pure series reactance $+j[K/(B^2-K^2)]P_1$. If the network input impedance is to be considered, however, it is necessary to consider the components of this pi as being multiplied by the vector $(q - jB^2/K)$.

In order to study the network input impedance Z_i analytically, a tee representation is very useful, since Z_i then becomes merely $(Z_1 + Z_3)$ which can be obtained directly from Z_1 and Z_3 . (Z_1 , Z_2 and Z_3 are here defined as branch-arm impedances of a tee equivalent to the parallel- T resistance-capacitance network considered, the subscripts being specified in the same manner as those in the tees shown in Fig. 2.)

Conventional formulas exist for obtaining Z_1 , Z_2 , and Z_3 from the expressions for Z_{13} , Z_{23} , and Z_{12} ((26), (27), and (28), respectively). Substitution in these formulas yields the following expressions for Z_1 , Z_2 , and Z_3 :

$$Z_1 = \left[\frac{q - jB^2/K}{(P + Q) + jM} \right] [jPM]R = V[jPM]R \quad (29)$$

$$Z_2 = \left[\frac{q - jB^2/K}{(P + Q) + jM} \right] [jQM]R = V[jQM]R \quad (30)$$

$$Z_3 = \left[\frac{q - jB^2/K}{(P + Q) + jM} \right] [PQ]R = V[PQ]R. \quad (31)$$

P , Q , and M are as previously defined; V is a vector common to all three impedances. Hence, the parallel- T resistance-capacitance network in which $A^2B^2=1$ may be considered as equivalent, from point of view of transmission, to a single tee network in which Z_1 and Z_2 are reactances of the same sign, and Z_3 is a pure resistance. The actual network input impedance may be expressed as

$$Z_i = Z_1 + Z_3 = VP[Q + jM]R. \quad (32)$$

ACKNOWLEDGMENT

The author wishes to express appreciation to Mr. R. F. Wild and Mr. L. B. Cherry, of the Brown Instrument Company, for assistance in the final preparation of this paper.

Additional References

- (1) H. W. Augustadt, "Electric Filter," United States Patent No. 2,106,785; February 1, 1938.
- (2) E. S. Purington, "Universal Resistance-Capacitance Filter," United States Patent No. 2,354,141; July 18, 1944.

“A New Type of Automatic Radio Direction Finder”*

C. C. PINE

H. Busignies:¹ The system described by Pine is quite similar to a system described in U. S. Patent No. 1,741,282, issued to H. Busignies, which was filed on February 18, 1927, corresponding to a French application filed February 20, 1926.

The system described therein makes use of two cardioid diagrams, the switching system, one receiver, one switching output system, and one magnetic indicator. In Fig. 1, which is Fig. 14 of the patent, C_1 and C_2 are the loops being fed into a switching system L_5 and L_6 . A_1 is the sense antenna, which is coupled at all times to the amplifier. S , S_1 and S_2 is a rotating switch which switches the output of the amplifier into two crossed coils B_1 and B_2 . In this system, B_1 and B_2 were two crossed coils of an indicating meter; however, they are equivalent to the two deflecting voltages in a cathode-ray indicator. The only slight difference is in the fact that the switching in the case of Pine's system is made on a three-step basis, while in this case it was made on a four-step basis.

In the system described by Pine, the step corresponding to the sense antenna alone takes one third of the period and is applied to the two windings of the magnetic indicator simultaneously. In the system described in the patent the step corresponding to the sense antenna alone was applied to one winding of the indicator for one quarter of the period, and the other winding of the indicator for the other quarter of the period. This produces an identical effect. The switching of the sense pattern takes place during the time that the radio-frequency switch is disengaged from L_5 and L_6 . Outside of this, the two systems differ only in minor details of realization of the switching system and the indicator. The system described in the patent was tested in 1926 and found to have some merits. It has never been abandoned as a good possible solution for a simple radio compass, but preference has been given to some other designs and principles which, in the meantime, have known large practical application.

C. C. Pine:² In answer to Busignies' discussion on my paper, "A New Type of Automatic Radio Direction Finder," I am in agreement that the system described by me is based on the same general principle as described in his U. S. patent No. 1,741,282.

The main difference between the system under discussion and Busignies' system is in the method of integrating the amplified voltages. In my system use

is made of electrical integrating circuits which make it possible to apply a nonfluctuating-unidirectional flux field to the indicator, while in Busignies' system the voltages are applied, successively, to the armature, and the integration is dependent upon the inertia of the armature itself.

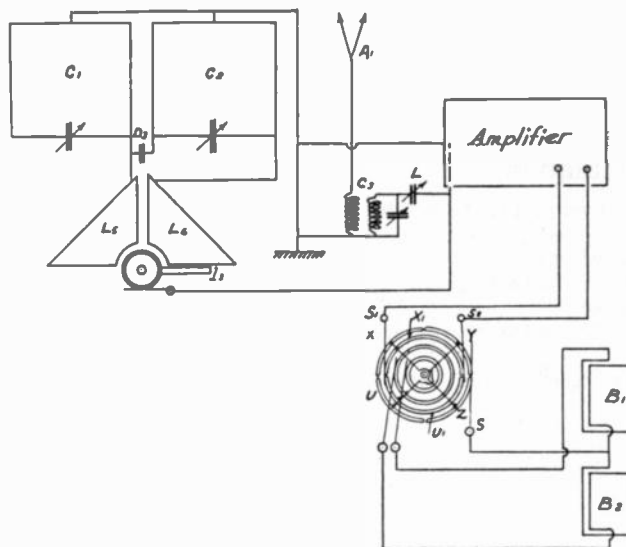

FIG. 1

Further evidence of this feature in my system is indicated by the fact that the output voltages obtained can be utilized to operate a cathode-ray tube, which is, for all intents and purposes, an inertialess meter. In fact, experimentation has shown that a single receiver used with my system will give results comparable to a system using three separate amplifiers to drive the indicating device.

It might be mentioned that a four-point commutation could be adapted to the system under discussion that would seem to have advantages over the three-point method described in my paper.

By applying the individual loop voltages to the input of the receiver, first in aiding and then in opposing combination with the sense voltage, direct voltages may be obtained to give the following results:

$$E_x = (1 + \cos \theta) - (1 - \cos \theta) = 2 \cos \theta$$

$$E_y = (1 + \sin \theta) - (1 - \sin \theta) = 2 \sin \theta.$$

If these voltages are applied to the y and x axes of the cathode-ray tube (or to the crossed coils of the magnetic indicator), the action described in my paper will be duplicated; however, in this case a gain factor of 2 is realized.

* PROC. I.R.E., vol. 33, pp. 522-527; August, 1945.

¹ Federal Telecommunication Laboratories, New York, N. Y.

² 86-19 260 St., Floral Park, L. I., N. Y.

Correspondence

Correspondence on both technical and nontechnical subjects from readers of the PROCEEDINGS OF THE I.R.E. and WAVES AND ELECTRONS is invited, subject to the following conditions: All rights are reserved by the Institute. Statements in letters are expressly understood to be the individual opinion of the writer, and endorsement or recognition by the I.R.E. is not implied by publication. All letters are to be submitted as typewritten, double-spaced, original copies. Any illustrations are to be submitted as inked drawings. Captions are to be supplied for all illustrations.

Simplified Frequency Modulation

The purpose of the circuit is threefold:

1. To make a tube oscillate at a constant average frequency.
2. To make it possible to frequency-modulate it.
3. To control the linearity of modulation.

Disregarding L_2C_2 , the tube acts like

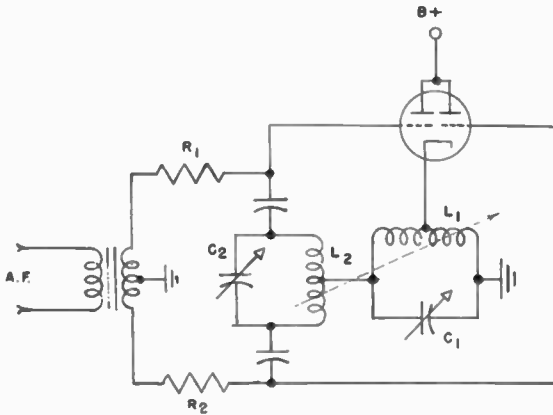

Fig. 1—Frequency-modulation oscillator.

a Hartley oscillator. As such, the grid receives one impulse every cycle (class C). The relatively high grid resistances are limiting the peak grid voltages practically to zero.

At resonance, the voltage across L_2C_2 is at right angles to the one across L_1C_1 . Each grid receives an impulse once per cycle, but the two voltages are in equilibrium. There are now two plate-current pulses present for each cycle.

Assume now that for some reason the frequency is shifting. The angular relationship is upset. Grid 1 receives a larger signal than grid 2. Grid bias 1 becomes larger, re-

ducing the angle of flow and decreasing the contents of fundamental in that part of the plate current originating in section 1 of the tube. The opposite thing happens on the other side. Effect: the phase of the total plate current is shifted in such a way as to compensate for the frequency shift.

If an audio-frequency voltage is applied in push-pull at the two grids by way of R_1R_2 , it alternately increases and decreases the angle of flow on either side of the tube. Thereby the contribution on either side of the tube towards the total plate current is altered and its phase is shifting back and forth. Result: frequency modulation.

Simultaneously a voltage is built up across R_1 and R_2 tending to counteract the modulating voltage. This is the negative feedback. The voltage-frequency characteristic of this device is, therefore, essentially independent of tube characteristics and depends only upon the discriminator curve of $L_1L_2C_1C_2$.

It is generally known how to analyze this type of circuit, but there are a few considerations to be taken into account, which make this arrangement different from the Seeley-Foster type. The load for once is not the same. It may be shown that the system works best if the coupling between L_1 and L_2 reduces the phase shift in the primary to zero in the neighborhood of resonance. This is accomplished with a coupling coefficient of approximately 0.50 of transi-

while the angle of flow of the two impulses turns out to become approximately 90 degrees for best performance.

The circuit, as outlined above, will lend itself particularly well to recover higher (fourth) harmonics in the plate circuit and may be used in numerous combinations with or without amplifiers and even with an integrated mixer. Tapping C_2 at the center will make an excellent frequency-modulation phonograph pickup, which is highly linear, simple, and does not need any additional discriminator. The audio-frequency can be recovered right at R_1 and R_2 . The tube acts as oscillator, amplifier, and discriminator, all at once. If single-ended action is preferred, it may be obtained with less efficiency by putting the capacitance of the pickup in parallel with C_1 instead of C_2 . It is highly important to choose for each application proper values of coupling, load resistors, Q ratio, and L ratio. According to the use of the circuit these values turn out to be widely different from each other.

GEORGE G. BRUCK
157 S. Harrison St.
East Orange, N. J.

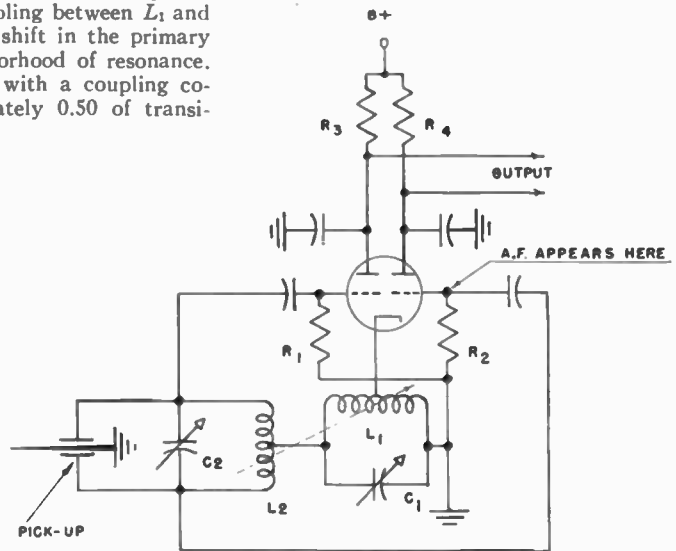

Fig. 2—Frequency-modulation pickup.

tional. Choosing $L_2=3$ to 4 times L_1 will give best results. Either too high or too low coupling is unfavorable. The first because the circuit may oscillate on either of two distinct frequencies, both different from the resonant frequency of L_2C_2 . The second, because the frequency of oscillation becomes dependent on both circuits, while it should, for best performance, depend only on L_2C_2 .

The amount of negative feedback may be controlled by R_1 and R_2 . If very low feedback is desired, a common grid resistor and two radio-frequency chokes must be added.

The angle of flow of the original impulse (L_1 and C_1 only) must be around 120 degrees,

Phase Inverter

While Drukey's letter may prove a useful reminder in the U. S. A., I should like to point out that this circuit has been widely used in England as an input circuit for push-pull amplifiers, following an article by W. T. Cocking in the *Wireless World*, February 7, 1936. I believe there was an earlier description in *Electronics*, October, 1935.

E. F. GOOD
30 Kenbourne Rd.
Sheffield 7, England

¹ D. L. Drukey, "Phase inverter," *Proc. I.R.E.* vol. 33, p. 722; October, 1945.

Contributors to the Proceedings of the I.R.E.



WILLIAM KELVIN

William Kelvin (A'45), was born in New York City on June 27, 1917. He received the M.S. degree in communications engineering from the Harvard Graduate School of Engineering in February, 1945.

Since March, 1945, Mr. Kelvin has been employed as a radio engineer at Federal Telecommunication Laboratories. Varied technical experience gained prior to attendance at the graduate engineering school includes work in electronics at Radiomarine Corporation of America, in New York, N. Y., in 1940, and laboratory work at Raytheon Manufacturing Company, in Waltham, Massachusetts, in 1941.



Rudolf Feldt was born at Berlin, Germany, on August 14, 1907. He studied at the Technische Hochschule in Berlin and received his Engineer's diploma in 1931. From 1931 to 1933 he was employed as research



RUDOLF FELDT

engineer with Lignes Telegraphiques et Telephoniques S.A. at Conflans Ste. Honore, France. He was mainly engaged in problems connected with oscillographic applications.

From 1934 to 1942, he was associated as chief engineer with the Radiophon Company in Paris, which served as distributors for American manufacturers, particularly the General Radio Company and Allen B. Du Mont Laboratories, Inc. This activity was interrupted by his enlistment in the French Army from the beginning of the war in 1939 until after the Armistice in 1940.

Since 1942, Mr. Feldt has been employed in this country with the Allen B. DuMont Laboratories as a development engineer in connection with cathode-ray tube development. At present he is head of the applications engineering department of that organization.



HAROLD B. LAW

Harold B. Law was born September 7, 1911, at Douds, Iowa. He received the B.S. degree from Kent State University in 1934, and at the same time, the B.S. degree in education. In 1936, he was granted the M.S. degree, and in 1941 the Ph.D. degree in physics from Ohio State University. He taught elementary mathematics at Maple Heights, Ohio, in 1935, and at Toledo, Ohio, in 1937 and 1938. In 1941, he joined the electronic-research group of the Radio Corporation of America, and at present is associated with the RCA Laboratories in Princeton, N. J.

Dr. Law is a member of the American Physical Society and Sigma Xi.



Irving E. Lempert (S'39-A'41-M'45) was born on April 11, 1917, at New York City. He received the B.S. degree in electrical engineering with highest honors and spe-



IRVING E. LEMPERT

cial honors in mathematics from Lehigh University in 1939. From 1939 until the present time he has been associated with the Allen B. Du Mont Laboratories, engaging in development and production engineering work on television equipment, cathode-ray tubes, and other electronic equipment.

From 1941 to 1946, Mr. Lempert was in charge of cathode-ray tube engineering in the Du Mont Laboratories. During the war, he served on the Radio Manufacturers Association committee on cathode-ray tube standardization, as chairman of the subcommittee of cathode-ray tube glass characteristics, and later as chairman of the J.E.T.E.C. committee on cathode-ray tubes. He is now in charge of television receiver development at the Du Mont Laboratories.

Mr. Lempert is a member of Eta Kappa Nu, Phi Beta Kappa, Pi Mu Epsilon, and Tau Beta Pi.



Leonard Stanton was born on August 21, 1917, in Philadelphia, Pennsylvania. He



LEONARD STANTON

Contributors to the Proceedings of the I.R.E.



PAUL K. WEIMER

received the A.B. degree in physics from Temple University in 1938, after having served as teaching assistant in physics during 1937 and 1938.

In 1939, Mr. Stanton took part in an instruction course in industrial instrumentation at the Brown Instrument Company, and later in the same year joined the Fischer and Porter Company, taking charge of the theoretical department. In 1940 he was employed by the United States Weather Bureau, leaving the following year to accept a research position on a confidential project with the National Bureau of Standards.

Mr. Stanton joined the research department of the Brown Instrument Company in 1942, and became engaged in war work directly related to contracts essential to the synthetic-rubber program. He has specialized in the development of electronic circuits and their mathematical analysis, for application to precision measuring instruments.

Paul K. Weimer (A'43) was born at Wabash, Indiana, on November 5, 1914. He

received the B.A. degree from Manchester College in 1936, the M.A. degree in physics from the University of Kansas in 1938, and the Ph.D. degree in physics from the Ohio State University in 1942.

During 1936 to 1937, he was a graduate assistant in physics at the University of Kansas. From 1937 to 1939, he taught physics and mathematics at Tabor College, Hillsboro, Kansas. While at the Ohio State University, he was a graduate assistant in physics. Since 1942, he has been engaged in television research at the RCA Laboratories, Princeton, New Jersey.

Dr. Weimer is a member of the American Physical Society and Sigma Xi.



CHAI YEH

search laboratories, RCA Laboratories. Dr. Rose is a member of the American Physical Society.

Chai Yeh was born on September 21, 1911, in China. He received the B.S. degree in electrical engineering in 1931 from the National Chekiang University, China. From 1931 to 1933, he was an assistant in Telefunken and Siemens Central Laboratories in Germany. In September, 1933, he came to America, where he received the M.S. degree in 1934 and the D.Sc. in electrical communication engineering in 1936 from Harvard University.

Dr. Yeh was an assistant in physics and communication engineering at Harvard University from 1935 to 1936. From 1936 to 1937, he was a professor in electrical engineering at National Peiyang University, Tientsin, China. He is now a professor at the Radio Research Institute, National Tsing Hua University, Kunming, China.

Albert Rose (A'36-M'40-SM'43) was born in New York City on March 30, 1910. He received the A.B. degree from Cornell University in 1931 and the Ph.D. degree in physics in 1935. From 1931 to 1934 he was a teaching assistant at Cornell University and since 1935 he has been a member of the re-



ALBERT ROSE

Institute News and Radio Notes

Report of the Secretary—1945

Pursuant to direction in Section 18 of the Bylaws of the Institute, there is here presented a report of the Secretary for the calendar year 1945. This report is designed to portray, as simply as possible, the Institute's general state of well-being, its physical growth, its development in intellectual activities, and the strength of its pulse. I am happy to render a good bill of health for this robust organization which, in comparison with many of its sister engineering institutions, is still a youth; but one rapidly reaching maturity.

It will be seen in the following that the Institute's membership has grown by leaps and bounds under the abnormal stimulus of the war; the flow of members from the broad base of Associates to the higher grades has been increasingly satisfactory; in spite of various war restrictions, the Institute has maintained in its PROCEEDINGS a dignified, scholarly, and informative publication; its technical activities have been somewhat curtailed because of the stress of war and initial pressures of reconversion; and by strengthening of the paid staff and the purchase of new office facilities, it is endeavoring to meet the contingencies of the future.

It is hoped that the readers will find in this report the factual information for the year 1945 which may be useful to them in establishing plans for a strong and virile Institute in the years ahead.

Membership

At the close of the year 1945, the membership of the Institute, including all grades, was 15,782; this number representing a 20 per cent increase over the corresponding figure for the previous year. It is interesting to view this growth in respect to corresponding changes in recent years: for example, in each of the four years in the period 1937 to 1940 the annual increment in the number of members of all grades was under 5 per cent; in each of the next three years this figure rose to about 25 per cent, dropping to 20 per cent in 1944 and 1945. Should these figures drop to 10 per cent and 5 per cent in the next two years, respectively, the Institute would have a total membership of just over 18,000 by the end of 1947. The membership trend from 1912 to date is shown graphically in Fig. 2.

With regard to the distribution of members in the various grades, Fig. 3 shows at a glance the comparison for the years 1944 and 1945. (Actual figures for the distribution in grades are given in Table I.) There has been a growth in all categories, with the exception of Student grade in which the loss of nearly 200 members reflects perhaps the inroads of the Selective Service on men of college age. Although Associates comprise about 70 per cent of the total membership, it is gratifying to note that the relative increase is greatest in the Member grade where the number has

more than tripled in the past year. As a matter of record, the membership ratio (Associates)/(Higher grades) was, in 1939, about 5 to 1. This ratio rose to 6 to 1 in 1944, and dropped to 4 to 1 in 1945.

TABLE I
Membership Distribution by Grades

Grade	As of Dec. 31, 1945		As of Dec. 31, 1944	
	Number	Per cent of total	Number	Per cent of total
Fellow	213	1.2	184	1.4
Senior Member	1,288	8.2	1,025	7.8
Member	1,238	7.9	337	2.6
Associate	11,145*	70.6	9,508†	72.4
Student	1,898	12.1	2,083	15.8
Totals	15,782		13,137	

* Includes 2,048 Voting Associates.

† Includes 2,292 Voting Associates.

The geographical distribution of membership is set forth in Table II which gives an analysis for the past five years of the distribution of membership at home and abroad.

With reference to Table II, it may be seen that in spite of the war, the foreign membership has gradually increased, although such increase was less rapid than in the United States.

It is with deep regret that this office records the death of the following members of the Institute during the year 1945:

SENIOR MEMBERS

Hugh A. Brown (A'16-M'29-SM'43)
C. W. Caldwell (M'41-SM'43)
Walter Dehlinger (A'36-M'37-SM'43)
Bernard A. Engholm (A'22-M'27-SM'43)
R. T. Griffith (A'24-SM'45)
Arthur R. Nilson (J'16-A'18-M'25-SM'43)
Donald W. Short (A'27-M'37-SM'43)
Donald C. Woodruff (M'29-SM'43)

ASSOCIATES

LeRoy C. Anderson (VA'39)
Dana H. Bacon (VA'31)
William S. Booth (S'42-A'43)
Wallace B. Caufield, Jr. (S'41-A'44)
James W. Conklin (VA'31)
Gerald W. Cooke (VA'26)
Robert W. Fischer (S'43)
J. H. C. Hunter (A'43)
Ronald C. Miller (A'45)
Alan V. Ritchie (VA'36)
Luther Creath Smith, Jr. (A'40)

STUDENT

Wayne Crawford (S'42)

Editorial Department

Throughout the year 1945 the Editorial Department has maintained in the publication of the PROCEEDINGS OF THE I.R.E. a high quality in scholarship and general attractiveness to the membership of the Institute. This singular success has been achieved in spite of limitations on the use of paper during the war and a scarcity of really good paper following the cessation of hostilities. The year has likewise seen changes in personnel and office space of the Editorial Department which have permitted it to expand its activities and to prepare to take over some of the important routine work which previously was handled by the Editor in the interest of the Institute.

Although the value of a technical journal is admittedly not measured entirely by the number of its published pages, there are offered here a few statistics for the purpose of showing the growth in size of this publication. In 1945 there were 906 pages of technical and editorial material; an increase of 17 per cent over the year 1944. The amount of technical and editorial material published each year since 1913 is given in the graph in Fig. 1. The pages of advertising likewise increased by about 17 per cent to a total of 976 pages.

The number of technical papers published was 103, written by 138 authors, of which number 105 were members of the Institute. These authors represented 41 different organizations, academic institutions, and the military services.

With the authorization of the Board, the Editorial Department has undertaken the publication of a 1946 YEARBOOK. During the year covered by this report there was initiated the major task of editing almost 13,000 cards for the membership index; and in addition, a second set of cards was prepared for the geographical listings. Much correspondence was involved in preparing the biographies of Fellows of the I.R.E. which are to be a new feature of this YEARBOOK.

In April, 1945, the Editorial Department was moved to the fourth floor of a loft building at 26 West 58th Street in order to relieve the congestion at I.R.E. Headquarters and at the same time to permit expansion of the Editorial staff. In these new quarters the regular personnel increased from four to ten persons, the latter figure including one on loan from headquarters. During the year two new positions were created on the editorial staff; that of Publications Manager,

TABLE II
Five-Year Analysis of United States and Foreign Membership

	1945	1944	1943	1942	1941
TOTAL	15,782	13,137	11,079	8,794	7,021
United States and Possessions	14,053	11,596	9,892	7,788	6,020
Foreign (including Canada)	1,726	1,541	1,187	1,006	1,001
Per Cent Foreign	10.9	11.7	10.7	11.6	14.3

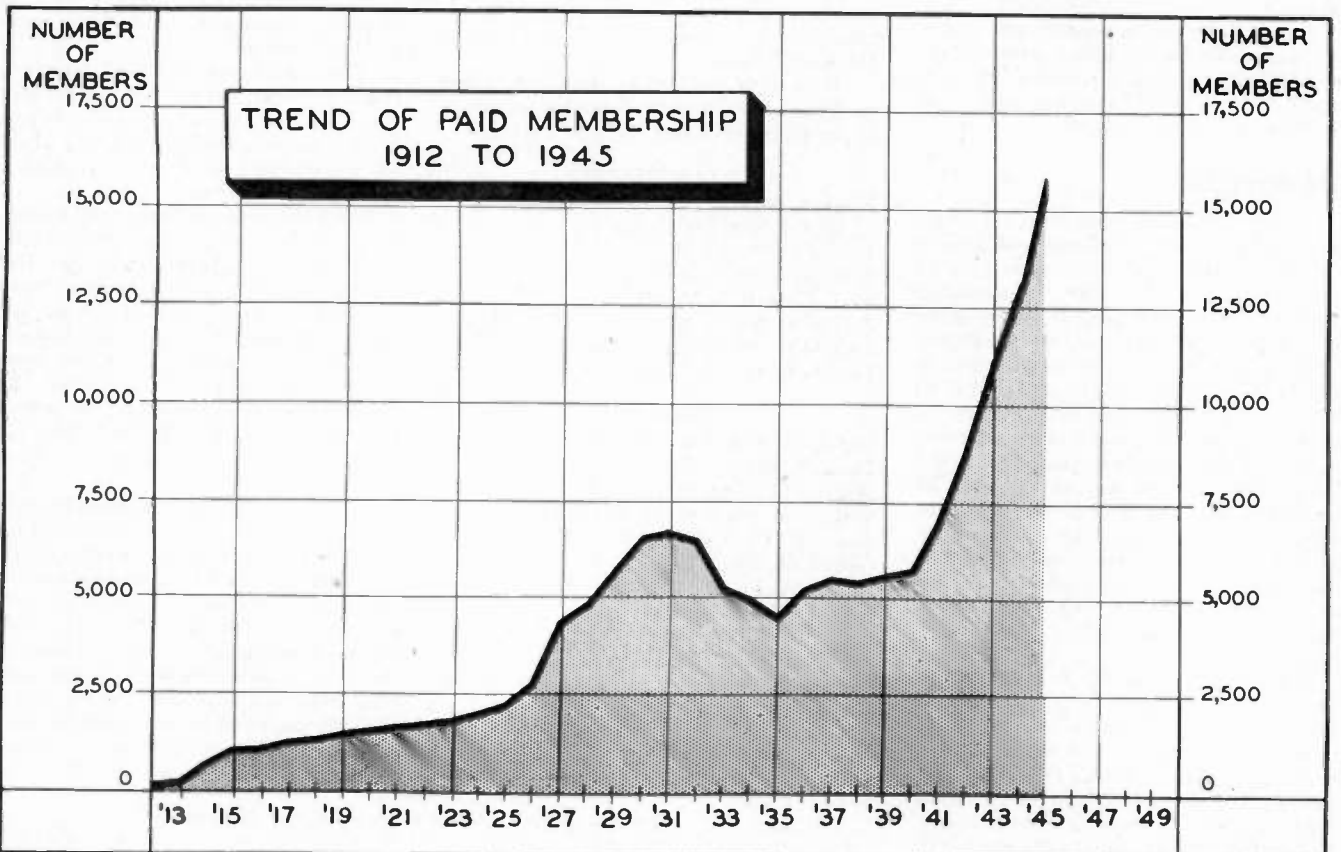
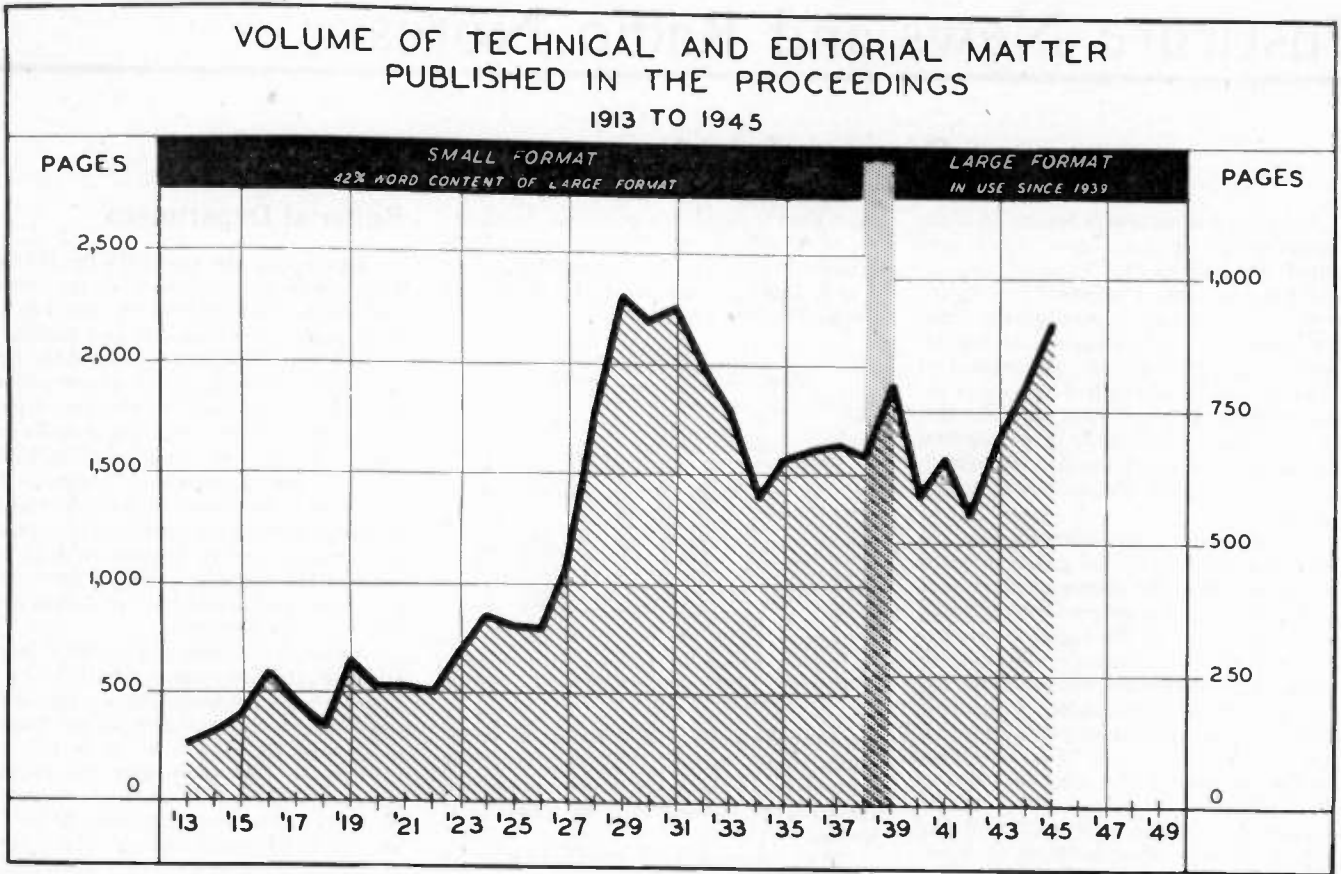

FIGURES 1 - 2

CHART-FACTS, NYC

63-1

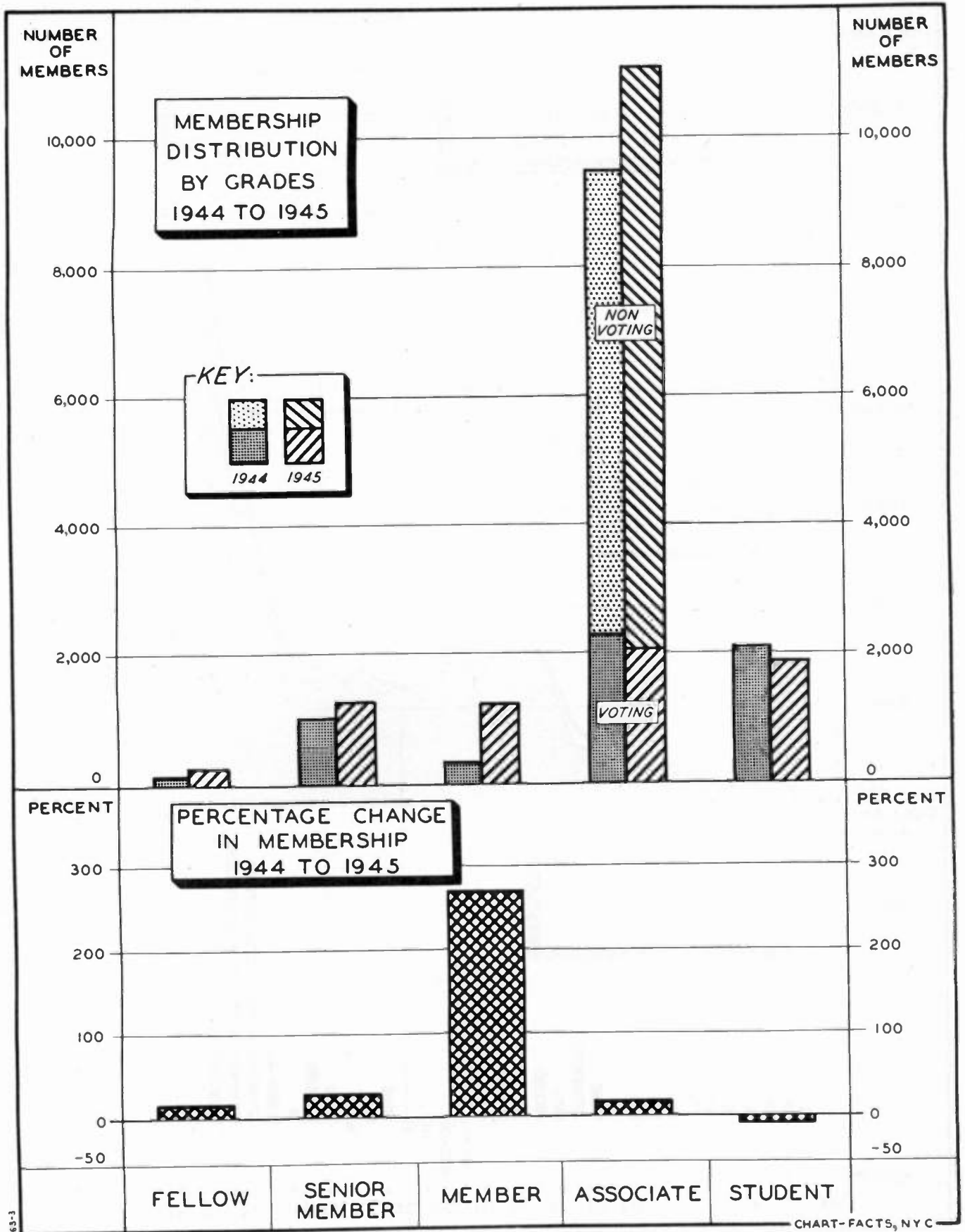

FIGURE 3

CHART-FACTS, N.Y.C.

63-3

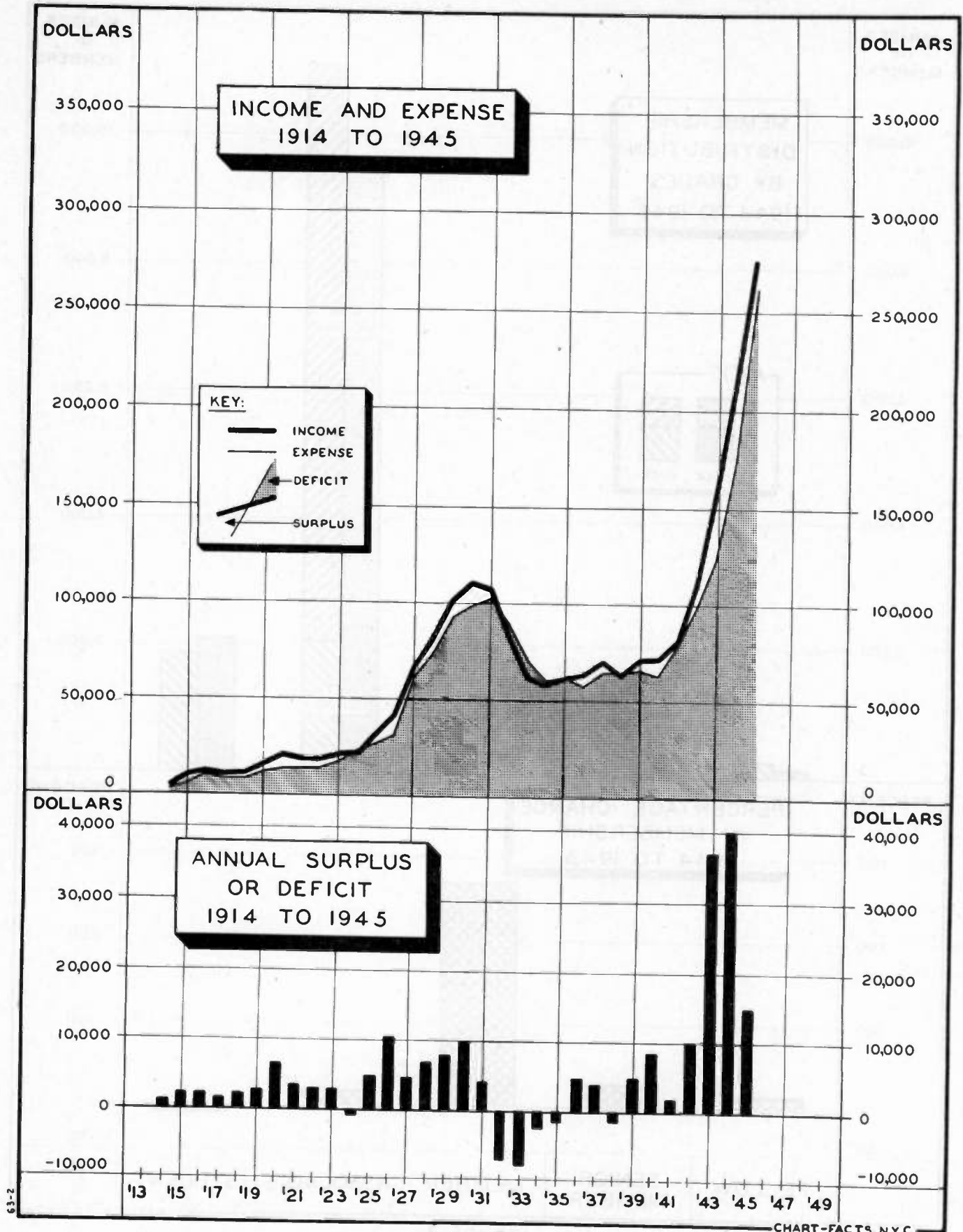

FIGURE 4

CHART-FACTS, N.Y.C.

63-2

being filled by Miss Helen M. Stote, formerly Associate Editor; and the position of Technical Editor, initially being filled by Mr. R. D. Rettenmeyer.

Fiscal

A comparison of the Institute's income and expenses for the years 1944 and 1945 is given in Table III. Although the total income for 1945 was 28 per cent greater than the previous year, the net income dropped more than 50 per cent. This latter fact reflects the relatively large increases in the salary item, travel, office repairs and equipment, and Sections' expenses.

The incomes and the expenses for each year beginning with 1914 are plotted graphically in Fig. 4.

TABLE III
Condensed Comparison of Income and Expenses for
1944 and 1945
(From Accountant's Report dated Dec. 31, 1945)

	1945	1944
<i>Income</i>		
Membership Dues	\$ 95,813.18	\$ 78,949.00
Advertising	122,623.89	98,911.40
Subscriptions	20,333.82	15,122.15
Others	37,513.57	21,661.82
<i>Total Income</i>	<u>\$276,284.46</u>	<u>\$214,644.37</u>
<i>Expenses</i>		
Printing PROCEEDINGS	\$ 50,307.27	\$ 39,292.37
Salaries	79,017.99	42,840.00
Advertising Commissions	32,039.50	26,063.46
Others	99,841.21	66,692.46
<i>Total Expenses</i>	<u>\$261,205.97</u>	<u>\$174,888.29</u>
<i>Net Income</i>	<u>\$ 15,078.49</u>	<u>\$ 39,756.08</u>

Technical Activities

The technical activities of the Institute, outside of its publications, are carried on primarily through its Sections, its Committees, and the Winter Technical Meeting. To some degree, the war has suppressed these technical activities; but since the termination of hostilities plans are being laid to step up these vital functions of the Institute.

The Sections, which number 33 in all, have for the most part shown a substantial increase in membership. Although no new Sections have been authorized during the calendar year of 1945, some of the present Sections have established and nurtured small groups functioning under their aegis. These groups have been unofficially designated as Subsections and some of them show promise of developing into full-fledged Sections in the near future. These groups have been formed at Columbus, Ohio; Ft. Wayne and South Bend in Indiana; Milwaukee, Wisconsin; and Ft. Monmouth and Princeton in New Jersey.

During 1945 the Technical Committees labored under the restrictions of war and the pressures of reconversion in industry. As a result, progress has been limited to a few fields which were of vital current importance. A notable accomplishment however has been the establishment of close co-ordination of I.R.E. technical activities with the corresponding functions of the Radio Manufacturers Association.

A Winter Technical Meeting of the I.R.E. was held in January, 1945 at the

DELAYS MAY OCCUR—PLEASE WAIT!

It is intended that the PROCEEDINGS OF THE I.R.E. AND WAVES AND ELECTRONS shall reach its readers approximately at the middle of the month of issue. However, present-day printing and transportation conditions are exceptionally difficult. Shortages of labor and materials give rise to corresponding delays. Accordingly, we request the patience of our PROCEEDINGS readers. We suggest further that, in cases of delay in delivery, no query be sent to the Institute unless the issue is at least several weeks late. If numerous premature statements of nondelivery of the PROCEEDINGS were received, the Institute's policy of immediately acknowledging all queries or complaints would lead to severe congestion of correspondence in the office of the Institute.

Hotel Commodore in New York City. An enthusiastic response to this convention was exemplified by the registration of 2,018 persons at the height of the war and at a time when travel facilities were at an extremely low ebb. In spite of Government security regulations which affected much of the technical work of the Institute members, 43 technical papers of commendable quality, were presented at this meeting.

Significant Board Actions

Regional-Representation Plan. At its meeting on March 7, 1945, the Board first considered the idea of redistricting the Sections in a limited number of discrete Regions which in sum total would embrace the entire area of the United States. Under this plan, which has been under study by a special committee throughout most of the year, each member of the Institute residing in the United States automatically would come under the jurisdiction of some one Section; and his voice in Institute affairs would channel through his Section to elected Regional Representatives on the Board of Directors. By these means it is hoped to assure broader representation on matters of high policy to all members throughout the length and breadth of the country.

RMA Co-ordinating Committee. Four members of the Institute were appointed as a committee, the purpose of which was to improve the co-ordination of functions of the RMA and the I.R.E.; and jointly with a similar group from the RMA, to recommend definitions of the proper spheres of activities of each organization.

Westman Amendment. During the current year the Board presented to the membership, and obtained endorsement thereof, an amendment to the Constitution embracing changes in the dues structure of the Institute. In essence, these changes embody an increase in dues for Members from \$6 to \$10 per year, and for Associates from \$6 to \$7 for the first five years in that grade and to \$10 thereafter. They embody also the

elimination of transfer fees and the establishment of a uniform entrance fee of \$3 for all grades except Student, for which there is no entrance fee.

Radio Technical Planning Board. The Institute sustained its status as a Contributing Sponsor for the Radio Technical Planning Board by assignment of \$500 toward the support of that body. As of October 1, 1945, Mr. Haraden Pratt became chairman of the Radio Technical Planning Board; Dr. William H. Crew has been its secretary since June, 1945.

Society for the Promotion of Engineering Education. By action of the Board, the I.R.E. accepted an Institutional Membership in the S.P.E.E.

Building Fund and New Office Quarters. At the Board meeting of December 5, 1945, it was reported that subscriptions to the I.R.E. Building Fund amounted to \$623,000 and that the Board of Standards and Appeals had granted to the Institute permission for occupancy of the Brokaw Mansion at 1 E. 79th Street, New York City. On December 28, 1945, the sale of this property to the Institute was consummated and as soon as necessary alterations can be carried out it is planned to move the office staff and Editorial Department to this new location. The I.R.E. Building Fund Committee and the Office-Quarters Committee are worthy of the highest commendations for their respective achievements leading to the acquisition of this new headquarters and home of the Institute.

Staff Changes. As a result of the rapid growth of the Institute membership and the imminent broadening of its activities, the need for enlargement and strengthening of the staff at the office Headquarters was abundantly evident. To meet these circumstances the Board created the office of "Executive Secretary," in the filling of which the Institute is most fortunate in securing the able services of Mr. George W. Bailey, whose distinguished career in the field of amateur radio communication and in responsible administrative positions is well known.

Following the withdrawal of Mr. W. B. Cowlich as Assistant Secretary, this office was filled by Dr. William H. Crew who is on a half-time basis pending termination of his wartime activities with the National Defense Research Committee.

In order to supplement the work of the editorial staff the Board established the office of "Technical Editor" which was originally filled by R. D. Rettenmeyer, recently of the Editorial Department of the General Electric Company. The Board also created a staff position of "Technical Secretary," of which the incumbent is to facilitate and co-ordinate the work of the several technical committees of the Institute. Up to the end of the year no one was found to fill this position.

Respectfully submitted,



Haraden Pratt, Secretary

May 10, 1946

NOMINATIONS—1947

At its June 5, 1946, meeting, the Board of Directors received the recommendations of the Nominations Committee for officers for 1947. They are as follows:

For President
1947

W. R. G. Baker

For Vice-President
1947

Noel Ashbridge

Directors 1947-1949

M. G. Crosby
R. F. Guy
R. A. Heising

G. T. Royden
J. E. Shepherd
D. B. Smith

PROCEEDINGS FOR I.E.E. MEMBERS

A notice was published in the January, 1946, issue of the PROCEEDINGS OF THE I.R.E. AND WAVES AND ELECTRONS that subscriptions to PROCEEDINGS would be available to I.E.E. members at a price of \$6.00 per year (including \$1.00 for foreign postage). Since the Board of Directors has raised the price of PROCEEDINGS to members from \$5.00 to \$6.00, it is now necessary to increase the price of PROCEEDINGS (including \$1.00 for foreign postage) to I.E.E. members from \$6.00 to \$7.00.

EDITORIAL ADMINISTRATIVE COMMITTEE

The Executive Committee approved the recommendation that the name "Editorial Executive Committee" be changed to "Editorial Administrative Committee" which was selected to avoid possible confusion with the Executive Committee of the Board of Directors.

The Editorial Administrative Committee, composed of R. S. Burnap, E. W. Herold, Donald McNicol, Haraden Pratt, and L. E. Whittemore (with the Editor as chairman), is the administrative committee of the Board of Editors and functions between meetings of the Board of Editors. Actions of the Editor and Editorial Administrative Committee are subject to validation or overruling by the Board of Editors and the Board of Directors.

WINNIPEG SUBSECTION

Mr. R. A. Hackbusch reported that members in Winnipeg, Canada, now form a Subsection of the Toronto Section.

AMERICAN STANDARDS ASSOCIATION

F. R. Lack, director of the American Standards Association representing The Institute of Radio Engineers, reported to the Board of Directors on the aims of the organization. Following a discussion, a vote of thanks was extended to him, and a motion that the I.R.E. give its full support to the project of extending the activities of the ASA as outlined by Mr. Lack was unanimously approved.

BROWDER J. THOMPSON
MEMORIAL PRIZE FOR 1946

The first Browder J. Thompson Memorial Prize was presented to Gordon M. Lee during the banquet of the I.R.E. Fourth Electron Tube Conference held at Yale University, New Haven, Connecticut, June 27 and 28, 1946.

Readers of the PROCEEDINGS no doubt will remember that a memorial prize, to be awarded yearly in memory of the late Browder J. Thompson, was made possible through the donations of many of his friends. The fund, so established, was turned over to the Institute to administer, the income therefrom being employed to provide an annual award.



GORDON M. LEE

This award is known as the Browder J. Thompson Memorial Prize. Its purpose is to stimulate research in the field of radio and electronics and to provide incentive for the careful preparation of papers describing such research. The award shall be made annually to the author or joint authors under thirty years of age for that paper of sound merit recently published in the technical publications of The Institute of Radio Engineers which, in the opinion of the Awards Committee of the Institute, constitutes the greatest contribution to the field of radio and electronics and the best presentation of the subject.

The Awards Committee unanimously concluded that a paper by Gordon M. Lee admirably met the above qualifications and that he should be given the award for his paper, "A Three-Beam Oscillograph for Recording at Frequencies up to 10,000 Megacycles."* The Awards Committee believed this paper to be of sound merit and that it constituted an excellent combination of presentation of the subject and a great technical contribution to the field of radio and electronics.

Gordon M. Lee (A'45) was born on January 3, 1917, at Minneapolis, Minnesota. He received the B.E.E. degree from the University of Minnesota in 1938. For the following year he was employed as a research and teaching assistant in electrical

engineering at the University of Missouri and received the M.S. degree in electrical engineering from that school in 1939. From 1939 to 1945 he was associated with the Laboratory for Insulation Research at the Massachusetts Institute of Technology, receiving the D.Sc. degree in electrical engineering from M.I.T. in 1944.

In 1945 he became one of the technical directors of the newly organized Central Research Laboratories, Inc., of Red Wing, Minnesota, an organization devoted to consultation, research, development, and limited production in the fields of chemistry, physics and electrical engineering.

Dr. Lee is a member of the American Institute of Electrical Engineers, the American Physical Society, Sigma Xi, Tau Beta Pi, and Eta Kappa Nu.

TELEVISION BROADCASTERS ASSOCIATION CONFERENCE AND EXHIBITION

The Second Television Conference and Exhibition of the Television Broadcasters Association, Inc., will be held in the Waldorf-Astoria Hotel in New York City, on October 10 and 11, 1946. The Conference will be devoted to meetings at which television papers will be presented; an exhibit of post-war television receivers, transmitters, studio equipment, and parts; presentation of TBA awards for outstanding contributions to the development of the television art; and demonstrations of television broadcasting with programs originating at the Conference, at New York studios, and at remote points, connected via coaxial cable and relays. Panel meetings, banquet sessions, luncheon sessions, and a cocktail party are also features of the interesting program.

POSTWAR PUBLICATION FUND

The remaining \$10,000 of the previously earmarked \$20,000 Postwar Publication Fund has been released for the publication of additional pages in 1946 in the PROCEEDINGS OF THE I.R.E. AND WAVES AND ELECTRONS, and the Executive Secretary has been authorized to notify the Editor of the total number of technical pages which may be included within the adopted 1946 budget with the \$20,000 Postwar Publication Fund added thereto.

RADIO TECHNICAL PLANNING BOARD

The Institute of Radio Engineers plans to enlarge its technical-committee activities to include in their scope practical engineering applications and technical operating problems with a view to providing a more extensive basis of engineering information for the use of other groups such as the Radio Technical Planning Board. Also, the policy of the I.R.E. Standards and Technical Committees will be to work closely with the Radio Technical Planning Board in carrying out studies that may arise in its sphere of activity.

* PROC. I.R.E. AND WAVES AND ELECTRONS, vol. 34, pp. 121W-127W; March, 1946.

JOINT IRE-IEE MEETING HELD BY RADIOTELEPHONE DURING 1946 MIDWINTER TECHNICAL MEETING

As one of the events of the recent I.R.E. Midwinter Technical Meeting held at the Hotel Astor in New York January 23-26, a joint session was conducted by means of transatlantic radiotelephone with the Institution of Electrical Engineers in London. The paper, "An Introduction to Hyperbolic Navigation" by J. A. Pierce, was read in London at the same time that Mr. Pierce delivered it in New York. Thereafter, the following exchange occurred across the ocean, being reproduced by loudspeakers in the meeting rooms on both sides.

The Chairman (in London): We are now joined, through the radio link, with the meeting of the Institute of Radio Engineers in New York. I call upon Dr. Dunsheath, president of the Institution of Electrical Engineers in London, to speak.

The President of the Institution of Electrical Engineers (Dr. P. Dunsheath) (recording from London): I understand that at this moment you are meeting in the Rose Room of the Hotel Astor, New York, and it is my very great privilege, as president of the Institution of Electrical Engineers, to send you a message of greeting on behalf of the members assembled in our lecture theater at our headquarters overlooking the Thames in London. This is a special, occasion, on which for the first time a joint technical discussion is being held between our two institutions, connected by radio link. This is, moreover, the first occasion since the war when we are able to confirm the close collaboration which has existed between our two countries in all matters scientific and technical.

Mr. Pierce's paper describes a recent application of an outstanding scientific discovery which has been one of the vital factors in the successful prosecution of the war. It will also have important peacetime applications in the development of increased safety in travel, whether by sea or air.

The Institution of Electrical Engineers is proud to be able to take a leading part in discussions on radio subjects, in view of the fact that it was founded as the Society of Telegraph Engineers exactly 75 years ago. We all feel, on this side, that the present meeting is an augury of even closer collaboration between us. We are looking forward to your contribution to our own Radar Convention in March, and for my own part I am very glad to know that during the next few weeks I shall be able to make personal contact with many of you in the United States when I visit your great country in connection with a forthcoming trip to Canada.

Mr. Mumford (chairman of the Radio Section, Institution of Electrical Engineers): I now invite Dr. Llewellyn, president of the Institute of Radio Engineers in New York, to speak.

The President of the Institute of Radio Engineers (speaking in New York): Dr. Dunsheath and members of the Institution

of Electrical Engineers: It is indeed a great pleasure to hear from you directly and to join with you in this technical discussion, even though we are separated by so many miles of ocean that you are having an evening meeting while here it is early afternoon. The engineering collaboration that was built up during the war, and especially the warm personal friendships which developed, belong to those truly worth-while things of life which must be preserved. We are especially glad that a number of your members are able to be with us here in New York, including Brigadier Deedes, Mr. Ross, Mr. Forshaw, Major Wilson, Commander Affleck Graves, Lieutenant Rowley and Lieutenant Dodds. Besides these, Sir Robert Watson Watt and our own former vice-president, Mr. F. S. Barton, are with us. I also understand that our Board is to have the very great pleasure of meeting with you and Mr. Brasher in New York in February. At that time I hope we can further the plans which have been discussed with Dr. Smith-Rose and Mr. Kirke when they were here last year, for collaboration with the Institution of Electrical Engineers.

It is particularly fitting that the paper by Mr. Pierce, to which we have listened together, should deal with instrumentalities for increasing the safety and precision of travel between our two countries. We are now anticipating hearing a discussion of that paper from your side of the ocean. Please accept our thanks for your very gracious greeting.

Mr. Mumford (from London): As chairman of the Radio Section of the Institution of Electrical Engineers, it gives me very great pleasure to send greetings from the many members of my Section to the members of The Institute of Radio Engineers of America and perhaps, as I do so, it is not inappropriate that my words should bridge the ocean that has been navigated in the past few years so many times using a form of the system which has been described today and a system which has satisfied a great operational need.

Talking over the short-wave radio link reminds me of a study that we made in November, 1942, of the inherent possibilities of a position-indicator scheme for use over distances of several thousand miles, using a carrier frequency below 100 kilocycles per second, modulated with a low frequency. The accuracy of such a system naturally depends upon the constancy of the envelope delay occurring in propagation over the distances concerned and we made, therefore a short series of tests to determine the total variation of the envelope delay of the two long-wave radiotelephone channels linking our two countries; these channels operate on frequencies of 60 and 68 kilocycles, respectively, for the two directions of transmission. Using a modulation frequency of 600 cycles per second it was found that the apparent over-all variation of envelope delay for the two channels in tandem was within plus and minus 90 microseconds; this corresponds to an error of less than 9 miles on a line between two stations on opposite sides of the Atlantic. These remarks may be of interest to the author in view of his reference to the development of a low-frequency loran system and in this connection, I should be

interested to know the frequency range in which this development is contemplated and the reasons for its choice.

The standard loran system provides the same facilities as the British Gee System and in much the same way, but it operates over much longer distances. The facility has, however, been provided at the expense not only of considerable effort and ingenuity—of which there seems to be an almost inexhaustible supply—but also of space in the frequency spectrum which is in very limited supply and is indeed to all intents and purposes irreplaceable. It might perhaps be claimed that although the band occupied by a loran transmission is as wide as 100 kilocycles per second, the duration of the pulses is so small compared with that of the intervals between them that the intensity of the interference at any point of the spectrum is not excessive. It would, however, be interesting to have the author's views on the possibility of reducing the interference caused by the system and the effect of any such reduction on the accuracy.

While I note that the bandwidth required for a complete system is conserved by operating as many as eight pairs in a single radio-frequency channel, it would be interesting to know why the number is limited to eight. I apologize for being somewhat like *Oliver Twist* in asking for more but frequencies are very precious.

Mr. Pierce has introduced us gently to the art of hyperbolic navigation and it will, I am sure, give him great pleasure to know that at the conclusion of the joint meeting we will continue this discussion for some time here, in London. I have therefore much pleasure in proposing a vote of thanks to the author for his paper and the excellent way in which he has presented it simultaneously in New York and London and to express the hope that we may have many more such joint discussions in the future. I now ask the author to reply.

Mr. J. A. Pierce (speaking in New York): Mr. Mumford, I am afraid, has raised altogether too many questions to be answered in the minute or two which remain to us. I wish very much that I could join with our friends in London this afternoon or this evening in a really extended discussion of these matters. I have frequently claimed that it takes at least three weeks to introduce a new victim to the mysteries of hyperbolic navigation, but I should very much relish an opportunity to answer the specific questions which have been raised. There are, I can assure you, good answers to all of them. The answers in many cases have been dictated by the fact that we were building a system under stringent military necessity. We had to standardize in almost every instance on the first bit of equipment which could be shown to be reasonably satisfactory, without waiting for another that came closer to the heart's desire.

If I recall Dr. Mumford's questions correctly, perhaps the most significant one at the moment is the question of the choice of a frequency for a low-frequency loran system. The actual frequency upon which experimentation has been done so far is 180 kilocycles per second. The frequency is chosen essentially as the lowest frequency that we thought we could generate and

radiate a pulse. That is a very simple answer to what is actually a highly complicated question. I am afraid that without going into the question of mass interference which limits the number of frequencies available for standard loran, the number of stations usable at a frequency, it has the unfortunate result at 2 megacycles per second that if we transmit one pulse we may get back 20, 40, or 50 and the intolerable effect of superimposing 200 at the same recurrence rate is forbidding, to say the least.

I should say just a word to express my regret that it is not possible in such a short time to give due credit to all of those who have made a system of this sort possible. There have been a hundred or so of us in the radio laboratory in the early days, but the system has gone far beyond that and has required the training of tens of thousands of navigators, and that is not done easily. The Services, the Canadian Army and Navy, the Royal Air Force, and the British Admiralty have all collaborated on standards with remarkable ease. They have trained people and they have spread the system across the face of the earth in a time which is completely inconceivable to me.

I wish I could go on with this indefinitely, but time does not permit. All I can say is that it has been a great pleasure to join in the simultaneous presentation and an immense privilege to me, speaking from New York, to participate in a joint session with the Institution of Electrical Engineers. Thank you, London.

Mr. Mumford (in London): Thank you, New York. Goodbye.

NATIONAL BUREAU OF STANDARDS REVISES CLASSIFICATION OF RADIO SUBJECTS

The National Bureau of Standards has issued a "Revised Classification of Radio Subjects Used in National Bureau of Standards" in pamphlet form. This publication is an expansion and revision of National Bureau of Standards Circular C-385, "Classification of Radio Subjects—An Extension of the Dewey Decimal System," which was published in the August, 1930, issue of the PROCEEDINGS OF THE INSTITUTE OF RADIO ENGINEERS. The pamphlet is for use in classifying references to radio literature, radio reports, books, or any radio materials or items of interest to workers in the radio field. Its numbers will be used hereafter in classifying the articles in THE PROCEEDINGS OF THE I.R.E. AND WAVES AND ELECTRONS.

Intercomparison of the revision with the older classification will show the same basic classifications, but great expansion of some parts and some additions. One of the chief merits of the system is its capability of indefinite expansion. It is expected that additions to the present system will be made: (1) from suggestions received by users, (2) as the need develops, and (3) as secret material becomes unclassified.

The present revision, like the original NBS Circular C-385, is based upon the twelfth edition, 1927, of Dr. Melvin Dewey's

January, 1946, copies of The PROCEEDINGS OF THE I.R.E. and WAVES AND ELECTRONS, in good condition, will be purchased by The INSTITUTE OF RADIO ENGINEERS at 50 cents a copy.

book "Decimal Classification and Relative Index for Libraries, Clipping Notes, etc.," and should not be confused with the fourteenth edition, 1942, of that book, which devoted some space to radio. The radio subjects covered in the 1942 edition have numbers differing from those assigned in the Bureau's pamphlet.

A copy of this pamphlet is available, without charge, from the National Bureau of Standards, Washington 25, D. C., to those having need for such a classification.

FREQUENCY-MODULATION INDUCTIVE-TUNING RECEPTION

At a joint meeting of The Institute of Radio Engineers and The Radio Club of America, held on March 28, at the Engineering Societies Building in New York City, Paul Ware (A'28-VA'39-SM'44) of the engineering staff of Allen B. DuMont Laboratories, Inc., presented a paper on an inductive-tuning system for frequency-modulation television receivers. The system offers a method for covering the 44- to 216-megacycle frequency-modulation television frequencies with continuous tuning and no switching required. The flexibility as to selection of a channel anywhere within the band was pointed out, and various applications, including a push-button automatic-selecting mechanism, were described. A demonstration of the new input system was given in conjunction with one of the DuMont 20-inch direct-viewing television receivers, the program originating in Washington and thence by radio from WABD in New York.

CONTRIBUTIONS FROM BUENOS AIRES SECTION

The Institute of Radio Engineers recently received a substantial contribution to its Building Fund from the Buenos Aires Section. Adolfo DiMarco (VA'39-M'45), chairman of the Section, stated that the support of its members has been willingly and gladly forthcoming for the worth-while purpose that all are eager to see developed successfully.

Cordial letters expressing the Institute's thanks were sent to Mr. DiMarco, emphasizing the spirit of unity that exists through the Institute and the pioneering work the Section has been doing, which serves as a model for the establishment of other Sections throughout the world. The gratitude of the Institute was extended to every member of the Buenos Aires Section for the generosity and spirit of co-operation that prompted the gift.

NEW SCIENTIFIC DEPARTMENT AT HARVARD UNIVERSITY

A move in the direction of better training of scientists and engineers for research in communications and allied subjects was made by Harvard University last February with the creation of a new Department of Engineering Sciences and Applied Physics. The new department represents a consolidation of some of Harvard's facilities for instruction and research in applied science and will provide both undergraduate and graduate instruction devoted to emphasis on the fundamental basic training in mathematics and physics which is necessary for advanced research and development work in electronics, acoustics and other branches of the communication arts and the mechanical engineering sciences. In addition to support of the faculty groups already engaged in applied science instruction and research, including the staff of the Cruft Laboratory, the University has allocated to the new department \$2,000,000 from the Gordon McKay Endowment Fund. Associate Professor F. V. Hunt (A'28-VA'39-M'41-SM'43) has been appointed chairman of the new department.

RCA REVIEW RESUMES PUBLICATION

Publication of the *RCA Review*, a technical journal of radio-and-electronic research and engineering, was resumed in March, 1946, on a quarterly basis, it was recently announced by the RCA Laboratories Division of the Radio Corporation of America Founded in 1936, the *Review* was suspended in 1942 when distribution of technical information was restricted by wartime security regulations.

Contents of the *RCA Review* consist of papers prepared by scientists, engineers, and executives of The Radio Corporation of America and its various divisions and subsidiaries. All fields of radio-and-electronic research will be treated including television, radar, electron optics, vacuum tubes, marine and air navigational systems, and communications. A board of twenty editors is headed by Dr. C. B. Jolliffe (M'25-F'30), executive vice-president in charge of RCA Laboratories Division. Editorial offices are at Princeton, New Jersey.

NEW PATENT PUBLICATION

Public Domain, a new weekly publication of the Scientific Development Corporation, 614 West 49 Street, New York 19, N. Y., first appeared in May, 1946. Each issue will contain over 1000 patents due to expire four weeks after the date of the issue, plus a simplified index, and each patent shown will include a reproduction of a draftsman's drawing together with a digest of typical claims and salient features. Charter subscriptions are offered for one year at \$45.00, for six months at \$25.00, and for 10 weeks at \$10.00.



Bachrach

DAVID C. PRINCE

DAVID C. PRINCE RECEIVES LAMME MEDAL

David C. Prince (A'45-SM'45), vice-president of General Electric Company's general engineering and consulting laboratory, Schenectady, New York, was recently awarded the 1945 Lamme Medal of the American Institute of Electrical Engineers. The award, given annually for achievement in electric apparatus or machinery development, was presented to Mr. Prince for his work on high-voltage switching equipment and electronic converters.

Dr. Prince attended the University of Michigan for two years; received his B.S. and M.S. degrees in electrical engineering from the University of Illinois; attended Lincoln College of Law; and received the honorary degree of Sc.D. from Union College. He was first employed in General Electric's test and railway motor department in 1913, and, in 1914 he became assistant to the electrical engineer in the Public Utilities Commission of Illinois. A first lieutenant in World War I, Dr. Prince received a citation from Washington for his services in the solution of aircraft engineering problems. In 1919, he joined General Electric's radio department, and in 1923, became associated with the research laboratory. He served as chief engineer of the switchgear department of the Philadelphia, Pennsylvania, plant in 1931, and, in 1940, he returned to Schenectady as manager of commercial engineering. The following year, Dr. Prince was named vice-president in charge of application engineering.

A professional engineer in New York State, Dr. Prince is a Fellow and member of the Board of Directors of the American Institute of Electrical Engineers. He is a member of the American Society of Mechanical Engineers, the Institute of Aeronautical Sciences, and the Society of Automotive Engineers. He was selected as one of the "Modern Pioneers of Industry" by the National Association of Manufacturers in

Conjunction with the observance of the 150th Anniversary of the United States Patent System.



FREDERICK E. TERMAN AND MERLE A. TUVE

Membership in the National Academy of Sciences was conferred on Frederick E. Terman (A'25-F'37) and Merle A. Tuve (F'45) on April 24. Dr. Terman, dean of the Stanford University School of Engineering, was director of the Radio Research Laboratory at Harvard University in charge of its work on radar countermeasures. Dr. Tuve, pioneer in the experimental proving of the ionosphere and initiator of the pulse method of probing by reflection, holds the position of chief physicist at the Carnegie Institution of Washington.



J. ERNEST SMITH

J. Ernest Smith (A'37) has joined the Raytheon Manufacturing Company to head its microwave communication engineering department. A graduate of Jamestown College, he received the degree of master of electrical engineering from the Polytechnic Institute of Brooklyn.

During the past twelve years, Mr. Smith has been associated with the Radio Corporation of America, subsequently becoming research division head of RCA Laboratories. A communication engineering instructor at RCA Institutes for four years, Mr. Smith also was graduate lecturer on radio and television for three years at New York University. The author of "Simplified Filter Design," he holds the title of adjunct professor at NYU, and has had granted to him numerous patents on modulation systems, radio-relay control systems, and frequency-modulation systems.



J. ERNEST SMITH



Underwood and Underwood

GEORGE C. SOUTHWORTH

GEORGE C. SOUTHWORTH RECEIVES LEVY MEDAL

The 1946 winner of The Franklin Institute's Levy Medal is George C. Southworth (M'26-F'41) of the Bell Telephone Laboratories. The award, presented to the author of a paper of especial merit published in the *Journal of The Franklin Institute*, with preference being given to one describing the author's experimental and theoretical researches in a subject of fundamental importance, was given for Dr. Southworth's paper, "Microwave Radiation from the Sun," which appeared in the April, 1945, issue. It reported the discovery of short-wave radiation in the light coming from the sun, and it is hoped that this discovery will lead to the finding of a source of radio waves outside the earth to provide a new method of attack on the problems of the earth's atmosphere.

A graduate of Grove City College, Dr. Southworth received his Ph.D. degree from Yale University in 1923 where he was an instructor and assistant professor of physics for five years. Since 1923, he has been engaged in communication research for the Bell System where he conducted experiments in which extremely short radio waves were transmitted through the interior of hollow metal pipes. Subsequent development led to a system for dealing with such waves, and this method, sometimes called the waveguide technique, has been used extensively in radar applications and is an important part of the proposed intercity relay systems for television.

Dr. Southworth is a Fellow of the American Physical Society and the American Association for the Advancement of Science. In 1931, he received the honorary degree of Doctor of Science from Grove City College, and in 1938, he was awarded the Morris Liebmann prize of The Institute of Radio Engineers.



I.R.E. People



ARCHIBALD S. BROWN

ARCHIBALD S. BROWN RECEIVES BRITISH MEDAL

Captain Archibald S. Brown (A'39), United States Naval Reserve, recently was awarded a medal welcoming him as an officer of the Distinguished Order of the British Empire by Lord Halifax. The award was given for Captain Brown's services in assisting the Royal Navy in his capacity as radio matériel officer and electronics officer at the Navy Yard in Brooklyn, New York.

His citation reads in part as follows: "In his capacity as radio matériel officer at New York, Captain Brown controlled the arrangements for fitting and overhauling radio, radar, and underwater sound apparatus in His Majesty's ships built or refitted in the Third Naval District. During the difficult days of 1941 and 1942 when the refitting of His Majesty's ships was delayed by the Atlantic shipping losses, he placed the facilities of laboratory, equipment, technical staff, and dockyard labor at the disposal of the Royal Navy immediately and without reserve. Later, when the training of British radar officers had to be arranged at short notice, Captain Brown readily accommodated these officers in his Navy Yard radar school. The unstinted measure of co-operation which the British radar staff in New York enjoyed at the hands of Captain Brown ensured the success of this important undertaking."

A graduate in electrical engineering of Montana State College, Captain Brown has had a long career in radio engineering, mainly with the Navy, Army Signal Corps, and Air Corps.

BERTRAM WELLMAN

Bertram Wellman (A'37-VA'39) is president of The Electrodyne Company, located in Boston, Massachusetts, a newly formed corporation providing research and development service in the fields of electro-mechanics, vacuum-tube applications, and optics. The firm is also engaged in the manufacture of electronic equipment of its own design.

JOHN L. RENARTZ AND JOHN F. RIDER

The Radio Corporation of America has announced the assignment of Captain John L. Reinartz (M'32-SM'43) to the commercial engineering and power-tubesections, in charge of the amateur radio program, at the Lancaster, Pennsylvania, plant, and the appointment of Lieutenant Colonel John F. Rider (A'36-VA'39) as consultant on test equipment co-operating with the test and measuring section.

Associated with the radio industry since 1908 when he experimented with spark coils and coherers, Captain Reinartz won recognition in the industry in 1921 when he devised the Reinartz receiver. In 1925, he published his "Reflection of Short Waves," and in 1925, he served as communications officer with the Byrd Arctic Expedition, maintaining constant contact with the outside world by short-wave radio. Captain Reinartz has recently been released from the United States Navy after seven years' service as communications and electronics officer.

Well known for his technical writings and work in the field of radio servicing and servicing methods, Colonel Rider developed the chanalyst and the voltohmyst, and pioneered in the development of signal tracing as a means of diagnosis. In his new position, he will supplement the activities of RCA's staff of test-equipment specialists, with his reports being made available to RCA distributors and servicemen.

LOUIS KAHN

Louis Kahn (A'31), assistant chief engineer of Aerovox Corporation, New Bedford, Massachusetts, has been elected to the board of directors of Aerovox Canada, Ltd., Hamilton, Ontario. Formerly an electronics instructor at Rutgers University, Mr. Kahn has been with Aerovox since 1937 engaging in original research and production engineering activities.



BERTRAM WELLMAN



ALBERT PREISMAN

ALBERT PREISMAN

Albert Preisman (M'38-SM'43) has been elected vice-president in charge of engineering of the Capitol Radio Engineering Institute, Washington, D. C. He has been associated with the Institute for three years during which time he directed radio engineering activities, lesson-text revision, and the development of new lesson material. Mr. Preisman received his A.B. and E.E. degrees from Columbia University and, prior to his affiliation with the Institute, was senior engineer at the Federal Telephone and Radio Corporation.

DONALD G. HAINES

Donald G. Haines (A'43-SM'45), secretary of the Chicago Section of The Institute of Radio Engineers, has been appointed sales and commercial engineer for Hytron Radio and Electronics Corporation and will be located in Chicago, Illinois. Mr. Haines was graduated from the University of Toronto in 1930.

As radio-tube-design engineer with the Radio Corporation of America, Harrison, New Jersey, Mr. Haines developed the pentagrid converter tube and received many patents in the tube-design field. In 1936, he was affiliated with the Ken-Rad Tube and Lamp Corporation as tube-development engineer. Mr. Haines came to Chicago in 1938 to join Zenith Radio Corporation where he specialized in the design of automatic-tuning devices, loop antennas, and export radio receivers, and in 1939, he became associated with the National Union Radio Corporation as Chicago field engineer.

While a member of wartime committees of the Radio Manufacturers Association and the War Production Board, Mr. Haines was associated with many midwest manufacturers of electronic equipment for the Armed Services.



WINFIELD WAGENER

WINFIELD WAGENER

Winfield Wagener (A'29-SM'44), former chairman of the San Francisco Section of The Institute of Radio Engineers, has recently been appointed to the sales-engineering staff of Eitel-McCullough, Inc., San Bruno, California. After receiving his M.S. degree from the University of California, Mr. Wagener became associated with the Radio Corporation of America. He was then named chief engineer for Heintz and Kaufman in charge of all tube development and design, and in 1944, he joined the Litton Engineering Laboratories where, as head of the tube division, he conducted research and development in tubes for radar counter-measure.



E. R. EWALD

E. R. Ewald (A'43) has recently joined the Rauland Corporation of Chicago, Illinois, as superintendent of the electronics division. Associated with the Radio Corporation of America's RCA Victor Division at Lancaster, Pennsylvania, for a period of eleven years, Mr. Ewald served as tube design engineer and chief engineer of the cathode-ray production engineering department.



Fritz Franke

D. F. SCHMIT

Election of D. F. Schmit (A'25-M'38-SM'43) as vice-president in charge of the engineering department of the Radio Corporation of America's RCA Victor Division was recently announced by David Sarnoff (A'12-M'14-F'17), president of RCA. Mr. Schmit received his degree in electrical engineering from the University of Wisconsin in 1923.

Before his association with RCA, Mr. Schmit served as engineer with the General Electric Company and with the E. T. Cunningham Company, both of New York. Joining RCA in 1930, he became manager of research and engineering in tube manufacture at Harrison, New Jersey. Manager of the New Products Division in 1939, he was appointed assistant chief engineer of the RCA Victor Division in 1943 and director of engineering in 1945.



D. F. SCHMIT



Fritz Franke

Promotion of Fritz Franke (M'46) to the position of assistant sales manager of the Hallicrafters Company, Chicago, Illinois, has recently been announced. Formerly a radio engineer for American Airlines, Mr. Franke operated his own airline ground-equipment and special electronic-devices business. Joining Hallicrafters in 1940, he was one of the group of engineers who produced the SCR-299, army mobile communications unit. Prior to his new position, he served as chief engineer in charge of research and design and has recently directed the styling and special features for the 1946 Hallicrafters radios.

An alumnus of Northwestern University, Mr. Franke is a member of the Illinois Ham Club and chairman of the marine section, transmitter division, of the Radio Manufacturers Association.



RALPH A. HACKBUSCH

RALPH A. HACKBUSCH

Ralph A. Hackbusch (A'26-M'30-F'37) has recently been made a Fellow of the Institution of Radio Engineers Australia in recognition of his contribution to the development and application of radio science during the war as manager of the radio division of Research Enterprises, Department of Munitions and Supply, in Canada. Formerly secretary and chairman of the Toronto Section of The Institute of Radio Engineers, Mr. Hackbusch is vice-president and managing director of the Stromberg-Carlson Company in Toronto.



CARL O. JETT

Carl O. Jett (A'42) has been named system telegraph and telephone engineer for the Union Pacific Railroad to handle communication-facilities engineering problems. Mr. Jett attended the University of Kentucky, Eastern Kentucky State Teachers' College, and George Washington University.



CARL O. JETT

I.R.E. People



SIDNEY L. CHERTOK

Prior to World War I, Mr. Jett was employed by the Bell System Telephone Company, Cumberland National Forest, and the Tennessee Valley Authority as an electrical engineer in charge of various forms of communication. He began his new duties after having served in the maintenance division of the Army Service Forces, Headquarters, Washington, D. C., where he directed maintenance and investigation of failures occurring in all types of signal and communication equipment.

A licensed electrical engineer (communications) in the State of Kentucky, Mr. Jett is a member of the American Institute of Electrical Engineers.

NELSON P. CASE

Nelson P. Case (A'26-M'31-SM'43) has become chief engineer for the entire organization of Hallicrafters Company, Chicago, Illinois. He received his A.B. degree in physics from Stanford University in 1924 and his E.E. degree in 1926. Mr. Case, holder of approximately thirty patents on radio-receiver circuits, was affiliated with the Bureau of Standards as assistant physicist; the University of Michigan as research physicist; Hazeltine Electronics Corporation in charge of the New York license laboratory; and Hamilton Radio Corporation as director of engineering design and development.

ROBERT B. BONNEY

Robert B. Bonney (A'41-M'44-SM'45) has become associated with Burgess Dempster (A'31-V'A39-M'44), Los Angeles, California, and will specialize in sales engineering. Formerly design engineer on transmitters at the Radio Corporation of America, Camden, New Jersey, Mr. Bonney then handled the design of radar and identification-friend-or-foe projects at the Crosley Corporation, Cincinnati, Ohio.

SIDNEY L. CHERTOK

Sidney L. Chertok (A'43) has recently been named advertising manager of Solar Manufacturing Corporation. Formerly manager of Solar's technical service bureau, he will also serve as advertising manager of the Solar Capacitor Sales Corporation. A graduate of Rensselaer Polytechnic Institute, Mr. Chertok was affiliated with the American Standards Association as staff engineer, and associated, in various capacities, with the Signal Corps Laboratories, The Albany *Knickerbocker News*, and The *Troy Observer-Budget*.

GEORGE C. CROM, JR.

Colonel George C. Crom, Jr., (A'22-M'24-SM'43), after more than five and one-half years of active duty with the United States Army Air Forces, will continue to serve in a civilian capacity at Wright Field, Ohio, as research consultant in the engineering division's equipment laboratory.

A graduate of the University of Florida with a B.S. degree in electrical engineering, Colonel Crom served overseas in World War I as a radio expert for the United States Signal Corps. His military service in this war was highlighted by his contributions to the development of a wide range of aircraft electrical equipment while located at Wright Field. He is also credited with a major role in the development of 400-cycle power systems for aircraft, and his service included tours of duty in Alaska and England in connection with cold-weather tests on turbosupercharger regulators.

Colonel Crom is a Fellow of the American Association for the Advancement of Science, and a member of the Acoustical Society of America, Society of Automotive Engineers, Reserve Officers' Association, and The Veterans of Foreign Wars.

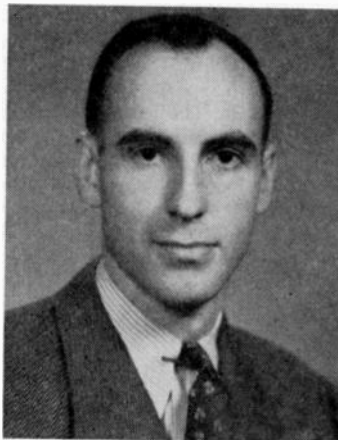

ROBERT B. BONNEY



COL. GEORGE C. CROM, JR.

JOSEPH SLEPIAN

RECEIVES FRENCH DECORATION

Joseph Slepian (SM'45-F'45), associate director of Westinghouse Research Laboratories, recently received a French government decoration, which he was awarded in Paris in 1939, naming him officially an "Officier d'Academie." The delay in completing the formalities was caused by the outbreak of war and subsequent events. Given by the French Ministry of National Education, the award followed a visit by Dr. Slepian to France in 1938 when he lectured on scientific subjects and conferred with French scientists.

A graduate of Harvard University, Dr. Slepian received his Ph.D. degree in mathematics from that institution in 1913 and then studied abroad for a year as a Sheldon Fellow at the University of Goettingen in Germany and the Sorbonne in Paris. During 1942, Dr. Slepian worked at the University of California on an ionic centrifuge method of separating uranium for atomic-bomb production, and he later continued his research at Pittsburgh Laboratories. His duties as consultant to the Office of Scientific Research and Development included work on other methods of uranium separation and various phases of atomic-bomb production.

JOHN D. KRAUS

John D. Kraus (A'32-M'43-SM'43) has been appointed associate professor in the department of electrical engineering at Ohio State University. He was formerly affiliated with the Radio Research Laboratory, Harvard University, where he headed the direction-finder group of the antenna and direction-finder division. Active for many years in the design of antenna systems, Dr. Kraus is the originator of several types, including corner-reflector antenna and the "flat-top" beam or W8JK types.

Books

Currents in Aerials and High-Frequency Networks, by F. B. Pidduck.

Published (1946) by Oxford University Press, 114 Fifth Avenue, New York 11, N. Y. 97 pages. 29 illustrations. $5\frac{1}{2} \times 9$ inches. Price \$2.50.

This book is an advanced treatise on the calculation of currents in antennas and networks immersed in radio-frequency fields. The converse problem of calculating the radiation from antennas carrying known currents is not discussed extensively, this being the more commonly treated problem. The book should be of interest principally to specialists in the theory of antennas.

Pidduck's development is based on a theory published by H. C. Pocklington in the *Proceedings of the Cambridge Philosophical Society* in 1897 and on the work of F. H. Murray published in the *American Journal of Mathematics* in 1931, and in the *PROCEEDINGS OF THE I.R.E.* in January, 1933. The theory is applied in particular to thin antennas. The determination of the length yielding maximum current is discussed for a straight receiving antenna both terminated and unterminated, for loops, and for linear antennas parallel to the earth. Parasitic elements and Lecher wires are treated, and, by an extension of the theory, currents in sheets are also considered.

JOHN D. KRAUS
Newton Centre, Mass.

A Theoretical Survey of the Possibilities of Determining the Distribution of the Free Electrons in the Upper Atmosphere, by Olof E. H. Rydbeck

Published (1942) by Elanders Boktrycker Aktiebolag, Göteborg, Sweden. 74 pages. 37 illustrations. 7×10 inches. Price, 4.50 kronor.

This book is an advanced mathematical treatise on the principles underlying the propagation and measurement of radio-frequency pulses reflected from the ionosphere. By integrating the wave equations, under suitable boundary conditions, solutions are found for the propagation of the wave train in the ionosphere, the dispersion of the returning pulse, the virtual path length in the ionosphere, and the calculation of the actual height of reflection in the ionosphere, and the calculation of the collisional frequency, which is of importance in studying the absorption of waves in the ionosphere. The exact wave functions are given for an idealized parabolic layer, to which the F_2 layer is often a good approximation. The treatment is directed mostly toward F_2 -layer calculations, since this is the most interesting of the ionospheric layers from the standpoint of their variations.

The problem of solving the electromagnetic-field equations in an ionized medium of varying density in the presence of the earth's magnetic field is quite a complex

one, and it is not to be expected that any simple formulas can be obtained. Consequently the results, which the author leaves in integral form, are not easily adaptable to numerical computation, although the rigorous treatment leads to confidence in the correctness of any numerical results.

Examples are given of numerical results in some specific cases, and indicate the order of magnitude of the difference between virtual and true heights of reflection in the ionosphere, as well as how the total equivalent electron ionization varies with time of day and season. The results support the hypothesis of the physical expansion of the upper atmosphere.

The book is not one that can be easily read or used except by one with a relatively great mathematical training and background. For such a reader, however, it is a clear-cut logical presentation of one method of calculating radio sky-wave propagation. It represents a notable contribution to the mathematical theory underlying ionospheric and radio propagation observations.

NEWBERN SMITH
National Bureau of Standards
Washington, D. C.

Electrical Coils and Conductors, by Herbert Bristol Dwight

Published (1945) by the McGraw-Hill Book Company, Inc., 330 W. 42 St., New York 18, N. Y. 348 pages plus 3-page index plus IX pages. 90 illustrations. $8\frac{1}{2} \times 5\frac{1}{2}$ inches. Price, \$5.00.

A new book by Professor Dwight of Massachusetts Institute of Technology gives the theory and electrical characteristics of electrical coils and conductors as found in power transformers, armature coils, coils without iron cores, transmission lines, bus bars, and conductors of various cross sections.

Among the specific subjects treated are reactance, eddy-current loss, iron cross section and operation of transformers, eddy-current loss and connection of armature coils, sag, resistance loss and conductor size of transmission lines, reactance of conductors of various shapes, eddy-current loss and proximity effect in wires, skin effect in concentric tubular conductors, mutual inductance and force between reactance coils, self-inductance of circular coils, and magnetic field strength near a cylindrical coil in air.

Four chapters not related to the main topic deal with resistance to ground for direct current or 60 cycles, heat transfer, inverse functions of complex quantities, and graphical flux plotting.

The book would serve as a supplemental text on electrical machinery, as the author states, "Many of the chapters in this book have been used as class notes on the subject of electrical machinery." Also, "Although some of the characteristics of apparatus are presented in the form of curves and can be read directly without trouble, for most of the calculations a knowledge of the principles of operation of the different types of electrical apparatus and a working knowledge of elementary integral calculus are

assumed." Many practical numerical problems are given throughout the book.

Much of the material presented in the thirty-nine chapters is taken from previously published papers to which references are given. Although the book treats chiefly of power and audio-frequency applications, it should be a welcome addition to an electrical or communication engineer's reference library, because of the many useful formulas and information compiled from numerous sources. It will be of interest to engineers specializing in high power.

E. L. HALL
National Bureau of Standards
Washington, D. C.

Electronics for Engineers, Edited by John Markus and Vin Zeluff

Published (1945) by McGraw-Hill Book Company, Inc., 330 W. 42 St., New York 18, N. Y. 390 pages + x pages. 561 illustrations. $8\frac{1}{2} \times 11\frac{1}{2}$ inches. Price, \$6.00.

In almost every issue of *Electronics* a short article appears which provides the graphical solution of a common electronic problem. This new book is a compilation of these articles, primarily, and a few other short articles, selected on the basis of being the "142 articles, reference sheets, charts, and graphs that have been in greatest demand for their reference value" (from the preface).

The articles are grouped in sections which cover many subjects: Audio Circuit Design, Electronic Heating, Networks, Relays, Sound, and Tuned Circuits are a few section titles chosen at random. The Mathematical Section, for example, provides graphical means of doing a number of complex-number operations. Other sections are concerned with the graphical computation of circuits: Filters, Networks, and Audio-Frequency Impedance-Matching Networks exemplify this type of section. There are also a few descriptive articles on rectifiers, permanent magnets, etc. The use of each graph is explained, and, generally, an illustrative problem is worked. The derivations of the equations on which the graphs are based are not given, but reference is made to the sources.

Many subjects are treated thoroughly; others are not as complete. This is understandable in view of the fact that the editors were restricted to data already published. The "general-practitioner" type of engineer will derive much valuable help from this book; the specialist will have to make a personal inspection to determine that his respective field is covered in a fashion usable for him. Students particularly will find many of the charts timesavers in eliminating mathematical manipulations and calculations. Since this book only presents means to solutions, rather than derivations, only those who are competent to work the problem the hard way would find it useful. This book can save those who have this knowledge a lot of time.

RUSSELL A. BERG
Coles Signal Laboratory
Red Bank, N. J.

Meetings of Technical Committees I.R.E.

ANTENNAS

Date..... March 25, 1946
Place..... McGraw-Hill Building,
New York 18, New York
Chairman..... P. S. Carter

Present

P. S. Carter, *Chairman*

J. C. Davis	D. C. Ports
Harry Diamond	S. A. Schelkunoff
W. S. Duttera	J. Schelleng
J. E. Eaton	George Sinclair
R. B. Jacques	Philip H. Smith

Former definitions of terms in the I.R.E. Standards of Transmitters and Antennas, 1938, were examined for correctness and completeness of context. Some terms were corrected, a small number deleted, and the resulting list approved for submission to the Standards Committee. Much discussion occurred regarding the advisability of deleting a number of obsolete definitions.

ANTENNAS

Date..... April 29, 1946
Place..... McGraw-Hill Building
New York, New York
Chairman..... P. S. Carter

Present

P. S. Carter, *Chairman*

Andrew Alford	H. J. Riblet
Harry Diamond	S. H. Schelkunoff
S. Frankel	George Sinclair
W. E. Kock	P. H. Smith
D. C. Ports	L. C. Van Atta

Subcommittees brought in reports on the following: Suggestions for Revision of 1939 I.R.E. Definitions of Antenna Terms, Television Antenna Standards, and Revised Definitions of Microwave Antenna Terms. Work on revision of the I.R.E. 1938 Standards on Definitions of Antenna Terms was continued from the last meeting. Dr. Schelkunoff introduced a number of new definitions, which were discussed at some length.

ELECTRON TUBES

Date..... March 19, 1946
Place..... McGraw-Hill Building,
New York 18, New York
Chairman..... R. S. Burnap
Secretary..... R. L. Freeman

Present

R. S. Burnap, *Chairman*

R. L. Freeman, *Secretary*

J. W. Greer	G. D. O'Neill
S. B. Ingram	H. J. Reich
R. B. Jacques	A. C. Rockwood
J. A. Morton	A. L. Samuel
I. E. Mouromtseff	J. R. Steen
	C. M. Wheeler

Mr. Samuel reported progress of his group in organizing the forthcoming Electron-Tube Conference which will be held June 27 and 28, 1946 at New Haven, Connecticut. Several definitions submitted by subcommittees were corrected and approved for submission to the Standards Committee.

SECTIONS

Chairman

Secretary

	ATLANTA September 20	M. S. Alexander 2289 Memorial Dr., S.E. Atlanta, Ga.
R. N. Harmon 1920 South Rd. Mt. Washington Baltimore 9, Md.	BALTIMORE	F. W. Fischer 714 S. Beechfield Ave. Baltimore, Md.
Glenn Browning Browning Laboratories 750 Main St. Winchester, Mass.	BOSTON	A. G. Bousquet General Radio Co. 275 Massachusetts Ave. Cambridge 39, Mass.
H. W. Staderman 264 Loring Ave. Buffalo, N. Y.	BUENOS AIRES	Raymond Hastings San Martin 379 Buenos Aires, Argentina
T. A. Hunter Collins Radio Co. 855—35 St., N.E. Cedar Rapids, Iowa	BUFFALO-NIAGARA September 18	J. F. Myers Colonial Radio Corp. 1280 Main St. Buffalo 9, N. Y.
Cullen Moore 327 Potomac Ave. Lombard, Ill.	CEDAR RAPIDS	R. S. Conrad Collins Radio Co. 855—35 St., N.E. Cedar Rapids, Iowa
J. D. Reid Box 67 Cincinnati 31, Ohio	CHICAGO September 20	D. G. Haines 4000 W. North Ave. Chicago 39, Ill.
R. A. Fox 2478 Queenston Rd. Cleveland Heights 18, Ohio	CINCINNATI September 17	P. J. Konkle 5524 Hamilton Ave. Cincinnati 24, Ohio
R. C. Higgy 2032 Indianaola Ave. Columbus, Ohio	CLEVELAND September 26	Walter Widlar 1299 Bonnieview Ave. Lakewood 7, Ohio
Dale Pollack Templetone Radio Corp. New London, Conn.	COLUMBUS August 9	Warren Bauer 376 Crestview Rd. Columbus 2, Ohio
R. M. Flynn KRLD Dallas 1, Texas	CONNECTICUT VALLEY September 19	R. F. Blackburn 2022 Albany Ave. West Hartford, Conn.
J. E. Keto Aircraft Radio Laboratory Wright Field Dayton, Ohio	DALLAS-Ft. WORTH	J. G. Rountree 4333 Southwestern Blvd. Dallas 5, Texas
H. E. Kranz International Detrola Corp. 1501 Beard Ave. Detroit 9, Mich.	DAYTON September 19	Joseph General 411 E. Bruce Ave. Dayton 5, Ohio
N. L. Kiser Sylvania Electric Products, Inc. Emporium, Pa.	DETROIT September 20	A. Friedenthal 5396 Oregon Detroit 4, Mich.
E. M. Dupree 1702 Main Houston, Texas	EMPORIUM	D. J. Knowles Sylvania Electric Products, Inc. Emporium, Pa.
H. I. Metz Civil Aeronautics Authority Experimental Station Indianapolis, Ind.	HOUSTON	L. G. Cowles Box 425 Bellaire, Texas
R. N. White 4800 Jefferson St. Kansas City, Mo.	INDIANAPOLIS	V. A. Bernier 5211 E. 10 Indianapolis, Ind.
B. S. Graham Sparton of Canada, Ltd. London, Ont., Canada	KANSAS CITY	Mrs. G. L. Curtis 6003 El Monte Mission, Kansas
	LONDON, ONTARIO	C. H. Langford Langford Radio Co. 246 Dundas St. London, Ont., Canada

Chairman

Frederick Ireland
950 N. Highland Ave.
Hollywood 38, Calif.

P. B. Laeser
9410 Harding Rd.
Milwaukee, Wis.

J. C. R. Punchard
Northern Electric Co.
1261 Shearer St.
Montreal 22, Que., Canada

J. T. Cimorelli
RCA Victor Division
415 S. Fifth St.
Harrison, N. J.

W. A. Steel
298 Sherwood Dr.
Ottawa, Ont., Canada

Samuel Gubin
4417 Pine St.
Philadelphia 4, Pa.

J. A. Hutcheson
852 N. Meadowcroft Ave.
Pittsburgh 16, Pa.

C. W. Lund
Rt. 4, Box 858
Portland, Ore.

A. E. Newlon
Stromberg-Carlson Co.
Rochester 3, N. Y.

B. B. Miller
2356A Lawrence St.
St. Louis 10, Mo.

David Kalbfell
941 Rosecrans Blvd.
San Diego 6, Calif.

R. V. Howard
Mark Hopkins Hotel
San Francisco, Calif.

E. H. Smith
823 E. 78 St.
Seattle 5, Wash.

H. S. Dawson
Canadian Association of
Broadcasters
80 Richmond St., W.
Toronto, Ont., Canada

M. E. Knox
43-44 Ave., S.
Minneapolis, Minn.

F. W. Albertson
Room 1111, Munsey Bldg.
Washington 4, D. C.

W. C. Freeman, Jr.
2018 Reed St.
Williamsport 39, Pa.

Secretary

LOS ANGELES
July 16
Walter Kenworth
1427 Lafayette St.
San Gabriel, Calif.

MILWAUKEE
E. L. Cordes
3304 N. Oakland Ave.
Milwaukee, Wis.

MONTREAL, QUEBEC
October 9
E. S. Watters
Canadian Broadcasting Corp.
1440 St. Catherine St., W.
Montreal 25, Que., Canada

NEW YORK
October 2
J. R. Ragazzini
Columbia University
New York 27, N. Y.

OTTAWA, ONTARIO
September 19

PHILADELPHIA
October 3
A. N. Curtiss
RCA Victor Division
Bldg. 8-9
Camden, N. J.

PITTSBURGH
September 9
C. W. Gilbert
52 Hathaway Ct.
Pittsburgh 21, Pa.

PORTLAND
L. C. White
3236 N.E. 63 Ave.
Portland 13, Ore.

ROCHESTER
October 17
K. J. Gardner
111 East Ave.
Rochester 4, N. Y.

ST. LOUIS
N. J. Zehr
1538 Bradford Ave.
St. Louis 14, Mo.

SAN DIEGO
August 6
Clyde Tirrell
U. S. Navy Electronics Laboratory
San Diego 52, Calif.

SAN FRANCISCO
Lester Reukema
2319 Oregon St.
Berkeley, Calif.

SEATTLE
August 8
W. R. Hill
University of Washington
Seattle 5, Wash.

TORONTO, ONTARIO
C. J. Bridgland
Canadian National Telegraph
347 Bay
Toronto, Ont., Canada

TWIN CITIES
Paul Thompson
Telex Incorporated
1633 Eustis Ave.
St. Paul, Minn.

WASHINGTON
September 9
G. P. Adair
Federal Communications
Commission
Washington 4, D. C.

WILLIAMSPORT
September 4
S. R. Bennett
Sylvania Electric Products,
Inc.
Plant No. 1
Williamsport, Pa.

SUBSECTIONS

MONMOUTH
(New York Subsection)
N. F. Schlaack
Bell Telephone Laboratories,
Inc.
463 West St.
New York 14, N. Y.

PRINCETON
(Philadelphia Subsection)
C. W. Mueller
RCA Laboratories
Princeton, N. J.

SOUTH BEND
(Chicago Subsection)
October 17
H. E. Ellithorn
417 Parkovash Ave.
South Bend 17, Ind.

**Meetings of
Technical Committees
I.R.E.**

The work of this group on Definitions and Test Methods for electron tubes is rapidly approaching conclusion and the results should appear in print in the near future.

Advanced Developments

Date..... March 15, 1946
Place..... McGraw-Hill Building,
New York 18, New York
Chairman..... A. L. Samuel

Present

A. L. Samuel, *Chairman*
A. E. Anderson J. B. H. Kuper
S. J. Angello L. B. Linford
A. E. Harrison T. Moreno
G. Hok L. S. Nergaard
E. W. Houghton H. T. Pekin
W. A. Huggins R. M. Ryder
R. B. Jacques W. G. Shepherd
S. Krasik C. M. Wheeler

Proposed standards on ultra-high-frequency electrons 1U1 on general definitions, and 1U4 on definitions for electronic interaction, were approved with minor corrections for submission to the Committee on Electronics. Section 2, on Crystal Rectifiers was also approved, with minor corrections, for submission to the parent body. Dissatisfaction was expressed by a number of committee members over the present tentative definitions of Q and resonance mode as applied to microwave devices. The controversy arises over the difficulty encountered when two or more exist simultaneously in a resonant system. A special subgroup was appointed to attempt a solution to this problem. Considerable progress was made on Section 4, Magnetrons, and Section 5, Transmit-Receive Switches was approved with minor corrections. The section on Symbols was accepted with only two revisions. A subgroup was appointed to expedite the work on Measurements. The material being prepared by this subcommittee should appear in print at an early date.

Gas Tubes

Date..... April 18, 1946
Place..... Editorial Office I.R.E.,
New York 19, New York
Chairman..... D. E. Marshall

Present

D. E. Marshall, *Chairman*
C. E. Greef R. B. Jacques
V. L. Holdaway D. S. Peck
W. Widmaier

A discussion involving the "Testing of Ionization Time of Thyratrons" brought forth a description of such a test which would be usable. The test was written and approved. Several changes were made in the Definitions on Gas Tubes and the list of definitions was approved for submission to the main committee for action. A definition for cold-cathode thyratrons was considered but no action was taken until the question had been studied further. A definition for control ratio in thyratrons was written and approved.

**Meetings of
Technical Committees
I.R.E.**

**ELECTRON TUBES
(Continued)**

Power-Output High-Vacuum Tubes

Date.....April 26, 1946
Place.....Editorial Office, I.R.E.,
New York 19, New York
Chairman.....I. E. Mouromtseff
Secretary.....C. E. Fay

Present

I. E. Mouromtseff, *Chairman*
C. E. Fay, *Secretary*

T. A. Elder	H. E. Mendenhall
J. W. Greer	A. G. Nekut
R. B. Jacques	C. M. Wheeler

Previously presented material on Methods of Testing of Power-Output High-Vacuum Tubes was discussed and corrected. Proposed methods of obtaining the Flexion-Point Emission Current and the Inflection-Point Emission Current from the diode characteristic of high-vacuum tubes were discussed and several methods selected and approved. Additional material to be prepared was assigned to various subcommittee members. This material will be presented at the next subcommittee meeting for revision and approval.

Small High-Vacuum Tubes

Date.....April 12, 1946
Place.....McGraw-Hill Building
New York 18, New York
Chairman.....A. C. Rockwood
Secretary.....E. C. Homer

Present

A. C. Rockwood, *Chairman*
E. C. Homer, *Secretary*

E. M. Boone	R. B. Jacques
A. S. Bousquet	J. A. Morton
E. H. Hurlburt	G. D. O'Neill
E. F. Peterson	

A discussion took place in regard to the last list of vacuum-tube definitions passed on by the main committee and edited by H. J. Reich. They were declared satisfactory for submission to the Standards Committee. It is to be brought to the attention of the Circuits Committee that definitions for Admittor and Impedor, or equivalent terms, should be defined. It was also decided that the following terms needed symbols: Forward Admittance, Feedback Admittance, Transfer Admittance, Input Admittance, and Output Admittance. These were to be referred to the Symbols Committee for action. The resignation of R. L. Freeman from this committee was accepted as he is too heavily involved in the main committee on Electron Tubes as secretary.

PIEZOELECTRIC CRYSTALS

Date.....April 15, 1946
Place.....Editorial Office I.R.E.,
New York 19, New York
Chairman.....W. G. Cady

Present

W. G. Cady, *Chairman*

H. G. Baerwald	W. P. Mason
C. F. Baldwin	Hans Mueller
W. L. Bond	P. L. Smith
C. Frondel	R. A. Sykes
R. B. Jacques	K. S. Van Dyke
J. M. Wolfskill	

A request from the Transmitter Committee of the Radio Manufacturers Association for definition of terms on piezoelectric crystals led to a discussion on what should be defined. A crystal-orientation system for monoclinic crystals involving 36 systems of crystals was submitted by W. L. Bond. After much discussion, a subcommittee was appointed to study this problem further. A system of co-ordinates involving X, Y, and Z axes to be co-ordinated with the crystallographers co-ordinate systems using a, b, and c axes was selected and approved for monoclinic crystals. A report on "Specifications of the Variables" was given by P. L. Smith as work of his subgroup. After much discussion, it was decided that this report should be revised for the next meeting.

TELEVISION

Date.....January 23, 1946
Place.....Hotel Astor, New York
City
Chairman.....I. J. Kaar
Acting Chairman...D. W. Pugsley

Present

D. W. Pugsley, *Acting Chairman*

W. F. Bailey	H. M. Lewis
R. B. Jacques	H. T. Lyman
D. L. Jaffe	J. Minter
A. G. Jensen	G. Mountjoy
P. J. Larsen	C. M. Sinnett
L. M. Leeds	M. E. Strieby

The activities of the various subcommittees were discussed and any progress made was reported by the chairman of the subcommittees. The problem of a suitable dummy-antenna standard for use in testing television receivers was brought up and referred to the subcommittee on Television Receiver Test Methods. The Symbols subcommittee reported that its work was nearly completed and had been turned over to the Review subcommittee. The report from the subcommittee on Testing Television Transmitters was turned over to the main committee for action and comments. Work on television antennas was referred to the I.R.E. Technical Committee on Antennas. Transmission lines was referred to the Technical Committee on Wave Propagation and Utilization. The work of the Television Committee on new Standards is rapidly nearing completion and should appear in print as I.R.E. Standards in the near future.

TELEVISION

Date.....April 10, 1946
Place.....American Institute of Physics,
New York City
Chairman...I. J. Kaar

Present

I. J. Kaar, *Chairman*

W. F. Bailey	H. T. Lyman
R. B. Jacques	J. Minter
A. G. Jensen	B. Shmurak
L. M. Leeds	M. E. Strieby

Reports of the activities and progress of the subcommittees were made. It was decided that, in view of the new proposal to issue Standards reports in loose-leaf form as rapidly as they clear the Standards Committee, the completed work of the subcommittees should be approved and sent to the Standards Committee for action. Much of the material that is completed will be of immediate use to the members of The Institute of Radio Engineers. The original work of the subcommittee on Transmitter Testing is completed and approved by this committee. The subcommittee on Television Definitions will make one last revision taking into account the constructive criticism of the RMA Television Committee, and then their work will be turned over to the I.R.E. Standards Committee for approval. The completed work of the subcommittee on Testing of Television Receivers was approved and will be sent to the Standards Committee.

TRANSMITTERS

Date.....May 9, 1946
Place.....McGraw-Hill Building
New York 19, New York
Chairman.....E. A. Laport
Acting Chairman.H. R. Butler

Present

H. R. Butler, *Acting Chairman*

Cledo Brunetti	L. A. Looney
Harry Diamond	C. H. Meyer
F. A. Gunther	J. F. Morrison
R. B. Jacques	Robert Serrell
J. B. Knox	I. R. Weir

J. E. Young

An opening message from E. A. Laport, chairman, was read by acting chairman H. R. Butler, outlining the task ahead of the Transmitters Committee. Work on definitions is to be started immediately. Several members were assigned to the task of obtaining all known existing definitions from other sources than The Institute of Radio Engineers. Subcommittee chairmen were appointed for the following subcommittees: Antenna Liaison, Harry Diamond; Television Transmitters, Robert Serrell; Frequency-Modulation Transmitters, J. E. Young; Circuits and Advanced Developments, Cledo Brunetti; Facsimile Transmitters, J. C. Schelleng; Navigational Aids Transmitters, W. C. Jackson; Power Tubes, K. C. DeWalt; Amplitude-Modulated Transmitters, I. R. Weir.

AIRBORNE INSTRUMENTS LABORATORY

Outstanding electronic engineers from wartime laboratories at Harvard University, Massachusetts Institute of Technology, and Columbia University have been assembled at Airborne Instruments Laboratory, Inc., Mineola, Long Island, to serve the commercial airlines and the continuing needs of the Army and Navy with immediate peacetime applications and long-range developments complementing each other, it was recently announced by Hector R. Skifter (A'31-M'36-SM'43), president of the company. Ownership of the new corporation will be vested in Aeronautical Radio, Inc. Commercial assignments from the Air Transport Association and military research for the Army and Navy are now in progress.

The bulk of America's electronic, radar, and countermeasures research was conducted by the Radiation Laboratory at M.I.T., Harvard's Radio Research Laboratory, and Columbia's Airborne Instruments Laboratory. These units were established by Vannevar Bush, director of the Office of Scientific Research and Development, set up by President Roosevelt early in the war. Reaching a peak in 1944, some 5000 scientists, engineers, and technical specialists waged a constant battle in these three laboratories against the best scientists available to the enemy. Not only did they attain a high degree of excellence in radar-attack techniques but they also succeeded in rendering most of the enemies' equipment impotent. Racing against time and anticipating Axis developments, all under deep cloaks of secrecy, provided many an exciting chapter in the history of the war.

When it was planned to cease operations of the Office of Scientific Research and Development and the laboratories faced dissolution, it became apparent that the Armed Services both wished certain projects to be

continued, and welcomed the participation of the airlines. The services also were desirous of holding together a unit of trained personnel and valuable electronic equipment. Out of these thoughts developed a plan for a laboratory, flexible in operation, with independent commercial sponsorship. The cessation of war projects, however, occurred last August before arrangements were completed and, in the interim, American Airlines, Inc., took over the sponsorship of the Laboratory from Columbia University and operated it as a wholly owned subsidiary.

With the present transfer of ownership to Aeronautical Radio, Inc., which is owned by the airlines, a new pattern for joint scientific research serving military and commercial interests became possible. In time of war, the military depends on rapid conversion which is expedited by having commercial practices at highest standards. Commercial applications will benefit by the more rapid progress created through military participation. The know-how of engineers is built up at a greater rate, permitting them to make faster progress for both commercial and military application.

Through the Air Transport Association and under the supervision of Brigadier General Milton Arnold, commercial airlines are sponsoring this co-ordination and assigning electronic projects designed to produce better service and safer travel. Traffic controls and radar-warning devices are among the immediate projects.

In addition to this commercial research, a master contract has been negotiated with the United States Navy Bureau of Aeronautics under which some seventeen assignments are now in progress. Many of these are described as electronic research for the newest and fastest aircraft and projectiles for which there are no immediate peacetime applications.

Although the company develops new products and procedures, it is not engaged in manufacturing. In general, new develop-

ments and applications start by utilizing existing equipment of radio and instrument makers. The policy is to license manufacturers to produce resulting inventions.

Hector R. Skifter, the wartime associate director of Airborne Instruments Laboratory, is president of the company and John F. Byrne, the wartime associate director of Radio Research Laboratory, is vice-president and director of research and engineering. Chester D. May, formerly of American Airlines, is treasurer. The personnel of the Laboratory numbers 171, of whom 65 are scientists and engineers and 20 are skilled technicians.

The engineering staff of Airborne Instruments Laboratory, Inc., numbers over a score who held prewar prominence in the broadcast field and whose work in the three electronic laboratories caused them literally to drop out of sight and print until now. Among them are the following who are members of The Institute of Radio Engineers:

John F. Byrne (SM'45) went to Radio Research Laboratory in 1942 after having been an engineer for Collins Radio Company, Cedar Rapids, Iowa, since 1937 where in co-operation with the engineering staff of WHO he became widely known as the inventor of polyphase broadcasting.

John N. Dyer (J'30-A'32-SM'45), prewar assistant chief television engineer for Columbia Broadcasting System, disappeared into Radio Research Laboratory where he became director of the American British Laboratory, Division 15 of the Office of Scientific Research and Development in England. During 1933-1935 he was attached to the Byrd Antarctic Expedition III in charge of radio engineering.

Donald M. Miller (A'37-VA'39), well known for his design, installation, and testing of directive antennas of KSTP and stations of the northwest group, was associated as consulting engineer in the middle west with Hector R. Skifter (A'31-M'36-SM'43), seven years director of engineering for KSTP. Both men, together with Robert F.



I.R.E. MEMBERS AT AIL

Front row—Francis C. Cahill, John W. Leas, Reuben A. Isberg, John G. Stephenson, Warren D. White, Russell R. Yost, Jr., Matthew T. Lebenbaum, Lyman C. Ihrig, Eugene G. Fubini.

Second row—Price M. Keeler, Donald M. Haring, Jack F. Bisby, Robert F. Schulz, John N. Dyer, Hector R. Skifter, John F. Byrne, Donald M. Miller, Eugene Novikoff, and Herbert W. DeWeese.

Last row—Ernst Leroy Bock, Joseph M. Pettit, Walter E. Tolles, Winfield E. Fromm, William R. Rambo, George C. Izenour, Arthur C. Weid, Ralph H. Hoglund, Otto H. Schmitt, and Joseph W. Kearney.

Schulz (A'41) from the same area, have been with Airborne Instruments Laboratory since its inception in 1942.

Francis C. Cahill (S'38-A'40-SM'45) left radar designing at the Radio Corporation of America in Camden for Radio Research Laboratory, where he became leader of a group devoted to research on the jamming vulnerability of radar systems. In 1943, he led a mission to the Pacific to introduce the Ferret aircraft. In 1944, he became head of the antijamming division of RRL, and later the same year, associate director of the American British Laboratory, Division 15, OSRD, in England.

Warren D. White (A'37-VA'39) and Eugene G. Fubini (A'36-SM'46) both joined Radio Research Laboratory in 1942, leaving respectively the television and short-wave divisions of the Columbia Broadcasting System. Mr. Fubini was a key man attached to the Eighth Air Force Headquarters on countermeasures. After VE Day, he returned to the United States where he became expert consultant to Major General McClelland, Air Communications Officer, Army Air Forces. Also well known in the television field was Reuben A. Isberg (J'31-A'41-SM'46) who joined AIL in 1942, coming

from the National Broadcasting Company.

Many of the engineers played a prominent part in actual battle testing of various radar and countermeasures equipment. Among them are Joseph M. Pettit (S'39-A'40-M'45), who was a technical observer in the China-Burma-India theater and assisted in the first use of radar-intercept equipment over Japan proper. Subsequently he was associate technical director of the American-British Laboratory, Division 15, OSRD. Dr. Pettit is a member of the I.R.E. Technical Committee on Radio Receivers.

Otto H. Schmitt (SM'44), who did outstanding work in applying electronic techniques to the measurement of biological effects and nerve functions both in London and in Minnesota, made major contributions to the development of an antisubmarine device at Airborne Instruments Laboratory. Subsequently, his inventive resourcefulness was applied to countermeasures activity.

Walter E. Tolles (M'46) served with an overseas mission securing intelligence from the Germans, following combat units to examine captured equipment and assisting in the interrogation of prisoners.

The following men were attached to Airborne Instruments Laboratory in scientific

research during the war and are continuing in the new phases of the Laboratory's work. Lyman C. Ihrig, (M'45), George C. Izenour (M'46), Arthur C. Weid (M'44), Russell R. Yost, Jr. (M'45), and Winfield E. Fromm (A'41-M'44). Prior to joining AIL, Mr. Fromm was communications engineer for one and a half years with TWA.

Nine I.R.E. members joined Airborne from Radio Research Laboratory at Harvard:

Price M. Keeler (A'45), Matthew T. Lebenbaum (A'42), and John G. Stephenson (A'45) all had overseas service in connection with their work.

Ernst L. Bock (A'45), Ralph H. Hoglund (S'42-A'44), Joseph W. Kearney (S'43-A'45), Raymond O. Petrich (S'43-A'45), and William R. Rambo (S'39-A'40) worked principally in the laboratory in Cambridge. After two and a half years as shipboard and airborne radar officer, Jack F. Bisby (S'41-A'42) served two years in the Navy liaison office at RRL.

Richard N. Close (A'45), who specialized in radar-bombing attachments and was a specialist in Manila in 1945, came from the Radiation Laboratory.

COMMITTEES

At the March 6, 1946, meeting of the Board of Directors, it was unanimously approved to modify Bylaw Section 46, proposed on February 15, 1946, and to combine the Industrial Electronics and Medical Electronics Committees and to call the combined group the Industrial Electronics Committee. The formation of a new technical committee on Navigation Aids was approved.

Raymond F. Guy was appointed chairman of a committee to present suggestions for the establishment of One East 79th Street of suitable ways and means of honoring appropriately the founder members of the Institute.

James E. Shepherd was appointed by the Executive Committee on March 5, 1946, to the chairmanship of the Convention Policy Committee. This committee will bring recommendations to the Executive Committee concerning policies, dates, appointments, and selection of subcommittee chairmen. The other members of this committee are E. J. Content, Austin Bailey, B. E. Shackelford, and G. W. Bailey.

RALPH A. POWERS

Ralph A. Powers (M'41-SM'43), active and prominent in certain phases of industrial electronics, died on April 9, 1946, in Milwaukee, Wisconsin. Recently associated with Allis-Chalmers and the Square D Company, Mr. Powers developed many new and ingenious applications for photoelectric relays widely used in the Detroit, Michigan, district.

Prospective Authors

The Institute of Radio Engineers has a supply of reprints on hand of the article "Preparation and Publication of I.R.E. Papers" which appeared in the January, 1946, issue of the PROCEEDINGS OF THE I.R.E. AND WAVES AND ELECTRONS. If you wish copies, will you please send your requests to the Editorial Department, The Institute of Radio Engineers, Inc., 26 West 58th Street, New York 19, New York, and they will be sent to you with the compliments of the Institute. It would be greatly appreciated if your requests were accompanied by a stamped, self-addressed envelope.



RAYMOND D. HUTCHENS

TENTATIVE I.R.E. STANDARDS

For the present, tentative I.R.E. Technical Standards will not be published in the PROCEEDINGS OF THE I.R.E. AND WAVES AND ELECTRONS. Mimeographed copies of these tentative standards may, however, in some cases be available upon request. From time to time, there will be mentioned in the PROCEEDINGS those tentative standards which are available and the person to whom requests for such copies should be addressed.

EDISON CENTENNIAL

President F. B. Llewellyn will serve on the committee to make arrangements for the Edison Centennial to be held in 1947 on the 100th anniversary of the birth of Thomas A. Edison.

RAYMOND D. HUTCHENS

Raymond D. Hutchens (A'36-VA'39), editor of *Relay*, died on April 16, 1946, in New York City. He served for several years as radio operator on ships of the Ward and United States Lines before joining the Radio Corporation of America in 1928 as technician in the radiophoto department. From 1935 to 1939, while located in the company's Chicago office, Mr. Hutchens installed and maintained point-to-point radiotelegraphic equipment, and he was transferred to New York in 1940 to establish and edit *Relay*, a publication of RCA Communications, Inc. Mr. Hutchens was a member of the Radio Club of America.

Waves and Electrons Section

Editors of technical journals are usually in a favorable position to note the developments and trends in their field, and to comment analytically and constructively on these trends. Accordingly guest editorials from such editors have been invited. There follows such a presentation from the managing editor of both the *Wireless World* and the *Wireless Engineer*, who is also a Member of the Institution of Electrical Engineers (England) and a Senior Member of The Institute of Radio Engineers. His viewpoints are commended to the attention of our readers.
The Editor.

Professional Institutions and the Technical Press

HUGH S. POCOCK

Looking back over a quarter of a century of editorial responsibility, I am impressed by the sensational growth in the quantity of material published by the radio engineer and research worker.

In the early days, radio engineers were expected to be conversant with everything published on their subject. We have reached a point today when no engineer can hope to keep pace with more than a fraction of what appears in the proceedings of professional institutions and the technical press and is doing well if he can assimilate all that his fellow workers record in one specialized branch of radio engineering.

Why does the scientist or engineer publish his findings? As I see it it is for one or more of three reasons:

- (1) The natural desire to share his knowledge with others working in the same field.
- (2) To enhance the reputation of his university or the research organization where he is engaged.
- (3) To obtain personal credit and perhaps advancement as a result of giving publicity to his capabilities.

Every engineer should be trained to record his findings in a form suitable for publication and if he is unable to do so the organization to which he is attached should shoulder the responsibility.

A bibliography incorporated with every new paper of major interest is important. Not only is it valuable to the reader but it is an indication of the degree to which the author is familiar with the work of others.

From the point of view of the student (and here I use the word to mean anyone who has anything to learn) it would be ideal if all published matter relating to his interests could be found between the covers of one or two publications. But the student today must scan through hundreds of journals in various languages in the year if he wishes to see all that is written on his subject.

There is perhaps no greater service which can be done to the student than to make available to him abstracts and references to what is being published in his field throughout the world. Yet here again, a multiplicity of such services would be adding to the literature which the student would have to search.

There are two main channels for publication of radio matter; the professional institutions and the technical press. These two great organizations share the responsibility of selecting and presenting the findings of the scientist and engineer.

A healthy rivalry amongst the technical press is important to stimulate enterprise and so ensure the best service to the reader. Professional institutions are not governed by the same commercial considerations. Their professional status discourages commercialization and their financial needs are mainly met by the membership dues.

Whilst rivalry between journals of the technical press is essential it would be an unhealthy attitude to encourage as between the press and the professional institutions. These two should be complementary one to the other. The press should persistently aim to maintain and enhance the standing of the professional institution of its industry. The professional institution should guard against usurping the proper functions of the press. There should be little overlapping in the character of matter published by both but each should know his own sphere.

The time has come, I believe, when the professional institutions of the radio industry and of its technical and trade press should come together to promote the best interests of both parties and seek to define their respective activities whenever overlapping or rivalry may arise.

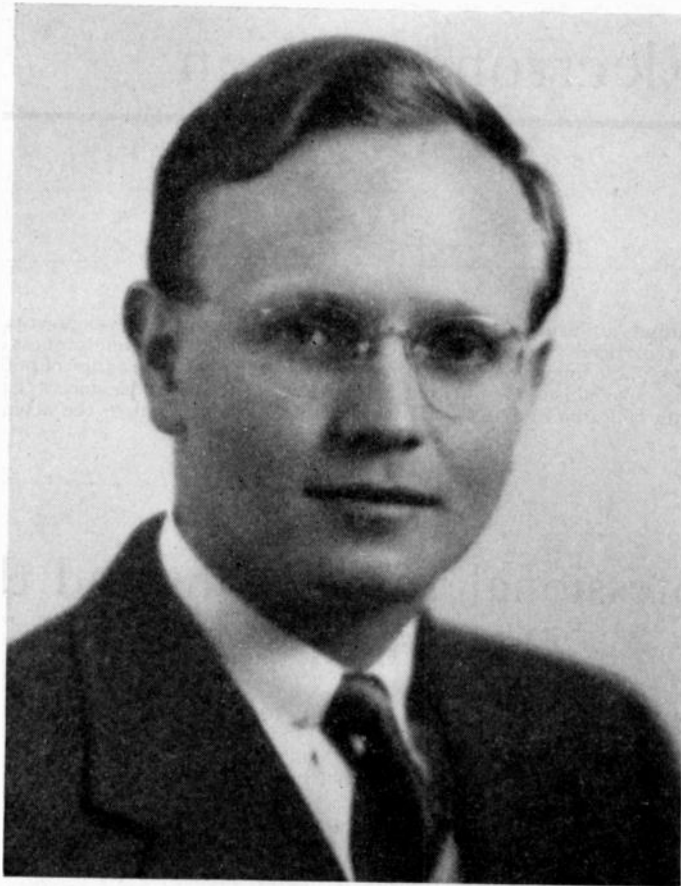

J. Griffiths Barry

Secretary-Treasurer, Princeton Subsection, 1946

J. Griffiths Barry was born in Albany, New York, on April 9, 1915. He received the degree of B.S. in electrical engineering from George Washington University in 1935, graduating "With Distinction." Awarded a graduate fellowship by the University of Pennsylvania, he transferred to that institution and received degrees of M.S. in electrical engineering in 1936 and Ph.D. in 1938. For his Doctor's thesis, he utilized the differential analyzer at the University of Pennsylvania to solve a difficult electrical-machinery problem.

In 1938, Dr. Barry became associated with the Bartol Research Foundation, located in Swarthmore, Pennsylvania. Here he assisted Dr. Thomas H. Johnson in cosmic-ray measurements, principally accomplished through use of apparatus carried to high altitudes by free balloons and employing radio transmission of data to ground recording stations. Together with Dr. Johnson, he visited the Panama Canal Zone to make balloon flights near the equator.

In 1940, he joined the staff of Princeton University, where he is now assistant professor of electrical engineering. At Princeton, he inaugurated new courses in electronics and radio engineering, and during the war, was active in organizing and teaching courses sponsored by the United States Office of Education. Among the

latter was the well-known "ultra-high-frequency techniques" which prepared many students for radar service with the armed forces. In 1943, he assisted in organizing at Princeton a Pre-Radar Training School for Naval Officers.

Because of war conditions, he obtained a leave of absence from Princeton in 1945 to become chief engineer for the radio manufacturing firm of Barker and Williamson, where he developed special equipment for the Armed Forces. On returning to Princeton, he assumed technical direction of a research project being carried on for the Bureau of Ships of the United States Navy.

Dr. Barry has published several papers in technical periodicals on the results of his research, particularly in the field of cosmic rays.

He joined The Institute of Radio Engineers as an Associate in 1941 and transferred to Senior Member grade in 1945. When the Princeton Subsection was formed in 1945, he was elected to the office of Secretary-Treasurer. Other societies of which Dr. Barry is a member are the American Institute of Electrical Engineers, the American Physical Society, the American Association for the Advancement of Science, the Society for Promotion of Engineering Education, and Sigma Xi. He is also a licensed Professional Engineer.

A Note on Electrical Engineers Trained During the War*

G. H. FETT†, SENIOR MEMBER, I.R.E.

During World War II, educational activities in all countries suffered serious derangement. The types of training, and the number of men trained, differed markedly from those corresponding to prewar conditions. As a result, certain deficits in technically trained men and certain backlogs of men readily available for further engineering training now exist. Accordingly, at the request of the Committee on Education of The Institute of Radio Engineers, under the Chairmanship of Professor A. B. Bronwell of Northwestern University, Evanston, Illinois, the author of the following report has kindly assembled and analyzed the pertinent and instructive data which it contains.

The Editor

Summary—The decline in the number of electrical engineers trained during the war and the somewhat compensating effect of the government training programs are discussed. The large number of technicians trained by the government is tabulated.

THE COMMITTEE on Education of The Institute of Radio Engineers decided that it would be helpful if a survey of the training of electrical engineers trained by the schools during the war years were made. These data will be of interest to young men entering the electrical-engineering profession and can be used as a guide to advise the large numbers of entering students in the colleges and universities.

The curves given in Fig. 1 show graphically what

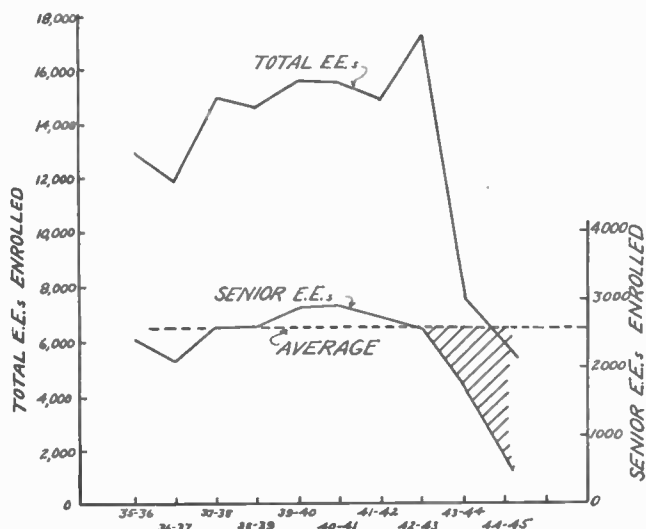

Fig. 1—Electrical-engineering students enrolled in engineering colleges in the United States during last decade. The effect of the war on the number of seniors is shown by the shaded deficit area.

happened to both the senior electrical engineers and the total number of electrical engineers registered during

* Decimal classification: R070. Original manuscript received by the Institute, April 18, 1946.

† University of Illinois, Urbana, Ill.

the period from 1935 to 1945. If it is assumed that the "average" line represents the number of seniors which industry could be expected to absorb, the shaded area indicates the accumulated deficit of college-trained electrical engineers because of the effect of Selective Service.

College-trained electrical engineers (on basis of seniors) 6-year total (1940-1945)	13,452
Probable number required by industry, 6×2600	15,600
Estimated deficit	2148

This deficit would appear to be more serious when it is noticed that the total number of electrical students has dropped also, indicating that it will be some time before incoming students can build up the senior classes.

On the other side of this picture, however, are the numbers of men who have been trained by the Armed Forces. A very large number is represented by radio- and radar-trained officers and enlisted men, some of whom may have acquired the equivalent of the college training. The following totals may be of interest to appreciate the large number of men involved.

Navy College Training Program (V-12, 8 semesters)	3029
Army Specialized Training Program (completed 21 months)	1329
Radar schools—Army	2573
—Navy	4860
Radio engineer schools—Air Forces	8196
	<hr/>
	19,987

It is not to be thought that these 19,987 men are all trained electrical engineers. The writer taught Army Specialized Training Program courses and knows from this experience that, while the training covered many of the essentials of electrical engineering, the short time available did not permit the development of a technically disciplined thinking. These men, however, will provide a backlog of individuals who can go into the engineering schools with advanced standing. Furthermore, many who completed the V-12 program, which is college training, will choose to remain in active service.

In a letter to the writer, Professor C. E. Tucker, director of the Massachusetts Institute of Technology Radar School, estimated that between 40 and 50 per cent of the graduates would be qualified as radio engineers because many of them held bachelor's degrees in electrical engineering and physics. This means that there is a great deal of duplication between the list of electrical-engineering graduates and the list of graduates from the radar school. Every college teacher also knows that a large percentage of the communication

majors graduated during the last few years went to the M.I.T. Radar School. Furthermore, not all of those who did not have the background and completed the course could be considered as engineers, and as a matter of fact, probably only a very few.

Therefore, the large total of service-trained men represents actually a comparatively small contribution to the electrical-engineering deficit.

Of interest to the electronics industry is the number of technicians who have been trained by the various government agencies. Some of these men will be encouraged to take engineering training and others will form the group of technicians required by industry. The following typical tabulation may be of interest; it is to be remembered, however, that there is very likely a considerable duplication of numbers between the various classifications.

Engineering, Science and Management War Training¹

Communications	126,278
Electronics	59,755
Electricity and magnetism	22,726

208,759

Army Service Forces Schools²

Radio repairmen (basic)	25,940
Radio operators (code)	34,190
Radio repairmen, air equipment	2,335
Radio repairmen, fixed station	776
Radio repairmen, very-high frequency	248

63,489

Army Air Force Schools³

Radio mechanics	41,084
Radio operators	156,246
Radar operators	11,743
Radar mechanics	41,084

250,157

Similar tremendous numbers could be shown for other branches of the government service. That the technician training is well taken care of is evident.

An idea of the future may be obtained from the pres-

¹ From H. H. Armsby, Field Co-ordinator, Office of Education.

² From Colonel Stuart McLeod, Director, School Division, Army Service Forces.

³ From Major E. M. Adam, Military Personnel Division, Army Air Forces.

ent increase in enrollment. Because data from all schools will not be available for many months, Fig. 2 indicates the trend in enrollment of the University of Illinois, Department of Electrical Engineering, which probably is typical of engineering departments throughout the country. The immediate and very great rise in the en-

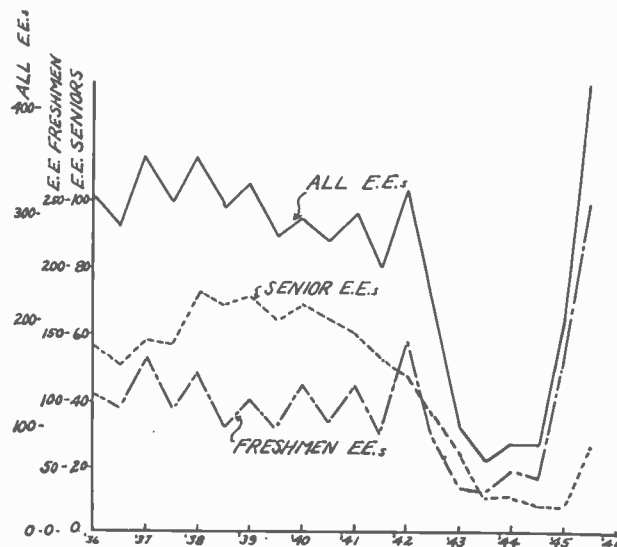

Fig. 2—Electrical-engineering students enrolled in the University of Illinois. Note the recent rise in number of freshmen and the time lag in the number of seniors.

rollment, especially in the freshman and sophomore years, would seem to show that the deficit which accumulated over the war years will be overcome in the matter of five years if this trend continues. It is to be emphasized, however, that it does take time not only to train the man in college, but to "season" him in industry, and the effect of the deficit which has occurred will last for many years. The "second harmonic" in Fig. 2 is caused by the decrease which occurs between the numbers registered in the fall and spring semesters. This decrease is much more pronounced in the freshman year and the attrition is a serious problem in colleges.

The data on reduction in numbers of masters' and doctors' degrees in science and engineering granted during the war years and the effect of the reduction have been presented before. It is only to be emphasized that, like the training of undergraduate students, it takes time, and the lag in graduate training will be greater than that for the bachelor degree.

Power Amplifiers with Disk-Seal Tubes*

H. W. JAMIESON†, MEMBER, I.R.E., AND J. R. WHINNERY‡, SENIOR MEMBER, I.R.E.

Summary—Laboratory studies of power amplification using disk-seal tubes are reported for frequencies from 200 megacycles up to the vicinity of 3000 megacycles. Operational data in the 200-megacycle band agree well with the predictions from conventional class-C calculations making use of static characteristics. In the 3000-megacycle band, the output and efficiency are approaching zero, although appreciable power gains at appreciable efficiencies are still obtainable on most tubes with especially well-designed circuits. The circuit types and some physical examples are discussed in the paper. Also discussed are certain transit-time effects which may contribute to the poor performance at high frequencies. One such effect is back-heating of the cathode because of returned electrons.

INTRODUCTION

THE RECENTLY described disk-seal tubes¹ may be used in power-amplifier applications over a wide range of frequencies, from very low frequencies up to microwave frequencies of the order of 3000 megacycles. The greatest interest is, of course, in the range from about 200 megacycles upwards, since there are many applications possible in this range with these tubes that are not possible with any other available tubes known to the authors. The disk-seal tube of greatest interest in microwave power-amplifier performance is the 2C39 tube, and most of this paper will be concerned with applications of that tube.

1. CHOICE OF CIRCUIT TYPE

Nearly all of the circuits used with disk-seal tubes in power amplifier applications at very-high frequency and higher are of the grid-return² type, in which signal input is applied between cathode and grid, and the load tank circuit is connected between grid and plate. Such a circuit is sketched in Fig. 1(a) (radio-frequency elements only), with the conventional cathode-return connection sketched in Fig. 1(b).

Basic equations for the gain of the grid-return circuit are readily derived for low frequencies and small signals, and are available in the literature.^{3,4} The voltage gains for the two circuits illustrated are, cathode return:

$$G_v = \frac{\mu Z_L}{r_p + Z_L} \quad (1)$$

grid return:

$$G_v = \frac{(\mu + 1)Z_L}{r_p + Z_L} \quad (2)$$

The grid-return circuit requires input driving power even at frequencies where transit-time effects are negligible and with bias conditions such that no grid current flows. This results from the load current flowing through the input driving source to return to the cathode. For low frequencies, small signals, no grid current, and pure resistance load, the power gain of the grid-return circuit is equal to the voltage gain.

$$G_p = G_v = \frac{(\mu + 1)R_L}{r_p + R_L} \quad (3)$$

For a cathode-return circuit operating under the above conditions there would be no driving power required in the ideal case, and even in practice its power gain could be made much higher than for the grid-return circuit, though its voltage gain is seen from (1) and (2) to be less. For practical power amplifiers, signals are not small and the grid is driven positive over some part of the cycle, so that grid-current does flow. We are also interested here in discussing some frequencies where transit times become relatively large. The comparison is then more complex, but the following may be said:

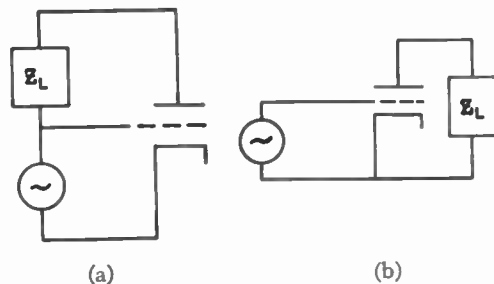

Fig. 1—Radio-frequency connections of input and load for (a) grid-return circuit, and (b) cathode-return circuit.

(1) At low frequencies (transit times negligible) the driving power is considerably greater for the grid-return circuit, because it depends upon the fundamental component of grid current plus plate current, while that for the cathode-return circuit depends only upon the fundamental component of grid current.

(2) At higher frequencies, where transit times are important, driving power for the cathode-return circuit increases and its driving-power advantage over the grid-return circuit decreases, but remains appreciable up to frequencies where other considerations eliminate the possibility of using cathode return.

* Decimal classification: R339.2X R355.7. Original manuscript received by the Institute, January 25, 1946; revised manuscript received, April 3, 1946.

† Formerly, Research Laboratory, General Electric Company, Schenectady, N. Y.; now at Hughes Aircraft Company, Los Angeles, California.

‡ Formerly, Research Laboratory, General Electric Company, Schenectady, N. Y.; now at University of California, Berkeley, California.

¹ E. D. McArthur, "Disk-seal tubes," *Electronics*, vol. 18, pp. 98-102; February, 1945.

² This circuit type is also referred to by the names "grounded grid," "cathode input," and "grid separation." The authors prefer, for all-frequency work, the name "grid-return," suggested to us by Dr. F. B. Llewellyn, and the corresponding names of cathode-return and plate-return for the other two possible connections of a triode.

³ M. C. Jones, "Grounded-grid radio-frequency voltage amplifiers," *Proc. I.R.E.*, pp. 423-430; July, 1944.

⁴ Milton Dishal, "Theoretical gain and signal-to-noise ratio of the grounded-grid amplifier at ultra-high frequencies," *Proc. I.R.E.*, pp. 276-283; May, 1944.

(3) Power output for the grid-return circuit is commonly greater than for the corresponding cathode-return circuit. At low frequencies, this increase is equal to

$$\frac{P(\text{grid return})}{P(\text{cathode return})} = \frac{|E_{pk}| + |E_{\theta k}|}{|E_{pk}|} \quad (4)$$

where E_{pk} and $E_{\theta k}$ are the fundamental components of plate-cathode and grid-cathode voltages, respectively. This increase comes about because of the 180-degree phase difference between input and output voltages, so that the actual alternating-current voltage between plate and grid is greater than that between plate and cathode. This increase in output power comes from a portion of the input driving power, so that it is possible for the plate-circuit alternating-current power output to be greater than the direct-current power input to the plate circuit.

(4) As frequency increases into the region where transit time is an appreciable part of a cycle, the phase shift between grid-cathode and plate-cathode voltages departs from 180 degrees, and the ratio of power output with grid return to that with cathode return decreases, but usually remains greater than unity up to frequencies where other considerations determine the choice between the two circuits.

(5) The increase of grid-return driving power over cathode-return driving power is usually greater than the increase of grid-return output power over cathode-return output, so that the cathode-return circuit retains the advantage in power gain over all the frequency ranges of interest.

The above considerations are important, but are often secondary to two other considerations, which are the actual determining factors at the highest frequencies. These are:

(1) The relatively high plate-grid capacitance requires neutralization in a cathode-return circuit at the higher frequencies. It becomes increasingly difficult to perform this neutralization effectively and without parasitic oscillations as frequency increases. In the grid-return circuit the feedback element is the cathode-plate interelectrode capacitance, which is much less than the grid-plate capacitance. For example, typical figures for a 2C39 are

$$C_{gp} = 1.95 \text{ micromicrofarads} \quad (2.1 \text{ max}).$$

$$C_{kp} = 0.02 \text{ micromicrofarad} \quad (0.035 \text{ max}).$$

$$C_{\theta k} = 6.5 \text{ micromicrofarads} \quad (7.5 \text{ max}).$$

From this comparison, one could expect the grid-return circuit to operate in the order of 100 to 1 higher in frequency without neutralization than would the cathode-return circuit with comparable gain.

(2) For frequencies above 1000 megacycles, it will usually be desired to use coaxial-type circuits or other similar self-enclosed circuits. Physical considerations make it impossible to connect such circuits directly to the tubes with a cathode-return circuit. A grid-return

circuit with such self-shielding cavities or lines can be attached easily.

Primarily because of the last-mentioned reasons, the grid-return circuit has been used almost exclusively for power amplifiers with disk-seal tubes at frequencies in the very-high-frequency band and above. Parallel-wire-line techniques have been used extensively for frequencies up to 500 megacycles and in certain laboratory amplifiers up to 1000 megacycles. Coaxial-line systems are used for frequencies higher than these.

2. CIRCUIT EXAMPLES AND PERFORMANCE FIGURES

A. Very-high-frequency amplifiers: Amplifiers have been constructed in the range 200 to 400 megacycles using 2C39 tubes. Because of the small interelectrode spacings, transit times are small in this frequency range, and the tubes, as would be expected, perform with good efficiency; performance is calculable from static tube curves by conventional means. For example, the calculated and measured quantities for a typical push-pull amplifier in this frequency range are as they appear in Table I.

TABLE I
(values per tube)
 $V_b = 600$ volts

	Calculated	Experimental
Grid bias	30	30 volts
Direct-current plate current	0.054	0.050 ampere
Direct-current grid current	0.032	0.030 ampere
Driving power	4	5 watts
Power output	21.5	20 watts
Plate efficiency	72 per cent	67 per cent
Power gain	5	4 times

In making such a calculation, any of the accepted procedures for class-C analysis may be used, one of the approximate methods usually being good enough.⁵ If the circuit uses grid return it must, of course, be remembered that the tube curves are published with plate-cathode voltages, and the load voltage is plate-grid. The analysis may be carried through in the usual order, using grid-cathode and plate-cathode voltages until power output and load impedance are to be calculated. The fundamental component of plate current is then used with the vector difference between plate-cathode and grid-cathode alternating-current voltages. The driving power is calculated using the grid-cathode alternating-current voltage and the sum of fundamental components of grid and plate currents.

The push-pull 200- to 400-megacycle circuit for which the measurements above were quoted was a parallel-wire-line circuit essentially as pictured in Figs. 2 and 3. In this circuit, two 2C39 tubes are set with axes parallel and about $1\frac{1}{2}$ inches apart, their grid sleeves fitting into slotted cylinders which are either connected directly or by-passed to a large, flat grid plane. One parallel-wire line, consisting of two pieces of $\frac{3}{8}$ -inch tubing $1\frac{1}{2}$ inches apart and $1\frac{1}{2}$ inches above this grid plane, is connected between the two plates to form the output resonant cir-

⁵ F. E. Terman, "Radio Engineer's Handbook," McGraw-Hill Book Company, New York, N. Y., 1943; p. 499.

cuit. A second similar parallel-wire line below the grid plane is connected between the two cathodes to form the input resonant circuit. Slidable short-circuiting bars are provided on each line for tuning, with large plates attached to close off the end space from the active region as completely as possible.

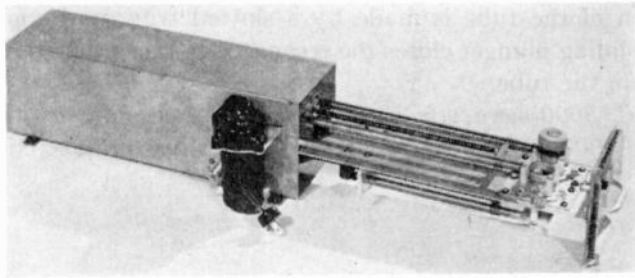

Fig. 2—The 200- to 400-megacycle developmental push-pull power amplifier using GL-2C39 tubes; side view showing chassis deck partly removed from shield can and one tube removed from socket.

The length of line required for resonance at a given frequency can be closely precalculated, although the chief difficulty is in accounting for the stray plate-to-ground capacitance from the radiators. However, a bridge measurement can be made with the tube in place

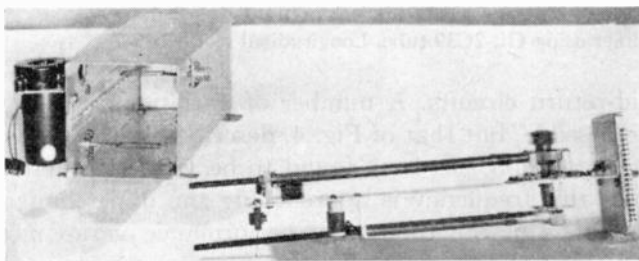

Fig. 3—The 200- to 400-megacycle developmental push-pull power amplifier using GL-2C39 tubes; view showing chassis deck completely removed and location of coupling loops inside shield can.

to give the sum of this stray and the grid-plate internal capacitance. The characteristic impedance of the line in the presence of the shield can be estimated from a flux plot or from formulas for a parallel-wire line in a coaxial shield.⁶

The plate transmission line is insulated for direct current from the grid plane. The cathode transmission line may be grounded at the far end and a direct-current blocking capacitance introduced at the tube. Heater leads and the cathode connection are brought out through the inside of the cathode-line rods.

For many applications it is desirable to have the shield box at ground potential, in which case the grid must be isolated for direct current from ground for application of grid-leak bias. A certain minimum grid leak is usually specified on the tube ratings for class-C conditions to minimize arcing. The size of the by-pass capacitor is governed by the feedback which could produce oscillations near the operating frequency of the

amplifier, because of voltage divider action between this by-pass and the output capacitance. A value about 100 times the output capacitance may be necessary, and can be obtained in the small space available through the use of silvered mica to minimize the air gap in the capacitor. Since some cathode-resistance holding bias is usually desirable to keep the current reasonable when the amplifier is not operating, the by-passes in the cathode connections are also retained.

Power is coupled in and out through relatively large rectangular loops placed in a plane parallel to the plane of the transmission lines. The lines connected to these loops are brought out asymmetrically in the amplifier shown in Figs. 2 and 3, and this may cause some unbalance of the tubes. It is consequently better to bring the lines out symmetrically, if possible. Matching may be accomplished by standard techniques, often by two movable dielectric slugs on the input and by double stubs or stubs and line stretchers on the output. Input power in the example cited was measured by taking the product of maximum and minimum voltage on the standing wave in a calibrated slotted section. Output power was measured at various times by load lamps, water loads, and thermocouples. All three methods agreed within 10 or 15 per cent, with the last-mentioned giving the most optimistic results.

B. 1000-megacycle amplifiers: The 1000-megacycle region is discussed because it is the intermediate range in a number of respects. It is about the highest frequency at which the parallel-line techniques described for the very-high-frequency amplifier can be used with much success, and even here the single-ended coaxial circuit has many advantages. The plate efficiency obtainable at 1000 megacycles is also intermediate between the typical class-C high efficiencies obtainable in the few-hundred-megacycle band, and the low efficiencies obtainable in the few-thousand-megacycle band.

A parallel-wire-line circuit may be built for 1000 megacycles, and is essentially like that described previously. However, the coaxial circuit of Figs. 4, 5, and 6 has given better performance and had less regeneration difficulties, and was therefore found superior. This particular amplifier would operate from a little below 1000 megacycles to something above 3000 megacycles. Performance figures at the highest frequency band are to be described later; typical performance figures at 980 megacycles were as follows:

- Plate voltage = 1000 volts
- Direct-current plate current = 90 milliamperes
- Direct-current grid current = 15 milliamperes
- Bias = grid leak, around 1000 ohms
- Driving power = 7 watts (measurement not precise)
- Power output = 45 watts (water-load measurement)
- Percentage ratio of alternating-current output power to direct-current plate input power = 50 per cent
- Power gain = 7 (approximately)

The rated cathode current of 100 milliamperes was exceeded in these tests, so that this represents one limitation on power output. Larger driving powers also

⁶ E. L. Green, F. A. Leibe, and H. E. Curtis, "The proportioning of circuits for minimum high-frequency attenuation," *Bell Sys. Tech. Jour.*, vol. 15, pp. 248-283; April, 1936.

produced arcing between cathode and grid and caused grid burn-outs on some of the tubes, although the production tubes have since been improved in this respect. There were some indications of regeneration in the operation, even at this frequency, which may account for the relatively good power gain.

The circuit of Figs. 4, 5, and 6 consists of a long coaxial input line, and a shorter and larger-diameter coaxial output cavity, both closed by sliding plungers. The inner conductor of the input line is a long $\frac{1}{8}$ -inch inside-diameter, $\frac{3}{8}$ -inch outside-diameter tube. A by-pass of approximately 80 to 100 micromicrofarads is

cylinder of the grid-plate resonator is a $1\frac{3}{8}$ -inch inside-diameter, $1\frac{1}{2}$ -inch outside-diameter tube, with two side arms brought out through which probes or loops may be introduced for coupling power out. The by-pass is a mica sheet between two flat plates near the plate end of the outer cylinder, providing about 800 micromicrofarads capacitance. Good contact on the plate connection of the tube is made by a slotted truncated cone. A sliding plunger closes the resonator at the end farthest from the tube.

C. 3000-megacycle performance: The circuits used in the 3000-megacycle range are almost invariably coaxial

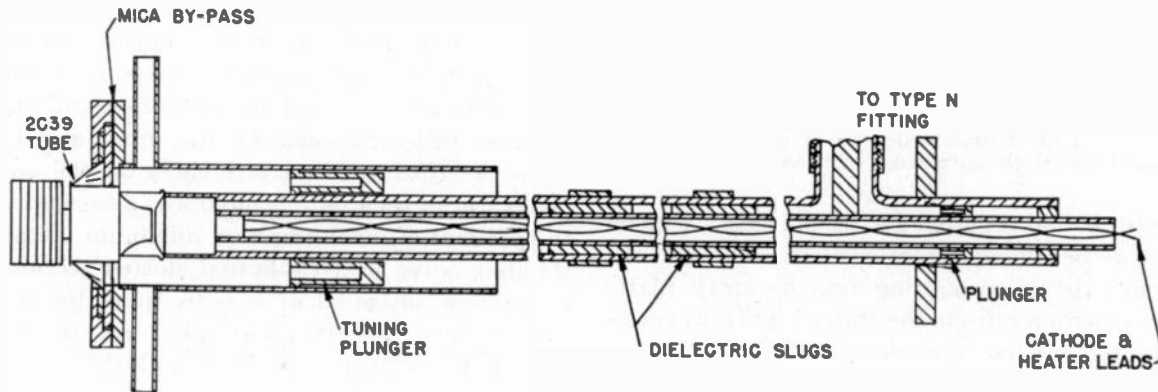

Fig. 4—The 1000- to 3000-megacycle coaxial power amplifier using GL-2C39 tube. Longitudinal section.

formed in this tube near the cathode end by a conical-section capacitor having mica or other high-temperature insulation, to provide cathode direct-current isolation. Polystyrene and similar dielectrics are not satisfactory for this by-pass because of the small thickness required and the temperature rise from heater power. The direct-current-isolated end fits over the cathode connection of the tube, and the heater and cathode leads are brought out through the inside of the inner cylinder. The outer cylinder of the input line,

grid-return circuits. A number of variations in design are possible, but that of Fig. 4, described in the preceding paragraph, has been found to be very satisfactory. Since this frequency is approaching the upper limit of usefulness of the tubes, the performance varies more from tube to tube than at lower frequencies. However, power gains up to four or five times, plate efficiencies up to 15 or 20 per cent, and power outputs up to 15 or 17 watts have been obtained without exceeding the tube ratings.

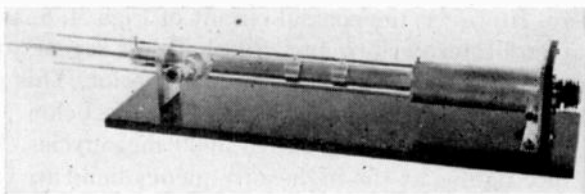

Fig. 5—The 1000- to 3000-megacycle coaxial power amplifier using GL-2C39 tube.

which is also the inner cylinder of the output resonator, is a $\frac{3}{8}$ -inch inside-diameter, $\frac{3}{4}$ -inch outside-diameter tube, machined to $\frac{1}{8}$ -inch inside diameter near the grid end and slotted to form a sliding fit over the grid connection of the tube. A lead sleeve is added around the tube's grid connection before the tube is inserted, to decrease feedback through this connection. A side arm with a standard type-N connector is added to the input line near the far end, with the plunger introduced beyond. Two slidable quarter-wave mycalex cylinders are placed in the input line for matching purposes. The outer

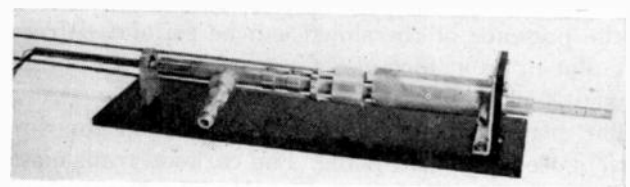

Fig. 6—The 1000- to 3000-megacycle coaxial power amplifier using GL-2C39 tube; tube removed and inner cylinder extended.

The factors which limit performance at these high frequencies are very important, and will be discussed further in a separate section. However, it is important to note here that one of the results of the transit-time effects for these frequencies is to make the tube work best with a load whose impedance is higher than that normally used at lower frequencies. This means that at these higher frequencies the shunting impedance of losses due to conductors, glass, contacts, and by-passes may then be comparable with the useful load, and it is consequently of great importance to keep these losses

to a minimum. For this reason, the losses of all newly designed circuits should be studied before the circuit is considered satisfactory. We have usually done this by bandwidth Q measurements taken by coupling the cavity lightly to the output of a swept reflex oscillator, and coupling lightly to a crystal through the second output to an oscilloscope. For the circuit of Fig. 4, Q 's up to 1500 were measured with the tube in the circuit, corresponding to a shunting impedance of the order of 20,000 ohms referred to the grid-plate terminals. In poor circuits, Q 's as low as a few hundred were observed and operation with such circuits was much poorer. Too-large slots in the tuning plunger turned out to be the most important factor in one of the poor circuits measured.

The cavities actually used with disk-seal tubes may be represented by transmission lines with relatively complex end-effects. However, for many purposes it is sufficiently accurate to consider the end effect only as a lumped capacitance. For high- Q circuits, the relation between the resonant impedance R that can be built up at the gap of a capacitively foreshortened resonant transmission line and the Q is

$$R = QZ_0 \left[\frac{2 \sin^2 \theta}{\theta + \sin \theta \cos \theta} \right] \quad (5)$$

where Z_0 is the characteristic impedance of the line and θ the electrical length determined by the equation

$$\tan \theta = \frac{1}{\omega CZ_0} \quad (6)$$

ω is angular frequency and C the end-loading capacitance.

As an example, if $C = 2 \times 10^{-12}$ farad, $\omega = 2\pi \times 3 \times 10^9$, $Z_0 = 30$ ohms, equation (6) gives $\theta = \tan^{-1}(0.885) = 0.724$ radian, and equation (5) gives $R = 0.719(QZ_0) = 21.6Q$. Note that, for a "three-quarter"-wave circuit (more accurately a capacitively foreshortened three-quarter-wave circuit) with the same parameters, θ would be selected as $(0.724 + \pi)$ radians and (5) would give $R = 0.202(QZ_0) = 6.06Q$, so that the impedance for a given Q is much less than for the "one-quarter"-wave circuit. This does not mean immediately that the three-quarter-wave circuit is poorer, although it may be under certain conditions. If the required bandpass fixes the Q , then the three-quarter-wave circuit gives a much lower impedance. Also, if the Q is a result of losses mainly distributed along the line, the one-quarter- and three-quarter-wave circuits will have about the same Q , and the latter will have the lower impedance. However, if Q is not fixed by bandwidth requirements and losses are mainly concentrated at the tube, the three-quarter-wave circuit will have a higher Q for the same losses and the two circuits will then present about the same impedance to the gap.

The circuit efficiency can be calculated if values of loaded and unloaded Q are measured. The following formula is good for reasonably high Q 's:

$$\frac{\text{power to load}}{\text{total radio-frequency power from tube}} = \frac{Q(\text{unloaded}) - Q(\text{loaded})}{Q(\text{unloaded})} \quad (7)$$

D. Power amplification with other disk-seal triodes: The circuits shown are for the 2C39 triodes, which are built in the "oilcan" envelope. Other disk-seal tubes of interest in power amplification are the 3C22 and the 2C43. The 3C22 is a larger tube and has a higher rating but a lower useful upper frequency. The 2C43 is a smaller tube with smaller ratings but about the same upper frequency limit and roughly the same plate efficiencies and power gains as those quoted for the 2C39, but with a smaller output. Output of 10 watts from two 2C43 tubes in push-pull at 1500 megacycles, with 350 volts on the plate and a driving power of 3 watts, is quoted as typical. This tube is built in the "lighthouse" envelope, and may use any of the circuit configurations described by McArthur in his original paper.¹

3. SPECIAL PHENOMENA AT TRANSIT-TIME FREQUENCIES

In this section we wish to discuss some of the factors which affect the behavior of the power-amplifier tubes described in the paper at their highest useful frequencies. The discussion is to be mainly qualitative, since a more complete description of the quantitative study will be given in a later paper. It should also be understood that it is incomplete, since we do not yet know the relative importance of all the limiting phenomena, but the effects to be described are believed to be important, whether or not they are the only ones.

The performance figures given previously show that the power output and efficiency of the 2C39 tube in the 3000-megacycle range are only a small fraction of their low-frequency values, and the upper limit of usefulness is in the range of 3000 to 4000 megacycles. Calculations show that, for voltages used with the tube, the transit time of electrons at these frequencies must be a large part of a cycle, so transit-time effects are important possibilities as limiting factors. Extensive transit-time analyses are available for small signals,⁷ but the study of large-signal transit-time electronics has been much less complete because of the increased complexity of the problem. A paper by Chao-Chen Wang⁸ presents an excellent beginning, and, in an unpublished thesis, Salzberg uses a similar approach but treats the temperature-limited problem so that calculations may be carried out more easily and the phenomena more readily visualized. Both of these reports reveal the essentials of the phenomena to be described below.

A. Cathode bombardment by returned electrons: For

⁷ F. B. Llewellyn, "Electron Inertia Effects," Cambridge University Press, New York, N. Y., 1941.

⁸ Chao-Chen Wang, "Large-signal high-frequency electronics of thermionic vacuum tubes," *PROC. I.R.E.*, pp. 200-214; April, 1941.

small signals, the main movement of the electrons is determined by the direct-current potentials on the tube electrodes, and the superposed high-frequency signals cause only small perturbations in that movement. For large signals, the movement is affected in a very important way by the alternating-current signal. Thus, for an ordinary class-C amplifier, electrons flow only over that part of the cycle for which the signal input produces an attractive force on the electrons large enough to overcome the repelling force of the negatively biased grid. When the transit time of the electrons into the region where the attractive force from the anode captures them is a negligible part of a cycle, essentially all of the electrons from the cathode complete their

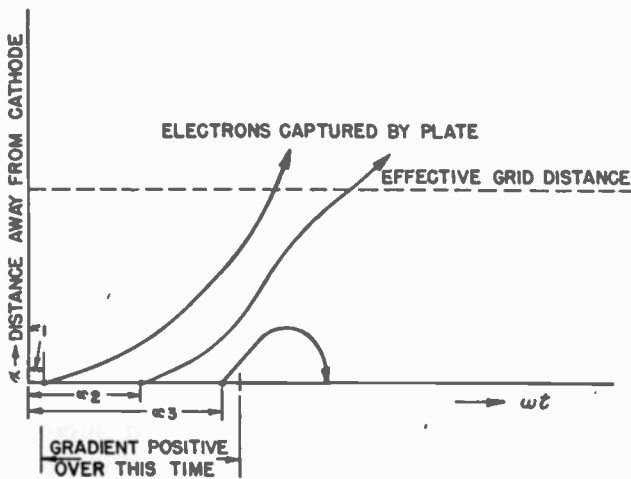

Fig. 7—Demonstration of electron return to cathode under class-C transit-time conditions.

paths to either the plate or grid. When that transit time is an important part of the period, some or all of the electrons will be returned to the cathode under class-B or -C bias conditions, thus decreasing the useful current and causing back-heating of the cathode by the returned electrons.

This return of electrons may be visualized by studying Fig. 7. For the sake of simplicity we will assume that all electrons have about the same transit time to the grid plane, though this difference in transit time caused by the varying fields throughout the cycle is important and must be taken into account in an actual analysis. Let us consider a condition in which bias and driving signal are adjusted so that electrons should be attracted from the cathode over 120 electrical degrees, and let us say that the transit time to the grid plane is about the same amount. The first electron is emitted at angle α_1 , when the gradient at the cathode first becomes positive, and this electron will have an accelerating field on it all the way to the grid plane where it will be captured definitely by the positive gradient from the plate. Later electrons, such as that emitted at angle α_2 , a small angle later, will not reach the grid plane before the gradient in the grid-cathode space has reversed, and they will experience a decelerating force for the last part of their transit into the grid-plate space. For the early electrons, this decelerating force

will not be great enough to overcome their prior acceleration, so they will pass on into the grid-plate space (or hit the grid), but for some electrons still later, such as that emitted at α_3 , the deceleration will be enough to cancel the previously obtained acceleration and these electrons will be returned to the cathode. The first physical evidence of this is the back-heating of the cathode due to the energy of bombardment of these electrons, each returning to the cathode with a definite velocity. At 3000 megacycles, in a 2C39 power amplifier, this phenomenon has been observed in such degree that, after the amplifier was operating, the heater power could be completely removed without any appreciable change in performance. Conversely, if the heater power is left on, this increase in temperature caused by the electron back-heating is enough to decrease seriously the life of the cathode.

B. Increased input loading caused by returned electrons: The power that goes into the back-heating of the cathode by returned electrons comes from the accelerating fields in the cathode-grid space which are primarily from the high-frequency driving source, so this phenomenon causes an increase in loading to the driving source without giving much in return for it, since 60-cycle cathode-heating power is much cheaper than heating power at a few thousand megacycles. This back-heating usually amounts to a few watts, as might be guessed from its effectiveness in heating the cathode, and this may be an important part of the total driving power. The increase in input loading may, of course, be expressed as an increase in input conductance of the tube.

C. Decrease of useful output because of returned electrons: The electrons returned to the cathode subtract from the useful current passing into the grid-plate space. This means that the power output capabilities of the tube are decreased, and, since the same phenomenon acts to increase driving power, the power gain is decreased in two ways. The plate efficiency is not necessarily decreased by this particular phenomenon, since the average plate current is decreased along with the fundamental component, but other factors to be discussed later may act to decrease this efficiency.

The alternating-current plate swing required for optimum operation will remain more or less constant, so that, as the useful current decreases, the optimum load impedance increases. The shunting effect of losses, which are usually negligible compared with the relatively low optimum impedance required when the tube is operating without transit-time complications, may then become important, especially since the loss conductance increases with increasing frequency. And, although the ohmic losses of the circuit increase only as the square root of frequency, the total losses may increase considerably faster because of the loss in the glass envelope and its seals, and stray leakage or radiation, at the higher frequencies. The effective shunt impedance may thus finally become comparable with the useful load impedance and result in a poor circuit efficiency.

If the optimum impedance to be presented to the tube terminals should be higher than the unavoidable impedance due to circuit losses, it could not be obtained, and the tube would not be used to its best advantage. This increase in tube impedance may then be a very serious consequence of the returned electrons.

D. Increase in returned electrons with increasing class-C conditions: Further study of the example in Fig. 7 reveals that for a given tube the percentage of returned electrons must become higher as the conditions are made more and more class C. Thus, if current were emitted from the cathode for only 60 electrical degrees, even the first electron emitted would be less than half-way to the grid-plane when the gradient reversed, and this would rapidly meet a large decelerating force, so that even the first electron would be returned. There would be no useful current in this case. This extreme example demonstrates the way in which returned electrons increase as the angle of current leaving the cathode decreases. We are thus led to a first conflict: *If high plate efficiency is required, it could not for the usual reasons be obtained without operating definitely class C; but extreme class-C operation with a very narrow angle of plate current flow will, at high frequencies, increase all of the bad effects traceable to returned electrons, which have just been described.* Thus, at transit-time frequencies, best operation is often obtained with conditions nearer class B than extreme class C.

E. Transit-time effects in grid-plate space: In a triode, a second conflict arises when we consider the transit-time effects in the grid-plate space. High plate efficiencies cannot be obtained unless the electrons strike the plate with small velocities; they cannot do this when the

gradient is all in the same direction *unless it is small* all the time the electron is in the space; this cannot be so with large variations in plate voltage with time unless the transit time through this space is small, *but to keep the transit time down the gradient should be large.* The effectiveness of current induction in this space, or gap-coefficient as it is sometimes called, decreases with increasing transit time, so for this reason also the transit time cannot be allowed to become large. The above difficulties would not be present in a tetrode and might be minimized to some extent in a triode by allowing large enough radio-frequency voltages between plate and grid to reverse the gradient over a part of the transit, reducing the velocity at the end to a smaller value. This would require still higher impedances and could only be used with small angles of entrance of electrons into the grid-plate space, so would probably not represent a satisfactory operating adjustment.

F. Conclusions: Although the exact reasons for poor operation at the highest frequencies are not understood, the transit-time phenomena discussed are important possibilities. The cathode back-heating is certainly present and must be considered. The tendency for the tube to require higher operating impedances as frequency increases has also been observed experimentally. This latter effect may be responsible for much of the poor operation, since the difficulty of obtaining high impedances also increases with increasing frequency, and circuit efficiency may consequently become low. The returned current to the cathode also subtracts directly from the useful current entering the grid-plate space, and therefore decreases directly the output capabilities of the tube in this manner.

Problems in the Design of High-Frequency Heating Equipment*

WESLEY M. ROBERDS†

Summary—Although some of the first high-frequency power generators which were used for industrial-heating purposes were merely converted radio transmitters, it was found, as the art progressed, that the problems involved were quite peculiar to the industrial class of service. Probably the greatest problem facing the designer of industrial radio-frequency generators is that of the coupling circuit through which the generated power is fed into the load.

INTRODUCTION

WHENEVER high frequencies are used in industrial-heating applications, there is usually involved, in the over-all process, the conversion of 60-cycle power into heat energy within the work. As is well known, this conversion is carried out in four

Various coupling schemes are discussed and the advantages and disadvantages of each are pointed out. A simple analysis of a transformer-coupled circuit is made by showing how the inherent Q of the load is reflected into the tank circuit.

The advantages of close coupling are compared with those of loose coupling, and it is suggested that a generator can be made more versatile if low-impedance tank circuits are employed.

steps by four devices or groups of circuits. The first of these is the rectifier unit; the second is the oscillator tube, with its attendant tank and auxiliary circuits; the third is the coupling circuit and applicator which takes energy from the tank and transforms it into alternating electric or magnetic fields within the work; and the fourth is the work itself, whose electrons and atoms change the high-frequency energy into heat.

The designer of radio-frequency heating equipment must consider all these steps and work out acceptable

* Decimal classification: R598. Original manuscript received by the Institute, December 28, 1945; revised manuscript received, March 11, 1946.

† Radio Corporation of America, RCA-Victor Division, Camden, N. J.

designs for each component part of the system. As for the rectifier and oscillator units, good designs of these components have long since been attained through years of radio-communication practice. Moreover, beyond slightly modifying the shape of the part to be heated, there is nothing which can be done to improve the conversion of high-frequency field energy into heat energy within the work. In the third conversion step, however, there is much room for development, and there exists considerable disagreement as to proper methods and types of equipment for handling the coupling problems. In other words, the coupling circuits constitute the bottleneck of the designing process. They are a bottleneck in more than one sense, since they are the funnel through which must be channeled the power which is to heat the work. Because of this important function the coupling circuits determine, to a large extent, the percentage of available power which finally gets into the work.

In the ideal case, a radio-frequency heating equipment would furnish its full rated power into any load which might be connected to it. This ideal cannot be attained, however, since the electronic generator behaves like more-common electrical apparatus, in that the power output is determined by the electrical characteristics of the load.

Let us say that the "load" which is to be connected to a radio-frequency generator consists of the work to be heated together with such applicators as will give the desired heating pattern. Obviously, the material of the work and the heating pattern desired will determine whether the induction or dielectric-heating method should be used, and will also fix the decade of the frequency. It can also be seen that these properties determine the equivalent inductance, capacitance, and resistance of the load. It then becomes the problem of the design engineer to plan tank and coupling circuits which will not only provide the desired frequency but which will *feed the desired power into the predetermined load*. It is apparent that the latter requirement is the difficult one to meet.

The load will most likely have an impedance that is far different from that into which an electronic tube will work effectively. Therefore, some means of impedance matching is usually necessary. Moreover, the coupling between applicator and work is often low, so that the tank kilovolt-amperes must be large. This, of course, means that tank and coupling circuits must be so constructed that their power losses will be small, even though the currents are great.

In many cases it is physically impossible or exorbitantly expensive to build the necessary tank and coupling circuits. Moreover, it is impractical to make a complete custom-designed generator for every application, even though it may be possible to build it. Fortunately, the requirements of many important heating applications are nearly enough the same so that a relatively few basic designs of generators will handle a wide

range of heating jobs with fair efficiency and economy.

In general, the aim of the designer is to produce an equipment which will work well on some specific type of load and which will handle as many as possible related applications. This, of course, requires a high sense of compromise and a considerable ability to guess what type of application will be the most important.

Perhaps the best that can be done to approach a universal design is to build a generator in which the various circuits are as closely coupled as possible and which will have as low an internal impedance as possible. Then for those jobs which require looser coupling or less than maximum power, some means of increasing flux leakage or of decreasing power to the oscillator tube is to be provided.

Of course, close coupling means a high order of interaction between the component circuits. Thus, although the coupling circuits themselves may be the chief point of interest, this group of circuits cannot be treated as an isolated system; it must be considered as a part of the whole. It is best, therefore, to look at the over-all picture first; to outline the whole design so that a complete picture can be formed of the tank circuit, coupling circuit, and applicator, and of their relationships. Then later, particular problems of the coupling circuit will be taken up.

IMPORTANCE OF THE QUANTITY Q

First consider the work itself. The power-absorbing qualities of a sample are often expressed by a so-called "power factor"; that is, by the ratio of the power converted into heat to the equivalent volt-amperes in the form of electric or magnetic flux which threads through the sample. Moreover, since the whole problem is one of energy transfer, in an analysis of each of the above-mentioned circuits the power factor of the circuit is an important consideration. This suggests that analyses can be made most simply by utilizing the concept of the Q of the circuit.

It will be remembered that the Q of a circuit is defined as the ratio of the circuit's reactance to its resistance. Thus, for an inductive circuit, if L is the inductance, R the resistance, and ω is 2π times the frequency, $Q = (L\omega/R)$, and for a capacitive circuit, $Q = (1/C\omega R)$. To show how this quantity is involved in power-factor considerations: by definition, power factor $= (I^2R/EI) = (I^2R/I^2Z)$, and since, for the circuit used in the present work, Z , the impedance, is approximately equal to $L\omega$, the power factor can be taken as equal to $1/Q$.

Similarly, for a capacitive load,

$$\frac{I^2R}{I^2/C\omega} = RC\omega = \frac{1}{Q}$$

Thus, a "high- Q " load is one having small losses—a low power factor. Moreover, as it will be demonstrated subsequently, if the coupling is good, a high- Q load will, when placed in the applicator, cause the tank-circuit Q

to be high; conversely, a low- Q material (i.e., one having high losses) will cause the tank-circuit Q to be less.

GOALS TO BE SOUGHT IN TANK-CIRCUIT DESIGN

For an electronic generator to oscillate with stability, the value of tank circuit Q must be 10 or more—preferably more. On the other hand, however, the lower the value of Q , the lower is the circulating kilovolt-ampere value, and hence the smaller the circuit losses.

In designing a radio-frequency power generator, therefore, the first consideration is to plan tank and coupling circuits which will not only handle the rated power and which will oscillate at the desired frequency, but which will also result in the tank circuit showing a Q of 10 to 20 when the applicator is loaded with the given work. Probably the best way to illustrate the problem is to calculate, in the simplest fashion, the values of electrical quantities needed in a hypothetical radio-frequency generator.

Suppose that the generator is to furnish 20 kilowatts to a steel sample at a frequency of 400 kilocycles, and that the tube (or tubes) must operate on a plate voltage of 8.5 kilovolts. Further, suppose that it is possible to build a practical circuit which will have an efficiency, tank-to-work, of 75 per cent and which will have a Q of 20 when fully loaded. (Indeed, several types of circuits can be built which will have these characteristics.) The general type of circuit is shown in the diagram of Fig. 1.

The values of tank-circuit inductance and capacitance can be calculated as follows:

The power delivered to the tank circuit by the tube is

$$P_t = EI(\text{p.f.}) = \frac{EI}{Q} \quad (1)$$

Here E is the root-mean-square value of voltage impressed on the tank circuit. It will be approximately $8.5 \times 0.9 \times 0.707 \times 1.25$, or 6.6 kilovolts. The factor 1.25 enters, since in most popular circuits both the grid and plate voltages are impressed across the tank and a good value of grid excitation is about one fourth the plate voltage.

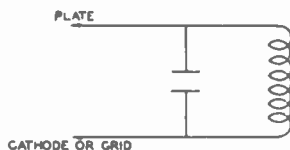

Fig. 1—Typical tank circuit.

The tank current is represented by I and is determined by the tank capacitance C and E in the relationship $I = EC\omega$.

Since the power in the work is 0.75 of that delivered to the tank, then

$$20,000 = 0.75 \frac{EI}{Q} \\ = \frac{0.75(6600)^2 C \times 2\pi \times 400 \times 10^3}{20}$$

From this equation, $C = 0.005$ microfarad and it follows that, since the frequency is 400 kilocycles, the impedance of the capacitor will be 80 ohms; therefore, the inductance in the tank circuit must be 32 microhenries.

From the simple equation (1) several important deductions can be made. In the first place, the higher the value of Q , the higher must be the kilovolt-amperes, in order to furnish the desired power. This bears out the statement made above, that the Q of the tank should be made as low as possible, in order to keep down losses. A higher kilovolt-ampere value is usually obtained by increasing the circulating currents and, of course, the copper losses increase with the square of the current.

Another useful deduction which can be made from (1) involves the impedance into which the power tube is to work. The power going to the tank circuit from the tube is $P_t = (EI/Q)$.

Since I is the circulating tank current, this equation can be written

$$P_t = \frac{E}{Q} \cdot \frac{E}{Z}$$

where Z is the impedance of either the inductance limb or the capacitance limb of the tank circuit. The product QZ is essentially the impedance of the parallel circuit as seen by the tube. The quantity QZ determines the type of tube which will be best for the application considered. For each power-oscillator tube there is a characteristic impedance *into* which it works most effectively. In general, the more powerful the tube, the lower is this optimum load impedance.

Finally, it should be noted from (1) that the ratio (EI/P_t) , a quantity which is often called the kilovolt-ampere ratio, is nothing more than the Q value of the circuit.

TYPICAL COUPLING CIRCUITS

Let us now see how some typical coupling circuits may be used to meet the requirements which have been assumed in the above calculation.

The simplest way to couple energy into a piece of work would be (1) to put the sample directly inside the tank inductance for induction heating; or (2), if it is a dielectric material, to put the work between the plates of the tank capacitor.

While these procedures might work well if the generator were designed to heat one specific load, obviously the same generator could not be used to heat loads of widely different sizes, shapes, or dielectric constants. Therefore, some modifications will have to be made. For induction heating the first step in the solution of the problem is to bring out a part of the tank-inductance coil and wind it to fit the work to be heated (Fig. 2). Similarly, in dielectric heating two applicator electrodes, together with the

load, can be used as a capacitor in parallel or in series with the main tank capacitance.

Again, while such expedients may be simple, they are far from ideal. For in both the above arrangements, unless the load branch constitutes most of the tank inductance or capacitance, there is a lack of "coupling" to the work. In other words, the circulating kilovolt-amperes must be raised to a very high value in order to get the full rated power of the generator into the work.

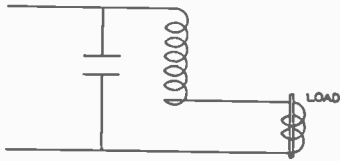

Fig. 2—A portion of the tank circuit may be brought out and used as an applicator coil.

For example, in the case of a certain induction-heating generator the main tank inductance consists of a helix of $\frac{3}{8}$ -inch copper tubing containing 14 turns wound on a 5-inch radius. The length of the coil is about $7\frac{1}{2}$ inches. In series with this coil is connected an applicator consisting of 7 turns of $\frac{1}{4}$ -inch copper tubing. The inside diameter of this coil is approximately $2\frac{1}{4}$ inches and the length is about 3 inches. The work to be heated is a thick-wall steel tube with an outside diameter of 2 inches. The two coils together constitute the tank inductance of the oscillator. Alone, the larger coil is found to have a Q of 220 at a frequency of 400 kilocycles. When the applicator coil is connected in series with the larger coil, the Q of the combination is 200 and a capacitance of 0.00509 microfarad is necessary to complete a tank circuit which will oscillate at 400 kilocycles.

The work is then placed within the applicator and the Q of the combination of coils is found to be 100 instead of the 200 which existed when the applicator was unloaded. Moreover, the addition of the work caused the frequency to increase from 400 to 408 kilocycles.

The efficiency of the arrangement can be shown to be approximately

$$\mathcal{E} = 1 - \frac{f_2 Q_2}{f_1 Q_1}$$

Thus

$$\begin{aligned} \mathcal{E} &= 1 - \frac{408}{400} \frac{100}{200} \\ &\approx 0.48 \text{ or } 48 \text{ per cent.} \end{aligned}$$

It can be seen that if 20 kilowatts are to be fed into the work, the circulating kilovolt-amperes must be

$$\begin{aligned} EI &= \frac{20}{0.48} \times Q \\ &= \frac{20 \times 100}{0.48} = 4200 \text{ kilovolt-amperes.} \end{aligned}$$

If the capacitance and inductance of the tank circuit

are assumed to be fixed at above-mentioned values, the only way to secure such a high value of kilovolt-amperes is to increase the voltage on the circuit.

To continue the calculations, $EI = 4,200,000$ volt-amperes, and if I is replaced by $EC\omega$,

$$E^2 \times 0.00507 \times 10^{-6} \times 6.28 \times 400 \times 10^3 = 4200 \times 10^6$$

from which $E = 57.5$ kilovolts.

Obviously, such a high voltage in itself makes the whole design very bad, to say nothing of resulting low efficiency.

If the number of turns in the applicator coil is increased to 18 and the number of turns in the larger coil is reduced, so that the frequency stays the same, the unloaded Q of the circuit is 155 while the loaded Q is 50.

When calculations similar to those above are made using these new figures, it is found that the efficiency is about 66 per cent and that the tank voltage which is necessary to put 20 kilowatts into the load is 34.5 kilovolts. This is still so high that further modification will be necessary to attain a workable design. As the turns in the applicator are increased, however, the heating is applied to a larger and larger area, and thus the power concentration is steadily decreased.

To make this system of coupling workable and at the same time to maintain a reasonable power concentration, one or both of the two following modifications can be made:

(1) The "nonworking" section of the inductance can be reduced and the capacitance increased correspondingly; so that the frequency remains constant, or

(2) a tuning capacitor may be connected across the applicator coil and this section of the tank inductance thus partially tuned. Perhaps a better way of expressing it, however, is to say that, by the addition of a parallel capacitance, the power factor of the applicator section is increased, or that the Q of the loaded applicator is reduced.

By (1) above the tank-circuit impedance is lowered, and thus for a given impressed voltage the tank current is increased. Moreover, a larger proportion of the magnetic flux which threads the tank inductance also threads through the work. That is, by decreasing the inductance and increasing the capacitance of the tank circuit the kilovolt-ampere value is increased and closer coupling is secured, simultaneously. This lowering of the tank-circuit impedance is limited, however, by the increasing cost of the capacitors. Since the circuit losses increase with the square of the current, the greater the circulating current becomes, the greater are the copper losses.

When, as in (2), the load circuit is tuned, the impedance of the applicator part of the circuit becomes a greater proportion of the whole (which is equivalent to better coupling) and the current in the applicator may be increased to three or four times the current in the tank circuit.

The chief objections to this expedient lie in the type

of capacitors which are used for tuning the applicator. They must have high current ratings, be of a relatively low-loss type, and should be easily variable. They should also be of minimum size with closely spaced lead connectors, since even short leads may add as much inductance as corrected by the capacitor.

In both of these modifications the applicator generally requires a relatively large number of turns, and consequently the power concentrations are usually low.

A slight variation of the above procedure can be made by tapping the applicator coil across a portion of the main inductance, rather than by placing the two in series. The characteristics of this type of coupling are, in general, similar to these of the circuit described. Here, again, tuning or power-factor correction is necessary to obtain high powers at reasonably high efficiencies.

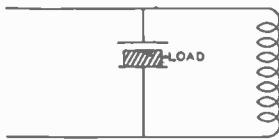

Fig. 3—The simplest method of applying the electric field for dielectric heating is to place the work directly in the tank capacitor.

For dielectric heating, the equivalent expedient is to put the "load capacitor" in series with the main tank capacitor. This can be done most easily merely by leaving an air gap between one or both surfaces of the work and the electrodes, as shown in Fig. 3. As was the case in induction heating, this effectively decreases the coupling to the work in that, as the air gap is increased, a larger proportion of the tank voltage appears across the gap and a smaller proportion appears across the load.

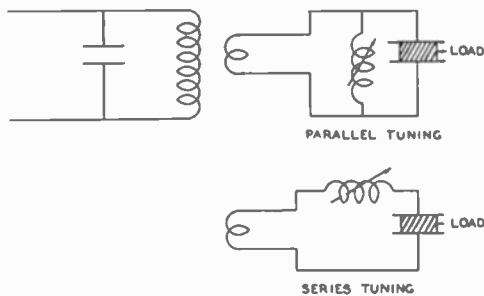

Fig. 4—The use of a tuned load circuit is a simple means of producing high voltages across the work.

In a great many cases, the power which can be applied to a dielectric load is limited not by the characteristics of the load, but by the voltage which is available across the tank circuit. Moreover, if an air gap is used in series with the work, voltage across the work is even more limited. It is often desirable, on the other hand, to increase the voltage across the load to a value several times as great as that across the tank circuit. This can be done most easily by placing the load in a separate tuned circuit which is coupled to the tank circuit as shown in Fig. 4. If the coupling between the circuits is greater than critical, the familiar two-humped resonant

condition appears and frequency skipping is likely to occur. It is generally preferable to cope with this condition, however, than to provide in the design for the high values of kilovolt-amperes which are necessary to attain full loading, when the coupling is critical or less.

Although the tuned load circuit makes possible the application of higher powers to the load, it is not an unmixed blessing. It is necessary to tune the circuit continually as the load heats and the electrical characteristics change. Automatic tuning circuits can be built, however, which operate to keep the load tuned no matter how its electrical characteristics change. In carefully designed equipment the advantages of the tuned load circuit greatly outweigh its disadvantages.

It is sometimes found, especially in thin work samples, that in order to get the desired power into the work the necessary voltage will break down the material. When this condition exists, the only recourse is to go to a higher frequency.

OTHER TYPES OF COUPLING CIRCUITS

For induction heating, probably the most useful coupling circuit is an isolated-secondary type of transformer. In its simplest form this transformer consists

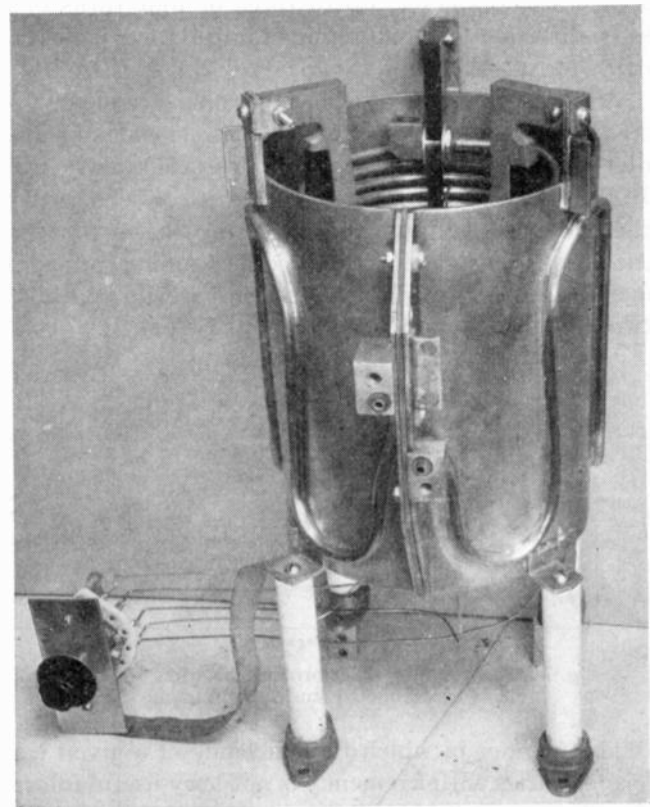

Fig. 5—An air-insulated coupling transformer.

of a helix of copper tubing to act as primary and a sheet of copper making a single-turn secondary about the primary (Fig. 5).

A unit capable of handling 25 kilowatts may have a primary consisting of 20 turns of $\frac{1}{4}$ -inch copper tubing

wrapped in a helix whose inside diameter is 6 inches and whose length is about 8 inches. The secondary is made of $\frac{1}{8}$ -inch copper sheet 9 inches wide and is wrapped about the primary with a spacing of about $\frac{3}{8}$ inch between secondary and primary. The spacing, of course, varies with the voltage to be applied across the primary and with the material used as insulation between the windings. Tapered copper sheets extending two to four inches out from the secondary act as leads (Fig. 6).

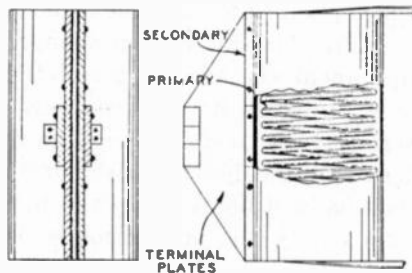

Fig. 6—General design of coupling transformer.

The tank capacitor is connected across the primary and the applicator coil is connected to the secondary leads. Both windings are water cooled. Applicators may vary from a single turn of 3/16-inch tubing in a loop 2 inches in diameter, up to three or four turns of the same diameter. The matching of impedances is not critical.

A family of curves of efficiency versus frequency for a transformer of this general type, but one which had been designed to work at high frequencies, is shown in Fig. 7. The efficiencies were measured with a Q meter while the work was at room temperature. The applicator in each case was a single turn of copper tubing formed in a loop of 2 inches inside diameter and with a spacing between applicator and work of about 1/16 inch.

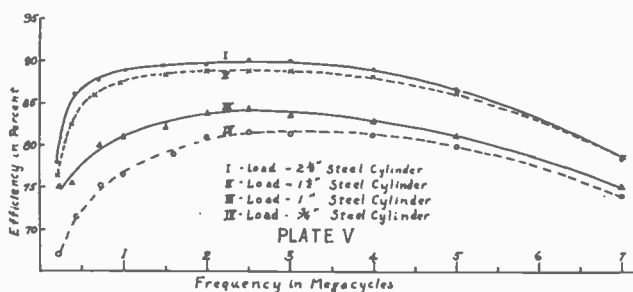

Fig. 7—The coupling transformer. Variation of efficiency with frequency and type of load.

The manner in which the efficiency of a given transformer varies with frequency is not very useful information, however, since the impedance also varies with frequency and it was shown in a former paragraph that, as far as electrical conditions are concerned, the impedance determines the power level at which the transformer should work. Thus, the same transformer should normally be used at a different power level for each frequency. It might well be, therefore, that the peak efficiency occurs at a frequency which would indicate a

power level far different from that for which the physical dimensions were suited.

For example, suppose this transformer is to be worked at a frequency of 1 megacycle. The values of capacitance and Q when the circuit was loaded were measured and found to be 0.004 microfarad and 17, respectively. Thus, the impedance of the tank circuit as seen by the oscillator tube is approximately 640 ohms. This means that the power to the tank circuit would be 100 kilowatts when the voltage impressed on it is 8 kilovolts. Since the efficiency is in the order of 85 per cent, the power into the work would be approximately 85 kilowatts. The physical size of the components of this transformer were so small, however, that the cooling would be entirely inadequate to handle such powers.

This condition is not as bad as it might be, however, for, as can be seen from the curves, over a wide range of frequencies the efficiencies are essentially constant. It is not hard, therefore, to design a transformer which will have both the proper electrical and physical characteristics to work at a given power level.

To return to the transformer described above: This instrument was designed to handle as much as 30 kilowatts at a frequency of 5 megacycles. At 5 megacycles, the tuning capacitance is 0.0003 microfarad and the Q is 22. Thus, to the tube, the impedance of the tank circuit is about 2200 ohms. At a voltage of 8 kilovolts and an efficiency of 85 per cent the power delivered to the work would be 25 kilowatts, and at this power level the transformer in question would work very well.

COUPLING-CIRCUIT THEORY

Consider now the tank-coupler-load combination circuit as diagrammed in Fig. 8.

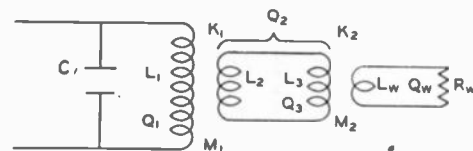

Fig. 8—Equivalent coupled circuits when a coupling transformer is used.

The circuit $L_w R_w$ represents the work itself, while L_3 represents the applicator coil. It will be assumed, for the sake of simplicity, that the actual resistance of the applicator is negligible compared to the equivalent resistance reflected from the load. Of course, such an assumption for a real setup is not valid, especially for such high conductivity loads as copper or aluminum, but this assumption will serve to illustrate the point and it will probably not be far wrong for a steel load.

The transformer is represented by $L_1 L_2$, and again the resistance of the elements will be neglected.

The following table of symbols will be useful:

C_1 = tank capacitor

L_1 = inductance of primary winding

L_1' = equivalent inductance of the primary when the applicator coil is connected to the secondary and is loaded

- R_1' = the "reflected" resistance in the primary circuit
- $\omega = 2\pi$ times the frequency
- $Q_1 = (L_1'\omega/R_1')$
- K_1 = coefficient of coupling between primary and secondary of the transformer
- M_1 = mutual inductance between primary and secondary
- L_2 = inductance of the secondary
- L_3 = inductance of applicator coil
- L_3' = equivalent inductance when the work is in place
- R_3' = reflected resistance in the applicator
- $Q_3 = (L_3'\omega/R_3')$
- Q_2 = total equivalent reactance of the L_2, L_3 link divided by the reflected resistance in this circuit (R_3')
- K_2 = coefficient of coupling between applicator and work
- M_2 = mutual inductance between applicator and work
- L_w = equivalent inductance of the work
- R_w = equivalent resistance of the work
- Z_w = the impedance of the work
- $Q_w = (L_w\omega/R_w)$.

The complete derivation of the equations involves much tedious algebra. From the following, however, it will be seen how the equations are developed.

The equivalent inductance L_3' and resistance R_3' are, respectively,

$$L_3' = L_3 - \left(\frac{M_2\omega}{Z_w}\right)^2 L_w$$

and
$$R_3' = R_w \left(\frac{M_2\omega}{Z_w}\right)^2$$

Hence
$$Q_3 = \frac{L_3'\omega}{R_3'} = \frac{\left[L_3 - \left(\frac{M_2\omega}{Z_w}\right)^2 L_w\right]\omega}{R_w \left(\frac{M_2\omega}{Z_w}\right)^2} \quad (2)$$

Substituting the values

$$K_2^2 = \frac{M_2}{L_3 L_w}$$

and
$$Q_w = \frac{L_w\omega}{R_w}$$

and
$$R_w^2 + L_w^2\omega^2 = Z_w^2$$

it is found that

$$Q_3 = \frac{Q_w}{K_2^2} \left(1 - K_2^2 + \frac{1}{Q_w^2}\right) \quad (3)$$

Now consider the link formed by L_2 and L_3 . The "reflected" resistance in this circuit, due to its being coupled to the work; is just R_3' , but the total inductance is $L_2 + L_3'$. Therefore, the total Q of this circuit is

$$Q_2 = \frac{(L_2 + L_3')\omega}{R_w'} = \frac{\left[L_2 + L_3 - \left(\frac{M_2\omega}{Z_w}\right)^2 L_w\right]\omega}{\left(\frac{M_2\omega}{Z_w}\right)^2 R_w}$$

Making substitutions for M_2 and Z_w as before,

$$Q_2 = \frac{Q_w}{K_2^2} \left(\frac{L_2}{L_3} + 1\right) \left(1 + \frac{1}{Q_w^2}\right) - K_2^2 \quad (4)$$

Proceeding in a similar manner, it can be shown that

$$Q_1 = \frac{K_2^2 L_3}{K_1^2 L_2} Q_w \left(\frac{Q_2^2 + 1}{Q_w^2 + 1}\right) - Q_2 \quad (5)$$

Of course, (4) and (5) can be combined, but the expression is so complicated that little is gained by this move. It can be seen, however, how the value of Q_1

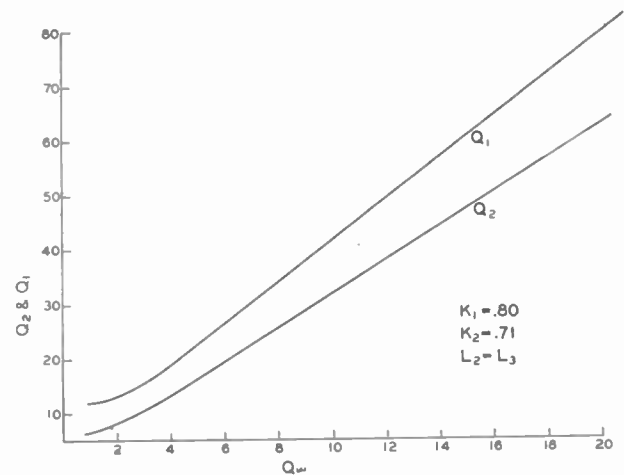

Fig. 9—Curves showing how the Q of the transformer primary and of the link circuit vary with the Q of the work.

shown by the inductance in the primary of the transformer depends upon the value of Q_w of the work and upon the coefficients of coupling in the transformer and between applicator and work.

By assuming reasonable values for K_1, K_2 , and the ratio L_2/L_3 , values of Q_1 and Q_2 can be plotted against Q_w . This has been done in the curves of Fig. 9. The value of K_1 was taken as 0.80, that of K_2 taken as 0.71, and it was assumed that $L_2 = L_3$. It is seen that, except for low values, Q_1 and Q_2 are proportional to Q_w .

COEFFICIENT OF COUPLING IN TRANSFORMER

In order to see how the values of primary Q and efficiency vary with the spacing between primary and secondary in the type of transformer discussed above, and to see how the coefficient of coupling varies as this spacing changes, a set of experiments was performed as follows:

Two primaries were made up with roughly the same dimensions. Coil A was a helix of 13 turns of $\frac{5}{8}$ -inch copper tubing wound with an outside diameter of $6\frac{1}{2}$ inches.

Coil B consisted of 17 turns of 3/8-inch copper tubing with an outside diameter of 6 inches. Each coil was 11 inches long. Secondaries were made of 1/32-inch copper sheet wrapped in a single turn around the primaries. The spacing between primary and secondary in each case was maintained with bakelite spacers. The secondary terminals were copper blocks, silver soldered at the center of the secondaries. To these terminals were attached the applicator coils, made from 3/16-inch copper tubing. The applicator was a single turn with a 2-inch diameter. Measurements were made (1) with the primary alone, without the secondary being present; (2) with the secondary in place but with the terminals open; (3) with the secondary short-circuited; (4) with the applicator

attached but unloaded; and (5) with the applicator connected and with the work in place as for heating. The results are discussed in the following paragraphs.

VARIATION OF PRIMARY Q WITH PRIMARY-SECONDARY SPACING

The manner in which the resultant primary Q (shown as Q_1) varies with the spacing between primary and secondary is shown by the curves of Figs. 10, 11, 12, and 13. The results shown are for the loaded condition, the applicator containing a 2-inch steel cylinder which fitted within it with a spacing of about 1/16 inch. The efficiencies are also plotted in these same graphs.

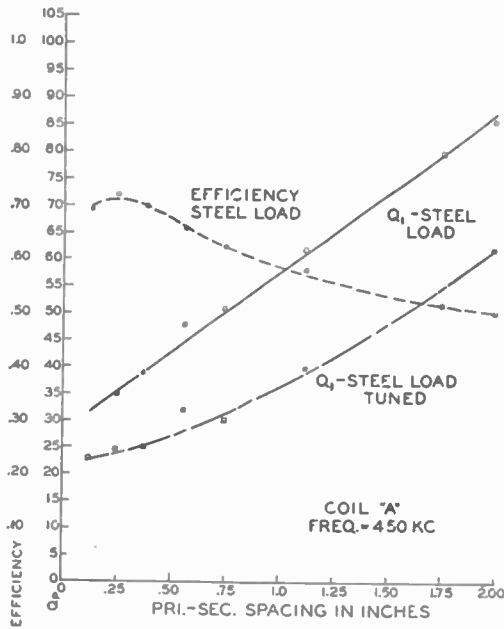

Fig. 10

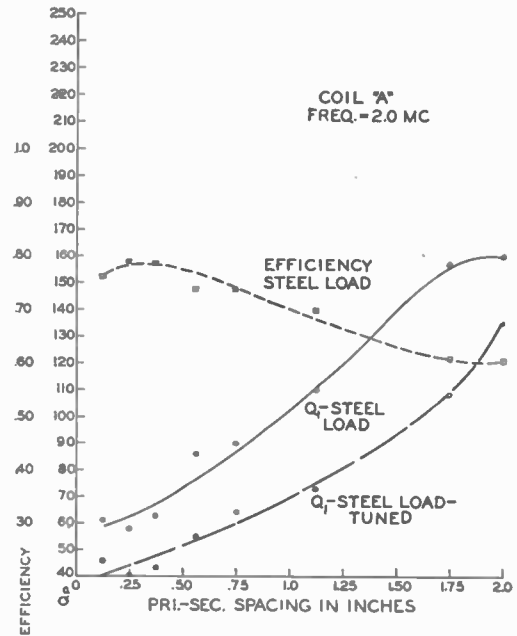

Fig. 12

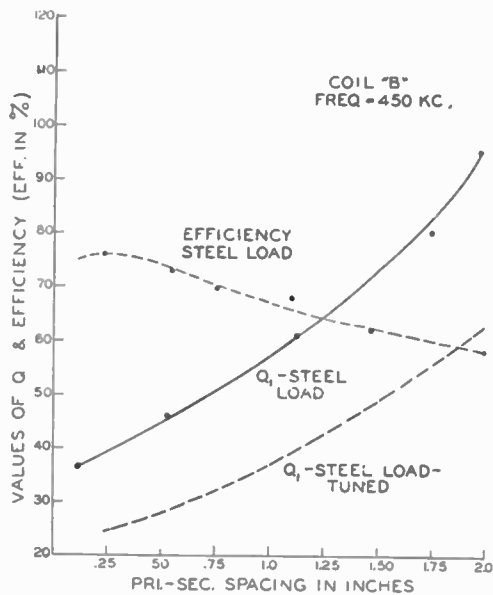

Fig. 11

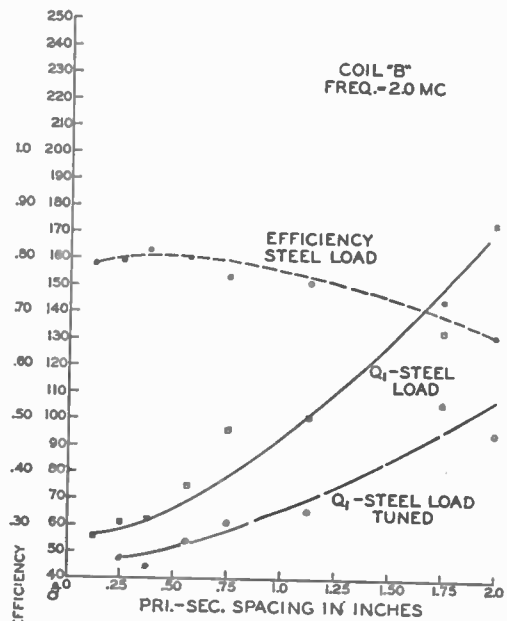

Fig. 13

COUPLING COEFFICIENTS

It is very difficult to obtain reliable values for the coefficient of coupling between the applicator and the work, especially when the work is a magnetic material. It is possible, however, to measure the coefficient between primary and secondary. The secondary is placed in its normal position around the primary and the primary is connected to the Q meter and tuned to the approximate frequency for which the transformer was designed. This frequency is designated as f_1 . The secondary is then short-circuited with a heavy copper connection and the frequency adjusted until the circuit is again tuned. The new frequency is called f_2 . Then

$$\frac{f_1^2}{f_2^2} = \frac{L_1'}{L_1}$$

where L_1 is the inductance of the primary alone and L_1' is its equivalent inductance when the short-circuited secondary is present. Also let L_2 be the inductance of the secondary alone. Then

$$L_1' = L_1 - L_2 \frac{L_1 L_2 \omega^2 K_1^2}{L_2^2 \omega^2}$$

Here the resistance of the secondary is neglected and its full impedance is taken as $L_2 \omega^2$.

Simplifying

$$L_1' = L_1 - L_1 K_1^2$$

Hence

$$\frac{f_1^2}{f_2^2} = \frac{L_1 - L_1 K_1^2}{L_1} = 1 - K_1^2$$

from which

$$K_1 = \sqrt{1 - \frac{f_1^2}{f_2^2}}$$

In this manner results were calculated for the curves of Fig. 14.

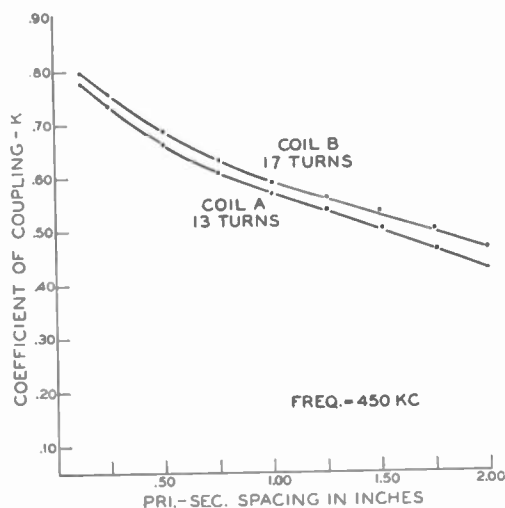

Fig. 14

EFFECT OF LEAD LENGTHS

As the leads from the secondary to the applicator are made longer, the flux leakage is increased and K_2 (the coefficient of coupling between the applicator and the work) is effectively reduced. This has the effect of increasing the primary Q as was shown in (4) and (5). Of course, the smaller the number of turns in the applicator, the more important the effect becomes.

The importance of the leads, in determining the amount of power which can be obtained from a given design of oscillator, is shown by the curves of Fig. 15. In these curves a given kilovolt-ampere value was assumed in the primary, and from the efficiencies and the corresponding Q_1 values taken from curves like those in Fig. 10, the effective powers in the work were computed. These were then plotted for various lengths of "work coil" leads on a power-output versus primary-secondary spacing diagram. Values are given, however, for only the 0.75-inch value of primary-secondary spacing. (On this same diagram is also shown the power output when the load coil is nearly tuned. A discussion of this condition is given in a later section of this paper.)

The flux leakage caused by the leads may be greatly reduced and the over-all coupling may be improved by providing broad, flat, triangular-shaped connectors for leads (Fig. 6). These leads are usually of $\frac{1}{8}$ -inch copper plate and are spaced about $\frac{1}{8}$ -inch apart.

Since the Q of the tank circuit, and hence the power output, varies so markedly with the varying length of applicator leads, this effect can be made the basis of a convenient power-output control. In series with one lead to the applicator is placed a "trombone" type of detour circuit. When the trombone slide is extended to produce a large leakage, the power output of the oscillator may

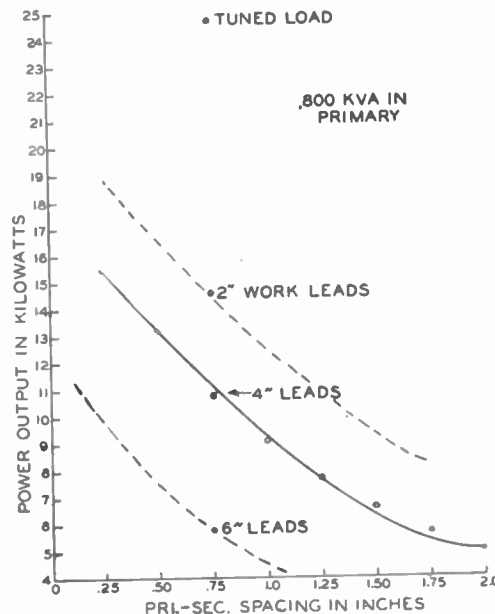

Fig. 15—Curves showing the effects of primary-secondary spacing and of applicator lead length on the power output of a coupling transformer.

be reduced to as low as 30 per cent of its value when the slide is in closed position. Such a control device is more effective on applicators that have only one or two turns.

The method is convenient, since the control device is right at the work position; it is safe, because the potential across the work loop seldom exceeds 200 volts and is entirely a high-frequency voltage.

EFFECT OF TUNING APPLICATOR COIL

As was mentioned in an earlier paragraph, a tuned or partially tuned applicator coil is very helpful in coupling the tank circuit to the load. When this is done, the simplified circuit looks similar to the diagram of Fig. 16.

In order to simplify the algebra, let the work circuit be replaced with its equivalent reflected values in the C_3 , L_3 circuit. Then the equivalent circuit would appear like that of Fig. 17.

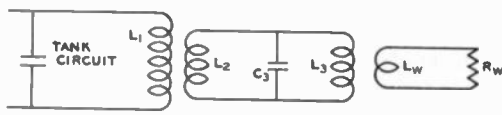

Fig. 16

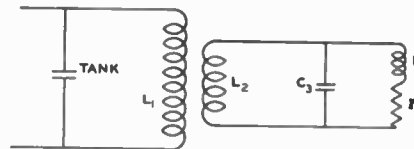

Fig. 17

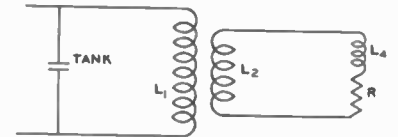

Fig. 18

Here r is the equivalent resistance in circuit (2) and will represent the resistance reflected from the coupled work circuit. Similarly, L is the equivalent inductance of the applicator coil when the work is in place. The capacitor C_3 is the "tuning capacitor" and is used to correct the power factor of the applicator. In other words, the presence of C_3 helps to reduce the Q of the applicator circuit. Let it further be assumed that the impedance of the applicator is inductive at all times.

Then for the capacitor the admittance is $y_c = j\omega C$.

For the inductive limb of the applicator circuit the admittance is

$$y_L = \frac{r}{r^2 + (L\omega)^2} - j \frac{L\omega}{r^2 + (L\omega)^2}$$

For the combination of inductance and capacitance the admittance is

$$Y = y_c + y_L$$

Thus

$$Y = \frac{r}{r^2 + (L\omega)^2} + j \left[\frac{-L\omega}{r^2 + (L\omega)^2} + C\omega \right]$$

Assuming that $r^2 \ll (L\omega)^2$, the expression becomes

$$Y = \frac{r}{(L\omega)^2} - j \left(\frac{1}{L\omega} - C\omega \right)$$

Inverting this expression in the usual manner, the equivalent resistance is

$$R = \frac{r/(L\omega)^2}{r^2/(L\omega)^4 + ((1/L\omega) - C\omega)^2}$$

$$= \frac{r}{r^2/(L\omega)^2 + (1 - L\omega C\omega)^2}$$

and the equivalent inductive reactance is

$$X_4 = \frac{\left(\frac{1}{L\omega} - C\omega \right)}{\frac{r^2}{(L\omega)^4} + \left(\frac{1}{L\omega} - C\omega \right)^2}$$

$$= \frac{L\omega(1 - L\omega C\omega)}{\frac{r^2}{(L\omega)^2} + (1 - L\omega C\omega)^2}$$

This reactance can be written as $X_4 = L_4\omega$, where

$$L_4 = \frac{L(1 - L\omega C\omega)}{\frac{r^2}{(L\omega)^2} + (1 - L\omega C\omega)^2}$$

and the equivalent circuit transforms into one similar to that shown in Fig. 18.

By definition $Q_1 = (L_1'\omega/R')$, where, as before, L_1' and R' are the equivalent inductance and resistance in the tank circuit when the applicator is loaded.

Thus

$$Q_1 = \frac{L_1\omega - \frac{\omega(L_2 + L_4)M_1^2\omega^2}{Z_2^2}}{R \frac{M_1^2\omega^2}{Z_2^2}}$$

$$= \frac{L_1\omega Z_2^2}{RM_1^2\omega^2} - \frac{(L_2 + L_4)\omega}{R}$$

Replacing M_1 by its value $K_1\sqrt{L_1L_2}$; replacing Z_2^2 by its value $(L_2 + L_4)^2\omega^2 + R^2$; and introducing the symbol Q_2 for its value $(L_2 + L_4)\omega/R$, the expression becomes

$$Q_1 = \frac{R(Q_2^2 + 1)}{L_2\omega K_1^2} - Q_2 \tag{6}$$

The ratio $(R/L_2\omega)$ can be put in terms of Q_2 , L , C , ω , and r in the following manner:

$$Q_2 = \frac{L_2\omega + X_4}{R}$$

and the ratio

$$\frac{X_4}{R} = \frac{(1/L\omega) - C\omega}{r/(L\omega)^2} = \frac{1 - L\omega C\omega}{r/L\omega}$$

Therefore

$$Q_2 = \frac{L_2\omega}{R} + \frac{1 - L\omega C\omega}{r/L\omega}$$

and hence the quantity

$$\frac{L_2\omega}{R} = Q_2 - (1 - L\omega C\omega) \frac{L\omega}{r}$$

Equation (6) can be rewritten

$$Q_1 = \frac{Q_2^2 + 1}{K_1^2} \left[\frac{1}{Q_2 - (1 - L\omega C\omega)L\omega/r} \right] - Q_2$$

But
$$L = L_3 - L_w \frac{M_2^2\omega^2}{Z_w^2}$$

where
$$M_2 = L_3 L_w K_2^2$$

and
$$r = r_w \frac{M_2^2\omega^2}{Z_w^2};$$

and it shall again be assumed that $Z_w^2 = L_w^2\omega^2$ since the Q_w is in the order of 10 or more. With this simplifying assumption,

$$r = \frac{K_2^2}{Q_w} L_3\omega$$

and
$$L = L_3(1 - K_2^2).$$

Therefore
$$\frac{L\omega}{r} = Q_w \left(\frac{1 - K_2^2}{K_2^2} \right).$$

Therefore, substituting these values and simplifying, the expression for Q_1 becomes

$$Q_1 = \frac{1}{Q_2 - \left(\frac{1 - K_2^2}{K_2^2} \right) Q_w (1 - L\omega C\omega)} \cdot \frac{Q_2^2 + 1}{K_1^2} - Q_2$$

To evaluate Q_2 from the relations shown above

$$\begin{aligned} Q_2 &= \frac{L_2\omega}{R} + (1 - L\omega C\omega) \frac{L\omega}{r} \\ &= \frac{L_2\omega}{r} \left[\frac{r^2}{(L\omega)^2} + (1 - L\omega C\omega)^2 \right] + (1 - L\omega C\omega) \frac{L\omega}{r} \\ &= \frac{L_2 Q_w}{K_2^2 L_3} \left[\frac{K_2^4}{(1 - K_2^2)^2 Q_w^2} + (1 - L\omega C\omega)^2 \right] \\ &\quad + (1 - L\omega C\omega) \frac{Q_w (1 - K_2^2)}{K_2^2} \end{aligned}$$

It will be convenient to express both Q_1 and Q_2 in terms of the ratio of the reactance of the tuning capacitor to the reactance of the applicator coil. If this ratio is called m , then

$$m = \frac{1/C\omega}{L\omega} = \frac{1}{C\omega L\omega}$$

By substituting these values in the expressions above, it will be found that

$$\begin{aligned} Q_2 &= Q_w \left[\left(\frac{1}{K_2^2} - 1 \right) \left(1 - \frac{1}{m} \right) + \left(1 - \frac{1}{m} \right)^2 \frac{1}{K_2^2} \frac{L_2}{L_3} \right] \\ &\quad + \frac{1}{Q_w} \frac{L_2}{L_3} \frac{K_2^2}{(1 - K_2^2)^2} \end{aligned}$$

and

$$Q_1 = \frac{Q_2 + 1}{Q_2 K_1^2 - \frac{K_1^2}{K_2^2} (1 - K_2^2) Q_w \left(1 - \frac{1}{m} \right)} - Q_2$$

Again there seems to be little point in combining these equations. Considerable information can be gained from them by proceeding as before and assuming reasonable values of K_1 , K_2 , Q_w , and the ratio L_2/L_3 ,

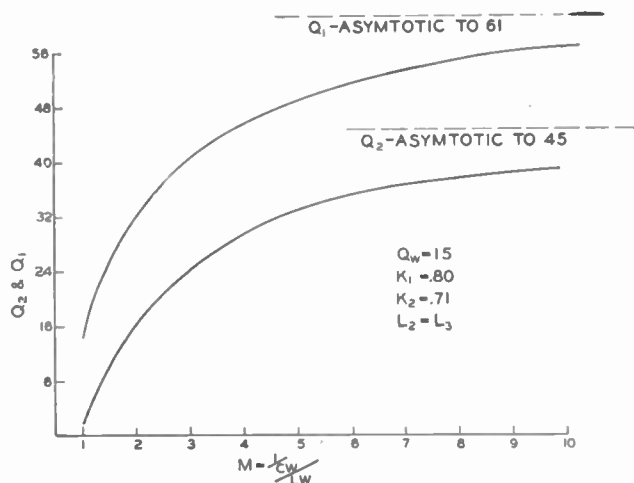

Fig. 19—Curves showing the effect of balancing out the reactance of the applicator coil.

then plotting Q_2 and Q_1 for various values of the ratio m . This has been done in the graphs of Fig. 19. The value of K_1 was taken as 0.80, that of K_2 as 0.71, and Q_w was assumed to be 15 (a value it would have for a high conductivity load). The values of L_2 and L_3 are again taken as being equal.

It will be noted from the curves that, if the reactance of the tuning capacitor is as low as 1.5 times that of the applicator coil, Q_1 takes on the workable value of 32, while without the capacitor the tank Q would be nearly twice this. As would be expected, as the power-factor correction becomes more complete the tank-circuit Q drops rapidly.

CONCLUSION

It has been shown that, in designing a coupling system for a radio-frequency generator, one must first decide from the requirements of the possible loads whether a closely coupled system is desirable or whether looser coupling and an accurately tuned load circuit is preferable. Experience has shown that, although the accurately tuned circuit is universally adaptable, when this method is used some automatic means of keeping the

load tuned is almost mandatory. On the other hand, for induction heating, where load voltages are nearly always lower than tank-circuit voltages, a very closely coupled system will, for most work, provide full loading without the aid of a tuned load circuit. The simplicity of this scheme usually warrants the greater expense involved in gaining the necessary close coupling.

Circuits which provide high power concentrations have low impedances, and in order to maintain close coupling in such circuit the isolated secondary transformer is shown to be a very useful device.

In a well-designed radio-frequency generator the characteristics of the load are reflected into the tank circuit, so that not only the power output but the power taken by the generator varies to a large extent with the type of load. For this reason a generator which will feed nearly its full rated power into a wide range of steel loads will fail to "load up" when the load is a material of high conductivity.

Three methods of taking care of this contingency are

suggested:

(1) Build the generators with very closely coupled radio-frequency circuits and provide tank circuits which have low impedances and relatively high values of circulating kilovolt-amperes. This will take care of the high- Q loads. Then some simple method of decoupling can be used to handle the low- Q loads; or

(2) provide a means of tuning or partially tuning the load circuit. In dielectric heating an automatic tuning device is very desirable, and to work at high power concentrations in induction heating, power-factor correction requires a tuning capacitor which is something special; or

(3) various compromises and combinations of (1) and (2) are always possible.

Therefore, the designer of radio-frequency heating generators is faced with a number of crucial decisions, and only years of experience and the development of new equipment will finally establish what is best practice in the art.

Amplifier-Gain Formulas and Measurements*

SYLVESTER J. HAEFNER†, ASSOCIATE, I.R.E.

Summary—The existence of numerous definitions of amplifier gain, not all of which are generally available or understood, has caused considerable confusion. This paper gives precise mathematical statement to the most widely accepted definitions and applies them in sample cases to make their full meaning evident and assure that they may be understood correctly. In addition, it develops and illustrates the application of a practical method for expressing the insertion gain of amplifiers used primarily for voltage amplification.

GENERAL CONCEPTS

MANY recognized textbooks and technical papers make the unqualified assertion that a given amplifier has a certain gain; but in the absence of a statement of the method used to determine this gain, the assertion is meaningless. The purpose of this paper is to uncover the assumptions implicit in the common methods of measuring gain and to make those methods fully available for correct use.

Simulative Generator

Nearly all gain measurements require a generator with an open-circuit voltage E and a specified internal impedance Z . An example of this is the microphone of a speech-amplifier system which may be considered as a generator feeding an amplifier network. Its characteristics are usually expressed in terms of the open-circuit voltage which it generates for a given sound pressure at a certain frequency. Since the open-circuit voltage is a function of frequency, a sensitivity curve of the micro-

phone is necessary showing the relationship between frequency and its generated voltage at a standard sound-pressure level of 1 dyne per square centimeter. The internal impedance of the microphone is known or can be measured; therefore a generator may be set up in the laboratory which in all electrical respects simulates the microphone's characteristics.

In Fig. 1 it is assumed that the source voltage is sinusoidal and that the impedances of the load and generator do not depend upon the current through them. In order to make the generator simulate the microphone, E as read by a vacuum-tube voltmeter must be maintained constant at the open-circuit voltage of the microphone for the frequency used. This is accomplished by adjusting the volume control of the oscillator

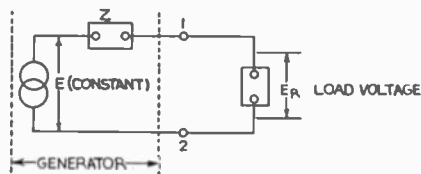

Fig. 1—Constant-voltage method of simulating a power source when its open-circuit voltage E and its internal impedance Z are known.

shown in Fig. 1 as the load is varied. The oscillator then behaves as though its internal impedance were zero and as though the impedance Z , which is made up of resistances, coils, and capacitors, were the only effective impedance between the oscillator voltage E and the load. The simulative generator may thus be considered to consist of the impedance Z and the constant voltage E .

* Decimal classification: R255.1X R032. Original manuscript received by the Institute, January 7, 1946.

† United States Navy Underwater Sound Laboratory, Fort Trumbull, New London, Conn.

The well-known generalized statement about networks called Thévenin's theorem bears out this conclusion.

The most common definition of gain (or of attenuation, which is negative gain) expresses in logarithmic form the ratio between two amounts of power. The conditions under which the power is measured are, of course, a matter of definition, and will determine the form of the gain equation. In the two circuits of Fig. 2 there are two amounts of power, P_1 and P_2 , differing by N decibels where

$$N = 10 \log_{10} \frac{P_1}{P_2} \tag{1}$$

The equations expressing the power in terms of the voltage or current in the circuits shown in Fig. 2 are

$$P = \frac{E^2 k}{Z} = I^2 Z k = I^2 R \tag{2}$$

in which

- P = power consumed in the load
- E = effective voltage drop (magnitude) across the load
- Z = impedance (magnitude) of the load
- R = resistance component of load
- I = effective current (magnitude) in circuit
- k = power factor.

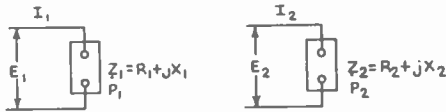

Fig. 2—Two different circuits in which there are different amounts of power consumed.

Substituting currents and resistances for power in the decibel equation (1) gives

$$N = 10 \log_{10} \frac{I_1^2 R_1}{I_2^2 R_2} = 20 \log_{10} \frac{I_1}{I_2} + 10 \log_{10} \frac{R_1}{R_2} \tag{3}$$

or, in terms of voltages, impedances, and power factors,

$$N = 10 \log_{10} \frac{E_1^2 Z_2 k_1}{E_2^2 Z_1 k_2} = 20 \log_{10} \frac{E_1}{E_2} + 10 \log_{10} \frac{Z_2}{Z_1} + 10 \log_{10} \frac{k_1}{k_2} \tag{4}$$

It is apparent from the above formulas that, when ratios between currents or between voltages are used for gain characteristics of circuits involving different impedances, the magnitude and the phase angle of the impedances must be taken into account. In case the currents are measured, the effective resistances must be known; if the voltages are measured, the effective resistances and the effective reactances of the circuits must be known.

Insertion Gain

In the usual application, gain refers to the amount of power transferred across a junction from a power source

considered as the generator to a load. In Fig. 1 a power source or generator of voltage E and internal impedance Z is shown connected directly to a load. Assuming, for simplicity, unity power factor in both generator and load, the power delivered across the junction 1-2 from the generator to the load is readily calculable. If the

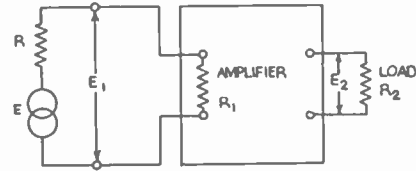

Fig. 3—Amplifier inserted between load and generator. The input resistance of the amplifier is R_1 .

junction is opened and an amplifier is inserted as in Fig. 3, there will be an increase of power in the load. The ratio of the load power when the amplifier is in the circuit to the load power when the generator is directly connected to the load is a possible expression of gain. If this expression is used, the power in the load when it is connected directly to the generator is the reference power or reference condition.

Transmission Gain—Insertion Gain

It has generally been agreed, however, to connect the generator to the load through an ideal transformer to determine the reference condition. An ideal transformer¹ is defined as a transformer which neither stores nor dissipates energy and in which there is perfect flux linkage between the windings. In such a transformer the primary and secondary self-impedances approach infinity and the mutual impedance equals the square root of the product of the self-impedances. When these conditions are applied to the well-known equations of a loaded

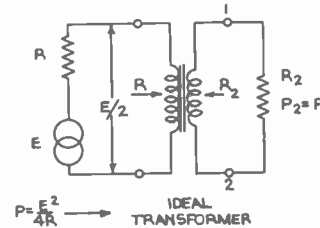

Fig. 4—The generator delivers maximum power¹ to the load when coupled to the load through an ideal transformer for the reference power.

transformer it is found that an ideal transformer will modify the magnitude of the load impedance, as viewed from the sending end, without introducing power loss or change in phase angle. If L_p/L_s is the ratio of the primary and secondary self-inductances of the ideal transformer, then a load impedance Z_2 on the secondary side will appear as (L_p/L_s) times Z_2 on the primary side. By proper choice of the ratio (L_p/L_s) the generator views an impedance equal to its own impedance and

¹ K. S. Johnson, "Transmission Circuits for Telephonic Communication," D. Van Nostrand Company, New York, N. Y., 1925, pp. 34-39.

half of its voltage appears across the transformer primary. For the resistive case, the power transferred from the generator to the load through the ideal transformer, or the available reference power, is $(E^2/4R)$ (see Fig. 4). The gain is ten times the logarithm of the ratio of the load power realized with the amplifier in the circuit to the load power which existed at the reference condition.

Insertion Power Gain—Amplifier Circuit with Resistance Only

Referring to Fig. 3, assume an amplifier with voltage amplification, or ratio of output to input voltage, of

$$A = \frac{E_2}{E_1} \quad (5)$$

The generator current is

$$I = \frac{E}{R + R_1} \quad (6)$$

where R is the generator resistance and R_1 the amplifier input resistance. The input voltage to the amplifier is

$$E_1 = IR_1 = \frac{R_1 E}{R + R_1} \quad (7)$$

The amplifier output voltage is

$$E_2 = A E_1 \quad (8)$$

The power output of the amplifier is

$$P_{\text{out}} = P_2 = \frac{E_2^2}{R_2} = \frac{A^2 E_1^2}{R_2} = \frac{A^2 R_1^2 E^2}{(R + R_1)^2 R_2} \quad (9)$$

The reference power is

$$P_{\text{out}'} = P_1 = \frac{E^2}{4R} \quad (10)$$

Therefore the gain is

$$\begin{aligned} \text{gain} &= 10 \log \frac{P_2}{P_1} \\ &= 10 \log A^2 \left(\frac{R_1}{R + R_1} \right)^2 \times \frac{E^2}{R_2} \times \frac{4R}{E^2} \end{aligned} \quad (11)$$

which can be expressed as

$$\text{gain} = 20 \log A + 20 \log \frac{R_1}{R + R_1} + 10 \log \frac{4R}{R_2} \quad (12)$$

This formula may be written in terms of the generator voltage E by substituting (5) and (7) into (12), giving

$$\text{gain} = 20 \log \frac{2E_2}{E} + 10 \log \frac{R}{R_2} \quad (13)$$

or

$$\text{gain} = 20 \log \frac{E_2}{E} + 10 \log \frac{4R}{R_2} \quad (14)$$

Insertion Power Gain—Amplifier Circuit with Resistance and Reactance

Suppose in Fig. 3 that impedances replace the resistances and

$$Z = Z/\alpha = \text{the generator impedance}$$

$$Z_1 = Z_1/\alpha_1 = \text{the amplifier input impedance}$$

$$Z_2 = Z_2/\alpha_2 = \text{the load impedance} = (R_2 + jX_2)$$

expressed in the magnitude angle form. Also let the generator voltage E be the reference vector and the vector amplification

$$A = A/\beta = \frac{E_2/\beta}{E_1}$$

The generator current is then

$$I = \frac{E}{Z/\alpha + Z_1/\alpha_1} \quad (15)$$

The vector amplifier output voltage is

$$E_2 = A E_1 \quad (16)$$

The magnitude of the output voltage is

$$E_2 = \frac{A E Z_1}{|Z/\alpha + Z_1/\alpha_1|} \quad (17)$$

The power output of the amplifier is

$$P_{\text{out}} = P_2 = I_2^2 R_2 = \left(\frac{E_2}{Z_2} \right)^2 R_2 \quad (18)$$

For the reference condition, using the ideal transformer shown in Fig. 4 with turns ratio $\sqrt{(Z/Z_2)}$, the generator current is $(E/2Z)$ and the load current

$$I_2' = \sqrt{\frac{Z}{Z_2}} \frac{E}{2Z} = \frac{E}{2\sqrt{ZZ_2}} \quad (19)$$

The reference power in the load is

$$P_{\text{out}'} = (I_2')^2 R_2 = \left(\frac{E}{2\sqrt{ZZ_2}} \right)^2 R_2 = \frac{E^2 R_2}{4ZZ_2} \quad (20)$$

and the gain is

$$\text{gain} = 10 \log \frac{P_{\text{out}}}{P_{\text{out}'}} = 10 \log \frac{E_2^2}{Z_2^2} R_2 \times \frac{4ZZ_2}{E^2 R_2} \quad (21)$$

Substituting (17) in (21)

$$\text{gain} = 10 \log \frac{A^2 E^2 Z_1^2}{|Z/\alpha + Z_1/\alpha_1|^2} \times \frac{Z_2}{Z_2^2} \times \frac{4Z}{E^2} \quad (22)$$

or

$$\begin{aligned} \text{gain} &= 20 \log A + 20 \log \frac{Z_1}{|Z/\alpha + Z_1/\alpha_1|} \\ &\quad + 10 \log \frac{4Z}{Z_2} \end{aligned} \quad (23)$$

but since

$$A = \frac{E_2}{E_1} \quad \text{and} \quad E_1 = \frac{Z_1 E}{|Z/\alpha + Z_1/\alpha_1|}$$

equation (23) becomes

$$\text{gain} = 20 \log \frac{E_2}{E} + 10 \log \frac{4Z}{Z_2} \quad (24)$$

A Practical Method for Measuring Amplifier Gain

The circuit arrangement shown in Fig. 5 can be used to measure gain and is especially suitable for measurements on high-gain amplifiers. The resistance pad and generator resistance R or impedance Z are preferably mounted within a metal shield case equipped with cable-plug receptacles. All shields of the units are interconnected by means of shielded cables. The attenuator and oscillator are located at some distance from the amplifier and a single direct ground connection is used to avoid cross talk. The circuit shown in Fig. 5 can be used over a rather wide range of frequency without introducing error provided the attenuator holds its calibration. The pad arrangement has the advantage of simplicity inasmuch as the value of generator impedance used is never in doubt. A calibrated attenuator and pad are convenient and avoid the necessity of measuring the small voltage E of the generator. If this attenuator is adjusted so that the load voltage E_2 equals the attenuator input voltage E_2 then, assuming the amplifier gain to be linear, the expression $20 \log (E_2/E)$ appearing in (14) is the sum of the attenuator reading and the fixed pad loss ex-

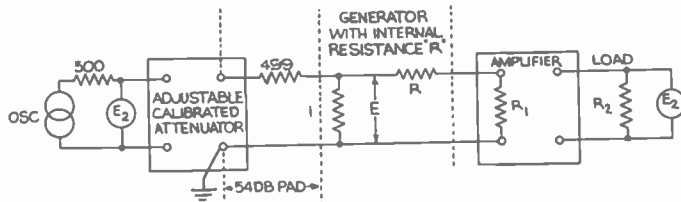

Fig. 5—A practical circuit for measuring amplifier gain.

pressed in decibels. For the particular 500-ohm pad shown in Fig. 5 the fixed pad loss is $20 \log 500$, or 54 decibels. Since R_2 and R are known, $10 \log_{10} (4R/R_2)$ can be calculated.

The gain is then equal to

$$\text{gain} = 20 \log \frac{E_2}{E} + 10 \log \frac{4R}{R_2} \quad (25)$$

which, for Fig. 5, reduces to

$$\begin{aligned} \text{insertion power gain} &= \text{attenuator reading} + \text{pad loss} \\ &+ 10 \log \frac{4R}{R_2} \end{aligned} \quad (26)$$

Other pads having different values of fixed loss can be used, provided that the adjustable attenuator is properly matched and that the value of the pad resistance

across which the generator voltage E appears remains essentially unchanged by the shunting effect of $R+R_1$. In the arrangement shown in Fig. 5 it is assumed that $R+R_1$ is large compared with 1 ohm.

Formula (26) may be applied to cases involving impedances. Then it appears as follows:

$$\begin{aligned} \text{insertion gain} &= \text{attenuator reading} + \text{pad loss} \\ &+ 10 \log \frac{4Z}{Z_2} \end{aligned} \quad (27)$$

EXAMPLES OF AMPLIFIER-GAIN MEASUREMENTS

Amplifier Circuit with Resistance Only

A four-stage resistance-capacitance coupled amplifier was used as the amplifier shown in Fig. 5. The values of the components were

$$\begin{aligned} R &= 2000 \text{ ohms resistive} \\ R_1 &= 2000 \text{ ohms resistive} \\ R_2 &= 4000 \text{ ohms resistive.} \end{aligned}$$

The attenuator reading was 26 decibels when $E_2 = 6$ volts. The pad loss was 54 decibels. The insertion power gain, using (26), is

$$\text{gain} = 26 + 54 + 10 \log \frac{4 \times 2000}{4000} = 83 \text{ decibels.}$$

The open-circuit generator voltage E can be calculated since it is equal to the attenuator reading plus the pad loss in decibels below E_2 or $26 + 54 = 80$ decibels below 6 volts.

$$E = \frac{E_2}{\text{antilog} \frac{80}{20}} = 0.6 \text{ millivolt}$$

Since $R_1 = R$, $E_1 = (E/2) = 0.3$ millivolt.

The gain formulas listed in the appendix of this paper yield a wide variety of results when applied to this amplifier. The results are as follows:

- 1 (a) Voltage amplification using a zero-impedance generator, gain = 86 decibels.
- (b) Voltage amplification using the generator open-circuit voltage as reference voltage (the generator has an internal impedance), gain = 80 decibels.
- 2 (a) Current amplification, gain = 80 decibels.
- (b) Current sensitivity, gain = 14 decibels.
- 3 (a) Power amplification, gain = 83 decibels.
- (b) Insertion gain (the generator is connected directly to the load for the reference power), gain = 83.52 decibels.
- (c) Insertion gain (the generator is connected to the load through an ideal transformer for the reference condition), gain = 83 decibels.
- (d) Power sensitivity, gain = 50 decibels.

Amplifier Circuit with Resistance and Reactance

Let the impedance of the generator shown in Fig. 5 equal $Z/\alpha = 2000/\underline{-75}$ degrees. This impedance is a

resistance of 518 ohms in series with a negative reactance of 1932 ohms. Since at 1 kilocycle a capacitor of 0.0825 microfarad is equivalent to 1932 ohms, the generator impedance was simulated by a resistance of 518 ohms in series with a capacitor of 0.0825 microfarad. R_1 and R_2 had the same values as in the preceding case.

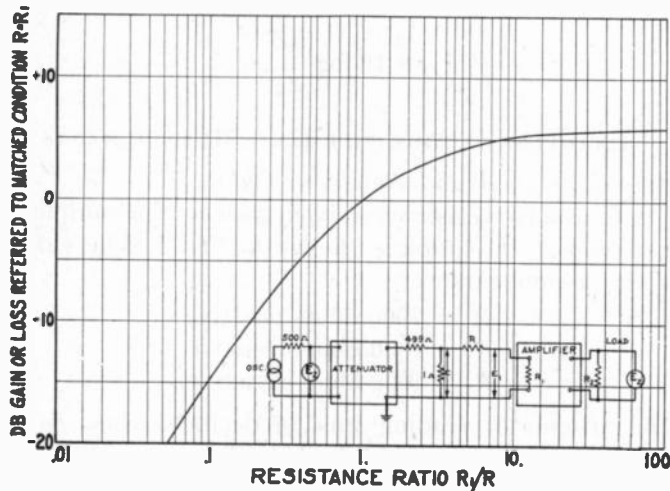

Fig. 6—Variation of voltage gain and insertion power gain as a function of the resistance ratio R_1/R . Voltage gain equals $20 \log E_2/E$.

The following measurements were taken on the amplifier at 1 kilocycle:

$$E_2 = 6 \text{ volts}$$

$$\text{attenuator} = 28 \text{ decibels.}$$

The insertion gain, using (27), is

$$\begin{aligned} \text{gain} &= 28 + 54 + 10 \log \frac{4Z}{Z_2} \\ &= 82 + 10 \log \frac{4 \times 2000}{4000} = 85 \text{ decibels.} \end{aligned}$$

Since the amplifier is the same as that described previously, the voltage gain A (zero-impedance generator), where $A = 20 \log (E_2/E_1)$, is the same and equals 86 decibels.

A calculation of the insertion gain using (23) follows:

$$\begin{aligned} \text{gain} &= 86 + 20 \log \left| \frac{2000}{2518 - 1932j} \right| + 10 \log \frac{4 \times 2000}{4000} \\ &= 85 \text{ decibels.} \end{aligned}$$

Variation of Voltage and Insertion Gain as a Function of the Resistance Ratio (R_1/R)

The insertion power gain of an amplifier with a given generator of resistance R as expressed in (12) depends on the ratio R_1/R . The variation of power gain using the matched condition $R_1=R$ as reference can be written $20 \log (R_1/R + R_1) - 20 \log \frac{1}{2}$ or $20 \log (2R_1/R)/(1 + R_1/R)$. A plot of this variation of gain in decibels is shown in Fig. 6. The same variation can be expected for the voltage gain, $20 \log E_2/E$.

Insertion-Gain Variation as a Function of the Generator- and Amplifier-Input Phase Angles when the Impedance Magnitudes are Equal

Formula (23) shows that the insertion gain of an amplifier depends upon the generator- and amplifier-input impedance magnitudes and their phase angles. The variation of insertion gain in decibels for the case where $Z = Z_1$ and using the insertion gain for the resistive case as a reference can be written

$$20 \log \frac{\sqrt{2}}{\sqrt{1 + \cos \theta}}$$

where

$$\theta = \alpha - \alpha_1.$$

A plot of this expression appears in Fig. 7.

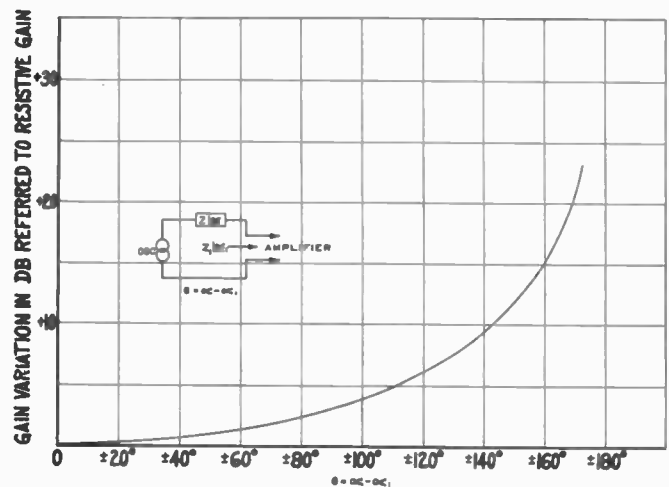

Fig. 7—Insertion-gain variation as a function of the difference between the generator and amplifier input-impedance phase angles when $Z = Z_1$.

CONCLUSIONS

From the examples given, it is clear that expressing the gain of an amplifier as so many decibels is meaningless without qualifying statements as to just how the gain is measured. The usual purpose of the amplifier is to deliver to the load an electrical voltage, power, or current which is a function of the generator voltage and the generator impedance. Obviously the measurements must be realistic, that is, reveal any faults the amplifier might introduce into the system of which it is to become a part. It becomes of paramount importance, therefore, to simulate for the measurements in the laboratory not only the load impedance but also the generator voltage and impedance which the amplifier will meet in its actual application.

The choice of the formula to employ is determined by the use to be made of the amplifier being measured. For example, if the amplifier is to be used to increase the voltage from a generator, the generator open-circuit voltage should be used as the reference voltage. The formula to be used in this case would be

$$\text{gain} = 20 \log \frac{\text{output voltage of amplifier}}{\text{open-circuit generator voltage}}$$

This formula is suitable to the majority of amplifier applications in connection with underwater sound measurements since most of the generators from which an amplifier must work are electromechanical, electroacoustic, or transmission lines. Except for the latter the characteristics of the generator are usually described by curves of the open-circuit voltage at a standard sound pressure of 1 dyne per square centimeter plotted against the frequency, and the hydrophone impedance plotted against the frequency. Using the generator open-circuit voltage as reference makes it unnecessary to determine the amplifier's input impedance, and considerably simplifies the measurements.

An inspection of Fig. 6 shows that the greatest insertion power gain (as expressed by (12)) and voltage gain with generator voltage as reference occur when the amplifier input resistance approaches open circuit with respect to the generator resistance, or for all practical purposes that the ratio R_1/R becomes greater than about 10.

The voltage gain (generator voltage as reference) or the insertion gain can be increased as compared to the gain obtained for the resistive case by changing some or all of the resistances R and R_1 to reactances if $\theta = \alpha - \alpha_1 \neq 0$. This increase is shown in Fig. 7 for the case $|Z| = |Z_1|$.

Other factors are as important for optimum voltage gain and power gain in an amplifier as those discussed above. The signal-to-noise ratio, frequency-response characteristics, and the relation of amplifier output impedance to load impedance can influence the design of the amplifier and of associated circuits. These factors, however, are not discussed in this paper.

APPENDIX

COMMON METHODS OF EXPRESSING GAIN

The most usual methods of expressing gain, some of which have not been discussed in this paper, are stated below for purposes of reference.

1. In terms of voltage

- (a) "Voltage amplification"³ using a zero-impedance generator:

$$\text{gain} = 20 \log \frac{\text{output voltage of amplifier}}{\text{input voltage of amplifier}}$$

- (b) "Voltage amplification" using the generator open-

circuit voltage as reference voltage (the generator has an internal impedance):

$$\text{gain} = 20 \log \frac{\text{output voltage of amplifier}}{\text{open circuit generator voltage}}$$

2. In terms of current²

- (a) "Current amplification":

$$\text{gain} = 20 \log \frac{\text{output current of amplifier}}{\text{input current of amplifier}}$$

- (b) "Current sensitivity":

$$\text{gain} = 20 \log \frac{\text{output current of amplifier}}{\text{input voltage of amplifier}}$$

3. In terms of power

- (a) "Power amplification"²:

$$\text{gain} = 10 \log \frac{P_{\text{out of amplifier}}}{P_{\text{in of amplifier}}}$$

- (b) "Insertion gain or loss"²⁻⁶: (The generator is connected directly to the load for the reference power $P_{\text{out}'}$):

$$\text{gain} = 10 \log \frac{P_{\text{out of amplifier}}}{P_{\text{out}'}}$$

- (c) "Transmission insertion gain or loss"^{6,7,8} (the generator is connected to load through an ideal transformer for the reference power $P_{\text{out}'}$):

$$\text{gain} = 10 \log \frac{P_{\text{out of amplifier}}}{P_{\text{out}'}}$$

- (d) "Power sensitivity"^{2,9}:

$$\text{gain} = 20 \log \sqrt{\frac{P_{\text{out of amplifier}}}{E_{\text{in of amplifier}}}}$$

ACKNOWLEDGMENT

Mr. J. T. Kroenert and Dr. L. E. Holt have given valuable advice and assistance in the preparation of this report. Mr. A. F. Magaraci contributed the measurements data for the illustrative problems.

³ See pages 87, 91 of footnote reference 1.

⁴ T. E. Shea, "Transmission networks and wave filters," D. Van Nostrand Company, New York, N. Y., 1929, pp. 48-50.

⁵ "Electrical Engineers' Handbook, Communication and Electronics," edited by Harold Pender and Knox McIlwain; John Wiley and Sons, New York, N. Y., 1936, vol. 5, sec. 3, p. 13.

⁶ Research Council of the Academy of Motion Picture Arts and Sciences, "Motion picture sound engineering," D. Van Nostrand Company, New York, N. Y., 1938, pp. 226-227.

⁷ See pages 48-50 of footnote reference 4.

⁸ See sec. 10, pages 31-33 of footnote reference 5.

⁹ Stuart Ballantine and H. L. Cobb, "Power output characteristics of the pentode," Proc. I.R.E., vol. 18, pp. 450-471; March, 1930.

³ Herbert J. Reich, "Theory and application of electron tubes," McGraw-Hill Book Company, New York, N. Y., 1939, p. 158.

Contributors to Waves and Electrons Section



H. W. JAMIESON



G. H. FETT

G. H. Fett (SM '45) was born in Chicago, Illinois, on June 19, 1909. He received the B.S. degree in electrical engineering in 1931 from the University of Illinois; the M.S. degree in 1932, from Iowa State College; and the Ph.D. degree in engineering from the University of Illinois, in 1940.

From 1933 to 1935, Dr. Fett was engaged in research work with Littelfuse Laboratories, Chicago, Illinois. He joined the staff of the University of Illinois, in 1935, as assistant in the electrical engineering department. He was subsequently appointed instructor, promoted to the rank of associate, later assistant professor, and is at present professor, in that department. He is a member of the American Institute of Electrical Engineering, the American Physical Society, the American Welding Society, Sigma Xi, and Tau Beta Pi.

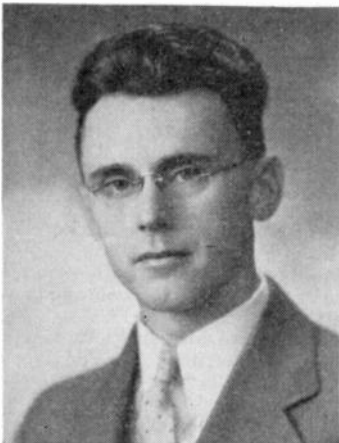

SYLVESTER J. HAEFNER

Sylvester J. Haefner (A'37) was born at Brooklyn, New York, on August 1, 1903. He received the B.S. degree in electrical engineering in 1925, the M.S. degree in 1926, and the Ph.D. degree in 1932, all from Union College.

From 1925 to 1927, Dr. Haefner was employed by the General Electric Company, and worked in the test department. While engaged in graduate study he was instructor in electrical engineering at Union College from 1926 to 1937, when he became assistant professor. In 1942 he joined the Scientific staff of Columbia University Division of War Research at the United States Navy Underwater Sound Laboratory, Fort Trumbull, New London, Connecticut, and since 1945 has been development supervisor in electronic design and measurements for that organization.

Dr. Haefner is a member of Sigma Xi and Eta Kappa Nu, and associate member of The American Institute of Electrical Engineers.



H. W. Jamieson (A'42-M'45) was born in Shreveport, Louisiana, on January 19, 1918. He was graduated from the University of California with a B.S. degree in electrical Engineering in 1939. In January, 1940, he was employed by the General Electric Company, where he was with the instrument-transformer development section until July, 1941. He was with the high-frequency development section of the General Engineering Laboratory until August, 1942. In 1944, he was a graduate of the three-year advanced engineering program and until August 1945 was associated with the Electronics Laboratory and Research Laboratory of that company. Mr. Jamieson is now with the Radio Division of the Hughes Aircraft Company in Los Angeles, California.



Wesley M. Roberds was born at Burlington, Kansas, in 1903. He received the A.B. degree from the University of Kansas in 1925, and the A.M. and Ph.D. degrees from the same institution in 1926 and 1935, respectively.

From 1925 to 1927 Mr. Roberds was assistant professor of physics at the University of Kansas, and was on the staff of the University of Arkansas from 1927 to 1942. In 1942 he became associated with the Radio Corporation of America as development engineer in the field of applications of radio-frequency power.



WESLEY M. ROBERDS



He is a member of Sigma Xi and the American Physical Society.

J. R. Whinnery (A'41-SM'44) was born on July 26, 1916, at Read, Colorado. He received the B.S. degree in electrical engineering from the University of California in 1937, at which time he was employed by the General Electric Company at Schenectady, N. Y. In 1940 he was a graduate of the three-year program of the advanced course in engineering of the General Electric Company, and during the following two years supervised the high-frequency section of that program. From 1942 to January of 1946, he was with the electronics laboratory and the research laboratory of the General Electric Company. Mr. Whinnery is now with the division of electrical engineering of the University of California, in Berkeley, California.

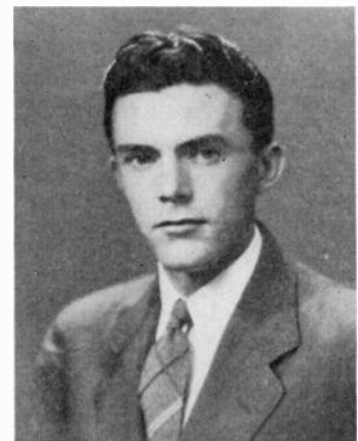

J. R. WHINNERY

Abstracts and References

Prepared by the National Physical Laboratory, Teddington, England, Published by Arrangement with the Department of Scientific and Industrial Research, England and *Wireless Engineer*, London, England

The number at the upper left of each Abstract is its Universal Decimal Classification number and is not to be confused with the Decimal Classification used by the United States National Bureau of Standards. The number in heavy type at the top right is the serial number of the Abstract.

The Institute of Radio Engineers has made arrangements to have these Abstracts and References reprinted on suitable paper, on one side of the sheet only. This makes it possible for subscribers to this special service to cut and mount the individual Abstracts for cataloging or otherwise to file and refer to them. Subscriptions to this special edition at \$15.00 per year, will be accepted only from members of the I.R.E. and subscribers to the *Proceedings of the I.R.E. and Waves and Electrons*. Subscribers to this special edition will also receive an Annual Index to Abstracts and References as part of their subscription service. All others, who are not subscribers to this service, but who are either members of the Institute or subscribers to the *Proceedings of the I.R.E. and Waves and Electrons* may purchase the Annual Index for \$5.00. Subscriptions to the Index only must be received by the Institute not later than March 1, 1947. All subscriptions for the Abstract service and its Annual Index should be sent to

Mr. George W. Bailey
Executive Secretary
The Institute of Radio Engineers, Inc.
330 West 42nd Street
New York 18, N. Y.

	PAGE
Acoustics and Audio Frequencies	507
Aerials and Transmission Lines	508
Circuits	509
General Physics	511
Geophysical and Extraterrestrial Phenomena	512
Location and Aids to Navigation	512
Materials and Subsidiary Techniques	514
Mathematics	515
Measurements and Test Gear	516
Other Applications of Radio and Electronics	517
Propagation of Waves	519
Reception	520
Stations and Communication Systems	521
Subsidiary Apparatus	521
Television and Phototelegraphy	523
Transmission	523
Vacuum Tubes and Thermionics	524
Miscellaneous	524

ACOUSTICS AND AUDIO FREQUENCIES

534.21 1422
Propagation of Sound Waves in a Liquid Layer between Two Absorbing Half-Spaces—L. M. Brekhovskikh. *Compt. Rend. Acad. Sci. U.R.S.S.*, vol. 48, pp. 397-400; 1945. In English.) Theoretical analysis of a problem in sound-wave propagation which "may find application in geophysics (propagation through an oil layer), in architectural acoustics, and in hydroacoustics (propagation of sound through the sea)."

534.213:621.395.623.7 1423
Wave Propagation and Outdoor Field Tests of a Loudspeaker System—F. L. Hopper and R. C. Moody. (*Jour. Soc. Mot. Pic. Eng.*, vol. 46, pp. 115-123; February, 1946.) Propagation tests at frequencies between 100 cycles per second and 8 kilocycles per second are described, indicating an inverse square-law attenuation up to a distance of 400 wavelengths for heights of transmitter and receiver of 7½ feet and 3 feet, respectively. The effects of snow, wind, and pressure are also discussed.

534.321.9:620.179 1424
Supersonic Inspection of Strip Materials—(*Electronics*, vol. 19, pp. 166-170; March, 1946.) See also 1149 of May.

534.41+534.781 1425
Visible Speech—R. K. Potter. (*Bell Lab. Rec.*, vol. 24, pp. 7-11; January, 1946.) An account in general terms of the system described in 823 of April.

534.43 1426
Spotting and Repeating Record Player—R. H. Bailey. (*Radio News*, vol. 35, pp. 29-128; February, 1946.) Brief general account of a device to enable accurate location of any particular passage on a disk record, and to enable the accurate setting of the pickup to repeat any passage of which the position has been noted.

534.6:621.395.623.7 1427
On the Maximum Possible Reinforcing of Sound under Outdoor Conditions: and in an Enclosure—G. M. Suharevsky. (*Compt. Rend. Acad. Sci. U.R.S.S.*, vol. 26, pp. 885-891, 892-899; 1940. In English.) The degree of "sound reinforcing" is defined as $10 \log (I_a/I_0)$ where I_a is the average level of intensity at the point of audition, and I_0 is the average level of intensity at the microphone. This quantity is limited by acoustical feedback, and by associated frequency distortion. Very detailed formulas are given, depending on the polar diagram and location of the loudspeaker, and the constants of the boundaries of the sound field. The acoustic feedback limitation is very severe in an enclosure. One means of raising the possible level of reinforcement is to "mix up" the standing-wave systems by revolving the loudspeaker so that its axis describes a cone, or by means of a revolving screen in the horn or at the mouth of the loudspeaker. A gain of 6 to 8 decibels can be realized in this way.

534.62:061.6 1428
Acoustic Laboratory—(*Elec. Ind.*, vol. 5, p. 78; March, 1946.) Description of the Harvard "Anechoic Chamber"; reflection coefficient at walls 0.1 per cent; development of sound-insulating assemblies; investigation of speech intelligibility at high altitudes. See also 1429 below.

534.62:061.6 1429
Achievements of Harvard's Electro-Acoustic Laboratory—(*Electronics*, vol. 19, pp. 312-323; March, 1946.) A review of the work done in soundproofing aeroplane

cabins and in improving the system of communications between the members of the crew, including a description of the construction of an echo-free room. See also 1428 above.

534.845:677.521 1430
Forms, Properties and Functions of Fibrous Glass Acoustical Materials—W. M. Rees. (*Communications*, vol. 26, pp. 36-38; January, 1946.) The materials are provided as wool, blankets, etc., or bonded with resin to form boards. A table gives absorption data. Graphs show that for layers of wool, etc., up to about 2 inches thick the absorption increases equally with density throughout the frequency spectrum. At greater thicknesses absorption is little affected by density at frequencies above 500 cycles per second. Encasing boards in paint, cellophane, etc., causes a small increase in absorption at low frequencies and a large decrease at high frequencies. See also 1156 of May (Rees and Taylor).

534.88+621.395.625.3 1431
I.R.E. Winter Technical Meeting, January, 1946—(PROC. I.R.E. AND WAVES AND ELECTRONS, vol. 1, pp. 80W-93W; February, 1946.) Abstracts are given of the following papers read at the meeting: "Magnetic Recorder as an Adjunct to the Home Receiver."—S. J. Begun. (Title only) "Basic Principles of Underwater Sound-Equipment Design."—R. Bennett. For other abstracts, see *Electronics*, vol. 19, pp. 92-108, March, 1946; and *Elec. Ind.*, vol. 5, pp. 62-74; March, 1946. For titles of other papers read, see other sections.

534.88:533.6.013.22 1432
On the Propagation of Sound in Turbulent Atmosphere—V. Krassilnikov. (*Compt. Rend. Acad. Sci. U.R.S.S.*, vol. 47, pp. 469-471; 1945. In English.) The phase fluctuations of a sound wave propagated in a turbulent atmosphere are calculated, and applied to the problem of locating a source of sound by spaced microphones. The inaccuracy of sound rangiers in conditions of strong wind is attributed to the effect of turbulence on the mean velocity of sound along the path.

621.395.42:534.7 1433
Infrasonic Switching—Montani. (See 1667.)

621.395.614 1434
A Unidirectional Crystal Microphone—A. M. Wiggins. (*Communications*, vol. 26, pp. 20-22; January, 1946.) A unidirectional microphone is obtained by placing a damped, dead diaphragm of correct mechanical impedance behind the crystal. The formulas for calculating the correct resistance and mass of this diaphragm are given. The response rises at the rate of 6 decibels per octave, and this is counteracted by a resistance-capacitance filter of complementary characteristics.

621.395.615 1435
Electronic Microphone—J. Rothstein. (*Electronics*, vol. 19, pp. 230-232; March, 1946.) A flexible diaphragm is mechanically

coupled to the grid of a parallel-plane electron tube. Motion of the diaphragm changes the position of the grid relative to the anode and cathode, and so changes the amplification factor of the tube. Summary of U. S. Patent 2,389,945.

621.395.623.7: 621.392.53 1436

Reduction of Loudspeaker Distortion—F. C. Jones. (*Radio*, vol. 30, pp. 26–28; January, 1946.) Harmonic distortion at low frequencies, which is serious at high inputs, arises from the low resonant frequency of the moving-coil system. It may be substantially reduced by using a "bass reflex" cabinet enclosure with an air vent adjacent to the speaker cone. High-frequency distortion, arising from frequency modulation of the high frequencies by a low frequency, may be reduced by using two speakers in a dual system, one for the high and the other for the low frequencies. The design of crossover filter networks for use in such a system is discussed and practical constructional data are given. The circuits described are for 6-ohm speech coils and give crossovers at about 1500 cycles. See also 529 of March.

621.395.623.75 1437

Design of Compact Two-Horn Loudspeaker—P. W. Klipsch. (*Electronics*, vol. 19, pp. 156–159; February, 1946.) "For room-corner locations, where walls can be utilized to produce reflections that multiply the mouth area of the woofer sufficiently for efficient propagation of sound waves down to 40 cycles. Companion tweeter gives wide-angle radiation." Based on 830 of April (Klipsch) and back references.

621.395.623.8 1438

Massive Speaker Cabinet—C. A. Volf. (*Electronics*, vol. 19, pp. 207–214; March, 1946.) Another account of the system described in 531 of March and 1162 of May.

621.395.623.8 1439

High-Power Military Sound Systems—(*Electronics*, vol. 19, pp. 216–222; February, 1946.) An outline of the device described in 532 of March, and of a giant loudspeaker system installed in a bomber, for addressing an entire city from the air.

621.395.645 1440

Hi-Fi Amplifier Contest—J. W. Straede. (*Radio Craft*, vol. 17, pp. 249–272; January, 1946.) Details of the four best amplifiers in an Australian contest, limited to amateurs, in which the fidelity was judged by a public audience, and the technical details by a special panel.

621.395.92 1441

The Testing of Deaf Aids—T. H. Turney. (*Jour. Sci. Instr.*, vol. 23, pp. 58–59; March, 1946.) Describes the measurement of the gain by a 2-voltmeter method and by an artificial-ear method. Substantial agreement is obtained.

621.395.92: 534.771 1442

Historic Firsts: The Audiometer—(*Bell Lab. Rec.*, vol. 24, pp. 57–58; February, 1946.) An instrument for investigating hearing ability at any frequency between 30 and 16,000 cycles.

621.396.611.21 + 621.317.361 1443

Duplex Crystals—Lane. (See 1582.)

621.396.97 1444

Radio Sound Effects. [Book Review]—J. Cramer and W. B. Hoffman. Ziff-Davis, New York, N. Y., 1945, 71 pp., \$1.50. (*Electronics*, vol. 19, p. 360; February, 1946.) "Not a text, but a syllabus of study for broadcasters, sound technicians . . . makes no pretense of teaching its readers in one easy lesson."

AERIALS AND TRANSMISSION LINES

621.317.79: 621.315.212.1.029.62/.63 1445

Measuring Coaxials at Ultra-High Frequencies—Fleming. (See 1597.)

621.392 1446

The Capacity of Twin Cable—I—J. W. Craggs and C. J. Tranter. (*Quart. Appl. Math.*, vol. 3, pp. 380–383; January, 1946.) An extension of 660 of March (Craggs and Tranter) to the case in which the dielectric sheaths enclosing the two conductors are separated and surrounded by another dielectric medium. Two methods are given, leading to series solutions, one converging more rapidly than the other, according to the ratio of the dielectric constants of the two dielectrics involved.

621.392 1447

Waves and Wave Guides: Part III—G. G. (QST, vol. 30, pp. 61–134; March, 1946.) Nomenclature of modes of guided waves, and determination of cutoff frequencies. A practical consideration of guide dimensions for the amateur bands. For previous parts, see 546 of March and 284 of February.

621.396.67 1448

I.R.E. Winter Technical Meeting, January, 1946—(PROC. I.R.E. AND WAVES AND ELECTRONS, vol. 1, pp. 80W–93W; February, 1946.) Abstracts are given of the following papers read at the meeting: "Antenna for Frequency-Modulation Station WGHF."—A. Alford. "Broad-Band Antennas and Direction-Finding Systems for Very High Frequencies."—A. Alford, J. D. Kraus, A. Dorne, and J. Christensen. "Metal Lens Antennas."—W. E. Kock. "Design Considerations in Broadside Arrays."—J. Ruze. "Ultra-High-Frequency Television Transmitters and Antennas."—R. Serrell. "Model Aircraft-Antenna Measurements."—G. Sinclair, E. W. Vaughan, and E. C. Jordan. "Beam-Shaping Methods in Antenna Design."—L. C. Van Atta. "Directional Couplers."—W. W. Mumford. "From Wiring to Plumbing."—E. M. Purcell. "Equivalent Circuits for Wave-Guide Structures."—J. Schwinger. For other abstracts, see *Electronics*, vol. 19, pp. 92–108, March, 1946; and *Elect. Ind.*, vol. 5, pp. 62–74; March, 1946. For titles of other papers read, see other sections.

621.396.67 1449

The Effective Length of a Half-Wave Dipole—G.W.O.H. (*Wireless Eng.*, vol. 23, pp. 95–96; April, 1946.) The equivalence of a dipole with sinusoidal-current distribution, and an aerial λ/κ long carrying a uniform current equal to that at the center of the dipole, is not exact for points off the equatorial plane, and the field deduced

therefrom is shown to be up to 5 or 6 per cent in error. See also 1802 of 1945 (G.W. O.H.).

621.396.67 1450

Some Experiments with Linear Aerials—J. S. McPetrie and J. A. Saxton. (*Wireless Eng.*, vol. 23, pp. 107–114; April, 1946.) A method of determining the polar diagram of a linear aerial based on the summation of the effect of current waves induced in the aerial by an incident electromagnetic field gives satisfactory agreement between theoretical and experimental polar diagrams for aerials an integral number of half-waves in length. An experimental investigation of front-to-back ratios of a half-wave dipole and parasite shows that, as a reflector system, the optimum length and spacing of the parasite were 0.5 and 0.1 of the wavelength, respectively, giving an 11-decibel ratio, and as a director system, the corresponding values were 0.47 and 0.05, giving a 20-decibel ratio.

621.396.67 1451

Antenna Construction—A. Alford and M. Fuchs. (*Radio*, vol. 30, pp. 43, 58; January, 1946.) A dipole consists of two metal sleeves end to end, insulated from and surrounding a coaxial tubular metal mast which projects beyond the upper sleeve. The aerial is substantially balanced, and is fed from a transmission line carried through the interior of the mast, Summary of U. S. Patent 2,385,783.

621.396.67: 621.396.82 1452

QRM—The Electronic Life Saver: Part II [Aerials for Radar Countermeasures]—Robbiano. (See 1527.)

621.396.671 1453

The Cylindrical Antenna: Current and Impedance—R. King and D. Middleton. (*Quart. Appl. Math.*, vol. 3, pp. 302–335; January, 1946.) A theoretical analysis of an idealized case, with premises similar to those postulated in earlier investigations (see Hallén, 2763 of 1939, and King and Harrison, 817 of 1944). The aim of the paper is solely analytical improvement of the solution of the problem. This has been achieved by introducing parameters different from those used by Hallén (*loc. cit.*) in order to fit the actual current distribution to an analytical form. A comparison of first-order solutions for the current distribution in Hallén's and the present work shows that "The new, more exact theory leads to a distribution with somewhat greater relative amplitudes nearer the outer parts of the antenna, and with a somewhat larger component in phase with the driving-potential difference." The impedance, on the new theory, differs in detail but not in any major manner from that given by the previous work. In general, resistances are smaller at antiresonance, and are greater at resonance; these differences are most significant for large values of antenna radius. A comparison is made between the new theory and unpublished experimental determinations, by D. D. King, of the impedance characteristics of such an antenna. The agreement is good for all quantities in the second-order theory, but only approximate in the first-order.

621.396.671 1454

The Efficiency of a Short Transmitting Antenna—V. J. Andrew. (*Communications*, vol. 26, pp. 52-53; January, 1946.) The inefficiency of aerials of lengths less than 0.18 wavelength is due to the fact that they have a low radiation resistance and a large negative reactance, resulting in relatively high losses in the loading inductor. The adverse effect of the lead-in capacitance can be reduced by placing the loading inductor at the base of the aerial.

621.396.673 1455

The Quadrant Aerial—N. Wells. (*Marconi Rev.*, vol. 9, pp. 21-23; January-March, 1946.) This is a horizontal aerial system with an omnidirectional pattern. It can be used over a wide frequency band for both transmission and reception. The system comprises two aerials with figure-of-eight diagrams set at right angles to each other and in phase quadrature. The omnidirectional character is well maintained over a frequency range of 2 to 1, as is the vertical-directivity pattern, which is governed by the height of the aerial. A group of four poles carrying four aerials can together cover the band 2 to 30 megacycles.

621.396.677 1456

A Generalized Radiation Formula for Horizontal Rhombic Aerials—H. Cafferata. (*Marconi Rev.*, vol. 9, pp. 24-35; January-March 1946.) Limitations of the earlier calculations of the radiated field are pointed out and a more general treatment is given. In particular, the positions where mixed polarized waves are received is considered, and account is taken of current attenuation in the conductors. "The source considered is that of a multiple array of horizontal rhombic elements arranged n in cascade and m cascades in parallel, and all contained in the same horizontal plane. The formula allows for arbitrary phase relations as between cascades and between elements in each cascade. This permits of "steering" the main lobe of radiation and control of the interference pattern in the XZ plane." To be continued.

621.396.677.029.6 1457

High-Gain Microwave Antennas—W. G. Tuller. (*QST*, vol. 30, pp. 34-40, 122; March, 1946.) A survey of antenna arrays developed for radar during the war, and of their possible uses in amateur communication. Types discussed include a dipole array with a plane reflector, a parabolic dish fed by a dipole, and a cut dish fed by a wave guide and radiating horn. Types of feeder include the solid-dielectric coaxial line, the rectangular wave guide, and the stub-supported coaxial line. Design and performance data for representative arrays for 200 megacycles and 3000 megacycles are given. Brief mention is made of many possible variations.

CIRCUITS

621.317.733 1458

Note on the Helmholtz Make-and-Break Theorem and an Application to the Wheatstone Net—Freeman. (*See* 1593.)

621.318.572 1459

Pulse-Integrating Circuit—W. N. Tuttle. (*Radio*, vol. 30, p. 42; January, 1946.) The pulses to be counted are passed through

a tube with zero plate voltage to a capacitor with a suitable leak resistance. The direct-current potential difference created across the capacitor is proportional to the rate of arrival of the pulses, and is measured with a triode voltmeter. Summary of U. S. Patent 2,374,248.

621.318.572 1460

Geiger-Muller Counter Technique for High Counting Rates—C. O. Muehlhause and H. Friedman. (*Phys. Rev.*, vol. 69, p. 46; January 1-15, 1946.) A Geiger-Muller counter coupled to a 4-megacycle wide video amplifier followed by a scaling circuit and a triggered-sweep oscilloscope (see 1859 of 1942, Stever) enabled counting rates up to 10^6 per second to be obtained. Summary of an American Physical Society paper.

621.318.572:621.317.361 1461

Decade Counting Circuits—Regener. (*See* 1581.)

621.392+621.396[.622+.64 1462

I.R.E. Winter Technical Meeting, January, 1946—(PROC. I.R.E. AND WAVES AND ELECTRONS, vol. 1, pp. 80W-93W; February, 1946.) Abstracts are given of the following papers read at the meeting: "Capacitance-Coupled Wide-Band Intermediate-Frequency Amplifiers."—M. J. Larsen and L. L. Merrill. "Directional Couplers."—W. W. Mumford. "From Wiring to Plumbing."—E. M. Purcell. "Equivalent Circuits for Wave-Guide Structures."—J. Schwinger. "Discriminators for Frequency-Modulation Receivers."—S. W. Seeley. "Stagger-Tuned Wide-Band Amplifiers."—H. Wallman. For other abstracts, see *Electronics*, vol. 19, pp. 92-108, March, 1946; and *Electronic Ind.*, vol. 5, pp. 62-74; March, 1946. For titles of other papers read, see other sections.

621.392.5:621.396.619.018.41 1463

The Transmission of a Frequency-Modulated Wave Through a Network—W. J. Frantz. (PROC. I.R.E. AND WAVES AND ELECTRONS, vol. 34, pp. 114P-125P; March, 1946.) The paper was prompted by the increasing use of frequency-modulated signal generators in conjunction with a cathode-ray-tube display for investigating the bandwidth, etc., of amplifiers. The possible errors arising in such testing procedure are investigated in detail, but the results are of general application. "A practical [and simple] method for calculating the effect of a 4-terminal network upon a frequency-modulated wave being transmitted through it is developed and demonstrated. . . . [It is] equally accurate and practicable for large and small values of modulation index and for any physical network." The amplitude and phase of the output voltage are expressed as a function of time or of instantaneous input frequency. A simple expression is derived giving the necessary correction to the output voltage versus frequency characteristic determined under steady-state conditions. Practical worked examples are included.

621.392.52 1464

Analysis of a Resistance-Capacitance Parallel-T Network and Applications—A. E. Hastings. (PROC. I.R.E. AND WAVES AND ELECTRONS, vol. 34, pp. 126P-129P; March, 1946.) ". . . to find the conditions

for a null in output and the transfer characteristic. Its use in the return circuit of a feedback amplifier is considered, and the bandwidth of the resulting tuned amplifier is found. The requirements for stability of the amplifier and for its use as an oscillator are discussed." The discussion deals with three arrangements, and is mainly concerned with networks in which the resistive and capacitive elements, respectively, comprising the horizontal arms of the two T's, are equal. For such a network interposed in the feedback link of an amplifier, the maximum available "effective Q " of the amplifier is a quarter of the voltage gain of the unit before feedback is applied.

621.392.52 1465

Bridged-T Null Networks—Z. Bryl. (*Proc. I.R.E., Aust.*, vol. 6, pp. 8-9; November, 1945.) Mathematical derivation of conditions necessary for zero transmission.

621.392.52 1466

Bridged-T Circuit—R. B. Essex. (*Radio Craft*, vol. 17, p. 316; February, 1946.) The use in amplifier design is described. The circuit can be arranged either to suppress one particular frequency or to suppress all but one frequency. Numerical data for computing the network parameters are given.

621.392.52:512.831 1467

Application of Matrix Algebra to Filter Theory—P. I. Richards. (PROC. I.R.E. AND WAVES AND ELECTRONS, vol. 34, pp. 145P-150P; March, 1946.) "After a brief introduction to matrix notation, methods are presented for the derivation of design equations for filter sections with special attention to symmetrical types. Finally, insertion and mismatch loss formulas, obtainable directly from the matrices, are given." The matrix notation for each of the circuit components normally encountered in filter design is given. It is shown that the matrix for the whole filter is formed by multiplying, in the order of connection, the individual matrices of the circuit components. From a knowledge of the elements in the complete filter matrix it is shown how to derive the properties of the filter: conversely, the method may be used to design a filter having specified properties.

621.394/.397].645 1468

On Maximum Gain-Band Width Product in Amplifiers—W. W. Hansen. (*Jour. Appl. Phys.*, vol. 17, p. 109; February, 1946.) Correction to 3810 of 1945 (Hansen).

621.394/.397].645 1469

Radio Design Worksheet: No. 44—The Cathode Follower Circuit—(*Radio, N. Y.*, vol. 30, p. 44; January, 1946.)

621.394/.397].645 1470

Network Design Using Electrolytic Tanks—R. W. Kenyon. (*Elec. Ind.*, vol. 5, pp. 58-60; March, 1946.) "Every amplifier has specific complex frequencies at which the gain is infinity [poles], and other complex frequencies at which the gain is zero [zeros]." In the electrolytic tank the locations of the poles and zeros (which uniquely determine the shape of the frequency-versus-gain curve) are represented by electrodes suitably placed and energized. A probe electrode connected to a vacuum-tube

voltmeter enables the gain function to be determined. A short account of the design and an outline of typical applications of the tank in amplifier design are given.

621.394/.397].645: 621.396.822 1471

Noise Factor of Valve Amplifiers—N. R. Campbell, V. J. Francis, and E. G. James. (*Wireless Eng.*, vol. 23, pp. 116–121; April, 1946.) Conclusion of 1191 of May. A definition of noise factor is given, and on the assumption that all the quantities concerned are either zero or a constant value, formulas are derived and applied to transformer-coupled stages and to a common-cathode pentode stage. The effect on the noise factor of the addition of a preamplifier before the first stage of an amplifier is shown to be the same as if the amplifier produced no noise, but the load conductance of the preamplifier were increased.

621.394/.397].645.34 1472

Selective Amplifiers—B. M. Hadfield. (*Elec. Ind.*, vol. 5, p. 104; March, 1946.) "... a frequency-selective amplifier or oscillator of the feedback type... which permits frequency control by adjustment of one potentiometer in the feedback circuit." Summary of U. S. Patent 2,386,892.

621.395.645. 1473

Telephone Amplifier—H. K. van Jepmond. (*Electronics*, vol. 19, p. 139; March, 1946.) Simple two-way amplifier for use on privately serviced telephone lines.

621.395/.397].645: 621.396.619.018.41 1474

Carrier-Frequency Amplifiers: Transient Conditions with Frequency Modulation—C. C. Eaglesfield. (*Wireless Eng.*, vol. 23, pp. 96–102; April, 1946.) The "transient-modulation ratio" is defined as the ratio of the modulation at the output to that at the input, and the general equations for it are obtained assuming an instantaneous change of amplitude or frequency at the input. The equations are simplified by considering small modulation values only, and by making the carrier frequency coincide with the central frequency of the amplifier. For "staggered" circuits a simple relation between modulation ratios for amplitude modulation and frequency modulation is obtained, and graphical results for representative amplifiers are shown. With modification, the results can be used for coupled circuits. See also 1196 of May and 68 of January (Eaglesfield).

621.395.645: 621.395.44 1475

A New Linear Amplifier Circuit—S. T. Fisher. (*QST*, vol. 30, pp. 21–26; February, 1946.) A less-detailed account of the system described in 877 of April.

621.395.645: 621.395.8 1476

Hum Elimination—J. C. Hoadley. (*Radio Craft*, vol. 17, pp. 313–356; February, 1946.) A review of possible sources of mains-voltage hum in amplifiers together with design hints for its elimination. Some of the less-obvious causes of hum, such as multiple grounding to chassis and emission from the exposed parts of cathode-heater elements, are dealt with.

621.395.645: 621.395.8 1477

The Effect of Negative Voltage Feedback on Power-Supply Hum in Audio-Frequency Amplifiers—G. Builder. (*Proc.*

I.R.E. AND WAVES AND ELECTRONS, vol. 34, pp. 140W–144W; March, 1946.) Analysis leading to the conclusions (a) Under conditions of simple negative feedback, the signal-to-hum ratio at constant-signal output is improved by the gain-reduction factor $(1-\beta M)$. This factor is, in general, complex and frequency-dependent. (b) "Failure to achieve the improvement in signal-to-hum ratio thus predicted may be due to the feedback voltage's including voltage other than the fraction β of the output voltage required for simple negative feedback..." (c) "In general, hum balancing within the amplifier is independent of the feedback only when the conditions for simple negative feedback are satisfied." (d) With an amplifier employing feedback, it is not generally valid to calculate the output-hum voltage by simple potential division between the load impedance and the effective anode impedance of the tube if the latter is taken to be $R_a/(1-\mu\beta)$. A particular case is considered, however, when this procedure is permissible. The case of an amplifier having transformer coupling to the load is discussed in detail, with extensions to cover other types of output arrangements.

621.395.645.3: 621.385.2 1478

A Voltage Amplifier Using a Pre-Saturation Diode as Load—A. M. I. A. W. Durnford. (*Canad. Jour. Res.*, vol. 22, Sec. A, pp. 67–76; September, 1944.) "Presaturation characteristics for various types of diodes indicate that for constant plate voltage, the product of plate current and plate resistance is constant for each diode. ($i_{dtpd} = K$). For different diodes, the value of K varies from 200 to 700 volts for a plate voltage of 125 volts. Tubes with thoriated-tungsten cathodes have the highest K values with K proportional to plate voltage which renders the logarithmic characteristics linear and parallel. The presaturation diode when used as a load provides a high resistance that does not require an exceedingly large supply voltage. If the quiescent plate voltage E_{b0} is kept constant, the effective-load lines converge at a common point, the voltage of which represents a virtual supply voltage equal to $E_{b0} + K$. Voltage gain and maximum distortionless output are both greater than when a fixed resistance is used as load. Variation of the filament current of the diode, or of a self-bias resistor, provides a distortionless gain control. The gain is almost constant for frequencies less than 300 cycles but for high frequencies drops more rapidly."

621.395.645[.33+.35 1479

A Constant Time Interval Reference Potential Indicator for Use with R-C Coupled Amplifiers—E. W. Kammer. (*Rev. Sci. Instr.*, vol. 17, pp. 102–106; March, 1946.) A device used for the observation of low-frequency signals such as those produced in the recording of dynamic strain in structures. The input signal is chopped rapidly to form a carrier which can then be amplified. The electronic switch, consisting of two cathode followers and a differential amplifier, is operated by a pulse with recurrence frequency of 1000 per second and 10^{-4} second duration.

621.395.645.34+621.396.63 1480

[Frequency] Selective Control Circuit—E. S. Purington. (*Radio*, vol. 30, p. 59;

January, 1946.) A double-triode amplifier circuit with selective feedback designed to operate a relay when excited with a predetermined frequency of about 10 cycles per second. Summary of U. S. Patent 2,382,097.

621.396/.397].645.31 1481

Some Considerations in the Design of Wide-Band Radio-Frequency Amplifiers—J. E. Cope. (*Jour. I. E. E.* (London), Part I, vol. 93, p. 109; February, 1946.) Summary of 576 of March.

621.396.611: 621.396.615.14.029.63 1482

Tunable Microwave Cavity Resonators—J. J. Guarrera. (*Elec. Ind.*, vol. 5, pp. 80–122; March, 1946.) Design of coaxial resonators and associated components for use with disk-sealed triode oscillators, with particular reference to tuning, feed-back, and short circuiting plug problems. The design and testing of assemblies for operation under service conditions are briefly discussed. See also 1483.

621.396.611: 621.396.615.14.029.63 1483

Cavity Oscillator Circuits—A. M. Gurewitsch. (*Electronics*, vol. 19, pp. 135–137; February, 1946.) Outline of the design of re-entrant-type cavity circuits for use with disk-sealed triodes (lighthouse tubes) in the decimeter band of wavelengths. A number of different mechanical arrangements are described and illustrated; typical dimensions are given for wavelengths in the 9- to 30-centimeter region together with an indication of operating voltages and currents under continuous wave and pulsed conditions.

621.396.611.2.029.62/.63 1484

Tuned Circuit Design for U.H.F.—M. Apstein and M. Joffe. (*QST*, vol. 30, pp. 13–16, 106; February, 1946.) Photographs and drawings of an inductance-capacitance circuit with three interchangeable coils, for use with an acorn triode to oscillate over the range 140 to 450 megacycles.

621.396.611.3: 621.396.615.1 1485

Bimodal Oscillator—S. Lubkin. (*Electronics*, vol. 19, pp. 242–248; February, 1946.) Various examples are quoted of circuits having two closely spaced natural frequencies. The advantages to be expected from using such circuit elements in the construction of beat-frequency oscillators, together with methods for varying the frequency separation, are discussed. Possible circuits are described; one suggested arrangement is to pulse-excite the double-peaked circuit, using the output beat frequency to synchronize the exciter.

621.396.615.17 1486

Rectangular-Pulse Generator—R. K. McCombs and F. C. Walz. (*Electronics*, vol. 19, pp. 222–228; March, 1946.) A long summary of 4136 of 1945.

621.396.615.17: 578.088.7 1487

Nerve Stimulator—Weiss. (*See* 1609.)

621.396.615.17: 621.397.335 1488

Synchronizing Generators for Electronic Television—A. R. Applegarth. (*Proc. I.R.E. AND WAVES AND ELECTRONS*, vol. 34, pp. 128W–139W; March, 1946.) "The system of electronic circuits employed to generate the complex wave forms required as a base for television picture transmission is described. It comprises four principal sections

which are: (1) source of accurately timed pulses; (2) frequency-divider chain; (3) components-generating circuits; and (4) signal-synthesis circuits. The various means for accomplishing these functions are briefly discussed, and illustrated by circuits which have been used successfully for such purposes in practical applications."

621.396.619 1489

Carrier Wave Modulation—W. R. Bennett. (*Radio*, vol. 30, p. 42; January, 1946.) A circuit for reducing second-harmonic distortion in a ring-type balanced modulator when the signal frequency is too close to the sideband frequency to be conveniently separated by filters. Summary of U. S. Patent 2,377,858.

621.396.619; 621.396.933.2 1490

Modulation Circuit—Alford and Paterson. (See 1548.)

621.396.619.018.41; 621.396.622 1491

Frequency Discriminator—G. G. Bruck. (*Jour. Appl. Phys.*, vol. 17, p. 213; March, 1946.) Letter giving preliminary notice, with circuit diagram, of a discriminator that is insensitive to amplitude. "The circuit . . . is essentially an oscillator which falls into step with an incoming signal. The differential plate current of the two halves of the [double triode] tube is the discriminator output."

621.396.621.53 1492

Calculation of the Output from Non-Linear Mixers—H. Stockman. (*Jour. Appl. Phys.*, vol. 17, pp. 110-120; February, 1946.) A detailed critical survey of existing methods of determining the mixer performance of nonlinear conductors from an assumed knowledge of the current-versus-voltage characteristic. The methods are compared for consistency by application to a typical diode characteristic, and the discrepancies range from -25 per cent to +35 per cent. It is concluded that there is no "best" method and that "all methods require simplifying assumptions that frequently lead the converter designer to consider practical measurements or special methods such as the frequency-conversion diagram technique." The latter is a compromise between direct measurement and complete computation, due to Chaffee, and described in detail in a number of papers by H. Stockman (e.g., 778 of 1945 and 408 of 1946).

621.396.645+621.396.61 1493

Analysis of Parasitic Oscillations in Radio Transmitters—Jackson. (See 1714.)

621.396.645 1494

A 4.3-Mc. F.M./A.M. I.F. and Audio Amplifier—J. W. Brannin. (*QST*, vol. 30, pp. 51-54; March, 1946.) Circuit and constructional details. A beat oscillator is included for continuous-wave reception.

621.396.645.029.62 1495

A V.H.F. Amplifier Using the 829—G.G. (*QST*, vol. 30, no. 3, pp. 55-56; March, 1946.) Constructional details. 50-watt output at 144 megacycles.

621.396.645.34 1496

Selective Amplifier or Oscillator—B. M. Hadfield. (*Radio*, vol. 30, pp. 42-43; January, 1946.) A feedback amplifier with a narrow pass band that can be varied over sev-

eral octaves by a single potential divider. It may also be used as an oscillator over the same frequency range. Summary of U. S. Patent 2,386,892.

621.396.662.32 1497

The Ideal Low-Pass Filter in the Form of a Dispersionless Lag Line—M. J. E. Golay. (*PROC. I.R.E. AND WAVES AND ELECTRONS*, vol. 34, pp. 138P-144P; March, 1946.) "Some theoretical and practical aspects of the design . . . are considered. It is shown, in particular, that an artificial line made up of series inductances and shunt capacitances, with 18 per cent aiding mutual inductance between adjacent coils and 8 per cent shunt capacitance between alternate tie points, forms, for many purposes, a sufficiently good approximation of a dispersionless lag line. The mathematical study of the function $f(n) = \int_0^\pi (1 - \cos \phi/\phi^2) \cos n\phi d\phi$, which is of pertinent interest in lag-line theory, is given in an appendix." The modification of the values of line components to take account of resistive losses, and the effective characteristic impedance of the line are briefly examined.

621.396.662.34 1498

H.F. Band-Pass Filters: Part III—H. P. Williams. (*Elec. Eng.*, vol. 18, pp. 89-93; March, 1946.) Examination of the response of coupled dissimilar circuits with unequal damping and staggering. The position and separation of the peaks, the gain on tune and the response well off tune are derived, and the results applied to interstage and aerial-coupling circuits. An approximate treatment of the signal-to-thermal-noise ratio is given. For previous parts, see 895/896 of April.

621.396.9 1499

Loran Indicator Circuit Operation—Davidson. (See 1529.)

621.397.335 1500

Synchronizing and Separation Circuits: Part 12—Noll. (See 1710.)

621.397.645 1501

Compensating Amplifier—Gillespie. (See 1712.)

621.392.4; 621.3.015.33 1502

Pulsed Linear Networks. [Book Review]—E. Frank. McGraw-Hill Book Company, New York, N. Y., 267 pp., \$3.00. *PROC. I.R.E. AND WAVES AND ELECTRONS*, vol. 34, pp. 159-160; March, 1946.) The networks examined are limited to simple types, but the treatment (by the classical method only) is clear and thorough.

GENERAL PHYSICS

532.517.4 1503

A Contribution to the Statistical Theory of Turbulence—V. G. Nevzgljadov. (*Compt. Rend. Acad. Sci. U.R.S.S.*, vol. 47, pp. 466-468; 1945. In English.)

535.215; 621.383 1504

Investigation of the Surface Photoelectric Effect of Metallic Films under the Influence of Strong Electrostatic Fields—V. P. Jacobsmeier. (*Phys. Rev.*, vol. 69, p. 50; January 1-15, 1946.) Photoelectric current from bismuth films and a "liquid bright Pt" surface measured in fields up to 1.4×10^6 volts per centimeter give a "Schott-

ky line" which is consistent with the theoretical predictions of Guth and Mullin (1909 and 2766 of 1941). Summary of an American Physical Society paper.

535.3 1505

Transmission of Light by Water Drops 1 to 5 M in Diameter—R. Ruedy. (*Canad. Jour. Res.*, vol. 22, Sec. A, pp. 53-66; May, July, 1944.) The size of growing drops of water formed as water vapor condenses can be determined by application of Mie's theory. As the drop size increases, the intensity of the transmitted light passes through a series of maximum and minimum values. This results in colored light, and from observation of the cycles in changes of color, radius of the growing drops can be determined.

535.43 1506

Scattering of Light by Small Drops of Water—R. Ruedy. (*Canad. Jour. Res.*, vol. 21, Sec. A, pp. 99-109; December, 1943.) Scattering of light of wavelength λ obeys Rayleigh's law for drop diameters up to $\lambda/4$. For diameters between $\lambda/4$ and λ , back radiation decreases almost to zero, and forward radiation obeys approximately a sixth power law. At the same time, the color of the scattered light changes gradually from blue, through the spectrum, to red.

536.2 1507

A Cylinder Cooling Problem—S. A. Schaaf. (*Quart. Appl. Math.*, vol. 3, pp. 356-360; January, 1946.) The problem of an infinitely long circular cylinder at an initial temperature above zero which is instantaneously immersed in an infinite medium initially at zero is solved by means of a Laplace transformation, leading to a solution in terms of Bessel functions.

536.2; 621.315.2.017.7 1508

On a Modification of Forchheimer's Problem—I. A. Charny. (*Compt. Rend. Acad. Sci. U.R.S.S.*, vol. 48, pp. 27-30; 1945. In English.) A mathematical paper on the determination of the heat losses from a length of tube buried in the ground, when the coefficient of heat transfer from the surface of the ground to the air has a finite value.

537.122; 538.3 1509

Some Criticisms of the Theory of Point Electrons—T. Lewis. (*Phil. Mag.*, vol. 36, pp. 533-541; August, 1945.) Dirac's analyses of the behavior of point electrons (1822 of 1942 and previous work) contain a serious mathematical error, leading to false conclusions. Some of his results are invalid in so far as they are supposed to contain a term corresponding to radiation damping.

537.525 1510

On the Theory of the Varying Electric Discharge in Gases—V. L. Granovsky. (*Compt. Rend. Acad. Sci. U.R.S.S.*, vol. 26, pp. 876-880; 1940. In English.) Varying discharge phenomena may be classified into (a) those associated with the electrical inertia of the discharge; (b) those associated with the thermal inertia of the gas and the electrode system. The paper deals with (a), with the following limitations: 1. The plasma is the main part of the discharge. 2. Displacement current small compared

with conduction current. 3. Pressure not too low. 4. Plasma quasi-neutral (cf Schottky's theory of ambipolar diffusion). 5. Maxwellian electron-velocity distribution. 6. Energy of the electron gas derived from the electric field and lost by collision with gas molecules. 7. The normal atoms are directly ionized. 8. Tube connected to a source of electromotive force through a resistance. Formulas are given for the balance of ions, the equation of ionization, the balance of energy in the electron gas, the equation of mobility, and the current. See 1224 of May (Granovsky) for a sequel to this paper.

537.525: 621.3.029.64 **1511**
Initiation of High Frequency Gas Discharges—Holstein. (See 1726.)

537.525.82 **1512**
Computation of the Positive Column Characteristics—B. Klarfeld. (*Compt. Rend. Acad. Sci. U.R.S.S.*, vol. 26, pp. 873-875; 1940. In English.) Deals with the calculation of the discharge characteristics from the atomic properties of the gas. The theory, now freed from previous simplifying assumptions which limited the pressure range, has been extended to cover the whole range within which the low-pressure plasma theory remains valid, and has been confirmed by experiments with mercury vapor. (See V. Granovsky, *Bull. Acad. Sci. U.R.S.S.*, Sér. Phys., p. 419, 1938.)

537.581 **1513**
An Explanation of Anomalous Thermionic Emission Current Constants—N.-T. Sun and W. Band. (*Proc. Camb. Phil. Soc.*, vol. 42, Part 1, pp. 72-77; February, 1946.) Anomalous large or small values of the constant A in the thermionic current formula for metals ($I = A T^2 e^{-\chi/kT}$), are explained by taking into account the sharing of free electrons by two competing overlapping energy bands. Cases where one overlapping energy band is nearly full and where both overlapping bands are nearly empty are considered, and are used to explain the observed values of A for nickel and hafnium.

538.1 **1514**
Resonance Absorption by Nuclear Magnetic Moments in a Solid—E. M. Purcell, H. C. Torrey, and R. V. Pound. (*Phys. Rev.*, vol. 69, pp. 37-38; January 1-15, 1946.) The absorption of radio-frequency energy by a solid material in a strong magnetic field due to changes of orientation of nuclear spin has been observed. The experimental method of determining the proton magnetic moment (using the transition relation $h\nu = 2\mu H$) is described. A resonant cavity (frequency 29.8 megacycles) filled with paraffin wax was placed in a magnetic field and the radio-frequency power transmitted through the cavity balanced by a direct signal in antiphase. The magnetic field was varied until the very sharp resonance absorption (about 10 oersteds wide) was observed at 7100 oersteds, giving 2.75 nuclear magnetons for the proton moment. The relaxation time to establish thermal equilibrium between the spins and the lattice was apparently less than a minute.

538.3 **1515**
Initial Boundary Problems of Electrodynamics—J. N. Feld (*Compt. Rend. Acad.*

Sci. U.R.S.S., vol. 48, pp. 172-174; 1945. In English.) A formal solution of the electromagnetic field within a space v bounded by a closed surface s when the tangential components of the electric and/or magnetic vectors are given as arbitrary functions of time. Equations (6) and (7) give the electric and magnetic fields at the point of observation assuming zero conductivity within v and zero tangential field at the surface s .

538.3 **1516**
A Study of Stationary Electromagnetic Modes for Region Between Parallel Perfectly Conducting Planes and Application to Electron Accelerator—E. S. Akeley. (*Phys. Rev.*, vol. 69, p. 50; January 1-15, 1946.) Theoretical evaluation of the TM modes with circular symmetry and their relation to the design of the surfaces and the energy dissipation in an electron accelerator. Summary of an American Physical Society paper.

538.3 **1517**
Reciprocal Electric Force—F. W. Warburton. (*Phys. Rev.*, vol. 69, p. 40; January 1-15, 1946.) From the assumed potential energy of two charges e and e' with relative velocity u the reciprocal force between them is obtained in a form involving certain undetermined coefficients and the relative acceleration of the charges. When the radius vector, velocity, and acceleration are parallel, the usual mass-energy relation is found. The formulas are applied to calculating the change of magnetization and torque of a rod by a longitudinal current. It is suggested that the treatment provides a unified electromagnetic theory which is more complete than the conventional theory with the necessary relativity corrections.

553.631: 621.3.011.2 **1518**
Effect of Transverse Pressure on the Steady-State Electrical Conductivity of Rocksalt—Hamtil. (See 1557.)

621.314.632 **1519**
A Method for Measuring Effective Contact E.M.F. Between a Metal and a Semiconductor—W. E. Stephens, B. Serin and W. E. Meyerhof. (*Phys. Rev.*, vol. 69, pp. 42-43; January 1-15, 1946.) Bethe's theory for the current in a rectifier formed by the potential barrier between a metal and a semiconductor gives $j = j_0$ exponent $(-\phi/kT)$ [exponent $(eV/kT) - 1$] where j_0 is the available current, ϕ the effective contact electromotive force, and V the applied voltage across the contact. If the resistance of the contact at zero applied voltage is R at temperature T and $\log(R/T)$ is plotted against $1/T$ the effective contact electromotive force ϕ can be deduced. [Reference is made to Fig. 1 which has been omitted.] ϕ is of importance in the operation of rectifiers and thermistors, and by correcting it for image force and the tunnel effect, the true difference of work function can be estimated.

GEOPHYSICAL AND EXTRATERRESTRIAL PHENOMENA

523.5: 621.396.11 **1520**
Meteoric Impact Ionization Observed on Radar Oscilloscopes—O. P. Ferrell. (*Phys. Rev.*, vol. 69, pp. 32-33; January 1-15, 1946.) Report on short-duration echoes observed on about 40 megacycles and 100

megacycles and attributed to ionic clouds formed by meteoric impact. On 105 megacycles, the echoes lasted for about $\frac{1}{2}$ to 3 seconds, and occurred at ranges of 30 to 125 kilometers with maximum rate of occurrence in the early morning (0100-0700) peaking at about 0400 hours.

523.72 **1521**
Radio Noise from the Sun—Department of Scientific and Industrial Research. (*Electronic Eng.*, vol. 18, p. 98; March, 1946.) A brief account of the phenomenon described in 323 of February.

551.515.43: 621.396.9 **1522**
Spotting Hurricanes and Thunderstorms by Radar—Winters. (See 1541.)

631.437: 621.3.011.2 **1523**
The Use of Cumulative Resistance in Earth-Resistivity Surveys—R. Ruedy. (*Canad. Jour. Res.*, vol. 23, Sec. A, pp. 57-72; July, 1945.) When the soil consists of layers having different resistivities, an almost linear relation is obtained between the cumulative resistance and the electrode spacing until the distance between electrodes is equal to the thickness of the upper material. Earth resistivity and cumulative resistance curves are interpreted for some typical terrains.

551.5(021) **1524**
Dynamic Meteorology [Book Review]. —J. Holmbe, G. E. Forsythe, and W. Gustin. John Wiley & Sons, New York, N. Y., \$4.50; Chapman & Hall, London. (*Curr. Sci.*, vol. 15, p. 54; February, 1946.) "... an ideal and up-to-date text-book for the advanced student."

LOCATION AND AIDS TO NAVIGATION

621.383 **1525**
Sensory Aid for the Blind—Cranberg. (See 1620.)

621.396.62+621.396.9 **1526**
Germany's UHF Tubes [Radar camouflage]—Combined Intelligence Subcommittee. (See 1648.)

621.396.82: 621.396.67 **1527**
QRM—The Electronic Life Saver: Part II—P. Robbiano. (*QST*, vol. 30, pp. 27-35; February, 1946.) Description of receiving equipment and of aerial systems used in radar countermeasures, including a cone aerial for 300 to 3000 megacycles, and a "fish-hook" aerial for 500 megacycles. For part I, dealing with jamming transmitters, see 1060 of April.

621.396.9 **1528**
I.R.E. Winter Technical Meeting, January, 1946—PROC. I.R.E. AND WAVES AND ELECTRONS, vol. 1, pp. 80W-92W; February, 1946.) Abstracts are given of the following papers read at the meeting: "Considerations of Frequency, Power, and Modulation for a Long-Range Radio Navigation System."—P. R. Adams. "Broad-Band Antennas and Direction-Finding Systems for Very High Frequencies."—A. Alford, J. D. Kraus, A. Dorne, and J. Christensen. "Naval Airborne Radar."—L. V. Berkner. "Airborne Radar Equipment for Aircraft Interception."—F. L. Holloway, R. P.

Burrows, and J. E. Keto. "The Theory and Application of the Radar Beacon."—R. D. Hultgren and L. B. Hallman, Jr. "Enemy Radio and Radar Equipment."—E. L. Luke and J. C. Link (Title only). "Application of Radar Techniques to Aircraft Fire-Control Systems."—E. A. Massa, I. Paganelli, and F. A. Best, Jr. "The Role of Electronics in Antiaircraft Gun-Fire Control."—F. B. MacLaren. "Aircraft Automatic Position Plotter."—A. C. Omberg and W. L. Webb. "Radar Model XAF."—R. M. Page. "An Introduction to Hyperbolic Navigation."—J. A. Pierce. "A Frequency-Modulated Altimeter for Meter and Light Indication and the Automatic Altitude Control of Aircraft."—R. C. Sanders, Jr., W. R. Mercer, J. Wolff, and J. C. Smith. (Title only.) "An Automatic Visual-Indication Radio Direction Finder."—A. Scandurra and S. Stiber. "Ground-Controlled Approach."—E. Storrs, W. Devitt, and B. Green. "Radar Aspects of Naval Fire Control."—D. P. Tucker. "A Pulse Altimeter for High Accuracy at High Altitudes."—I. Wolff, W. D. Hershberger, G. W. Leck, and R. R. Welsh. (Title only.) For other abstracts, see *Electronics*, vol. 19, pp. 92-108, March, 1946; and *Elec. Ind.*, vol. 5, pp. 62-74, March, 1946. For titles of other papers read, see other sections.

621.396.9 1529

Loran Indicator Circuit Operation.—D. Davidson. (*Elec. Ind.*, vol. 5, pp. 84-132; March, 1946). Brief discussion of propagation factors in loran, leading to the following requirements in the design of the receiver-indicator:—(1) a *slow* time base . . . to examine the entire recurrence cycle (40,000 microseconds); (2) a *fast* . . . time base (say, 200 to 2500 microseconds) to enable identification of pulse train components and to permit a coincidence measurement of master and slave pulses; (3) a *delay* circuit . . . so that a coincidence measurement can be made [that] will result in a time-difference reading equal to the delay; (4) an *amplitude-balance* scheme so that the two pulses . . . may be made identical in shape during measurement; (5) an effective method for sweep calibration in order that the time difference can be read with the required precision and rapidity; (6) a method of splitting the time base so that the pulse from one station may be brought under that of its mate for superposition; (7) a method of identifying the recurrence rates of the station pairs in a positive manner; (8) ample sensitivity in the receiver . . . ; (9) the receiver bandwidth should be wide enough to allow satisfactory discrimination of sky- and ground-wave components and yet narrow enough to keep adjacent-channel interference at a minimum." The manner in which these requirements have been met in the DAS-1 equipment for shipboard use is discussed in detail. The design of the airborne model is briefly mentioned, together with other variants of the basic design, in existence or contemplated.

621.396.9 1530

Loran Transmitting Stations.—D. G. F. (*Electronics*, vol. 19, pp. 109-115, March, 1946.) A description of the circuits and operating functions of the transmitter, timer, and synchronizer. The transmitter, generating 40-microsecond pulses at 1.7-2.0 megacycles at a peak power of 75 to 150 kilo-

watts, consists of a self-excited tuned-grid, tuned-anode, push-pull oscillator, pulse-modulated in the cathode circuit. The modulator is driven by two exciters, so that two pulse sequences at slightly different rates can be generated simultaneously when necessary, the timing unit consisting of a 50 kilocycle quartz-crystal oscillator-circuit and six divider-circuits. The timer repeats the pulses at 25 or 33½ pulses per second, so precisely that the accumulated timing error does not exceed 1 microsecond over a period of several minutes. To synchronize the pulse sequence of the slave station with that of the master station, the remote and local signals are displayed on a cathode-ray indicator and the phase of the transmitted keying system is adjusted until the two signals are superimposed. The phase adjustment may be made manually, or automatically, by switching in the synchronizing unit which holds the two sequences in synchronism to an accuracy of 1 microsecond. This paper concludes a series. For previous parts, see 605/606 of March.

621.396.9 1531

Loran—the Latest in Navigational Aids: Part III, Navigators' Equipment and Summary.—A. A. McKenzie. (*QST*, vol. 30, pp. 62-124; February, 1946.) For previous parts, see 926 of April.

621.396.9 1532

Loran—Radio Navigation Aid.—E. F. Brissie. (*Radio Craft*, vol. 17, pp. 236-292; January, 1946.) A simple account of the system.

621.396.9 1533

Technical and Tactical Features of Radar.—J. H. DeWitt, Jr. (*J. Franklin Inst.*, vol. 241, pp. 97-123; February, 1946.) Military uses of ground radar include aircraft warning, gun laying, searchlight control, and ground-controlled interception. The basic principles are common to all these systems, the essential components being a timer, transmitter, antenna system, receiver, indicator, and power-supply unit. These components, and the operational use of a radar system, are discussed in general terms, and details are given of sets designed for various specific requirements. Precision must often be sacrificed in operational sets to obtain simplicity and reduce weight.

621.396.9 1534

The [AN/] MPG-1 Radar.—H. A. Straus, L. J. Rueger, G. A. Wert, S. J. Reisman, M. Taylor, R. J. Davis, and J. H. Taylor. (*Electronics*, vol. 19, pp. 140-147; March, 1946.) Details of the timing, plan position indicator, B-indicator, and remote B-indicator systems. Crystal-controlled sweeps, together with a special quadrant-type capacitive phase shifter, enable a static range accuracy of ±3 yards to be obtained. When calibrated by transmitted pulses, the accuracy is about ±20 yards. For previous parts of this 3-part series, see 610 of March and 1250 of May.

621.396.9 1535

Radar on 50 Centimeters.—H. A. Zahl and J. W. Marchetti. (*Electronics*, vol. 19, pp. 98-103; February, 1946.) Details of the transmitter, receiver and display systems of the AN/TPS-3 equipment of which other

parts were described in 1249 of April. The transmitter comprises four triodes in parallel-push-pull within a common envelope which also contains the grid and anode resonant lines. Tuning is effected externally by operation of a shorting bar on the filament lines. Power is taken by direct coupling to the anode line. The tube is modulated by 1.5-microsecond pulses from an artificial line circuit discharged 200 times per second by a rotary spark gap: peak output power is 200 kilowatts at 25 to 30 per cent efficiency. The receiver comprises 2-stages of signal-frequency amplification, a crystal first detector, 6 intermediate frequency stages (bandwidth 1.25 megacycles), a diode second detector, and separate video stages for the A-scope and plan position indicator. The noise figure of the receiver is about 10 decibels. Time-base lengths equivalent to 20-, 60-, and 120-mile range are provided for both display tubes. Separate time-base units, each triggered from the transmitted pulse, are provided, the time-base length in each case being controlled by variation of the characteristics of an asymmetric multi-vibrator. In the case of the plan position indicator, the linear sweep voltage is distributed to the deflector coils by a rotary transformer (goniometer), the search coil of which rotates in synchronism with the aerial system, and carries the sweep currents. Range markers at 10-mile intervals are provided on the A-scope and plan position indicator, use being made of a 9.3-kilocycle oscillator keyed by the transmitted pulse.

621.396.9 1536

Lightweight Radar for Early Warning.—W. C. Hendricks. (*Communications*, vol. 26, p. 54; January, 1946.) Some details of the radar set AN/TPS-3. For a longer account see 1535 above.

621.396.9 1537

The SCR-584 Radar [part III].—D. G. F. (*Electronics*, vol. 19, pp. 110-117; February, 1946.) "Details of the circuits for timing echoes to 0.01 microsecond, the deflection system for the plan position indicator, and the automatic-antenna-positioning gear are presented in this final installment." See 608/609 of March for earlier parts. A crystal oscillator at 81.95 kilocycles is used to develop circular traces (on separate cathode-ray tubes) with circumferences equivalent to ranges of 32,000 yards and 2000 yards, respectively, and also a trigger at 1707 cycles per second for actuating the transmitter. Signals appear as radial deflections. A cursor on the 32,000-yard screen can be rotated to cover the selected echo. The 2000-yard display is "gated" so that the trace is illuminated only for the equivalent of ±250 yards on each side of the echo selected by the cursor on the long-range tube. A cursor on the 2000-yard tube enables the range to be measured accurately. The plan-position-indicator circuits are arranged to provide magnetically deflected sweeps of either 70,000- or 35,000-yard range. Precautions are taken to ensure that the spot is at the center of the tube at the beginning of each radial sweep. Intensity modulation is provided by the following signals: (a) a signal to ensure that the tube is illuminated only during the outward sweep of the spot to the edge of the tube, (b) echoes from targets, (c) 10,000-yard marker

pulses derived from a 16.4-kilocycle oscillator shock-excited by the transmitted pulses, (d) an azimuth-marker pulse derived from the cursor setting on the long-range dial. Automatic target-following is provided.

621.396.9 1538

Elements of Radar: Parts II and III—J. McQuay. (*Radio Craft*, vol. 17, pp. 246-287 and 317-337; January and February, 1946.) Brief general descriptions of oscillators, aeriels and wave guides, and of receivers and display systems. For part I, see 930 of April.

621.396.9 1539

I.F.F.—(*Radio Craft*, vol. 17, p. 332; February, 1946.) A simple explanation of the principles of the system used during the war for distinguishing between enemy and friendly aircraft.

621.396.9: 518.5 1540

Post Office Equipment for Radar—P. A. Marchant and K. M. Heron. (*Post Office, Elec. Eng. Jour.*, vol. 38, pp. 117-120; January, 1946.) The solution is given of the problems concerning the rapid interpretation of radar observations to a form suitable for teleprinter transmission to a control center. The technique is an extension of multichannel selection circuitry.

621.396.9: 551.515.43 1541

Spotting Hurricanes and Thunderstorms by Radar—S. R. Winters. (*Radio News*, vol. 35, pp. 45-104; March, 1946.) An illustrated account of the plotting of the path of a hurricane. See also 618 of March.

621.396.9: 621.3.089.6 1542

Artificial Radar Target—(*Electronics*, vol. 19, pp. 214-216; February, 1946.) The radar pulse received on a dipole is heterodyned to a lower frequency, converted by a piezoelectric transducer to a pulse of mechanical vibration which is delayed by transmission along a glass rod, is reconverted by the transducer, and retransmitted at carrier frequency from the dipole to simulate a radar echo. The device is set up about 20 yards from the radar set, and, on account of the time delay, the echo appears as if from a distant target. It is used for test purposes. A German device.

621.396.9: 623.26 1543

Land Mine Locators—West. (See 1626.)

621.396.9: 623.454.25 1544

Proximity Fuzes for Artillery—Selvidge. (See 1627.)

621.396.931.933].22.029.54/.56 1545

Twin Bearing DF Unit—(*Elec. Ind.*, vol. 5, pp. 79, 124; March, 1946.) Brief description of a compact, rotating, cross-loop, twin-channel direction finder with crossed-pointer indication—the Simon Radioguide, a variant of SCR-503-A. Frequency range 0.1 to 3.0 megacycles in two units. Messages may be read while bearings are being taken.

621.396.933 1546

The Teleran Proposal—P. J. Herbst, I. Wolff, D. Ewing, and L. F. Jones. (*Electronics*, vol. 19, pp. 124-127; February, 1946.) Teleran (Television-Radar Air Navigation) is "a system of navigation and traffic control, utilizing existing television and

radar techniques to present visual information directly to the pilot . . . proposed to cope with the expanding needs of commercial and military aviation." It comprises, in each aircraft, a television receiver, and a transponder beacon coupled to the altimeter. The transponder is interrogated by ground radar equipments located near each aerodrome, and coding introduced by the altimeters in the respective aircraft enables the position and track of the machines within given height limits to be displayed on plan-position-indicator tubes particular to the respective strata. These pictures are televised, together with superposed information (map of neighborhood, wind velocity, visibility, etc.), to the aircraft. The pilot receives the information appropriate to his height; he thus sees a map of the aerodrome neighborhood, his own position, and the position and course of other aircraft at roughly his own height. The system is designed also to assist the aircraft in landing. The properties of Teleran are compared with those of other navigation systems.

621.396.933.1/.2 1547

Radio and Radar Aids to Aerial Navigation—R. L. Rod. (*Radio*, vol. 30, pp. 35-60; January, 1946.) An outline of systems, including the radio-range, very-high-frequency direction finder, loran, the radar plan position indicator, and racon (radar beacon).

621.396.933.2: 621.396.619 1548

Modulation Circuit—A. Alford and G. K. Patterson. (*Radio*, vol. 30, pp. 41-42; January, 1946.) A circuit to produce an ordinary modulated carrier, and, simultaneously from different terminals, the sidebands without the carrier. Its use is proposed for a beacon system, in which the carrier is applied to one member of an aerial array, and sidebands only are applied to the other members, so that the modulation of the received signal is directional, but a constant carrier is available for automatic volume control. Summary of U. S. Patent 2,383,456.

621.396.029.64 1549

Radiation Laboratory Technical Series [Book Notice]—(*Jour. Appl. Phys.*, vol. 17, pp. 105-106; February, 1946.) The results of five years' wartime work on radar ("20,000 technical man-years") are to be embodied in a series of 28 books on the physics and engineering of microwave radio. "For the first time the technical literature of a large subject is being created all at once on a uniform basis." The books will be prepared by staff of the Radiation Laboratory, with British collaboration, and will be published by the McGraw-Hill Book Company, New York, N. Y. See also *Electronics*, vol. 19, pp. 254-262; February, 1946.

MATERIALS AND SUBSIDIARY TECHNIQUES

531.788+533.5 1550

Audio Aid for Vacuum-Leak Hunting—V. Wouk. (*Electronics*, vol. 19, pp. 138-141; February, 1946.) For use with vacuum systems equipped with gauges which provide a variation of output voltage when there is a change in partial pressure of one or more of the gases in the system. The outside of the vacuum system is sprayed at the doubtful points with the appropriate gas; when a leak is discovered, the change in direct-current

output voltage (amplified if necessary) is applied to the grid of a thyratron relaxation oscillator, thus causing a frequency change. See also 1551 below.

531.788+533.5 1551

Frequency Modulated Oscillator for Leak Hunting—W. M. Brubaker and V. Wouk. (*Rev. Sci. Instr.*, vol. 17, pp. 97-98; March, 1946.) Leaks representing pressure rises of less than 4×10^{-8} millimeter have been detected. The circuit can also be used for general monitoring purposes. See also 1550 above.

531.788.6 1552

A Pirani Gauge for Use at Pressures up to 15 mm.—E. S. Rittner. (*Rev. Sci. Instr.*, vol. 17, pp. 113-114; March, 1946.) Thin tungsten wire is supported inside pyrex capillary tubing, and used in a constant-resistance bridge circuit. Pressures up to 15 millimeters of mercury can be recorded with an accuracy of ± 2.5 per cent or better.

533.5 1553

Iron-Nickel-Cobalt Alloy for Sealing to Glass—G. D. Redston and J. E. Stanworth. (*Jour. Sci. Instr.*, vol. 23, pp. 53-57; March, 1946.) A report on some Kovar-type alloys for sealing to borosilicate glass. Expansion curves are shown, and the effect of composition is discussed. An alloy containing 29 ± 0.5 per cent nickel, 17 per cent cobalt, 0.3 per cent manganese, and 0.15 per cent silicon is proposed. Impurities affect the expansion, so the alloy is specified by comparing with a molybdenum rod. The differential expansion coefficient should be zero at 25 degrees centigrade and the curve should pass through $(3 \pm 1) \times 10^{-4}$. The stresses in sandwiches of alloy and glass are discussed, using measured-stress versus temperature curves. It is shown that seals can be made with very low stresses at all temperatures.

533.5: 621.791.3 1554

A Simple [Laboratory] Method of Sealing Gas- or Vacuum-Packed Tins—W. A. Bryce and H. Tessier. (*Canad. Jour. Res.*, vol. 23, pp. 304-305; September, 1945.) ". . . The heating element is a coil of resistance wire supported over a hole in a flat surface of the tin. When the heating circuit is closed, a small piece of solder previously hung in the upper end of the coil is melted and drops on the area about the hole and thereby produces an effective seal."

535.87: 539.234 1555

High-Reflection Films—K. M. Greenland. (*Jour. Sci. Instr.*, vol. 23, pp. 48-50; March, 1946.) An account of single- and multiple-layer films for neutral or colored filters and beam splitters operating on the interference principle, and having a high optical efficiency. They are made by high-vacuum evaporation.

539.232: 621.317.794 1556

Production and Properties of Nickel Bolometers—F. G. Brockman. (*Jour. Opt. Soc. Amer.*, vol. 36, pp. 32-35; January, 1946.) Filaments as thin as 0.1 micron are obtained by nickel-plating copper foil. Ribbons of foil are soldered to a platinum frame and the copper dissolved in potassium cyanide solution, leaving nickel ribbons with a temperature coefficient of resistance of 0.005 per degree, and a time constant of 5 milliseconds. An equation is derived relating

resistance to the ambient temperature and current. Bismuth ribbons have been similarly prepared.

553.631: 621.3.011.2 1557

Effect of Transverse Pressure on the Steady-State Electrical Conductivity of Rocksalt—C. N. Hamtil. (*Phys. Rev.*, vol. 69, p. 50; January 1–15, 1946.) Transverse pressure of 33 kilograms per square centimeter produced a 7 per cent increase of direct-current conductivity (at 100 volts) in the temperature range 300 to 317 degrees centigrade, attributed to the reduction of the polarization counter electromotive force. Summary of an American Physical Society paper.

62 "1945" 1558

Progress in Engineering Knowledge during 1945: Materials Engineering—P. L. Alger, J. Stokley, C. F. Scott, H. B. Marvin, J. L. Tugman, and K. W. Given. (*Gen. Elec. Rev.*, vol. 49, pp. 9–19; February, 1946.) A review, with an extensive bibliography, covering many materials for mechanical and electrical use.

621.315.613.1 1559

Some Physical Properties of Mica—P. Hidnert and G. Dickson. (*Jour. Res. Nat. Bur. Stand.*, vol. 35, pp. 309–353; October, 1945.) Samples of mica from different sources have widely different physical and electrical properties. The coefficients of thermal expansion of samples have been measured in a direction normal to the cleavage plane under a pressure of 30 pounds per square inch and at temperatures up to 700 degrees centigrade. Some samples have coefficients of only a few parts in 10^6 per degree centigrade, while others are 5 per cent per degree over small temperature ranges. Large changes between initial and final dimensions may result from a heating and cooling cycle, and successive cycles may produce quite different effects. Power factors of raw samples, measured at 100 kilocycles and 1000 kilocycles lie between 0.03 and 1 per cent, but may be considerably different at the two frequencies. In general, a heating and cooling cycle causes a substantial increase in power factor. Heating also produces changes in opacity, and color, and X-ray diffraction photographs show that the over-all physical changes are often associated with changes in fine structure.

621.315.616 1560

Synthetic Rubbers and Plastics: XI (Part I) Water and the High Polymer—F. T. White. (*Distrib. Elec.*, vol. 18, pp. 107–110; April, 1946.) The water absorption characteristics of various organic materials are discussed in relation to molecular structure, with particular reference to the effect of the presence of the hydroxyl (–OH) group. The absence of this group in a polymer chain generally means low absorption, and *vice versa*. For part X, see 585 of March.

621.315.616.011.2(213) 1561

Some Wartime Problems with Electrical Insulating Materials—S. A. Prentice. (*Jour. Inst. Eng., Aust.*, vol. 17, pp. 197–204; October, December, 1945.) The chief conditions under which the performance of insulating materials is impaired are temperature extremes, humidity, and fungus growth. Curves are given for some phenolic resins showing the decay of insulation resistance

with time under various conditions of temperature and humidity. The adverse effect of a period of storage at high humidity is illustrated. A cyclic humidity change also produces gradual deterioration. Ceramics are free from these defects, but surface conductivity is often serious. Some thermoplastic materials, e.g. polyvinyl chloride, are little affected by humidity, but most are subject to distortion at temperatures above about 70 degrees centigrade. Humidity effects are minimized by treatment with varnishes or waxes. Conditions of high humidity are conducive to fungus growth, which leads to surface leakage directly, and also by assisting condensation. The required properties and applications of a number of base materials and protective coatings used in insulation are tabulated, and testing techniques described.

621.315.616.011.2(213) 1562

The Effect of High Humidity and Fungi on the Insulation Resistance of Plastics—J. Leutritz, Jr., and D. B. Herrmann. (*Bull. Amer. Soc. Test. Mat.*, pp. 25–32; January, 1946.) A description of experiments determining the effect of prolonged exposure to fungi and 97 per cent humidity on the insulation resistance of methyl methacrylate, glass-bonded mica, glass-mat-laminated phenolic, phenon fabric, phenol fiber, and wood-flour-filled phenol plastic. Lowering of resistance is produced, reaching a steady value in a period varying from a few hours to several weeks, according to the material. Fungus appears on all specimens during this period, but even in its presence resistance recovery eventually occurs on reduction of humidity to 52 per cent. Re-exposure to 97 per cent humidity causes a rapid drop in insulation resistance, even in the case of methyl methacrylate, which, on initial exposure in the absence of fungus, shows only a very gradual increase. In all cases, original insulation can be recovered by cleaning and drying, and deterioration under humid conditions can be retarded by surface varnishing. Water adsorption and absorption determine insulation degradation, the additional effect of fungus being negligible. A comprehensive bibliography is given.

621.357.5/.6]: 621.396.69 1563

Electroforming Microwave Components—F. Hassell and F. Jenks. (*Electronics*, vol. 19, pp. 134–138; March, 1946.) Use is made of electroforming techniques to overcome the difficulty of obtaining accurately machined surfaces on the insides of wave guides and other microwave circuit components. Where the shape is such that the mandrel can be withdrawn from the finished component, use is made of differential expansion on heating to secure separation of plating and mandrel. Alternatively, a separating film of tin is first deposited on the mandrel and the film is melted before the mandrel is withdrawn. Where the shape prevents withdrawal, the mandrel is made of fusible alloy, wax, or of a material easily dissolved. The electroformed products are stress-free. The process is "noted for precision, if not for economy."

621.385.1.032.2 + 533.5 + 539.234 1564

Fine Wires in the Electron-Tube Industry—G. A. Espersen. (PROC. I.R.E. AND

WAVES AND ELECTRONS, vol. 34, pp. 116W–120W; March, 1946.) ". . . Some fundamental basic properties which confront the wire manufacturer are briefly discussed. Design formulas, including a nomograph, are given for electron-tube filaments. The use of platings of gold, platinum, and zirconium on metals of the refractory group have assisted in the reduction of grid emission. A unique method of utilizing zirconium, both to accelerate the vacuum exhaust process and to serve as a continuous 'getter' is described. A novel method of securing a uniform rate of evaporation of thin films of metals is discussed." The nomograph gives the length and diameter of tungsten wire needed to obtain a desired operating temperature under various conditions of voltage and current.

621.385.8.032.7 1565

Glass Problems in the Manufacture of Miniature Tubes—H. J. Miller. (PROC. I.R.E. AND WAVES AND ELECTRONS, vol. 1, p. 87W; February, 1946.) Abstract of a paper read at the Institute of Radio Engineers Winter Technical Meeting, January, 1946.

679.5 1566

Frictional Heat—C. A. Breskin. (*Sci. Amer.*, vol. 174, pp. 20–22; January, 1946.) A new process for welding, bonding, and moulding thermoplastics by generation of frictional heat. Bonding to nonplastics is also possible.

679.5: 53.084 1567

Plastics and [plastic] Cements: Applications to Scientific Instruments—J. C. Swallow. (*Jour. Sci. Instr.*, vol. 23, pp. 44–48; March, 1946.) A discourse delivered at the Physical Society's thirtieth annual exhibition.

778: [5+6 1568

Photography in Research and Development—W. H. Banyard. (*Distrib. Elec.*, vol. 18, pp. 115–118; April, 1946.)

MATHEMATICS

512.831: 621.392.52 1569

Applications of Matrix Algebra to Filter Theory—Richards. (See 1467.)

517.93+518.12 1570

Solution of Linear and Slightly Nonlinear Differential Equations—S. A. Schelkunoff. (*Quart. Appl. Math.*, vol. 3, pp. 348–355; January, 1946.) A method based on the idea that solutions of linear differential equations may be regarded as distorted or "perturbed" sinusoidal or exponential functions, similar to the Rayleigh-Schrödinger treatment. Better results are obtained than by Picard's method which regards the solutions as perturbed straight lines. The method would be suitable for numerical solution of at least a certain class of differential equations, though it was originally developed to obtain convenient analytical approximations to a number of problems in wave theory.

517.947.4 1571

A Method of Solution of Field Problems by means of Overlapping Regions—H. Poritsky and M. H. Blewett. (*Quart. Appl. Math.*, vol. 3, pp. 336–347; January, 1946.) "In problems involving the determination of fields, it often happens that the region R

for which the field is to be determined is difficult to handle directly, but can be broken up into several overlapping regions R_1, R_2, \dots for each of which the field can be determined by standard methods. We suppose that the breaking up is carried out in such a manner that every point of the region R falls into at least one of the regions R_1, R_2, \dots The procedure is illustrated by consideration of the problem of propagation of a transverse electromagnetic wave around a corner formed by the junction at right angles of two regions bounded by infinite parallel plates.

517.948 1572

Some Integral Equations of Potential Theory—H. Bateman. (*Jour. Appl. Phys.*, vol. 17, pp. 91–102; February, 1946.) Deals with integral equations of the type $f(x) = (1/\pi) \int_{-\infty}^{\infty} (yF(t)dt / (x-t)^2 + y^2)$ where y is a "fixed positive quantity," $f(x)$ is an analytic function supposed to be determined from observation, and $F(t)$ is the function to be determined. Such integrals arise from inverse potential problems. The function $F(t)$ is required to be such that the integral exists and represents a potential $V(x, y)$ regular for $y > 0$, which is the solution of the Dirichlet problem for the half plane.

518.61 1573

Calculation of the Magnetic Field in Dynamo-Electric Machines by Southwell's Relaxation Method—H. Motz and W. D. Worthy. (*Jour. I.E.E. (London)*, Part I, vol. 93, pp. 108–109; February, 1946.) Summary of 658 of March.

519.2 1574

On a Problem Connected with Purely Discontinuous Random Processes—V. M. Dubrovsky. (*Compt. Rend. Acad. Sci. U.R.S.S.*, vol. 47, pp. 459–461; 1945. In English.)

518.2 1575

Table of Arc Sin X . [Book Review]—Mathematical Tables Projects. Columbia University Press, New York, N. Y., 1945, 124 pp., \$3.50. (*Proc. I.R.E. AND WAVES AND ELECTRONS*, vol. 34, p. 160W; March, 1946.) Gives values in radians to 12 decimal places, with 0.0001 intervals from 0 to 0.9890 and 0.00001 intervals from 0.9890 to unity. Interpolation aids are included.

MEASUREMENTS AND TEST GEAR

621.317 1576

I.R.E. Winter Technical Meeting, January, 1946—(*Proc. I.R.E. AND WAVES AND ELECTRONS*, vol. 1, pp. 80P–93P; February, 1946.) Abstracts are given of the following papers read at the meeting. "Test Equipment and Techniques for Airborne Radar Field Maintenance."—E. A. Blasi and G. C. Schutz. "A Spectrum Analyzer for Microwave Pulsed Oscillators."—F. J. Gaffney. "Electrical Characteristics of Quartz-Crystal Units and Their Measurement."—W. D. George, M. C. Selby, and R. Scolnik. "A Three-Beam Oscillograph for Recording at Frequencies up to 10,000 Megacycles."—G. M. Lee (See 1692). "Microwave-Power Measurement."—T. Moreno and O. C. Lundstrom. "A New High-Speed Recording Potentiometer."—V. L. Parsegian. "Electronic-Frequency Stabilization of Microwave Oscillators."—R. V. Pound. "Metalized-Glass Attenuators for Radio-Frequency Applications."—E. Weber. "The

New 'Speedomax' Power-Level Recorder."—A. J. Williams, Jr., and W. R. Clark. For other abstracts, see *Electronics*, vol. 19, pp. 92–108; March, 1946; and *Elec. Ind.*, vol. 5, pp. 62–74; March, 1946. For titles of other papers read, see other sections.

621.317.31.082.5: 621.362 1577

Electric Precision Measurements by Means of Incandescent Lamp Used as Indicator of Current Equality in Two Circuits—A. I. Fürstenberg. (*Compt. Rend. Acad. Sci. U.R.S.S.*, vol. 48, pp. 23–26; 1945. In English.) "In an incandescent lamp with a metal filament the appearance of a barely visible light emission is a very fine criterion for visual estimation of the heating current. A circumstance of interest for metrology is that under conditions of a vanishingly small light emission by the filament, slight increments in the current passing through the lamp have a considerable effect upon brightness." Experiment shows that in the neighborhood of this threshold-light emission, an increase of ± 0.5 per cent in current results in ± 50 per cent increase in brightness. The possible use of the method for determining the equality of the currents in circuits is considered, with a brief discussion of the errors involved in using it for comparing inductors and capacitors. Errors are limited to a few parts in ten thousand.

621.317.33: 621.317.755 1578

Impedance Measurements with the Cathode-Ray Oscilloscope—W. Vissers, Jr. (*Radio*, vol. 30, pp. 23, 62; January, 1946.) A source of voltage of the required frequency is connected to the unknown impedance in series with a known impedance. The voltage across the unknown is applied to the X deflection plates of a cathode-ray oscilloscope, while the total voltage is applied to the Y plates. Measurements of the resulting ellipse enable the magnitude and phase of the unknown impedance to be found.

621.317.334/.335 1579

Simple Capacitance and Inductance Measurements—T. A. Gadwa. (*QST*, vol. 30, pp. 71, 136; March, 1946.) The frequency-variation method is used.

621.317.361+531.76 1580

WWV Schedules—(*QST*, vol. 30, p. 41; February, 1946.) Details of the standard-frequency transmissions by the National Bureau of Standards (station WWV) at 2.5, 5, 10, and 15 megacycles per second. The accuracy of the carrier and modulation frequencies and of the time signals is better than 1 part in 10^7 .

621.317.361: 621.318.572 1581

Decade Counting Circuits—V. H. Reegeger. (*Phys. Rev.*, vol. 69, p. 46; January, 1–15, 1946.) Ten miniature pentodes (6AK6) in a ring with 30 resistors and 10 capacitors, or 10 twin-pentodes (12L8-GT) with 20 resistors and no capacitors form counters suitable for frequency measurement up to 100 kilocycles with cathode-ray indication. Summary of an American Physical Society paper.

621.317.361+621.396.611.21 1582

Duplex Crystals—C. E. Lane. (*Bell. Lab. Rec.*, vol. 24, pp. 59–62; February, 1946.) Two quartz-crystal plates bonded together enable the lowest natural flexure frequency of a free bar to be excited and give

resonance frequencies in the range 1 to 10 kilocycles. Methods of bonding and of inducing the required vibrations in the crystals are given, and their uses as oscillators and filters are described in general terms.

621.317.4 1583

A New Magnetomotive Force Gauge and Magnetic Field Indicator—W. B. Ellwood. (*Rev. Sci. Instr.*, vol. 17, pp. 109–111; March, 1946.) A compact instrument in which a magnetically operated reed switch is closed by the field being measured. Current through an external winding reopens the switch, and the value of current required to do so is a measure of the field.

621.317.7: 621.316.93 1584

An Electronic Bypass for Measuring Purposes—L. A. Finzi. (*Electronics*, vol. 19, pp. 196–202; February, 1946.) A simple gas-tube circuit "for protection of . . . measuring instruments [against transient overloads] . . . where it is necessary to restore the normal instrument operation as soon as the current falls back within the limits of the instrument range."

621.317.714+621.317.725].089.6 1585

Production Testing of [d.c.] Panel Meters—R. Amon. (*Electronics*, vol. 19, pp. 170–178, February, 1946.) A 6N7 is used with variable grid bias to provide a smoothly variable rheostat; with a direct-current voltage source, the rheostat is used to adjust the voltage across a standard 100-volt voltmeter connected in parallel with the meter under test, which is itself arranged as a 100-volt voltmeter by the use of a suitable series resistor.

621.317.714 1586

Multi-Range Milliammeter—R. P. Turner. (*Radio News*, vol. 35, pp. 49, 142; February, 1946.) Conversion of a commercial 0–1 milliammeter meter to read 0–1 ampere direct current in four decade ranges. The circuit is arranged so that standard-value resistors can be used.

621.317.725 1587

An Integrating Meter for Measurement of Fluctuating Voltages—H. E. Haynes. (*Jour. Soc. Mot. Pict. Eng.*, vol. 46, pp. 128–133; February, 1946.) The meter integrates the voltage over a chosen interval, e.g., 0.5 to 5.0 seconds, and indicates the average value that has existed. A combined voltage amplifier and phase inverter is followed by a full-wave rectifier and capacitor-charging circuit. Timing is accomplished by a resistance-capacitance circuit and a thyatron relay. The frequency response is flat from 50 cycles to 15 kilocycles, and the instrument can withstand considerable overload.

621.317.725: 621.314.632 1588

A.C. Voltage Measurements—O. E. Carlson. (*Radio Craft*, vol. 17, pp. 250, 275; January, 1946.) Summary of the properties of copper-oxide rectifiers in relation to their use in alternating-current voltmeters.

621.317.725: 621.385.2 1589

A Stable Diode Voltmeter—Furzehill Laboratories, Ltd. (*Electronic Eng.*, vol. 18, p. 94; March, 1946.) A television-type diode feeding a triode direct-current amplifier in a bridge circuit with a microammeter for peak voltage measurements. The arrangement of the circuit to give a stable zero is described.

- 621.317.725: 621.385.3 1590
High-Resistance D-C Voltmeter—D. L. Waidelich. (*Electronics*, vol. 19, pp. 158-160; March, 1946.) The design of a reflex-type valve voltmeter that has maximum errors of 8 per cent and 5 per cent when measuring voltages of sources having internal resistances of 1000 megohms and 100 megohms, respectively. Over-voltage protection is provided, and no electrical zero adjustment is required. Voltage ranges 0 to 50, 100, 250 volts.
- 621.317.725.029.3/.62]: 621.385.2 1591
R. F. Probe Design—D. F. McAvoy. (*Radio News*, vol. 35, pp. 135, 135; March, 1946.) Constructional details of a radio-frequency diode probe used as an accessory for a direct-current valve voltmeter. A suitable circuit is described.
- 621.317.73.029.54/.58 1592
A Radio-Frequency Capacitance and Conductance Bridge—R. F. Proctor and E. G. James. (*Jour. I.E.E.* (London), Part I, vol. 93, p. 103; February, 1946.) Summary of 676 of March.
- 621.317.733 1593
Note on the Helmholtz Make-and-Break Theorem and an Application to the Wheatstone Net—G. F. Freeman. (*Phil. Mag.*, vol. 36, pp. 541-546; August, 1945.) In bridge networks it is often advantageous to consider a change in impedance as the independent variable, and to use the galvanometer as a deflectional instrument. Examples relating to the Wheatstone network are given.
- 621.317.761.029.63 1594
V.H.F. Heterodyne Frequency Meter—A. A. Goldberg. (*Radio News*, vol. 35, pp. 32, 128; March, 1946.) A split concentric-tuned oscillator, using an acorn valve, covers the range from 280 to 430 megacycles. Harmonic operation is possible up to 3000 megacycles and the oscillator may be pulsed or square-wave modulated.
- 621.317.763.029.63/.64 1595
Types and Applications of Microwave Frequency Meters—W. J. Jones. (*Radio*, vol. 30, pp. 29-34; January, 1946.) Three instruments commonly used are the coaxial-line, cylindrical-cavity, and transition types, the latter being a combination of the other two. The principles and methods of operation are described, and their accuracies briefly discussed.
- 621.317.763.029.63/.64 1596
A Resonant-Cavity Wavemeter—J. McQuay. (*Radio News*, vol. 35, pp. 36, 78; February, 1946.) Description of a wave guide fitted with an adjustable plunger and a neon indicator.
- 621.317.79: [621.315.212.1.029.62/.63 1597
Measuring Coaxials at Ultra-High Frequencies—C. C. Fleming. (*Bell Lab. Rec.*, vol. 24, pp. 2-5; January, 1946.) Methods of measuring cable attenuation by insertion loss are briefly described. Measurements at frequencies from 120 to 420 megacycles can be made directly and can be extended to 3000 megacycles by a heterodyne system. Characteristic impedance is obtained at 100 megacycles by a resonance method using a Q meter and standard calibrating resistors
- 621.317.79: 621.385 1598
A Method of Measuring Grid Primary Emission in Thermionic Valves—A. H. Hooke. (*Electronic Eng.*, vol. 18, pp. 75-80; March, 1946.) In most tubes, the grid becomes contaminated and raised in temperature due to proximity to the cathode. The resulting primary emission is of importance, though not readily measurable because of the grid current due to gas and to secondary emission. The test circuit described supplies periodic voltages consecutively to the grid and anode, followed by the application of a high negative potential to the grid, during which time the grid primary emission is measured. The cycle is repeated at 60-millisecond intervals. The details of the circuit and its operation are given, and the interpretation of the meter readings discussed. Typical curves showing the grid emission as a function of grid dissipation, anode power, and grid material are given. Two appendixes give theoretical analyses of (i) the conversion of the measured average current and voltage to mean power for a linear and a 3/2-power law and (ii) the relation between the anode and grid dissipations for a given grid primary emission.
- 621.317.79: 621.396.619.16 1599
Measuring Pulse Characteristics—A. Easton. (*Electronics*, vol. 19, pp. 150-154; February, 1946.) Outline description of methods and apparatus required for measuring pulse spacing, pulse length, time of rise, and time of decay. A bibliography of 54 references is given.
- 621.317.79: 621.396.82 1600
Effectiveness of Conduit as R-F Shielding—S. L. Shive. (*Electronics*, vol. 19, pp. 160-166; February, 1946.) Equipment for measuring the screening properties of conduits in the frequency range 0.1 to 150 megacycles, is described with typical results. A screening box contains a transmitting coil at the end of a polystyrene rod, over which the conduit is slipped; a receiving loop mounted outside the conduit feeds a receiver external to the box. A standard-signal generator energizes the transmitting loop: the figure of merit for the conduit is the ratio of voltages (decibel) applied to the transmitter with and without the conduit, for a constant output from the receiving loop.
- 621.317.791 1601
Universal Test Instrument—M. Silver. (*Radio News*, vol. 35, pp. 32, 118; February, 1946.) A detailed description of a direct-current and alternating-current instrument with 51 ranges for voltage, current, resistance, and attenuation measurement. The voltmeter can be used at frequencies up to 100 megacycles.
- 621.317.794: 539.232 1602
Production and Properties of Nickel Bolometers—Brockman. (*See* 1556.)
- 621.395.92 1603
The Testing of Deaf Aids—Turney. (*See* 1441.)
- 621.396.615: 621.317.79 1604
Wide-Range Electronic Sweeper—A. D. Smith, Jr. (*Communications*, vol. 26, pp. 24, 31; January, 1946.) Detailed description of a high-frequency wobulator for aligning television receivers. Range of mean frequency 500 kilocycles to 110 megacycles extensible to 220 megacycles by harmonic operation, frequency sweep adjustable up to 10 megacycles per second. Output independent of frequency to ± 10 per cent. The signal is derived by a heterodyne process using a reactance tube to produce the sweep. 1 megacycle and 10 megacycle crystals are included to provide frequency markers.
- 621.396.615.12 1605
Signal Generator Covers All Bands—B. White. (*Radio Craft*, vol. 17, pp. 243-244; January, 1946.) Constructional details of a mains-operated generator with continuous coverage from 65 kilocycles to 34 megacycles, with plug-in coils. Internal modulator range 24 to 20,000 cycles.
- 621.396.615.12: 621.317.79 1606
TF.867 Signal Generator—L. Hauser. (*Jour. Sci. Instr.*, vol. 23, p. 63; March, 1946.) Letter correcting a statement on provisional operating data given in 1289 of May.
- 621.317.7: 621.396 1607
Radio Test Instruments [Book Review]—R. B. Turner. Ziff-Davis Publishing Co., New York, N. Y., 1945, 228 pp., \$4.50. (*Elec. Ind.*, vol. 5, p. 154; March, 1946.) "Of particular interest to amateur radio operators and experimenters, this book describes how to construct the great majority of instruments commonly used . . ."
- OTHER APPLICATIONS OF RADIO AND ELECTRONICS**
- 538.3 1608
A Study of Stationary Electromagnetic Modes for Region Between Parallel Perfectly Conducting Planes and Application to Electron Accelerator—Akeley. (*See* 1516.)
- 578.088.7: 621.396.615.17 1609
Nerve Stimulator—W. I. Weiss. (*Electronics*, vol. 19, p. 155; February, 1946.) "Thyratron-type relaxation oscillator with plate-supply keying [foot-operated, or panel switch] eliminates high initial pulse, provides 0.3 cycle to 30 kilocycle pulses for biological research and medical therapy." Circuit diagrams are given.
- 615.84: 621.3.029.62 1610
Shortwave Diathermy—J. M. Oxley. (*Radio Craft*, vol. 17, pp. 245, 281; January, 1946.) Brief discussion of the biological basis of electrotherapeutic effects, with an outline of the principal methods used.
- 621.317.39.083.7: 629.13 1611
Fuel Consumption Indicator—D. W. Moore, Jr. (*Electronics*, vol. 19, pp. 152-153; March, 1946.) "Electronic servo transmits the position of an aircraft fuel-flow valve to a remote indicator. A mechanical integrator combines this information with impulses from a 100-cycle time standard to totalize the liquid flow. The device is applicable to industrial telemetering problems."
- 621.317.39.087.4+621.3.078 1612
Instruments for the Automatic Controlling and Recording of Chemical and Other Processes—Prinz. (*See* 1691.)
- 621.36/.39 1613
I.R.E. Winter Technical Meeting, January, 1946—(PROC. I.R.E. AND WAVES AND

ELECTRONS, vol. 1, pp. 80W-93W; February, 1946.) Abstracts are given of the following papers read at the meeting: "Electronics in Naval Warfare."—R. Bennett. "Navy Radio and Electronics in World War II."—J. B. Dow. "The Role of Electronics in Antiaircraft Gun-Fire Control."—F. B. MacLaren. "A New System of Radio Telemetering."—D. W. Moore, Jr. and F. G. Willey. "Duplex Operation of Independent High-Power Oscillators for Induction Heating."—W. C. Rudd. "A Frequency-Modulation Altimeter for Meter and Light Indication and the Automatic Altitude Control of Aircraft."—R. C. Sanders, Jr., W. R. Mercer, I. Wolff, and J. C. Smith (Title only). "One-Millionth-of-a-Second Radiography and its Applications."—C. M. Slack and D. C. Dickson. For other abstracts, see *Electronics*, vol. 19, pp. 92, 108; March, 1946; and *Elec. Ind.*, vol. 5, pp. 62-74; March, 1946. For titles of other papers read, see other sections.

621.365.52 1614

Induction Heating of Hollow Metallic Cylinders—A. Gemant. (*Jour. Appl. Phys.*, vol. 17, pp. 195-200; March, 1946.) "The rigorous expression for the heat input, valid for the whole frequency range, is developed. . . . It is shown in an example how the equation is used for numerical computations. Existing approximate formulas for the low-frequency and the high-frequency range are checked by means of the rigorous equation; the maximum deviation between the rigorous and approximate equations is about 10 per cent."

621.365.52: 621.385.1 1615

Induction Heating in Radio Electron-Tube Manufacture—E. E. Spitzer. (PROC. I.R.E. AND WAVE AND ELECTRONS, vol. 34, pp. 110W-115W; March, 1946.) The following applications are considered: degassing, getter-flashing, vacuum-firing, metal-to-glass sealing, brazing, and welding. Frequencies in the range of 200 to 500 kilocycles and powers of 2 to 15 kilowatts are usually employed. The theory of this method of heating metallic elements is considered.

621.365.52: 621.791.3 1616

R-F Soldering of Metal-to-Glass Seals—R. A. Ammon. (*Electronics*, vol. 19, pp. 120-121; March, 1946.) 30-megacycle heating generators, distributed throughout the plant and fed from a central power supply, are used in the production of sealed meters. Increased efficiency over ordinary techniques, such as soldering irons, is obtained in the use of soldering edge-metallized glass windows and glass-insulated feed-through terminals to the metal case of the instrument, in mounting pole pieces on instrument magnets, and in soldering metallized-glass-jewel bearings in position. The generator circuit is given.

621.365.92: 678.028 1617

High-Frequency Heating Developments—(*Electronics*, vol. 19, pp. 170-178; March, 1946.) Features of a 125-kilowatt 13.6-megacycle unit developed by Westinghouse for curing and drying a new sponge-rubber product. See also 698 of March.

621.365.92: 678.028 1618

Electronic Rubber Preheater—E. Mittelmann and G. P. Bosomworth. (*Electronics*,

vol. 19, pp. 128-130; March, 1946.) A brief general description of the use of a 20-kilowatt 27-megacycle heating unit for preheating rubber parts, in readiness for curing.

621.38: 62 1619

Economics of Electronics—J. Markus. (*Sci. Amer.*, vol. 173, pp. 349-351; December, 1945.) A discussion on recent electronic developments, including references to ingenious but uneconomical devices.

621.383 1620

Sensory Aid for the Blind—L. Cranberg. (*Electronics*, vol. 19, pp. 116-119; March, 1946.) A detailed account of the device noted in 1309 of May.

621.385.833 1621

Filmless Sample Mounting for the Electron Microscope [Airborne particles supported on thin glass fibres]—J. H. L. Watson. (*Jour. Appl. Phys.*, vol. 17, pp. 121-127; February, 1946.)

621.386.1: 620.179 1622

Production Control with 2,000-Volt X-rays—D. Goodman. (*Electronics*, vol. 19, pp. 146-149; February, 1946.) "Details of super-voltage installation using conventional X-ray tube construction and resonant transformer, and description of continuous industrial radiographic setup used during war for inspection of powder charges in large loaded shells and bombs."

621.386.1: 621.396. 1623

Notes on Radiography in the Wireless Industry—R. M. Mitchell. (*Marconi Rev.*, vol. 9, pp. 13-20; January, March, 1946.) A simple introduction to the subject is followed by a description of modern industrial X-ray plant. After a survey of the factors governing the making of satisfactory radiographs, practical applications, chiefly relating to physical examination of vacuum tubes, are illustrated.

621.43: 621.317.39 1624

Pressure-Time Curves in Electronic Observation of Engines—W. F. Brown. (*Electronics*, vol. 19, pp. 168, 170; February, 1946.) Comprises a 100-kilocycle bridge in which one of the arms includes a diaphragm-operated capacitor which is subjected to the pressure changes. An amplifier and detector system associated with the bridge enables either the full 100-kilocycle output, the output with negative half-waves suppressed, or the envelope, together with timing marks, to be displayed on a synchronized oscillograph.

621.9: 621.38 1625

Contouring Control for Machine Tools—(*Electronics*, vol. 19, p. 178; February, 1946.) A stylus guides itself round a template at constant speed, or is drawn round a diagram like a pencil, and its motion controls the cutting operation through electronic mechanisms. "The new control . . . is capable of a variety of intricate cutting operations. . . ."

623.26: 621.396.9 1626

Land Mine Locators—S. S. West. (*Electronic Eng.*, vol. 18, pp. 69-74; March, 1946.) Models I, II, and III are based on the Felici bridge in which equal and opposite mutual inductances give zero output. Two overlapping circular coils are adjusted to have zero coupling so that, when brought

near a metallic object, an unbalance due to external coupling is produced. This unbalance is indicated by feeding one coil from an alternating-frequency oscillator and amplifying the output from the other to headphones. A balancing circuit enables the initial stray reactive and resistive coupling to be annulled. A detailed description of the construction and of the circuit is given. A novel and improved locator (Model IV) gives discriminatory detection. The coils are connected respectively to the input and output of a 3-stage amplifier having negligible phase shift; the coupling between the coils provided by a nearby object causes audio-frequency self-oscillation. By introducing a controllable phasing network the detector can be made to have greatest sensitivity to a ferrous object, which produces a 90-degree phase shift.

623.454.25: 621.396.9 1627

Proximity Fuzes for Artillery—H. Selvidge. (*Electronics*, vol. 19, pp. 104-109; February, 1946.) A description of the problems encountered, and the methods used in overcoming them. General details of a proximity fuze suitable for shells of 75-millimeter caliber and upwards are given. A satisfactory fuze must withstand the high accelerations experienced when the shell is in the barrel (although it is not then operative), and the high spin accelerations throughout its flight; its battery must not deteriorate when stored under adverse conditions; its electrical characteristics must be reproducible, and the polar diagram of the aerial should "roughly match the fragmentation pattern of the projectile." The fuze described comprises a self-quenched superregenerative oscillator which acts as transmitter and also as detector for the receiver, the further stages of the latter comprising two resistance-capacitance-coupled pentodes feeding the grid of a thyratron. The latter is normally in the quiescent state, but when an audio-frequency signal of appropriate amplitude is applied to its grid (due to the interaction at the detector of the transmitted signal and that received back from the target) the thyratron fires and sets off the detonating cap. The battery is of the "reserve" type, the electrolyte being kept out of contact with the plates until the instant of firing. The mechanical construction of the fuze is discussed, together with the design of the rugged tubes. Methods used in testing the vacuum tubes and fuzes under production conditions are indicated. For a description of a fuze suitable for low-acceleration projectiles, see 624 of March (Huntoon and Miller).

629.13: 621.38 1628

Future of Electronics in Aviation—J. D. Goodell and D. J. Coleman. (*Radio News*, vol. 35, pp. 25, 135; February, 1946.) Some applications of wartime developments, e.g., radar, control of cabin temperature, autopilots, etc., are discussed. The principle of the ceilometer, a photoelectric device for measuring cloud height, is described.

629.13: 621.398 1629

Radio Target Planes—(*Radio Craft*, vol. 17, pp. 242, 279; January, 1946.) A short general account. See also 1323 of May.

639.2: 621.383 1630

Photoelectric Fish Counter—L. V. Whitney and A. D. Hasler. (*Electronics*, vol. 19,

pp. 178-182; March, 1946.) The beam from a light source falling on a photocell is interrupted by fish swimming across the beam. The interruptions are observed on a microammeter in a simple amplifier connected to the photocell. The size of catch correlates with the rate of count.

639.3.06: 621.38 1631

Electronic Control of Fish Fence—(*Electronics*, vol. 19, p. 164; March, 1946.) Rapid pulses of special wave form used with an electric fence turn back both small and large fish without harming them.

771.36: 621.317.39 1632

Electronic [Camera-] Shutter-Testers—R. F. Redemske. (*Electronics*, vol. 19, pp. 128-134; February, 1946.) The first device is a recorder which plots aperture area as a function of time for an iris shutter, and the screen speed at the beginning, middle, and end of the traverse for a focal-plane shutter. The delay in functioning of light-operated shutters may also be measured. Teledeltos paper is used for recording and, in the case of the iris shutter for example, the record consists of ten straight lines drawn parallel to each other and to the direction of uniform motion of the recording paper. Each line corresponds to a definite shutter area, and the length of the line represents the time for which the particular shutter area is exceeded. The curve enclosing the extremities of the lines gives aperture area as a function of time. The result is achieved by a photoelectric cell, voltage divider and associated amplifiers, the design of which is discussed. The second device gives on a meter the percentage departure of actual shutter speed from rated speed. Here, the photoelectric current is arranged, through suitable amplifiers, to charge a capacitor through a series pentode. The voltage so developed is used as a measure of the time for which the shutter is open.

621.385.833: 54 1633

Major Instruments of Science and Their Applications to Chemistry [Book Review]—R. E. Burk and O. Grummitt (Editors). Interscience Publishers Inc., New York, N. Y., 1945, 151 pp., \$3.50. (*Elec. Ind.*, vol. 5, p. 153; March, 1946.) Vol. IV in the series "Frontiers in Chemistry." Contains "Electron Diffraction," by H. Germer, "The Electron Microscope," by L. Marton, "X-Ray Diffraction," by M. L. Huggins, and articles on spectroscopy by W. R. Brode and R. R. Barnes.

PROPAGATION OF WAVES

517.947.4 1634

A Method of Solution of Field Problems by Means of Overlapping Regions—Poritsky and Blewett. (See 1571.)

621.396[.11+81 1635

Forecasting Long-Distance Transmission—W. R. Foley. (*QST*, vol. 30, pp. 36-41; February, 1946.) Description of a method using maximum-usable-frequency charts for the determination of optimum frequencies and times for long-distance transmission.

621.396.11 1636

I.R.E. Winter Technical Meeting, January, 1946—(PROC. I.R.E. AND WAVES AND ELECTRONICS, vol. 1, pp. 80W-93W; February, 1946.) Abstracts are given of the fol-

lowing papers read at the meeting: "Field Intensities Beyond Line of Sight at 45.5 and 91 megacycles."—C. W. Carnahan, N. W. Aram, and E. F. Classen. "Development in Radio Sky-Wave Propagation Research and Applications during the War."—J. H. Delling and N. Smith. "The Role of Atmospheric Ducts in the Propagation of Short Radio Waves."—J. E. Freehafer. "Three- and Nine-Centimeter Propagation Measurements in Low-Level Ocean Ducts."—M. Katzin and R. W. Bauchman. "Microwave Propagation: Part I. The Effect of Rain Upon the Propagation of Waves in the One- and Three-Centimeter Region."—S. D. Robertson and A. P. King. "Microwave Propagation: Part II. Propagation of Six-Millimeter Waves."—G. E. Mueller. "Measurement of the Angle of Arrival of Microwaves."—W. M. Sharpless. For other abstracts, see *Electronics*, vol. 19, pp. 92-108; March, 1946; and *Elec. Ind.*, vol. 5, pp. 62-74; March, 1946. For titles of other papers read, see other sections.

621.396.11 1637

Curved Earth Geometrical Optics—G. Millington. (*Marconi Rev.*, vol. 9, pp. 1-12; January, March, 1946.) "In this paper the effect of the earth's curvature in the geometric-optical treatment of propagation within the visual range is presented as a correction to the flat-earth geometry. Factors to be applied to the flat-earth values of the angle of elevation at the point of reflection, and of the path difference between the direct and reflected waves, are derived by a simple graphical process, and also the divergence factor arising from the increased divergence on reflection from the convex surface of the earth is obtained. Asymptotic values are given for points very near to the horizon."

621.396.11 1638

On a Modification of the Interference Method of Investigating the Propagation of Radio Waves—L. I. Mandelstam and N. D. Papalexi. (*Compt. Rend. Acad. Sci. U.R.S.S.*, vol. 26, pp. 775-779; 1940. In English.) The interference method referred to is the measurement of the phase difference between emitted waves and those returned to the sender from a distant "reflector" or reradiator which transforms the frequency in a simple integral or fractional ratio. The distance of the reradiator can be found in terms of an unknown whole number of wavelengths and a phase constant of the apparatus. These unknowns must be determined separately, e.g., by a small change of wavelength. It is pointed out that the method is capable of greater accuracy if applied to the determination of small changes of distance, the wavelength being constant, e.g., with the radiating station on a boat or car. The method was used to determine the mean velocity of radio waves over water (Black Sea, Lake Ilmen, and White Sea) and over land, the distance changes being independently measured by ordinary surveying methods. In the Black Sea measurements the velocity was found to be $(2.999 \pm 0.005)10^{10}$ centimeters per second. The land experiments (130 to 195 meters) were carried out to determine the phase structure of the field, both in the immediate neighborhood of the transmitter and at gradually increas-

ing distance from it. Theoretical expectations were confirmed. There was a sharp distortion of the phase structure near a deep ravine. This work is to be described in a separate publication.

621.396.11 1639

Influence of the Earth's Surface upon Phase Structure of the E.M. Field of a Radiating Aerial—J. L. Alpert and V. V. Migulin. (*Compt. Rend. Acad. Sci. U.R.S.S.*, vol. 26, pp. 881-884; 1940. In English.) An experimental study of the upward extent of the influence of the earth's surface on the propagation of radio waves. A transmitter on the surface radiated two coherent oscillations with frequencies in the ratio 3/2, (wavelengths 120 to 180 meters and 300 to 450 meters) and observations of the phase difference $\Delta\phi = \phi_1 - 3\phi_2/2$ were made on receivers carried by captive balloons. It was found that the effect of the earth's surface, as shown by the magnitude of $\Delta\phi$, gradually diminishes with increase of height above the earth's surface and practically ceases at a height of about 4λ . The distances at which this effect was observed were about 25 to 50λ on the shorter wavelengths and 10 to 20λ on the longer, and the total variation in $\Delta\phi$ was about 30 degrees on the shorter wavelengths and 18 degrees on the longer.

621.396.11 1640

Irregularities in Radio Transmission: Part 2—O. P. Ferrell. (*Radio*, vol. 30, pp. 25, 63; January, 1946.) Description of several instances of anomalous radar reflections from clouds, hot air, birds, and auroral ionized regions. For part 1, see 1333 of May.

621.396.11: 551.51.053.5 1641

On the Connection between the Anomalies of Polarization of Half-light and the State of Ionization—V. M. Bovcheverov, A. V. Mironov, I. M. Mikhailine, V. M. Morozov, Z. L. Ponizovsky, S. P. Sokolov, and I. A. Khvastikov. (*Compt. Rend. Acad. Sci. U.R.S.S.*, vol. 26, pp. 900-903; 1940. In French.) According to Rayleigh's theory of molecular scattering, the degree of polarization of half-light (dawn and twilight) should decrease uniformly with ϕ the zenithal distance of the sun, according to $p = (1 - \cos^2 \phi)/(1 + \cos^2 \phi)$, but in fact the polarization shows a well-marked minimum. This may be attributable to effects of the ionized layers. The experiments described (simultaneous observations of polarization and of critical frequency of pulsed radio transmissions) were carried out to find whether there was any correlation between ionization and the degree of anomalous polarization. A comparison between the observed decreases of polarization from the theoretical values and the corresponding critical frequencies show that there is such a correlation, i.e., the maximum decrease is associated with the highest critical frequencies.

621.396.11.029.62 1642

Need There be Line-of-Sight?—E. P. Tilton. (*QST*, vol. 30, pp. 47-50; March, 1946.) A line-of-sight path is not always necessary for good communication in the 144, megacycle band. Aerial systems are described which have led to improved reception under conditions where the transmitter has been obscured by hills.

631.437: 621.3.011.2

1643
The Use of Cumulative Resistance in Earth-Resistivity Surveys—Ruedy. (See 1523.)

RECEPTION

621.395.8: 621.395.645

1644
Audio Distortion in Radio Reception—J. Minter. (*Proc. Radio Club Amer.*, vol. 23, pp. 1-5; January, 1946.) Discussion of transient response and cross-modulation distortion. Cross modulation between high and low audio frequencies can be reduced by suitable transformer design.

621.396.611.1: 621.396.621.54

1645
Practical Radio Course, Part 41. Analysis of the Various Causes of Drift in the Resonance Frequency of Tuned Circuits and in the Frequency of the Superheterodyne oscillator—A. A. Ghirardi. (*Radio News*, vol. 35, pp. 50, 98; February, 1946.) Methods of reducing the effects of temperature, humidity, and age on coils and capacitors. For part 40 of the series, see 1342 of May.

621.396.611.1: 621.396.621.54

1646
Practical Radio Course: Part 42. Covering Various Easily Applied Methods of Minimizing and Compensating for Oscillator Frequency Drift in Superheterodyne Receivers—A. A. Ghirardi. (*Radio News*, vol. 35, pp. 46, 100; March, 1946.) For previous parts, see 1645 above.

621.396.619.018.41: 621.396.622

1647
Frequency Discriminator—Bruck. (See 1491.)

621.396.62+621.396.9

1648
Germany's UHF Tubes—Combined Intelligence Sub-Committee. (*Elec. Ind.*, vol. 5, pp. 162-168; March, 1946.) A continuation of 1399 of May, dealing very briefly with "radar camouflage" (materials of low radio-reflecting power), and ultra-high-frequency receivers of various types.

621.396.62

1649
I.R.E. Winter Technical Meeting, January, 1946—(PROC. I.R.E. AND WAVES AND ELECTRONS, vol. 1, pp. 80W-93W; February, 1946.) Abstracts are given of the following papers read at the meeting: "Design of Communication Receivers for the Naval Service with Particular Consideration to the Very-High-Frequency and Ultra-High-Frequency Ranges."—T. McL. Davis. "Microwave Converters."—C. F. Edwards. "Tunable Receivers for Very High Frequencies."—G. E. Hulstede, J. M. Pettit, H. E. Overacker, K. Spangenberg, and R. R. Buss. "Ultra-High-Frequency Television Receivers."—H. T. Lyman. "Noise Spectrum of Crystal Mixers."—P. H. Miller. "Discriminators for Frequency-Modulation Receivers."—S. W. Seeley. "Theory of Impulse Noise in Ideal Frequency-Modulation Receivers."—D. B. Smith and W. E. Bradley. "Crystal Rectifiers in Heterodyne Receivers."—H. C. Torrey. For other abstracts, see *Electronics*, vol. 19, pp. 92-108; March, 1946; and *Elec. Ind.*, vol. 5, pp. 62-74; March, 1946. For titles of other papers read, see other sections.

621.396.62

1650
CAA Alaskan Diversity Receiving System: Part 1—Ivers. (See 1669.)

621.396.62

1651
New Svenskradio Wireless Receivers—C. Fredin. (*Ericsson Rev.*, vol. 22, pp. 187-193; 1945.) Includes illustrations and a comparative table of details of types 1453, 1454, 1457, and 1458 V(LV).

621.396.62

1652
Wide-Range Converter-Receiver—B. E. Hargrove. (*Radio News*, vol. 35, pp. 40-42, 140; February, 1946.) Constructional details of a superregenerative receiver for 112-megacycles and a 14-, 21-, 28-, 50-megacycle converter for use with a lower-frequency receiver. High signal-to-noise ratio, good stability, and freedom from image troubles are claimed.

621.396.62: 621.317.755

1653
Panoramic Reception, 1946—J. R. Popkin-Clurman and B. Schlessel. (*QST*, vol. 30, pp. 22-27; March, 1946.) Description of a receiver adaptor for displaying signals received within a wide frequency band, using a cathode-ray tube with X deflection representing signal frequency and Y deflection representing signal strength. Prewar development and wartime applications are reviewed.

621.396.621: 621.396.619.018.41

1654
Frequency Modulation Receiver—M. Ziegler. (*Radio*, vol. 30, pp. 41; January, 1946.) The receiver incorporates a feedback arrangement to allow a narrow-band intermediate-frequency amplifier to be used, and a frequency-counter circuit is used instead of the conventional discriminator. Summary of U. S. Patent 2,383,359.

621.396.621.029.62

1655
144-Mc Radio—I. Queen. (*Radio Craft*, vol. 17, pp. 239, 289; January, 1946.) Constructional details of a superregenerative receiver.

621.396.621.029.62

1656
A Non-Radiating Superregenerative Receiver for Two Meters—E. P. Tilton. (*QST*, vol. 30, pp. 53, 108; February, 1946.) The circuit comprises a tuned radio-frequency stage, superregenerative detector, and two audio-frequency stages, all using miniature valves. The receiver is battery-operated, with low current consumption.

621.396.621.029.62

1657
Service Considerations in Megacycle Bands—C. J. Sheridan. (*Radio News*, vol. 35, pp. 38, 96; March, 1946.) An outline of very-high-frequency and frequency-modulation reception techniques.

621.396.621.53

1658
Calculation of the Output from Non-Linear Mixers—Stockman. (See 1492.)

621.396.621.54

1659
Single Signal C.W. Reception and Crystal Filters—B. G. (*QST*, vol. 30, pp. 59-61; March, 1946.) If the beat-oscillator frequency is set to one side of a narrow intermediate-frequency response curve, the heterodyne whistle on one side of the zero-beat position is suppressed.

621.396.621.54

1660
Oscillatorless Superheterodyne—R. W. Woods. (*Electronics*, vol. 19, pp. 224, 234; February, 1946.) Comprises two mixers, each fed with the signal. The load of one is tuned

to intermediate frequency, and is connected to a second input terminal of the other mixer; the load circuit of the latter is tuned to (signal \pm intermediate) frequency and is connected to a second input terminal of the first mixer. Output at intermediate frequency is taken from the load circuit of the first mixer. An analogous arrangement may be used as a beat-frequency "oscillator" to follow the intermediate-frequency stages of a continuous-wave code receiver. Theory and properties of these arrangements are given, with suggested additional applications.

621.396.621.54.029.58

1661
A 28-Mc. Receiver/Converter—B. Goodman. (*QST*, vol. 30, pp. 17-20, 106; February, 1946.) Constructional details of an oscillator and frequency converter giving an intermediate-frequency of about 1.5 megacycles, intended to precede an ordinary broadcast receiver.

621.396.622.7

1662
Superregenerative Detector Selectivity—A. Easton. (*Electronics*, vol. 19, pp. 154-157; March, 1946.) "Experimental determination of characteristics . . . indicates that selectivity and sensitivity increase and noise decreases with decreasing quench frequency. Selectivity decreases with increasing quench amplitude."

621.396.622.7

1663
The Application of Modulation-Frequency Feedback to Signal Detectors—G. Builder. (PROC. I.R.E. AND WAVES AND ELECTRONS, vol. 34, pp. 130P-137P; March, 1946.) "Positive modulation-frequency feedback to the load circuit of a signal detector may be adjusted to make the effective modulation-frequency admittance of the load circuit equal to its direct-current conductance, thus eliminating peak clipping and improving the efficiency of detection. Conversely, negative feedback to the detector tends to increase peak clipping. Incidental effects in the amplifier from which the positive feedback voltage is derived may correspond to positive or negative, voltage or current, feedback, depending on the general circuit arrangement. Design formulas and some equivalent circuits are given and the major design considerations are outlined. Typical examples include a detector arrangement which provides automatic-volume-control voltages and has a high input impedance and a very low output impedance, as well as Varrell's arrangement which is in agreement with the design procedure outlined in this paper. Attention is also drawn to the great care necessary in the design of detector-amplifier circuits, using multipurpose vacuum tubes . . . to avoid distortion due to incidental negative modulation-frequency feedback to the detector." Methods previously suggested for avoiding the type of detector distortion dealt with in the paper are discussed.

621.396.66

1664
A.S.C. Radio—E. Aisberg. (*Radio Craft*, vol. 17, pp. 240, 263; January, 1946.) Automatic selectivity control is obtained by use of parallel intermediate-frequency channels of different bandwidths for the upper and lower audio ranges, the effect being enhanced by crossing the automatic-volume-control lines.

- 621.396.822 1665
Noise Figures of Microwaves Receivers—W. G. Hawkins. (*Radio*, vol. 30, pp. 21, 64; January, 1946.) An elementary survey. The noise figure is defined, and its measurement is explained, with numerical examples for typical microwave receivers.
- STATIONS AND COMMUNICATION SYSTEMS**
- 621.39 1666
I.R.E. Winter Technical Meeting, January, 1946—(PROC. I.R.E. AND WAVES AND ELECTRONICS, vol. 1, pp. 80W-93W; February, 1946.) Abstracts are given of the following papers read at the meeting: "Phase and Frequency Modulation.—A New Method."—R. Adler, F. M. Bailey, and H. P. Thomas. "Some Technical Developments in Light-Wave Communications."—J. M. Fluke and N. E. Porter. "A New System of Angular Velocity Modulation Employing Pulse Techniques."—J. F. Gordon. "Naval Warfare Communications Problems."—J. O. Kinert. "Two Multichannel Microwave Radio-Relay Equipments for the U. S. Army Communication Network."—R. E. Lacy. "Frequency Allocations."—P. D. Miles. For other abstracts, see *Electronics*, vol. 19, pp. 92, 108; March, 1946; and *Elec. Ind.*, vol. 5, pp. 62-74, March, 1946. For titles of other papers read, see other sections.
- 621.395.42: 534.7 1667
Infrasonic Switching—A. Montani. (*Electronics*, vol. 19, pp. 214, 222; March, 1946.) It is shown that the ear perceives as continuous a sound which has been suppressed for 0.033 second at a repetition rate of 15 cycles. A system is outlined, utilizing this phenomenon, to give simultaneous two-way communication over a single-channel link.
- 621.396.1 1668
Diversity System—C. W. Hansell. (*Elec. Ind.*, vol. 5, p. 104; March, 1946.) A two-carrier system in which the channels are derived at the transmitter by beating a strong carrier with a weak one (on which the intelligence modulation is superposed) of slightly different frequency. The amplitude modulation due to the mixing process is removed and the resultant phase-modulated carrier (having two principal intelligence-carrying sidebands separated from the carrier by the beat frequency) is fed to the aerial through amplifiers and frequency multipliers. Summary of U. S. Patent 2,388,053.
- 621.396.1 1669
CAA Alaskan Diversity Receiving System: Part I—J. Ivers. (*Communications*, vol. 26, pp. 40-46; January, 1946.) Technical description, with circuit diagrams of an 8-channel system using four frequencies between 100 kilocycles and 20 megacycles. A common automatic volume control is used so that a signal received in one channel suppresses the noise from others. The system provides high-speed automatic tape recording up to 250 words per minute, radio signal relays, or aural reception.
- 621.396.61 1670
Three-Channel 25-Watt Radiotelephone System for Ship-to-Shore—D. A. Heisner. (*Communications*, vol. 26, pp. 32-44; January, 1946.) The system operates on any one of three crystal-controlled frequencies between 2 and 3 megacycles. The "push-to-talk" operation is avoided by rectifying part of the speech voltage and using it to operate a relay that activates the transmitter. The transmitter-receiver occupies a space $20 \times 18 \times 9 \frac{1}{2}$ inches, and the power supply $12 \times 10 \times 7 \frac{1}{2}$ inches. It can operate from 6, 12, 32, or 110 volts. The circuits are described.
- 621.396.619.018[.12+.41 1671
A Review of Frequency Modulated Systems—A. E. Murphy. (*Proc. I.R.E., Aust.*, vol. 6, p. 10; November, 1945.) Extract only, dealing with phase modulation.
- 621.396.619.018.12 1672
Further Note on the Phase Modulator and Two Applications—R. A. Wooding. (*Proc. I.R.E., Aust.*, vol. 6, pp. 5-8; November, 1945.) A supplement to 2943 of 1945 dealing with a circuit modification, in which grid phase-shift networks are replaced by cathode-circuit reactances, giving phase deviation linear up to a theoretical limit of ± 53 degrees. Application to Armstrong and Chireix systems is described.
- 621.396.619.018.41 1673
Extract from "A Review of Frequency Modulated Systems"—A. E. Murphy. (*Proc. I.R.E., Aust.*, vol. 7, p. 13; January, 1946.) Nonmathematical outline of the theory of the phase discriminator, using vector diagrams. The use of pre-emphasis and deemphasis for improving signal-to-noise ratio is mentioned. Long extract only.
- 621.396.619.018.41 1674
Probable Fallacies and Truths about Frequency Modulation—E. G. Beard. (*Proc. I.R.E., Aust.*, vol. 7, pp. 3-14; February, 1946.) Discussion of frequency and phase modulation giving detailed methods and claims of early experimenters. It is shown by diagrams that frequency modulation gives no advantage over amplitude modulation respecting interference represented by an amplitude-modulated carrier. It is suggested that the high signal-to-noise ratios of frequency-modulation reception can be achieved by amplitude-modulation reception using wide bandwidths and suitable circuits. Nonmathematical explanations are given of five methods of phase-modulating a stabilized frequency.
- 621.396.619.018.41 1675
Fundamental Relationships of F-M Systems—N. Marchand. (*Communications*, vol. 26, pp. 56-61; January, 1946.) Equations for frequency-modulated waves are derived and compared with those for amplitude and phase modulation. This is the first of a series of papers on the operation and design of frequency-modulation transmitters.
- 621.396.619.16 1676
Pulse Modulation—R. B. Shepherd. (*Wireless Eng.*, vol. 23, pp. 114-115; April, 1946.) A letter criticizing statements by Roberts and Simmonds in 183 of January. "A chain of rectangular pulses is a succession of discrete phenomena to which the idea of continuous variation cannot be applied." A mathematical method of obtaining the Fourier series of the modulated chain of pulses is outlined.
- 621.396.619.16 1677
PPM—New Technique—F. Shunaman. (*Radio Craft*, vol. 17, pp. 314, 359; February, 1946.) An outline of the system of pulse-position modulation with particular reference to the AN/TRC-6 system described in 1056 of April.
- 621.396.931 1678
New Radio Dispatching System—J. E. Hubel. (*Radio News*, vol. 35, p. 68, 70; March, 1946.) Short general description of the Milwaukee police and fire departments' radio control system.
- 621.396.933.42 1679
The Martin Aircraft H-F Test Network—F. Albrecht. (*Communications*, vol. 26, pp. 15-19, 45; January, 1946.) A general description of the radio equipment used at a small airport and testing ground, including the circuit diagram of a 75-watt, six-channel high-frequency radio telephone transmitter and receiver.
- 621.396.1 1680
Two-Way Radio [Book Review]—S. Freedman. Ziff-Davis Publishing Co., Chicago, Ill., 1946, 506 pp., \$5.00. (*Elec. Ind.*, vol. 5, pp. 153-154; March, 1946.) Deals with the systems and equipment used in two-way or point-to-point communications.
- SUBSIDIARY APPARATUS**
- 531.788+533.5 1681
Audio Aid for Vacuum-Peak Hunting—Wouk. (See 1550.)
- 535.215: 621.383 1682
Investigation of the Surface Photoelectric Effect of Metallic Films under the Influence of Strong Electrostatic Fields—Jacobs-meyer. (See 1504.)
- 621.3.087.64 1683
Electrodynamic Direct-Inking Pen—H. B. Shaper. (*Electronics*, vol. 19, pp. 148-151; March, 1946.) "Mathematical analysis, choice of drive, constructional details, and performance curves of a high-speed unit capable of inking wave forms of transients directly on a moving paper chart. Response is essentially flat from zero up to 100 cycles." A compact design permits easy construction of multichannel recorders.
- 621.314.1 1684
High-Voltage Rectified Power Supply Using Fractional-Mu Radio-Frequency Oscillator—R. L. Freeman and R. C. Hergenrother. (PROC. I.R.E. AND WAVES AND ELECTRONICS, vol. 34, pp. 145W-147W; March, 1946.) A specially designed triode is arranged in a self-biased oscillator circuit operating at a few hundred kilocycles, in which the unidirectional voltage built up across the grid leak is many times the applied anode voltage. "... the oscillator circuit should have a large voltage step-up ratio from anode to grid and the [vacuum-tube] amplification factor ... should be ... less than unity. ... The transconductance of the tube at small grid voltages should exceed the total circuit conductance." Various experimental vacuum-tube types are described. Performance figures quoted include: 4.9 kilovolts across a leak of 23.6 megohms at an anode current of 21.5 milliamperes at 312 volts, and 7.75 kilovolts

across 12.6 megohms at 43.0 milliamperes, 485 volts anode input.

621.314.22/23 1685

The Impedances of Multiple-Winding Transformers: Part I—S. A. Stigant. (*Beama Jour.*, vol. 53, pp. 70-74; February, 1946.) Practical formulas used for the predetermination of power-transformer leakage reactances have fundamental academic shortcomings. The reactances may be measured, however, and a mathematical analysis shows how they affect the current and voltage equations.

621.314.632 1686

A Method for Measuring Effective Contact E.M.F. Between a Metal and a Semiconductor—Stephens, Serin, and Meyerhof. (See 1519.)

621.314.632.029.62: 546.289 1687

Germanium Crystal Diodes—Cornelius. (See 1728.)

621.316.722.078.3: 621.396.682 1688

Voltage-Regulated Power Supplies: Part III—G. E. Hamilton and T. Maiman. (*Communications*, vol. 26, pp. 48-49; January, 1946.) Further details of the equipment described in 1076 of April.

621.316.74 1689

Analysis of Operation of a Thermostat with Contact Thermo-Regulator—Z. Jelonok. (*Proc. Camb. Phil. Soc.*, vol. 42, Part 1, pp. 62-72; February, 1946.) Theoretical analysis for the case in which heater current starts and stops suddenly in the form of rectangular pulses.

621.316.86 1690

High Stability Carbon Resistors—G. V. Planer and F. E. Planer. (*Electronic Eng.*, vol. 18, pp. 66-97; March, 1946.) Description of the manufacture and properties of the pyrolytic or cracked-carbon resistor. The particle size and the choice of a suitable ceramic carrier give a low temperature coefficient of resistance (0.02 to 0.07 per cent per degree centigrade). The resistance value is adjusted by grinding a helical groove in the carbon deposit, but this increases the self-inductance. Carbon-composition resistors are briefly discussed, and the difficulty of controlling their values is stressed. A new technique of carbon-coating fine carrier particles (e.g., quartz) gives improved controllability, but the process is elaborate.

621.317.39.087.4+621.3.078 1691

Instruments for the Automatic Controlling and Recording of Chemical and Other Processes—D. G. Prinz. (*Jour. Sci. Instr.*, vol. 23, pp. 41-44; March, 1946.) Report of a joint conference of the Institute of Physics, the Institution of Chemical Engineers, and the Chemical Engineering Group (Society of Chemical Industry) held in London on October 19, 1945.

621.317.755 1692

A Three-Beam Oscillograph for Recording at Frequencies up to 10,000 Megacycles—G. M. Lee. (*Proc. I.R.E. and Waves and Electrons*, vol. 34, pp. 121W-127W; March, 1946.) "... A description is given of a [continuously evacuated] three-beam high-speed microscillograph which extends the range of application of single-

sweep oscillographic recording by a factor of approximately 10 in frequency over previous limits imposed by transit-time distortion. The reduction in deflection sensitivity attributable to transit-time effect is calculated to be 4 per cent at 3000 megacycles and 40 per cent at 10,000 megacycles. Single-sweep oscillograms of 3000 and 10,000 megacycle oscillations and breakdown transients with fronts of the order of 10^{-9} second duration are shown." Electromagnetic focusing is used (spot diameter 0.01 millimeter). Provision is made to prevent fogging of photographs due to light from the filament. Enlargement of the recorded trace by 100 diameters is used, and, at this magnification, the sensitivity is 0.1 millimeters per volt. For recording in the microwave region, an accelerating voltage of 50 kilovolts is used. At this voltage, the total beam current is 5 milliamperes, of which about 2 per cent strikes a triggering probe in the deflexion chamber. The tube is biased to cut off in the stand-by position. For examination of single-stroke phenomena, the bias is restored to normal for 1 millisecond; the front edge of the resulting current pulse received by the probe is used to trigger the sweep, the phenomenon to be examined, or both. "The instrument in its present state of development opens up entirely new fields of research..." See also 1976 of 1940 (von Ardenne).

621.317.755.087.5 1693

High Speed Photography of the Cathode-Ray Tube—H. Goldstein and P. D. Bales. (*Rev. Sci. Instr.*, vol. 17, pp. 89-96; March, 1946.) Techniques are described for the periodic recording of single traces at rates up to 4000 per second. Writing speeds as high as 70 centimeters per microsecond can be obtained without sacrifice of sensitivity, using commercial tubes and films. High-speed, 16-millimeter cameras are also described.

621.327.4 1694

Gaseous Discharge Tubes and Applications—Hilliard. (See 1729.)

621.352.12 1695

Characteristics of Mercury Type Batteries—(*Elec. Ind.*, vol. 5, p. 74; March, 1946.) Short statement of the design and properties of the Ruben-Mallory cell. High ampere-hour capacity versus volume ratio; capacity is the same under continuous and intermittent operation; long shelf life; good performance at high temperatures; low resistance.

621.352.7 1696

Dry Battery Characteristics and Applications—N. M. Potter. (*Proc. I.R.E., Aust.*, vol. 7, pp. 3-11; January, 1946.) The theory and construction of dry cells is outlined, with mention of the newer flat forms of construction using duplex plates and rubber or plastic seals between cells. This form of construction saves up to 50 per cent in volume and 33 per cent in weight. The measurement of voltage, short-circuit current, and internal resistance is discussed. "The test that best represents any particular service is that which most nearly represents the rate of energy output of the battery when in actual use. There is no direct relation between the results of continuous tests and intermittent tests of longer duration." Curves show the effect of discharge conditions on service life

and ampere-hour capacity. Decrease in temperature increases the shelf life but increases the internal resistance, and the cells become useless at about -21 degrees centigrade although no permanent damage is done. Applications of cells and design considerations for battery-operated receivers are reviewed.

621.383.5 1697

An Apparatus for Use in the Selection of Barrier-Layer Photocells—J. A. Hall. (*Jour. Sci. Instr.*, vol. 23, pp. 59-60; March, 1946.) Twelve cells mounted in a wheel are in turn balanced in a bridge circuit against a standard cell, all the cells being illuminated by the same source for some time before the comparison is made.

621.385.832: 621.316.578.1 1698

Tube-Seasoning Timer—M. Silverman. (*Electronics*, vol. 19, p. 145; February, 1946.) For applying "seasoning" voltages to batches of about 20 cathode-ray tubes during manufacture. Comprises time switches connected in the electrode circuits, which operate at various times, up to a maximum of 55 minutes, after the commencement of the seasoning operation.

621.394/.397].645 1699

Network Design Using Electrolytic Tanks—Kenyon. (See 1470.)

621.396 1700

I.R.E. Winter Technical Meeting January, 1946—(*Proc. I.R.E. and Waves and Electrons*, vol. 1, pp. 88W-93W; February, 1946.) Abstracts are given of the following papers read at the meeting: "Electrical Characteristics of Quartz-Crystal Units and Their Measurement"—W. D. George, M. C. Selby, and R. Soolnik. "Linear Servo Theory"—R. E. Graham. "A Three-Beam Oscillograph for Recording at Frequencies up to 10,000 Megacycles"—G. M. Lee (See 1692.) "Problems Associated with the Standardization of Quartz-Crystal Units for Military Equipment"—C. J. Miller, Jr. "Directional Couplers"—W. W. Mumford. "High-Frequency Plated Quartz-Crystal Units for Control of Communications Equipment"—R. A. Sykes. "Hermetically Sealed Metal Holder for Crystal Units"—A. W. Zeigler. For other abstracts, see *Electronics*, vol. 19, pp. 92-108, March, 1946; and *Elec. Ind.*, vol. 5, pp. 62-74, March, 1946. For titles of other papers read, see other sections.

621.396.662.2 1701

Wire Length of Universal Coils—A. W. Simon. (*Electronics*, vol. 19, p. 162; March, 1946.) Procedure for calculating outside diameter and total wire length in terms of number of turns, form diameter, gear ratio, and wire size. See also 1085 of April (Simon).

621.398 1702

Self-Synchronous Transmission System—E. Hansen. (*Radio News*, vol. 35, pp. 38-143; February, 1946.) The use of the selsyn motor for remote control. Simple diagrams illustrate the basic principles.

TELEVISION AND PHOTO-TELEGRAPHY

621.383.8 1703

The Image Orthicon—(*Radio*, vol. 30, pp. 10-16; January, 1946.) See also 1376 of May.

- 621.397.1704
I.R.E. Winter Technical Meeting January, 1946—(PROC. I.R.E. AND WAVES AND ELECTRONS, vol. 1, pp. 80W-93W; February, 1946.) Abstracts are given of the following papers read at the meeting: "Television in the Ultra-High Frequencies"—P. C. Goldmark. "Ultra-High-Frequency-Television Receivers"—H. T. Lyman. "Television-Studio Equipments"—J. J. Reeves. "The Image Orthicon, A Sensitive Television Pickup Tube"—A. Rose, P. K. Weimer, and H. B. Law. "Electrooptical Characteristics of Television Systems"—O. H. Schade. "Sight and Sound on One Carrier"—K. Schlesinger. "A Kinescope for Home Projection-Type Television Receivers"—L. E. Swedlung. "Color-Television Transmitter"—N. H. Young. For other abstracts, see *Electronics*, vol. 19, pp. 92-108, March, 1946; and *Elec. Ind.*, vol. 5, pp. 62-74, March, 1946. For titles of other papers read, see other sections.
- 621.397.1705
A Writing Cathode-Ray Tube—H. Lineback. (*Radio News*, vol. 35, pp. 30, 31, 126; February, 1946.) A device for making a cathode-ray-tube spot follow a predetermined path of arbitrary shape, e.g., trace a written word. The required path is translated by a graphical process into an opaque pattern on a transparent disk, something like a variable-width film sound track. The pattern is scanned by two photocells, the outputs from which control the deflector voltages of the cathode-ray tube.
- 621.397.1706
Television Must Sound Right—R. Hubbell. (*Radio News*, vol. 35, pp. 46-137; February, 1946.) The need for new and spacious studios is stressed. The main points for their design are outlined.
- 621.397.1707
CBS Shows Its Color—(*Elec. Ind.*, vol. 5, pp. 75-125; March, 1946.) Demonstration of color television (using rotating color disk) with sound transmitted by frequency modulation during the flyback period. A short description of some items of the equipment used.
- 621.397.1708
Highlights of Dr. P. C. Goldmark's Paper on Color Television—R. G. Peters. (*Communications*, vol. 26, pp. 50-51; January, 1946.) A brief account of the Baird tri- and dichromatic systems, a comparison between color photography and television, and a discussion of the present Columbia Broadcasting System trichromatic system.
- 621.397.335 1709
Facsimile Synchronizing Methods—D. Schulman. (*Electronics*, vol. 19, pp. 131-133; March, 1946.) The required accuracy of synchronization of transmitters and receiver drives is investigated, and methods for obtaining this accuracy are described, ranging from simple manual control at the receiving end to electronic methods. Self-contained frequency-control systems operate on local standard-frequency sources (tuning fork or crystal), the phase of receiver and transmitter being matched by a transmitted pulse. Other methods have been devised in which the same audio-frequency tone drives both transmitter and receiver motors, or where each line in the receiver scan is synchronized by a transmitted pulse. Descriptions are given of several devices aimed at stabilization of drive frequencies.
- 621.397.335 1710
Synchronizing and Separation Circuits: Part 12—E. M. Noll. (*Radio News*, vol. 35, pp. 54-60; March, 1946.) For parts 10 and 11, see 782 of March and 1381 of May. (The series does not begin with 782 as stated in 1381).
- 621.397.335: 621.396.615.17 1711
Synchronizing Generators for Electronic Television—Applegarth. (See 1488.)
- 621.397.645 1712
Compensating Amplifiers—C. N. Gillespie. (*Electronics*, vol. 19, pp. 232-234; March, 1946.) To compensate for the distortion produced by the nonlinearity of the recording method and paper of a facsimile system, an equal but opposite nonlinearity is introduced into the amplifier. Summary of U. S. Patent 2,378,999.
- 621.397.5 1713
Television Programming and Production [Book Review]—R. Hubbell. Murray Hill Books, New York, N. Y., 1945, 203 pp., \$3.00. (*Electronic Eng.*, vol. 18, p. 96; March, 1946.) "... I have not seen a better or simpler introduction to the peculiar problems which beset the television producer or his team..." See also 785 of March.
- TRANSMISSION
- 621.396.61:621.396.645 1714
Analysis of Parasitic Oscillations in Radio Transmitters—J. S. Jackson. (*Radio News*, vol. 35, pp. 68-88; February, 1946.) The occurrence and suppression in class-C radio-frequency amplifiers.
- 621.396.61} 1715
I.R.E. Winter Technical Meeting January, 1946—(PROC. I.R.E. AND WAVES AND ELECTRONS, vol. 1, pp. 80W-93W; February, 1946.) Abstracts are given of the following papers read at the meeting: "Generation of Continuous-Wave Power at Very High Frequencies"—W. G. Dow, J. N. Dyer, W. W. Salisbury, and E. A. Yunker. "Electronic Frequency Stabilization of Microwave Oscillators"—R. V. Pound. "Ultra-High-Frequency Television Transmitters and Antennas"—R. Serrell. "Color-Television Transmitter"—N. H. Young. For other abstracts, see *Electronics*, vol. 19, pp. 92-108, March, 1946; and *Elec. Ind.*, vol. 5, pp. 62-74, March, 1946. For titles of other papers, see other sections.
- 621.396.61: 621.396.619.018.41 1716
Twelve-Tube F-M Handie-Talkie—J. M. Lee. (*Electronics*, vol. 19, pp. 194-200; March, 1946.) Weight, 8 pounds; frequencies, 47 to 55.4 megacycles; range, 1 mile in open country and 300 yards in dense jungle. A United States Signal Corps equipment, type AN/PRC-6.
- 621.396.61: 621.396.933 1717
Low Power Aircraft Transmitter—A. B. Kaufman. (*Radio News*, vol. 35, pp. 29-88; March, 1946.) A 3-megacycle crystal-controlled transmitter using a suppressor-modulated output tube has low current consumption and reasonable voice quality.
- 621.396.61.029.56/.58 1718
A Band-Switching V.F.O. Exciter Unit—W. E. Bradley. (*QST*, vol. 30, pp. 29-33; March, 1946.) With calibrated band spread for 3.5, 7, 14, and 28 megacycles. Special attention is given to the switching device and mechanical construction. Performance data are given.
- 621.396.61.029.58 1719
350 Watt—5 Band Transmitter—H. S. Brier. (*Radio News*, vol. 35, pp. 40-125; March, 1946.) Constructional details of a self-contained, crystal-controlled transmitter with switched coils for amateur bands from 3.5 to 29.7 megacycles.
- 621.396.61.029.58 1720
Home Built Signal Shifter—S. Heytow. (*Radio News*, vol. 35, pp. 48-117; March, 1946.) Constructional details of a variable-frequency oscillator for amateur transmitters, giving 20-watt output at 20- or 80-meter wavelengths.
- 621.396.61.029.58 1721
A Low-Power 28-Mc. Phone-C. W. Transmitter—D. Mix. (*QST*, vol. 30, pp. 13-21; March, 1946.) Circuit and constructional details. The power-supply unit can be used for either the transmitter or a receiver by switching. A separate modulator is provided for telephone operation. "Complete equipment for the beginner."
- 621.396.61.029.62: 621.396.619.018.41 1722
Design of F-M Transmitter for 88-108 Mc—S. L. Sack. (*Electronics*, vol. 19, pp. 184-194; March, 1946.) A high-fidelity transmitter, output 250 watts, incorporates balanced modulators, a push-pull primary oscillator, and linear circuit elements in the anode tank circuits. Stable center-frequency control is obtained by the variation of the primary oscillator tuning capacitance by a motor controlled by the difference in frequency between the primary oscillator and a standard crystal oscillator.
- 621.396.615.12.029.62 1723
144-Mc Transmitter—I. Queen. (*Radio Craft*, vol. 17, pp. 319-363; February, 1945.) Simple description of self-oscillator circuits, using standard receiver-type vacuum tubes.
- 621.396.619.2 1724
Premodulation Speech Clipping and Filtering—W. W. Smith. (*QST*, vol. 30, pp. 46-50; February, 1946.) By incorporating amplitude limitation, or clipping, and low-pass filtering in an amplitude-modulated transmitter, it is possible to realize an effective power gain of nearly 100 times. The intelligibility of weak signals is greatly increased with a slight loss in quality.
- 621.396.664 1725
Instantaneous Program Switching—J. Zelle. (*Electronics*, vol. 19, pp. 142-144; February, 1946.) Simple circuit for feeding a given wire channel in succession from a number of input channels. "The arrangement has three advantages: circuits can be preset in the order in which they are to be used, so that switching becomes virtually errorless and semiautomatic; second, the switching will be practically instantaneous...; and third, the circuits are interlocked, therefore only one circuit can be put on the outgoing channel at a time."

VACUUM TUBES AND THERMIONICS

537.525: 621.3.029.64 1726

Initiation of High Frequency Gas Discharges—T. Holstein. (*Phys. Rev.*, vol. 69, p. 50; January 1-15, 1946.) The microwave sparking field in a gas is investigated theoretically as a function of electrode spacing, pressure, electron temperature, and Townsend's coefficient α . Summary of an American Physical Society paper.

537.581 1727

An Explanation of Anomalous Thermionic Emission Current Constants—Sun and Band. (See 1513.)

621.314.632.029.62: 546.289 1728

Germanium Crystal Diodes—E. C. Cornelius. (*Electronics*, vol. 19, pp. 118-123; February, 1946.) Construction, theory of operation, properties, and typical applications of the rectifier type 1N34. The unit is enclosed in a small metal cylinder with leads for soldering it into circuit. It consists of a tungsten wire touching an optically polished surface of germanium mixed with a small quantity of tin. The equivalent circuit and the current-versus-voltage characteristics are discussed in relation to the energy levels of the free electrons in the crystal and the tungsten. It is shown that the slope resistance becomes negative when the steady voltage across the device exceeds a particular tube that depends on the polarity of the voltage, the temperature, and the particular crystal unit used. The 1N34 is suitable for use as a rectifier for frequencies up to 100 megacycles, and with low-load resistances compares well with a conventional thermionic diode. "Preliminary tests show that no failure or deterioration has occurred for more than 1000 hours of continuous operation [under adverse conditions]." Other applications, e.g., voltage regulation and for relaxation oscillators (up to 500 kilocycles) are briefly mentioned. For brief accounts, see *Elec. Ind.*, vol. 4, p. 80, December, 1945; and *Electronics*, vol. 19, p. 252, January, 1946.

621.327.4 1729

Gaseous Discharge Tubes and Applications—R. C. Hilliard. (*Electronics*, vol. 19, pp. 122-127; March, 1946.) Details are given of a robust and reliable modulator glow lamp suitable for portable sound-on-film recording systems. The lamp is of the crater type in which the ionization of the gas excites the cathode material, giving a high-intensity-point source of light. The mean-filled strobotron designed as a medium-intensity light source for stroboscopic applications is also described. It can be operated either as an arc-discharge tube with short-duration high-peak anode currents (300 to 400 amperes), or as a glow-discharge tube with low currents, as required in control devices. Other types of this tube have been developed for special features of operation such as high hold-off voltage (2 kilovolts), high repetition rate (1 kilocycle), low time-jitter, and high light output, and for use in systems requiring the generation of short current pulses of high intensity (e.g., welding control). For photographic analysis of motion and for extremely short-exposure photography, a series of externally excited

discharge tubes with high light output and short flash duration have been developed. The design of the discharge circuit is discussed. See also 2351 of 1937 (Edgerton, Germeshausen, Nottingham, and White).

621.38 1730

I.R.E. Winter Technical Meeting January, 1946—(PROC. I.R.E. AND WAVES AND ELECTRONS, vol. 1, pp. 80W-93W; February, 1946.) Abstracts are given of the following papers read at the meeting: Design of Small Size High-Voltage Rectifier, Type 1Z2—George Baker. Two New Miniature Tubes for Frequency-Modulation Conversion—R. M. Cohen, R. C. Fortin, and C. M. Morris. Microwave Magnetrons —G. Collins. Improved Cathode-Ray Tubes with Metal-Backed Luminescent Screens —D. W. Epstein and L. Pensak. A Medium-Power Triode for Frequencies about 600 Megacycles—S. Frankel, J. J. Glauber, and J. Wallenstein. Microwave Triodes Adapted to Modern Usage—E. M. Goodell. Cascade Amplifier Klystrons—E. C. Levinthal. Secondary-Emission Cathodes for Magnetrons—J. W. McNall, H. C. Steele, Jr., and C. L. Shackelford. Glass Problems in the Manufacture of Miniature Tubes—H. J. Miller. Joint Electron Tube Engineering Council—O. W. Pike. Magnetron Cathodes—M. A. Pomerantz. The Image Orthicon, A Sensitive Television Pickup Tube—A. Rose, P. K. Weimer, and H. B. Law. For other abstracts, see *Electronics*, vol. 19, pp. 92-108, March, 1946; and *Elec. Ind.*, vol. 5, pp. 62-74, March, 1946. For titles of other papers read, see other sections.

621.383.8 1731

The Image Orthicon—(*Radio*, vol. 30, pp. 10-16; January, 1946.) See also 1376 of May.

621.385 1732

The Resnatron—W. W. Salisbury. (*Electronics*, vol. 19, pp. 92-97; February, 1946.) Constructional details and properties of a very-high-power tunable tetrode suitable for continuous-wave operation in the decimeter region either as a self-oscillator or as an amplifier. The tube has tuned cavities between directly heated cathode and control grid, and between anode and screen, respectively. The tungsten filament requires 2 volts, 1800 amperes. Typical plate operating conditions are 8 amperes, 17½ kilovolts. Under these conditions, about 85 kilowatts output may be obtained. The tube described is continuously pumped, and extensive use is made of water cooling. For use in counter-measures operations during the war, see 1356 of May.

621.385: 621.317.79 1733

A Method of Measuring Grid Primary Emission in Thermionic Tubes—Hooke. (See 1598.)

621.385.1 1734

Reflex-Klystron Oscillators—E. L. Ginzton and A. E. Harrison. (PROC. I.R.E. AND WAVES AND ELECTRONS, vol. 34, pp. 97P-113P; March, 1946.) "A comprehensive analysis of reflex klystrons is developed by considering the electrons as particles

acted upon by forces which modify their motion. The analysis is similar to earlier explanations of electron bunching in a field-free drift space and predicts a similar current distribution when bunching takes place in a reflecting field. The effect of the bunched electron beam is treated qualitatively by considering the effect of the beam admittance upon a simple equivalent circuit. A quantitative mathematical analysis based upon oscillator theory is also derived and the results are presented in a series of universal curves which are used to explain the operating characteristics of these tubes. Power output, efficiency, starting current, electronic tuning, and modulation properties are discussed. Some general remarks on reflex-oscillator design considerations are also included." The effect of transit time across the gap of the resonator is considered. The equivalent circuit mentioned above comprises a parallel inductance-capacitance circuit representing the resonator, connected in shunt with the equivalent admittance of the bunched beam and with resistances to simulate circuit losses and loading. The design criteria for reflex klystrons designed to have wide-band electronic tuning are discussed relative to considerations of power output and efficiency.

621.385.1: 537.122 1735

"Electron Transit Time in Time-Varying Fields"—L. A. Ware and H. B. Phillips; A. B. Bronwell. (PROC. I.R.E. AND WAVES AND ELECTRONS, vol. 34, pp. 151P; March, 1946.) Comments on 3884 of 1945 (Bronwell).

621.385.1: 621.365.52 1736

Induction Heating in Radio Electron-Tube Manufacture—Spitzer. (See 1615.)

621.385.1.032.2+533.5+539.234 1737

Fine Wires in the Electron-Tube Industry—Espersen. (See 1564.)

621.385.2: 621.395.645.3 1738

A Voltage Amplifier Using a Pre-Saturation Diode as Load—Durnford. (See 1478.)

621.385.832: 621.316.578.1 1739

Tube-Seasoning Timer—Silverman. (See 1698.)

MISCELLANEOUS

061.22: 621.396(054) 1740

Waves and Electrons—The journal which appeared under this title in January and February, 1946, is continued as a section of the PROC. I.R.E., from March, 1946. See 1122 of April.

621.38/.39(038) 1741

Electronics Dictionary [Book Review]—N. M. Cooke and J. Markus. McGraw-Hill Book Co., New York, N. Y., 1945, 433 pp., \$5.00. (*Elec. Ind.*, vol. 4, p. 162; December, 1945. Also *Electronics*, vol. 19, pp. 344-348; January, 1946.)

621.38(075.8) 1742

Electronics Laboratory Manual [Book Review]—R. R. Wright. McGraw-Hill Book Co., New York, N. Y., 77 pp., \$1.00 (PROC. I.R.E. AND WAVES AND ELECTRONS, vol. 1, p. 103W; February, 1946.)

621.396.029.64 1743

Radiation Laboratory Technical Series [Book Notice]—(See 1549.)

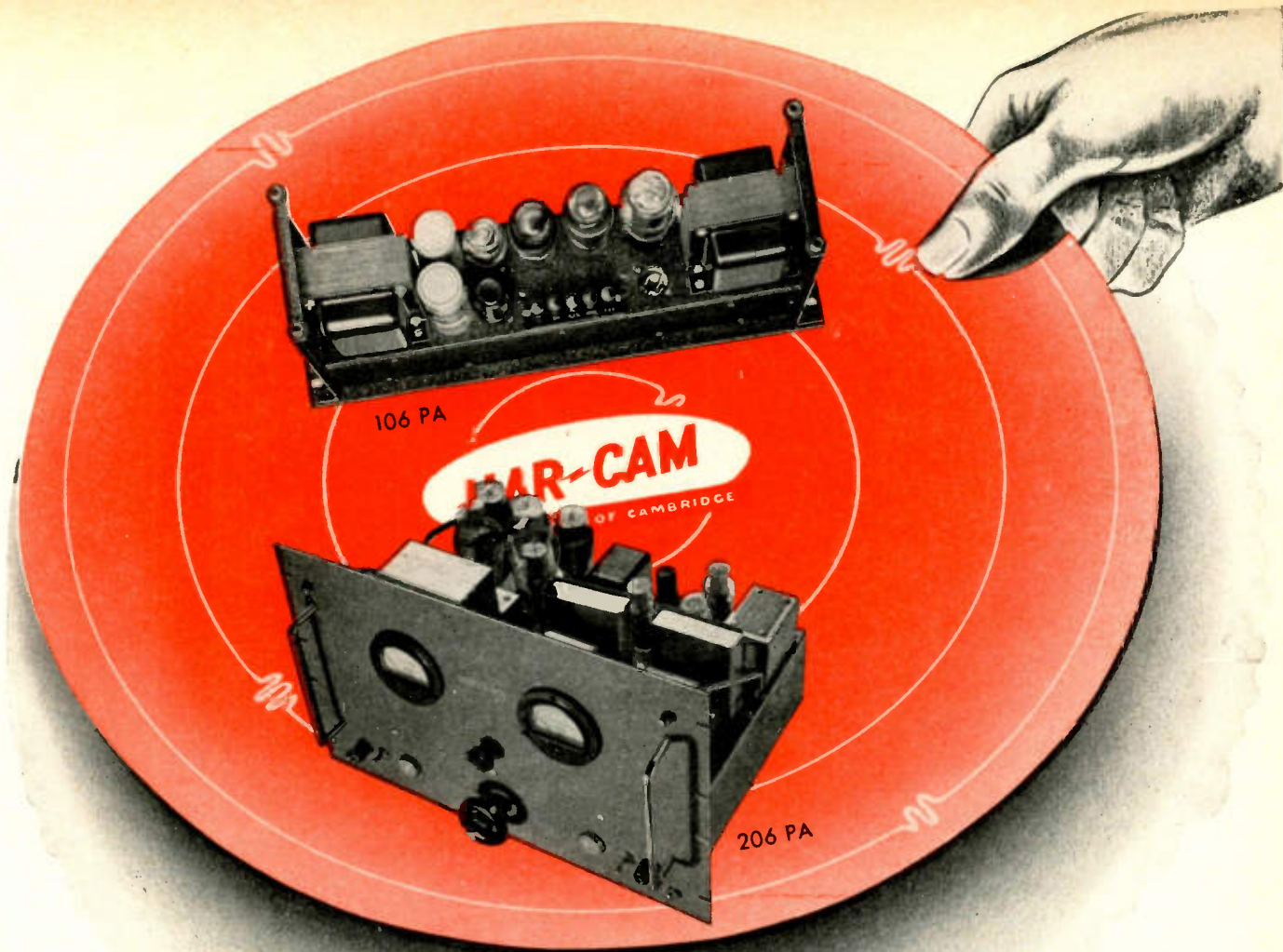

Provide **STEADY D. C. POWER TO YOUR LABORATORY EQUIPMENT WITH HARVEY Regulated Power Supplies**

Amplifiers, pulse generators, constant frequency oscillators, measurement equipment — in fact any apparatus requiring a constant source of laboratory D.C. power — performs more efficiently and effectively when teamed with HARVEY Regulated Power Supplies. Designed specifically for the job, HARVEY 106 PA and 206 PA Regulated Power Supplies perform their functions with utmost precision, dependability and operating ease.

The HARVEY Regulated Power Supply 106 PA meets every need for a controllable, dependable source of laboratory D.C. power between 200-300 volts. Operates from 115 volts A.C. . . . output remains constant even though line voltage varies between 95 and 130 volts. Ripple content is less than 10MV . . . two separate filament voltages available . . . 6.3 volts, 5 amps. each . . . parallel operation possible making 6.3 volts at 10 amps. available. D.C. voltmeter for measuring output.

The HARVEY Regulated Power Supply 206 PA operates precisely and efficiently in the 500 to 1000 volt range. It provides a regulated flow of D.C. power in two ranges: 500 to 700 at ¼ amp; 700 to 1000 at 1/5 amp. Ripple content 1/10 of 1% or less in any voltage . . . 300 MV at 1000 volts or better. Output is constant within 1% from no load to full load in each range; regulation 1% or better. The HARVEY 206 PA has many safety and operating features that make it as easy to use as the 106 PA.

HARVEY RADIO LABORATORIES, INC.

456 CONCORD AVENUE • CAMBRIDGE 38, MASS.



Typical HARVEY products. Above left: The HAR-CAM Model MFT-25 FM Transmitter. Center: The HAR-CAM Visual Alignment Signal Generator Model 205 TS. Right: The HAR-CAM Model MFT-15 FM-AM Receiver. Write for bulletins.

ANDREW DRY AIR EQUIPMENT

for
pressurizing
coaxial cable
lines



TYPE 1800 AUTOMATIC DEHYDRATOR

A compact, *completely automatic* unit that pressurizes coaxial transmission lines with clean, dry air. Starts and stops itself. Maintains steady pressure of 15 pounds. A motor driven air compressor feeds air through one of two cylinders containing a chemical drying agent where it gives up all moisture and emerges absolutely clean and dry. Weighs 40 pounds; 14 inches wide, 14 inches high, 11 inches deep. Power consumption, 210 watts, 320 watts during reactivation.



TYPE 720 PANEL MOUNTING DRY AIR PUMP

Specially designed for use in equipment requiring a small, built-in source of dry air. Only 2 inches in diameter, 6 inches long. Pressures as high as 30 pounds are easily generated. Piston type compressor drives air through a chemical drier. Pump supplies dry air with only 7 to 10% relative humidity. Additional silica gel refills available at reasonable cost.

TYPE 876-B

Designed over the simple tire pump principle, this all-purpose dry air pump has numerous applications. Output of each stroke is about 26 cubic inches of free air. Transparent lucite barrel holds silica gel. Supplied complete with 7-foot length of hose. Height 25½ inches. Net weight 8½ pounds.

Andrew Dry Air Equipment is used in a multitude of other applications. Write for further information.



ANDREW CO.

363 E. 75th ST., CHICAGO 19, ILLINOIS
Pioneer Specialists in the Manufacture of a
Complete Line of Antenna Equipment



ATLANTA

"Symposium on Microwaves," by J. H. Howey, Frank Lowance, W. A. Edson and H. M. Herreman, Georgia Institute of Technology; April 19, 1946.

BUENOS AIRES

"Notes on a Recent Visit to the United States of America and Canada," by G. Van Spankeren, Fabrica Argentina de Productos Electricos S. A.; May 3, 1946.

BUFFALO-NIAGARA

"Recent Development in Miniature and Ultra-miniature Radio Tubes," by M. L. Kiser, Sylvania Electric Products, Inc.; April 17, 1946.

"Methods of Transmitting Video and Audio On One Carrier Wave," by James E. Robinson, American Optical Company; May 15, 1946.

Election of Officers, May 15, 1946.

CEDAR RAPIDS

"Bell System Plans in Radio and Electronics," by Donald B. Harris, Northwest Bell System; April 24, 1946.

"Fundamentals of Vacuum-Tube Oscillators," by W. L. Cassell, Iowa State College; April 24, 1946.

"Disk Recording," by George Sansbury, Collins Radio Company; May 22, 1946.

"Magnetic Recording," by T. E. Lynch, Brush Development Laboratories; May 22, 1946.

CINCINNATI

Round-Table Discussion of the Engineering Aspects of Recent Developments in Color Television and Present Status of Black-and-White Television; May 14, 1946.

COLUMBUS

"Vacuum Tubes for Radar Circuits," by J. A. Morton, Bell Telephone Laboratories; April 19, 1946.

CONNECTICUT VALLEY

"Adventures in Research," by Phillips Thomas, Westinghouse Electric Corporation; April 23, 1946.

"Story of Sonar in World War II," by J. M. Ide, Technical Director, United States Navy Underwater Sound Laboratory; May 16, 1946.

Election of Officers, May 16, 1946.

DALLAS-Ft. WORTH

"How to Develop the Engineering Profession," by Elgin B. Robertson, Professional Engineer; May 21, 1946.

"Pulse-Time Modulation," sound color film by Federal Telephone and Radio Corporation; May 21, 1946.

(Continued on page 36A)

Largest MYCALEX Part Ever Molded

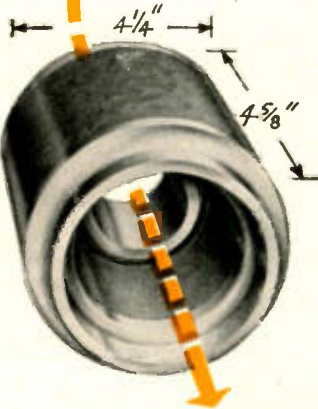
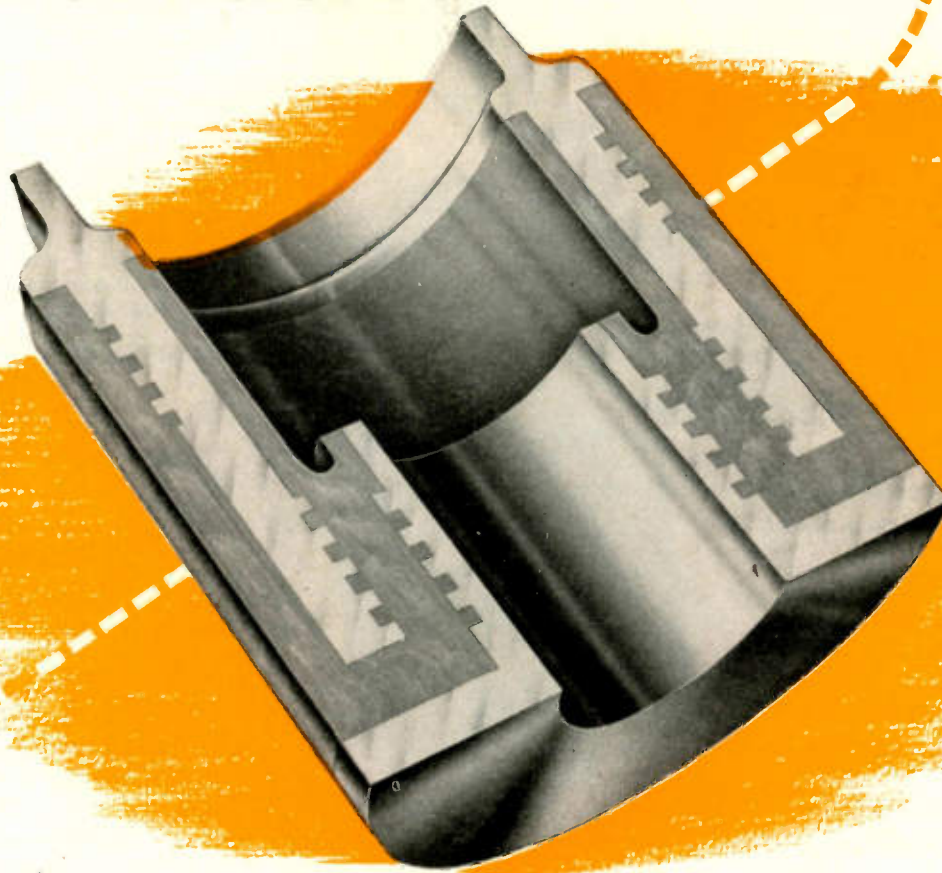

This cross section of a MYCALEX-to-metal molded component part was made for one of the country's leading manufacturers, and is the result of close cooperation between the customer's and our own engineering staffs. It exemplifies a new development in the molding of MYCALEX 410 with metal to form a hermetic seal.

The objective was to take advantage of the low loss factor and other desirable properties of MYCALEX 410 to produce a rugged bushing assembly in a single molding operation.

A difficulty was presented by the extremely long and branched path which the MYCALEX 410 had to follow. Total charge of MYCALEX 410 was 7 pounds, while the metal weighed 6 pounds to make a total weight of 13 pounds.

The MYCALEX and metal were sealed into one closely-bonded integral part, held to extremely close dimensional tolerances.

For more than 27 years MYCALEX has met and surpassed the most exacting needs engineers have been able to devise from year to year. MYCALEX 410, together with our highly perfected methods of molding it, is the greatest advancement in this high frequency low loss insulation to date.

Our technical staff is at your service. What is your problem in low loss insulation?

MYCALEX CORPORATION OF AMERICA

"Owners of 'MYCALEX' Patents"

Plant and General Offices, CLIFTON, N. J.

Executive Offices, 30 ROCKEFELLER PLAZA, NEW YORK 20, N. Y.

THE

Individual TOUCH

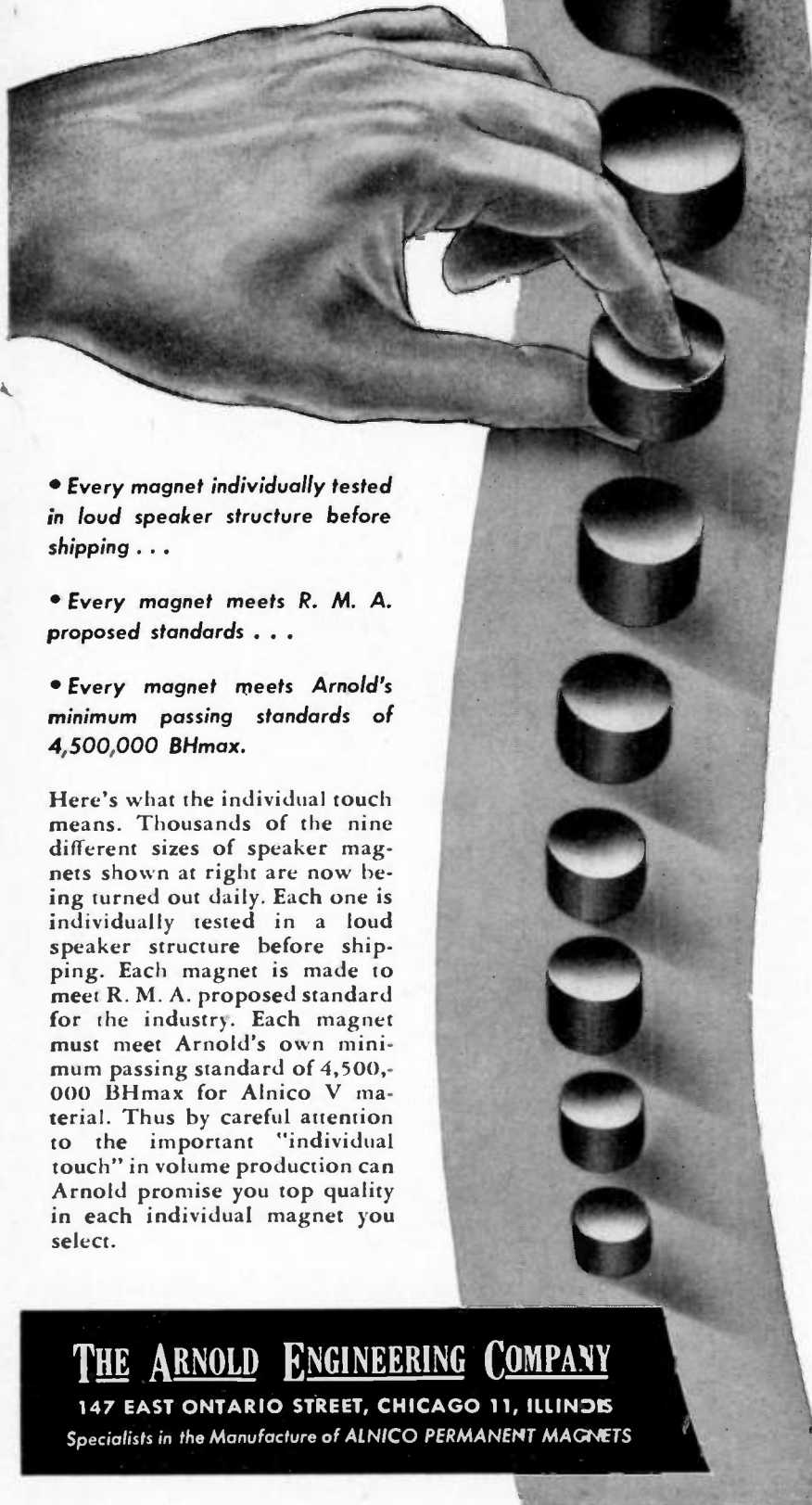

• Every magnet individually tested in loud speaker structure before shipping . . .

• Every magnet meets R. M. A. proposed standards . . .

• Every magnet meets Arnold's minimum passing standards of 4,500,000 BHmax.

Here's what the individual touch means. Thousands of the nine different sizes of speaker magnets shown at right are now being turned out daily. Each one is individually tested in a loud speaker structure before shipping. Each magnet is made to meet R. M. A. proposed standard for the industry. Each magnet must meet Arnold's own minimum passing standard of 4,500,000 BHmax for Alnico V material. Thus by careful attention to the important "individual touch" in volume production can Arnold promise you top quality in each individual magnet you select.

THE ARNOLD ENGINEERING COMPANY

147 EAST ONTARIO STREET, CHICAGO 11, ILLINOIS

Specialists in the Manufacture of ALNICO PERMANENT MAGNETS



(Continued from page 34A)

DAYTON

War Department Films—"DZ—Normandy"—"V-2 Rocket Launching"—"M.E.—163 Tests"; May 16, 1946.

DETROIT

"Shifted Frequency—Diversity Reception," by Jack Sellers, Research Engineer, May 17, 1946.

HOUSTON

"General Aspects of Frequency Modulation from the Broadcasters' Viewpoint," by G. R. Chinski and C. V. Clarke, Harris County Broadcasting Company; May 20, 1946.

Election of Officers, May 20, 1946.

KANSAS CITY

"Precipitation Static and Its Reduction in Aircraft," by R. C. Ayres, TWA; January 30, 1946.

"Physics of Nuclear Energy," by K. K. Darrow, Bell Telephone Laboratories; March 19, 1946.

"Radar Countermeasures," by W. W. Salisbury, Collins Radio Company; April 16, 1946.

Student Paper Competition—

"The Phasitron Tubes as Applied to Frequency-Modulation Transmitters," by A. V. Holman, Electrical Engineering Student, Kansas State University; May 7, 1946.

"Wave-Shaping Circuits and Applications," by D. H. Bartlett and E. R. Petesch, Electrical Engineering Students, University of Kansas; May 7, 1946.

"Induction in Dielectric Heating," by J. Nichols, Electrical Engineering Student, University of Kansas; May 7, 1946.

Election of Officers, May 7, 1946.

MILWAUKEE

"VT Radio Proximity Fuze," by C. Brunetti, National Bureau of Standards, J. M. Pearce, John Hopkins University, A. S. Khouri, Globe Union Manufacturing Company; February 8, 1946.

"The Magnetic-Wire Recorder," by H. A. Leedy, Armour Research Foundation; February 20, 1946.

"The Cyclophon—A Multipurpose Electronic Commutator Tube," by D. D. Grieg, Federal Telephone and Radio Company; April 12, 1946.

PHILADELPHIA

"Measurement of Impulse Noise in Frequency-Modulation Receivers by Photographic Methods," by C. T. McCoy, Philco Research Division; May 2, 1946.

Election of Officers, May 2, 1946.

(Continued on page 38A)

MORE *POWER* FOR FM BROADCAST SYSTEMS!

with

Federal's "Specialized" Triodes 1000 and 3000 Watts at

88 to 108 MEGACYCLES
(MAXIMUM OUTPUT UP TO 150 MC)



THESE TWO high-performance power triodes have been especially designed in every detail, to provide the best possible combination of operating characteristics for FM transmitters.

Every feature—from electrical characteristics to the most minute detail of mechanical construction—has been "custom tailored" to meet the specific requirements of frequency-modulated transmission service up to 150 megacycles.

Highly efficient forced-air-cooling is assured by the use of pure copper anodes, joined to the cooling fins by a thin solder film of high thermal conductivity. Radial cooling fins provide large surface area and unrestricted airflow path. Federal's vast tube-making facilities, backed by 37 years of experience, give you real assurance of matchless performance, rugged dependability and maximum tube life.

RATINGS FOR FM BROADCAST SYSTEMS IN THE 88 TO 108 MEGACYCLE BAND (MAXIMUM OUTPUT UP TO 150 MC)

	7C 26	7C 27
Maximum plate dissipation	1000 watts	3000 watts
Filament voltage	9.0 volts	16.0 volts
Filament current	29.0 amp.	28.5 amp
Amplification factor	17	21
Mutual conductance	20,000 Umhos	20,000 Umhos
Cooling air velocity at maximum output	75 cu ft/min.	150-175 cu ft/min
Maximum overall dimensions		
Height	4¼ in.	.8 in
Diameter	2½ in.	3½ in

Federal tells how to make tubes last longer—
Write to Department K337 for this interesting and in-
formative 20-page book which gives helpful hints on
how to get the most out of your electronic tubes.



Federal Telephone and Radio Corporation

In Canada:—Federal Electric Manufacturing Company, Ltd., Montreal
Export Distributor:—International Standard Electric Corporation

Newark 1, New Jersey





(Continued from page 36A)

PITTSBURGH

"New Frequency-Modulation Transmitters," by L. O. Krause, General Electric Company; April 8, 1946.

PORTLAND

"Measurement and Control Apparatus," by F. M. Brown and D. C. Strain, Brown Engineering Company; April 10, 1946.

"Procedures in Microwave Antenna Design," by J. J. Brady, Oregon State College; May 8, 1946.

ROCHESTER

"Charting the Course of The Institute of Radio Engineers," by F. B. Llewellyn, Bell Telephone Laboratories; May 16, 1946.

Election of Officers, May 16, 1946.

ST. LOUIS

"Urban Mobile Radio-telephone Systems," by A. C. Peterson, Jr., Bell Telephone Laboratories; May 23, 1946.

Election of Officers, May 23, 1946.

SAN DIEGO

"Communication Transformers and Reactors," by C. Biggs, University of California, Division of War Research; May 3, 1946.

TORONTO

"Radio Broadcasting in Canada," by H. Hillard (read Dr. Frigon's paper in *absentia*), Regional Engineer, Canadian Broadcasting Corporation; April 8, 1946.

"The Radio Proximity (VT) Fuze," by P. E. Pashler, Canadian Army Armament Research and Development Establishment; May 13, 1946.

Election of Officers, May 13, 1946.

TWIN CITIES

"Low-Power Microwave Signal Sources for Wide Tuning Ranges," by J. M. Pettit, Airborne Instruments Laboratory; May 21, 1946.

Election of Officers, May 21, 1946.

WILLIAMSPORT

"Processing and Pressing of Transcriptions," by K. R. Smith, Muzak Corporation; May 1, 1946.

SUBSECTIONS

PRINCETON

(Philadelphia Subsection)

"Electronic Computing Circuits of the ENIAC," by A. W. Burks, Princeton University; May 8, 1946.

Election of Officers, May 8, 1946.



Designs NEW Pickup Cartridge with NYLON Chuck and REPLACEABLE, Long-Life, Sapphire-Tipped NYLON Needle

● Constantly alert to the possibilities for improvement in the design and performance of phonograph pickup cartridges. Astatic research has unearthed a material, other than metal, for the better transmission of signals from the record grooves to the crystal element. That material is NYLON! No other known substance possesses all the properties which make Nylon ideal for this purpose. Astatic, therefore, has employed this revolutionary material in the manufacture of a new crystal pickup cartridge known as Astatic Nylon 1-J . . . a low pressure, wide-range, general purpose cartridge incorporating a Nylon chuck and Nylon, sapphire-tipped needle.

CONTROL OF QUALITY OF REPRODUCTION

In using this Nylon 1-J Crystal Pickup Cartridge, the phonograph manufacturer, as well as the user, is assured that the quality of reproduction will REMAIN CONSTANT regardless of needle replacements, because the cartridge is matched to the needle, and the Nylon needle designed for this particular Cartridge is the ONLY one that can be used with it.



PARTIAL VIEW of cartridge, showing knee-action Nylon needle and metal needle guard. The cushioning action of Nylon affords additional protection for the sapphire stylus.

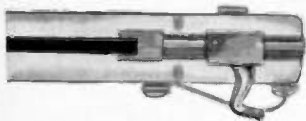

INTERIOR VIEW showing crystal element, Nylon chuck and sapphire-tipped Nylon needle.



PHANTOM VIEW showing how tapered shank of Nylon needle fits into tapered hole in Nylon chuck.

Astatic Crystal Devices manufactured under Brush Development Co. patents.

THE Astatic CORPORATION
ASTATIC CONNEAUT, OHIO
IN CANADA: CANADIAN ASTATIC LTD., TORONTO, ONTARIO

For Better Remote Broadcasts . . .



Construction is compact and clean



. . . Complete in One Package!

The light weight, small size, a-c or battery operated Collins 12Z remote amplifier is a modern contribution to the furtherance of high quality remote broadcasts. Its frequency response of 30-12,000 cps \pm 1.0 db and noise level of more than 55 db below program level are in keeping with high fidelity AM and FM standards.

The 12Z features excellent performance, program protection, and convenience. Stabilized feedback maintains program quality over a wide variation of operating conditions. The self-contained batteries are connected automatically should the a-c power source fail. If the program line should fail, a twist of a knob connects a second line. The four microphone input channels have individual attenuator controls, in addition to the master control. The large, illuminated VU meter reads output level or operating voltages.

Complete in one package, the equipment weighs only 40 pounds and can be carried readily by one person. Transportation and set-up problems are reduced to a minimum. Maintenance is greatly simplified through advanced chassis design. Write us for full information.

Collins Radio Company, Cedar Rapids, Iowa

11 W. 42nd St., New York 18, N. Y. • 458 S. Spring St., Los Angeles 13, Cal.

Specifications:

Mixing channels: four
Gain: approximately 90 db
Frequency response: 30-12,000 cps \pm 1.0 db
Noise level: more than 55 db below program level
Distortion: less than 1% from 50-7500 cps
Input impedance: 30/50 ohms. 200/250 ohms on special order
Output impedance: 600 ohms (150 ohms available)
Power output: 50 milliwatts (+17 dbm)
Power source: 115 volts a-c, or self-contained batteries
Batteries: standard types, easily obtained
Weight: 40 lbs. complete
Size: 14½" w, 11½" h, 8¼" d

FOR BROADCAST QUALITY, IT'S . . .



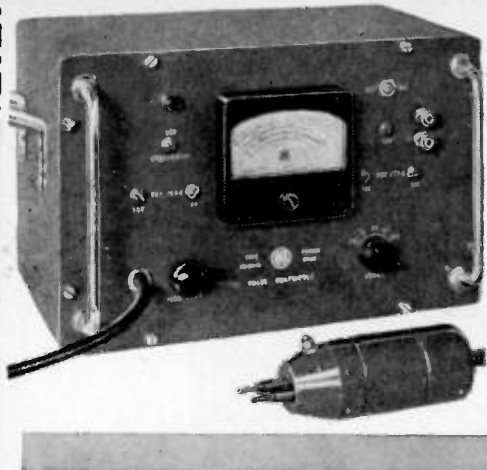

*Precision
Instruments*
FOR
**RESEARCH
AND
INDUSTRY**



VALVE VOLTMETER

An instrument having a universal application for voltage measurements where a very high input impedance is required. It is suitable for use from low audio to high radio frequencies, typical applications being the measurement of oscillator output voltages, and both input and output voltages of audio amplifiers, R.F. amplifiers and filters.

Features: 0.2 volt to 150 volts in 5 ranges, capacity multipliers available to 7500 volts RMS, meter scales directly calibrated, shielded probe, voltmeter stabilised with respect to mains variations, self calibrating.

Other A.W.A. Instruments

● **B.F.O. TYPE A96060**

20 to 20,000 cycles, 40 in. spiral scale, incremental frequency dial, internal crystal calibration at subharmonics of 100 kes. down to 2 kes. Calibration of multiples of mains frequency up to 500 cycles. Output 1 watt. Distortion 1%. Variety of output impedances.

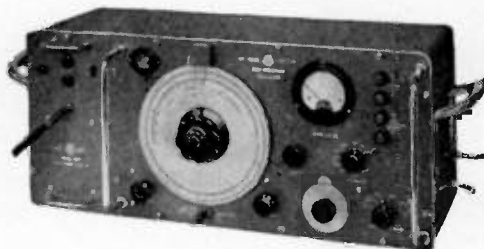

● **C.R.O. TYPE R6673**

2" cathode ray valve, fine trace, time base oscillator frequency continuously variable from 30 cycles to 40 kc., horizontal and vertical amplifiers suitable for audio and low R.F. Portable, rack mounting and intensity modulation types.



Amalgamated Wireless (Australasia) Ltd.

AUSTRALIA'S NATIONAL WIRELESS ORGANISATION

47 York Street, Sydney, Australia

- SIGNAL GENERATORS.
- "Q" METERS.
- C.R. OSCILLOGRAPHS.
- HETERODYNE CALIBRATORS.
- A.F. METERS.
- IMPEDANCE MATCHING EQUIPMENT.
- BEAT FREQ. OSCILLATORS.
- OUTPUT METERS.
- DECADE RESISTANCE BOXES.
- WAVEMETERS.
- VALVE VOLTMETERS.
- MULTIVIBRATORS.



The following transfers and admissions were approved on June 4, 1946:

Transfer to Senior Member

- Arnold, P. N., Sound Division, Naval Research Laboratory, Washington 20, D. C.
- Bailey, G. W., 1 E. 79 St., New York, N. Y.
- Bain, J. R., 4515 Old Orchard Ave., Montreal, Que., Canada
- Bereskin, A. B., 452 Riddle Rd., Cincinnati 20, Ohio
- Budenbom, H. T., Box 257, Wellington Ave. W., Short Hills, N. J.
- Cole, N. D., 55 Roycroft Ave., Pittsburgh 16, Pa.
- Davis, J., 6439 Glenwood Ave., Chicago 26, Ill.
- DeMello, W., Western Electric Co., (Caribbean), Apartado 1967, Caracas, Venezuela, South America
- Dishal, M., 5 Adams Court, Nutley 10, N. J.
- Ekstrand, P. A., 432 Maple Ave., Vallejo, Calif.
- Ellithorn, H. E., 417 Parkovash, South Bend 17, Ind.
- Fisher, R. C., 602 N. C St., Tacoma 3, Wash.
- Flory, L. E., 29 Harold Ave., Princeton N. J.
- Gager, F. M., 127 Rowe Terrace, Auburndale 66, Mass.
- Goldsmith, T. T., Jr., 69 Rugby Rd., Cedar Grove, N. J.
- Gottier, T. L., 106 Church, Waltham 54, Mass.
- Hough, R. R., Bell Telephone Laboratories, Whippany, N. J.
- Hutchinson, H. P., 3808 Windom Pl. N.W., Washington 16, D. C.
- Inman, J. F., 231 S. Green St., Chicago 7, Ill.
- Jackson, W. C., 1010 Pleasant St., Oak Park, Ill.
- Tupper, B. R., Northwest Telephone Co., 1955 Wylie St., Vancouver, B. C., Canada

Admission to Senior Member

- Anderson, K. W., 4827 Liberty, Kansas City 2, Mo.
- Ballard, W. C., Jr., Franklin Hall, Ithaca, N. Y.
- Barclay, A. P. H., 107 McRae Dr., Leaside, Toronto 12, Ont., Canada
- Boucheron, P., Farnsworth Television and Radio Corp., Fort Wayne, Ind.
- Cassell, W. L., Department of Electrical Engineering, Iowa State College, Ames, Iowa
- Haxby, R. O., Sperry Gyroscope Co., Garden City, L. I., N. Y.
- Hill, A. G., Massachusetts Institute of Technology, Cambridge 39, Mass.
- Hinman, W. S., Jr., 410 Great Falls St., Falls Church, Va.
- Holst, P. F. G., 7309 Clovernook Ave., Mt. Healthy 31, Ohio

(Continued on page 42A)

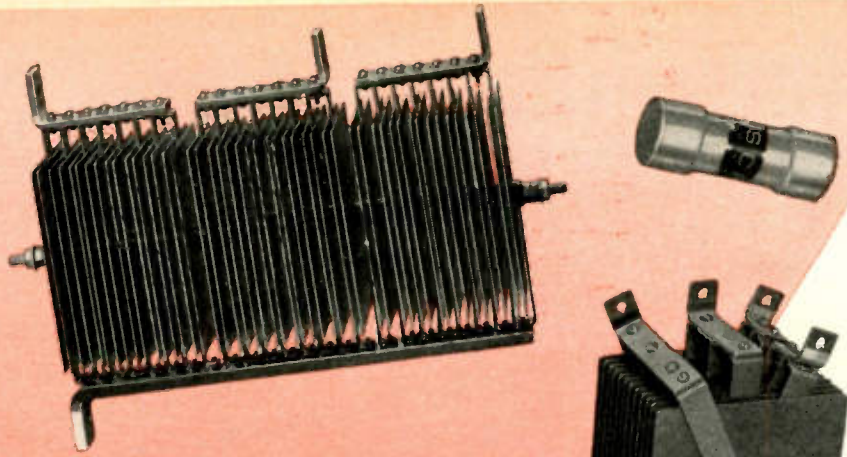

FROM 10 MICRO AMPERES TO 10,000 AMPERES

SELENIUM RECTIFIERS

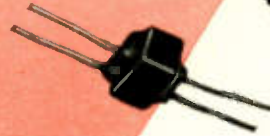

**IMMEDIATE
DELIVERY**

Manufacturers of a broad line of SELENIUM Power and Instrument Rectifiers, Photo-Electric Cells and allied scientific products.

Solve your rectification problems with SELENIUM. SELENIUM rectifiers are rapidly becoming standard in industry. Check these outstanding features:

- ✓ Permanent characteristics.
- ✓ Adaptability to all types of circuits and loads.
- ✓ Unlimited life—no moving parts.
- ✓ Immunity to atmospheric changes.
- ✓ High efficiency per unit weight.
- ✓ Hermetically sealed assemblies available.
- ✓ From 1 volt to 50,000 volts RMS.
- ✓ From 10 micro-amperes to 10,000 amperes.
- ✓ Economical—No maintenance cost.



SELENIUM CORPORATION OF AMERICA

Affiliate of **VICKERS**, Incorporated
 1719 WEST PICO BOULEVARD • LOS ANGELES 15, CALIFORNIA
 Export Division: Frazer & Hansen, 301 Clay Street, San Francisco 11, Calif.
 In Canada: Canadian Line Materials, Ltd., Toronto 13, Canada

ARE YOU PLANNING TO GIVE MORE LISTENERS BETTER RECEPTION ?

If you're planning to add load to your output, you can take a load off your shoulders by turning your antenna problem over to Blaw-Knox.

Unequalled experience in this field—backed by thousands of successful installations ranging in size up to 1000 feet—means that you can rely on Blaw-Knox for full responsibility in the fabrication of FM and Television Towers.

BLAW-KNOX DIVISION
of Blaw-Knox Company
2037 FARMERS BANK BUILDING
PITTSBURGH, PENNSYLVANIA

BLAW-KNOX

VERTICAL RADIATORS
FM and TELEVISION TOWERS



(Continued from page 40A)

- Kellerman, K. F., 15 Macopin Ave., Upper Montclair, N. J.
 Kloeffler, R. G., Department of Electrical Engineering, Kansas State College, Manhattan, Kan.
 Law, H. B., 201 Harrison St., Princeton, N. J.
 LePage, W. R., Research Department, Stromberg Carlson Co., Rochester 3, N. Y.
 Meyers, S. T., 64 Whittlesey Ave., East Orange, N. J.
 Norwine, A. C., 463 West St., New York 14, N. Y.
 Rajchman, J. A., 90 Westcott Rd., Princeton, N. J.
 Salmon, V., 6220 S. Moody Ave., Chicago 38, Ill.
 Schimpf, L. G., Ridgeview Ave., New Providence, N. J.
 Stillwell, A. L., 527 Kimball Ave., Westfield, N. J.
 Stocker, A. C., 311 Newton Ave., Collingswood, N. J.
 Strutt, M. J. O., Joh. Vestersstreet 40, Eindhoven, Netherlands

Transfer to Member

- Affias, I. M., 3339 Hull Ave., New York 67, N. Y.
 Bell, R. A., 242 Harrogate Rd., Penn Wynne, Philadelphia 31, Pa.
 Bopp, C. C., 1114 Maycliff Pl., Cincinnati 30, Ohio
 Cosby, J. R., 215 Bosley Ave., Towson 4 Md.
 Criddle, C. B., Commodore Hotel, Brementon, Wash.
 Culbertson, G. K., 5133 Juanita Ave., Edina, Minneapolis 10, Minn.
 Durkee, C. E., 4245 Elston Ave., Chicago 18, Ill.
 Frankart, W. F., 1429 E. 125 St., Compton Calif.
 Freeman, W. H., 601 Laurel Ave., Wilmette, Ill.
 Gates, C. E., 1435 W. 31 St., Minneapolis 8, Minn.
 Ghosh, S. P., c/o Mr. B. B. Ghosh, Adra, B. N. R., Manbhum, District Bihar, India
 Glassey, R. B., Physics Department, Auckland University College, Princes St., Auckland, New Zealand
 Grunwald, R., 804 Marion St., Oak Park, Ill.
 Hance, H. V., 1 Ridge Rd. S.E., Washington 19, D. C.
 Hansen, I. C., 23 Kenny Rd., Remuera, Auckland S.E. 2, New Zealand
 Hebal, W. H., R.F.D. 5, Box 817, Waukesha, Wis.
 Hudgins, W. D., c/o Bonneville Power Administration, Mid-Columbia District Office, Box 118, Walla Walla, Wash.
 Hunt, J. M., 3609 Forest Ave., Kansas City 3, Mo.
 Jenkins, J., 1121 Dormont Ave., Pittsburgh 16, Pa.

(Continued on page 44A)

TWO GREAT NEW LABORATORY INSTRUMENTS



Full, accurate use of station WWV, the world's finest primary frequency and time standard, is obtained from the Browning Model RH-10 Standard Frequency Calibrator. The standard Browning RH-10 is pre-tuned for 5 and 10 megacycles per second reception, at sensitivities better than $\frac{1}{2}$ microvolt on either band. A dual filter system provides selection of either the 440 or 4000 cycle modulation of WWV for use as a primary frequency standard.

Checking equipment against station WWV, at accuracies up to one part in five million, the Browning Frequency Calibrator enables compar-

BROWNING MODEL RH-10 STANDARD FREQUENCY CALIBRATOR

isons to be made in three general categories:

1. Precision radio frequency standards measurements.
2. Precision audio frequency standards measurements.
3. Precision time and pulse standards for physical measurements.

The Browning RH-10 consists of a high Q antenna transformer, a sharply tuned R-F amplifier, converter, oscillator, two IF stages, detector, selective amplifier output stages and a cathode ray zero beat indicator. Although normally supplied for 5 and 10 megacycles per second operation, any two combinations of 2.5, 5, 10, or 15 megacycles may be had on special order.

WRITE FOR DESCRIPTIVE LITERATURE

BROWNING MODEL OL-15 OSCILLOSCOPE

Designed for observing phenomena requiring extended range amplifiers and a wide variety of time bases, the Browning Model OL-15 Oscilloscope incorporates improvements that make it useful in numerous applications where ordinary oscilloscopes are inadequate.

For instance, the Browning OL-15 is particularly adaptable to television, radar and facsimile work, as well as with radio-frequency equipment where it is desirable to know actual r.f. waveform composition. The low repetition sweep gives visual observation when recurring phenomena of a few sweeps per second are encountered.

Suitable time base facilities for studying signals with a constant time difference, or those with an inconstant time separation between consecutive phenomena, are provided by the Browning OL-15. In general, the improved design and superior construction of the Browning OL-15 make it a highly flexible instrument for use in all laboratory work, production testing, or research applications.

WRITE FOR DESCRIPTIVE LITERATURE

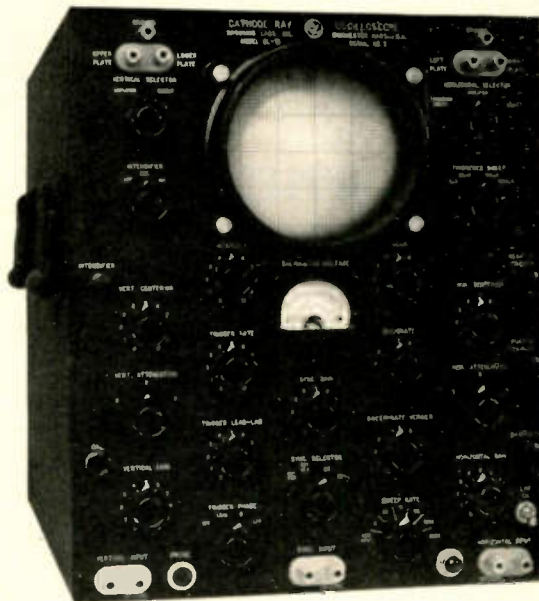

BROWNING

LABORATORIES, INC.
WINCHESTER, MASS.

Do you have a
TRANSFORMER
COMPONENT PROBLEM?

If so

Choose The Source
with--

COMPLETE FACILITIES

plus--

MANUFACTURING KNOW-HOW

At Chicago Transformer, facilities for every step in transformer manufacture—from production of coils, cores and mounting parts thru final assembly—are combined with plant-wide manufacturing know-how, gained during C.T.'s years of experience in the specialty transformer field.

Thus, in selecting a source for your transformer components, consider Chicago Transformer, an established manufacturer in the Electronic Industry.



CHICAGO TRANSFORMER

DIVISION OF ESSEX WIRE CORPORATION

3501 ADDISON STREET · CHICAGO, 18



(Continued from page 42A)

- Jipp, J., Room 1104, Praetorian Bldg., Dallas 1, Texas
 Kass, S., 236 First St., Perth Amboy, N. J.
 Klein, R. M., 2200 Morris Ave., New York 53, N. Y.
 Marsal, P., Box 6087, Cleveland 1, Ohio
 Maxwell, J. F., 742 Clement St., San Francisco, Calif.
 Morrow, J. E., 410 S. Lawn Ave., Kansas City 1, Mo.
 Pineau, N. T., Sr., U.S.N. Material Catalog Office, 111 E. 16 St., New York 3, N. Y.
 Roberts, W. K., 329 Talbot Ave., Laurel, Md.
 Rylsky, G. V., Eclipse-Pioneer, Bendix Aviation Corp., Teterbori, N. J.
 Sayre, A. G., 6 Windsor Court, Milton Junction, Wis.
 Shuey, P. F., 358 Grove Ave., Galion, Ohio
 Smail, J. E., 2, Bright's Crescent, Edinburgh 9, Scotland
 Staderman, H. W., 264 Loring Ave., Buffalo 14, N. Y.
 Steele, O. A., 1506 S.W. Montgomery St., Portland 1, Ore.
 Swinney, J. C. C., Jr., 101 Merriman Rd., Draper, N. C.
 Talbot-Jones, R. V., Civil Radio Station, St. Michaels Rd., Singapore, China
 Toivonen, E. O., 371 North St., North Weymouth 91, Mass.
 Wolfskill, J. R., 450 Long Branch Ave., Long Branch, N. J.
 Zandonini, E. M., 4430 Garrison St., N.W., Washington 16, D. C.

Admission to Member

- Abajian, H. B., Airborne Instruments Laboratory, 160 Old Country Road, Mineola, N. Y.
 Abberhouse, R. P., 11 Henderson St., Passaic, N. J.
 Anderson, C. R., 341 Willis Ave., Mineola, L. I., N. Y.
 Andrade, E. A., 4517 N. Magnolia St., Chicago 40, Ill.
 Aveney, R. J., 14 Lenox Dr., West Hempstead, L. I., N. Y.
 Bobroff, D. L., 1406 Drake St., Madison 5, Wis.
 Bragg, H. E., 130 W. 44 St., New York 18, N. Y.
 Brown, W. R., 98—120 Queens Blvd., Forest Hills, L. I., N. Y.
 Burkett, K. V., Northern Electric Co. Ltd., 1261 Shearer St., Montreal, Que., Canada
 Burtner, R. L., Telicon Corp., 851 Madison Ave., New York 21, N. Y.
 Campbell, C. J., 276 Ash St., Winnipeg, Manit., Canada
 Carlisle, C. H., 3813 Southwestern, Houston 5, Texas
 Carver, L. A., School of Engineering, Rutgers University, New Brunswick, N. J.
 Clark, B. L., 146 Arch St., San Francisco 25, Calif.

(Continued on page 46A)

Callite filament

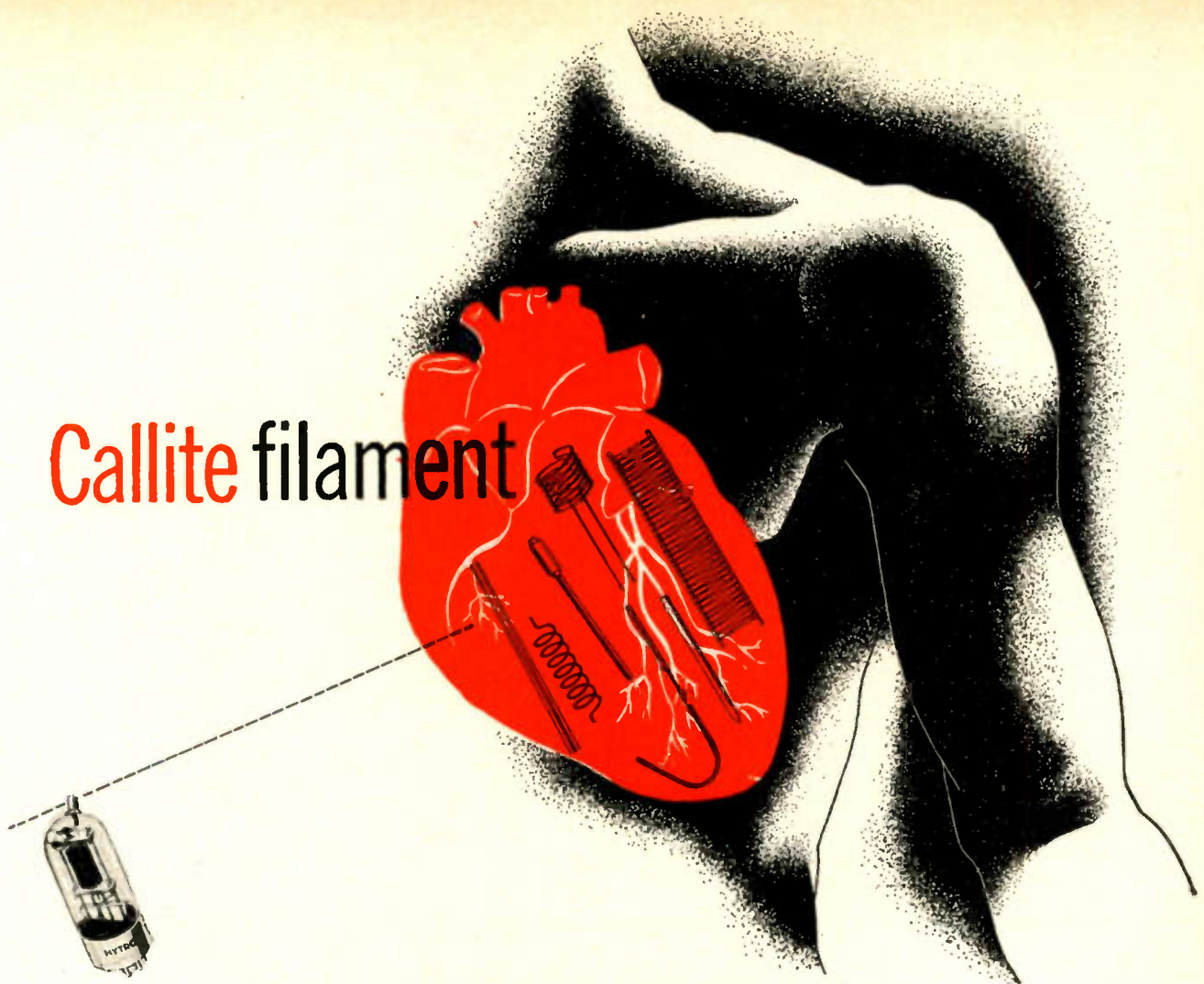

the heart of this Hytron Triode

The little HY75, medium-power triode, long a favorite of radio amateurs for its highly efficient operation at frequencies from 50 to 300 megacycles, now leads a versatile life. Widely used in War Emergency Radio Service networks, the HY75 has also found favor in Government and industrial research laboratories.

Callite supplies the Hytron Radio & Electronics Corp. with formed filament coils of 88.5 milligram thoriated tungsten wire for the HY75. Callite carefully processes tungsten wire with the right proportions of tungsten and thoria to give the required electronic emission, plus rugged strength to resist vibration and shock.

Leading tube manufacturers look to Callite for tube components, known throughout the industry for their quality and uniformity. It will pay you to investigate our complete range of metallurgical components. Callite Tungsten Corporation, 544 Thirty-ninth Street, Union City, New Jersey. Branch Offices: Chicago, Cleveland.

Callite
Tube components



Hard glass leads, welds, tungsten and molybdenum wire, rod and sheet, formed parts and other components for electron tubes and incandescent lamps.

new...
improved
portable

Radiotone

HOLLYWOOD



"America's
Finest Portable Recorder"
illustrated—Model RA-116

Here's the answer to your recording problems in a single, compact, portable unit! Radiotone, a pioneer in instantaneous recording, with over 10-years experience backed by thousands of units in service is now manufactured by Ellinwood Industries, famous for Design Simplicity—Dependability. Check these features—note the improvements—then send for name of local representative and complete, illustrated catalog describing the RA-116 and other portable models.

FEATURES

THE RA-116—Produces acetate recordings of professional quality from 6" up to 16". Accommodates 17½" masters for 16" pressings.

DUAL SPEED—78 or 33½ r.p.m. instantly selected by an improved lever shift which locks into position.

LEAD SCREW—Positive feed overhead lead screw insures perfect grooves and dependable operation. Direction of cut can be changed instantly from outside-in to inside-out. Run-in grooves may be made when desired.

VARIABLE LINES—The number of lines per inch on the disc may be varied from 90 to 130.

DEPTH OF CUT ADJUSTMENT—Accurate regulation of pressure at the cutting stylus is obtained by turning a calibrated knob.

DRIVE SYSTEM—Radiotone has perfected a positive silent drive insuring perfect motion, correct pitch, and stability. Moving parts have been reduced to a minimum. Speed accuracy is maintained within .3% at 78 rpm. and .4% at 33½ rpm. Single revolution accuracy is maintained within .1%.

TURNABLE—A 16" dynamically balanced cast aluminum turntable is used. The hardened steel driving shaft revolves on a single steel ball at the bottom of a 6" cast bearing well which contains two bronze "oilite type" bearings.

DUO-CHROMATIC EQUALIZERS—Two controls allow continuously variable response over both high and low registers.

MULTIPLE INPUT CHANNELS—Two high impedance input channels are provided. (Low impedance also available.) Two jacks are for

microphone use and have an overall gain of 130 DB. The other two have an overall gain of 80 DB, which is suitable for most any crystal, magnetic or dynamic pickup as well as a zero level line.

MIXERS—Two independent volume controls are provided and may be operated simultaneously.

VOLUME INDICATOR—A volume indicator meter is provided for accurate monitoring of recording level.

OUTPUTS—All output impedances are 8 ohms.

AMPLIFICATION STAGES—The amplifier has four stages. The first one is a dual pre-amplifier utilizing one 7F7 tube which provides the two microphone inputs. The second is the duo-harmonic equalizer stage also utilizing one 7F7 tube. The third uses two 7F7 tubes in push-pull as phase inverted degenerative resistance coupled drivers. The fourth is the power output stage using two 7C5 tubes in push-pull class "A" feeding an extra heavy duty output transformer. Inverse feedback is employed to insure stability. Power output is 14 Watts. Harmonic distortion at cutting level is less than 1%.

RADIO—A radio receiver designed for recording is available as an accessory to the RA-116 and space is provided by removing the panel at the left side of the amplifier.

POWER REQUIREMENTS—110-120 Volts. 50 or 60 cycles AC. 150 Watts. May be used on DC by addition of converter.

SPEAKER—Heavy duty 12-Inch high fidelity, permanent magnet dynamic type.

FINISH—Handsome leatherette case with chromium hardware. Exterior metal parts finished in baked crackle lacquer with chrome trim.

ELECTRONICS DIVISION
Ellinwood
INDUSTRIES

170 WEST SLAUSON AVE., LOS ANGELES 3, CALIF.



(Continued from page 44A)

- Colangelo, O. R., 102 Colebrook St., Hartford, Conn.
- Cook, W. F., 9921 Markham St., Silver Spring, Md.
- Creveling, C. J. Army Section, Combined Research Group, Naval Research Laboratories, Washington 20, D. C.
- Cronin, L. J., 8 Townsend Rd., Belmont 78, Mass.
- Crouch, G. E., Jr., Electrical Engineering Department, Princeton University, Princeton, N. J.
- Daniels, H. L., 2714 Upshur St., Mt. Rainier, Md.
- DeBlois, S. W., 118 Marlborough St., Boston, Mass.
- Dibrell, J. W., 23 W. Irving St., Chevy Chase 15, Md.
- Duncan, J. H., Hotel Gloria, Rio de Janeiro, D. F., Brazil, South America
- Dunn, C. M., United States Navy Underwater Sound Laboratory, Box 271, Fort Trumbull, New London, Conn.
- Elliot, W. H., 3564 N. Murray, Milwaukee 11, Wis.
- Fails, W. A., 23 Albemarle Ave., Hempstead, L. I., N. Y.
- Feagin, F. J., 202 Humble Bldg., Houston 1, Texas
- Fielder, C. K., 3833 Southwestern, Houston 5, Texas
- Fisk, N. C., 3005 W. Chicago Ave., Detroit 6, Mich.
- Grant, E. W., 319½ S. Third St., Alhambra, Calif.
- Griffiths, R. W., Graybar Electric Co., King and Occidental Sts., Seattle 1, Wash.
- Grissler, H. W., 27 West End Ave., Summit, N. J.
- Hadden, G. H., 35½ Becher St., London, Ont., Canada
- Harding, G. C., 5320 Norwood Rd., Kansas City 3, Kan.
- Hardy, H. C., Armour Research Foundation, Chicago 16, Ill.
- Harney, P. J., Thunderstorm Project, Army Air Base, Orlando, Fla.
- Herkart, P. G., 25 Palmer Sq. W., Princeton, N. J.
- Hower, P. A., Polytechnic Research and Development Co., 66 Court St., Brooklyn 2, N. Y.
- Jensen, A. S., RCA Laboratories, Princeton, N. J.
- Kagalwala, A. F., 69 W. 38 St., New York, N. Y.
- Kelton, W., 40 Halsey Dr., Dayton 3, Ohio
- Kilgallen, A., 1300 N. Kirkwood Rd., Arlington, Va.
- King, E. J., Jr., 3282 Coronado Rd., Kansas City, Kan.
- Klotz, J. W., 2419 Massachusetts Ave. N.W., Washington 8, D.C.
- Lee, G. F., International Division, Room 7511, Federal Communications Commission, Washington 25, D. C.
- McKnight, W. J., TACA Airways Agency, 630 Fifth Ave., New York, N. Y.

(Continued on page 48A)



LABORATORY INSTRUMENTS FOR SPEED AND ACCURACY

**HOW -hp- INSURES ACCURACY
OF EACH MODEL 400A
VACUUM TUBE VOLTMETER**

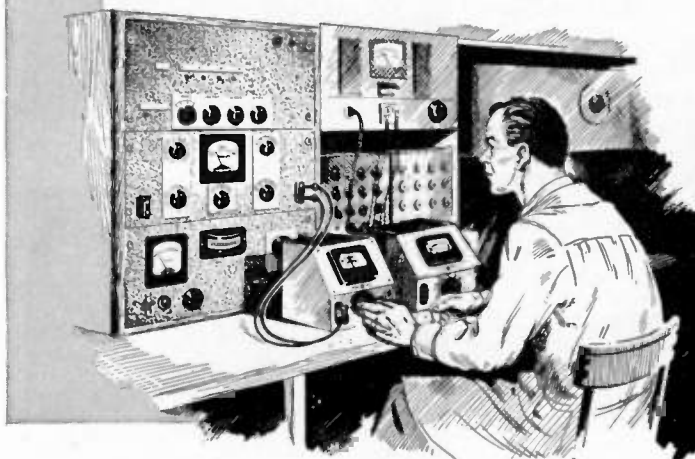

The accuracy of -hp- instruments begins with the engineers' blueprints, but it does not stop there. Precision assembly, individual hand calibration for each instrument, and pre-calibration tests over the entire range of the instrument are your assurance that speed and accuracy will be maintained under all operating conditions.

UNIQUE VOLTAGE GENERATOR

Take the -hp- Model 400A Vacuum Tube Voltmeter for example. This measuring instrument is unusually versatile, because of its wide frequency range, wide voltage range, and high order of accuracy. For adequate production tests of the 400A, it was necessary to develop known voltages ranging from 3 millivolts to 300 volts, at frequencies from 10 cycles to 1,000,000 cycles. HP engineers solved the problem by building a unique voltage generator

which would function as a test set by generating known voltages over the entire range of the Model 400A. Circuits were devised to develop 160 different combinations of voltages and frequencies, each a separate calibration point for the 400A. Each of these voltages is related to the other with an accuracy of better than 1/2%. The absolute magnitude of each voltage is held to better than ±1%. This voltage is compared regularly with standard laboratory instruments of high accuracy. The voltages which are developed are sinusoidal so that no error in calibration is introduced by poor wave form.

DEPENDABLE ACCURACY

Because of this careful checking and re-checking, you can depend on the operating efficiency and accuracy of the Model 400A Vacuum Tube Voltmeter for many measuring jobs, including measuring voltages in

the audio, supersonic, and lower rf regions, amplifier gain; network response; output level; hum level; power circuit, high frequency, video, and carrier current voltages; capacity; and coil figure of merit. An outstanding feature of the -hp- Model 400A is that voltage indication is proportional to average value of the full wave.

For complete data on the Model 400A, and on other -hp- laboratory instruments, write today to Hewlett-Packard Company.

HEWLETT-PACKARD COMPANY

BOX 1199D · STATION A · PALO ALTO, CALIFORNIA



- Audio Frequency Oscillators
- Signal Generators
- Vacuum Tube Voltmeters
- Square Wave Generators
- Noise and Distortion Analyzers
- Wave Analyzers
- Frequency Meters
- Frequency Standards
- Attenuators
- Electronic Tachometers

**These -hp- Representatives
Are at Your Service**

Eastern Representative:
Burlingame Associates, Ltd.
11 Park Place
New York 7, N. Y.—Worth 2-2171

Midwestern Representative:
Alfred Crossley
549 West Randolph Street
Chicago 6, Illinois—State 7444

Western Representative:
Norman B. Neely Enterprises
7422 Melrose Avenue
Hollywood 46, California—Whitney 1147

Canadian Representative:
Atlas Radio Corporation
560 King Street West
Toronto 2, Canada—Wa 4761

1199



Tube-type RESISTORS

★ Clarostat Series MT tube-type resistors remain the ideal voltage-dropping means in AC-DC receivers and other compact electronic assemblies. Handy. Compact. Inexpensive. Identical in size, shape, appearance and mounting to the 25Z6 and 25A6 metal radio tubes. Also readily serviced out in the field with Clarostat replacements.

This type provides connections to "hot" leads under the chassis, yet dissipates the heat above it.

Exceedingly high leakage resistance—well over 1000 megohms under adverse conditions—between resistance element and chassis, permits use in the most sensitive circuits without introduction of AC hum.

Terminal connections and leakage resistance meet Underwriters requirements.

Available in a wide range of pilot lamp combinations.

Resistance element comprises coiled resistance winding supported on notched mica form. No sagging. No shorts.

★ Write for DATA . . .

Clarostat Engineering Bulletin 107 contains all necessary technical details. Write for your copy. And submit that resistance or control problem!



CLAROSTAT MFG. CO., Inc. • 285-7 N. 6th St., Brooklyn, N. Y.



(Continued from page 46A)

- Mankin, A. H., 508 E. Johnson St., Philadelphia 44, Pa.
 Marlowe, E. W., 1233 Franklin Ave., Wilkensburg P.O., Pittsburgh 21, Pa.
 Marshall, J. N., 4 Clare Rd., Cambridge, England
 Mennie, J. H., 23 East Dr., Livingston, N. J.
 Morton, G. W., 160 Old Country Rd., Mineola, L. I., N. Y.
 Mossman, J. R., Midwestern Schools, Inc., 623 Porter Bldg., 34 and Broadway, Kansas City 2, Mo.
 Neal, R. B., 4 Dartmouth St., Forest Hills, L. I., N. Y.
 Nicolay, A. A., 1109 Cliff Dr., Santa Barbara, Calif.
 O'Brien, J. C., 283 Malden St., Rochester 13, N. Y.
 Oppenheim, J. N., 15 Taft Ave., Lexington, Mass.
 Paden, G. O., 20 N. Wacker Dr., Chicago 6, Ill.
 Peters, C. E., 1815 Locust St., St. Louis, Mo.
 Porter, E. F., 49 Fairmont Ave., Ottawa, Ont., Canada
 Rand, P. S., Westview Lane, R.F.D. 1, South Norwalk, Conn.
 Rehm, W. L., 11 Locust Dr., Asbury Park, N. J.
 Renner, J. J., Airborne Instruments Laboratory, 160 Old Country Rd., Mineola, L. I., N. Y.
 Ritter, J. W., 740 S. Olive St., Los Angeles 55, Calif.
 Rubin, S., Hazeltine Electronics Corp., 58—25 Little Neck Parkway, Little Neck, L. I., N. Y.
 St. Martin, L., Box 35, Pacific Beach Station, San Diego 9, Calif.
 Schmidt, C. R., 75 W. 190 St., New York 63, N. Y.
 Schor, H., 87 Watson Ave., East Orange, N. J.
 Shamis, S. S., 401 N.E. 16 Ave., Fort Lauderdale, Fla.
 Sichak, W., Federal Telecommunication Laboratories, 67 Broad St., New York 4, N. Y.
 Silver, S., 101 Aberdeen Ave., Cambridge 38, Mass.
 Smart, T. E., 3918 Stickney Ave., Cleveland 9, Ohio
 Smith, J. A., 254 Humble Bldg., Houston 1, Texas
 Spindell, F. A., Sherburne Ave., Tyngsboro, Mass.
 Thomson, C. R., 3411 Harley Rd., Toledo 6, Ohio
 Van Haste, W., Bell Telephone Laboratories, 463 West St., New York 14, N. Y.
 Ware, M., Box 239, Franklin Station, Washington, D. C.
 Warshaw, J., 6002 W. Oxford St., Philadelphia 31, Pa.
 Wille, F. A., 718 Walnut St., Iowa City, Iowa

(Continued on page 56A)

B & W

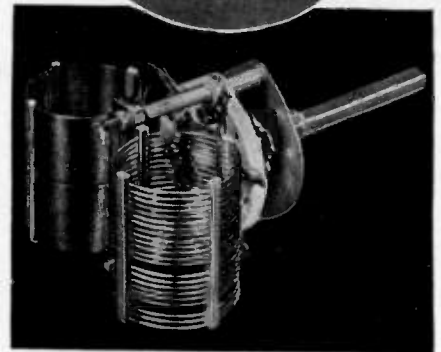

"BAND HOPPERS"

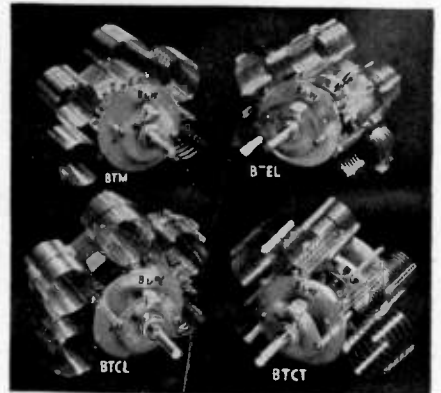

TURRETS

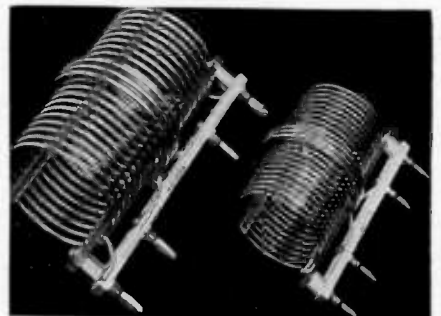

ANTENNA COILS

From amateur radio types to units for broadcast, r-f heating and other electronic uses, B & W offers a complete line of AIR INDUCTORS and assemblies for practically every requirement. Samples to your specifications on request, or send details of your application for recommendation based on standard B & W Inductor type.



BARKER & WILLIAMSON

"Inductor Headquarters"

Dept. IR-76 235 Fairfield Avenue
Upper Darby, Penna.

Give Your New Portable Receivers

LONGER LIFE

Design them with "EVEREADY" BATTERIES



No. 754



No. 482

No. 467

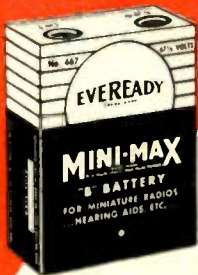

FOR PERSONAL PORTABLES

67½-volt "B" battery: The "Eveready" No. 467 "B" battery is made on the same flat-cell principle as the No. 482, above, providing an unequalled reservoir of energy for this type of portable radio.

1½-volt "A" battery: For long life in an "A" battery, use one or more "Eveready" No. 950 batteries (ASA Size D).

No. 950



For detailed specifications...

Send for Engineering Bulletins No. 1 and No. 2



The registered trade marks "Eveready" and "Mini-Max" distinguish products of National Carbon Company, Inc.



No. 746

FOR PICK-UP PORTABLES



7½-9-volt "A": 90-volt "B": The new "Eveready" "Mini-Max" "A-B" pack, No. 754, contains more energy — gives longer life to portable radios — than any other "A-B" pack of equal size. This is the result of the famous flat-cell principle used exclusively in "Eveready" "B" batteries, which packs more power into less space. Using this "A-B" pack, you can simplify construction and can design more powerful receivers in the same amount of space.

45-volt "B" battery: This "Eveready" "Mini-Max" "B" battery, the No. 482, is smaller and lighter, yet more powerful than the bulkier round-cell type.

4½-volt "A" battery: Radio engineers have found the No. 746 "Eveready" "A" battery gives long, reliable service in pick-up portable receivers.

Other types of battery are available for 1½-volt or 6-volt sets.



No. 412

FOR POCKET RADIOS



22½-volt "B" battery: No. 412 is no larger than a matchbox. No other battery equals it for packing such power in so small a space.

30-volt "B" battery: For pocket radios requiring higher voltage, use the No. 413. Similar in size to the above battery, but ½ inch longer.

For companion "A" battery, use the No. 1016 — fits the same space as two No. 915 (ASA Size AA) standard Penlight cells.

NATIONAL CARBON COMPANY, INC.

30 East 42nd Street, New York 17, N. Y.
Unit of Union Carbide and Carbon Corporation





The following positions of interest to I.R.E. members have been reported as open. Apply in writing, addressing reply to company mentioned or to Box No.

The Institute reserves the right to refuse any announcement without giving a reason for the refusal.

PROCEEDINGS of the I.R.E.

330 West 42nd Street, New York 18, N.Y.

RADIO ENGINEER

Project engineer having a minimum of five years transmitter experience. Activities include design and manufacture of high and medium power transmitters, frequency shifters, communication terminal equipment and other communication products. N.Y.C. area. Salary open. Box 419.

MICROWAVE DEVELOPMENT ENGINEERS

Experience desirable on antenna, waveguide component and general system design. Permanent. Write giving full details regarding education and experience to Personnel Department, Raytheon Manufacturing Company, Waltham 54, Mass.

ENGINEER OR PHYSICIST

Small research and development company in New York City has opening for a graduate engineer or physicist with an electronic or communications background. Work affords great opportunity for exploration and ingenuity in servos, optics, and radiation. Salary open. Box 420.

PHYSICISTS AND ELECTRICAL ENGINEERS

Research project leaders for work combining electronics and general applied physics. Bachelor's degree in physics or engineering plus graduate work and two to four years practical experience.

Junior research engineers for work in electronics. Bachelor's degree in electrical engineering or physics plus one or two years of graduate work or practical experience.

Communicate with R. F. Simons, Airborne Instruments Laboratory, Inc., 160 Old Country Rd., Mineola, N.Y.

WANTED:

Engineer for Transformer Design

- Wide experience (5 yrs. minimum) in the design of laminated iron core coils and transformers. Must be capable of doing original development work and able to handle the design of filters and complex transformers.

Box No. 423

Proceedings of the I.R.E.

APPLIED PHYSICISTS—MICROWAVE ENGINEERS

Organization with long term research and development program in microwaves, electronics and other branches of applied physics has openings for several senior and junior staff members. Seniors should have advanced degrees in physics or electrical engineering and be capable of taking complete charge of project. Juniors require B.S. degree and preferably two or more years experience in development of electronic or microwave equipment. Salaries commensurate with abilities. Location N.Y.C. Give all details in first letter. Box 421.

PHYSICISTS

Wanted by a large Mid-West petroleum company for the Physics Section of the Research and Development Laboratories. A man well versed in the design and construction of the electronic components of physical apparatus used in the testing of petroleum and its products, for example, spectrographs, mass spectrometers, electron diffraction and recording instruments. Some knowledge of and experience with high frequency oscillators would be desirable. This position is permanent and offers unusual and interesting opportunities for the right man. Give complete details as to personal history, education, experience and salary required in first letter. Box 422.

PHYSICISTS

Two Physicists, M.S. or Ph.D. (experience preferred) for long term project in microwave research and development. For details write Box 417.

ENGINEERS AND PHYSICISTS

With experience in radar and/or microwave research, development and design, interested in working along these lines. Write full details as to education and experience to Box 424.

RADIO INSTRUCTORS

Receiver servicing experience. Degree preferred. \$3600 to start; \$4200 after 4 months. Work in the heart of the radio industry. Write Raleigh G. Dougherty, c/o New York Technical Institute of New Jersey, 158 Market St., Newark 2, N.J.

PRODUCTION EXECUTIVES

Two executives: Production Manager also Head Production Control Department with several years experience in electronic equipment manufacturing and assembly. Salary \$5000 to \$8000. Write for interview describing background and experience especially peacetime production responsibilities before the war. Box 418.

ENGINEERS & PHYSICISTS

With experience in radar and/or microwave research, development and design.

Interested in working along these lines.

Write giving full details as to education and experience.

Box PRE 7653, 113 W. 42nd N.Y. 18

EXECUTIVE ELECTRONICS ENGINEER

At once by Connecticut manufacturer who is fast moving into the realms of larger business—must be an engineering school graduate; experienced in radio, electronics, and electricity; must have administrative experience and stature; must have product and production evaluation knowledge; must get along with an energetic, independent organization. Write all details in first letter; salary expected; recent picture. Box No. 415.

FACTORY ENGINEER

We have openings in our Factory Engineering Division for two outstanding men. Experienced background of at least five years engineering work on factory problems relating to receiving tube manufacture required. Engineering degree would be helpful, but primary requirements of the positions are the experience and ability to successfully solve the everyday problems encountered in the manufacture of receiving tubes. Apply by letter to Personnel Department, National Union Radio Corporation, Lansdale, Pa.

ENGINEERS

TELEVISION. Experienced television receiver senior engineer.

RADIO. Experienced home set senior engineer.

Both positions are permanent and offer excellent opportunity and pay. United States Television Manufacturing Corp., 3 West 61st Street, New York 23, N.Y.

HERE THEY COME!



THE NEW S-38's 4 Bands—540 kc. to 32 Mc.

\$39.50
ADD 3%
IN
ZONE 2

The Model S-38 meets the demand for a truly competent communications receiver in the low price field. Styled in the post-war Hallicrafters pattern and incorporating many of the features found in more expensive models, the S-38 offers performance and appearance far above anything heretofore available in its class. Four tuning bands, CW pitch control adjustable from the front panel, automatic noise limiter, self-contained PM dynamic speaker and "Airodized" steel grille, all mark the S-38 as the new leader among inexpensive communications receivers.

FEATURES

1. Overall frequency range—540 kilocycles to 32 megacycles in 4 bands.
Band 1—540 to 1650 kc.
Band 2—1.65 to 5 Mc.
Band 3—5 to 14.5 Mc.
Band 4—13.5 to 32 Mc.
Adequate overlap is provided at the ends of all bands.
2. Main tuning dial accurately calibrated.
3. Separate electrical band spread dial.
4. Beat frequency oscillator, pitch adjustable from front panel.
5. AM/CW switch. Also turns on automatic volume control in AM position.
6. Standby/receive switch.
7. Automatic noise limiter.
8. Maximum audio output—1.6 watts.
9. Internal PM dynamic speaker mounted in top.
10. Controls arranged for maximum ease of operation.
11. 105-125 volt AC/DC operation. Resistor line cord for 210-250 volt operation available.
12. Speaker/phones switch.

CONTROLS: SPEAKER/PHONES, AM/CW, NOISE LIMITER, TUNING, CW PITCH, BAND SELECTOR, VOLUME, BAND SPREAD, RECEIVE/STANDBY.

EXTERNAL CONNECTIONS: Antenna terminals for doublet or single wire antenna. Ground terminal. Tip jacks for headphones.

PHYSICAL CHARACTERISTICS: Housed in a sturdy steel cabinet. Speaker grille in top is of airodized steel. Chassis cadmium plated.

SIX TUBES: 1—12SA7 converter; 1—12SK7 IF amplifier; 1—12SQ7 second detector, AVC, first audio amplifier; 1—12SQ7 beat frequency oscillator, automatic noise limiter; 1—35L6GT second audio amplifier; 1—35Z5GT rectifier.

OPERATING DATA: The Model S-38 is designed to operate on 105-125 volts AC or DC. A special external resistance line cord can be supplied for operation on 210 to 250 volts AC or DC. Power consumption on 117 volts is 29 watts.



hallicrafters RADIO

THE HALLICRAFTERS CO., MANUFACTURERS OF RADIO
AND ELECTRONIC EQUIPMENT, CHICAGO 16, U. S. A.



Patterson Phosphors for Contrast... Brilliance...Detail in Television Images

PATTERSON PHOSPHORS are designed for maximum luminescence with minimum input energy. Quality phosphors for television, radar, oscilloscopes and other electronic instruments are available from Patterson Screen Division of E. I. du Pont de Nemours & Co. (Inc.), Towanda, Pa. Manufacturers, experimental laboratories and schools are invited to write us outlining their requirements.

PATTERSON PHOSPHORS ARE AVAILABLE
IN A WIDE RANGE OF

1. Colors
2. Grain Size
3. Brilliance
4. Type of Excitation
5. Afterglow
6. Special Blends

PATTERSON LUMINESCENT CHEMICALS



BETTER THINGS FOR BETTER LIVING . . . THROUGH CHEMISTRY

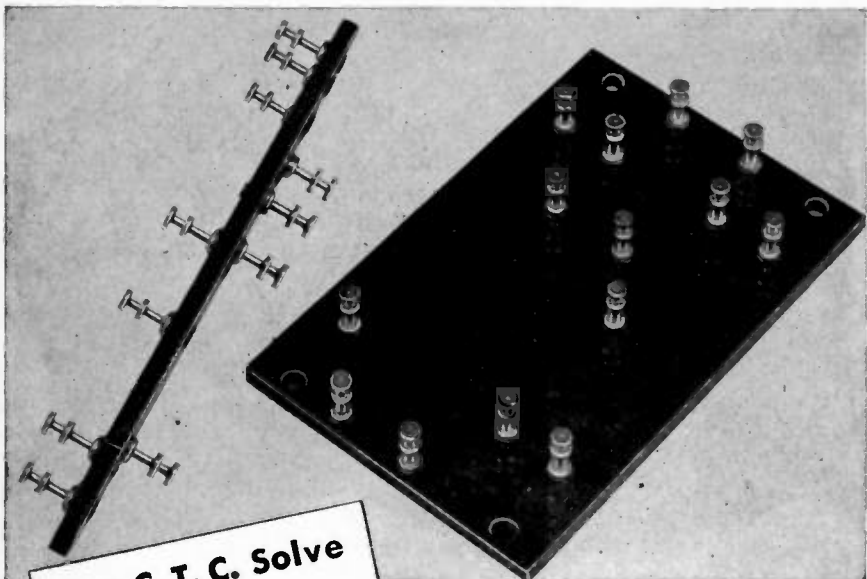

Let C. T. C. Solve
Your
**TERMINAL
BOARD
Troubles**

You'll save time and money if you order your Terminal Boards ready-made from C.T.C. Just send in complete specifications and in short order you'll receive perfectly cut and finished linen bakelite boards with quick soldering C.T.C. Lugs firmly anchored in exact position and ready to use.

Boards can be furnished with any type of C.T.C. Lug and in a variety of thicknesses.

Write for complete information or, better still, send us your specifications and let us show you just how inexpensively and quickly we can meet them.



CAMBRIDGE THERMIONIC CORPORATION
456 Concord Avenue Cambridge 38, Mass.



Positions Wanted By Armed Forces Veterans

In order to give a reasonably equal opportunity to all applicants, and to avoid overcrowding of the corresponding column, the following rules have been adopted:

The Institute publishes free of charge notices of positions wanted by I.R.E. members who are now in the Service or have received an honorable discharge within a period of one year. Such notices should not have more than five lines. They may be inserted only after a lapse of one month or more following a previous insertion, and the maximum number of insertions is three per year. The Institute necessarily reserves the right to decline any announcement without assignment of reason.

ELECTRICAL ENGINEER

BEE, R.P.I. plus one year training in electronics at Harvard, M.I.T. and Corpus Christi, Texas, for Navy. Two and one-half years Naval Electronics Officer installing, maintaining shipboard radar and aircraft radio and radar. Seven months commercial design and development experience in television video circuits. Age 27, married. Alfred R. Petrocelli, 21 Harrison Pl., Clifton, N.J.

ENGINEER

BS in EE, S.C. Harvard and M.I.T. electronics courses, advanced AAF electronics installation and maintenance; practical radio and industrial electronic and general EE experience; AAF Reserve Major, desire engineering position on West Coast. Box 26W.

RADIO ENGINEER

BS in EE and nearly BS in Physics, now at more study in both fields. Age 25, married, desire test, design, or maintenance in Central or West Coast. Taught Army A.A. radar one year. Navy, three years, taught fire control radars and like equipment plus installations. Milton H. Crothers, 914 8th St., Brookings, S.D.

RADIO ENGINEER

Army captain, 26, graduate radio engineer, one year research, three years commanding officer of large radar installations; good appearance, pleasant personality. Interested in engineering sales, finance, or administrative work. Box 27W.

DRAFTSMAN

A start at the electronic bottom—capable draftsman—civilian and Army experience. Attending engineering college evenings, completing third year. Resume of qualifications upon request. Bernard Meyer, 1320 Sheridan Ave., New York 56, N.Y.

(Continued on page 54A)



MICA CERAMIC SOCKETS and INSULATORS

NOW AVAILABLE FOR THE FIRST TIME FOR CIVILIAN USE



ETS-4 Standard
4 Prong Socket

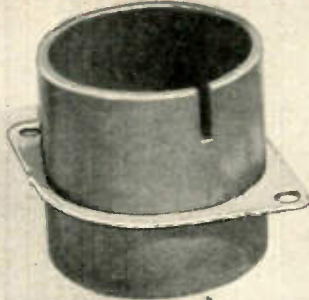

EMTS-4HVH 4 Prong
High Voltage or High
Frequency Socket

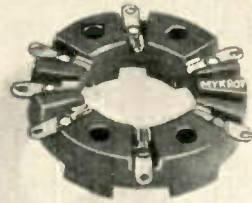

EAT-75 5-7
Prong Acorn Socket



ETS-5 Standard
5 Prong Socket

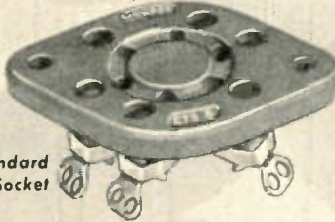

ETS-6 Standard
6 Prong Socket

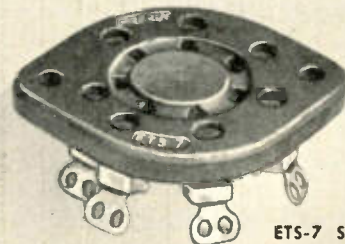

ETS-7 Standard
7 Prong Socket

BEST FOR HIGH FREQUENCY AND HIGH VOLTAGE APPLICATIONS



ES-250H 2 1/2"
Feed Through
Insulator

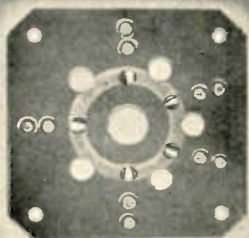

EMS-4-125A Five Prong
H. F. Socket with Air Holes



ENB-750 Through
Panel Bushing with
Plug Terminal



Sheet and Rod Stock
Available in many sizes



EBI-175H 1 3/4"
Feed
Through Insulator



EBI-187H 1 7/8"
Compact Feed
Through Insulator

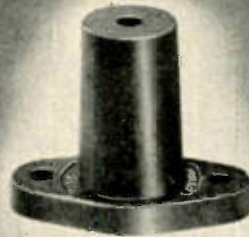

ESO-150 Stand-off
Insulator 1 1/2"

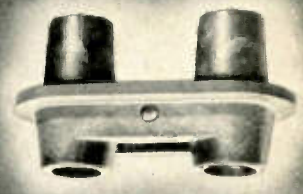

High-Voltage Twin
Bushing for Transformers

ORDER FROM YOUR DEALER OR WRITE TO

MADE EXCLUSIVELY BY

70 CLIFTON BLVD., CLIFTON, N. J.
CHICAGO 47; 1917 N. Springfield Ave., Tel. Albany 4310
EXPORT OFFICE: 89 Broad Street, New York 4, New York



MICRO-DIMENSIONAL

**WIRE & RIBBON for
VACUUM TUBE
FILAMENTS & GRIDS**

● Many sizes and alloys for a range of applications such as miniature tubes, hearing aid tubes, low-current-drain battery tubes, receiving tubes . . .

● Melted and worked to assure maximum uniformity and strength. WIRES drawn to .0004" diameter; RIBBON rolled to .0001" thickness . . .

● Wollaston Process Wire drawn as small as .000010"; made to your specifications for diameter and resistance.

SPECIAL ALLOYS made to meet individual requirements. Write for list of stock alloys.

SIGMUND COHN & CO.

44 GOLD ST. NEW YORK
SINCE  1901

Positions Wanted

(Continued from page 52A)

ENGINEER

BS in E.E. Navy schooling in radar-gunnery, security, and circuit intercept. Desires position in radio communications or electronics, particularly personnel supervision on equipment maintenance. Age 22. James P. Anthony, Jr., Box 526, Manitou Springs, Colo.

SALES ENGINEER

Age 25, B.S. in Commerce and A.S.T.P. in E.E. Desire position in the electrical industry. Sales and laboratory experience. Box 12W.

PART TIME WORK

Desire part time while completing MEE, permanent after June, 1947. Age 23, married. Two years design, production experience on radar. Navy RT instructor. Available June. East Coast. Box 13W.

SALES ENGINEER TRAINEE

MIT-Harvard trained electronics-radar officer, AAF, B.S., age 27, married. Experienced test engineer, electronic equipment. In service field, supervised men in installation and maintenance of all airborne navigational aids and high altitude microwave bombing equipment and computers. R. I. Gaines, 29 Wadsworth Ave., New York 33, N.Y.

EXECUTIVE'S ASSISTANT

M.S., stenographer, age 28. Four years electronic engineering experience. Will work in New York City or environs. Box 14W.

RADIO ENGINEER

B.S. E.E., Purdue University. Age 26, married. Four years experience design, development, production, test and installation of electronic and microwave equipment. Box 6W.

EXECUTIVE ASSISTANT

M.I.T. trained electronics-radar officer, AAF. 26 years old, married. B.A., M.S. degrees Industrial Management. Experienced in supervision Loran, GCA, microwave equipment; also public accounting, budgets, costs. Available March. Box 7W.

ELECTRONICS TECHNICIAN

Age 25, married. Desires electronics research position preferable in Los Angeles area. B.S.; First Phone license; experience in broadcast, radar, and teaching. Author articles in RADIO and QST. E. M. McCormick, 3455 Lemon St., Riverside, Calif.

BROADCAST AND COMMUNICATIONS ENGINEER

Pre-war resident in Middle East now serving Royal Air Force and employed by Forces Broadcasting Service (M.E.) in search of congenial, responsible position anywhere in world beginning winter 1946-47. Familiar aircraft radio installations and conventional equipment. Offers to BM/ZC6, London W. C. 1, England.

PREMAX

Just Off the Press

*Premax
Antennas
and Mountings*



**Get the New Premax
Catalog of Antennas
and Mountings**

Detailed descriptions and specifications of Premax Tubular Adjustable and Fixed Vertical Antennas in steel, monel, aluminum and stainless steel . . . elements for arrays . . . marine installations . . . police and mobile antennas . . . mountings and insulators.

If your jobber cannot supply you, write direct, enclosing his name.

Premax Products

Division Chisholm-Ryder Co., Inc.

4613 Highland Ave. Niagara Falls, N.Y.



Techniquality

Every product that enjoys the full confidence of those who use it has its "priceless ingredient" In Bliley crystals it's "techniquality."

Cutting, grinding, and finishing alone do not transform raw quartz into a sensitive frequency control device. Behind these operations there must be a background of technical skill and creative engineering that is gained only through years of experience.

Bliley crystals have a reputation for "techniquality" that started fifteen years ago. Today, the fact that Bliley crystals are used in practically every phase of radio communications is tacit proof that leading engineers have found it is best to specify Bliley "techniquality" crystals.

Bulletin 27 describes the crystal units engineered for the needs of today. Write for your copy.



Bliley
CRYSTALS

BLILEY ELECTRIC COMPANY • UNION STATION BUILDING, ERIE, PENNSYLVANIA



TURNER Model 33

meets every requirement
for a **RUGGED**
ALL-PURPOSE MICROPHONE

Packed with power to spare — built to take rough handling and bad climate conditions — engineered for smooth response to both music and voice pickups, the Turner Model 33 is an all-around microphone for recording, P.A., call system, studio, and amateur work. A professional unit for professional results. Ask your distributor or write.

Free Turner Catalog
Write for your copy

THE TURNER COMPANY

909 17th Street, N.E.
Cedar Rapids, Iowa

Licensed under U.S. Patents of the American Telephone & Telegraph Company, and Western Electric Company, Incorporated.

Crystals licensed under patents of the Brush Development Company



TURNER

Microphones

LOOK at these
Performance Features

33X Crystal

- Moisture-sealed crystal.
- 90° tilting head.
- Wind and blast-proofed.
- Barometric compensator.
- Chrome finished case.
- Level -52DB.
- Range 30-10,000 cycles.
- Removable cable set.

33D Dynamic

- Heavy duty dynamic cartridge.
- 90° tilting head.
- Wind and blast-proofed.
- Chrome finished case.
- Level -54DB.
- Range 40-10,000 cycles.
- Removable cable set.
- Choice of impedances.



(Continued from page 48A)

- Williams, W. E., 159 E. California St., Pasadena 5, Calif.
Willis, H. R., 4329 Arista St., San Diego 3, Calif.
Young, A. E., 7534 Canton Ave., St. Louis 14, Mo.
Youdin, M., 123 E. 37 St., New York 16, N. Y.
Zartman, I. F., Johns Hopkins University, 34 and Charles St., Baltimore 18, Md.

Admission to Associate

- Abramovich, A., 894 Riverside Dr., New York 32, N. Y.
Aguete, A., 216 Suydam St., Brooklyn, N. Y.
Aldrich, D. F., 6744 Penn Ave., Pittsburgh 8, Pa.
Amelotti, E., 9 Yale Rd., Haventown, Pa.
Anderson, R. C., 2622—18 Ave., San Francisco 16, Calif.
Ansorge, H. W., Michigan Bell Telephone Co., 626 Bell Bldg., Saginaw, Mich.
Barnes, C. B., 4448 Union Ave., Box U, RFD 1, La Canada, Calif.
Beck, R. J., 65 Lake Dr., Mountain Lakes, N. J.
Beecher, D. W., 919 L St. N.W., Washington 1, D. C.
Bena, J. J., 4 Stefanikova, Prague XVI, Czechoslovakia
Berlin, W. N., 233 Cornelia St., Boonton, N. J.
Bettencourt, J. P., 11 Carlisle, Cambridge 39, Mass.
Bjerke, J. O., 1258 Ferguson Ave., Newport News, Va.
Black, J. R., Ordnance Research Laboratory, State College, Pa.
Blair, R. E., Jr., Box 3019, Station A, El Paso, Texas
Bleazey, J. C., 169 W. Maple Ave., Morrisville, Pa.
Brandt, L., Uruguay 618, Buenos Aires, Argentina
Briggs, J. P., WSLs, Roanoke 7, Va.
Bruun, G., Strandboulevarden 44, Copenhagen, Denmark
Buehler, F. A., 665 W. Warren Ave., Detroit 1, Mich.
Call, G. R., 20 McDonald Dr., Sioux City 17, Iowa
Callen, R. J., 100 S. Edinburgh Ave., Los Angeles 36, Calif.
Carpenter, E. C., 1257 W. 57 St., Los Angeles 37, Calif.
Carpenter, F. R., 182 S. Orange Grove Ave., Pasadena 2, Calif.
Chiles, J. R., Jr., 556 Twin Oaks Ave., Chula Vista, Calif.
Coffland, A. E., N.A.T.T.C. Ward Island (Compound), Corpus Christi, Texas
Colino Lopez, A., Avenida del Estadio, 4, Madrid, Spain
Coss, W. L., 1109 Third Ave., New Brighton, Pa.
Cozzens, C. C., 44 Main St., Orange, N. J.
Deem, W. D., 4573 MacArthur Blvd. N.W., Washington 7, D. C.

(Continued on page 58A)

An extensive line of A.R.C. radio and electronic components

Precision Built to Aircraft Standards



Since 1928 the Aircraft Radio Corporation has devoted its engineering and production facilities to the design and manufacture of high-quality radio equipment for aircraft use. Components similar to those listed here proved their worth in the A.R.C. receivers and transmitters used in nearly all military aircraft during the war.

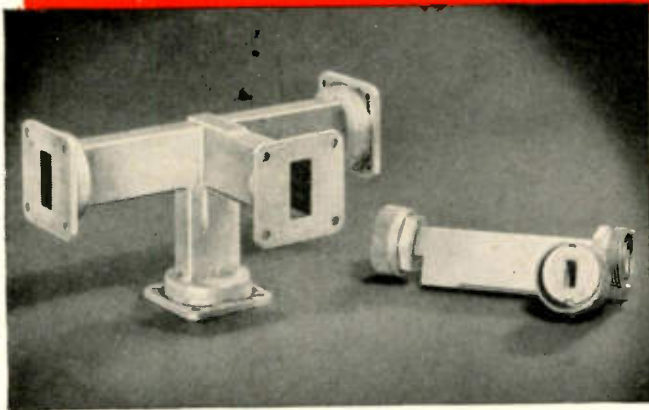

ARC "Magic Tee" and Microwave Coupler

MICROWAVE PLUMBING AND ACCESSORIES — A complete line of Microwave Plumbing and Accessories, engineered to A.R.C. precision standards, is now available. With the increasing emphasis on microwave transmission in modern aircraft navigation and control, A.R.C. has pioneered in the design of equipment for this type of operation. Typical of A.R.C. Microwave Accessories are the "Magic Tee" and Directional Coupler illustrated. Other items, such as the 24,000 megacycle attenuator, use the unique "split plate" construction developed by A.R.C.

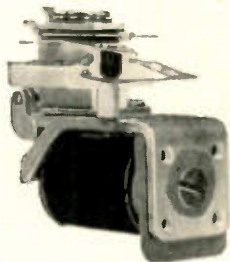

Miniaturized D.C. Relay by ARC

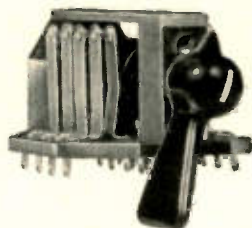

Precision Built "Music Box" Type Switch

RELAYS AND SWITCHES — Compact, lightweight relays designed by A.R.C. have had years of use under the extreme conditions of vibration, humidity and temperature encountered in military aircraft operation: Available in several types and sizes, they meet rigid requirements for reliability and specified performance.

A.R.C. Precision-built Switches are made in Drum-Type, "Music-Box" Type, and special Toggle and Push Types, and are available in various contact combinations. All are designed to stand up under the hardest usage, and are manufactured to the highest standards of the aviation industry.

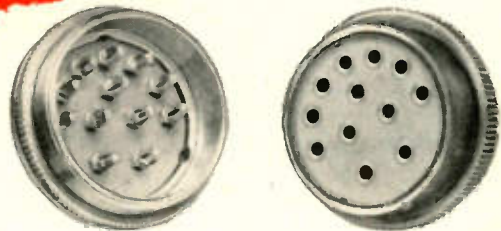

ARC Multi-contact Connector with Ceramic Inserts

MULTI-CONTACT CONNECTORS WITH CERAMIC INSERTS — A.R.C. has developed a line of Ceramic-Insulated Multi-Contact Plugs and Receptacles to combat carbon-tracking due to flashover. Floating, self-aligning female contacts and replaceable pin-plugs mean ease of maintenance and assembly as well as efficient service. Completely interchangeable with A.R.C. Bakelite insulated Plugs and Receptacles, the Ceramic type is provided in all types and sizes for use with shielded or unshielded cable, or with open wiring.

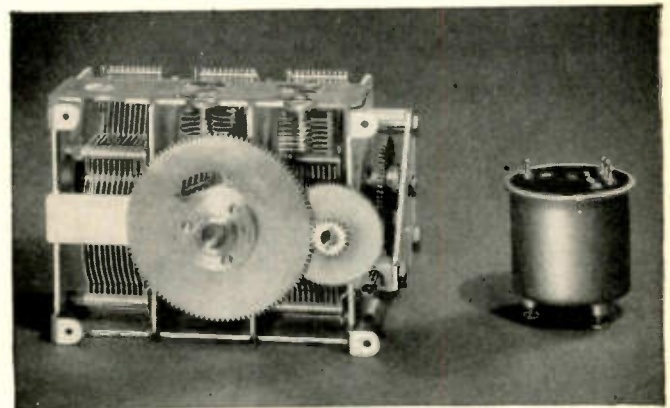

ARC Variable Air Condenser and Sealed, Oil Paper Type

CONDENSERS — VARIABLE, ADJUSTABLE, AND SEALED — Variable and adjustable air condensers by A.R.C., designed for use in both receivers and transmitters, are available in both single and multiple sections. Features of this equipment include the use of forked springs to provide positive grounding of rotor shafts, a special glass-ball method of stator support which keeps dielectric losses to a minimum, and cadmium plating of rotor and stator assemblies.

A complete line of Sealed Oil Paper and Dry Electrolytic Condensers have been designed by A.R.C. in both cylindrical and rectangular types, sealed in cadmium-plated brass cans. Minimum leakage path to ground is approximately 1/16th inch, good for a breakdown test of 2000 volts D.C.

Sealed Chokes and Transformers are also available in the cylindrical design.

For complete Parts Catalog, or specific information, write

AIRCRAFT RADIO CORPORATION

BOONTON, NEW JERSEY



The Most Indispensable Reference in Radio-Electronics

Electronic Engineering Master Index

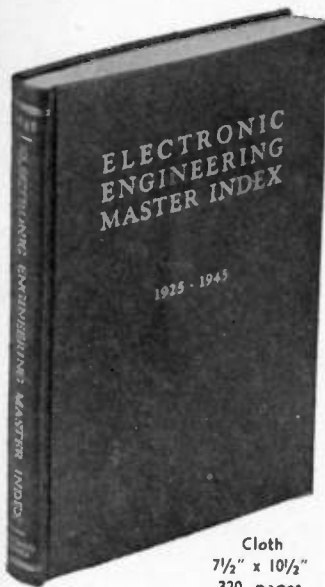

Cloth
7 1/2" x 10 1/2"
320 pages

A master compilation of over 15,000 titles of texts and articles selected for their value to the research engineer, this INDEX covers the years 1925-1945 and enables you to survey twenty years of research literature on any subject in a matter of minutes!

Vitally Needed in Every Laboratory and Library

COMPLETE IN ONE VOLUME

PART I

January 1925 to
December 1934

PART II

January 1935 to
June 1945



PARTIAL LIST FROM 65 PERIODICALS INDEXED

Bell Laboratories Record	General Electric Review
Bell System Technical Journal	Journal of Applied Physics
Communications	Proceedings of I.R.E.
Electrical Communication	Transactions of A.I.E.E.
Electronics	Radio News
Electronic Industries	R.C.A. Review
Journal of I.E.E.	Wireless Engineer

A \$500 Reference Library in One Volume for \$17.50

Descriptive circular on request.

ELECTRONICS RESEARCH PUBLISHING COMPANY

2 W. 46th Street

New York 19, N.Y.



(Continued from page 56A)

- Denny, W. I., 3961 Cumberland Ave., Los Angeles 27, Calif.
- Doherty, D. E., 911 S.E. 60 Ave., Portland 15, Ore.
- Dreessen, W. B., 703 N. Atlantic Blvd., Alhambra, Calif.
- Ducoff, G., 4844 N. Oakley Ave., Chicago 25, Ill.
- Duffany, H. P., Jr., 60 Van Norden Rd., Woburn, Mass.
- Durfee, G. H., 4414 Underwood Rd., Baltimore 18, Md.
- Edelberg, S., 37 E. 58 St., Brooklyn 3, N. Y.
- Emig, I. L., 4852 Marlborough Dr., San Diego 4, Calif.
- Escudero, J. P., Av. Almirante Barroso 91 8-and., Rio de Janeiro, Brazil
- Foster, J. E., 149 Broadway, New York 6, N. Y.
- Fратиanni, S. V., 129 Galveston Pl. S.W., Washington 20, D. C.
- Frondorf, V. L., 2294 Coutts Ave., Los Angeles 22, Calif.
- Frosch, A., 2159 Swift, Houston 5, Texas
- Fry, H. M., Department of Physics, Franklin and Marshall College, Lancaster, Pa.
- Gada, N., 250 Roxbury Rd., Syracuse 6, N. Y.
- Gago, F. J., 916 S. Encina, Visalia, Calif.
- Gallo, F. J., 340A Vallejo St., San Francisco 11, Calif.
- Gentry, R. I. L., 19 Rhode Island Ave., Somerville, Mass.
- Goff, J. E., 1333 1/2 Warren Ave., Bremerton, Wash.
- Gordon, W. E., Box F, University Station, Austin, Texas
- Gowans, W. K., 500 South West St., Angola, Ind.
- Graf, R., 12 Harrison Ave., Brooklyn 11, N. Y.
- Guernsey, E. D., 2360 Southway Dr., Columbus 8, Ohio
- Hamilton, R. D., 2919 Glenwood Ave., Minneapolis 5, Minn.
- Hanna, C. L., Box 16, Burlington, Ind.
- Harmon, N. F., Molton Hotel, Birmingham, Ala.
- Hautaniemi, B. W., 1 Hall Pl., S. Boston 27, Mass.
- Heaviside, M. G., Staff Department, Cable and Wireless Ltd., Electra House, Victoria Embankment, London W.C. 1, England
- Heinmiller, D. R., 3922 First St. S.W., Washington, D. C.
- Hetherington, G. V., 524 Eagle Rock Ave., West Orange, N. J.
- Huddleston, R. H., 1111 S. Second St., Temple, Texas
- Kim, Y. S., 90 St. Mary's, Boston 15, Mass.
- Kirkpatrick, C. L., 1744 Pacific Beach Dr., San Diego 9, Calif.
- Klein, W. J. J., 2107-31 St. S.E., Washington 20, D. C.
- Koci, J., 3 Plavecka, Praha II, Czechoslovakia

(Continued on page 60A)

VACUUM TUBE VOLTMETER

MODEL 62



SPECIFICATIONS:

RANGE: Push button selection of five ranges—1, 3, 10, 30 and 100 volts a.c. or d.c.

ACCURACY: 2% of full scale. Useable from 50 cycles to 150 megacycles.

INDICATION: Linear for d.c. and calibrated to indicate r.m.s. values of a sine-wave or 71% of the peak value of a complex wave on a.c.

POWER SUPPLY: 115 volts, 40-60 cycles—no batteries.

DIMENSIONS: 4 3/4" wide, 6" high, and 8 1/2" deep.

WEIGHT: Approximately six pounds. Immediate Delivery

MANUFACTURERS OF
Standard Signal Generators
Pulse Generators
FM Signal Generators
Square Wave Generators
Vacuum Tube Voltmeters
UHF Radio Noise & Field
Strength Meters
Capacity Bridges
Megohm Meters
Phase Sequence Indicators
Television and FM Test
Equipment

MEASUREMENTS CORPORATION
BOONTON NEW JERSEY



10,000,000,000 OHMS

for leakage resistance measurements at low potentials

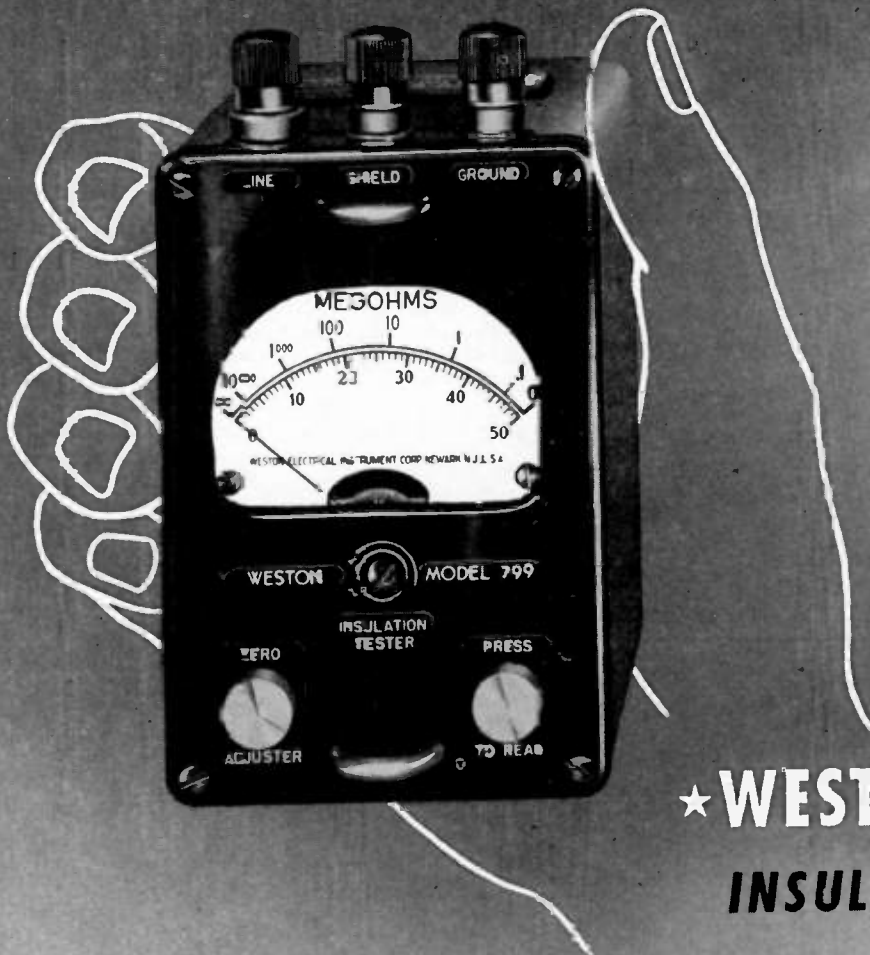

WILL INDICATE:

Insulation Properties

Leakage Resistance

Conductivity of
Insulating Materials

Leakage due to
moisture absorption
and surface moisture

★ **WESTON** (MODEL 799)

INSULATION TESTER

● A compact, one-hand operated Insulation tester . . . range .1 to 10,000 megohms . . . easily read scale . . . test potential less than 50 volts d-c. Ideal for testing electrical components, devices, materials, and new and existing installations. Details from the WESTON representative near you, or write for bulletin.

Weston Instruments

Weston Electrical Instrument Corp., 589 Frelinghuysen Ave., Newark 5, New Jersey

Albany · Atlanta · Boston · Buffalo · Chicago · Cincinnati · Cleveland · Dallas · Denver · Detroit · Jacksonville · Knoxville · Los Angeles · Meriden · Minneapolis · Newark · New Orleans · New York · Philadelphia · Phoenix · Pittsburgh · Rochester · San Francisco · Seattle · St. Louis · Syracuse · In Canada, Northern Electric Co., Ltd., Powerlite Devices, Ltd.

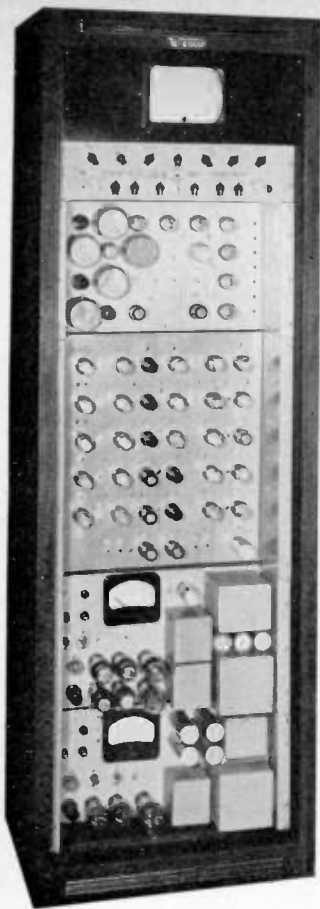

TELEVISION SYNCHRONIZING GENERATOR and MONITOR

.....
Designed by R. E. DE COLA
W. S. DRUZ

Designed for application in television transmitting plants, and for development research, engineering and production testing in television receiver manufacture. Produces signals having all the necessary synchronizing, blanking and driving pulses required for operation of Iconoscope and Kinoscope units. In substantial agreement with basic FCC-RMA standards. Rack unit includes one Timer Unit, one Shaper Unit, and one Monitoring Oscilloscope (each with electronically regulated power supply). Timer Unit produces the three basic output signals from which all synchronizing pulses are derived. Shaper Unit forms, locates and mixes the required signal by processes of clipping, integrating and differentiating. Monitoring Oscilloscope provides a short 7-inch electrostatic deflection cathode ray tube for display . . .

You are invited to write for a detailed description of the TELEQUIP Synchronizing Generator and Monitor . . . as well as for data covering the TELEQUIP Monoscope Picture Generator and Distribution Unit. For television testing apparatus, look to TELEQUIP, specialists in the design and manufacture of advanced Television Equipment.

.....
TELEQUIP RADIO COMPANY

1901-07 S. Washtenaw Ave. Chicago 8, Ill.

*Designers . . . Manufacturers of Television and
Communications Equipment . . . Electronic Products*

.....



(Continued from page 58A)

- Koepke, W. E., 140 New Montgomery St., San Francisco, Calif.
- Krampel, H., 1251 Grant Ave., New York 56, N. Y.
- LaHiff, W. J., 87 Hamilton Pl., New York 31, N. Y.
- Lamb, W. G., 8 Merrymount Rd., Baltimore 10, Md.
- LaRose, A. P., 4915 N. Damen Ave., Chicago 25, Ill.
- Levine, G., 389 Alabama Ave., Brooklyn 7, N. Y.
- Liao, S. G., c/o Mr. M. Li, Bank of China, 40 Wall St., New York 5, N. Y.
- Lima, O. A., Standard Electrica S.A., Avenida Almirante Barroso 91-8°, Rio de Janeiro, Brazil
- Lohr, L. A., Naval Research Laboratory, Vacuum Tube Development Section, Bldg. 16, Washington, D. C.
- MacGregor, W. R., 58 Grove Pl., East Orange, N. J.
- McDougall, N. R., 22 Hordeka Ave., (Mt. Eden), Auckland S. 2, New Zealand
- Miner, W. A., Jr., 2242 Webster Ave., New York 57, N. Y.
- Montanari, R. E., 22 Pondview Rd., Arlington, Mass.
- Moor, W. L., College Corner, Ohio
- Morse, L. H., 909 E. 47 St., Kansas City 4, Mo.
- Moyer, W. A., Jr., 5511 Glenbrook Rd., Chevy Chase 15, Md.
- Nester, R. A., 1207 S. Meadow St., Richmond 20, Va.
- Newman, W. P., 16 Bellevue Dr. S.W., Washington 20, D. C.
- O'Bryan, R. L., 1357 Nebraska St., Vallejo, Calif.
- Olski, J., 674 South Ave., Syracuse 7, N. Y.
- Papas, J., 1007 Paul Ave., Scranton, Pa.
- Parrott, A. D., 1515-45 St., Des Moines 11, Iowa
- Perlenfein, H. H., 25 Colonial Ave., Waltham 54, Mass.
- Pesce, W. V., 2886 Philip Ave., Bronx 61, N. Y.
- Pomerantz, M., 322 W. 88 St., New York 24, N. Y.
- Ragonese, F. L., 120 Washington St., Middletown, Conn.
- Raymond, C. A., 44 Spring St., Princeton, N. J.
- Reinhold, H. W., 12546 Wade, Detroit 13, Mich.
- Richer, K. A., 3602 Southern Ave., Baltimore 14, Md.
- Rickards, W. H., 741 E. 126 St., Cleveland 8, Ohio
- Rosenberg, S., 16 Washington Village, Asbury Park, N. J.
- Rowand, G. E., Box 164, Sandston, Va.
- Rudd, W. C., 389 Lafayette St., Induction Heating Corp., New York, N. Y.
- Ruickbie, G. P., Box 477, 26 Douglas St., Bathurst, N. B., Canada
- Runkle, L. D., 1992-15 St., Troy, N. Y.
- Sanders, J. R., 44 Marianne Rd., Waltham 54, Mass.
- Satyendra, K. N., 188, Subbaram Chetty Rd., Basavnagudi, Bangalore, India

(Continued on page 64A)

there is
NO SUBSTITUTE

for GOOD communications
and industrial wire. We are
shipping you more and
more of it now . . .



WIRES



cornish
WIRE COMPANY, INC.
15 Park Row, New York 7, N. Y.
"Made by Engineers for Engineers"

Remler Appointed Agent for WAR ASSETS ADMINISTRATION

(Under Contract No. 59A-3-48)

. . . to handle and sell a
wide variety of

ELECTRONIC EQUIPMENT

released for civilian use

Write for Bulletin Z-1A

Remler Company Ltd.
2113 Bryant St.
San Francisco 10, Calif.

REMLER

SINCE 1918

Radio • Communications
Electronics



WHAT'S NEW IN BRITISH RADIO, TELEVISION AND ELECTRONICS?

Read Britain's most authoritative Journals for the answer to this vital question

THE JOURNAL OF RADIO RESEARCH AND PROGRESS FOR SCIENTIST & TECHNICIAN

WIRELESS ENGINEER is read by research engineers, designers and students, and is accepted internationally as a source of information for advanced workers; its Editorial policy is to publish only original work. The Editorial advisory board includes representatives of the National Physical Laboratory, the British Broadcasting Corporation and the Engineering Department of the General Post Office, under the Technical Editorship of Prof. G. W. O. Howe, D.Sc., M.I.E.E. Regular features include British patent specifications and abstracts and references compiled by the Radio Research Board.

WIRELESS ENGINEER

PUBLISHED MONTHLY, 32/- (\$6.50) PER ANNUM.

THE JOURNAL FOR MANUFACTURERS, DESIGNERS, SERVICE-MEN & AMATEURS

WIRELESS WORLD is Britain's leading technical magazine in the general field of radio, television and electronics. Founded over 35 years ago, it has consistently provided a complete and accurate survey of the newest British technique in design and manufacture. Articles of a high standard cover every phase of the radio and allied industries, with reviews of equipment, broadcast receivers and components. Theoretical articles deal with design data and circuits for every application.

Wireless World

PUBLISHED MONTHLY, 20/- (\$4) PER ANNUM.

SUBSCRIPTIONS (by International Money Order) and correspondence should be addressed to:- Dorset House, Stamford St., London, S.E.1., England. Cables: "ILIFFEPRES. SEDIST. London."

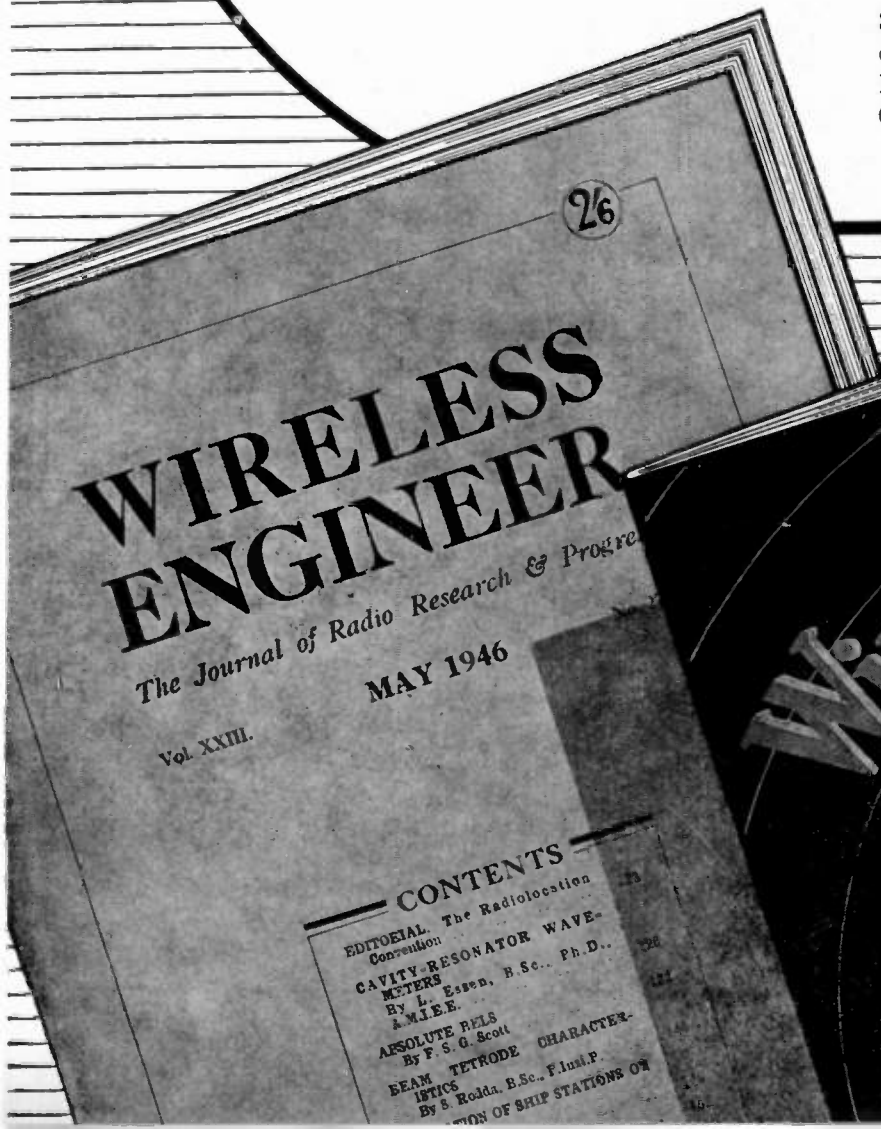

Announcing—

The latest data on BASIC RADAR CIRCUITS

Prepared by the
radar specialists
of the

MASSACHUSETTS
INSTITUTE OF
TECHNOLOGY

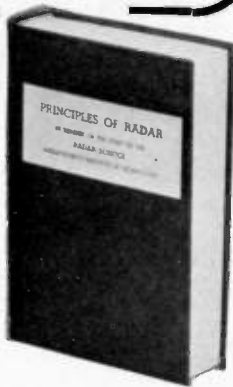

Now—with this single reference manual—you can quickly bring yourself abreast of latest developments in radar.

It is the first complete and up-to-date volume published in this important new field—covering the subject for all engineers and physicists who are concerned with electronic applications. Reflecting the broad experience of M.I.T. radar specialists, this book deals with pulse circuits and high-frequency devices common to nearly all radar equipment. The lucid explanations of circuit operation are based on physical concepts and make free use of numerical examples.

Just Out
NEW
2nd Edition

PRINCIPLES OF RADAR

By members of the staff of the Radar School, Massachusetts Institute of Technology, 960 pages, 6 × 9, profusely illustrated, \$5.00

Originally this book was prepared to give a sound, rapid grounding in radar principles and their wartime applications. Now, in view of the many advances of the past few years, the book has been fully revised and brought up-to-date—so that it will be helpful not only to those interested in radar but also to those concerned with ultra-high frequencies and microwaves, television, pulse-time communication systems, or pulse navigation systems.

This new edition begins with a brief description of the components and functions of radar systems and continues with detailed discussion of typical system components. Expositions of circuits and devices provide an unusual combination of technically thorough and accurate treatments with minimum dependence upon mathematics. Emphasis in the discussions of circuits is on quantitative analysis directly from tube characteristics and physical principles.

Supplies timely data on:

- Timing Circuits
- Indicators
- Receivers
- Magnetrons
- Modulators
- Triode Transmitters
- Radio-frequency Lines
- Radar Antennas and Propagation
- Wave Guides and Cavity Resonators
- Transmit-receive Devices
- Synchron and Servomechanisms

Mail coupon for 10 DAYS' FREE EXAMINATION

McGraw-Hill Book Co., 330 W. 42nd St.
New York 18

Send me M.I.T. Radar School—Principles of Radar for 10 days' examination on approval. In 10 days I will send \$5.00 plus a few cents postage or return book postpaid. (Postage paid on cash orders.)

Name
Address
City and State
Company
Position IRE 7-46
For Canadian price write Embassy Book Co.
12 Richmond St. E., Toronto 1

Professional Cards

W. J. BROWN

Electronic & Radio Engineering Consultant
Electronic Industrial Applications, Commercial and Broadcasting Transmitter and Receiver Design, Test Equipment, etc.

23 years experience in electronic development

1420 East 25th St., Cleveland 14, Ohio
Superior 1241

EDWARD J. CONTENT

Acoustical Consultant

and

Audio Systems Engineering, FM Standard Broadcast and Television Studio Design.
Roxbury Road Stamford 3-7459

Stamford, Conn.

R. A. DINZL

Electronic Consultant

Ultra High Frequency Transmitters and Receivers, Pulse Modulation, Broadcast Studio Circuits and Equipment Selection.

648 Nottingham Place
Westfield, N.J. Telephone 2-4539

STANLEY D. EILENBERGER

Consulting Engineer

INDUSTRIAL ELECTRONICS

Design—Development—Models
Complete Laboratory and Shop Facilities
6309-13—27th Ave.

Kenosha, Wis. Telephone 2-4213

F. T. Fisher's Sons Limited

Consulting Engineers

Broadcast Transmitters, Antenna Systems, Studio Equipment, Mobile and Fixed Communication Systems.

6202 Somerled Ave., Montreal 29, Quebec

DAVID C. KALBFELL, Ph.D.

Engineer — Physicist

Complete laboratory facilities
Industrial instrumentation and control
Broadcast engineering and measurements

941 Rosecrans St. Bayview 7303
San Diego 6, California

FRANK MASSA

Electro-Acoustic Consultant

DEVELOPMENT PRODUCTION DESIGN
PATENT ADVISOR

ELECTRO-ACOUSTIC & ELECTRO-MECHANICAL
VIBRATING SYSTEMS

SUPERSONIC GENERATORS & RECEIVERS
3393 Dellwood Rd., Cleveland Heights 18, Ohio

M. F. M. Osborne Associates

Consulting Physicists

Fluid Dynamics, Mechanics, Electronic Design, Electromagnetic and Acoustic Wave Propagation, Mathematical Analysis.

703 Albee Bldg., Washington 5, D.C.
Atlantic 9084

ALBERT PREISMAN

Consulting Engineer

Television, Pulse Techniques, Video Amplifiers, Phasing Networks, Industrial Applications

Affiliated with

MANAGEMENT TRAINING ASSOCIATES
3308-14th St., N.W. Washington 10, D.C.

HAROLD A. WHEELER

Consulting Radio Physicist

Radio - Frequency Measurements

Special Antenna Problems

Wideband Amplifiers and Filters

259-09 Northern Boulevard
Great Neck, New York Imperial 648

Paul D. Zottu

Consulting Engineer

Industrial Electronics

High Frequency Dielectric and Induction Heating Applications, Equipment Selection, Equipment and Component Design, Development, Models.

272 Centre St., Newton, Mass. BIG-9240

RAWSON SEMI-SUSPENDED METERS



Type .503

For ULTRA-HIGH SENSITIVITY

0.5 Microampere Full-Scale 7000 ohms)
0.24 Millivolt Full-Scale (10 ohms)

High Resistance Voltmeters (Megohm per volt). Many other ranges.

Accurate Portable Meters, need no leveling. Will often replace light-beam galvanometers or vacuum tube voltmeters.

Write for bulletin

WE ALSO SUPPLY

REGULAR DC METERS
THERMOCOUPLE AC METERS
MULTIMETERS
FLUXMETERS
ELECTROSTATIC VOLTMETERS

Special apparatus built to order

**RAWSON ELECTRICAL
INSTRUMENT COMPANY**

118 POTTER ST. CAMBRIDGE, MASS.
Representatives
CHICAGO LOS ANGELES NEW YORK CITY

*Now...
a complete line of dependable*

OHMITE RESISTORS

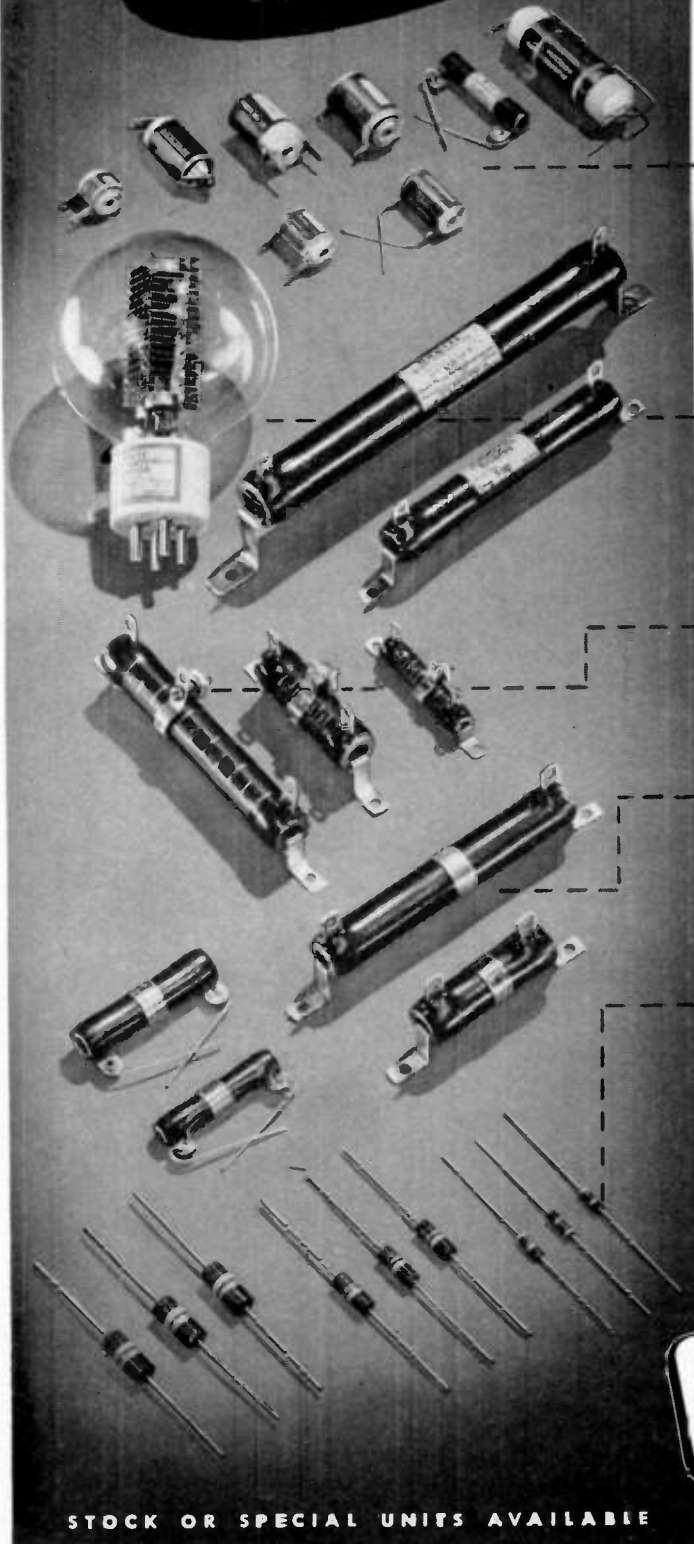

"RITEOHM" PRECISION RESISTORS

Six types—including non-inductive pie-wound vacuum-impregnated units, pie-wound hermetically sealed glass units, and single-layer vitreous-enameled units. Tolerance $\pm 1\%$. Five types available from stock in $\frac{1}{2}$ - and 1-watt units ranging from 0.10 to 2,000,000 ohms.

NON-INDUCTIVE RESISTORS

For use in radio frequency circuits where resistors of practically constant resistance and impedance are required. Available in the vitreous-enamel tubular type with special winding and in hermetically sealed-in glass type with special winding and vacuum tube base.

"DIVIDOHM" ADJUSTABLE VITREOUS ENAMELED RESISTORS

Use them for multi-tap resistors or voltage dividers, and for obtaining odd values of resistance quickly. Consist of vitreous-enameled resistors of the lug type with wire exposed along one side for contact with adjustable lugs.

"BROWN DEVIL" AND LUG-TYPE VITREOUS ENAMELED RESISTORS

Ohmite's dependable, general-purpose resistors. Available in ratings of 10 to 200 watts. Smaller sizes have tinned copper wire terminals; larger sizes have lug terminals.

"LITTLE DEVIL" INSULATED COMPOSITION RESISTORS

An extremely small, sturdy resistor. Three sizes— $\frac{1}{2}$, 1, and 2 watt, in 10 ohms to 22 megohms. Tolerance $\pm 10\%$. Light, compact, easy to install. Available only from Ohmite distributors.

Write for Catalog 40 on company letter-head. Contains helpful information on rheostats, resistors, tap switches, chokes, and attenuators.



OHMITE MANUFACTURING CO.
4860 Flournoy St., Chicago 44, U.S.A.

Be Right with...
OHMITE
RHEOSTATS •
RESISTORS • TAP SWITCHES

STOCK OR SPECIAL UNITS AVAILABLE

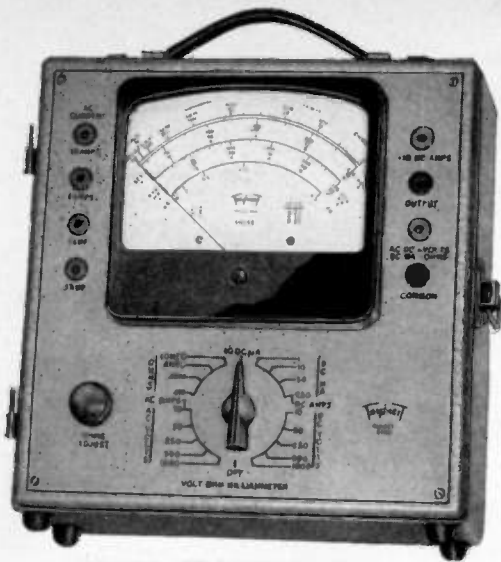

MODEL 2405

Volt • Ohm Milliammeter

25,000 OHMS PER VOLT D. C.

STANDARDS ARE SET BY



SPECIFICATIONS

NEW "SQUARE LINE" metal case, attractive tan "hammered" baked-on enamel, brown trim.

■ **PLUG-IN RECTIFIER**—replacement in case of overloading is as simple as changing radio tube.

■ **READABILITY**—the most readable of all Volt-Ohm-Milliammeter scales—5.6 inches long at top arc.

Model 2400 is similar but has D. C. volts Ranges at 5000 ohms per volt.

Write for complete description

Triplet

ELECTRICAL INSTRUMENT CO.

BLUFFTON OHIO

NEW ENGINEERING NEW DESIGN • NEW RANGES 50 RANGES

Voltage: 5 D.C. 0-10-50-250-500-1000
at 25000 ohms per volt.

5 A.C. 0-10-50-250-500-1000
at 1000 ohms per volt.

Current: 4 A.C. 0-.5-1-5-10 amp.

6 D.C. 0-.50 microamperes—
0-1-10-50-250 milliamperes—
0-10 amperes.

4 Resistance 0-4000-40,000 ohms—4-
40 megohms

6 Decibel -10 to +15, +29, +43,
+49, +55

Output Condenser in series with
A.C. volt ranges

The First Comprehensive Treatment
of the Production of Quartz Crystals

QUARTZ CRYSTALS For ELECTRICAL CIRCUITS Their Design and Manufacture

By **RAYMOND A. HEISING, E.E., M.S.**
Radio Research Engineer
Bell Telephone Laboratories, Inc.

Here is a book of truly great scope. It discusses in full the theory and practice of the preparation of quartz crystals, and covers the instruments used, including new types developed for special purposes. It offers an unusually thorough presentation of the problems encountered in the various uses of quartz crystals, and the full details of the methods devised for their solution.

There are discussions of new practical methods of adjustment to frequency, of the new performance indicator, of a new type of crystal cut that operates at very low frequencies, and many new developments that represent great advances in crystal technology.

And the accounts of the manufacturing process are most complete. In fact, the various processing chapters, dealing with cutting and grinding, plating and other topics, include much information that appears for the first time in any book.

QUARTZ CRYSTALS FOR ELECTRICAL CIRCUITS embodies the vast experience of the Bell Laboratories—the organization that has done by far the greatest volume of work in research and manufacture of quartz crystals.

563 Pages Illustrated 6 × 9 Cloth \$6.50

Write for examination copy.

D. VAN NOSTRAND COMPANY, INC.

250 Fourth Avenue

New York 3, N.Y.



(Continued from page 60A)

- Schreiner, W. A., 4111 Baltimore Ave., Philadelphia 4, Pa.
Schweizer, E. G., Naval Research Laboratory, Washington, D. C.
Sears, H. A., Box 6116, Houston 6, Texas
Seldin, L., 2830 Grand Concourse, New York 58, N. Y.
Shnitzler, R. K., 18 Oldfields St., Boston, Mass.
Smith, J. A., 368 N. Ogden Dr., Los Angeles 36, Calif.
Spano, A. J., College Ave., Arvada, Colo.
Spencer, H. H., 5 Chiltern Rd., Wellesley Farms, Mass.
Tagliaferro, C., Salguaro 480, Buenos Aires, Argentina
Tavora, A. M. F., Edificio Zacatecas, Rua Larangeiras 210, Rio de Janeiro, Brazil
Tickell, E. B., 202 E. Slattery Blvd., Shreveport, La.
Treurnicht, J. J., Lavalley 1943—2 F., Buenos Aires, Argentina
Van Patten, J. R., 723 Albany St., Schenectady 7, N. Y.
Waters, F. J., 315 S. West St., Angola, Ind.
Watson, L. E., 715 W. Melrose, Chicago 13, Ill.
Wehrle, R. P., 921 Ontario St., Oak Park, Ill.
Welch, G. H., 135 Russell St., Waltham 54, Mass.
Willoughby, R. B., 20 Monroe Pl., Brooklyn, N. Y.
Wilson, R. S., 455 Banning Way, RFD 1, Vallejo, Calif.
Wolthall, D. A., 555 W. 170 St., New York 32, N. Y.
Wong, H. T., Box 1490, Shanghai, China
Wright, E. R., 480 Woodward Ave., New Haven, Conn.
Yahn, P. F., 509 Roscoe St., Chicago 13, Ill.
Yost, R. H., 408 Stowers St., Bluefield, W. Va.
Zuckerman, J. V., 8280 W. Fourth St., Los Angeles 36, Calif.



DuMont proudly presents the
NEW Type 274
CATHODE-RAY OSCILLOGRAPH



SPECIFICATIONS

INPUT IMPEDANCE: Vertical-direct 5 meg. 60 μ f; amp. 1 meg. 70 μ f; Horizontal-direct 5 meg. 80 μ f, amp. 5 meg. 30 μ f.

FREQUENCY RANGE: Sine wave response (at full gain) uniform within $\pm 20\%$ from 20 to 50,000 c.p.s., down less than 50% 100,000 c.p.s.

DEFLECTION SENSITIVITY: Amplifiers at full gain 0.65 r.m.s. volt/in., direct ± 18 r.m.s. volts/in.

LINEAR TIME BASE: Variable from 8 to 30,000 c.p.s. Synchronization from vertical amplifier or external signal.

POWER SUPPLY: 115 volts, 50 to 60 cycles a.c. Power consumption app. 50 watts.

TUBES: All tubes, including 5BP1-A CRT, included.

PHYSICAL: Green wrinkle-finish steel cabinet with plastic carrying handle. Modern design green front panel, white characters, black knobs. Height 14"; width 8 3/8"; depth 19 3/8". Weight 35 lbs.

- ★ 5-inch cathode-ray tube.
- ★ linear time-base, 8 to 30,000 c.p.s.
- ★ identical vertical and horizontal amplifiers—20 to 50,000 c.p.s.
- ★ provision for intensity modulation.
- ★ modern design cabinet and panel.

Everything you want in a
general-purpose oscillograph

◆ It's here—Du Mont's new Type 274 Oscillograph—our post-war answer to a long-standing need for a good instrument for routine laboratory and production testing, and for radio servicing—at a low price of only **\$99.50**

Send for descriptive literature!

© ALLEN B. DUMONT LABORATORIES, INC.

DUMONT

Precision Electronics & Television

ALLEN B. DUMONT LABORATORIES, INC., PASSAIC, NEW JERSEY • CABLE ADDRESS: ALBEEDU, PASSAIC, N. J., U. S. A.

Proceedings of the I. R. E.

THE INSTITUTE OF RADIO ENGINEERS

Incorporated · Founded 1912

330 West 42nd Street, New York 18, N.Y.

Dear Reader: Re. Abstract Reprints.

In the June issue of the PROCEEDINGS of the I.R.E. the "Waves and Electrons" Section will present a new service to readers in the most comprehensive abstracts of technical articles of interest to our field, published in America.

Brilliantly condensed, these abstracts will keep you informed on the contents of practically every article published in the world's technical and engineering press on radio, communications, electronics, and physics, acoustics, optics and related sciences as they apply to radio and electronics. The abstract authors have proved their competence and gained world-wide recognition among radio scientists, for these are the Wireless Engineer (Ilfiffe & Sons) abstracts produced by the Department of Scientific and Industrial Research of the British Government--and now available in the PROCEEDINGS of the I.R.E.

As a further service to I.R.E. members and PROCEEDINGS subscribers only, the abstracts can be obtained for \$15.00 per year, reprinted on suitable paper on one side only, and available for card and reference book mounting. This permits convenient carding and sorting by your own subject classifications and will be of great value to your company librarian and for research files.

A limited edition of 500 of these special reprints will start with June, 1946. May I urge that you take this up immediately with your research department and library personnel. They may wish to avail themselves of this new I.R.E. service and to purchase these reprints in which case they should order immediately.

Cordially yours,

THE INSTITUTE OF RADIO ENGINEERS

The Institute of Radio Engineers
330 West 42nd Street,
New York 18, N.Y.

- () Please send the "Technical Abstracts" printed on one side of paper suitable for mounting or filing, at member or subscriber rate \$15.00
- () Please send the "Technical Abstracts" and a year's subscription to "Proceedings of the I.R.E." for \$10.00, plus \$15.00 for Abstracts, total \$25.00.

Address to: (Name)

(Firm)

(Address)

(Place) (Zone).... (State).....



FUSE PROTECTION

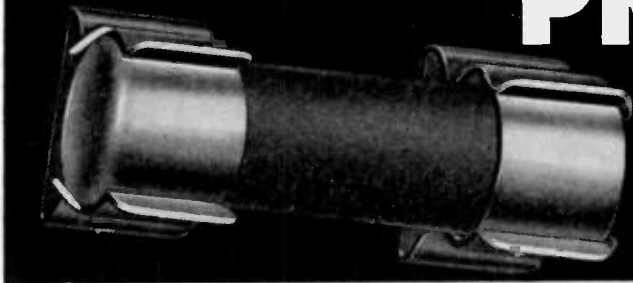

As a built-in component of the newly designed 2 KVA POWERSTAT variable transformers*, the fuse in the output brush contact lead offers economies in set-up time and replacement costs. Needless to say — replacing fuses is decidedly less expensive than replacing POWERSTATS. But . . . instrument protection is not the only new feature of the fused POWERSTATS. User protection is also incorporated. A totally enclosed aluminum terminal box houses all "hot" connections. With the input cord-plug and output receptacle combination, anyone can operate a POWERSTAT without danger of personal injury.



To suit each requirement, the output receptacle is available in a variety of types. It

can be supplied to accommodate a two or three wire — straight blade or twist-lock type plug. Connection of the load is a simple matter. There is no bother of clip-leads or direct wiring.

OUTPUT RECEPTACLE

Although the fuse has been so selected that the maximum rated current can be drawn at any dial position, it opens the circuit immediately when this value is exceeded. Burned-out coils and ruined brush contacts from overloading are a virtual impossibility. Situated in the recessed bottom portion of the durable cast-aluminum terminal box, the cartridge type fuse can be removed with very little effort. It is protected by a cast-aluminum section which is held in place by screw-connection.

FUSE PROTECTION

Logically, the input cord and plug is a duplication of the output receptacle 2 or 3 wire — straight blade or twist-lock arrangement. In the 3 wire system the 3rd wire is solidly grounded to the POWERSTAT frame. By plugging the cord into a convenient outlet, the POWERSTAT is ready for use.

INPUT CORD AND PLUG

* Write factory for further details on either terminal stud or fused type POWERSTATS.

Send for Bulletins ER

THE SUPERIOR ELECTRIC COMPANY

787 LAUREL STREET,

BRISTOL, CONNECTICUT

ROLLING UP THEIR SLEEVES

There's a lot more to reconversion than the word implies and for everyone who piously speaks of the things to be done, there are precious few who have dug in, rolled up their sleeves and had a go at really preparing for the post war electronic and radio markets.

Plant and product changes are mainsprings but an overhauling of sales and promotional practices is an equally important step in establishing the necessary firm foothold in the not-too-distant "Buyer's Market".

We point with justifiable pride to these reconversion minded advertisers who have been using the Proceedings of the Institute of Radio Engineers as part of their planned program for selling the future by reaching the man who purchases or specifies for purchase in this 2 billion dollar market . . . the RADIO ENGINEER . . . focal point of approval in an industry with unlimited horizons.

Accurate Spring Mfg. Co.
 Acme Electric & Mfg. Co.
 Aerovox Corporation
 Aireon Mfg. Corp.
 Allen Bradley Company
 Alliance Manufacturing Corp.
 Alltes Lansing Corporation
 American Lava Corporation
 American Phenolic Corp.
 American Transformer Co.
 Amerplex Electronic Corp.
 Andrew Company
 Arnold Engineering Co.
 Astalite Mfg. Corp.
 Automatic Mfg. Corp.
 Ballantine Labs., Inc.
 Alfred W. Barber Laboratories
 Barker & Williamson
 Bell Telephone Laboratories
 Bendix Aviation Corp.
 Bendix Electronic Corp.
 Bird Knox Company
 Bliley Electric Company
 Blount Radio Corporation
 Brown Engineering Co.
 Callite Tungsten Corp.
 Cambridge Thermionic Corporation
 Capitol Radio Engineering Inst.
 Capitol Radio Mfg. Corp.
 Allen D. Cardwell Mfg. Union, Inc.
 Centralab Div. of Globe Union, Inc.
 Centralab Transformer Corp.
 Chicago Transformer Corp.
 Cinescograph Speakers, Inc.
 Cincin Manufacturing Corp.
 Cinnel Manufacturing Co.
 Clarostat Mfg. Co.
 Sigmund Cohn & Co.
 Collins Radio Co.
 Communication Measurements Lab.
 Communication Parts
 Condenser Products Company

Continental-Diamond Fibre Co.
 Cook Electric Company
 Cornell-Dubilier Electric Co.
 Corning Glass Works
 Cornish Wire Company, Inc.
 Crystal Research Labs., Inc.
 H. L. Dallis Inc.
 The Daven Company
 DeMornay-Budd, Inc.
 Drake Manufacturing Co.
 Allen B. DuMont Labs., Inc.
 E. I. DuPont de Nemours & Co., Inc.
 Eastern Engineering Co.
 Hugh H. Eby, Inc.
 Eitor, Inc.
 Eitel-McCullough, Inc.
 Electrical Reactance Corp., Inc.
 Electronic Engineering, Inc.
 Electronic Mechanics, Inc.
 Electronics Research Publishing Co.
 Electro-Voice, Inc.
 Electro Resistor Corp.
 Erie Resistor Corp.
 Fairchild Camera & Instrument Corp.
 Federal Tel. & Radio Corp.
 F. M. & Television
 Foote Mineral Company
 Freed Radio Corporation
 Gates Radio Co.
 General Aniline & Film Corp.
 General Electric Co.
 General Instrument Corp.
 General Instrument Company
 General Radio
 Girder Corp.
 Goat Metal Stampings, Inc.
 Guardian Electric Mfg. Co.
 Hallcrafters Co.
 Hammarlund Mfg. Company, Inc.

Harvey Radio Laboratories, Inc.
 Harvey-Wells Electronics, Inc.
 Heintz & Kaufman, Ltd.
 Hewlett-Packard Co.
 Hytron Radio & Electronics Corp.
 Industrial Condenser Corp.
 Insulation Manufacturers Corp.
 International Nickel Co., Inc.
 International Resistance Co.
 International Tel. & Tel. Corp.
 Jackson Electrical Instrument Co.
 E. F. Johnson Company
 Joliet Chemicals, Ltd.
 Langevin Co., Inc.
 Lewis Electronics
 Machlett Laboratories, Inc.
 Madison Electrical Prod. Corp.
 Manufacturers Screw Products
 Measurements Corp.
 Mycelac Corp. of America
 National Carbon Company, Inc.
 National Company, Inc.
 National Union Radio Corp.
 National Vulcanized Fibre Co.
 Newark Electric Co., Inc.
 Newark Transformer Co.
 New York Philips Company, Inc.
 North American Philips Co.
 Ohmite Manufacturing Co.
 Pierce Paper Products Co.
 Premax Products
 Press Wireles, Inc.
 Presto Recording Corp.
 Radio Corp. of America
 Radio Engineering Labs., Inc.
 Radio Receptor Co., Inc.

Rauland Corp.
 Raytheon Mfg. Company
 Rayther Co., Ltd.
 Rehrer Co. and Brass Inc.
 Revere Copper and Brass Inc.
 Bernard Rice's Sons, Inc.
 The Richardson Company
 The Richardson Company
 Shallcross Mfg. Company
 Sherron Electronics Co.
 Sherron Brothers
 Simpson Electric Co.
 Skydync, Inc.
 Sperry Gyroscope Co., Inc.
 Sola Electric Company
 Solar Mfg. Corp.
 Sonotone Corporation
 Sprague Electric Company
 Stackpole Carbon Company
 Stamford Transformer Corp.
 Standard Aircraft Radio Co.
 Stoddart Aircraft Mfg. Co.
 Stupackoff Ceramic & Mfg. Co.
 Sun Radio & Electronics Co., Inc.
 Superior Electric Company
 Superior Electric Products Inc.
 Sylvania Electric Products Inc.
 Tech Laboratories
 Triplett Electrical Inst. Co.
 Truseon Steel Company, Inc.
 Tung-Sol Lamp Works, Inc.
 United Cinephone Corp.
 United States Television Corp.
 United Transformer Corp.
 Universal X-Ray Products
 Universal Products Co.
 Waterman Products Co.
 Western Electric Company
 Westinghouse Electric Corp.
 Weston Electrical Inst. Corp.
 Weston Electric Company, Inc.
 Wilcox Electric Company, Inc.
 John Wiley & Sons, Inc.

To sell the Radio Industry . . . Tell the Radio Engineer

PROCEEDINGS OF THE
I. R. E.
 THE INSTITUTE OF RADIO ENGINEERS
 WILLIAM C. COPP — National Advertising Manager
 303 West 42nd Street, New York 18, N. Y. CL 6-6357
 SCOTT KINGWILL Central States Representative 35 E. Wacker Dr., Chicago 1



THE RIGHT Combination

FOR EFFICIENT PRODUCTION

**of drawn shells, coil shields, housings,
radio chassis and complete or sub-assemblies**

Paul and Beekman has the men, the machines and the experience to produce component parts economically for you. Many of the items shown here were made in lots of from 100,000 to millions. All of them were made to exacting specifications . . . finished carefully . . . and completed on schedule.

Find out about the advantages of letting Paul and Beekman act as your Parts Division. Our engineers are always available for preliminary consultation . . . with no obligation to you. Write us.

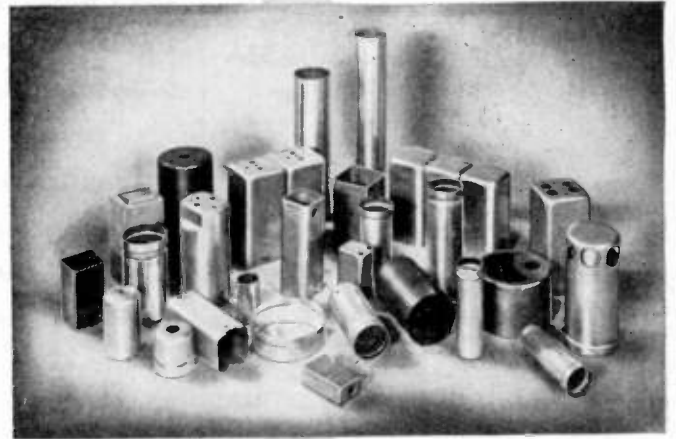

Drawn cans and housings from aluminum, steel and copper.

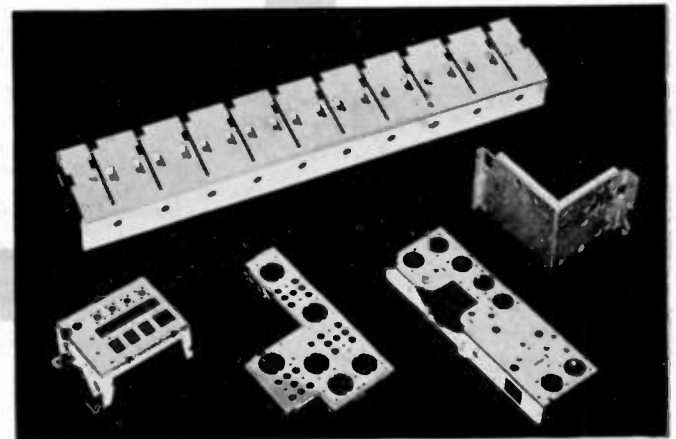

Chassis and sub-assemblies for the radio and electronic industries.

Below: Paul & Beekman plant, largest producer in the East of cans for the radio industry.



PAUL and BEEKMAN Division 1810 COURTLAND ST., PHILADELPHIA 40, PA.

PORTABLE PRODUCTS CORPORATION
 MANUFACTURERS OF: LAWN MOWERS • ELECTRICAL APPLIANCES • PRECISION STAMPINGS
 INDUSTRIAL INSTRUMENTS • RADIOS • SAFETY EQUIPMENT

INDEX AND DISPLAY ADVERTISERS

Section Meetings	34A
Membership	40A
Positions Open	50A
Positions Wanted	52A

Display Advertisers

Aerovox Corporation	26A	Daven Co.	29A	National Carbon Company, Inc.	49A
Aircraft Radio Corp.	57A	DeMornay-Budd, Inc.	15A	National Company, Inc.	28A
Amalgamated Wireless Ltd.	40A	R. A. Dinzl	62A	Ohmite Mfg. Co.	63A
American Lava Corp.	8A & 9A	Allen B. DuMont Labs., Inc.	16A, 65A	M. F. M. Osborne Associates	62A
American Transformer Co.	22A	E. I. DuPont de Nemours & Co., Inc. ..	52A	Portable Products Corp.	69A
Amperex Electronic Corp.	Cover II	Stanley D. Eilenberger	62A	Albert Preisman	62A
Andrew Co.	34A	Eitel-McCullough, Inc.	72A	Premax Products	54A
Arnold Engineering Co.	36A	Electronic Mechanics, Inc.	53A	Press Wireless Mfg. Corp.	7A
Astatic Corp.	38A	Electronics Research Publishing Co. ..	58A	Presto Recording Corp.	1A
Barker & Williamson	48A	Ellinwood Industries	46A	Radio Corporation of America	32A, 71A
Bell Telephone Laboratories	19A	Erie Resistor Corp.	23A	Rauland Corp.	18A
Bendix Aviation Corp. (Radio Div.) ..	10A	Federal Telephone & Radio Corp. ...	3A, 37A	Rawson Electrical Instrument Co.	62A
Blaw-Knox Co.	42A	F. T. Fisher's Sons	62A	Raytheon Mfg., Co.	4A, 5A
Bliley Electric Company	55A	General Electric Co.	13A	Remler Co., Ltd.	60A
W. J. Brown	62A	General Radio Co.	Cover IV	Revere Copper & Brass, Inc.	12A
Browning Laboratories, Inc.	43A	Hallicrafters Company	51A	Selenium Corporation of America	41A
Callite Tungsten Corp.	45A	Hammarlund Mfg. Company, Inc.	20A	Sprague Electric Company	6A
Cambridge Thermionic Corp.	52A	Harvey Radio Laboratories, Inc.	33A	Stackpole Carbon Co.	24A
Centralab	2A	Hewlett-Packard Company	47A	Superior Electric Co.	67A
Chicago Transformer Corp.	44A	Hytron Radio & Electronics Corp.	21A	Sylvania Electric Products	30A
Clarostat Mfg. Co.	48A	Iliffe & Sons	61A	Telequip Radio Co.	60A
Sigmund Cohn & Co.	54A	Insulation Manufacturers Corp.	25A	Triplett Electrical Inst. Co.	64A
Collins Radio Co.	39A	International Tel. & Tel. Corp.	3A, 37A	Tung-Sol Lamp Works, Inc.	14A
Edward J. Content	62A	David C. Kalbfell	62A	Turner Co.	56A
Continental-Diamond Fibre Co.	11A	Langevin Company, Inc.	31A	United Transformer Corporation	17A
Cornell-Dubilier Electric Corp.	Cover III	Frank Massa	62A	D. Van Nostrand Company, Inc.	64A
Comish Wire Co.	60A	McGraw Hill Book Co., Inc.	62A	Western Electric Company	27A
		Measurements Corp.	58A	Weston Electrical Inst. Corp.	59A
		Mycalex Corporation of America	35A	Harold A. Wheeler	62A
				Paul D. Zottu	62A

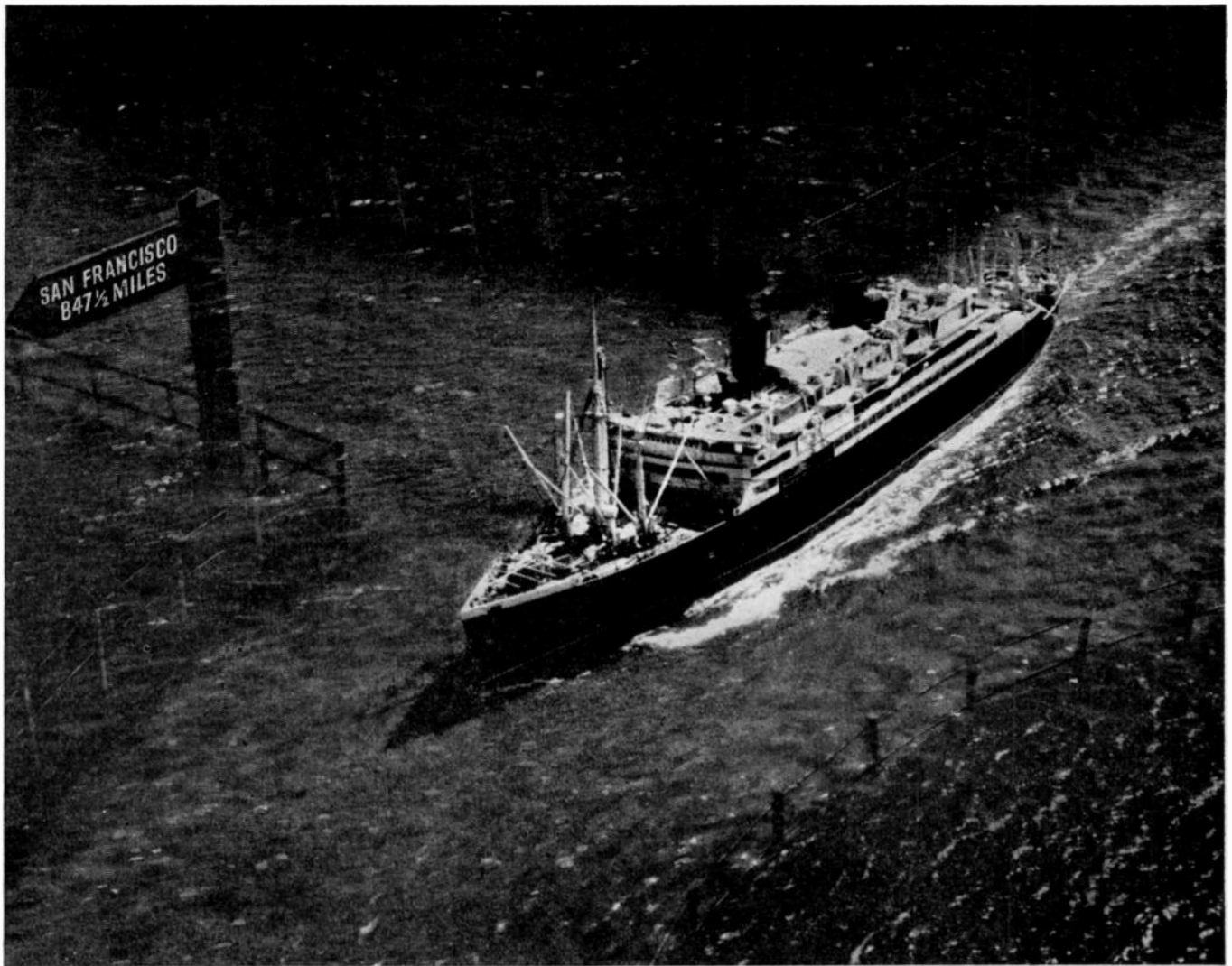

Developed during the war, Loran projects long-distance radio beams to guide ships on lanes charted by radio-electronics.

Loran—"highway signposts" for the seas and skies!

Loran provides a new kind of road map for the sea and air, day or night, and in almost any kind of weather.

With Loran, ships and planes as far as 700 to 1400 miles offshore in the densest fog can determine their positions with uncanny accuracy. Trial installations of Loran are being successfully conducted on both the Atlantic and Pacific by Radiomarine Corporation of America—a service of RCA.

The same scientists and engineers at RCA Laboratories who were largely

responsible for the development and refinement of Loran also devote their skills and knowledge to every RCA product.

This never-ending research at RCA Laboratories is your assurance that when you buy anything bearing the RCA or RCA Victor monogram you are getting one of the finest instruments of its kind science has yet achieved.

• • •

Radio Corporation of America, RCA Building, Radio City, New York 20. Listen to The RCA Victor Show, Sundays, 2:00 P. M., Eastern Daylight Time, over the NBC Network.



Loran (short for LONG RANGE Navigation) uses radio waves which hug the earth's surface instead of going off into space. Two sets of stations, about 300 to 400 miles apart, send out impulses to a Loran receiver on shipboard like the one shown above. It then shows the ship's exact position.



RADIO CORPORATION of AMERICA



THE COUNTERSIGN OF DEPENDABILITY IN ANY ELECTRONIC EQUIPMENT

Tests Prove 100% Longer Life in this New *Eimac* 3-750A2

made possible by:

- NEW COOLER OPERATING PLATE
- NEW NON-EMITTING GRID
- NEW FILAMENT STRUCTURE

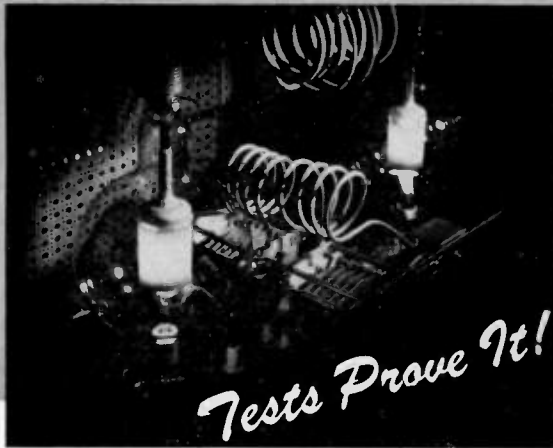

Tests Prove It!

Two Eimac 3-750A2 Tubes undergoing life tests in the Eimac testing laboratory

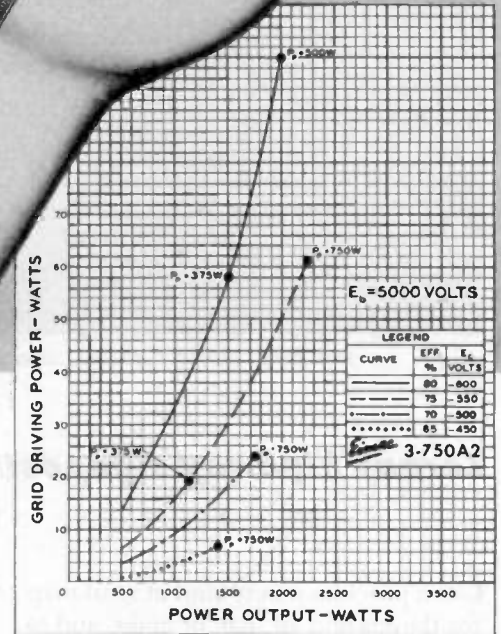
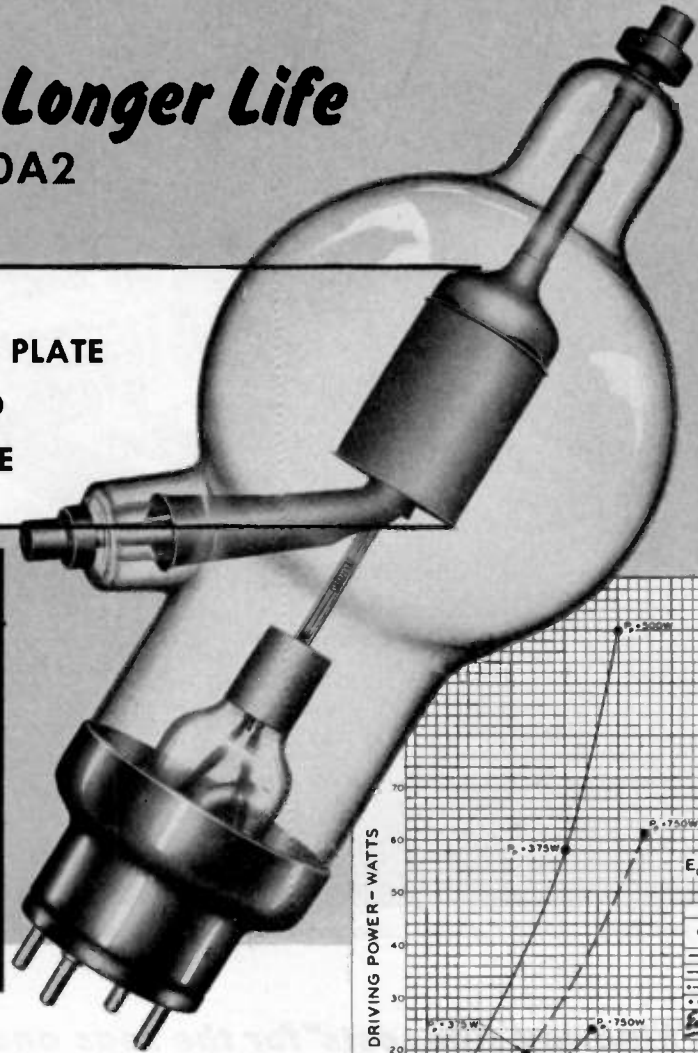

Typical of the outstanding performance of this new triode is its high power gain. With 5000 volts on the plate, the new Eimac 3-750A2 will deliver 2000 watts output with only 30 watts driving power, at a plate efficiency of 75%. (See above chart.)

Repeated tests of the new Eimac 3-750A2 in the Eimac testing laboratory show 100% longer life than previous models operated under the same conditions.

This increase in life expectancy is a result of continuing research, culminating in this new version of the 750TL triode. Among its many new features are a new cooler operating plate, new non-emitting grid and a new filament structure.

The new 3-750A2 is a power triode, interchangeable with the previous model 750TL, and is but one example of the constant effort made at Eimac to furnish better tubes at lower cost. For further information and complete engineering data on Eimac tubes, write direct or contact your nearest Eimac representative.

Follow the leaders to



EITEL-McCULLOUGH, INC., 1102 J, San Mateo Ave., San Bruno, California
Plant located at: San Bruno, California
Export Agents: Frazer and Hansen, 301 Clay St., San Francisco 11, California, U. S. A.

ELECTRICAL CHARACTERISTICS

Filament: Thoriated tungsten	
Voltage	7.5 volts
Current	21.0 amperes
Amplification Factor (Average)	15
Direct Interelectrode Capacitances (Average)	
Grid-Plate	5.8 uuf
Grid-Filament	8.5 uuf
Plate-Filament	1.2 uuf
Transconductance ($I_b = 1.0$ amp., $E_b = 5000$, $e_c = -100$)	3500 umhos
Frequency for Maximum Ratings	40 mc

CALL IN AN EIMAC REPRESENTATIVE FOR INFORMATION

ROYAL J. HIGGINS (W9A10), 600 S. Michigan Ave., Room 818, Chicago 5, Illinois. Phone: Harrison 5948.
VERNER O. JENSEN CO., 2612 Second Ave., Seattle 1, Washington. Phone: Elliott 6871.
M. B. PATTERSON (WSCI), 1124 Irwin-Kessler Building, Dallas 1, Texas. Phone: Central 5764.

ADOLPH SCHWARTZ (W2CN), 220 Broadway, Room 2210, New York 7, New York. Phone: Courtland 7-0011.
HERB BECKER (W6QD), 1406 S. Grand Ave., Los Angeles 15, California. Phone: Richmond 6191.
TIM COAKLEY (W1KKP), 11 Beacon Street, Boston 8, Massachusetts. Phone: Capital 0050.

"Must be somethin' he et!..."



THERE'S ALWAYS A GOOD REASON why one kid shoots up faster than all the others in the neighborhood. It isn't luck. Most likely, it's more vitamins, more sunshine and better care.

Companies like Cornell-Dubilier don't grow up overnight either. Experts like C-D engineers don't just "happen". Only here it isn't what you *eat* or *dream*; it's what you *do*. You dig behind what others have told you. That's research. You look beyond what others have seen. That's pioneering. You spend more time and money, than might seem immediately profitable, to become proficient in your field. And when the "unheard of" has to be done, industry expects you to do it.

When giant capacitors, that could handle severe temperatures without the use of water-cooling coils, were needed, they came to Cornell-Dubilier. And when capacitors were needed for the Proximity Fuze, in sizes so tiny they had never before been envisioned, C-D engineers were handed the problem.

Remember that when your plans call for the unusual in capacitor design and dependability.



Cornell-Dubilier Electric Corp. South Plainfield, New Jersey. Five other plants in New Bedford, Brookline, Worcester, Mass. and Providence.



CORNELL-DUBILIER
world's largest manufacturer of
CAPACITORS

MICA • DYKANOL • PAPER • ELECTROLYTICS

NEW VARIACS with these **12** Features

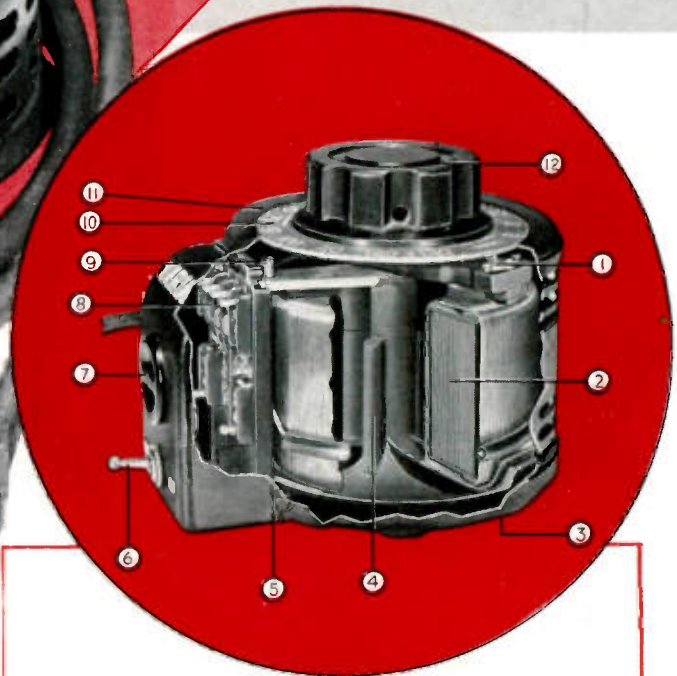

for
Improved Performance
Greater Convenience
Longer Life

● This new Type V-5 VARIAC replaces the popular Type 200-C. Through entirely new design and radical changes in basic structure the new model is 25% lighter, with the same rating of 860 va. This is achieved both through improved magnetic performance of the core and less copper, and through use of aluminum in most of the structure.

Some of the new VARIAC's many features are listed at the right. Externally, the new VARIAC has been streamlined to eliminate all sharp corners. The cord on the mounted model is arranged to be wound around the VARIAC, plugged into the outlet, and then used as a carrying strap.

This is the first radical change in basic design of the VARIAC since it was introduced by G-R almost 15 years ago. These many changes were made not to dress up the VARIAC in a new case but to provide real improvements to better its performance, increase its convenience and lengthen its life, and to be sure that when you use a VARIAC you are using the best means possible for controlling any alternating-current operated device where perfectly s-m-o-o-th variation in voltage is desired.

TYPE V-5 860 va VARIAC STYLE

TYPE	STYLE	PRICE
V-5	Basic (115-volt input) unmounted model	\$16.50
V-5M	Above with protective case around winding	17.50
V-5MT	A V-5 with protective case, terminal cover, 6-foot cord, switch and outlet	20.00
V-5H	Same as V-5, except for 115- or 230-volt input	21.50
V-5HM	Same as V-5M, except for 115- or 230-volt input	22.50
V-5HMT	Same as V-5MT, except for 115- or 230-volt input	25.00

WRITE FOR COMPLETE DATA

- 1 New G-R Unit Brush — low sprung weight reduces hammering and arcing under vibration — correct pressure provided by coil spring — holder cannot make contact with winding and cause short-circuit — brush changed quickly without tools.
- 2 New grain-oriented core of cold-finished silicon-steel with guaranteed maximum core loss — strip wound.
- 3 Three rubber feet prevent marring table top and make it unnecessary to screw units down to prevent slippage.
- 4 Aluminum structure contributes to greatly increased output per pound.
- 5 Only two screws hold both case and terminal cover — a screwdriver or a spare dime remove each in a second.
- 6 Heavy-duty switch breaks both sides of the line, in mounted models.
- 7 Polarity indication provided in convenience outlet — useful if one side of line is grounded.
- 8 Improved molded terminal plate protected by a metal, fiber-lined cover — molded barriers between terminals prevent short-circuits from whiskers on stranded wire — both screw and solder terminals — engraved circuit diagram shows normal VOLTAGES between terminals — 2 extra terminals for use with auxiliary transformers.
- 9 New resilient stop allows brush arm to bounce instead of break if you are too vigorous in rotating knob.
- 10 BIG calibration figures and extra points on dial — easy to read at a distance — easier to reset — pointer provided for panel mounting.
- 11 A single screw, readily accessible under dial, loosens shaft for reversing dial and knob to change from table to panel mounting without affecting brush or stop settings.
- 12 Newly designed, larger knob — easier to hold — easier to turn.

GENERAL RADIO COMPANY

Cambridge 39,
Massachusetts



90 West St., New York 6 920 S. Michigan Ave., Chicago 5 950 N. Highland Ave., Los Angeles 38