

PROCEEDINGS OF THE I·R·E



AND



WAVES AND ELECTRONS

Millon

May, 1946

Volume 34

Number 5

PROCEEDINGS
OF THE I.R.E.

Loran

Precipitation Static

Transmission Formula

Amplitude Nonlinearity in F-M
Systems

Waves and Electrons
Section

I.R.E. War Participation

Navy Radio and Electronics

CBS Control-Room Design

Liquid Dimethylsilicones

Ionization Gauge

Resonant-Cavity Resonators

Cylindrical Shielding

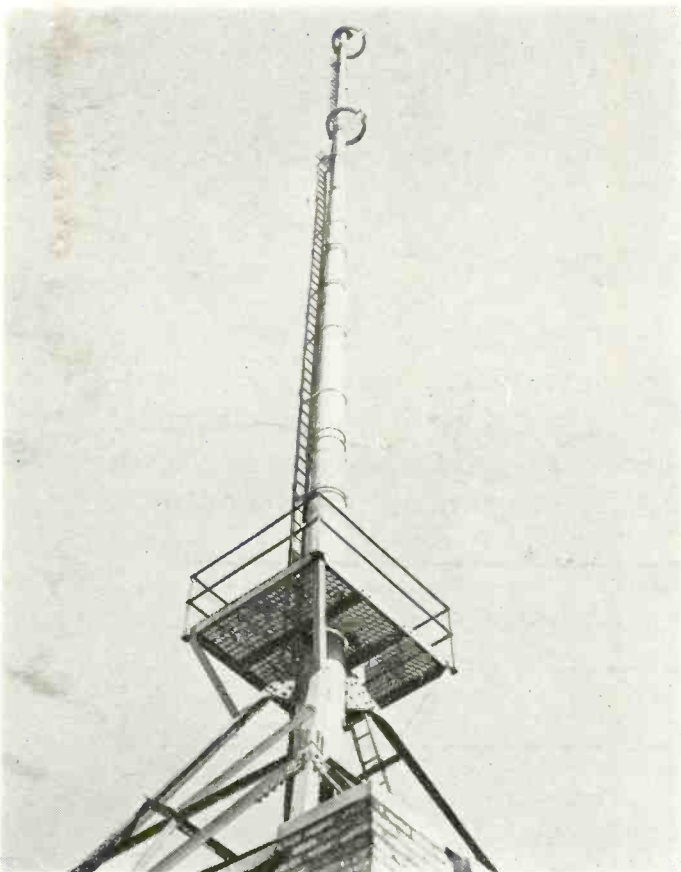

General Electric and CBS

Antenna Atop Manhattan Skyscraper. Seven-hundred feet above New York's streets a two-bay circular antenna carries frequency-modulation programs to metropolitan listeners.

The Institute of Radio Engineers

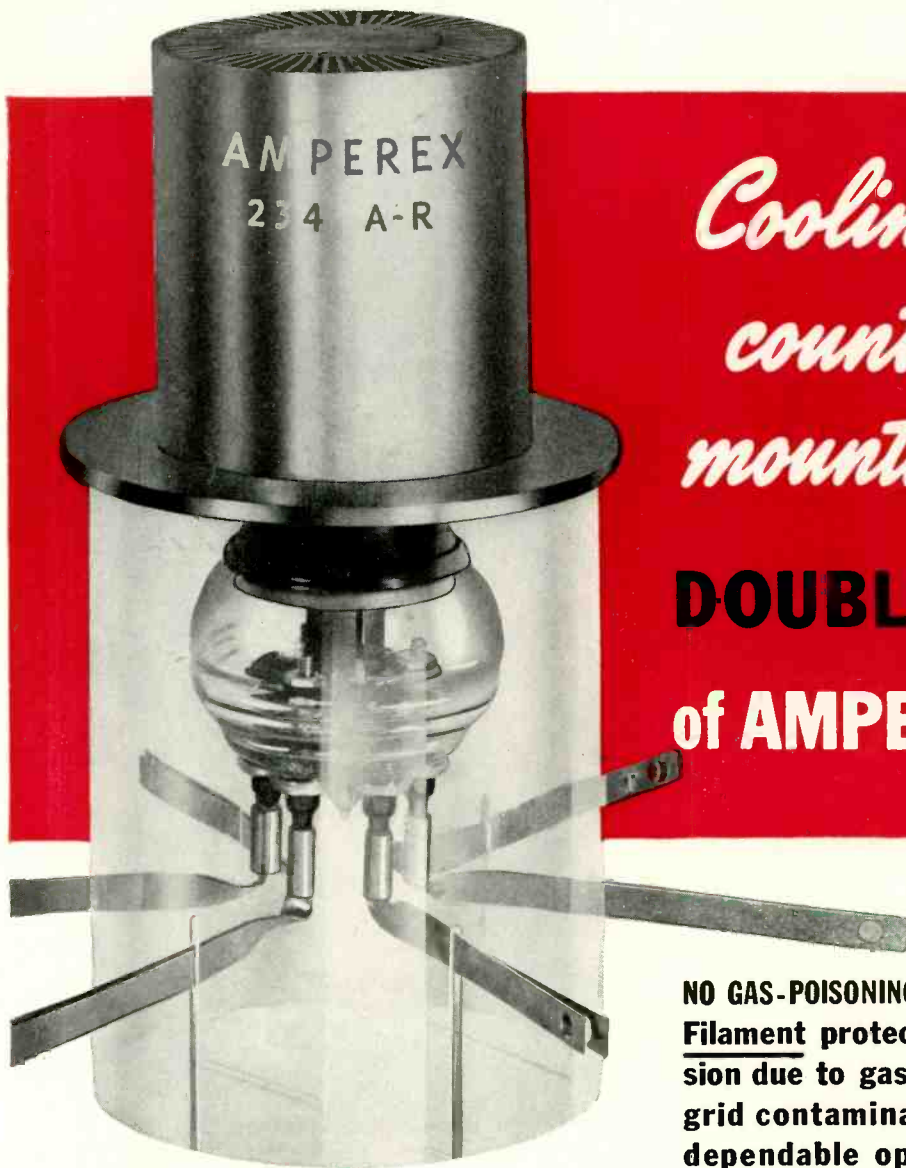

*Cooling where it
counts in new
mounting position*
DOUBLES OUTPUT
of AMPEREX 234 A-R

NO GAS-POISONING WORRIES: Pure Tungsten Filament protects against reduced emission due to gas evolution and eliminates grid contamination thus insuring more dependable operation and longer life.

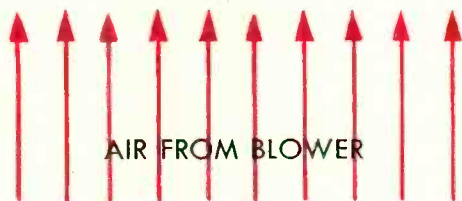

AIR FROM BLOWER

WRITE FOR Detailed Technical Rating and Data Sheets. Industrial and communication engineers are invited to consult with the Amperex Application Engineering Department on all tube, circuit and related problems. Amperex designs and engineers a complete line of power tubes: Communication, Rectification, Industrial, Electro-Medical, Special Purpose.



AMPEREX
ELECTRONIC CORPORATION

25 Washington Street, Brooklyn 1, N. Y., Cables: "ARLAB"
In Canada and Newfoundland: Rogers Majestic Limited,
622 Fleet Street West, Toronto 2B, Canada

MAXIMUM RATINGS AND TYPICAL OPERATING CONDITIONS
R.F. Power Amplifier and Oscillator Class C —
Industrial, FM and Telegraphy

| | Maximum Rating | | Typical Operation | |
|----------------------------------|----------------|------|-------------------|-----------|
| | per Tube | | One Tube | Two Tubes |
| Operating Frequency (mc) | 110 | 200 | 27 | 110 |
| Filament Voltage | 15.0 | 15.0 | 15.0 | 15.0 |
| D.C. Plate Voltage | 3500 | 2000 | 3500 | 3500 |
| D.C. Grid Voltage | -450 | -250 | -330 | -275 |
| Peak RF Grid Voltage | — | — | 830 | 675 |
| D.C. Plate Current (amps) | .900 | .800 | .860 | 1.43 |
| Plate Input (watts) | 3000 | 1600 | 3000 | 5000 |
| Plate Dissipation (watts)* | 1000 | 1000 | 1000 | 1700 |
| D.C. Grid Current (ma) (approx.) | 200 | 160 | 110 | 220 |
| Driving Power (watts) (approx.) | — | — | 87 | 140 |
| Plate Power Output (watts) | — | — | 2000 | 3300 |

*Based on air flow data.

POWER TUBE SPECIALISTS SINCE 1925

Again...FEDERAL makes NEWS...with the

FIRST TRIODE

EVER DEVELOPED THAT GIVES YOU

600 watts at
600 MC!



ACTUAL
SIZE

TENTATIVE MAXIMUM RATINGS AND TYPICAL OPERATION

Key-down conditions without amplitude modulation. Maximum ratings for frequency of 600 MC.

Typical operation— Self-excited oscillator

| FREQUENCY MC | PLATE VOLTAGE VOLTS | PLATE CURRENT AMPERES | POWER OUTPUT WATTS |
|-----------------|---------------------------|-----------------------------|--------------------------|
| 300 | 2500 | 0.70 | 900 |
| 400 | 2500 | 0.65 | 800 |
| 500 | 2200 | 0.70 | 680 |
| 600 | 2000 | 0.65 | 500 |

DC Plate Voltage . . . 2500 Volts
DC Plate Current . . . 0.75 Amperes
DC Grid Current . . . 0.075 Amperes
Plate Input 1875 Watts
Plate Dissipation . . . 1000 Watts

Now being used successfully in the powerful CBS color television transmitter operating at 490 MC carrier frequency with 10 MC bandwidth at 1 KW peak power output.

Federal's 6C22 is the *only* tube of this type ever to operate at this power output at such high frequency. It's *the* triode to use . . . as oscillator, amplifier, or frequency multiplier.

Four years of Federal engineering effort were spent in its development for radar equipment. Now it's ready for commercial broadcast use . . . with features making it especially suitable in the UHF spectrum.

For example, Federal's 6C22 has ring-seal electrode construction which reduces lead inductance . . . and extremely close interelectrode spacings to lower transit time losses.

And with 37 years of tube-building experience behind all Federal tubes, you'll find "extras" of rugged mechanical design in the 6C22, in addition to trustworthy electrical performance. It has no internal spacers to break down. Built with solid copper anode block, and water cooled, it works at the high power levels with complete safety. Write for complete information.

Federal Telephone and Radio Corporation

Export Distributor:
International Standard Electric Corporation

Newark 1, New Jersey



PROCEEDINGS OF THE I.R.E. AND WAVES AND ELECTRONS, April, 1946, Vol. 34, No. 5. Published monthly in two sections by The Institute of Radio Engineers, Inc., at 450 Ahnaip St., Menasha, Wis., or 330 West 42nd Street, New York 18, N.Y. Price \$1.00 per copy. Subscriptions: United States and Canada, \$10.00 a year; foreign countries, \$11.00 a year. Entered as second-class matter, October 26, 1927, at the post office at Menasha, Wisconsin, under the act of March 3, 1879. Acceptance for mailing at a special rate of postage is provided for in the act of February 28, 1925, embodied in Paragraph 4, Section 412, P. L. and R., authorized October 26, 1927.

Table of contents will be found following page 32A

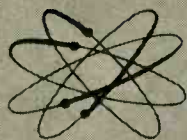

Designer's

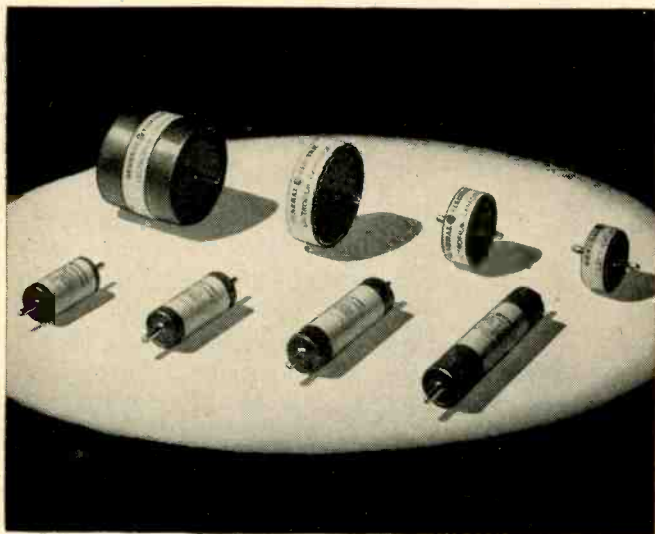

LECTROFILM *at a glance*

Lectrofilm is the name of a new synthetic-resin dielectric developed by General Electric Laboratories which combines a greater number of desirable mechanical and electrical properties than any other single capacitor dielectric material. It is admirably suited for use in dry-type, high-voltage capacitors because it—

- 1.** Withstands high and low ambient temperatures
- 2.** Has low power factor and its power factor decreases as temperature rises
- 3.** Has high dielectric strength and constant
- 4.** Is chemically stable
- 5.** Is strong and flexible
- 6.** Has uniform characteristics
- 7.** Is moisture resistant

New High-Voltage CAPACITORS for TELEVISION Pulse Rectifiers

To smooth out the rectified high-voltage power supply in television and similar electronic applications, G.E. has developed a new line of small, light-weight, high-voltage capacitors. These new components are specially designed to meet the exacting restrictions in size and weight made necessary by the compact design of modern television receivers.

Currently available in two widely usable designs—flat cylindrical and long cylindrical—these Lectrofilm* units are equipped with prong-type terminals, designed to meet the special mounting requirements of modern television receivers.

Constructed of thoroughly tested and proved materials, these new Lectrofilm capacitors make available to the television engineer the high quality and reliability demanded by today's television applications. Write for Bulletin GEA-4558.

G-E Lectrofilm capacitors, for use in television pulse rectifiers, are now available in the ratings given in the following table. (Other ratings and designs will be available on request.)

RATINGS AND DATA

Capacitance ratings: all sizes .0005 Mu-f. Capacitance tolerance, plus 35 per cent, minus 0 per cent.

| Peak Working Voltage | Cat. No. | Maximum R-F Current (Milliamperes) | | | Net Wt. in Oz. | Approx. Dimensions in Inches | |
|---|----------|------------------------------------|---------|---------|----------------|------------------------------|-------------------------|
| | | at frequencies of | | | | Diameter | Length (Inc. terminals) |
| | | 20 Kc. | 100 Kc. | 300 Kc. | | | |
| FLAT CYLINDRICAL UNITS, with Terminals on Axis | | | | | | | |
| 5000 | 29F201 | 15 | 50 | 150 | 1/2 | 1 1/8 | 1 1/8 |
| 7500 | 29F200 | 20 | 75 | 200 | 3/4 | 1 3/8 | 1 3/8 |
| 10,000 | 29F196 | 25 | 100 | 300 | 1 1/2 | 2 1/8 | 1 3/8 |
| 16,000 | 29F206 | 30 | 120 | 350 | 4/2 | 2 1/8 | 3 1/2 |
| LONG CYLINDRICAL UNITS, with Terminals on Axis | | | | | | | |
| 5000 | 29F203 | 10 | 40 | 100 | 3/4 | 1 1/8 | 2 1/2 |
| 7500 | 29F204 | 10 | 40 | 100 | 1 | 1 1/8 | 3 |
| 10,000 | 29F202 | 10 | 40 | 100 | 1 1/2 | 1 1/8 | 4 |
| 16,000 | 29F205 | 15 | 50 | 125 | 3 | 1 1/8 | 5 |

* General Electric's new synthetic-resin dielectric

GENERAL  ELECTRIC

Digest

TIMELY HIGHLIGHTS ON G-E COMPONENTS

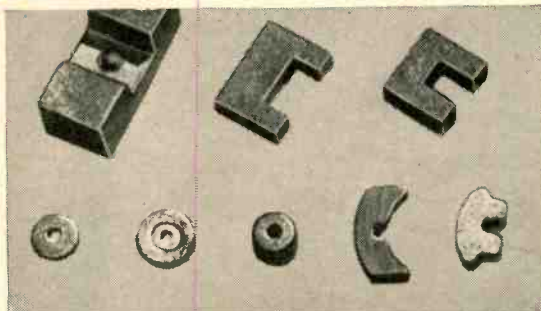

MORE MAGNET *in less space*

G-E alnico magnets are the answer to many a tough problem in design, where coercive force must be large, and the magnet small.

They are formed by the cast as well as the sintered process which makes possible rapid, large-scale, close-tolerance manufacture of both complex and simple shapes. Compact, with uniform flux distribution and great stability, these mighty midgets facilitate the design of small devices of high precision. Write for Bulletin GEA-3682A.

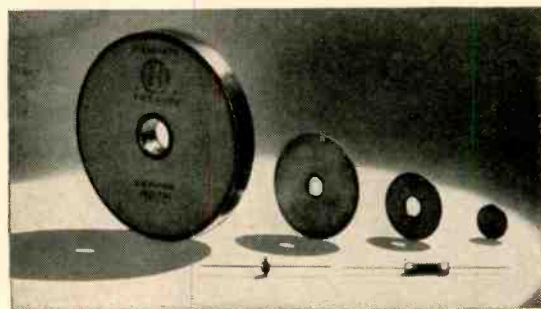

EVER NEED *a non-linear resistance?*

Frequently, electronic designers need a non-linear resistance to protect against voltage surges, to stabilize power voltages or to control voltage-selective circuits. In Thyrite*, General Electric's silicon-carbide resistance material, current varies as a power of the applied voltage. That is, I varies as E^n .

For example, with a Thyrite resistor whose exponent is 4, doubling the voltage multiplies the current by 2^4 or 16, whereas doubling the voltage applied to a wire-wound resistor merely doubles the current.

Thyrite resistors are supplied in discs or rods, in diameters from 0.25 in. to 6.0 in. Write for Bulletin GEA-4138A.

* Trade-mark Reg. U. S. Pat. Off.

TIGHT, FAST JOINTS

begin with the soldering iron

With the new line of G-E soldering irons, operators can solder just as fast as the nature of the job permits. Tips stay hot during constant use. The Carlod heating element close to the tip gives a short, low-loss heat path to the work.

Sturdy construction prevents work interruptions due to iron failure. Repairs are infrequent, even under severe conditions. Available in five sizes and types, from 75 to 300 watts, 115 volt or 230 volt. Write for Bulletin GEA-4519.



A LOT OF INSTRUMENT

in a little space

These thin, internal-pivot panel instruments have high torque, good damping, and a lightweight moving element that withstands vibration. They respond rapidly and accurately. They give you more instrument in less space, because the internal-pivot construction makes the entire element assembly 20 per cent thinner than most outside-pivoted types. Ask for details of the Type DW voltmeter or ammeter—milli, micro, or radio frequency. Bulletin GEA-4064.



REMOTE CONTROLS *that stay in step*

G-E selsyns *stay* synchronized; that is why they are so widely used for remote control and indication applications with single and multiple receivers.

Three sizes of high-accuracy selsyns give operation to within plus or minus 1 degree. Where plus or minus 5 degrees is close enough, use lower cost general-purpose selsyns.

Accuracy values are for 60 cycle, 110 volt operation. Write for Bulletin GEA-2176A.



General Electric Company, Sec. 642-11
Apparatus Dept., Schenectady 5, N. Y.

Please send me

- GEA-4558 (Lectrofilm capacitors)
- GEA-3682A (Sintered alnico magnets)
- GEA-4064 (Panel Instruments)
- GEA-4138A (Thyrite)
- GEA-4519 (Soldering irons)
- GEA-2176A (Selsyns)

NOTE: more data available in Sweets' File for Product Designers

Name

Company

Address

City State

Data for all designers

CARBONYL IRON POWDER

comes in 5 different grades

L C E TH SF

For use in cores for different applications the powders are processed:

1. With different amounts of particle-to-particle insulation,
2. With different types of insulation or bonding material,
3. With different ratios of iron to inert material,
4. With different pressures to different densities, and
5. With different form factors and shapes.

To obtain exactly specified:

1. Permeability
2. Q value
3. Eddie current loss
4. Hysteresis loss
5. Temperature coefficient



Data for circuit & coil designers



COMPARISON OF AIR-CORED AND CARBONYL IRON CORED COILS: For Medium Frequencies



| Specification | Typical air-cored coil | Typical CARBONYL IRON cored coil | Thus: |
|--|------------------------|----------------------------------|---------------------------------|
| VOLUME | 0.61 cubic-inches | 0.12 cubic-inches | Saves 80% of Space |
| WEIGHT Exclusive of Housing, Mounting, etc. | 1.5 ounces | 1.0 ounces | Saves 33% of Weight |
| WIRE-LENGTH | 25 feet | 11 feet | Saves 60% of Wire |
| INDUCTANCE | 117 Micro-Henries | 169 Micro-Henries | Increases Inductance 40% |
| Q Value at 1.0 Mc | 94 | 260 | Increases Q Value 170% |

For further data write: General Aniline & Film Corp., Special Products Sales Department,
270 Park Avenue, New York 17, N. Y.

G.A.F.



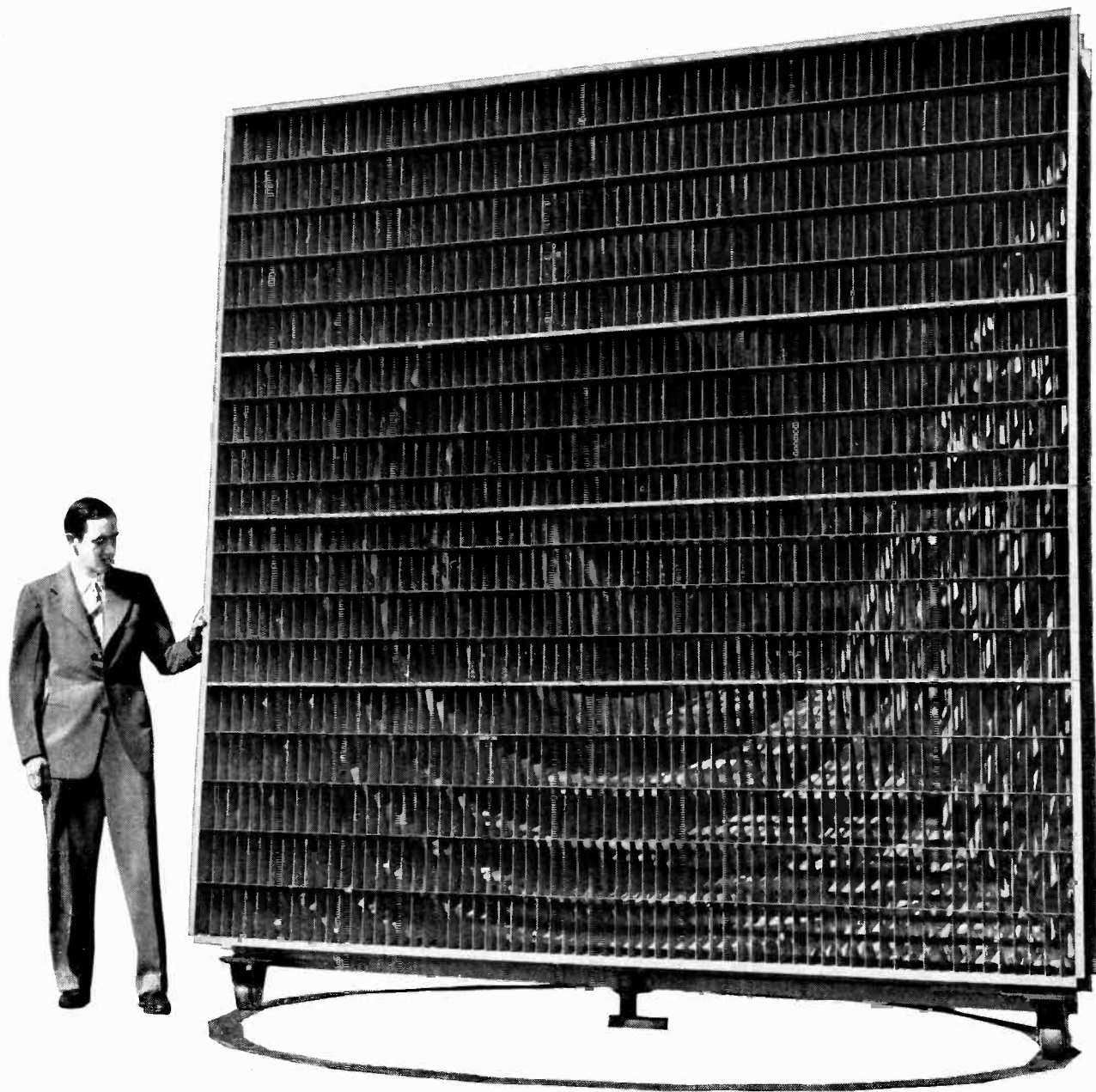

A "SEARCHLIGHT" TO FOCUS RADIO WAVES

In the new microwave radio relay system between New York and Boston, which Bell Laboratories are developing for the Bell System, giant lenses will shape and aim the wave energy as a searchlight aims a light beam.

This unique lens—an array of metal plates—receives divergent waves through a waveguide in the rear. As they pass between the metal plates their direction of motion is bent in-

ward so that the energy travels out as a nearly parallel beam. At the next relay point a similar combination of lens and waveguide, working in reverse, funnels the energy back into a repeater for amplification and re-transmission.

A product of fundamental research on waveguides, metallic lenses were first developed by the Laboratories during the war to produce precise radio beams.

This "searchlight" is a milestone in many months of inquiry through the realms of physics, mathematics and electronics. But how to focus waves is only one of many problems that Bell Telephone Laboratories are working on to speed microwave transmission. The goal of this and all Bell Laboratories research is the same—to keep on making American telephone service better and better.



BELL TELEPHONE LABORATORIES

EXPLORING AND INVENTING, DEVISING AND PERFECTING FOR CONTINUED IMPROVEMENTS AND ECONOMIES IN TELEPHONE SERVICE



The Mark of Quality

With the dawn of the new electronic era CENTRALAB again dominates the scene. The "CRL IN THE DIAMOND" identifies a group of QUALITY components engineered to the exacting requirements of the new electronic age . . . always specify CENTRALAB.

Centralab

Division of GLOBE-UNION INC., Milwaukee

PRODUCERS OF



Ceramic Trimmers
Bulletin 695



Ceramic High Voltage Capacitors
Bulletin 814



Variable Resistors
Bulletin 697

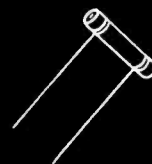

Tubular Ceramic
Capacitors
Bulletins 630 and 586

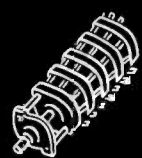

Selector Switches
Bulletin 722



Something New HAS BEEN ADDED TO IRC DISTRIBUTOR SERVICE...

**NEW INDUSTRIAL SERVICE PLAN GIVES YOU
QUICK DELIVERIES ON STANDARD RESISTORS!**

Now, IRC Distributors are better prepared than ever before to give manufacturers quick, complete and intelligent service. The IRC Industrial Service Plan, developed by IRC in cooperation with its more than 300 distributors, gives you "just around the corner" sources of supply for the resistance units you need in experimental work, pre-production models, pilot runs, smaller production runs and for service and maintenance!

The IRC Catalog #50 lists standard IRC products stocked by distributors. By aiming toward standardization of your resistor requirements on these items, you will find that reasonable quantities can be delivered quickly by local distributors. In addition, the wider use of standardized items will eventually result in lower unit cost, it will provide better emergency service for your products when in use, and your customers will benefit by a more dependable piece of equipment.

FOR BETTER-THAN-STANDARD QUALITY ... *Standardize on IRC*

WRITE TO DEPT. 10-E FOR IRC CATALOG #50 AND NAMES OF LOCAL DISTRIBUTORS

INTERNATIONAL RESISTANCE CO.
401 N. BROAD ST., PHILADELPHIA 8, PA.
Canadian Licensee: International Resistance Co., Ltd., Toronto

Sometimes they are SIMPLER THAN THEY SEEM



EXTRUDED



CUT

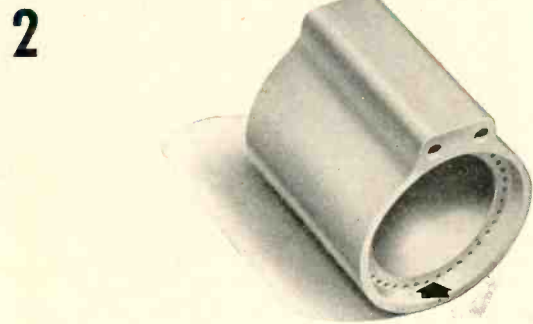

COUNTER-SUNK

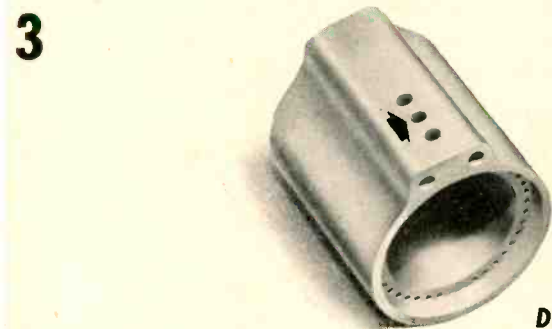

DRILLED

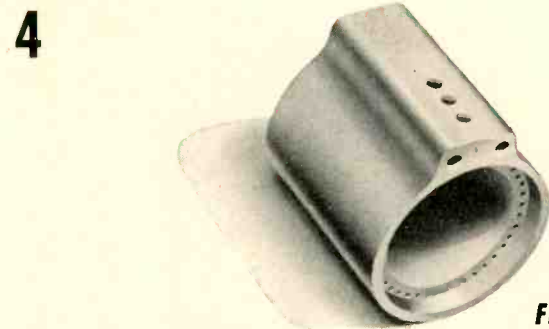

FIRED

SOME intricate ceramic designs machined from steatite seem unbelievably complicated. Actually they are simpler than they seem. By incorporating complex design details in extruded, pressed or cast basic shapes, American Lava Corporation frequently has been able to minimize the relatively slow and costly machining process. Production study may show desirable design alternatives which permit faster deliveries, lower cost.

Here in one organization you will find engineering vision and practical knowledge of AlSiMag technical ceramics, backed by highly versatile equipment of our own design. Send us your unusual, intricate, or complicated designs. Perhaps we can suggest practical design simplifications and streamline manufacture by a combination of production facilities and experience available from no other source. *We like tough jobs.*



Original Award July 27, 1942
Second Award February 13, 1943
Third Award September 25, 1943
Fourth Award May 27, 1944
Fifth Award December 2, 1944

AMERICAN LAVA CORPORATION
CHATTANOOGA 5, TENNESSEE

ALSiMAG
TRADE MARK REGISTERED U.S. PATENT OFFICE

43RD YEAR OF CERAMIC LEADERSHIP

You Can Depend on These Famous Names

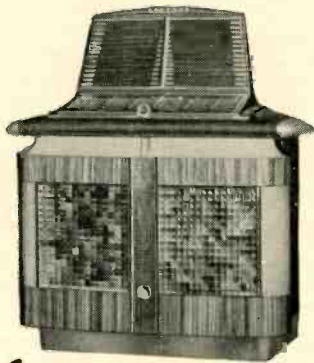

"Electronic" Tone Quality

Aireon Electronic Phonographs, achieve a tone quality never before approached in coin-operated music. Heart of their sensational performance is the specially designed 15-inch, 12,000 cycle Cinaudagraph Speaker which carries a maximum range of harmonics and tone.

The Aireon Manufacturing Corporation is proud of the enviable reputation Cinaudagraph Speakers have attained for high fidelity, superior performance and ruggedness. This standard of perfection will not only be maintained in Cinaudagraph Speakers but will be extended through the exceptional research, engineering and production facilities of Aireon. Recognition and acceptance of Cinaudagraph Speakers by leading radio manufacturers is an assurance of their high fidelity performance.

A complete line of speakers from two-inch units for portable radios to fifteen-inch models for commercial phonographs and public address systems is produced at the Slater, Missouri plant. Write us about your speaker requirements.

Cinaudagraph Speakers, Inc.

MANUFACTURED AT SLATER, MISSOURI

Subsidiary of **Aireon** Manufacturing Corporation

SALES OFFICES: 1401 FAIRFAX TRAFFICWAY,
KANSAS CITY 15, KANSAS



New Tetrode for Fixed or Mobile Use

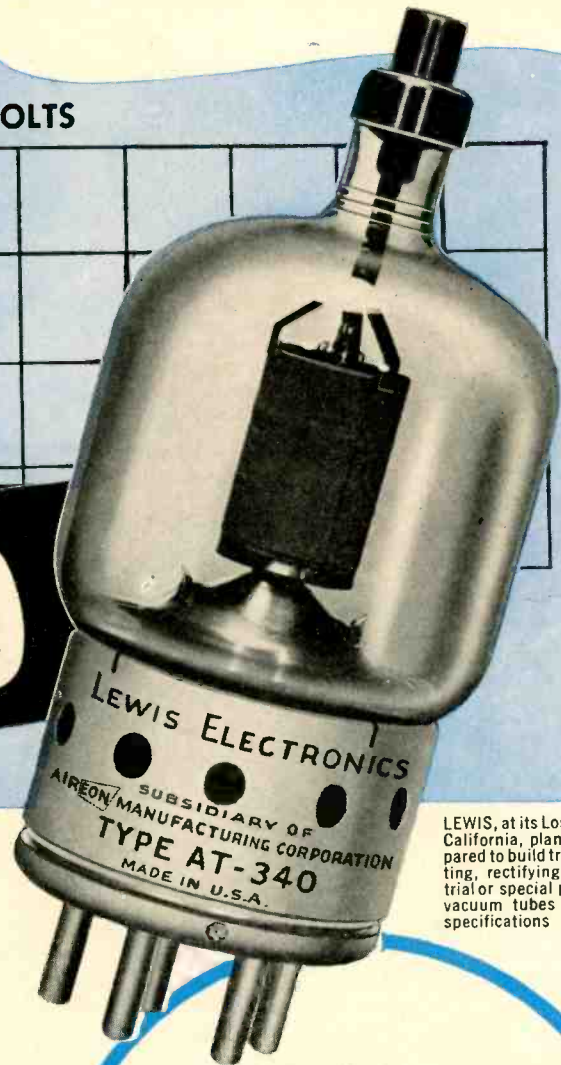
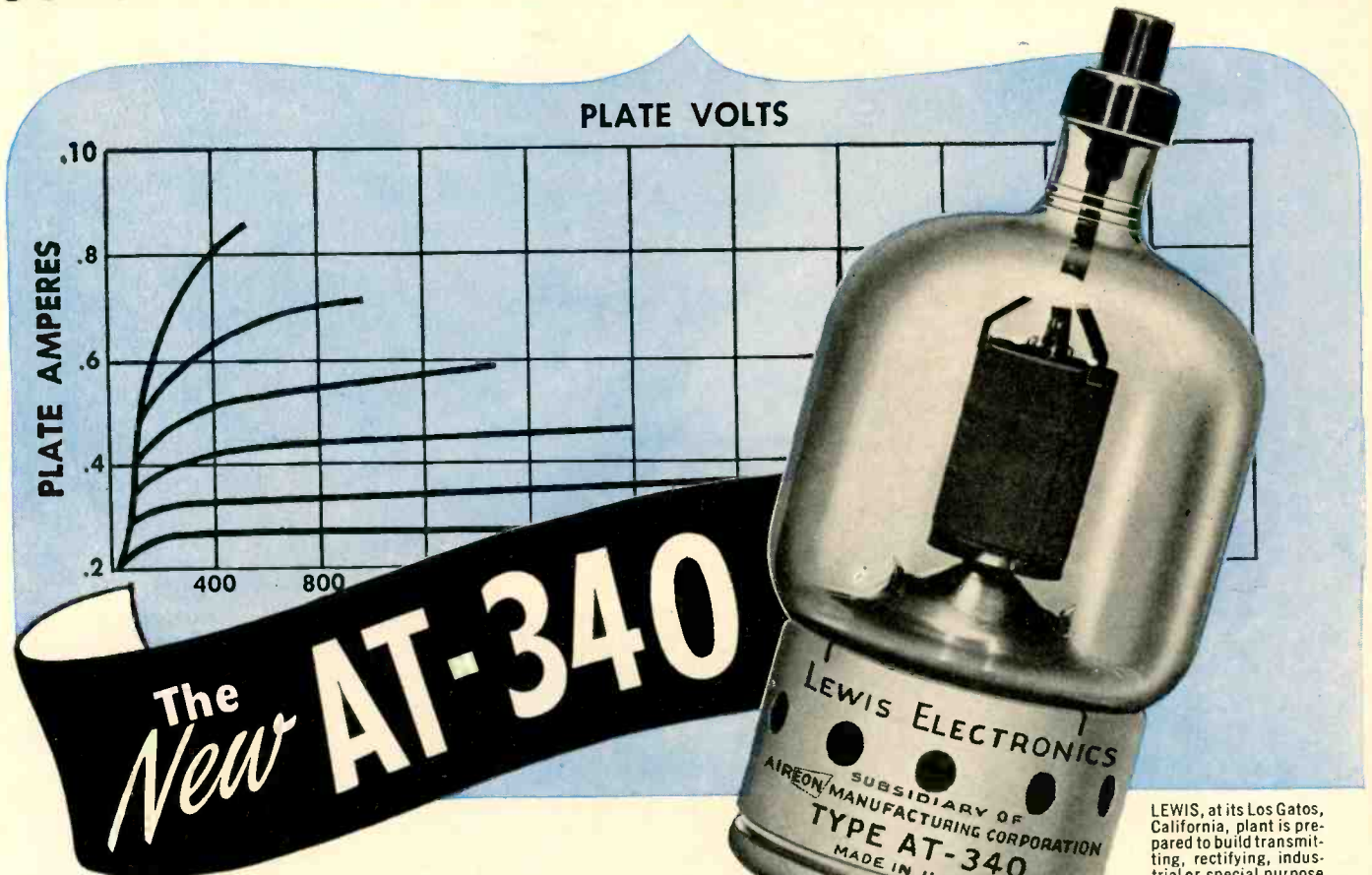

LEWIS, at its Los Gatos, California, plant is prepared to build transmitting, rectifying, industrial or special purpose vacuum tubes to your specifications

LEWIS AT-340 was designed with several specific ideas in mind. First, to give design engineers a rugged and versatile 150 watt class beam tetrode to simplify transmitter circuit design. Secondly, to develop to a high degree the inherent low driving power requirements of the beam tetrode. Thirdly, to accomplish both these ends at low "per-hour-cost" by conservative ratings and careful manufacture.

A minimum of structural insulation support enables operation under maximum conditions to 120 megacycles. Also permits high dissipation with a relatively small bulb cooled by convection only.

The AT-340 has a 5-pin metal sleeve base and top plate connection. Filament is thoriated tungsten at 37.5 watts, plate is molybdenum, dark body.

Tubes and catalogs are now ready.

MAXIMUM RATINGS Class "C" Radio Frequency Power Amplifier and Oscillator

| | |
|---------------------------|------------------------|
| D-C Plate Voltage . . . | 4000 volts |
| D-C Plate Current . . . | 225 ma |
| Plate Input | 750 watts |
| Plate Dissipation | 150 watts |
| To 120 Megacycles | |
| Filament | 5.0 volts, 7.5 amperes |

Lewis

Subsidiary of **Aireon**
MANUFACTURING CORPORATION

ELECTRONICS
LOS GATOS • CALIFORNIA

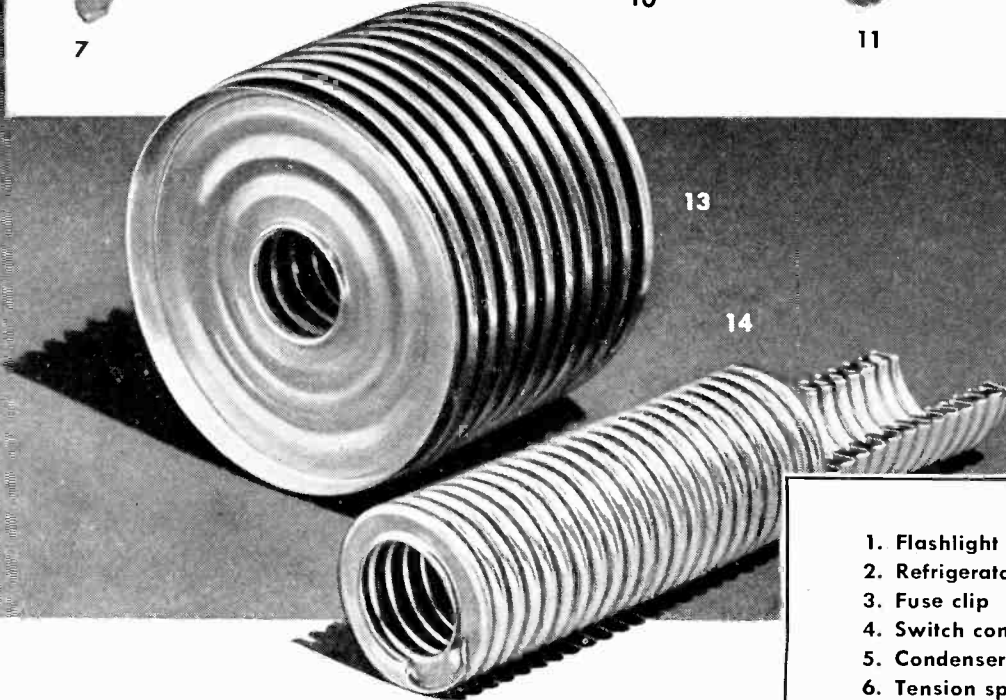
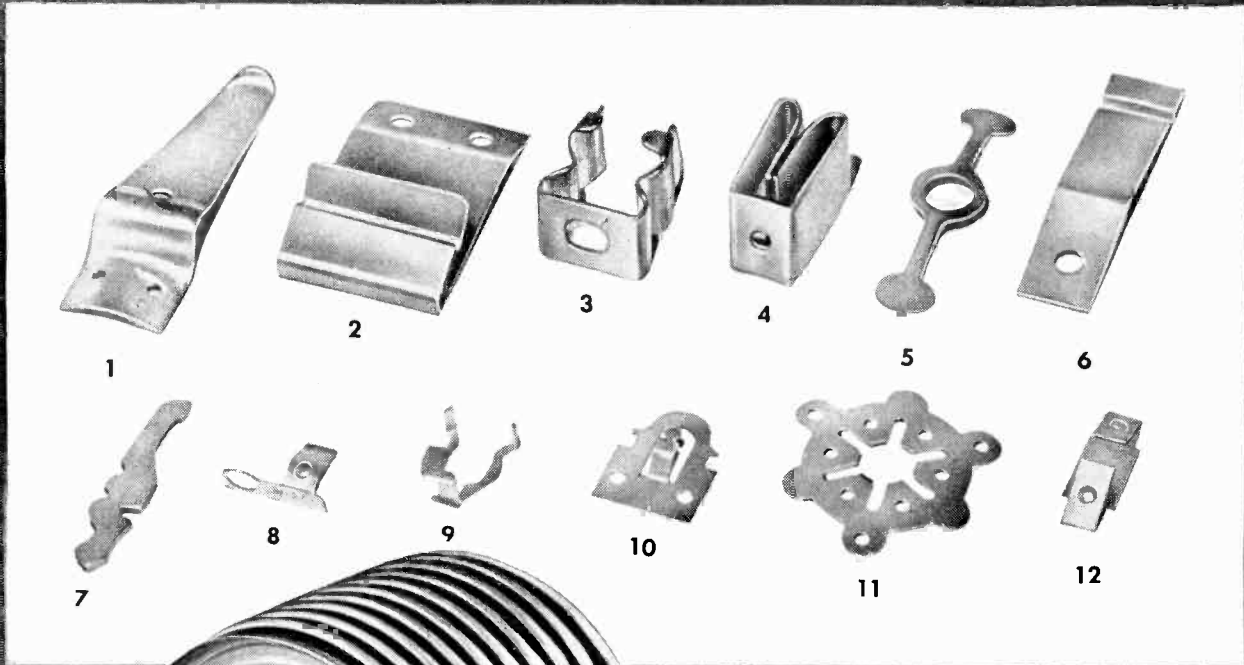

1. Flashlight clip
2. Refrigerator door catch
3. Fuse clip
4. Switch contact
5. Condenser member
6. Tension spring
7. Contact blade
8. Sliding contact
9. Guide fork spring
10. Switch tension spring
11. Spring pressure plate
12. 3-way plug contact
13. Tin-coated bellows
14. Flexible hose

REVERE PHOSPHOR BRONZES OFFER MANY ADVANTAGES

Strength — Resilience — Fatigue Resistance — Corrosion Resistance — Low Coefficient of Friction — Easy Workability — are outstanding advantages of Revere Phosphor Bronzes, now available in several different alloys.

In many cases it is the ability of Phosphor Bronze to resist repeated reversal of stress that is its most valuable property. Hence its wide employment for springs, diaphragms, bellows and similar parts. In addition its corrosion resistance in combination with high tensile properties render it invaluable in chemical, sewage disposal, refrigeration, mining and similar applications. In the form of welding rod, Phosphor Bronze has many advantages in the welding of copper, brass, steel, iron and the repair of worn or broken machine parts. Revere suggests you investigate the advantages of Revere Phosphor Bronzes in your plant or product.

REVERE

COPPER AND BRASS INCORPORATED

Founded by Paul Revere in 1801
 230 Park Avenue, New York 17, N. Y.
 Mills: Baltimore, Md.; Chicago, Ill.; Detroit, Mich.; New Bedford, Mass.; Rome, N.Y. — Sales Offices in principal cities, distributors everywhere.

Listen to *Exploring the Unknown* on the Mutual Network every Sunday evening, 9 to 9:30 p.m., EDST.

Not jet propelled...

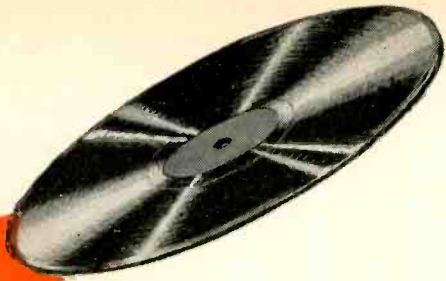

PRESTO 8-D

but just as **NEW!**

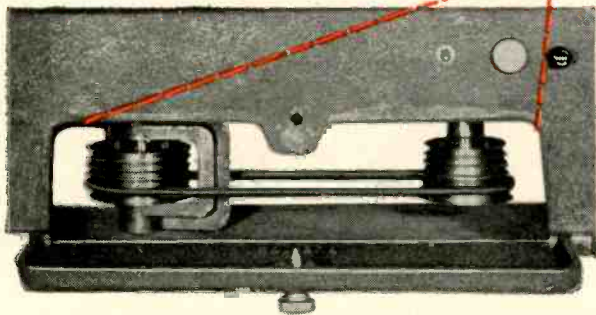
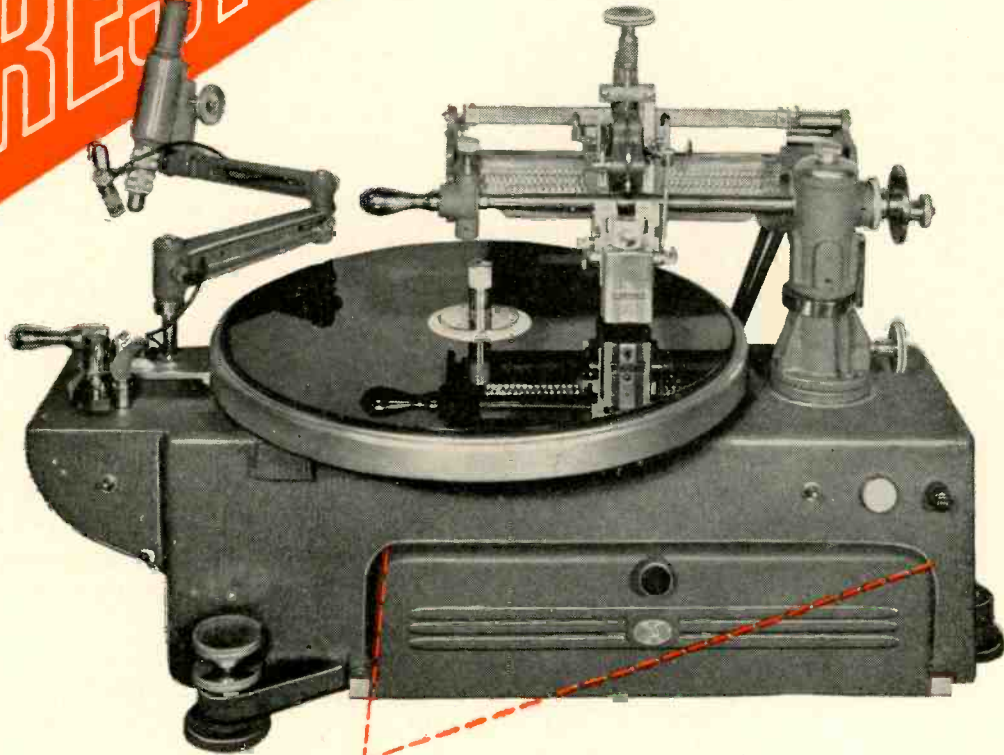

The belt on step pulleys slips instantly to any position to set cutting pitch at 96-104-112-120-128 or 136 lines per inch. Other pitches available on special order.

PRESTO'S newest *turntable*... for highest quality master or instantaneous recordings. The 8-D features instantaneous change of cutting pitch. An improved cutting head provides higher modulation level, more uniform frequency response and retains its calibration under all normal temperature conditions.

The heavy cast-iron turntable and mounting base insure exceptionally low background noise. Adjustable feet permit accurate leveling on bench or stand at a height to suit the operator.



RECORDING CORPORATION
242 West 55th Street, New York 19, N. Y.
WALTER P. DOWNS, Ltd., in Canada

WORLD'S LARGEST MANUFACTURER OF INSTANTANEOUS SOUND RECORDING EQUIPMENT AND DISCS

✓ CHECK THESE FEATURES...

-features that emphasize the versatility of The DUMONT TYPE 247 OSCILLOGRAPH

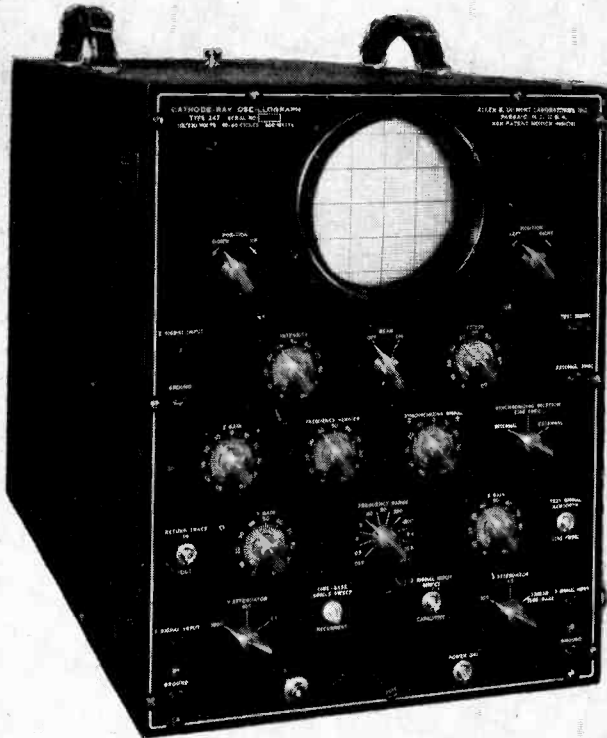

all these features *plus...*

exceptionally fine quality . . . well planned mechanical design . . . and completely dependable electrical performance . . . all of which make the DuMont Type 247 Cathode-Ray Oscilloscope the logical choice for all applications that require a measuring instrument of fine accuracy.

★ WRITE FOR DESCRIPTIVE LITERATURE

© ALLEN B. DUMONT LABORATORIES, INC.

1 ✓ AUTOMATIC BEAM CONTROL FOR PHOTOGRAPHIC PURPOSES

Permits high-contrast photographic recordings by holding the spot brightness at zero until the transient under study is initiated - then the spot is automatically raised to full brilliance.

2 ✓ EXTENDED TIME BASE RANGE 0.5 to 50,000 C. P. S.

A compensated circuit assures a linear sweep at all operating frequencies. The single sweep operates over a range corresponding to 0.5 to 10,000 c.p.s. The sweep is initiated by the controlling signal.

3 ✓ VERTICAL AMPLIFIER RESPONSE UNIFORM-2 to 200,000 C. P. S.

The response curve does not exhibit a positive slope above 1,000 c.p.s., thus assuring a linear phase-frequency relationship for the amplifier.

4 ✓ HORIZONTAL AMPLIFIER MAY BE USED AS A D-C AMPLIFIER

This amplifier is direct-coupled throughout, with the exception of an input capacitor which can be shorted out by operating a front-panel switch.

5 ✓ 3,000-VOLT ACCELERATING POTENTIAL PROVIDES BRIGHTER CRT PATTERN

Sufficient brilliance for all but the highest writing rates without using special equipment.

DUMONT Precision Electronics & Television

ALLEN B. DUMONT LABORATORIES, INC., PASSAIC, NEW JERSEY • CABLE ADDRESS: ALBEEDU, PASSAIC, N. J., U. S. A.

FULLY SHIELDED



The "Super-Pro's" high-fidelity amplifier provides excellent broadcast quality—fine for use with record players when DX isn't coming through.

"SUPER PRO"

Series 400

.54-30 MC.

If you are troubled with spurious beats and images from powerful stations, you need a "Super-Pro." Complete shielding right up to the antenna terminals is one of the many features of the new Series 400 "Super-Pro."



HAMMARLUND

THE HAMMARLUND MFG. CO., INC., 460 W. 34TH ST., NEW YORK 1, N. Y.
MANUFACTURERS OF PRECISION COMMUNICATIONS EQUIPMENT

TELEVISION

Projection...

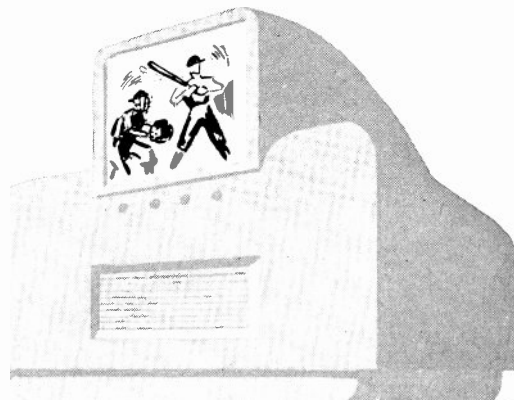

and Direct-Viewing

Whether your television plans embrace direct-viewing, projection, or both, you'll find RAULAND Cathode Ray Tubes adaptable to your needs. Research, continuing from television's early beginnings to development of theatre-size screen projection, has enabled RAULAND engineers to produce the finest direct-viewing and projection type tubes, using either reflective or refractive optics.

Consult with our engineers about your television problems with respect to Cathode Ray Tubes.

Be sure to visit Rauland Booth No. 83 while at Radio Parts and Electronic Show, Stevens Hotel, Chicago. May 13-16.

RADIO • RADAR • SOUND

Rauland

COMMUNICATIONS • TELEVISION

Electroneering is our business

THE RAULAND CORPORATION • CHICAGO 41, ILLINOIS



FOR HIPERM ALLOY TRANSFORMERS

The UTC Hiperm alloy audio transformers are specifically designed for portable and compact service. While light in weight and small in dimensions, neither dependability nor fidelity has been sacrificed. The frequency characteristic of the Hiperm alloy audio units is uniform from 30 to 20,000 cycles. These units are similar in general design and characteristics to the famous Linear Standard audio Series.

UTC Hiperm Alloy Transformers Feature

- True Hum Balancing Coil Structure** . . . maximum neutralization of stray fields.
- Balanced Variable Impedance Line** . . . permits highest fidelity on every tap of a universal unit . . . no line reflections or transverse couplings.
- Reversible Mounting** . . . permits above chassis or sub-chassis wiring.
- Alloy Shields** . . . maximum shielding from induction pick-up.
- Multiple Coil, Semi-Toroidal Coil Structure** . . . minimum distributed capacity and leakage reactance.
- High Fidelity** . . . UTC Hiperm Alloy Transformers have a guaranteed uniform response of ± 1.5 DB from 20-20,000 cycles.



FOR IMMEDIATE DELIVERY

From Your Distributor



Typical Curve for HA Series

| Type No. | Application | Primary Impedance | Secondary Impedance | ± 1 db from | Max. Level | Max Unbal. DC in primary | List Price |
|----------|---|----------------------------------|---------------------------------------|-----------------|------------|--------------------------|------------|
| MA-100 | Low impedance mike, pickup, or multiple line to grid. | 50, 125, 200, 250, 333, 500 ohms | 60,000 ohms in two sections | 30-20,000 | +22 DB | 5 MA | 16.25 |
| HA-100X | Same as above but with tri-alloy internal shield to effect very low hum pickup. | 50, 125, 200, 250, 333, 500 ohms | 120,000 ohms overall, in two sections | 30-20,000 | +22 DB | 5 MA | 20.90 |
| HA-101 | Low impedance mike, pickup, or multiple line to push-pull grids. | 50, 125, 200, 250, 333, 500 ohms | 135,000 ohms 1.5:1 ratio, each side | 30-20,000 | +22 DB | 5 MA | 18.55 |
| HA-101X | Same as above but with tri-alloy internal shield to effect very low hum pickup. | 50, 125, 200, 250, 333, 500 ohms | 135,000 ohms 1.5:1 ratio, each side | 30-20,000 | +22 DB | 0 | 23.20 |
| HA-108 | Mixing, low impedance mike, pickup or multiple line. | 8,000 to 15,000 ohms | 50, 125, 200, 250, 333, 500 ohms | 30-20,000 | +22 DB | 1 MA | 16.25 |
| HA-106 | Single plate to push-pull grids. | 8,000 to 15,000 ohms | 50, 125, 200, 250, 333, 500 ohms | 30-20,000 | +32 DB | 5 MA | 13.90 |
| HA-113 | Single plate to multiple line. | 5,000 to 10,000 ohms | 30, 20, 15, 10, 7.5, 5, 2.5, 1.2 | 30-20,000 | +32 DB | 5 MA | 15.65 |
| HA-134 | Push-pull 89's or 2A3's to line. | 3,000 to 5,000 ohms | | 30-20,000 | +32 DB | 5 MA | 17.40 |
| HA-135 | Push-pull 2A3's to voice coil. | | | 30-20,000 | +32 DB | 5 MA | 16.25 |

The above listing includes only a few of the many Hiperm Alloy Transformers available . . . write for catalog.

United Transformer Corp.

150 VARICK STREET

EXPORT DIVISION: 13 EAST 40th STREET, NEW YORK 16, N. Y.

NEW YORK 13, N. Y.

CABLES: "ARLAB"

CAPACITOR SPECIFICATIONS MATCHED

Whatever your capacitor requirement, Sprague can match it —mechanically as well as electrically. The many standard types plus literally hundreds of specials regularly produced offer a broad range of selection from which even the most exacting specifications can be met. Catalog of any type on request.



MICA

PAPER
DIELECTRIC

DRY ELECTROLYTIC

SPRAGUE

SPRAGUE ELECTRIC CO., NORTH ADAMS, MASS.

CAPACITORS • *KOOLOHM RESISTORS • *CEROC INSULATION

*Trademarks Registered U. S. Pat. Off

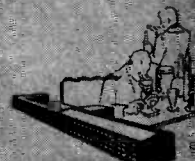

BUILT TO ORDER

Designers of mobile equipment and amateur vhf enthusiasts asked for this driver tube. The 2E30 (outgrowth of the Hytron development type HD59) is a filamentary-type beam tetrode. Standby current is eliminated. Yet the 2E30 is ready to operate a second after electrode potentials are simultaneously applied.

In vhf equipment, the 2E30 is ideal as a class C oscillator, frequency multiplier, or audio frequency amplifier. Important to you—the 2E30 is a transmitting tube—not just a re-hashed receiving type.

Check its versatility and its many features. Quite possibly you will discover that the 2E30 was built to order for you too.



HYTRON TYPE 2E30

Instant-Heating Miniature Beam Tetrode
GENERAL CHARACTERISTICS

| | | |
|------------------------|-------|--------------------------|
| Filament | | Oxide coated |
| Potential, a-c or d-c | | 6.0 ± 10% volts |
| Current | | 0.7 ampere |
| Grid-plate capacitance | | 0.5 mmfd |
| Input capacitance | | 10.0 mmfd |
| Output capacitance | | 5.0 mmfd |
| Max overall length | | 2 5/8 in. |
| Max diameter | | 3/4 in. |
| Base | | T-5 1/2 min button 7-pin |

ABSOLUTE MAXIMUM RATINGS

| | | |
|-----------------------------|-------|---------------|
| D-c plate potential | | 250 volts max |
| D-c screen-grid potential | | 250 volts max |
| D-c plate current | | 60 ma max |
| D-c screen-grid input power | | 2.5 watts max |
| Plate dissipation | | 10 watts max |

OUTPUT—TYPICAL OPERATION

| | | |
|--|-------|------------|
| Output, class A1 power amplifier | | 4 watts |
| Output, class C oscillator | | 7.5 watts† |
| Output, class C doubler (80 to 160 mc) | | 3 watts† |

†Useful power output delivered to load under normal circuit efficiency. Total plate power output (including power actually lost in circuit and by radiation) is at least two watts higher.

FEATURES THE 2E30 OFFERS YOU

- Designed, manufactured, and tested for transmitting
- Special testing controls assure interchangeability*
- Oscillator, frequency multiplier, or a-f amplifier
- Filament power is fully adequate for transmitting
- 1/10 watt driving power for 4 watts output at 80 mc
- 10 watts plate dissipation—surplus reserve for vhf
- Miniature bulb saves space and has low base losses
- Low lead inductance and capacitance—ideal for vhf
- High efficiency at low plate potential—250 volts
- Instant-heating filament—approximately one second

*For example, characteristics are tested at positive grid potentials.

TYPICAL CIRCUIT FOR VERSATILE HYTRON 2E30

Extremely Compact Driver Giving 3 Watts to Load at 160 Mc

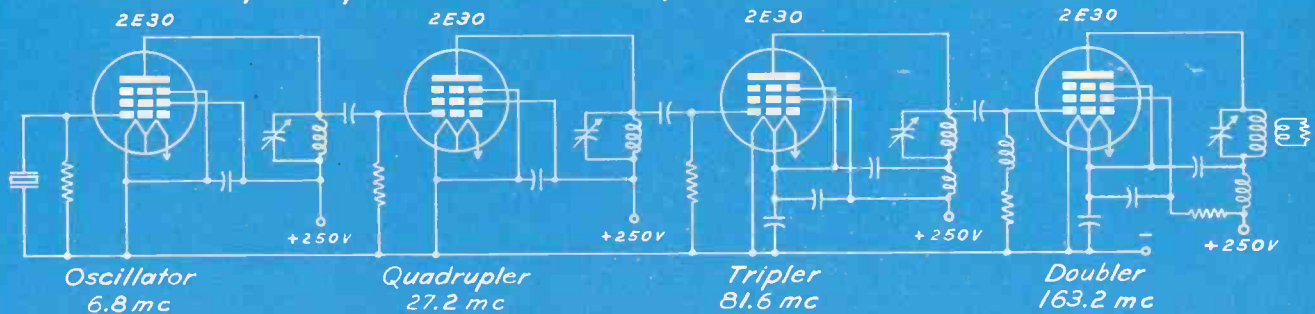

OLDEST MANUFACTURER SPECIALIZING IN RADIO RECEIVING TUBES



HYTRON

RADIO AND ELECTRONICS CORP.



MAIN OFFICE: SALEM, MASSACHUSETTS

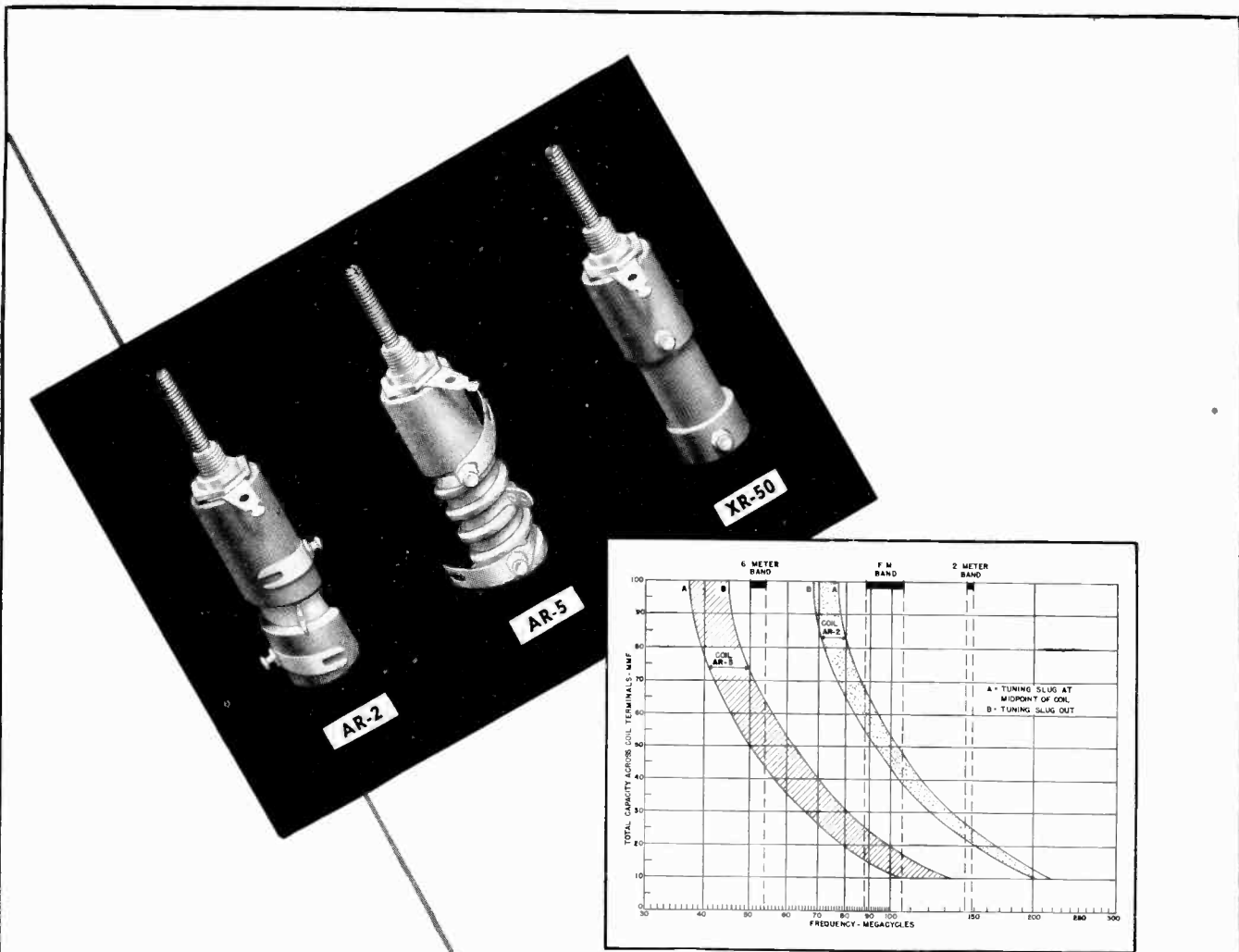

Here are the postwar high frequency coils amateurs will need for work with the micro-waves. Originally designed to meet Navy requirements, these new high-Q units have adjustable inductance and give fine performance as high frequency oscillators, RF stages or frequency multipliers. Two coils are available covering the range from 37 to 220 Mc. A blank form, Type XR-50, may be wound as desired. All three are small and compact, and all are designed for convenient single-hole mounting.



NATIONAL COMPANY, INC., MALDEN, MASS. U.S.A.

LITTLE COMPONENT*



HUGE SUCCESS

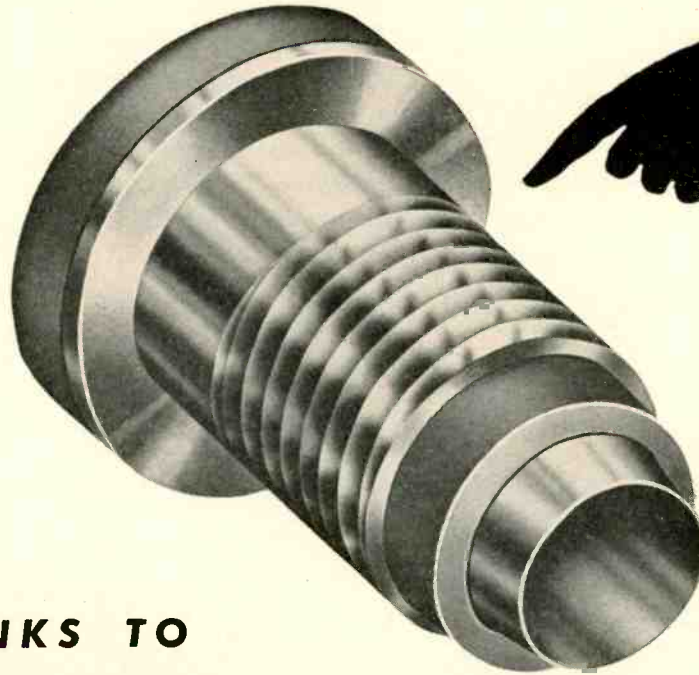

... THANKS TO
MYCALEX
THE "PERFECT" LOW LOSS INSULATION

The problem was to mold insulating material of exceptionally low loss factor and high dielectric strength into a closely integrated bond with a metal insert of high conductivity. The difficulty was acute, for both materials had to have virtually the same coefficient of expansion in order to insure an efficient electrical and mechanical seal. High resistance to arcing in the insulator was also imperative. It had to be moisture-proof and heat-resistant.

MYCALEX 410 (Molded Mycalex) proved to be the only solution after many other insulators had been tested and rejected . . . because MYCALEX has the ideal combination of electrical and mechanical

properties for today's high frequency applications.

Have you a problem involving the sealing of highest type insulation with metal? Are your specifications particularly exacting? More than 25 years of leadership in solving the toughest high frequency insulating problems make MYCALEX a "natural" to solve yours. Our engineers will be pleased to cooperate.

*PANEL JACK



MYCALEX CORPORATION OF AMERICA

"Owners of 'MYCALEX' Patents"

Plant and General Offices, CLIFTON, N. J.

Executive Offices, 30 ROCKEFELLER PLAZA, NEW YORK 20, N. Y.

STACKPOLE GA MIDGET CAPACITORS

goodbye to gimmicks!

Still twisting insulated wires together to form inefficient, makeshift "gimmick" low value capacitors?

Stackpole GA Capacitors cost no more in the long run. Even more important, they bring you outstanding advantages in terms of greater stability, higher Q, better insulation resistance and higher breakdown voltage.

In addition, they are mechanically superior and eliminate the undesirable inductive characteristic common to twisted wires. Sturdily molded, with leads securely anchored and tinned, they are widely used in circuits similar to those illustrated. Standard capacitors include 0.68; 1.0; 1.5; 2.2; 3.3 and 4.7 mmfd. with tolerances of $\pm 20\%$.

Electronic Components Division

STACKPOLE CARBON COMPANY, St. Marys, Pa.

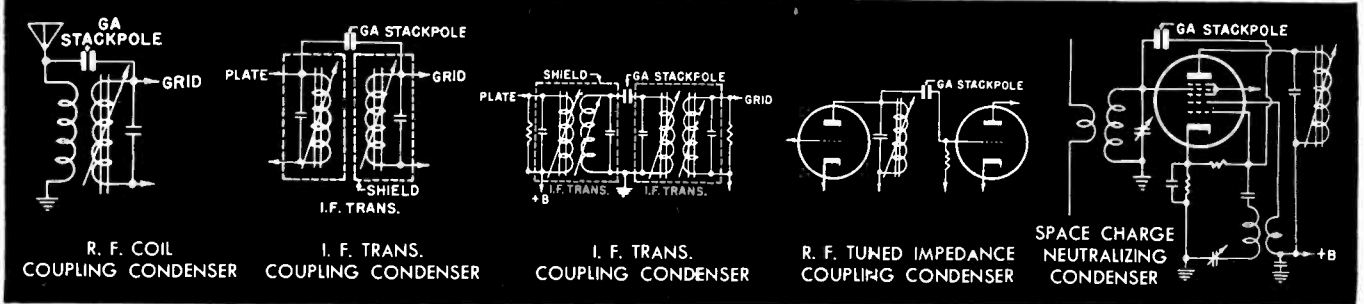
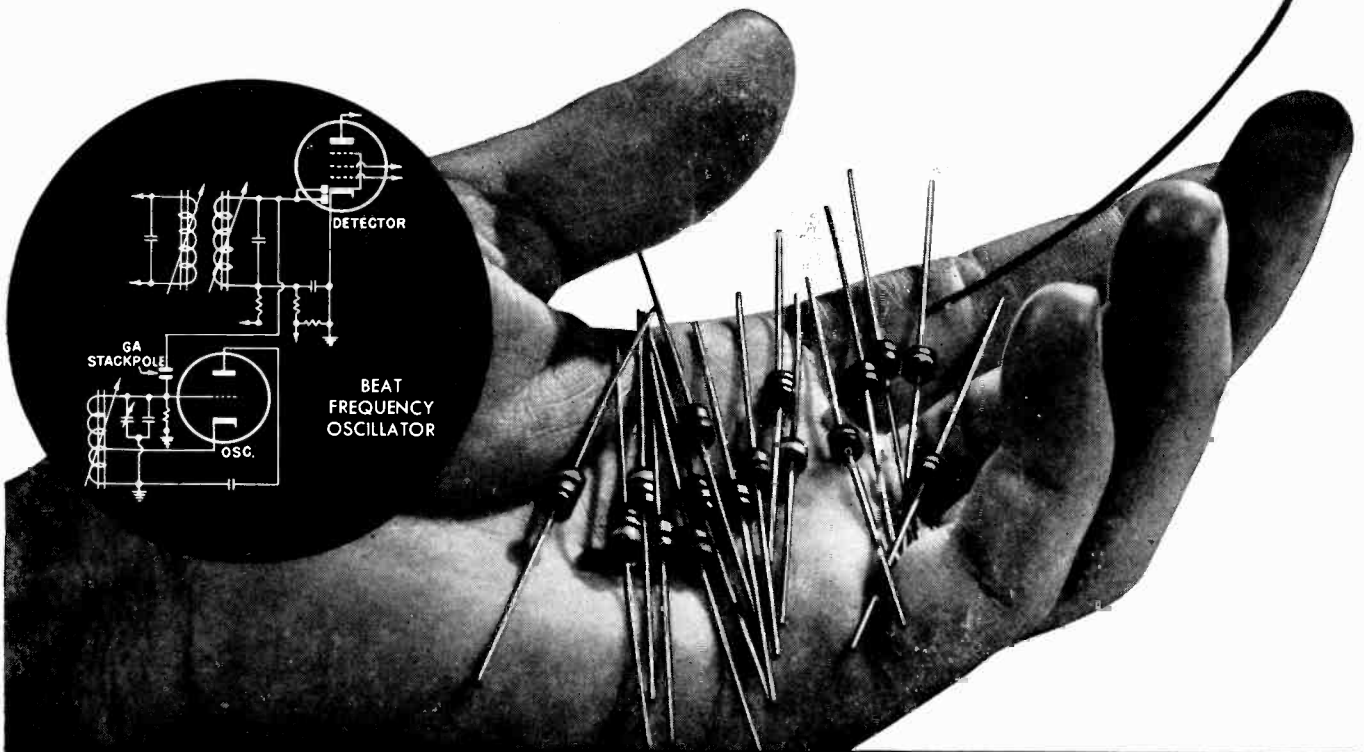

FIXED and VARIABLE RESISTORS • INEXPENSIVE SWITCHES

IRON CORES • COIL FORMS • POWER TUBE ANODES • BRUSHES AND CONTACTS • ALNICO II
RHEOSTAT PLATES and DISCS • ANODES and ELECTRODES, ETC.

AMPHENOL

Covers the Spectrum

**WITH CABLES
AND CONNECTORS
FOR EVERY FREQUENCY**

Amphenol serves the electrical and electronic industries with the most complete line of cables, connectors, plugs and fittings for every application. No matter what the need—from high-current, low-voltage cables and connectors such as are used in power lines, to high-voltage, high-frequency components required in the upper regions of the spectrum—there is an Amphenol product for the job. Amphenol cables and connectors are used in Radar, F.M., Television, Standard Broadcast, electronic controls and equipment... and in numerous industrial applications.

Amphenol connectors are engineered and constructed so as to afford the absolute minimum of loss of power, potential or waveform even at the highest frequencies. These components reflect the greatest advancement in all phases of electrically correct design and mechanically correct manufacture. Amphenol makes the most complete line of cables, connectors, plugs and fittings for the most efficient transmission of power at all frequencies.

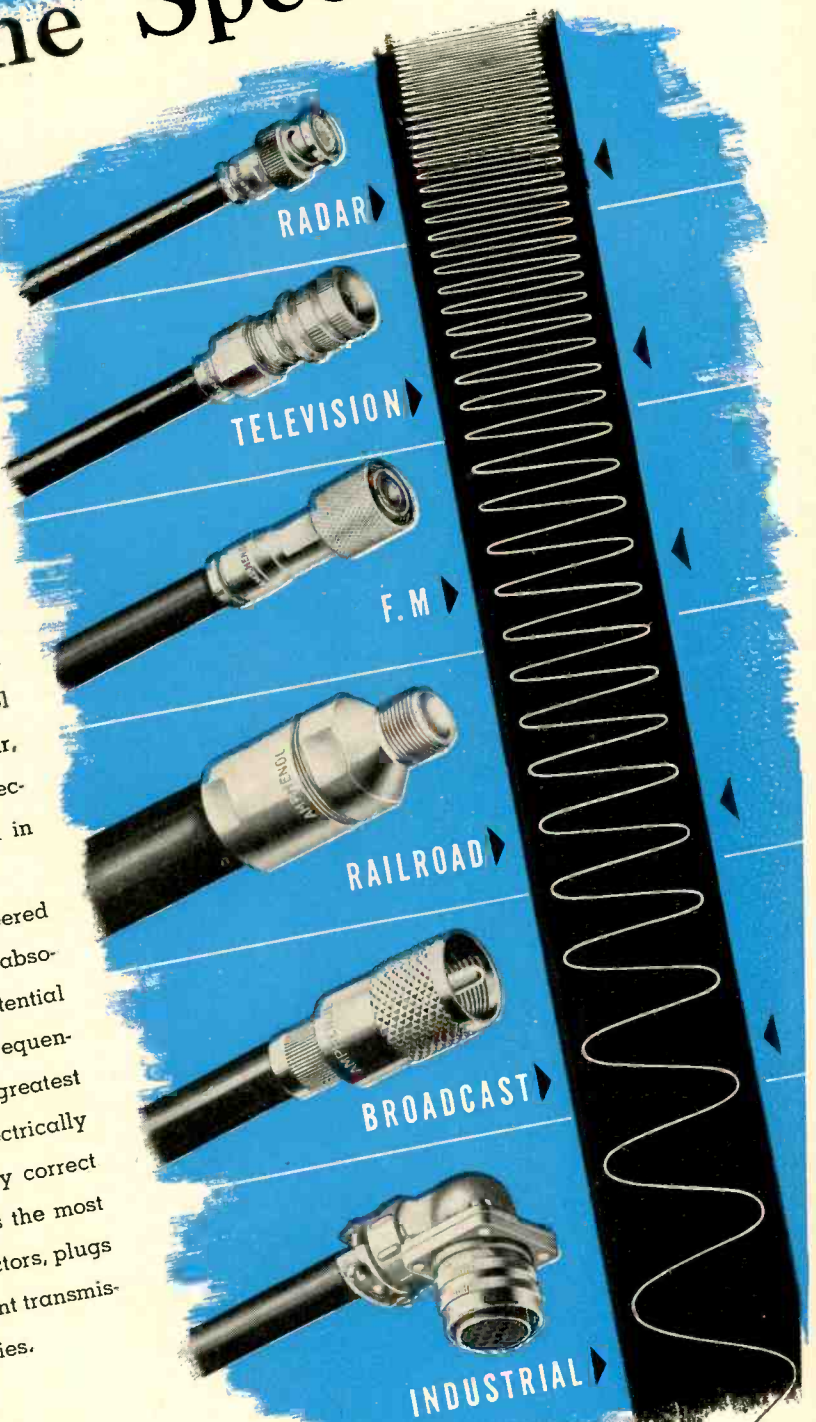

AMERICAN PHENOLIC CORPORATION
CHICAGO 50, ILLINOIS
In Canada • Amphenol Limited • Toronto

COAXIAL CABLES AND CONNECTORS • INDUSTRIAL CONNECTORS, FITTINGS AND CONDUIT • ANTENNAS • RADIO COMPONENTS • PLASTICS FOR ELECTRONICS





more efficient
... in miniature

To accommodate the reading matter we find between the covers of a small book would have required several dozen unwieldy, hand inscribed, parchment scrolls in Roman days. This is a striking example of greater efficiency in miniature but no more so than TUNG-SOL Miniature Electronic Tubes.

From everyone's viewpoint Miniatures are superior, especially for high frequency circuits. More compact equipment and less storage space are obvious advantages of Miniatures to both manufacturers and dealers. The engineer, however, sees their greater resistance to the effects of vibration

Visit our booth No. 61 at the
RADIO PARTS AND ELECTRONIC EQUIPMENT SHOW
STEVENS HOTEL, CHICAGO, MAY 13 to 16

and shock, lower lead inductance, lower inter-element capacities and higher mutual conductance.

Manufacturers of radio sets and other electronic devices are invited to work with TUNG-SOL engineers in the development of more compact and more efficient electronic equipment through the use of Miniature Tubes. Of course, consultation work of this nature is strictly confidential.

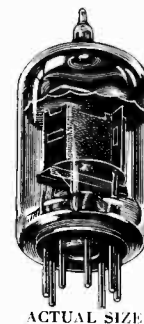

ACTUAL SIZE

TUNG-SOL

vibration-tested

ELECTRONIC TUBES

TUNG-SOL LAMP WORKS, INC., NEWARK 4, NEW JERSEY
Sales Offices: Atlanta • Chicago • Dallas • Denver • Detroit • Los Angeles • New York
Also Manufacturers of Miniature Incandescent Lamps, All-Glass Sealed Beam Headlight Lamps and Current Intermittors

RADIO TRANSMITTERS by Press Wireless

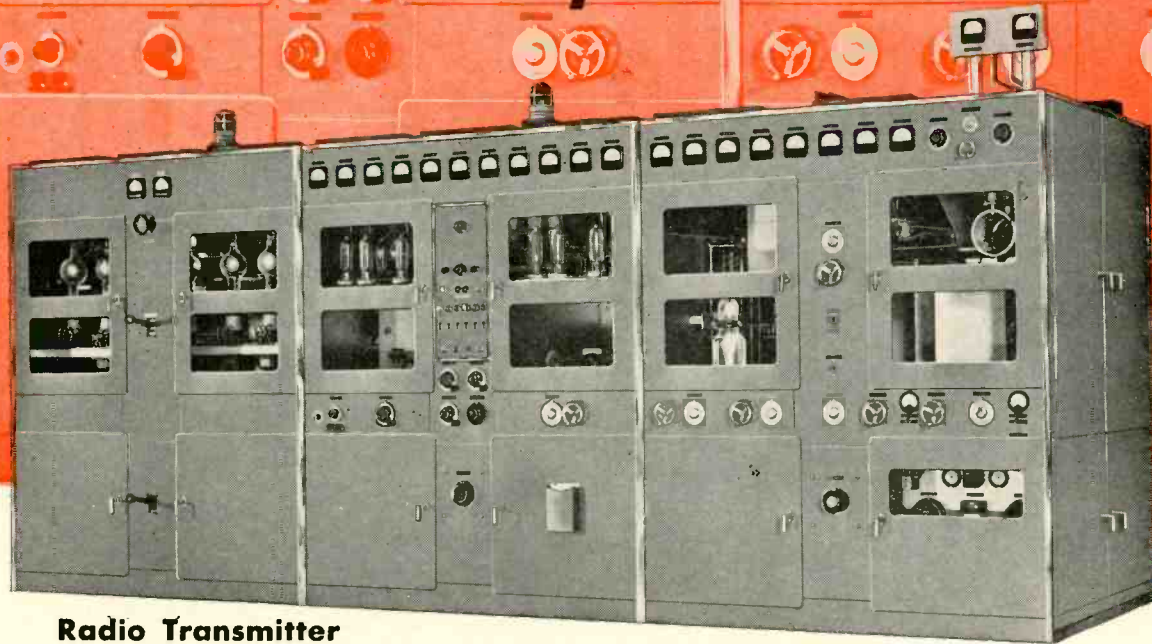

Radio Transmitter Model T50CF-1

This modern, 50-kilowatt, 4 to 21 megacycle radio transmitter is actually two transmitters in one. The entire unit may be used as a 50kw transmitter for on-off CW or frequency-shift keying with an FS keyer and may be modulated by a high-level Class-B modulator. Complete controls and an individual power supply for the exciter and driver stage provide a medium-power r-f carrier of 3-kilowatts on CW or FS—separate and independent of the power amplifier section.

The separate controls and high-voltage power supply for the PA make this section available as an independent Class-C final amplifier unit for use with a suitable double-sideband Class-B modulator-driver. The PA section may be adjusted for operation as a Class-B linear amplifier when used with a suppressed-carrier exciter or other r-f driver source.

DESIGNED for CW or FS operation, this equipment with companion Modulator Model TM 50-1 will transmit MODUPLEX* where AM and FS signal intelligence appear simultaneously on the same carrier.

MODEL T50CF-1 provides protection throughout for personnel and equipment by elaborate interlocking and automatic recycling control circuits. An automatic-shutdown feature cuts off the transmitter after a preset interval if the external (remote) keying line is idle.

Press Wireless will deliver this high quality transmitter and others of 2,500, 5,000, or 20,000 watts with associated equipment within five months from the receipt of your order.

Descriptive literature sent at your request.

*Trade Mark

PRESS WIRELESS MANUFACTURING

C O R P O R A T I O N

Executive Offices: 38-01 35th AVENUE, LONG ISLAND CITY 1, NEW YORK

Overture

TO A NEW ERA IN SOUND

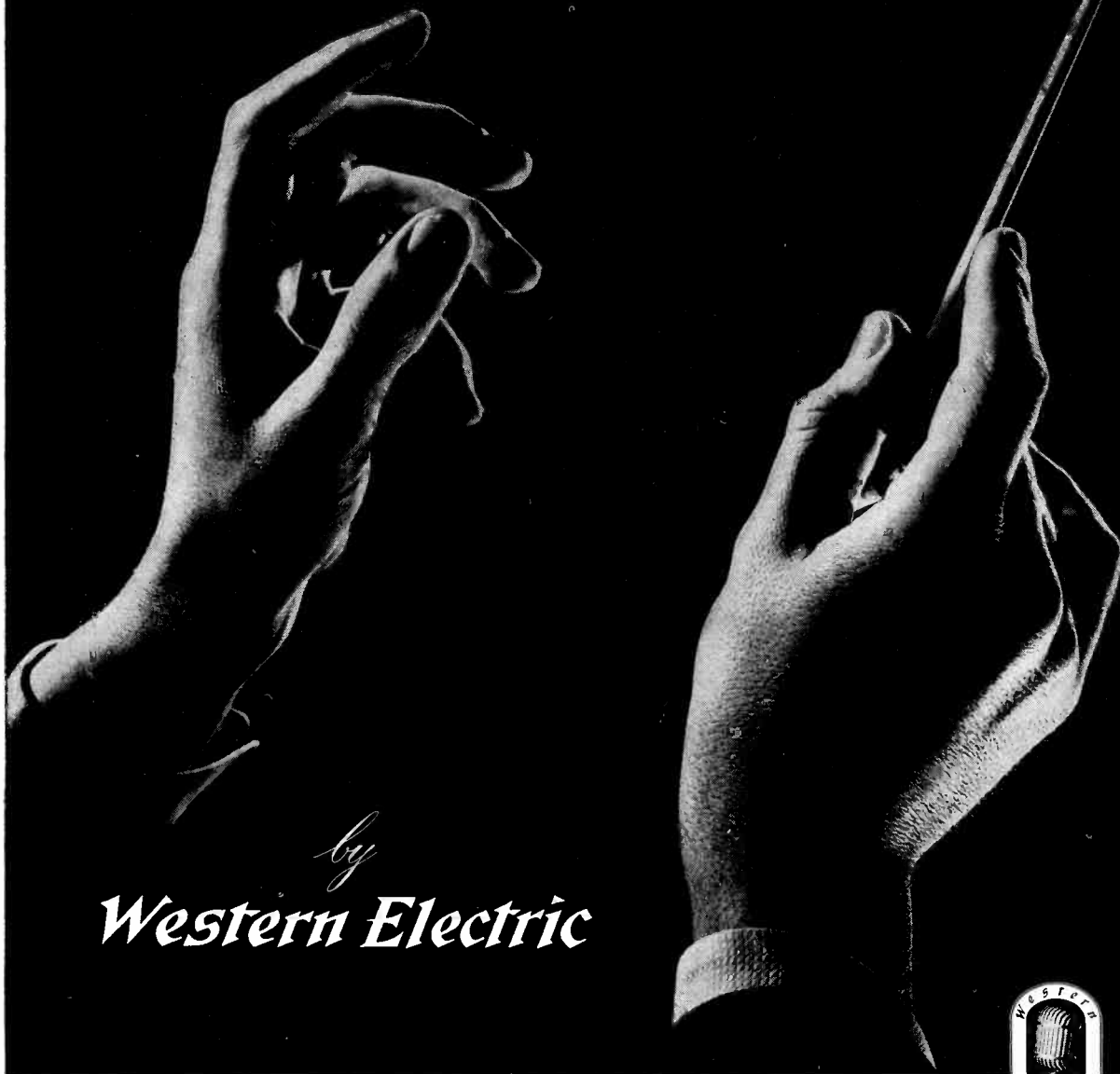

by
Western Electric



HAVE you ever heard a sound system with such natural tone, such emotional quality, such "presence" that you didn't know instantly that a sound system was in action? It's pretty safe to say you never have. But now you can!

Revolutionary advances born of wartime research have resulted in a new Western Electric

loudspeaker that reproduces speech and music with unsurpassed fidelity.

You'll find it hard to believe you are listening to *reproduced* sound rather than the original. That is why this new Western Electric loudspeaker is destined to open a new era in all fields of sound reproduction.

EVERY DE MORNAY-BUDD WAVE GUIDE is Electrically Tested, Calibrated and Tagged



Crystal Mount DB-453



Rotating Joint DB-446



90° Elbow (H Plane) DB-433



Pressurizing Unit DB-452



Mitered Elbow (H Plane) DB-439



Uni-directional Broad Band Coupler DB-442

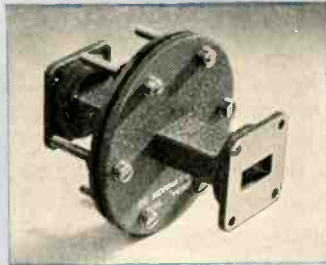

Bulkhead Flange DB-451



Uni-directional Narrow Band Coupler DB-440



90° Twist DB-435

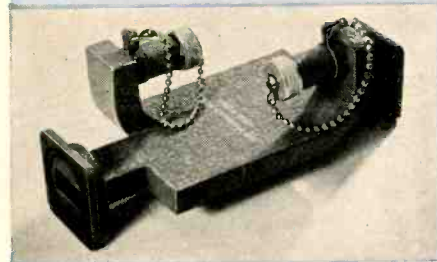

Bi-directional Narrow Band Coupler DB-441

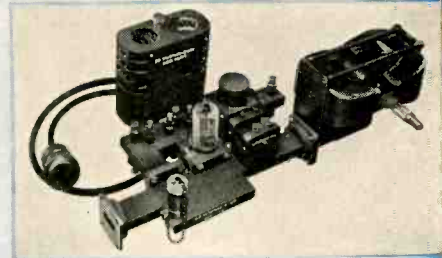
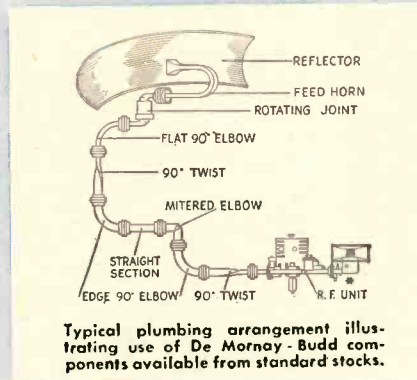

RF Radar Assembly DB-412

When you use any De Mornay-Budd plumbing arrangement, you know exactly how each component will function electrically. You avoid possible losses in operating efficiency through impedance mismatches, or breakdown and arcing caused by a high standing wave ratio. (See chart below.)

De Mornay-Budd wave guides are manufac-

tured from special precision tubing, and to the most stringent mechanical specifications. Rigid inspection and quality control insure optimum performance.

Complete laboratory service and consultations on micro-wave transmission line problems available.

The curve shows the manner in which the reflected power increases with an increase in the voltage standing wave ratio. The curve is calculated from the following equation:

$$\% \text{ Power Reflected} = \left(\frac{\left(\frac{V_{\max}}{V_{\min}} \right) - 1}{\left(\frac{V_{\max}}{V_{\min}} \right) + 1} \right)^2$$

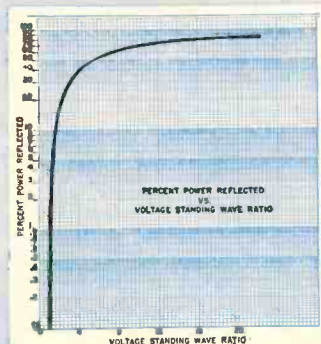

De Mornay-Budd, Inc., 475 Grand Concourse, New York 51, N. Y.

Be sure to visit the De Mornay-Budd display at Booth III, at the 1946 Radio Parts and Electronic Equipment Show, Hotel Stevens, Chicago, May 13-16th.

That hour-after-hour steady grind calls for
PERFORMANCE INSURANCE as provided by
AEROVOX Rating-plus CAPACITORS

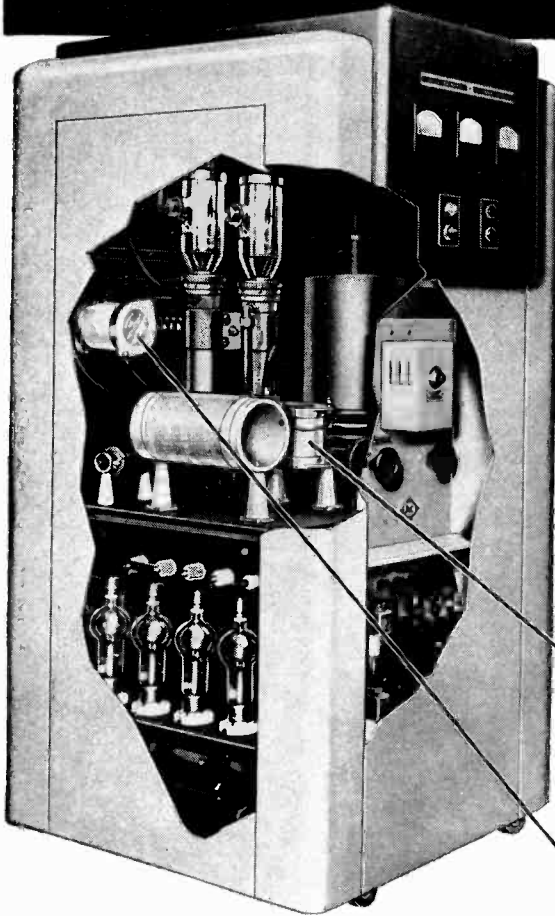

• This induction heating unit bears the name of a world-famous manufacturer. A great reputation is at stake. Such equipment must stand up—hour after hour, day in and day out, for months and years to come.

None but outstandingly dependable components can be risked in such equipment. And the selection of Aerovox Series 1940 stack-mounting capacitors is based on two good reasons:

First, Aerovox are *rating-plus* capacitors. A comparative study of specifications is invited. Second, Aerovox provides *Continuous Service Rating Data* for all its current-handling capacitors. The equipment designer knows precisely what such capacitors can and cannot do. These two points alone can write a *performance insurance policy*.

Continuous Service Rating Data
TYPES 1940-1950-1960-1970-1980

Maximum Current in Amperes at an Ambient Temperature of 60° C.
 Barometric Pressure 28 to 32 inches Mercury and Relative Humidity 10 to 80%. Maximum Ambient Temperature 70° C.

| Cap. Mfd. | Test Volts Eff. | Catalog Number | TYPE 1940 | | | |
|-----------|-----------------|----------------|-----------|----------|---------|---------|
| | | | 3000 kc. | 1000 kc. | 300 kc. | 100 kc. |
| .000075 | 35,000 | 1940-236 | 7.5 | 4.5 | 1.8 | .6 |
| .0001 | 35,000 | 1940-203 | 10. | 6. | 2.2 | .8 |
| .00015 | 35,000 | 1940-204 | 13. | 8. | 3. | 1.2 |
| .0002 | 35,000 | 1940-205 | 16. | 12. | 4. | 1.5 |
| .00025 | 35,000 | 1940-206 | 17. | 13. | 5. | 2.0 |
| .0003 | 35,000 | | | 15. | 6. | 2.4 |
| .00035 | 35,000 | | | 15. | 7. | 2.5 |
| .0004 | 35,000 | | | 16. | 8. | 3.3 |
| .0005 | 35,000 | | | 20. | 10. | 4. |
| .0006 | 35,000 | | | 22. | 10. | 4.5 |
| .0007 | 35,000 | | | 22. | 12. | 5. |
| .0008 | 35,000 | | | 24. | 12. | 6. |
| .001 | 35,000 | | | 24. | 14. | 8. |
| .00125 | 35,000 | | | 24. | 15. | 8. |
| .0015 | 35,000 | | | 24. | 18. | 10. |
| .002 | 30,000 | | | 21. | 21. | 11.5 |
| .0025 | 25,000 | | | 22. | 22. | 12. |
| | 25,000 | | | 20. | 25. | 13. |
| | 20,000 | | | 15. | 30. | |

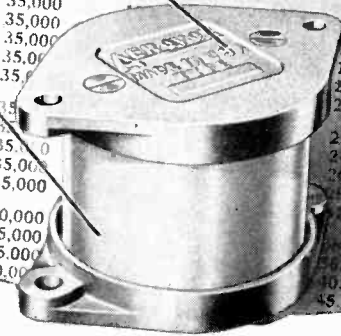

• Interested in performance insurance protection for your assemblies? Then insist on rating-plus specifications and continuous service rating data—or simply specify AEROVOX. Literature on request.

FOR RADIO-ELECTRONIC AND INDUSTRIAL APPLICATIONS



AEROVOX CORPORATION, NEW BEDFORD, MASS., U.S.A.

SALES OFFICES IN ALL PRINCIPAL CITIES • Export: 13 E. 40th St., NEW YORK 16, N. Y.

Cable: 'ARLAB' • In Canada: AEROVOX CANADA LTD., HAMILTON, ONT.

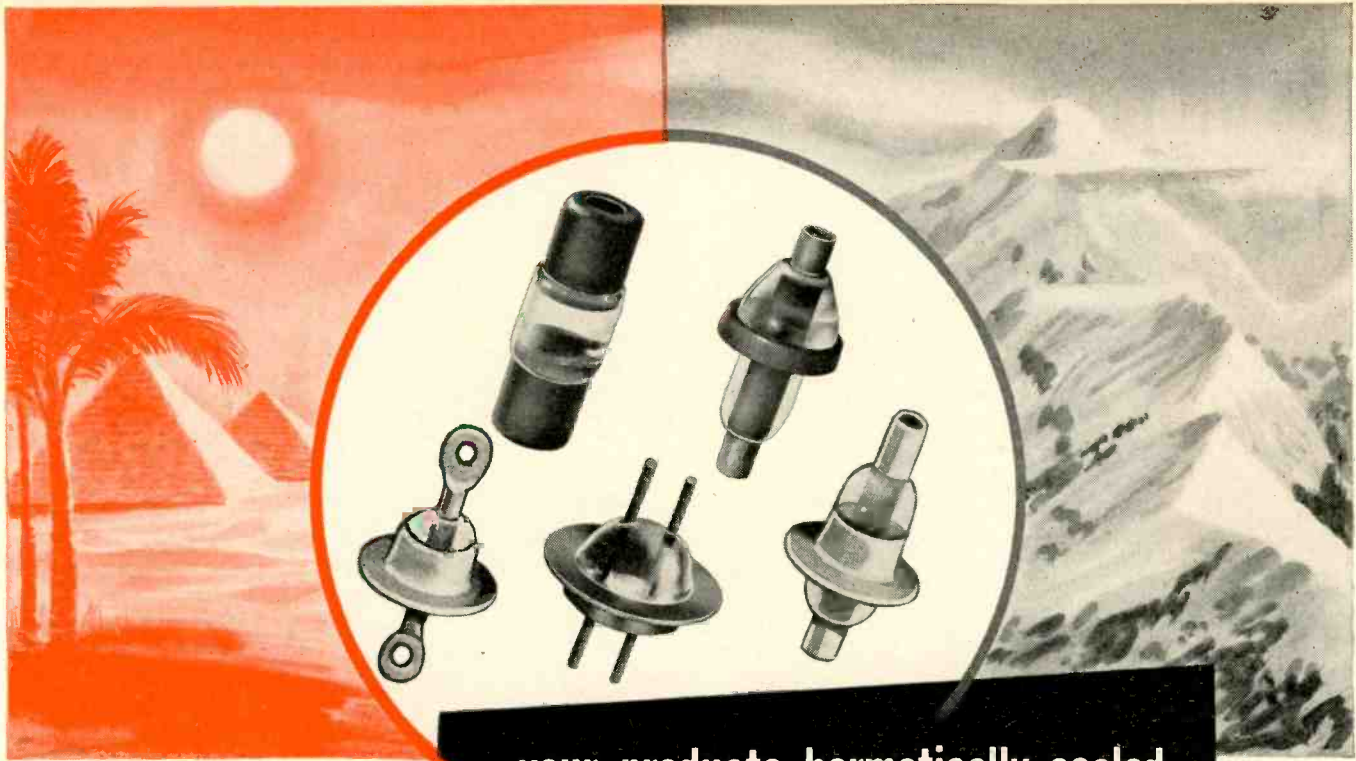

**your products hermetically sealed
against Extreme Climatic Conditions**

..with STUPAKOFF KOVAR*-GLASS SEALS

Stupakoff metal-glass terminals form permanent pressure-tight seals, without cement or gaskets. They protect your products under most adverse climatic conditions and guard against humidity, fungus and other elemental hazards.

Stupakoff Kovar-glass seals are made in standard shapes and sizes or to your exact specifications for electronic tubes, transformers, resistors, capacitors, condensers, vibrators, switches, relays, instruments, gauges, transmitters, meters, receivers and other components . . . with single, multiple, solid or tubular electrodes.

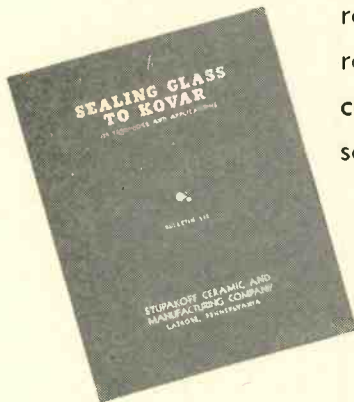

**Write today for Bulletin 145
for complete data on Stupakoff
Kovar-glass seals.**

* Trade Mark 337962

Reg. U.S. Pat. Off.

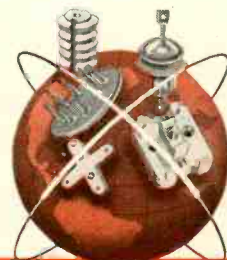

STUPAKOFF

CERAMIC AND MANUFACTURING CO. · LATROBE, PA.

One more step in AMERTRAN CARE

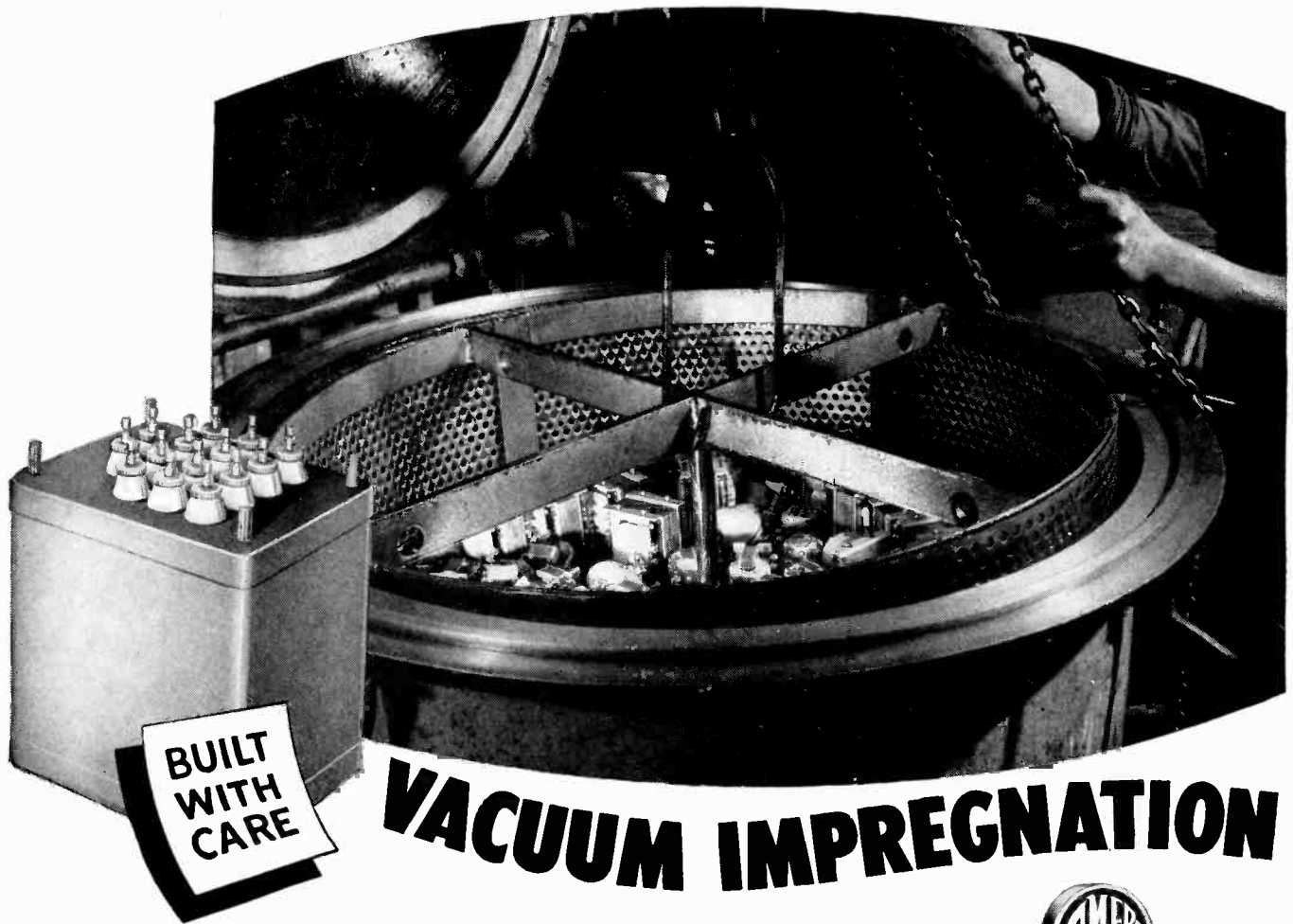

Vacuum impregnation helps to stabilize the performance characteristics of AmerTran-Transformers. Each unit is subjected to both heat and a vacuum process to withdraw all moisture. While still in the vacuum chamber, the compound is introduced and forced into every interstice and around all surfaces of the windings.

This process eliminates trouble from deterioration of insulation and corrosion of windings due to moisture. It insures continuous conduction of heat to outer surfaces, resulting in a cooler unit—or a smaller transformer for a given temperature rise. It provides permanent protection from moisture.

AMERTRAN

MANUFACTURING SINCE 1901 AT NEWARK, N. J.

Pioneer Manufacturers of Transformers, Reactors and Rectifiers for Electronics and Power Transmission



AMERICAN TRANSFORMER CO.,
178 Emmet St., Newark 5, N. J.



The AmerTran
trademark is
found on...

Audio Transformers
and Reactors
Modulation Transformers
(to 500 KVA)
Hermetically Sealed
Transformers
Plate and Filament
Transformers
Filter Reactors
Wave Filters, High
Voltage Rectifiers
Microphone and Inter-
stage Transformers
Transtat A. C. Voltage
Regulators
Other Electronic and
Industrial Transformers



Blazing four trails to better product control

Pioneer explorers fought their way across America, blazing single indistinct trails most of the way. Today modern four lane highways speed motor traffic on its way.

Alert to the needs of modern industry, North American Philips developed high-efficiency x-ray diffraction apparatus. And to further the efficiency of that equipment the NORELCO four window x-ray diffraction tube was introduced.

Through its use the speed with which materials can be analyzed is greatly increased. In many cases the four available camera positions make it possible to carry on research investigations and control work at one and the same time.

NORELCO x-ray diffraction equipment has many present and potential uses in industrial research. In addition this equipment has found an important place in production control through the analysis of materials before and during manufacture.

The application of NORELCO x-ray equipment to the problems of expanding industry is further evidence of the Philips principle of wedding science and productive ability in the electronics field.

NORELCO products include: Quartz crystals, cathode ray tubes, industrial and medical x-ray equipment, fine wire, diamond dies, tungsten and molybdenum products.



Norelco
Reg. U. S. Pat. Off.



ELECTRONIC PRODUCTS



NORTH AMERICAN PHILIPS COMPANY, INC.

DEPT. F-5, 100 EAST 42ND STREET
NEW YORK 17, N. Y.

BLUE
SENSITIVE



RCA-931-A. Current amplification is 1,000,000. Has S-4 spectral response. Maximum response at 4200 Angstroms. Range, approximately 3000 to 7000 Angstroms.

BLUE
SENSITIVE



RCA-1P21. Current amplification is 2,000,000. Has S-4 spectral response. Maximum response at 4200 Angstroms. The tube has extremely low dark current.

BLUE-GREEN-
RED SENSITIVE



RCA-1P22. Current amplification is 200,000. Has S-8 spectral response. Maximum response at 4200 Angstroms. Range, approximately 3000 to 7500 Angstroms.

ULTRAVIOLET
SENSITIVE



RCA-1P28. Current amplification is 200,000. Has S-5 spectral response. Maximum response at 2537 Angstroms. The tube has extremely low dark current.

RCA Multiplier Phototubes

For Measurement and Detection at Low Light Levels

THE extraordinarily high values of amplification obtainable from RCA Multiplier Phototubes make them particularly applicable to the measurement and detection of weak illumination in the fields of science and industry. Because of the high gain, amplifier stages are not required, resulting in an improved signal-to-noise ratio at very low light levels.

Because the photocurrent produced at the light-sensitive cathode is multiplied many times by secondary emission occurring at successive dynodes, multiplier phototubes are capable of multiplying feeble currents produced under weak illumination *hundreds of thousands of times*. The resultant output current is a *linear function* of the exciting illumination under normal operating conditions. Since secondary emission occurs almost instantaneously, *frequency response is flat* up to frequencies at which capacitance effects become the limiting factor.

The characteristics of the RCA-931-A Multiplier Phototube make it particularly suitable to light-operated

relay circuits, sound reproduction from films, facsimile transmission and scientific research. The extreme sensitivity of the RCA-1P21 suggests its use in scientific research involving exceedingly weak light radiation. The RCA-1P22 is especially useful in colorimetry and spectroscopy, sound-on-film applications and light-operated relay circuits. The RCA-1P28 is intended for specialized industrial and scientific applications involving weak ultraviolet radiation.

RCA tube application engineers are ready to assist you in the adaptation of these or any other RCA tube types to commercial, scientific, or industrial electronic equipment. Technical data sheets on the phototubes illustrated are available and may be obtained upon request. Address your inquiries to RCA, Commercial Engineering Department, Section D-18E, Harrison, N. J.

TWO NEW PHOTOTUBES WITH LOW-LOSS BASES

The RCA 1P39 and 1P40 phototubes are provided with non-hygroscopic bases which insure a value of resistance between anode and cathode pins about 10 times higher than conventional bases under adverse operating conditions of high humidity. As a result, more output for a given light input is obtainable under high-humidity conditions.

RCA-1P39 is a high-vacuum phototube similar to the 929. It has very high sensitivity to light sources predominating in blue-radiation, and has negligible sensitivity to infrared radiation. It is particularly adaptable to light-operated relay circuits, measurement, and color-control applications.



RCA-1P40 is a gas phototube similar to the 930. It has high response to red and near infrared radiation. Because of its high sensitivity, it is recommended for use in sound-on-film equipment, light-operated relays, and light-measurement devices employing an incandescent light source.



The Fountainhead of Modern Tube Development is RCA



TUBE DEPARTMENT

RADIO CORPORATION of AMERICA

HARRISON, N. J.

PROCEEDINGS OF THE I.R.E.

AND

WAVES AND ELECTRONS

Published Monthly by

The Institute of Radio Engineers, Inc.

VOLUME 34

May, 1946

NUMBER 5

BOARD OF DIRECTORS, 1946

Frederick B. Llewellyn
President

Edmond M. Deloraine
Vice-President

William C. White
Treasurer

Haraden Pratt
Secretary

Alfred N. Goldsmith
Editor

Hubert M. Turner
Senior Past President

William L. Everitt
Junior Past President

1944-1946

Raymond F. Guy
Lawrence C. F. Horle

1945-1947

Stuart L. Bailey
Keith Henney
Benjamin E. Shackelford

1946-1948

Walter R. G. Baker
Virgil M. Graham
Donald B. Sinclair

1946

Ralph A. Hackbusch
Frederick R. Lack
George T. Royden
William O. Swinyard
Wilbur L. Webb
Edward M. Webster

Harold R. Zeamans
General Counsel

George W. Bailey
Executive Secretary

William H. Crew
Assistant Secretary

BOARD OF EDITORS

Alfred N. Goldsmith
Chairman

PAPERS REVIEW COMMITTEE

Murray G. Crosby
Chairman

PAPERS PROCUREMENT COMMITTEE

Dorman D. Israel
General Chairman

Edward T. Dickey
Vice General Chairman

PROCEEDINGS OF THE I.R.E.

| | | |
|---|-------------------------------------|-----|
| The Engineer's Social Responsibility..... | E. Finley Carter | 214 |
| David Beach Smith—Chairman, Philadelphia Section, 1946..... | | 215 |
| An Introduction to Loran..... | J. A. Pierce | 216 |
| Army-Navy Precipitation-Static Project | | |
| Part IV—Investigations of Methods for Reducing Precipitation-Static Radio Interference..... | Gilbert D. Kinzer and John W. McGee | 234 |
| Part V—The High-Voltage Characteristics of Aircraft in Flight..... | Ross Gunn and James P. Parker | 241 |
| Part VI—High-Voltage Installation of the Precipitation-Static Project..... | M. Newman and A. O. Kemppainen | 247 |
| A Note on a Simple Transmission Formula..... | Harald T. Friis | 254 |
| Nonlinearity in Frequency-Modulation Radio Systems Due to Multipath Propagation..... | S. T. Meyers | 256 |
| Discussion on "Concerning Hallén's Integral Equation for Cylindrical Antennas," by S. A. Schelkunoff. Ronold King and S. A. Schelkunoff | | 265 |
| Contributors to Proceedings of the I.R.E..... | | 269 |
| Corrections to "The Application of Modulation-Frequency Feedback to Signal Detectors," by Geoffrey Builder..... | | 270 |

INSTITUTE NEWS AND RADIO NOTES

| | | |
|---|-------------------------------|-----|
| Board of Directors and Executive Committee..... | | 271 |
| Broadcast Engineering Conference..... | | 271 |
| Committees..... | | 271 |
| Second National Electronic Conference..... | | 271 |
| Regional-Committee Success is Assured..... | | 272 |
| I.R.E. People..... | | 273 |
| Sections..... | | 278 |
| Books: | | |
| "Network Analysis and Feedback Amplifier Design," by Hendrik W. Bode..... | Reviewed by Milton Dishal | 277 |
| "Radar," by Orrin E. Dunlap, Jr..... | Reviewed by Loren F. Jones | 277 |
| "Television Programming and Production," by Richard Hubbell..... | Reviewed by Irwin A. Shane | 278 |
| "Inside the Vacuum Tube," by John F. Rider..... | Reviewed by Harry C. Likel | 279 |
| "Table of Associated Legendre Functions," prepared by The Mathematical Tables Project, Arnold N. Lowan, Project Director, and a Technical Staff of Seven Persons, together with Seven Supervisory and Editing Assistants, and Conducted under the Sponsorship of the National Bureau of Standards, Lyman J. Briggs, Director and Official Sponsor of the Project..... | Reviewed by J. R. Whinnery | 280 |
| "Television Show Business," by Judy Dupuy..... | Reviewed by Ralph B. Austrian | 280 |
| "Encyclopedia of Substitutes and Synthetics," Edited by Morris D. Schoengold..... | Reviewed by Harold L. Brouse | 280 |

WAVES AND ELECTRONS

SECTION

| | | |
|--|-------------------------------------|-----|
| Moral Reflections..... | Floyd A. Firestone | 281 |
| David C. Kalbfell—Chairman, San Diego Section, 1946..... | | 282 |
| I.R.E. War Participation..... | Harry C. Ingles | 283 |
| Navy Radio and Electronics During World War II..... | Jennings B. Dow | 284 |
| CBS Studio Control-Console and Control-Room Design..... | Howard A. Chinn | 287 |
| The Use of Liquid Dimethylsilicones to Produce Water-Repellent Surfaces on Glass-Insulator Bodies..... | O. K. Johannson and Julius J. Torok | 296 |
| An Ionization Gauge of Simple Construction..... | Charles M. Fogel | 302 |
| Resonant-Cavity Measurements..... | R. L. Sproull and E. G. Linder | 305 |
| Cylindrical Shielding and Its Measurement at Radio Frequencies..... | Alton R. Anderson | 312 |
| Contributors to Waves and Electrons Section..... | | 323 |
| Section Meetings..... | 36A Positions Wanted..... | 48A |
| Membership..... | 42A Positions Open..... | 50A |
| Advertising Index..... | | 70A |

EDITORIAL DEPARTMENT

Alfred N. Goldsmith
Editor

Helen M. Stote
Publications Manager

Clinton B. DeSoto
Technical Editor

William C. Copp
Advertising Manager

Lillian Petranek
Assistant Advertising Manager

Responsibility for the contents of papers published in the PROCEEDINGS OF THE I.R.E. and WAVES AND ELECTRONS rests upon the authors. Statements made in papers are not binding on the Institute or its members.

Changes of address (with advance notice of fifteen days) and communications regarding subscriptions and payments should be mailed to the Secretary of the Institute, at 450 Ahnaip St., Menasha, Wisconsin, or 330 West 42nd Street, New York 18, N. Y. All rights of republication, including translation into foreign languages, are reserved by the Institute. Abstracts of papers, with mention of their source, may be printed. Requests for republication privileges should be addressed to The Institute of Radio Engineers.



Proceedings of the I.R.E.

Increasingly the position of the engineer, not only as a technically skilled producer but also as an element in a more effectively co-ordinated social system, becomes of major importance and interest. It is accordingly greatly to the benefit of our readers that we present an analysis of this segment of the life of the professional engineer ably prepared by a recent Director of the Institute, who is himself a Vice-President of Sylvania Electric Products, Inc.—*The Editor*.

The Engineer's Social Responsibility

E. FINLEY CARTER

In the midst of the turmoil that historically follows great conflicts, we have heard the question asked time and again—"Why can't we work together in peace as we did in war?" It is a logical question that demands a logical answer. An approach to it can best be made by asking why did we work so well together during the war, recognizing, of course, that even then there was not perfect harmony and co-operation. The answer is simply that the cause for which we were fighting was bigger than any one of us. Furthermore, the motivation was the very deeply entrenched law of self-preservation.

Now that the war is over and we are freed from the desperate urgency of self-preservation, it is necessary that we find new goals and a new motivating force. Without such a goal, we are faced with the ugly prospect of an era when the slogan becomes "Every man for himself."

Having made such great achievements through the logical mastery and application of laws of the physical sciences, is it not time for the engineer to use his logic and ingenuity in mastering and applying the basic social laws, and thereby insure the proper application of his inventions to the good of society. For here is the proper sphere of science today. There may not long be an alternative. The scientists who are so deeply concerned with the international control of atomic energy realize this. The devices we have invented can be applied for great good or for evil; for developing understanding and co-operation or for arousing the ire of mobs; for prolonging life or for destroying it; for serving mankind or for making him a servant. No longer can an engineer say with a clear conscience, "I am not responsible. The fruits of my effort have been diverted by others from good to bad uses," unless he has interested himself enough in society and in its basic laws to be concerned with the social aspects involved in the applications of his developments.

When an experiment goes wrong because of failure to apply a fundamental law properly, a scientist does not become prejudiced against one component that is involved in favor of another. He rather seeks to understand why results are as they are and to judge accordingly. In some of the human conflicts we face, we are not as thorough. We fail to search with the same intense interest for the motivating factors which create human conflicts and misunderstandings. Rather, we are inclined to form prejudices and dislikes, often allowing our good judgment to be so distorted that we become a party to mass disharmony instead of a factor for co-operation and understanding. I should like to challenge our profession not only to continue the adaption of its great discoveries to the physical welfare of mankind, but as effectively to apply the same logic and reason to the solution of our social maladjustments. Each of us carries with him a portable research laboratory, namely, himself. There is not a day but that an opportunity is afforded to perform an experiment directed toward improving human relations. Is not this worthy of some profound thinking before we miss the opportunity that is ours today?

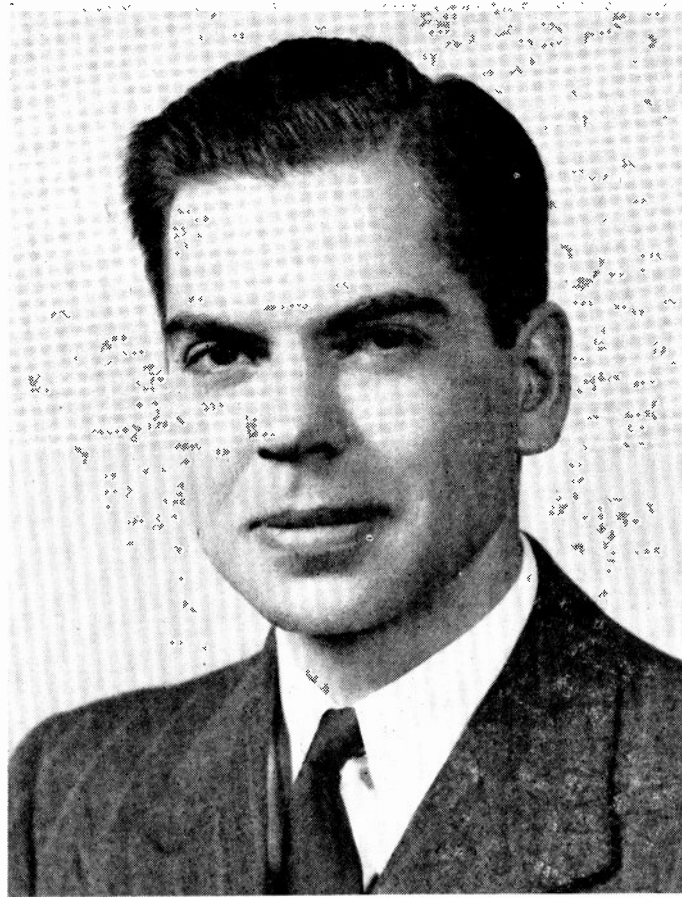

Wanamaker—Underwood & Underwood

David Beach Smith

Chairman—Philadelphia Section, 1946

David Beach Smith was born on December 3, 1911, in Newton, New Jersey, and received the degree of S.B. in E.E. with high honors from Massachusetts Institute of Technology in 1933, and the S.M. degree in 1934.

Mr. Smith joined Philco that same year and served from 1934 to 1936 as a patent engineer dealing with a wide variety of inventions in radio, television, and other applications of electronics. He was later placed in charge of a special advanced-studies group in the Philco research and engineering department, handling a number of projects that involved basic research in electronics.

Mr. Smith was appointed technical consultant to the vice-president in charge of engineering in 1938, and was promoted to director of research in 1941. In this capacity, he directed the fundamental microwave and ultra-high-frequency research that led to the production of many important types of radar used by the Army and Navy. His department made numerous important contributions, especially to the successful development of microwave airborne search radar systems for anti-submarine warfare and both high- and low-altitude bombing, as well as identification friend or foe radar systems, loran receivers for aircraft, and the VT proximity fuze.

Mr. Smith was appointed vice-president in charge of engineering of Philco Corporation in December, 1945,

to direct all research and engineering activities of the corporation. He has also taken an active part in the development of television and in the establishment of national television standards. He was a member of the original Television Committee of the Radio Manufacturers Association, and chairman of Panel 9 on Propagation and Polarization of the National Television System Committee in 1940. Named to the Radio Technical Planning Board when it was organized, he served as chairman of Panel 6 on Television, which formulated and presented a detailed postwar program for the television industry to the Federal Communications Commission. In November, 1945, he was named chairman of the new Television System Committee of the RMA at the associations's Fall meeting.

He is a member of the American Association for the Advancement of Science, the American Institute of Electrical Engineers, and of Tau Beta Pi. Mr. Smith is the author of various technical papers in the fields of television, frequency modulation, and mathematics, and is now serving as chairman of the Philadelphia Section of The Institute of Radio Engineers. He is credited with a substantial number of patents and patent applications, covering inventions in radio, radar, and television. He joined the Institute as an Associate in 1939 and became a Senior Member in 1944.

An Introduction to Loran*

J. A. PIERCE†, SENIOR MEMBER, I.R.E.

Summary—In less than five years, loran, the American embodiment of a new method of navigation, has grown from a concept into a service used by tens of thousands of navigators over three tenths of the surface of the earth. Even under the stress of military urgency, the direct development cost of this system has been less than two per cent of the seventy-five million dollars so far spent for operational equipment.

The first part of the present paper describes the history of this program as an example of the efficient "mass production" of research and development under the National Defense Research Committee. A second section deals with the fundamental concepts of hyperbolic navigation and gives some details regarding the kinds of equipment now employed for transmission, reception and interpretation of pulse signals for this service. The third part of the paper discusses the potential usefulness of hyperbolic navigation and suggests some of the many devices which will simplify the navigation of the future and enhance its reliability. The final section mentions the organizational problem immediately before us.

I. HISTORY

Project 3

IN NOVEMBER, 1940, the Microwave Committee of the National Defense Research Committee, in its third project, placed a number of contracts for equipment to be used as an ultra-high-frequency radio aid to navigation which had been suggested by A. L. Loomis. The system was intended to permit navigators to determine lines of position, and therefore fixes, by the measurement of the difference in transmission time of pulses of radio-frequency energy arriving from widely separated synchronized transmitting stations. The initial specifications were controlled by two obvious facts. Since the velocity of propagation of radio waves is about 983 feet per microsecond, the time of transmission of the pulses would have to be controlled to a few millionths of a second and the resolving power of the receiving equipment would need to be equally good, if the method were to yield fixes of an accuracy comparable to that of other methods of navigation. Second, if the transmissions were to be of use over sufficient area to be of interest to aircraft, it was necessary that the power be high.

Two transmitters were therefore ordered, from two large corporations, to emit short pulses at about 30 megacycles at an output level of two megawatts. Receiving and indicating equipment was ordered from two other sources, according to two proposed methods of indication, and very versatile timing equipment, capable of operation under any of several proposals, was ordered to control the emission of the transmitters.

* Decimal classification: R512.2. Original manuscript received by the Institute, January 3, 1946.

† Formerly, Radiation Laboratory, Massachusetts Institute of Technology, Cambridge, Massachusetts; now at Harvard University, Cambridge, Massachusetts.

This paper is based on work done for the Office of Scientific Research and Development under contract OEMsr-262.

These contracts represented a total expenditure of about \$400,000, a figure which indicates the energy with which this problem was attacked at the start.

In the clear light of retrospect, it is obvious that two defects, one technical and one administrative, existed in these original arrangements. The technical limitation lay in the fact that none of the proposed schemes for indication of the time difference could now be described as other than cumbersome and inaccurate, while the administrative difficulty was that the technical control was exercised in occasional meetings of busy men, so that revision of the original plans was essentially impossible.

In the spring of 1941, during the long procurement interval necessitated by the new and high standards set for the equipment, a small technical group was formed to receive and test the gear when it should be delivered. This group, headed by Melville Eastham of the Microwave Committee, was organized under the newly formed Radiation Laboratory of the Massachusetts Institute of Technology, from which it drew two or three of its key personnel, while other members were recruited from outside sources. The new group fully realized the severe range limitations of the ultra-high frequencies and began to wonder whether waves reflected from the ionosphere in the high-frequency region might not be used to extend the service radius without encountering intolerable errors. After a preliminary paper investigation had indicated that maximum reasonable slopes of the E layer might cause errors not greater than five miles at distances of a few hundred miles, an experimental study of the time stability of ionospheric reflections was begun in the summer of 1941.

Standard Loran

Until experiments in September, 1941, indicated clearly the potential stability of sky-wave transmission, the lower-frequency work was considered only as an extension of the proposed ultra-high-frequency system. By that time, it was realized that the measuring methods proposed for the ultra-high-frequency system would not be satisfactory and that entirely new treatment would have to be worked out. This factor, as well as a growing realization that an ultra-high-frequency system could not give ranges commensurate with the operational requirement for a system to aid convoy operations in the North Atlantic, served to discourage further effort on the Project 3 proposal. Work on that system was therefore immediately abandoned, even before the delivery of much of the equipment on order. The entire Radiation Laboratory group began the development of new indicating equipment and of methods for synchronization of the transmitting stations which would

permit what is now known as loran to exist in its own right.

During this first year of the project, some information became available about a British system, now known as gee, which was under development. Operating upon identical principles, the gee system is exactly what the National Defense Research Committee ultra-high-frequency system might have become, given equally good techniques and development skill. Loran copied gee concepts rather than techniques and may be said to have been invented in America in the sense in which Galileo is said to have invented the telescope.

The first two loran transmitters, in Delaware and on Long Island, were operated in synchronism at radio frequencies of 3, 5, or 8 megacycles; and a receiver and indicator were sent to Bermuda for a study of the apparent "drift" of that island. Only one family of lines of position was available and the transmitter peak power of 5 kilowatts did not provide a ground-wave signal at that distance, yet the experiments constituted the first proof that the timing accuracy of sky waves was good and that the indicator design was sound. The average of all the readings agreed with the computed figure within a microsecond, and the average deviation of the readings corresponded to a lateral shift of only 2.8 miles.

Aside from this proof that the system could be made to work, two factors of great importance to the future program were discovered in Bermuda. The first was that it would be very difficult to operate the wide-band receivers necessary for reception of short pulses without encountering overpowering interference from other services at frequencies between 5 and 10 megacycles. Since lower frequencies cannot successfully penetrate the daytime atmospheric absorption, there seemed relatively little hope of achieving a range of more than a few hundred miles by sky-wave transmission in the daytime. A second and more surprising fact was that the nighttime E-layer transmission at a frequency of 3 megacycles failed to exhibit the expected skip effect associated with penetration of the reflecting layer. This meant that transmission at 3 megacycles or below might well be available throughout the night at distances overlapping and extending beyond the range of the ground waves. The combined effect of these two factors was to discourage the use of the higher frequencies, so that the development of the system became concentrated in the upper part of the medium-frequency spectrum where a ground-wave range of 700 or 800 miles could be expected in the daytime and where sky waves, although effective only at night, would be useful to about twice the daytime range.

The success of the Bermuda experiments led to acceleration of the development of higher-powered transmitters, which had already begun, and to the development of new and simplified transmitter timers. The new timing and monitoring equipment and new 2-megacycle 65-kilowatt pulse transmitters were installed in

the two original test stations. The first air-borne and sea-borne trials were conducted with the co-operation of the United States Navy. These trials were so successful that high-level interest within the Navy was immediately aroused. The National Defense Research Committee was requested to build and install a chain of stations extending from Delaware to Greenland, and to procure a few hundred sets of navigator's equipment for shipboard use. The Royal Canadian Navy exhibited an immediate and sustained interest in the system and proceeded at once, under the supervision of Radiation Laboratory engineers, with the construction of two transmitting stations in Nova Scotia. At the same time, other sites were chosen, and the United States Navy, through its operating agency, the Coast Guard, began preparations for the construction of stations in Newfoundland, Labrador, and Greenland.

On October 1, 1942, a chain of four stations, comprising the two original experimental stations and the two in Nova Scotia, began operation. By this date, a few of the navigators' instruments had been delivered, and installation on selected naval vessels was begun by a group of radio technicians assigned by the Commander-in-Chief of the Atlantic Fleet. Within the next six months some forty or fifty shipboard installations were made and a great deal of data were gathered on sky-wave propagation and on the operational behavior of the system. With the realization that an effective new aid to navigation had come into being, a Naval Training School for station operators and navigators was set up and the operation of the transmitting stations was turned over by the Radiation Laboratory to the Coast Guard and the Canadian Navy. The three northern stations came into operation in the spring of 1943, and were also turned over to the Coast Guard after operation had become routine. The Bureau of Ships began to take over the procurement of ground-station equipment, while the Army Air Forces were contracting for the development of an air-borne receiver-indicator.

SS Loran

At this time, the Radiation Laboratory loran division had grown to its stable size of about 60 people. Its efforts, in the summer of 1943, were about equally divided between the construction and procurement of standard loran equipment, of which some \$1,750,000 worth was delivered to the Navy, and the development and testing of a new form of operating system called "sky-wave synchronized (SS) loran." This modification consisted chiefly in the use of pairs of 2-megacycle stations separated by 1000 or 1200 nautical miles, rather than the 200 or 300 miles in general use at that time. Such a system can only be used at night when sky waves are strong, but the average accuracy increases approximately in the proportion that the baseline is lengthened.

The most obvious use for such a system was to provide a nighttime aid to navigation over the continent of Europe. The concept was therefore introduced to the

Royal Air Force as well as the United States Army and Navy, and preparations were made to conduct full-scale trials of the system in the United States. A network of stations was set up, linking Florida, Long Island, Cape Cod, and Minnesota, to provide fixes over most of the United States east of the Mississippi. A number of Army, Navy, and Royal Air Force aircraft participated in tests in October and November, 1943, and in addition many thousands of observations were made at several fixed monitor stations. The average

the last months of the European war; so effective, in fact, that the Royal Air Force's Mosquito Force used it regularly for blind bombing of Berlin.

Other Radiation Laboratory and Service Efforts

While this SS loran system was being set up in Europe, the Radiation Laboratory group undertook crash production of a number of air-transportable loran ground stations which were requested by the Army Air Forces. These stations were essentially a redesign of equipment

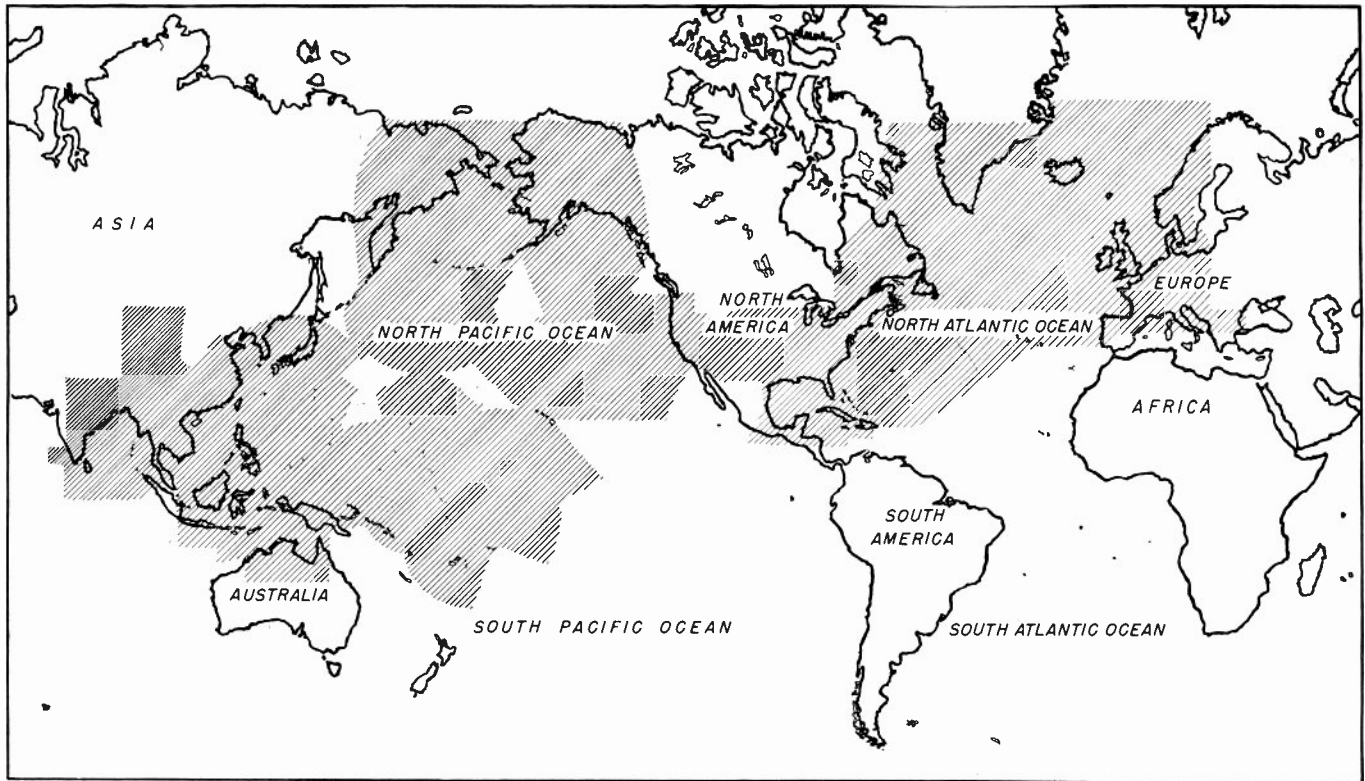

Fig. 1—The shaded area shows where loran can be used for navigation at night (as of August 15, 1945). By day the service area is about one fourth as great.

fix error was found to be only about 1.5 miles and the serviceability of the system was good, except that the more northern pair suffered somewhat from being too close to the magnetic pole. The tests were considered successful and equipment for the necessary stations was shipped to the United Kingdom and to North Africa as soon as possible, together with about ten members of the Radiation Laboratory to assist with the installation and training programs. At about the same time, the first air-borne receivers were beginning to come from the production lines, and a large fraction of the earliest sets were sent to the Royal Air Force.

Because of difficulty in obtaining a frequency allocation, as well as slow shipment and the other more usual delaying factors, it was found impossible to get the system ready for operation before the first of May, 1944. Since the summer nights in Northern Europe are short, it was decided to defer use of the system until September, when it could be used more effectively. In spite of these delays, the system was very useful for

which had been very hurriedly constructed for a half-dozen stations to provide navigation across the Hump between Burma and China. These Hump stations have given very good service, but the air-transportable equipment, although it had absorbed about eight months full-time effort of the Radiation Laboratory group, had not found its way into operation at the end of the war, with the exception of six stations which were used in the United States to provide signals for air-borne training of B-29 crews.

As soon as the air-transportable loran construction program was completed, the Radiation Laboratory had its first opportunity to begin effective work toward loran operation at low radio frequencies, a change which seemed to offer hope of a system with about twice the range of standard loran over sea water, and vastly improved range over land, without any serious loss of accuracy. This program was interrupted, while still in the development stage, by the end of the war, although a trial system had been in operation along the east coast

of the United States for about four months. While it did not lead to tactical operation during the war, this program provided the first opportunity to re-examine the concepts and standards of hyperbolic navigation so that the prototype equipment constructed for low-frequency loran represents a tremendous technical improvement over the equipment now in operation.

which were erected closely upon the heels of the invading forces. Of special significance in the Pacific warfare were stations in the Mariannas, which provided very effective guidance for the 20th Air Force in its bombing of Japan.

At the end of the war some seventy loran transmitting stations were in operation providing nighttime service

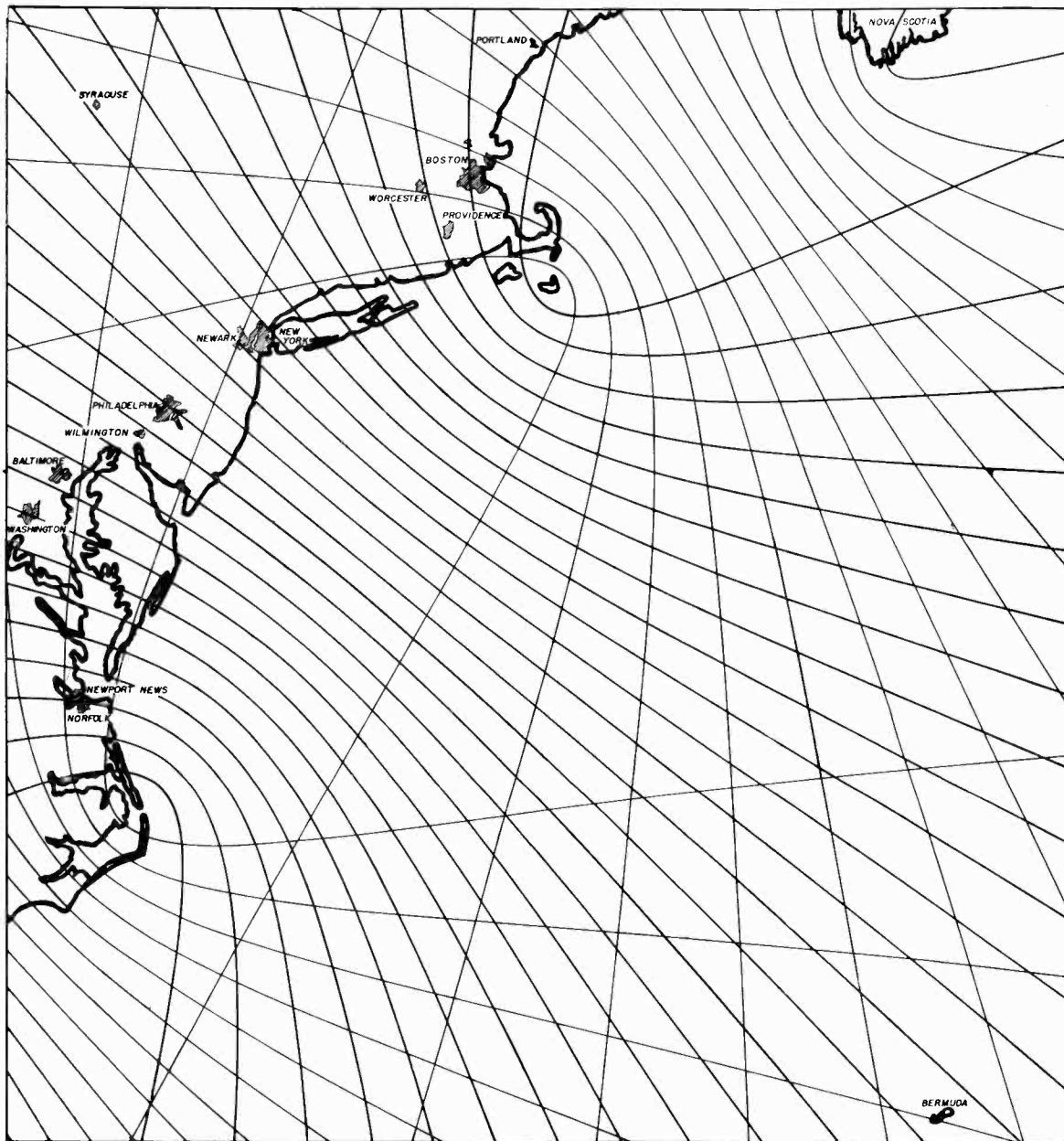

Fig. 2—A tracing of the more important features of a loran chart. Readings are ordinarily made to 1/200 of the spacing of the lines in the figure. On the actual chart the lines are more frequent and are numbered directly in the units indicated by the receiving equipment, so that no computation is required.

In the summer of 1943, the United States Coast Guard made its first independent installations of loran transmitting stations in the Aleutian Islands. The equipment in this case had been constructed in the Radiation Laboratory, as Naval procurement had not yet come into effect. Since then, the Coast Guard has installed some twenty-five more stations in the Pacific, climaxing its efforts with stations at Iwo Jima and Okinawa,

over 60 million square miles or three tenths of the earth's surface, the approximate area being shown in Fig. 1. About 75,000 ship-borne and air-borne navigator's receivers had been delivered by a number of manufacturers. The Hydrographic Office, which had been preparing loran charts since the early days of naval use of the system, had shipped two-and-a-quarter million charts to various operating agencies.

The total cost of the loran research, development and procurement program of the Radiation Laboratory (including the abandoned Project 3 work) was about \$5,300,000, but over \$3,800,000 of this represented the cost of equipment delivered to the Army or Navy for operation. The actual costs of the research and development which produced the loran system may therefore be set at about \$1,500,000. The total investment in loran, neglecting shipping, installation, and operating costs which are difficult to assess in the military system, has been estimated by the Services at as much as \$130,000,000. This figure is certainly excessive; it presumably includes the contract figures for orders which were cut back at the cessation of hostilities. A careful survey, however, indicates that at least \$75,000,000 worth of equipment had been delivered before V-J Day. We may, therefore, conclude that, even if no further orders should ever be placed, the charges for the research and development which produced the loran system can be assessed at no more than 2 per cent of the investment in equipment. This would be a very favorable figure in any organization and clearly indicates that research and development can exist and be efficient even under the difficult conditions obtaining in wartime.

II. TECHNIQUE

The Loran Idea

The basic operation performed by a loran navigator is the determination of a line of position. He does this by measuring the relative time of arrival of two pulses, which are known to have left two separated transmitters at times differing by a known interval. He observes the received time difference, which is equal to the transmitted time difference only if he is equidistant from the two stations. If, for example, the time difference between pulses received from Nantucket Island and from Cape Sable is found to be 2500 microseconds, while the Cape Sable pulse is known to have been transmitted 3000 microseconds after that from Nantucket, the navigator knows that he is farther from Nantucket, the station whose signal is transmitted first and received first, and that the difference in the distances from the two points is the distance traveled by a radio wave in 500 microseconds, or about 93 miles.

With this information, a chart, and a pair of compasses, the navigator could find a number of points which would satisfy this relation and could connect these points with a smooth curve which would represent his line of position; but he would have no way of determining his position along this line without additional information, which might be obtained from a similar observation on a second pair of stations, say at Nantucket and Cape Hatteras. The crossing of this second line of position with the first gives the navigator his position, or fix.

These lines of position are approximately spherical hyperbolas, and would be exactly plane hyperbolas, with the transmitting stations at the focuses, if the earth

were flat. Because of this, the method is usually called "hyperbolic navigation." The observations are made by a sort of electronic stop watch, which uses a cathode-ray tube and reads to a millionth of a second. The required synchronism between the transmitted pulses is established by a similar device. Since the stations are fixed, the lines of position do not change; thus they can be presented to the navigator on a chart or in a table, eliminating the computation usually associated with taking a fix. Fig. 2 is a sketch of such a chart, showing some of the lines established by a chain of stations. In practice, the lines in the different families are presented in different colors and each line is marked with its distinctive number which is read directly from the indicator. In Fig. 2, the interval between lines is 200 microseconds, which is about 200 times the ordinary error of a measurement at these short distances. Charts are prepared in various scales and with various intervals between the lines depending upon the use for which they are intended.

A sample chart for the SS loran system of operation is shown, with considerable deletion of detail, in Fig. 3. The transmitting stations are in Scotland and North Africa. In this case, the average timing error is larger, about 8 microseconds. In the SS loran service area, however, traveling a mile across a set of lines changes the reading by from 5 to 10 microseconds, so that the average positional error is little more than a mile.

In all loran practice, each of the two stations of a pair transmits its pulses in an indefinitely long train, in which the pulses recur at a precisely controlled rate. To facilitate instrumentation, the pulses from the two stations are transmitted alternately instead of nearly simultaneously, making the time difference to be measured always of the order of half the recurrence interval.

Range and Accuracy

Standard loran was developed primarily for over-water navigation. It operates on one of several frequencies between 1700 and 2000 kilocycles, and therefore enjoys propagation characteristics determined primarily by soil conductivity and ionospheric conditions. The transmitters currently in use radiate pulses of about 100 kilowatts and give a ground-wave range over sea water of about 700 nautical miles in the daytime. The daytime range over land is seldom more than 250 miles even for high-flying aircraft, and is scarcely 100 miles at the surface of the earth. At night, the ground-wave range over sea water is reduced to about 500 miles by the increase in atmospheric noise, but sky waves, which are almost completely absorbed by day, become effective and increase the reliable range to about 1400 miles. The transmission times of the sky waves are somewhat variable, thus reducing the accuracy of the system, but the timing errors grow smaller with increasing distance and partially compensate for the increasing geometrical errors; therefore, navigation by sky waves, appropriately enough,

compares tolerably well with celestial navigation. Except in the case of over-land ground-wave transmission, the signal strength, and therefore the usefulness of the system, does not vary at all with the altitude of the receiver. Even in the over-land case, the signals increase rapidly with height so that there is little improvement

The navigator can choose from among these the pairs he will use for determining a fix in the same way that he would choose stars for celestial navigation; that is, by taking those whose lines of position cross at the most favorable angle. In fact, he frequently uses three or four line fixes if he wishes to attain maximum pre-

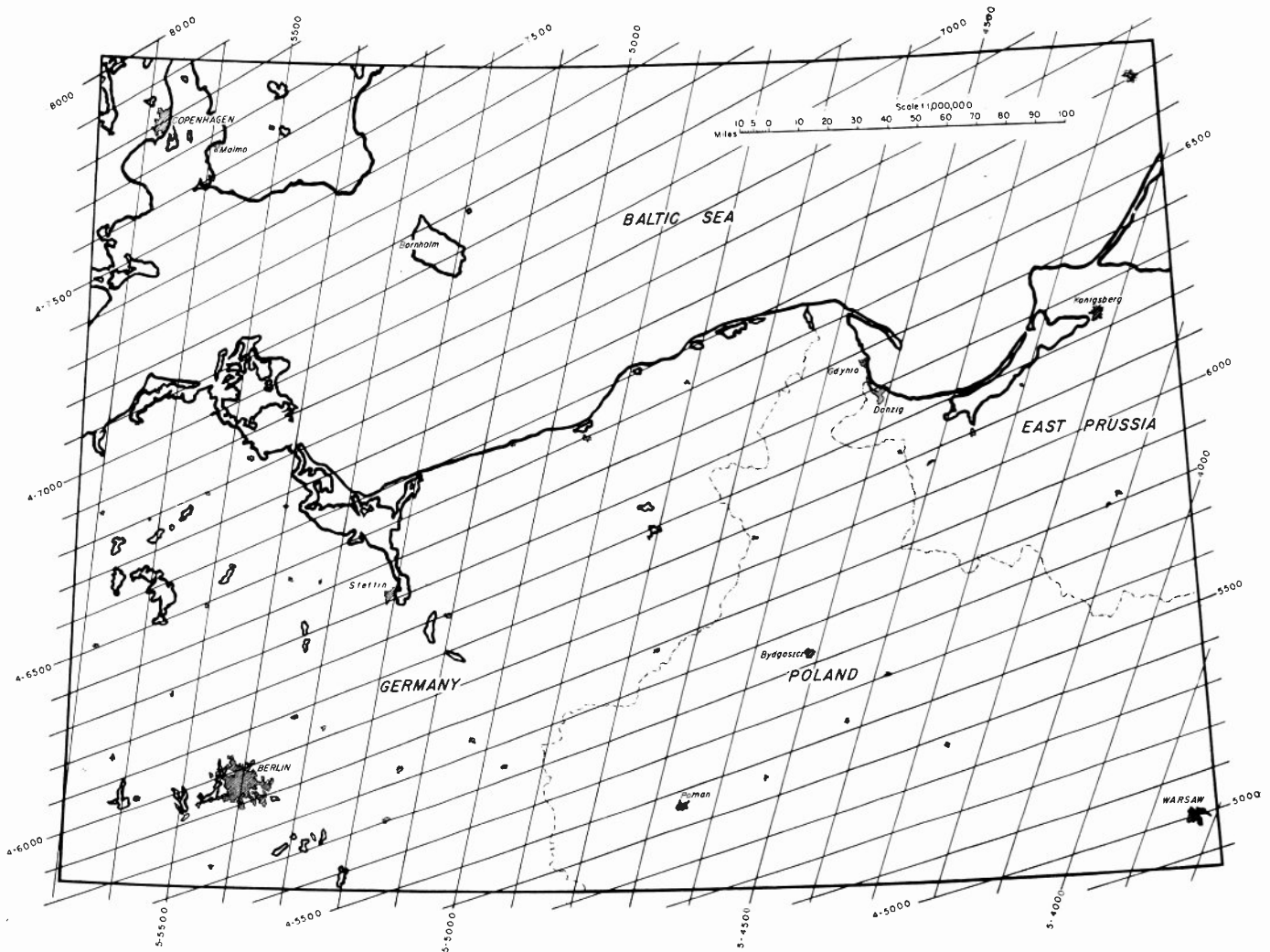

Fig. 3—A portion of the area served by sky-wave synchronized loran over Europe. In this system, which was used by the Royal Air Force for blind bombing in the last months of the European war, the average errors are about one twelfth of the line spacing shown.

to be had by going to altitudes greater than 3000 feet.

If three loran stations are used as a triplet, the average error at short distances is of the order of 300 yards and increases smoothly throughout the ground-wave service area to a little more than one mile at 700. At night, the sky waves may be used at distances between 300 miles and 1400 with average errors ranging from $1\frac{1}{2}$ to about 8 miles.

The average errors of fix are frequently smaller than these estimates at long ranges, because pairs can often be found with crossing angles better than those obtainable from a triplet. Loran stations are often installed in a chain, along a coast line, or between islands. The number may be anything greater than two, and each station may or may not operate as a member of two pairs with the stations at each side.

cision, the reading of a single line of position at a time permitting great freedom of choice. This arrangement stems directly from the concept that loran navigation is to be effective over an area large in comparison to that which could be served by a single pair or triplet.

The operation of selecting and matching the pulses and reading the time difference ordinarily occupies somewhat less than one minute, so that the taking of a fix may be thought of as requiring about three minutes; one minute each for two lines of position and a third minute for finding the corresponding point on a chart of the form of Fig. 2 or Fig. 3.

The Navigator's Instrument

Neglecting, for the moment, the method of establishing synchronism between two transmitters, let us

examine the method of measurement of the time interval with a navigator's receiver-indicator. Assume that, as indicated in Fig. 4(a), a series of pulses is received from transmitter *A* at a recurrence rate of 25 per second, and a similar series is received from a more

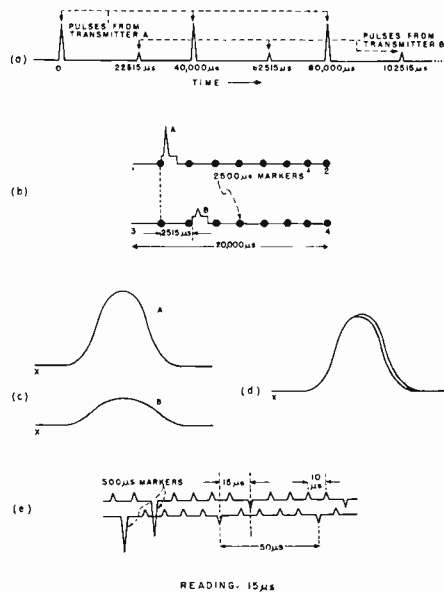

Fig. 4—Diagrams of various oscilloscope patterns exhibited on a loran indicator.

distant station *B* with each *B* pulse arriving 22,515 microseconds after an *A* pulse, and consequently 17,485 microseconds before the succeeding *A* pulse. These pulses are displayed, as shown in Fig. 4(b), as vertical deflections on an oscilloscope whose beam is deflected horizontally by a 50-cycle, or 20,000 microseconds, saw-tooth wave and vertically by a 25-cycle square wave, so that alternate traces appear as parallel lines. The sequence may be thought of as beginning at the left of the upper trace (1). A nearly linear sweep (1-2) of almost 20,000 microseconds duration is followed by a fast retrace (2-3) with a downward component; the lower trace begins (3) exactly 20,000 microseconds after the beginning (1) of the upper trace, is equally long (3-4=1-2), and is followed by a retrace (4-1) with an upward displacement to complete the cycle. The pulse intervals are always such that when the *A* pulse (which is defined as the one followed by the longer interval) is placed on a pedestal near the beginning of the upper trace, the *B* pulse will fall somewhere to the right and on the lower trace. The *A* and *B* pedestals are small square-wave deflections, indicating regions of the total picture which can be examined later in detail. The *A* pedestal is fixed near the beginning of the upper trace, while the *B* pedestal is always on the lower trace and can be continuously adjusted to occupy any position to the right of the *A* pedestal.

If the recurrence rate of the horizontal sweeps on the indicator is exactly twice the recurrence rate of the received signals, a single *A* pulse and a single *B* pulse will be seen, and both will stand still on the pattern,

provided the receiver is not moving.¹ A small temporary change in the recurrence rate of the indicator may be made to cause the pulses apparently to slide around the oscilloscope pattern from their original random positions until the *A* pulse occupies the upper pedestal. Then the pedestal on the lower trace may be brought into position under the *B* pulse to produce the pattern illustrated in Fig. 4(b). After this adjustment has been made, the oscilloscope may be switched so that its horizontal deflections are provided by a fast sweep circuit which operates only during the intervals indicated by the tops of the pedestals. This produces a much magnified exposition of the pulses, as shown in Fig. 4(c). Most of the horizontal separation of the pulses has now disappeared, although small readjustments of the "delay controls," which establish the position of the *B* pedestal, now cause the *B* pulse apparently to slide to the left or right.

The pulses are now to be "matched" by removing the separation between the upper and lower sweeps and attempting to produce visual coincidence, as shown in Fig. 4(d), by small readjustments of the delay controls. Because the *B* pulse, in our illustration, is the smaller in amplitude, it is necessary to make the gain of the receiver greater during the time occupied by the lower, or *B*, sweep than during the *A* sweep. This is done by introducing into the receiver a voltage obtained from the square-wave generator which establishes the trace separation.

When the pulses have been matched, the knowledge of their time difference has been stored in the indicator, because the pips which trigger the fast sweeps and the pedestals on the *A* and *B* traces, at *X-X* in Fig. 4(c), have now exactly the same time separation as the *A* and *B* pulses. The receiver is, therefore, disconnected from the indicator and the time difference is read from families of marker pulses which are switched onto the traces as in Fig. 4(e), where a reading of 15 microseconds may be obtained by intercomparison of 50 and 10 microsecond markers and by interpolation. Other families of markers (not shown, but often at intervals of 500 and 2500 microseconds) may be switched onto traces of appropriate lengths so that the 15 microseconds shown may be added to one 2500-microsecond interval (there are no 50-microsecond or 500-microsecond intervals included in this example) seen on the pattern of Fig. 4(b) between the point on the lower trace directly below the beginning of the *A* pedestal and the beginning of the *B* pedestal. This establishes the time interval from the *A* pulse to the *B* pulse at 22,515 microseconds, although, for convenience, half the recurrence interval is neglected and the "reading" or "time difference" is considered to be 2515 microseconds. The making of this reading is simplified by locking the *A* pedestal at the

¹ If the receiver is on a moving vehicle, the Doppler effect will, in general, be of different magnitude for the *A* and the *B* pulses. The crystal which times the sweeps may be adjusted to make either pulse stand still, but cannot stop the apparent motion of both pulses.

first 2500-microsecond marker on the upper trace, so that the interval is read from the first similar marker on the lower trace to the beginning of the *B* pedestal.

Because of the large bandwidth of pulse transmissions, about 100 kilocycles for the pulses used in loran, it is necessary to operate a number of pairs of stations in each of the three radio-frequency channels in use. This is done by establishing each pair of pulses at an individual recurrence rate so that, when the receiving equipment is adjusted for that rate, the selected pulses will stand still while pulses from other pairs drift around the screen. The relative rates are so chosen that the interfering effects of unwanted pulses are not noticeable on the fast sweep, while the motion visible on the slow sweep is slow enough not to be distracting. The first loran operations were at repetition frequencies of the order of 25 per second, or pulse intervals of about 40,000 microseconds. The various "rates" were established by successively subtracting 100 microseconds from the basic interval. Thus, eight pairs of stations operate at 40,000-, 39,900-, and 39,800 microsecond intervals, or approximately 25, 25-1/16, and 25-2/16, . . . 25-7/16 cycles per second. When crowding made it advisable to add more discrete rates, a family based on $33\frac{1}{3}$ cycles was chosen. In that case the intervals are 30,000, 29,900, and 29,800 . . . 29,300 microseconds.

Fig. 5 shows a very much simplified block diagram of a loran receiver-indicator. A crystal oscillator, at 100

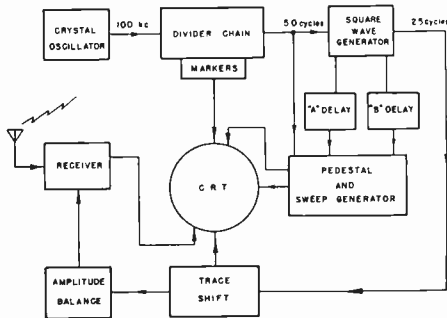

Fig. 5—A block diagram showing the major components of a loran navigator's receiver-indicator.

kilocycles, drives a divider chain of the step-counter variety which reduces the frequency to fifty cycles and incidentally provides several families of marker pulses at intermediate frequencies. The output of the divider chain operates a square-wave generator, which further divides the frequency by two, and also drives a saw-tooth sweep generator when "slow sweeps" are desired on the oscilloscope. The output of the square-wave generator is used to provide trace shift for separating the traces on which the *A* and *B* pulses are exhibited and also, if necessary, to decrease the gain of the receiver throughout the trace displaying the stronger signal. The delay circuits *A* and *B* are operated, respectively, by the positive and negative fronts of the square-wave cycles and, after suitable intervals, trip the pedestal

generator and, if desired, the coincident "fast-sweep" generator. The *A* delay circuit controls the position of the pedestal and fast sweep on the upper trace (see Fig. 4(b)) and is locked at a suitable position. The *B* delay performs the same functions on the lower trace, but is adjustable with coarse and fine controls. The recurrence-rate control is comprised in the divider chain. It is operated by a switch which is often marked "station selector." This switch, the *B* delay controls, the amplitude balance, and a sequence switch (which selects the sweep speeds and trace separation, and which connects the markers or received pulses to the oscilloscope) are the primary operating controls.

One of the more common ship-borne receiver-indicators is shown in Fig. 6, and an air-borne receiver-indicator, which is roughly similar although considerably lighter, is shown in Fig. 7. In an effort to conserve

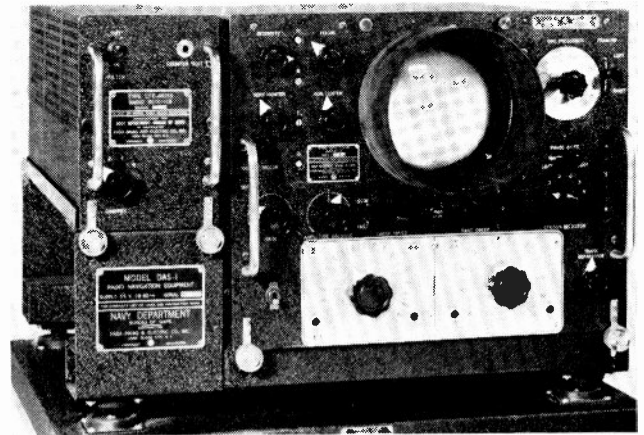

Fig. 6—A typical ship-borne navigator's set. The small unit at the left is the receiver. A separate loading coil is ordinarily used at the base of the antenna.

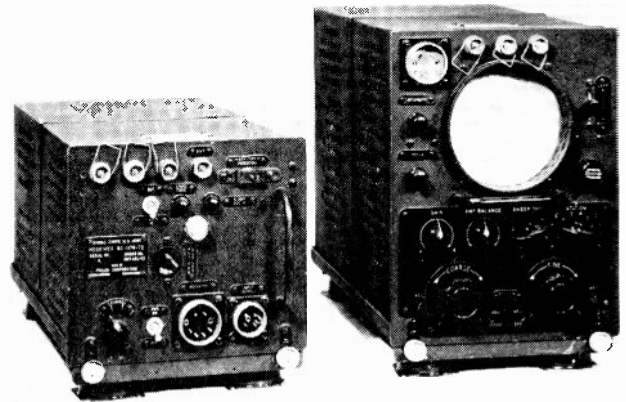

Fig. 7—An air-borne loran receiver-indicator, shown without the interconnecting cables. The smaller unit contains the receiver and the main power supply for both units, and need not be immediately accessible. 45,000 of these sets had been delivered by August 1, 1945.

valuable space, the receiver and power supply are consigned to a separate box which need not be immediately accessible to the navigator. A later model of the air-borne set, in which the weight is about halved, is shown in Fig. 8.

The Transmitter Timer

Synchronization of the transmitting stations in a pair is achieved through the use of a "timer," which is

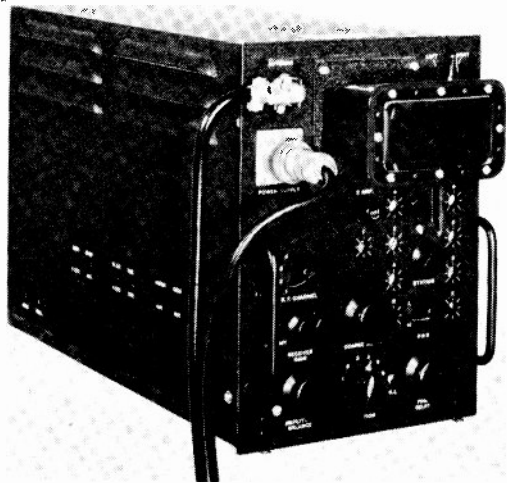

Fig. 8—A later form of air-borne set which weighs about 40 pounds. Production had almost completely swung to this set at the end of the war, but only about 25,000 had been delivered.

very similar to the navigator's indicator, as seen in the block diagram of Fig. 9. The philosophy of operation differs in this case, because the time difference is established in advance. This means that the delays, here adjusted by selector circuits rather than simple delay multivibrators, are preset to the required time difference so that synchronism is reached and maintained by operating upon the oscillator frequency. One station of the pair is designed as "master" and usually emits the *A* pulse of the pair. Its only primary duty is to establish the pulse repetition frequency within a few parts in a million of the nominal frequency and to maintain the frequency constant over short periods with an accuracy of the order of one part in a billion. The second station is called the "slave" and is charged with maintaining its emissions at the same repetition frequency and at constant phase (or "time difference"). This is done by tripping the local (slave) transmitter with the same trigger pulse which initiates the *B* fast sweep, so that the local pulse always appears in the same position on the oscilloscope trace, while the distant pulse drifts about as the crystal-oscillator frequency is varied. With the *A* and *B* pedestals and sweeps set for the desired time difference, the master pulse may be drifted to obtain and maintain visual coincidence. Since highly stable oscillators are used, it is necessary to use a phase shifter between the oscillator and the divider chain so that momentary changes of frequency can be induced without creating a residual permanent change in the oscillator frequency. A mechanical link between the phase shifter and the oscillator frequency control is a great operating convenience. If the phase shifter is being consistently rotated in one direction to maintain synchronism, the oscillator frequency is automatically cor-

rected in the proper sense. Thus, the necessary phase shifting reduces to zero and the frequency converges upon the frequency of the master station. When this condition is obtained, in about half an hour in most cases, an adjustment every ten or fifteen minutes is adequate to maintain synchronism to about half a microsecond.

In addition to the inclusion of the phase shifter, the diagram of Fig. 9 differs in only two major respects from that of Fig. 5. Two cathode-ray tubes are used (neglecting one provided for inspection and maintenance) so that both the "slow-sweep" and "fast-sweep" pictures can be seen without switching. The second, and more serious, difference stems from the fact that the timer is used in the same station, and usually in the same room, with a 100-kilowatt transmitter. As a result the amplitude of the local signal is typically some hundreds of thousands of times greater than that of the distant signal, while, as noted above, the two must be displayed at very nearly the same amplitude if errors are to be kept small. Further, the circuits in which the attenuation of the local signal is obtained must have a bandwidth of several megacycles if the time difference is to be trustworthy to better than a microsecond. These requirements have been satisfied in an electronic attenuator which operates as a wide-band amplifier with small gain except during an interval within which the local signal is transmitted. At this time, it sensibly disconnects the receiving antenna from the receiver, leaving the local signal to be introduced through a special network which may operate from the transmitting antenna coupling unit, from a separate "sampling" antenna, or

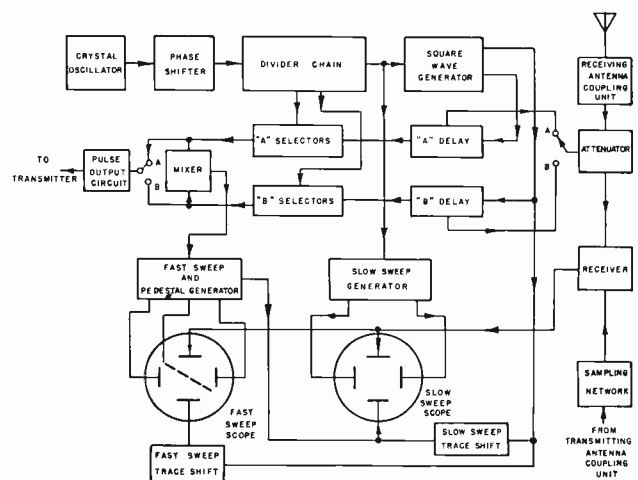

Fig. 9—A block diagram of the major units in the timer which is used to maintain synchronism between transmitting stations.

from the receiving antenna itself. Each of these arrangements is in use to some extent, as none has been developed which combines all their minor advantages.

Since space, weight, and cost are not serious problems in the ground-station equipment, the construction of the transmitter timers is, as shown in Fig. 10, not hampered

by considerations of economy. The design is such as to lead to easy operation and maintenance and to over-all reliability.

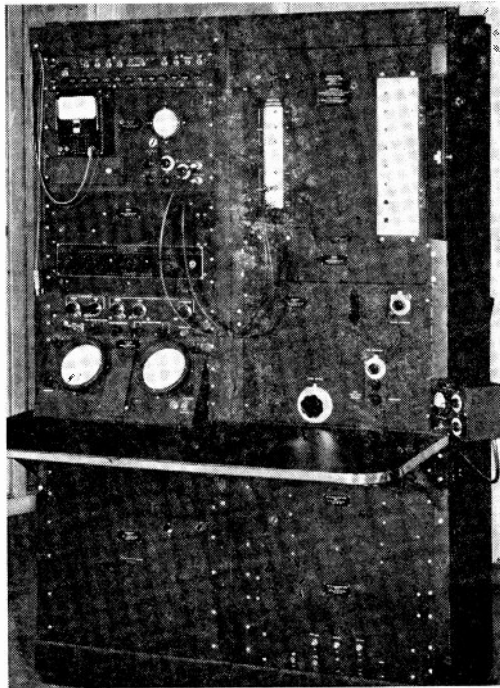

Fig. 10—A typical transmitter timer. The high-precision crystal oscillator is at the right, with the "central," or timer proper, above it. The twin oscilloscopes are at the left, surmounted by a control panel, receiver, and oscilloscope for servicing the equipment. Power supplies are below the shelf. At the right is a small control box for an automatic-frequency-control unit which may be used with the oscillator.

The Station Assembly

The transmitters used for loran are not (with the exception of some improved varieties so far used only experimentally) unorthodox, except in the sense that pulse transmitters are still a little unusual. As the duty cycle is low, about one part in a thousand, the problems of power consumption and heat dissipation are minor, but the voltage requirements are the same as for any 100-kilowatt transmitter. A simple push-pull oscillator is used with a form of grid modulation. A sharp trigger pulse is received from the timer and formed in the modulator into a square wave about forty microseconds long which effectively reduces the oscillator bias from far beyond cutoff to the operating value. Rather surprisingly, there is little tendency to instability, so that successive pulses are not only similar in shape but start always in the same radio-frequency phase. Transmission lines and antenna-coupling networks are normal, and the antenna usually consists of a guyed tower about 110 feet high set upon a good ground system. A typical transmitter is shown in Fig. 11, in which the unit at the right is the 25-kilovolt power supply, and that at the left contains the radio-frequency oscillator and modulators. A monitor oscilloscope, used for checking the radio frequency and pulse shape, stands on a shelf bolted to the left side of the transmitter.

To enhance the reliability of operation, all units appear in duplicate with provisions for quick interchange of operating and stand-by units. In addition to this, a "double" station, which is simultaneously a member of

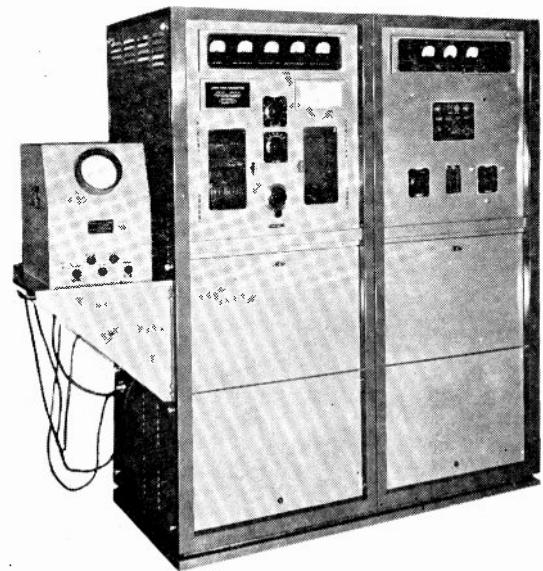

Fig. 11—A loran transmitter, capable of about 100-kilowatt pulse output. The high-voltage power supply is at the right, with the modulator and radio-frequency unit in the center. On the shelf at the left is a monitor oscilloscope used to check the output frequency and pulse shape.

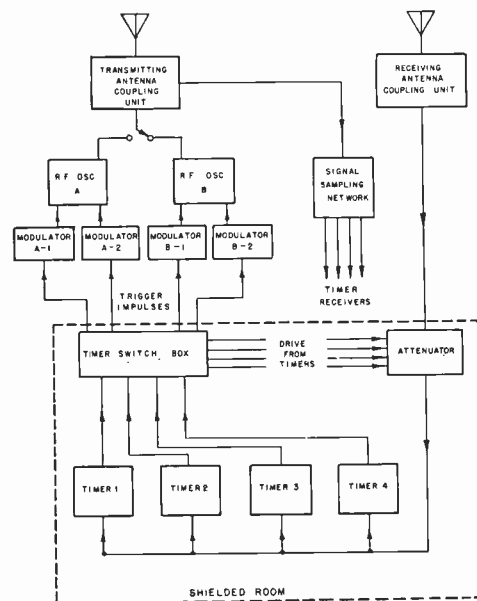

Fig. 12—A block diagram showing the general scheme of interconnections between the major operating and stand-by units in a double transmitting station.

two pairs at two recurrence rates, has two timers for each rate. The two operating timers both trigger a common transmitter, thus creating a slight irregularity at times when the two timers request pulses almost simultaneously. This effect is fortunately infrequent and is

negligible, as far as the navigator is concerned, so that the net result is a considerable saving in equipment. Fig. 12 shows the major equipment and the approximate interconnections in a double station. The shielded room is ordinarily used to protect the timers and receivers from the ambient field of the transmitter, although it may be dispensed with when very careful attention is given to construction and assembly.

pair are satisfactory about 99 per cent of the time.

It is always difficult to locate transmitting stations where the coverage will be that desired, because, in general, the world does not have enough islands in the right places. This results in a sort of natural law that stations will be erected in the most inconvenient places which can be found. A station in the Faeroes is shown in Fig. 13. Installations run the gamut from this sort of location

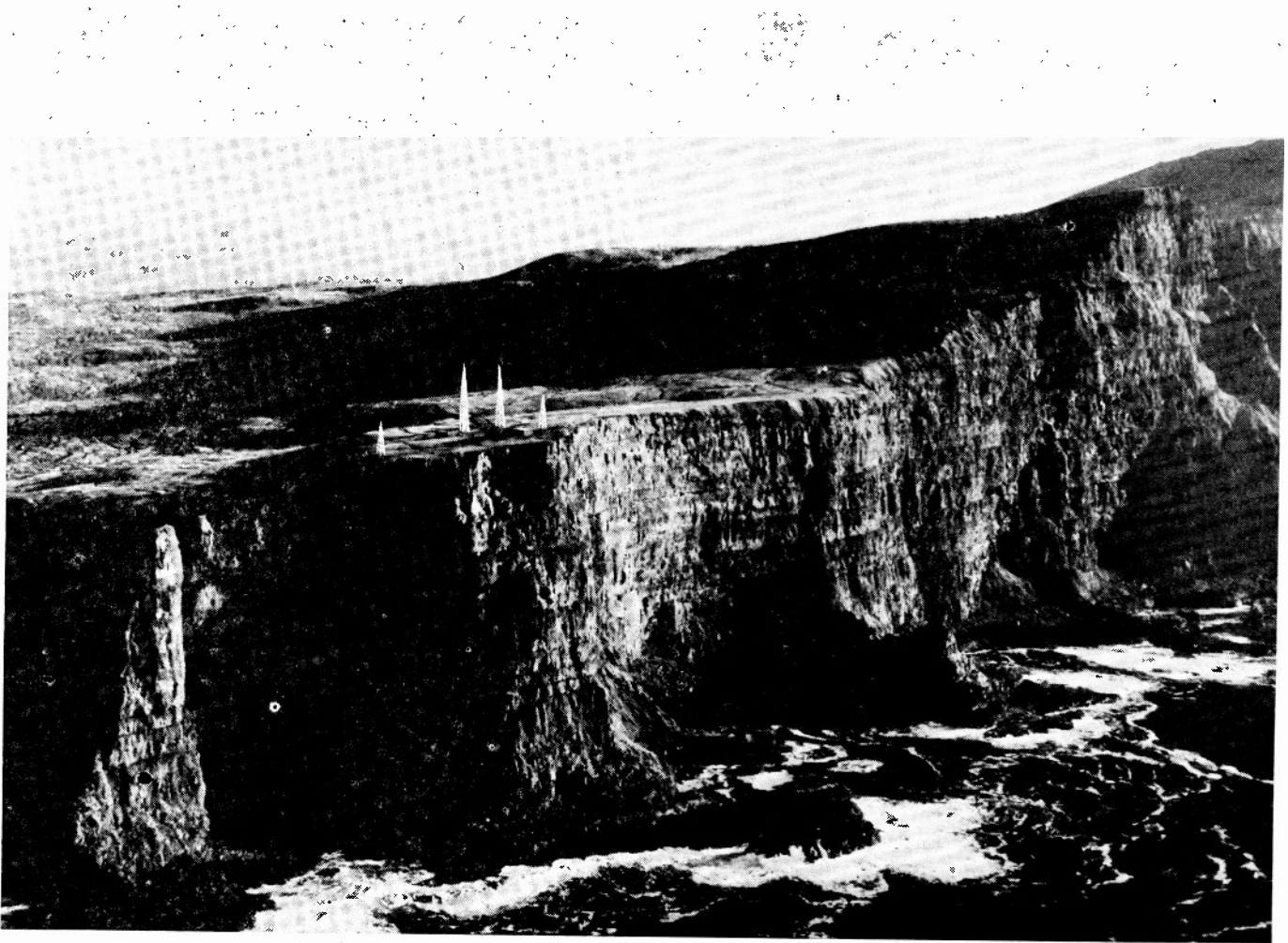

Fig. 13—An aerial view of a loran transmitting station in the Faeroes Islands. The wooden antenna towers are about 120 feet high. The height of the cliff is not an advantage.

It will be noticed that there is no distinction in the equipment of master and slave stations. They differ only in the operating instructions given to them. As shown in Fig. 9, the transmitter may be connected to provide either an *A* or *B* pulse and, in other ways, the equipment may be preset for either use. A secondary duty of the master station is to provide the primary check on improper operations of the pair. Because the time at which the slave pulse should reach the master station is known, the master continuously monitors this quantity and is prepared to alert the slave station if a discrepancy is observed. Either station may initiate a signal of warning to navigators, if, for any reason, the operation of the pair is below standard. In practice, even with the relatively primitive gear so far in use, the emissions of a

to atolls so small as to be completely covered by the ground system.

III. POTENTIAL USES

Potential Accuracy and Range

The factors which control the timing accuracy with which two pulses can be compared do not, in general, vary except with radio frequency. If the pulses are visually superimposed and have their amplitudes made equal, and if the signal-to-noise ratio is really good, the precision of measurement is of the order of one per cent of the length of the pulses. This accuracy can be realized in practice because, in the hyperbolic systems, the two signals to be compared pass through the same receiving

networks and encounter exactly the same artificial delays and distortions, so that their time difference is not at all affected by the circuit parameters, except to the extent that the pulses are lengthened beyond their proper duration.

A considerable number of experiments indicate that the length of pulses which can be used effectively cannot easily be made less than some fifty or sixty cycles of the radio frequency employed. Combination of this estimate with that of the preceding paragraph indicates that a loran system should yield matches which are accurate to about a half wavelength. This accuracy corresponds to a minimum position-line error of a quarter wavelength, or 125 feet at the frequency used for standard loran. Actually the minimum error in standard loran is about 500 feet, an increase due in part to the use of pulses of about twice the length quoted above, and in part to the use of reading techniques which are not as precise as they might be.

The accuracy of loran, in the ground-wave service area, could no doubt be quadrupled by the use of shorter pulses and navigators' indicators having more stable circuits and more closely spaced families of marker pips, but these improvements would not enhance the sky-wave service (which contributes a large part of the usefulness of the system) because in that case the accuracy is controlled by propagational variations which seldom permit an average error of less than two microseconds, which is twice the current reading error.

The low-frequency loran system which was under development at the end of the war should, on this argument, give average errors of about a quarter-mile in the best areas.² Unfortunately, propagational factors as well as geometrical factors will probably operate to increase the errors over a large part of the service area.

Transmission ranges and service areas also depend primarily on frequency, but in this case the lower the frequency the better. Throughout the microwave region the reliable range is little more than the optical range. Even in the ultra-high-frequency band, ranges are not more than about $1\frac{1}{2}$ times the optical range. This often results in good cover for high-flying aircraft, but the distances usable at the surface of the earth are discouraging from the point of view of navigation.

As the frequencies decrease through the high- and medium-frequency regions, ground-wave ranges increase and the differential between high- and low-altitude behavior grows smaller, especially over sea water, but the propagation of signals is no longer simple because of the complex structures of multiple sky-wave reflections, which vary tremendously with the time of day and which, at the higher frequencies, are extremely unpredictable.

These sky-wave phenomena become simpler and more predictable in the lower part of the medium-frequency

range, but only at the low frequencies is there such a degree of stability that sky waves can be used without some undesirable confusion of the navigator. At the very low frequencies propagation over thousands of miles is easy and reliable, but wide-band antenna systems are not available (because the required size is prohibitive) so that, as long as current techniques prevail, the pulse methods cannot be expected to operate there. It seems at present that 100 to 150 kilocycles is about the lower limit at which pulse systems can be used. At these frequencies, ranges of 1500 miles should be obtained by day or night, over land or sea, and at any altitude.

Automatic Data Analysis

It requires only limited acquaintance with a loran receiver to realize that it will be simple to perform all of the set manipulations automatically. That is, there is no technical problem in producing a receiver which will automatically present, say, the loran readings on two lines of position at two selected rates on a pair of dial counters. For military purposes there has been little or no requirement for this sort of receiver, and it has been advisable so far to apply the available research and development efforts to standardization and rapid production of manually operated sets.

With the application of hyperbolic navigation to commercial transportation, however, there will be a demand for a position-determining set which operates continuously, like the chronometer in the chart room, and at which the navigator may look when he wishes to know his position. There are a great many ways in which such machines can be built, but all, or most, of them may be so complicated that the navigator would be properly skeptical of their reliability.

The most common suggestion for a device of this kind is that, essentially by recording loran charts or tables in mechanical form, the machine be made to read directly in latitude and longitude rather than in loran co-ordinates. This is a natural but a misguided desire, as there is little that is inherently more desirable in latitude and longitude than there is in the loran co-ordinates themselves. The two things a navigator always wants to know are the distance and direction to one or to several points.

The next picture which comes to mind is that of a black box containing a number of push buttons and a pair of visible counter mechanisms. A navigator might push the button marked "Bermuda," whereupon the counters would spin and stop so that he could read "distance, 342 miles; course, 114 degrees." This device, however fine a toy it may be, fails because the navigator should not be satisfied unless he is told his relation to a great many different places. To obtain this information he must, with either the black box or the latitude-longitude indicator, proceed to plot his position on a chart before he can understand the interrelations between his position and all other interesting points.

² A new technique, however, shows promise of permitting drastic revision of this estimate, at least for distances up to six or eight hundred miles. The method is mentioned in the last section of this paper.

Obviously, the only really effective automatic aid to navigation will plot the vessel's position continuously, and preferably leave a permanent track on the chart, so that the navigator can see at a glance his current position in its relation to all other points on the chart, and also can have the history of his voyage presented before his eyes.

There are many ways to build a device of this sort, and most of them suffer from a high degree of complexity. The desirability of such an instrument, however, will be especially obvious to the sales managers of our larger electronic corporations who, after the war as before it, may be expected to be in a position to see that the necessary development time is spent to reduce such a device to practice. The only prerequisites are that ground stations must be in operation to provide the necessary coverage, and that the control of the ground stations be in responsible hands.

It is worthwhile here only to point out a single concept which, while it violates sea-going tradition, may have some influence because of its simplicity. In any loran indicator there is sure to be a shaft whose rotation is more or less linearly proportional to the loran reading. This shaft may be connected to a pen through a mechanism such that the lateral position of the pen also bears a linear relation to the loran reading. A second shaft from the same or a second indicator may be connected so that a rotation of that shaft in accordance with a second loran reading produces a linear motion of the pen at an angle to the first motion. With this arrangement any pair of loran readings which define a point on the earth's surface also define a position of the pen point on a plane. A sheet of paper over which the pen moves is therefore a chart drawn in loran co-ordinates. This simple system has the defect of considering all loran lines in a family to be straight and parallel, and also considering that the angles of intersection between the lines of the two families are constant all over the chart. These limitations, however, may not be too severe, especially in the case of an area at some distance from the ground stations. The angle between the two directions of motion of the pen may be set at the mean value of the crossing angle of the loran lines in the area and the rates of motion in the two directions may be set to be proportional to the relative separations of the lines in each family.

This plotting board concept has the immense advantage of mechanical and electrical simplicity. In many cases, if the area on a chart is not too great and if the ground stations themselves are not in the charted area, the distortions encountered in drawing such a chart in loran co-ordinates are no greater than those involved in many other projections.

Fig. 14 is a chart in these loran co-ordinates which represents nearly the worst possible conditions. In this case, as seen in Fig. 2, both of the families of lines have a focus at a station on Nantucket Island, so that the curvature and the divergence of the lines are both at a maximum. Even though the distortion of Cape Cod,

Nantucket, and Martha's Vineyard is extreme, the outline of Southeastern New England is clearly recognizable and the chart is useful for navigation.

Right-Left Indicators

It is mentally only a very short step, and mechanically not a long one, from automatic presentation of position on a map to the making of a connection between the map and the rudder of a vessel so that a predetermined track may be followed automatically. The means are easy to visualize and are already at hand. Only a little incentive and time are required, so that, here again, commercial enterprise may be relied upon to bring a family of such devices into being.

One variant from past experience with direction finding must be pointed out. When using a direction-finding system, any change of course is immediately indicated and measured so that its correction, if it be accidental, may be made instantaneously. When a hyperbolic system is used, however, a change of course does not lead to any change of indication until after the new course has been held for a finite time. That is, the hyperbolic system gives an indication of position, not of direction, and the indication does not at all depend upon the attitude of the vehicle. This is an important point and a valuable one. It makes navigation independent of currents in sea or air because all courses and speeds directly derived from hyperbolic systems are ground courses and ground speeds.

If a simple right-left indicator be built to show an airplane pilot whether he is to the right or left of a loran line he wishes to follow, and even how far to the right or left he is, it will not be very successful as a means for aiding him to follow the line. This is so because there is no appreciable relation between the indications on the meter and the course the pilot should follow, so that he tends to turn more and more to the right, if the meter shows him to be to the left of his desired track, until he crosses the line at a large angle and has to repeat the process in reverse. The net result is a very zigzag track which does, in fact, pass nearly over the objective but which wastes unconscionable quantities of time, fuel, and pilot's energy on the way.

This difficulty could be removed theoretically if the pilot would study the behavior of the right-left meter in enough detail to appreciate both his displacement from the line and his rate of progress toward or away from it. With a knowledge of both these factors, he could determine a reasonable course change which would bring him gently to the desired track and maintain him on it with only small excursions. The pilot is, however, too much occupied with his proper business to enter into such a study; so it is necessary to advance the equipment another stage and to present to the pilot both his rate of approach and the distance to the line he wishes to follow. Thus he may be shown two meter readings, one of which tells him, perhaps, that he is a thousand feet to the left of the line, while the other

shows him he is approaching the line at fifty feet per second. It is immediately clear that, if he continues on the same course he has been holding, he will reach the line in twenty seconds and that, if he wishes to come smoothly onto the line he should begin to change course to the left. This conclusion is, of course, the opposite to that which would be derived from the simple right-left indicator and shows clearly the defect in that presentation.

Within certain limits, it is possible to combine the factors of displacement and rate of change of displacement automatically, so that, instead of the two meters mentioned in the preceding paragraph, the pilot could be presented with a single indicator calibrated in terms

that case the linkage to the automatic pilot could easily be given the appropriate time constant to prevent over-correction.

The Lorchumb Line

The mechanism suggested above is the simple and natural way to build a device which will automatically follow a loran line. This is worthwhile because there is always a line passing through any target in a loran service area, but it falls far short of the really desirable solution. The most important quality which the automatic equipment, like the human pilot-navigator combination, should have, is the ability to proceed by a

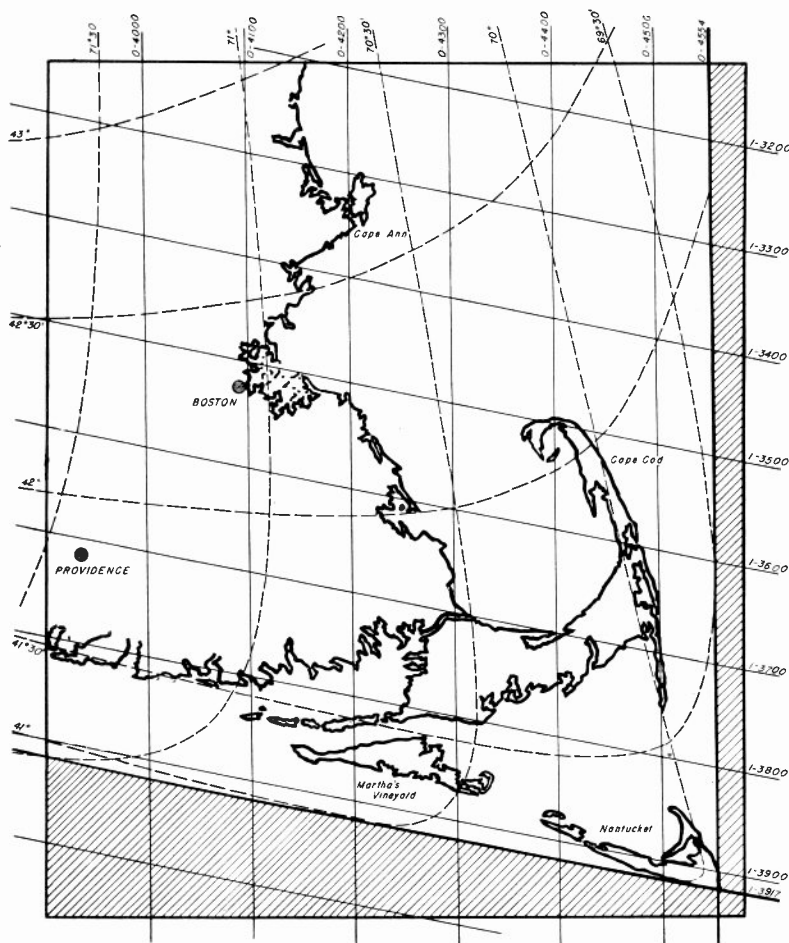

Fig. 14—A map drawn by assuming that loran lines of position are straight and parallel. By use of this sort of map the construction of devices for automatically plotting position becomes easy. The example shown exhibits almost the worst possible distortion.

of the appropriate course correction such as "two degrees to the left." The only defect in this instrument would be the existence of a time constant dependent upon the time required to analyze the rate of approach to the track, so that the pilot would have to learn not to make a second correction too closely upon the heels of the first.

This difficulty would vanish if the meter indication, instead of being presented to a human pilot, were connected to a gyro-controlled automatic pilot, because in

simple and reasonably direct course from wherever the vessel happens to be to wherever it should go.

This ability can only stem from simultaneous examination of two families of hyperbolas. There are many ways to make this examination, as there are many ways to make a plotting board, but one of them offers such great advantages of simplicity that it should be developed here.

Assume a loran receiver capable of automatically following two loran readings in two families of hyperbolic

lines. The shaft rotation corresponding to either of these readings could be connected through the displacement-and-rate device mentioned previously to the rudder of the vessel, so that any desired loran line in the corre-

sponding family could be followed automatically. A loran line passing through the initial position of the vessel could, for instance, be followed until it intersected a line passing through the objective, after which

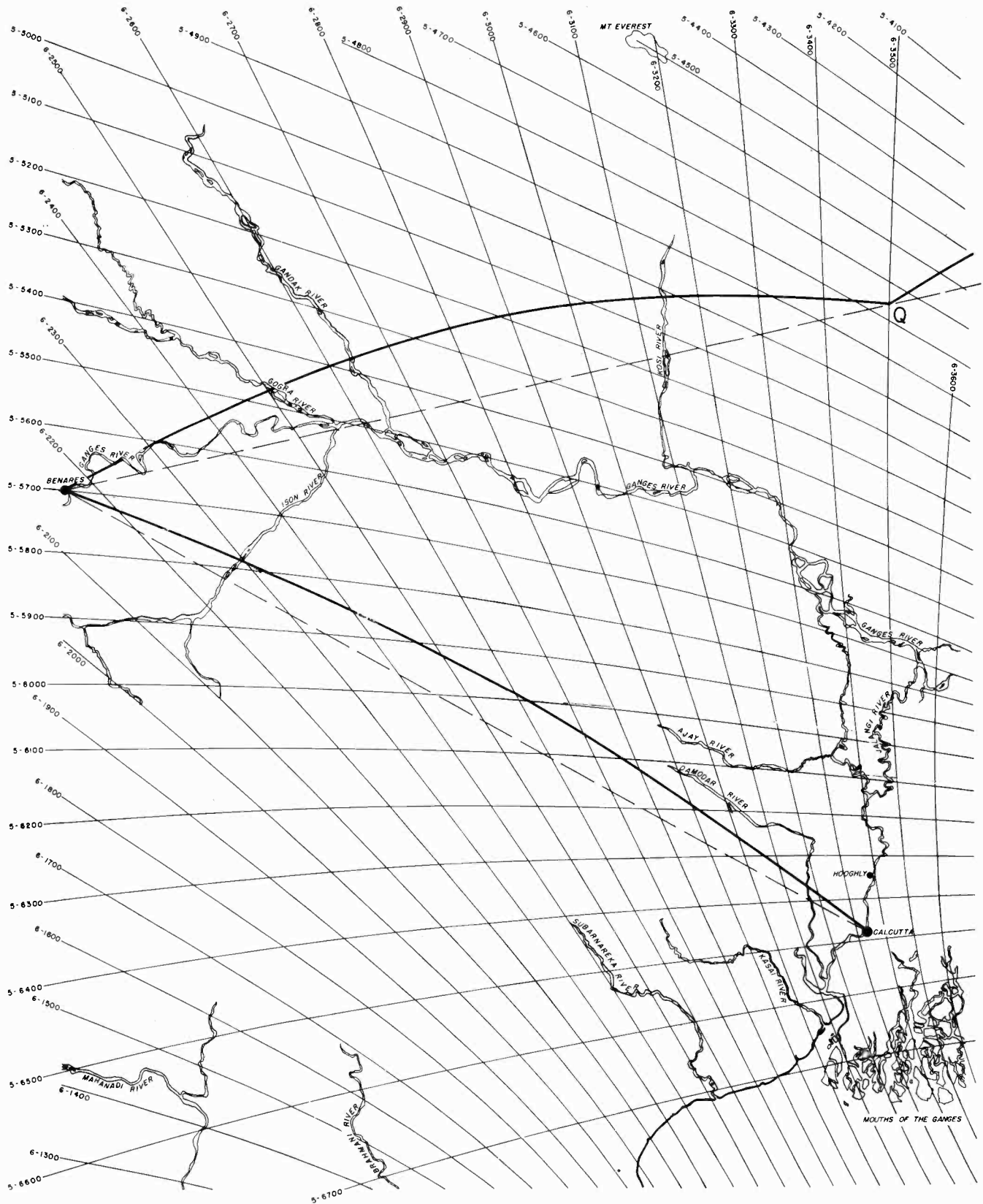

Fig. 15—Two examples of the loximuth line, or curve which intersects two families of loran hyperbolas at a constant ratio. These lines can be followed automatically by the use of relatively simple equipment.

instant the second line could be followed. This would produce the desired end result, but it might be by a very indirect route indeed.

A much more direct path would be one cutting across both families of lines in such a way that the rates of change of the two loran readings constantly bore the same ratio to each other as the total changes between initial and final readings. Along such a path, if the changes in one loran reading were automatically followed while the delay between the second pair of cathode-ray traces were constrained to vary in the designated ratio to the variation in the first reading, then the second pair of pulses, once set to coincidence, would remain so. The steering mechanism might be controlled by the second pair of pulses so as to maintain the coincidence, thus directing the vessel along the chosen path.

For example, if the readings were 3500 at the initial point and 2700 at the objective on the first loran pair, and 1400 and 1800 on the second pair, the linkage between the indications would be set at $-\frac{1}{2}$. The vessel would then follow a course such that it would successively pass through points whose loran co-ordinates were (3400, 1450) (3300, 1500) . . . (2800, 1750) to the objective at (2700, 1800). The course would be quite direct unless it passed very near one of the transmitting stations. In fact, the course would differ from a great circle only in proportion as the loran lines differed from being straight and parallel.

Fig. 15 shows two lines of this sort drawn upon a loran chart of part of India. The great circle from Calcutta to Benares is shown as a dashed line while the proposed curve, or "lorhumb line," which crosses the east-west lines at two-thirds the rate that it crosses the north-south lines, is shown as a solid line. In this case the shortest distance is 387 miles. The lorhumb line is 1.9 miles, or 0.5 per cent longer.

A second lorhumb line is drawn between Benares and point Q, which is about halfway from Benares to Chabua. Here the geometry of the loran lines is less favorable, so that the proposed course is 2.0 per cent, or 7.0 miles, longer than the great circle distance of 358 miles. If an attempt were made to span the distance from Benares to Chabua with a single lorhumb line, the excess distance would be about 30 miles, or 4 per cent of the total distance.

This sort of path has been called the lorhumb line because it is the exact parallel, in hyperbolic navigation, of the rhumb line in Mercator sailing. Various lorhumb lines might be connected together by the navigator as indicated in Fig. 15 to form an approximate great-circle or any other desired path. Devices utilizing this principle probably will be adequate for navigational purposes (as distinguished from problems of pilotage) and will presumably be more simple than others which, through more complete analysis of the exact forms of the hyperbolic lines, could follow slightly more direct paths. The advantages of the design are so obvious that devices which embody this principle may be expected to

be ready for experimental operation soon after the release of engineering talent from more immediate military requirements.

Relayed Fixes

A device for retransmitting the hyperbolic indications from the receiving point to a remote indicator may be applied to loran. Equipment of this sort may take the form of a pulse transmitter which is triggered by the various pulses in the output of a receiver tuned for a hyperbolic system, or may be essentially a superheterodyne receiver in which the intermediate frequency is sufficiently amplified and radiated. An indicator, of course, may or may not be used at the relay point.

The obvious uses for a system involving relayed fixes are those in which it is more necessary or convenient for a distant controller to have knowledge of position than it is for the occupants, if any, of the vehicle under control. Probably the only really military use might be in the control of fighter aircraft (or pilotless aircraft) where it could be expedient to relay fixes to a carrier or other base for analysis and appreciation, and then to retransmit the appropriate action information through a communication circuit.

A somewhat similar use may be for extensive study of ocean currents. In this case, a number of automatic drifting buoys could relay their fixes to one or more control stations, afloat or ashore, and thus permit the gathering of precise continuous data in any weather and over long periods of time.

Probably the most important peacetime use of such a system, however, would involve the standardized installation of relay equipment in lifeboats. The information received from them would be far more useful for rescue work than directional data because it would permit potential rescuing vessels to determine at once not only the direction but the distance to those in need of assistance. Such a program must await the general use of loran receivers on shipboard, but could then easily be integrated with an automatic distress signal receiving mechanism, provided that a frequency channel entirely devoted to such operation can be made available.

Guidance of Pilotless Aircraft

Since hyperbolic navigation does not call for the transmission of any information from the vehicle under control, it is a mechanism with vast potentialities for the two-dimensional guidance of automatic projectiles. If flying bombs are to become the all-weather air forces of the future, no other system offers such immediate possibilities for the mass control of very large numbers of projectiles.

Systems which require some contact between a projectile and ground operators, other than the launching crew, may well have many tactical uses in close support operations, but the possibility of maintaining strategic bombardment by such methods is remote. A hyperbolically controlled flight of pilotless aircraft, on the other

hand, could be operated without any close co-ordination between launching crews and the controlling groups, and without saturation of the guiding facilities.

The receivers for hyperbolic operations of this sort would differ greatly from the present loran receivers. In fact, their evolution should be in nearly the opposite direction from that suggested in the last few pages. Instead of being adapted to more flexible and versatile methods for general navigation, the equipments for pilotless aircraft should be reduced to the stage where they know only a single time difference, but know it well. The corresponding ground equipment, however, must have a degree of flexibility not now in use, so that the hyperbolic lines recognized by the aircraft might be made to lie across any desired target. A pair of ground stations would establish a line of position extending from the launching area to the target, while a second pair would define the intersecting line at which the projectiles would descend. Under gyroscopic control the projectiles could be launched at any time and in any number, and the accuracy of their initial courses would need only to insure an intersection with the first hyperbolic line before passing the target.

With a system of this sort, aircraft could be launched from many points in a large area. Dozens or hundreds of launching sites would independently send off aircraft sensitive to a single line of position, without any requirements for co-ordination except that the control system would have to be in operation. These aircraft would follow their independent courses, perhaps for half the distance to the target, until they came within the zone of influence of the hyperbolic line; whereupon, each would change its course and come about exponentially to ride the line to the objective. The effect would be that of raindrops falling into a gigantic funnel and being concentrated into a steady stream playing upon the target.

Such a stream of bombs would, of course, rapidly obliterate any objective. In practice, therefore, the ground station operators would steadily alter their timing constants so that the line followed by the projectiles would be caused to sweep back and forth over the target area, while the constants of the release line would be altered, perhaps in steps, to provide the requisite variations in range. Thus the stream could be played back and forth across the target area like the stream of a fire hose or, more exactly, like the stream of electrons scanning a television screen; and all this control could be exercised without any co-operation from the launching crews who would, like the loaders on a battleship, simply maintain the flow of projectiles without giving thought to their destination.

Similarly, the beam of pilotless aircraft could be swung from target to target, to satisfy tactical requirements, without requiring any change in the launching technique or orders, provided only that the rate of sweep of the beam must be commensurate with the transverse acceleration available in the aircraft.

This use of the hyperbolic principle differs from loran

in that many types of transmission should be made available for it. While coding and other features may reduce the susceptibility to jamming, the best defense is unexpected variation of the operating frequency. If this sort of mass control of pilotless aircraft is to be developed, great attention should be given to all the timing elements to insure that none of the boundary conditions of the system shall inhibit the free choice of radio frequency. The indicating and control mechanisms should be standardized and reduced to practice in the simplest and most reliable form, but the method of transmission and detection of the hyperbolic information should be capable of alteration at a moment's notice, so that, while loran frequencies might be used for one tactical operation, microwaves, or infrared, might be used for the next.

In this respect, as in the additional flexibility of the ground stations and the simplification of the air-borne equipment, the development of hyperbolic control of pilotless aircraft lies in a direction different from that in which commercial development of a general navigation system may be expected to go. It is, therefore, clear that, while the exploitation of the new methods of navigation may be left to private enterprise, the development of a "hyperbolic air force" must, if it is desired, be obtained through direct and positive action by the Armed Services.

Hyperbolic Surveying

A version of low-frequency loran which may become extremely important, at least for certain applications, is called "cycle matching" and consists in comparing the phase of the radio-frequency or intermediate-frequency cycles of a pair of pulses, rather than in comparing the envelopes of the two pulses. Equipment for utilizing this technique is still in such an early stage of laboratory development that an accurate appreciation is impossible, but it seems reasonable to expect that measurements may be made to a tenth of a microsecond over ground-wave ranges. The facility with which such readings can be taken is as yet unknown, but it is probably safe to predict that, after a difficult development program, cycle matching can provide a blind-bombing system with errors in the tens of yards and with a range of six or eight hundred miles.

Whatever the merits of cycle-matching low-frequency loran for navigation or blind bombing, it shows great promise for the precise measurement of distances of several hundred miles. Under "laboratory" conditions it seems reasonable to expect an error of the order of ten feet in a single measurement of the distance between two transmitting stations, and the average of a number of observations made under good conditions in the field should exhibit about the same precision in the hands of skilled crews. This is about the accuracy with which a good trigonometrical survey measures a distance of one hundred miles.

It seems probable, therefore, that radio surveying

can supplement the ordinary methods for regions in which the basic triangulation system can be on a large scale. The procedure might be as follows. Three stations could be set up at the vertices of an equilateral triangle several hundred miles on a side, and the lengths of the side determined by repeated measurements of the bounce-back time over a period of several weeks. During these measurements a number of "navigator" receivers could be set up and operated for brief periods at points which could be identified on airplane photographs, thus providing a network of points of secondary accuracy, based upon the original triangle. After thus surveying the area contained in the triangle, one station could be removed to a new location on the opposite side of the remaining base line, and the process could be repeated. Thus a precise triangulation would be extended over immense areas in a relatively short time, while as many points as desired could be located with respect to the basic network. Neighboring secondary points would not be known, with respect to each other, with the precision obtainable by optical survey, but the absolute errors should not be more than a few yards and the speed of the whole operation should make it economically available in parts of the earth's surface which could not otherwise be surveyed for many years to come. By this method, of course, islands and shoals which cannot be reached by optical means could be accurately charted.

Unfortunately, this is the sort of enterprise which cannot be undertaken on a small scale but which must be attacked with vigor and with the expenditure of considerable money and time. It appears, however, that, once in motion, the method could produce surveys of an accuracy comparable to that of any other method, and produce them in a time far shorter than that now required. Good co-ordination of these methods with airplane photography may permit the charting, within the next few years, of very large areas which are relatively inaccessible and therefore not well known, but which nevertheless may be of actual or potential military or economic importance.

IV. THE CURRENT PROBLEM

Hyperbolic navigation is no longer a secret. It may develop into a great aid to international commerce, but its availability for wartime navigation is at an end. If we are faced with another war, one of the first steps taken at its onset will be to shut down all loran stations exactly as the lighthouses were darkened at the beginning of the last war. Hyperbolic navigation must, therefore, be exploited commercially or reserved for occasional specialized and limited military purposes. It is obvious that the first course will lead to the greater good.

All of the equipment now in loran operation is of 1942 design. In every category it was necessary, because of the wartime need for speed and for standardization, to adopt and build in quantity the first device which could be shown to be reasonably satisfactory. While the present equipment is obsolete, it cannot be abandoned

immediately because of the financial investment it represents and because nothing is available with which to replace it.

The major question of the moment is this: who is to be responsible for the development of new equipment and, more especially, who shall control its introduction?

During the war, loran was used internationally with good success because there was only a single source of transmitting equipment—the "Navy pool"—and, therefore, problems of technical and operational standardization were reduced nearly to zero. As we look forward into an era of peace, this unifying force will no longer exist. Major decisions must be made on an international basis, if loran service over the oceans of the world is to be available to all. This can only mean that control of loran in the United States must be vested in an authority which can make the necessary international commitments and enforce American compliance with them.

Even on a national basis, unified control must be set up. At present, with the dissolution of the Massachusetts Institute of Technology Radiation Laboratory, there exists no central technical organization. The Naval Research Laboratory should accept much of this responsibility but has, so far, had to confine its activities to routine testing of equipment after the fact of its manufacture. The Bureau of Ships and Bureau of Aeronautics of the Navy and the Army's Air Technical Service Command have all made efforts to assume technical control by writing specifications for production equipment and, to some extent, by writing development contracts with commercial manufacturers. These steps, however successful, will not lead to the establishment of a single, qualified, technical group having cognizance of the operational needs of all services. The system planning, which should be similarly unified and based upon the knowledge of such a technical group, has hitherto been exercised by arbitration between the Chief of Naval Operations Office and the Air Communications Office of the Army Air Forces, with some independent action by the Royal Air Force. The United States Coast Guard, which has done well as the Navy's operating agency, has made some attempts to conduct research leading to improved equipment, but has been forced by circumstances to spend most of its available energy on day-to-day operation, as have the Royal Navy and Royal Canadian Navy. The latter service has dealt magnificently with the simultaneous problems of loran transmission, navigation, and training, but has had to follow the lead of the United States Navy in all technical matters.

The problem of integrating all the varied activities which have contributed to make up loran as we know it, and, we hope, of adding other activities in the future, is complicated by the fact that most of the Army and Navy officers who have been closely associated with the program are now returning to varied civilian activities. They must be replaced. Ways must be found for giving civil aviation and maritime groups a voice in the

technical and administrative decisions of the future. The organizational problem is severe enough on a national basis. Internationally, it is acute.

Probably those of us who have been close to loran throughout its development feel too strong an urge to see it find its place in the sun, and find it quickly. We believe that hyperbolic navigation, now less than five years old, will become the primary method of the future. It may be that our desire to see the infant trained and guided leads us to expect too much from its young strength. We should, perhaps, have faith in the inherent power of the method and trust that the system which can best serve the public cannot fail eventually to find its place in the spectrum, if not in the sun.

Bibliography

- (1) B. W. Sitterly, "Elements of loran," MIT Radiation Laboratory Report No. 499; March, 1944; also available as Navships 900,027, Bureau of Ships; April, 1944.
- (2) Bureau of Ships, "Loran Handbook for Shipboard Operators," Ships 278; July, 1944.
- (3) Army Air Forces, "Loran Handbook for Aircraft," Air Forces Manual No. 37; published by training aids division, Office of Assistant Chief of Air Staff, Training; September, 1944.
- (4) Bureau of Ships, "Loran Transmitting Station Manual," Navships 900,060A; March, 1945.
- (5) J. A. Pierce, "The future of hyperbolic navigation," MIT Radiation Laboratory Report No. 625; August, 1945.
- (6) "The loran system," *Electronics*, vol. 18, pp. 94-100, November, 1945; vol. 18, pp. 110-116, December, 1945; and vol. 19, pp. 109-115, March, 1946.
- (7) Alexander A. McKenzie, "Loran—the latest in navigational aids," *QST*, part 1, vol. 29, pp. 12-16, December, 1945; part 2, vol. 30, pp. 54-57, January, 1946; part 3, vol. 30, pp. 62-65, February, 1946.

Army-Navy Precipitation-Static Project

Part IV—Investigations of Methods for Reducing Precipitation-Static Radio Interference*

GILBERT D. KINZER† AND JOHN W. MCGEE‡

Summary—Investigations of methods for control of precipitation static are discussed. Because of difficulties associated with careful studies of the performance of antistatic devices on aircraft flying in natural charging conditions, methods were devised that permitted natural conditions to be simulated in fair-weather flights and in a laboratory hangar constructed especially for this purpose. Studies showed that interfering noise associated with the use of bare-wire antennas was roughly proportional to the amount of corona-current discharge. It was found that the use of antennas insulated with polyethylene provided comparatively static-free radio reception by preventing corona discharge from the antenna. Correlated ground and flight experiments showed that, unless the corona discharge occurs at areas adjacent to antennas, little noise is produced in the radio receiver. The characteristics of several types of electrostatic dischargers, intended to reduce the equilibrium potential of the airplane for a given charging condition, were examined. The dry-wick discharger recently adopted by the military services was found to give the best over-all electrical and mechanical performance.

THE PURPOSE of this paper is to describe an investigation that has been made of precipitation static and of means for its control. Some of the experimental methods that will be discussed are new, others are adaptations from older methods devised independently, in some cases, by more than one investigator. Most of the practical methods for controlling or limiting precipitation-static interference have been examined carefully, and those showing the most

promise have been carried forward to a point where guiding principles are established for the use of the design and development engineer.

It is known that a discharge of electricity or a redistribution of surface electric charge accompanies either autogenous or exogenous electrification of aircraft. The discharge and redistribution occur mainly in the form of corona or sparks, and constitute the main sources of the radio interference called precipitation static. Electrification of aircraft in flight and the accompanying corona discharge have been discussed in an accompanying paper,¹ but no mention has been made of quantitative measurements of noise interference, or of the relative amounts of noise produced by many possible sources on an airplane.

The interfering signal found in precipitation static is a rapidly rising transient voltage coupled into the radio antenna circuits. It is generally agreed that the interference consists of a shock excitation of the tuned circuits in the radio receiver into damped oscillation. When factors responsible for these voltage transients are such as to maintain a rapid rate of production of the pulses, radio reception becomes not only difficult but often impossible.

One of the important tasks performed in the investigation was the determination of the relative importance of the various sources of interference. It had been

* Decimal classification: R521.3×R272.3. Original manuscript received by the Institute, November 19, 1945.

† United States Naval Research Laboratory, Washington, D. C.

‡ Aircraft Radio Laboratory, Wright Field, Dayton, Ohio.

¹ R. G. Stimmel, E. H. Rogers, Franklin Waterfall, and Ross Gunn, "Electrification of aircraft flying in precipitation areas," *Proc. I.R.E.*, vol. 34, pp. 167P-178P; April, 1946.

previously established by several investigators^{2,3,4} that when corona occurs directly on antennas, it produces an especially intense interference. Anticipating measurements to be discussed later, it may be simply stated with respect to corona discharge on other parts of the airplane, that *unless the area in corona is close to an antenna the noise produced is not severe.*

Although it has been stated frequently by responsible observers that there is an appreciable noise associated with the impinging of precipitation particles on antennas or, possibly, even on other surfaces of the aircraft, such impressions have not been verified in the present investigation.

Certain areas of an airplane, such as plexiglass domes and turrets, windshields, and exposed metallic objects insulated from the main structure, are charged by precipitation particles to voltages which frequently differ

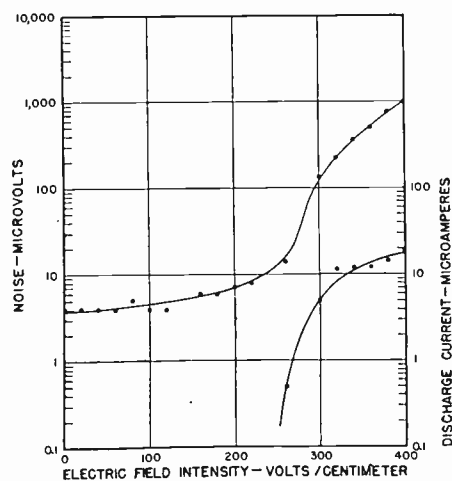

Fig. 1—Corona-current and 300-kilocycle noise characteristics for 0.04-inch bare-wire antenna on a B-25 airplane flying in natural autogenous charging conditions. Airplane charged negatively.

from the equilibrium voltage of the airplane. The voltages may then equalize by a spark-over along the insulating surfaces, and signals originated by these sparks may be coupled into nearby radio antennas. It has been found, for example, that if the lead-in wire on the interior of the B-17 research airplane is placed within 12 inches of the plexiglass cover of the radio compartment, the precipitation-static noise intensity may be increased an appreciable amount by spark-over on the outside of this plexiglass.

Most of the longer antennas installed on aircraft extend from some forward position on the fuselage back through a highly exposed region to the vertical or horizontal stabilizers, and are unusually susceptible to corona discharge. A typical set of measurements of the

corona noise and current on the long exposed command antenna of the B-25 research airplane, when flown in autogenous charging conditions, is shown in Fig. 1, plotted against the electric field on the bottom of the fuselage. It will be seen that the radio interference rises above the base noise level as soon as appreciable corona current exists. Thereafter the noise rises with increasing current.

In making these measurements, it was necessary to adopt a standard noise detector rather than to depend upon aural estimates. An RCA Model 312-B Radio-Frequency Noise Meter, measuring directly the microvolts of noise signal on an antenna, was found to serve this purpose when used in the circuit shown in Fig. 2. Most flight measurements have been made with the

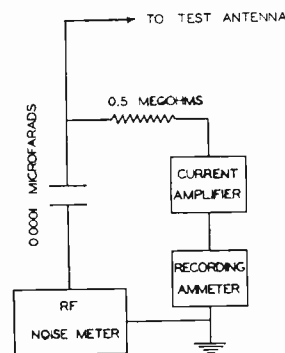

Fig. 2—Diagram of instrumentation used for measuring antenna noise and current characteristics.

receiver circuit of the noise meter tuned to a frequency of 300 kilocycles, because at such frequencies the interference encountered is ordinarily severe. The frequency and magnitude of individual bursts of corona discharge can be detected as unidirectional pulses of electric current by the use of oscillography, but it is inconvenient to do this in a flying airplane. It has been found that a satisfactory measure of the corona intensity is the effective direct current to the areas in question. The usual arrangement for measuring the corona current employing a current amplifier and a recorder is shown in Fig. 2.

The amount of corona noise produced by discharge from the tail structure, the wing tips, and other sharp points or edges on an airplane has never been measured directly in flight because of the impossibility of sorting out the individual components of signal which combine to give the readings of the noise meter. In experiments to be described later, where the conditions of electrification in the air were simulated in a laboratory hangar, it was found possible to evaluate some of these corona sources.

Exogenous electrification varies rapidly in time because of the nature of the isolated and unpredictable distribution of atmospheric charge occurring in thunderstorms and in convective meteorological activity. Autogenous electrification, on the other hand, remains much more steady, but even here the resulting airplane potential varies in an uncontrolled manner. It is not

² Ross Gunn and W. C. Hall, "First Partial Report on Precipitation Static Problem," Naval Research Laboratory Report No. 0-1919; August, 1942.

³ Herbert M. Hucke, "Precipitation-static interference on aircraft and at ground stations," *Proc. I.R.E.*, vol. 27, pp. 301-316; May, 1939.

⁴ E. C. Starr, "Precipitation-Static Radio-Interference Phenomena Originating on Aircraft," *Oregon State College Eng. Exp. Sta. Bull.*, No. 10, June, 1939.

surprising, then, that natural electrification of aircraft encountered in flight was of too variable a nature to permit making careful studies of radio interference, and that a means had to be found for simulating the electrical conditions produced by natural charging. Flights in bad weather were used in this investigation only for spot checks to corroborate results obtained under simulated conditions.

The artificial charger using water jets, described in the paper on instrumentation,⁵ was found adequate to produce moderate voltages on flying aircraft, and its

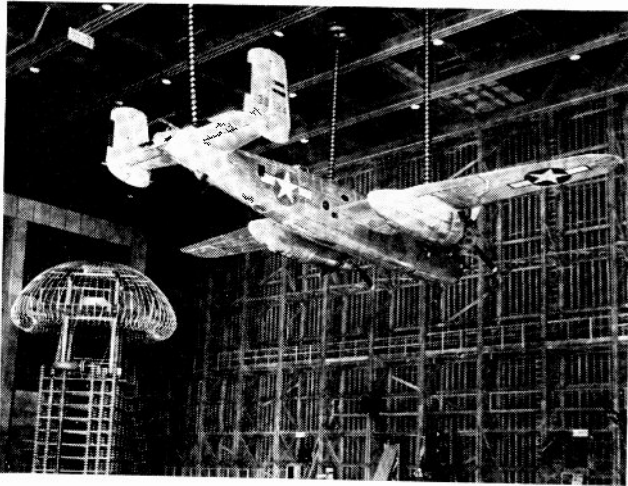

Fig. 3—B25 airplane suspended on strain insulators in Minneapolis hangar. High-voltage generator shown in background.

use permitted carefully controlled studies to be made in fair-weather flight. Even an airplane so equipped, however, does not satisfy all the requirements desirable for careful investigation. In the first place, the artificial charger cannot produce airplane potentials approaching those found in the more severe natural charging conditions. Furthermore, it is difficult to construct and shock-mount delicate electronic instruments of high sensitivity for use in flying aircraft subjected to the shock of rough flight conditions.

An arrangement was set up whereby a full-size airplane could be suspended on strain insulators in a laboratory hangar constructed especially for this purpose. Such an airplane could then be connected to a high-voltage direct-current generator, and potentials equivalent to the most severe autogenous electrification could be easily applied and adjusted at will. It was found that corona and noise on such an airplane suspended in the hangar were similar to the corona and noise encountered in flight. There were, however, measurable differences due to the absence of the exhaust gases, and due to the fact that corona discharge ions form a space charge throughout the hangar which is more concentrated than that in flight. In correlating laboratory data with flight data it was necessary, because of the presence of nearby

hangar walls, to apply corrections to the electric fields measured on the surface of the airplane in order to reduce them to values equivalent to those found in flight.

Most of the research work carried out for reducing precipitation-static interference was performed in the laboratory hangar. The photograph shown in Fig. 3 shows a B25 Mitchell twin-engine bomber suspended in the middle of the hangar on three strings of strain insulators. The strings of insulators are raised and lowered by elevators that may be controlled individually, or operated as one unit to adjust the airplane to any desired elevation. A 1,200,000-volt direct-current generator visible in the background consists of a bank of rectifiers arranged in a voltage-multiplying circuit and topped by a large umbrella-shaped dome which serves as a corona shield for the high-voltage terminal. The instrumentation used to make measurements inside the suspended plane is shown in Fig. 4 and consists of direct-current amplifiers, a noise meter, an electric-field meter, and a standard aircraft receiver for monitoring noise signals. The noise and current meters used in this antenna study were coupled to the antennas and other sources of corona discharge according to the schematic diagram of Fig. 2.

An antenna that was free of self-generated noise was necessary to evaluate the interference caused by the antenna system and by surfaces other than antennas, in terms of microvolts input to the receiver. Separating the noise caused by discharge on the airplane from that generated on the antenna is difficult, especially when an antenna is located in a region where it is susceptible to corona discharge. The problem was to free an antenna from the electrostatic fields that would cause it to discharge corona, without interfering with its radio-frequency characteristics. This was accomplished by mount-

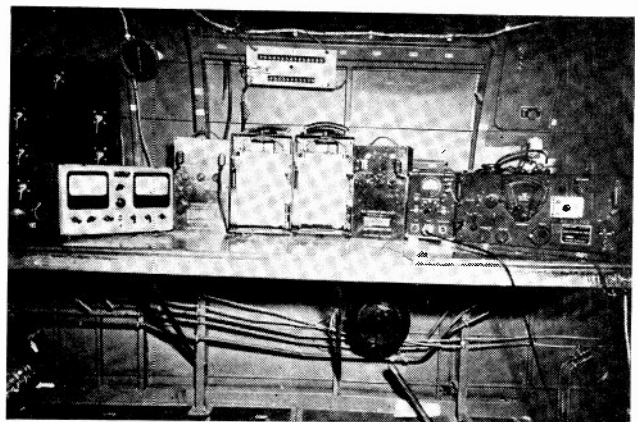

Fig. 4—Instrumentation, installed in cabin of RB-37, consisting of noise meter, electric-field meter, current amplifiers, and radio receiver.

ing a high-resistance cord impregnated with aquadag solution parallel to and four inches above a bare-wire antenna. The resistance of this cord was 10 megohms per foot. The amplitude of the voltage transients associated with the corona discharge from the cord was so limited

⁵ R. C. Waddell, R. C. Drutowski, and W. Blatt, "Aircraft instrumentation for precipitation static research," *Proc. I.R.E.*, vol. 34, pp. 156P-161P; April, 1946.

and pulse shapes were so modified by the high resistance of the fibers, that the noise signals coupled into the antenna were of negligible strength. The high resistance cord served as a termination for the electrostatic lines of force that would otherwise terminate on the antenna wire, and thus it prevented corona from occurring on the antenna. A typical base noise curve of the laboratory hangar setup obtained with this antenna is illustrated in Fig. 5. For the convenience of correlation with aural observations, all hangar-noise measurements were made with the noise meter tuned to 900 kilocycles.

If a bare rod, $\frac{1}{4}$ -inch in diameter, is placed on the wing tip of the airplane in the laboratory hangar and simultaneous readings of electric field, current from the rod, and noise are taken, the noise is found to increase suddenly when the rod reaches its corona threshold voltage. Thereafter, the noise continues to rise with the corona current from the rod. The noise also becomes greater when the rod is moved nearer to the receiving antenna. For example, the coupled noise for a given current discharge from the rod placed on the wing tip may increase the base noise of the airplane by 20 microvolts. If the rod is placed on the vertical stabilizer, there will be a noise increase of 200 microvolts. If it is placed at the top of the antenna mast, the noise will increase to 500 microvolts.

This method of evaluating the noise is very useful in determining the best location for aircraft accessories, from a precipitation-static point of view. As an illustration, Fig. 5 showed that the base noise without accessories installed was 14 microvolts when the airplane electric field was 1000 volts per centimeter. After placing a pitot tube in a position on the leading edge of the right wing, 20 feet from the receiving antenna, and repeating the test, the noise level increased to 30 microvolts at the same field.

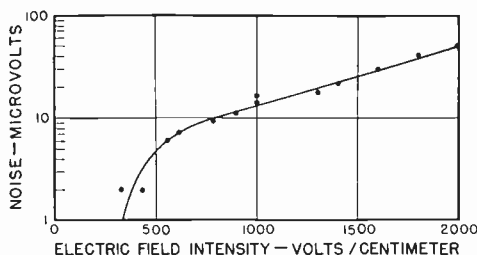

Fig. 5—Base noise characteristic of 0.128-inch bare copper wire protected by a high-resistance cord and installed on RB-37 suspended in the hangar. Noise measured at 900 kilocycles, airplane charged negatively.

As evidence that these discharge surfaces behave in a similar manner in flight, the B-17 research airplane was equipped with the same $\frac{1}{4}$ -inch rod placed at corresponding positions, and the noise coupled from the rod was found to be nearly the same as observed in the hangar experiment for the same corona current.

A plot of noise on bare-wire antennas unshielded by a high-resistance cord is shown in Fig. 6. Comparing this

plot to the curve shown in Fig. 5, it is clear that the magnitude of the noise coupled from various accessories is insignificant compared to that generated on a bare-wire antenna. It is also evident from the observed increase in the measured noise when the $\frac{1}{4}$ -inch rod is moved to points closer to the antenna protected by the high-resistance cord, that surfaces adjacent to the antenna must not be permitted to discharge corona. *Summarizing, corona dis-*

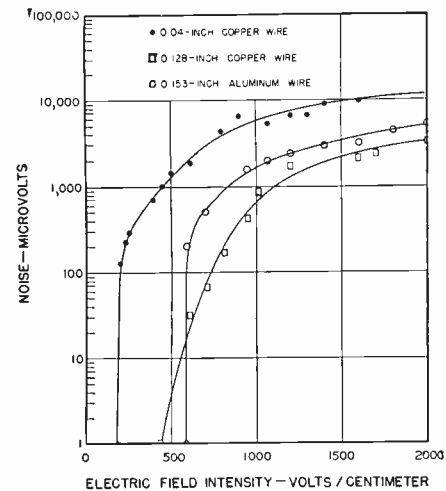

Fig. 6—Noise characteristics for three bare-wire antennas measured at 900 kilocycles on RB-37 suspended in the hangar. Airplane charged negative.

charges from other surfaces on the airplane become important as noise sources only after the antenna itself is relieved of the effects of corona discharge.

The most important objective of the antenna investigation was to increase the threshold of self-generated antenna noise to a value of the airplane potential high enough to be of practical value in flight. If an antenna had a threshold of noise at an electric field on the bottom of the fuselage of 280 volts per centimeter, it was felt that by increasing this threshold to 400 or 500 volts per centimeter the number of flights where the radio would be usable would be notably increased. This method of approach has been followed throughout the program of antenna investigation and "threshold" as used has become an expression of merit when making comparative antenna tests.

Antenna studies on the laboratory hangar airplane have been made principally with two fixed-wire installations. One is thirty feet long extending from an antenna mast mounted on the fuselage above the cockpit to a position on the right vertical stabilizer one fourth the distance from the top. The second is a mirror image of the first on the left side of the airplane. The position on the right, called the liaison antenna, has been used to interchange various types of wires for test purposes, while the left-hand antenna, called the command antenna, has served as a standard of comparison protected by the high-resistance cord.

Precautions were taken when examining an experimental antenna, to cover all strain insulators, tension

units, and any other fittings with several layers of insulating rubber tape. This was a necessary precaution in order to insure that any measured noise or current was from the antenna itself, and not from associated parts. In the investigation of bare-wire antennas of various diameters, care was taken to see that each surface was cleaned and polished in a uniform manner. Even then, some doubt existed as to the exact threshold for the bare wires, due to extreme sensitivity to surface conditions. In one case it was found that the threshold

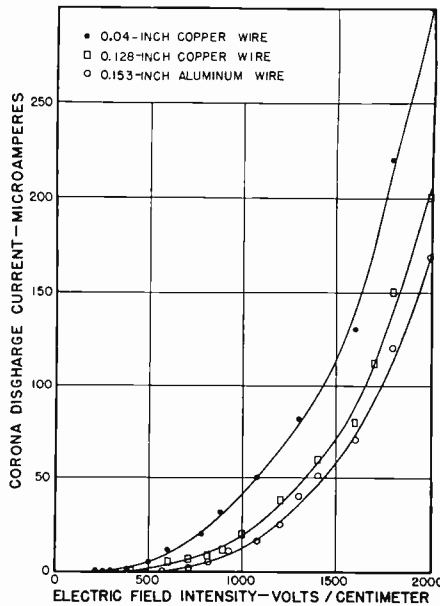

Fig. 7—Corona-discharge characteristics for three bare-wire antennas on RB-37 suspended in hangar. Airplane charged negatively.

of corona was 100 volts per centimeter lower, because of the failure to clean the wire with alcohol after buffing.

Bare-wire antennas are of interest because they have been used universally on aircraft. In the case of a small diameter bare wire, it is readily seen that the antenna will be among the first elements to start discharging because of its small radius of curvature as well as its exposed position. It is well known that the potential gradient required to produce corona on a wire depends upon the radius of the wire; that is, for a given voltage, the surface electric field decreases as the diameter increases. In general, the field at the surface of the wire must be reduced to as small a value as possible, and this is most easily accomplished by using a larger wire. However, a practical limit soon intervenes because, for aerodynamic reasons, it is usually considered inadvisable to use a wire of greater than 0.2 inch in diameter.

In a series of carefully checked tests, bare wires consisting of 0.153-inch aluminum, 0.128-inch copper, and 0.04-inch copperweld have been examined as antennas. Curves in Fig. 7 give the observed relationship on the airplane in the hangar between the corona current associated with these antennas and the electric field measured on the bottom of the fuselage. It can be seen that the corona current to the antenna is inap-

preciable for the 0.04-inch wire below 190 volts per centimeter. The 0.128-inch wire has no appreciable current below 440 volts per centimeter, and the 0.153-inch wire has no current below 580 volts per centimeter. Remembering that the electric field is approximately proportional to the airplane voltage, it will be seen that the order of appearance of corona current is in proper agreement with the wire diameters. Particular reference to Fig. 6 containing curves of noise as a function of electric field for these antennas reveals that the noise rises very rapidly after the threshold voltage for corona current shown in Fig. 7 is reached. Due possibly to the lack of similarity of the two surfaces, it has been observed in repeated checks that, while onset field for noise on the 0.153-inch aluminum is above that of 0.128-inch copper wire, the noise of the larger aluminum wire rises immediately to a higher value than the noise of the latter.

Because the measured noise interference is such a critical function of discharge current, an antenna cannot be permitted to discharge more than a fraction of a microampere of direct current, if communication is to be maintained.

Since the corona current from the antenna is so critical, there remain two possible methods of reducing the noise. One method is to insulate the wire with a dielectric material that will prevent corona from occurring on the surface of the wire. An alternate method is to allow the wire to discharge, but to treat it in a manner that will make the discharge noiseless.

Studies have been made of the possibilities of covering bare-wire antennas with high-resistance fibers and semiconducting material for the purpose of forcing the corona transients to assume a time variation, which is known to produce noninterfering corona discharge. For the purpose of the test it was convenient to use a No. 16 copper, cotton-covered magnet wire saturated with a solution of water and glycerine. There were then a multitude of tiny high-resistance fibers that reduced the

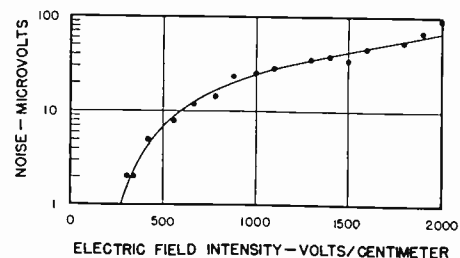

Fig. 8—Noise characteristic for discharging magnet wire antenna measured at 900 kilocycles on RB-37 suspended in the hangar. Airplane charged negatively.

steepness of the discharge current wave front. Also, the coupling capacitance along the very fine fibers was so small that transient electrostatic effects were not coupled into the radio receiver. It is interesting to observe that, while being tested in the laboratory, this type of antenna wire discharged up to 300 microamperes and still permitted intelligible reception of a local broadcast station. A plot of noise versus electric field in Fig. 8

shows that the maximum noise measured is but a few microvolts above that of the corona-free antenna (Fig. 5). This system of providing an improvement in reception during precipitation-static conditions was believed to be of real significance for two reasons: first, because of the quiet nature of the directly coupled corona discharge; second, because the antenna acts as an efficient airplane discharger.

The use of this type of antenna as a noise-free antenna in actual flight has not been found satisfactory. While it is apparent that the effect of the wind blowing over the discharge fibers has an effect upon discharge, thus changing the character of the corona noise, a complete explanation for the discrepancy must await the development of a sufficiently high-speed oscillograph suitable for flight tests.

As emphasized previously, the noise produced in a receiver by an antenna is usually quite small until corona current is observed. This suggests that if corona current could be suppressed completely by covering the wire with an insulating layer the antenna would be satisfactory. This, however, offers several problems in choosing the proper insulating material. If it be remembered that the antenna is in an exposed location and subject to very high electric fields, and, also, that aircraft are flown in a wide range of weather and temperature conditions, the varied requirements for the material become apparent. In general, the following specifications must be met:

- (1) very high electrical resistance;
- (2) high dielectric strength;
- (3) low radio-frequency loss;
- (4) operating temperature range (-100 to $+100$ degrees centigrade);
- (5) minimum deterioration due to ultraviolet radiation.

Extensive laboratory and flight tests have shown that a comparatively new plastic, known as polyethylene, comes close to meeting all of these requirements. Completely insulated antennas will not discharge corona current until electric fields sufficient to puncture the dielectric are encountered, and they will be comparatively free of noise until that time. The puncture, when it occurs, is usually about ten mils in diameter and extends radially from the outside of the insulation to the surface of the embedded wire. It is interesting to note that on polyethylene insulated antennas having well taped fittings, the puncture always occurs at the point most exposed relative to the surface of the airplane, or more specifically, in the position of maximum field intensity. With a single puncture the discharge current and accompanying noise are about the same as if the wire were completely bare.

Another characteristic of the insulated antenna wire is the quasi-periodic redistribution of free charge on the outside surface of the insulation, due to the changing electrical conditions. This redistribution of charge introduces into the receiver an occasional popping noise

of low intensity that is found not to interfere with the intelligibility of the communication.

When it became clear in the course of investigation that the interfering signals generated by corona bursts from the antenna itself were of much greater importance than the signals coupled from other sources of corona discharge, and the insulated antenna had been devised experimentally as a remedy, flights with the B-17 research airplane were made under simulated autogenous charging conditions to check the extent of reduction of precipitation static that could be accomplished by the replacement of bare-wire antennas.

Measurements of the 300 kilocycle-noise on an 0.04-inch bare-wire antenna and on a polyethylene insulated antenna are shown in Fig. 9. These antennas were symmetrically located on the B-17 in much the same manner as the command and liaison antennas on the RB-37

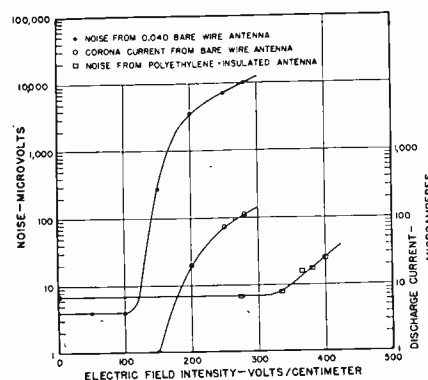

Fig. 9—Noise and corona-discharge characteristics for bare-wire and insulated antenna installed on B-17 in flight under simulated autogenous charging conditions. Airplane charged negative. No measurable corona current observed from insulated antenna at highest electric field attainable with artificial charger.

airplane. The noise measurements necessarily include components from all interfering signals on the airplane which might be coupled into the receiving antenna, including noise due to corona discharge from antenna accessories, and commutator sparking in servomotors and similar equipment. The base noise level may, therefore, vary slightly from day to day or between the two test antennas as indicated by the difference in base noise levels of the two noise curves. To show the correlation between the noise level on an antenna and the corona-discharge current, the discharge current from the bare-wire antenna is plotted in Fig. 9. No discharge current was measured from the insulated antenna wire at the highest potential attainable by use of the artificial charger. The noise curves show clearly that, as the electric field of the airplane is increased, there is a fairly constant base noise signal until some potential is reached which produces interfering corona-discharge current, either from the antenna itself, as was the case for the bare-wire antenna, or from some adjacent portion of the airplane or antenna system, as must have occurred in the case of the insulated antenna at an electric field of about 350 volts per centimeter.

It is desirable, as will be shown later, to promote discharge from an airplane flying through charging conditions and the $\frac{1}{4}$ -inch rod tests have shown that it is feasible from the point of view of noise interference to encourage discharge of corona currents from the airplane extremities farthest from the antennas, for example, the wing tip. This can be done by means of special discharging devices designed to take advantage of the high electric fields existing at these points. If these dischargers can be so constructed that the corona current from them is "quiet," that is, does not

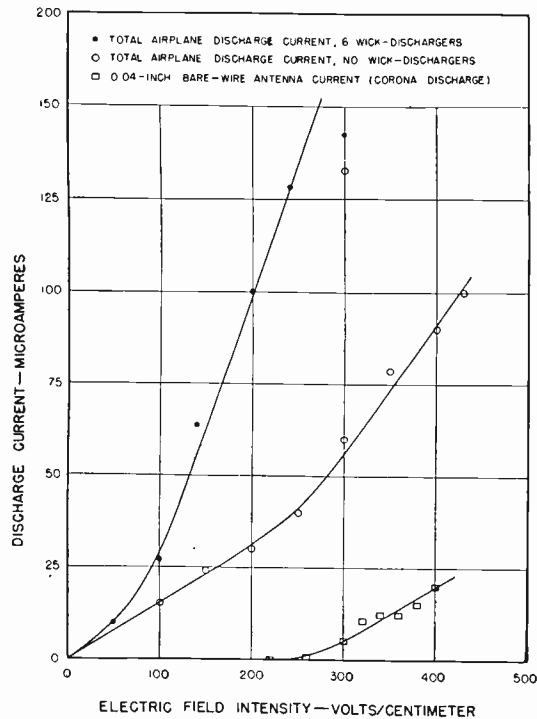

Fig. 10—Discharging characteristics of B-25 airplane in flight under simulated autogenous charging conditions. Airplane charged negative.

cause as much noise interference as a blunt point discharging the same current, there will be an additional gain. Mechanical strength must play an important part in discharger design, because the areas of efficient operation are almost always exposed to turbulent, high-speed air streams.

Many types of discharge elements have been proposed, among them the Bendix Trailing Wire discharger which has been widely used by commercial airlines, arrays of sharp points, radio frequency arc dischargers, flame dischargers, and the wick discharger developed by the Naval Research Laboratory.^{1,4} Nearly all of these dischargers are "quiet." The arc and flame dischargers operate quietly because they furnish a copious

⁴J. R. Clement, Jr., "Seventh Partial Report on Precipitation Static Problem," Naval Research Laboratory Report No. 0-2309, June, 1944.

supply of ions from which those of proper sign can be carried away by the electric field surrounding the airplane without producing a disruptive spark or corona breakdown. The sharp points have an inherent "quiet" type of corona discharge. The wick and wire dischargers are quiet because the discharge is from a sharp point and because the discharging elements are isolated from the airplane structure by a high resistance that rounds off the sharply rising fronts of the corona pulses. The wick discharger has been found to have the most satisfactory mechanical and electrical characteristics. Two types have been in production for the armed services, the earlier "wet" wick discharger requiring the use of a reservoir of glycerine or ethylene glycol and a later, or "dry," type prepared by impregnating cotton wicking with a silver deposit and providing mechanical strength by inserting the wicking in a flexible plastic tube.

Fig. 10 illustrates the advantages of discharger installation on a B-25 airplane. The currents represent the rate of charge generation on the airplane at corresponding values of the electric field measured on the bottom of the fuselage. If, for example, a condition exists in which a 100-microampere charging current is supplied to the airplane (a typical autogenous charging condition) it will be noted from Fig. 10 that with no wicks on the airplane the electric field would rise to a value of 430 volts per centimeter with a corresponding bare-wire antenna current of 25 microamperes, which is large enough to block all signals on that antenna. However, with an installation of two dry-wick dischargers on each wing tip and one at the top of each vertical stabilizer, the same charging current would raise the airplane field to only 200 volts per centimeter, which is below the corona onset field for the bare-wire antenna. The performance of this and, correspondingly, the performance of all other antennas on the airplane, will be tremendously improved. Engineering data relating to the number and location of wicks for maximum effectiveness have been prepared for issue to the services.^{4,5}

The above considerations are intended to show the value of the dischargers under autogenous electrification. Their value in exogenous fields is not as great, because the current conducted through the dischargers usually does not result in any appreciable reduction of the exogenous field, and also because the orientation of the exogenous field may not always be such as to draw corona from an aircraft extremity equipped with a discharger. However, some advantage is gained by the noise-free character of the discharge currents when they pass through wick units.

⁵John W. McGee and R. C. Drutowski, "Installation of dry wick type electrostatic dischargers," Army-Navy Precipitation Static Project, Tech. Report; October 1, 1945.

Part V—The High-Voltage Characteristics of Aircraft in Flight*

ROSS GUNN†, ASSOCIATE, I.R.E., AND JAMES P. PARKER†

Summary—The important high-voltage electrical characteristics of aircraft in flight are determined from (a) flight operations in precipitation areas; (b) flight operations using a new artificial charger to electrify the airplane in flight; (c) high-voltage experiments on the airplane supported in a giant hangar; and (d) theoretical analysis.

It is shown how the fundamental electrical constants of the airplane may be approximately determined and how these may be used to forecast the high-voltage behavior of a flying aircraft. It is shown that, at a given altitude, the current I discharged by an airplane in flight is of the form

$$I = AE + B(E^2 - E_0^2)$$

where E is the magnitude of the electric field as measured on the belly and A , B and E_0 are constants.

The electrical capacitance of an aircraft in flight is about 20 per cent of the wing span expressed in centimeters.

AS A RESULT of hundreds of bad-weather airplane flights by the precipitation-static research team at Minneapolis, it is well established that airplanes flying through various kinds of precipitation become highly electrified and break into corona. The estimated voltages may exceed 500,000 volts under severe conditions and it is of value to analyze the electrical characteristics and the performances in flight of airplanes when subjected to such high voltages. It is evident that an airplane in free flight does not permit the direct determination, by the use of a voltmeter, of its potential even with respect to its immediate surroundings, and therefore new methods and a new approach must be used.

In all flight operations it has been found necessary to photograph simultaneously on a photorecorder all the measured electrical quantities because meteorological conditions are highly variable when encountered in a high-speed aircraft. Even then, the interpretation of the data is frequently difficult and it has been found profitable to supplement the air observations by a study of the behavior of aircraft when subject to very high voltages and supported by long strings of insulators in the middle of a giant hangar especially built for the work. Voltages up to 1,200,000 have been applied to full-size airplanes and their electrical behavior compared with the same airplanes when highly electrified by actual flight through natural precipitation. As a guide to the interpretation of the transition from flight to laboratory experiment, an artificial charger was invented that permits an experimenter, *in flight*, to place a free electrical charge of either sign on the airplane and control its potential up to 350,000 volts. Because this device can maintain steady charging conditions and can be operated in any kind of weather it has been most valuable in expediting the work of the project.

* Decimal classification: 629.13×537.26. Original manuscript received by the Institute, November 19, 1945.

† United States Naval Research Laboratory, Washington, D. C.

In general, a flying airplane encounters two different types of electrical conditions. The most important one occurs when the airplane is charged by encountering dry snow or ice crystals that communicate a normally negative electric charge to the airplane. In this case the sign of the electric charge carried by the plane is everywhere the same. We have described this type of unipolar charging as "autogenous" because the charge is self-generated by the plane. Another important type of airplane charging occurs whenever the airplane is adjacent to a highly charged thundercloud. Because in this case the charge is transferred from a free charge already existing in a cloud outside the airplane, this type of charging is called "exogenous."

ELECTRIC FIELD AND CHARGE DISTRIBUTION UNDER AUTOGENOUS OR UNIPOLAR CHARGING CONDITIONS

In another paper¹ of this series is described an electric-field meter for measuring the electrical field at selected positions on the airplane. These meters, operating on electrostatic-induction principles, may be installed anywhere on a metallic airplane and will measure the direction and magnitude of the electric field where they are installed. It has been found convenient to mount them on the belly of the plane just aft of the main wing sections, on the top of the fuselage, and on the nose. By the use of these meters, it has been possible to determine a multiplier for any selected point on the plane. This factor when multiplied by the electric field at the reference position on the belly of the plane, gives the electric field at the selected point.

Another convenient way to determine the distribution of electric field over the plane in terms of the electric field on its belly (which may always be determined in flight by means of an electric-field meter) is to use a small model airplane. This model may be supported by a wire connected to a high-voltage source whose potential is known. The model may be supported at great distances from the walls of the laboratory, or it may be enclosed by a grounded metallic shield having the scaled-down dimensions of the large hangar. By the use of a "proof-plane" consisting of a small ball bearing attached to a quartz fiber, the charge from selected areas on the electrified model may be transferred to an electrometer for measurement. It can be shown that the charge carried by the proof plane is proportional to the electric field on the model at the last point touched. Thus, the small proof plane may be touched to a point

¹ Ramond C. Waddell, Richard C. Drutowski, and William N. Blatt, "Aircraft instrumentation for precipitation-static research," *Proc. I.R.E.*, vol. 34, pp. 161P-167P; April, 1946.

on the belly of the plane where the electric-field meter is normally installed in the full scale, and the charge from this point measured. In a similar way, the proof plane is brought in contact with various interesting points on the airplane and the ratio of the measured charge to that at the referenced point on the belly is noted. Evidently, then, the ratio of the electric fields at the two points may be specified. Care is taken to see that the charge supplied to the model airplane from the high-voltage source is through a wire which the proof plane cannot "see" at the time of its last contact. In this way the corrections for distortion are kept at a minimum. Representative results for a typical two-engine airplane are shown in Figs. 1 and 2. The numbers in the circles when divided by ten give the ratio of the electric field at the point to the field at the point of reference. For ex-

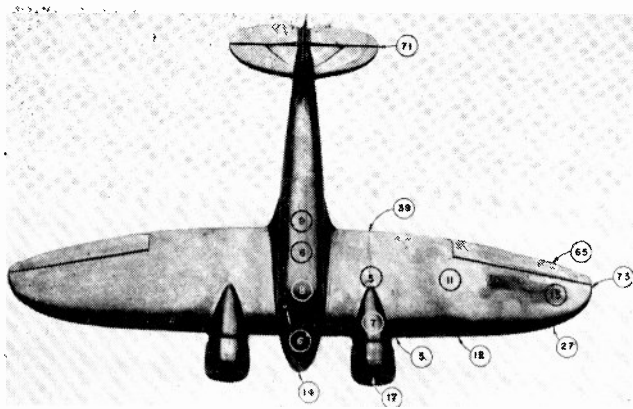

Fig. 1—Top view of model plane showing the field measurements relative to reference base of 10.

unfortunately the pictures are not suitable for reproduction.

It is important to determine just how the magnitudes and distributions of electric field over the airplanes are modified by bringing them into a hangar where the walls play an appreciable part. Employing Gauss' law, one may write

$$4\pi Q = 4\pi CV = \iint E dA \quad (1)$$

where Q is the total charge on the airplane, C is its capacitance, V is the applied voltage relative to space several wing spans away or the walls of the hangar, E is the normal component of the electric field and dA is the element of surface area. Assign the subscript H to the

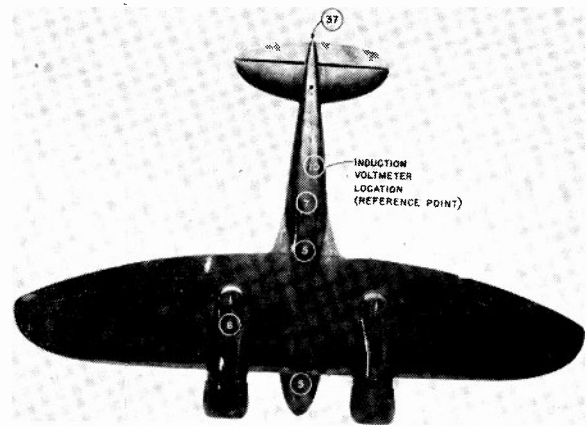

Fig. 2—Bottom view of model plane showing the field measurements relative to the reference base of 10.

ample, the field at the wing tip is 7.3 times the reference field at the belly of the plane.

As a result of these model tests, adequately checked by full-scale measurements using the induction electric-field meters, it is found that the outermost areas of an airplane experience electric fields many times the value measured on the belly. Therefore, as the average charge on the airplane increases, these outermost areas are the first to experience fields sufficient to break down the air and thus produce corona. On many planes the antennas extend so far from the plane that these go into corona first. On a typical midwing monoplane, the observed order of appearance of corona is as follows: antenna, propeller tips, pitot tube, wing tips, and empennage. Thus, as the charging current to an airplane increases and its voltage rises, various areas, beginning frequently with the antenna, successively break into corona and in this way discharge more and more current until an equilibrium is established between the charging and discharging rates. In a darkened hangar one may actually watch the development of corona on the airplane. At 750,000 volts, beads of corona become visible on a bare-wire antenna and at 1,100,000 volts, all the outer areas of considerable curvature are outlined. We have successfully photographed the distribution of this corona but

airplane in the hangar and F for it in free flight; then one may write

$$\frac{Q_H}{Q_F} = \frac{C_H V_H}{C_F V_F} = \frac{(\iint E dA)_H}{(\iint E dA)_F} = \frac{E_H}{E_F} \quad (2)$$

One observes that the ratio of the belly electric fields is equal to the ratio of the surface integrals of the field because model experiments show that, although the fields are increased by the presence of conducting walls, yet at the distances actually employed the distribution of electric field was not appreciably changed by their presence. Thus by (2) it is seen that at constant voltage, the ratio of the measured belly electric fields inside and outside the hangar is proportional to the capacitance of the airplane in the two situations.

Although the above discussion considers the distribution of electric field over the airplane, the reader is reminded that the surface free-charge density σ is connected to the electric field E by

$$E = 4\pi\sigma \quad (3)$$

so that the approximate magnitude and distribution of the free charge are simultaneously described.

THE CAPACITANCE OF A FLYING AIRPLANE

Because of the complicated geometric shape of an airplane it is impossible accurately to calculate its capacitance. The electrical capacitance C of an isolated sphere is equal to its radius expressed in centimeters. Similarly, the capacitance of a thin flat disk is 63 per cent of its radius. An airplane is not equivalent either to a sphere or a disk but obviously its capacitance will be some appreciable fraction of its semiwing span. The above-given capacitance is that which results when the compensating charges are at infinity. When these compensating charges are brought close to the plane, as on the walls of an enclosing hangar, the capacitance is always increased. The capacitance C of a sphere of radius R_1 enclosed by, and concentric, with another sphere outside of radius R_2 , is

$$C = \frac{R_1}{1 - \frac{R_1}{R_2}} \quad (4)$$

The analogous equation for a thin disk of radius R_1 surrounded by an ellipsoid of revolution spaced from it along the axis of the disk by a distance bR_1 is

$$C = \frac{R_1}{\tan^{-1} b} \quad (5)$$

From (4) and (5), one may make Table I where C_F is the capacitance when the concentric enclosing equipotential surface is at infinity, $C_{S=R}$ when the enclosing surface is separated by one radius from the central conducting system, and $C_{S=2R}$ is its value when the surface is two radii away. Table I is given to emphasize the fact

TABLE I

| | Sphere | Circular Plate |
|------------|----------------|-----------------------|
| C_F | $\frac{2R}{2}$ | $\frac{2R}{\pi}$ |
| $C_{S=2R}$ | $\frac{3R}{2}$ | $\sim \frac{3R}{\pi}$ |
| $C_{S=R}$ | $\frac{4R}{2}$ | $\frac{4R}{\pi}$ |

that the distance of an enclosing equipotential surface from the central electrode (expressed in the dimensions of this electrode) produces substantially the same fractional increase in the capacitance and is relatively insensitive to the exact shape of the body. Thus, it is permissible to determine the approximate capacitance of an airplane in free flight by measuring its capacitance suspended in the middle of a large hangar and correcting for the presence of the walls by a relation having the form of (4). Noting that the capacitance of a sphere in free space is equal to its radius and employing (4), it is found that

$$C_F = \frac{C_H R_2}{C_H + R_2} \quad (6)$$

Where C_H is the capacitance measured in the hangar, R_2 is the radius of the equivalent sphere surrounding the plane whose effective radius or isolated capacitance is C_F . It has been found convenient in discussing the distribution of electric fields and potential around an airplane to describe these quantities in terms of an "equivalent sphere" whose radius is identical with the capacitance of the airplane in flight. As an example, the measured capacitance of one of the laboratory planes (a B25 or Mitchell Bomber) suspended in the closed research hangar was 769 micromicrofarads or 700 centimeters, while the height of the shielded hangar was 2000 centimeters. Therefore, taking $R_2 = 1000$ centimeters and C_H equal to 700 centimeters, it is found that C_F is equal to 412 centimeters. Expressing this capacitance in terms of the *semiwing span* of the plane which was 1004 centimeters, it is found that the plane's capacitance is 41 per cent of the *semiwing span*. The capacitance of a similar airplane model suspended in a room so large that the presence of the walls could be ignored turned out to be 40 per cent of the *semiwing span* expressed in centimeters. Thus, a rough rule of value in quickly determining the capacitance of a typical midwing monoplane once its dimensions are known is simply to take 40 per cent of its *semiwing span* or 20 per cent of its wing span, all expressed in centimeters.

THE EFFECTIVE POTENTIAL AS DETERMINED FROM THE BELLY ELECTRIC FIELD

The potential of an airplane in relation to the space several airplane diameters away is an important characteristic of the airplane. The total current discharged depends on the integrated value of the electric field throughout the discharge circuit rather than the electric field as measured at the belly. That is to say, the current flowing in any circuit depends on the voltage applied rather than the electric field at some selected place. All our experimental data point to this fact and show that comparable interfering conditions are encountered on an aircraft at the same voltage whether the airplane is in the air or supported on insulators in the hangar.

Laboratory experiments show that, except at the very highest voltages, the voltage is proportional to the electric field on the belly of the plane, and this constant of proportionality is easily determined from hangar measurements because both quantities may be measured simultaneously. However, in free flight the determination of voltage from the measured belly electric field must be determined in other ways. Two methods are useful and lead to results that approximately agree.

One method of determining the voltage from observed quantities in free flight is to determine the effective discharge resistance of the airplane from measurements of the time of discharge of an initial quantity of free electricity. A free charge is placed on the airplane in flight

at a selected altitude; the charging device is sharply cut off, and the subsequent decay of charge as determined from the belly electric-field meter is measured. Provided the discharge obeys Ohm's law, and this is usually true only at the lowest voltages, the decay is exponential with a time constant $\tau = RC$ where C is the capacitance of the charged system and R the effective discharge resistance. Now at the same altitude and employing the artificial charger a curve is obtained for the relation between the equilibrium current I to the airplane as a function of the belly electric field E . Since the charging and discharging currents are identical in the steady state, the resistance R of the equivalent discharge circuit in flight is

$$R = \frac{V}{I} = \frac{KE}{I} \quad (7)$$

Thus one may solve for K the constant of proportionality between electric field and voltage in terms of measurable quantities or

$$K = \frac{V_F}{E_F} = \frac{IR}{E_F} = \frac{I\tau}{E_FC_F} \quad (8)$$

The method is satisfactory if τ can be determined with sufficient accuracy. Another more practical method of determining the effective voltage on the airplane in flight is to solve (2) for

$$V_F = \frac{C_H}{C_F} \frac{V_H}{E_H} E_F = KE_F \quad (9)$$

Thus, if hangar data are available so that V_H/E_H can be determined and if the capacitances both inside and outside the hangar are known, then K is easily determined. From this the effective potential on the aircraft in flight is easily determined by multiplying k by the observed belly electric field.

CURRENT, ELECTRIC FIELD, AND VOLTAGE RELATIONSHIPS IN FLIGHT AND IN THE HANGAR

By use of the artificial charger it is practicable to determine the current discharged by an airplane, in flight, as a function of its electric field. For small values of electric field the discharge current rises linearly with the electric field but starts to increase more rapidly as the belly fields exceed 75 volts per centimeter, as may be seen by reference to Fig. 3. This curve was obtained in free flight in a B25 medium bomber at an altitude comparable to that of the hangar. A project airplane supported in our hangar and supplied by the high-voltage source has been shown.² It is of interest in view of our ability to estimate the effective voltage applied to the airplane in flight, to compare these discharge characteristics with those measured in the experimental hangar. Attention is drawn to the fact that the physical conditions existing in the hangar and in flight are not strictly comparable. In flight the air surrounding the airplane is constantly being replaced and space charge is not a very

important factor. Moreover, in flight the engine exhaust provides a copious supply of ions that serve to discharge a part of any accumulated electrification.

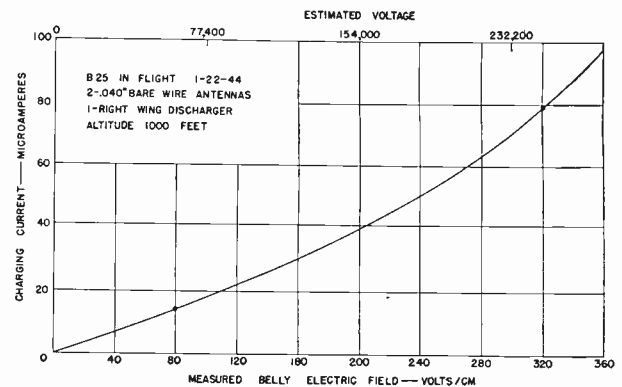

Fig. 3—Observed charging current versus belly electric field in flight

It has been observed in many experiments in which the mixture and operating conditions of the engine were changed, that the effective discharge resistance at small electric fields was approximately doubled when a single engine was used instead of two. The recombination of ions outside the actual flame areas of the exhaust stacks is so great that the ion stream does not extend very far behind the airplane, but in spite of this rapid recombination, some free ions do escape and these contribute to the discharge of the airplane. In normal flight a B25 airplane will dissipate about 30 microamperes without appreciable interference, and this corresponds, as will be seen presently, to the general area where the current is directly proportional to the voltage and to the electric field and therefore obeys Ohm's law. At high discharge rates the current is carried by corona-produced ions and the current-voltage relationship is distinctly nonlinear. When comparing the discharge performance of an airplane in the hangar and in flight one must recognize that the ohmic portion of the conduction will not be present in an ordinary hangar because the engines are not in operation and the normally copious supply of exhaust ions existing in free flight are quite absent. The current discharged in the hangar is largely that due to the ions produced by localized corona discharges widely distributed over the airplane. It is evident that this type of discharge also occurs in flight and the observed discharge relationship for the flying airplane should be the sum of the ohmic and corona discharge currents.

Fig. 4 shows the measured relationships on the B25 when it is supported in the giant laboratory and high voltage applied, as the electric-field meter and the charging current are read by an observer hoisted in the airplane. Simultaneously the electric field is measured on the floor below. The airplane supported in position is shown in Fig. 5. Because of space charge in the stagnant air surrounding the airplane, the electric field is not a linear function of the applied voltage, but evidently the slope of the curve for small potentials is significant when used in (9). The electric-field meters are arranged exactly as they are used in flight while the voltage is

² Gilbert D. Kinzer and John W. McGee, "Investigations of methods for reducing precipitation-static radio interference," (Fig. 3), pp. 234-241; this issue.

measured on the ground by the use of a calibrated high-voltage resistor.

The total currents discharged from the airplane in flight cannot be read directly because the current discharged by the engine exhaust cannot be made to pass through any microammeter. However, the current may

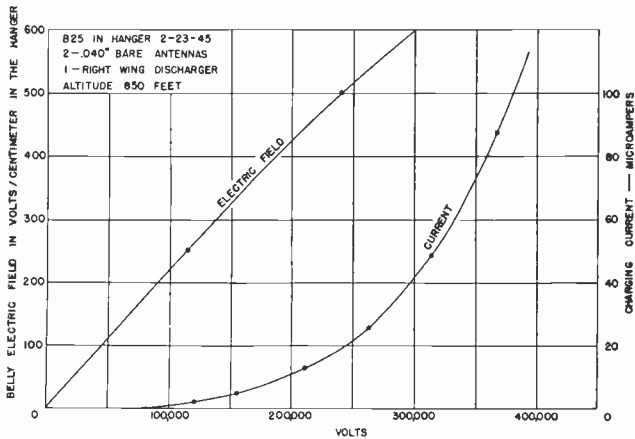

Fig. 4—Voltage-belly electric field-charging current characteristics for B25 supported in hangar.

be determined by noticing that, in a steady state, the charging current to the airplane is exactly equal to the total discharging current. Therefore, by the use of an artificial charger whose charging rate can be measured, the total-discharge characteristic curve of the airplane may be determined as a function of the belly electric field. These data for the B25 are plotted in Fig. 3.

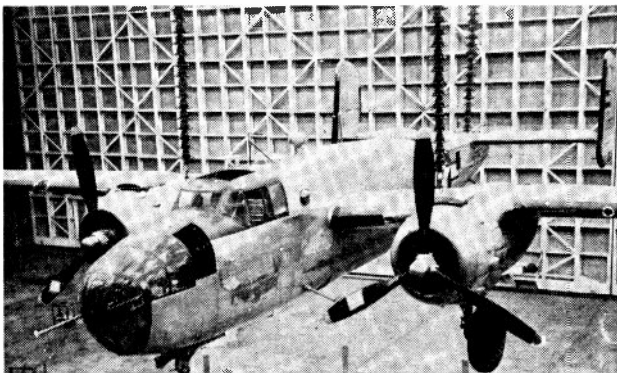

Fig. 5—B25 airplane supported and ready for study.

Upon plotting the discharge current from the airplane in the hangar and in free flight, it may be seen that the flight curve of Fig. 3 systematically lies above the value measured in the hangar (see Fig. 4), even though the latter is corrected for the influence of the adjacent walls on the readings of the electric-field meters in accordance with (2). The reasons for this situation will become apparent if the discharge current is plotted against applied voltage rather than belly electric field. These data are immediately available in the hangar, but the electric field in flight must be converted to applied voltage by means of the conversion factor of (9).

From the data of Fig. 4 it is found that $V_H/E_H = 455$ centimeters and, since C_H/C_F was determined to approximate 1.70 in our particular hangar, it follows from

(9) that $K = 774$ centimeters. Utilizing these constants, a and b of Fig. 6 may be plotted. It is possible that K may be somewhat large because space-charge effects at low voltage have been neglected.

A study of Fig. 6 shows that the current discharged in

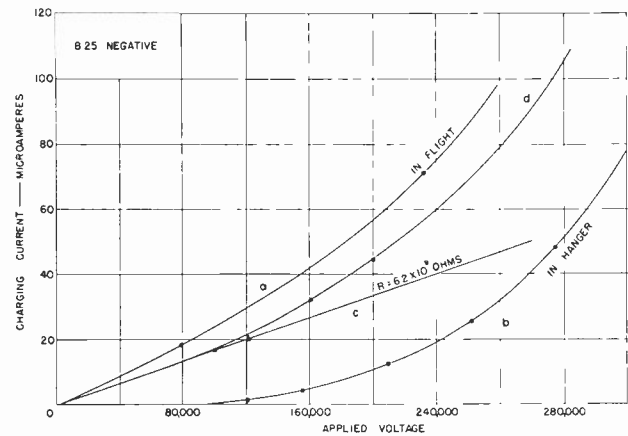

Fig. 6—Charging current to airplane in the hangar. Compared with that in the air for same applied voltage.

flight always exceeds that measured in the hangar. This is obviously due to the ions discharged by the engine. The effective discharge resistance, for low fields, can be calculated from the measured relaxation time ($\tau = RC$) which was observed to be 2.8 seconds. Since the in-flight capacitance of the B25 is 455 micromicro-

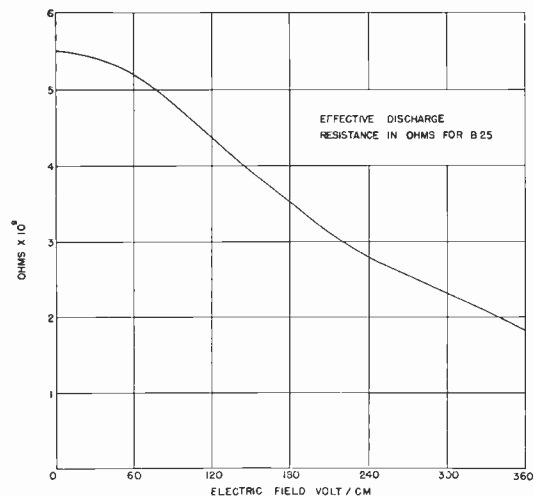

Fig. 7—Effective discharge resistance of B25 in free flight at 4000 feet.

farads, the discharge resistance at 1000-foot altitude is 6.2×10^9 ohms. The voltage-current relationship for such a resistance is plotted in curve c of Fig. 6. Assuming that the exhaust discharge obeys Ohm's law, curve d may be plotted to represent the sum of the hangar-discharge and exhaust-discharge currents. Curve d of Fig. 6 is to be compared with the measured in-flight values of curve a . The agreement is satisfactory in view of the consecutive steps necessary to determine curve d , and is within the limit of experimental error.

Using the data of curve a of Fig. 6, a curve for the equivalent discharge resistance of the B25 airplane

operating at 4000 feet altitude has been plotted in Fig. 7. It is of value to note that, at low and modest electric fields, the discharge is essentially ohmic and creates relatively little noise disturbance, but at the higher values of the field the discharge becomes unstable because of the nonlinear discharge characteristics, and severe radio interference may intervene.

MAGNITUDE OF THE CORONA CURRENT TAKING ACCOUNT OF SPACE CHARGE

The parallelism in behavior of the currents discharged in flight and in the hangar emphasizes the desirability of obtaining a quantitative understanding of the processes that take place around the airplane under steady-state conditions. Because the air surrounding the airplane in the hangar is essentially stagnant, it is evident that the effects of space charge must be carefully considered. It was thought worthwhile to examine theoretically the distribution of current, electric field, free charge, and potential when a very high potential was artificially applied to the airplane suspended in the middle of the hangar. At these voltages, due to the produced corona, it is legitimate to assume that a copious supply of ions all around the plane is available and sufficiently uniformly distributed to simulate the assumed conditions necessary for calculation.

In order to formulate the problem precisely, assume the airplane is again equivalent to a sphere of radius R_0 whose capacitance is the same as the flying airplane. Suppose, further, that this equivalent sphere is covered by conducting textile dischargers like those employed on some of our discharging antennas. Then, as appreciable voltages are applied to the sphere the sharp, fuzzy points break into corona and produce a copious supply of ions. Although the field at the end of the fuzzy fibers is very large, the electric field a very short distance outside the sphere will be normal for the free charge carried by the sphere. The electric field on the sphere is measured by a generating electric-field meter and we seek to determine the current flowing from this suspended sphere both as a function of the observed electric field on the surface of the sphere and the effective voltage. To evaluate the current at the surface it is necessary to consider the volume of air outside the sphere and determine the currents and charge densities there.

By Poisson's equation, the free space charge per unit volume ρ surrounding the sphere is given by the familiar relation

$$\frac{1}{R^2} \frac{d}{dR} \left(R^2 \frac{dV}{dR} \right) = -4\pi\rho \quad (10)$$

where V is the electric potential and R is the radius from the center of the sphere to any selected point. The total current I from the sphere is

$$I = 4\pi R^2 \rho \mu E \quad (11)$$

where μ is the mobility of the ions in the air and E is

the electric field. Substituting from (10) and noting that $E = -dV/dR$ one finds

$$I = 2\mu R E^2 + \mu R^2 E \frac{dE}{dR} \quad (12)$$

The solution of this relation is

$$E^2 = \frac{2I}{3\mu R} + \frac{C}{R^4} \quad (13)$$

where C is a constant of integration. Directing attention to the electric field as measured at the surface of the sphere or belly of the airplane, (13) may be written

$$I = \frac{3}{2}\mu R_0 (E^2 - E_0^2) \quad (14)$$

where R_0 is the effective radius of the central conductor and E_0 is the electric field as determined just as appreciable current is measured. In spite of the irregular shape of the airplane compared to a sphere, (14) may be compared with the current actually measured in the hangar. One adopts $\mu = 510$ centimeters per second per electrostatic units per centimeter, $C = R_0 = 412$ centimeters, and $E_0 = 2.2$ electrostatic units per centimeter.

It is interesting to note that the observed and calculated currents as shown in Fig. 8 agree very well over

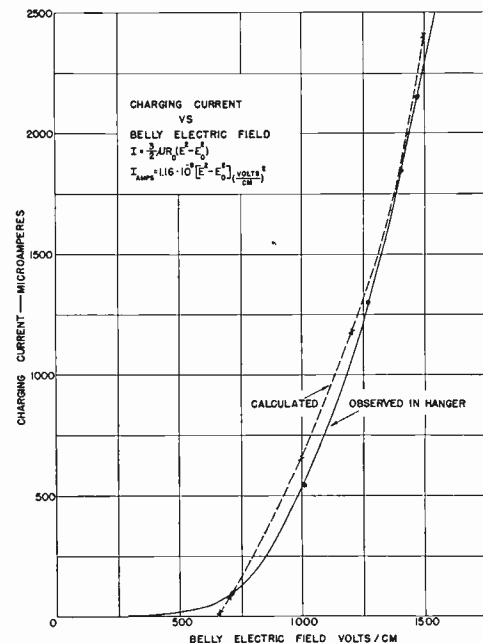

Fig. 8—Charging current to B25 in hangar compared with the calculated values.

most of the range and that the agreement is better at the high electric fields than at the lower. It is seen that some current is actually discharged at values of E below E_0 . This emphasizes the fact that an airplane is very irregular in shape and that electric fields sufficient to produce corona are produced in special outer areas before the surface is generally covered by corona discharge. Attention is drawn to the fact that the form of (14) is such that the discharge current rises sharply after the critical surface electric field is reached. This

form of variation is consistent with that observed both for the airplane suspended in the hangar and for the general behavior of the textile-type fuzzy-wick discharger. Considering the simplicity of (14), the agreement with observation is perhaps better than one has a right to expect.

One now turns to the evaluation of the radial distribution of electric field, space charge, and voltage in the air outside the sphere. From (13)

$$E = \sqrt{\frac{E_0^2 R_0^4}{R^4} + \frac{2I}{3\mu R}} \quad (15)$$

and the space charge is, by (11),

$$\rho = \frac{I}{4\pi\mu \sqrt{\frac{E_0^2 R_0^4}{R^4} + \frac{2IR^3}{3\mu}}} \quad (16)$$

The potential with respect to surrounding space several wing spans away is an elliptic integral given by

$$V = \int E dR = \int_{R_0}^R \left(\frac{E_0^2 R_0^4}{R^4} + \frac{2I}{3\mu R} \right)^{1/2} dR \quad (17)$$

It may be noted that, when the threshold values are negligible or when I is very large, this reduces to

$$V^2 = \frac{8IR}{3\mu} \quad (18)$$

The foregoing relations all contain important terms that involve the space charge in the air outside the airplane. It has been determined that rapidly circulating air in the hangar due to open doors and an outside wind have a noticeable influence on the magnitude and distribution of the space charge. In actual flight through precipitation, space-charge effects are not as big as they are in the hangar. Qualitatively, however, the relations show that the space charge around the airplane is of the same sign as the airplane and therefore, were the airplane suddenly grounded, there should be a reversal of electric field as measured on its belly. This experiment has been performed in the hangar and re-

versed electric fields observed for a considerable period of time even though the airplane and the surrounding walls of the hangar are grounded. The magnitude of this reversed field approximates one hundred volts per centimeter even after the plane has been grounded for a period of three seconds. The decay after this period appears to be roughly inversely proportional to the length of time measured from the instant of grounding.

In general, the measurements of the current discharged from an airplane obey ordinary electrodynamic laws and it is possible to calculate approximately its general behavior even in flight. It is clear from Fig. 6 that the current discharged from an airplane in flight is given approximately by

$$I = \frac{KE}{R} + \frac{3}{2} \mu R_0 (E^2 - E_0^2) \quad (19)$$

where the equivalent discharge resistance R depends critically on the detailed design of the engine exhaust stacks and upon the gasoline mixture employed.

Additional References

- (1) H. M. Hucke, "Precipitation-static interference on aircraft and at ground stations," *Proc. I.R.E.*, vol. 27, pp. 301-316; May, 1939.
- (2) H. K. Morgan, "Rain Static," *Proc. I.R.E.*, vol. 24, pp. 959-963; July, 1936.
- (3) H. M. Hucke, "Snow static effects on aircraft communications and broadcast," *Engineering*, (London), vol. 4, pp. 7-10, 28; July, 1937.
- (4) T. Nakai, "Some notes on rain static in Japan," *Proc. I.R.E.*, vol. 25, pp. 1375-1380; November, 1937.
- (5) V. J. Andrew, "Some notes on snow static," *Communications*, vol. 18, p. 25; March, 1938.
- (6) Department of Commerce, "Antistatic Antennas," *Department of Commerce, Air Commerce Bull.*, vol. 7, pp. 162-163; January 15, 1936.
- (7) E. C. Starr, "Precipitation-static and radio-interference phenomena originating on aircraft," *Oregon State College Eng. Exp. Sta. Bull.*, ser. 10; June, 1939.
- (8) Donald G. Fink, "Bendix round-up," *Aviation*, vol. 38, pp. 32-33, 45-47; October, 1939.
- (9) Anonymous, "The problem of rain, snow and dust static by the Wright Field correspondent," *Air Corps News Letter*, Washington, D. C., vol. 23, p. 7; June 15, 1940.
- (10) J. C. Breitwieser, "Approach to the problems of radio precipitation static," *Aviation*, vol. 43, pp. 142-144; April, 1944; *Aviation*, vol. 43, pp. 151-153; May, 1944.
- (11) David S. Little, "Precipitation static," *Aero Digest*, vol. 39, pp. 56, 58, 151; November, 1941.
- (12) E. C. Starr, "Aircraft precipitation-static radio-interference," *Trans. A.I.E.E. (Elec. Eng.)*, June, 1941, vol. 60, pp. 363-370; June, 1941.

Part VI—High-Voltage Installation of the Precipitation-Static Project*

M. NEWMAN† AND A. O. KEMPPAINEN‡

Summary—A special artificial-lightning generator has been developed through the University of Minnesota co-operation with the Naval Research Laboratory, to provide accurate laboratory duplication of thunderstorm-cloud field conditions. Conditions of electrical-

field stress before the lightning discharge are produced by an automatically controlled transition of a generator of high-voltage direct current into a surge generator, resulting in a doubled field stress and a surge breakdown with lightning current characteristics. The combination is thus very suitable for studying certain phases of aircraft operation, particularly communications, under controlled laboratory conditions, corresponding to flight under electrical-storm conditions.

* Decimal classification: 537.4×621.375.6. Original manuscript received by the Institute, November 19, 1945.

† University of Minnesota, Minneapolis, Minn.

‡ United States Naval Research Laboratory, Washington, D. C.

I. THE HIGH-VOLTAGE AND LIGHTNING-GENERATOR INSTALLATION

THE HIGH-voltage-installation design was largely influenced by the particular application to research requiring the production of electrical stresses about an airplane corresponding to flight conditions. The laboratory production of a lightning stroke to an airplane is illustrated in Fig. 1. Besides the lightning phases of the work where impulse voltages and currents were necessary, researches on precipita-

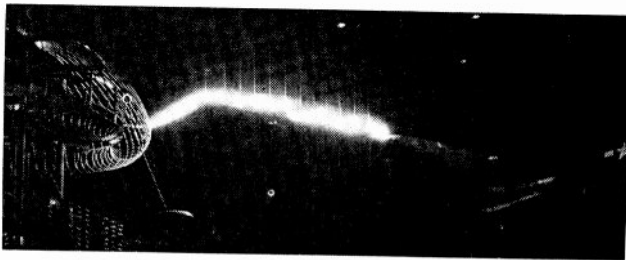

Fig. 1—Artificial lightning discharge in the laboratory.

tion static required the test airplane to be brought up to, and held at, various steady potentials. This led to a generator design which would allow, by simple recon-nections, any of the following:

- (a) direct-current voltages controllable up to 1.5 million volts at 5 milliamperes;
- (b) impulse voltages of different wave shapes up to 5,000,000 volts;
- (c) impulse currents up to 200,000 amperes.

Preliminary calculations indicated that the installation should come close to reproducing electrical-stress conditions encountered by an airplane in flight. An experimental check on differences to be expected from the proximity of the generator and the surrounding wall surfaces was made by using a scale model of the entire installation immersed in an electrolyte, and measuring the IR drops in the electrolyte which are then proportional to the electrostatic field potentials about the actual laboratory apparatus and test objects. Measurements checked that the physical presence of the generator had a negligible effect on gradients about the plane under test.

An important requirement of the installation was that the direct-current connection should be reasonably free from radio noise radiation up to 750 kilovolts. Since the generator was insulated for impulses to 5000 kilovolts, it was considered that in the direct-current connection for only 750 kilovolts the subdivided voltages per element would be so low as to eliminate serious corona effects. The same general approach was used in the design of the over-all corona-shield cap for the generator, as shown in the close-up photograph of Fig. 2. Instead of a solid spherical cap surface, it was found simpler to fabricate a system of curved lengths of aluminum tubing. The field outside the multiple-pipe system is similar to the field about a grating such as the classical calcu-

lated plot by Maxwell.¹ A short distance away from the cap the field is essentially the same as if the cap were solid, while the individual pipes are largely shielded by the presence of all the others so that in the particular configuration the maximum gradient at a given pipe surface is only about four times greater than if the cap surface had been perfectly smooth. The curvatures of the cap aggregate were designed with sufficient margin for the much higher impulse voltages, so that it was found in actual practice, as expected, free of corona for the required 750-kilovolt direct-current voltages.

The vertical column to the left of the generator, Fig. 2, is a voltage-measuring resistance potentiometer. The resistance elements are under oil and the connections between them are made externally with tubing loops which form a corona-shielding network in the same manner as the shielding-pipe system in the generator corona cap. This potentiometer gives a very accurate check of the generator voltages in the direct-current connection but is not suitable for impulse measurements because of stray-capacitance effects. Therefore, in the case of impulse measurements, a low-resistance potentiometer is lowered from the ceiling opening above the generator to

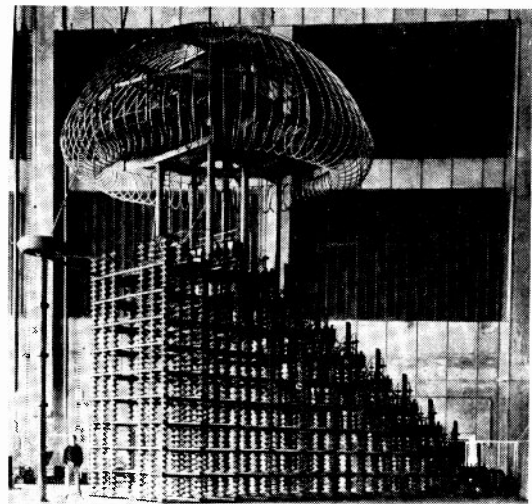

Fig. 2—Photograph of the generator and voltage-measuring potentiometer.

the corresponding opening in the generator corona cap. That space location provides a fairly uniform field in which a potentiometer may be placed for accurate impulse-voltage measurements. Measurements can be made either on the ground or inside the shield cap. The inside of the shield cap acts as a Faraday cage² and was designed to provide laboratory space for measurements from the high-voltage termination, in either impulse or direct-current applications.

A special connection system was incorporated into the design so that a direct-current field may be created

¹ Clark Maxwell, "Electricity and Magnetism," vol. 1, third edition, Clarendon Press, 1904, plate XIII.

² M. Faraday, "Experimental Researches," the "Ice-Pail Experiment."

about the airplane preceding a simulated lightning surge, corresponding to flight conditions where a relatively steady field precedes a lightning discharge. This connection system is shown in the photograph of the generator, Fig. 3, and in the corresponding schematic diagram in Fig. 4. A great deal of attention was given to the design of the various connections to provide for quick changes; for instance, the output polarity of the generator is very quickly changed simply by reversing the direction of slant of the double diagonal pipes seen between steps in Fig. 3.

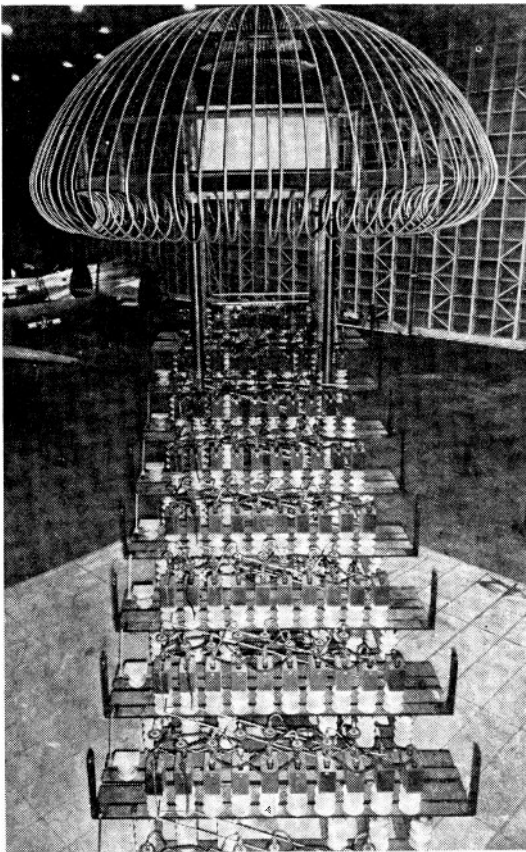

Fig. 3—Close-up view of the high-voltage generator showing the rectifier cascade.

The high constant potentials are built up, as is shown in Fig. 4, by the familiar "voltage doubler" cascaded many times. This method has been long known³ in principle and is now most generally referred to as the Cockroft-Walton⁴ method after their successful application of such a scheme in nuclear work. Some new improvements have been developed in the present circuit particularly with reference to compensating for voltage drops in passing power through the capacitor banks; these and the general theory are taken up in detail later. It is of interest to note briefly here that the introduced

³ M. Schenkel, "Eine neue Schaltung für die Erzeugung hoher Gleichspannungen," *Elek. Tech. Zeit.*, vol. 40, pp. 333-334; July, 1919.

⁴ J. D. Cockroft and E. T. S. Walton, "Further developments in method of obtaining high velocity positive ions," *Proc. Royal Soc. (London)*, vol. 136, pp. 619-630; June, 1932.

system of gaps, shown in heavy lines in the schematic diagram of Fig. 4, throws the double row of capacitors, effectively in parallel when operating as a direct-current generator, into a single-series row resulting in a surge of

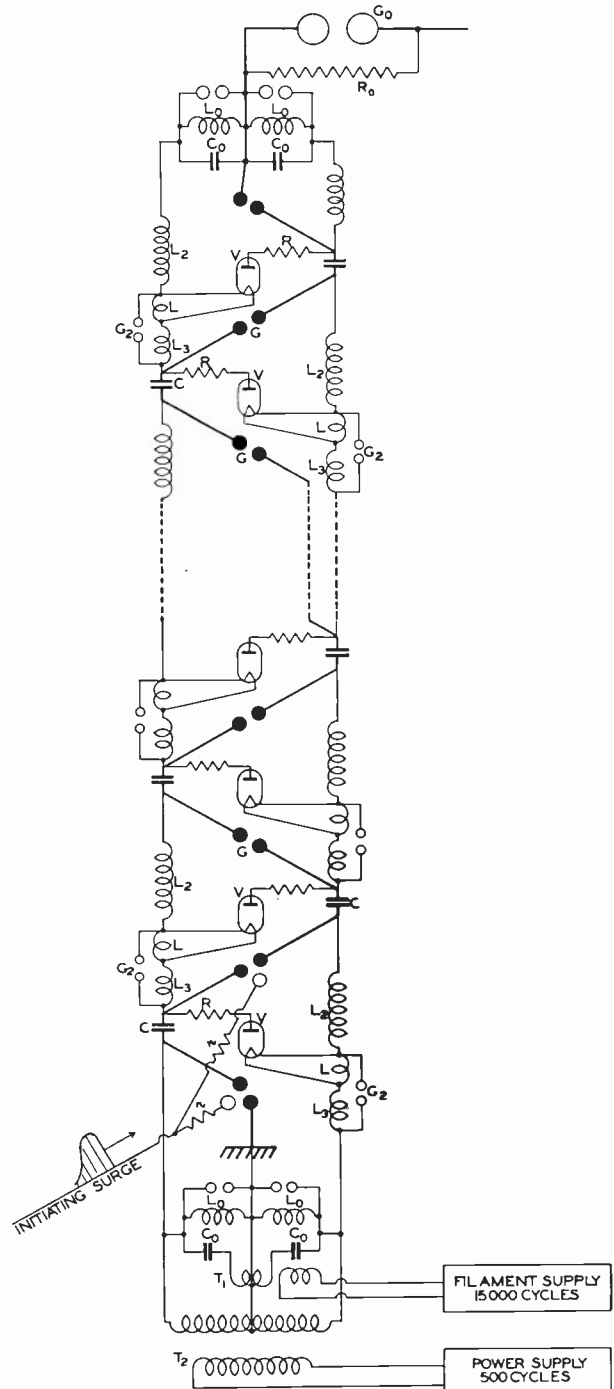

Fig. 4—Schematic diagram of the high-voltage generator.

voltage double the prior existing direct-current potential.

The combination of a greater surge superposed on a prior existing steady field is of particular interest as this is exactly the condition occurring about an airplane in flight in an electrical storm. The slow build-up of cloud-charge centers causes a relatively steady field stress

about the flying plane, with suddenly superposed surge stresses resulting from a sudden redistribution of cloud-charge centers by a lightning stroke to some other part of the cloud or to the airplane itself. As an illustration, consider the laboratory-test result shown in Fig. 5. There the bright spots at the propeller tips and along the radio antenna are due to corona from a constant

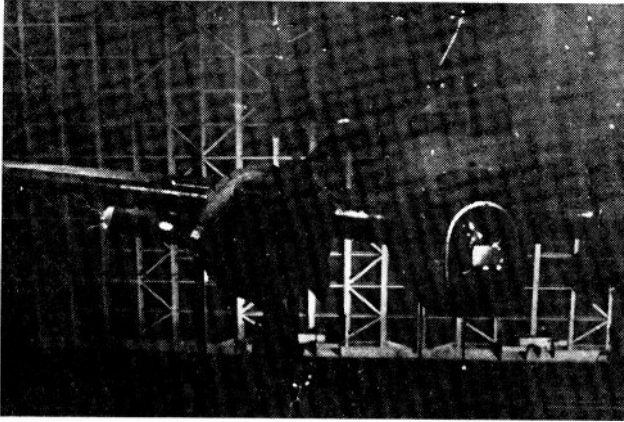

Fig. 5—Lightning-induced streamers at high gradient points.

field, while the streamers are the result of the superposed voltage surge obtained by the impulsive reconnection with the intermediate gaps (Fig. 4) functioning.

The resultant streamers from the superposed surge explain how lightning may hit and leave burning marks at only one point on a plane with the exit current leaving in a number of streamer currents, each too small to cause pitting. Also, it is clear that if the potential were either higher or of longer duration the streamers would grow in length and form individual lightning channels and thus leave actually more points of burning than one point of entry and one point of exit. Both the above conditions are found in cases of airplanes hit by lightning and would seem explainable by the streamer theory.

A great deal of research has already been done with the generator supplying various voltages and currents, and many other research applications are possible. In connection with such researches it is important to be familiar with the characteristics of the high-voltage installation. Therefore, the different generator arrangements will be discussed in greater detail as to general theory of operation.

II. HIGH-VOLTAGE DIRECT-CURRENT OPERATION

There are a number of possible methods of producing high-voltage direct currents which have been developed for X-ray and nuclear researches. A very simple means of producing high constant potentials on the Faraday cage principle has been developed by Van de Graaf.⁵ Electrical charges are carried mechanically on a moving belt through an opening into the inside of a metallic

sphere insulated from ground. The moving belt is charged by passing through a brush discharge; the input energy is chiefly mechanical, expended in moving the charges against the electric field from the sphere being charged. Inside the sphere the charged belt is, by superposition of fields, at a higher potential than the sphere and the charges are transferred to the metallic sphere through a brush discharge. With the charges continually transferred to the insulated metallic sphere, the potential of the latter rises to a value limited by rate of external leakage of charge due to field currents, corona, and insulation breakdown. Such installations have been built inside pressure chambers providing increased insulation to voltages as high as 4,000,000 with currents up to several milliamperes.

But in all electrostatic methods so far, except for sealed installations under gas pressure,⁶ the charge-transfer process is affected by atmospheric-humidity conditions and becomes difficult where higher currents are needed, so that for general laboratory application where currents of much more than a milliampere may be desirable, some sort of power-rectifier cascade is most suitable.

A cascade of a number of separate rectifier circuits with transformer coupling is shown in (a) of Fig. 6. In the case of transformers providing the insulation between stages, it is clear that each transformer has to be of a kilovolt-ampere capacity equal to the load of the sum of all the stages above it. It is readily apparent also that the potential distribution becomes impossibly bad as the number of cascade steps is increased because of the potential drops due to the leakage reactance, as is apparent from the equivalent diagram (b) of Fig. 6. It occurred to the writer to consider compensating the leakage reactance with capacitive reactance by introducing capacitors as shown in (c), which in turn led to other interesting variations.

The next change considered transfers the burden of insulation between the transformer into these capacitors as in (d). A logical consequent step transfers the power-coupling function also to the capacitors as shown in (e). Now to compensate for the capacitive reactance drops, inductive reactance may be introduced as in (f). The final logical step is to use these coupling capacitors as smoothing capacitors, which is accomplished by re-converting the schematic diagram of (f) of Fig. 6 into the practical equivalent as shown in (g) of Fig. 6.

Examining the resultant circuit, it is seen that the storage capacitors act also as the coupling network supplying power to the transformers, but to keep the potential drops low, it is advisable to use a higher input frequency. Simple rotating inductor generators are available in ratings of several hundred kilowatts with frequencies of the order of 10,000 cycles. The transformers incidentally may be so designed to compensate, by parallel resonance,

⁵ R. J. Van de Graaf, K. T. Compton, and L. C. van Atta, "Electrostatic production of high voltages for nuclear investigations," *Phys. Rev.*, vol. 43, pp. 149-157; February 1, 1944.

⁶ R. G. Herb, D. B. Parkinson, and D. W. Kerst, "The development and performance of an electrostatic generator operating under high air pressure," *Phys. Rev.*, vol. 51, pp. 75-83; January 15, 1937.

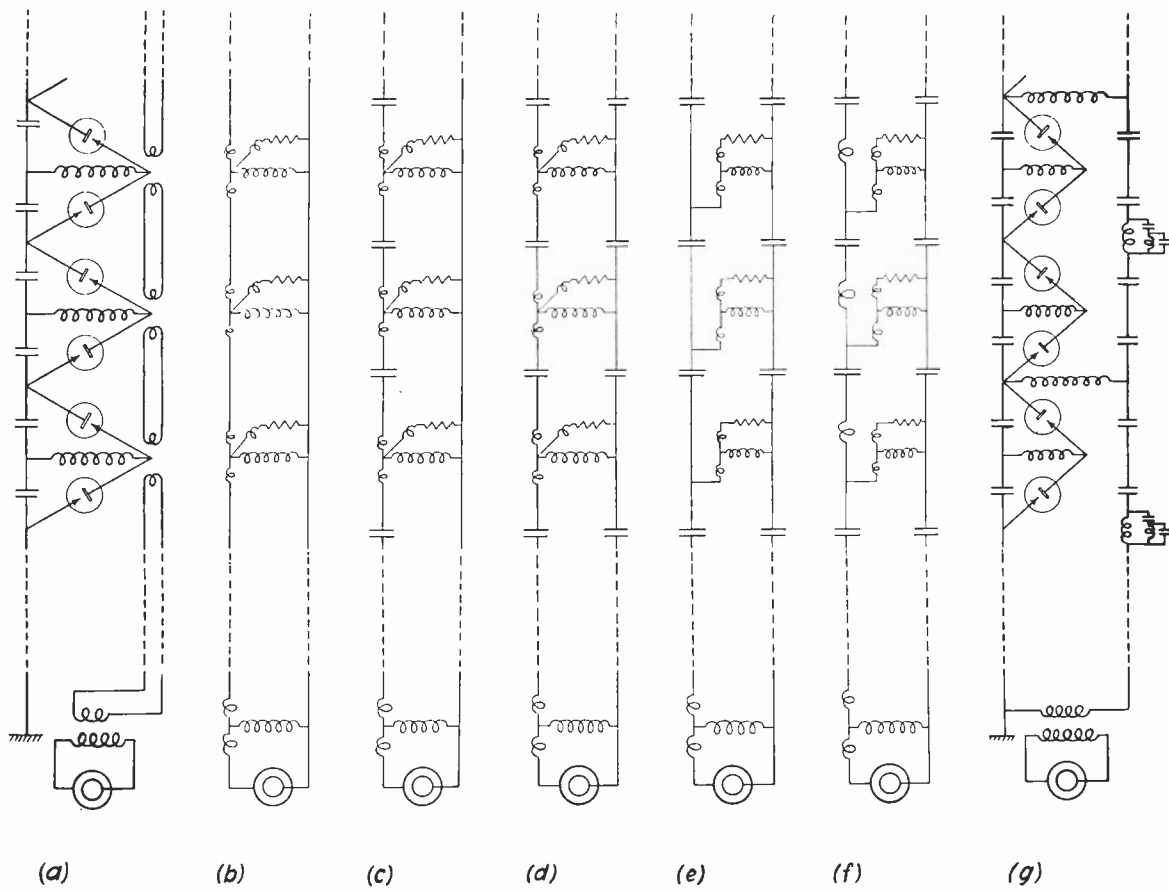

Fig. 6—Consecutive modifications of a transformer-coupled rectifier cascade into a capacitor-coupled system.

for the stray-capacitance charging current between the capacitor banks. The series reactors compensate for the series-coupling capacitor impedance, though not completely for the rectified currents. For heavy output load the steady-state rectifier-transformer currents may be as shown in Fig. 7(a), which might be considered as made up of harmonics as in Fig. 7(b).

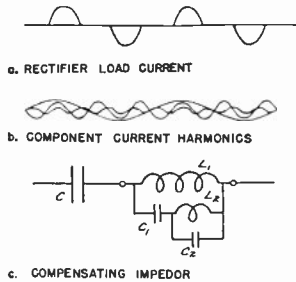

Fig. 7—Compensating scheme for load-current voltage drops.

It is not difficult to arrange a circuit of practically negligible impedance for the chief harmonics; a filter circuit as shown in Fig. 7(c) might replace the reactor to compensate for the third and fifth harmonics as well as the fundamental. The effect of the higher harmonics would be relatively negligible.

Thus, with the suggested cascade scheme it is possible to have a large number of units and yet retain good po-

tential distribution in a relatively simple manner. It is of interest that, in the resultant cascade, the filament current for the Kenotrons is also supplied by the transformers through the capacitor network. In the same manner, power may be drawn at the high-potential end for various purposes, as, for example, for ion or electron-source apparatus in nuclear or X-ray applications. Calculations indicate that it becomes technically feasible to construct such a cascade with an output potential of 5×10^6 volts, and possibly 10×10^6 volts, with less than 1 per cent ripple at output currents from 10 to 100 milliamperes.

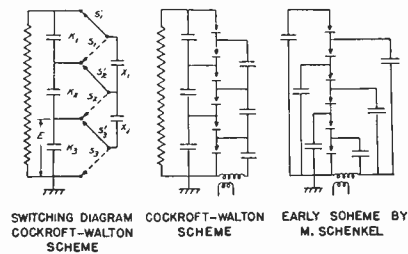

Fig. 8—Fundamental diagram of the Cockcroft-Walton scheme.

The resultant circuit developed uses a double row of capacitors and thus resembles somewhat similar schemes^{3,4} developed and explained on the basis of a switching operation, as in Fig. 8, by Cockcroft and

Walton for application to ion acceleration. No transformers were used in the original Cockroft-Walton circuit with the Kenotron filaments supplied by insulated storage batteries as shown in Fig. 9(b). It is of particular interest to compare further the developed compensated-transformer cascade as shown in Fig. 9(a) with

actually existed as shown in Fig. 9(c). With the above theoretical approach it becomes clear how improvements could be made in the Cockroft-Walton circuit by use of resonant compensating inductors as developed in the compensated-transformer system.

For very high direct voltages at relatively high

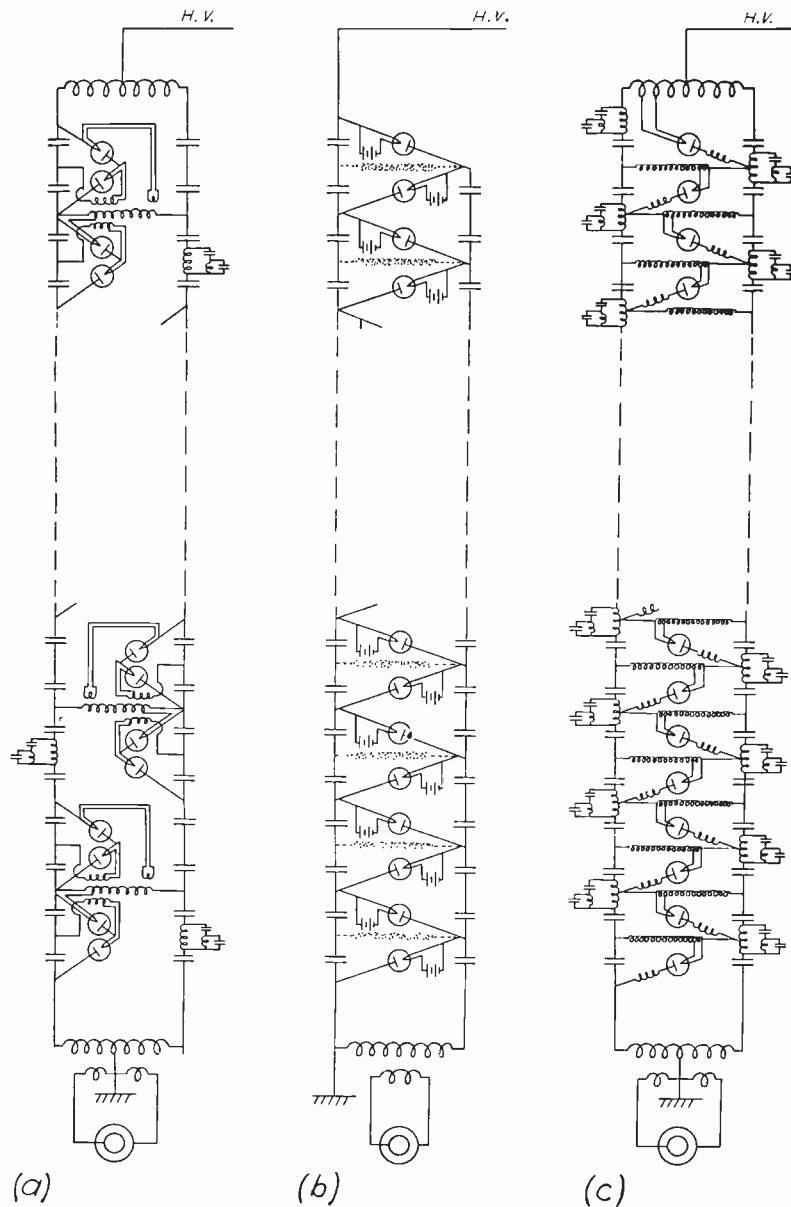

Fig. 9—Various forms of capacitor-coupled rectifier cascades.

the Cockroft-Walton scheme of Fig. 9(b). If autotransformers were used in the transformer system and the ratio made unity, the schematic diagram of Fig. 9(a) would reduce to that shown in 9(c). The resemblance is seen to be very close, and indeed if only the charging voltage function of the autotransformers is considered, then as their ratio is made unity they could obviously be taken out, if the filaments were supplied some other way, and the result would be identical with the Cockroft-Walton circuit. This equivalent development is of interest in that it clarifies just how the Cockroft-Walton circuit has essentially the same characteristics of power-transfer as if a series of "imaginary" transformers

power output the compensated-transformer system has advantages in that parallel as well as series compensation is provided. But for the particular laboratory installation, which for the present did not require extremely high voltages, it was considered simplest to use features of the transformerless Cockroft-Walton system with a superposed higher-frequency feed such as also suggested and used by Bowers,⁷ and incorporating new features of series-resonant compensation for much of the power drop in the capacitor columns.

The operation of the generator in the direct-current

⁷ A. Bowers, F. A. Heyn, and A. Kuntke, "A neutron generator," *Physica*, vol. 4, pp. 153-159; February, 1937.

connection is illustrated by the test run of Fig. 10 with point-to-plane corona loading at various voltages. It is of interest to note that care must be taken in making and interpreting measurements with such high direct-current voltages. The resistance potentiometer used

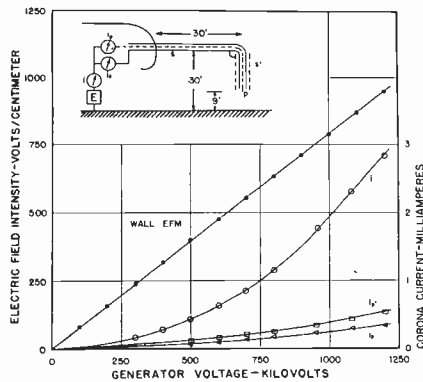

Fig. 10—Field stress and corona-current variation.

proved very suitable for determining the voltage of the generator and gave excellent agreement with field strength readings (electric-field-meter curve of Fig. 10), in the field of the corona shield. The exact proportionality indicated an absence of corona effects in the space chosen for the electric-field method⁸ of measurement of the generator voltage. However, in general experimental work where corona currents are involved, the electrostatic field may be distorted by resultant space charge. Thus in Fig. 10, i_p is the point-to-plane corona current in the presence of a corona-current drift from the connecting lead shield S . When the external ionization was reduced by using a larger-diameter shield section S' , the point current increased as shown by curve i_p' . It is clear, therefore, that space charges, and in that connection also humidity, are important factors to be considered in such high-voltage direct-current experimental work.

III. IMPULSE OPERATION

Impulse-voltage generators to as high as 5×10^6 volts to ground have long been in use for lightning research in many laboratories⁹⁻¹¹ to reproduce artificially the lightning-stroke effects on electrical transmission systems. The generator shown in Fig. 1, rated at 5×10^6 volts standard surge waves, can produce, in the impulse connection, voltage crests of about 8 million volts. The design was made such as to allow future expansion to a standard surge-wave rating of 10 million with possible 15 million peaks. The characteristic advantage of the impulse generator is that it is possible to design for a short-time operation at very high energy outputs of the order of 50,000,000 kilowatts. This allows great leeway in

securing a proper potential distribution with potentiometer arrangements and eliminates many problems with corona leakages inherent in constant potential schemes. There are also electrical-insulation advantages which

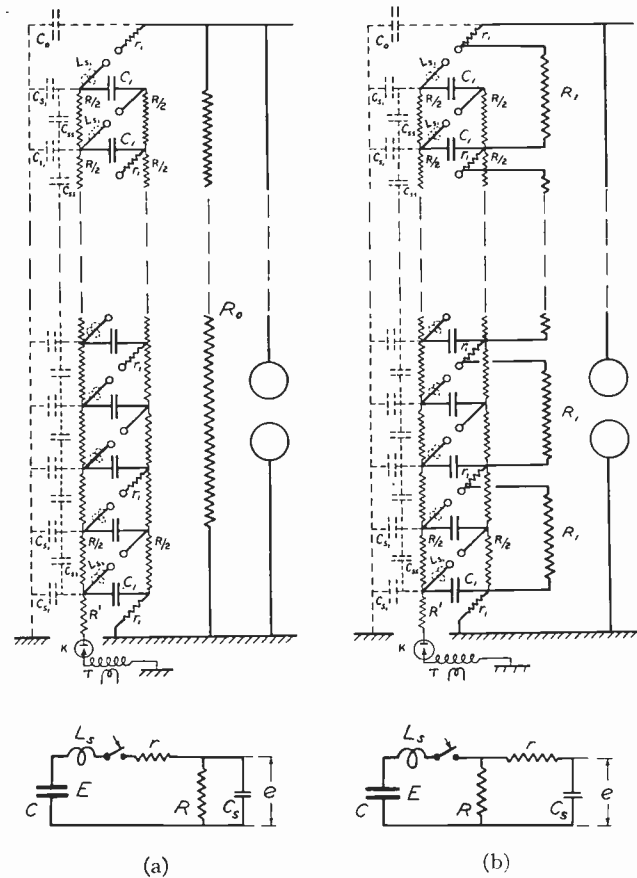

Fig. 11—Impulse generator connections and equivalent circuits for standard surge waves; (a) 1.5- to 40-microsecond surge wave, (b) 1- to 5-microsecond surge-wave connection.

make the impulse generator the easiest means of obtaining very high potentials. In applying such potentials in particular investigations a thorough analysis of the transients involved was considered important, and calculations were made including the effect of the distributed constants¹² which space limitations put beyond the scope of the present paper.

Briefly, the principle of the impulse generator, which has been generally used in lightning researches, is the Marx connection¹³ as in Fig. 11(a). A bank of capacitors is charged in parallel; when the voltages of the capacitors exceed the intermediate gap-setting value, these gaps break down, which effectively reconnects the capacitors in series. If there were no stray capacitances as those indicated by dashed lines in Fig. 11, the voltage thus suddenly obtained would be nominally n times the individual capacitor voltage, where n is the number of capacitors. The parallel resistors eventually bring the voltage down to zero exponentially, but the decay process may be extended so that the time of decrease to

⁸ Ross Gunn, "Principles of a new portable electrometer," *Phys. Rev.*, vol. 40, pp. 307-312; April 15, 1932.

⁹ E. Marx, P. Jacottet, "Recommendations for the generation and use of surge voltages for test purposes," *E. T. Z.*, vol. 60, pp. 870-874; July 20, 1939.

¹⁰ P. L. Bellaschi, "Full lightning currents attained in laboratory," *Elec. World*, vol. 103, pp. 430-431; March 24, 1934.

¹¹ W. E. Burton, "Determining the effect of lightning on the aeroplane," *Aviation*, vol. 28, pp. 149-151; January, 1930.

¹² M. Newman, "Production of very high voltages for research application," (Thesis), University of Minnesota; 1937.

¹³ E. Marx, "Erzeugung von verschiedenen Hochspannungsarten zu Versuchs- und Prüfzwecken," *Elek. Tech. Zeit.*, vol. 46, pp. 1298-1299; August, 1925.

one half the initial maximum may be hundreds of microseconds long. The duration of the wave is controlled by changing the effective value of shunt resistance in the discharge process, or by changing the value R_0 in the

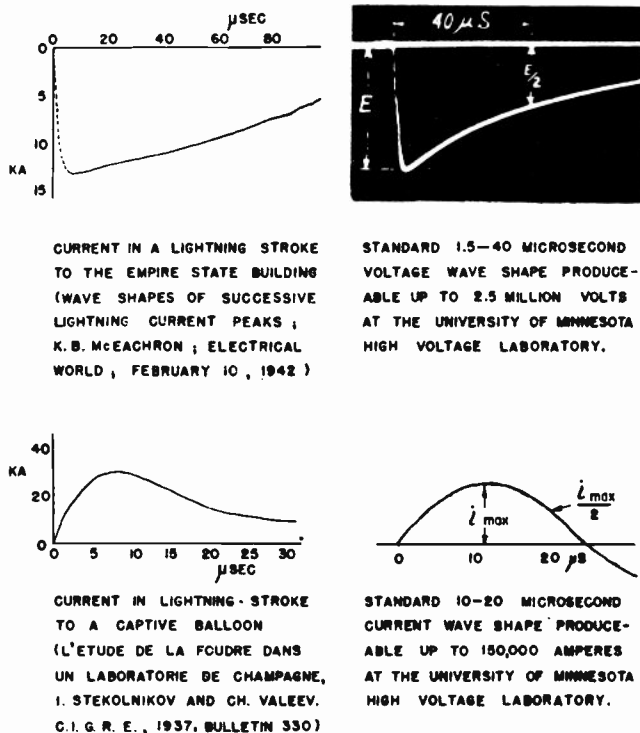

Fig. 12—Typical field records of lightning currents.

generally used impulse generator connection shown in Fig. 11(a). The equivalent circuit diagrams as given in the lower part of Fig. 11 have been proved a rather good approximation of the distributed network allowing fairly accurate calculation of the output wave shapes produced.

A comparison of typical laboratory wave shapes with similar field records of lightning surges is given in Fig. 12. By reconnecting the capacitors of the generator in

parallel groupings, very high crest-current magnitudes are attainable which come quite close to duplicating field conditions. The natural-lightning record shown in Fig. 12 is quite easily reproducible, and even the greatest crest values recorded with natural lightning, of the order of 200,000 amperes, are readily possible in the laboratory. Where very large currents are encountered their duration is relatively short, and the laboratory generator with its Q of 5 coulombs in the parallel connection provides a very respectable imitation of the real thing. In cases of repeated lightning strokes or lower-current long-duration strokes where charge transfers of 100 coulombs have been observed in the field, the laboratory-lightning generator could be synchronized with a high-current power-line source at 60 cycles to duplicate pitting and burning effects of natural lightning. With such voltages and currents it is possible to duplicate fairly closely actual lightning-surge conditions.

The specially designed generator discussed in this paper has been used in the direct-current-connection series-compensating inductances incorporated directly in the lead connections between the capacitors as seen in Fig. 3. The similarity of the resultant set-up with that of the resistance-coupled impulse generator led in turn to a consideration of the possibility of a simple conversion-gap system capable of superposing surge potentials on the direct-current output voltage. The resultant combination circuit was worked out quite simply as shown in Fig. 3 and the schematic diagram of Fig. 4. The combination direct-current and impulse connection provides probably the nearest approach yet made to lightning-stress conditions where there is an electrostatic field preceding the discharge. This opens interesting possibilities for making a comprehensive study of lightning hazards in relation to aircraft¹⁴ and studies on means of protection to minimize such hazards.

¹⁴ J. M. Bryant and M. Newman, "Lightning discharge investigation—1," University of Minnesota Eng. Exp. Sta., Technical Paper No. 38; April, 1942.

A Note on a Simple Transmission Formula*

HARALD T. FRIIS†, FELLOW, I.R.E.

Summary—A simple transmission formula for a radio circuit is derived. The utility of the formula is emphasized and its limitations are discussed.

INTRODUCTION

THIS NOTE emphasizes the utility of the following simple transmission formula for a radio circuit made up of a transmitting antenna and a receiving antenna in free space:

$$P_r/P_t = A_r A_t / d^2 \lambda^2 \quad (1)$$

where

| | |
|---|------------------------|
| P_t = power fed into the transmitting antenna at its input terminals. | } Same units of power |
| P_r = power available at the output terminals of the receiving antenna. | |
| A_r = effective area of the receiving antenna. | } Same units of length |
| A_t = effective area of the transmitting antenna. | |
| d = distance between antennas. | |
| λ = wavelength. | |

The effective areas appearing in (1) are discussed in the next section and this is followed by a derivation of the formula and a discussion of its limitations.

* Decimal classification: R120. Original manuscript received by the Institute, December 6, 1945.

† Bell Telephone Laboratories, Holmdel, N. J.

EFFECTIVE AREAS

The effective area of any antenna, whether transmitting or receiving, is defined for the condition in which the antenna is used to receive a linearly polarized, plane electromagnetic wave. The author suggests the adoption of the following definition:

$$A_{\text{eff.}} = P_r/P_0 \tag{2}$$

or

$$P_r = P_0 A_{\text{eff.}} \tag{3}$$

where P_r is the received power as defined above and P_0 is the power flow per unit area of the incident field at the antenna. In words, (3) states that the received power is equal to the power flow through an area that is equal to the effective area of the antenna. Note that the definition does not impose the condition of no heat loss in the antenna. Equation (3) shows that the effective area of an antenna is proportional to its power gain.

The effective areas of antennas of special interest are given in the following:

A. Small Dipole with No Heat Loss

For a small uniform current element the available output power is equal to the induced voltage squared, divided by four times the radiation resistance. Thus

$$P_r = E^2 a^2 / 4R_{\text{rad.}}$$

where

E = effective value of the electric field of the wave.
 a = length of the current element.

$R_{\text{rad.}}$ = radiation resistance of the current element
 ($R_{\text{rad.}} = 80\pi^2 a^2 / \lambda^2$).¹

Since the power flow per unit area is equal to the electric field squared divided by the impedance of free space, i.e., $P_0 = E^2 / 120\pi$, we have

$$A_{\text{dip.}} = P_r / P_0 = 3\lambda^2 / 8\pi = 0.1193\lambda^2. \tag{4}$$

The effective area of a half-wavelength dipole with no heat loss is only 9.4 per cent, 0.39 decibels,² larger than the effective area of the small dipole. Therefore

$$A_{0.5\lambda} = 0.1305\lambda^2. \tag{5}$$

The area of a rectangle with one-half wavelength and one-quarter wavelength sides is $0.125\lambda^2$ and it is, therefore, a good approximation for the effective areas of small dipoles and half-wavelength dipoles.

B. Isotropic Antenna with No Heat Loss

The hypothetical isotropic antenna has the same radiation intensity in all directions. It has two thirds of the gain³ or effective area of the small dipole. Therefore

$$A_{\text{isotr.}} = \lambda^2 / 4\pi. \tag{6}$$

¹ S. A. Schelkunoff, "Electromagnetic Waves," D. Van Nostrand Company, Inc., New York, N. Y., 1943, p. 134, equation (3-3).

² See p. 341 of footnote reference 1.

³ See p. 337, equation (5-2), of footnote reference 1.

C. Broadside Arrays (Pine-Tree Antennas)

The effective area of an antenna array made up of a curtain of rows of half-wave dipoles spaced half a wavelength was calculated several years ago by the method of Pistolkors.⁴ Equal amplitude and phase of the currents in all the dipoles and no heat loss were assumed. The effective area of such an array with a reflector that doubled the gain was found to be approximately equal to the actual area occupied by the array; thus

$$A_{\text{pine-tree}} \approx n \times 0.5\lambda \times 0.5\lambda \tag{7}$$

where n is the total number of half-wave dipoles in the front curtain. Formula (7) is a good approximation for large antennas. For example, an antenna of 6 rows of 17 dipoles each gave a calculated effective area only 3 per cent below the value obtained by (7). It should be pointed out that the heat loss in the connecting transmission lines will reduce the effective areas in actual antennas.

D. Parabolic Reflectors

The effective area of the parabolic type of antenna with a proper feed has been found experimentally to be approximately two thirds of the projected area of the reflector.

E. Electric Horns—Aperture Sides $\gg \lambda$

The effective area of a very long horn with small aperture dimensions is 81 per cent of the area of the aperture. For an optimum horn, where the aperture is dimensioned to give maximum gain for a given length of the horn, the effective area is approximately 50 per cent of the area of the aperture.⁵

DERIVATION OF TRANSMISSION FORMULA (1)

Having defined the effective area of an antenna, it is a simple matter to derive (1). As shown in Fig. 1, consider a radio circuit made up of an isotropic transmitting



Fig. 1—Free-space radio circuit.

antenna and a receiving antenna with effective area A_r . The power flow per unit area at the distance d from the transmitter is

$$P_0 = P_t / 4\pi d^2. \tag{8}$$

Assuming a plane wave front at the distance d , definition (2) for the effective area and formula (8) give

$$P_r / P_t = A_r / 4\pi d^2. \tag{9}$$

Replacing the isotropic transmitting antenna in the

⁴ A. A. Pistolkors, "The radiation resistance of beam antennas," PROC. I.R.E., vol. 17, pp. 562-579; March, 1929. See also Table I in "Report of Radio Research in Japan," vol. 3, no. 1, June, 1933.

⁵ See pp. 364 and 365 of footnote reference 1.

illustration with a transmitting antenna with effective area A_t will increase the received power by the ratio $A_t/A_{\text{isotr.}}$, and we obtain

$$P_r/P_t = A_r A_t / 4\pi d^2 A_{\text{isotr.}} \quad (10)$$

Introducing the effective area (6) for the isotropic antenna, we have (1).

LIMITATIONS OF TRANSMISSION FORMULA (1)

In deriving (1), a plane wave front was assumed at the distance d . Formula (1), therefore, should not be used when d is small. W. D. Lewis, of these Laboratories, has made a theoretical study of transmission between large antennas of equal areas with plane phase fronts at their apertures and he finds that (1) is correct to within a few per cent when

$$d \geq 2a^2/\lambda \quad (11)$$

where a is the largest linear dimension of either of the antennas.

Formula (1) applies to free space only, a condition which designers of microwave circuits seek to approxi-

mate. Application of the formula to other conditions may require corrections for the effect of the "ground," and for absorption in the transmission medium, which are beyond the scope of this note.

The advantage of (1) over other formulations is that, fortunately, it has no numerical coefficients. It is so simple that it may be memorized easily. Almost 7 years of intensive use has proved its utility in transmission calculations involving wavelengths up to several meters, and it may become useful also at longer wavelengths. It is suggested that radio engineers hereafter give the radiation from a transmitting antenna in terms of the power flow per unit area which is equal to $P_t A_t / \lambda^2 d^2$, instead of giving the field strength in volts per meter. It is also suggested that an antenna be characterized by its effective area, instead of by its power gain or radiation resistance.⁶ The ratio of the effective area to the actual area of the aperture of an antenna is also of importance in antenna design, since it gives an indication of how efficiently the antenna is utilizing the physical space it occupies.

⁶ The directional pattern, which has not been discussed in this note, is, of course, always an important characteristic of an antenna

Nonlinearity in Frequency-Modulation Radio Systems Due to Multipath Propagation*

S. T. MEYERS†

Summary—A theoretical study is made to determine the effects of multipath propagation on over-all transmission characteristics in frequency-modulation radio circuits. The analysis covers a simplified case where the transmitted carrier is frequency-modulated by a single modulating frequency and is propagated over two paths having relative delay and amplitude differences. Equations are derived for the receiver output in terms of the transmitter input for fundamental and harmonics of the modulating frequency. Curves are plotted and discussed for various values of relative carrier- and signal-frequency phase shift and relative amplitude difference of the received waves.

The results show that a special kind of amplitude nonlinearity is produced in the input-output characteristics of an over-all frequency-modulation radio system. Under certain conditions, sudden changes in output-signal amplitude accompany the passage of the input-signal amplitude through certain critical values. Transmission irregularities of this type are proposed as a possible explanation of so-called "volume bursts" sometimes encountered in frequency-modulation radio circuits. In general, it appears that amplitude and frequency distortion are most severe where the relative delay between paths is large and the amplitude difference is small.

THE INFLUENCE of multipath propagation on the transmission properties of frequency-modulation radio circuits is of considerable interest. The subject has been treated at some length in previous

papers from both experimental and theoretical standpoints.^{1,2,3} It is the purpose here to extend the theoretical side in an effort to obtain a clearer understanding of the true nature of the over-all circuit transmission changes induced by multipath propagation. Experimental support of the conclusions has not been obtained, due to the lack of time and facilities brought on by the pressure of war work.

Many of the causes of multiple paths over which radio waves sometimes travel from transmitter to receiver are well known and need not be recounted here. It is sufficient to state that when these paths exist simultaneously and are of different lengths and time of travel, interference at the receiver takes place between arriving waves. This interference is manifest by alterations in the amplitude and phase-versus-frequency characteristics of the resultant received wave as compared to the wave which is transmitted. In all types of radio systems such alterations in the received wave usually result in a

¹ Murray G. Crosby, "Frequency-modulation-propagation characteristics," *Proc. I.R.E.*, vol. 24, pp. 898-913; June, 1936.

² Murray G. Crosby, "Observations of frequency-modulation propagation on 26 megacycles," *Proc. I.R.E.*, vol. 29, pp. 398-403; July, 1941.

³ Murlan S. Corrington, "Frequency-modulation distortion caused by multipath transmission," *Proc. I.R.E.*, vol. 33, pp. 878-891; December, 1945.

* Decimal classification: R630.11. Original manuscript received by the Institute, November 13, 1945.

† Bell Telephone Laboratories, Inc., 180 Varick St., New York 14, N. Y.

demodulated output at the receiver which is a distorted copy of the input to the transmitter.

By considering the radio system as a whole with the transmitter, transmission medium, and receiver in tandem it is possible to state the over-all transmission performance in terms similar to those used in describing the performance of an amplifier or any other self-contained transmission unit. Such performance is usually given in terms of input-output frequency characteristic or input-output amplitude characteristic or both. Any modulation produced within the transmission unit and appearing in the output is usually expressed in per cent of the fundamental output amplitude and plotted as a function of either the output or input fundamental amplitude. Characteristics such as these form a convenient picture and are adopted here to describe the over-all performance of a frequency-modulation radio system having multipath propagation between transmitter and receiver.

Because of the complexity of the analysis, consideration is given only to the case where the desired wave arrives at the receiver over two paths, each having constant time delay and attenuation over the transmitted radio-frequency band. The transmitted wave is assumed to consist of a sinusoidal carrier frequency-modulated by a single sinusoidal modulating frequency. The limiter in the receiver is assumed to have a zero-order characteristic⁴ to insure limiting at low amplitudes. Noise is neglected, although in any practical consideration it becomes the controlling factor where multipath interference reduces the signal strength at the receiver below that of noise.

If two frequency-modulation waves reach the receiver over the two paths just described, they will have relative amplitude and phase differences proportional to the amplitude and phase differences between the paths. Mathematically, on applying these two waves to a frequency-modulation receiver, equations for the resultant demodulated output can be derived in conventional manner (see Appendix). These equations can be expanded so that the receiver output may be expressed in terms of transmitter input for the fundamental and harmonics of the modulating frequency. The final results as derived in the appendix are the basis of the discussion which follows.

What are called single-frequency amplitude characteristics of an over-all radio system under the influence of two-path propagation are shown in Fig. 1. With the receiver output plotted in terms of transmitter input, these curves are computed from the fundamental term of (10) in conjunction with the computed curves for D_1 , in Fig. 10 in the appendix. The constants associated with the curves of Fig. 1 are

⁴ The instantaneous current-voltage relationship in a resistance limiter may be expressed $I = K|E|^n$, $n < 1$, where the sign of I follows the sign of E . A zero-order characteristic obtains when $n=0$, and

$$I = K, \quad E > 0$$

$$= -K, \quad E < 0.$$

β = relative carrier phase shift between paths
 α = relative modulating-frequency phase shift between paths; i.e., the relative difference in phase-shift differential between the carrier and the first-order sideband in each path

r = voltage ratio of the later wave to the earlier wave or the amplitude ratio corresponding to the loss of the longer to the shorter path

f_d/f_p = deviation index

f_d = maximum carrier-frequency deviation

f_p = modulating frequency

h = factor proportional to the signal amplitude of the transmitter input.

The co-ordinates in Fig. 1 are expressed in decibels. The signal input to the transmitter is proportional to h

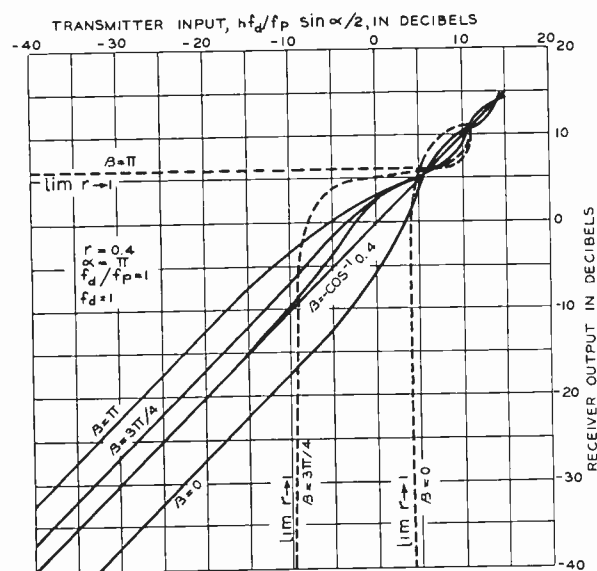

Fig. 1—Single-frequency amplitude characteristics of an over-all frequency-modulation radio system.

and is plotted as abscissa. The deviation index f_d/f_p and $\sin \alpha/2$, the sine of half the relative signal-frequency phase shift, serve as multiplying factors of h . For the curves as they are shown these two factors are unity or zero decibels. Other values are discussed later. An arbitrary reference has been chosen where $h f_d/f_p \sin \alpha/2 = 1$. Expressed in decibels this is zero on the abscissa of Fig. 1. The receiver output is given by the fundamental term of (10) and is plotted as ordinate for unit value⁵ of f_d . The ordinate scale is the same as that of the abscissa so that if the over-all system is distortionless the input-output characteristic will be a straight line having a 45-degree slope. Any deviation from this slope means the output does not follow the input linearly, and amplitude distortion results.

A reference characteristic is established in Fig. 1 representing a normal distortionless system in which multipath interference does not exist. This is the 45-degree

⁵ To avoid confusion concerning the meaning of f_d it will be assumed here that it is a fixed quantity representing maximum carrier-frequency deviation in the usual sense when $h=1$.

line passing through the point 0, 0 which is the plot of (10) when r , the amplitude ratio of the longer to the shorter path, is zero. The other characteristics shown in solid lines are plotted for $r=0.4$ in addition to $\alpha=\pi$ and $f_d/f_p=1$ mentioned previously. The parameter is the relative carrier-frequency phase shift $\beta=0, 3\pi/4, -\cos^{-1}0.4$ and π . The values of $\beta=0$ and π represent extreme deviations of the amplitude characteristic from that of a normal distortionless system. For values of β between 0 and π the deviation from the normal system becomes less as shown by the other two values⁶ of $\beta=3\pi/4$ and $-\cos^{-1}0.4$.

It will be noticed that at low values of h all the characteristics approach straight lines having a 45-degree slope. This signifies that the system input and output in each case is approaching linear relationship and distortion is approaching zero as $h \rightarrow 0$. The displacement of the various characteristics above and below that for a normal system signifies a corresponding increase or decrease in over-all circuit transmission. This is reasonable since an inspection of the frequency spectrum of a frequency-modulation wave shows that when $\beta=0$ and $\alpha=\pi$, the separate-path carrier frequencies add while the sidebands subtract, giving a net reduction in instantaneous phase of the carrier. This, in turn, results in reduced output signal for a given signal input. Conversely, when $\beta=\pi$, and $\alpha=\pi$ the carrier frequencies subtract while the sidebands add, giving a net increase in instantaneous carrier phase resulting in an increase in output signal for a given signal input.

When $\beta = -\cos^{-1} r$ the load characteristic, at small values of h , approaches the normal as h decreases. This value of β forms, in this region, the dividing line between characteristics of increased and decreased over-all system transmission. In Fig. 1 such a characteristic is obtained when $\beta = -\cos^{-1} 0.4$.

As h increases beyond these small values just mentioned, the various characteristics sooner or later depart from the 45-degree slope giving rise to amplitude distortion. The characteristic for $\beta=\pi$ up to about +5 decibels on the co-ordinates resembles somewhat the sort of overload characteristic obtained in an ordinary vacuum-tube circuit when it is driven into the region of compression. However, as h increases further, the slope of the characteristic reverses and the curve returns to cross the normal again and to continue on in undulating fashion in ever-decreasing deviations about the normal, approaching the normal as a limit.

The characteristic for $\beta=0$ up to about +5 decibels on the co-ordinates has somewhat the inverse characteristic of the one just discussed. It is similar to the load characteristic of a vacuum-tube circuit in which there is expansion associated with threshold. Such a characteristic might be obtained in a class AB amplifier. As h

increases beyond the +5-decibel region, this characteristic likewise reverses in curvature and progresses in undulating fashion in decreasing deviations about the normal and approaches the normal, as a limit.

A sort of critical region seems to exist, in the neighborhood of +5 decibels, above which all characteristics for all values of r , β , and α converge in undulating fashion on the normal as h increases. This is an interesting property since the effects of fading would be greatly reduced in a frequency-modulation radio system by maintaining the useful range of h above this critical region.

It is of interest to note that the normal distortionless system characteristic (the straight line passing through 0, 0) is also the system characteristic for the two-path case when $\alpha=0$. This may be seen from (9) and (10) in the appendix when $\sin \alpha/2 = 0$. If the delay differential of the two paths of propagation is small enough, $\sin \alpha/2$ may be neglected and a substantially distortionless system may be obtained even with two-path propagation.

As mentioned previously, the characteristics in solid lines in Fig. 1 were computed for $r=0.4$. As the two paths of propagation approach equal transmission, the over-all system characteristics deviate further from the normal; as $r \rightarrow 1$ the curves for $\beta=0, 3\pi/4$, and π approach the dotted lines as limits. The manner in which this takes place will be made clearer by comparing Fig. 1 with Fig. 2, where similar characteristics are plotted for $r=0.8$ for the same value of β .

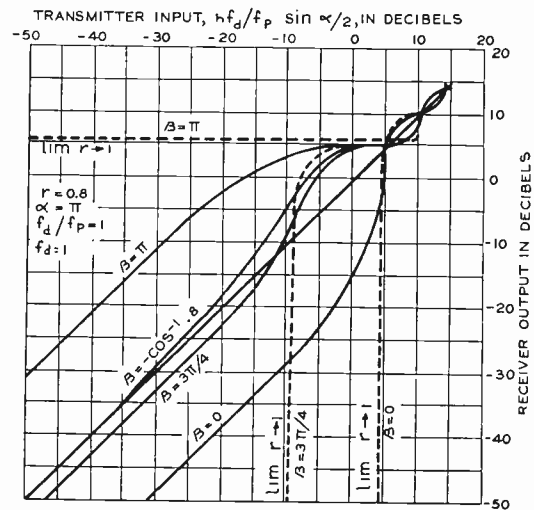

Fig. 2—Single-frequency amplitude characteristics of an over-all frequency-modulation radio system.

The deviation from normal transmission, at very small values of h , changes with r in a manner portrayed in Fig. 3, which shows over-all system deviations from normal transmission as a function of r . These were computed from the limiting value of D_1 given in (13) and substituted in (10) in the appendix.

Let us return now to the factors f_d/f_p and $\sin \alpha/2$ in the abscissa. It will be remembered these were made unity for the purposes of the above discussion as well as for establishing a convenient reference for other characteristics in which these quantities are not unity. In practice these quantities are most likely not to be

⁶ The values of β and α used in the discussion here are limited to the range 0 to 2π because the numerical values of the equations identically repeat in successive 2π intervals. When β is given any value with respect to α it is supposed that the phase-frequency characteristics of the two paths have such displacement and slope within the transmitted band that $\beta+2\pi n$ coincides with α .

unity. For instance, the deviation index f_d/f_p is inversely proportional to the modulating frequency and has a different value for every frequency in the modulating-frequency band. It is also directly proportional to the maximum carrier-frequency deviation and for any given modulating frequency it has a different value in radio systems having different deviation ratios. A correction may be applied directly to the curves of either Fig. 1 or Fig. 2 so that they will show the amplitude characteristics of a system for any value of deviation index. For example, on a frequency-modulation radio system having a deviation ratio of 5, f_d/f_p would be 5 for the top frequency in the modulating-frequency band.⁷ For this frequency, then, a reading on the abscissa scale of Fig. 1 would be increased 14 decibels to obtain the correct ordinate reading of the receiver output. For every value of h the curves would be read 14 decibels to the right.

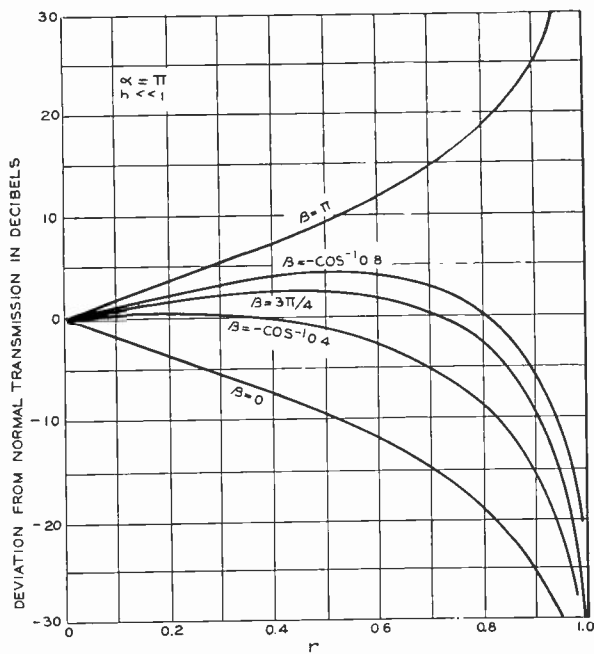

Fig. 3—Over-all-system transmission deviations as a function of path-loss amplitude ratio.

In the general case the curves are read the requisite number of decibels to the right or left of a given abscissa according to whether the corresponding value of f_d/f_p is greater or less than one.

Variations in the relative modulating-frequency phase shift α may be applied directly to the curves of Fig. 1 and Fig. 2 for qualitative purposes only. While the factor $\sin \alpha/2$ in the abscissa may be applied to give shifts in abscissa readings in a manner similar to that for the deviation index, it should be noticed that the shape of the curves is altered when α is varied. This is brought about by the factor $\sin^2 \alpha/2$ in the fundamental term of (10). This factor, as α departs from π , tends to reduce the deviations from normal system transmission from the maximum values shown in Figs. 1 and 2.

⁷ At lower modulating frequencies values of f_d/f_p would be proportionately greater.

The points where the various characteristics cross the normal remain fixed, however. This tends to keep the critical region about in the position shown. This is an aid in a qualitative understanding of the effects of variation in α . However, if it is necessary to know the trans-

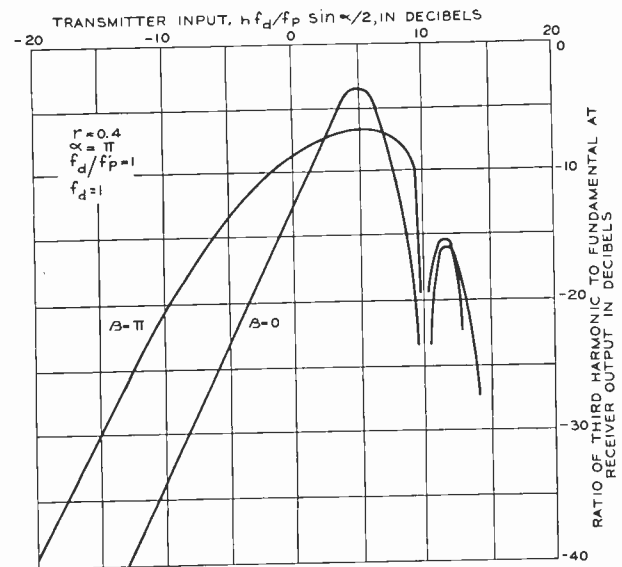

Fig. 4—Single-frequency harmonic output as a function of fundamental input to transmitter.

mission changes accurately for quantitative purposes, it is necessary to plot new sets of curves for different values of α .

Before attempting to interpret the curves of Figs. 1 and 2, it may be well first to proceed to a discussion of some of the modulation products attending amplitude characteristics of this type. In Figs. 4 and 5 are shown

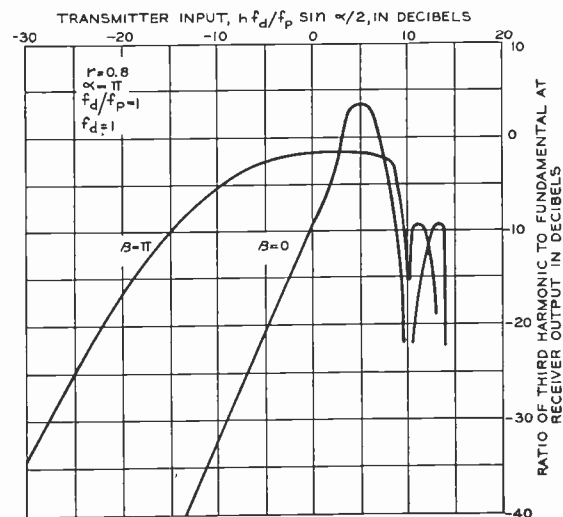

Fig. 5—Single-frequency harmonic output as a function of fundamental input to transmitter.

computed third-harmonic characteristics that go with the amplitude characteristics for $\beta = 0$ and π in Figs. 1 and 2, respectively. These curves are obtained from H , the harmonic-distortion part of (10), as expressed by D in (9) when $m > 1$. The curves represent the ratio of har-

monic to fundamental amplitude at the receiver output as expressed by the ratio D_3 to the fundamental term of (10). The values of D_3 for Figs. 4 and 5 are given in Figs. 10 and 11, respectively, in the appendix. Even-order distortion is not present because as seen from (9) it vanishes when $\beta = n\pi$.

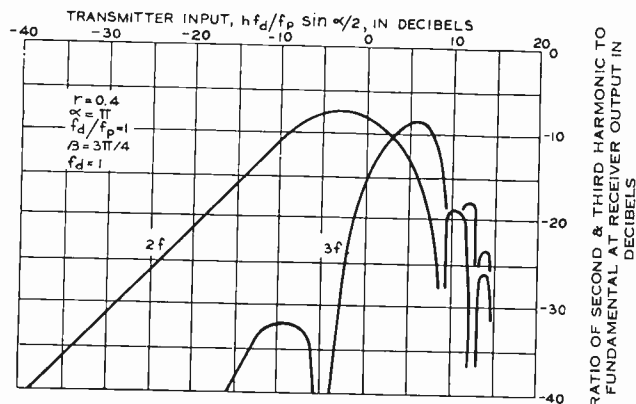

Fig. 6—Single-frequency harmonic output as a function of fundamental input to transmitter.

The co-ordinates in Figs. 4 and 5 are expressed in decibels. As in Figs. 1 and 2, the abscissas are proportional to transmitter input with f_d/f_p and $\sin \alpha/2$ both unity. The ordinates are proportional to harmonic output expressed in decibels below the fundamental at the receiver output for unit value of f_d . It is seen that third-harmonic distortion is high, for most uses, in the critical

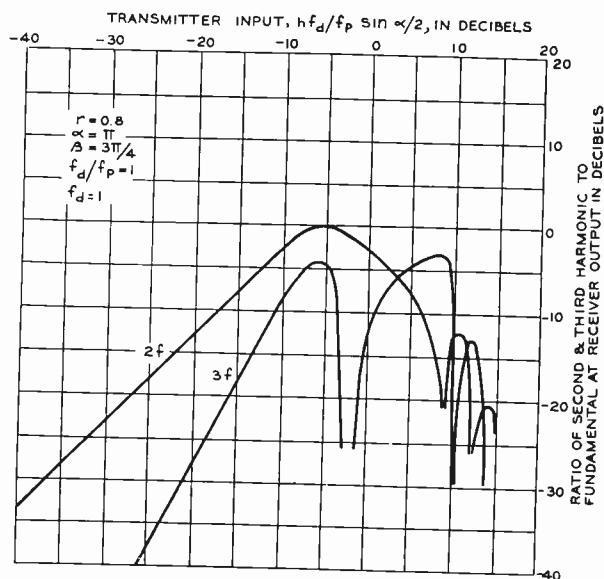

Fig. 7—Single-frequency harmonic output as a function of fundamental input to transmitter.

region. On each side of this region the distortion becomes less. Because D_3 is a multiplier in the harmonic amplitude the sharp dips in the characteristics are at points where D_3 passes through zero. The sign of the harmonic in both curves alternates in successive lobes. At low input amplitudes the harmonic behaves like normal third-order modulation and follows a cube-law characteristic. This is shown analytically in (12) in the appendix.

The harmonic associated with the amplitude characteristic for $\beta = 3\pi/4$ in Figs. 1 and 2 is shown in Figs. 6 and 7. Both $2f$ and $3f$ are present and are plotted to the same scales as $3f$ in the previous set of curves. These curves exhibit the same general properties as those in the previous set except that at small inputs $2f$ decreases half as fast as $3f$.

Higher harmonics than the second and third may be plotted in similar manner. It is sufficient for the present purpose, however, to go no further than these two.

The curves of harmonic output shown here may be considered reference curves. Since the abscissa co-ordinates are identical with those for the fundamental or amplitude characteristics, they are manipulated in the same way for various values of deviation index and $\sin \alpha/2$. However, as in the case of the curves for fundamental, the amplitude changes with $\sin \alpha/2$ so that harmonic distortion decreases as α departs from π . The points at which the sharp dips occur, however, remain fixed. If

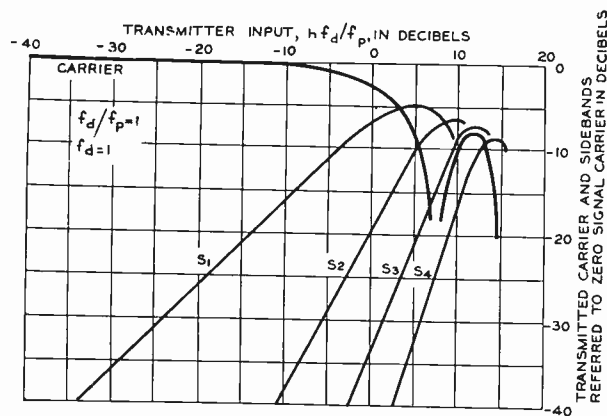

Fig. 8—Carrier and sideband distribution as a function of transmitter input.

accurate information is desired for quantitative purposes, a new set of characteristics must be plotted for the required value of α .

As an additional aid to the understanding of the amplitude nonlinearity depicted by the amplitude and harmonic characteristics of Figs. 1, 2, 3, 4, 5, 6, and 7, a set of curves, Fig. 8, has been arranged to show the relative strength of transmitted carrier and associated sidebands as a function of transmitter input. The co-ordinates are expressed in decibels. As the relation between carrier and sidebands depends only on hf_d/f_p the factor $\sin \alpha/2$ is omitted from the abscissa. To determine the wave make-up at the transmitter output associated with any point on the curves in Figs. 1, 2, 3, 4, 5, 6, and 7, it is only necessary to know the associated value of hf_d/f_p and apply it to Fig. 8.

For $\alpha = \pi$ the abscissa zero of Fig. 8 coincides with those of Figs. 1, 2, 3, 4, 5, 6, and 7. A convenient picture of the sideband distribution for a load or harmonic characteristic may be obtained by considering Fig. 8 superimposed on the other figures with abscissa zeros coinciding. When α is other than π the abscissa zero of Fig. 8 is moved to the left of the others the number of decibels

corresponding to $\sin \alpha/2$. A study of the characteristics in this manner shows that the critical region in the load characteristics is reached with smallest number of sidebands (about two) when $\alpha = \pi$. As α departs from π the number of sidebands necessary to reach this point increases until when $\alpha = 0$ it would take an infinite number of sidebands. Above the critical region the number of sidebands in all cases is large.

Something should be said now concerning alterations of the over-all-system frequency characteristic due to two-path interference. By the original assumption the phase-versus-frequency characteristic in the radio-frequency band varies linearly with frequency making α a linear variable with frequency. Curves which are proportional to the frequency characteristic of an over-all system may be obtained if the fundamental output at the receiver is plotted against α . In Fig. 9 the corresponding deviations from normal system transmission

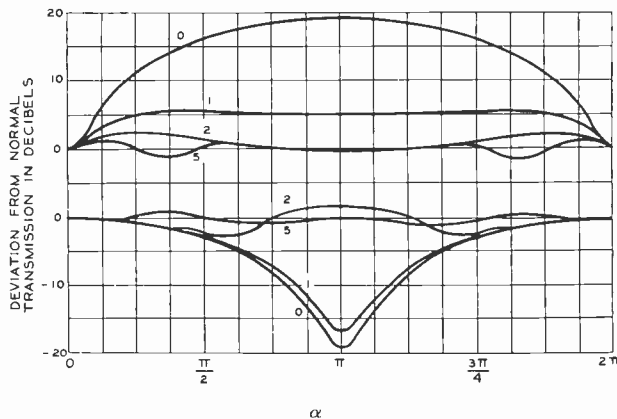

Fig. 9—Frequency distortion; α = linear variable with frequency. The number on each curve is the value of hf_a/f_p used in computation. $\beta = \pi$ in the upper group; $\beta = 0$ in the lower group. $r = 0.8$.

are plotted against α . These were obtained from (10) and the associated values of D_1 in Fig. 11. The curves are computed for $r = 0.8$ and $\beta = 0$ and π with the factor hf_a/f_p serving as parameter. The upper group represents $\beta = \pi$ and the lower group $\beta = 0$. It is evident that for a given value of deviation index the various characteristics of Fig. 9 will be obtained at different values of h . It should be expected, then, that the frequency characteristic of an over-all system would vary with signal-input level to the transmitter.

Viewing amplitude nonlinearity as a whole, we see from Figs. 1, 2, 3, 4, 5, 6, and 7 that if at any modulating frequency at the transmitter input h were made to vary over a wide range of values, a wide variety of transmission changes would be introduced by the over-all system. It should be remembered in the cases shown that the characteristics are all a function of the product of input amplitude h , deviation index, and $\sin \alpha/2$. Because the deviation index is inversely proportional to modulating frequency, the input amplitude necessary to obtain these characteristics is directly proportional to modulating frequency. It results that over a band of modulating frequencies, such as a speech or program

band, sudden changes in transmission as shown in Figs. 1 and 2 would occur at different input levels depending on the part of the band in which the assumed conditions of phase and amplitude are realized. The curves for $\beta = 0$ could be used to explain what has been termed "volume bursts" in frequency-modulation reception brought about by fading. If the delay between paths is sufficient to satisfy the conditions for these curves at some frequency in the audible band, a passage of the input level upward through the critical point will increase the output amplitude giving a sudden increase in loudness. This sudden change will, of course, be attended by a whole spectrum of harmonics as illustrated. A decrease in level back to the starting point will pass through the critical point in reverse, giving a sudden decrease in loudness. If the change in input level is up and down through this point in a short interval, the effect will be a change corresponding to impulse.

If voice or program material is applied to the transmitter input and amplitude characteristics similar to the above exist, it would be possible to obtain sudden changes in receiver output as the variable amplitude of this material passed haphazardly up and down through critical values of input amplitude. The effect on the listening ear could very well be that which has been described as volume bursts.

Some degree of theoretical corroboration of experimental observations is established in the harmonic characteristics shown. In the operation of actual circuits having multiple-path transmission it has been observed by Crosby^{1,2} and others that harmonic distortion appears to be worse at low modulating frequencies than at high. On the other hand, it has been observed by Corrington³ that the reverse is true. With harmonic characteristics as shown in Figs. 4, 5, 6, and 7, it is apparent that if hf_a/f_p is large enough to reach beyond the region of maximum distortion (critical region), a general reduction in distortion follows a decrease in f_p for a given value of transmitter input (represented by h). This agrees with the second observation. But if the transmitter input is reduced, distortion increases (except for the sharp dips) to a maximum in the critical region and then decreases steadily. If hf_a/f_p is small enough to maintain system operation below the critical region, an increase in distortion follows a reduction in f_p for a given value of transmitter input. This agrees with the first observation. Either observation, then, is true depending on how hard the transmitter is driven.

We have seen from the foregoing what variations in over-all transmission may be expected in frequency-modulation radio systems having single-frequency modulation of the carrier and two-path propagation between transmitter and receiver. Because multiple-path propagation produces amplitude nonlinearity in the system, the principle of superposition cannot be applied to determine what might be expected in over-all performance as the number of paths or the number of frequencies are increased. But what has been shown here may be used

as a gauge to explain in an approximate way some observations that have been made on over-all transmission in frequency-modulation radio circuits.

APPENDIX

Let e_1 and e_2 represent two received sinusoidal frequency-modulated waves delayed one with respect to the other t_0 seconds. Let E_0 and E_1 be the peak amplitudes of the earlier wave and the later wave, respectively. Then at the limiter input

$$e_1 + e_2 = E_0 \sin \left(\omega_c t + h \frac{\omega_d}{\omega_p} \cos \omega_p t \right) + E_1 \sin \left[\omega_c(t + t_0) + h \frac{\omega_d}{\omega_p} \cos \omega_p(t + t_0) \right] \quad (1)$$

where

$\omega_c = 2\pi \times$ carrier frequency

$\omega_p = 2\pi \times$ modulating frequency

$\omega_d = 2\pi \times$ maximum-deviation frequency

$t_0 =$ delay in seconds

$h =$ factor proportional to the amplitude of signal input at the transmitter.

Let $\beta = \omega_c t_0$ and $\alpha = \omega_p t_0$. Then following a procedure identical with that used by Crosby¹ in solving the same case, the desired frequency-modulated wave leaving the limiter is found. The resultant instantaneous frequency is

$$f_i = f_c - hf_d \sin \omega_p t + D, \quad D = -hf_d 2 \sin \frac{\alpha}{2} \frac{r + \cos \theta}{\frac{1}{r} + r + 2 \cos \theta} \cos \left(\omega_p t + \frac{\alpha}{2} \right) \quad (2)$$

where $r = \frac{E_1}{E_0}$

and

$$\text{and } \theta = \beta - l \sin \left(\omega_p t + \frac{\alpha}{2} \right) \quad l = 2h \frac{f_d}{f_p} \sin \frac{\alpha}{2}.$$

If the discriminator and detector circuits are assumed to be distortionless, the detector output will be proportional to f_i , so we may confine our analysis to f_i . Accordingly, the first term of (2) is a constant giving rise to direct current. The second term is the fundamental component of the modulating frequency having a peak amplitude of hf_d . The third term is the distortion produced by two-path interference and is of immediate interest. By application of Fourier analysis to that part of D involving $\cos \theta$ an expansion into a series involving r and $\cos \theta$ may be obtained. The result is

$$\frac{r + \cos \theta}{\frac{1}{r} + r + 2 \cos \theta} = - \sum_{n=1}^{\infty} (-r)^n \cos n\theta, \quad r < 1 \quad (3)$$

making use of the value of θ given in (2)

$$\left. \begin{aligned} \cos n\theta &= \cos \left[n\beta - nl \sin \left(\omega_p t + \frac{\alpha}{2} \right) \right] \\ &= \cos(n\beta) \cos \left[nl \sin \left(\omega_p t + \frac{\alpha}{2} \right) \right] \\ &\quad + \sin(n\beta) \sin \left[nl \sin \left(\omega_p t + \frac{\alpha}{2} \right) \right] \end{aligned} \right\} \quad (4)$$

This may be expanded so that

$$\cos n\theta = \sum_{m=-\infty}^{\infty} J_m(nl) \left[\cos(n\beta) \cos m \left(\omega_p t + \frac{\alpha}{2} \right) + \sin(n\beta) \sin m \left(\omega_p t + \frac{\alpha}{2} \right) \right] \quad (5)$$

where J_m is an m th order Bessel function of the first kind. On the substitution of (5) into (3) we have

$$\frac{r + \cos \theta}{\frac{1}{r} + r + 2 \cos \theta} = - \sum_{n=1}^{\infty} \sum_{m=-\infty}^{\infty} (-r)^n J_m(nl) \left[\cos(n\beta) \cos m \left(\omega_p t + \frac{\alpha}{2} \right) + \sin(n\beta) \sin m \left(\omega_p t + \frac{\alpha}{2} \right) \right], \quad r < 1. \quad (6)$$

Then substituting (6) in the expression for D in (2) the complete distortion component is obtained and

$$\begin{aligned} D &= hf_d \sin \left(\frac{\alpha}{2} \right) \sum_{n=1}^{\infty} \sum_{m=-\infty}^{\infty} (-r)^n J_m(nl) \\ &\quad \times \left\{ \cos(n\beta) \left[\cos(m+1) \left(\omega_p t + \frac{\alpha}{2} \right) + \cos(m-1) \left(\omega_p t + \frac{\alpha}{2} \right) \right] \right. \\ &\quad \left. + \sin(n\beta) \left[\sin(m+1) \left(\omega_p t + \frac{\alpha}{2} \right) + \sin(m-1) \left(\omega_p t + \frac{\alpha}{2} \right) \right] \right\}. \quad (7) \end{aligned}$$

It will be noticed that in the sine and cosine terms as m progresses from 1 to $\pm \infty$ like frequencies appear at m and $m \pm 2$. Thus when $m=0$ the fundamental of the modulating frequency appears. When $m = \pm 2$ the fundamental and third harmonic appear. When $m = \pm 4$ the third and fifth harmonics appear, etc. Due to this overlapping the coefficients of the sine and cosine terms include the sum of two Bessel functions instead of one. By means of the recurrence formula for Bessel functions of the first kind these may be resolved into one. When this resolution has been made the final expression for the distortion becomes

$$D = hf_d \sin\left(\frac{\alpha}{2}\right) \sum_{n=1}^{\infty} \sum_{m=-\infty}^{\infty} (-r)^n \frac{2m}{nl} J_m(nl) \times \left[\cos(n\beta) \cos m\left(\omega_p t + \frac{\alpha}{2}\right) + \sin(n\beta) \sin m\left(\omega_p t + \frac{\alpha}{2}\right) \right], \quad r < 1. \quad (8)$$

When m is odd, the $+$ and $-$ values of m cause the sine terms to cancel and the cosine terms to add. Conversely when m is even the $+$ and $-$ values of m cause the cosine terms to cancel and the sine terms to add, so that odd-order distortion is represented by the cosine terms and even-order distortion by the sine terms. Some simplification in notation in (8) may be achieved by allowing m to designate the order of the frequency. Then

$$D = hf_d \sin\left(\frac{\alpha}{2}\right) D_m \cdot \cos \left[m \left(\omega_p t + \frac{\alpha}{2} \right) - \frac{\pi}{2} \frac{1 + (-1)^m}{2} \right], \quad (9)$$

$$D_m = \frac{4m}{l} \sum_{n=1}^{\infty} (-r)^n \frac{J_m(nl)}{n} \cdot \cos \left[n\beta - \frac{\pi}{2} \frac{1 + (-1)^m}{2} \right].$$

Either (8) or (9) shows the composition of the distortion component at the receiver output in terms of the fundamental and odd and even harmonics of the modulating frequency.

Several interesting points may be gathered from these equations. $D = 0$ when the attenuation ratio of the two paths is 0, which is to be expected. For in such a case one path has no transmission and no interference exists. $D = 0$ when the relative phase shift of the modulating frequency is $\alpha = 2\pi n$, because the series summation is fi-

nite when $r < 1$ and $\sin(\alpha/2) = \sin \pi n = 0$. As α is a function of relative delay it is possible to infer from this that distortion is small when the relative delay between paths is small. $D = 0$ when l is very large because

$$J_m(nl) \cong \left(\frac{2}{\pi nl}\right)^{1/2} \cos\left(nl - \frac{\pi}{4} - \frac{m\pi}{2}\right) \doteq 0, \quad l \doteq \infty$$

and when substituted in D_m the series summation likewise approaches zero when $r < 1$. But l is large when hf_d/f_p is large. We may infer from this that a system having high input amplitude or high deviation index or both will have small distortion.

These points may be seen more clearly in the curves of D_m versus l shown in Figs. 10 and 11. Here $D_1, D_2,$ and D_3 (fundamental, second, and third harmonic) are plotted against l for three values of relative carrier phase shift between paths, $\beta = 0, 3\pi/4,$ and π ; and amplitude ratios of the path losses of $r = 0.4$ and 0.8 . Each point on the curves involves a summation of the series for $D_1, D_2,$ and D_3 . D_2 is absent when $\beta = 0$ and π because even-order modulation vanishes when $\beta = \pi n$.

The curves for D_1 are shown on the lower half of Figs. 10 and 11. These exhibit the same general properties as the curves for D_2 and D_3 . However, D_1 , being a component of fundamental in the distortion term D , must be combined with the regular fundamental term in (2) to give the complete output fundamental component. Such a combination alters (2) so that

$$f_i = f_c - hf_d \sqrt{1 + D_1(2 + D_1) \sin^2 \frac{\alpha}{2}} \cdot \sin(\omega_p t - \phi) + H, \quad (10)$$

$$\phi = \tan^{-1} \frac{D_1 \sin \alpha}{2 \left(1 + D_1^2 \sin^2 \frac{\alpha}{2} \right)}$$

$$H = D \quad \text{for } m > 1$$

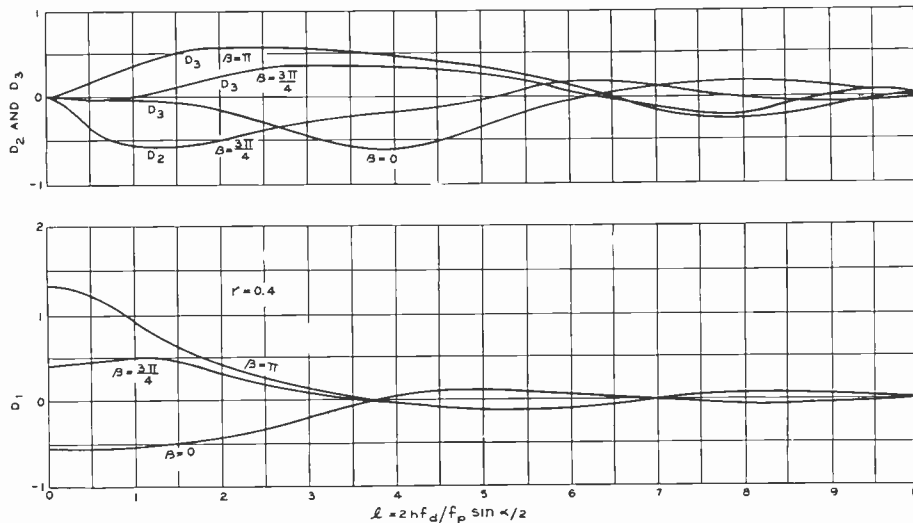

Fig. 10— D_m as a function of l for the indicated values of $r, \beta,$ and m .

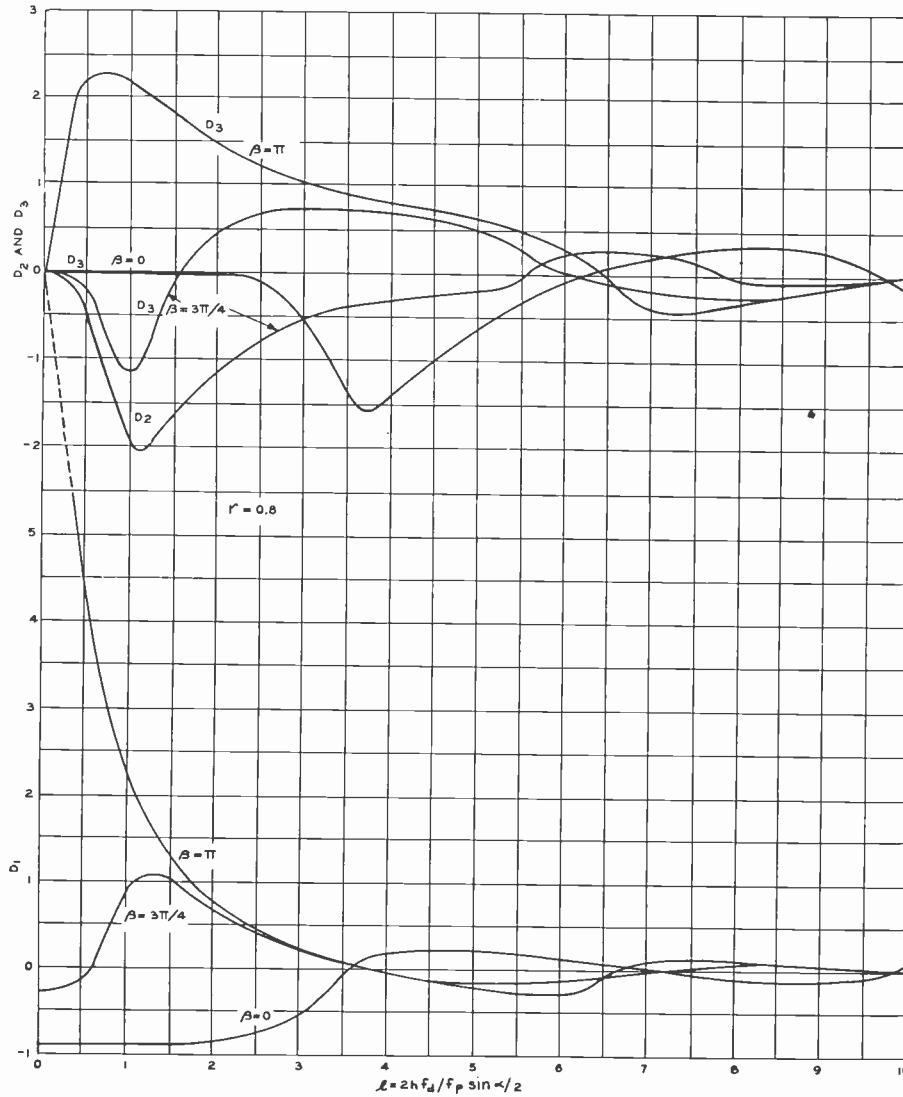

Fig. 11— D_m as a function of l for the indicated values of r , β , and m .

The coefficient of the complete fundamental term now increases and decreases with positive and negative values of D_1 above and below its normal value for zero distortion. H is used here to represent harmonic distortion in D and is equal to D in (9) with the fundamental term removed.

It is sometimes of interest to know how the distortion varies at low-signal amplitudes such as shown in Figs. 2 and 3 in the text. This may be obtained from (9) for very small values of h by replacing $J_m(nl)$ by the first term of the Bessel's series expansion. The result is

$$D_m \sim 2 \frac{\left(\frac{l}{2}\right)^{m-1}}{(m-1)!} \sum_{n=1}^{\infty} (-r)^n (n)^{m-1} \cdot \cos \left[n\beta - \frac{\pi}{2} \frac{1 + (-1)^m}{2} \right] \quad (11)$$

letting

$$\psi = \sum_{n=1}^{\infty} (-r)^n (n)^{m-1} \cos \left[n\beta - \frac{\pi}{2} \frac{1 + (-1)^m}{2} \right]$$

we have

$$D \sim h^m \frac{2f_d \sin^m \left(\frac{\alpha}{2}\right) \left(\frac{f_d}{f_p}\right)^{m-1}}{(m-1)!} \psi \cdot \cos \left[m \left(\omega_p t + \frac{\alpha}{2} \right) - \frac{\pi}{2} \frac{1 + (-1)^m}{2} \right]. \quad (12)$$

From (12) the amplitude of the m th-order harmonic varies as h^m which is proportional to m th power of the input amplitude.

A summation of (11) is most readily made for specific values of m . For present purposes, where fundamental, second, and third harmonic only are considered, it is sufficient to let $m = 1, 2, 3$ to obtain the necessary limiting values of D_m as $l \rightarrow 0$. The resulting values of D_m are

$$\begin{aligned}
D_1 &\sim -2r \frac{r + \cos \beta}{1 + r^2 + 2r \cos \beta} \\
D_2 &\sim -\frac{lr(1-r^2) \sin \beta}{(1+r^2+2r \cos \beta)^2} \\
D_3 &\sim -\left(\frac{l}{2}\right)^2 r(1-r^2) \frac{2r(1+\sin^2 \beta) + (1+r^2) \cos \beta}{(1+r^2+2r \cos \beta)^3}.
\end{aligned} \tag{13}$$

As h is a factor in l , these expressions are also valid for

$h \neq 0$, making them useful in computing load and harmonic characteristics for small values of h .

ACKNOWLEDGMENT

The author wishes to express appreciation to his colleagues for many helpful suggestions and constructive criticism generously offered during the preparation of this paper.

Discussion on

“Concerning Hallén’s Integral Equation for Cylindrical Antennas”*

S. A. SCHELKUNOFF

Ronold King:¹ The integral equation of Hallén in the form

$$\int_{-l}^l \frac{I(\xi)e^{-j\beta r}}{r} d\xi = A \cos \beta z + B \sin \beta |z| \tag{1}$$

applies to a perfectly conducting cylinder of sufficiently small cross section so that the axial distribution of current may be treated as independent of the transverse distribution. The evaluation of the constants A and B is carried out subject to the idealized boundary condition $I(l) = 0$ and in terms of an idealized “slice” generator which is exactly like the rest of the conductor except for a discontinuity in scalar potential at the center, $z = 0$. This discontinuity in scalar potential is not in the form of a dielectric gap between the halves of the antenna placed end to end, but is assumed to exist at the center of a continuous conductor. The degree in which these conditions may be approximated in practice has been discussed in some detail in another place² where it is pointed out and experimentally verified that an antenna which is center driven from a two-wire line does not approximate well the assumed driving conditions. This is due both to the gap and to the more or less adjacent end surfaces of the halves of the antenna, the two having somewhat compensating effects. Neither an infinitesimal gap nor a wide gap (as suggested by Dr. Schelkunoff) is a satisfactory experimental equivalent of the “slice” generator assumed in the theory. While an exact physical counterpart of a “slice” generator is unavailable, the best approximation would seem to be achieved in a base-driven antenna over a sufficiently large conducting plane. If the antenna is made the continuation above the plane of the inner conductor of a

coaxial line, with inner and outer conductors nearly equal in size, a significant rotationally symmetrical driving field is maintained only over a very short distance along the base of the antenna in a manner resembling a “slice” generator with skin effect.

Dr. Schelkunoff’s comparison of the expansions due to Hallén and to Gray may be supplemented by a third method of expanding the integral on the left in (1) that appears to be very much superior to both of those discussed. Let the three methods be considered in turn. The Hallén method proceeds from

$$\begin{aligned}
\int_{-l}^l \frac{I(\xi)e^{-j\beta r}}{r} d\xi &= I(z) \int_{-l}^l \frac{d\xi}{r} \\
&+ \int_{-l}^l \frac{I(\xi)e^{-j\beta r} - I(z)}{r} d\xi,
\end{aligned} \tag{2}$$

which is equivalent to assuming as a first approximation a *uniform* current along the entire antenna equal to the current $I(z)$ at the point of calculation, and, in addition, to neglecting retardation. It leads to the simple expansion parameter $\Omega = 2 \ln(2l/a)$ that is independent of βl .

The assertion by Dr. Schelkunoff that “Hallén’s first approximation involves a tacit assumption that the antenna is short compared with the wavelength” appears to rest solely on the argument (p. 875) that the first term on the right in (2) is “a better approximation to the integral on the left if βr is small; that is, if $2\pi l/\lambda$ is small.” No proof is given of this statement and it certainly is *not correct* in general. This is easily reasoned out qualitatively, but is perhaps most quickly and convincingly verified by computing a simple numerical case. For a short antenna which satisfies the condition $\beta l < 0.5$ the distribution of current is very well approximated by $I(\xi) = I(0)(1 - [|\xi|/l])$. If this is substituted in the integral on the left in (2) the result is $I(0)[\Omega - 2 - j\beta l]$. The first integral on the right gives $I(0)\Omega$. The

* PROC. I.R.E., vol. 33, pp. 872-878; December, 1945.

¹ Cruft Laboratory, Harvard University, Cambridge, Mass.

² R. King and D. D. King, “Microwave impedance measurements with application to antennas, II,” *Jour. Appl. Phys.*, vol. 16, pp. 445-453; August, 1945.

difference between the two is $I(0)[2+j\beta l]$. For an antenna of half length $\lambda/4$ the distribution of current is very well approximated by

$$I(\xi) = I(0) \cos \beta \xi.$$

If this is substituted in the integral on the left in (2), it can be evaluated in closed form.³ With $\Omega=10$, for example, the numerical value with $z=0$ is

$$\int_{-\lambda/4}^{\lambda/4} \frac{\cos \beta \xi}{r} e^{-i\beta r} d\xi = 8.5 - j1.9.$$

The first integral on the right is $\Omega=10$. Clearly the integral on the right in (2) with a value $\Omega=10$ is a *better* approximation of the integral on the left for the *long* antenna ($\beta l = \pi/2$) for which its value is $8.5 - j1.9$ with a magnitude 8.7, than it is for the very short antenna ($\beta l < 0.5$) for which its value is only $8 + j\beta l$ with a magnitude of 8. Possibly Dr. Schelkunoff overlooked that fact that the degree in which the first integral on the right in (2) approximates the integral on the left is determined as much or more by the accuracy with which $I(\xi)$ is represented than by whether retardation is neglected or not. His argument appears to be based entirely on the fact that the retardation factor $e^{-i\beta r}$ is approximated by 1 and not on the fact that the entire term $I(\xi)e^{-i\beta r}$ is approximated by $I(z)$. It is, therefore, *not correct to conclude in general that the Hallén formula is a better approximation for short antennas than for long.*

The Gray method begins with

$$\int_{-l}^l \frac{I(\xi)e^{-i\beta r}}{r} d\xi = I(z) \int_{-l}^l \frac{\cos \beta r}{r} d\xi + \int_{-l}^l \frac{I(\xi)e^{-i\beta r} - I(z) \cos \beta r}{r} d\xi, \quad (3)$$

which is equivalent to assuming as a first approximation a distribution of current of the form $I(z) \cos \beta r$ along the antenna referred to the point of calculation at z , and in addition to neglecting radiation. Alternatively, since the contribution from the integral involving the imaginary part of $e^{-i\beta r}$ is small at $z=0$, the Gray method is approximately equivalent (at least for calculating the impedance) to setting,

$$\int_{-l}^l \frac{I(\xi)e^{-i\beta r}}{r} d\xi = I(z) \int_{-l}^l \frac{e^{-i\beta r}}{r} d\xi + \int_{-l}^l \frac{[I(\xi) - I(z)]e^{-i\beta r}}{r} d\xi. \quad (4)$$

This expansion is equivalent to assuming as a first approximation a *uniform* current along the antenna just as in the Hallén form, but it *does not neglect* retardation. As a consequence it leads to a more complicated expansion parameter that is a function of βl as

well as of l/a , and this permits a somewhat closer fitting.

The final expression obtained by Gray using (3) in determining the expansion parameter is not entirely satisfactory in the form given⁴ for several relatively minor reasons. Thus Gray uses an *average* value as the expansion parameter in all integrals, but a different value, namely that at $z=0$, in the principal factor. It is not obvious why the average value should not be used throughout. Furthermore, Gray's final formula arbitrarily retains only half of the second-order terms. Two reasons are given. It is stated in the first place that the second-order terms retained are not negligible compared with the first-order terms. However, since no attempt was made to investigate the magnitude of the second-order terms omitted, this does not seem to be a satisfactory argument. Suppose, for example, that the omitted terms were still larger, or nearly equal to and opposite in sign to those retained! The second reason given is that the terms retained are needed to make the current at the end of the antenna more nearly zero. Since the current *is zero* at $z=l$ with or without these terms, this reason does not seem to be pertinent.

An alternative evaluation of the Gray expansion using average values of the parameter throughout and retaining *all* second-order terms has been carried out in a slightly modified form. Some of the results are given in Tables I and II in columns headed "Modified Gray." On the whole they are in better agreement with the experimental results than is the original Gray solution.

Whereas the Gray expansion is a slight improvement in calculating the impedance over the method of Hallén in that in effect it takes account of retardation in evaluating $I(0)$, both methods fail completely to represent the *true distribution of current* in obtaining a first approximation and in deriving an expansion parameter. And the distribution of current is more important in obtaining a good approximation than is retardation! It is well known that any process of iteration converges the more rapidly the better the arbitrarily selected approximate function represents the true, but unknown, function. Accordingly, any procedure that expands the integral on the left in (1) in terms of a function that actually approximates the true distribution $I(\xi)$ and that, in addition, takes into account retardation necessarily is superior to methods that do not. Such a function and the associated parameter of expansion may be determined by setting³

$$I(z) = I(0)f(z); \quad I(\xi) = I(0)f\xi \quad (5)$$

so that

$$I(\xi) = I(z)f(\xi)/f(z) = I(z)g(z, \xi) \quad (6)$$

where $g(z, \xi)$ is the unknown distribution function that is to be approximated. Upon defining the function $\psi(z)$ as in (7),

³ R. King and D. Middleton, (Appendix), *Quart. Appl. Math.*, vol. 4, January, 1945.

⁴ M. C. Gray, "A modification of Hallén's solution to the antenna problem," (equation (12)), *Jour. Appl. Phys.*, vol. 15, pp. 61-65; January, 1944.

$$\psi(z) = \int_{-l}^l g(z, \xi) \frac{e^{-j\beta r}}{r} d\xi, \tag{7}$$

equation (1) may be written as follows:

$$I(z)\psi(z) + \int_{-l}^l [I(\xi) - I(z)g(z, \xi)] \frac{e^{-j\beta r}}{r} d\xi = A \cos \beta z + B \sin \beta |z|. \tag{8}$$

If $g(z, \xi)$ were the true relative distribution function, the difference integral in (8) would vanish and $\psi(z)$ would be exactly proportional to the ratio of the axial component of the vector potential on the surface of the antenna at z and the current; i.e., $\psi(z) \sim \Pi(z)/I(z)$. Since the vector potential $\Pi(z)$ is determined largely by the current at and near z , the ratio $\Pi(z)/I(z)$ is reasonably constant and predominantly real. Hence, let

$$\psi(z) = \psi + \gamma(z) \tag{9}$$

where ψ is the magnitude of $\psi(z)$, and where $\gamma(z)$ is a small complex correction function. If $g(z, \xi)$ is not the true relative distribution function but only approximate, it is still correct to write (9).

TABLE I
(R_0) ANTIRESONANT

| Ω | King-Middleton | Modified Gray | Experimental from Schelkunoff's Table I |
|----------|----------------|---------------|---|
| 10 | 860 | 885 | 860 |
| 15 | 2465 | | 2450 |
| 20 | 5250 | 5400 | 4840 |

After substituting (9) in (8), the formal solution for $I(z)$ may be carried out using ψ as the expansion parameter instead of Ω as in the Hallén analysis. This leads to a series similar to that of Hallén with a zeroth-order solution (like Hallén's and Gray's) that has the form $\sin \beta(l - |z|)$. Accordingly, (5) is well approximated by

$$I(\xi) = I(z) \frac{\sin \beta(l - |\xi|)}{\sin \beta(l - |z|)} \tag{10}$$

so that

$$g(z, \xi) = \frac{\sin \beta(l - |\xi|)}{\sin \beta(l - |z|)} \tag{11}$$

This approximate value now may be substituted in (7) and $\psi(z)$ evaluated in closed form. As predicted, $\psi(z)$ is found to be predominantly real and to be sensibly constant over the greater part of the length of the antenna. It is, then, a good approximation to replace $\psi(z)$ by this constant value ψ which is given below and is plotted in Fig. 1.

$$\psi = |\psi(0)|; \quad l \leq \lambda/4 \tag{12a}$$

$$\psi = |\psi(l - \lambda/4)|; \quad l \geq \lambda/4. \tag{12b}$$

Using ψ as defined in (12) as the parameter of expansion, expressions are obtained for the current and for the impedance. These are formally like those in the solution of Hallén, but the coefficients of the terms are different and the parameter ψ appears throughout in place of Ω .

The resistance at antiresonance computed in this way for a center-driven antenna is given in Table I in the column headed "King-Middleton" for the values $\Omega = 10, 15,$ and 20 listed by Dr. Schelkunoff in his Table I.

In comparing theoretical results with experimental values it is not sufficient to use only the resistance at antiresonance. While this value is undoubtedly the most critical, it is also the value which is most difficult to determine accurately experimentally. In Table II other critical values determined from the several theories under discussion are listed together with a new set of experimental data obtained by D. D. King with a specially constructed coaxial line. The design of the measuring line was such that dielectric supports were eliminated and the driving conditions implied by the "slice" generator were approximated as closely as possible. Measurements were made using both the standing-wave-ratio method and the resonance-curve method, since the former is more accurate for low standing-wave ratios, the latter for high standing-wave ratios. A detailed description of these measurements is in preparation for publication.

TABLE II
CRITICAL VALUES OF CYLINDRICAL ANTENNA, $\Omega = 10$

| | Experimental D. D. King* | Hallén Bouw-kamp (second order) | Gray ⁷ (1½ order) | King-Middle-ton ⁸ (second order) | Schel-kunoff ⁸ | Modified Gray ⁹ (second order) |
|--|--------------------------|---------------------------------|------------------------------|---|---------------------------|---|
| $(R_0)_{\text{antiresonant}}$ | 800(860) ⁶ | 1150 | 740 | 860 | 740 | 885 |
| $\frac{\pi - \beta l_{\text{antiresonant}}}{ X_{\text{min}} }$ | 0.60 | 0.41 | 0.34 | 0.614 | 0.47 | 0.665 |
| $\frac{ X_{\text{max}} }{(R_0)_{\text{resonant}}}$ | 1.95 | 1.06 | 1.54 | 1.8 | 1.4 | 1.84 |
| $\frac{\pi - \beta l_{\text{resonant}}}{2}$ | 0.098 | 0.0885 | 0.026 | 0.094 | 0.094 | 0.0895 |
| $(R_0)_{\beta l = \pi/2}$ | 85 | 73.5 | 80 | 88 | 75 | 83.5 |
| $(X_0)_{\beta l = \pi/2}$ | 47 | 43.5 | 12 | 42.5 | 45 | 38 |

* Data from as yet unpublished Ph.D. thesis.

⁶ The value (860) is reproduced from Dr. Schelkunoff's Table I for convenient comparison.

⁷ Note that Gray has omitted one half of the second-order terms, retained the other half without verifying that the omitted terms are negligible. The significance of the results is, therefore, questionable.

⁸ Estimated from S. A. Schelkunoff, "Theory of antennas of arbitrary size and shape," Proc. I.R.E., vol. 29, pp. 510, 511, Figs. 23, 24, 25, 26; September, 1941; and Jour. Appl. Phys., vol. 15, p. 56, Fig. 2; January, 1944. The value of R_0 at antiresonance is not corrected for capacitance of flat ends since the experimental data apply to hemispherical ends for which no correction is required as explained in footnote reference 2. The ratio $|X_{\text{min}}|/|X_{\text{max}}|$ is a very rough estimate from extrapolation and use of the usually good approximation $R_{\text{max}} = |X_{\text{max}}| + |X_{\text{min}}|$.

⁹ D. Middleton and R. King, Jour. Appl. Phys., vol. 17; April, 1946.

It is significant to note that the Gray theory *fails completely* to determine the resonant and antiresonant lengths; that the results both of Hallén and Bouwkamp and of Schelkunoff are satisfactory in determining resonant lengths but are only a little better than those of Gray in giving antiresonant lengths. (The value of antiresonant resistance (740 ohms) listed for Gray in Table II differs considerably from that (680 ohms) given by Dr. Schelkunoff. The value 740 was computed

directly from Gray's formula⁴ independently by two people, one a professional computer, and is believed to be correct.)

It is perhaps well to emphasize once again that the impedance of an antenna depends to a very considerable extent upon the manner in which it is driven. Therefore, great care must be exercised not to overemphasize either a close agreement or a considerable disagreement between theoretical and experimental values

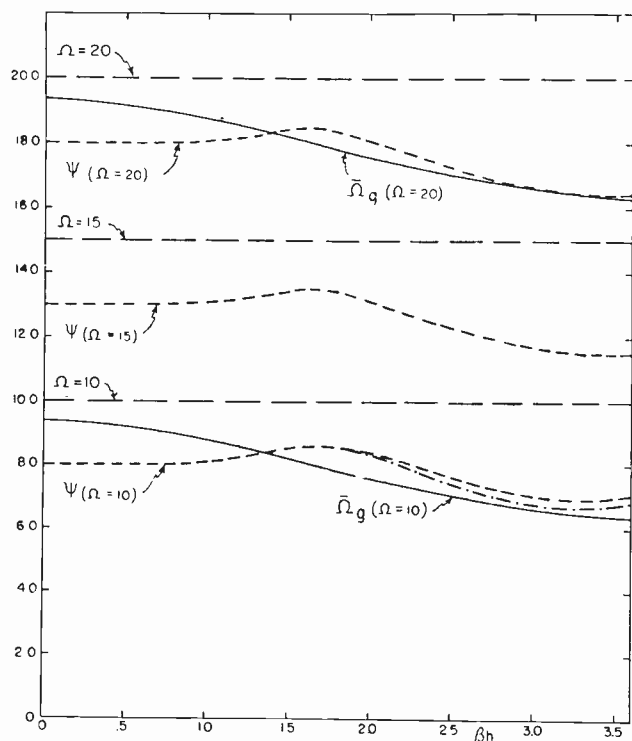

Fig. 1—Expansion parameters Ω (Hallén and Bouwkamp); $\bar{\Omega}_g$ (Gray and modified Gray) for $\Omega = 10, 20$; and ψ (King and Middleton), for $\Omega = 10, 15, 20$. The curve for ψ ($\Omega = 10$) is shown divided into two parts. The lower part was calculated using the zeroth-order sinusoidal distribution of current (10). The upper part was calculated using a function approximating the first-order distribution of current.

The above curves for ψ are the same as those on Fig. 11 of footnote reference 3 for $\beta h \geq \pi/2$. For $\beta h \leq \pi/2$, Fig. 11, footnote reference 3, incorrectly gives $\psi \sin \beta h$ instead of ψ . Hence, for $\beta h \leq \pi/2$ the correct ψ is obtained from the curves of Fig. 11, footnote reference 3, by dividing the ordinates by $\sin \beta h$. Correspondingly, in footnote reference 3, $|\psi_1(0)|$ both in equation (58) and two lines above it should be divided by $\sin \beta h$. No other changes are thereby made necessary in footnote reference 3.

unless a really close correspondence is achieved between the driving conditions implied in the theory and those actually existing in experiment. The impedances calculated from the King-Middleton improvement of the integral-equation method due to Hallén (which implies a generator equivalent to a discontinuity in scalar potential in a continuous conductor) are in as good agreement in *all* significant respects as might be expected with impedances measured using a carefully designed *coaxial line*. They are *not* in agreement with impedances measured using a *two-wire drive with a gap at the center of the antenna*², nor should they be.

In conclusion, the writer wishes to add that he does not concur with Dr. Schelkunoff's view that the brilliant

pioneer work of Hallén is characterized by lack of mathematical care and by improper handling. Science as a co-operative development of human knowledge and understanding of natural phenomena progresses *not* from careless to careful work, but from poorer to better approximations and methods, all carried out properly and with care.

S. A. Schelkunoff:¹⁰ From the point of view of those who have not been following antenna papers very closely, it is to be regretted that Professor King did not include Hallén's first approximation in Tables I and II. After all, this is the approximation which Professor King and his students have used consistently in a series of more than ten papers, beginning with the King and Blake paper¹¹; this is the approximation which is criticized in the paper under discussion as well as in a previous paper¹²; it is the continuous use of this approximation by Professor King that has led to the writing of the paper under discussion; but instead of making a clear statement of his present attitude to the approximation, Professor King cites very recent calculations (January, 1946) by King and Middleton. (A pre-publication copy of this paper came to my attention at the end of 1945 after the proofs of my paper had been sent to the PROCEEDINGS and it was too late to make a reference to it.) His recent value of the antiresonant impedance is only half as large as the original King and Blake value, and is about what it should be. This is very gratifying; but there should be a clear understanding that there exists a wide discrepancy between the theory in the King series of papers and the theory he now quotes in the King-Middleton column.

In Table II, the column marked "Schelkunoff" should have included the qualification "first order"; this is important since most other columns give second-order approximations. This particular column was not calculated in accordance with Schelkunoff's instructions and should not have been used for comparison. For low values of $\Omega = (K_a/60) + 2$ the cap capacitance should definitely be included; unlike Hallén's theory, Schelkunoff's theory permits total exclusion of electric lines of force from the interior of the cylinder either by caps of zero impedance (perfect conductors) or by caps of infinite impedance (hypothetical perfect magnetic conductors). For $K_a \geq 650$ the difference is negligible but not for $K_a = 480$ ($\Omega = 10$).

The experimental value of the antiresonant resistance in the "D. D. King" column of Table II is less than half as large as the one which would be obtained from the R. King and D. D. King paper.¹³

In Table I of the paper under discussion, the

¹⁰ Bell Telephone Laboratories, 463 West Street, New York, N. Y.

¹¹ Ronald King and F. G. Blake, Jr., "The self-impedance of a symmetrical antenna," Proc. I.R.E., vol. 30, pp. 335-349; July, 1942.

¹² S. A. Schelkunoff, "Antenna theory and experiment," Jour. Appl. Phys., vol. 16, pp. 54-60; January, 1944.

¹³ Ronald King and D. D. King, "Microwave impedance measurements with application to antennas II," Jour. Appl. Phys., vol. 16, pp. 445-453; August, 1945.

antiresonant resistances in the column "M. C. Gray" were communicated to me by Dr. Gray. She has informed me that, for $\Omega=10$, the value should have been 750 instead of 680. Dr. Gray and I are very grateful to Professor King for calling attention to this error. The corrected value brings our results closer together for this low value of $\Omega=(K_a/60)+2$, where the two formulas begin to diverge from each other.

I have not had an opportunity to examine closely the recent King-Middleton paper; but looking at the curves, I find that their new results are much closer to mine than the original theory in the King series of papers.

In conclusion, I should like to say that Professor King appears to have misinterpreted some statement of mine, made somewhere, and is ascribing to me a view of Hallén's work which I do not share.

Contributors to Proceedings of the I.R.E.



HARALD T. FRIIS

Harald T. Friis (A'18-M'26-F'29) was born in Denmark on February 22, 1893. He received the Electrical Engineering degree from the Royal Technical College in Copenhagen in 1916 and the Ph.D. degree in 1938. During 1916 he served as an assistant to Professor P. D. Pedersen, and in 1917 and 1918 he was a technical advisor at the Royal Gun Factory in Copenhagen. In 1919, Dr. Friis was made a Fellow of the American Scandinavian Foundation and did graduate work at Columbia University. He joined the research engineering staff of the Western Electric Company in 1920; this became the Bell Telephone Laboratories in 1925 and his work continued in that organization. In 1939 Dr. Friis received the Morris Liebmann Memorial Prize for his investigations in radio transmission including the development of methods of measuring signals and noise and the creation of a receiving system for mitigating selective fading and interference. He served as a director of the Institute from 1941 to 1944.



Arthur O. Kempainen was born on October 14, 1922, at Swan River, Minnesota. He received the B.E.E. degree from the University of Minnesota in December, 1943. He worked with the University of Minnesota as



JOHN W. MCGEE

a research assistant in high voltage until commissioned an ensign in the United States Naval Reserve in May, 1944. Since his assignment to the naval research laboratory in December, 1944, Lieutenant (jg) Kempainen has been an engineer with the Army-Navy precipitation-static project at Minneapolis, Minnesota.

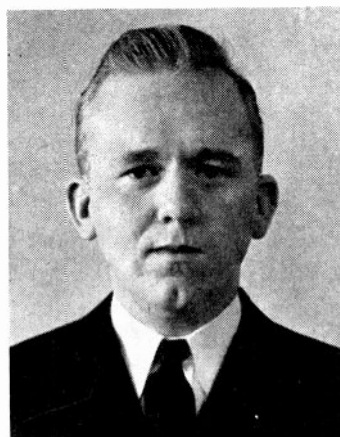

ARTHUR O. KEMPAINEN



S. T. MEYERS

John W. McGee was born on November 29, 1915, at Mt. Pleasant, Tennessee. He was an undergraduate at the Y.M.C.A. College from 1937 to 1941, when he became an associate radio engineer at the aircraft radio laboratory at Wright Field, Dayton, Ohio. He was assigned to the Army-Navy precipitation-static project in 1943, and has continued to work with this group since that time.



S. T. Meyers was born at Nyack, New York, on February 9, 1905. He received the M.E. degree from Stevens Institute of Technology in 1927, and joined the technical staff of the Bell Telephone Laboratories in the same year. As a member of the systems development department he has been doing circuit-design work in connection with voice-frequency and carrier telephone-communication systems. More recently he has been engaged in studies of speech transmission on overseas radio circuits.



Morris Newman was born on September 7, 1909, at Lodz, Poland. He received the

Contributors to Proceedings of the I.R.E.



MORRIS NEWMAN

B.S.E.E. degree in 1931, and the M.S. and E.E. degrees in 1937, from the University of Minnesota. From 1931 to 1933 he was a research consultant in the high-voltage laboratory of the electro-physical institute of Leningrad, U.S.S.R. From 1933 to 1935 he was head of the theoretical division of the same laboratory.

In 1937 Mr. Newman joined the staff of the University of Minnesota, working on lightning research. Since 1943 he has been assistant professor of electrical engineering and associate director of the lightning and transients laboratory.

James P. Parker was born in Asheville, North Carolina, in 1918. He received the B.S. degree in physics from the University

of North Carolina in 1940. After a summer with the aeronautical-instrument section of the National Bureau of Standards, he went to the mechanics and electricity division of the United States Naval Research Laboratory, where he made some of the first flights in the precipitation-static investigation. He was in charge of the Minneapolis branch of the naval research laboratory from its beginning until the fall of 1944, when he returned to Washington as an ensign in the Navy.

J. A. Pierce (SM'45) was born in Spokane, Washington, in 1907. He received the B.A.

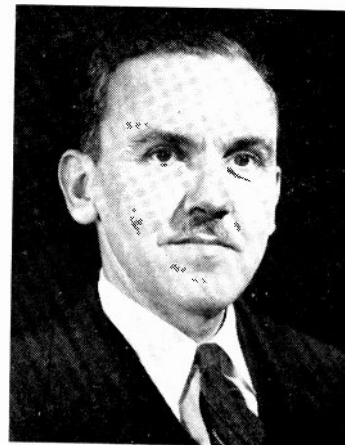

J. A. PIERCE

degree in physics in 1933 from the University of Maine. From 1934 to 1941 he was engaged in research, primarily on the physics of the ionosphere, at Cruft Laboratory, Harvard University. From 1941 through 1945 he was a staff member of the Radiation Laboratory of the Massachusetts Institute of Technology, where he assisted in the development of the Ioran system. He is now a Research Fellow at Cruft Laboratory, working in the fields of radio propagation and long-range pulse transmission and utilization.



JAMES P. PARKER

Corrections

It has been brought to the attention of the Editor that on page 135P of the paper "The Application of Modulation-Frequency Feedback to Signal Detectors," by Geoffrey Builder, which appeared in the March, 1946, issue of the PROCEEDINGS OF THE I.R.E. and WAVES AND ELECTRONS, the expression "milliangstrom per volt" should read "milliamperes per volt." On page 133 P, the four sections of Fig. 4 are not in the proper order. The top section is (a), the bottom section is (b), the one next to the top is (c), and the third one is (d).

Institute News and Radio Notes

BOARD OF DIRECTORS AND EXECUTIVE COMMITTEE

The regular monthly meeting of the Board of Directors was held on March 6, 1946, at the McGraw-Hill Building in New York City. Those present were F. B. Llewellyn, president; E. M. Deloraine, vice-president; G. W. Bailey, executive-secretary; S. L. Bailey, W. R. G. Baker, W. H. Crew, assistant secretary; Alfred N. Goldsmith, editor; V. M. Graham, R. F. Guy, R. A. Hackbusch, Keith Henney, R. B. Jacques, technical secretary; F. R. Lack, Haraden Pratt, secretary; G. T. Royden, D. B. Sinclair, W. O. Swinyard, H. M. Turner, W. L. Webb, and W. C. White, treasurer.

On March 5, 1946, the Executive Committee held its regular monthly meeting at the McGraw-Hill Building, and was attended by F. B. Llewellyn, president; G. W. Bailey, executive secretary; W. H. Crew, assistant secretary; Alfred N. Goldsmith, editor; R. F. Guy, Keith Henney, R. B. Jacques, technical secretary; and W. C. White, treasurer.

BROADCAST ENGINEERING CONFERENCE

Radio's wartime technical advances were the subject of a meeting among leaders in the technical and production phases of radio when the Ohio State University and the University of Illinois cosponsored the Sixth Annual Broadcast Engineering Conference in Columbus, Ohio, on March 18 to 23. The meeting was sponsored jointly by the electrical engineering departments of both universities, with W. L. Everitt (A'25-M'29-F'38), head of the Illinois department, as director, and E. M. Boone (A'43) of Ohio State's department as associate director. Meetings alternated between Columbus and Urbana, Illinois. Also co-operating in the Conference were the Institute of Radio Engineers and the National Association of Broadcasters.

New equipment and manufacturers' products were displayed, and a discussion of wartime developments in improved techniques and the use of new materials given. Among the speakers leading various symposia and round-table talks were A. B. Chamberlain (A'27-M'30-F'42), chief engineer, Columbia Broadcasting System, whose topic was "Contributions of War Developments to Broadcasting"; L. C. Smeby (A'27-M'42-SM'43), associate director, operational research staff, office of the Chief Signal Corps Officer, United States War Department, who led a symposium on recording techniques; and C. E. Nobles (SM'45) of Westinghouse Electric Corporation and W. K. Ebel of Glenn L. Martin Aircraft Company, whose topic was stratovision.

Other speakers at the Conference included A. J. Ebel (J'33-A'35-M'43-SM'43), chief engineer, University of Illinois Radio Service; G. H. Brown (A'30-VA'39-F'41), research engineer, Radio Corporation of America; E. J. Content (M'39-SM'43),

Prospective Authors

The Institute of Radio Engineers has a supply of reprints on hand of the article "Preparation and Publication of I.R.E. Papers" which appeared in the January, 1945, issue of the PROCEEDINGS OF THE I.R.E. AND WAVES AND ELECTRONS. If you wish copies, will you please send your requests to the Editorial Department, The Institute of Radio Engineers, Inc., 26 West 58th Street, New York 19, New York, and they will be sent to you with the compliments of the Institute. It would be greatly appreciated if your requests were accompanied by a stamped, self-addressed envelope.

WOR; George Sinclair (A'37), department of electrical engineering, Ohio State University; R. E. Shelby (A'29-M'36-SM'43), National Broadcasting Company; W. W. Salisbury (SM'44), Collins Radio Company; P. B. Laeser (A'41-M'44), *Milwaukee Journal* Company; R. C. Higgy (A'26-VA'39-SM'45), director of WOSU, Ohio State University; D. B. Sinclair (J'30-A'33-M'38-SM'43-F'43), General Radio Company; Frank Gunther (A'25-M'30-SM'43), Radio Engineering Laboratories; H. R. Summerhayes, Jr. (A'36), General Electric Company; R. M. Wilmotte (M'38-F'38), consulting engineer; Howard S. Frazier (M'43-SM'43); and W. L. Everitt.

RADAR COUNTERMEASURES

The major role that Stanford University played in the development of radar countermeasures at Harvard University's Radio Research Laboratory was recently revealed. The entire project was under the supervision of F. E. Terman (A'25-F'37), dean of Stanford's School of Engineering, who organized the staff of 270 scientists in 1942.

Some of the results of the work performed by Dr. Terman and his staff included the reduction by 75 per cent of the effectiveness of German anti-aircraft fire; the confusion to the enemy on D-Day as a result of the Allied radar blitz; and the boomerang made of Axis radar so that the enemy often ceased using radar lest it betray their own positions. The Allied radar countermeasures developed were of two general types: aluminum foil, called "window," and electronic detectors and jammers. It is estimated that Allied air forces dropped more than 20 million pounds of foil strips over Europe alone. A six-ounce bundle of 6000 strips was so "tuned" that when enemy radar recorded the false echoes, it looked on the radar scope like three heavy bombers and enemy gunners fired at the foil strips instead of Allied planes.

Among the faculty members working with Dr. Terman included Karl Spangenberg (A'34-SM'45), head of a group responsible for research and development of micro-

wave oscillators and filters; S. W. Athey (S'41-A'45), head of the motion-picture group which made training films; and O. G. Villard, Jr. (S'38-A'41), member of the liaison division at the Laboratory and in the European theater of operations with the United States strategic air forces.

COMMITTEES

At the March 6, 1946, meeting of the Board of Directors, it was unanimously approved to modify Bylaw Section 46, proposed on February 15, 1946, to combine the Industrial Electronics and Medical Electronics Committees and to call it the Industrial Electronics Committee. The formation of a new technical committee on Navigation Aids was approved.

Raymond F. Guy was appointed chairman of a committee to present suggestions for the establishment at One East 79th Street of suitable ways and means of honoring appropriately the founder members of the Institute.

James E. Shepherd was appointed by the Executive Committee on March 5, 1946, to the chairmanship of the Convention Policy Committee. This committee will bring recommendations to the Executive Committee concerning policies, dates, appointments, and selection of subcommittee chairmen. The other members of this committee are E. J. Content, Austin Bailey, B. E. Shackelford, and G. W. Bailey.

SECOND NATIONAL ELECTRONIC CONFERENCE

The Second National Electronic Conference sponsored by the Illinois Institute of Technology, Northwestern University, and the Chicago Sections of The American Institute of Electrical Engineers and The Institute of Radio Engineers with the co-operation of the Chicago Technical Societies Council and the University of Illinois will be held at the Edgewater Beach Hotel in Chicago from October 3 to 5, 1946, inclusive.

The nation's outstanding authorities on the theory and applications of this ever-broadening science will be heard in morning, afternoon, and evening sessions scheduled for each of the three days. Panel discussions will be arranged on an industry basis so that delegates may concentrate on their special fields of interest. Details of the program will be announced as fast as final arrangements can be made.

COUNTERRADAR TECHNIQUE

At the Radio Club of America meeting on June 10 at Columbia University, New York, Oswald G. Villard, Jr. (S'38-A'41), research associate of the Radio Research Laboratories, Cambridge, Massachusetts, will disclose the counterradar technique developed and used against our enemies during the war. He will tell how equipment designed to jam, confuse, and take advantage of enemy radars was so successful that thousands of lives and hundreds of bombers were saved.

REGIONAL-COMMITTEE SUCCESS IS ASSURED

That valuable benefits are offered the Sections forming the Regional Committee as planned by the Regional-Representation Plan was again evidenced by the success and enthusiasm of the second Midwest Intersection Conference held in Chicago on February 8, 1946. The first Intersection Conference was held in Chicago last year, July 20. The activities of both conferences corresponded to the Regional-Committee function of discussing the affairs of the Sections of the region as expressed in the Regional-Representation Plan presented to the Committee on Sections at the New York Winter Technical Meeting in January. Cullen Moore introduced the delegates from Cedar Rapids, Chicago, Cincinnati, Detroit, Fort Wayne, Kansas City, Milwaukee, and Twin Cities. The Dayton, Indianapolis, and St. Louis Sections were unable to send delegates.

W. O. Swinyard discussed national Institute activities and presented interesting data relative to the distribution of members in various grades and also the various educational qualifications of members in each of the grades. As a result of this information, the Conference agreed to initiate in each of the Sections a campaign for transferring Voting Associates to the higher grades.

The Conference also recommended improving the form of the annual financial reports of the Sections so that they would compare regular meeting expenses directly against Institute refunds, and also show how much of the deficit and expense is met by the initiative of the Sections in raising additional funds for their activities.

H. E. Kranz explained the operation of the Detroit Engineering Society and the advantages gained from affiliation by the Detroit Section. Where fifteen per cent of the membership of the society are individ-

ually members of the Detroit Engineering Society, the Section or Chapter is granted affiliated status. The following discussion brought out that Cincinnati is using a similar plan, but the Chicago Technical Societies Council operates on a totally different basis. Milwaukee is carefully considering whether or not to join in an engineering-society council now being formed there.

J. A. Green presented an interesting viewpoint on Section activities and problems. He suggested an extension of the co-ordinated program scheduling of speakers resulting from the previous conference, and endorsed the traveling-lecture plan. He called attention to the problems of giving service to members where, as in the case of Cedar Rapids, several centers of interest are located within convenient traveling distance. Thus far, the solution seems to lie in holding some of the Section meetings in these different centers. Consideration must be given to possible problems arising where the new territorial limits effective the first of this year greatly increase the Section area. If at all possible, the newly included members should be given some service or activities in addition to receiving Section meeting announcements.

The remainder of the meeting was devoted to discussion led by Alois W. Graf covering various activities. If the Sections are to give more serious consideration to Institute problems, it appears advisable to give greater publicity to the problems in our publications. It would be particularly beneficial if principal activities and problems of the various Institute committees were reported in an interesting manner in WAVES AND ELECTRONS. The actions of the Sections Committee in January are of vital interest not only to those who attended, but to every active I.R.E. member. Similarly, the activities of other committees such as Education, Membership, Public Relations, and the like

should be given publicity. In the past, the annual YEARBOOK reported activities, but in recent years no reports or summaries have been published. The Conference recommended appropriate action to correct this deficiency.

The suggestion of the Education Committee that each Section have an Education committee was considered. Such committee, depending upon local conditions, would participate in any or all of the following:

1. Co-operate with near-by technical educational groups, colleges, and schools in guiding curricula;
2. Co-operate with students in high schools, technical schools, and colleges by informing them of our profession;
3. Assist and establish student sections;
4. Establish lecture courses; and
5. Co-operate with local libraries in selecting the best technical reference books within their budget.

On the basis of the recently received lists of speakers and topics available forwarded by headquarters to the secretaries, each Section will select preferences for speakers and send them to J. A. Green. The most popular topics and speakers will then be scheduled so that speakers can visit several sections in one itinerary. The plan is to be placed into effect for the April and May meetings and is to be continued on a larger scale next fall.

The Intersection Conference which lasted half a day preceded the Chicago Technical Conference and banquet which on the following day was attended by the Section delegates. The next meeting of the Midwest Sections is to be a six-hour session May 15, 1946. Each Section will suggest to Mr. Graf matters for the agenda which will be prepared and mailed to all delegates in advance of the next meeting. Another meeting is also planned for the first week in October just prior to the National Electronics Conference.



MIDWEST INTERSECTION CONFERENCE

Those attending the Midwest Intersection Conference held in Chicago on February 8, 1946, were, left to right: W. O. Swinyard (A'37-M'39-SM'43-F'45), Chicago; Ralph Glover (A'28-SM'44), Chicago; M. E. Knox (A'31-M'45), Twin Cities; H. Salinger (A'37), Ft. Wayne; Theodore A. Hunter (M'45), Cedar Rapids; R. N. White (S'40-A'41-M'45), Kansas City; Phil Laeser (A'41-M'44), Milwaukee; J. A. Green (S'39-A'42-M'45), Cedar Rapids; H. E. Kranz (M'23), Detroit; L. E. Packard (M'41-SM'43), Chicago; Don Haines (A'43-SM'45), Chicago; Cullen Moore (A'37-SM'44), Chicago; and Alois W. Graf (A'26-M'44-SM'45), Chicago, not in picture.



W. G. H. FINCH

RICHARD E. MATHES AND W. G. H. FINCH

Captain W. G. H. Finch (J'16-A'18-M'25-SM'43), United States Naval Reserve, recently re-elected president of Finch Telecommunications, Inc., has announced that Lieutenant Richard E. Mathes, United States Naval Reserve, has joined the company in the capacity of chief engineer and plant manager.

Mr. Mathes has recently been released from active duty in the Navy's Bureau of Ships, where he assisted Captain Finch in the development and design of special electronic equipment for ships and aircraft of the fleet. Mr. Mathes has been engaged in the development of facsimile equipment with RCA Laboratories since 1925.

Owner of the new frequency-modulation broadcasting station WGHF, Captain Finch was awarded the Legion of Merit medal by President Truman on March 7, 1946. The citation reads as follows: "For exceptionally meritorious conduct in the performance of outstanding service to the Government of the United States as Head of the Counter-



RICHARD E. MATHES

measures Design Section, Electronics Division, Bureau of Ships, from December 1, 1941, to September 1, 1945. Directly in charge of research, development and design of countermeasure electronic systems, Captain Finch was personally responsible for the basic organization and effective implementing of a program which played a vital part in the successful prosecution of the war. His enthusiasm and tenacity of purpose resulted in the successful performance of a task of great magnitude and importance to the welfare of the United States."



GEORGE L. HALLER

Colonel George L. Haller (A'28-M'36-SM'43), special assistant to the chief of the electronics subdivision, Wright Field, Ohio, has been named assistant dean of the School of Chemistry and Physics of Pennsylvania State College. A graduate of Mercersburg Academy in 1924, he received his B.S. degree in electrical engineering in 1927, his professional degree in electrical engineering in 1934, his M.S. degree in physics in 1935, and his Ph.D. degree in physics in 1942, all from Pennsylvania State College.

From 1926 to 1929, Colonel Haller was employed as a radio engineer with Westinghouse Electric and Manufacturing Company (now Westinghouse Electric Corporation), and from 1929 to 1933, he was an engineer with E. A. Myers and Sons. Two years later, he went to Wright Field to work on aircraft communications; in 1942, as senior radio engineer of the communication and navigation division of the Aircraft Radio Laboratory, he was commissioned a major in the United States Signal Corps and made assistant chief of the division. Later that year, he organized and directed the research division and was responsible for ultra-secret radio and radar countermeasures, submarine detection from aircraft, and radio and radar control of guided missiles.

In 1943, Colonel Haller was assigned to duty in Trinidad involving the detection of enemy submarine by airborne magnetic detectors. He was then assigned to the Northwest African Air Forces where he led the radar countermeasures group consisting of three investigational aircraft and sixteen bombers containing the first installation of electronic jamming devices to be used in an operational theater. He became attached to Advanced Headquarters, NAAF, to plan and execute the jamming of enemy Wurzburg radar systems. The entire Army Air Forces program for radio and radar control of guided missiles was placed under Colonel Haller's direction in 1944. The following year, he was sent to Tokio as chief of the electronic section, Air Technical Intelligence, Far East Air Forces, to engage in assessing the worth of the electronics phases of our war against the Japanese and to determine the progress of Japanese scientists in this field. He returned to Wright Field in January of this year to work on postwar tests of the latest weapons.

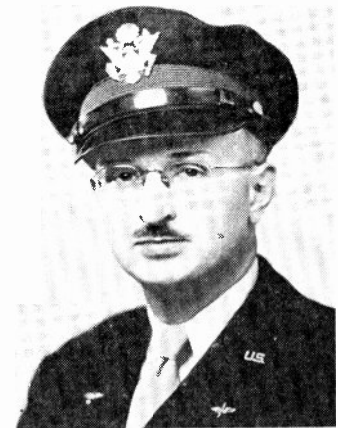

GEORGE L. HALLER

A Fellow of the American Physical Society, Colonel Haller is a member of the Institute of Electrical Engineers, the Institute of Aeronautical Sciences, the Franklin Institute, the Society for the Promotion of Engineering Education, and the Binaural Sons of the C (antisubmarine workers of World War I and II). He is also a member of Sigma Xi, Sigma Pi Sigma, Tau Beta Pi, Eta Kappa Nu, Pi Mu Epsilon, and Sigma Pi.



WEBSTER F. SOULES

Lieutenant Colonel Webster F. Soules (A'46) has been appointed sales manager of the South Bend, Indiana, plant of Electro-Voice, Inc. After graduation from the University of Minnesota School of Electrical Engineering and a period of seventeen years' service with the Northern States Power Company, Colonel Soules entered military service in 1940.

At the Fort Monmouth, New Jersey, Signal Corps Laboratories, and as Signal Corps member of the Armored Force Board, Fort Knox, Kentucky, he engaged in developmental work on radio apparatus and



WEBSTER F. SOULES

I.R.E. People

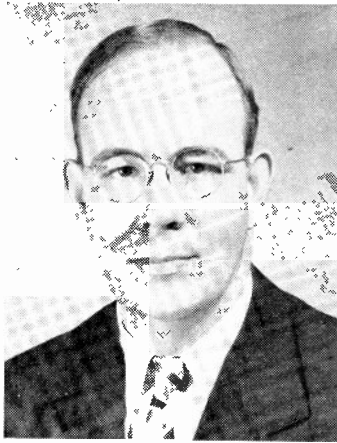

THOMAS C. STEPHENS

installations in Armored Force vehicles. He was appointed engineering and executive officer of the Armed Force's signal section, and the following year, he was graduated from the Command and General Staff School at Fort Leavenworth, Kansas. Colonel Soules commanded a signal service battalion in Ceylon to provide communication for the Supreme Allied Commander, southeast Asia command, after which he was located in China as signal officer, Tactical Headquarters. At the termination of war in the Pacific, he became executive officer of the China staging area.

During his amateur radio work, Colonel Soules was president of the Minneapolis Radio Club and was active in the American Radio Relay League and the Army Amateur Radio Service.

IRVING F. BYRNES

Irving F. Byrnes (A'23-M'39-SM'43) has been elected vice-president in charge of engineering of Radionarine Corporation of America according to a recent announcement by Charles J. Pannill (F'29), president of the corporation. Mr. Byrnes has been the company's chief engineer since 1930.



IRVING F. BYRNES

THOMAS C. STEPHENS AND ARTHUR H. WULFSBERG

Thomas C. Stephens (A'44) and Arthur H. Wulfsberg (S'41-A'44) have recently joined the research division of Collins Radio Company, Cedar Rapids, Iowa.

Formerly a radio and electrical engineering instructor and a research engineer for the physics engineering development project at the University of Iowa, Mr. Stephens was associated with radio proximity-fuze development. Mr. Wulfsberg, a graduate of the University of Minnesota, was engaged in radar and loran equipment design and production at Sylvania Electric Products, Inc. He is a member of the American Institute of Electrical Engineers, Eta Kappa Nu, and Tau Beta Pi.

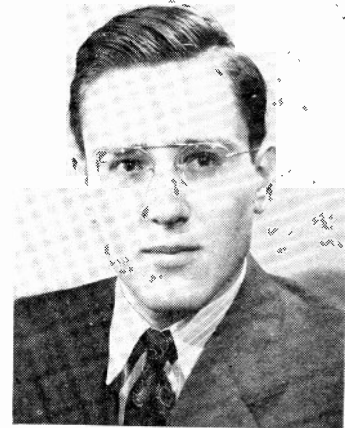

ARTHUR H. WULFSBERG

GARRARD MOUNTJOY

Garrard Mountjoy (A'37-M'40-SM'43) has recently been appointed vice-president in charge of engineering of the Electronic Corporation of America, New York, New York. Mr. Mountjoy, holder of numerous patents on radio and television design, was chief engineer of the Sparks Withington Company; head of the license consulting section of the Radio Corporation of America's License Laboratories; and director of radio research and development and director of the New York laboratories of Lear, Inc. A recipient of the "Modern Pioneer" award of the National Association of Manufacturers, he participated in development work on the loran navigation system during the war.

SAMUEL GUBIN

Samuel Gubin (A'35-SM'44) has joined the staff of Spectrum Engineers, Inc., a newly organized engineering and consulting firm located in Philadelphia, Pennsylvania. As vice-president in charge of engineering, he will be responsible for electronic equipment design and development. Mr. Gubin, vice-chairman of the Philadelphia Section of The Institute of Radio Engineers, was formerly associated with the Radio Corporation of America at Camden, New Jersey, where he supervised the aviation advance development section and the microwave beacon group.

HARRY E. RICE

Harry E. Rice (SM'45) has been named assistant chief engineer of the radio division of Lear, Incorporated. He assumes complete charge of home radio, aircraft radio, and television production, and will be located at Grand Rapids, Michigan. Mr. Rice was formerly affiliated with Radio Marine Corporation, Stromberg-Carlson Company, and Sprague Electric Company.

ROBERT R. BUSS AND JOHN LYON

Robert R. Buss (S'37-A'42-M'45) and John Lyon (A'42) have been appointed assistant professors of electrical engineering at the Technological Institute of Northwestern University, Evanston, Illinois. Mr. Buss was with the radio research laboratory at Harvard University, and Lieutenant Lyon has recently been discharged from the United States Navy.

HERBERT C. FLORANCE

The appointment of Herbert C. Florance (M'45) as chief engineer of the newly established broadcast station WGHF in New York City was recently announced by Captain W. G. H. Finch (S'16-A'18-M'25-SM'43), owner of the station. Mr. Florance was associated with the National Broadcasting Company and station WNYC, and he later became affiliated with the countermeasures section of the electronics division, Bureau of Ships, United States Navy.



HERBERT C. FLORANCE

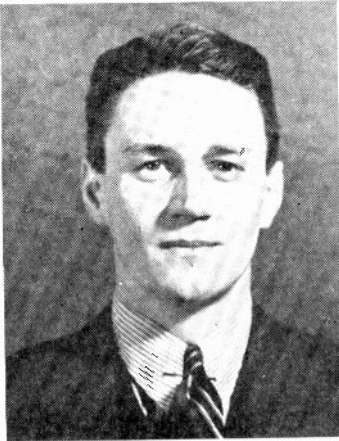

L. E. PACKARD

H. H. SCOTT AND L. E. PACKARD

Among the directors of Technology Instrument Corporation, Waltham, Massachusetts, newly organized for electronic and laboratory equipment development and manufacture, are H. H. Scott (M'35-SM'43), president, in charge of technical development, and L. E. Packard (M'35-SM'43), treasurer, in charge of sales engineering.

Mr. Scott received his S.M. degree from Massachusetts Institute of Technology in 1931 and, since that date, has been associated with the General Radio Company as executive engineer. He developed that company's sound- and vibration-measuring equipment frequency-modulation and broadcast-station-monitoring equipment, and radio-frequency and audio measuring instruments. A Fellow of the Acoustical Society of America, Mr. Scott is a member of the American Institute of Electrical Engineers and an Associate Member of the Society of Motion Picture Engineers. He received the "Electrical Manufacturing" product-design award in 1937 and 1939.



IVAN G. EASTON

Mr. Packard received his S.B. degree in electrical engineering from The Massachusetts Institute of Technology in 1935, after which he joined the General Radio Company to engage in development and sales engineering. He became, successively, district manager of the company's New York and Chicago engineering offices and has specialized in the study of sound and vibration-measuring techniques and nondestructive testing of insulation, dielectrics, and bridge methods. Secretary of the Chicago Section of The Institute of Radio Engineers for 1945, Mr. Packard is a member of the Radio Engineers Club of Chicago, a Fellow of the Radio Club of America, and a member of the American Institute of Electrical Engineers.

EUGENE H. FRITSCHEL

Eugene H. Fritschel (A'40) has been named manager of sales of General Electric Company's tube division, electronics department, with headquarters in Schenectady, New York.

Mr. Fritschel was graduated from Iowa State College in 1926 with a B.S. degree in electrical engineering and later that year joined General Electric as student engineer on the test course. In 1927, he went to Uruguay, South America, as construction foreman to install radio transmitting equipment, and upon returning to this country, he performed development work at Schenectady. In 1929, he was transferred to the radio (now electronics) department where he handled radio transmitter and industrial electronic tube sales. Mr. Fritschel is a member of Eta Kappa Nu.

IVAN G. EASTON AND KIPLING ADAMS

Ivan G. Easton (S'39-A'41-SM'45) has been appointed manager of General Radio Company's New York engineering and sales office, and Kipling Adams (A'41) has been named manager of the company's Chicago office.

Mr. Easton received his B.S. degree in electrical engineering from Northeastern University in 1938 and his M.S. degree from Harvard University in 1939. He then joined General Radio Company's engineering staff, working in the development engineering and sales engineering groups. During the war, he taught engineering sciences and engineering war training courses in radio engineering at Northeastern University. Program chairman for the Boston Section of the I.R.E. for the past two years, Mr. Easton is a member of the American Institute of Electrical Engineers, the Society for Experimental Stress Analysis, and company representative of the American Society for Testing Materials.

Mr. Adams, associated with the General Radio Company since 1934, received his technical education at the Massachusetts Institute of Technology. He was formerly assistant manager of the service department.



H. H. SCOTT

MERLE A. TUVE

Dr. Merle A. Tuve (A'45-F'45), director of the applied physics laboratory at Johns Hopkins University and a scientist on the War Department's Manhattan project atom-bomb undertaking, discussed the proximity fuze and other scientific achievements of the war on the program "Adventures in Science" presented February 23, 1946, over station WABC, New York, of the Columbia Broadcasting System. He was interviewed by Watson Davis, CBS science editor.

J. HOWARD WRIGHT

J. Howard Wright (A'41) has been appointed to the technical staff of Battelle Memorial Institute, Columbus, Ohio, to engage in industrial physics research. He received his B.S. and M.S. degrees from the University of Nebraska and attended both York College and Pennsylvania State College. Formerly associated with the Naval Research Laboratory, Washington, D. C., Mr. Wright is a member of the American Physical Society, Pi Mu Epsilon, and Sigma Xi.

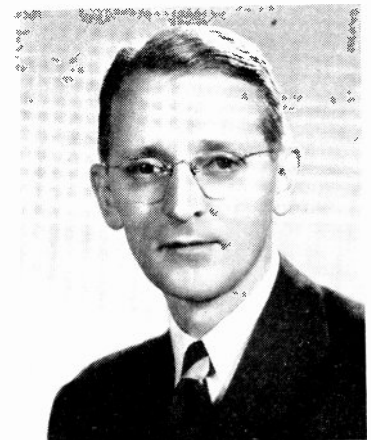

KIPLING ADAMS

I.R.E. People

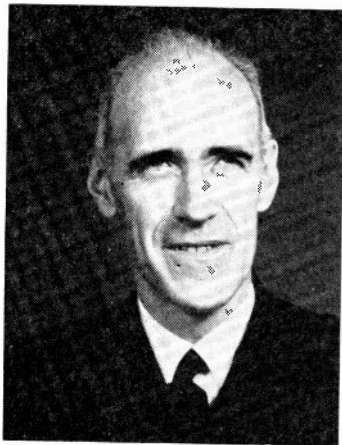

RALPH DECKER BENNETT

RALPH DECKER BENNETT

Captain Ralph Decker Bennett (SM'44), United States Naval Reserve, was awarded the Legion of Merit medal for his services as technical director of the Naval Ordnance Laboratory, Washington, D. C. Prior to this, he received the decoration of Honorary Officer of the Military Division of the Most Excellent Order of the British Empire from Lord Halifax at the British Embassy. Captain Bennett left Massachusetts Institute of Technology to begin active duty in the Naval Reserve in 1940.



ARTHUR F. VAN DYCK RECEIVES MEDAL

Commander Arthur F. Van Dyck (A'13-M'18-F'25), United States Naval Reserve, has been awarded the Legion of Merit medal by Secretary of the Navy James Forrestal, acting for President Truman. Rear Admiral Monroe Kelly made the presentation on February 14, 1946, and the citation reads as follows: "For exceptionally meritorious conduct in the performance of outstanding services to the Government of the United States as Officer-in-Charge of Navigational Aids in the Office of the Chief of Naval Operations during the period from April 19, 1943, to October 1, 1945. Exercising initiative and sound judgment, Commander Van Dyck successfully developed and established the Long-Range Electronics Navigational Aids system in the United States Navy and, developing universal operating methods and procedures, formulated world-wide plans for Loran installations. Contributing materially to the successful completion of vital combat operations by co-ordinating such plans with the United States Army and the military forces of our Allies Commander Van Dyck greatly increased the striking efficiency of the Allied forces."

Commander Van Dyck received his Ph.B. degree from Yale University in 1911. He joined the Radio Corporation of America in 1919 and became manager of the technical and test department in 1929. Appointed manager of RCA's Industry Service Laboratory in 1930, he directed its activities until called to service with the Navy in 1943.

Following his release from duty early this year, Commander Van Dyck was appointed assistant to the executive vice-president in charge of RCA Laboratories division. A recipient of the National Association of Manufacturers' Modern Pioneer Award in 1942, he was president of The Institute of Radio Engineers in 1942.



WILLIAM E. BRADLEY

William E. Bradley (SM'45) has recently been named research director of the Philco Corporation, Philadelphia, Pennsylvania. After graduation from the University of Pennsylvania's Moore School of Electrical Engineering, Mr. Bradley joined Philco in 1936 to serve as factory test engineer in the radio receiver production department. In 1937, he became research engineer in the television engineering department, assisting in the design of wide-band amplifiers for experimental television receivers and contributing to the development of a new amplifier theory.

Later, Mr. Bradley was placed in charge of the advanced-research section of Philco's research division, and in 1945, he was appointed assistant director of the division. A holder of numerous patents and patent applications in the frequency-modulation radio, television, and radar fields, Mr. Bradley is a member of Tau Beta Pi and Sigma Xi.



P. B. ALGER

P. B. Alger (A'42) has joined Sprague Electric Company, North Adams, Massa-



WILLIAM E. BRADLEY



chusetts, as application engineer. A graduate of the Massachusetts Institute of Technology, Mr. Alger was an engineer for the New England Power Company prior to his service with the United States Navy. As Lieutenant Commander, he had charge of naval inspection at Stromberg-Carlson Company's Buffalo, New York, plant.



CORRECTION

On page 151W of the March, 1946, issue of the PROCEEDINGS OF THE I.R.E. and WAVES AND ELECTRONS, the gentleman shown accepting the Fellow Awards is not Dr. Julius A. Stratton but is Mr. C. W. Hansell.



ADMIRAL KELLY PRESENTS MEDAL TO COMMANDER VAN DYCK

Books

Network Analysis and Feedback Amplifier Design, by Hendrik W. Bode

Published (1945) by D. Van Nostrand Co., Inc., 250 Fourth Ave., New York, N. Y. 529 pages+21-page index+xii pages. 430 illustrations. $9\frac{1}{2} \times 6\frac{1}{2}$ inches. Price \$7.50.

This new book was originally written as the text for one of the Bell Telephone Laboratory "out-of-hour" courses. The text considers the complex field of analysis and synthesis or design of passive circuits, and both nonfeedback and feedback amplifiers; particularly of the wide-band type. The communication engineer whose mathematical foundation has been well laid and well used, will find this advanced text to be an authoritative and up-to-date contribution to the field of network-theory application. Because much of the material in the book has not been presented in previous texts and because of the mathematical and fundamental character of all of the material, the book demands slow and careful study rather than quick, easy reading.

The first chapter considers the conventional theory of the analysis of networks (both passive and containing vacuum tubes) by means of mesh and node equations and the determinant method of solution.

The importance of the poles and zeros of the driving point and transfer impedances and admittances of a network are considered in Chapter 2. These poles and zeros are, in general, complex numbers and in order to plot them on a graph, the concept of real and imaginary co-ordinates of the "complex frequency" plane are introduced.

For the engineer who unfortunately has tried to conceive of the action of a complex multiple-loop feedback circuit (i.e., more than one feedback path) in terms of the simple μ and β circuits, Chapters 3 to 6 of this text will be welcomed with open arms. In these chapters, a general feedback theory is developed in terms of the mesh or nodal equations for the overall circuit. Two important mathematical definitions introduced are the "return-voltage difference" for a feedback circuit, and the "sensitivity" of a feedback circuit to changes within the circuit. Consideration is given to the effect of these two characteristics upon the input and output impedance of amplifiers, reduction of distortion, external gain, noise level, etc.

In Chapters 7, 9, 10, 11, and 12, the properties of the poles and zeros of network functions in the complex plane are used to develop a method of synthesizing networks to produce desired input impedances and desired transfer impedances. Chapter 7 considers the restrictions which must be placed upon the driving-point and transfer impedances or admittances, the "return difference," and the "sensitivity" and upon the location of the zeros and poles of these network functions in the complex frequency plane if the circuits which they specify are to be physically realizable and stable. In Chapter 9, the method developed by Brune (using resistance reduction and reactance reduction) to find a physical network which

produces a desired impedance function is described. Some properties of the two types of negative resistance (short-circuit stable and open-circuit stable) are considered. Chapter 10 shows that so long as the requirements of Chapter 7 upon the poles in the complex plane are satisfied, a general driving-point function can be represented by a number of simple impedances in series or parallel. The method is given for reconstructing the complete passive network from a knowledge of either the resistance or reactance component of minimum resistance and reactance networks. Also considered in this chapter is the transformation of the frequency variable of an equation whereby, for example, a band-pass circuit and response can be obtained from a low-pass structure and response. Chapters 11 and 12 deal with the problem of synthesizing networks to produce a desired transfer impedance by considering the properties of the poles and zeros of the desired function. These chapters show the close parallelism between the resistance and reactance of driving-point impedances considered in Chapters 9 and 10 and the attenuation and phase shift of transfer impedances.

In all the chapters mentioned in the above paragraph, the properties of network functions in the complex-frequency plane are considered, whereas in practical design considerations we are interested in only the real-frequency characteristics. Therefore, in Chapters 8, 13, 14, and 15, Dr. Bode makes use of Cauchy's theory of integration in the complex plane to transform the complex-frequency properties into equivalent properties at real frequencies. In Chapter 8, the mathematical tools supplied by Cauchy's theory are considered and as one application of the theory the familiar Nyquist diagram method of determining stability is developed. In Chapters 13 and 14, useful relationships between the real and imaginary components of network functions are given in terms of contour-integral formulas and in Chapter 15 a set of charts is presented to aid in the approximate computation of attenuation-phase relations.

In Chapters 16 and 17, the general methods and contour-integral formulas developed in the preceding chapters are applied to specific problems in amplifier design. Chapter 16 considers input and output circuit design. The maximum response which can be obtained over a given band with the best possible input or circuit is considered for the case where the designer is forced to accept a shunt capacitance or a capacitance and resistance in parallel. Chapter 17 deals with interstage circuit design. Two-terminal interstages are examined principally by means of a theorem which relates the gain of a two-terminal interstage in the useful pass band and its phase shift beyond the band to the parasitic capacitance in the circuit. Four-terminal interstages are considered more briefly because, in a feedback amplifier, four-terminal interstages produce phase shifts of such magnitudes that it becomes hard to satisfy the necessary conditions for stability. The chapter ends with a set of useful charts giving the exact variation with frequency of the magnitude and phase angle of the input impedance to the high-frequency compensation networks whose configuration is that of one-half sec-

tion and a complete section of a low-pass filter; the latter case is considered for input and output capacitance ratios between 2 and $\frac{1}{2}$.

The final two chapters of the book, Chapters 18 and 19, deal with the over-all design of single-loop feedback amplifiers which are absolutely stable (i.e., the loop phase shift does not exceed 180 degrees until the gain around the loop has been reduced to unity or less). Ideal and asymptotic cutoff characteristics are considered, and the methods for achieving a desired cutoff characteristic are discussed. Also given are formulas for the maximum obtainable feedback. A number of specific examples of feedback-amplifier designs are given in Chapter 19.

In a book written by a mathematician of Dr. Bode's caliber, which has also been given the effective editing resulting from its use in the classroom, one can be sure that the chance of finding technical errors is practically nil. One very minor point noted by this reviewer occurs on pages 64 and 65 where a resistor in Fig. 4.9 is called an output impedance instead of a load impedance. Also, in the section on negative resistances in Chapter 9, it would be helpful to add a circuit to Fig. 9.8 showing a simple circuit which produces negative resistance of the open-circuit stable type.

Most probably one of the major uses of this book will be as one of the texts of graduate communication engineering courses.

MILTON DISHAL
Federal Telecommunications
Laboratories, Inc.
Nutten, New Jersey

Radar, by Orrin E. Dunlap, Jr.

Published (1946) by Harper and Brothers, 49 E. 33 St., New York 16, N. Y. 203 pages+5-page index+xiv pages. 30 illustrations. $5\frac{1}{2} \times 8\frac{1}{2}$ inches. Price, \$2.50.

The author's purpose is "to give a popular version [of radar] without equations or technical language, so that the layman may appreciate the significance of radar . . ." The book fulfills this purpose, and many portions furnish fascinating reading, even for engineers. As it is intended primarily for the public, the few technical errors noticeable to radar engineers are of little importance.

The history of radar and its accomplishments in World War II are reviewed. War-time press releases are quoted. The explanation that there is no single inventor of radar is excellent, with proper credit being given to the many scientists who made radar possible.

Radar applications described include ground, shipboard and air search, fire control, blind bombing, proximity fuze, aerial and marine navigation, blind landing, surveying and mapping, and radar counter-measures.

The text is well written, easily read, and up to date. This book apparently is the first in the United States pertaining to the history and background of radar. It is a valuable nontechnical contribution to inform the general public on one of the great scientific and production achievements of our time.

LOREN F. JONES
Radio Corporation of America
Camden, N. J.

Books

Television Programming and Production, by Richard Hubbell

Published (1945) by Murray Hill Books, Inc., 232 Madison Avenue, New York 16, N. Y. 203 pages+3-page index+xii pages. 70 illustrations. $9\frac{1}{4} \times 6\frac{1}{4}$ inches. Price, \$3.00.

The purpose of his newest book, Mr. Hubbell states in the preface, is to "provide a foundation for the techniques of television program production." This Dick Hubbell does very thoroughly and in an interesting fashion.

Of the six parts into which the book is divided, four are important, namely: "The Nature of Television," "The Camera," "Video Technique and Theory," and "The Audio." Each of the sections is well illustrated.

The most interesting section, to a student of production, is his discussion of camera techniques, which is charmingly and aptly illustrated with cartoon-style pen drawings. Because it is in camera techniques that lie the crux of good television production, both from the studio and producer's point of view, this section with its seven chapters is well worth careful study.

His chapter on "Video Effects and Lighting," should be of special interest to engineers. In this chapter, Mr. Hubbell capably covers the various types of lighting and devices used in television to achieve special effects.

To radio and sound engineers, Hubbell's chapter on "Realism and Acoustic Perspective," is especially recommended.

A major criticism of the book is Hubbell's running apology for today's television. He explains again and again that the photographs and techniques he describes were all based on prewar or wartime equipment. This tends to date the book in the reader's mind, although the basic concepts have changed little, if any at all.

Hubbell's major conclusions are:

1. Studios must be intelligently and flexibly arranged.
2. Studios must be much larger than anything yet in existence, approximating the size of Hollywood sound stages.
3. Greater stress must be placed on the mobility of the camera.
4. Television lighting must be improved.
5. Cameras must be lighter and more sensitive.

Many of Hubbell's conclusions have already found expression in the design of new television equipment, pickup, tubes, and studios.

To every person with vision, Hubbell's book is recommended reading.

IRWIN A. SHANE
Editor-in-Chief
Televiser Magazine
New York, N. Y.

SECTIONS

| Chairman | | Secretary |
|---|--|--|
| | ATLANTA May 17 | M. S. Alexander 2289 Memorial Dr., S.E. Atlanta, Ga. |
| R. N. Harmon 1920 South Rd. Mt. Washington Baltimore 9, Md. | BALTIMORE | F. W. Fischer 714 S. Beechfield Ave. Baltimore, Md. |
| C. C. Harris Tropical Radio Telegraph Co. Box 584 Hingham, Mass. | BOSTON May 24 | A. G. Bousquet General Radio Co. 275 Massachusetts Ave. Cambridge 39, Mass. |
| A. DiMarco Carabobo 105 Buenos Aires, Argentina | BUENOS AIRES | H. Krahenbuhl Transradio Internacional San Martin 379 Buenos Aires, Argentina |
| J. M. Van Baalen 282 Orchard Dr. Buffalo 17, N. Y. | BUFFALO-NIAGARA May 15 | H. W. Staderman 264 Loring Ave. Buffalo, N. Y. |
| T. A. Hunter Collins Radio Co. 855—35 St., N.E. Cedar Rapids, Iowa | CEDAR RAPIDS | R. S. Conrad Collins Radio Co. 855—35 St., N.E. Cedar Rapids, Iowa |
| Cullen Moore 327 Potomac Ave. Lombard, Ill. | CHICAGO May 17 | D. G. Haines 4000 W. North Ave. Chicago 39, Ill. |
| J. D. Reid Box 67 Cincinnati 31, Ohio | CINCINNATI May 14 | P. J. Konkle 5524 Hamilton Ave. Cincinnati 24, Ohio |
| R. A. Fox 2478 Queenston Rd. Cleveland Heights 18, Ohio | CLEVELAND May 16 "Microwave Relay Systems" C. W. Hansell Radio Corporation of America | Walter Widlar 1299 Bonnieview Ave. Lakewood 7, Ohio |
| R. C. Higgy 2032 Indianaola Ave. Columbus, Ohio | COLUMBUS June 14 | Warren Bauer 376 Crestview Rd. Columbus 2, Ohio |
| H. W. Sundius Southern New England Tele- phone Co. New Haven, Conn. | CONNECTICUT VALLEY May 16 | L. A. Reilly 989 Roosevelt Ave. Springfield, Mass. |
| R. M. Flynn KRLD Dallas 1, Texas | DALLAS-Ft. WORTH | J. G. Rountree 4333 Southwestern Blvd. Dallas 5, Texas |
| L. B. Hallman 3 Crescent Blvd. Southern Hills Dayton, Ohio | DAYTON May 16 Dayton Engineers Club "Railroad Communications Systems" George Phelps Westinghouse Electric Corporation | Joseph General 411 E. Bruce Ave. Dayton 5, Ohio |
| H. E. Kranz International Detrola Corp. 1501 Beard Ave. Detroit 9, Mich. | DETROIT May 17 | A. Friedenthal 5396 Oregon Detroit 4, Mich. |
| N. L. Kiser Sylvania Electric Products, Inc. Emporium, Pa. | EMPORIUM | D. J. Knowles Sylvania Electric Products, Inc. Emporium, Pa. |
| F. M. Austin 3103 Amherst St. Houston, Texas | HOUSTON | L. G. Cowles Box 425 Bellaire, Texas |
| H. I. Metz Civil Aeronautics Authority Experimental Station Indianapolis, Ind. | INDIANAPOLIS | V. A. Bernier 5211 E. 10 Indianapolis, Ind. |
| R. N. White 4800 Jefferson St. Kansas City, Mo. | KANSAS CITY | Mrs. G. L. Curtis 6003 El Monte Mission, Kansas |

Chairman

B. S. Graham
Sparton of Canada, Ltd.
London, Ont., Canada

Frederick Ireland
General Radio Co.
1000 N. Seward St.
Hollywood, Calif.

P. B. Laeser
9410 Harding Rd.
Milwaukee, Wis.

L. A. W. East
Canadian Pacific Railway
204 Hospital St.
Montreal, Que., Canada

G. B. Hoadley
85 Livingston St.
Brooklyn, N. Y.

W. A. Steel
298 Sherwood Dr.
Ottawa, Ont., Canada

D. B. Smith
Philco Corporation
Philadelphia 34, Pa.

J. A. Hutcheson
852 N. Meadowcroft Ave.
Pittsburgh 16, Pa.

C. W. Lund
Rt. 4, Box 858
Portland, Ore.

G. R. Town
Stromberg-Carlson Co.
Rochester 3, N. Y.

B. B. Miller
2356A Lawrence St.
St. Louis 10, Mo.

David Kalbfell
941 Rosecrans Blvd.
San Diego, Calif.

R. V. Howard
Mark Hopkins Hotel
San Francisco, Calif.

E. H. Smith
823 E. 78 St.
Seattle 5, Wash.

F. H. R. Pounsett
Stromberg-Carlson Co., Ltd.
211 Geary Ave.
Toronto 4, Ont., Canada
H. E. Hartig
University of Minnesota
Minneapolis, Minn.

F. W. Albertson
Room 1111, Munsey Bldg.
Washington 4, D. C.

W. C. Freeman, Jr.
2018 Reed St.
Williamsport 39, Pa.

N. F. Schlaack
Bell Telephone Laboratories,
Inc.
463 West St.
New York 14, N. Y.

W. C. Johnson
Princeton University
Princeton, N. J.

H. E. Ellithorn
417 Parkovash Ave.
South Bend 17, Ind.

LONDON, ONTARIO

LOS ANGELES
May 21

MILWAUKEE

MONTREAL, QUEBEC

NEW YORK
June 5

OTTAWA, ONTARIO
May 16

PHILADELPHIA

PITTSBURGH
June 10

PORTLAND

ROCHESTER
May 16

ST. LOUIS
May 23

SAN DIEGO
June 4

SAN FRANCISCO

SEATTLE
June 13

TORONTO, ONTARIO

TWIN CITIES

WASHINGTON
June 10

WILLIAMSPORT
June 5

SUBSECTIONS

MONMOUTH
(New York Subsection)

PRINCETON
(Philadelphia Subsection)

SOUTH BEND
(Chicago Subsection)
May 16

Secretary

C. H. Langford
Langford Radio Co.
246 Dundas St.
London, Ont., Canada

Walter Kenworth
1427 Lafayette St.
San Gabriel, Calif.

E. L. Cordes
3304 N. Oakland Ave.
Milwaukee, Wis.

R. R. Desaulniers
Canadian Marconi Co.
Box 1690 (Place D'Armes)
Montreal 1, Que., Canada

J. T. Cimorelli
RCA Victor Division
415 S. Fifth St.
Harrison, N. J.

P. M. Craig
Philco Corporation
Philadelphia 34, Pa.

C. W. Gilbert
52 Hathaway Ct.
Pittsburgh 21, Pa.

L. C. White
3236 N.E. 63 Ave.
Portland 13, Ore.

A. E. Newlon
Stromberg-Carlson Co.
Rochester 3, N. Y.

N. J. Zehr
1538 Bradford Ave.
St. Louis 14, Mo.

Clyde Tirrell
U. S. Navy Radio and Sound
Laboratory
San Diego 52, Calif.

Lester Reukema
2319 Oregon St.
Berkeley, Calif.

W. R. Hill
University of Washington
Seattle 5, Wash.

Alexander Bow
137 Oxford St.
Guelph, Ont., Canada

M. R. Ludwig
315 E. 24 St.
Minneapolis 4, Minn.

G. P. Adair
Federal Communications
Commission
Washington 4, D. C.
S. R. Bennett
Sylvania Electric Products,
Inc.
Plant No. 1
Williamsport, Pa.

C. D. Samuelson
5 Russel Ave.
Fort Monmouth, N. J.

J. G. Barry
Princeton University
Princeton, N. J.

J. E. Willson
WHOT
St. Joseph and Monroe Sts.
South Bend, Ind.

Books**Inside the Vacuum Tube, by John F. Rider**

Published (1945) by John F. Rider Publisher, Inc., 404 Fourth Avenue, New York 16, N. Y. 407 pages+xiii pages. 274 illustrations. 5¼×8½ inches. Price, \$4.50.

Mr. Rider states in his foreword that his latest "Inside the Vacuum Tube," "has but one purpose; to present a solid elementary concept of the theory and operation of the basic types of vacuum tubes as a foundation upon which can be built a more advanced knowledge of tubes in general." However, it is probable Mr. Rider had in mind that his book would serve to give a foundation upon which an understanding at the same level of complete circuits in which tubes are circuit elements, could be built. The book is to be recommended for this purpose to the group at which it is aimed but does not seem a suitable starting place for one with the necessary background to take up the advanced study of vacuum-tube theory.

The book seems aimed at that large group of technicians whose formal training stopped short of college but who, by application, have already gained a working knowledge of things electrical and who now seek a better understanding of how electron tubes perform their functions.

The book proceeds from an elementary discussion of the composition of matter and the electron theory of current flow through electron emission, movement of charges, space charge and plate current, fundamentals of tube characteristics, the diode, the triode, static characteristics of triodes, triode dynamic characteristics and load lines, dynamic transfer characteristics, voltage amplification, the tetrode and pentode vacuum tubes, the cathode circuit, power amplifiers, and miscellaneous vacuum tubes. The handling and coverage of these subjects for the assumed intended purpose of the book is well done.

The style of the author is quite different from that used in more formal texts, the author writing as though he were talking to the reader and frequently addressing him directly. This together with the generous use of diagrams which are never allowed to become complicated and enlivenment of the diagrams in the early chapters of the book with "little men" to represent charges etc. helps to make the book clear and easy to read. Three of the diagrams are drawn double in red and blue and when viewed through the red and blue spectacles provided with the book, stand out in three dimensions very nicely but do not add a great deal to the presentation.

No problems are provided for the reader to solve although some examples are provided in the text. A short appendix lists the symbols used which are for the most part those standardized by The Institute of Radio Engineers. No index is provided.

HARRY C. LIKEL
Western Union Telegraph Company
Brooklyn 5, N. Y.

Books

Tables of Associated Legendre Functions, prepared by The Mathematical Tables Project, Arnold N. Lowan, Project Director, and a Technical Staff of Seven Persons, together with Seven Supervisory and Editing Assistants, and Conducted under the Sponsorship of the National Bureau of Standards, Lyman J. Briggs, Director and Official Sponsor of the Project.

Published (1945) by Columbia University Press, 2960 Broadway, New York, N. Y. 305 pages + xlvii pages. $7\frac{1}{2} \times 10\frac{3}{4}$ inches. Price, \$5.00.

This latest publication in the well-known Mathematical Tables Project Series will be especially welcome to workers in electromagnetic theory who have occasion to use associated Legendre functions in calculation, for previous tabulations have been limited in scope and not readily available. The present volume gives values of $P_n^m(x)$, and $Q_n^m(x)$ (associated Legendre functions of first and second kinds, respectively) for orders (n) up to 10 and degrees (m) up to $4(m \leq n)$. Values are given for real and imaginary arguments, and tabulations of the derivatives are made for each case. Values of the function and derivatives are also given for half-integral orders $P_{n+1/2}^m(x)$ and $Q_{n+1/2}^m(x)$ for n from -1 to 4 and m from 0 to 4 . In these tables, values are generally given to six significant figures with intervals in the argument of 0.1 from zero (or unity) up to 10 . There are also tables presenting $P_n^m(\cos \theta)$ and its derivative for orders (n) up to ten and degrees (m) up to 4 with 1 -degree intervals of θ . In the section of supplementary tables, certain exact values of the functions, the Legendre normalizing factor, and several aids to interpolation are tabulated. Accuracy obtainable by interpolation in any range is given before each table, and an extensive bibliography is included.

Dr. Lowan points out that the interval selected limits interpolation accuracy in certain ranges, and further work to correct this, interrupted by the war, may be published in a supplementary volume. The present volume, nevertheless, fills a great need and will be immediately useful.

J. R. WHINNERY
General Electric Company
Schenectady, N. Y.

Television Show Business, by Judy Dupuy

Published (1945) by General Electric Company, Schenectady 5, New York. 233 pages + 12-page index. 68 illustrations. $8\frac{1}{2} \times 11$ inches. Price, \$2.50.

Miss Judy Dupuy has made an outstanding contribution to the literature of television. She decided from the outset not to write a book about the rosy-hued future of television but to set down in clear, lucid form the experiences of station WRGB of the General Electric Company, Schenectady, New York, over its five years of pioneering operation. She overlooks nothing. She takes you by the hand and leads you from "back stage" to "on stage" right into the audience. On this trip you meet face to face the problems of operating a pioneer station in a new art. It is the kind of a book which will enable anyone contemplating entering the television field obtain the background of station operation. Incidentally, it should be very useful to the operators of other television stations.

The reader will find nontechnical information on how television works, how programs are conceived, designed, and put together. The problems of scenery preparation, writing, make up and the thousand and one other details, all of which are integral parts of this new art, are treated. Last but by no means least, there is a very interesting audience survey which explains, sometimes in no uncertain terms, the likes and dislikes of about 300 to 350 set owners in the service area of WRGB which means an average audience of approximately 1500. The greatest value of this survey is not so much the conclusions arrived at as they will change as the audience becomes larger and more diversified, but the methods used to obtain the information. Likes and dislikes are certain to change as the art progresses. Methods of securing audience reactions however are apt to remain fairly constant.

Miss Dupuy has created an interesting study of what went on during five years of "cut and try and try again" at WRGB. It should be read by everyone who has any interest in television.

RALPH B. AUSTRIAN
RKO Television Corporation
New York, N. Y.

January, 1946, copies of **The PROCEEDINGS OF THE I.R.E. and WAVES AND ELECTRONS**, in good condition, will be purchased by **The INSTITUTE OF RADIO ENGINEERS** at 50 cents a copy.

Encyclopedia of Substitutes and Synthetics, Edited by Morris D. Schoengold

Published (1943) by Philosophical Library, Inc., 15 E. 49 Street, New York, N. Y. 360 pages + 18-page index. $6\frac{1}{2} \times 9\frac{1}{4}$ inches. Price, \$10.00.

This volume was made available during the height of hostilities to satisfy an urgent need for a classified list of products which might be used in place of critical materials. In its preparation, the author undertook the Herculean task of presenting information which inherently involves applications in many specialized fields, ranging from metallurgy to pharmaceuticals.

Captioned an encyclopedia, the work is essentially a handbook with encyclopedic information, such as, chemical or physical properties, solubility, and uses, for most of the materials described. The subject matter is not confined to the treatment of substitutes and synthetics, but includes basic materials as well.

The materials are arranged and discussed in conventional dictionary order. In the case of products known by more than one name, each is properly listed with a reference to the main discussion. All of the known substitutes are given for each material, thereby providing numerous cross references. By way of explanation, if one wishes to find a substitute for *China-Wood Oil*, a reference is given to see *Tung Oil*. Under *Tung Oil*, substitutes listed include Dehydrated Castor Oil, Trienol, Castung, etc. Each of these materials is, in turn, independently described under its names.

An Index of Trade Names giving the manufacturer and his address occupies ten pages of space. The Subject Index is arranged according to groups such as Adhesives, Catalysts, Paints, etc., under which specific page numbers are given for reference.

Owing to the rapid progress in the development of new synthetic materials and the lifting of restrictions since the war's end, a revised edition would be desirable in order to bring information up to date. The index of Trade Names should be expanded and might include composition, thereby eliminating a repetition of discussion for some of the common materials marketed under a trade name. Potting compounds and fungicides could be added.

Substitutes which later established a place by virtue of their own merits might be indicated as Alternates to distinguish them from their original Substitute classification.

This reviewer knows of no similar volume which presents information covering some fifteen-hundred different substances. It will always fill a reference need for anyone concerned with product engineering involving the choice and application of new materials.

HAROLD L. BROUSE
The Crosley Corporation
Cincinnati 25, Ohio

Waves and Electrons Section

Information and opinion in the radio-and-electronic field necessarily reach the editors of journals in this field and are closely studied by them. Thus, this group of analysts are in a favorable position to offer valuable, guiding comment to engineers. This journal accordingly has asked the privilege of presenting their views as guest editorials. As a result, and in particular, there follows a commentary by the Editor of The Acoustical Society of America.—*The Editor.*

Moral Reflections*

FLOYD A. FIRESTONE

The war-crimes trials now in progress are carefully assembling evidence which corroborates the reports of our newspapers and congressional investigating committees, that many of the acts and the aims of those in power in the Axis countries have been for a period of years immoral, that is, they failed to conform to the rules of conduct which *we* accept as right.

As scientists, and I use the word in its broader sense to include all who use the scientific method in research, development, engineering, or invention, we are aware of the great increase in the effectiveness of armed forces due to the contributions of scientists. What should be our moral judgment concerning the scientists of the Axis nations, whose scientific contributions during the war added very materially to the effectiveness of the armed forces supporting a regime which we hold to be immoral?

I leave the reader to form his own judgments of Axis scientists who might be classified roughly as follows:

1. Those who disapproved of their rulers and refused to use their talents in their support. In some instances, these men are "missing."
2. Those who disapproved, but through fear of punishment of themselves or their families considered themselves forced to do scientific work. We can distinguish here between the man who merely did an honest day's work, such as the design of an effective radio set from known principles, and the man who used the full extent of his genius in inventing something basically new, like frequency modulation or an atomic bomb.
3. Those who were given unusual facilities for research or development and considered that the advancement of science was itself good under any circumstances.
4. Those whose patriotism caused them to support their country and its leaders, right or wrong.
5. Those who may have been ignorant of these features of their regimes of which they would have disapproved.
6. Those who were fully informed and enthusiastic supporters.

The fundamental bases for moral judgments are mere assumptions which are differently chosen at different times and places; in this respect they are like the assumptions and axioms which form the bases of science. In science we say that the axioms are justified by the usefulness of the scientific deductions derived from them. In cases of disagreement as to moral principles, each man may properly use his own thoughtfully determined principles in the judging of others. We should not refuse to make moral judgments because of uncertainty in the assumptions; the judgments are justified by their usefulness in contributing to group happiness, welfare, or whatever we assume the final value in life to be. The pronouncement of judgment upon a man for his past actions is a useful activity only insofar as it influences the future conduct of all men, either through fear of disapproval or other forms of punishment, or through directing the attention of all men to those rules of conduct which are considered moral by the judge.

It would not be fitting for us to grow emotional over this question. We may surmise that under similar circumstances we would have been statistically distributed in the above six categories in roughly the same proportions as the Axis scientists were. But this war has been a revelation to scientists themselves everywhere, of the extreme importance of scientific and technical contributions in warfare; we knew we were good, but we didn't know we were that good. In view of the demonstrated importance of the scientist's contributions, the time has come when he must give more attention to the *aims* of the fellow who appropriates the funds to support the scientific development, and who will receive the immediate benefits from it. . . . It is only because this time has come, that an editorial on this painful subject is not out of place in a technical journal. Our services must not be fully available to support the warlike ambitions of groups whose aims we disapprove; and it behooves us be informed and to form opinions.

While it is not probable that we shall take any group action censuring those categories of Axis scientists whom we believe to have used their talents to support an immoral project, on the other side it seems inappropriate that we should give prizes, awards, or honors to a scientist whose contributions to the advancement of science were of great importance but who first made these contributions available to the armed forces of a social group of whose aims we grossly disapprove. There are some conditions under which the advancement of science is not a good thing.

* (Reference: The Legal Basis of the Nuremberg Trials. Murray C. Bernays, Formerly Colonel, General Staff Corps, AUS. *Reader's Digest*, February 1946, page 56.)



David C. Kalbfell

Chairman—San Diego Section, 1946

David C. Kalbfell was born in Indianapolis, Indiana, on August 20, 1914. He received the degree of Bachelor of Arts from the University of California at Los Angeles in 1934; the Master of Arts degree from the University of California at Berkeley in 1936; and the degree of Doctor of Philosophy in physics from the same institution in 1939. While an undergraduate, he specialized in sound, studying under Professor Vern O. Knudsen. His graduate work was in nuclear physics under Professor Ernest O. Lawrence, where he participated in the development of two Berkeley cyclotrons and their associated electronic equipment. As a graduate student, he also received appointments as Teaching Fellow and Research Fellow.

In 1939, Dr. Kalbfell joined the Research Department of The Standard Oil Company of California, and worked on combustion experiments until 1941 when he was called to San Diego to work on a project of the Office of Scientific Research and Development. He served there until March, 1946, developing electronic devices. During the last two years he specialized in designing piezoelectric hydrophones and projectors to meet the exacting requirements of certain sonar systems. In addition to the design of the crystal systems,

this involved studies of impedance networks to match the highly reactive crystal devices to their power amplifiers over a wide band of frequencies. He also developed a preamplifier having very high input impedance, for use with small crystal hydrophones. A special impedance bridge for analyzing multiple terminal networks was another of his developments. Throughout the war he taught courses in radio engineering under the War Training Program, and is now teaching for the University of California Extension Division.

Dr. Kalbfell has designed a number of new electronic instruments. The ending of the war has permitted him to develop some of these for commercial applications, and a company has been formed which is engaged in their manufacture. He is now president of the K. and O. Laboratories, Inc., and is owner-manager of Kalbfell Laboratories. These companies develop and manufacture new electronic instruments for industrial control and for laboratory measurements.

He became an Associate Member of the Institute of Radio Engineers in 1944 and a Senior Member in 1945. He is a member of Phi Beta Kappa, Sigma Xi, and Pi Mu Epsilon.

I.R.E. War Participation*

HARRY C. INGLES†

THIS IS a welcome opportunity for the Signal Corps to pay tribute to the indispensable role played by members of The Institute of Radio Engineers during the war that now is history.

A host of members of your organization, both civilian and military, were in the forefront of our struggle to meet the needs of the Army for radio and radar equipment, an undertaking which made it necessary to utilize virtually the entire capacity of the electronics industry.

Your scientists, and engineers in countless numbers, unselfishly gave up their own pursuits and helped speed up laboratory research to a point where years of peacetime progress were compressed into a matter of months. Your members helped to expand industrial, university, and service laboratories and aided in setting up new ones. I am glad to say that your production people, too, extended every effort to help us keep pace with laboratory developments and assured our forces of an increasing flow of electronic devices.

But the responsibility of the Signal Corps and its associated scientists did not end when the equipment was developed, manufactured, and issued to troops. Of vital interest and importance to engineers and designers were those crucial questions of maintenance when new equipment was first used in combat operations, when it was employed in a new type of operation or in a locale where different conditions of temperature, humidity, rainfall, static, dust, and vegetation prevail. Members of your organization materially assisted in solving these problems and thus assured efficiently operating equipment for our troops.

Then, too, the problem of obtaining widespread substitutes without sacrifice of performance or quality control was inevitably difficult but the accomplishments and contributions of I.R.E. members in this field were many and noteworthy.

The war so rapidly proved the practical military value of so many electronic devices that it was necessary to put great emphasis on the exercise of economy in types

* Decimal classification: R560. Original manuscript received by the Institute, February 10, 1946. Presented, by transcription, 1946 Winter Technical Meeting, January 24, 1946.

† Chief Signal Officer, War Department, Washington, D. C.

of equipment, in the selection of essential projects, and in the standardization of equipment and component parts. In these fields, members of your Institute made outstanding contributions. They placed the war needs of the nation above all other considerations and by their unselfish public service earned the acclaim of a grateful nation.

In the brief time allotted me it would be impossible to call the honor roll of all those who aided the Signal Corps in carrying out a procurement program which aggregated more than six billion dollars. Yet I feel sure you will not charge me with discrimination if I mention your retiring president, Dr. William L. Everitt, as one whose achievements in his chosen field have been especially noteworthy. As director of the operational research staff in the Office of the Chief Signal Officer, Dr. Everitt organized a group of distinguished engineers, many of them members of the I.R.E. With their assistance he directed a scientific study on the best employment of equipment and personnel, and utilized field experience in guiding the development and procurement programs.

One of the most notable contributions of your Institute is its determination to bring to as high a level as possible the quality of radio engineers and radio engineering. Your conventions offer a meeting place for men of distinction where ideas can be mutually exchanged and scientific advances can be discussed. To my mind, the publications of the Institute should form one of the most important sections of every radio engineer's library.

For the first time since Pearl Harbor, the deliberations of the Institute can be concerned with peaceful topics. Wide vistas are open to radio. The immensity of its field is almost limitless. Radio engineers by the hundreds will be diverted from their wartime preoccupations to new problems of civilian economy. The extension of radio horizons both for war and peace applications should be unceasing.

In closing, I would like to express to you my appreciation for your help in the past and my confidence in the continuing assistance that you will render in the future.

Navy Radio and Electronics During World War II*

JENNINGS B. DOW†, FELLOW, I.R.E.

Summary—This paper reviews briefly some of the uses to which Navy radio and electronic equipment were put during the recent war, and emphasizes the importance to the Navy of developments which have taken place in these fields. Two chronological records are quoted from action reports to illustrate the importance of such equipment to successful naval engagements.

ONE OF the most decisive factors in our victory over the Axis powers in World War II was the demonstrated superiority in design, manufacture, and use of myriad types of electronic equipment. The phenomenal advances made in this art were rapidly transformed into equipment which had a most significant effect on the tactics and strategy employed by both sides in the conflict, and which made our ultimate victory more certain and less costly in men and material. Many of you have been associated with projects involving certain of these electronic developments during the war and have knowledge regarding many others. Many of you contributed directly and importantly to these developments. It is not my purpose to explain operational principles of such equipment as radar, sonar, loran, radio, etc., but rather to review the uses to which some of this equipment was put in winning the war, and its importance in modern warfare.

As the direct result of developments in the electronics art which took place between 1939 and the present moment, the military uses of electronic equipment have grown and expanded in scope from modest though important roles to new and vastly more important places in our Navy. It may be truly stated that electronic equipment now provides the eyes, ears, and seven-league boots of the fleet. The offensive and defensive power of a modern fleet depends largely on the quality, quantity, and intelligent use of its electronic equipment. As the war progressed through its third and fourth years, our naval commanders, in the normal day-to-day operation of the fleet, depended more and more upon apparatus utilizing electronic principles. The development of high-speed radio teletype, for example, has greatly facilitated many types of naval intelligence. The use of the so-called panoramic receivers in conjunction with instantaneous indicating types of direction finders has made it possible to seek out and discover enemy radio transmitters with unbelievable speed, and has unveiled intelligence information of the greatest value over the miles between opposing forces to our fleet commanders. Radio direction finders have been improved vastly in facility for use, sensitivity, and accuracy, while an entirely new navigational art has been provided by loran, a system which makes possible almost instantane-

ous navigational fixes. This new and rapid method of obtaining navigational data hundreds of miles from land, without resort to celestial navigation, has increased greatly the efficiency of fleet operations. It, like radar, will be extensively employed in commercial air and merchant shipping.

Radar, which more than any other one factor made it possible for that courageous and historic "few," to whom Mr. Churchill paid such a glowing and well-deserved tribute, to turn back the German aerial "blitz" on England, was of equally great service to our own forces. Radar was an indispensable tool in the hands of our navy in wiping out the real and dangerous menace to our shipping in the Atlantic of scores of submarine "wolf-packs." It played a most vital part in the demoralization and ultimate destruction of the Japanese fleet and air force. Radar made it possible for our surface vessels to locate and destroy enemy forces in night engagements, and under conditions of poor daytime visibility, and frequently this occurred before the enemy discovered the location of our own ships. The heavy and accurate bombardment of enemy-held beaches in all theatres of the war in preparation for amphibious landings was made possible by the employment of radar. Used both for long range reconnaissance and for fire control, it paved the way for the destruction by our guns of thousands of Japanese planes.

The story of the development of radar in the United States is a very interesting account of the pooling of scientific knowledge and effort on the part of thousands of scientists and technicians who were united in a common undertaking. That story has been told very adequately by others. I would much prefer to utilize my allotted time in emphasizing the importance of radar to the success of naval forces in action.

I shall quote a few extracts from an action report by the Commanding Officer of a light cruiser to illustrate by example the degree of importance of radar. Any one of hundreds of other equally impressive reports by commanders of ships and aircraft units might be quoted for this purpose. This particular report covers an engagement between opposing cruiser forces. The times designated are local civil times.

"2200: conducting continuous search through 360 degrees with search and fire-control radars.

"2338: made radar contact with a group of objects bearing 295 true distance about 14,000 yards. Checked with navigator to insure that contact was not land.

"2339: radar plot reported contact as 5 ships bearing 065 relative and 295 true, range 13,300 yards. Set condition affirm with guns loaded.

"2342: main battery was laid on, and tracked target showing largest radar impulse, believed to be leading

* Decimal classification: R565. Original manuscript received by the Institute, January 18, 1946. Presented, 1946 Winter Technical Meeting, New York, N. Y., January 24, 1946.

† Bureau of Ships, Navy Department, Washington, D. C.

enemy cruiser. Starboard anti-aircraft battery was on second target from left of a group of three ships. These were believed to be screening destroyers, ahead of the cruisers. Course and speed of both targets 140 true, 26 knots.

"During tracking phase, our van destroyers were known to be coming up on the starboard quarter en route to their position in the van. However, the continuous radar track of the approaching enemy force was completely distinct from the tracks of own ships.

"2346: commenced firing with both batteries immediately following the next cruiser astern. The main battery concentrated with the cruiser astern on leading enemy heavy ship, in continuous fire, using radar train and ranges. Hits were observed in the first salvo, which was a short straddle. Fire was maintained, with a spot of up 100, and in a relatively short time the target was lighted up by a fire amidships. She was tentatively identified by several officers as a heavy cruiser. Our gun-fire was apparently very effective at this short range, and the target was hit almost continuously. At about 2350 the enemy sank, going down by the bow, with her screws still turning, and her turrets apparently still trained in.

"The anti-aircraft battery opened fire on the center smaller ship in the enemy van, bearing slightly to the left of the main battery target. Fire control was with radar ranging and training, and shortly after fire opened, splashes were observed on either side of the target ship in the range notch. About 2350 the target disappeared from both screens, leaving own splashes still showing. Reports from other stations indicated that this target was a destroyer, which broke in two and sank.

"2351: during this period we fired with both batteries on a target, believed to be another destroyer, in the vicinity of the first anti-aircraft battery target. 'Cease firing' was ordered when an explosion was observed on the target, and it disappeared from the radar screens. At least three enemy ships were observed on fire in the target area at this time.

"2353: commenced firing at a ship to the right of previous target. Firing was at full radar control without illumination. Fires breaking out on the bow of this ship illuminated her midsection for a short time. She was observed to be a two-stack cruiser with trunk forward of stack and latticed tripod mast close to after stack. This ship was returning our fire. Some damage was sustained from the fire of this ship but radar continued to function satisfactorily.

"2359: fires were observed burning on an enemy destroyer. This ship fired on her for two minutes in radar control. Hits were observed. 'Cease firing' was ordered when target disappeared from radar screen at 0001."

From what I have quoted, it will be noted that two Japanese cruisers and two destroyers were disposed of in a period of 15 minutes during darkness. I leave to your own imagination the chaos which must have existed in this Japanese force which, in the darkness of

night and without apparent knowledge or warning, suddenly found itself caught in the devastation of fire of our own ships. I leave also to your imagination the tremendous importance of radar to the successful outcome of this and many similar sea engagements.

Not much is known by the general public of the equipment known as sonar. This equipment, consisting of a specially designed supersonic projector and receiver mounted on the hulls of submarines and surface vessels of many types, was instrumental in sinking approximately 2,500,000 tons of Japanese shipping. The destruction of the means of supplying the Japanese army in the Marshall Islands, the Gilberts, and the Philippines, had a great but little-appreciated effect in the ultimate collapse of the war-making ability of the Japanese. It has been stated by the Japanese military leaders that their position in the Philippines became untenable as a result of the wholesale destruction of their shipping upon which they depended. Raw materials could not be shipped to the home islands for fabrication into the instruments of warfare, nor could supplies and reinforcements reach the Philippines in sufficient quantity to permit the army to carry on a successful campaign. Sonar played a part in undersea warfare comparable to the part played in surface and air warfare by radar. It came to our aid at that critical juncture of the "battle of the Atlantic," when we were moving large groups of men and millions of tons of supplies to the coasts of Africa and England. The Germans knew that to prevent the ultimate invasion of France and then Germany, they would be forced to prevent the initial assembly of an army in England, or if unable to do this they could still prevent a successful invasion by cutting the lifelines of supply, and reducing the stream of materials to an ineffectual trickle. This they hoped to accomplish by the employment of a large submarine force. While it is true that many means were successfully used to overcome the submarine menace, including air bombardment of shipyards and berthing areas, attack by surface units employing sonar for search and attack were responsible for wholesale sinkings of submarines.

The following is quoted from a report covering an action between our surface forces in the Pacific and a Japanese submarine to show how, by means of sonar equipment, it is possible to track a submarine over a long period of time to await a favorable opportunity for attack:

"2000: on 30 May one of our destroyers made sonar contact on a submarine and asked for assistance from four destroyer escorts of the force. The destroyer then proceeded with her assigned duties when the first two destroyer escorts arrived at the spot. These escorts proceeded to make a number of attacks on rather doubtful sonar contacts. The contacts were believed to be a reef, but acting carefully one escort was directed to maintain contact at about 1000 yards throughout the night, in the belief that if it were a submarine it would surface. The other escort proceeded to search

the surrounding area.

"0302: on 31 May a large enemy submarine surfaced between the two destroyer escorts which were then about 4000 yards apart. Before the line of fire could be cleared, the submarine dived. One escort then made sonar contact and attacked without results. The second also gained contact and held contact until sunrise without attacking.

"0550: the remaining two destroyer escorts had joined for the kill. At 0649 one escort attacked with depth charges with negative results.

"0659: a second attacked with negative results.

"0713: the third attacked with negative results.

"0735: the fourth attacked, resulting in six to ten detonations about 9 seconds after the splash. Approximately $5\frac{1}{2}$ minutes after this attack, a tremendous underwater explosion occurred. A tremendous 'shock' type of explosion without visible local disturbance was felt. About two hours later, oil and debris began rising within 500 yards of the position of the last mentioned attack. The usual deck planking, cork stoppers with Japanese characters, a bar of soap, and a split reed containing powder were collected. The area was littered with granulated cork."

Another type of equipment which was little publicized during the war was an electronically operated apparatus on ships and planes which made it possible for them to challenge other ships or planes and receive an immediate response, indicating clearly whether the challenged ship or plane was enemy or friendly. This device was familiarly known as I.F.F., which is translated as "identification friend or foe." The necessity for the most careful co-ordination in joint and combined operations where the military forces of several nations were engaged, created a need for some means of mutual recognition of friendly forces. The system of I.F.F., which was developed to fill this need, did much to facilitate the successful tactical operation of diverse military units of the allied nations participating.

Other naval equipment employing electronic principles included beacons used by shore parties to lead other groups to satisfactory landing points, to control gunfire from ships or land batteries in spotting the fall of shells into target areas, or to indicate to planes the desired target or their course back to beacon-equipped carriers.

Harbors were protected against the approach of submarines by automatic electronically operated warning devices. The navy used in a very effective manner the antiaircraft shell employing an electronic fuse which controlled the explosion of the charge by means of a radio wave reflected from the target plane. The effectiveness of antiaircraft fire is largely dependent on the accurate setting of fuses to provide an explosive burst at the precise time of arrival of the projectile in the near proximity of the plane. The proximity fuse accomplished this objective in a highly effective manner.

Inasmuch as it was known that the Germans pos-

sessed radar, and that the Japanese had made considerable progress as well, it was necessary to develop various types of countermeasures to nullify the effectiveness of enemy sets. Our countermeasures were of tremendous value, especially against the Germans in the invasion of France. Here the Germans had set up countless batteries of antiaircraft guns, heavy caliber coast defense guns to be used against attacking warships, and mortar batteries to be used against the smaller amphibious landing vessels and vehicles. The fire of these batteries was known to be controlled by radar, and in the preparation for invasion, plans were made to employ countermeasures which would interfere with the proper operation of the radar and provide the enemy with either no range and location data, or to provide only faulty firing data which would seriously hamper the defensive fire power. These electronic devices, thoroughly tested to prove their effectiveness, insured the success of the invasion. Battleships, cruisers, and destroyers stood well into the beach area at night and under cover of smoke in the daytime delivering a withering volume of accurate fire against the German positions, while they themselves were little damaged by the fire from the German guns. In addition, many types of radio "jammers" were successfully used to interfere with enemy airborne radar and radio communications.

As the war came to a close, the navy had under development many other offensive and defensive weapons which in a short time would have been used in combat. Most of these weapons depended extensively upon applications of electronic principles, and would have exerted a profound influence on the nature of warfare. Pilotless planes carrying tremendous loads of high explosives would have carried terrible destruction to the enemy, guided to the targets by distant controls. Flying bombs and various types of rockets easily controlled from a distance would have taxed the best defensive efforts of the enemy to stop this form of sudden attack.

The unleashing of the ultimate power of the atom is so new to most of us that we find it difficult properly to appraise its application to warfare. We can only hope that, as nations begin to realize its potentialities, atomic explosive power can be in some way successfully outlawed. We cannot, however, overlook the other possibility. To say that this country or any other country can keep the secret of atomic power is deliberately to refuse to face the facts. Just as the development of radar proceeded independently in several countries simultaneously, the development of atomic power will be carried on by many nations. We must, therefore, in our planning, proceed on the assumption that other nations will possess atomic power, and may some day use it against us in sudden attack. I have digressed momentarily in order to emphasize the fact that in any future conflict, when atomic power may be utilized, the electronic art will play an even larger part in our offensive and defensive weapons than it did during World War II.

While there still remain many problems before us in

the demobilization of the navy and its reduction to its peacetime strength, the outline of the postwar naval establishment is beginning to be seen clearly. The fleet and its supporting air arm will be large, larger than anything visualized before the war, and the job of keeping it equipped with the most modern electronic devices will be a challenge to the best efforts of American science and industry. It is now planned to divide the fleet into two parts: the active fleet, which will be fully operable and will be scrupulously maintained in fighting condition; and the reserve fleet, which will be maintained in such a way as to permit its vessels to be put rapidly into fighting condition of complete readiness at short notice. It is also planned to rotate at suitable intervals the ships of the active and reserve fleets to provide opportunities for testing all shipboard equipment under operating conditions at sea. The electronic equipment aboard vessels of the active fleet will be modernized continuously to take advantage of all advances and improvements as they become available.

I wish to emphasize the fact that we of the navy are well aware of the problems facing us, and that we ap-

preciate the fact that we cannot afford to "rest on our oars," now that the war is won, but that instead, we must be unremitting in our research and development of new weapons, in order that we may continue to enjoy the advantage of a technical lead over any possible enemy or combination of enemies. It is a certainty that a most energetic and progressive program of research will be carried out to the limit of the funds made available by Congress.

We face the future with confidence in the will of the people and Congress to maintain a fleet which will continue to be "second to none." We have recently experienced in the course of a long and difficult war the wholehearted support of industry, scientists, engineers, and technicians of America, who gave unstintingly of their time and ability to build and equip the most powerful fleet the world has ever seen. With their continued support, we cannot fail to maintain that supremacy which is our best guarantee for the future safety of our country. You can be assured that we of the navy will do our part to foster and continue a program to this end.

CBS Studio Control-Console and Control-Room Design*

HOWARD A. CHINN†, FELLOW, I.R.E.

Summary—Heretofore, it has been the general practice, both in the United States and abroad, to assemble the audio equipment components used for broadcasting and motion-picture sound studio operation in so-called relay racks or cabinets. These assemblies were generally supplemented with a control console, separate from the equipment racks, but connected thereto with a suitable multipair shielded cable.

While convenient from the viewpoint of servicing and of utilizing "standard" interchangeable panels of equipment, an assembly of this nature is wasteful of studio control-room floor space, does not result in the optimum location of the numerous controls generally considered essential for modern network-originating program operations, and architecturally is seldom attractive.

The studio control console described in this paper incorporates in one unit all the equipment normally contained in two or three relay racks and an associated control panel. In addition, it includes the many accessories that present-day, elaborate program production demands. Furthermore, these facilities are assembled in a compact, readily accessible, relatively small unit which does not sacrifice any of the flexibility of the old-style assembly; in fact, the console provides many new conveniences. The equipment differs from any consolettes and desk-type equipment heretofore developed in the type of construction employed and the extent of the facilities involved.

If maximum advantage is to be taken of a carefully designed control console, it is essential that certain architectural features be incorporated in the control-room layout. Some of the features that enter into these considerations are discussed and their correlation with console design indicated.

* Decimal classification: R613.11. Original manuscript received by the Institute, December 10, 1945.

† Columbia Broadcasting System, Inc., New York, N. Y.

INTRODUCTION

IN THE early days of radio broadcasting, the studio microphone (and there was sometimes only one) and its associated audio equipment were considered a minor accessory which must necessarily be provided to complete the system. In many instances, the audio facilities were installed in the same room with the transmitter, and in some instances, this room also served as the studio.

At times, the handiest carbon-button telephone transmitter and telephone repeater-type amplifier were pressed into service. In fact, early broadcast audio facilities became so intimately associated with telephone practice that relay-rack type of construction was employed and, in addition, the term "speech-input equipment" was applied. Broadcast-studio audio facilities have progressed a long way since "speech" only was transmitted directly to the "input" of the transmitter. Studios and their associated equipment are now a major part of a complete broadcasting plant and the transmitter is generally located at a remote point. Furthermore, present-day radio productions require relatively elaborate facilities so that modern studio equipment incorporates extensive means for meeting the demands.

The Columbia Broadcasting System 2A console, which was originally developed for use in CBS's New York studio building, illustrates a new solution to the problem of

locating the numerous controls, switches, jacks, instruments, etc., within convenient reach of the operator, while still maintaining the flexibility, ease of servicing and of modification inherent in the relay-rack type of construction. In addition, the console presents an appearance more in keeping with the surroundings and does not require the large floor areas back of equipment racks that are necessary for access to the equipment, but useless during normal operations. Furthermore, the console, being completely self-contained, requires only the minimum of connections to effect its installation in the studio control room. Finally, the unit may be completely tested in the shop and any necessary adjustments made prior to delivery. In this day of stringent performance characteristics, this ability to undertake tests and adjustments in the shop or laboratory where adequate means are available saves considerable time on the job where, during the normal course of construction, conditions are generally far from ideal for undertaking precise measurements and adjustments.

PHYSICAL CONSIDERATIONS

As is all too evident from even a casual inspection of some studio control-room installations of the past, the design engineer has often been so absorbed in the technical aspects of the equipment, circuits, etc., that little, if any, thought has been given to the location of the numerous controls from the viewpoint of operating convenience. At times, when thought has been given to this very important aspect of the problem, some constructional difficulty has presented an obstacle to securing the optimum arrangement. When consideration is given to the many thousands of hours during which a technician will be at the controls of the equipment, it is evident that a great amount of effort is justified in the design and construction in order to overcome all obstacles to greater operating convenience.

Among the more important physical aspects affecting the design of studio consoles are: (a) the location of controls; (b) the location of visual monitoring facilities; (c) visibility into the studio; (d) appearance.

The location of all controls is predicated on two requirements. First, they must be within convenient reach so that operation may be undertaken over long periods of time with the minimum of effort. Second, they should be so arranged that they may be located readily and identified by touch without the need for looking away from the studio action. It would not be satisfactory, for instance, to place the master gain control for the complete channel and the monitor-loudspeaker gain control immediately adjacent to each other. Under these circumstances, the monitor gain control might be operated in error when it is desired to modify the over-all level of the transmission. Based on aural monitoring in the studio control room, the desired effect would seem to have been achieved in spite of the operating error; whereas, in fact, the program transmission from the studio would not be affected. Similarly, due considera-

tion must be given to the location of all other controls so that the incorrect one is not unwittingly operated under the stress of program production.

In general, the location of controls is limited by the maximum distance that one can conveniently reach. Where a large number of controls are involved, this requirement makes it necessary to adopt a U-shaped console (with the base of the U towards the studio and the operator seated in the slot) since, if the controls are located at successively higher levels in front, the technician's vision into the studio will be effectively blocked. Furthermore, any controls that require continuous adjustment during the course of operations (such as mixer volume controls) must be located close to the table top in order to provide adequate support for the arm and a natural, convenient operating position. If the centers of such controls are more than $2\frac{1}{2}$ inches above the table, operating convenience and ease of control are needlessly sacrificed.

In this regard, it is pertinent to note that the consensus of a large group of experienced operating personnel is that the mixer volume-control panel should be at an angle of 30 to 45 degrees from the vertical. If the usual type of rotary control is mounted on a panel that is in the horizontal plane, or nearly so, it is impossible to accomplish a complete rotation of the mixer knob, for a complete fade, without shifting one's grip on the knob several times during the process. This procedure does not, of course, facilitate smooth operation.

Another advantage afforded by the preferred panel slope is the fact that all graduations on the dial are readily visible, none being hidden from sight by the control knob. This obtains since the panel is essentially at right angles to the normal line of sight; which condition does not exist in the case of either a vertical or horizontal mixer panel.

Of the visual monitoring facilities, the most important is the volume indicator. Ideally, this instrument should be located so as to be directly in the path of vision from the control room to the studio. Consideration has, in fact, been given to the use of a projection volume indicator whose image would be visible on the control-room observation window or on the wall of the studio. This arrangement has its advantages, but after experimentation its adoption was not considered advisable for a number of reasons. However, a conventional volume-indicator instrument may be located readily in the line of sight, provided certain layout and architectural features are followed. One solution to the problem is shown in Fig. 1, which is a front view of the CBS 2A console wherein the volume indicator (and also a clock) is located in a center section that is slightly raised above adjoining parts of the console. By the simple expedient of making the sections on either side of the volume indicator and clock as low as possible, consistent with providing enough space for the required controls, maximum visibility into the studio is provided and the instruments are more or less in the line of vision.

The need for keeping the entire front panel of the console low in height is further evidenced by Fig. 2, which illustrates some of the details that make it necessary carefully to co-ordinate both the architectural and the technical features of studio control-room design.

For ease of operation, it is desirable to place the seated occupants of the control room on the same eye level as those in the studio with whom visual communication is desired. By this arrangement, the need for either party

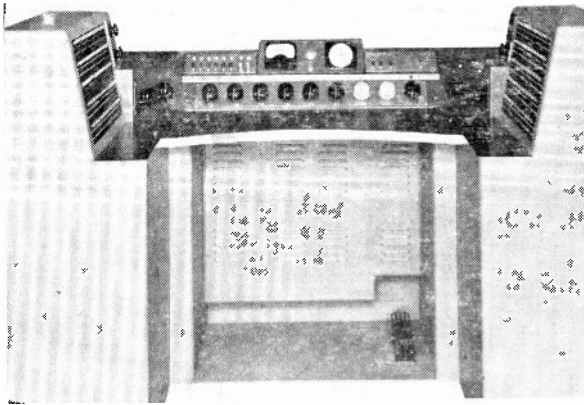

Fig. 1—Front view of CBS 2A studio control console. The eight-position mixer and master gain controls occupy the lower portion of the center section. The six-microphone mixer controls on the left are distinguished from the two incoming-line controls on the right by the use of different-colored knobs. The master gain control is on the extreme right-hand end.

Although not visible in the photograph, small "magic slates" are mounted immediately above each mixer knob on a ledge provided for this purpose. Thus, a simple means is available for temporarily marking channel assignments without defacing the equipment with pencil markings. Such notations can be removed immediately by lifting the clear plastic covering of the white slate. Markings may be made with any dull point; not even a pencil is needed.

The associated microphone and line keys are in the upper left-hand part of the center section, while the utility, rehearsal-break, and outgoing-line keys are in the upper right-hand part.

The upper center section contains the standard volume indicator, electric clock, and, between the two, a rehearsal-break microphone.

The left-hand wing contains the "high-level" jack field while the "low-level" circuits are accommodated by the right-hand jack field.

A utility volume control and a rehearsal-break volume control are in the upper right-hand section of the left wing. An amplifier current meter and associated switch occupy the corresponding location in the right-hand wing.

A sound-effects filter is contained in the angled portion between the center section and the left-hand wing, while a two-position reverberation-channel mixer is contained in the corresponding location to the right of the center section.

The foot-operated rehearsal-break switch is located on the base of the console as shown.

Note the clean-cut, uncluttered layout with places for all controls within easy reach of the operator.

continually to look upwards or downwards when watching the other is avoided. In the particular case illustrated, it is assumed that it is desirable to have a conductor on a podium on the same eye level as those in the control room. The amount by which the control-room floor must be raised above that of the studio is determined by the height of the podium and the average heights of persons standing and seated. In a smaller studio, on the other hand, where only dramatic productions are undertaken, for example, it might be desirable

to adjust the height so that persons standing on the studio floor would be at the same eye level as those seated in the control room.

Having raised the control-room floor it is necessary, however, to incorporate means for seeing those in the studio that are seated and located close to the studio wall adjacent to the control room. This is provided for again by keeping the control console low in height and by sloping the sill of the control-room window¹ as shown in Fig. 2. In the particular case illustrated, a rather high podium is assumed, resulting in the control-room floor being elevated by a considerable amount and yet, by employing the arrangement shown, a person seated within less than 3 feet of the wall can readily be seen by those in the control room.

Consideration must also be given to the field of vision in the horizontal plane. As is evident from Fig. 2, the closer one is to the control room window the greater the amount of studio floor area that can be seen. This factor also influences the design of a control console, since its depth must be kept to an absolute minimum if maximum advantage is to be taken of a control window of given length. As a matter of fact, the "blind" area in the studio is more or less directly proportional to the distance that the control-room occupants sit from the observation window. Many hundreds of square feet of studio area may often be brought into view if the overall depth of the control console and table is reduced a few inches.

Increased field of vision into the studio may be effectively obtained also by allowing the control room to come out into the studio slightly, as shown in the plan view of Fig. 2. This type of construction provides vision to practically all parts of the studio, while decreasing the total volume of the studio by a negligible amount. The sloping observation window, combined with the curved section does, however, require the glazers to work to close tolerances, since the glass in this portion is a section of a cone and not simply cylindrical.

The architectural features of broadcast studios have, from the viewpoint of appearance, undergone a marked change for the better since the early days of heavy rugs and draperies, vertical observation windows, oak microphone stands, and the like. In line with this, it is only fitting that the appearance of the associated audio facilities be more in keeping with their present-day surroundings.

A relay-rack assembly, excellent as it may be from a purely technical viewpoint, certainly lacks dynamic symmetry and is difficult, if not impossible, to work into the architectural features of the control room. Where appearance is of importance and where the economics of the situation permit, a properly designed studio console will not only provide the flexibility, accessibility,

¹ In cases where the depth of the control console is unavoidably great, the top of the console should also be sloped in much the same manner as the window sill. This expedient not only greatly improves vision into the studio, but, in practice, reduces the apparent depth of the console by a surprising amount.

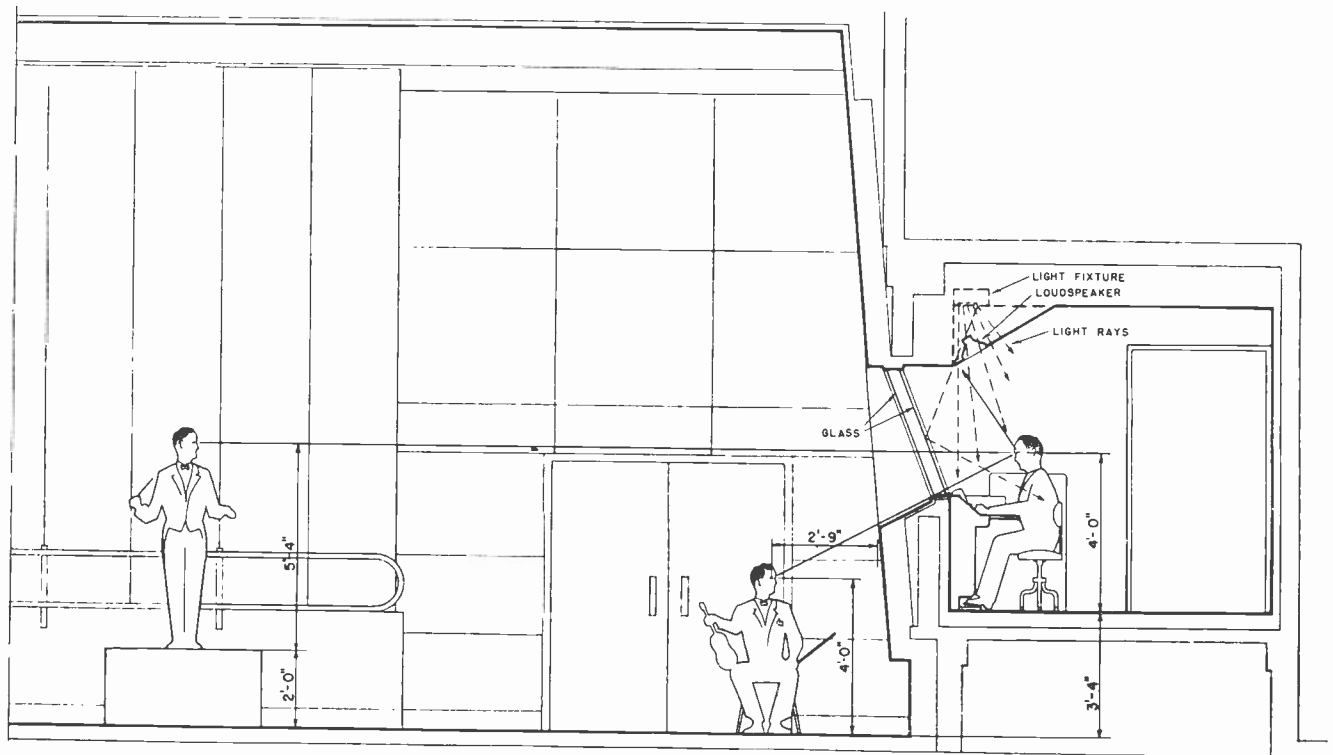
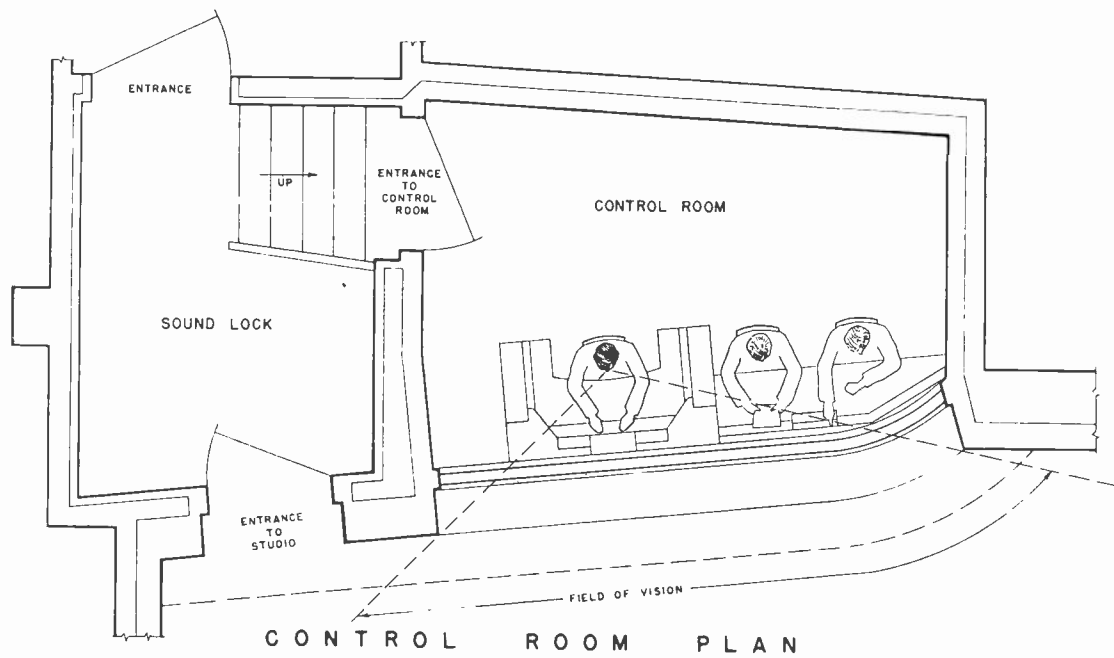

STUDIO & CONTROL ROOM SECTION

STUDIO NO. 21

Fig. 2—A study of a plan view of the studio control room shows the importance, for maximum vision, of placing all occupants as close as possible to the observation window. Moving only a few inches nearer the glass may sometimes make it possible to see hundreds of square feet more of the studio floor area.

The important relations between control-room floor elevation, the angle of the observation window, location of control-room lights, etc., are shown in the section of a studio and control room. The procedure for determining the control-room floor height is covered in the accompanying text.

Note from the drawing how the location of the control lighting fixtures and the slope of the observation window must be co-ordinated in order to avoid reflections that are visible to the control-room occupants. Similar consideration must be given to the studio lighting.

and other advantages of a relay-rack assembly, but, in addition, will present an appearance that leaves little, if anything, to be desired.

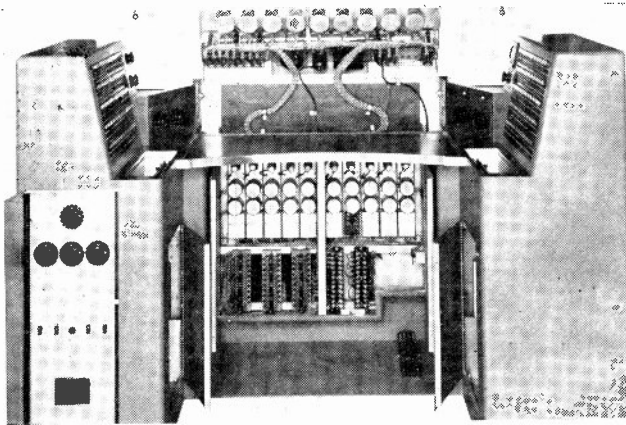

Fig. 3—Front view of the CBS 2A studio control console with access doors and mixer-control panel opened. The door in the left wing reveals the control panel containing the loudspeaker monitor-channel volume control at the top, and individual volume controls for three loudspeakers (studio, observation room, and control room) immediately below. The entire panel is hinged, horizontally, near the center to provide ready access to the volume controls for maintenance and inspection.

The on-off and the regular-emergency alternating-current tumbler switches are mounted in the center of the panel together with pilot light and the regular-emergency low- and high-voltage transfer switches.

Dead front, cartridge fuses for the regular and emergency alternating-current supplies are located at the bottom of the panel.

In the wings, immediately below each jack field, there is a pocket containing a disappearing shelf which carries sixteen double plugs which are associated with seven complete patch cords and two "across-the-desk" patch cords. The sliding covers to these compartments are shown opened in this photograph, but the shelves are in the "retracted" position.

The doors in the sides of the console just below the patch-cord compartments give access to the patch-cord weights and pulleys that retract unused cords and seat them in their retaining sockets.

The underside of the mixer-control panel (see Fig. 4 for close-up) and the pre-amplifier and terminal-block compartment (see Fig. 5) are shown in the center portion of the console.

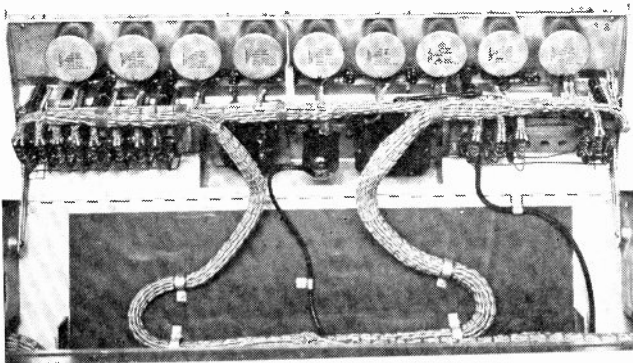

Fig. 4—A close-up of the opened mixer-control panel showing the ready accessibility of the volume controls for cleaning and inspection.

The formation of the audio cables consisting of tightly laced, individually shielded pairs of wire are of particular interest because of the need for providing adequate slack in the small space available to avoid sharp bends and to give sufficient flexibility to this naturally stiff cable. The formation of the fixed portion of this cable, back of the panel, is such that ready access is provided to all component parts.

The back of the rehearsal-break microphone can be seen between the backs of the volume-indicator meter and the electric clock.

In addition to those physical considerations already covered, there are several other items which warrant attention in the design of control consoles. It is important that the table height and width be such as to provide the most comfortable operating conditions for the average person. Furthermore, frequently used controls must be within convenient reach. These essential dimensions and other important points can best be determined by the construction of a full-scale wooden model that is adjustable as regards the factors in question, and by

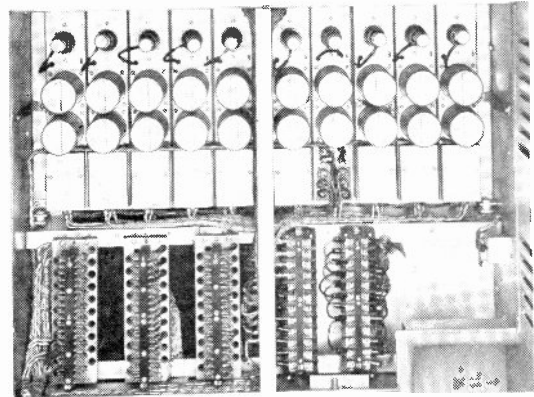

Fig. 5—A close-up of the pre-amplifier and terminal-block compartment (see Fig. 3 for general view) showing the ready accessibility of the tubes and terminals of the ten "shock-mounted" preamplifiers. Three 80-terminal audio blocks are located at the lower left, while two 12-terminal blocks for alternating-current and direct-current power are located at the lower right.

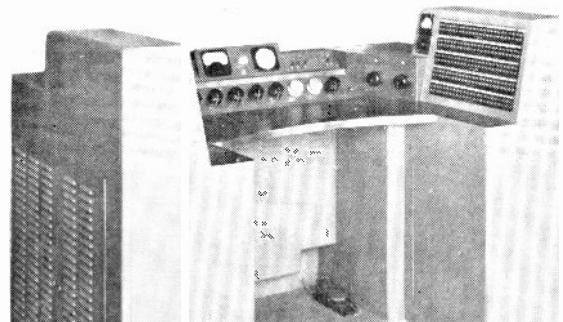

Fig. 6—Three-quarter view showing access doors to jack field and equipment compartments in wings of studio control console. The large number of doors (16) that was used to provide ready access to all parts of the console necessitated unusually heavy internal bracing to insure against deformation of the unit during shipment and handling. In order to maintain the accurate alignment of the flush doors a very rigid structure was necessary. The weight of the completed assembly was approximately 1300 pounds.

determination of the consensus of a large group of those who are concerned with the operation of the finished product. This procedure was followed in the case of the CBS 2A console, and the results have fully justified the effort expended in this direction.

Equally as important as the question of external features is the matter of equipment accessibility and method of mounting. The former is important from the viewpoint of ready maintenance, whereas the latter permits changes in the event that operating requirements or advances in the art dictate the installation of

new facilities. Since the provisions made for coping with these problems are illustrated in Figs. 3, 4, 5, 6, 7, and 8 and explained in the accompanying captions, they are not reiterated here.

AUDIO FACILITIES PROVIDED

The features incorporated in the CBS 2A console provide all the facilities necessary for the production of the most complex program originations. The extent of the means that are available can be illustrated most readily by reference to a block diagram of the circuit, Fig. 9, and the photographs. Some of the basic features of the arrangement have been outlined heretofore^{2,3} and will not, therefore, be repeated here.

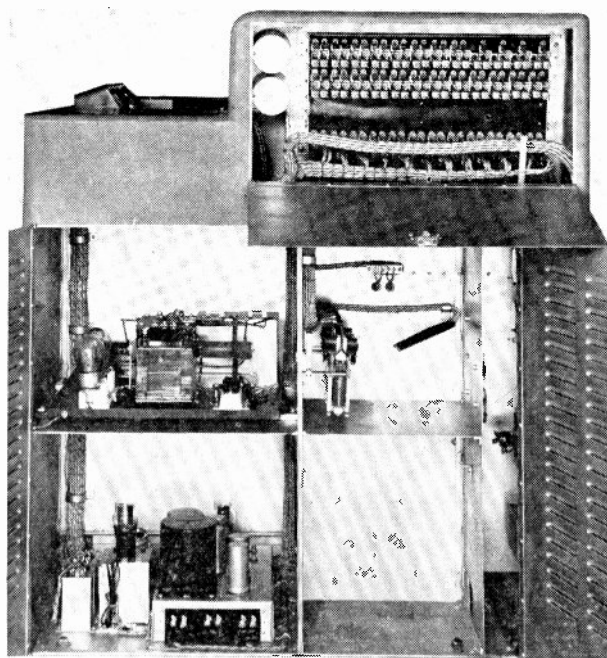

Fig. 7—A view of the contents of the jack field and equipment compartments in the left wing of the console. The uppermost compartment contains the high-level jack field and the utility and rehearsal-break volume controls (at upper left).

Of the four lower compartments, the upper left contains the regular low-voltage direct-current power-supply unit; the lower left contains the preamplifier filament transformers, regular high-voltage (B) direct-current power supply, and a loudspeaker field-supply unit.

The upper right compartment contains all audio and "on-air" sign relays, while the space on the lower right is available for future additions.

An eight-position mixer is provided for simultaneously accommodating six studio microphones and two incoming-program lines. These latter may be used for supplementing program originations in the studio by the introduction of program material from other near-by or remotely located sources. Each incoming-line position is equipped with an isolation coil (C_1) and a resistance attenuation pad (P_1); the latter to minimize, from the viewpoint of the mixer-control input, any impedance

² H. A. Chinn, "Broadcast studio audio-frequency system design," *PROC. I.R.E.*, vol. 27, pp. 83-88; February, 1939.

³ H. A. Chinn and R. A. Bradley, "CBS Hollywood studios," *PROC. I.R.E.*, vol. 27, pp. 421-429; July, 1939.

variations that may be present in the incoming-line circuit.

Because of the extremely low output level of currently available high-fidelity microphones, it is necessary to employ amplification prior to the mixer controls in order to maintain the signal-to-noise ratio that exists at the terminals of the microphone. In this connection, it is interesting to note that, for all intents and purposes, the signal-to-noise ratio that exists at this point determines the performance, in this respect, of present-day facilities.

Each mixer position is provided with an on-off key switch (K_1) and an associated pilot light. When a key associated with a microphone circuit is in the "off"

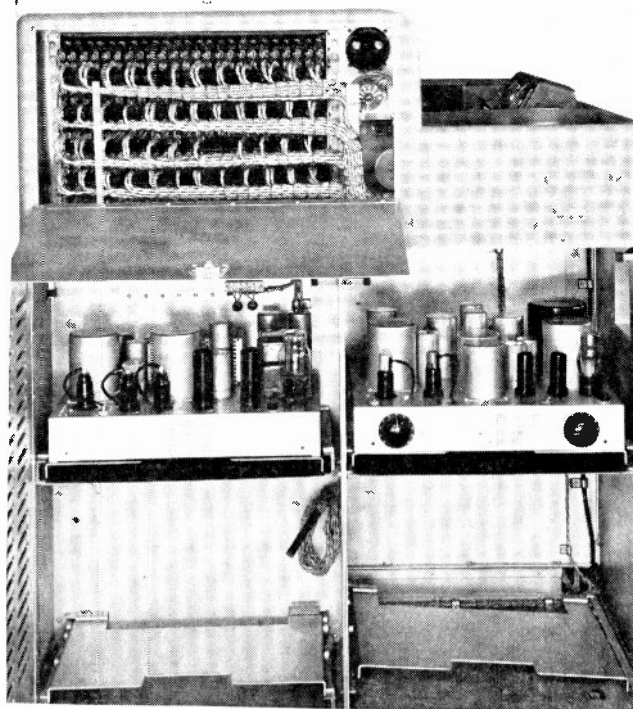

Fig. 8—The right-hand wing of the control console contains, in addition to the low-level jack field, compartments for four amplifier chassis. Two such units (a channel and a monitor amplifier) are shown installed in this photograph. These amplifiers are mounted on a shelf that slides forward, file-drawer fashion. The amplifiers can then be tilted up and back, thereby providing ready access to the top and the underside of the chassis for inspection, test, and repair. The lower compartments provide space for future additions or special equipment, if necessary.

position, a short-circuit is placed on the microphone-amplifier output circuit, while a terminating resistor is connected to the input of the mixer control. The short circuit is essential to prevent transmission, when the microphone key is in the "off" position, to the reverberation channel which may be bridged across the output of the microphone amplifier.⁴ The termination, on the other hand, insures that the mixer control faces a constant source impedance at all times.

When the keys associated with incoming-line positions are in the "off" position, terminating resistors are

⁴ H. A. Chinn, "Reverberation control in broadcasting," *Electronics*, vol. 2, pp. 28-29; May, 1938.

applied both to the output of the line coil and the input to the mixer control. This arrangement insures against any change in level on the incoming line resulting from operation of the mixer key. This is important in cases where other circuits are bridged across the incoming line prior to the on-off key.

The mixer controls, which are variable bridged-T attenuators, have their outputs connected by means of a differential network which provides correct source and load impedances for all circuits concerned. In the design of this network it is necessary to take into account not only the input-impedance requirements, but also the special conditions existing at the output of the network. The network operates from a finite source impedance (600 ohms) and presents a like impedance to the mixer controls. The output of the network, on the other hand, must present a finite output impedance to the following amplifier, while working into what is essentially an open circuit.

This requirement occurs since, in the interest of keeping the number of amplifier types to a minimum, it is common practice to use a microphone amplifier as a "booster" at the output of the differential network. The input impedance of this type of amplifier is relatively high and for practical design purposes may be considered infinite over most of the frequency range. The impedance of the source to which the amplifier is connected, on the other hand, must be a finite value.

The remainder of the program channel, following the booster amplifier (A_b), consisting of a master gain control (VC_1), a channel amplifier (A_c), line key (K_3) and resistance attenuation pad (P_2), follows conventional lines as already set forth.^{2,3}

Visual monitoring facilities consist of two standard volume indicators,⁵ one located on the control console and the other on the production desk. Both volume indicators are connected to a common range-attenuator (P_7) by means of a differential network (P_6) and are provided with means (P_8) for adjusting the sensitivity exactly to standard.

The aural monitoring facilities follow conventional lines and, as already described,² the operation of these circuits is interlocked with the operation of the line and the rehearsal-break keys.

AUXILIARY FACILITIES

The above described facilities, which may be considered of a basic nature, are supplemented by utility equipment which provides means for coping with essentially every requirement encountered during normal operations. These auxiliary units include a "sound-effects" filter consisting of adjustable low- and high-pass filters (F_{lp} and F_{hp}) connected in tandem, and an adjustable attenuator or volume control (VC_1) which is

⁵ H. A. Chinn, D. K. Gannett, and R. M. Morris, "A new standard volume indicator and reference level," *PROC. I.R.E.*, vol. 28, pp. 1-17; January, 1940; and *Bell Sys. Tech. Jour.*, vol. 19, pp. 94-137; January, 1940.

provided with isolation transformers (C_1) on both the input and output, in order that it may be used with either balanced- or unbalanced-to-ground circuits. In addition, there are double-pole, three-way key switches (K_2), parallel jacks, a utility bridging coil (C_2), and auxiliary circuits from the control room to the studio itself for extra microphones ($M-7$ and $M-8$), headphone "cue" transmission ($PII-Q$), private-line telephone extensions ($PL-X$), and general-utility circuits ($U-1$ and $U-2$). Another arrangement that often proves useful is the installation of a microphone ($M-9$ and $M-10$) and two utility circuits ($U-1$ and $U-2$) from the control room to the observation room and the storage room that is associated with each studio.

Still another useful facility is the auxiliary mixer shown in the upper right of Fig. 9. This circuit consists of a two-position mixer provided with bridging transformers (C_2) ahead of each volume control (VC_1).

When used in conjunction with a reverberation chamber as already detailed,⁴ this arrangement provides means for increasing the apparent reverberation time of the studio. The effect is often used for special dramatic effects.

This auxiliary two-position mixer is also useful for supplementing the regular mixer positions and can be connected into the circuit in a variety of ways by means of patch cords.

PERFORMANCE

Although the CBS 2A console has been used primarily for standard amplitude-modulation broadcast service, it was designed with frequency-modulation requirements in mind. The measured performance of the units readily meets such standards.

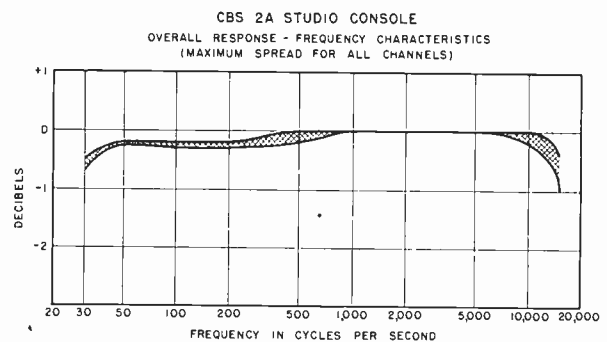

Fig. 10—The over-all response-frequency characteristic of the program channel of the Columbia Broadcasting System 2A studio console is well within the requirements dictated by good engineering practice. Measurements made on a number of channels illustrate this fact and, also, show the high degree of uniformity between channels.

The response-frequency characteristic of the program channel is uniform, within 0.3 decibel of the 1000-cycles-per-second value over the frequency range from 50 to 10,000 cycles per second and within 1 decibel over the range from 30 to 15,000 cycles per second. Fig. 10 graphically shows the extreme range of values obtained for a number of different channels.

The single-frequency nonlinear distortion of the program channel at output levels of +10 vu is less than 0.3 per cent over the test-tone fundamental-frequency range from 200 to 7500 cycles per second, and less than 0.75 per cent for test-tone frequencies from 50 to 7500 cycles per second. At output levels of +20 vu, that is, 10 decibels above normal, the distortion is less than 0.5 per cent over the frequency range from 100 to 4500 cycles per second and less than 0.75 per cent over the range from 50 to 7500 cycles per second. Fig. 11 shows the extreme range of values for a number of different channels.

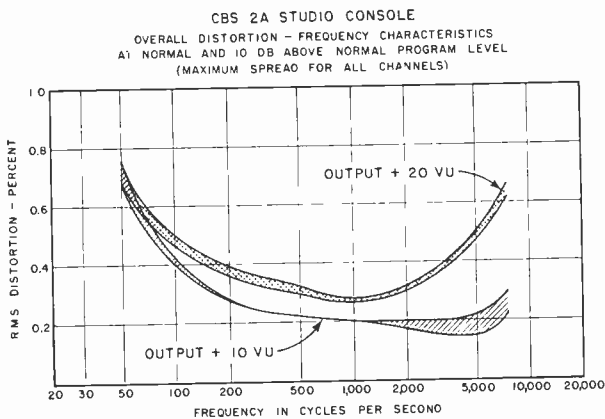

Fig. 11—The harmonic distortion, as a function of frequency, of the complete program channel of the Columbia Broadcasting System 2A studio console is shown above. The measurements are full single-frequency test tones at output levels corresponding to normal program level (+10 vu) and at levels 10 decibels above normal (+20 vu). The absolute magnitude of the harmonic distortion and the spread for a number of channels are seen to be quite small.

All of the above measurements are for the complete program channel from microphone preamplifier input to the output of the line pad. Normal gain-control settings were employed and the over-all insertion gain was 68 decibels. Under these circumstances the signal-to-noise ratio at +10 vu output levels ranged from 59.5 to 61.5 decibels for various channels. It is to be noted, however, that these measurements are not nearly as poor as they may seem, since they were made with respect to a single-frequency test tone, corresponding to normal program levels (+10 vu) as read by a standard volume indicator. Of course, the peak value of actual program material is many decibels higher than the indicated values—the peak factor ranging from perhaps 8 to 14 decibels, depending upon the program content. CBS established practice, which is now accepted by the industry (e.g., Radio Manufacturers Association), has been to use an average value of 10 decibels for the peak factor. Transmitters are designed accordingly, and the 100 per

cent modulation point for sine waves is considered to be 10 decibels above the normal program level. Obviously, signal-to-noise ratios should also be measured with respect to the sine-wave test-tone level that produces 100 per cent modulation of the transmitter, that is, 10 decibels above the normal program level. When this was done, the signal-to-noise levels of the CBS 2A console were found to be from about 69 to 71 decibels.

CONCLUSION

In the final analysis, the excellence of any design is proved by its performance under actual operating conditions, and the enthusiasm with which the device is accepted by the profession. The CBS 2A console has met both of these tests with distinction.

These equipments have been in constant service since 1940, or for over six years. During that time, no modifications or alterations have been necessary to meet any of the requirements of a large broadcast network program-origination center in New York—even though the period included the trying war years. The additional initial cost of the console, as compared to more prosaic designs, has been more than justified by the subsequent saving in material, labor, and lost time that a less complete assembly would have entailed when additions and modifications, made necessary by program-production demands, were undertaken.

The acceptance by the profession can best be judged by the interest now being manifested by others in the design and by the requests for permission to duplicate, in whole or in part, various features that are incorporated. In fact, it is because of current interest in the basic layout that this paper is being published. Although originally prepared in 1941, but not quite finished because of the war, the material presented will not only make available to others certain fundamental studio-console-design considerations, but also serve as a basis for new designs. The relay-rack-and-panel age for broadcasting studio audio facilities is probably a thing of the past.

ACKNOWLEDGMENT

A description of the CBS 2A studio control console would not be complete without acknowledgment of the many helpful suggestions received from members of the CBS technical operations group. Unfortunately, because of the large number of persons who were canvassed, it is not possible properly to credit each individual for his contribution. Particular recognition is due J. H. Swenson, however, for his pioneer work which led to the design finally adopted.

The Use of Liquid Dimethylsilicones to Produce Water-Repellent Surfaces on Glass-Insulator Bodies*

O. K. JOHANNSON† AND JULIUS J. TOROK‡

Summary—The need to render ceramic surfaces water-repellent in certain electrical applications under high humidities is discussed.

Organosilicon compounds have been found to make ceramic surfaces water-repellent. The nature of a family of such compounds, the dimethylsilicones, is briefly described. Methods of preparing and treating glass surfaces with silicones are presented.

Results of tests on treated and untreated glass-insulator bodies are presented in detail. The advantages of the treatment as tested under adverse conditions such as immersion in sea water are shown.

I. INTRODUCTION

GLASS and ceramic insulators are used in practically all types of electrical equipment. In many applications, particularly in radio and precision equipment, such insulators have given trouble under conditions of high humidity. Under such conditions, although the volume resistance of an insulator usually remains constant, the surface resistance decreases markedly. This latter effect is due to adsorption of water.¹⁻⁷ If the temperature of the insulator is below the dew point, condensation of water on the surface occurs as well, and over a clean surface a continuous conducting film of water is formed.

Waxes and greases have been applied to ceramic insulator surfaces to render them water-repellent so that condensed water will form small droplets rather than a continuous film. Although these materials are effective in this respect, they are limited in their use due to their relatively low softening points and poor adhesion to the glass or ceramic base.

The ability of organosilicon compounds to produce water-repellent surfaces on glass and ceramics was noted by Hyde⁸ in early researches on these materials. Glassware which had been in contact with organosilicon chlorides or their hydrolysis products, now commonly known as "silicones,"⁹ was found to be water-repellent and to remain so on long immersion in water.

* Decimal classification: R281. Original manuscript received by the Institute, October 29, 1945.

† Corning Glass Works, Corning, N. Y.

¹ H. L. Curtis, "Insulating properties of solid dielectrics," *Bull. Bur. Stand.*, vol. 11, pp. 359-420; May, 1915.

² H. L. Curtis, "The volume resistivity and surface resistivity of insulating materials," *Gen. Elec. Rev.*, vol. 18, pp. 996-1001; October, 1915.

³ M. Fulda, "Über das elektrische Leitvermögen der Gläser," *Sprechsaal*, vol. 60, pp. 769-772, 789-791, 810-813, 831-833; 1927.

⁴ G. G. Smail, R. J. Brooksbank, and W. M. Thornton, "Electrical resistance of moisture films on glazed surfaces," *Jour. I.E.E.* (London), vol. 69, pp. 427-436; March, 1931.

⁵ H. H. Housner, "Influence of humidity on dielectric properties of high-frequency ceramics," *Jour. Amer. Ceram. Soc.*, vol. 27, pp. 175-181; June, 1944.

⁶ W. A. Yager and S. O. Morgan, "Surface leakage of Pyrex glass," *Jour. Phys. Chem.*, vol. 35, pp. 2026-2042; July, 1931.

⁷ R. F. Field, "How humidity affects insulation," *Gen. Rad. Exper.* vol. 20, pp. 6-12; July and August, 1945.

More recently, Norton¹⁰ and Patnode¹¹ have reported the use of the vapors of organosilicon chlorides to treat ceramic insulators so as to render them water-repellent and increase their resistance to electrical surface leakage. In this treatment, a silicone polymer is formed on the surface by reaction of the organosilicon chlorides with moisture adsorbed on the surface, according to the following equation:

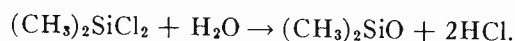

This paper deals with the use of silicones which have been partially polymerized before application. Methods of applying and fixing these to the surfaces of glassware and of evaluating the permanence of such treatments are given.

II. MATERIALS USED

The silicones, the use of which is described here, are dimethylsilicon-oxide polymers, corresponding substantially to the formula

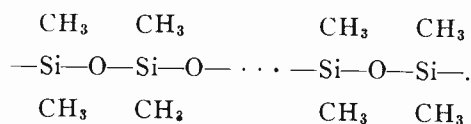

These liquid silicones¹² are water-white, inert, non-toxic, noncorrosive, and oxidation resistant. Their electrical volume resistivities are at least 10¹⁴ ohm-centimeters and their power factors are less than 0.0002 at frequencies up to 8 megacycles. Medium-viscosity grades were selected (Dow Corning type 200 fluids, 100 to 1000 centistokes) which have a flash point greater than 600 degrees Fahrenheit and withstand oxidation at temperatures up to 500 degrees Fahrenheit.

III. LIQUID-SILICONE PROCESS FOR TREATING GLASS SURFACES

It has been found that the most effective treatments with the DC 200 fluids, as determined by the maintenance of high surface resistances under accelerated aging conditions, are obtained with the following procedure:

1. The surface of the article to be treated is thoroughly cleaned.

⁸ J. F. Hyde, (unpublished), Corning Glass Works.

⁹ S. L. Bass, J. F. Hyde, E. C. Britton, and R. R. McGregor, "Silicones, high-polymeric substances," *Modern Plastics*, pp. 124-126, 212, 214; November, 1944.

¹⁰ F. J. Norton, "Organo-silicon films," *Gen. Elec. Rev.*, vol. 47, pp. 6-16; August, 1944.

¹¹ W. I. Patnode, United States Patent No. 2,306,222 to General Electric Company.

¹² Dow Corning Fluids, Dow Corning Corporation, Midland, Mich., July, 1944.

2. The article is dipped in a solution of the liquid silicone in an inert solvent, drained, and allowed to dry.

3. It is then baked to fix the silicone film on the surface.

The following is a discussion of these three steps in detail:

A. Cleaning the Ware before Treatment

It has been found that the most durable silicone-treated surfaces are obtained when the ware is carefully cleaned before treatment. Traces of grease, oil, and electrolytes on the surface yield markedly less-durable surface treatments. Apparently these materials interfere with the attachment of the silicone molecules to the surface.

The cleanest surfaces are those obtained with ware taken directly from the firing kiln or the annealing oven. Consequently, best results are obtained with such ware. The articles should be allowed to cool in a dry and clean atmosphere, well away from oil or burner nozzles. The ware may be treated while still warm but the temperature, at treatment, should not be greater than the boiling point of the solvent used. All handling should be done with clean, grease-free utensils. A cleaning operation is necessary if the article has been machined or handled after firing. Two methods of cleaning have been found effective:

(1) Heating to above 400 degrees centigrade for at least one hour. The article is then handled just as it would be when taken from the firing kilns.

(2) In the event that the article cannot be fired, the ware may be degreased by a solvent degreasing operation. The article should be taken, untouched by hand, directly to the treating operations after such degreasing. If the article is contaminated with electrolytes it should be immersed in boiling distilled water for 30 minutes and then dried prior to either of the above cleaning procedures.

B. Application of Liquid Silicones to the Glass Surface

It has been found that only a very thin film of the liquid silicone is required to modify the surface of the insulator. An excess, as indicated by an oily appearance, is unnecessary and undesirable. For this reason, it is preferable to apply the liquid silicone from a dilute solution in an inert solvent.

A 2 per cent solution of the liquid silicone is prepared in carbon tetrachloride or perchloroethylene. The articles are taken directly from the firing kiln or annealing oven, and, while still warm but not above the boiling point of the solvent in temperature, are dipped in the silicone solution. They are drained and the solvent is allowed to evaporate. Good solvent elimination can be obtained by allowing the article to stand in open air from two to twenty-four hours, or by heating it for one-half hour at 100 degrees centigrade. Fans or ventilators should be provided to remove the solvent fumes. The articles are then ready for baking.

C. Baking the Treated Ware

After coating the pieces, baking is required to fix the silicone film on the surface. Optimum times and temperatures of baking are given by the curves of Fig. 1. For most of the data reported below, a standard baking schedule of one half hour at 300 degrees centigrade was used.

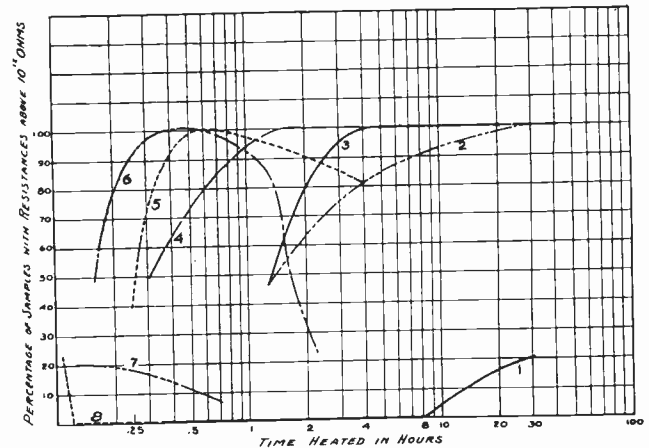

Fig. 1—Surface resistances of 774 Pyrex-brand glass rods after immersion in salt water as a function of time and temperature of baking.

- 1—Heated at 150 degrees centigrade; 8 days in salt water.
- 2—Heated at 175 degrees centigrade; 11 days in salt water.
- 3—Heated at 225 degrees centigrade; 11 days in salt water.
- 4—Heated at 275 degrees centigrade; 11 days in salt water.
- 5—Heated at 300 degrees centigrade; 11 days in salt water.
- 6—Heated at 325 degrees centigrade; 11 days in salt water.
- 7—Heated at 350 degrees centigrade; 7 days in salt water.
- 8—Heated at 375 degrees centigrade; 7 days in salt water.

Consideration should be given to the mass and heating time of the ceramic bodies as well as the capacity of the heating oven to get the pieces up to temperatures.

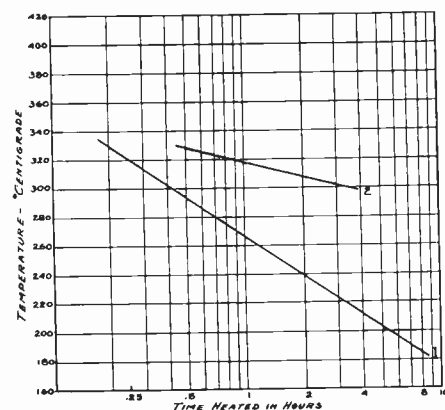

Fig. 2—Optimum baking conditions for 774 Pyrex-brand glass rods, treated with a DC 200 fluid; the times of baking should not be less than those given by curve 1 or greater than those given by curve 2.

The curve of Fig. 2 was based on results obtained with glass rods, $\frac{1}{8}$ inch in diameter and $1\frac{1}{2}$ inches long. Much more massive bodies will require longer times to come up to oven temperatures and proper compensation should be made, especially at the higher temperatures and shorter times, where the heating conditions are more critical. This baking completes the treatment.

IV. TEST METHODS

A casual inspection of glassware after treatment reveals no discernible film. The surfaces are more slippery to the touch, but otherwise it is almost impossible to differentiate between treated and untreated pieces. Contact with water, however, reveals the difference between them. The water on a clean untreated sample will adhere to the surface as an extended film, but on a treated surface will form droplets which are easily dislodged. The contact angle of these droplets is high, usually of the order of 90 degrees.

The initial magnitude of the contact angle of a drop of water against a treated surface has not proved to be of value in predicting the length of time that high surface resistance will be maintained in the presence of water. Measurements of surface resistances after exposure to water vapor or liquid water are necessary to determine the permanence of treatment.

The review of the possible conditions existing in military service indicated that insulator bodies, in such applications, might be exposed to high humidities, to water condensed on their surfaces, to sea water, to weathering, and to environments favoring the growth of fungi. In accordance with these possibilities the stability of a particular method of treatment of a glass body was determined under the following conditions:

- (1) Exposure to 100 per cent relative humidity at 25 degrees centigrade.
- (2) Immersion in distilled water.
- (3) Immersion in a 2 per cent solution of sea salt.
- (4) Exposure in a weatherometer and on factory roofs.
- (5) Storage in mildew cabinets.

After exposure, the surface resistance of the samples was determined at 100 per cent relative humidity, with moisture condensing on the surfaces of the samples. In some cases, power-factor measurements were also made.¹³ A variety of test pieces were used, including rods, disks, and coil forms.

It was found that a parallelism existed between the first three types of durability test in that the order of permanence of various treatments was the same regardless of the environment to which the samples were exposed. However, the exposure to salt water was much more severe than the others and has been used extensively throughout this work as an accelerated test.

V. TEST APPARATUS AND EQUIPMENT

For the measurement of surface resistance the apparatus of Fig. 3 was used. This consisted of a direct-current amplifier with a sensitivity¹⁴ of at least 10^{12} ohms, a 100- to 500-volt direct-current supply, and a glass humidity cabinet in which the sample was suspended during the measurements. The surface resistance

to be measured is in series with the input resistance of the amplifier. In most of the work the test pieces used were rods of No. 774 Pyrex-brand glass. In some cases, metallized rods, shown in Fig. 4, were also used.

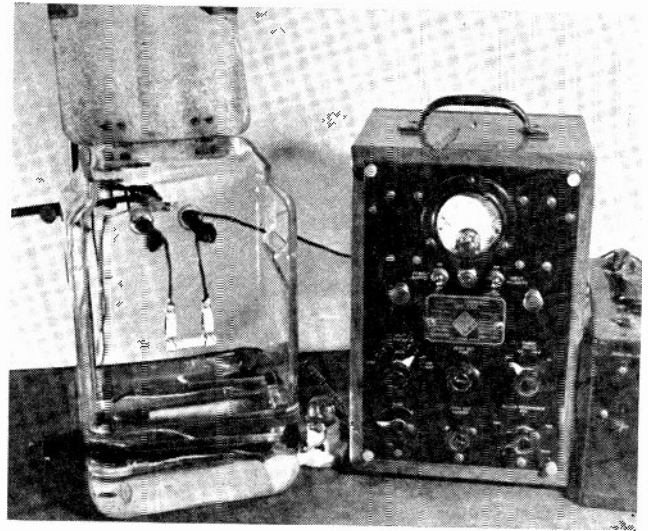

Fig. 3—The direct-current amplifier and glass humidity cabinet used for the measurement of surface resistance.

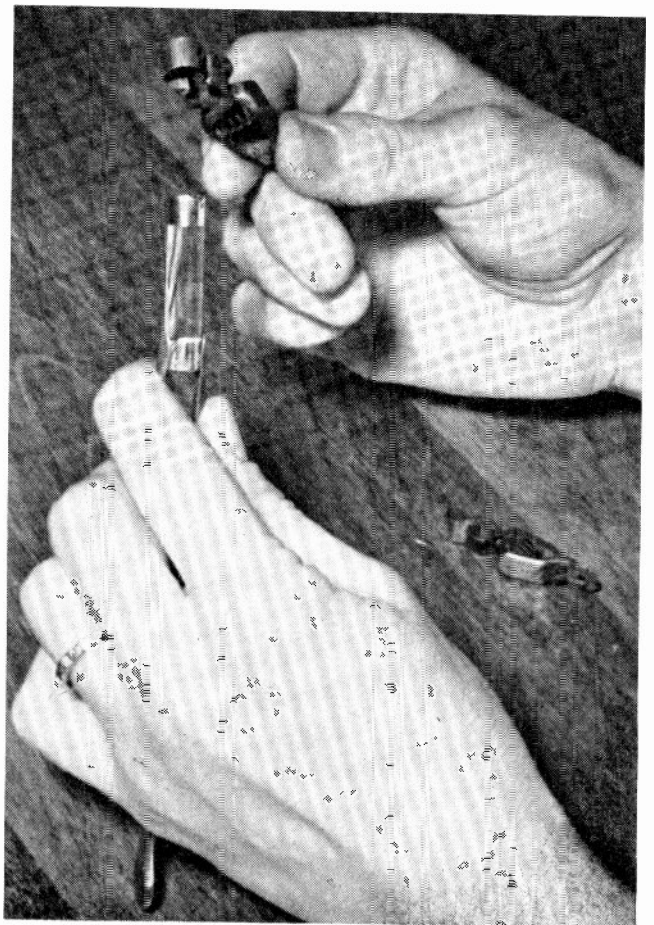

Fig. 4—One of the metallized-rod test pieces.

The samples for measurements are removed from the environment to which they were exposed and immediately placed in the test cabinet. The samples that have

¹³ In accordance with American War Standard ASA-C75.1, Ceramic Radio Insulating Materials, Class L, 1943.

¹⁴ General Radio 715A direct-current amplifier. A megohm bridge may be used in place of the amplifier.

been in salt water are not rinsed before testing. The glass cabinet is fitted with a hinged cover, which enables the operator to change samples and make adjustments readily. The leads to the electrodes are brought through two holes without contacting the sides of the jar, thus eliminating the necessity for guard circuits. The bottom of the jar is covered with water maintained at 60 degrees centigrade with a thermostatically controlled heater. The electrodes are stainless-steel bands, which are forced into intimate contact with the surfaces of the sample by battery clips, to which the bands are soldered. The leads to the clips are adjusted so that the sample is held a few inches above the surface of the water. The electrodes are placed on the sample approximately one inch apart, taking care that they do not slide over the surface under measurement when attaching or removing the clips.

Since the sample is at room temperature when placed in the test cell, water rapidly condenses on its surface. The resistance is determined when the readings have become reasonably constant.

The method of measuring power factor differs from the customary procedure only in that the foil electrodes were not pasted onto the test sample with petroleum jelly but firmly pressed against the siliceous surface by a rubber backing. In this way contamination of the surface of the test pieces was avoided. In the case of the coil forms the interior pressure was obtained by inserting a rubber bag in the coil form and inflating it.

VI. EXPERIMENTAL RESULTS

A. Cleaning the Ware before Treatment

The test pieces employed for most of the work were rods of 774 Pyrex-brand chemical-resistance glass, $\frac{1}{8}$ inch in diameter, $1\frac{1}{2}$ inches in length. The cleaning process used, which appeared to be generally satisfactory, was to immerse these in boiling distilled water for 30 minutes, rinse them with distilled water, and then fire them at 450 degrees centigrade for one half hour. Rods treated in this manner were found to be completely wetted by water. Surface resistances of such test pieces are given in Table I.

TABLE I

Surface resistances of untreated clean No. 774 Pyrex-brand glass rods on immersion in 2 per cent sea-salt solution

| Time of Immersion | Resistance in Megohms | | | | | | | |
|-------------------|-----------------------|------|------|------|------|------|------|------|
| 1 minute | 0.07 | 0.04 | 0.07 | 0.05 | 0.04 | 0.05 | 0.05 | 0.04 |
| 1 day | 0.09 | 0.04 | 0.05 | 0.05 | 0.06 | 0.04 | 0.04 | 0.04 |
| 2 days | 0.07 | 0.05 | 0.05 | 0.04 | 0.04 | 0.04 | 0.02 | 0.05 |
| 4 days | 0.01 | 0.03 | 0.06 | 0.06 | 0.09 | 0.04 | 0.09 | 0.05 |
| 5 days | 0.07 | 0.04 | 0.04 | 0.03 | 0.05 | 0.03 | 0.06 | 0.01 |
| 6 days | 0.07 | 0.03 | 0.04 | 0.04 | 0.04 | 0.03 | 0.05 | 0.04 |

Since cleaned glass surfaces rapidly become water-repellent on standing under ordinary conditions, the pieces to which a solution of the DC fluid in perchloro-

ethylene was applied were treated as soon as they had cooled to about 100 degrees centigrade after firing.

The sensitivity of the treatment to the presence of foreign materials on the glass prior to dipping is indicated on comparing the data of Table II and Table III. The rods used in the experiment summarized by Table II were treated as received; the other set, the surface resistances of which are given in Table III, was cleaned as described previously, but was otherwise treated in the same manner as the set which was not cleaned. The former set showed large variability in their initial resistances and dropped to low resistance values in two to four days.

B. Baking the Treated Ware

The importance of baking the glass after treatment is indicated by a comparison of the data given in Tables III and IV. The resistances of the samples which were not baked had decreased appreciably after 1 day in salt water. The relation between the effectiveness of a treatment and the time and temperature of baking is shown by the curves of Fig. 1 and is also indicated by a comparison of Tables III and V. It is to be seen that, at temperatures below 175 degrees centigrade, more than 10 hours of baking are required to obtain treated samples which will maintain high resistances after 11 days in salt water. As the temperature is increased to 275 degrees centigrade the time required is decreased to one to two hours. Further decrease in the time of baking necessary for a given durability of the treatment occurs as the temperature of baking is increased above 275 degrees centigrade. However, in the neighborhood of 300 degrees centigrade the durability of the treatment passes through a maximum. There is, thus, an upper as well as a lower time limit for any desired degree of permanence of the treatment on glass immersed in salt water.

At temperatures above 325 degrees centigrade the time interval for which the highest durabilities are obtained becomes very short and these highest durabilities are considerably lower than those obtained in the temperature range from 175 to 325 degrees centigrade.

The time intervals for optimum results at different temperatures are given in Fig. 2. The lengths of time of heating after which 90 per cent of the samples have a resistance greater than 10^{12} ohms after 11 days in salt water are taken arbitrarily as the optimum.

C. Removal of Solvent before Baking

The treated samples used in the above set of experiments were heated one-half hour at 100 degrees centigrade before they were heated to the higher temperatures at which they were baked. This is to eliminate the larger part of the perchloroethylene used as the solvent in the application of the DC fluid. Such drying is found to be a necessary part of the procedure as may be observed on comparing the data of Tables VI and III. If the samples were not heated at 100 degrees centigrade

TABLE II

Surface resistances of uncleaned No. 774 Pyrex-brand glass rods treated by dipping in a 2 per cent solution of Dow Corning 200 fluid (1000 centistokes) in perchloroethylene, baking 30 minutes at 100 degrees centigrade and then 30 minutes at 300 degrees centigrade.

| Time in 2 Per Cent Salt Solution | Resistances in Megohms | | | | | | | | | |
|--|------------------------|----------|----------|------|--------|----------|---------|------|----------|------|
| 1 minute | 12,000 | infinite | infinite | 2800 | 22,000 | infinite | 500,000 | 2000 | infinite | 7000 |
| 1 day | 5000 | infinite | infinite | 1500 | 2300 | infinite | 15,000 | 4000 | infinite | 45 |
| 2 days | 5000 | 80,000 | 40,000 | 70 | 0.5 | 100,000 | 0.5 | 5.0 | infinite | 0.2 |
| 3 days | 40 | 6000 | 150,000 | 0.1 | 80 | 10,000 | — | 0.2 | infinite | — |
| 4 days | 30 | 1500 | 30,000 | 0.2 | 0.7 | 5500 | — | 17 | infinite | — |
| 7 days | 6 | 500 | 14,000 | — | — | 1000 | — | 0.1 | 20,000 | — |
| | | | | | | | | | 900 | — |

TABLE III

Surface resistances of 774 Pyrex-brand glass rods treated, after firing one-half hour at 450 degrees centigrade, by dipping in 2 per cent DC 200 (100 centistokes) in perchloroethylene, baking 30 minutes at 100 degrees centigrade and then baking 30 minutes at 300 degrees centigrade.

| Time in 2 Per Cent Salt Solution | Resistances in Megohms | | | | | | | | | |
|--|------------------------|----------|-----------|----------|----------|----------|----------|----------|----------|----------|
| 1 minute | infinite | infinite | infinite | infinite | infinite | infinite | infinite | infinite | infinite | infinite |
| 2 days | infinite | infinite | infinite | infinite | infinite | infinite | infinite | infinite | infinite | infinite |
| 4 days | infinite | infinite | infinite | infinite | infinite | infinite | infinite | infinite | infinite | infinite |
| 6 days | infinite | infinite | infinite | infinite | infinite | infinite | infinite | infinite | infinite | infinite |
| 20 days | infinite | infinite | infinite | infinite | infinite | infinite | infinite | infinite | infinite | infinite |
| 45 days | infinite | infinite | 1,000,000 | 15,000 | infinite | infinite | infinite | infinite | infinite | infinite |

TABLE IV

Surface resistances of No. 774 Pyrex-brand glass rods fired two hours at 450 degrees centigrade then treated by dipping in 2 per cent Dow Corning 200 fluid (1000 centistokes) in perchloroethylene but not baked.

| Time in 2 Per Cent Salt Solution | Resistance in Megohms | | | | | | | | | |
|--|-----------------------|----------|----------|----------|----------|----------|----------|----------|----------|----------|
| 1 minute | infinite | infinite | infinite | infinite | infinite | infinite | infinite | infinite | infinite | infinite |
| 1 day | 16,000 | 150,000 | 7500 | 0.1 | 56,000 | 50,000 | 150,000 | 45,000 | infinite | infinite |
| 2 days | 3000 | 50 | 4500 | 0.6 | 5000 | 5600 | 11,300 | 180 | 32,500 | 12,000 |
| 3 days | 900 | 0.005 | 0.04 | 0.01 | 2600 | 1400 | 4100 | 64 | 3750 | 3750 |
| 4 days | 800 | 0.09 | 0.06 | 0.04 | 300 | 175 | 500 | 0.07 | 1400 | 1200 |
| 5 days | 580 | 0.06 | 0.06 | 0.04 | 3800 | 1200 | 1750 | 0.04 | 150 | 110 |
| | | | | | | | | | 2500 | 400 |

TABLE V

Surface resistances of No. 774 Pyrex-brand glass rods treated after firing two hours at 450 degrees centigrade by dipping in 2 per cent DC 200 (1000 centistokes) in perchloroethylene and baking two hours at 160 degrees centigrade.

| Time in 2 Per Cent Salt Solution | Resistances in Megohms | | | | | | | | | |
|--|------------------------|----------|----------|----------|----------|----------|-----------|----------|----------|----------|
| 1 minute | infinite | infinite | infinite | infinite | infinite | infinite | infinite | infinite | infinite | infinite |
| 1 day | infinite | infinite | infinite | infinite | infinite | infinite | infinite | infinite | infinite | infinite |
| 2 days | infinite | infinite | 15,000 | 640 | 225,000 | 13,000 | infinite | 45,000 | 113,000 | infinite |
| 3 days | infinite | 56,000 | 900 | 3200 | 20,500 | 1200 | 1600 | 9000 | 45,000 | 64,000 |
| 4 days | infinite | 14,000 | 140 | 90 | 3000 | 6000 | 1,000,000 | 175,000 | 41,000 | 80,000 |
| 5 days | infinite | 15,000 | 300 | 30 | 15,000 | 700 | infinite | 9000 | 18,000 | 20,000 |

TABLE VI

Surface resistances of 774 Pyrex-brand glass rods treated after firing one-half hour at 450 degrees centigrade by dipping in 2 per cent DC 200 (1000 centistokes) in perchloroethylene and immediately baking one-half hour at 300 degrees centigrade.

| Time in 2 Per Cent Salt Solution | Resistance in Megohms | | | | | | | | | |
|--|-----------------------|----------|----------|----------|----------|----------|----------|----------|----------|----------|
| 1 minute | infinite | infinite | infinite | infinite | infinite | infinite | infinite | infinite | infinite | infinite |
| 1 day | infinite | 38,000 | 6400 | 150,000 | infinite | infinite | 3500 | 150,000 | 45,000 | 90,000 |
| 3 days | infinite | 5000 | 4500 | 4100 | 75,000 | 1100 | 32,000 | 300 | 150 | 2500 |
| 4 days | 26,400 | 3000 | 562 | 0.05 | 20,000 | 128 | 409 | 0.04 | 28 | 9 |
| 5 days | 40,000 | 1800 | 950 | 0.01 | 65,000 | 580 | 7900 | 0.02 | 7.8 | 12.5 |
| 6 days | 20,000 | 1500 | 210 | 600 | 3000 | 140 | 650 | 0.04 | 31 | 30 |

TABLE VII
RELATIVE SEVERITY OF ACCELERATED AGING CONDITIONS ON SILICONE-TREATED GLASS
Surface resistances of No. 774 Pyrex brand glass rods heated one-half hour at 450 degrees centigrade and then treated with Dow Corning 200 Fluid by dipping in a 2 per cent solution, followed by baking two hours at 160 degrees centigrade

| Time of Exposure | Immersed in Per Cent Salt Water | | | | | | Immersed in Distilled Water | | | | | | Exposed to 100 Per Cent Humidity | | | | | |
|------------------|---------------------------------|--------|--------|--------|---------|--------|-----------------------------|------|---------|--------|------|---------|----------------------------------|------|------|------|------|------|
| | inf. | inf. | inf. | inf. | inf. | inf. | inf. | inf. | inf. | inf. | inf. | inf. | inf. | inf. | inf. | inf. | inf. | inf. |
| 1 minute | inf. | inf. | inf. | inf. | inf. | inf. | inf. | inf. | inf. | inf. | inf. | inf. | inf. | inf. | inf. | inf. | inf. | inf. |
| 1 day | inf. | 23,000 | 15,000 | inf. | inf. | 23,000 | inf. | inf. | inf. | inf. | inf. | inf. | inf. | inf. | inf. | inf. | inf. | inf. |
| 2 days | inf. | 4000 | 3000 | 64,200 | 150,000 | 22,500 | inf. | inf. | inf. | inf. | inf. | inf. | inf. | inf. | inf. | inf. | inf. | inf. |
| 4 days | 56,300 | 1100 | 300 | 30,000 | 11,300 | 4500 | inf. | inf. | inf. | inf. | inf. | inf. | inf. | inf. | inf. | inf. | inf. | inf. |
| 5 days | 7500 | 900 | 200 | 11,000 | 2400 | 9000 | inf. | inf. | inf. | inf. | inf. | inf. | inf. | inf. | inf. | inf. | inf. | inf. |
| 7 days | 6400 | 400 | 200 | 4000 | 2000 | 3500 | inf. | inf. | inf. | inf. | inf. | inf. | inf. | inf. | inf. | inf. | inf. | inf. |
| 11 days | 900 | 100 | 150 | 200 | 200 | 200 | 900 | 1100 | 16,000 | inf. | inf. | inf. | inf. | inf. | inf. | inf. | inf. | inf. |
| 18 days | 300 | 100 | 60 | 500 | 200 | 130 | 11,300 | 1800 | 225,000 | 41,000 | inf. | 225,000 | inf. | inf. | inf. | inf. | inf. | inf. |
| 26 days | 300 | 30 | 45 | 150 | 900 | 400 | 12,800 | 9000 | inf. | 2600 | inf. | inf. | inf. | inf. | inf. | inf. | inf. | inf. |
| 33 days | 75 | 200 | 30 | 65 | 40 | 40 | 20 | 3 | 900 | 350 | 7500 | 400 | inf. | inf. | inf. | inf. | inf. | inf. |
| 40 days | 300 | 30 | 40 | 110 | 60 | 60 | 90 | 60 | 20,000 | 2300 | 3500 | 7500 | inf. | inf. | inf. | inf. | inf. | inf. |

before raising their temperature to 300 degrees centigrade, their surface resistances fell off rapidly in contact with salt water.

Allowing the samples to stand at room temperature for at least 16 hours before baking, without deliberate circulation of air, appears to be equivalent to drying one-half hour at 100 degrees centigrade.

D. Relative Severity of Test Condition

Table VII compares the effects, as measured by change in surface resistance, of immersion in 2 per cent salt water, immersion in distilled water and exposure to an atmosphere saturated with water vapor at 25 degrees centigrade. It is apparent that immersion in salt water is an extremely severe test relative to immersion in distilled water. Exposure to 100 per cent relative humidity has little effect on the treated samples.

E. Comparison of Silicone and Wax Treatments

A comparison of the durability of untreated, waxed, and silicone-treated Multiform ware is given in Fig. 5. In this instance the silicone-treated samples were baked two hours at 160 degrees centigrade. The samples were

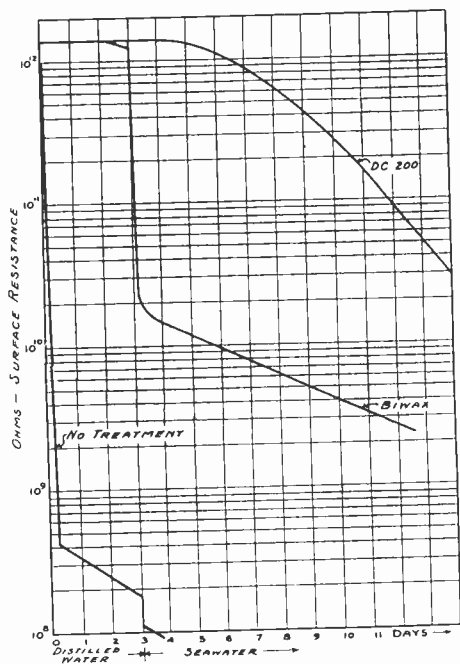

Fig. 5—Surface resistances of coil forms as affected by immersion in water.

first immersed in distilled water for three days, then immersed in sea-salt solution. It is to be noted that the treated surfaces retained their insulating properties in distilled water, but directly upon placing in sea water the resistance of the waxed surface dropped sharply, whereas the silicone-treated surfaces retained their high insulating value, dropping noticeably only after four days in salt water. These curves are plotted for average values.

F. Effect of Liquid Silicone Treatment on Power Factor

Extensive power-factor measurements on the DC 200 fluids used showed such low values that they were at, or beyond, the sensitivity limits of the bridge. Because the

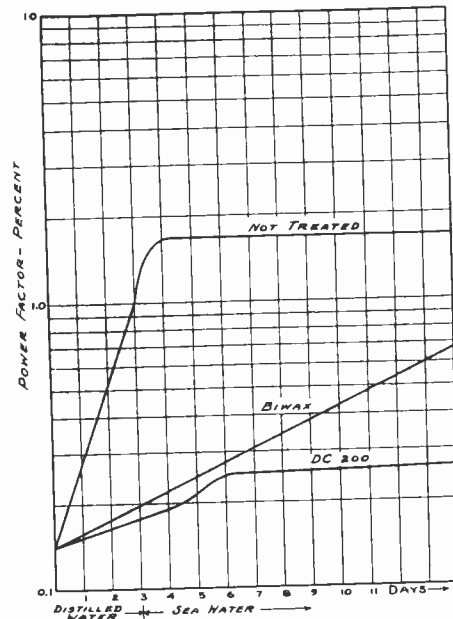

Fig. 6—Power factors of coil forms as affected by immersion in water.

power factor of these fluids is so much lower than that of the ceramics to be treated, the treatment is without effect on the over-all power factor, when measured dry. When the specimens are exposed to water, the liquid silicone treatment, with a two-hour bake at 160 degrees centigrade, markedly improves the performance of the ceramic, as is shown by the curves of Fig. 6. Here again, the coil forms were first immersed for three days in distilled water and then in sea water. The first measurements were made 1 minute after immersion in distilled

water. Fig. 7 shows the effect of exposure to sea water on the power factor of No. 790 Multiform disks, 4 inches in diameter and 0.15-inch thick.

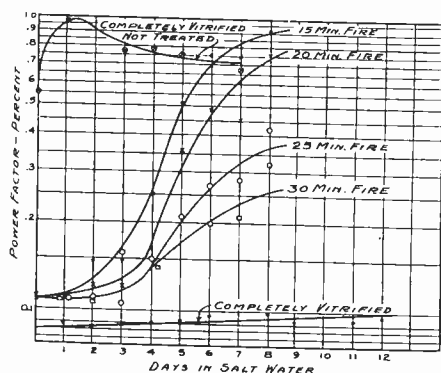

Fig. 7—Effect of firing time on DC-treated porous disks.

G. Effect of Porosity on Power Factor Obtainable by Treatment

The effect of porosity on the power factor of the test disks is shown in Fig. 7. The porosity of the ware, of course, decreases with the time the ware was fired. The liquid silicone treatment greatly improves the power factor of porous and nonporous bodies. However, it does not make a poorly fired ware equivalent to a treated nonporous body.

II. Other Exposure Conditions

Dust-collecting experiments have shown that the amount of foreign matter accumulated, as measured by weight increase on standing in the open air, is the same for treated and untreated samples. Coil forms which

were under test for 45 days in a fungus-growth cabinet and a standard "weatherometer" cabinet had increased somewhat in power factor, but stayed within their classification ratings. The silicone is not a fungicide in itself but neither is it a nutrient for fungus growth.

I. Treatment of Metallized Ceramic Ware

Preliminary work on metallized ceramic and steatite pieces indicates that the DC treatment produces beneficial results; further work will be necessary to determine the best set of conditions for the treatment of such ware.

VII. CONCLUSIONS

1. Glass insulators may be rendered water-repellent under conditions of high humidity and condensation of water on their surfaces, for long periods of time, by fixing on their surface an extremely thin film of a silicone polymer.

2. Conditions required are: (a) a "clean" surface; (b) application of a thin film of liquid silicone by dipping in a dilute solution of the silicone in a nonflammable solvent; and (c) baking to fix the film of silicone on the surface.

3. Accelerated aging tests show the stability and strength of attachment of the silicone film. Aging conditions in order of severity are: immersion in 2 per cent salt solution; immersion in distilled water; exposure to an atmosphere saturated with water vapor; and exposure to 90 per cent relative humidity or less.

4. Long-lasting water repellency is accompanied by retention of high surface resistance and low power factor in glass-insulation bodies treated with liquid silicones.

An Ionization Gauge of Simple Construction*

CHARLES M. FOGEL†, ASSOCIATE, I.R.E.

Summary—A new ionization gauge is described for measuring pressures from 10^{-4} to less than 10^{-8} millimeters of mercury. Except for a multiplying factor of 10, it gives a direct reading of residual air pressure. The gauge employs two plates, as the electron and ion collector, respectively. They are located on opposite sides of the filament, but equidistant from it. This allows easy outgassing of parts, either by electron bombardment or by radio-frequency heating. A protective shield in front of the ion collector aids in reducing the electrical leakage to that element. Danger of filament burnout due to vacuum leaks has been removed by the choice of an oxide-coated filament.

INTRODUCTION

THE USE of a vacuum manometer for checking the operating conditions of a vacuum system has proved itself almost indispensable. An ionization gauge, with its ability to give a continuous reading

* Decimal classification: 621.375.621. Original manuscript received by the Institute, October 11, 1945; revised manuscript received, January 21, 1946.

† Formerly, National Union Radio Corporation, Newark, N. J. now, University of Buffalo, Buffalo, N. Y.

of pressure, has a definite advantage for this purpose. The operation of such a manometer was described by Baeyer,¹ and later by Buckley,² Hauser-Ganschwindt, and Rukop.³ Buckley experimentally showed that within a certain range of pressure, the amount of ionization produced by a constant electron stream through a gas is directly proportional to the gas pressure. This was verified by Simon,⁴ and by Dushman and Found,⁵ down to pressures of about 10^{-6} millimeter of mercury. The constant of proportionality depends on the operating

¹ O. V. Baeyer, "Slow cathode rays," *Phys. Zeit.*, vol. 10, pp. 168-176; March, 1909.

² O. E. Buckley, "An ionization manometer," *Proc. Nat. Acad. Sci.*, vol. 2, pp. 683-685; December, 1916.

³ K. Hauser-Ganschwindt, and H. Rukop, "High vacuum tubes," *Telefunken Zeit.*, vol. 19, pp. 14-26; February, 1920.

⁴ H. Simon, "Ionization manometer," *Zeit. für Tech. Phys.*, vol. 5, pp. 221-233; 1924.

⁵ S. Dushman and C. G. Found, "Studies with ionization gauge, Part 1," *Phys. Rev.*, vol. 17, pp. 7-19; January, 1921; Part 2, *Phys. Rev.*, vol. 23, pp. 734-743; June, 1924.

conditions and the gas present in the system, as was shown experimentally by Dushman and Found,⁵ Jaycox and Weinhart,⁶ and N. B. Reynolds.⁷ Morgulis⁸ evaluated this proportionality factor by theoretical means.

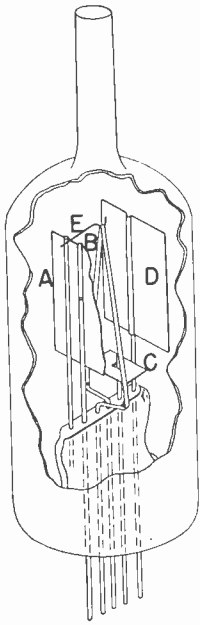

Fig. 1—The ionization gauge.

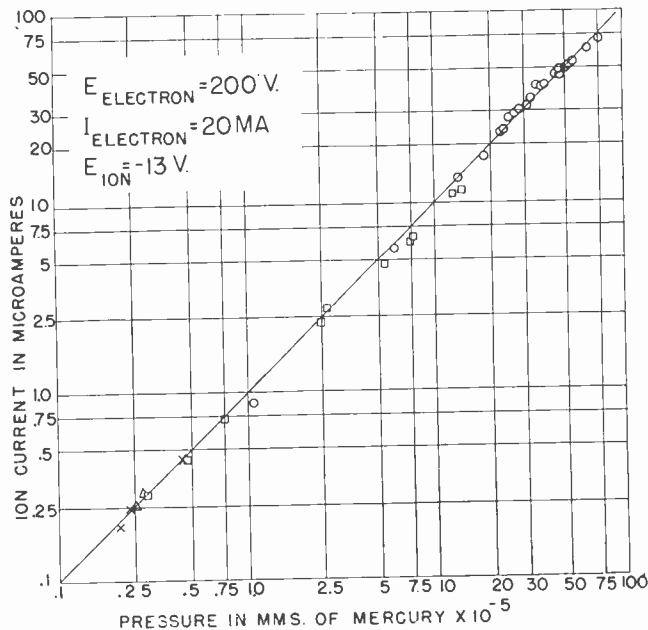

Fig. 2—Ion current versus pressure. \circ and \square represent readings taken one week apart on the same gauge (#1). \times and Δ represent readings taken on the same gauge (#2), with the latter readings being taken after the tube had been burned in air three times, being partially evacuated after each time.

Many of the original gauges were ordinary three-electrode tubes. Recently, others, such as Spivak and

⁶ E. K. Jaycox and H. W. Weinhart, "New design of ionization manometer," *Rev. Sci. Instr.*, vol. 2, pp. 401-411; July, 1931.

⁷ N. B. Reynolds, "Studies with an ionization gauge," *Physics*, vol. 1, pp. 182-191; September, 1931.

⁸ N. Morgulis, "Theory of the ionization manometer," *Phys. Zeit. Sowjetunion*, vol. 5, pp. 407-417; 1934.

Ignatow,⁹ and Montgomery and Montgomery,¹⁰ have described modifications in this use of radio tubes as gauges. More frequently, however, tubes have been specially designed for this purpose.^{5,6,11-13} Despite the numerous designs, the very nature of an ionization

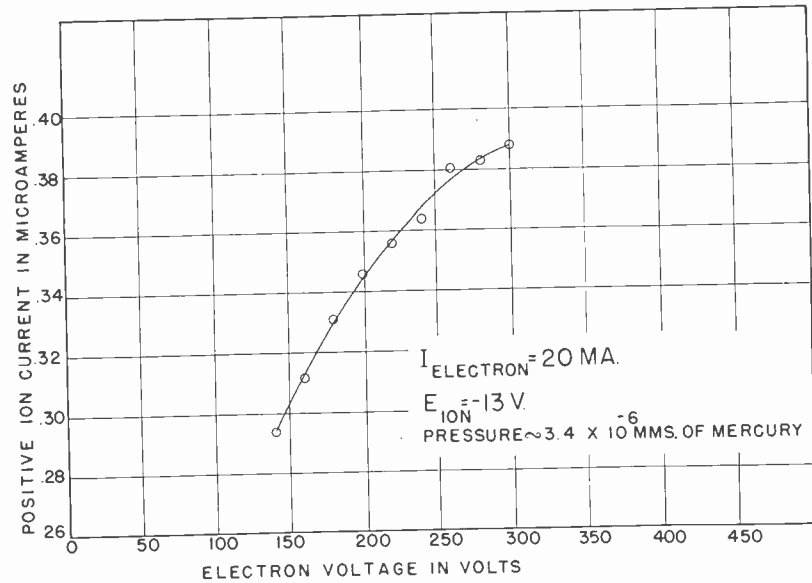

Fig. 3—Positive-ion current versus electron-collector voltage.

gauge has required that three elements of construction be present in all of them, namely, an electron emitter, an electron collector receiving a constant electron flow, and an ion collector. The differences have generally resided in the position and character of these electrodes. Thus, in some cases, a grid and a plate, respectively, have been used as the electron and ion collector, while in others, two concentric grids have been used. This paper suggests the use of two plates for this purpose.

DESCRIPTION OF NEW GAUGE

The details of the gauge are shown in Fig. 1. *A* and *D* are plates of 0.010-inch nickel, $1\frac{1}{8}$ inches \times $\frac{3}{4}$ inch. *A* serves as the electron collector, while *D* is the ion collector; both are equally spaced ($9/32$ inch) with respect to the filament *B*, which is supported at its center by the hook *E*. The filament is oxide-coated nickel and is coated over its entire length. *C* is a shield of 0.005-inch nickel extending $1/16$ inch above the surface of the press between *B* and *D*. The bulb is of nonex, except for the tubulation which is of pyrex. All leads are of tungsten with flexible extensions, although the filament leads are tungsten to nickel.

⁹ G. Spivak and A. S. Ignatow, "Ionization gauge for low pressures," *Phys. Zeit. Sowjetunion*, vol. 6, pp. 53-68; 1934.

¹⁰ G. G. Montgomery and D. D. Montgomery, "A grid controlled ionization gauge," *Rev. Sci. Instr.*, vol. 9, pp. 58-59, February; 1938.

¹¹ M. J. Copley, T. E. Phipps, and J. Glasser, "An ionization gauge for the detection of molecular rays," *Rev. Sci. Instr.*, vol. 6, pp. 371-372; November, 1935.

¹² R. D. Huntoon and A. Ellett, "The ionization gauge for atomic beam measurements," *Phys. Rev.*, vol. 49, pp. 381-387; March, 1936.

¹³ R. S. Morse and R. M. Bowic, "A new style ionization gauge," *Rev. Sci. Instr.*, vol. 11, pp. 91-94; March, 1940.

Since the ion collector lead is brought out from the same press as the other elements, precaution had to be taken to reduce leakage from these other elements to the ion collector. This has been done with the aid of the shield *C* in Fig. 1, which entirely covers the surface of the glass press between filament and ion collector without touching it, approaching quite closely to these elements. By being in such a position, it prevents the evaporation of any metallic material onto the press in this region. Further to insure the protection against leakage, the shield lead may be electrically attached to the same voltage supply as the ion collector. The leakage resistance has been measured between ion collector and nearest filament leg as 3.0×10^{10} ohms, allowing pressure readings down, at least 10^{-8} millimeter of mercury.

METHOD OF USE

After the gauge has been sealed to the vacuum system and the system has been pumped down to the range in which it is desired to obtain pressure readings, it is

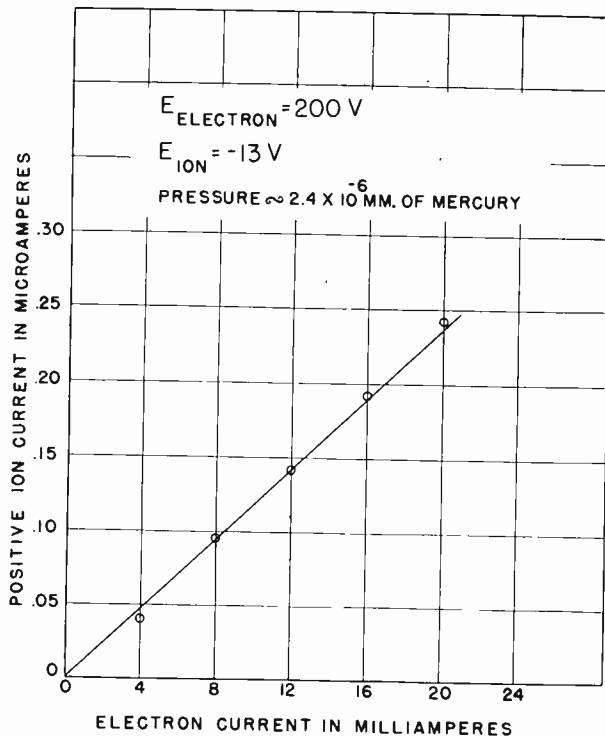

Fig. 4—Positive-ion current versus electron-collector current.

necessary to degas the plates of the tube. Since the two collector plates are equally spaced with regard to the filament, degassing is easily accomplished by electron bombardment, although radio-frequency heating can also be used with ease if such equipment is available. In using the former, either alternating current or direct current can be applied between the filament and the two plates in parallel; but direct current is preferred, due to the occasionally detrimental electron bombardment of the filament on the reverse cycle of alternating current at pressures above approximately 10^{-4} millimeter of mercury. About 300 to 400 volts,

giving in the neighborhood of 30 watts per plate, will heat them red hot. This normally takes about two minutes only, although the first time that degassing is employed a ten-minute period was found to be preferable.

Following this cleaning process, the operating conditions can be applied and the actual pressure measurement made. Experiment has shown that the optimum operating conditions are obtained when the electron current is maintained at 20 milliamperes with 200 volts being applied to the electron collector and -13 volts to the ion collector. The filament voltage is adjusted so that the electron current is the value stated, at which time the voltage is in the neighborhood of 3 volts and the current about 2 amperes. Under these conditions, 1 microampere of ion current equals 1.0×10^{-5} millimeter of mercury pressure for residual air; or otherwise stated, ten times the ion current in amperes equals the pressure in millimeters of mercury (Fig. 2). This relationship permits a direct reading of pressure without the need of any multiplying factor other than the 10 term. Several tubes were used in order to check this sensitivity at pressures ranging from about 2×10^{-6} to 8×10^{-4} millimeter of mercury. Although the indicated operating conditions seemed preferable, other conditions can be used. The sensitivity can be determined from the easily obtained graphs of electron voltage versus ion current and electron current versus ion current (Figs. 3 and 4.) Thus, by this means, and verified by actual trial, the alternate operating condition of electron voltage 150 volts and electron current 20 milliamperes gives a sensitivity of 1 microampere equal to 1.2×10^{-5} millimeter of mercury.

Whenever reactivation of the filament seems necessary, it may be accomplished by increasing the filament voltage from one half to one volt above normal for about a minute, and then operating the tube in the degassing position until the plates begin to get hot. This procedure will be needed whenever a break develops in the vacuum system while the filament is operating.

For very low pressures, in the order of magnitude of 10^{-7} millimeter of mercury, the residual leakage in the tube may be reduced by attaching the shield lead (*C* in Fig. 1) to the same voltage supply as the ion collector, but in such a fashion that any current to it will not register on the ion-current microammeter. For higher pressures, unless the gauge becomes very dirty, it is not necessary to apply any voltage to the shield. The actual leakage current can be measured at any time by observing the ion-current meter when the filament circuit is opened.

ADVANTAGES

In order to be of general utility, an ionization gauge should have certain essential characteristics. These include easy outgassing of parts, good sensitivity, simply obtained pressure readings, and relatively small leakage

to the collector plate. Although using a simple construction, all of these features have been shown to be present in this ionization gauge. There is still one other characteristic, however, to be considered—the ability of the filament to burn in air.

It would be a very definite advantage if an ionization gauge could remove the danger of burning out its filament due to leaks in the system, or due to lighting the filament before sufficiently good vacuum has been reached. This frequently is the result if tungsten is used as the filament. In this gauge, the filament has been rigidly tested in this respect and tubes have been burned in normal air as many as ten times for several minutes each time, without affecting the operation. As aforementioned, however, the filament will require reactivation after such an occurrence.

Since ordinary coated filaments do not withstand frequent exposure to humid air, additional tests of this filament coating were made to supplement those mentioned. Air was allowed to bubble very slowly through water, becoming saturated, before entering the system containing an evacuated ionization gauge that had been activated. This air was allowed to remain in the gauge for varying periods, following which the system was

again evacuated and the gauge reactivated. This procedure was able to be repeated four times before the filament coating showed noticeable deterioration, and even then the necessary emission was still obtainable. The same results occurred, irrespective of whether the filament was hot or cold when the moist air entered the system. To increase the life of the gauge, however, it is evident that it would be best to prevent exposure to humid air whenever possible.

CONCLUSION

Thus, with a quite simple construction, this gauge measures pressure from above 10^{-4} to less than 10^{-8} millimeter of mercury with a sensitivity of 1 microampere per 1.0×10^{-5} millimeter of mercury, and all danger of filament burnout due to vacuum leaks has been removed.

ACKNOWLEDGMENT

I would like to express my thanks to Dr. A. M. Skellett and Mr. Bayard Corson, both of these laboratories, for their assistance. Without the suggestions of the former, this investigation would not have been accomplished.

Resonant-Cavity Measurements*

R. L. SPROULL† AND E. G. LINDER†, ASSOCIATE, I.R.E.

Summary—Satisfactory methods are described for measuring the resonant frequency, Q , and shunt resistance of resonant cavities. Some of the wavemeters and other equipment developed for these measurements are described.

The methods of determining resonant frequencies permit moderate accuracy in absolute measurements and very high precision in the comparison of the resonant frequencies of two cavities.

Three methods of measuring Q are described which are similar in principle but different in detail.

Shunt resistance has been determined by two methods which are convenient and reliable. By inverting these methods, the dielectric constants and dielectric conductivities of liquids and gases can be measured.

I. INTRODUCTION

CAVITY resonators are indispensable in the microwave art, and in order to exploit them effectively it is necessary to be able to measure their characteristic properties. The parameters generally used to describe cavities are resonant frequency, Q , and shunt resistance. The methods in use at longer wavelengths for measuring these properties of resonant circuits are not generally applicable in the centimeter-wave region of frequencies. For several years, measuring procedures suitable for resonant cavities in this frequency region have been developed concurrently with applications of

cavities. The most satisfactory methods are described here. These methods have been used successfully in the wavelength range from 2 to 12 centimeters and should also be useful at longer and shorter wavelengths.

II. APPARATUS

The frequency stability of microwave oscillators is usually poor, and it is desirable to avoid reliance on the constancy of frequency of the signal generator in any measurements in this frequency region. A "sweep frequency" technique¹ was therefore used, as sketched in Fig. 1. The apparatus used is illustrated in Fig. 2 and Fig. 3.

The frequency of the oscillator is modulated at a 60-cycle rate. A short, tunable transmission line from the oscillator ends in a probe, which may be inserted into the cavity being tested. A similar probe abstracts from the cavity a very small fraction of the oscillator's power, and another short, tunable transmission line connects this probe to a crystal detector. The rectified current from the detector is applied to an audio amplifier, the output of which is connected to the vertical-deflection system of a cathode-ray oscilloscope. The horizontal deflection is at a 60-cycle rate.

* Decimal classification: R209. Original manuscript received by the Institute, December 3, 1945.

† Radio Corporation of America, RCA Laboratories, Princeton, N. J.

¹ F. E. Terman, "Radio Engineers' Handbook," McGraw-Hill Book Company, New York, N. Y., 1943.

The pattern traced out on the oscilloscope screen is, therefore, crystal current as a function of the modulating voltage applied to the oscillator. With some restrictions, this pattern is also a measure of the "response" of the cavity (the square of the absolute magnitude of its

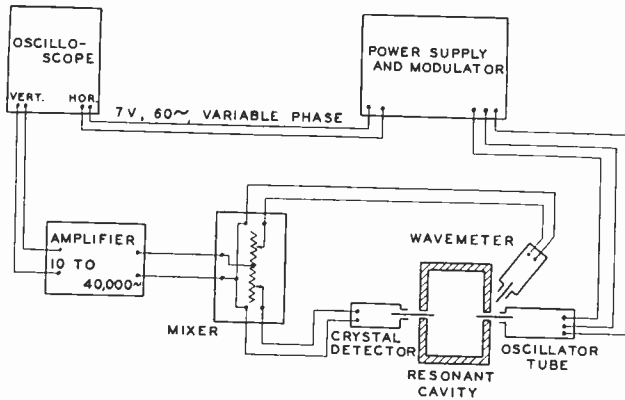

Fig. 1—Diagram of measuring equipment.

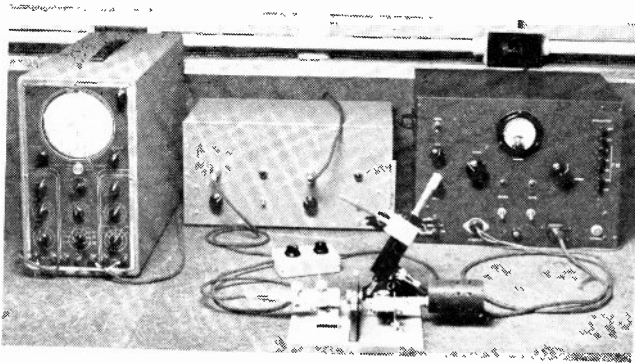

Fig. 2—Photograph of measuring equipment. The oscilloscope, audio amplifier, and power-supply modulator are in the background. The mixer box is in the center. In the foreground are the detector, cavity mounting, wavemeter, and oscillator.

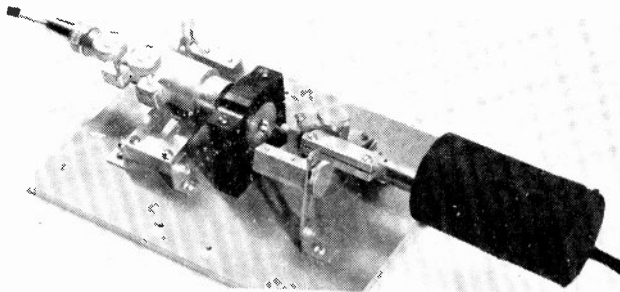

Fig. 3—Detector, cavity mounting, and oscillator. The low- Q crystal detector circuit is a coaxial line, tunable by a rack-and-pinion control. Another rack and pinion controls the insertion of the detector probe into the resonator. The tunable transmission line from the oscillator is terminated by the small wire probe which projects into the cylindrical cavity being tested.

impedance) as a function of frequency. These restrictions are: (1) the coupling into and out from the test cavity must be very loose; (2) the crystal must be "square law"; (3) the bandwidth of the coupling systems must be much greater than that of the cavity; (4) the amplifier and oscilloscope amplifiers must not distort the signals applied to them; (5) the oscillator must have

negligible amplitude modulation over a frequency region of several times the bandwidth of the cavity; (6) the frequency modulation must be linear; that is; frequency must be a linear function of the modulating voltage.

The first four requirements can be satisfied quite generally, and the last two do not constitute serious difficulties except for very low- Q cavities. The probe coupling has been used in most of the measurements because the only modification of the cavity required for the measurements is the provision of two small holes in the cavity walls. For precise work, waveguide systems have been used, but they suffer from lack of versatility.

The mixer shown in Fig. 1 permits the simultaneous appearance on the screen of resonance curves of two cavities, one of which is usually a wavemeter or secondary frequency standard. When these two cavities are tuned to nearly the same frequency, the oscilloscope vertical deflection is the algebraic sum of the signals

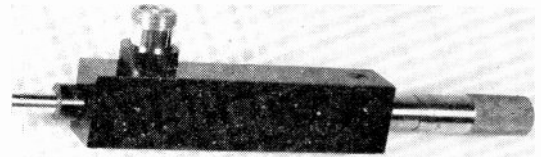

Fig. 4—Resonant-cavity wavemeter. The dielectric-covered antenna is at the left, and the threaded bushing above it and to the right is the connector for rectified crystal current. The micrometer which fixes the piston position is at the right.

from the two detectors. The relative amplitudes of the two signals may be varied by adjusting the coupling of the oscillator to the two cavities, or by adjusting the potentiometers in the mixer.

Three kinds of wavemeters have been used, all based on resonant cavities. A carefully constructed concentric transmission line with movable terminating piston has been used as a frequency standard. The Q of this type of wavemeter is low, of the order of 1000, but it will appear that this does not constitute a serious limitation for most frequency measurements. This meter is not satisfactory for measuring small frequency differences because of its low Q and small dispersion (small travel of piston and change in scale reading per unit of wavelength change).

A resonant-cavity wavemeter, illustrated in Fig. 4, has been developed² for more accurate measurements. It consists of a rectangular cavity, the length of which is variable by a piston driven by a micrometer screw; a crystal detector and a small probe antenna are loosely coupled to the cavity. This type of wavemeter has the advantage of a high Q ; a further advantage is that a given motion of the piston corresponds to a smaller wavelength change than the same motion of the concentric-line plunger. Its chief disadvantage is its limited wavelength range. At the short-wavelength end of the scale the entrance of higher modes of oscillation of the

² D. Blitz and E. G. Linder.

cavity limits the range, while the long-wavelength limit is caused by the proximity of the "cut-off" point. The resonant wavelength can never be longer than twice the width of the cavity, regardless of the piston's position.

For higher dispersion in a much narrower range (about one half per cent of the mean wavelength) a wavemeter has been built using the $TE_{1,2,0}$ mode, also called the (1, 2, 0) mode³ of a rectangular cavity, as shown in Fig. 5. The end of a micrometer screw was ground to form a small pin which was inserted through, but without touching the rim of, a small hole in the center of the broad side of the cavity. This arrangement

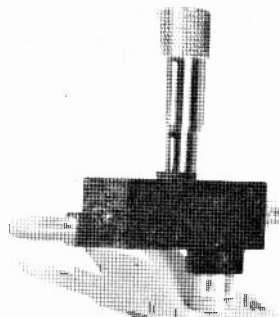

Fig. 5—Narrow-range resonant-cavity wavemeter. The small pin which varies the resonant frequency is driven by the micrometer screw.

permits very slight current flow on the part of the pin which lies outside the cavity, and secures maximum linearity of resonant wavelength as a function of the depth of insertion of the pin. Since the whole scale of the micrometer corresponds to only a fraction of a per cent change in a resonant wavelength, high dispersion is obtained. This wavemeter is made of Invar to minimize the temperature coefficient of frequency.

III. RESONANT-FREQUENCY COMPARISONS

No effort has been made in this work to attain great accuracy in the measurement of the absolute resonant frequencies of resonant cavities. The accuracy of such measurements has been limited by the accuracy of the frequency standards employed. The absolute accuracy of the coaxial-line wavemeter is probably no better than ± 0.1 per cent in the centimeter region.

It is frequently desirable to be able to compare the resonant frequencies of cavities with a precision much higher than this accuracy of the absolute measurement of frequency. Measurement of small frequency differences or the construction of an internally consistent set of secondary frequency standards require such high precision. The frequency-comparison method described here is capable of as great precision as can be profitably employed at the present stage of the microwave art.

As an introduction to the method actually used, it is worthwhile to describe a more rudimentary method. If, in the system shown in Fig. 1, the range of frequencies

³ E. U. Condon, "Principles of microwave radio," *Rev. Mod. Phys.*, vol. 14, p. 347; October, 1942.

generated by the oscillator includes the resonant frequencies of both the wavemeter and the cavity under test, the pattern on the oscilloscope screen will resemble Fig. 6(a).⁴ In this and subsequent figures, the wavemeter resonant frequency and Q are called f_w and Q_w ; f_c and Q_c are the properties of the cavity being tested. As f_w becomes nearly equal to f_c , the pattern of Fig. 6(b) results, and Fig. 6(c) portrays exact equality of fre-

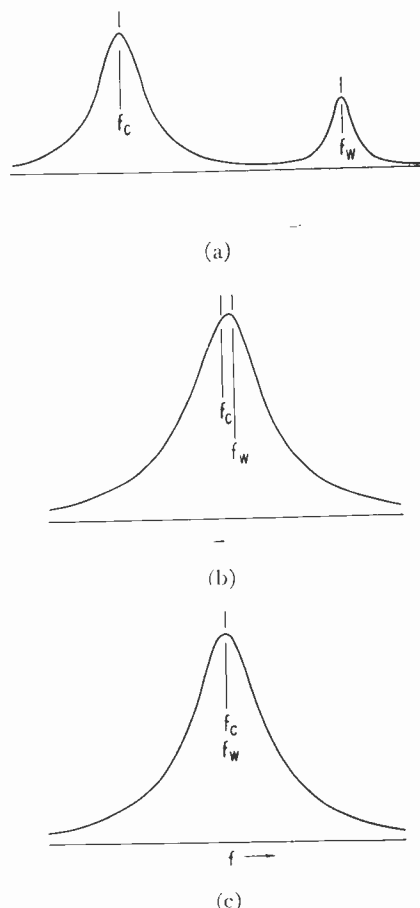

Fig. 6—Oscilloscope patterns for first method of frequency comparison.

- (a) Horizontal scale compressed. Wavemeter resonant frequency (f_w) and cavity resonant frequency (f_c) considerably different.
 (b) f_w nearly equal to f_c . $f_w = f_c + (f_c/10Q_c)$.
 (c) f_w exactly equal to f_c .

quencies. It is impossible to determine equality of frequencies with much less error than that represented by Fig. 6(b), and even the difference between Fig. 6(b) and Fig. 6(c) is difficult to detect if the amplifier gain or oscillator power fluctuates. This constitutes a frequency-comparison precision of about $\pm (10/Q_c)$ per cent. While this is sufficient for many purposes, it is not adequate for measuring small differences in resonant frequency, such as will be encountered in shunt-resistance measurements.

The frequency-comparison method actually used is a

⁴ E. U. Condon, "Forced oscillations in cavity resonators," *Jour. Appl. Phys.*, vol. 12, pp. 129-132; February, 1941. Figs. 6, 7, and 9 are computed from the known form of a high- Q cavity's transfer impedance as a function of frequency, when the coupling is very loose and the coupling systems are of low Q . The resonance curves are of the form $[1 + 4Q^2(f - f_c)^2]^{-1}$.

distinct improvement over this simple arrangement. In the improved method the detector outputs are combined in such a way that the signal from the wavemeter crystal decreases the deflection produced by the crystal coupled to the cavity under test. This may be accom-

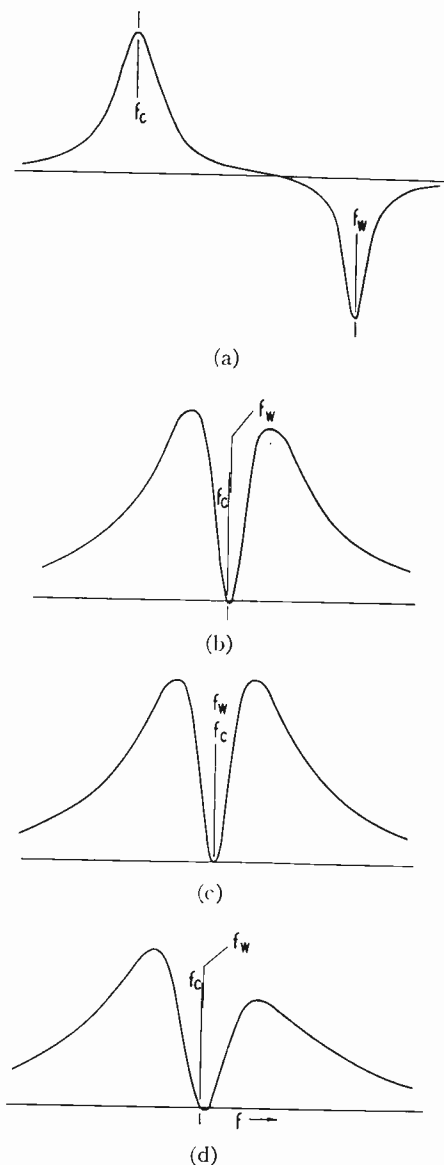

Fig. 7—Oscilloscope patterns for second precision method of frequency comparison.

- (a) Horizontal and vertical scales compressed. f_w considerably different from f_c . $Q_w = 2Q_c$.
 (b) f_w nearly equal to f_c . $f_w = f_c + 0.01 (f_c/Q_c)$; $Q_w = 2Q_c$.
 (c) f_w exactly equal to f_c . $Q_w = 2Q_c$.
 (d) f_w nearly equal to f_c , but a value of Q_w/Q_c different from parts (a), (b), and (c). $f_w = f_c + 0.008 (f_c/Q_c)$; $Q_w = 1.10Q_c$. Vertical scale expanded.

plished by using crystals which differ in the sign of the rectified current or merely by reversing the leads from one crystal to the mixer. The oscilloscope patterns thus obtained are shown in Fig. 7(a) for $f_w \neq f_c$, in Fig. 7(b) for $f_w \cong f_c$, and in Fig. 7(c) for $f_w = f_c$. The inequality in resonant frequencies is obvious from the unequal heights of the two limbs in Fig. 7(b), even though the frequency difference is only $1/Q_c$ per cent. One therefore has only to tune the wavemeter until the heights

of these two limbs are approximately equal to obtain precise equality of f_w and f_c .

This comparison is particularly sensitive when the wavemeter Q is nearly equal to that of the cavity. The mixer is then adjusted to give equal amplitudes to the two resonance curves. If $Q_w = Q_c$ and $f_w = f_c$, a straight line appears on the oscilloscope, and the slightest departure from equality of f_w and f_c is immediately apparent. A number of cavities and a wavemeter with Q 's within 10 per cent of 8000 have been used in this measurement work. Fig. 7(d) is typical of the patterns encountered with these cavities; the existence of a frequency difference is obvious, yet the difference is only one millionth of the resonant frequency f_c .

It is essential to this method that the amplitudes of the two resonance curves be of the same order of magnitude, but only when $Q_w \cong Q_c$ is it necessary to make them approximately equal. Some advantage is obtained when $Q_w \neq Q_c$ if the higher Q resonance is given a somewhat larger amplitude. Fluctuations in the power or frequency of the oscillator or in the gain of the amplifiers cannot cause errors. Amplitude modulation of the oscillator can cause a slight error, but this error is much smaller than its analogue in the former method. The resonance curves of both wavemeter and cavity must be undistorted, any resonances in the transmission lines must be of very low Q , and the coupling to the cavities must be loose. It is not necessary that the frequency modulation be linear, though linearity is a convenience in detecting distortion. The crystal capacitance and distributed capacitance of wiring must be kept low enough that it does not cause a significant phase delay of the signal from one crystal relative to that from the other. This is easily possible because of the low repetition frequency (60 cycles).

This method has proved reliable and convenient in operation. Photographs of the oscilloscope screen are shown in Fig. 8.

In the precision measurement of frequency using cavity wavemeters, corrections must be applied for atmospheric properties and cavity temperature. If the parts of the wavemeter which determine the dimensions of the resonant cavity are of a single metal, the temperature coefficient of wavelength is the coefficient of linear expansion of the metal. The temperature and humidity of the atmosphere within the wavemeter must be known in order to convert wavelength in this atmosphere to wavelength *in vacuo*, and hence to frequency. When comparing the frequencies of a wavemeter and a resonant cavity, both open to the same atmosphere, these corrections for the dielectric constant of the air need not be applied; but a correction for thermal expansion of the cavity dimensions must be applied whenever the cavities being compared are of different metals.

IV. Q MEASUREMENTS

The oscilloscope presentation of a cavity-resonance curve permits measurement of Q value by measuring the

difference Δf in frequency at the two half-power points and using the value of f_c already obtained to compute $Q_c \equiv f_c / \Delta f$. Under the conditions of coupling, linearity, etc., noted in the second section, the half-power points are the points where the vertical deflection is one half the maximum deflection. If a wavemeter of sufficiently

tuning it until it produces a dip in the resonance curve which just reaches the reference base line for the resonance curve, as in Fig. 9(b). This method may be used for any Q_w/Q_c ratio, but becomes unsatisfactory if Q_c is so large that the number of scale divisions of the wavemeter corresponding to the frequency difference becomes small.

When measuring high- Q cavities it is often found that the wavemeter dispersion is insufficient for accurate

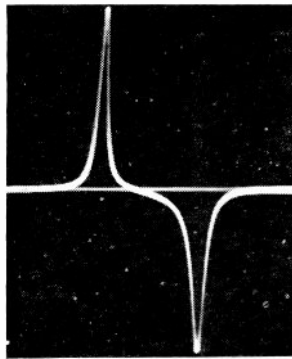

(a)

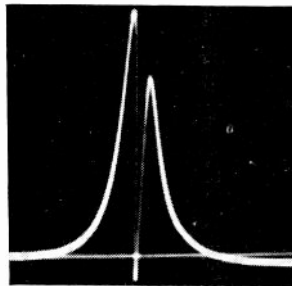

(b)

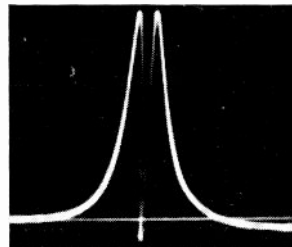

(c)

Fig. 8—Photographs of oscilloscope screen. The conditions correspond roughly to those of Fig. 7(a), (b), and (c).

high Q is available, the wavemeter detector signal may be combined with the resonance curve and the two frequencies at the half-power points determined directly; Fig. 9(a) shows a wavemeter tuned to one of these two frequencies, where the wavemeter Q_w is 15 times the Q_c of the cavity.

This method becomes less accurate as the ratio Q_w/Q_c becomes smaller than 10 or 15, since it becomes increasingly difficult to determine the half-power points in the presence of the wavemeter signal. To overcome this difficulty, the amplitude of the wavemeter signal may be made exactly one half of that of the cavity. The wavemeter may then be set to a half-power point by

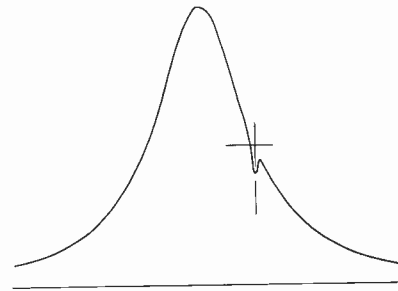

(a)

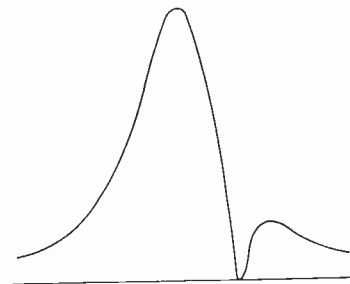

(b)

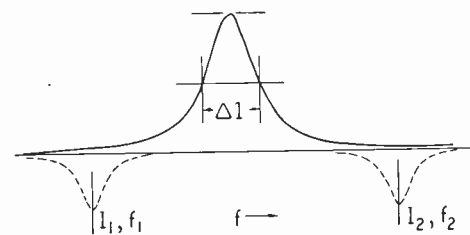

(c)

Fig. 9—Oscilloscope patterns for measurement of Q .
 (a) Method suitable when $Q_w/Q_c \gg 1$. $Q_w = 15Q_c$; $f_w = f_c + (f_c/2Q_c)$.
 (b) Method suitable for any Q_w/Q_c but not accurate if Q_c is extremely large. $Q_w = 4Q_c$; $f_w = f_c + (f_c/2Q_c)$.
 (c) Method suitable for any Q_w/Q_c .

measurements; the frequency difference between half-power points may correspond to only a fraction of a scale division of the wavemeter. It is then desirable to "calibrate the screen" of the oscilloscope as in Fig. 9(c). The frequencies f_1 and f_2 corresponding to two well-separated points l_1 and l_2 on the screen are determined by tuning the wavemeter until the peak of its resonance curve coincides with each of these points in turn. If the linear separation on the screen of the half-power points of the cavity being tested is Δl , then

$$\Delta f = \Delta l \left(\frac{f_2 - f_1}{l_2 - l_1} \right). \tag{1}$$

This is valid, of course, only if the frequency modulation and oscilloscope horizontal deflection are linear functions of the modulating voltage, and nonlinearity of modulation constitutes the most troublesome source of error in this method. This method also requires that the generated frequency at any one modulator voltage remain constant for the few seconds required to tune the wavemeter. None of the other methods described here has this limitation.

If the Q is very low, it may be necessary to correct the measurements for amplitude modulation of the signal generator. The amplifier must pass an undistorted resonance curve for accurate measurements with any value of Q , which requires that its gain and time delay be constant from 60 to about 6000 cycles. The input and output couplings of the cavity must be very small if the measured Q is to be the "unloaded" Q of the cavity. This last requirement means that the power transmission into the detector must be very small. For example, if the measured Q is to be within 5 per cent of the unloaded Q , the power into the detector can be at most only 0.5 per cent of the power which could have been obtained from the same oscillator when coupled for maximum power transfer into the detector.

V. SHUNT-RESISTANCE MEASUREMENTS

In many applications of cavity resonators it is necessary to know the shunt resistance of the cavity, which is its shunt impedance at resonance. This is particularly true if the resonator is to be excited by an electron beam, as in a microwave oscillator.

The shunt resistance R_0 of a cavity, like that of a conventional "lumped" circuit, can be defined from the relation

$$R_0 = \frac{V^2}{2W_l} \quad (2)$$

where W_l is the power dissipated per second in the cavity (watts) and V is the amplitude of the "voltage" between two points on the cavity walls. By "voltage" is meant the line integral of the alternating electric field.⁵ For a given W_l , the value of V , and hence of R_0 , depends on the two points chosen; this corresponds to the different values of resistance obtained by "tapping" at different turns of the coil in a coil-and-capacitor resonant circuit. R_0 also depends, in the case of a resonant cavity, upon the choice of the path between these two points over which V is evaluated. In most applications of resonant cavities, the particular value of R_0 of most interest is that obtained by choosing end points and path such that the maximum R_0 is obtained. The R_0 thus evaluated is consistent with the usual definition⁵ and will be used in the remainder of this section.

In applications involving electron beams, one is generally interested in cavities such that the amplitude of the electric field is nearly constant over the required

path; such a case is illustrated in Fig. 10(a), where R_0 is to be evaluated over the straight-line path between p and P . Only such constant-field cases are susceptible to the following measuring methods.

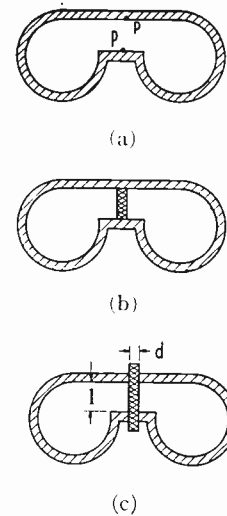

Fig. 10—Measurement of shunt resistance in a doughnut-shaped resonant cavity. Cylindrical symmetry about pP . The shunt resistance between the points p , P is required. In (b) a dielectric cylinder is inserted, and in (c) the dielectric has been inserted in an easier manner, which gives approximately correct results when $l/d \gg 1$.

Two methods of measuring shunt resistance have been developed, and they will be called the "resistance-insertion" and "capacitance-insertion" methods. In the former, a small resistor is inserted between the two points where R_0 is required and the effect upon the Q of the cavity is observed; in practice, this "resistor" is usually a rod of lossy dielectric. In the latter method, a small dielectric cylinder is inserted as before, but the effect upon the resonant frequency of the cavity is observed.

A small dielectric cylinder of cross-sectional area A and length l is inserted between the points p and P in Fig. 10(a), such that the ends are in intimate contact with the cavity walls and the axis of the cylinder is perpendicular to the cavity walls. Since the electric field in the neighborhood of the dielectric is nearly constant and parallel to the elements of the cylinder, the electric field at the surface of the dielectric is entirely tangential to this surface, and hence is the same intensity inside the dielectric as it is just outside. If the cross-sectional area, dielectric constant, and conductivity of the rod are sufficiently small, the Q will remain of the order of 100 or more and the change in resonant frequency can be kept of the order of one per cent or less. Under these circumstances the electric and magnetic fields at resonance will not be substantially changed by the presence of the dielectric, and R_0 can be calculated from either the change in Q or the change in f_c .

The algebraic expressions relating R_0 to the observables in the two methods can be derived in several ways. Using the energy-decrement definition of Q and (2), and

⁵ See p. 365 of footnote reference 3.

obtaining the power dissipated in the lossy dielectric from Maxwell's equations, the expression for the resistor-insertion method may be obtained. The relation for the capacitance-insertion method may be derived from the change in the average stored electric energy when the dielectric is inserted and the requirement that the average electric and magnetic energies must be equal at resonance.⁶ Also, both expressions may easily be verified directly from Maxwell's equations for the special cases of cavities the geometrical shapes of which permit analytical solutions for the fields before the dielectric was inserted. Derivations based on the "lumped"-circuit analogy are given below. The relations derived by any of these methods are identical and subject to the same restrictions.

In lumped circuits

$$Q_c = 2\pi f_c C R_0. \quad (3)$$

The essence of the methods for measuring R_0 of cavities is to express the unmeasurable quantity C in terms of observable quantities. In the resistance-insertion method a resistance R inserted between the points p and P , as in Figs. 10(a) and (b), is essentially a resistance in parallel with the shunt resistance R_0 between these points. If f_c and Q_c were the resonant frequency and Q before the resistor was inserted, and f_c' and Q_c' the new values with the resistor, Q_c' will be related to the parallel combination of R and R_0 in the same way that (3) related Q_c to R_0 :

$$\frac{1}{Q'} = \frac{1}{2\pi f_c' C'} \left(\frac{1}{R_0} + \frac{1}{R} \right) = \left(\frac{f_c C}{f_c' C'} \right) \frac{R_0}{Q_c} \left(\frac{1}{R_0} + \frac{1}{R} \right). \quad (4)$$

If the resistor's size and dielectric constant are sufficiently small, $f_c C$ nearly equals $f_c' C'$; setting $f_c C = f_c' C'$ and rearranging terms gives

$$R_0 = R(Q_c/Q_c' - 1). \quad (5)$$

Because of the limitation to situations of constant field, where the electric field is known to be substantially the same inside the resistor as it is outside, the effective resistance R of the cylinder is just the resistance calculated in the usual way: $R = l/\sigma A$. Skin effect need not be considered since the skin depth is much larger than the diameter of the cylinder for all useful values of A and σ . Therefore

$$R_0 = \frac{l}{\sigma A} (Q_c/Q_c' - 1) \text{ ohms.} \quad (6)$$

Of course one must use the value of σ , the dielectric conductivity,⁷ which pertains to the frequency at which the

⁶ See p. 351 of footnote reference 3. This property of resonance holds for systems of electromagnetic standing waves, provided one sums the energies over an integral number of half wavelengths of the standing-wave pattern, which is what is done in computing the electric and magnetic energies of a cavity at its resonant frequency.

⁷ σ is related to the tangent of the angle δ of loss by $\tan \delta = \sigma/2\pi f \kappa \epsilon_0$. The "Q" of the dielectric is $Q = 1/\tan \delta$ and $\sin \delta$ is its "power factor." σ here is measured in m-k-s units (mhos per meter), but (6) may be used with l and $A^{1/2}$ in centimeters and σ in mhos per centimeter.

measurements are made. Note that in using (6) the change in frequency upon insertion of the resistor must be small compared to the frequency itself, the resistor must be of constant cross section and parallel to the electric field, its ends must make good contact with the cavity walls, and the amplitude of the electric field must be constant in the neighborhood of the resistor. The "good-contact" restriction frequently may be removed, as explained below.

This method has been successfully used on a variety of cavities. The limitations associated with (6) make metallic resistors impractical, but lossy liquids and glasses exhibit the correct orders of magnitude of conductivities for use as resistors. The conductivities of common glasses and some common liquids range from about 0.015 (Corning 705BA glass) to 15 (water) mhos per meter in the centimeter-wavelength region. For most cavities a thin Pyrex capillary tube containing water, water-ethyl-alcohol mixtures, or carbon tetrachloride has produced a satisfactory resistor. With bores of the order of 10^{-3} or 10^{-4} square centimeter and lengths of 0.1 to 1 centimeter, resistances of the order of 1000 ohms to 10 megohms may be obtained. The size and conductivity of the dielectric are so chosen that Q_c/Q_c' is substantially different from unity, in order to avoid the situation where a small error in measuring Q_c/Q_c' introduces a large relative error in the determination of R_0 . On the other hand, Q_c' must not be too low or difficulty will be encountered in measuring it because of the limited frequency-modulation range of the oscillator.

In the capacitance-insertion method, the insertion of the small dielectric cylinder increases the capacity by the amount $\Delta C = (\kappa - 1)\epsilon_0 A/l$. This comes about because the contribution to the total cavity capacitance of the volume occupied by the dielectric was $\epsilon_0 A/l$ before the dielectric was inserted and $\kappa\epsilon_0 A/l$ afterwards. κ is the dielectric constant of the material, $\epsilon_0 = 8.85 \times 10^{-12}$ farads per meter, and l and $A^{1/2}$ are expressed in meters.

The rate of change of resonant frequency with change in capacitance is obtained by differentiating $2\pi f_c = (LC)^{-1/2}$ and it is

$$\frac{\partial f_c}{\partial C} = - \frac{f_c}{2C}.$$

For small finite changes it is approximately true that

$$\Delta f_c = - \left(\frac{f_c}{2C} \right) \Delta C = \frac{-f_c(\kappa - 1)\epsilon_0 A}{2Cl}. \quad (7)$$

Using (7) in (3) to eliminate the unknown and unmeasurable quantity C , one obtains

$$R_0 = \frac{-Q_c l (\Delta f_c)}{\pi f_c^2 (\kappa - 1) \epsilon_0 A}. \quad (8)$$

A simpler and more convenient relation is obtained by expressing the frequency change Δf_c in terms of a resonant-wavelength change $\Delta \lambda_c$; when this is done and the

approximation $(\pi c \epsilon_0)^{-1} = 120$ ohms is used, (8) becomes

$$R_0 = 120 \frac{Q_c l (\Delta \lambda_c)}{(\kappa - 1) A} \text{ ohms.} \quad (9)$$

M-k-s units have been used to derive (9) but of course it is valid if l , $\Delta \lambda_c$, and $A^{1/2}$ are in the same units, whether or not these units are meters. The restrictions mentioned in connection with (6) apply as well to (9).

This capacitance-insertion method is more convenient and accurate than the resistor method, since only one Q measurement is required in the former and the change in resonant wavelength, even though it may be very small, can be measured quite accurately by the method portrayed in Fig. 7. But the capacitance method is less flexible because the range of κ 's of available materials is small compared to the range of σ 's. This means that for cavities of very low shunt resistance, A must be larger than in the resistor-insertion method in order to preserve a $\Delta \lambda_c$ of sufficient magnitude.

In using either of these methods, it is much more convenient to drill small holes in the cavity walls and insert the dielectric cylinder through these holes than to install it completely inside the cavity. This "short-cut" is illustrated in Fig. 10(c). It is satisfactory provided $d \ll l$; under these circumstances the fringing field in the

dielectric near the cavity walls is not a serious source of error, and the contact of the dielectric rod with the walls is not important in either method. Tests have shown that even if $d \cong l/4$ the methods are still reliable.

Both methods of measuring shunt resistance have been tested by measuring R_0 of rectangular and cylindrical cavities, where the ratio of R_0 to Q_c could be calculated. The measured ratio agreed with the theoretical R_0/Q_c within a few per cent for all the cavities investigated. Since this ratio depends only on the cavity geometry and not upon the material or surface condition of the cavity walls, comparing experimental and theoretical values of this ratio is a better test of the measuring method than comparison of R_0 values.

The methods for measuring shunt resistance may be reversed to provide methods for measuring the conductivity σ and dielectric constant κ of solids and liquids at very high frequencies. A cavity of simple geometrical shape is employed and R_0/Q_c is computed from the known electric and magnetic fields in the cavity. Then from measurements of Q_c , and of Q_c' and $\Delta \lambda_c$ when a dielectric cylinder is inserted, σ and κ may be obtained from (6) and (9). This method has been used for many different materials, and wherever comparison with values of σ and κ obtained by other methods was possible, good agreement was secured.

Cylindrical Shielding and Its Measurement at Radio Frequencies*

ALTON R. ANDERSON†

Summary—The effectiveness of shields from the point of view of the wave theory of shielding is discussed. Specific consideration is given to cylindrical shielding against low-impedance fields and its measurement at radio frequencies. Various methods and concepts of measurement are discussed briefly; inadequacy of probe-type tests and the advantages of an integrating-type test are pointed out.

Equipment of the integrating type suitable for production testing of specimens of cylindrical shielding from 3/16 to 2 inches diameter at 3 megacycles is described and illustrated. With this equipment, shielding effectiveness of the unknown is determined in terms of the effectiveness of a specified rigid metal-tube standard. Sensitivity is sufficient to measure the leakage through 0.024 inch of copper at the test frequency. A shielded room is not required.

SOME THEORETICAL CONSIDERATIONS

ACCORDING to the wave theory of shielding,¹ the effectiveness of a metallic cylindrical shield surrounding wires carrying alternating current is in part due to reflections of the wave caused by im-

Experimental results obtained with this and similar equipment from 200 kilocycles to 10 megacycles are given. Tests at various frequencies on thin-wall copper tubes of different thicknesses are shown to be in agreement with the results predicted by theory. Included are data on metal tubes, wire braids, coaxial cable, and flexible-shielding conduits.

Test results are shown to be independent of current through the specimen, receiver gain or adjustment, and various other factors. Results are shown also, in general, to be independent of the length of specimen tested and its impedance. Various factors affecting test results are considered and formulas are given for correcting results obtained on exceptional specimens having abnormally high resistance.

pedance mismatches at the two metal-dielectric boundaries of the shield and in part to attenuation of the wave in passing through it. When the shield forms the outer conductor of a coaxial line, so that the shield itself serves as the "return" circuit for the wire to be shielded, there obviously is no reflection at the inner surface but there is attenuation through the metal and reflection at the outer metal-air boundary.

For shielding considerations, varying electromagnetic

* Decimal classification: R201.5. Original manuscript received by the Institute, November 19, 1945.

† The American Metal Hose Branch of The American Brass Company, Waterbury, Connecticut.

¹ S. A. Schelkunoff, "Electromagnetic Waves," D. VanNostrand Company, Inc., New York, N. Y., 1943, pp. 303-315.

fields may conveniently be classified as being of low impedance or high impedance, with respect to the intrinsic impedance of the dielectric in which they exist. Low-impedance fields have large magnetic components and small electric components, while high-impedance fields are those having relatively large electric and small magnetic components. Fields associated with alternating-current-carrying inductors and conductors are usually low-impedance fields; those associated with the alternating charges on the plates of a capacitor, for example, generally are high-impedance fields.

It can be shown that, when a high-impedance wave strikes any metallic surface, reflection is almost complete and that it becomes complete as the frequency approaches zero. It is for this reason that shielding against such fields is a relatively simple matter. On the other hand, shielding against a low-impedance field is not nearly so easy; reflection losses are much smaller and attenuation may not be adequate. At high frequencies the attenuation of most metals is sufficiently great that, except for very thin shields, attenuation usually constitutes the major component of the total shielding effectiveness. At low frequencies, however, the attenuation obtained with shields of practical thickness is small and reflection losses may predominate. At such frequencies, good use can often be made of the reflection occurring at metal-metal boundaries, by employing appropriate arrangements of laminated shields consisting of properly selected dissimilar metals.

Equations have been derived for calculating reflection losses for certain shields, which depend upon frequency, the metal used, and the shield geometry. Likewise, the attenuation of an electromagnetic wave of a given frequency in passing through any metal, in terms of the magnetic permeability, electrical conductivity, and thickness of the metal can be calculated.

The attenuation of any metal at a given frequency, expressed on a decibel basis, is proportional to the square root of the product of its electrical conductivity and magnetic permeability. The attenuation obtained from a particular metal is directly proportional to the thickness employed. The attenuation of any given shield increases as the square root of the frequency.

For pure copper (100 per cent electrical conductivity) the following simplified expression for attenuation may be used:

$$A = 3.338 t \sqrt{F} \quad (1)$$

where A = attenuation, in decibels

t = thickness, in mils (thousandths of an inch)

F = frequency, in megacycles per second.

If the attenuation per mil of a metal is known at a given frequency, the attenuation of any thickness obviously can readily be determined. A curve is shown in Fig. 1 from which the attenuation per mil of pure copper can be read for any frequency from 10 kilocycles to 900 megacycles. Points for plotting this curve were calculated from (1). The figure is based upon theoretical

considerations but has been verified by numerous measurements; it is given here because of its general usefulness and to facilitate comparison with experimental data to be presented.

The attenuation of commercial (deoxidized) copper, such as is commonly used for making tubing, may not be more than about 95 per cent of that of pure copper, due to the lower electrical conductivity of deoxidized copper. For the experimental work herein described pure (oxygen-free) copper tubes were obtained. The copper used is known to the metals trade as "O.F.H.C." copper and has a conductivity very close to 100 per cent International Annealed Copper Standard.

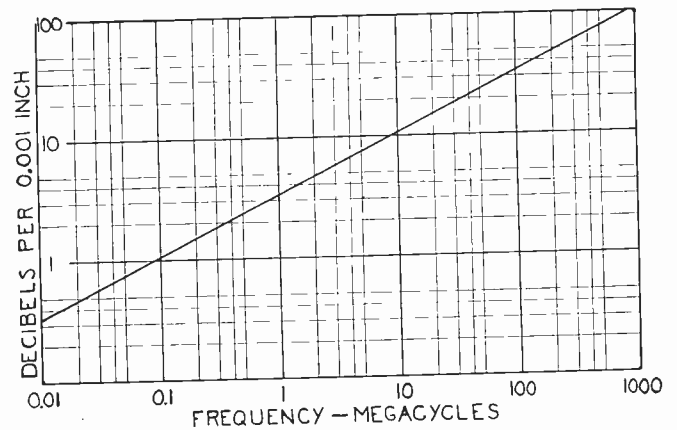

Fig. 1—Calculated attenuation of pure copper at various frequencies.

Fig. 1 can be used to determine the attenuation per mil of any metal if the value read for copper is multiplied by the square root of the product of its relative magnetic permeability and electrical conductivity (relative to copper). For example, if the permeability of a metal is 400 and its conductivity is 6.25 per cent International Annealed Copper Standard, it has an attenuation of $\sqrt{(400)(0.0625)} = 5$ times that of copper.

Attention will be confined hereafter to cylindrical shielding intended primarily for low-impedance fields; consideration of such fields will be implicit in all subsequent references to shielding effectiveness. Thin-wall metal tubes, flexible ignition-shielding conduit, and coaxial cable are examples of commercial products which find widespread use where their shielding properties to low-impedance fields are important.

For cylindrical shields of approximately the same diameter, made of the same metal, reflection losses will be nearly identical. Thus, for all practical purposes, differences in over-all shielding effectiveness at a given frequency, between successive specimens of a series of thin-wall tubes of a particular metal, having approximately the same nominal diameter but different thicknesses, will be equal to the differences in attenuation of the tubes. This fact can be utilized advantageously in studying the operation of equipment, such as that to be described, which is intended for testing the effectiveness of cylindrical shields.

MEASUREMENT CONSIDERATIONS

Various methods have been devised for measuring the effectiveness of cylindrical shielding. Proposed techniques frequently have been found unsatisfactory. They may lack precision, be too complicated, or measure something other than shielding effectiveness. The need for a simple test of shielding effectiveness readily applicable to cylindrical shields, which yields reasonably precise quantitative results, has been recognized by those concerned with design, production, or application of shielding products.

Skin-effect formulas have been unsuccessfully applied to rigid metal tubing in an effort to calculate the current or current density on the outside of the shield for a given total current or given current density on the inside. The exponential decay of intensity of alternating current with distance below the surface of a conductor expressed by such formulas is valid for an infinitely thick slab of the material but not for calculating the outside surface current of a shield. Such formulas, derived on the assumption of infinite thickness, neglect the (relatively large) effect of reflection at the outer metal-air boundary of the shield.

Different quantities have been measured in attempts to evaluate shielding effectiveness. Field-strength measurements at some specified external position without and with the shielding in place would give the desired information, but these may be very difficult or impossible to make. Most of the cylindrical shields upon which measurements are desired are so effective that, even for exceedingly strong incident fields, the external field is very weak and difficult to measure. Furthermore, for the types of shields in which we are here primarily interested, the shield itself usually serves as one of the conductors of the circuit to be shielded. In these cases removing the shield destroys the circuit, making such measurements impossible.

The concept of surface transfer impedance per unit length, such as (open-circuit) voltage per foot along the outside of the shield per ampere flowing in the shield, has been applied successfully in computing and measuring the effectiveness of coaxial cable and similar cylindrical shielding.² The lower the transfer impedance the better the shield. That is, transfer impedance per unit length measures the *inverse* of shielding. Hence, the reciprocal of this quantity, which is "transfer admittance" \times length, might be a more appropriate unit for expressing the *effectiveness* of the shielding.

Shielding may be employed for either or both of two purposes: to restrict electromagnetic interference fields to or to keep them out of the enclosed area. Obviously, shielding is never complete for there is no such thing as a perfect shield. Shielding need only be sufficient to keep interference between circuits or elements to an undetectable or tolerable value.

² S. A. Schelkunoff and T. M. Odarenko, "Crosstalk between coaxial transmission lines," *Bell Sys. Tech. Jour.*, vol. 16, pp. 144-164; April, 1937.

Seldom is the required degree of shielding actually known. It may not even be known approximately, since figures for the intensity of the generated interference field or the permissible interference level, or both, may not readily be available. However, if a given shield is not adequate it sometimes is possible to estimate how much better shield is required. For such purposes, comparative rather than absolute measurements of the effectiveness of shields under consideration are sufficient. In development work on or production testing of cylindrical shielding such measurements are very useful. The simplicity afforded by comparative as contrasted with absolute measurements is considerable.

When the effectiveness of an unknown specimen is determined by comparative tests in terms of the shielding effectiveness of a constant, reproducible standard, such as a specified thin-wall metal tube, such measurements become increasingly meaningful. Furthermore, if the shielding effectiveness of the reference tube is known or can be calculated, a figure for the absolute effectiveness of the unknown may be so obtained.

During the course of development work on flexible-shielding conduit at the American Metal Hose Branch of The American Brass Company, a number of different types of testing equipment, intended to give comparative measures of shielding effectiveness, were designed and tried. Those employing small probes, coupled either directly, capacitively, or inductively, to investigate "leakage" along the specimen, were found to be unsatisfactory and soon were replaced by integrating types of test which evaluate the effects of leakage over the entire length of specimen (usually 2 to 6 feet). Such probes are valuable tools for locating and localizing areas of leakage in shielding but have been found to have serious limitations when applied to the measurement of shielding effectiveness, even of such simple shields as thin-wall metal tubes.

Considerable work was done which showed that tests made with the small, one- or two-turn shielded-loop probes, such as have been rather widely used in recent shielding investigations, in general are not satisfactory for determining the effectiveness of cylindrical shields, whereas the results of integrating-type tests, such as performed with the equipment herein described, are directly related to the functioning of the specimen as a shield. A discussion of this investigation is beyond the scope of the present paper but it is hoped that publication of the experimental data and related material collected will be possible at an early date.

THE INTEGRATING-TYPE TEST

With the several test sets of the integrating type which have been constructed, what are believed to be reliable measurements have been made at frequencies from 0.2 to 10 megacycles. There seems to be no reason why the frequency range could not be extended appreciably downward and upward to the frequencies where standing waves introduce limitations. At higher

frequencies a somewhat different technique would appear to be preferable. Experience indicates, however, that for most purposes tests made between 0.2 and 10 megacycles are adequate to determine the suitability of a shield at the higher frequencies. This follows from the fact that shields tend to become more rather than less effective as the frequency is increased, unless they have holes, cracks, or other openings. In such cases the effects of these openings are readily detectable at the above frequencies and due allowance can be made for them.

The equipment to be described compares the voltage drop along the outside of an unknown specimen with that along the outside of an equal length of a standard, usually a 0.010-inch-wall pure-copper tube of the same nominal inside diameter, and gives, directly, the shielding effectiveness of the unknown in decibels above or below that of the standard.

A PRODUCTION-TEST MODEL

The equipment shown in Fig. 2 is a production-test model, operating at a fixed frequency of 3 megacycles, which accommodates specimens from 9 to 75 inches in length. By use of a series of threaded adaptors, cylindrical shielding from 3/16 to over 2 inches inside diameter can be tested. The range of satisfactory measurement is from about 20 to more than 140 decibels. Sensitivity is sufficient to *measure* the leakage through a 0.024-inch-wall copper tube at 3 megacycles. While somewhat simpler in construction than the adjustable-frequency models used for development work, the production-test model will serve to illustrate the technique employed, which is the same at all frequencies for which the method is applicable.

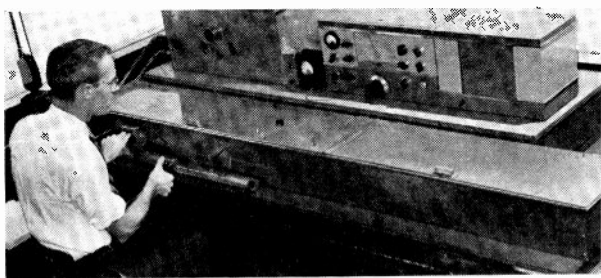

Fig. 2—Production-test equipment for comparative measurement of cylindrical shields at 3 megacycles.

On the shelf, at the left, is a copper box housing the signal source. To the right of this is a communications-type receiver and between the units can be seen a rectifier-type audio-output meter. The long copper box on the bench houses the specimen and "leakage" pickup circuits. This box enables measurements to be made in areas of high interference level, obviating the necessity for a shielded room. On the front of the box can be seen a shielded switch, used for connecting the receiver antenna circuit either to the pickup circuit or to the output of the calibrated attenuator which can be seen in the

foreground. The latter is of the coplanar, mutual-inductance type³ designed to provide 16 decibels attenuation per inch of movement.

Certain points of construction may be of interest. Fig. 3 is an inside view of the signal-source unit. The power supply is shown on the right. It furnishes rectified and filtered plate voltage to the oscillator and rectified, unfiltered plate voltage to the amplifier (which results

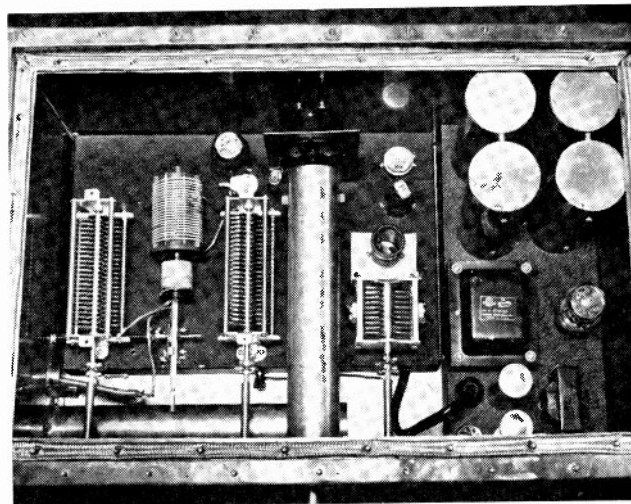

Fig. 3—Inside view of signal-source unit.

in almost 100 per cent, nearly sinusoidal, 120-cycle amplitude modulation, as determined from oscillographic study of the modulation envelope). The four vertical cylinders at the rear are copper cans shielding the line filters. (These must be really effective.) Leads entering and leaving the cylinders are enclosed in copper tubing and all joints are soldered all the way around.

To the left of the power supply can be seen the 6V6G 3-megacycle crystal-controlled oscillator and to the left of that the 6L6G modulated amplifier, the tank circuit of which is mounted in front of the tube. The additional coil and variable capacitor shown are used for coupling energy to the specimen and resonating this load circuit.

The scale of the plate-current meter in the center is illuminated by an internal light and viewed through the long, 2-inch diameter, cutoff tube which extends from the front panel almost to the meter face. Such tubes, functioning as wave guides well below cutoff frequency, are a most satisfactory though somewhat cumbersome means for effecting leak-proof openings in shield boxes. A second similar tube, for facilitating ventilation, can be seen protruding inward from the left. For all components requiring external adjustment, such as the variable capacitors, switch, and inductive coupling, 1/4-inch diameter nonconducting shafts enclosed in a few inches of 3/8-inch inside-diameter metal tubing soldered to the panel (cutoff tubes) are employed. Metal shafts are avoided since they would lead the signal out.

³ Daniel E. Harnett and Nelson P. Case, "The design and testing of multirange receivers," Proc. I.R.E., vol. 23, pp. 578-592; June, 1935.

TEST PROCEDURE

The test procedure is briefly as follows. The specimen in question is inserted in the equipment, due care being taken to ensure electrically tight joints at each end. Use of suitably designed seats and spherical-end ferrules soldered to the specimen is suggested, since good contact around the complete periphery is required. The box lid is closed to keep out extraneous noise. With the receiver tuned to the test frequency and its antenna circuit switched to the leads from the pickup circuit, the latter is carefully resonated. This adjustment is deter-

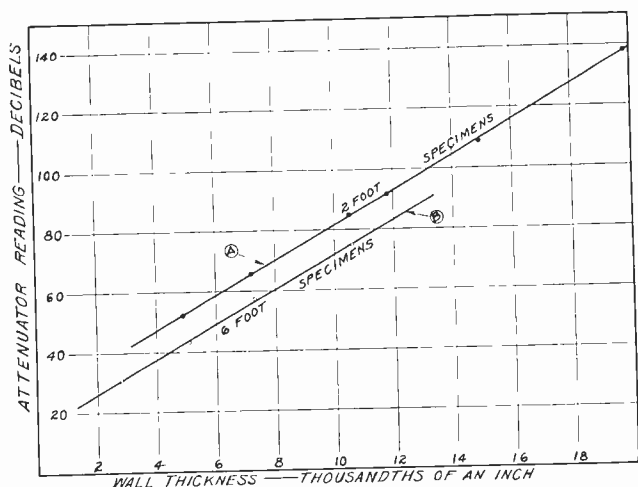

Fig. 6—Test results at 3 megacycles on 5/16-inch-inside-diameter pure-copper tubes of different wall thicknesses.

mined by observing the output-meter deflection, the gain of the receiver being reduced, as necessary, to avoid overloading. The receiver antenna circuit is then alternately switched to the movable coil of the attenuator and the pickup circuit and, without disturbing any signal source or receiver controls, the attenuator setting is varied until the same output-meter deflection is obtained with the switch in both positions. The signal from the attenuator then equals that from the specimen. The attenuator reading A_2 for this setting is recorded.

Preceding or following this, a reference copper tube of approximately the same diameter and of the same length is tested similarly and the corresponding attenuator reading A_1 obtained for this tube is also recorded. The difference in the two attenuator readings $A_2 - A_1$, which is in decibels, represents the apparent shielding effectiveness of the specimen with respect to the reference tube at the test frequency. In most cases, this is essentially equal to the true relative shielding effectiveness. The exceptional cases requiring correction are treated later.

The particular equipment described was designed for production testing of relatively large numbers of specimens of a given length. For this reason the attenuator is provided with both a fixed scale and a sliding plus-and-minus decibel scale having zero in the center. The reference tube is tested once, at which time the zero on the sliding scale is made to coincide with the pointer of the

attenuator. The shielding effectiveness of test specimens can then be read, directly from this scale, in decibels relative to the shielding effectiveness of the reference tube.

Using the technique just described, the shielding effectiveness of an unknown specimen is measured in terms of the reading on the attenuator scale which, in turn, is calibrated in terms of the shielding effectiveness of a stable, reproducible standard; namely, a specified copper tube. The attenuator thus provides a means for comparing the effectiveness of the unknown directly with that of the standard. Although it is necessary carefully to resonate the pickup circuit, if this is done the same setting on the attenuator will be obtained for a given specimen regardless of the gain of the receiver, its tuning adjustment, the calibration of the output meter, or the level of current through the specimen. The latter is true because, in case of variation, the current through the specimen and that through the fixed coil of the attenuator vary simultaneously and by precisely the same amount. Tests showing the independence of current level are given elsewhere.

EXPERIMENTAL RESULTS

Operation of the equipment can be judged from Figs. 6 and 7. Fig. 6 shows the attenuator readings obtained for a series of 2-foot specimens of 5/16-inch-inside-diameter pure-copper tube of different wall thicknesses and also for another series of similar 6-foot specimens. Curves obtained at other frequencies on 2-foot specimens of the same tubes using a different test set are

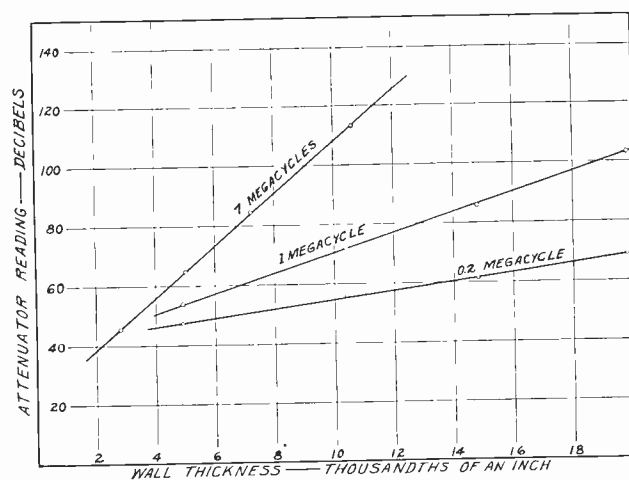

Fig. 7—Test results at three frequencies on 2-foot 5/16-inch-inside-diameter pure-copper tubes of different wall thicknesses.

shown in Fig. 7. By measuring the slopes of such curves, attenuation per mil thickness of the metal can be determined. For example, the measured slope of curve *A* of Fig. 6 is 5.75 decibels per mil while that of curve *B* is 5.72 decibels per mil. These values should be compared with the calculated attenuation of pure copper (5.781 decibels per mil) at 3 megacycles. (See Fig. 1 or apply equation (1)). Note that, as theory predicts, attenuation

differences in each case are directly proportional to the thickness differences of the tubes. Measurements on these tubes, made at several frequencies from 0.2 to 10 megacycles, in every case gave measured attenuations agreeing within 2 per cent or better with the calculated values as can be seen from Table I.

TABLE I
COMPARISON OF MEASURED AND CALCULATED VALUES OF
ATTENUATION OF PURE-COPPER TUBES

| Frequency (Megacycles) | Attenuation (Decibels per mil) | | Remarks |
|---------------------------|--------------------------------|----------|---------------|
| | Calculated | Measured | |
| 0.2 | 1.493 | 1.46 | (From Fig. 7) |
| 1.0 | 3.338 | 3.33 | (From Fig. 7) |
| 2.0 | 4.720 | 4.66 | |
| 3.0 | 5.781 | 5.74 | (From Fig. 6) |
| 5.0 | 7.464 | 7.52 | |
| 6.0 | 8.178 | 8.06 | |
| 7.0 | 8.832 | 8.73 | (From Fig. 7) |
| 10.0 | 10.56 | 10.40 | |

These tests also show that, as predicted by theory, attenuation of the tubes increases as the square root of the frequency. However, if specimens of flexible shielding employing wire braid or other constructions having inherent small openings are tested in comparison with rigid metal tubing, this behavior generally will not be observed. It is found that such shields ordinarily do not increase in effectiveness with frequency as rapidly as do rigid metal tubes, and that their shielding-versus-frequency characteristics may vary appreciably from the square-root relationship.

FACTORS NOT SERIOUSLY AFFECTING TEST RESULTS

As explained previously, attenuator readings obtained for a given specimen are not affected by the magnitude of the current through the specimen. The independence of current level is illustrated by the curve of Fig. 8 which shows the reading obtained for a 0.0106-inch-wall copper tube essentially unaffected over a 30-decibel range of current. The slight variations (less than 1 decibel) observed following changes in current were found to be attributable to changes in attenuation of the specimen due to changes in its temperature caused by altering the rate of heating. This point is demonstrated by curve A of Fig. 9 which shows the manner in which the shielding effectiveness of the same tube was found to decrease as it heats slightly from room temperature during a prolonged test. Upon cooling, the initial effectiveness is restored. Curve B in Fig. 9, calculated on the basis of the change in electrical conductivity of copper with temperature, shows that for small changes in temperature the attenuation of a 0.010-inch-wall copper tube at 3 megacycles would be expected to decrease about 0.1 decibel per degree centigrade increase in temperature.

Although mistuning of the receiver has no direct effect upon attenuator readings, it is desirable that the receiver be tuned reasonably close to the signal-source

frequency to obtain maximum sensitivity with minimum gain and background noise. Manual rather than automatic gain control is employed to attain sensitivity to small signal changes. In testing specimens having widely different degrees of leakage, it obviously becomes necessary to operate the receiver with the gain control at different levels. This may produce a change in the input impedance of the receiver which, as the receiver is switched from one position to another, does not necessarily load the pickup circuit and the attenuator by the same amount. As a result, a slight error is introduced from this source but tests have shown that, with the present equipment, it can be ignored since it amounts to but a small fraction of a decibel.

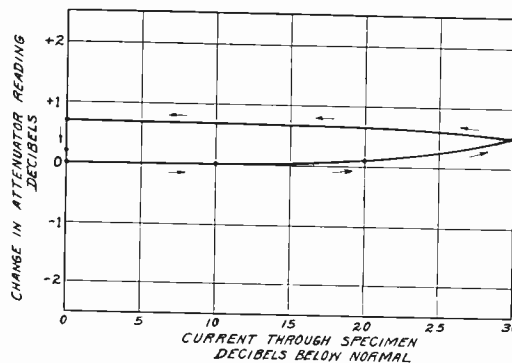

Fig. 8—Observed changes in attenuator readings for changes in current through specimen. 0.0106-inch-wall copper tube at 3 megacycles. Normal current 3 amperes.

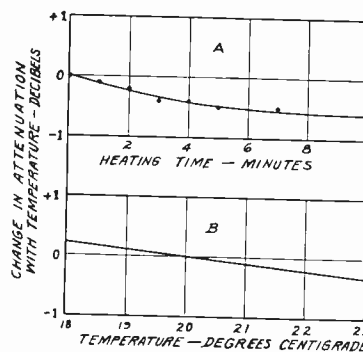

Fig. 9—(A) Measured change in attenuation of an 0.010-inch-wall copper tube at 3 megacycles as it heats during prolonged test. (B) Calculated change in attenuation of an 0.010-inch-wall copper tube at 3 megacycles with change in temperature.

While the equipment is intended to test straight lengths of a specimen, it has been found that no appreciable error results from testing considerably bowed or bent specimens provided allowance is made for the true length of such specimens. Also, if the center conductor does not touch the specimen (except where connected by means of the banana plug) no special precautions are necessary to keep it centered within the specimen. Identical test results have been obtained using precisely coaxial conductors and conductors deliberately thrown off-center.

Since the voltages it is desired to compare are open-circuit voltages, it would appear that an infinite-impedance

voltmeter would have to be employed to read true values, whereas the impedance of the measurement circuit used actually is quite low. That appreciable error will not ordinarily result from use of this low-impedance circuit, which is done to gain sensitivity, can be demonstrated mathematically and has been proved experimentally. It can be shown that *no* error results from use of a low-impedance measuring circuit if the specimen and the standard have the same outside surface resistance at the test frequency. Reactances do not enter the picture since the complete circuit is made series resonant and the current in the measuring circuit is limited only by the total circuit resistance. The resistance of most specimens likely to be tested for shielding effectiveness is so low that they can be compared directly with a copper reference tube. The subject of corrections for cases of specimens having exceptionally high resistance is taken up in the next section.

Since voltage introduced into the measuring circuit and the resistance of the specimen, standard, and measuring circuit all vary more or less with length tested, by far the most simple procedure is to compare *equal* lengths of specimen and standard. Fig. 10 shows the observed variations in attenuator readings with length

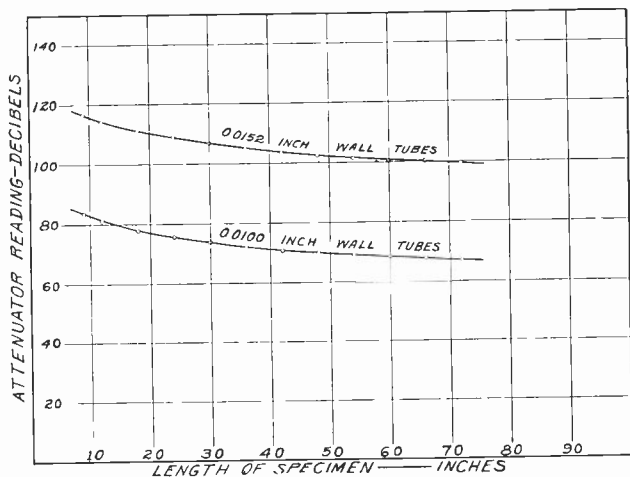

Fig. 10—Test results at 3 megacycles on two 5/16-inch-inside-diameter pure-copper tubes using specimens of various lengths.

tested for two copper tubes of different thickness. Note, however, that the readings for the two tubes vary similarly with length and by the same amounts. Thus, by comparing specimens of from 12 to 72 inches long the heavier tube is found by Fig. 10 to be 33 decibels better than the thinner one. It can readily be shown that if the low impedance of the measuring circuit were causing appreciable error, different values for apparent shielding effectiveness would be obtained by comparing different lengths.

The same independence of specimen length is apparent also in Fig. 6 and has been observed in comparing most shielding conduit, coaxial cable, and the like, with copper tube. This point is further illustrated by Fig. 11 which shows the measured shielding effectiveness at 3

megacycles, relative to 0.010-inch-wall pure-copper tubing, of various lengths of shields having widely different constructions.

It is perhaps preferable to compare unknown specimens with tube standards having the same diameter. However, since attenuation is independent of diameter and reflection does not change greatly with small changes in diameter, nearly identical results will be

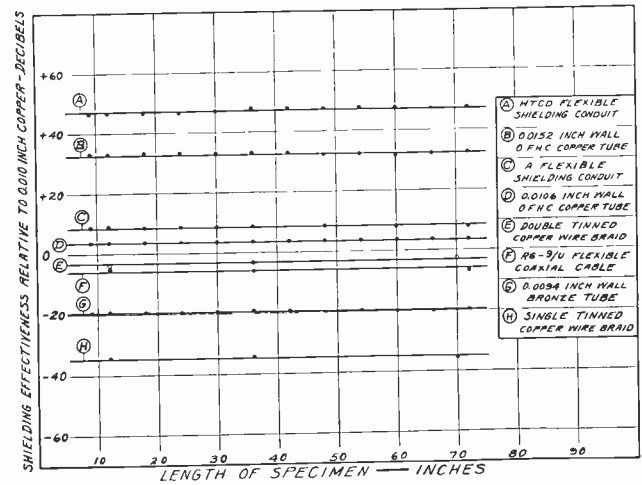

Fig. 11—Measured shielding effectiveness of various types of shields at 3 megacycles. Tests on specimens of different lengths.

obtained whether a specimen is compared with a standard tube of the same or approximately the same diameter.

SOME FACTORS AFFECTING TEST RESULTS

Stray leakage obviously must be kept to a value low compared with the specimen leakage to avoid significant error. The signal in the measuring circuit from all sources of stray leakage should be at least 30 decibels, preferably more than 40 decibels, below that produced by the leakage of the best specimen to be measured. Its magnitude can be evaluated conveniently by insertion of a very good specimen, known to have negligible leakage, such as, at 3 megacycles, a 0.050-inch-wall copper tube. Stray leakage is below the inherent background level of the receiver in the equipment here described.

As would be expected, such leakage becomes more troublesome the better the shield tested. This is illustrated in Fig. 12, which shows two cases where stray leakage deliberately was introduced. In general, stray leakage causes the attenuator readings for thick tubes to be reduced more than the readings for thin tubes and, for tubes in excess of a certain thickness, to remain constant with increasing thickness. However, depending upon the phase relationship between stray and specimen leakage the effect of stray leakage sometimes is to make a specimen appear better rather than worse. This effect can be seen in the figure; it becomes particularly noticeable when specimen and stray leakage are approximately equal. In any case, in the presence of stray leakage a plot of attenuator readings versus wall thickness

for a series of similar thin-wall tubes results in a curve of some sort, such as *B* or *C* of Fig. 12, while in the absence of appreciable leakage a straight line such as *A* invariably is obtained. Testing such a series of tubes with a view to obtaining a linear relationship is one way of determining whether stray leakage exceeds the permissible value.

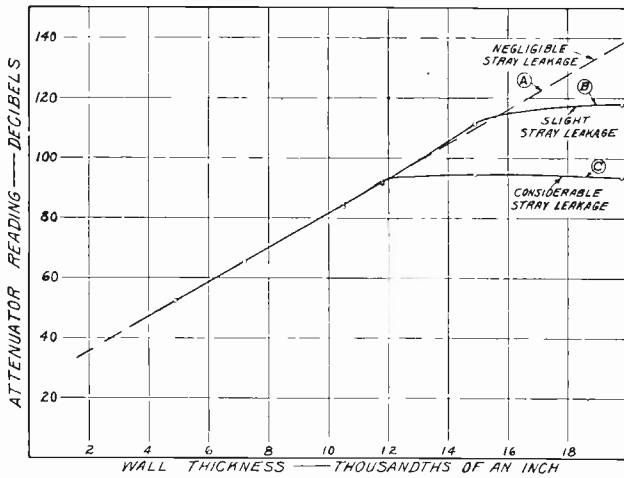

Fig. 12—Measured effects of stray leakage at 3 megacycles. Pure-copper tubes of different wall thicknesses.

To obtain meaningful and reproducible results it is necessary to maintain frequency with considerable precision inasmuch as the equipment is capable of measuring the small changes (such as 0.2 decibel) in attenuation which would result from relatively small frequency changes. The error resulting from a given frequency error can be calculated for copper tubes from (1). At 3 megacycles the error in the measurement of a 0.020-inch-wall copper tube is about 0.2 decibel per 10-kilo-cycle error in frequency.

Care obviously must be taken carefully to resonate the pickup circuit for each test. Since the gain of this circuit is introduced between the specimen and receiver the circuit is constructed with a view to mechanical and electrical stability. Poor contact between the end of the specimen and the rod of the measuring circuit and in the antenna change-over switch have been found likely sources of trouble.

It is absolutely essential that both ends of the specimen be attached to the test-equipment fittings with really tight joints making contact around the complete periphery. If successive tests on a given specimen show more than a fraction of a decibel variation, it is suggested first that contact between specimen and fittings be checked and then that the specimen be investigated to determine whether its shielding effectiveness varies with flexing. Some variation of this nature is ordinarily observable with flexible shields employing wire braid.

It has been mentioned that when specimens of shielding having excessively high (outside-surface) resistance are compared with a low-resistance standard, such as a copper tube, shielding effectiveness *apparently* varies

with the length compared and corrections have to be applied to the measured values to obtain true shielding effectiveness.

To study such resistance effects, specimens having exceptionally high resistance have been made up and tested. A typical test on one of these at 3 megacycles is shown in Fig. 13. From curve *A* the shielding effectiveness relative to the 0.010-inch copper reference tube appears to vary from -41 decibels to -34 decibels for specimens of 12 to 72 inches in length. Actually, all of these readings are appreciably in error. However, when proper correction is applied to the apparent shielding effectiveness found for any length of such a specimen, a consistent figure for shielding effectiveness is obtained. The corrected values are shown plotted in *B*. In the case at hand, it is -44 decibels. The outside-surface resistance of this particular specimen at 3 megacycles is very high (0.63 ohm per foot) while that of the copper-tube standard is indeed small compared either with this or with the measuring-circuit resistance, which, for the equipment described, is about 1.64 ohms at the test frequency. The latter, incidentally, remains essentially constant regardless of specimen length, since the resistance of the included copper rod, which changes with length of specimen, comprises but a small part of the total measuring-circuit resistance.

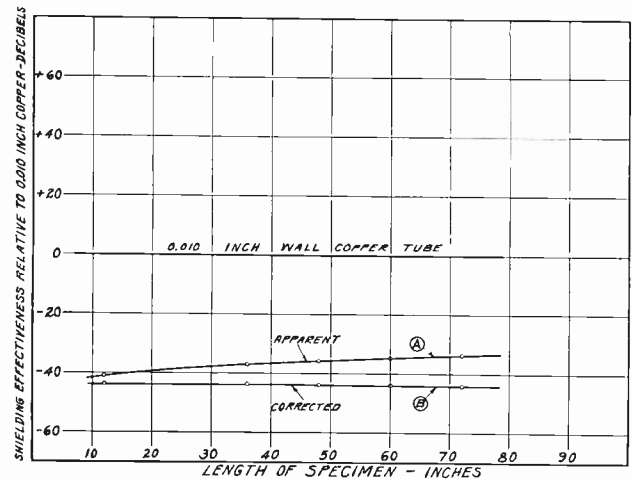

Fig. 13—(A) Measured apparent shielding effectiveness at 3 megacycles of a shield having exceptionally high resistance. Tests on specimens of different lengths. (B) True shielding effectiveness of the high-resistance shield obtained by correcting values shown in (A).

Since the resistance of most specimens having significant shielding is small compared with 1.64 ohms, relatively speaking the measuring-circuit impedance is high and negligible error results from neglect of resistance corrections. Calculation shows that with the particular equipment described, shielding specimens having outside surface resistances up to nearly 0.2 ohm can be compared directly with a copper-tube standard with an error not exceeding 1 decibel. However, if it becomes necessary to test relatively high-resistance specimens in comparison with standards having appreciably different

resistance, or it is desired to determine the magnitude of the resistance correction in any given case, the remarks immediately following are applicable.

If the resistances of the specimen, reference tube, and measuring circuit at the test frequency are known, it is quite easy to compute the true shielding effectiveness from the measured apparent value. True shielding effectiveness is given by (2) and (3).

$$S = S' + \Delta S \tag{2}$$

$$\Delta S = 20 \log_{10} \frac{R_s + R_M}{R_x + R_M} \tag{3}$$

where

- | | |
|--|-------------------------|
| S = true shielding effectiveness | } decibels |
| S' = apparent shielding effectiveness | |
| ΔS = correction to be applied | |
| R_s = resistance of the standard | } at the test frequency |
| R_x = resistance of the specimen | |
| R_M = resistance of the measuring circuit | |
| (that part of the pickup circuit exclusive of the specimen). | |

If the resistances are not known, the following procedure can be applied: (1) Measure the reference tube in the usual manner calling the attenuator reading obtained A_1 decibels.

(2) Measure the unknown specimen in the same manner, calling this attenuator reading A_2 decibels. Now, the *apparent* shielding effectiveness S' is

$$S' = A_2 - A_1 \tag{4}$$

(3) With the unknown specimen in place, add resistance R in series with the measuring circuit until the attenuator setting, necessary to give the same output-meter deflection with the antenna switch in both positions, is 6.0 decibels higher than A_2 . Call this setting A_3 decibels.

(4) With R in the measuring circuit, measure the reference tube, calling the attenuator reading obtained A_4 decibels. A new *apparent* shielding effectiveness S'' is thus determined where

$$S'' = A_3 - A_4. \tag{5}$$

Calculate the quantities

$$a = \text{antilog}_{10} (S'/20) \tag{6}$$

$$b = \text{antilog}_{10} (S''/20) \tag{7}$$

and compute the true shielding effectiveness S from

$$S = 20 \log_{10} \frac{ab}{2a - b} \tag{8}$$

The same result is obtained by applying (2) or (8). Derivations of (3), (6), (7), and (8) are given in the appendix.

CONCLUSIONS

With equipment such as that which has been described, it is possible to make reasonably precise comparative measurements of the over-all effectiveness of

a wide variety of cylindrical shields at radio frequencies. Test results on thin-wall metal tubes are in substantial agreement with calculations based upon the wave theory of shielding. The equipment has sufficient range to make possible measurements on shields differing in effectiveness by more than 120 decibels. Although the particular equipment described operates on a fixed frequency of 3 megacycles, adjustable-frequency versions can and have been made to operate equally as successfully at considerably higher and lower frequencies.

APPENDIX

DERIVATION OF EQUATIONS (3), (6), (7), AND (8)

In testing the standard reference tube, the current in the measuring circuit is

$$I_s = \frac{E_s}{R_s + R_M} \tag{9}$$

where

- I_s = current in measuring circuit with standard under test
- E_s = voltage developed across the standard as result of leakage
- R_s = outside-surface resistance of standard at test frequency
- R_M = resistance of measuring circuit at test frequency.

Since the complete circuit, measuring circuit plus specimen, is made series resonant, the current is limited only by resistance, and reactances are not involved in the expression. The equivalent circuit is shown in Fig. 14(a).

Similarly, in testing the unknown, the current

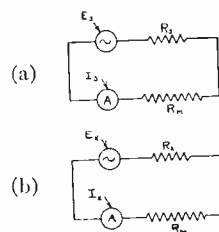

Fig. 14—Equivalent circuits.
(a) With standard under test (attenuator reads A_1).
(b) With unknown under test (attenuator reads A_2).

through the measuring circuit is given by

$$I_x = \frac{E_x}{R_x + R_M} \tag{10}$$

where

- I_x = current in measuring circuit with unknown under test
- E_x = voltage developed across the unknown as result of leakage
- R_x = outside-surface resistance of the unknown at test frequency.

The equivalent circuit is shown in Fig. 14(b).

The apparent shielding effectiveness S' of the unknown in terms of the standard, as determined by the test is

$$S' = 20 \log_{10} (I_s/I_x). \quad (11)$$

The desired quantity, referred to as the true shielding effectiveness S , is given by

$$S = 20 \log_{10} (E_s/E_x). \quad (12)$$

From (9) and (10) we find that

$$E_s/E_x = \frac{R_s + R_M}{R_x + R_M} (I_s/I_x) \quad (13)$$

whence

$$S = 20 \log_{10} \left(\frac{R_s + R_M}{R_x + R_M} \right) + 20 \log_{10} (I_s/I_x) \quad (14)$$

or

$$S = \Delta S + S' \quad (15)$$

where

$$\Delta S = 20 \log_{10} \left(\frac{R_s + R_M}{R_x + R_M} \right). \quad (16)$$

It will be seen that (16) and (3) are identical.

From (13) we obtain the following:

$$E_s/E_x = I_s/I_x - I_s/I_x + \frac{R_s + R_M}{R_x + R_M} (I_s/I_x) \quad (17)$$

$$E_s/E_x = I_s/I_x - \left(1 - \frac{R_s + R_M}{R_x + R_M} \right) (I_s/I_x) \quad (18)$$

$$E_s/E_x = I_s/I_x - \frac{R_x - R_s}{R_x + R_M} (I_s/I_x). \quad (19)$$

This equation obviously holds for *any* positive value of R_M . With the unknown under test, let us add resistance R to R_M , as shown in Fig. 15(a), until the total

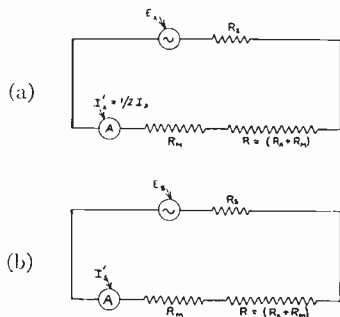

Fig. 15—Equivalent circuits with resistance R added to measuring circuit.

- (a) With unknown under test (attenuator reads A_3).
 (b) With standard under test (attenuator reads A_4).

circuit resistance is doubled. To accomplish this, R must have a value $(R_x + R_M)$. Designating the new value of measuring-circuit resistance by R_M' we have

$$R_M' = R_M + R = R_M + (R_x + R_M). \quad (20)$$

Since the total circuit resistance is now $2(R_x + R_M)$ the current I_x is halved, becoming I_x' , and a change of 6.0 decibels in the attenuator reading is required to restore balance. Hence this value of R can readily be determined experimentally.

If, now, both the unknown and standard are tested with this new value of measuring-circuit resistance we obtain a new apparent shielding effectiveness S'' (see Fig. 15)

$$S'' = 20 \log_{10} (I_s'/I_x') \quad (21)$$

and have

$$E_s/E_x = I_s'/I_x' - \frac{R_x - R_s}{R_x + R_M'} (I_s'/I_x') \quad (22)$$

$$E_s/E_x = I_s'/I_x' - \frac{R_x - R_s}{2(R_x + R_M)} (I_s'/I_x') \quad (23)$$

where

I_s' = current in measuring circuit with standard under test when measuring-circuit resistance equals R_M'

I_x' = current in measuring circuit with unknown under test when measuring-circuit resistance equals R_M' .

Equating (19) and (23) we obtain

$$I_s/I_x - \frac{R_x - R_s}{R_x + R_M} (I_s/I_x) = I_s'/I_x' - \frac{R_x - R_s}{2(R_x + R_M)} (I_s'/I_x'). \quad (24)$$

If we designate I_s/I_x by a and I_s'/I_x' by b we find that

$$\frac{R_x - R_s}{R_x + R_M} = \frac{2(b - a)}{b - 2a} \quad (25)$$

Substitution of this in (19) gives

$$E_s/E_x = a - \frac{2(b - a)}{b - 2a} \cdot a = \frac{ab}{2a - b}. \quad (26)$$

From (12)

$$S = 20 \log_{10} \frac{ab}{2a - b} \quad (27)$$

in which, from (11) and (21)

$$a = \text{antilog}_{10} (S'/20) \quad (28)$$

$$b = \text{antilog}_{10} (S''/20). \quad (29)$$

It will be seen that (27) and (8) are identical, as are (28) and (6) and also (29) and (7).

ACKNOWLEDGMENT

The author wishes to acknowledge, with thanks, the able assistance of Mr. H. J. Terrill, who constructed the equipment herein described and contributed in no small measure by performing most of the reported tests, and to express appreciation to Mr. E. T. Candee, technical and development supervisor of The American Metal Hose Branch of The American Brass Company, for his whole-hearted support and encouragement throughout the entire program which made possible the publication of this work.

Contributors to Waves and Electrons Section



JENNINGS B. DOW

Jennings B. Dow (M'26-F'42) was graduated from the United States Naval Academy in 1920 with the B.S. degree, and received the M.S. degree in electrical-communication engineering from Harvard University in 1926.

He served as radio and communications officer on various ships, and from 1922 to 1924 was a member of the staff of commander of battleship divisions in the battle fleet. He served as Asiatic Fleet radio officer from 1926 to 1927; radio materiel officer in the Navy Yard at Cavite, Philippine Islands from 1927 to 1929; in the radio division of the Bureau of Engineering from 1930 to 1932, and as head of that division from 1938 to 1939.

In 1940, Commodore Dow became director of the Navy Radio and Sound Laboratory at San Diego, California, and was sent to Great Britain on special duty as observer of radio and radar in 1940 and 1941. Since 1941 he has served as director of electronics for the Bureau of Ships, Navy Department, in Washington, D. C.



HOWARD A. CHINN

Howard A. Chinn (A'42-SM'45-F'45) was born in New York City on January 5, 1906. He attended the Polytechnic Institute of Brooklyn, later going to the Massachusetts Institute of Technology where he received the S.B. and S.M. degrees in 1927 and 1929, respectively. From 1927 to 1932 he was a research associate at the Massachusetts Institute of Technology. Mr. Chinn became associated with the Columbia Broadcasting System in 1932 as a radio engineer; from 1934 to 1936 he was assistant to the director of engineering; from 1936 to date he has been chief audio engineer, although, during the war years, the bulk of his time has been devoted to other activities associated with the war effort. From the beginning of 1942 to the end of 1943 he was technical co-ordinator of the Radio Research Laboratory of Harvard University, at Cambridge, Massachusetts, which is sponsored by the Office of Scientific Research and Development. From 1944 to date, he has been first a technical aide and currently a consultant to Division 15 of the Office of Scientific Research and Development. From 1939 to 1941, Mr. Chinn was a special lecturer in electrical engineering at the graduate school of New York University.



CHARLES M. FOGEL

Charles M. Fogel (A'44) was born in 1913 at Syracuse, New York. He received the B.A. degree in 1935 and the M.A. degree in physics in 1936, both at the University of Buffalo. He then attended Ohio State University for one year as a graduate assistant. The following four years were spent teaching science in the secondary schools. In 1941 he was appointed instructor of physics at the University of Buffalo where he also acted as supervisor of physics instruction in the war training program. In 1944 he joined the engineering staff of the Research Laboratory of National Union Radio Corporation where he was primarily concerned with tube design.

Mr. Fogel has now returned to the Uni-



ALTON R. ANDERSON

versity of Buffalo as assistant professor in engineering. He is a member of the American Physical Society.

Alton R. Anderson was born at Ansonia, Connecticut, on April 11, 1909. He attended Worcester Polytechnic Institute and has been interested in amateur radio since 1920. He spent four years with The American Brass Company working on mechanical testing of metals, and six years in the copper-alloys research laboratory of the same company, where he was engaged in a study of the endurance properties of nonferrous alloys.

Since 1943, Mr. Anderson has been associated with the American Metal Hose Branch of The American Brass Company, as research and development engineer, working on electronic problems involved in design, testing, and production of flexible shielding conduit, flexible wave guides, and similar products.

Harry C. Ingles was graduated from West Point with a B.S. degree in 1914, and during



HARRY C. INGLES

Contributors to Waves and Electrons Section

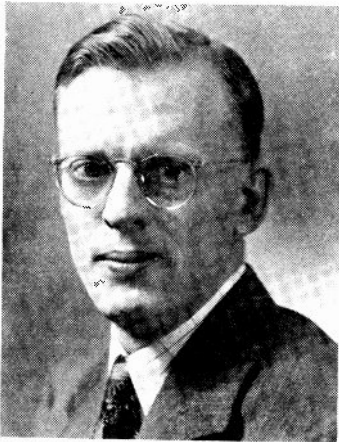

O. K. JOHANSSON

World War I was in charge of training Signal Corps officers. Since that time he has had various communication assignments, including signal officer of the Philippine Division; director of the Signal Corps School; instructor in communication at the Command and General Staff School; signal officer of the Third Army; and signal officer of the Caribbean Defense Command.

Major-General Ingles has also served on the War Department general staff, and as chief of staff of the Caribbean Defense Command, for which duty he was awarded the Distinguished Service Medal. He was deputy commander of the European Theater of Operations, and in 1943 was appointed chief signal officer of the army.



E. G. LINDER

O. K. Johansson received his A.B. and A.M. degrees from the University of Saskatchewan in 1930 and 1932, respectively, and his Ph.D. degree in physical chemistry from McGill University in 1937. He has been employed by the Corning Glass Works, Corning, New York, since 1938. For a number of years he has been engaged in research and development of the silicone field.

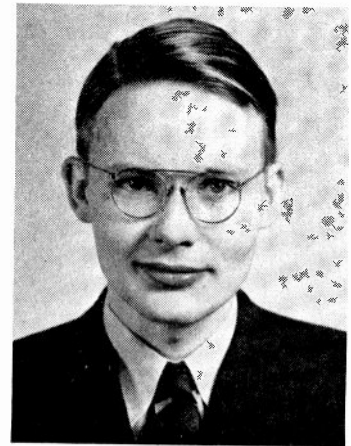

ROBERT L. SPROULL

Robert L. Sproull was born in 1918 at Lacon, Illinois. He received the B.A. degree from Cornell University in 1940. He was successively President White Fellow, Charles A. Coffin Fellow, and a research assistant in physics at Cornell University, where he received the Ph.D. degree in 1934. He was employed in the summer of 1940 by the development department of Eastman Kodak Company and in the summer of 1941 by the electronics research department of Bell Telephone Laboratories. Since 1943 he has been with RCA Laboratories at Princeton, New Jersey. He is a member of the American Physical Society and is President of Telluride Association, an endowed educational foundation.

Ernest G. Linder (A'40) was born in 1902 at Waltham, Massachusetts. He received the B.A. degree from the University of Iowa in 1925, and the M.S. degree in 1927. He was an instructor in physics at the State University of Iowa from 1925 to 1927; an instructor at California Institute of Technology from 1927 to 1928; a Detroit Edison Fellow at Cornell University from 1928 to 1932, where he received his Ph.D. degree in 1931. Dr. Linder was employed in the Research Division of the RCA Victor Company from 1932 to 1935; and the RCA Manufacturing Company, RCA Victor Division from 1935 to 1942. At present he is with the RCA Laboratories at Princeton, New Jersey. He is a member of the American Physical Society.

Julius J. Torok was born at Philadelphia, Pennsylvania, on July 16, 1903. He received the B.S. degree in mechanical engineering in 1925 from Pennsylvania State College, and an electrical engineering degree from the same institution in 1928.

From 1925 to 1935 he was employed by Westinghouse Electric Corporation in high-voltage research and transmission-line design. In 1935 he joined the research staff of the Corning Glass Works in charge of electrical-insulation development and design. More recently, he has been engaged in the application of silicone compounds.



JULIUS J. TOROK

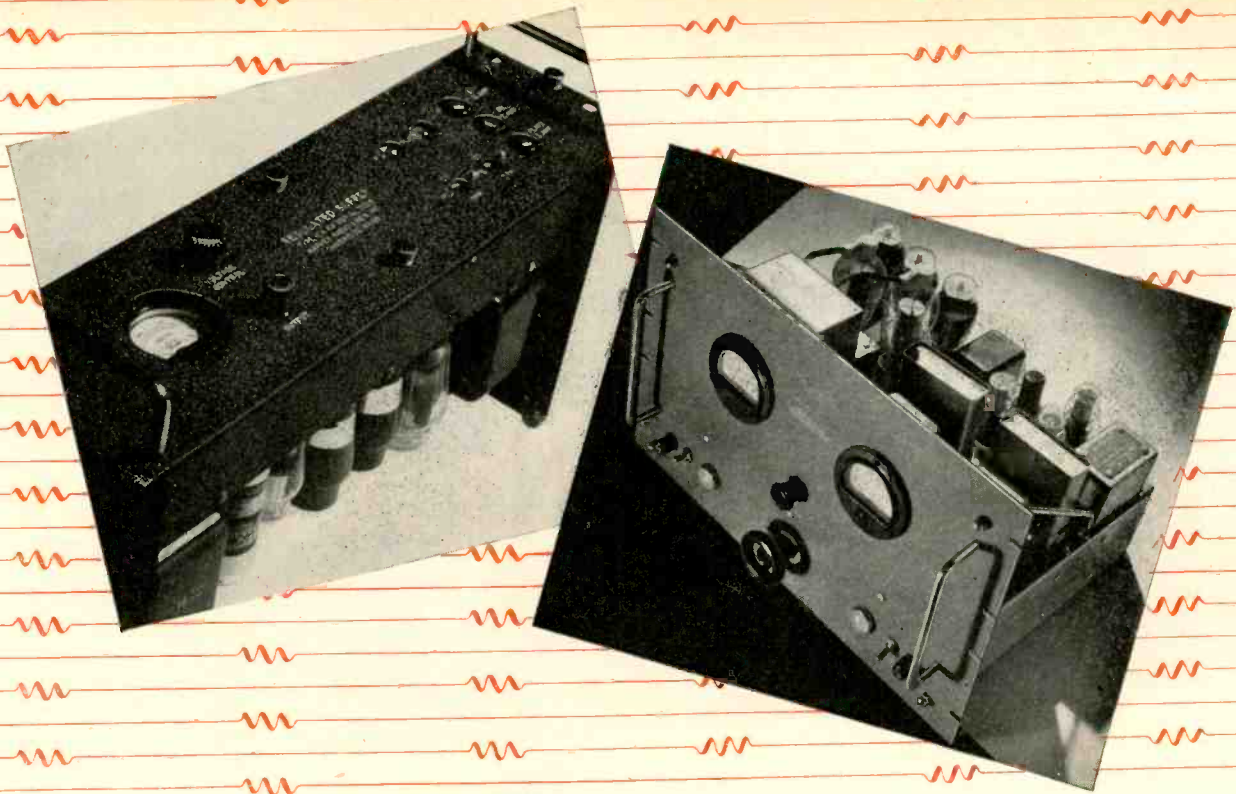

HARVEY OF CAMBRIDGE . . . YOUR BEST Source of Supply for REGULATED POWER SUPPLIES

If you operate equipment requiring a constant, regulated source of laboratory D.C. power — Amplifiers, Pulse Generators, Constant Frequency Oscillators, Measurement Equipment and the like — you'll find there's a HARVEY Regulated Power Supply that will suit your every requirement to a "T". As the products of pioneers in the development and manufacture of Regulated Power Supplies, HARVEY Units offer the latest and best in design, performance and dependability.

The HARVEY Regulated Power Supply

106-PA meets every need for a controllable, dependable source of laboratory D.C. power between 200-300 volts. Operates from 115 volts A.C. . . . output remains constant even though line voltage varies between 95 and 130 volts. Ripple content is better than 10MV . . . two separate filament voltages available . . . 6.3 volts, 5 amps. each . . . paralleled operation possible making 6.3 volts at 10 amps. available. D.C. voltmeter for measuring output.

The HARVEY Regulated Power Supply 206-PA operates precisely and efficiently

in the 500 to 1000 volt range. It provides a regulated flow of D.C. power in two ranges: 500 to 700 volts at $\frac{1}{4}$ amp; 700 to 1000 volts at $\frac{1}{5}$ amp. Ripple content $\frac{1}{10}$ of 1% or better at any voltage . . . 300MV at 1000 volts or better. Output is constant within 1% from no load to full load in each range; regulation 1% or better.

For complete specifications on the HARVEY 106-PA, write for Bulletin No. 25; on the HARVEY 206-PA, Bulletin No. 26. We'll be pleased to send you either or both. Write:

HARVEY RADIO LABORATORIES, INC.

456 CONCORD AVENUE • CAMBRIDGE 38, MASSACHUSETTS

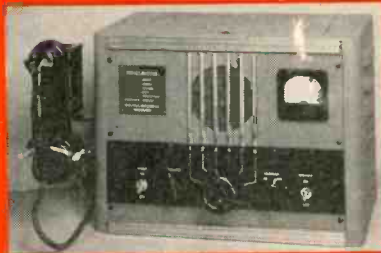

Typical HARVEY products: Above left: The HAR-CAM Visual Alignment Signal Generator Model 205 TS; center: The HARVEY Marine Radiotelephone Model M-25; right: The HAR-CAM Model MFT-25 FM Transmitter. Write for Bulletins.

OHMITE

OFFERS THE WIDEST, MOST COMPLETE
RANGE OF TYPES AND SIZES IN

CLOSE CONTROL Rheostats

10 Wattage Sizes from 25 to 1000 watts,
from 1-9/16" to 12" Diameter, with Standard or
Special Features, with Uniform or Tapered
Windings, in Stock or Special Resistances,
in Single, Tandem or Concentric Units.

Only Ohmite provides such a wide range of types
and sizes . . . to give you a quick and correct answer
to your Rheostat needs. Stock models in 25, 50,
100, 150, 300, and 500 watt sizes in a wide range
of resistance values.

All models have the time-proved features of Ohmite
design—the pioneer design that revolutionized
rheostat construction. Every Ohmite unit assures
permanently smooth close control . . . under every
operating condition.

Get the benefit of Ohmite experience in countless
applications. Let Ohmite engineers cooperate in
solving your rheostat control problems.

OHMITE MANUFACTURING COMPANY
4862 FLOURNOY STREET, CHICAGO 44, U.S.A.

* * *

VISIT BOOTH NO. 72 AT THE RADIO PARTS AND
ELECTRONIC EQUIPMENT CONFERENCE AND SHOW
HOTEL STEVENS, CHICAGO, MAY 13-16

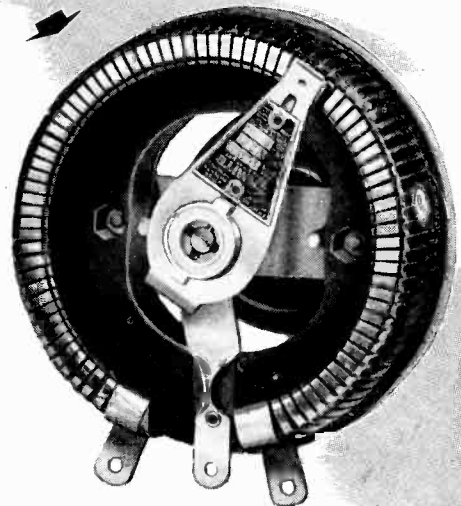
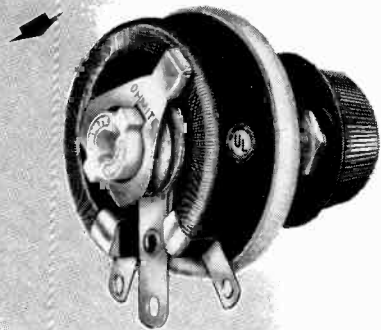

Send for Catalog and
Engineering Manual No. 40

Write on company letter-
head for this valuable
helpful guide in the selec-
tion and application of
rheostats, resistors, tap
switches, chokes and
attenuators.



Be Right with **OHMITE**
RHEOSTATS • RESISTORS • TAP SWITCHES

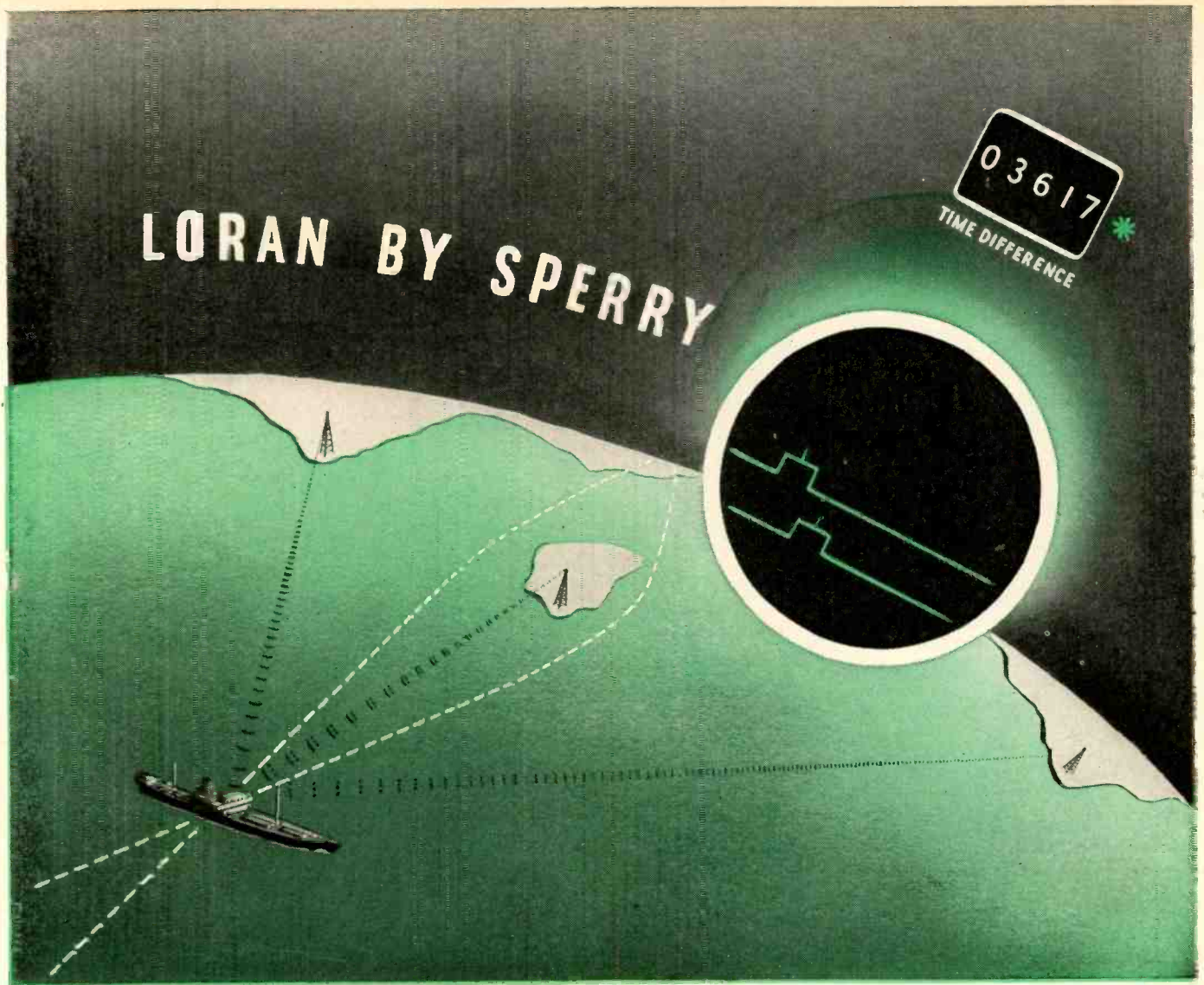

Accurate **LO**ng **RA**nge **N**avigation... anytime... in all weather

With Sperry Loran the navigator has at hand a quick and accurate means of determining a ship's position at any time, in all kinds of weather. This system involves the reception of accurately timed radio pulses from shore-based transmitting stations, usually 200 to 400 miles apart.

The *difference in time of arrival* of signals from a pair of transmitting stations is measured and the time difference is then used to determine, from special charts or tables, a line-of-position on the earth's surface. When two lines-of-position from two different pairs of Loran stations are

crossed, you have a "Loran fix." Fixes are obtainable at distances from shore stations up to 1400 miles at night, 700 miles in daytime.

In your consideration of Loran, note particularly that Sperry's equipment is easy to operate. A Time Difference Meter (see illustration above) greatly simplifies the operator's

work and prevents errors in readings.

Sperry Loran is backed by a world-wide service organization and meets the usual high standards of test and performance of all Sperry products. *Loran equipments in limited quantity are ready for immediate delivery.*

**The Time Difference Meter, giving position references directly, is a Sperry exclusive.*



Sperry Gyroscope Company, Inc.

EXECUTIVE OFFICES: GREAT NECK, NEW YORK • DIVISION OF THE SPERRY CORPORATION
 LOS ANGELES • SAN FRANCISCO • NEW ORLEANS • HONOLULU • CLEVELAND • SEATTLE
 GYROSCOPICS • ELECTRONICS • RADAR • AUTOMATIC COMPUTATION • SERVO-MECHANISMS

Your SHURE *Glider* Pickup Check List

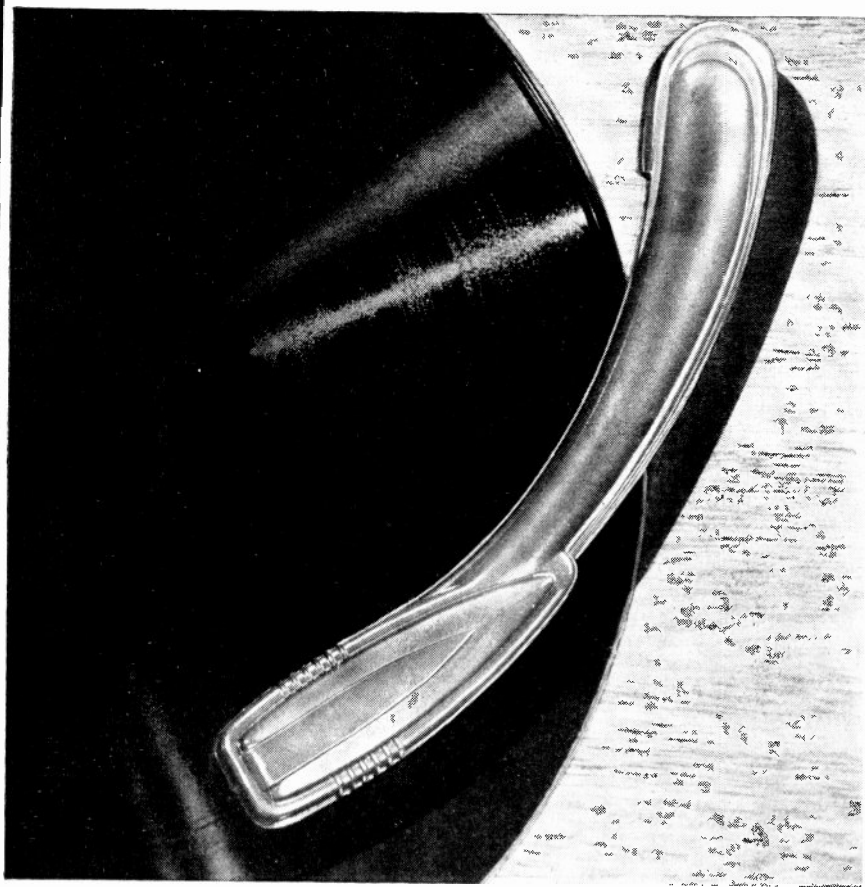

| | | | |
|---|--|---|-----------------------------------|
| ✓ | low mass | ✓ | no springs no counterweights |
| ✓ | faithful tracking | ✓ | absorbs shocks |
| ✓ | higher output | ✓ | longer record life |
| ✓ | greater lateral needle point compliance | ✓ | clearer, fuller tone qualities |
| ✓ | 1½ oz. needle force | ✓ | lever-driven crystal |

MODEL 93A—\$5.50 LIST

Immediately Available at Shure Distributors Everywhere

Patented by Shure Brothers. Licensed under the Patents of the Brush Development Company

SHURE BROTHERS

Designers and Manufacturers of Microphones and Acoustic Devices

225 West Huron Street, Chicago 10, Illinois

Cable Address: SHUREMICRO



BALTIMORE

"Frequency Modulation and Control Symposium," by James Day, Radio Engineering Laboratories, J. E. Young, Radio Corporation of America, W. G. Broughton, General Electric Company, M. R. Briggs, Westinghouse Electric Corporation; February 26, 1946.

"Aspects of Color Television," by P. C. Goldmark, Columbia Broadcasting System; March 26, 1946.

BOSTON

"Radar Countermeasures," by R. A. Soderman, General Radio Company; March 22, 1946.

BUFFALO-NIAGARA

"Methods of Electronic Control," by W. D. Cockrell, General Electric Company; February 20, 1946.

"Microwave Generation and Utilization in Communication," by J. B. H. Kuper, Federal Telecommunications Laboratories; March 20, 1946.

CEDAR RAPIDS

"New Methods in the Air Navigation Program," by H. I. Metz, Civil Aeronautics Authority; March 20, 1946.

"Printed Electronic Circuits," by R. L. Wolff, Centralab Company; March 20, 1946.

CHICAGO

"Development and Trends in Radio Receiving Tubes," by L. G. Hector, National Union Radio Corporation; March 15, 1946.

"Industrial Applications of Electron Tubes," by E. E. Moyer, General Electric Company; March 15, 1946.

CINCINNATI

"Television Equipment for Guided Missiles," by C. J. Marshall, ATSC Wright Field; March 19, 1946.

CLEVELAND

"Magnetic Recording, Physical Aspects and Recent Developments," by Otto Koreni, Brush Development Company; March 28, 1946.

COLUMBUS

"Experiences of the State Highway Patrol With Frequency Modulation," by A. B. Shirk, State Highway Patrol Radio; February 8, 1946.

CONNECTICUT VALLEY

"CBS Color Television," by Paul Reidy, Columbia Broadcasting System; February 21, 1946.

"Offensive Use of Radar," by D. P. Tucker, United States Navy; March 14, 1946.

DAYTON

"Engineering Education Meets the Challenge," by W. L. Everitt, University of Illinois; March 5, 1946.

"My Impressions of Japan," by G. L. Haller, Aircraft Radio Laboratory; March 5, 1946.

(Continued on page 38A)

magic
with
metals
by
electronic
heat

CALLITE

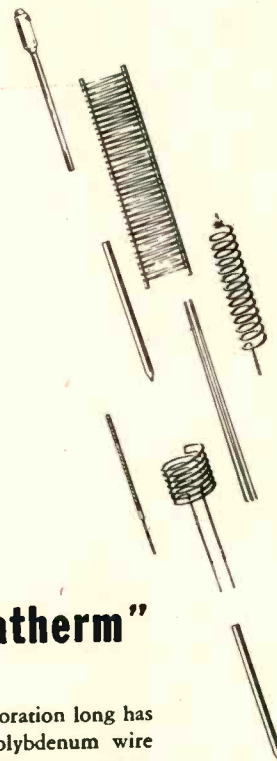

Callite components help Federal make the "Megatherm"

The Federal "Megatherm" Induction Heating Unit is designed to deliver a 25 kw output continuously at frequencies adjustable within a range of 2 to 5 mc. The use of this frequency range makes possible accurate control of heating depth and permits effective and speedy heating, soldering or brazing of brass, copper, aluminum alloys and steel.

The Federal Telephone and Radio Corporation long has relied on Callite for tungsten and molybdenum wire and fabricated parts such as filaments, filament supports, grid side rods, etc.

Callite processes tube components by methods perfected after years of research and experience. Let us cooperate with you. We may be able to save you time and money. Callite Tungsten Corporation, 544 Thirty-ninth St., Union City, N. J. Branch Offices: Chicago, Cleveland.



Callite
Tube components

Hard glass leads, welds, tungsten and molybdenum wire, rod and sheet, formed parts and other components for electron tubes and incandescent lamps.

For FM and TV

NEW ANDREW COAXIAL CABLE WITH
51.5 OHMS IMPEDANCE!

Meets Rigid FM-TV Standards

A new coaxial cable, especially designed for FM and TV use, is now a reality at the Andrew Co. Scheduled for mid-June delivery to the first orders received, these new cables, in 4 sizes, introduce the following important engineering features:

1. Characteristic impedance of 51.5 ohms. (The regular Andrew cables for AM applications have a nominal impedance of 70 ohms.)
2. Connectors and associated fittings have been engineered with special care to avoid reflections and discontinuities. Being completely solderless, these fittings simplify installation and eliminate problems of flux corrosion and pressure leaks.
3. Insulators are spaced 12 inches apart in the 3 large size cables, and 6 inches in the $\frac{7}{8}$ -inch cable.
4. Improved low loss insulation material is used, having a dielectric constant of 6.0 and a maximum loss factor of .004 at 100 mc.
5. Close tolerances have been established on conductor and insulator dimensions, in order to maintain a constant characteristic impedance.
6. Inner and outer conductors are made of copper having a minimum conductivity of 95% IACS at 25° centigrade.

Your order now is the best assurance of early delivery on this new coaxial cable for your FM or TV installation.

Write or wire the Andrew Co., 363 East 75th Street, Chicago 19, Illinois, for complete information or engineering advice on your particular application.

ATTENUATION CURVE

Attenuation is calculated to provide for conductor and insulator loss, including a 10% derating factor to allow for resistance of fittings and for deterioration with time.

- The new 51.5 ohm air insulated coaxial cable for FM and TV comes in 4 sizes, priced tentatively as follows: $\frac{7}{8}$ " , 42c per ft.; $1\frac{1}{8}$ " , 90c per ft.; $3\frac{1}{8}$ " , \$2.15 per ft.; $6\frac{1}{8}$ " , \$5.20 per ft. Andrew Co. also manufactures a complete line of accessories for coaxial cables.

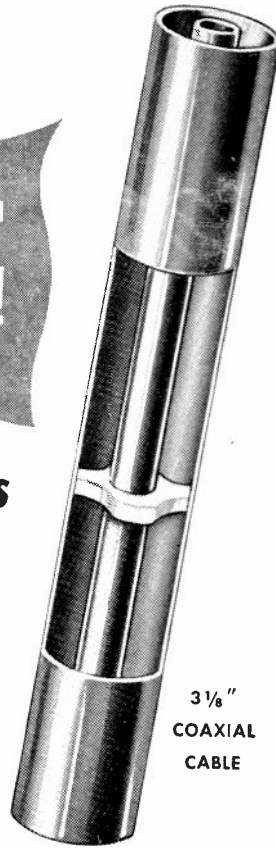
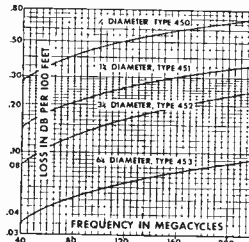

3 1/8" COAXIAL CABLE

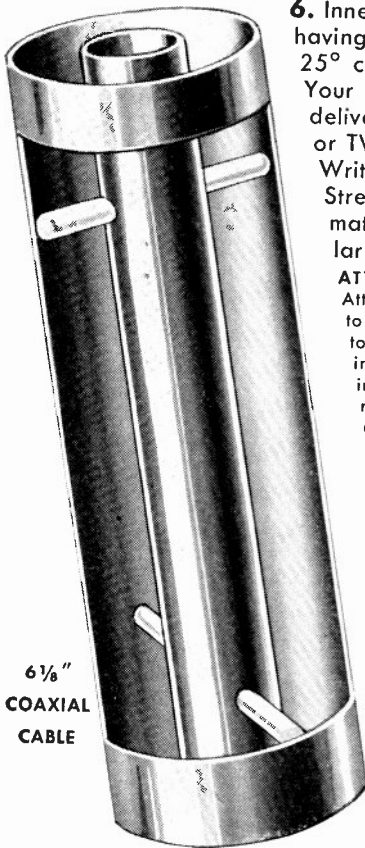

6 1/8" COAXIAL CABLE

ANDREW CO.

363 EAST 75th STREET
CHICAGO 19, ILLINOIS



(Continued from page 36A)

DETROIT

"The Design and Development of an Inter-modulation Test Set," by G. W. Archer, International Detrola Corp.; March 21, 1946.

MONTREAL

"Radio Broadcasting in Canada," by Augustin Frigon, Canadian Broadcasting Corporation; February 27, 1946.

"A Cylindrical Oscillograph," by R. P. Langlois, University of Montreal; March 13, 1946.

"A Compensated Cathode-Ray Tube Using a Nonlinear Time Base," by L. A. Dion, University of Montreal; March 13, 1946.

"Analysis of Multiplex Transmission Systems," by P. H. Lavallee, Laval University; March 13, 1946.

"Automatic Frequency Control for the Very Highs," by Bruce McCaffrey, Queens University; March 13, 1946.

"Radio Microwaves and Radar," by W. H. Doherty, Bell Telephone Laboratories; March 21, 1946.

OTTAWA

"Frequency-Shift Radio Teletype," by J. Mitchell, RCA Victor Company, Ltd.; January 17, 1946.

Demonstration of Captured German Army Equipment by Captain MacDonald, Lt. Cooke, and Sgt. Major Singer, Canadian Army; February 7, 1946.

"Canada's Short-Wave Stations," by R. C. Cahoon and Peder Aylen, Canadian Broadcasting Corporation; March 1, 1946.

"Microwave Antennas," by Keith MacKinnon, Consulting Engineer; March 21, 1946.

PHILADELPHIA

Part I—"Critical Comparison of Continuous Wave, Frequency Modulation, and Pulse Radar," by Irving Wolf, RCA Laboratories; March 7, 1946.

Part II—"Altimeter Developments," by Irving Wolf, RCA Laboratories; March 7, 1946.

PITTSBURGH

"Philco Philadelphia to Washington Television Relay Link," by F. J. Bingley, Philco Radio and Television Corporation; February 11, 1946.

PORTLAND

"Loran System," by Earl Schoenfeld, RCA Laboratories; February 27, 1946.

"Some Aspects of Atomic Energy," by Manuel Holtzman, Manhattan Atomic Bomb Project; March 13, 1946.

ROCHESTER

"Future Significance of Wartime Electronic Developments," by D. G. Fink, Electronics Magazine; March 14, 1946.

(Continued on page 40A)

FOR FM RADIOS

IT'S

ERIE RESISTOR



*Electronic Components
and Products*

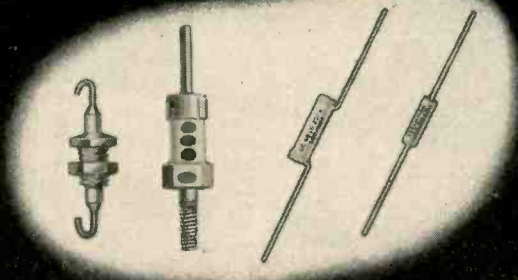

FEED-THRU, STAND-OFF, PIGTAIL CERAMICONS



CINCH-ERIE PLEXICON TUBE SOCKETS
with built-in By-Pass Ceramicons



ERIE BUTTON MICA CONDENSERS

Due to the high operating frequencies of FM, many electrical and mechanical characteristics not ordinarily considered in condensers, become of paramount importance. The most important of these is low inductance, both in leads and in the basic construction of the condensers themselves.

The condensers illustrated on this page fulfill this requirement through simplicity of design and low internal inductance. For by-pass applications, Erie Stand-Off Ceramicons and Erie Feed-Thru Ceramicons are most efficient for carrying off R.F. current to ground. Heavy terminals, with direct connection to ground, reduce external and internal inductance to a minimum. Available capacities, up to 1,000 MMF, are usually sufficient to efficiently by-pass frequencies of 80 MC or higher. Tubular Ceramicons, shown at the top right, have the same internal advantages as the Stand-Off and Feed-Thru type Ceramicons, because of their simplicity of construction, but are provided with regular pigtail leads necessary for many installations where

some moderate lead inductance can be tolerated.

The Cinch-Erie Plexicon Tube Socket, shown in the center photograph, with built-in by-pass Ceramicons, puts the condensers around the tube pins—where they belong. Leads are practically eliminated, and other components can be installed closer to the socket, further increasing efficiency. Any tube pin or groups of pins can be by-passed with condensers having up to 1,000 MMF capacity.

Erie Button Mica Condensers were designed specifically for high frequency work. Ribbon type leads, plus circular design, gives extremely short electrical path-to-ground through the entire area of the condenser. These compact units are available in a number of different mounting styles and in capacity ranges up to .006 mfd.

You can stake your reputation on these condensers for dependable use in tuned circuits, for by-pass applications, or as coupling condensers, in all FM applications. Write for complete details, giving desired operating characteristics.



Electronics Division
ERIE RESISTOR CORP., ERIE, PA.
LONDON, ENGLAND . . . TORONTO, CANADA

How Many Slices in a Loaf of Bread?



It's unimportant unless there aren't enough to go around. When the loaf isn't large enough to feed everyone who asks for a slice, the problem becomes involved. The size of each slice takes on significance.

We, at Stancor, are confronted with a parallel situation. A day never passes that we don't risk offending valued customers by keeping the slices as thin as feasible . . . that everyone may have his fair share.

We know how you feel about this. You need transformers, desperately perhaps, and it's been a long time since Stancor has been able to supply all you want. We're certain, however, that you would not condone a sacrifice of quality for quantity. In a sense, then, you dictate Stancor policy.

Because of our insistence on high standards of quality, production and delivery have never stayed apace with Stancor sales. Today there is a greater gap than ever. We feel you understand the reasons for this, since our current problems are also yours.

Soon, we hope to be able to meet your constantly increasing demands. Meanwhile, there can be no change in the Stancor policy of quality. We know you wouldn't want it any other way.

Jerome J. Kahn
PRESIDENT

STANDARD TRANSFORMER CORPORATION

1500 NORTH HALSTED STREET • CHICAGO 22, ILLINOIS

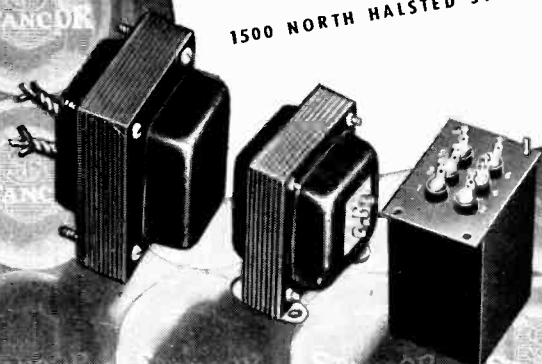

SECTION MEETINGS

(Continued from page 38A)

ST. LOUIS

"Electronic Applications in Aircraft Testing," by I. A. Shepard, Shepard Engineering Company; February 28, 1946.

"Physics of Nuclear Energy," by K. K. Darrow, Bell Telephone Laboratories; March 18, 1946.

"Television. Its Mechanism and Promise," by W. L. Lawrence, RCA-Victor Division; March 28, 1946.

SAN DIEGO

"Pulse-Position-Modulation Radio-Communication Equipment," by J. H. Clark, Southern California Telephone Company; March 5, 1946.

SEATTLE

"Aircraft Instrument-Landing Systems," by V. L. Palmer, University of Washington; February 8, 1946.

"The Loran System of Long-range Navigation," by Earl Schoenfeld, RCA Laboratories; February 28, 1946.

TWIN CITIES

A Three-Beam Oscillograph for Recording at Frequencies Up to 10,000 Megacycles," by G. M. Lee, Central Research Laboratories; March 19, 1946.

WASHINGTON

"Short-Wave Direction Finding," by Henry Busignies, Federal Telecommunications Laboratories; November 12, 1945.

"VT or Radio Proximity Fuse," by Harry Diamond, National Bureau of Standards, and Harner Selvidge, Johns Hopkins University; November 19, 1945.

"Research," by Dr. Kettering, General Motors Company; November 20, 1945.

"Precipitation Static," by Ross Gunn, Joint Army-Navy Precipitation-Static Group; December 10, 1945.

"Microwaves," by W. C. White, General Electric Company; January 8, 1946.

"Very-High-Frequency Wave Propagation, Particularly in the 50-to-100-Megacycle Region," by E. W. Allen, Jr., Federal Communications Commission, and C. W. Carnehan, Zenith Radio Corporation; January 14, 1946.

"Radar Echoes From the Moon," by E. K. Stodola, Evans Signal Laboratories; February 11, 1946.

"The Maximum Range of A Radar Set," by A. C. Omberg, Bendix Aviation Corporation; February 27, 1946.

"Complimentary Diversity Reception on Microwaves," by T. J. Carroll, Office of the Chief Signal Officer; March 11, 1946.

WILLIAMSPORT

"Measurements at Microwave Frequencies," by F. J. Gaffney, Polytechnic Research and Development Company; April 3, 1946.

SUBSECTIONS

PRINCETON

"The Measurement of Thermal Radiation at Microwave Frequencies," by R. H. Dicke, Princeton University; March 13, 1946.

THE IMC ENGINEER IS
On Your Staff-
 BUT NOT ON YOUR PAYROLL

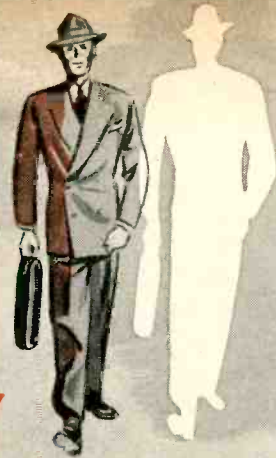

Call him when you need Insulation assistance

A quick summons brings the IMC engineer to your side to give expert consideration and advice on all your most intricate and stubborn electrical insulation problems. He will serve you well . . .

1. Assist in selection of best insulating materials for the specific job. (Note well-known nationally recognized products from which to make selections.)
2. Give instructions as to proper application.
3. Suggest ways to eliminate waste.
4. Speed up and increase your production.

He will welcome your call . . . any time. Phone or write to us or nearest branch office.

IMC PRODUCTS: Macallen Mica Products—Vartex Varnished Cloth and Tapes—Varslot Combination Slot Insulation—Varnished Silk and Paper—Fiberglas Electrical Insulation—Manning Insulating Papers and Pressboards—Dow Corning Silicones—Dieflex Varnished Tubings and Saturated Sleeveings of Cotton and Fiberglas—National Hard Fibre and Fishpaper—Phenolite Bakelite—Adhesive Tapes—Asbestos Woven Tapes and Sleeveings—Cotton Tapes, Webbing, and Sleeveings—Pedigree Insulating Varnishes—Wedgie Brand Wood Wedges.

Representatives in: MILWAUKEE 2: 312 East Wisconsin Avenue
 DETROIT 2: 11341 Woodward Avenue MINNEAPOLIS 3: 1208 Harmon Place
 PEORIA 5: 101 Heinz Court And other cities

INSULATION

MANUFACTURERS CORPORATION

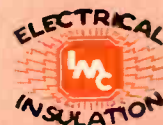

★CHICAGO 6
 565 W. Washing-
 ton Blvd.

★CLEVELAND 14
 1005 Leoder Bldg.



there
is

NO SUBSTITUTE

for good, honest WIRE, unwinding itself
cross-country, through mighty public buildings and
humble cottages, in and out of America's radio sets and
legion other communications units. You are getting some
CORWICO Wire now . . . and more is on the way . . .

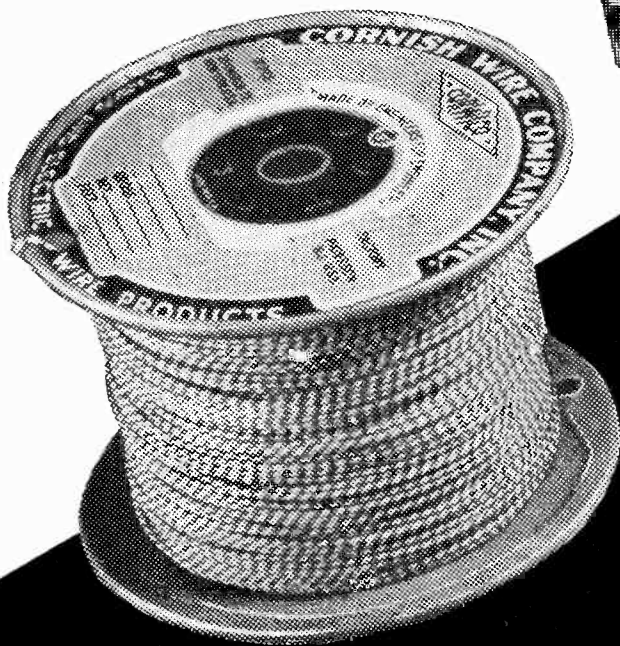

cornish
WIRE COMPANY, INC.

15 Park Row, New York 7, N. Y.

"Made by Engineers for Engineers"



The following transfers and admissions
were approved on April 2, 1946:

Transfer to Senior Member

- Black, L. J., 243-30 St., Oakland 11, Calif.
- Bliss, W. H., 235 Newton Ave., Riverhead, N. Y.
- Brady, F. B., 25 Arnold Pl., Dayton 7, Ohio
- Brunetti, C., National Bureau of Standards, Washington 25, D. C.
- Carnes, W. T., Jr., 2815 W. 68 St., Mission, Kan.
- Cole, R. I., Watson Laboratories, ATSC, Red Bank, N. J.
- Emurian, A. D., 617 W. Sedgwick St., Philadelphia 19, Pa.
- Ferguson, J. C., 1005 W. Packard Ave., Fort Wayne 6, Ind.
- Ferrier, D. T., 1737 Cambridge St., Cambridge, Mass.
- Fisher, B. A., Electrical Engineering Dept., U. S. Naval Academy, Annapolis, Md.
- Frink, F. W., 106 N. Grove St., East Orange, N. J.
- Gannaway, R. R., 411 S. Harvey, Oak Park, Ill.
- Greer, J. W., Code 930A, Electronics Div., Bureau of Ships, Navy Dept., Washington 25, D. C.
- Hansell, G. E., 140 Moriches Rd., Riverhead, N. Y.
- Hucke, H. M., Radio Corporation of America, Camden, N. J.
- Hussey, L. W., 24 Pine Ave., Madison, N. J.
- Kinsell, W. L., 4506 Wilmette St., Fort Wayne 5, Ind.
- Knight, A. R., 1657 Hearthstone Dr., Dayton 10, Ohio
- Koros, L., Echeverria 3368, Buenos Aires, Argentina
- Lowry, L. R., Rumson Rd., Little Silver, N. J.
- Magnuski, H., 2825 Logan Blvd., Chicago 47, Ill.
- Maxwell, D. E., Columbia Broadcasting System, Inc., General Engineering Dept., 485 Madison Ave., New York 22, N. Y.
- Meahl, H. R., Room 461, Bldg. 5, General Electric Co., Schenectady 3, N. Y.
- Morlock, W. J., 3723 N. Denny St., Indianapolis, Ind.
- Mullin, L. A., 25 Applied Science Bldg., Syracuse University, Syracuse 10, N. Y.
- Nottingham, W. B., Massachusetts Institute of Technology, 77 Massachusetts Ave., Cambridge 39, Mass.
- Reichle, W. E., Bell Telephone Laboratories, 180 Varick St., New York, N. Y.
- Rojas, F. R., 14 Sterling Pl., Malverne, N. Y.
- Sanders, E. R., 9407 Garwood St., Silver Spring, Md.
- Scott, E. D., 1103 Trenton Pl., S.E., Washington 20, D. C.
- Taylor, J. H., 243 Linden Ave., Towson 4, Md.

(Continued on page 44A)



You can Start!—Stop!—Reverse!—or
“Keep things moving!”

Alliance Power-pakt motors will do one or all! They'll multiply automatic operations, provide better control, and speed up performance.

Operating characteristics and power ratings are variable. For radio, electronic, electric and heating controls—for remote actuation, continuous and intermittent duty, there's probably an Alliance motor already “built to your order”.

Here Are Just A Few Places:

Electronic and electric controls, time, pressure, temperature and humidity controls, remote actuation controls, radio tuning and turntable drives, coin operated dispensers, fans, valves, blowers, door openers, signals, motion displays, projectors and specialized uses.

ALLIANCE MOTORS are made with centerless ground precision shafts; large, self-aligning, graphite bronze oilless-type bearings; and with adequate mounting facilities to incorporate them in any device. Shaded pole induction type motors for A.C. voltage from 24 to 250, and frequencies of 40, 50 or 60 cycles have starting torques from one-half ounce-inches at 10 watts, to two ounce-inches at 36 watt input. Split phase resistor type, enclosed reversible control motors for intermittent duty, with or without integral gear reduction are made for 60 cycles, 24 or 117 volts. Typical weights run from less than 13 ounces to more than two and one-half pounds.



MINIATURE MOTORS
THAT KEEP 'EM MOVING

WHEN YOU DESIGN—KEEP

alliance

MOTORS IN MIND

ALLIANCE MANUFACTURING COMPANY • ALLIANCE, OHIO

ALLIANCE TOOL AND MOTOR LTD., TORONTO 14, CANADA

At Last!

COAXWITCH

A Selector Switch FOR COAXIAL CIRCUITS...

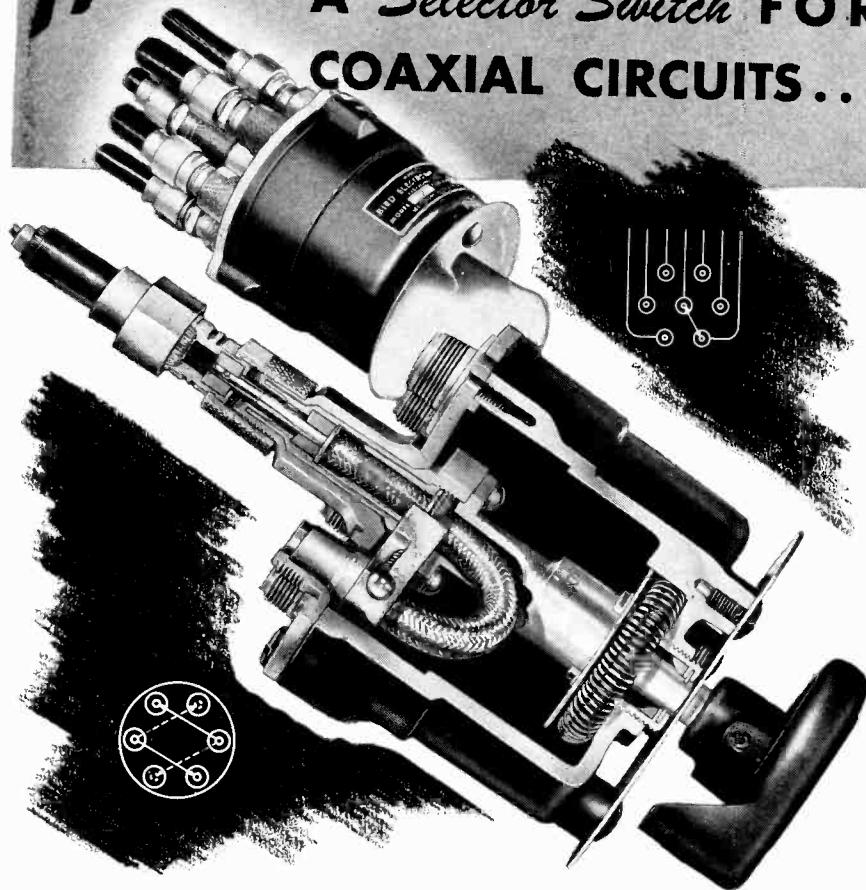

Here's the switch you've been looking for. Now a simple and efficient means of switching coax lines is available in three models. Present Types handle 50-ohm coax at frequencies up to 4000 megacycles. *Characteristic impedance is maintained thru all switch details.*

Application: Selection of antennas, receivers, low power transmitters; Intra-equipment switching in coax links; with phase monitors in directionals; double-ended selection of insertion devices, filters, etc.

Model 74 handles single line with choice of six channels. Model 718 is similar to Model 74 but with 8-channels. Model 72-2 is a double-pole, double-throw type for switching two circuits simultaneously. Other versions of the novel switching action of the COAXWITCH and other impedance levels are under development. If you have a coax switching problem, we can help you. Data sheets are available. Write Bird Electronic Corporation, 1800 East 38th St., Cleveland 14, Ohio, for your copy today.



BIRD ELECTRONIC
Instrumentation for
Coaxial Transmission



(Continued from page 42A)

- Tucker, D. P., 2707 Adams Mill Rd., N.W., Washington 9, D. C.
Upp, C. B., Naval Research Laboratory, Electronics Section, Washington 20, D. C.
Van Ryn, J. C., Woodstock, N. Y.
Watton, A., Jr., TSEPL-6, Propeller Laboratory, Hq. Air Technical Service Command, Wright Field, Dayton, Ohio
Webb, J. S., Electrical Engineering Dept., University of Minnesota, Minneapolis, Minn.

Admission to Senior Member

- Closson, L. E., Philco Corp., C and Tioga Sts., Philadelphia 34, Pa.
Colton, R. B., 927-15 St., N.W., Washington, D. C.
Dennis, J. L., 2 Parran Dr., Dayton 10, Ohio
Goddard, C. T., 1626 River St., Belmar, N. J.
Guarino, P. A., 3578 W. 130 St., Cleveland, Ohio
Hamlett, R. T., 339 Park Ave., Manhasset, L. I., N. Y.
Hessler, V. P., Electrical Engineering Dept., University of Kansas, Lawrence, Kan.
Hubbard, M. M., 15 Waldron Court, Marblehead, Mass.
Hunter, P. B., 136 Hillside Ave., Metuchen, N. J.
Knowlton, A. D., 9 Bedford Rd., Summit, N. J.
Lacy, R. E., 95 East River Rd., Rumson, N. J.
Lammers, E. S., Jr., Westinghouse Electric Corp., Box 4808, Atlanta, Ga.
Lewyt, A. M., 60 Broadway, Brooklyn, N. Y.
McMillan, E. B., 30 Avon St., Wakefield, Mass.
Plamondon, A. D., Jr., 6 N. Michigan Ave., Chicago 2, Ill.
Schrenk, M. H., 2618-32 St., S.E., Washington 20, D. C.
Thwaites, J. T., 111 Leinster Ave. S. Hamilton, Ont., Canada
Trotter, H., Jr., 357 Cobbs Hill Dr., Rochester 10, N. Y.

Transfer to Member

- Beers, Y., 8 Gorham St., Cambridge 38, Mass.
Belleville, L. M., RFD 14, Box 800, Portland 16, Ore.
Benner, H. J., 75 Riverview Ave., Longmeadow 6, Mass.
Bonadies, V. J., 28 Hillcrest Terrace, East Orange, N. J.
Bosman, E. H., 54-14-254 St., Little Neck, L. I., N. Y.
Cary, T. R., Jr., 13 Pleasant St., South Weymouth 90, Mass.
Curtis, C. T., 10 Agassiz St., Cambridge, Mass.
Denton, A. D., 52A High Rd., Bushey Heath, Herts, England

(Continued on page 46A)



MN-62A

THE **NEW** NA-1 AIRCRAFT NAVIGATIONAL SYSTEM

*Latest addition to the already famous
Bendix Radio Compass Line*

A new example of Bendix Radio Creative Engineering—The NA-1 System furnishes automatic visual bearings and simultaneous aural reception of cw, mcw or voice signals in the range 100-1750 kc. It also serves as a low frequency range receiver, or manual direction finder, and operates on a straight wire antenna or static reducing loop throughout its frequency range.

The MN-62A Radio Compass Receiver is designed for operation with r.f. transmission lines up to 30 feet in length, for flexibility in location of loop and sense antenna. All receiver and loop control circuits are included in a single case. The receiver operates from a primary power supply of 115 V., 400 cycles a.c. and 28 V. d.c.

The MN-60A Iron Core Loop—Small, streamlined, is ideal for highspeed craft. It increases payload of aircraft by reducing air-drag.

All functions of the NA-1 System are controlled with the type MN-63A Remote Control Unit, or with custom-built controls designed for specific overall systems and types of airplanes. Bendix Radio specializes in the design of such consolidated control assemblies.

Bearing indicators are available in several types and sizes for either a single or dual compass system. All components of the NA-1 System are built to the same rigid specifications that have made Bendix the Greatest Name in Aircraft Radio. They bear CAA type certification for scheduled airline operation.

For full information, write to Sales Department
BENDIX RADIO DIVISION • BALTIMORE 4, MARYLAND



MN-60A



MN-63A



MN-37



STANDARD FOR THE AVIATION INDUSTRY

THE *Individual* TOUCH



• Every magnet individually tested in loud speaker structure before shipping . . .

• Every magnet meets R. M. A. proposed standards . . .

• Every magnet meets Arnold's minimum passing standards of 4,500,000 BHmax.

Here's what the individual touch means. Thousands of the nine different sizes of speaker magnets shown at right are now being turned out daily. Each one is individually tested in a loud speaker structure before shipping. Each magnet is made to meet R. M. A. proposed standard for the industry. Each magnet must meet Arnold's own minimum passing standard of 4,500,000 BHmax for Alnico V material. Thus by careful attention to the important "individual touch" in volume production can Arnold promise you top quality in each individual magnet you select.

THE ARNOLD ENGINEERING COMPANY

147 EAST ONTARIO STREET, CHICAGO 11, ILLINOIS
Specialists in the Manufacture of ALNICO PERMANENT MAGNETS



(Continued from page 44A)

- Dickerson, B. C., 904 Raleigh Ave., Norfolk 7, Va.
 Dlouhy, F. W., 6 Peter Circle, Cranford, N. J.
 Dunn, H. C., Hoyclo Rd., Stamford, Conn.
 Dunn, J. E., Anwell Rd., RFD 1, Belle Mead, N. J.
 Eames, A. M., Jr., General Radio Co., 275 Massachusetts Avenue, Cambridge 39, Mass.
 Evans, C. P., 134 Dracena Ave., Piedmont 11, Calif.
 Freiermuth, V. J., 140 New Montgomery St., San Francisco 5, Calif.
 Gilfilen, L. J., 133 Nimitz Dr., Dayton 3, Ohio
 Granberry, D. S., Western Electric Co., 403 Hudson St., New York 14, N. Y.
 Hagler, D. L., Physical Research Unit, Boeing Aircraft, Seattle 14, Wash.
 Harris, L., 140 E. Second St., Brooklyn 18, N. Y.
 Holtzman, M., 1431 S.W. Park Ave., Portland, Ore.
 Huber, W. A., 50 W. Sylvania Ave., Neptune City, N. J.
 Hurrell, L. W., 3 Havelock St., Wellington S.W. 1, New Zealand
 Ives, G. M., 4221 Arthur Ave., Brookfield, Ill.
 Jaeger, J. H., Ohio Bell Telephone Co., 42 E. Gay St., Columbus 15, Ohio
 Jorysz, A., 8502 Fort Hamilton Pkwy., Brooklyn 9, N. Y.
 Kleinhofer, B. A., 428 W. Wharton Rd., Glenside, Pa.
 Kuhn, H. G., 211 Frankhauser Rd., Williamsville 21, N. Y.
 Leaver, E. W., 215 College St., Toronto, Ont., Canada
 Lehnhoff, R. G., 322 Joselin Ave., Cincinnati 20, Ohio
 Leslie, F. E., 596 Mitchell Ave., Elmhurst, Ill.
 Lutes, R. K., 210 Kansas St., Belleville, Ill.
 Marshall, J. L., Canadian Broadcasting Corp., 1440 St. Catherine St. W., Montreal 25, Que., Canada
 McCorvey, V. A., 1302-B St., Belmar, N. J.
 McGaughey, J. R., 1569 Catalina Blvd., San Diego 7, Calif.
 Metzger, S., 315 E. 88 St., New York 28, N. Y.
 Montgomery, D. J., Palmer Physical Laboratory, Princeton, N. J.
 Moseley, T. B., 3441 Amherst St., Dallas 11, Tex.
 Myers, H. W., National Union Radio Corp., Plane St. and Raymond Blvd., Newark, N. J.
 Norman, R. O., Officer's Mess, RCAF Station, Pennfield Ridge, N.B., Canada
 Peavey, E. A., NAB Communications, Naval Air Station, Seattle 5, Wash.
 Podolsky, L., 18 Lexington Pkwy., Pittsfield, Mass.

(Continued on page 52A)



LABORATORY INSTRUMENTS FOR SPEED AND ACCURACY

A New -hp- AF Oscillator

MODEL 201B

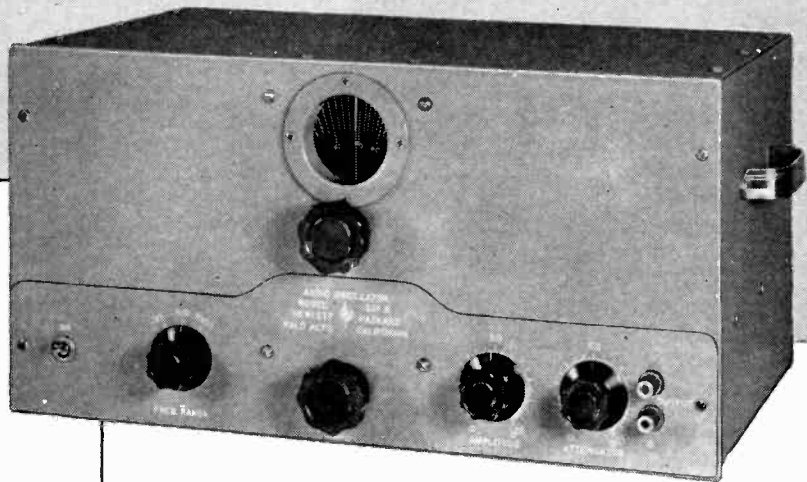

OUTSTANDING NEW FEATURES

3 Watts Output

Distortion Less Than 1/2 of 1%

Low Hum Level

New Dial With Ball-Bearing Drive

Accurate Expanded Frequency
Calibration

Improved Control of Output Level

In FM and other fields where high fidelity is important, this new -hp- Model 201B Audio Frequency Oscillator will meet every requirement for speed, ease of operation, accuracy and purity of wave form. The product of 6 years of -hp- oscillator development, this new oscillator has many brand new features, in addition to the revolutionary resistance-tuned circuit which has made -hp- a byword in engineering circles.

The 201B has an accurate, convenient method of frequency control. The 6" dial, with smooth ball-bearing action, may be tuned by a directly controlled knob, or for still greater accuracy, may be set by the vernier which has a ratio of 6 to 1 to the main dial. The illuminated main dial is designed so that parallax is eliminated. It is calibrated over 300 degrees with approximately 95 calibration points and has an effective scale length of about 47 inches. The frequency range is 20 cps to 20 kc.

The amplifier delivers up to 3 watts of power into a 600 ohm resistance load, with distortion held to 1%. Thus there is sufficient power available for driving almost any kind of laboratory

or production equipment. Harmonic distortion may be kept to less than 1/2 of 1%, if the output of the amplifier is limited to 1 watt.

Another important feature of this oscillator is the provision which is made for standardizing each frequency range against a reliable standard, such as -hp's- Model 100B Secondary Frequency Standard. By standardizing the instrument regularly, frequencies can be depended upon to be better than 1% accurate.

A new departure in oscillator design is the dual method for controlling output level. A volume control which is ahead of the amplifier controls the voltage at which the amplifier operates. An output attenuator is provided to attenuate the signal delivered by the amplifier. Attenuation is approximately linear from zero to 40 DB. Both hum level and output voltage are thus attenuated together. As a result, hum level may be kept 60 DB or more below the signal level, a special advantage in cases where small test signals are used.

The impedance looking back into the out circuit is about 50 ohms; thus the voltage regulation for varying loads is extremely good. For measurements where it is desirable to have impedance looking back into the instrument of 600 ohms, as in transmission measurements, the attenuator may be used to give about 6 DB or more of attenuation, making the reflected impedance of the instrument about 600 ohms.

Care has been taken to perfect every detail of this new oscillator. Improved chassis layout and placement of component parts minimizes thermal drift. The voltage on the oscillator is maintained constant with an electronic voltage regulator. The entire instrument is characterized by greater mechanical rigidity; the tuning assembly is mounted on a sturdy cast aluminum frame. The chassis itself is made of aluminum; the oscillator is light in weight and easy to handle. Write today for latest data, prices and delivery information on this versatile, accurate resistance-tuned oscillator.

HEWLETT-PACKARD COMPANY

BOX 1158D • STATION A • PALO ALTO, CALIFORNIA



Audio Frequency Oscillators

Noise and Distortion Analyzers

Square Wave Generators

Signal Generators

Wave Analyzers

Frequency Standards

Vacuum Tube Voltmeters

Frequency Meters

Attenuators

Electronic Tachometers

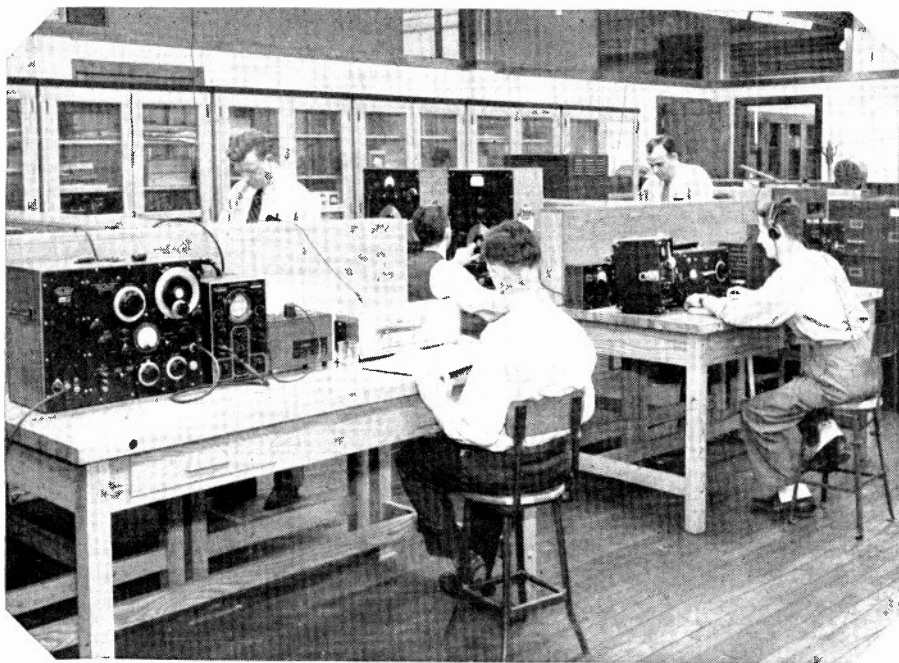

Clearing House FOR IDEAS

● Though little publicized, Astatic's large staff of research engineers and laboratory technicians are indispensable factors in Astatic's continued march forward. Their domain, recently enlarged and elaborately equipped, is at one and the same time both birthplace and clearing house for ideas. The practical application of new discoveries as they may be utilized in the improvement of sound pickup and reproduction devices, is in their hands. Theirs is the responsibility for the development of new designs, the adaptation of new principles or the use of new materials . . . constant, unending research that keeps Astatic Microphones, Phonograph Pickups, Cartridges and Recording Heads not alone abreast of the times, but, as is so often the case, a step or two ahead.

THE
Astatic
ASTATIC CORPORATION
CONNEAUT, OHIO
IN CANADA: CANADIAN ASTATIC LTD., TORONTO, ONTARIO

★ ★ ★ Positions Wanted By Armed Forces Veterans

In order to give a reasonably equal opportunity to all applicants, and to avoid overcrowding of the corresponding column, the following rules have been adopted:

The Institute publishes free of charge notices of positions wanted by I.R.E. members who are now in the Service or have received an honorable discharge within a period of one year. Such notices should not have more than five lines. They may be inserted only after a lapse of one month or more following a previous insertion, and the maximum number of insertions is three per year. The Institute necessarily reserves the right to decline any announcement without assignment of reason.

SALES ENGINEER

Age 25, B.S. in Commerce and A.S.T.P. in E.E. Desire position in the electrical industry. Sales and laboratory experience. Box 12W.

PART TIME WORK

Desire part time while completing MEE, permanent after June, 1947. Age 23, married. Two years design, production experience on radar. Navy RT instructor. Available June. East Coast. Box 13W.

SALES ENGINEER TRAINEE

MIT-Harvard trained electronics-radar officer, AAF, B.S., age 27, married. Experienced test engineer, electronic equipment. In service field, supervised men in installation and maintenance of all airborne navigational aids and high altitude microwave bombing equipment and computers. R. I. Gaines, 29 Wadsworth Ave., New York 33, N.Y.

EXECUTIVE'S ASSISTANT

M.S., secretary-stenographer, age 28. Four years electronic experience. Will work in New York City or environs. Box 14W.

RADIO ENGINEER

B.S. E.E., Purdue University. Age 26, married. Four years experience design, development, production, test and installation of electronic and microwave equipment. Box 6W.

EXECUTIVE ASSISTANT

M.I.T. trained electronics-radar officer, AAF. 26 years old, married. B.A., M.S. degrees Industrial Management. Experienced in supervision Loran, GCA, microwave equipment; also public accounting, budgets, costs. Available March. Box 7W.

ELECTRONICS TECHNICIAN

Age 25, married. Desires electronics research position preferable in Los Angeles area. B.S.; First Phone license; experience in broadcast, radar, and teaching. Author articles in RADIO and QST. E. M. McCormick, 3455 Lemon St., Riverside, Calif.

BROADCAST AND COMMUNICATIONS ENGINEER

Pre-war resident in Middle East now serving Royal Air Force and employed by Forces Broadcasting Service (M.E.) in search of congenial, responsible position anywhere in world beginning winter 1946-47. Familiar aircraft radio installations and conventional equipment. Offers to BM/ZC6, London W. C. 1, England.

When insulator design calls for *Quick Action*

DEPEND ON

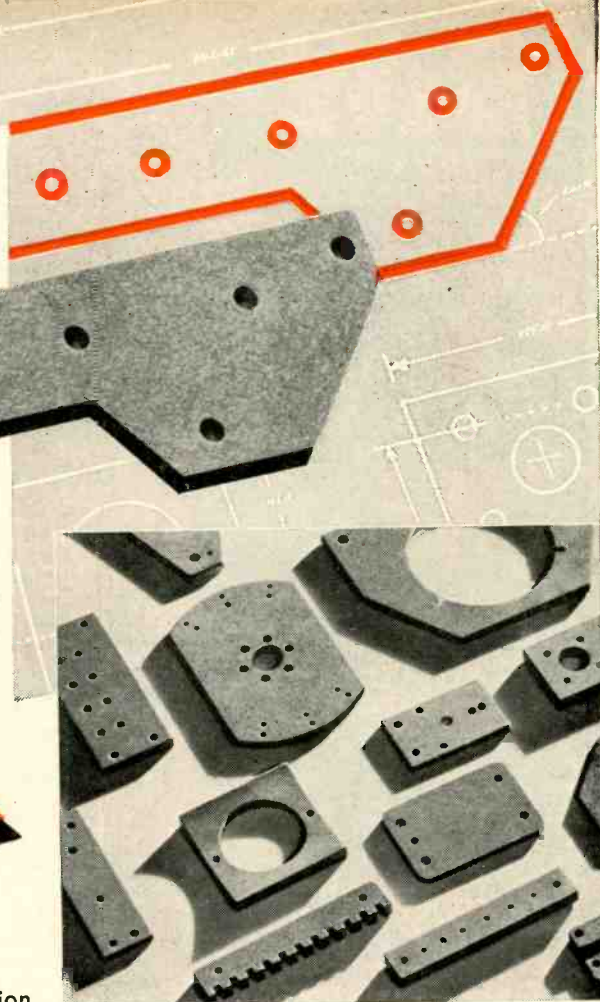

When time is of the utmost importance the ease and precision with which Mykroy can be fabricated into insulator parts makes it exceptionally useful to electronic and electrical engineers. Make those design changes on the spot . . . make them quickly and economically with Mykroy, for, here is a ceramic which can be worked in your own shop. Just transfer your design to the Mykroy sheet . . . then using conventional shop tools . . . produce the desired part by simple cutting, grinding, drilling, tapping and polishing techniques.

Because it has high structural strength and physical stability Mykroy can be machined to critical tolerances more readily than other types of ceramics. In addition, its electrical characteristics are of the highest order and do not shift under any conditions short of actual destruction of the insulation itself. This, plus excellent chemical and physical properties, makes it one of the best insulating materials ever developed for general and high frequency applications.

Get the full facts about this versatile dielectric now. Ask for a copy of the new MYKROY BULLETIN 102 which describes the new larger (19 1/4" x 29 3/4") sheet now available and call upon our engineers to help with your problems.



A representative group of parts fabricated in Mykroy to customer's specifications in our own plant. We have complete facilities to produce such parts in any quantities on rapid delivery schedules. Send us your specifications.

MECHANICAL PROPERTIES*

| | |
|--|----------------------------|
| MODULUS OF RUPTURE..... | 18000-21000psi |
| HARDNESS | |
| Mohs Scale 3-4 BHN. BHN 500 K9 Load. | 63-74 |
| IMPACT STRENGTH.....ASTM Charpy .34-.41 ft. lbs. | |
| COMPRESSION STRENGTH..... | 42000 psi |
| SPECIFIC GRAVITY..... | 2.75-3.8 |
| THERMAL EXPANSION..... | .000006 per Degree Fahr. |
| APPEARANCE..... | Brownish Grey to Light Tan |

ELECTRICAL PROPERTIES*

| | |
|---------------------------------|---------------------------|
| DIELECTRIC CONSTANT..... | 6.5-7 |
| DIELECTRIC STRENGTH (1/8")..... | 630 Volts per Mil |
| POWER FACTOR..... | .001-.002 (Meets AWS L-4) |

*THESE VALUES COVER THE VARIOUS GRADES OF MYKROY

- GRADE 8. Best for low loss requirements.
 - GRADE 38. Best for low loss combined with high mechanical strength.
 - GRADE 51. Best for molding applications.
- Special formulas compounded for special requirements.

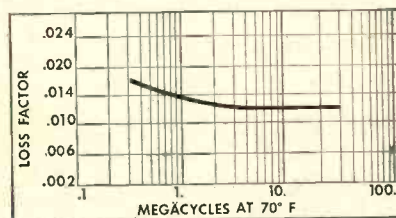

Based on Power Factor Measurements made by Boonton Radio Corp. on standard Mykroy stock.

MADE EXCLUSIVELY BY

ELECTRONIC MECHANICS INC.

70 CLIFTON BLVD., CLIFTON, N. J.
 CHICAGO 47; 1917 N. Springfield Ave., Tel. Albany 4310
 EXPORT OFFICE: 89 Broad Street, New York 4, New York

MYKROY IS SUPPLIED IN SHEETS AND RODS — MACHINED OR MOLDED TO SPECIFICATIONS



Plug-in Type AIR-WOUND INDUCTORS

No other type of coil can equal B & W AIR Inductors for all-around efficiency. AIR WOUND Inductors are lighter, easier to tap, wound to uniform pitch, have exceptionally low dielectric loss (no winding form in coil field) and are extremely durable. There is little about them to break if dropped. Even if bent completely out of shape, they can easily be repaired. B & W types include standard, fixed and swinging link assemblies in sizes and ratings for almost any application. Write for catalog.

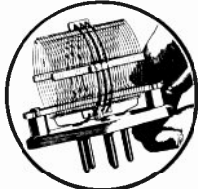

WE'LL MATCH ANY INDUCTOR REQUIREMENT



BARKER & WILLIAMSON

Dept. IR-56, 235 Fairfield Avenue
Upper Darby, Penna.



The following positions of interest to I.R.E. members have been reported as open. Apply in writing, addressing reply to company mentioned or to Box No. . . .

The Institute reserves the right to refuse any announcement without giving a reason for the refusal.

PROCEEDINGS of the I.R.E.
330 West 42nd Street, New York 18, N.Y.

EXECUTIVE ELECTRONICS ENGINEER

At once by Connecticut manufacturer who is fast moving into the realms of larger business—must be an engineering school graduate; experienced in radio, electronics, and electricity; must have administrative experience and stature; must have product and production evaluation knowledge; must get along with an energetic, independent organization. Write all details in first letter; salary expected; recent picture. Box No. 415.

APPLIED PHYSICISTS, COMMUNICATION AND ELECTRONICS ENGINEERS

Research minded with good theoretical background to engage in research in aeronautical science, advanced degrees preferred. Salary commensurate with qualifications. Address replies to Cornell Aeronautical Laboratory, Personnel Office, Box 56, Buffalo 5, N.Y. Replies will be held in strict confidence.

ACOUSTICAL ENGINEER

Primarily in the field of architectural acoustics, who is qualified to determine the acoustical properties of broadcasting and recording studios and to develop new methods and equipment for the measurement of these characteristics. A working knowledge of the acoustical problems associated with microphones and loudspeakers is also necessary.

Applications and requests for interviews should be made in writing to W. B. Lodge, Director of Engineering, Columbia Broadcasting System, Inc., New York 22, N.Y.

Remler Appointed Agent for WAR ASSETS CORPORATION

(Under Contract No. 59A-3-48)

. . . to handle and sell a
wide variety of

ELECTRONIC EQUIPMENT

released for civilian use

Write for Bulletin Z-7C

Remler Company Ltd.
2101 Bryant St.
San Francisco 10, Calif.

REMLER

SINCE 1918

Radio • Communications
Electronics

We will be grateful if
you will mention Proc-
ceedings of the IRE
when writing to our ad-
vertisers.

WANTED Loudspeaker Design Engineer

Large electronic equipment manufacturer located in the East with extensive research development and design facilities has opening for an experienced Loudspeaker Design Engineer capable of designing quality equipment. Permanent position with opportunities for advancement. Salary commensurate with past experience and ability.

Box 414

THE INSTITUTE OF RADIO ENGINEERS
330 WEST 42ND STREET, NEW YORK 18, N.Y.

KAAR *INSTANT HEATING* MOBILE FM



Now available! An FM Radiotelephone with a truly **NATURAL** voice quality!

New KAAR FM radiotelephones offer an improvement in tone quality which is surprising to anyone who has had previous experience with mobile FM equipment. The over-all audio frequency response through the KAAR transmitter and receiver is actually within plus or minus 5 decibels from 200 to 3500 cycles! (See graph below.) This results in vastly better voice quality, and greatly improved intelligibility. In fact, there is appreciable improvement even when the FM-39X receiver or one of the KAAR FM transmitters is employed in a composite installation.

KAAR FM transmitters are equipped with instant-heating tubes, thus making it practical to operate these 50 and 100 watt units from the standard 6 volt ignition battery without changing the generator. Inasmuch as standby current is zero, in typical emergency service the KAAR FM-50X (50 watts) uses only 4% of the battery current required for conventional 30 watt transmitters. Battery drain for the KAAR FM-100X (100 watts) is comparably low.

For full information on new KAAR FM radiotelephones, write today for Bulletin No. 24A-46.

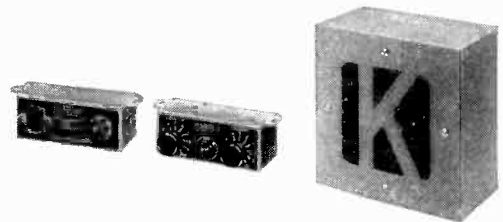

KAAR LOUD SPEAKER, remote controls for transmitter and receiver (illustrated above) and the famous Type 4-C push-to-talk microphone are among the accessories furnished with the equipment.

IMPROVED OVER-ALL FREQUENCY RESPONSE THROUGH KAAR FM TRANSMITTER AND RECEIVER

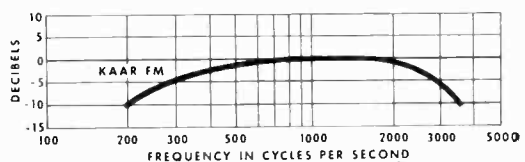

KAAR ENGINEERING CO.
PALO ALTO • CALIFORNIA





An Announcement To Those Who Require The Best

THIS advertisement is addressed to the manufacturers of electronic equipment whose product demands the best in component parts—who will want the best in transformers, if “the best” is offered at a price that will fit the cost specifications of their finished product.

By adapting to peace-time use the major features of the Hermetically-Sealed transformer construction that won war-time leadership, Chicago Transformer is prepared to provide the best in transformers to those who require them. Fully developed basic mounting parts, when utilized on a mass production basis, will provide the element of economy in manufacture.

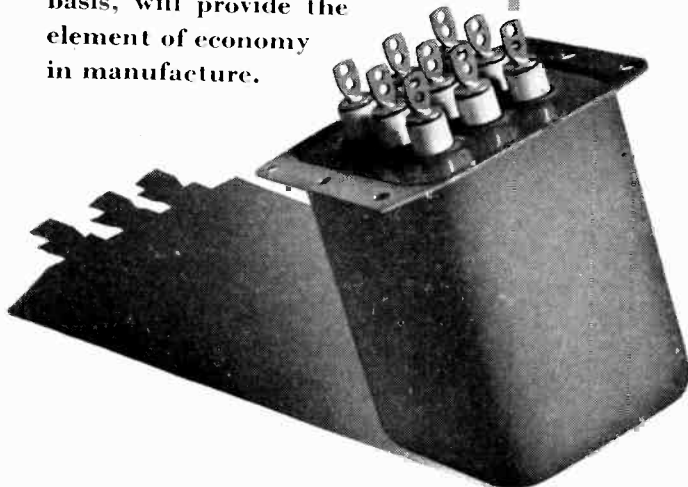

CHICAGO TRANSFORMER

DIVISION OF ESSEX WIRE CORPORATION

3501 WEST ADDISON STREET

CHICAGO, 18



(Continued from page 46A)

- Russell, D. C., 5555 Sheridan Rd., Chicago 40, Ill.
 Ruze, J., Box 95, Belmar, N. J.
 Scalbom, J. D., 109 Smithwood Ave., Catonsville 28, Md.
 Small, B. I., 30 Wendell St., Cambridge 38, Mass.
 Small, F. R., 63 Kendall Ave., Maplewood, N. J.
 Smith, M. S., 2042 Linn Blvd., S.E., Cedar Rapids, Iowa
 Starr, J. O., RFD 1, Camp Ave., Darien, Conn.
 Suydam, C. H., 451 Heywood Ave., Orange, N. J.
 Symonds, G. W., 4208 Belvieu Ave., Baltimore 15, Md.
 Tarkoff, P. B., 4024 Garrison Blvd., Baltimore 15, Md.
 Willson, J. E., 1002 Lombardy Dr., South Bend 21, Ind.
 Wood, J. O., 15 Stoddard Rd., Hingham, Mass.
 Wulfsberg, A. H., 1412 Third Ave., S.E., Cedar Rapids, Iowa
 Young, P. G., Box 2529, Phoenix, Ariz.

Admission to Member

- Aitken, R. A., 2012 Glenwood Rd., Brooklyn 10, N. Y.
 Alsop, S. E., Dept. 943, Electronics Div., Northern Electric Co., 1261 Shearer St., Montreal, Que., Canada
 Aurell, C. G. P., Telefonaktiebolaget L. M. Ericsson, Stockholm 32, Sweden
 Bain, D., RCA Victor Div., 445 N. Lake Shore Dr., Chicago 11, Ill.
 Baker, G. M. K., RCA Laboratories Div., Radio Corporation of America, Princeton, N. J.
 Barker, C. B., II, 205 Mt. Auburn, Cambridge 38, Mass.
 Bell, J. W., Box 37, Market St., Georgetown, Ont., Canada
 Bethel, C. D., Jr., Mackay Radio and Telegraph Co., Inc., 67 Broad St., New York 4, N. Y.
 Bohnert, J. I., 19 Shepard St., Cambridge Mass.
 Brandt, M. M., 532 Merion Ave., Haddonfield, N. J.
 Brickler, J. B., 1216 Kumler Ave., Dayton 7, Ohio
 Caplan, N., Lakeside Apts., Melrose Park, Pa.
 Chance, B., Radiation Laboratory, Massachusetts Institute of Technology, Cambridge, Mass.
 Christensen, H., Aircraft Radio Corp., Boonton, N. J.
 Cutten, H., 17, Beech Ave., Crews Hills, Enfield, Middlesex, England
 Davis, W. L., Ohio State University, Electrical Engineering Dept., Columbus 10, Ohio
 Delort, R., 1467 Girard St. N.W., Washington, D. C.
 Dentler, C. E., 10 Lancaster St., Cambridge 40, Mass.
 Dungan, M. R., Bell Telephone Laboratories, Whippany, N. J.

(Continued on page 54A)

NO CROWDING, PLEASE!

Everyone can see!



DU MONT
15AP4
 offers a picture
9" x 12"
PLUS

► **BIG NEWS!** A large screen television receiving tube with all the advantages of direct viewing — high picture definition and more than adequate brightness for demonstrating under usual showroom lighting conditions. Measures only 20 inches long to permit graceful cabinet design.

OTHER IMPORTANT FEATURES . . .

1. Essentially flat face
2. 7.5 — 10 KV anode supply
3. All-magnetic deflection and focusing
4. No ion trap

LET DU MONT'S REPRESENTATIVE PROVE THIS IS YOUR "BEST BUY!"

ALLEN B. DU MONT LABORATORIES, INC.

DU MONT Precision Electronics & Television

ALLEN B. DU MONT LABORATORIES, INC., PASSAIC, NEW JERSEY • CABLE ADDRESS: ALBEEDU, PASSAIC, N. J., U. S. A.

A Ballantine ELECTRONIC VOLTMETER

For every requirement

ALL MODELS HAVE THE
SIMPLIFIED
LOGARITHMIC
SCALE

STANDARD
Model 300

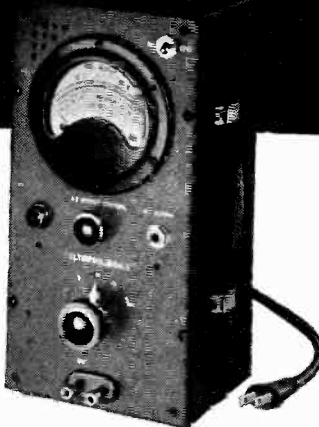

Ideal for the *Accurate* measurement of AC voltages in the Audio, Supersonic, Carrier Current and Television ranges.

Use of Logarithmic voltage scale assures uniform accuracy of reading over whole scale while permitting range switching in decade steps.

Each Voltmeter equipped with an output jack so that the instruments can be used as a high-gain stable amplifier.

SPECIFICATIONS

MODEL 300

RANGE—.001 to 100 volts.
FREQUENCY—10 to 150,000 cycles.
ACCURACY—2% at any point on scale.
AC OPERATION—110-120 volts.

MODEL 304

RANGE—.001 to 100 volts.
FREQUENCY—30 c.p.s. to 5.5 megacycles.
ACCURACY—0.5 DB.
AC OPERATION—110-120 volts.

MODEL 302

RANGE—.001 to 100 volts
FREQUENCY—5 to 150,000 cycles.
ACCURACY—2% at any point on scale.
DC OPERATION—self-contained batteries.

Send for Bulletin for further description



Model 304
R-F
VOLTMETER

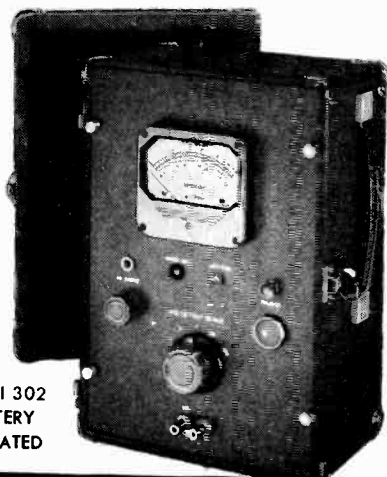

Model 302
BATTERY
OPERATED

BALLANTINE LABORATORIES, INC.

BOONTON, NEW JERSEY, U. S. A.



(Continued from page 52A)

- Eckhardt, D. L., 35 Lakewood Rd., Newton Highlands, 61, Mass.
Goldsmith, A., 519 Cornelia Ave., Chicago 13, Ill.
Graul, D. P., Watson Laboratories, ATSC, Red Bank, N. J.
Gregory, J. H., Research and Development, Nots., Inyokern, Calif.
Groom, B., The Hollies, Galashiels, Scotland
Heagy, M. S., Peddie School, Hightstown, N. J.
Heibel, J. D., 4217 Trask Ave., Erie, Pa.
Higgins, W. H. C., 61 Whittingham Pl., West Orange, N. J.
Hsu, Y., Moore School of Electrical Engineering, University of Pennsylvania, 200 S. Walnut St., Philadelphia 4, Pa.
Johnson, J. R., Jr., Mount Arlington, N. J.
Knauss, H. P., 42 Richardson Rd., Belmont 78, Mass.
Kraepelien, H. Y., Ericsson Telephone Sales Corp., 101 Park Ave., New York 17, N. Y.
Levine, R., 140 E. 52 St., New York 22, N. Y.
Luck, D. G. C., RCA Laboratories, Princeton, N. J.
Lynch, W. M., 4 E 70 St., New York 21, N. Y.
Martin, E. J., Box 1076, Schenectady 1, N. Y.
Martin, W. S., 1632 N. Halsted St., Chicago 14, Ill.
Mautner, L., 103 Rhoda Ave., Nutley, N. J.
McCandless, J. B., 6009 Belden St., Philadelphia 24, Pa.
McGee, K., Williamsville, Ill.
McLean, M. D., 2320 Lincoln Ave., Montreal, Que., Canada
McProud, C. G., 90 Bank St., New York 14, N. Y.
Meadow, W. L., 167 N.W. 38 St., Miami 37, Fla.
Miller, J. W., Research Dept. Laboratory, Stanolind Oil and Gas Co., Tulsa, Okla.
Morawetz, F., 103-26-68 Rd., Forest Hills, L. I., N. Y.
Musselman, F. I., 2341 Lorne St., Regina, Sask., Canada
Olds, O. S., 2340 S. 60 St., Milwaukee 14, Wis.
Olson, R. W., 323 Circle Dr., Dallas 16, Tex.
Oorthuys, H. J., University of California, Div. of War Research, Navy Electronics Laboratory, San Diego 52, Calif.
Plummer, J. H., Owens Illinois Glass Co., 1700 Westwood Ave., Toledo, Ohio
Quinn, R. B., 3221 Wheeler Rd. S.E., Washington 20, D. C.
Reed, R. I., 617 McClellan St., Schenectady, N. Y.
Rothman, M. I., 76 Lewis St., Eatontown, N. J.
Schoenfeld, M., 817 Meehan Ave., Far Rockaway, L. I., N. Y.

(Continued on page 56A)



Collins 26W-1 Limiting Amplifier

Collins Speech Equipment

provides better program transmission and stronger signals

THE COLLINS 26W-1 audio limiting amplifier is a product of the most advanced standards of broadcast engineering. It effectively raises the modulation level, yet prevents overmodulation of the r-f carrier. The resulting stronger signal assists materially in station area coverage.

Developed for high fidelity AM and FM applications, the 26W-1 has a frequency response flat from 30-15,000 cps, with a variation of less than 1.0 db. The compression ratio above the verge of compression is 20/1 in db. Harmonic and tone distortion are not more than 1.5% at any frequency, any setting of the input and output levels, and with any amount of compression up to 15 db. Hum and noise are 70 db below the operating level. Output range is -4 to +26 dbm.

Complete metering provides measuring facilities for individual tube currents, plate volt-

age, compression level, and output level. Inside-out chassis construction gives immediate access to all wiring and circuit components upon removal of the slip-on dust cover. Operate and release times are independently adjustable.

Dimensions, for standard rack mounting, 19" w, 14" h, 9" d. Weight, 45 pounds. Available in metallic gray or black wrinkle.

Collins speech equipment is thoroughly engineered for highest performance. Reliable in operation, accessible in maintenance, each unit meets rigid inspection and tests before it is approved for delivery. For your requirements, write today to the Collins Radio Company, Cedar Rapids, Iowa; 11 West 42nd Street, New York 18, N. Y.

FOR BROADCAST QUALITY, IT'S . . .



ALLOY-WIRE-RIBBON

WIRE & RIBBON
for
VACUUM TUBE
FILAMENTS & GRIDS

● Many sizes and alloys for a range of applications such as miniature tubes, hearing aid tubes, low-current-drain battery tubes, receiving tubes . . .

● Melted and worked to assure maximum uniformity and strength. WIRES drawn to .0004" diameter; RIBBON rolled to .0001" thickness . . .

● Wollaston Process Wire drawn as small as .000010"; made to your specifications for diameter and resistance.

● SPECIAL ALLOYS made to meet individual requirements. Write for list of stock alloys.

SIGMUND COHN & CO.

44 GOLD ST. NEW YORK

SINCE  1901



(Continued from page 54A)

- Siry, J. W., 125 Ivanhoe St., S.W., Washington 20, D. C.
 Snelling, E. A., 7755 Loomis Blvd., Chicago 20, Ill.
 Sperling, J. G., 210 Second Ave., Asbury Park, N. J.
 Stega, E. A., Box 101, Eatontown, N. J.
 Tull, W. J., 75 Bay State Rd., Arlington 72, Mass.
 Turrini, J. J., 3501 Hudson Blvd., Union City, N. J.
 Vant, L. M., 40 Paul St., Watertown, Mass.
 Watts, W. E., 2224 N. 70 St., Wauwatosa 13, Wis.
 Weigen, R. B., Box 345, Riverhead, L. I., N. Y.
 Wilhelm, H. T., 463 West St., New York 14, N. Y.
 Williams, P. B., 1961 E. 72 St., Chicago 49, Ill.
 Wouk, V., 1306 Wood St., Pittsburgh 21, Pa.

Admission to Associate

- Abbey, K., 3321 Victory St., San Diego 10, Calif.
 Adams, G. R., Federal Telecommunication Laboratories, 67 Broad St., New York, N. Y.
 Alexander, S. B., 5 W. 101 St., New York 25, N. Y.
 Allen, H. B., 2641 S. Taylor Rd., Cleveland Heights 18, Ohio
 Anderson, F. A., Albany Turnpike, Collinsville, Conn.
 Anderson, S. L., 817 Fourth St., Reading, Ohio
 Arvidson, R. F., Training Div., Barracks 6, NATTC, Ward Island, Corpus Christi, Tex.
 Ashley, F. R., 2 Beech Terrace, Yonkers 5, N. Y.
 Atwood, A. R., Public Service Bldg., Milwaukee 1, Wis.
 Balmer, D. W., 1459 W. Sparks St., Philadelphia 41, Pa.
 Beliss, G. J., 4819 Hutchinson St., Chicago 41, Ill.
 Benenson, S., 1012 Ave. K., Brooklyn 30, N. Y.
 Bennett, R. C., KWG, Hotel Wolf, Stockton 7, Calif.
 Benson, M. C., 230 S. Tenth St., Kansas City 2, Kan.
 Biefer, H., Zurcherstrasse 14, Baden, Switzerland
 Brooks, G., 301 Oriental Blvd., Brooklyn 29, N. Y.
 Brown, G. P., 16 Luscor Parade, Roseville, Sydney, N.S.W., Australia
 Bubb, A. H., 114 Haas Ave., Sunbury, Pa.
 Bundy, R. C., 1451 Main St., Stratford, Conn.
 Buyer, E. M., c/o Michael, 330 Wadsworth Ave., New York 33, N. Y.
 Buzzard, C. R., 190 N. State St., Chicago 1, Ill.
 Cavanaugh, D. E., 463 West St., New York 14, N. Y.
 Coffin, J. H., 4221 N. Maryland Ave., Milwaukee, Wis.

(Continued on page 58A)

DEPENDABLE!



Made right . . . to work right . . . and stay right. Whether in stock ratings or to your own specifications you will find Hi-Q components precise, dependable and long lived. Send for samples and complete information.

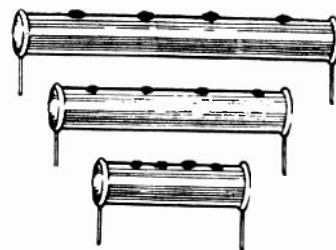

Hi-Q Ceramic Capacitors are of titanium dioxide (for temperature compensating types) and are tested for physical dimensions, temperature co-efficient, power factor and dielectric strength. CI type with axial leads; CN type with parallel leads.

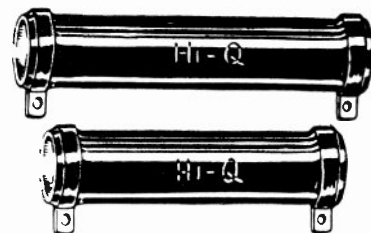

Hi-Q Wire Wound Resistors can be produced promptly and in quantity — with quality physical specifications and high performance electric specifications.

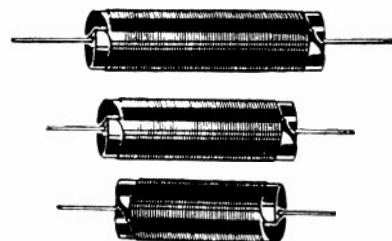

Hi-Q Choke Coils are uniform in their high quality performance. Ruggedly constructed for long service.

ELECTRICAL REACTANCE CORPORATION
FRANKLINVILLE, N. Y.

A MULTI-PURPOSE AMPLIFIER *of Broadcast Quality*

Worthy of an
Engineer's Careful
Consideration



Langevin 114-A Amplifier in 204-A Cabinet

THE Langevin 114-A Amplifier is primarily a monitor amplifier. It is used in offices, audition and control rooms of radio stations and recording studios, and also fits the needs of wired music installations and other industrial uses wherever an amplifier for a single or dual speaker installation is required.

This amplifier operates on 110-120 volts AC or DC. It can be rack mounted or used in its own metal cabinet, Type 204-A; it has a frequency response of 30 to 15,000 cycles and delivers 3 watts of audio power at less than 2% RSS total harmonic distortion at 400 cycle single frequency. At 4 watts output the distortion is less than 5%.

ELECTRICAL CHARACTERISTICS

GAIN—Approximately 61 db high gain and 43 db when bridging a 600 ohm source. **OPERATES FROM**—0-1000 ohms using nominal 600 ohm input, 0-25,000 ohms using nominal 25,000 ohm input, with maximum gain depending upon impedance of bridged source. **OPERATES INTO**—Nominal load impedance of 4 ohms. Working range 2 to 8 ohms. **OUTPUT POWER**—Approximately 4 watts with less than 5%, and 3 watts with less than 2%, RSS total harmonic distortion at 400 cycles single frequency into nominal 4 ohm load. **OUTPUT NOISE** 42 db below +35 VU (7 db below .001 watt) or better. **FREQUENCY CHARACTERISTIC**—Production run ± 1.5 db over the range of 30-15,000 cycles. **POWER REQUIREMENT**—110-120 volts, 25-1000 cycles AC, or 110-120 volts DC. Amplifier draws 70 watts at 120 volts. **SIZE**—Maximum length 10 1/4", depth 6 1/2" height 6 3/4".

The Langevin Company

INCORPORATED

SOUND REINFORCEMENT AND REPRODUCTION ENGINEERING

NEW YORK, 37 W. 65 St., 23 • SAN FRANCISCO, 1050 Howard St., 8 • LOS ANGELES, 1000 N. Seward St., 33

Compact Heater Holder by Crystalab

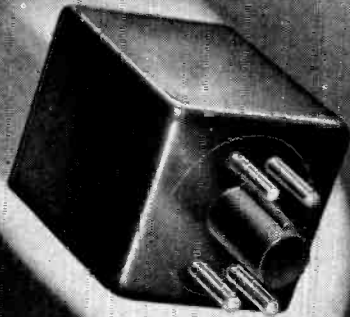

Specialists in
Special Crystals

Especially suitable for applications for close frequency tolerance . . . VHF services — police, aircraft, railway communications, etc. . . . works on 6.3v at 1 amp. . . . temp control within $\pm 3^{\circ}\text{C}$. . . operates at 60°C . . . frequency control of $\pm .005\%$. . . frequency range 3MC to 14MC . . . fits octal socket . . .

TYPICAL CRL — 30 FREQUENCY TEMPERATURE CURVE

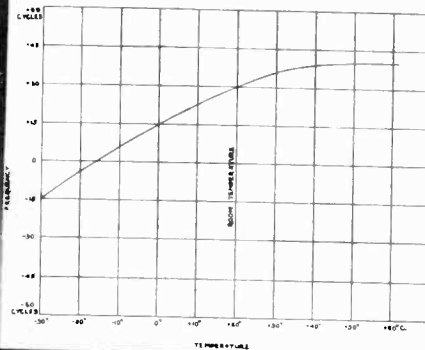

CRYSTAL RESEARCH LABORATORIES INC.

29 ALLYN ST., HARTFORD, 3, CONN., PHONE 7-3215

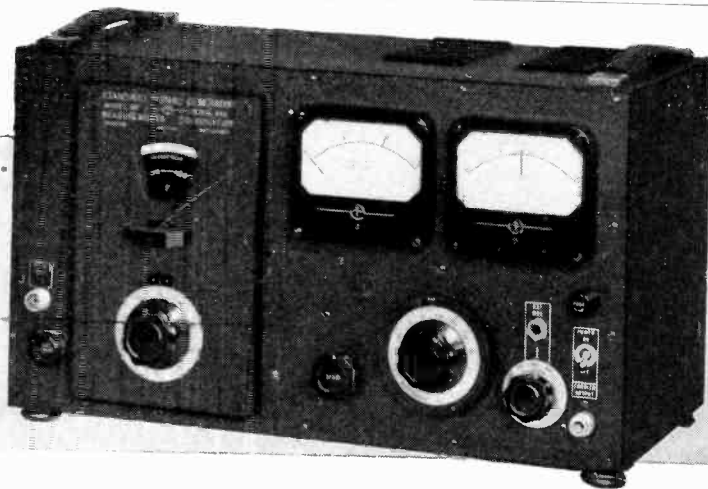

STANDARD SIGNAL GENERATOR Model 80

SPECIFICATIONS:

CARRIER FREQUENCY RANGE: 2 to 400 megacycles.

OUTPUT: 0.1 to 100,000 microvolts. 50 ohms output impedance.

MODULATION: A.M. 0 to 30% at 400 or 1000 cycles internal. Jack for external audio modulation.

Voice modulation jack for connection of external pulse generator.

POWER SUPPLY: 117 volts, 50-60 cycles.

DIMENSIONS: Width 19", Height 10 3/4", Depth 9 1/2".

WEIGHT: Approximately 35 lbs.

PRICE—\$465.00 f.o.b. Boonton.

Suitable connection cables and matching pads can be supplied on order.

MEASUREMENTS CORPORATION
BOONTON NEW JERSEY



(Continued from page 56A)

- Cole, B. T., 3810 Stearnlee St., Long Beach, Calif.
 Crissinger, W. W., 410 Grove Ave., Galion, Ohio
 Daily, L. L., Barracks 6, Training Div., Ward Island, NATTC, Corpus Christi, Tex.
 Dausman, R. H., 3703 Jardin St., Houston 5, Tex.
 Campbell, C. W., 39 Bold St., Hamilton, Ont., Canada
 Carter, F., 1405 W. Cherokee, Enid, Okla.
 Cooperman, P., 67 E. 175 St., New York 53, N. Y.
 Crum, P. C., 751 N. Central Ave., Chicago 44, Ill.
 Davidson, C., III, Bell Telephone Laboratories, Whippany, N. J.
 De Sarkar, S. S., East of Public Library, Chandernagor, Bengal, India
 Dreyfus, R. M., Sun Oil Co., Beaumont, Tex.
 Dugan, D. J., 866 Perkiomen St., Philadelphia 30, Pa.
 Earshen, J. J., 1054 Tiffit St., Buffalo 20, N. Y.
 Eidson, H. G., Jr., WIS, Columbia, S. C.
 Ferrell, D., 3723 Lovell Ave., Cheviot, Cincinnati 11, Ohio
 Geiger, J. R., 245 Marion St., Brooklyn, N. Y.
 Gibson, A. L., 1160 Clay St., San Francisco 8, Calif.
 Goldberg, C., Electronics Test Div., Naval Air Station, Patuxent River, Md.
 Gordon, G. B., 6524—40 St., S.W., Seattle 6, Wash.
 Granos, G. J., 108 Second St. N., Virginia, Minn.
 Greenhalgh, F. R., 2506 San Marcos Ave., San Diego 2, Calif.
 Griffin, R. S., No. 1 Officer's Mess, RAF, Cranwell, Lincs., England
 Gross, F. J., 6111 Kingsley Dr., Indianapolis 5, Ind.
 Guidi, G. J., 871 Post Rd., Scarsdale, N. Y.
 Hancess, E. A., 57a Zurcherstr., Baden, Switzerland
 Hancock, N. W., 351—18 St. S.E., Cedar Rapids, Iowa
 Hart, E. S., Box 344, York St., Sackville, N.B., Canada
 Helm, H. A., Bell Telephone Laboratories, Inc., Whippany Radio Laboratory, Whippany, N. J.
 Henning, R. E., 474 W. 238 St., New York 63, N. Y.
 Herriman, T. D., 719 E. Ave. 43, Los Angeles 31, Calif.
 Horwitz, A. H., 731 Interdrive, St. Louis, Mo.
 Jagers, H. D., Box 43, Rocky Point, L. I., N. Y.
 Johnson, G. D., Bell Telephone Laboratories, Whippany, N. J.
 Johnson, H. E., 86 Lawson St., Hempstead, L. I., N. Y.
 Jowdy, G. P., 275 Chestnut St., Lawrence, Mass.

(Continued on page 60A)

See the Turner Exhibit at the Parts Show,
Booth 49, Stevens Hotel, Chicago, May 13 to 16.



SWING OUT WITH TURNER

COLORTONE

Microphones

Turner pioneers again! *Colortones* are here to bring distinctive beauty to microphone applications.

Especially created for bands, television studios, entertainment spots and home recorders, these rugged plastic microphones come in a range of gem-like colors.

Their lustrous, streamlined beauty will blend, harmonize or contrast with any setting.

And new inside too! Improved crystal and dynamic circuits result in smoother, more accurate reproduction.

Write for complete specifications and information on *Colortone* colors now available.



Designed by
ARTHUR HAGGSTRÖM,
Noted Industrial Designer

The **TURNER** Company

909 17th Street, N. E., Cedar Rapids, Iowa

**TURNER-Pioneers in the
Communications Field**



Licensed under U. S. Patents of the American Telephone and Telegraph Company, and Western Electric Company, Incorporated.
Crystals licensed under patents of the Brush Development Company

When You Want TERMINAL LUGS...

TURRET



SPLIT



DOUBLE END



say **C.T.C.**

These heavily silver plated C.T.C. Terminal Lugs simply swage to the terminal board, provide strong, well-anchored, swift-soldering terminal posts in a jiffy.

C. T. C. Turret Terminal Lugs have two soldering spaces. Lugs heat quickly, make wiring firm and neat. Made to fit $\frac{1}{32}$ ", $\frac{1}{16}$ ", $\frac{3}{32}$ ", $\frac{1}{8}$ ", $\frac{3}{16}$ " and $\frac{1}{4}$ " terminal board thicknesses. Also available with single soldering space and in Midget size.

C.T.C. Split Terminal Lugs have a .050" hole through them, permit wiring from top or bottom side of board without drilling. Stocked to fit $\frac{3}{32}$ " boards. Ideal for transformers and other potted units.

C. T. C. Double End Terminal Lugs provide two terminal posts in one swaging operation. May be wired from top or bottom. Electrical connection perfect. Stocked to fit $\frac{3}{32}$ " boards. Also available in Midget size.

Write for C.T.C. Catalog 100 today.



CAMBRIDGE THERMIONIC CORPORATION
456 Concord Avenue • Cambridge 38, Mass.



(Continued from page 58A)

- Julien, V. O., 212 N. "E." St., Marion, Ind.
- Kaplan, S. V., H. de Keyserlaan 23, Hilversum, Holland
- Kaserman, P., 566 Beck St., New York 55, N. Y.
- Katz, R., 830 Xenia Ave., Yellow Springs, Ohio
- Klein, W., St. Ursustr. 6, Baden, Mt. Aargau, Switzerland
- Koehler, R. L., 2915 Broadway, Santa Monica, Calif.
- Krepps, J. E., Jr., 144 N. Front St., Sunbury, Pa.
- Kroft, H. M., 1807 Winans Avenue, Baltimore 27, Md.
- Krupen, P., 1211 Raum St., N.E., Washington 2, D. C.
- Larock, F. N., 47 Pickwick Rd., Hamden 14, Conn.
- Lewis, W. H., Ordnance Research Laboratory, State College, Pa.
- Litvenko, W., 16 Dow St., New Haven 10, Conn.
- Loeb, M., 115 E. Mosholu Pkwy., Bronx 67, N. Y.
- Lounsberry, E. P., 63 Hausman St., Brooklyn 22, N. Y.
- Lowman, C. O., 801 S. Eastman Ave., Los Angeles 23, Calif.
- MacKay, R. F., 20 Paine St., Worcester 5, Mass.
- Mansberg, H., 1887 Vyse Ave., New York 60, N. Y.
- Margulies, F., 3051 Brighton 14 St., Brooklyn 24, N. Y.
- Martin, P. J., 2901 Connecticut Ave., N.W., Washington 8, D.C.
- Mehring, J. S., 320 North Ave., Fanwood, N. J.
- Meyers, J. G., 1056 Sheridan Ave., Bronx 56, N. Y.
- McGuinness, J. W., 15 Weld Ave., Roxbury 19, Mass.
- Miller, H. J., 222 N. Fourth St., Lock Haven, Pa.
- Miller, V. F., 921 Peden Ave., Houston 6, Tex.
- Mills, G. L., 2631 Lenox Rd., Trenton, Mich.
- Monroe, D. G., RFD 1, Rives Junction, Mi.
- Murphy, E. J., 1 Conrad Court, Newport, R. I.
- Muse, D. W., Box 382, 215 McCoy St., Martinsville, Va.
- Nair, A. K., Nair Samaj Co-operative Lodge, Ltd., Dadar, Kohinor Rd., Bombay, India
- Naylor, J. E., 6857 Mohawk, San Diego 5, Calif.
- Neal, N. A., WBOE, Board of Education, Cleveland 14, Ohio
- Norby, H. A., Box 545, Metuchen, N. J.
- Ruffin, F. E., Jr., 10 Dickerson St., Newark 4, N. J.
- Nugent, J. T., Jr., 25 Kensington Ave., Jersey City 4, N. J.
- Obenland, D.K., 6022 N. Drake, Chicago 45, Ill.
- O'Keefe, P., 1553 Alexander Ave., Winnipeg, Manitoba, Canada

(Continued on page 62A)

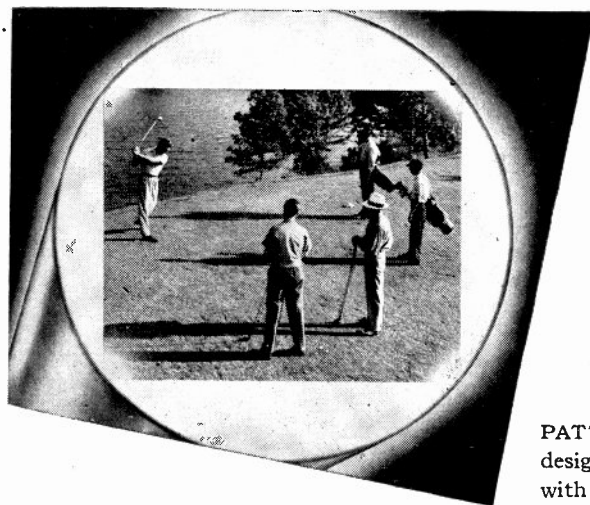

Patterson Phosphors for Contrast... Brilliance...Detail in Television Images

PATTERSON PHOSPHORS are designed for maximum luminescence with minimum input energy. Quality phosphors for television, radar, oscilloscopes and other electronic instruments are available from Patterson Screen Division of E. I. du Pont de Nemours & Co. (Inc.), Towanda, Pa. Manufacturers, experimental laboratories and schools are invited to write us outlining their requirements.

PATTERSON PHOSPHORS ARE AVAILABLE IN A WIDE RANGE OF

- | | |
|---------------|------------------------|
| 1. Colors | 4. Types of Excitation |
| 2. Grain Size | 5. Afterglow |
| 3. Brilliance | 6. Special Blends |

PATTERSON LUMINESCENT CHEMICALS

BETTER THINGS FOR BETTER LIVING . . . THROUGH CHEMISTRY



for U.H.F.

JOHNSON 122-101 SOCKET

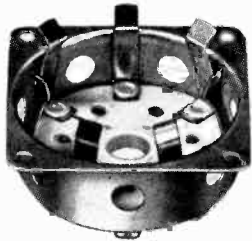

FOR TOP
PERFORMANCE
FROM
826-829
832
-TRANSMITTING
TUBES

Latest addition to the famous line of JOHNSON Tube Sockets is the 122-101. A ceramic wafer socket with aluminum base shield and JOHNSON superior contacts—the 122-101 is designed to really "take it"!

Socket is designed so that by-pass capacitors may be mounted directly on the tube socket base. Button mica capacitors are available in a range of capacitances enabling the tube to be used at its highest frequency.

Grid terminals are designed so that connecting wires may be isolated from other circuits.

Grid terminals are specially constructed to permit small grid coils to be mounted directly on the terminal ends, thus eliminating connecting leads.

Holes are provided for adequate ventilation of the tube.

Built-in retainer springs hold tube securely in place under conditions of heavy vibration and shock.

Write for Data Sheet 35 describing the 122-101 or see this socket at your JOHNSON Distributor.



Shown at left are JOHNSON 228 and 275 tube sockets. The 228 socket is ideal for many tubes including the "Tuf-20" and the 275 socket is designed for tubes including the 4-125-A, RK28, 125M, 803 and X404

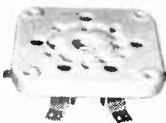

JOHNSON Tube Sockets are outstanding and are found widely used in commercial communication and industrial equipment. Write for specific information about sockets to meet your requirements. JOHNSON Tube Sockets, Condensers, Inductors, Insulators, Connectors, etc., for highest quality, adaptability, low cost and rapid delivery

Write for catalog 968

JOHNSON

a famous name in Radio



E. F. Johnson Co Waseca, Minn.



(Continued from page 60A)

- O'Sullivan, G. C., 1111 Meadowbrook Ave., Los Angeles 35, Calif.
- Patton, P. B., Federal Communications Commission, Washington 25, D. C.
- Paul, R. S., 453 Third Ave., San Francisco 18, Calif.
- Peart, J. D., Northern Electric Co., Ltd., 65 Rorie St., Winnipeg, Manitoba, Canada
- Perry, D. L., Sperry Products, Inc., 15 St. and Willow Ave., Hoboken, N. J.
- Polak, H. L., 111-50-75 Rd., Forest Hills, L. I., N. Y.
- Pollard, C. L., 17 S. Madison, Allentown, Pa.
- Porep, C. L., 573 Lake Park Ave., Oakland, Calif.
- Possner, J. B., 3804 Grayburn Ave., Los Angeles 43, Calif.
- Powell, D. S., RFD 1, Box 27, Monaca 6, Pa.
- Putz, H. R., 18, Carmichael Ave., Toronto, Ont., Canada
- Ramani, R. V., "Ananda Villa," Town Extensions, Kumbakonam, South India
- Reynolds, V. F., Kenilworth Apts., Alden Park, Philadelphia 44, Pa.
- Roll, A., c/o Milford, 50 E. 86 St., New York, N. Y.
- Sather, S. A., S.D.O. Telegraphs, Bangalore, India.
- Schulte, R. J., 1816 Holman St., Covington, Ky.
- Schultheis, H. B., Jr., 218 E. 135 St., Hawthorne, Calif.
- Scibilia, S. P., 50 E. 196 St., New York 58, N. Y.
- Searle, R. W., 1058 Main St., Waltham 54, Mass.
- Shen, C., Standard Telephones and Cables Co., Ltd., Ilminster, Somerset, England
- Smith, D. H., 815 S. Quincy St., Arlington, Va.
- Smith, E. W., RCAF Station, Clinton, Ont., Canada
- SoRelle, J. L., 238 Madison Ave., Decatur, Ga.
- Stand, T. R., 63 Ulloa St., San Francisco 16, Calif.
- Steward, J. F., 6 Norway Rd., North Haven, Conn.
- Stewart, W. A., Box 493, Natick, Mass.
- Streeter, R. A., 315 Fifth Ave. S.W., Cedar Rapids, Iowa
- Sudershan Lall, S., 40 Daryaganj, Delhi, India
- Temple, W. J., Brooklyn College, Bedford, Ave. and Ave. H., Brooklyn 10, N. Y.
- Seidner, O. R., Watson Laboratories, Red Bank, N. J.
- Simmons, J. G., 5612 Sunset Blvd., Hollywood, Calif.
- Swenson, G. W., Jr., Vint Hill Farms Station, Warrenton, Va.
- Thynell, G. V., The Bristol Co., Waterbury 91, Conn.
- Toth, W. S., A. T.-USNAS, Patuxent River, Md.

(Continued on page 68A)

PREMAX

Antennas Are Available

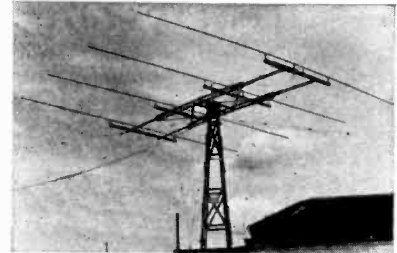

Fixed or Adjustable Types in Tubular Metal . . .

The same sturdy, rugged types of Tubular Metal Antennas that did such outstanding service in the armed forces is now available for commercial uses.

Many municipalities, public utilities and special services have made Premax standard equipment throughout their installations. They find it substantial . . . able to take extreme shocks . . . and still bring in sharp, clear signals.

Let us know your requirements.



Premax Products

Division Chisholm-Ryder Co., Inc.
4613 Highland Ave. Niagara Falls, N.Y.

C
O
N
D
E
N
S
E
R
S

I
N
D
U
C
T
O
R
S

T
U
B
E

S
O
C
K
E
T
S

I
N
S
U
L
A
T
O
R
S

A
N
T
E
N
N
A
S

SYLVANIA NEWS

CIRCUIT ENGINEERING EDITION

MAY

Prepared by SYLVANIA ELECTRIC PRODUCTS INC., Emporium, Pa.

1946

ANNOUNCING! EFFICIENT, NEW SYLVANIA R.F. AMPLIFIER TUBE

TYPE 7AG7



TYPICAL OPERATING CONDITIONS

| | |
|--|--------------|
| Heater voltage | 6.3 volts |
| Heater current | 0.150 ampere |
| Maximum plate voltage | 250.0 volts |
| Maximum plate dissipation | 2.0 watts |
| Maximum screen grid voltage | 250.0 volts |
| Minimum external negative grid voltage | 1.0 volt |
| Maximum screen grid dissipation | 0.75 watts |
| Maximum heater-cathode voltage | 90.0 volts |

Here's a new sharp cut-off r-f pentode amplifier designed especially for 6.3 volt and a-c/d-c series service in Television and Frequency Modulation receivers.

The tube may be operated with full plate voltage on the screen grid to produce high input resistance as a result of reduced electron transit

TYPICAL OPERATING CHARACTERISTICS OF TYPE 7AG7 AS A CLASS A1 AMPLIFIER

| | |
|---------------------|----------------|
| Plate current | 6.0 Ma. |
| Plate resistance | 0.75 megohm |
| Screen grid current | 2.0 Ma. |
| Mutual conductance | 4200 micromhos |

Direct Interelectrode Capacitances

| | |
|---------------|---------------------------|
| Grid to plate | .005 micromicrofarad Max. |
| Input | 7.0 micromicrofarads |
| Output | 6.0 micromicrofarads |

time. Identical voltage requirements for plate and screen grid also eliminate the need of screen grid filter resistors and by-pass capacitors in some circuit applications.

Inquiries concerning the new Sylvania Type 7AG7 r-f pentode amplifier tube are invited. Write Sylvania Electric Products Inc., Emporium, Pa.

SYLVANIA ELECTRIC

Emporium, Pa.

MAKERS OF RADIO TUBES; CATHODE RAY TUBES; ELECTRONIC DEVICES; FLUORESCENT LAMPS, FIXTURES, WIRING DEVICES; ELECTRIC LIGHT BULBS

The Most Indispensable Reference in Radio-Electronics
Electronic Engineering Master Index

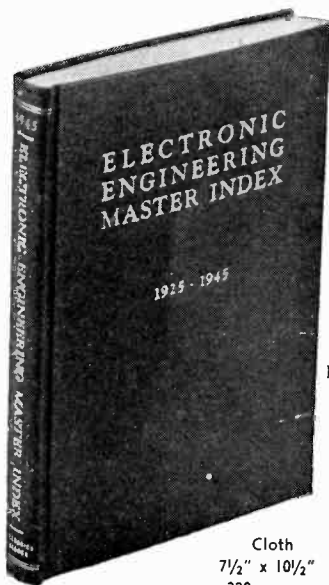

A master compilation of over 15,000 titles of texts and articles selected for their value to the research engineer, this INDEX covers the years 1925-1945 and enables you to survey twenty years of research literature on any subject in a matter of minutes!

Vitally Needed in Every Laboratory and Library

COMPLETE IN ONE VOLUME

PART I
 January 1925 to
 December 1934

PART II
 January 1935 to
 June 1945



PARTIAL LIST FROM 65 PERIODICALS INDEXED

- | | |
|-------------------------------|----------------------------|
| Bell Laboratories Record | General Electric Review |
| Bell System Technical Journal | Journal of Applied Physics |
| Communications | Proceedings of I.R.E. |
| Electrical Communication | Transactions of A.I.E.E. |
| Electronics | Radio News |
| Electronic Industries | R.C.A. Review |
| Journal of I.E.E. | Wireless Engineer |

Cloth
 7 1/2" x 10 1/2"
 320 pages

*A \$500 Reference Library in One Volume for \$17.50
 (Special Limited Edition. Part II in one volume, 200 pages, \$7.50)*

Descriptive circular on request.

ELECTRONICS RESEARCH PUBLISHING COMPANY

2 W. 46th Street

New York 19, N.Y.

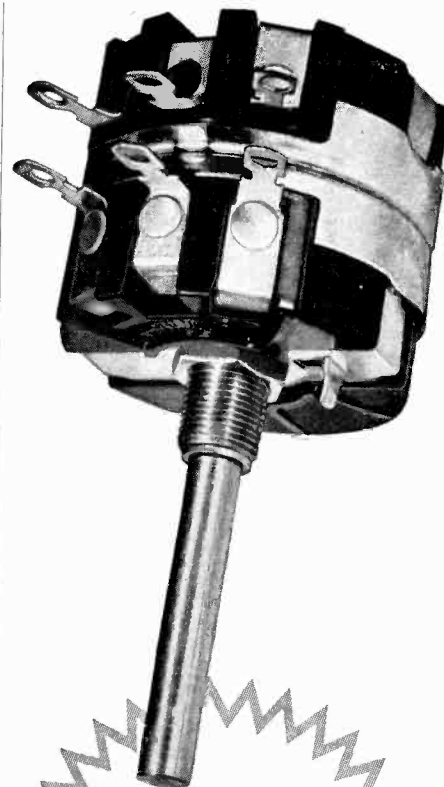

★ The improved, tougher Type 58 Clarostat wire-wound control provides among other notable advantages, a neat, more rugged, still more effective tandem dual assembly as here shown. Available with or without power switch.

Metal locating pin on front unit will not break or tear off. Bushing, keyed into the bakelite case, cannot slip or turn when locking nut is drawn up tightly. 1500 v. breakdown insulation between windings and shaft. Each center rail is in one piece with its terminal. Direct connection between winding and "L" and "R" terminals. Thus a real good dual control is made still better with these improved Type 58 units.

★ **Write for Literature . . .**



CLAROSTAT MFG. CO., Inc. • 285-7 N. 6th St., Brooklyn, N.Y.

FOR VHF

30 TO 200 MC

170-A

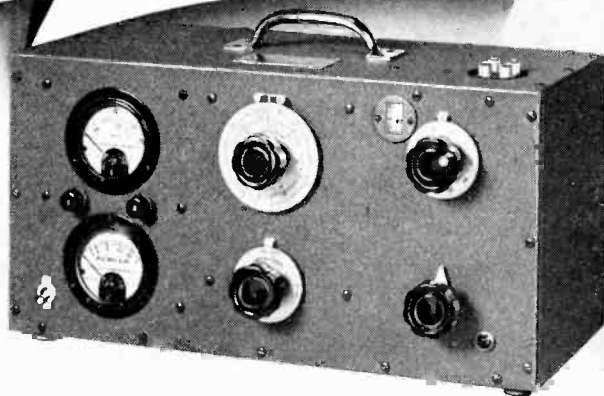

A ruggedly constructed direct reading laboratory instrument specially designed to measure Q, inductance, and capacitance values quickly and accurately. Invaluable in selecting proper low loss components for high frequency applications.

SPECIFICATIONS:—FREQUENCY RANGE: 30-200 mc, accuracy $\pm 1\%$

RANGE OF Q MEASUREMENT: 80 to 1200

Q CAPACITOR RANGE: 11-60 mmf; accuracy $\pm 1\%$ or 0.5 mmf, whichever is greater

Write for Catalog C



BOONTON RADIO Corporation

BOONTON · N · J · U · S · A ·



NEW PROBLEMS?

C-D has new electrical insulating materials to help you solve them

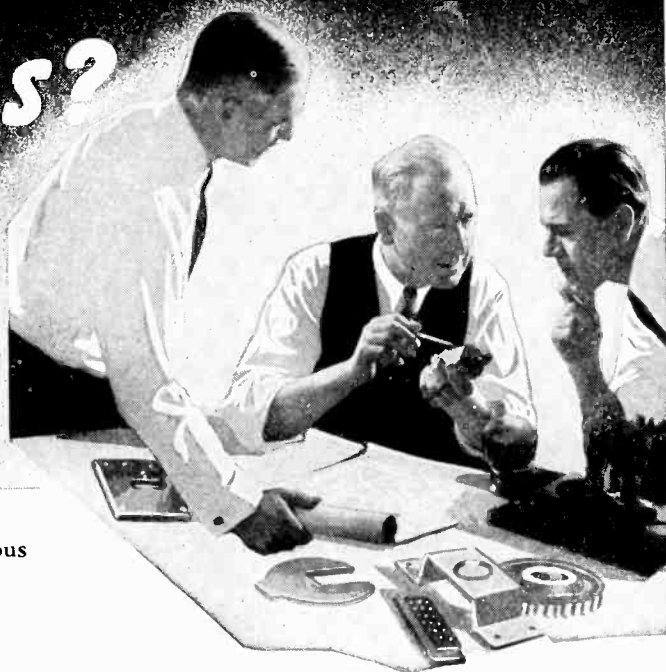

Here are some representative improved properties of various new C-D Electrical Insulating Materials.

| | |
|---|--------|
| Power Factor (at 10 ⁶ cycles per second) | 0.011 |
| Dielectric Strength, volts per mil. | 750 |
| Arc Resistance, seconds | 185 |
| *Insulation Resistance, megohms | 30,000 |

New higher standards are also obtainable on mechanical properties, heat and moisture resistance, dimensional stability and fabricating.

The parts illustrated were fabricated from new grade GB 128 M DILECTO which is a glass fabric base laminate employing a melamine the equivalent of Navy Type GHG. This new grade of DILECTO provides higher heat resistance, greater dimensional stability, superior arc resistance and improved mechanical properties, and is noncombustible when compared to standard paper and cotton fabric base phenolic laminates.

These new C-D insulating materials may be the answer to your "What Material?" problems, and will save you much time and worry. Investigate them while your products are in the planning stage. Wire, phone or write our nearest office and a C-D technician will be made available to you.

* Insulation Resistance values based on samples conditioned for 96 hours at 90% ± 2% relative humidity at 35° ± 1°C.

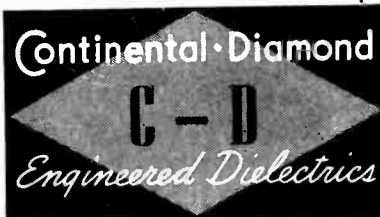
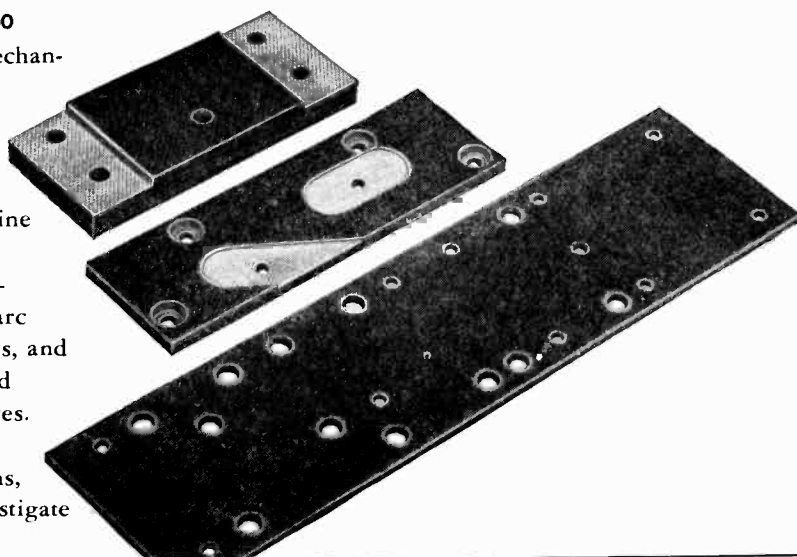

RHC-46

BRANCH OFFICES

NEW YORK 17 • CLEVELAND 14 • CHICAGO 11 • SPARTANBURG, S. C. • SALES OFFICES IN PRINCIPAL CITIES
 WEST COAST REPRESENTATIVES: MARWOOD LTD., SAN FRANCISCO 3
 IN CANADA: DIAMOND STATE FIBRE CO. OF CANADA, LTD., TORONTO 8

C-D PRODUCTS

The Plastics

DILECTO—Thermosetting Laminates.

CELORON—A Molded Phenolic.

DILECTENE—A Pure Resin Plastic Especially Suited to U-H-F Insulation.

HAVEG—Plastic Chemical Equipment, Pipe, Valves and Fittings.

The NON-Metallics

DIAMOND Vulcanized FIBRE

VULCOID—Resin Impregnated Vulcanized Fibre.

MICABOND—Built-Up Mica Electrical Insulation.

Standard and Special Forms

Available in Standard Sheets, Rods and Tubes; and Parts Fabricated, Formed or Molded to Specifications.

Descriptive Literature

Bulletin GF gives Comprehensive Data on all C-D Products. Individual Catalogs are also Available.



Continental - Diamond FIBRE COMPANY

Established 1895.. Manufacturers of Laminated Plastics since 1911—NEWARK 48 • DELAWARE

EASTERN PUMPS

COVER A WIDE RANGE OF PERFORMANCE

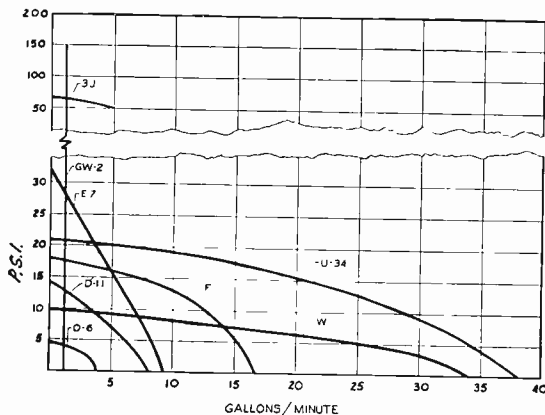

The performance chart shown above typifies the wide range of performance available through the selection of Eastern Midget Pumps. These pumps can provide the right equipment for your needs where small size and light weight combined with high performance and economy of operation are factors. They may be equipped with the easily adjustable stuffing boxes or rotary seals and will not leak at several times the maximum working pressures. Weights are from 2¾ to 100 lbs., capacity from ½ to 70 G.P.M. and pressures range up to 250 P.S.I. Standard models of many pumps are available in Monel Metal, Stainless Steel, Hastelloy "C", Cast Iron, Bronze and other metals and alloys. Models are motor driven, including Underwriters' approved explosion-proof motors, air driven or belt driven. Write for NEW CATALOG describing entire line of pumps.

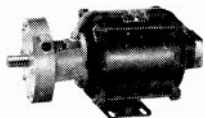

EASTERN ENGINEERING CO.
86 Fox Street, New Haven 6, Conn.

New!

RAWSON D. C. MULTI-VOLTMETERS

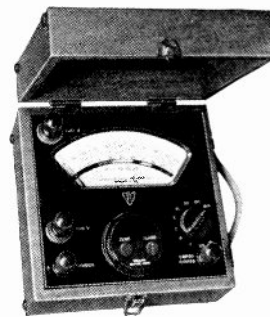

TYPE 501F

- 1) All the voltage ranges you need, on one instrument.
Ranges .01-.03-1-3-1-10-30-100-300-1000 volts full scale
- 2) Guaranteed accuracy ½ of 1%
- 3) 10,000 ohms per volt on all ranges
- 4) All resistors WIRE WOUND for permanent accuracy

TYPE 501G

Same as above except 100,000 ohms per volt. Ranges .1-3-1-3-10-30-100
Write for bulletin

We also supply: Regular DC Meters, Thermocouple AC Meters, Multimeters, Fluxmeters, Electrostatic Voltmeters.

Special apparatus built to order
RAWSON ELECTRICAL INSTRUMENT CO.
118 POTTER ST. CAMBRIDGE, MASS.
Representatives
Chicago, New York City, Los Angeles

BOOKS *designed for the* ENGINEER

UNDERSTANDING MICROWAVES

by VICTOR J. YOUNG

For those who have not previously considered radio waves shorter than 10 centimeters. Provides foundation for understanding various microwave developments of past five years. To simplify explanations, mathematics are placed in footnotes wherever possible.

CHAPTER HEADS

The Ultra High Frequency Concept • Stationary Charge and its Field • Magnetostatics • Alternating Current and Lumped Constants • Transmission Lines • Poynting's Vector and Maxwell's Equations • Wave-

guides • Resonant Cavities • Antennas • Microwave Oscillators • Radar and Communication • Section Two is devoted to descriptions of Microwave Terms, Ideas and Theorems Index.

OUT IN MAY—OVER 400 PAGES—PRICE \$6.00

SPEED AND SIMPLICITY A-C CALCULATION CHARTS

Student engineers will find that this book is invaluable. It simplifies and speeds any work involving AC calculations. The book contains 146 charts. Covers all AC calculations from 10 cycles to 1000 megacycles.

160 PAGES—PRICE \$7.50

ORDER TODAY

JOHN F. RIDER PUBLISHER, INC.
404 FOURTH AVENUE, NEW YORK 16, N.Y.
Export Division: Rocke-International Electric Corp., 13 E. 40th Street, New York 16, N.Y.

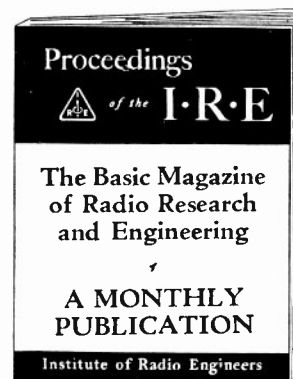

By Engineers—For Engineers

We will be grateful if you will mention Proceedings of the I.R.E. when writing to these advertisers.

POWERSTAT TYPE "LC"

The annoyance of off-nominal line voltage in production testing, laboratory investigation and factory processes can be eliminated by use of POWER-STAT Variable Transformers type LC... LINE CORRECTORS...

This equipment consists of a POWERSTAT Variable Transformer in conjunction with a fixed ratio auxiliary transformer for bucking or boosting the line. With this equipment high current loads can be economically and smoothly controlled. By sim-

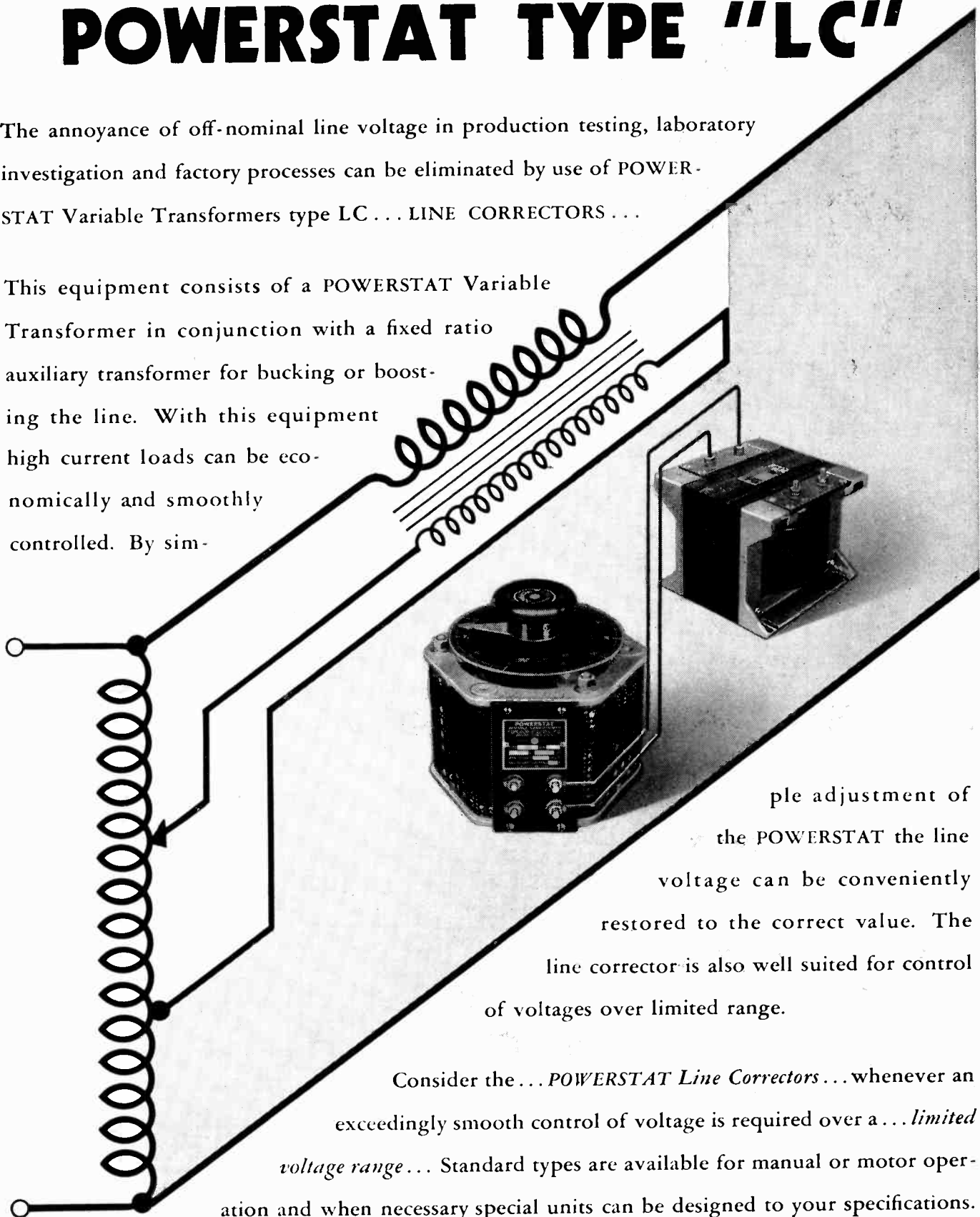

ple adjustment of the POWERSTAT the line voltage can be conveniently restored to the correct value. The line corrector is also well suited for control of voltages over limited range.

Consider the... *POWERSTAT Line Correctors*... whenever an exceedingly smooth control of voltage is required over a... *limited voltage range*... Standard types are available for manual or motor operation and when necessary special units can be designed to your specifications.

Send for Bulletins ER

SUPERIOR ELECTRIC COMPANY

785 LAUREL STREET,

BRISTOL, CONNECTICUT

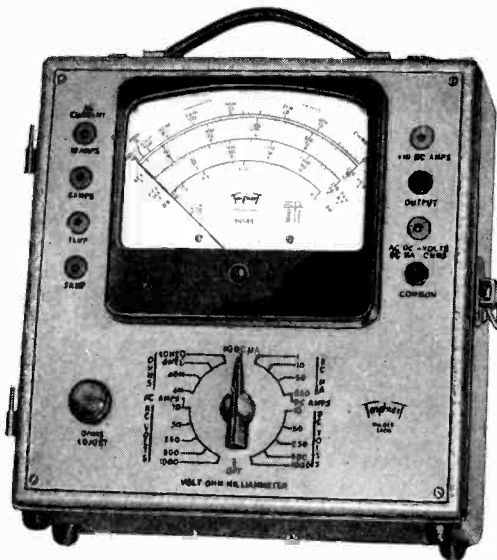

MODEL 2405
Volt · Ohm
Milliammeter

25,000 OHMS PER VOLT D. C.

STANDARDS ARE SET BY



SPECIFICATIONS

- NEW "SQUARE LINE" metal case, attractive tan "hammered" baked-on enamel, brown trim.
- **PLUG-IN RECTIFIER**—replacement in case of overloading is as simple as changing radio tube.
 - **READABILITY**—the most readable of all Volt-Ohm-Milliammeter scales—5.6 inches long at top arc.

Model 2400 is similar but has D. C. volts Ranges at 5000 ohms per volt.

Write for complete description

Triplet

ELECTRICAL INSTRUMENT CO.

BLUFFTON OHIO

NEW ENGINEERING
NEW DESIGN · NEW RANGES
30 RANGES

- Voltage:** 5 D.C. 0-10-50-250-500-1000 at 25000 ohms per volt.
 5 A.C. 0-10-50-250-500-1000 at 1000 ohms per volt.
- Current:** 4 A.C. 0-.5-1-5-10 amp.
 6 D.C. 0-50 microamperes—0-1-10-50-250 milliamperes—0-10 amperes.
- 4 Resistance** 0-4000-40,000 ohms—4-40 megohms
- 6 Decibel** -10 to +15, +29, +43, +49, +55
- Output** Condenser in series with A.C. volt ranges

ANOTHER
NEWARK
STORE!

Located at 212 Fulton St., New York 7, N. Y., another big Newark Electronic Company store has been opened to serve your radio and electronic needs. Stop in at the new downtown New York store, which is managed by HY Kahn, and you will find the same competent personnel that has made buying at other Newark stores a pleasure.

NEWARK BARGAIN SHEET AVAILABLE

Mail us your name and address and we will send you Newark Electric's famous bargain sheet each month. Write today. Address Dept. IR of nearest Newark branch.

CHICAGO
Newark ELECTRIC Company
 115-117 W. 45th St. NEW YORK 323 W. Madison St.
 (Adolph Gross) (Sam Poncher)
 New York 19 Chicago 6

And NOW! a "Pocket-Size" OSCILLOSCOPE

The **POCKETSCOPE**

- So **SMALL** in size (4" x 5 1/2" x 10")
- So **LIGHT** in weight (5 1/2 lbs.)
- So **COMPLETE** in performance
- So **INEXPENSIVE** in price (\$55 net)
- Plus **WIDE-ANGLE VISION**: on shelf, on floor, on bench
- Plus **RETRACTABLE LIGHT SHIELD**: for increased visibility

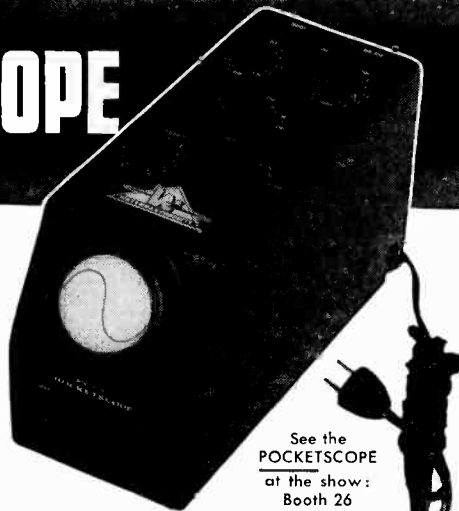

See the **POCKETSCOPE** at the show: Booth 26 Stevens Hotel May 13-16

WATERMAN PRODUCTS CO.
 INCORPORATED
 Phila. 25, Pa.

FOR DELIVERY :

Contact your nearest jobber. If he doesn't have the **POCKETSCOPE** available, contact us direct.



WATERMAN PRODUCTS



(Continued from page 62A)

- Tritter, A. O., Trans-Canada Air Lines Winnipeg, Manitoba, Canada
- Tullos, F. N., 6715 Keller, Houston 12, Tex.
- Turner, G. C., 148 Zetland Rd., Doncaster, England
- Tuttle, A. D., 61 Exeter St., Wollaston 70, Mass.
- Uzel, F., Jr., 158 N.E. Fifth St., Miami 36, Fla.
- Van Etten, J. P., 3815 Warren St., N.W., Washington, D. C.
- Walter, J. K., c/o Mrs. J. E., Tomlinson, 1515 Alton St., Pittsburgh 16, Pa.
- Warren, J. B., 49 Maplewood Ave., Dobbs Ferry, N. Y.
- Warwick, G., Cable and Wireless Ltd., Nairobi, Kenya, East Africa
- Wells, C. H., Ordnance Research Laboratory, State College, Pa.
- Wertz, H. J., RFD 3, Hamburg, N. Y.
- Westcott, H. H., 938 Mercer St., Gloucester, N. J.
- Wonnell, T. S., 502 E. 23 St., Indianapolis, Ind.
- Wright, J. F., Jr., 923 Harrison St., Lynchburg, Va.
- Zavitz, E. G., 65 Jacqueline St., London, Ont., Canada
- Ziolkowski, A., 73 Richards Ave., Dover, N. J.



Recorded Broadcasts become
"ALIVE"

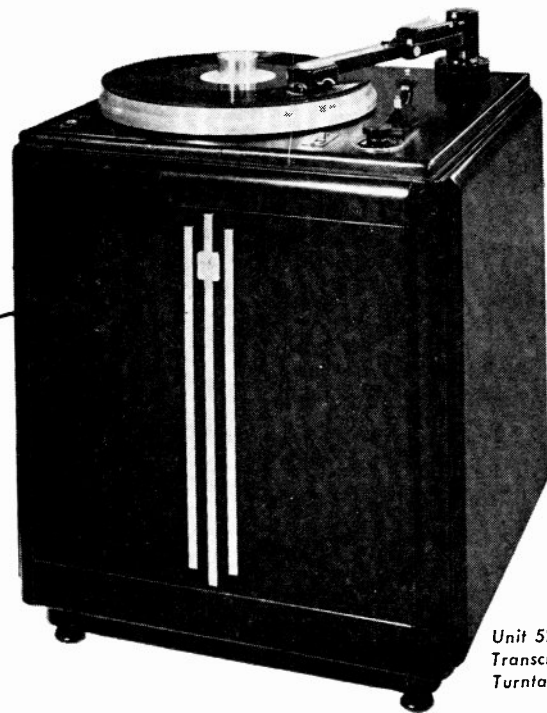

Unit 524
 Transcription
 Turntable

From now on your station announcement must be relied upon to *convince* your listeners that your program is recorded—not alive.

Why? Because there will be no tell-tale rumble, noise or 'wows' from the turntable. Rumble-free performance is assured through the unique method of mounting the famed Fairchild drive. This drive with its synchronous motor is mounted in a heavy casting in the base of the cabinet. It is connected to the turntable by means of a hollow shaft equipped with mechanical filters.

Vertical vibration is eliminated by mounting the turntable in a heavy cast aluminum panel on the top of the solidly constructed cabinet.

'WOW' is reduced to a minimum at either 33.3 or 78 rpm by the patented Fairchild direct-from-the-center, two-speed drive. Evenness of speed is assured by a carefully calculated loading of the drive mechanism that keeps the motor pulling constantly, by precision control of all alignments that might cause intermittent grab and release.

In addition, all of the natural beauty

of recorded music or speech can be reproduced *with full naturalness* on the new Unit 524 Fairchild Transcription Turntable when equipped with the Fairchild Unit 542 Dynamic Pickup described below. The 'floating' pickup arm practically eliminates record wear to add long life to your library of fine recordings.

Arrange to see the new desk-high Unit 524 Fairchild Transcription Turntable. Examine it closely. Listen to it critically. Address: 88-06 Van Wyck Boulevard, Jamaica 1, New York.



Fairchild CAMERA
 AND INSTRUMENT CORPORATION

SOUND
 EQUIPMENT



FOR IMPROVED
 PERFORMANCE



UNIT 542
 LATERAL DYNAMIC PICKUP

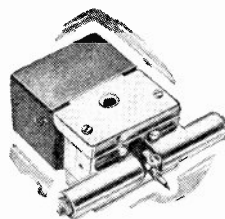

UNIT 541
 MAGNETIC CUTTERHEAD

Earlier FAIRCHILD portable models and many other types of recorder-playbacks will give vastly improved performance if equipped with an adapter and an improved Fairchild Pickup and Cutterhead.

Write for complete information.

Professional Cards

W. J. BROWN

Electronic & Radio Engineering Consultant
Electronic Industrial Applications, Commercial and Broadcasting, Transmitter and Receiver Design, Test Equipment, etc.
23 years experience in electronic development
1420 East 25th St., Cleveland 14, Ohio
Superior 1241

EDWARD J. CONTENT

Acoustical Consultant
and

Audio Systems Engineering, FM Standard Broadcast and Television Studio Design.
Roxbury Road Stamford 3-7459
Stamford, Conn.

R. A. DINZL

Electronic Consultant

Ultra High Frequency Transmitters and Receivers, Pulse Modulation, Broadcast Studio Circuits and Equipment Selection.
648 Nottingham Place
Westfield, N.J. Telephone 2-4539

STANLEY D. EILENBERGER

Consulting Engineer INDUSTRIAL ELECTRONICS

Design—Development—Models
Complete Laboratory and Shop Facilities
6309-13—27th Ave.
Kenosha, Wis. Telephone 2-4213

F. T. Fisher's Sons Limited

Consulting Engineers

Broadcast Transmitters, Antenna Systems, Studio Equipment, Mobile and Fixed Communication Systems.
1425 Dorchester Street W., Montreal

FRANK MASSA

Electro-Acoustic Consultant

DEVELOPMENT PRODUCTION DESIGN
PATENT ADVISOR
ELECTRO-ACOUSTIC & ELECTRO-MECHANICAL
VIBRATING SYSTEMS
SUPERSONIC GENERATORS & RECEIVERS
3393 Dellwood Rd., Cleveland Heights 18, Ohio

M. F. M. Osborne Associates

Consulting Physicists

Fluid Dynamics, Mechanics, Electronic Design, Electromagnetic and Acoustic Wave Propagation, Mathematical Analysis.
703 Albee Bldg., Washington 5, D.C.
Atlantic 9084

ADVERTISER'S INDEX

| | | | |
|--|-----------|---|----------|
| Section Meetings | 36A | Hewlett-Packard Company | 47A |
| Membership | 42A | Hytron Radio & Electronics Corp. | 19A |
| Positions Open | 50A | Insulation Manufacturers Corp. | 41A |
| Positions Wanted | 48A | International Resistance Co. | 8A |
| | | International Tel. & Tel. Corp. | 1A |
| | | E. F. Johnson Co. | 62A |
| Aerovox Corp. | 28A | Kaar Engineering Co. | 51A |
| Aireon Mfg. Corp. | 10A, 11A | Langevin Company, Inc. | 57A |
| Alliance Mfg. Co. | 43A | Lewis Electronics | 11A |
| American Lava Corp. | 9A | Frank Massa | 70A |
| American Phenolic Corp. | 23A | Measurements Corp. | 58A |
| American Transformer Co. | 30A | Mycalex Corporation of America | 21A |
| Amperex Electronic Corp. | Cover II | National Company, Inc. | 20A |
| Andrew Co. | 38A | Newark Electric Co. | 68A |
| Arnold Engineering Co. | 46A | North American Philips Co., Inc. | 31A |
| Astatic Corp. | 48A | Ohmite Mfg. Co. | 34A |
| | | M. F. M. Osborne Associates | 70A |
| Ballantine Labs., Inc. | 54A | Albert Preisman | 70A |
| Barker & Williamson | 50A | Premax Products | 62A |
| Bell Telephone Laboratories | 6A | Press Wireless Manufacturing Corp. | 25A |
| Bendix Aviation Corp. (Radio Div.) .. | 45A | Presto Recording Corp. | 13A |
| Bird Electronic Corporation | 44A | | |
| Boonton Radio Corp. | 64A | Radio Corporation of America | 32A, 71A |
| W. J. Brown | 70A | Rauland Corp. | 16A |
| | | Rawson Electrical Institute Co. | 66A |
| Callite Tungsten Corp. | 37A | Remler Co. Ltd. | 50A |
| Cambridge Thermionic Corp. | 60A | Revere Copper & Brass, Inc. | 12A |
| Centralab | 7A | John F. Rider, Publisher | 66A |
| Chicago Transformer Corp. | 52A | Shure Bros. | 36A |
| Cinaudagraph Speakers, Inc. | 10A | Sperry Gyroscope Co., Inc. | 35A |
| Clarostat Mfg. Co. | 64A | Sprague Electric Company | 18A |
| Sigmund Cohn & Co. | 56A | Stackpole Carbon Co. | 22A |
| Collins Radio Co. | 55A | Standard Transformer Corp. | 40A |
| Edward J. Content | 70A | Stupakoff Ceramic & Mfg. Co. | 29A |
| Continental-Diamond Fibre Co. | 65A | Superior Electric Co. | 67A |
| Cornell-Dubilier Electric Corp. | Cover III | Sylvania Electric Products | 63A |
| Cornish Wire Co. | 42A | | |
| Crystal Research Laboratories, Inc. | 58A | Triplett Electrical Inst. Co. | 68A |
| | | Tung-Sol Lamp Works, Inc. | 24A |
| DeMornay-Budd, Inc. | 27A | Turner Co. | 59A |
| R. A. Dinzl | 70A | United Transformer Corporation | 17A |
| Allen B. DuMont Labs., Inc. | 14A, 53A | Waterman Products | 68A |
| E. I. DuPont de Nemours & Co., Inc. | 60A | Western Electric Company | 26A |
| | | Weston Electrical Inst. Corp. | 61A |
| Eastern Engineering Co. | 66A | Harold A. Wheeler | 70A |
| Stanley D. Eilenberger | 70A | Paul D. Zottu | 70A |
| Eitel-McCullough | 72A | | |
| Electrical Reactance Corp. | 56A | | |
| Electronic Mechanics, Inc. | 49A | | |
| Electronics Research Publishing Co. | 64A | | |
| Erie Resistor Corp. | 39A | | |
| | | | |
| Fairchild Camera & Inst. Corp. | 69A | | |
| Federal Tel. & Radio Corp. | 1A | | |
| F. T. Fisher's Sons | 70A | | |
| | | | |
| General Aniline & Film Corp. | 4A & 5A | | |
| General Electric | 2A & 3A | | |
| General Radio Co. | Cover IV | | |
| | | | |
| Hammarlund Mfg. Company, Inc. | 15A | | |
| Harvey Radio Laboratories, Inc. | 33A | | |

HAROLD A. WHEELER

Consulting Radio Physicist

Radio—Frequency Measurements
Special Antenna Problems
Wideband Amplifiers and Filters
259-09 Northern Boulevard
Great Neck, New York Imperial 645

ALBERT PREISMAN

Consulting Engineer

Television, Pulse Techniques, Video Amplifiers, Phasing Networks, Industrial Applications
Affiliated with
MANAGEMENT TRAINING ASSOCIATES
3308-14th St., N.W. Washington 10, D.C.

Paul D. Zottu

Consulting Engineer Industrial Electronics

High Frequency Dielectric and Induction Heating Applications, Equipment Selection, Equipment and Component Design, Development, Models.
314 Washington St., Newton, Mass. BIG-9240



RCA airborne television will bring you thrilling news events that could not otherwise be "covered"—while they are happening.

You'll see news in the making—through Television

Imagine! A helicopter is "covering" the story of a man marooned on a burning building. Sitting at your home television receiver, you will get the same eye-witness view as though you were riding along in the nose of the plane!

To develop equipment compact enough to fit into a plane was a major problem. But RCA-NBC scientists and engineers in co-operation with the U. S. Navy did it—and airborne television became a wartime reality.

This portable equipment has many peacetime uses—and may lead to de-

velopment of a "walkie-lookie" with which a radio or news reporter might cover a story by television as readily as a news photographer does now with a camera.

Such progress-making research goes into each and every RCA product—and is your assurance that anything bearing the RCA or RCA Victor emblem is one of the finest instruments of its kind that science has achieved.

Radio Corporation of America, RCA Building, Radio City, New York 20... Listen to The RCA Victor Show, Sundays, 4:30 P.M., Eastern Standard Time, over the NBC Network.

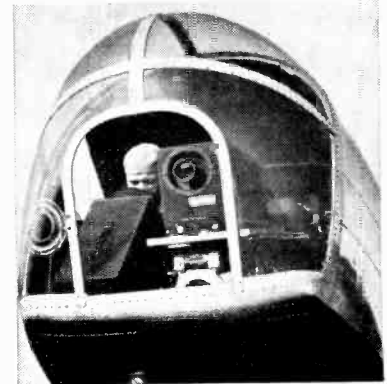

A television "eye" in the nose of a plane! Besides covering news events by plane, automobile or boat, such revolutionary equipment developed by RCA and NBC, can make accurate geographical surveys from planes flown by remote control. Moreover, similar television equipment can observe hazardous manufacturing processes from a safe distance.



RADIO CORPORATION of AMERICA

Eimac
TUBES

THE COUNTERSIGN OF
DEPENDABILITY IN ANY
ELECTRONIC EQUIPMENT

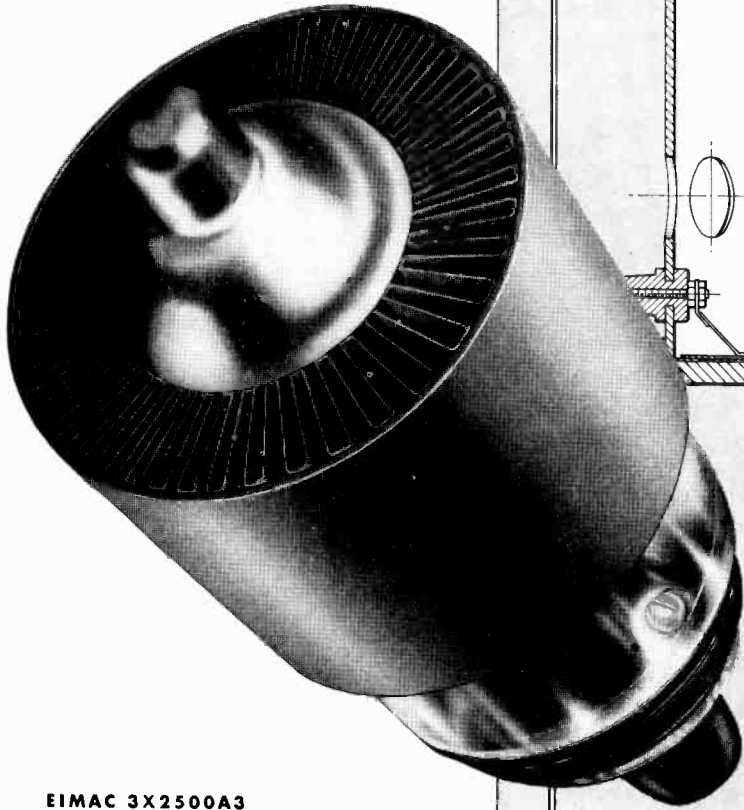

EIMAC 3X2500A3

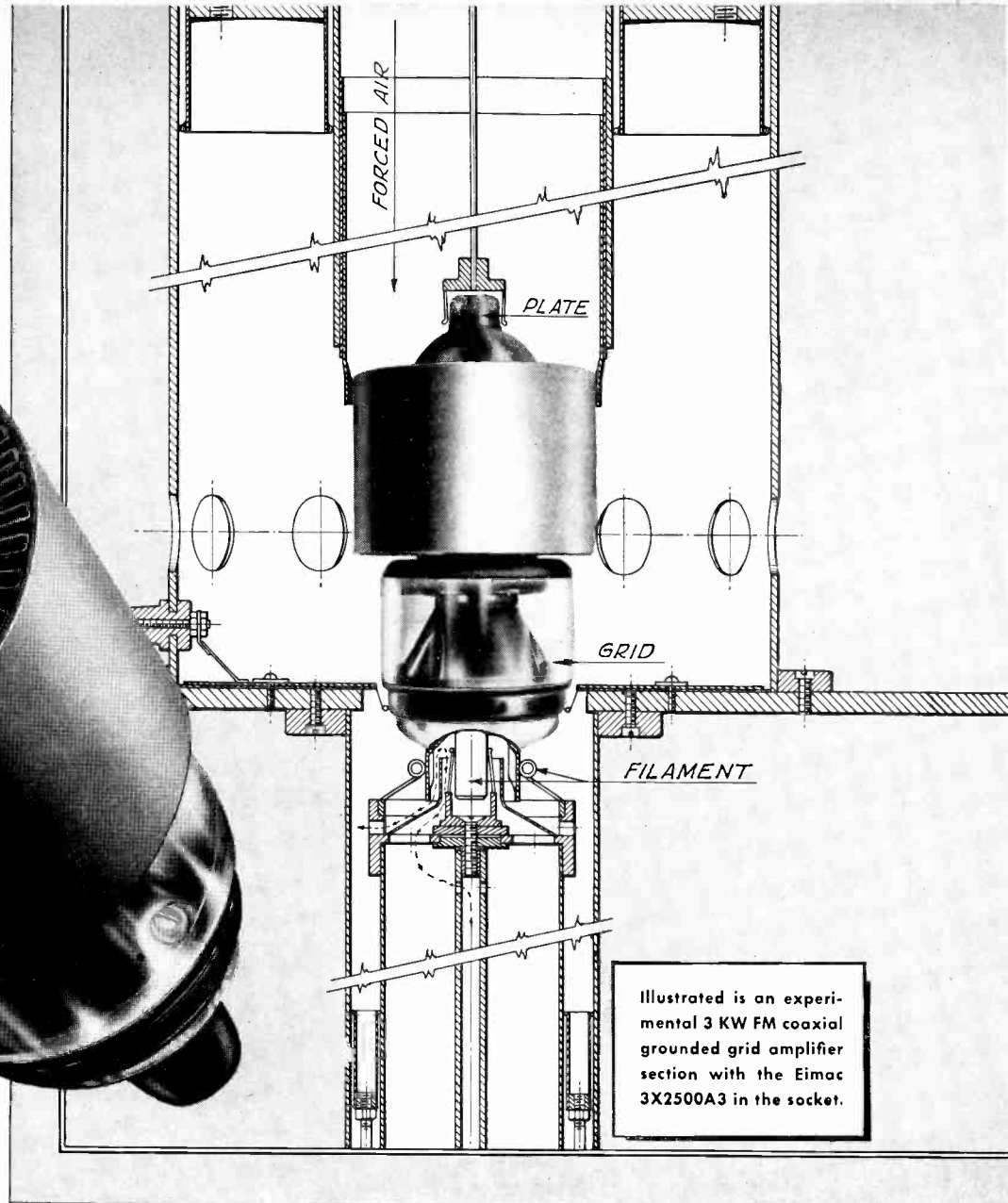

Illustrated is an experimental 3 KW FM coaxial grounded grid amplifier section with the Eimac 3X2500A3 in the socket.

READY FOR FM NOW 3500 watts (useful*) output at 88 to 108 mc

The radical and efficient mechanical design of this new Eimac external anode triode makes it ideal for use in any type transmitter circuit. For example, note in the illustration above how well the arrangement of the terminals enables it to fit into a grounded grid amplifier. Its design features will be very much appreciated in the efficient layout of FM transmitters—grounded grid or neutralized. In typical grounded grid operation at 110 mc, the Eimac 3X2500A3 will provide 3½ KW of useful* output with only 3000 volts on the plate. Furthermore, only 800 watts (approx.) of driving power are required for such operation. To get your FM transmitter on the air quickly and efficiently, use the new Eimac 3X2500A3 tube—tried and proven for the job. Complete technical data is available now.

1151-J

* Power actually delivered to the load.

FOLLOW THE LEADERS TO

Eimac
REG. U. S. PAT. OFF.
TUBES

EITEL-McCULLOUGH, INC.
1151-J San Mateo Ave., San Bruno, Calif.

Plants located at: San Bruno, Calif.
and Salt Lake City, Utah

Export Agents: Frazer & Hansen, 301
Clay St., San Francisco 11, Calif., U.S.A.

Typical Operation (110 mc., 1 tube)

| | |
|--|------------|
| D-C plate voltage | 3000 volts |
| D-C plate current | 1.6 amps. |
| D-C grid voltage | -350 volts |
| D-C grid current | 250 ma. |
| Driving Power (Approx.) | 800 watts |
| Plate dissipation (Approx.) | 1500 watts |
| Total power output (Approx.) | 3800 watts |
| Useful power output | 3500 watts |

CALL IN AN EIMAC REPRESENTATIVE FOR INFORMATION

- | | |
|--|--|
| ROYAL J. HIGGINS (W9A10) ... 600 S. Michigan Ave., Room 818, Chicago 5, Illinois. Phone: Harrison 5948. | ADOLPH SCHWARTZ (W2CN) ... 220 Broadway, Room 2210, New York 7, N. Y. Phone: Cortland 7-0011. |
| V. O. JENSEN, General Sales Co. , 2616 Second Ave., Seattle 1, Washington. Phone: Elliott 6871. | HERB BECKER (W6QD) ... 1406 S. Grand Ave., Los Angeles 15, California. Phone: Richmond 6191. |
| M. B. PATTERSON (W5C1) ... 1124 Irwin-Kessler Bldg., Dallas 1, Texas. Phone: Central 5764. | TIM COAKLEY (W1KKP) ... 11 Beacon Street, Boston 8, Massachusetts. Phone: Capital 0050. |

CAUTION!

Check serial numbers on Eimac tubes before you buy. Be sure you're getting newest types. Look for latest serial numbers.

Only a drop... but look at the stir



EVEN THE TINIEST COMPONENT is important. Like capacitors. If they "sit in" and do exactly the job you've visualized for them, your final product performs as planned.

That doesn't mean—make a major issue of capacitor purchases! Buy the kind you *don't* have to worry about . . . the kind we make at Cornell-Dubilier. They're inconspicuous, because they're so dependable.

If you have a special capacitor problem, our engineers can turn their thinking to it immediately. Consult us. Cornell-Dubilier Electric Corporation, South Plainfield, N. J. Other plants in New Bedford, Providence, Brookline and Worcester.

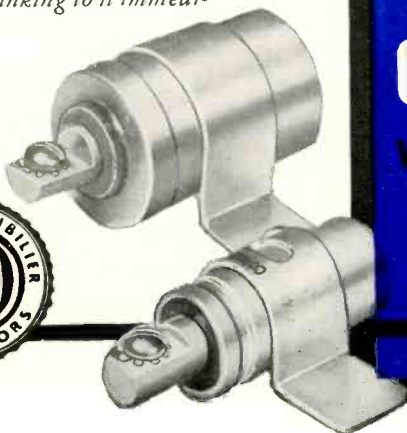

Others have tried to build capacitors like C-D's. They can imitate, but not duplicate. Because it's more than the paper and foil we use that makes C-D's different. It's the experience and engineering flexibility that comes of having made more capacitors of more different designs than anyone else. When you buy C-D, you buy a helpful amount of "freedom from worry".

CORNELL-DUBILIER
world's largest manufacturer of
CAPACITORS

NEW YORK - BOSTON - PHOENIX - SAN FRANCISCO

for Measuring Complex Waveforms

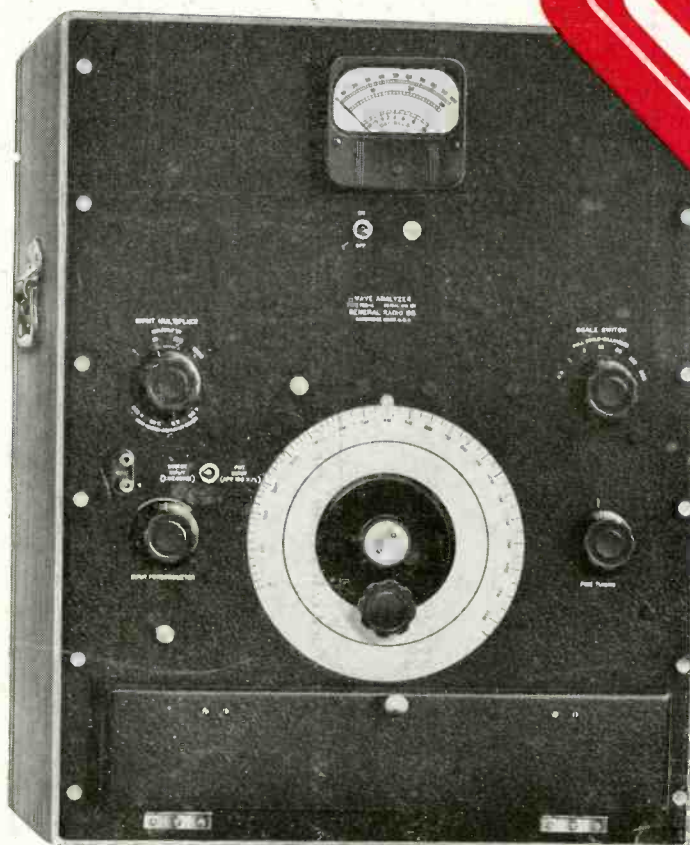

THIS analyzer offers the simplest, most accurate and most direct method of measuring the amplitude and frequency of the components of any complex electrical waveform.

It is ideally suited to hundreds of harmonic-distortion measurements on such equipment as any type of audio apparatus; broadcast receivers and transmitters; telephone and public address systems, oscillators, amplifiers and other vacuum-tube circuits; hum measurements in a-c operated communication equipment; harmonic studies of electric power systems and electric machinery; induction studies on telephone lines.

In its essentials this analyzer consists of a heterodyne-type vacuum-tube voltmeter with a highly selective filter using three quartz crystals. At only 60 cycles from resonance the attenuation is down by 75 decibels, yet tuning is very easy by virtue of the 4-cycle flat top characteristic at resonance. Standards for both voltage and frequency are built into the analyzer and can be used to check its calibration at any time.

The frequency range is 20 to 16,000 cycles and the voltage range 300 microvolts to 300 volts full scale. The instrument is completely a-c operated and has no pickup from external magnetic fields.

TYPE 736-A WAVE ANALYZER . . . \$720.00

WRITE FOR COMPLETE DATA

GENERAL RADIO COMPANY

Cambridge 39, Massachusetts

90 West St., New York 6

920 S. Michigan Ave., Chicago 5

1000 N. Seward St., Los Angeles 38