

Proceedings



of the

I·R·E

A JOURNAL of the Theory, Practice, and Applications of Electronics and Electrical Communication

- Radio Communication • Sound Broadcasting • Television • Marine and Aerial Guidance •
- Tubes • Radio-Frequency Measurements • Engineering Education • Electron Optics •
- Sound and Picture Electrical Recording and Reproduction •
- Power and Manufacturing Applications of Radio-and-Electronic Technique •
- Industrial Electronic Control and Processes • Medical Electrical Research and Applications •

OCTOBER, 1945

Volume 33 Number 10



ELECTRONIC LIFE SAVERS
ANTIPERSONNEL AND ANTITANK MINE DETECTION

Acme

Membership Talents and Volunteer
Service

V-T R-F Generator for Induction
Heating

60-KW H-F Radiotelephone
Amplifier

Dimensional Analysis of U-H-F
Tubes

L-F Compensation of V-F
Amplifiers

Aircraft Antenna Design

Cathode-Coupled Wide-Band
Amplifiers

Television I-F Amplifiers

Electron Transit Time

WINTER TECHNICAL MEETING, NEW YORK, N.Y.

January 23, 24, 25, and 26, 1946

The Institute of Radio Engineers



WHY CHOOSE UTC?

FOR WAR AND POSTWAR COMPONENTS

1. **UTC IS THE LARGEST TRANSFORMER SUPPLIER TO THE COMMUNICATIONS INDUSTRY.**
2. **THE SCOPE OF UTC PRODUCTS IS THE WIDEST IN THE INDUSTRY.**
3. **UTC ENGINEERING LEADERSHIP IN THE INDUSTRY IS ACCEPTED . . . WE DESIGN TO YOUR NEEDS.**
4. **THE QUALITY OF UTC PRODUCTS IS HIGHER THAN EVER.**
5. **THE DEPENDABILITY OF UTC PRODUCTS IS BACKED BY MANY YEARS OF EXPERIENCE. UTC IS NOT A WAR BABY.**
6. **UNEQUALLED PRODUCTION FACILITIES MAKE UTC'S PRICES RIGHT AND DELIVERIES ON TIME.**



United Transformer Corp.

150 VARICK STREET
EXPORT DIVISION: 13 EAST 40th STREET,

NEW YORK 13, N. Y.
NEW YORK 16, N. Y., CABLES: "ARLAB"



ALL PLANTS

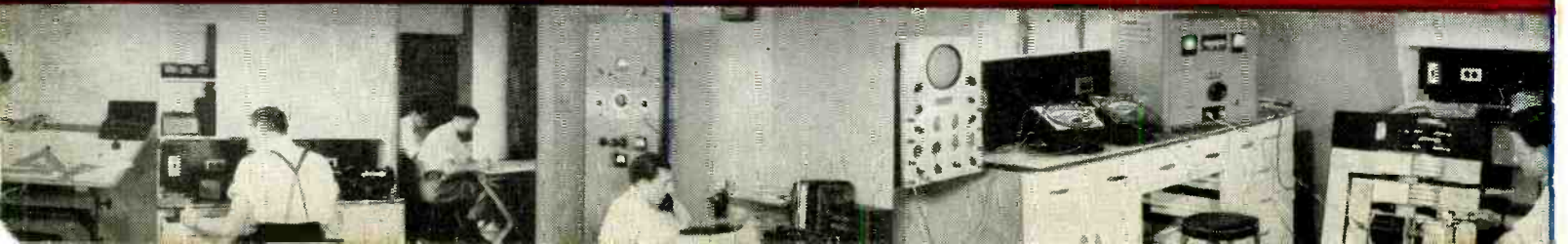

WHAT WILL YOU NEED TO PRODUCE BETTER POST-WAR PRODUCTS?

**CORNING
GLASS
GIVES YOU**

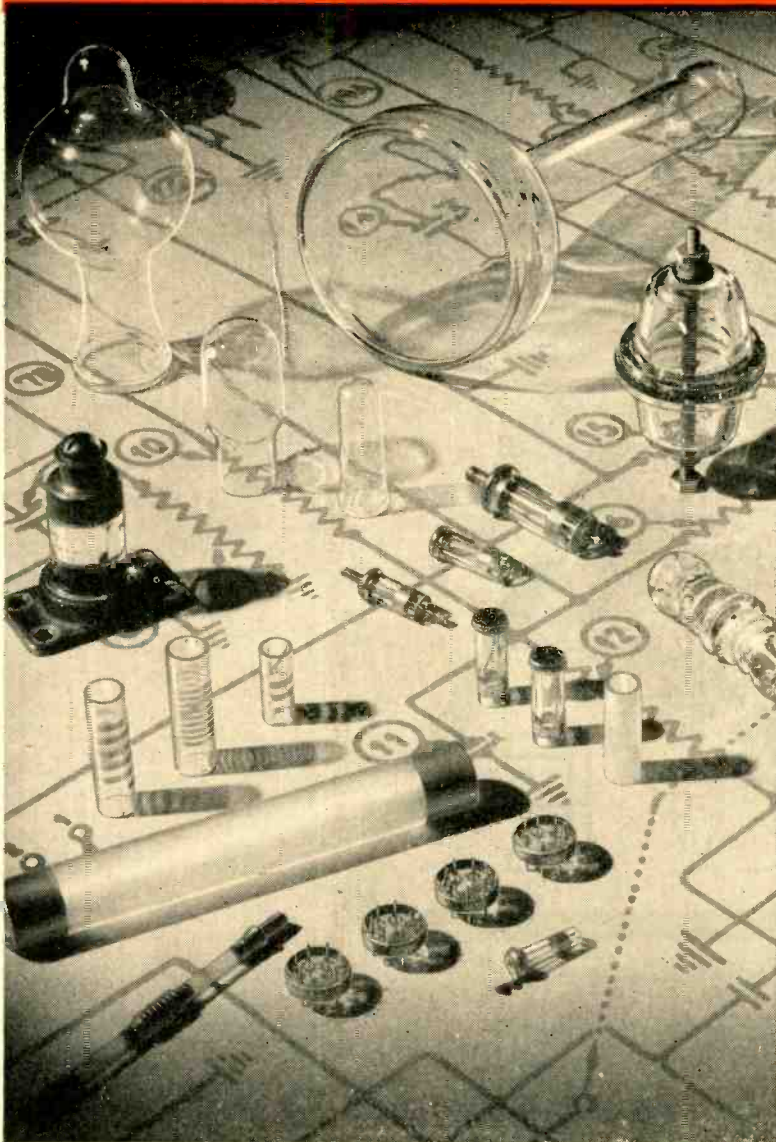

Special Electrical Qualities

Thermal Endurance

Hermetic Sealing

Mechanical Strength

Corrosion Resistance

Precision

Permanence

Metallizing

Dimensional Stability

High dielectric strength—high resistivity—low power factor—wide range of dielectric constants—low losses at all frequencies.

Permanent hermetic seals against gas, oil and water readily made between glass and metal or glass and glass.

Commercial fabrication to the fine tolerances of precision metal working.

Corning's metallizing process produces metal areas of fixed and exact specification, permanently bonded to glass.

AS YOU plan post-war electronic products, give a thought to versatile glass. We really mean glasses, for Corning has, at its fingertips, 25,000 different glass formulae from which to select those especially suited to your electronic applications. Let us show what glass can do for you. We may already have a solution — or Corning Research can find the answer for you. Address Electronic Sales Dept., P-10 Bulb and Tubing Division, Corning Glass Works, Corning, New York.

CORNING
— means —
Research in Glass

Electronic Glassware



“PYREX”, “VYCOR” and “CORNING” are registered trade-marks and indicate manufacture by Corning Glass Works, Corning, N. Y.

Proceedings of the I.R.E. October, 1945

1A

PROCEEDINGS of the I.R.E., October, 1945, vol. 33, no. 10. Published monthly by The Institute of Radio Engineers, Inc., 330 West 42nd St., New York 18, N.Y. Price, \$1.00 per copy. Subscriptions: United States and Canada \$10.00 a year; foreign countries, \$11.00 a year. Entered as second-class matter October 26, 1927, at the post office at Menasha, Wisconsin, under the Act of February 28, 1925, embodied in Paragraph 4, Section 538 of the Postal Laws and Regulations. Publication office, 450 Ahnaip Street, Menasha, Wisconsin.

Table of Contents will be found on page 32D.

1946

WINTER TECHNICAL MEETING

of the

Institute of Radio Engineers

INCORPORATED

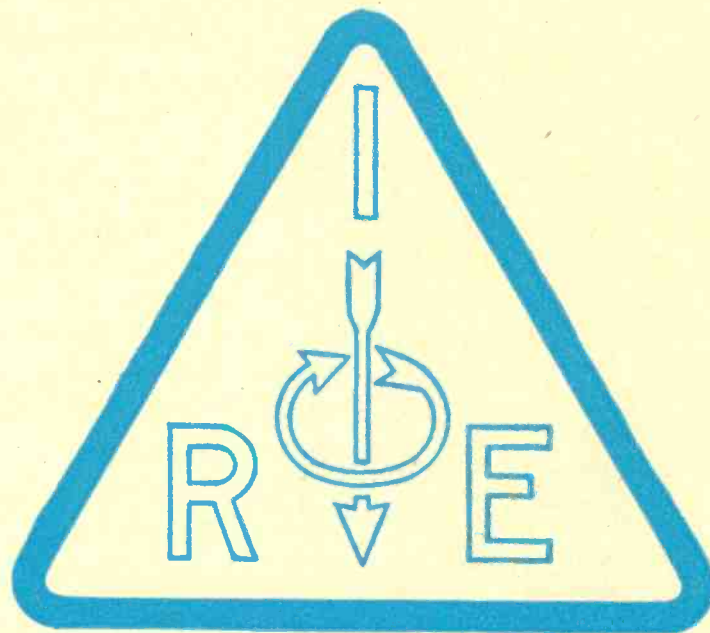

January 23, 24, 25, and 26
Hotel Astor, New York 18, N.Y.

Technical Sessions · Banquet · Annual Meeting
Exhibits of New Radio Products
President's Luncheon
Women's Program
Cocktail Party

Send In Your Hotel Reservations Early

SILENT

SAFEGUARD

Against CORROSION

This Federal Cathodic Protection unit was installed near Elizabeth, New Jersey, for the Public Service Electric and Gas Company, to protect 132KV underground lead sheathed power cables.

Operating silently . . . without moving parts, the dependable Federal Selenium Rectifier in this compact unit provides a small, steady direct current which counteracts the corrosive forces in the surrounding soil, and guards against interruption of vital power supply to industrial plants in the area.

For sure protection against galvanic or electrolytic damage to any underground power or other metal installation . . . a Federal Cathodic Protection unit is the logical choice . . . silent safeguard against corrosion.

Write us today for booklet "Cathodic Protection and Applications of Selenium Rectifiers" . . . get the full story of this effective means of protection.



STEEL RAIL
GROUND BED



LEAD SHEATHED
POWER CABLES



Federal Telephone and Radio Corporation

AN **IT&T**
ASSOCIATE

Newark 1, N. J.

Data for all designers



CARBONYL IRON POWDER

comes in 5 different grades

L C E TH SF

For use in cores for different applications the powders are processed:

1. With different amounts of particle-to-particle insulation,
2. With different types of insulation or bonding material,
3. With different ratios of iron to inert material,
4. With different pressures to different densities, and
5. With different form factors and shapes.

To obtain exactly specified:

1. Permeability
2. Q value
3. Eddie current loss
4. Hysteresis loss
5. Temperature coefficient



Data for circuit & coil designers

COMPARISON OF AIR-CORED AND CARBONYL IRON CORED COILS: For Medium Frequencies

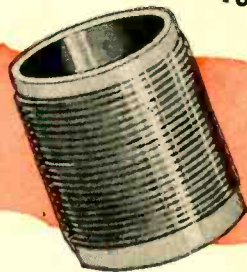

Specification	Typical air-cored coil	Typical CARBONYL IRON cored coil	Thus: CARBONYL IRON
VOLUME	0.61 cubic-inches	0.12 cubic-inches	Saves 80% of Space
WEIGHT Exclusive of Housing, Mounting, etc.	1.5 ounces	1.0 ounces	Saves 33% of Weight
WIRE-LENGTH	25 feet	11 feet	Saves 60% of Wire
INDUCTANCE	117 Micro-Henries	169 Micro-Henries	Increases Inductance 40%
Q Value at 1.0 Mc	94	260	Increases Q Value 170%

For further data write: General Aniline & Film Corp., Special Products Sales Department,
437 Hudson Street, New York 14, N. Y.

G.A.F. CARBONYL IRON POWDERS



SYLVANIA NEWS

ELECTRONIC EQUIPMENT EDITION

OCT.

Published by SYLVANIA ELECTRIC PRODUCTS INC., Emporium, Pa.

1945

SYLVANIA CATHODE RAY TUBES NOW AVAILABLE

Ready for New Television Sets To Be Produced

Sylvania Electric announces the welcome news that cathode ray tubes are once more available for the manufacturers of television sets.

Constant research in this field, combined with wide experience in large-

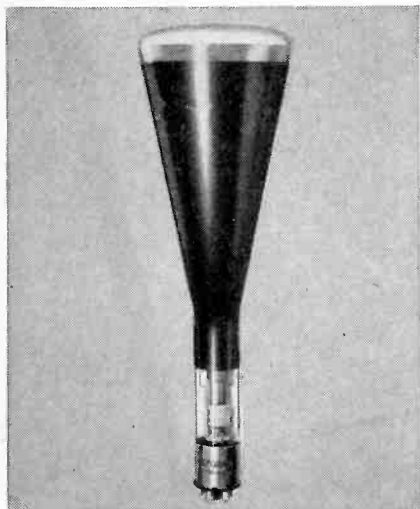

Sylvania Electric precision-built cathode ray tube now available to television set manufacturers.

scale production to meet war requirements, has placed Sylvania in a position to manufacture these tubes to a much higher standard than ever before.

This is an important factor to manufacturers of television receivers whose "plans" are rapidly becoming realities.

Check today with Sylvania Electric Products Inc., Emporium, Pa.

MANY MANUFACTURERS TO USE ELECTRICALLY SUPERIOR TUBE

Sylvania Lock-In Radio Tube Ideal For FM, Television, Radar

With the increasing trend toward higher frequencies—as shown by recent FCC decision assigning FM the band between 88 and 106 megacycles—set manufacturers will tend, more than ever, to use a tube ideally suited to the adoption of these very high frequencies.

The Sylvania Lock-In is known to be electrically and mechanically superior to any tube made.

Electrically, it is more efficient because the element leads are brought directly down through the low-loss glass header to become sturdy socket

pins—reducing lead inductance—and interelement capacity.

Mechanically, it is more rugged because support rods are stronger and thicker—there are fewer welded joints and no soldered joints—the lock-in lug is metal, not molded plastic—the elements are prevented from warping and weaving.

Today, set manufacturers considering the many developments in the field of communications, are looking to the Sylvania Lock-In Tube as a perfect electronic unit—the tube built to handle ultra-high frequencies.



The Sylvania Lock-In Tube showing construction—electrical and mechanical—that makes it superior to any tube made.

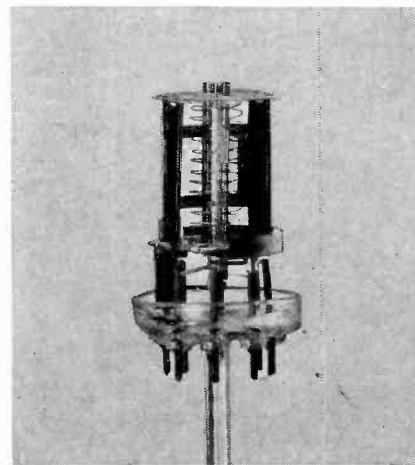

SYLVANIA ELECTRIC

Emporium, Pa.

MAKERS OF RADIO TUBES; CATHODE RAY TUBES; ELECTRONIC DEVICES; FLUORESCENT LAMPS, FIXTURES, WIRING DEVICES; ELECTRIC LIGHT BULBS

THEY'LL HELP YOU BUY AND USE CAPACITORS...EFFICIENTLY!



Up-to-the-minute CAPACITOR and APPLICATION DATA

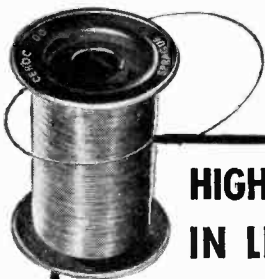

**HIGHER POWER
IN LESS SPACE**

**with this new 200° C.
Class C Insulation**

Manufacture coils, transformers, or similar wire wound devices? Then you owe it to yourself to investigate the tremendous possibilities of *CEROC 200—the Sprague inorganic, non-inflammable wire insulation that permits continuous operation to 200° C.

Write for Bulletin 505

A lot of time and effort has gone into making these new Sprague Catalogs invaluable guides to modern Capacitor selection and use for all who buy or use Capacitors.

CATALOG 10 brings you up-to-the-minute data on time tested *Sprague Dry Electrolytic*

types for practically any application. *CATALOG 20* does the same relative to the most modern line of *Paper Dielectric Capacitor* types on the market today. A copy of either or both will gladly be sent on request.

Write Today!

SPRAGUE ELECTRIC COMPANY • North Adams, Mass.

SPRAGUE

*Trademarks Reg. U. S. Pat. Off.

CAPACITORS — *KOOLOHM RESISTORS



50 YEARS OF X-RAYS

48 YEARS OF

MACHLETT ELECTRON TUBES



Piffard ray-proof tube



Water-cooled tube

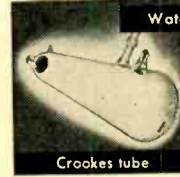

Crookes tube

X-RAY HISTORY IS

IT WAS 50 YEARS AGO, on November 8, 1895, that scientific investigation led Roentgen to the discovery of X-rays. In this semi-centennial year we honor his work, and the work of the pioneers who, sometimes at the sacrifice of their own lives, developed the theory and practice of a science that today means so much to all mankind.

Very soon after Roentgen publicly announced his discovery in 1896, Robert H. Machlett made the first practical American X-ray tube. Quickly he improved his techniques, creating a whole series of "firsts" such as the first ray-proof tube, the first cooled by water, the first for contact therapy. The organization he founded carries on his principle of constant research, improvement and initiative, and has many other firsts to its credit, culminating in the amazing and unique 2,000,000-volt, direct current, sealed-off, precision X-ray tube.

To a large extent, X-ray history is Machlett history, a history of service to mankind. Today, Machlett tubes are in use by doctors, hospitals, laboratories and factories in many parts of the world, saving lives, inspecting products, performing delicate analyses, expanding man's knowledge, serving with unmatched exactitude and economy. For the future, Machlett's talents will create other and still more valuable applications, for Machlett never stands still, is always creative, improving its tubes, developing new ones for old and new services.

In addition to X-ray tubes for all purposes, we also make oscillators, amplifiers and rectifiers for radio and industrial uses, all to the same high (and unmatched) standards to which our X-ray tubes are held. It will pay you to buy Machlett tubes. For information as to the available types, write Machlett Laboratories, Inc., Springdale, Connecticut.



Cornell contact therapy tube

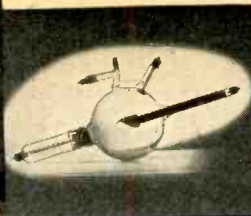

Transformer tube

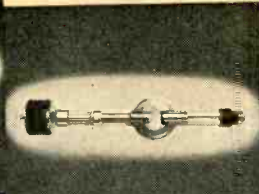

Pyrex heavy anode bulb tube type MR



Compact ray-proof tube, type CYR



Small shockproof tube, type CYS



Silver bearing long-life rotating target tube, type DX

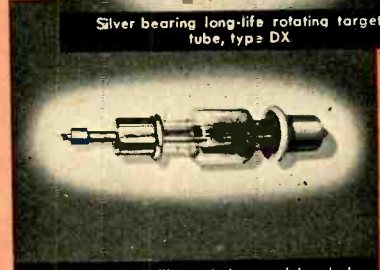

Tube with beryllium window and hooded anode, 250 k. v., type IR

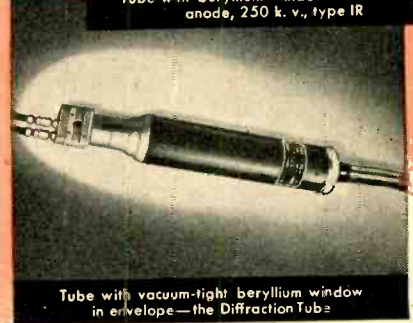

Tube with vacuum-tight beryllium window in envelope—the Diffraction Tube

2,000,000 volt direct current precision radiographic tube, type VM

first

MACHLETT HISTORY!

From the Beginning

"When in 1895 Professor Roentgen announced his discovery, Machlett was immediately interested and began experiments to reproduce the results of Roentgen. He was ideally equipped for such work, for just at that time he had perfected a mercury pump capable of producing a very high vacuum. He attacked the difficult task and before many days had passed, succeeded in producing the first X-ray tube in this country."—I. S. Hirsch, *Radiology* 8:254, 1927.



APPLIES TO RADIO AND INDUSTRIAL USES
ITS **48** YEARS OF ELECTRON-TUBE EXPERIENCE



Centralab METALLIZED STEATITE

COIL forms, spacer rods, strain insulators and rotor shafts of steatite can now be bonded in an inseparable union with brass, stainless steel, silver, copper and other metals. These shafts of steatite and metal are indicated wherever high frequency insulating material is specified. Both electrically and mechanically they fulfill the most exacting requirements. . . Centralab is now equipped to supply metallized Steatite in practically any form.



Centralab

Division of GLOBE-UNION INC., Milwaukee

PRODUCES OF: Variable Resistors • Selector Switches
• Ceramic Capacitors, Fixed and Variable • Steatite
Insulators and Button-type Silver Mica Capacitors.

NEW!

"HQ-129-A"

**\$129⁰⁰ AMATEUR
- NET
LESS SPEAKER**



PRICES SUBJECT TO CHANGE
WITHOUT NOTICE

WRITE TODAY
A postcard will bring description
of this outstanding new receiver.

FINEST LOW COST RECEIVER

By all measurement this is unquestionably one of the greatest values ever offered to amateurs . . . Here is "ham" communication at its best, streamlined for highest performance at a modest cost . . .

WRITE TODAY. Send card for descriptive folder.

HAMMARLUND

**THE HAMMARLUND MFG. CO., INC., 460 W. 34TH ST., NEW YORK 1, N.Y.
MANUFACTURERS OF PRECISION COMMUNICATIONS EQUIPMENT**

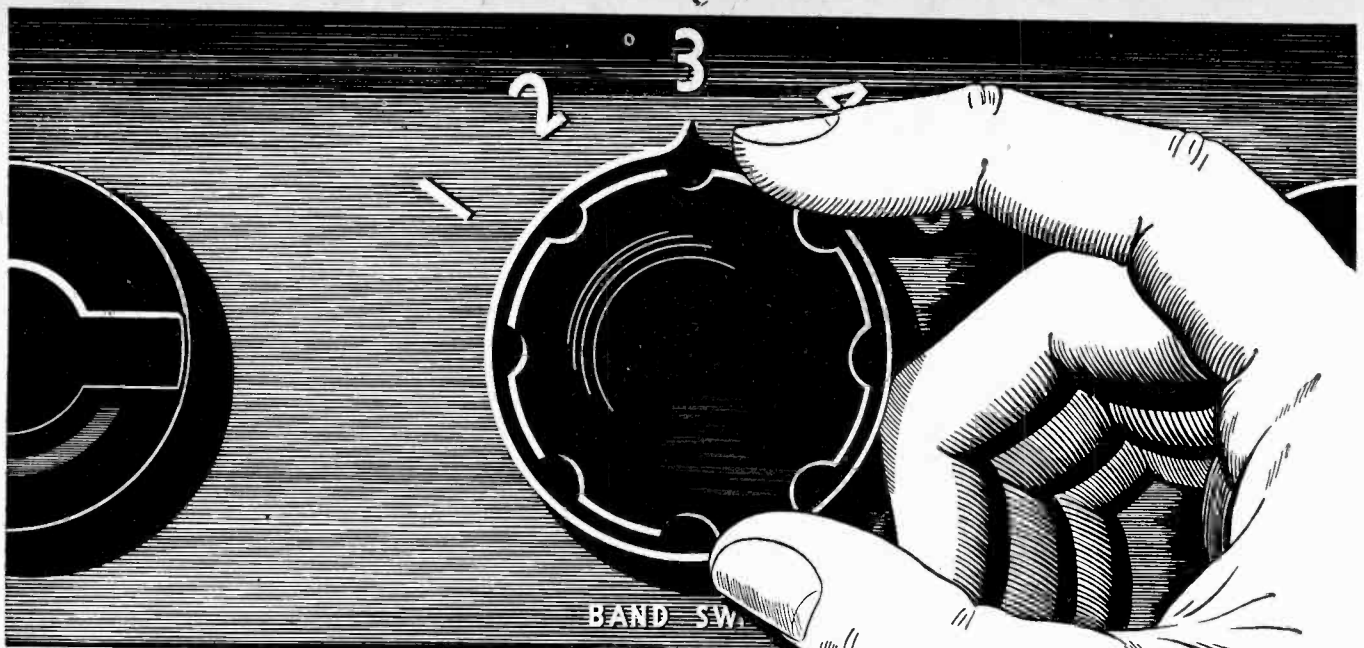

For easier bandswitching use the 257B Gammatron!

The HK-257B beam pentode, originated by Heintz and Kaufman engineers, facilitates the design, construction, and operation of multi-band transmitters since it requires very little driving power and no neutralization.

The wiring diagram below shows a transmitter capable of operating on all amateur bands from 10 to 160 meters. A single 6V6 metal tube in the oscillator circuit drives the r.f. amplifier to its full output. The precise internal shielding of the HK-257B makes neutralization unnecessary.

Write today for complete data on the 257B Gammatron, a versatile tube capable of very high frequency operation.



HEINTZ AND KAUFMAN LTD.

SOUTH SAN FRANCISCO • CALIFORNIA



Export Agents: M. Simon and Son Co., Inc.
25 Warren Street • New York City

KEEP IT UP...BUY WAR BONDS

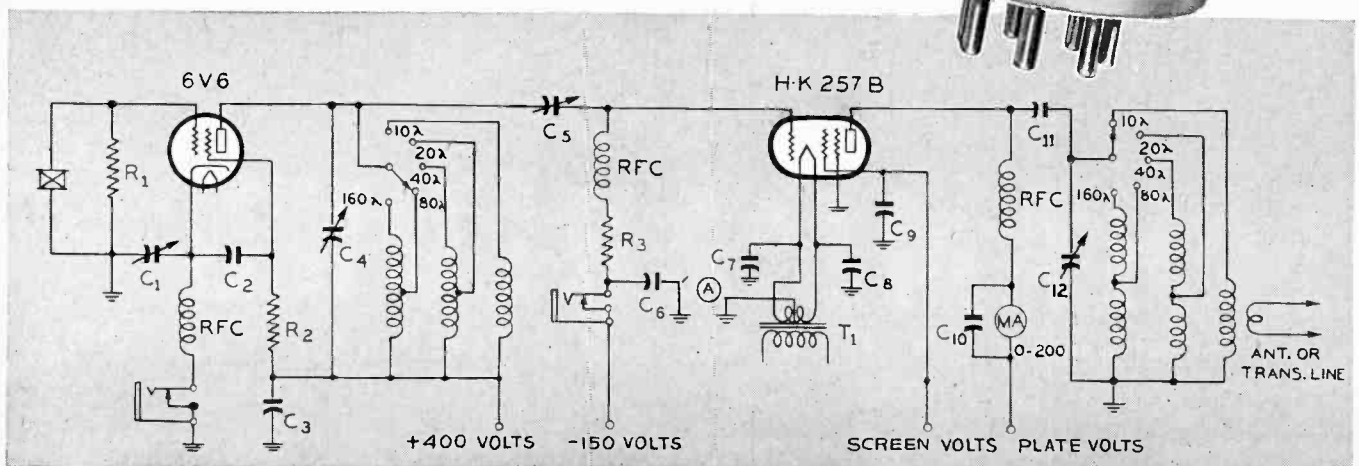

NEW "EVEREADY" "MINI-MAX"

"B" Battery has started Engineers figuring

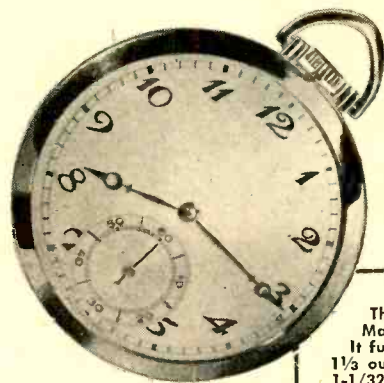

ACTUAL SIZE



This is "Eveready" "Mini-Max" "B" Battery No. 412. It furnishes 22½ volts, weighs 1½ ounces. Dimensions are 2" by 1-1/32" by 5/8". Compare its size with that of a pocket watch.

No. 412

WE BELIEVE IT WILL START YOU FIGURING TOO!

THIS is the latest "Mini-Max" 22½ volt "B" Battery made with National Carbon Company's exclusive construction. It is a challenge to the best inventive brains in the radio and electronics fields.

Why? Because this "Mini-Max" battery packs 22½ volts into the smallest unit ever dreamed of—well under half the size of anything of comparable voltage!

Imagine a battery as light and easy to carry as a pocket watch. Imagine what it means to portable radios and many electronic devices. It means sets that will be carried among the individual's personal effects—sets small enough to go into vest pocket or handbag. It means a whole new world of merchandise—new customers—new opportunities.

And to speed these important developments in your postwar business, National Carbon Com-

pany, Inc. invites the engineers and designers of America to consult its technical advisors... take advantage of its laboratory facilities and experience. From such cooperation can come important new merchandise for the future of the industry.

EVEREADY
TRADE-MARKS

MINI-MAX

RADIO "B" BATTERIES

NATIONAL CARBON COMPANY, INC.
Unit of Union Carbide and Carbon Corporation

UCC

General Offices: NEW YORK, N. Y.

The words "Eveready" and "Mini-Max" are registered trade-marks of National Carbon Company, Inc.

All of the big guns on Navy ships and a majority of their smaller guns are directed by radars designed by Bell Telephone Laboratories and made by Western Electric.

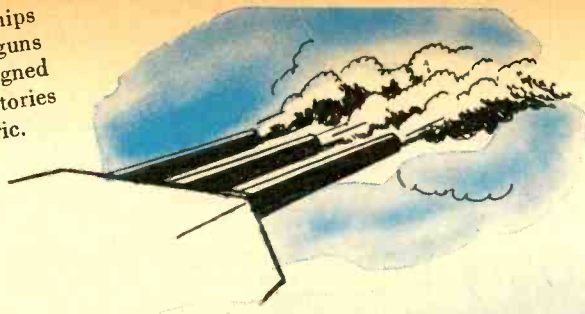

What **TEAMWORK**

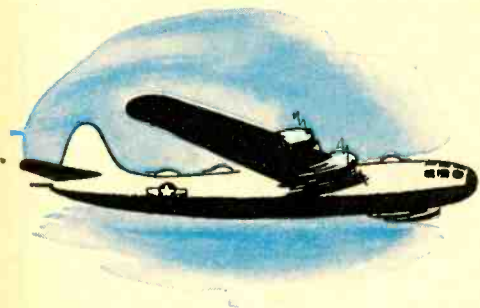

Bomb-directing radars used on B-29s were designed by the Laboratories and made by Western Electric.



This team developed and produced low altitude radar bombsights widely used against the enemy's merchant shipping.

Bell Telephone Laboratories and Western Electric were "naturals" for the leading part they played in the radar program. For years they've worked as a team in developing and producing complex electronic equipment.

Here are some unadorned facts about what their teamwork made possible.

Up to the end of the war, Western Electric had furnished the Army, Navy and Air Forces with more than 56,000 radars of 64 different types, valued at almost \$900,000,000.

In 1944 alone, Bell Laboratories worked on 81 different types of radar systems and Western Electric produced 22,000 radars of 44 different types — of which 20 were new in production that year.

Western Electric was the largest producer of the cavity magnetron and other essential vacuum tubes for radar. Number of tubes required for Western Electric radar systems varied from less than 100 to nearly 400 per system.

Complexity of radar manufacture is indicated by the fact that even a simple type may require 4,000 labor hours to manufacture and the larger types as much as 40,000 labor hours.

From the very beginning, ground radars made by Western Electric played an important role in all theatres of war.

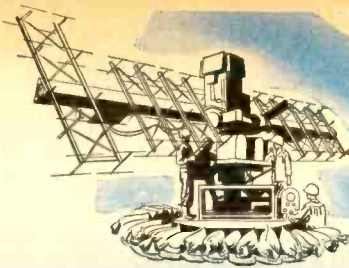

did for **RADAR**

Bell Laboratories developed more than 100 different radar test sets. In 1944, Western produced over 40,000 test sets of 68 types.

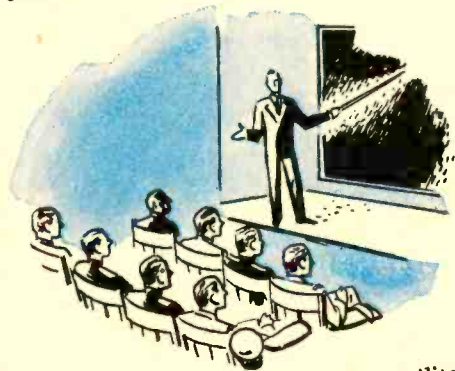

A school to train military personnel to operate and maintain radar was established by the Laboratories. Over 100 courses were given to some 4,000 officers and men.

The same team is working for YOU!

The unique combination of brain power and manufacturing facilities that made Bell Laboratories and Western Electric the nation's largest source of radar, is now devoted to bringing you the best in communications equipment for a world at peace. In peacetime off-shoots of radar—and in FM, AM and television broadcasting—in radio telephone equipment for every type of mobile service—this team can be counted on to lead the way.



Western Electric built up a Field Engineering Force of more than 500 specialists. They served with all branches of the Armed Forces on all fighting fronts.



BELL TELEPHONE LABORATORIES
World's largest organization devoted exclusively to research and development in all phases of electrical communication.



Western Electric
Manufacturing unit of the Bell System and nation's largest producer of communications and electronic equipment.

NATIONAL RECEIVERS ARE THE EARS OF THE FLEET

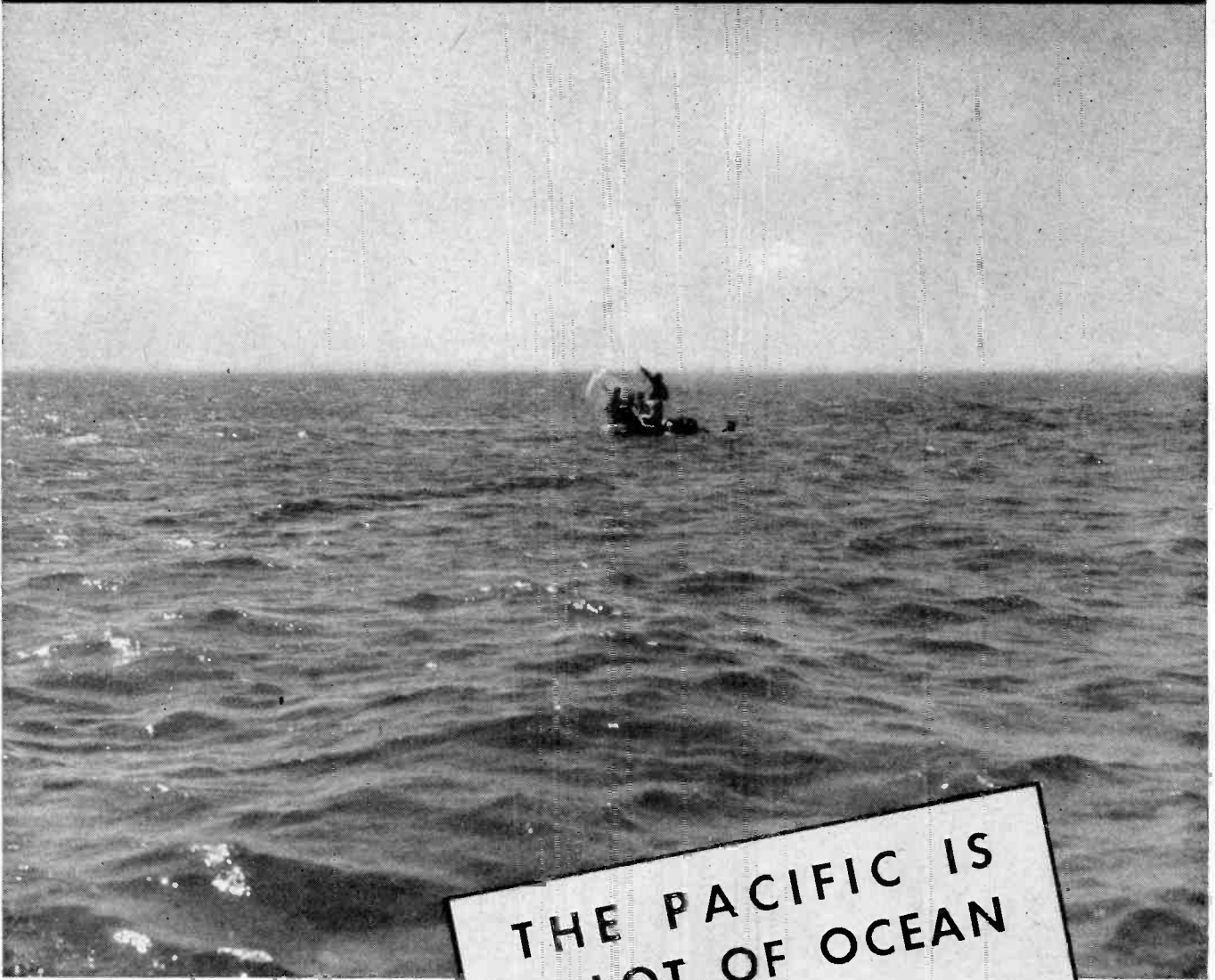

OFFICIAL U. S. NAVY PHOTOGRAPH

THE PACIFIC IS A LOT OF OCEAN

It is a big place to get lost in. The ceaseless search by Navy PBM "Mariners" has saved the lives of many downed fliers. Sometimes the plane can make the rescue; often radio sends help on its way.

The Navy knows how important radio equipment is. 3 out of 4 of the Navy's ships — landing craft and larger — use receivers designed by National.

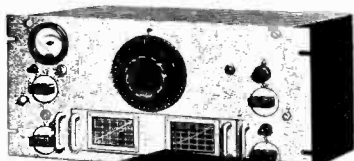

HRO

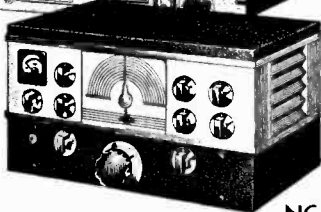

NC-200





NATIONAL COMPANY

MALDEN



MASS, U. S. A.

NATIONAL RECEIVERS ARE IN SERVICE THROUGHOUT THE WORLD



**EACH UTAH VIBRATOR
MAKES AND BREAKS MORE
THAN A *billion* CONTACTS
DURING ITS LIFETIME**

All of the well known Utah qualities of workmanship and design go into Utah vibrators, yet they cost no more than ordinary vibrators.

- ★ 70 vibrator replacement types.
- ★ 39 different hook-up diagrams.
- ★ Servicing 3651 different auto and farm radio models.
- ★ More than a million radio sets are equipped with Utah

There is a Utah vibrator for every replacement requirement!



UTAH RADIO PRODUCTS COMPANY • 820 ORLEANS STREET • CHICAGO 10, ILLINOIS

Utah Electronics (Canada) Ltd., 300 Chambly Road, Longueuil, Montreal (23) P. Q. • Ucoa Radio, S. A., Misiones 48, Buenos Aires.

Now it can be told...

The Type 5SP double-beam tube may be used to examine both the input signal to a circuit and the circuit response at the output. A square wave is here applied to an LC circuit. Both input and output signals can be studied simultaneously. Either signal may be expanded for detailed study.

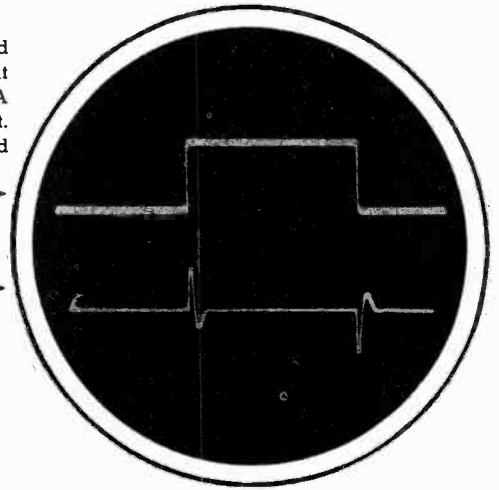
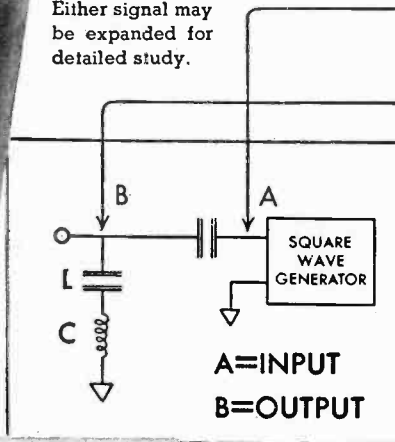

by means of the
new **DuMONT**

DOUBLE-BEAM TYPE 5SP CATHODE-RAY TUBE

◆ New and startling applications are ushered in by this latest DuMont development.

Two complete "guns" in a single 5" envelope converge on one screen for *simultaneous* and *superimposed* traces. Heretofore such simultaneous comparison of two phenomena could be accomplished either by (1) using two separate tubes or oscillographs placed side by side, or (2) using the electronic switch. Both methods presented limitations either in observation convenience, or in frequency response and inability to use independent time bases.

With the new DuMont Type 5SP double-beam tube there is *complete and independent control* of the X, Y and Z axis functions for each beam. Adequate shielding between "guns" and "plates" minimizes "cross-talk" particularly at high frequencies. Side-wall connections to the deflection plates minimize shunt-input capacitance and lead inductance; also provide better insulation and longer leakage paths. Army-Navy diheptal 12-pin base. Electrode rating similar to Army-Navy preferred Type 5CP1.

© ALLEN B. DUMONT LABORATORIES, INC.

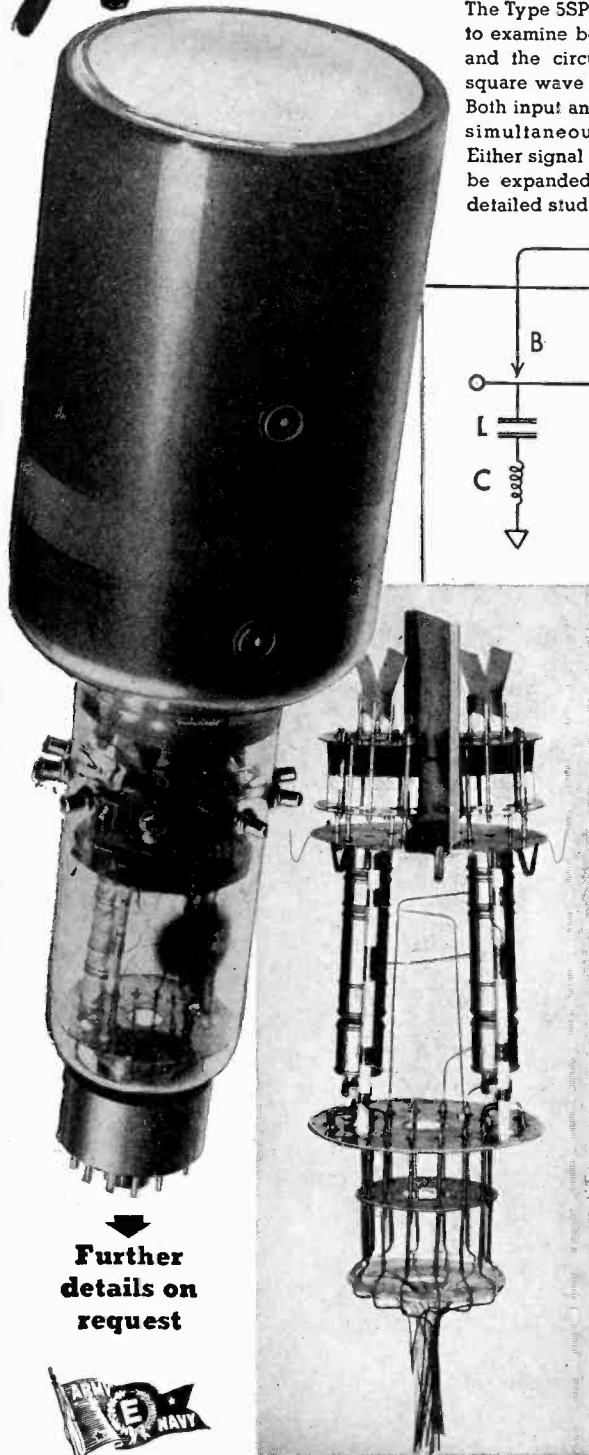

Further
details on
request



DUMONT Precision Electronics & Television

ALLEN B. DUMONT LABORATORIES, INC., PASSAIC, NEW JERSEY

Aireon rides again

OUR spirited steed is not only fast but well-gaited. We curled our lasso around the neck of "Electronics" a long time ago and with our strong personality, and kind treatment, turned it into our pet horse. It took a lot of skull work, a lot of smart engineering, but it worked out. Now our stable has 28 red hot electronic devices that should interest you. How about hitching your chariot to our fast-stepping organization, giving Aireon its head in helping solve your electronic problems?

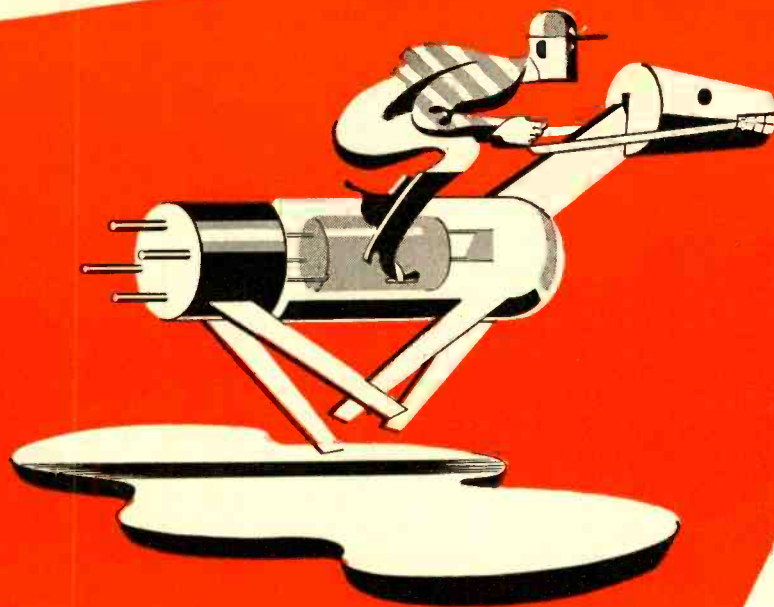

Aireon

MANUFACTURING CORPORATION

Radio and Electronics • Engineer Power Controls

NEW YORK • CHICAGO

KANSAS CITY • BURBANK



LABORATORY INSTRUMENTS FOR SPEED AND ACCURACY

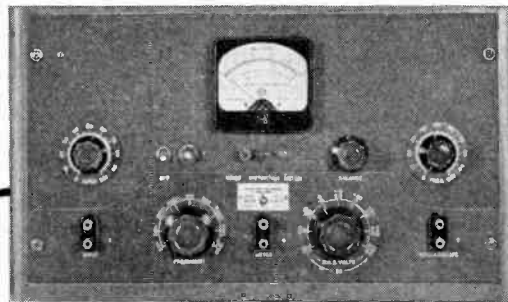

This instrument separates harmonics from a desired frequency

By eliminating the fundamental frequency, this instrument permits accurate measurement of noise, distortion and the harmonics of the wave. At balance its fundamental circuit has almost infinite attenuation at a single frequency and other frequencies are passed with little or no attenuation.

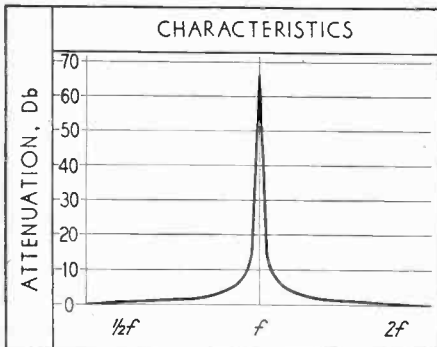

As shown in the chart: the attenuation at the 2nd harmonic ($2F$) would be in the order of $1/2$ db while at the resonant frequency it would be infinite—from 60 to 70 db in practical circuits making it possible to measure distortions as low as 0.1%.

The *-hp-* Model 325B Noise and Distortion Analyzer is really a combination of three separate elements: a frequency elimination circuit, a

stabilized 20 db amplifier and a vacuum tube voltmeter, any one of which may be used individually. The amplifier employs inverse feedback and is very stable . . . accuracy is independent of line voltage and tube characteristics. Because the input is to the grid of the amplifier and is equivalent to 200,000 ohms, it will not load down the circuit being measured. The sensitivity of the vacuum tube voltmeter in combination with the amplifier is such that hum may be measured directly and voltage measured as low as .0005.

The *-hp-* Model 325B covers the audio frequency spectrum, supplying frequencies of 30 cps, 50 cps, 100 cps, 400 cps, 1000 cps, 5000 cps, 7500 cps, 10,000 cps and 15,000 cps within $\pm 5\%$. These frequencies cover FCC recommendations for checking FM as well as AM broadcast. The meter scale is calibrated in volts and in db.

The *-hp-* Model 325B in combination with *-hp-* 200 series Audio Oscillators provides equipment to make most laboratory AF measurements including distortion, power, gain and frequency response. Write for complete information now.

OTHER *-hp-* INSTRUMENTS

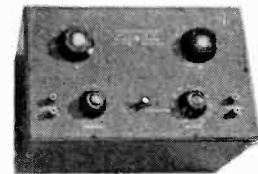

Distortion Analyzer

The Model 320A consists of two fundamental elimination circuits, 400 cps and 5000 cps, together with a calibrated attenuator reading in decibels.

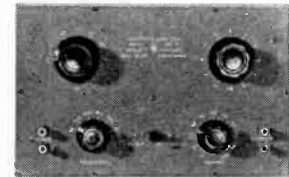

Distortion Analyzer

The Model 320B consists of six fundamental elimination circuits, 50, 100, 400, 1000, 5000 and 7500 cps, together with a calibrated attenuator reading in decibels.

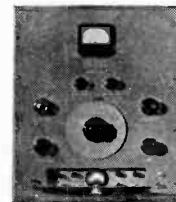

Harmonic Wave Analyzer

The Model 300A consists of a highly selective amplifier which measures the individual components of a complex wave.



Attenuator and Voltage Divider

The Model 350A is a bridged-T attenuator consisting of one 100 db attenuator with 10 db steps and a 10 db attenuator having 1 db steps.

HEWLETT-PACKARD COMPANY

BOX 1045D • STATION A • PALO ALTO, CALIFORNIA

- Audio Frequency Oscillators
- Signal Generators
- Vacuum Tube Voltmeters
- Noise and Distortion Analyzers
- Wave Analyzers
- Frequency Meters
- Square Wave Generators
- Frequency Standards
- Attenuators
- Electronic Tachometers



**20,000
VOLTS
IN A
2³/₈" BULB!**

ANOTHER "FIRST" BY NATIONAL UNION RESEARCH LABORATORIES

AN example of how war-time research by National Union engineers is helping to lay the foundation for vastly improved post-war Television, FM and radio reception, is this new half wave high vacuum rectifier—the NU 1Z2.

Here is a miniature with the voltage handling capabilities heretofore possible only in full size tubes. For a high voltage rectified supply in the operation of radar and television equipment, the NU 1Z2 saves space—operates with increased efficiency—is exceptionally rugged. Its low filament power consumption suggests many new fields in circuit design and application.

The NU 1Z2 joins a notable group of original electron tube developments by National Union Research Laboratories. For progress through research—count on National Union.

*National Union 1Z2
High Voltage Rectifier*

Inverse peak anode voltage—max.....	20,000 volts
Peak anode Current.....	10 ma.
DC Output Current.....	2 ma.
Filament Voltage.....	1.5 volts
Filament Current.....	300 ma.

The NU 1Z2 is designed to withstand shocks in excess of 500 G's.

Maximum overall length.....	2.70"
Maximum seated height.....	2.37"
Maximum diameter.....	.75"
Bulb.....	T5½
Base Miniature Button.....	7 pin
Mounting position.....	Any

**NATIONAL UNION
RADIO AND ELECTRON TUBES**

NATIONAL UNION RADIO CORPORATION · NEWARK 2, N. J.



GREAT GENERAL-PURPOSE TRANSMITTING TUBE

TYPE GL-805

\$10



Here is a leader in General Electric's highly developed, *complete* line of transmitting tubes! Type GL-805 not only gives you high power output at relatively low plate voltages (see ratings below), but the tube's grid-bias requirements are unusually low (zero for many Class B operating conditions). These features mean economy in use.

Type GL-805 does a wide variety of jobs efficiently. It is used in the low-power stages of large transmitters, and also as a power amplifier in smaller

stations. An excellent amateur tube, as well as standard for other communications, the GL-805 is one of the more versatile transmitting types.

High amplification factor, and a frequency range above most power-tubes in its class (30 megacycles at maximum plate output; 80 at reduced ratings)—these are still other advantages. See your nearest G-E office or distributor for further information, or write *Electronics Department, General Electric Company, Schenectady 5, N. Y.*

Check these ratings

New Booklet ETX-5 gives ratings and prices on General Electric's complete line of transmitting tubes. Ask for your free copy.

Continuous ratings	Class B A-F service (two tubes)	Class C R-F service, plate-modulated	Class C R-F service, without modulation
Filament voltage	10 v	10 v	10 v
Filament current	3.25 amp	3.25 amp	3.25 amp
Max plate voltage	1,500 v	1,250 v	1,500 v
Max plate current	210 ma (per tube)	175 ma	210 ma
Max plate input	315 w (per tube)	220 w	315 w
Max plate dissipation	125 w (per tube)	85 w	125 w
Driving power (approx.), typical operation	7 w	16 w	8.5 w
Plate power output, typical operation	370 w	140 w	215 w

GENERAL  ELECTRIC

161-D10-8850

TRANSMITTING, RECEIVING, INDUSTRIAL, SPECIAL PURPOSE
TUBES • VACUUM SWITCHES AND CAPACITORS

Proceedings of the I.R.E. October, 1945

A WISE TREND

A few years ago plugs and jacks were uncommon except for a few applications in radio and test equipment. Today the trend to greater use of plugs and jacks is fast becoming standard practice in radio and electronic industries.

Keeping up with this trend, Johnson has designed many new plugs to meet industries special requirements, as well as supplying standard plugs which are being used in an increasing number of new applications.

The use of plugs on components is growing more popular, speeding production, facilitating easy replacement and interchanging of parts.

Plug and jack assemblies make it possible to remove sections of equipment for repair and maintenance without disturbing the wiring, and in police, fire, railroad and similar installation, units which fail may be quickly replaced with little delay in operation.

Let Johnson, a pioneer in the manufacture of plugs and jacks, supply you with a plug and jack combination or assembly to meet your requirements.

Send us your problem.



Ask for catalog 968-S



JOHNSON

a famous name in Radio

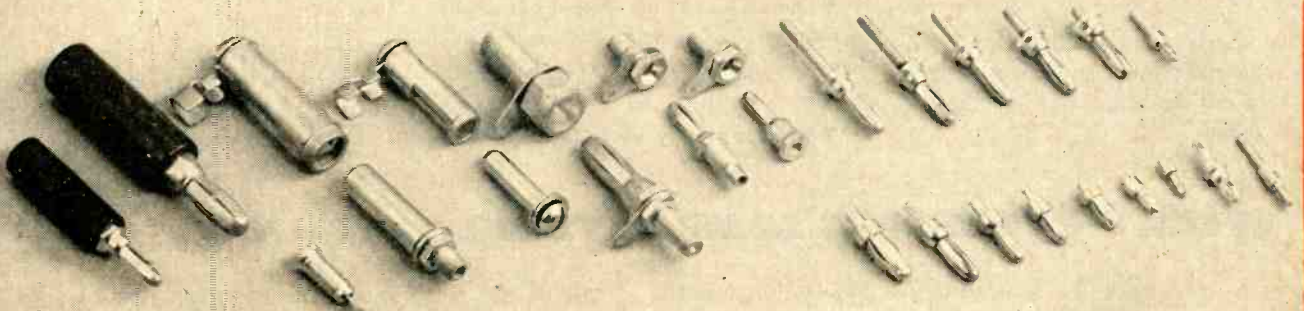

E. F. JOHNSON COMPANY • WASECA • MINNESOTA

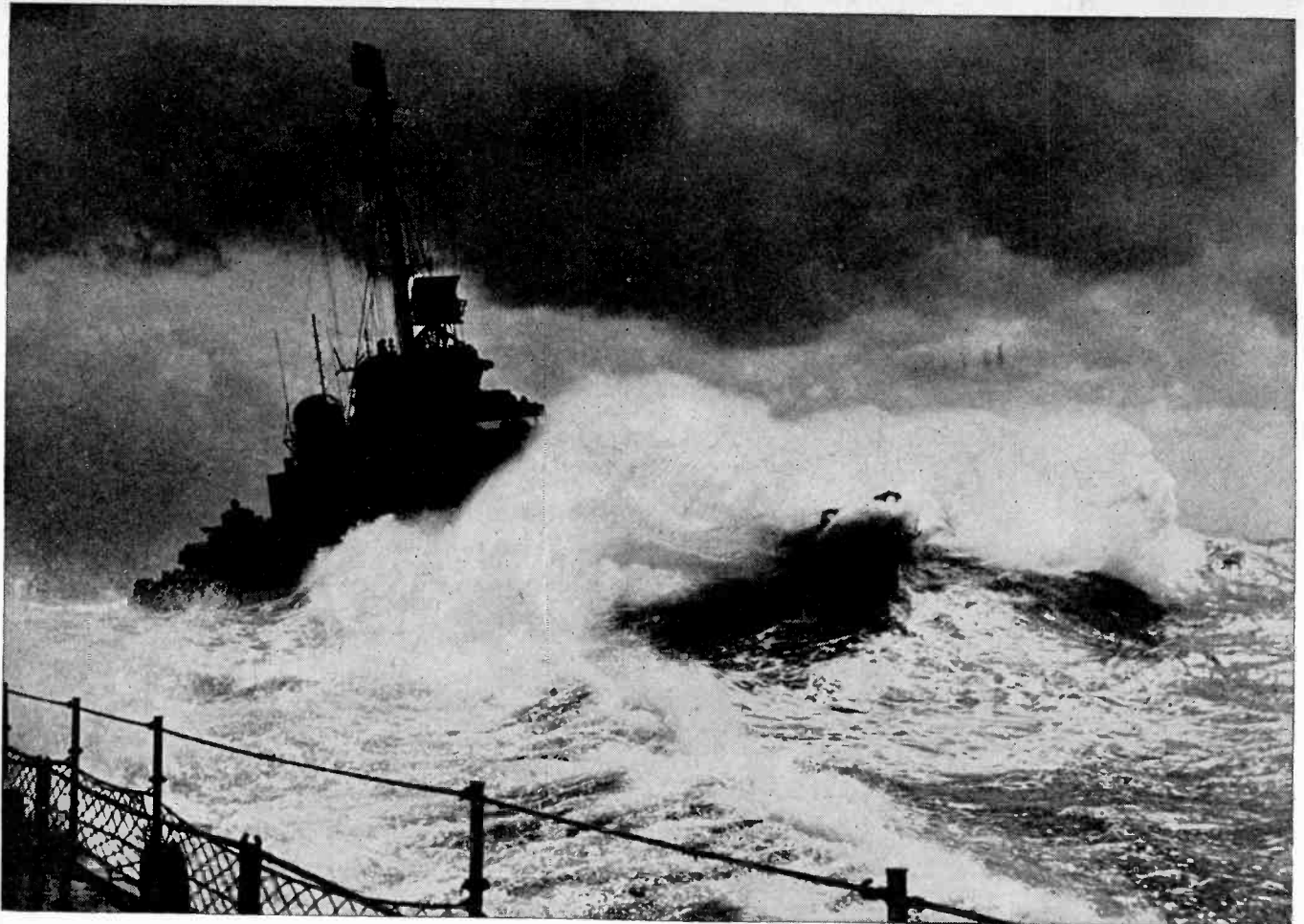

OFFICIAL U. S. NAVY PHOTO

Any port in a storm ... but there are no ports

More than one sailor has said, "It's a helluva place to fight a war!"

That's a miracle of understatement when you know the Pacific as well as the U. S. Navy knows it.

They know how many thousands of miles you have to go before you reach the fighting fronts.

They know there's almost continual rain and bad weather to hamper operations after you get there.

And they know there are no good ports!

Think of the thousands of ships, and the millions of tons of supplies it takes to keep our fighting forces moving toward Japan.

Imagine, if you can, the problem of handling those ships and supplies with no port facilities.

There are no giant cargo cranes...no miles of docks and warehouses...nothing but beaches, and human backs, and a refusal to call any job impossible.

Remember, too:

It takes 3 ships to do the supply job in the Pacific that 1 ship can do in the Atlantic.

It takes 6 to 11 tons of supplies to put a man on the Pacific battleline, and another ton per month to keep him supplied.

It takes a supply vessel, under ideal

conditions, half a year to make one round trip.

Add up those facts, multiply by the number of sailors, soldiers, and marines for whom the Navy is responsible.

Maybe you'll begin to realize what "no ports" can mean in the rough, tough waters of the Pacific.

Maybe you'll see that we have *two* reasons to be proud of the U. S. Navy. *First*, the way they've sunk the enemy's ships.

Second, the way they sail *your* ships... taking the worst the Pacific can hand them... but keeping the supply lines open... keeping the attack *on schedule!*

SPERRY GYROSCOPE COMPANY, INC. GREAT NECK, N. Y.



Division of the Sperry Corporation

★
LOS ANGELES • SAN FRANCISCO • SEATTLE • NEW ORLEANS
CLEVELAND • BROOKLYN • HONOLULU

MAKERS OF PRECISION INSTRUMENTS FOR THE ARMED FORCES

REMEMBER THE NAME

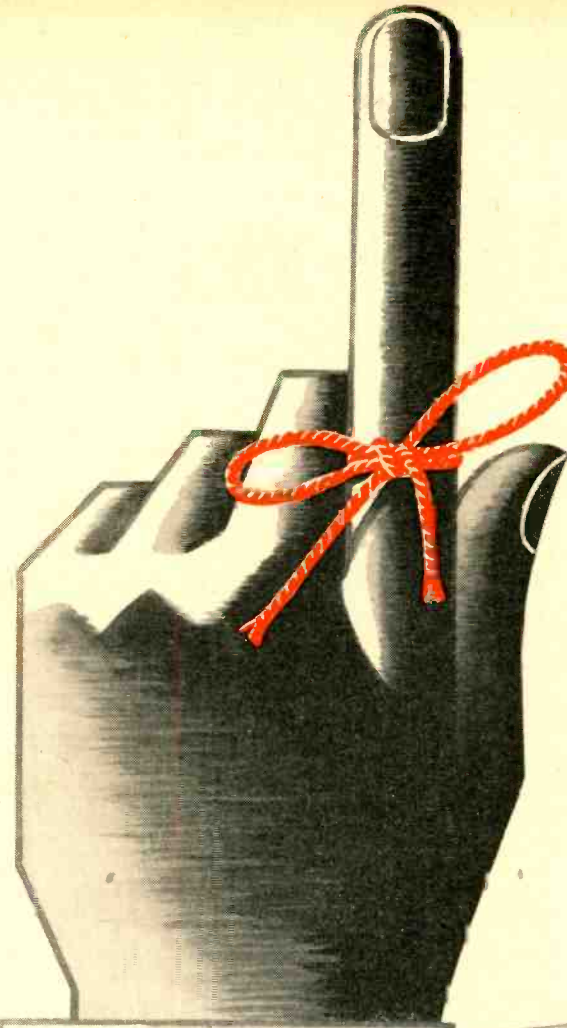

Remember the name ALSIMAG.

It represents the highest quality Steatite Ceramics for electrical and other technical uses.

Assembled in your design *you can forget the insulators.*

For they will give trouble-free, worry-free service from now on.

Whatever you are planning in the electronic or electrical field, we believe our specialized knowledge will be helpful.

Let's work together.

AMERICAN LAVA CORPORATION

CHATTANOOGA 5, TENNESSEE

43RD YEAR OF CERAMIC LEADERSHIP



ALCO has been awarded for the fifth time the Army-Navy "E" Award for continued excellence in quantity and quality of essential war production.

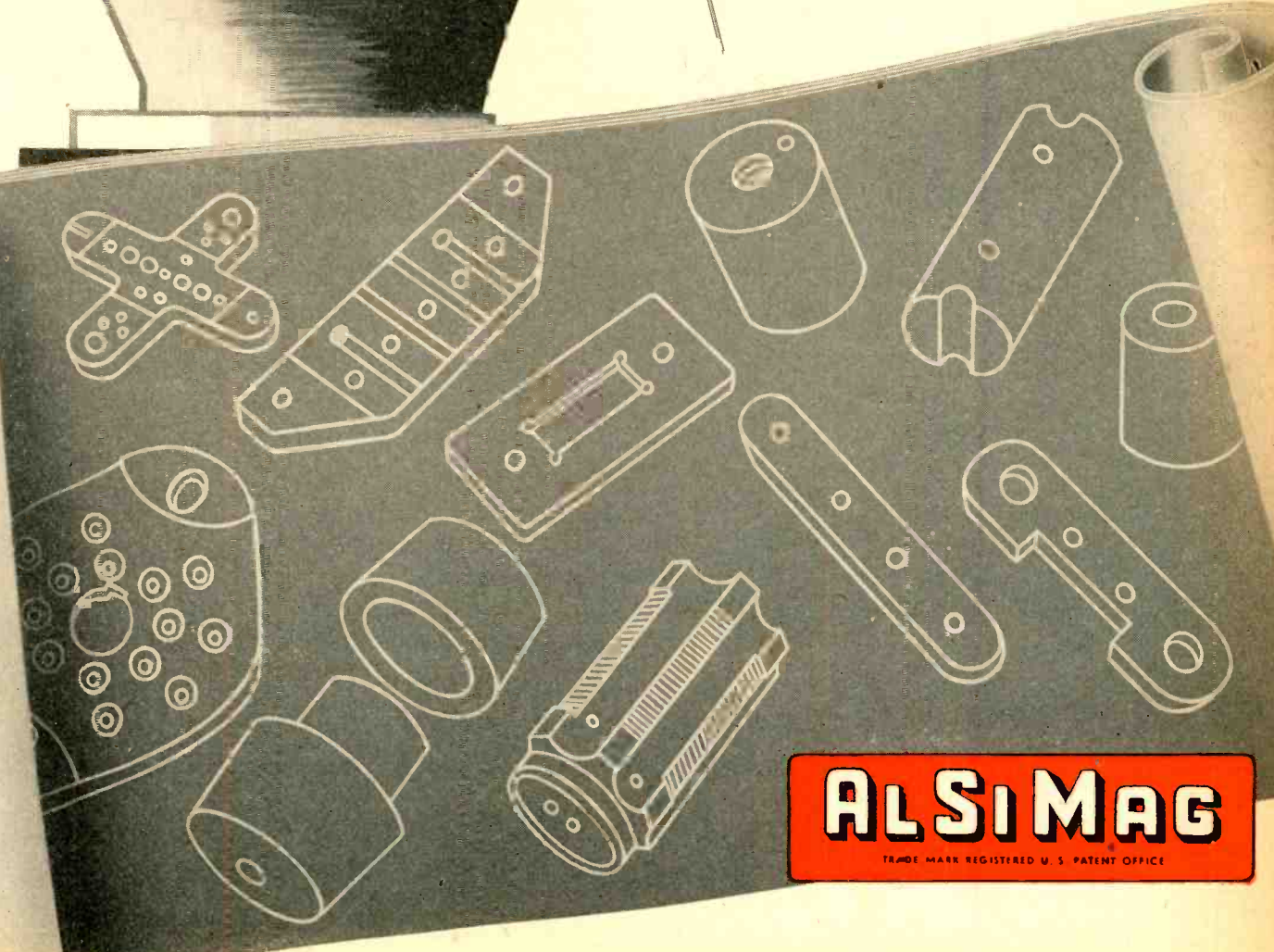

RADAR

is not new to the Blaw-Knox Company

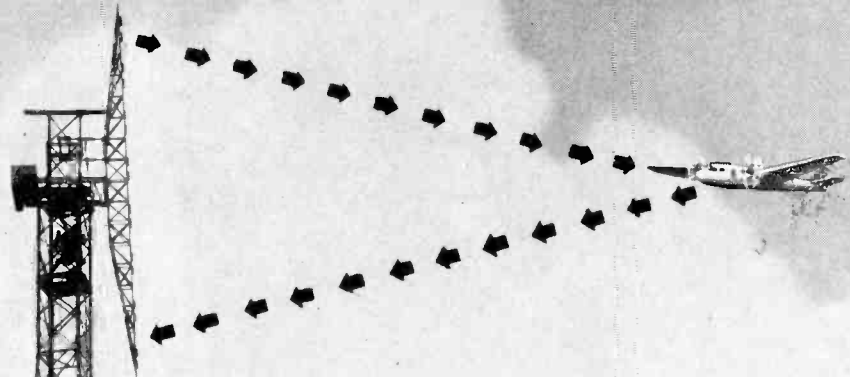

Blaw-Knox engineers, in close cooperation with the United States Army Signal Corps, developed and designed Radar Towers and Buildings in 1938, resulting in the construction of a complete operating unit in 1939.

Since then, many Tower Structures have been designed for different types of Army and Navy Radar service and produced in quantity.

As a result of these developments the Engineering and Manufacturing personnel of Blaw-Knox have gained an unparalleled experience which is now available to the Broadcast and Communication Industries.

Whether it's FM, AM, or Television, you can be sure of getting the most out of your power and equipment by "Putting the Call Through" on Blaw-Knox Vertical Radiators and Radio Towers.

BLAW-KNOX

BLAW-KNOX DIVISION OF BLAW-KNOX COMPANY
2037 Farmers Bank Building • Pittsburgh, Pa.

NEW YORK • CHICAGO • PHILADELPHIA • BIRMINGHAM • WASHINGTON • Representatives in Principal Cities

THYRATRON WL-678
Grid Controlled Mercury Vapor Rectifier

General Characteristics	50° C Max. Thg
Filament Voltage	5.0 Volts
Filament Current	7.5 Amperes
Filament Heating Time (Minimum)	1 Minute
Typical Control Bias at Rated Voltage	-75 Volts
Maximum Ratings	
Anode Voltage, Peak Forward	15000
Anode Voltage, Peak Inverse	15000
Anode Current, Average	1.6 Amperes
Anode Current, Peak	6 Amperes
Temperature Range, Condensed Mercury	25 to 50° C

THIS NEW

15,000 VOLT

THYRATRON

**provides split-cycle control of high power
for R. F. heating units, and radio transmitters**

The WL-678 combines the high voltage characteristics of a Kenotron, the efficiency of a Phanotron, and the controlability of a Thyatron. This latest feat of Westinghouse engineering offers the electronic equipment designer the following outstanding advantages:

- Smooth and instantaneous power control from 0% to 100% load . . .
- Simplified automatic load control . . .
- High speed automatic overload protection . . .
- Low space and weight requirements . . .
- Low control power requirements . . .

For more detailed information—write to your nearest Westinghouse office or to Westinghouse Electric Corporation, Lamp Division, Bloomfield, N.J. Westinghouse Electronic Tube distributors are located in principal cities.

Westinghouse
PLANTS IN 25 CITIES OFFICES EVERYWHERE

Electronic Tubes at Work

POWER TUBE ANODES

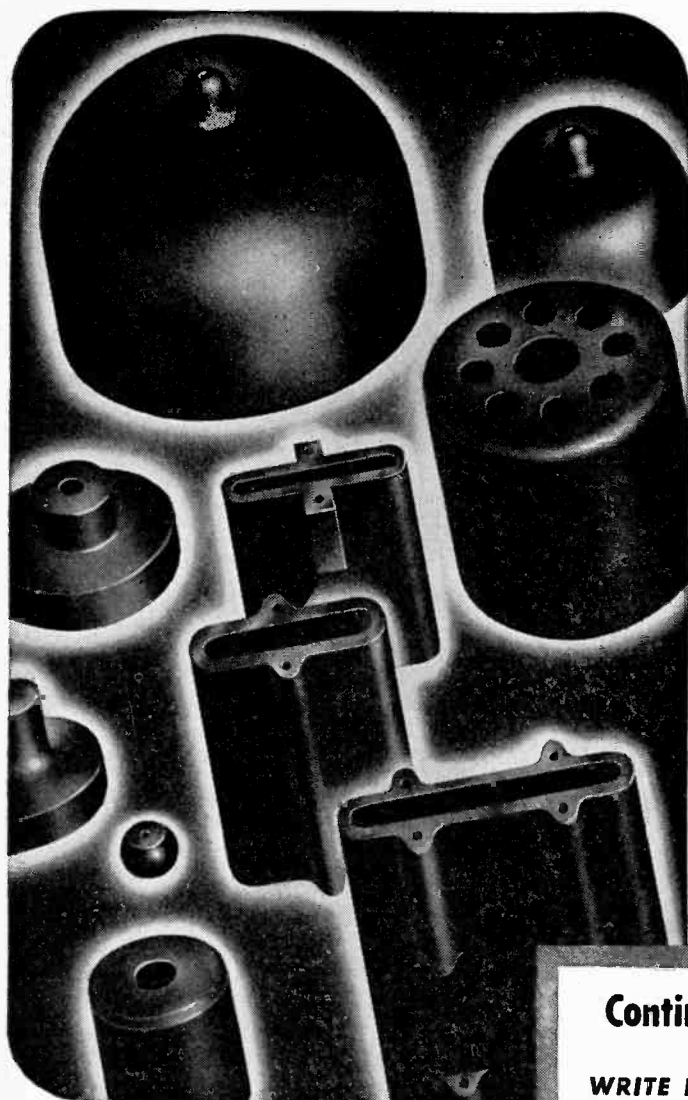

Standard or Special Types



Stackpole Power Tube Anodes are "tailor-made" for the specific tube type involved. Whether your need is for a standard type or something new for a tube type that has never been made before, Stackpole engineering is well equipped to serve you. Years of experience throughout the entire and highly ramified power tube field are your assurance of the closest possible match to your specifications—or samples which may enable you to set a new, higher standard for your present anode specifications.

STACKPOLE CARBON COMPANY
St. Marys, Pa.

STACKPOLE

ELECTRICAL BRUSHES and CONTACTS
(All carbon, graphite, metal, and composition types)

RARE METAL CONTACTS

WELDING RODS, ELECTRODES and PLATES

BRAZING BLOCKS

RHEOSTAT PLATES and DISCS

PACKING, PISTON and SEAL RINGS

CARBON REGULATOR DISCS

SINTERED IRON COMPONENTS

CARBON PIPE, etc.

Continuously Adjustable Carbon Rheostats

(CARBON PILES)

**WRITE FOR
THIS NEW
BOOKLET**

Stackpole Engineering has developed the Continuously Adjustable Rheostat formed of piles of carbon discs to a state of efficiency where it is now being used and considered for applications heretofore reserved for rheostats of other, but less satisfactory types. Write for new Bulletin, just off press, describing this development in detail.



STACKPOLE

"EVERYTHING IN CARBON BUT DIAMONDS"

And now . . .

MYCALEX

410

PRECISION-MOLDED

**Newest and Greatest Advancement
in Low Loss Insulation**

Just as sound advanced motion pictures and as television is advancing radio, so the new improved MOLDED MYCALEX will advance the cause of electronic engineers who seek ever-higher standards in insulating materials.

New and exclusive methods of MYCALEX CORPORATION now enable us to mold MYCALEX to far more exacting specifications . . . closer tolerances, with metal inserts molded in and other refinements.

Our technique affords a virtually endless variety of irregular shapes that compare with molded plastics for smoothness and precision. Yet MYCALEX offers so much more in electrical and physical advantages.

For example: greater strength and dimensional stability, freedom from cold flow, freedom from carbonization, imperviousness to moisture and gases . . . ability to withstand temperatures beyond 400 C.

Investigate the new uses and applications of this remarkable new advancement in MYCALEX. Get the facts about MYCALEX 410.



MYCALEX CORPORATION OF AMERICA

"Owners of 'MYCALEX' Patents"

Plant and General Offices, CLIFTON, N. J.

Executive Offices, 30 ROCKEFELLER PLAZA, NEW YORK 20, N. Y.

for POSITIVE HERMETIC SEALING

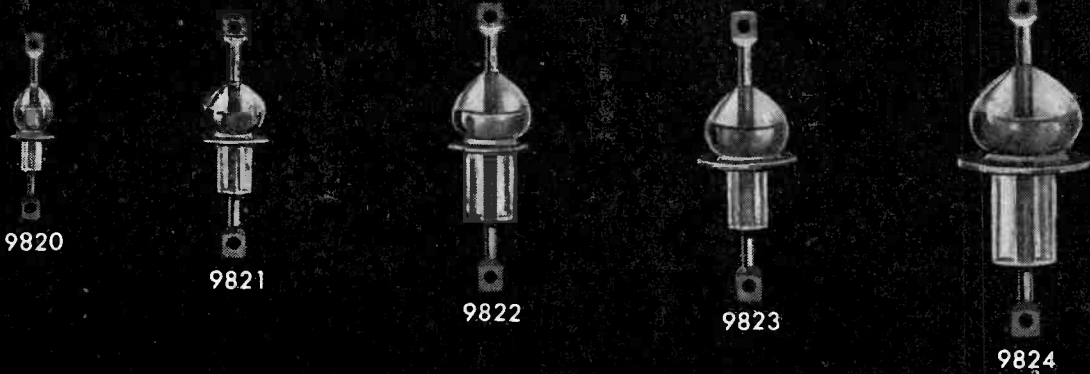

PART No.	Average of Actual Test Flash Over or Breakdown Voltage R.M.S.	Recommended Maximum Use Voltage at Sea Level R.M.S.
9820	4,750	2,500
9821	6,900	5,000
9822	9,624	7,500
9823	9,300	7,500
9824	12,725	9,000

INSULATION RESISTANCE OVER 1,000,000 MEGOHMS

Actual Size Photograph

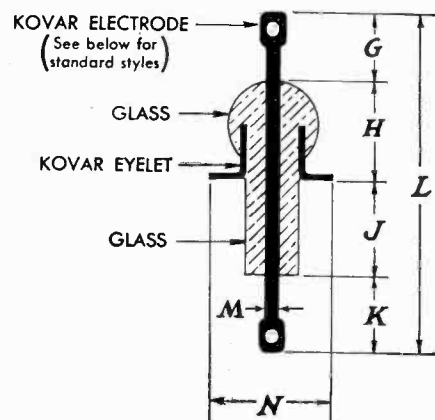

STANDARD SIZES (other sizes to your specifications)							
PART	G	H	J	K	L	M	N
9820	$\frac{3}{16}$	$\frac{3}{16}$	$\frac{3}{16}$	$\frac{3}{16}$	$\frac{1}{8}$.040	.212
9821	$\frac{1}{4}$	$\frac{3}{8}$	$\frac{1}{4}$	$\frac{1}{4}$	$1\frac{1}{8}$.060	.340
9822	$\frac{1}{4}$	$1\frac{1}{2}$	$1\frac{1}{2}$	$\frac{1}{4}$	$1\frac{1}{4}$.080	.380
9823	$\frac{1}{4}$	$1\frac{1}{2}$	$1\frac{3}{4}$	$\frac{1}{4}$	$1\frac{1}{4}$.080	.500
9824	$\frac{1}{4}$	$\frac{1}{2}$	$\frac{1}{2}$	$\frac{1}{4}$	$1\frac{1}{2}$.080	.672



STANDARD ELECTRODE STYLES AVAILABLE IN COMBINATION (EXCEPT B)

METAL-GLASS SEALS by STUPAKOFF

The series of Stupakoff metal-glass seals illustrated offers maximum electrical qualities consistent with space limitations and simplicity of design permitting mass production. They are suitable for operation at temperatures from -55°C to $+200^{\circ}\text{C}$, and are tested to meet thermal shock specifications of the services. The construction provides a hermetic seal with a long electrical leakage path, resistance to thermal shock and mechanical strength.

Such seals are made possible by the metal, Kovar, a cobalt, nickel, iron alloy which matches the expansion of certain hard glasses from -80°C to the annealing point of the glass (approx. $+450^{\circ}\text{C}$). Kovar forms a seal through a heating process in which the oxide of Kovar is dissolved into the glass to form a perfect bond—pressure and vacuum tight under extreme climatic conditions.

Stupakoff furnishes Kovar-glass seals with single or multiple electrodes in various styles. For those equipped for glass working, Stupakoff supplies Kovar as rod, sheet, wire, tubing or fabricated into cups, eyelets or special shapes.

Write Stupakoff today for assistance in developing hermetically sealed components for war applications. Samples and reprints of this advertisement may be obtained by writing department K-56.

Do More Than Before—Buy EXTRA War Bonds



STUPAKOFF CERAMIC AND MANUFACTURING CO., LATROBE, PA.

Products for the World of Electronics



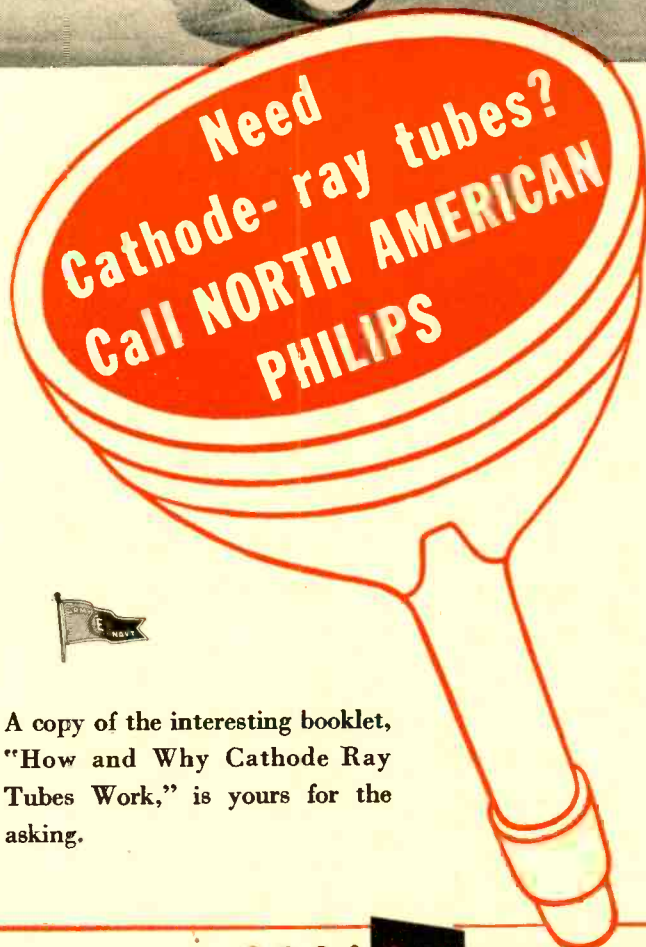

A copy of the interesting booklet, "How and Why Cathode Ray Tubes Work," is yours for the asking.

NORTH AMERICAN PHILIPS has the ability to supply many sizes and varieties of cathode ray tubes... every one backed with the long life reputation gained by NORELCO tubes now in service.

Because North American Philips is one of the largest specialists in the production of cathode ray tubes, your requirements are in the hands of experts when you specify NORELCO.

And this specialized knowledge goes back to the earliest work in cathode ray tubes, because North American Philips draws on the experience gained by an organization with a background of over fifty years of research and development in the electrical field.

Make North American Philips your headquarters for cathode ray tubes.

Norelco Electronic Products by
 Reg. U. S. Pat. Off.



OTHER PRODUCTS: Quartz Oscillator Plates; Searchray (Industrial X-ray) Apparatus, X-ray Diffraction Apparatus; Medical X-ray Equipment, Tubes and Accessories; Tungsten and Molybdenum Products; Fine Wire; Diamond Dies.

- We invite you to visit our office and showroom when in New York City.

NORTH AMERICAN PHILIPS COMPANY, INC.
 Dept. F-10 100 East 42nd Street, New York 17, N. Y.
 Factories in Dobbs Ferry, N. Y.; Mount Vernon, N. Y. (Metalix Div.); Lewiston, Me. (Elmet Div.)



We, the "decadent democracies," the "softies and amateurs," went in and tackled the "professionals"—showed them how to wage and win a war.

Now, Let's Show Them
How To Win The Peace!

Shortages of materials? Pricing problems? Production flow problems? G. I. is not alone with these problems. They are just hurdles in the race to attain peak production and the greatest possible employment. The war ended so suddenly, Glory be, that some hitches are inevitable. But like the rest of industry, we are taking a realistic view. Every day breaks another bottleneck and output surges ahead.

We are putting into practical operation the advanced techniques, the ingenuity and know-how which were the natural outgrowth of five years of intensive war effort, in the manufacture on an extensive scale of

*VARIABLE CONDENSERS • TUNING MECHANISMS • SPEAKERS
RECORD CHANGERS • AND OTHER RADIO COMPONENTS*

GENERAL **I**NSTRUMENT
CORPORATION •

829 NEWARK AVENUE, ELIZABETH 3, N. J.



Copyright 1945 G.I. Corp.

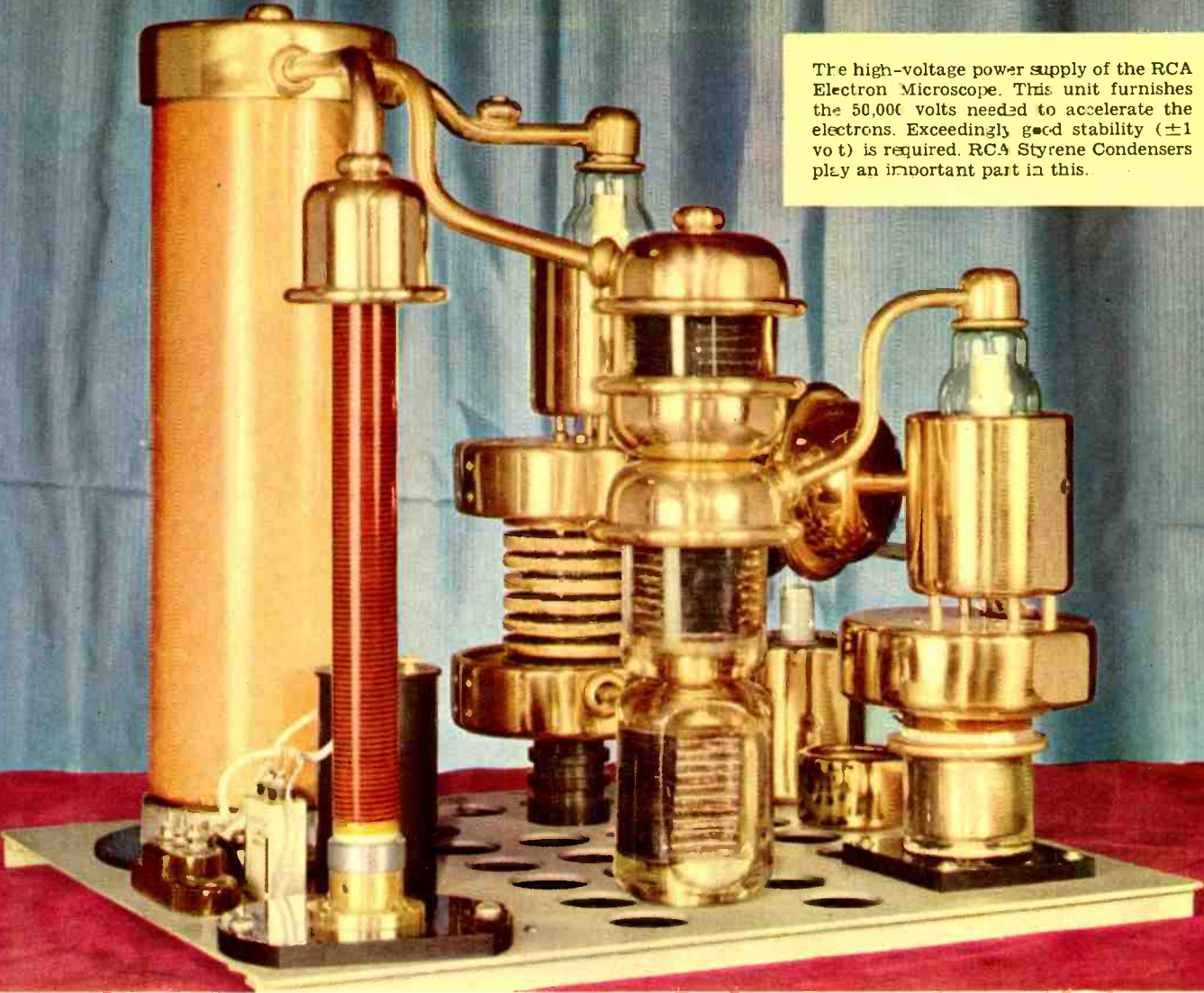

The high-voltage power supply of the RCA Electron Microscope. This unit furnishes the 50,000 volts needed to accelerate the electrons. Exceedingly good stability (± 1 volt) is required. RCA Styrene Condensers play an important part in this.

RCA STYRENE CONDENSERS FOR ELECTRONIC EQUIPMENT

THE latest development in mica capacitors is a new type of Faradon Condenser in which the mica and foil "stack" is imbedded in clear styrene.

The use of styrene, instead of the usual wax, improves the "sealing," thus providing much better stability. Moreover, because the styrene has a lower power factor, the losses are less, and current ratings (for the same temperature increase) are higher.

At the present time limited to use in high-priority equipment, styrene capacitors are expected to find a wide range of uses in postwar transmitting, communication, and electronic equipment.

For complete information on Faradon Capacitors, for any purpose, write to the Engineering Products Department, RCA Victor Division, Camden, New Jersey.

A two-section styrene condenser from the power supply shown above. In some instances, these condensers can be used without case as shown here. Usually, however, they are mounted in standard cases.

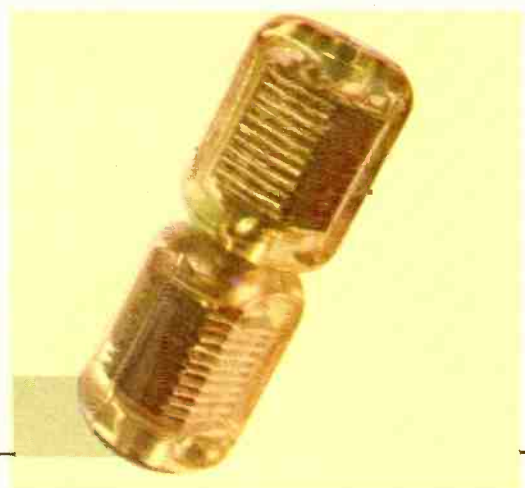

BUY MORE WAR BONDS



RADIO CORPORATION OF AMERICA

RCA VICTOR DIVISION • CAMDEN, N. J.

In Canada, RCA VICTOR COMPANY LIMITED, Montreal

THE PRICE OF RCA-833A's HAS BEEN REDUCED 26.5% IN LESS THAN 2 YEARS

Now listed at only \$62.50, this sturdily constructed, long-lasting triode has found many applications in industrial, as well as broadcasting, equipment.



THE 833A is RCA's most powerful glass triode. With forced-air cooling, under CCS ratings, it will take a maximum input of 1250 watts in plate-modulated service, and 1800 watts in oscillator service—at frequencies as high as 20 megacycles.

Under CCS ratings, with natural cooling, the RCA-833A will take a maximum input of 1250 watts at frequencies as high as 30 megacycles.

Among the applications of this tube are:

1. Radio transmitters, both fixed and mobile.
2. Electronic generators for dielectric heating.
3. Electronic generators for induction heating of small metal parts, such as gears.
4. High-power sound systems.
5. Variable-frequency measuring equipment.

DESIGN FEATURES

100-Watt Thoriated-Tungsten Filament—provides a tremendous emission reserve, which protects against unexpected overloads and adds greatly to filament life.



Giant Zirconium Anode—provides abundant dissipation for high power-output at frequencies up to 30 megacycles. (Maximum of 400 watts CCS rating, with forced-air cooling.)

Filament End-Shielding—special plate construction conserves input power by preventing bulb bombardment.

Post-Terminal Construction—Electronic heating, used in making metal-to-glass seals in the 833A, made possible a compact tube that packs high power into a minimum of space. Post terminals extend through bulb to provide support for electrodes. Results in a rugged construction that lends itself to heavy-duty industrial applications.

Write for Data: For complete technical data on this tube, write to RCA, Commercial Engineering Department, Section 62-35P, Harrison, N. J.

THE FOUNTAINHEAD OF MODERN TUBE
DEVELOPMENT IS RCA



62-6196-35

**RADIO CORPORATION
OF AMERICA**

RCA VICTOR DIVISION • CAMDEN, N. J.

BOARD OF DIRECTORS

1945

- William L. Everitt
President
Hendrik J. van der Bijl
Vice-President
Raymond A. Heising
Treasurer
Haraden Pratt
Secretary
Alfred N. Goldsmith
Editor
Lynde P. Wheeler
Senior Past President
Hubert M. Turner
Junior Past President
1943-1945
Wilmer L. Barrow
F. B. Llewellyn
Harold A. Wheeler
1944-1946
Raymond F. Guy
Lawrence C. F. Horle
William C. White
1945-1947
Stuart L. Bailey
Keith Henney
Benjamin E. Shackelford
1945
E. Finley Carter
Lewis M. Clement
Ralph A. Hackbusch
Donald B. Sinclair
William O. Swinyard
●
Harold R. Zeamans
General Counsel

BOARD OF EDITORS

- Alfred N. Goldsmith
Editor
Ralph R. Batcher
Robert S. Burnap
Philip S. Carter
Lewis M. Clement
J. D. Cobine
William G. Dow
Elmer W. Engstrom
William L. Everitt
William G. H. Finch
George W. Gilman
Peter C. Goldmark
Alois W. Graf
Frederick W. Grover
Lewis B. Headrick
C. M. Jansky, Jr.
Hugh S. Knowles
John D. Kraus
Donald G. Little
Frederick B. Llewellyn
Samuel S. Mackeown
Nathan Marchand
E. D. McArthur
Edward L. Nelson
Harry F. Olson
Harold O. Peterson
Greenleaf W. Pickard
Ralph A. Powers
Haraden Pratt
Conan A. Priest
Herbert J. Reich
Vernon W. Sherman
Lynne C. Smeby
E. C. Wente
Harold A. Wheeler
William C. White
Laurens E. Whittemore
Gerald W. Willard
William Wilson
Charles J. Young
Vladimir K. Zworykin

Proceedings of the I·R·E

Published Monthly by

The Institute of Radio Engineers, Inc.

VOLUME 33

October, 1945

NUMBER 10

Section Meetings.....	636
Responsibility of the Radio Engineer to the Engineering Profession..... H. W. Sundius	637
Keith Henney: Board of Directors—1945-1947.....	638
I.R.E. Special Committee on Obtaining Membership Talents and Volunteer Service..... E. Finley Carter	639
Vacuum-Tube Radio-Frequency-Generator Characteristics and Appli- cation to Induction-Heating Problems..... T. P. Kinn	640
A 60-Kilowatt High-Frequency Transoceanic-Radiotelephone Ampli- fier..... C. F. P. Rose	658
Study of Ultra-High-Frequency Tubes by Dimensional Analysis..... G. J. Lehmann and A. R. Vallarino	663
Low-Frequency Compensation of Video-Frequency Amplifiers..... M. J. Larsen	666
The Design of Broad-Band Aircraft-Antenna Systems..... F. D. Bennett, P. D. Coleman, and A. S. Meier	671
Cathode-Coupled Wide-Band Amplifiers..... G. C. Sziklai and A. C. Schroeder	701
Band-Pass Bridged-T Network for Television Intermediate-Frequency Amplifiers..... G. C. Sziklai and A. C. Schroeder	709
Electron Transit Time in Time-Varying Fields..... Arthur B. Bronwell	712
Institute News and Radio Notes.....	717
Executive Committee.....	717
I.R.E. People.....	718
Correspondence:	
"Phase Inverter"..... D. L. Drukey	722
"Tridimensional Equivalent Circuits"..... G. M. Krijanovsky	723
"High-Frequency Error Curves for Adcock Radio Direction- Finder Arrays"..... James Holbrook	723
Emission—Limited Diode..... Virgil M. Brittain	724
Institute Representatives on Other Bodies—1945.....	725
Institute Committees—1945.....	726
Books: (See page 670 for complete list of reviewed books)	
Contributors.....	728
Section Meetings.....	44A
Membership.....	44A
Positions Open.....	54A
Advertising Index.....	94A

SECRETARIAL DEPARTMENT

George W. Bailey William H. Crew
Executive Secretary *Assistant Secretary*

EDITORIAL DEPARTMENT

Helen M. Stote Ray D. Rettenmeyer
Associate Editor *Technical Editor*
Winifred Carrière
Assistant Editor

ADVERTISING DEPARTMENT

William C. Copp Lillian Petranek
Advertising Manager *Assistant Advertising Manager*

Responsibility for the contents of papers published in the PROCEEDINGS rests upon the authors. Statements made in papers are not binding on the Institute or its members.



Changes of address (with advance notice of fifteen days) and communications regarding subscriptions and payments should be mailed to the Secretary of the Institute, at 330 West 42nd Street, New York 18, N. Y. All rights of republication, including translation into foreign languages, are reserved by the Institute. Abstracts of papers, with mention of their source, may be printed. Requests for republication privileges should be addressed to The Institute of Radio Engineers.

Copyright, 1945, by The Institute of Radio Engineers, Inc.

PAPERS COMMITTEE

- Frederick B. Llewellyn
Chairman
Herman A. Affel
Wilmer L. Barrow
Howard A. Chinn
James K. Clapp
Ivan S. Coggeshall
Seymour B. Cohn
Edward J. Content
Clifford W. Corbett
Murray G. Crosby
Frederick W. Cunningham
Robert B. Dome
Enoch B. Ferrell
Donald G. Fink
Howard S. Frazier
Robert L. Freeman
Stanford Goldman
Frederick W. Grover
O. B. Hanson
Thomas J. Henry
Edward W. Herold
John V. L. Hogan
Frederick V. Hunt
Harley Iams
Loren F. Jones
John G. Kreer, Jr.
Emil Labin
Frederick R. Lack
Hugo C. Leuteritz
Charles V. Litton
Knox McIlwain
Harry R. Mimno
Ilia E. Mouromtseff
G. G. Muller
Albert F. Murray
James R. Nelson
Dwight O. North
Allen F. Pomeroy
Jack R. Poppele
Simon Ramo
Francis X. Rettenmeyer
Sergei A. Schelkunoff
Donald B. Sinclair
Karl Spangenberg
Dayton Ulrey
A. P. Upton
Karl S. Van Dyke
E. K. Van Tassel
John R. Whinnery
Irving Wolff
J. Warren Wright
Harold R. Zeamans

PAPERS

PROCUREMENT COMMITTEE

- Dorman D. Israel
General Chairman
Edward T. Dickey
Vice General Chairman

GROUP CHAIRMEN

- Arthur B. Bronwell
Madison Cawein
Ivan S. Coggeshall
Murray G. Crosby
Alfred C. Crossley
Harry Diamond
Arthur E. Harrison
Theodore A. Hunter
James R. Nelson
Harry F. Olson
John D. Reid
Donald B. Sinclair
Howard J. Tzyzer
Karl S. Van Dyke
Wilbur L. Webb
William C. White



The Institute of Radio Engineers

INCORPORATED



SECTIONS

Sections	Next Meeting	Chairman	Secretary	Address of Secretary
ATLANTA	October 26	R. A. Holbrook	I. M. Miles	Georgia School of Technology, Atlanta, Ga.
BALTIMORE	—	R. N. Harmon	F. W. Fischer	714 S. Beechfield Ave., Baltimore, Md.
BOSTON	—	C. C. Harris	A. G. Bousquet	General Radio Co., Cambridge, Mass.
BUENOS AIRES (Argentina)	—	A. DiMarco	H. Krahenbuhl	Transradio Internacional, San Martin 379, Buenos Aires, Argentina
BUFFALO-NIAGARA	October 17	J. M. Van Baalen	H. W. Staderman	264 Loring Ave., Buffalo, N. Y.
CEDAR RAPIDS	October 19	F. M. Davis	J. A. Green	Collins Radio Co., 855—35 St., N.E., Cedar Rapids, Iowa
CHICAGO	October 19	Cullen Moore	L. E. Packard	General Radio Co., 920 S. Michigan Ave. Chicago 5, Ill.
CINCINNATI	—	L. M. Clement	J. F. Jordan	The Baldwin Co., 1801 Gilbert Ave., Cincinnati 2, Ohio
CLEVELAND	October 23	H. B. Okeson	A. J. Kres	16911 Valleyview Ave., Cleveland 11, Ohio
CONNECTICUT VALLEY	October 18	H. W. Sundius	L. A. Reilly	989 Roosevelt Ave., Springfield, Mass.
DALLAS-FORT WORTH	—	J. D. Mathis	B. B. Honeycutt	9025 Roanoak, Dallas 18, Texas
DAYTON	October 18	L. B. Hallman	Joseph General	411 E. Bruce Ave., Dayton 5, Ohio
DETROIT	October 19	L. H. Larime	R. R. Barnes	1810 Sycamore, Royal Oak, Mich.
EMPORIUM	—	W. A. Dickinson	H. E. Ackman	West Creek, R. D. 2, Emporium, Pa.
INDIANAPOLIS	—	H. I. Metz	E. E. Alden	4225 Guilford Ave., Indianapolis, Ind.
KANSAS CITY	—	R. N. White	Mrs. G. L. Curtis	6003 El Monte, Mission, Kan.
LONDON (Canada)	—	B. S. Graham	C. H. Langford	Langford Radio Co., 246 Dundas St., London, Ont., Canada
LOS ANGELES	October 16	R. C. Moody	R. G. Denechaud	Blue Network Co., 6285 Sunset Blvd., Hollywood 28, Calif.
MONTREAL (Canada)	October 17	L. A. W. East	R. R. Desaulniers	Canadian Marconi Co., 2440 Trent Rd., Town of Mt. Royal, Que., Canada
NEW YORK	—	G. B. Hoadley	J. T. Cimorelli	RCA Manufacturing Co., 415 S. Fifth St., Harrison, N.J.
OTTAWA (CANADA)	—	W. A. Steel	L. F. Millett	33 Regent St., Ottawa, Ont., Canada
PHILADELPHIA	November 1	D. B. Smith	P. M. Craig	Philco Corp., Philadelphia 34, Pa.
PITTSBURGH	November 12	J. A. Hutcheson	C. W. Gilbert	52 Hathaway Ct., R.F.D. 1, Wilkins- burg 21, Pa.
PORTLAND	—	Kenneth Johnson	C. W. Lund	Route 4, Bqx 858, Portland, Ore.
ROCHESTER	October 18	G. R. Town	A. E. Newlon	Stromberg-Carlson Co., Rochester 3, N.Y.
ST. LOUIS	—	B. B. Miller	N. J. Zehr	KWK, Hotel Chase, St. Louis 8, Mo.
SAN DIEGO	—	David Kalbfell	Clyde Tirrell	U. S. Navy Radio and Sound Labora- tory, San Diego 52, Calif.
SAN FRANCISCO	—	David Packard	William Barclay	Stanford University, Calif.
SEATTLE	November 8	G. L. Hoard	K. A. Moore	5102 Findley St., Seattle 8, Wash.
TORONTO	—	F. H. R. Pounsett	Alexander Bow	Copper Wire Products, Ltd., 137 Ron- cesvalles Ave., Toronto, Ont., Canada
TWIN CITIES	—	—	Merle Ludwig	Minneapolis-Honeywell Regulator Co., Minneapolis, Minn.
WASHINGTON	November 12	H. A. Burroughs	L. C. Smeby	4801 Connecticut Ave., N.W., Wash- ington, D. C.
WILLIAMSPORT	November 7	L. E. West	F. L. Burroughs	2030 Reed St., Williamsport 39, Pa.

SUBSECTIONS

Subsections	Next Meeting	Chairman	Secretary	Address of Secretary
COLUMBUS	—	E. C. Jordan	Warren Bauer	376 Crestview Rd., Columbus 2, Ohio
FORT WAYNE	—	—	—	—
MILWAUKEE	—	P. B. Laeser	E. L. Cordes	3304 N. Oakland Ave., Milwaukee, Wis.
MONMOUTH	—	L. J. Giacoletto	C. D. Samuelson	5 Russel Ave., Ft. Monmouth, N. J.
PRINCETON	October 12	W. C. Johnson	J. G. Barry	Princeton University, Princeton, N. J.
SOUTH BEND	—	H. E. Ellithorn	J. E. Willson	1002 S. Lombardy Dr., South Bend, Ind.

The Chairmen of the Sections of the Institute have been invited to express to the membership, in such editorial form as they may desire, views which they believe will be contributory to the future of the engineering profession. Thoughtful analyses and forward-looking discussions of this nature have been received. There follows, accordingly, a statement from the Chairman of the Connecticut Valley Section of the Institute.

The Editor

Responsibility of the Radio Engineer to the Engineering Profession

H. W. SUNDIUS

In looking around, it seems fairly safe to say that the radio engineer is about the most hard-working chap in the category of engineers. He is engaged in one of the newest of engineering fields and one that seems to snowball in complexity as new facts become known and new vistas are opened. The net result is apt to be that the radio engineer lives with his head buried in a resistance-inductance-capacitance circuit and remains oblivious to the passage of the world about him.

Engineering is one of the oldest of professions. It dates back into ancient history when in military operations it was necessary to erect earthworks and tunnel underground for strategical operations. The builder of the pyramids must have employed engineers of no small ability. The present age of machinery, science, and invention has seen a huge amplification and subdivision of what was once only the military and civil engineer. The mother stone has been chipped into many pieces with many differently hued facets. The broad subdivisions that have emerged are mechanical, electrical, and chemical. These in turn have been chipped into tiny pieces too numerous to mention as specialization has progressed.

All this leads to a definite conclusion relative to the education and responsibilities of the radio engineer who is an important offshoot of the electrical profession. Is it not reasonable to suppose that the older heads in the engineering fraternity have something to offer the junior contemporary if he will avail himself of the experience, guidance, and fellowship afforded by already well-established councils of engineers?

In Connecticut there has existed for a number of years a so-called Connecticut Technical Council, Inc., comprising representation from ten engineering societies in which are included two architectural groups. This Council has a splendid record of achievement. Mention of some of the specific activities will serve to illustrate the advantages that have accrued to the practicing engineer, and perhaps suggest other fields of usefulness.

The Connecticut Technical Council assisted in evolving standards for licensing professional engineers and passed on a code of professional ethics. Enforcement of the licensing law and code of ethics has been an important and successful contribution of the council. Recommendations to the Governor for appointment to the State Board of Registration for Professional Engineers and Land Surveyors as well as other engineering boards in the state is a periodic and desirable function. Legislation affecting the engineer is carefully watched and the member societies stirred into appropriate action. Legislation favorable to the engineer and engineering is introduced. The administrator of the State Housing Authority was requested to include engineers on this Authority. Such Acts as the Science Mobilization Act and the National Labor Relations Act have been discussed and appropriate action taken.

The Council is now acting as an advisory body to manufacturers associations and chambers of commerce. In general, the object is to place the engineer on a plane commensurate with the importance of the profession even as the American Medical Association has acted for its constituents.

The radio engineer has, unfortunately for himself and for his profession, held himself aloof from such activities, generally speaking. There are a number of combined engineering councils throughout the country that are rendering equal or perhaps better performances than our own Connecticut group. You officers of I.R.E. Sections investigate the local opportunities that are awaiting you to serve and be served for your good, the good of your profession, and the ultimate welfare of the consuming public. In unity there is strength. Join with other engineers in a common undertaking for our mutual welfare.



Keith Henney

Board of Directors—1945-1947

Keith Henney was born in McComb, Ohio, on October 28, 1896. Here, in 1912, he had his first experience with radio via a crystal detector and a two-slide tuner. In 1915 he moved to Marion, Ohio, went through high school there, and acquired his first experience in publishing by spending a year as cub reporter on the daily paper. His radio experience continued by means of rotary spark gaps, Thordarson 1-kilowatt transformers, and glass-plate capacitors in his amateur station 8ZD. During his undergraduate years at Western Reserve University he taught radio in Waite High School, in Toledo, and served as wireless operator on the Great Lakes in the summers.

Mr. Henney was graduated from Western Reserve University in 1921, and went to Harvard University, where he took the courses offered by Pierce and Chaffee, in addition to undergraduate work in physics and mathematics.

In 1923 he joined the technical staff of the Western Electric Company, returning to Harvard in 1925 to earn his master's degree. The next five years were spent developing a radio laboratory for Doubleday, Doran and Company, publishers of *Radio Broadcast*. In 1929 his first book, "Principles of Radio" was published. It is now in its Fourth Edition. In 1930 he became associate editor of *Electronics* upon its founding by the McGraw-Hill Publishing Company, becoming managing editor in 1934, and editor-in-chief in 1935, a position which he still holds.

In 1933 he edited the "Radio Engineering Handbook," now in its Third Edition; published "Electron Tubes in Industry," in 1934; "Color Photography for the Amateur," in 1938; and with Beverly Dudley, a Fellow member of The Institute of Radio Engineers, edited the "Handbook of Photography," in 1939.

During 1944 and 1945 Mr. Henney served as editor-in-chief on a University of California National Defense Research Committee project, preparing maintenance manuals on electronic equipment for the Bureau of Ships of the United States Navy.

At the 1944 Rochester Fall Meeting he was awarded a plaque for "his many years of unselfish service to the radio and electronic industries through the technical press."

He became an Associate of The Institute of Radio Engineers in 1918, a Member in 1926, Senior Member in 1943, and a Fellow in 1943. He was appointed a member of the Board of Directors in 1945. A member of the New York Program Meetings and Papers Committee for a number of years before the formation of the New York Section, his continual urge for "papers with demonstrations" helped in bringing to the New York engineers papers which were interesting as well as instructive. He served on the Executive Committee of the newly formed New York Section during its formative stages. Mr. Henney is also a Fellow and past president of The Radio Club of America and a Fellow of the Photographic Society of America.

I.R.E. Special Committee on Obtaining Membership Talents and Volunteer Service*

E. FINLEY CARTER†, FELLOW, I.R.E. (Chairman)

DURING the past year, a special committee was appointed by the Executive Committee of the Institute for the purpose of obtaining membership talents and volunteer service to aid in broadening participation in various Institute activities. The immediate aim of this committee was to set up means of obtaining lists of qualified individuals from which members could be selected for appointment to committees or to other assignments.

In exploring the possible approaches for accomplishing this aim, a number of conclusions were reached and recommendations have been made to the Executive Committee and the Board of Directors. Some of these recommendations were of a general nature while others were more specific in their relation to the procedures for selecting committee members and administering committee activities.

Among the specific recommendations was the one to establish in each Section a Section Personnel Committee whose function it would be to advise the National Office of personnel whom it deemed capable of and interested in serving on various committees of the Institute. This local committee would also recommend members for transfer from Associate to higher grades and assist such members in making transfers by arranging for sponsors and by securing and transmitting relevant information to the Admissions Committee.

The underlying reasons for the recommendation that each Section have a Committee on Personnel can be more fully appreciated in the light of the expansion that has taken place both in membership and in the scope of the Institute's activities. It is no longer possible for the Board of Directors or any similar group to be well versed in the qualifications and the personal interests of the Institute's thousands of members. On the other hand, Personnel Committees in each of the various sections can know and appraise the talents of their respective members and should, therefore, be able to render invaluable service to the Institute through the recommendations they make. This service should result, not only in more effective committees, but also in a better distribution and wider representation in Institute affairs. The work of the various Section Personnel Committees may prove to be an important step in the decentralization of that part of the Institute's administrative activities which can best be executed within the Sections.

Although only two specific functions were enumerated in Professor Turner's letter recommending that Section

Personnel Committees be set up in the various Sections, others will, no doubt, become apparent to these committees as they get underway. In selecting the Committee members, the Chairmen will probably want to pick men who, through their associations, can well represent the personnel of the entire Section.

Organization and Duties of Section Personnel Committees

The Chairman of the Section Personnel Committee should be a man whose interest and abilities particularly qualify him for the appointment. He should be assisted by committee members who are in the aggregate well acquainted with most, if not all, of the Section's members and engineers of standing in near-by non-Section territory. They should be familiar with the major activities of the Institute, the requirements for admission to the various membership grades, and the interest and abilities of the Section personnel.

As the name implies, the Section Personnel Committee should be a service group assisting the personnel composing the Section to derive the maximum benefits from I.R.E. membership by making their individual contributions through active participation in Institute affairs. By rendering this service effectively, the Section Personnel Committee can materially aid in assuring the selection of interested and well-qualified personnel to man the many important Institute committees.

In order to carry out its work, the Section Personnel Committee should first obtain a list of all members within the geographical bounds of its respective Section. However, the list should not be limited to the participants from their particular Section. It should also contain suggested names of any communication and electronic engineers in the neighboring territory, even though not covered by a Section, which the Section Personnel Committee believes should be included. This list should be classified as to membership grades and should contain pertinent information which will be helpful in determining when members qualify for transfer to higher grades. It should record interest and qualifications of individual members to aid the Section Personnel Committee in supplying the National Office with information which will allow the maintenance of a current list of personnel whose particular interest and abilities qualify them for work on committees or in other Institute activities.

From the data assembled for its working records, the Section Personnel Committee can help the Admissions Committee by first determining which members are qualified for transfer to a higher grade and then by contacting these members and helping those who want to

* Decimal classification: R060. Original manuscript received by the Institute, March 12, 1945.

transfer to make certain that their applications contain sufficient information to aid the Admissions Committee in passing on these applications. By helping members in contacting the necessary sponsors and by seeing that sponsors are provided with information to evaluate properly the engineering accomplishments of the applicants, the Section Personnel Committee can appreci-

ably aid the Admissions Committee in expediting the transfers.

In the carrying out of its functions, the Section Personnel Committee should seek to maintain the closest co-operation with Membership Committees in their respective Sections as well as with any other committee whose activities involve personnel functions.

Vacuum-Tube Radio-Frequency-Generator Characteristics and Application to Induction-Heating Problems*

T. P. KINN†, SENIOR MEMBER, I.R.E.

Summary—Induction heating at radio frequencies is rapidly taking its place in many industrial processes. The high-power vacuum tube, in the past used principally in radio applications, is now generating radio-frequency energy for industrial use. To apply this energy properly to industrial heating problems, it becomes necessary that engineers active in all phases of industry understand the characteristics and limitations of the vacuum-tube radio-frequency generator.

The fundamentals of the vacuum-tube self-excited oscillator and design considerations which determine the characteristics of the radio-frequency generator are reviewed and illustrated. In general, the characteristics show a high-impedance, constant-current, variable-voltage generator which requires manipulation of load circuits to load the generator properly. Methods are illustrated for accomplishing proper loading, and numerical examples are given illustrating the formulas and procedures necessary to any induction-heating problems.

DU TO wartime conditions, radio-frequency heating has had a chance to demonstrate that it can be a very useful tool. The vacuum tube used as a generator of this radio frequency has therefore placed itself in industry along with the more common generators of electric energy. The vacuum-tube radio-frequency generator, like any other piece of electrical equipment, has its characteristics, and these characteristics dictate its uses and limitations. It is the purpose of this paper to define some of these characteristics and show how to apply the radio-frequency generator properly to induction-heating problems.

The phenomena of producing heat by an alternating magnetic field was known as far back as the 1880s. In 1890, Colby was granted a patent for heating in this manner. In 1900, it is believed the first practical induction furnace was placed in operation by Kjellin. It has taken the ensuing years to produce electrical equipment suitable for supplying the alternating current at various frequencies for the purpose of induction heating. How-

ever, it has taken the need for "all-out" war production during these past years to provide the incentive for wide-spread use of this type of heating in industry. With this rapid advance in the use of induction heating, the use of the vacuum-tube oscillator as a source of alternating power for induction heating has shown a very rapid advance.

Except in isolated cases, the small amount of induction heating used in industry, prior to the present war, used power obtained from rotating machines or spark-gap oscillators. The vacuum-tube radio-frequency generator, along with the vacuum tube itself, is now showing its usefulness in industry. Because the vacuum-tube radio-frequency generator has been confined to the radio field up to this time, its operation and its characteristics are not too well known to those not connected with the radio industry.

Induction heating is now being done at frequencies from 60 to 10,000 cycles and higher by rotating machinery. The rotating machine is a common source of power, and therefore its use and limitations for induction heating are well known. Service and maintenance problems are well established.

The spark-gap oscillator finds its most useful range of frequencies between 20 and 200 kilocycles. This type of generator is very useful for certain specific applications. The main advantages are its simplicity and ease of operating technique, while its limitations are power output and reliability. New developments surrounding the spark gap itself, which are appearing now and will appear after the war, will help better the output and reliability of this type of generator.

The scope of both the rotating machine and the spark-gap generator is limited, and it is for this reason that the vacuum-tube radio-frequency generator has stepped into the picture to pick up where these other machines leave off. The vacuum-tube oscillator can do many of the jobs now being done by the rotating machine or the spark gap, and in addition, do many more jobs which neither of these types can accomplish. At the present

* Decimal classification: R355.9×621.375.1. Original manuscript received by the Institute, September 21, 1944; revised manuscript received, June 8, 1945. Based in part on a paper presented before the Pacific Coast Technical Meeting of the American Institute of Electrical Engineers, Los Angeles, California, August 29–September 1, 1944. Printed by permission of the A.I.E.E.

† Westinghouse Electric Corporation, Baltimore, Md.

time, when a job can be done by either rotating machine or a vacuum-tube generator, the initial investment cost is two or three to one in favor of the rotating machine. This is primarily due to the well-established manufacturing procedures and facilities for the rotating machine. Postwar use of the vastly expanded radio facilities, plus ever-increasing demand, will reduce this difference rapidly.

RADIO-FREQUENCY-GENERATOR CHARACTERISTICS

To the radio engineers the generation of radio-frequency power is not new, but to the average user in industry and to many engineers not directly associated with the radio industry, the radio-frequency generator is definitely a new device. Because the radio engineer has the background necessary properly to design the vacuum-tube radio-frequency generator, it has fallen to his lot to design and help produce the equipments which are now finding their way into industry. The uses to which the radio-frequency generator is being put in industry are numerous and in most cases entirely foreign to the radio engineer. For this reason, the radio engineer has had to analyze and study the various requirements in industry and transcribe these requirements into electrical specifications around which the radio-frequency generator must be designed. This is not an easy task because new uses for radio-frequency heating are constantly being found, which in many cases rapidly make obsolete the specifications devised by the engineers. Properly to specify and design the radio-frequency equipment for high-frequency heating, the engineer must familiarize himself thoroughly with the theories and practices necessary for the application of high-frequency heating. It is the purpose of this paper to cover some of the more important characteristics that must be designed into the radio-frequency generator, and how these characteristics affect the application of the generator to induction-heating problems.

The radio-frequency generator goes into industry as another tool just the same as the lathe, the automatic screw machine, or the spot welder, and therefore its design must anticipate its use in a similar manner to these other industrial tools. The radio-frequency generator must conform to the following basic requirements:

1. *Minimum Cost:* Equipment designed and manufactured for competitive sale in industry must, of necessity, be low in cost. In the majority of cases radio-frequency heating is competing with more conventional types of heating processes, with the result that over-all product cost must be considered when installing a new heating process. Both the initial-equipment cost and maintenance cost always have a direct bearing on a final product cost.
2. *Simplicity:* The radio-frequency generator is installed in many different types of factories, the same as any other machine tool. The personnel who install and operate the equipment are, in practi-

cally all cases, unfamiliar with electronic equipment. There are no experienced radio operators available to operate and maintain the equipment. The radio-frequency equipment, therefore, must be as simple as possible so that, both from the maintenance standpoint and the operating standpoint, it will be possible for inexperienced personnel to perform the necessary functions.

3. *Ruggedness:* To stand the same rough treatment that other machine tools are designed to withstand, the radio-frequency generator and the components from which it is constructed must be capable of continuous operation under dirty conditions and hard handling by inexperienced personnel.
4. *Flexibility Output:* Practically all materials when heated change their electrical and physical characteristics. These changes in characteristics throughout a heat cycle reflect a variation in load on the radio-frequency generating equipment. Radio engineers have been accustomed to designing equipment for operation into constant loads reflected by antennas or transmission lines. This is not so with industrial radio-frequency generators, and therefore the circuits used must be capable of compensating for the changes in load initiated by changes in characteristics of the material being heated.

The self-excited oscillator has been universally adopted as the type of radio-frequency generator which comes the closest to fulfilling the above requirements. Because of its simplicity it meets the requirements of low cost and easy operation. The small number of components used in the self-excited oscillator reduces the chance of failure and permits expenditure on these components to

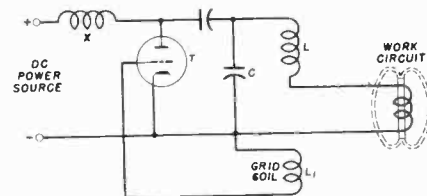

Fig. 1—Oscillator and work circuits.

produce rugged and trouble-free equipment. The self-excited oscillator is also a very ready answer to the problem of supplying power to a variable load. This latter condition is most readily accomplished in induction heating by making the work or load circuit a part of the oscillator tank circuit. This is illustrated in Fig. 1.

There are many types of self-excited oscillator circuits, the merits of which are all familiar knowledge to the radio engineer. Fig. 1 is the most commonly used self-excited oscillator circuit for induction-heating purposes. The circuit shown in Fig. 1 (see also the associate Figs. 6, 7, and 8) has been reduced to the basic fundamentals by elimination of filament supply, bias supply, plate supply, and control circuits normally associated with a complete oscillator, for the purpose of simplicity.

This circuit is commonly used for induction heating because it fulfills the following design requirements:

1. It is simple, to the point of having a minimum number of components.
2. Protection to operating personnel is obtained by having one side of the work or load coil grounded. This is extremely important where inexperienced personnel is using high-frequency equipment with dangerous high voltages.
3. Grid excitation can be varied readily and even automatically to assure proper excitation to the oscillator tube under varying load conditions.
4. The frequency of oscillation is determined by the plate tank circuit, of which the load circuit is a part. Variations in load are thereby accompanied by a shift in oscillator frequency to insure maximum efficiency from the oscillator tube.

Most induction-heating problems resolve themselves into the number of ampere turns necessary to produce a magnetic flux capable of inducing the desired heat into the material. This subject will be discussed later in the paper. The number of turns which can be used in the work coil is quite often restricted, and therefore it is almost always necessary that the generator be capable, not only of supplying power (kilowatts), but also of supplying a maximum of current flow. The current available from the self-excited oscillator is the tank current available in the plate circuit under full-load con-

dition. It is desirable that this tank current be as high as practicable within the limitations of efficient operation of the oscillator. The relation of kilovolt-amperes in the tank circuit to kilowatts in the work therefore becomes an important factor in the design of a radio-frequency generator. This ratio of kilovolt-amperes in the tank circuit to kilowatts in the work is commonly known as the working Q .

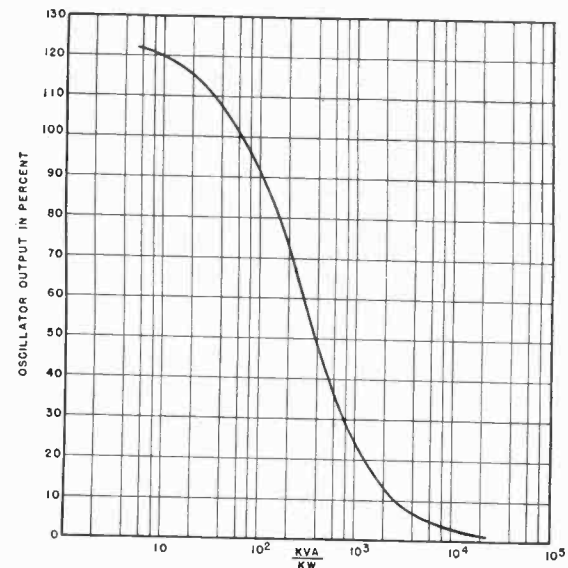

Fig. 3—Variation of oscillator output with tank-circuit-ampere-per-work-circuit-kilowatts ratio.

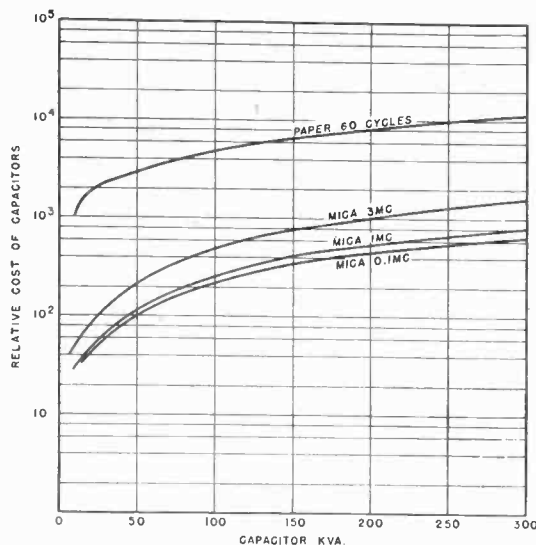

Fig. 2—Variation of capacitor cost with kilovolt-ampere requirements.

ditions. It is desirable that this tank current be as high as practicable within the limitations of efficient operation of the oscillator. The relation of kilovolt-amperes in the tank circuit to kilowatts in the work therefore becomes an important factor in the design of a radio-frequency generator. This ratio of kilovolt-amperes in the tank circuit to kilowatts in the work is commonly known as the working Q .

Oscillations in a self-excited oscillator normally take place around the circuit exhibiting the highest kilovolt-ampere-per-kilowatt ratio. It is therefore necessary to

maintain a higher value of kilovolt-amperes in the complete oscillator-tank circuit than exists in that portion of the tank circuit which is represented by the load. Circuit loss is normally expressed by the value $Q = \omega L/R$. If we multiply both the nominator and denominator by I^2 we have $\omega LI^2/RI^2 = EI/W = KVA/KW$. The kilovolt-ampere-per-kilowatt ratio or Q of the tank circuit must therefore be larger than the kilovolt-amperes per kilowatt or Q of the work circuit, to insure that oscillations take place around the total tank circuit. If the Q of the load circuit should become larger than that available in the oscillator tank circuit, oscillations will attempt to take place around only the work circuit with a resultant poor impedance match between the work and the oscillator tube and a resultant unstable condition. In other words, we have a parasitical oscillation around the work circuit which produces inefficient operation and probably overloads the oscillator tube.

To obtain the high circulating tank current required to satisfy the above conditions, it is necessary that the plate tank capacitor be as large as practicable. There are two main factors which usually control the maximum value of this capacitance. The first factor is that of economy and space. As the capacitance of the tank capacitor increases, the cost and size of this capacitor increase. The cost and size usually increase quite rapidly as the kilovolt-ampere rating of the capacitor goes beyond standard available ratings. It is usually impracticable to include large values of capacitance due to the added space required in the generator to house or package this additional capacitance. Fig 2 shows graphically the relative increase in cost of this type of capacitor. The second factor which controls the maximum size of the tank capacitor is the allowable loss in power that can be tolerated in the oscillator tank circuit. Normal design of vacuum tubes allows for practically no excess power

from the tube which may be dissipated in the oscillator circuit elements $L-C$ and still leave normal expected power for useful output from the generator. As the tank current increases due to increased tank capacitance, the tank-coil loss increases rapidly. This power must be supplied by the vacuum tube and is not useful output. Fig. 3 illustrates this condition and is plotted from data

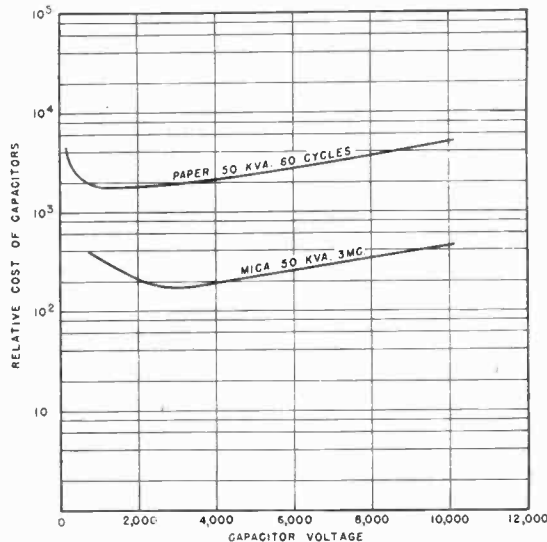

Fig. 4—Variation of capacitor cost with terminal voltage.

from an actual 10-kilowatt generator. This curve indicates that normal rated output from the radio-frequency generator takes place at a kilovolt-ampere-per-kilowatt ratio of approximately 50.

From Fig. 4, it is obvious that high current can be obtained more economically at low values of voltage. It would therefore seem desirable to use vacuum tubes which operate on low values of plate voltage, but here we run into the fact that the vacuum tube is basically a high-impedance device and consequently requires high voltages to obtain the power desired. The designer of the radio-frequency generator and also the designer of the vacuum tube itself are therefore required to use high-voltage and high-impedance circuits.

In general, the plate potential used for the operation of the vacuum tube increases with the power output of the tube. This condition requires the use of high-current, high-voltage, high-frequency, low-loss capacitors in the oscillating circuit of the oscillator. Such capacitors are at the present time constructed with mica, pressurized gas, paper, or oil as the dielectric material. Each type has its construction limitations which restrict the kilovolt-ampere ratings to rather low values compared to that needed in the higher-powered oscillators. The paper and conventional oil capacitors have too high a power factor, with the result that, although a relatively high value of kilovolt-amperes can be provided, the power dissipated in the capacitor at the high frequencies involved is abnormal and cannot be tolerated. The mica and compressed-gas capacitors have sufficiently low power factors to permit reasonable losses in the capac-

itor at high frequencies, but to date, physical limitations in construction restrict these types of capacitors to relatively low values of capacitance and current-carrying capabilities.

Keeping in mind the above limitations, the design engineer must produce an equipment with a maximum kilovolt-ampere-per-kilowatt ratio in line with cost limitations and size limitations on the complete equipment. Assuming that a kilovolt-ampere-per-kilowatt ratio of 50 is the most economical ratio, the designs for various standard NEMA ratings will result in characteristics approximately as shown in Fig. 5 when designed for frequencies lying in the range of 100 to 550 kilocycles.

Fig. 5 indicates that the kilovolt-ampere-per-kilowatt ratio has been held constant at a value of 50 for all ratings up to approximately 50 kilowatts. Above 50 kilowatts the effective kilovolt-ampere-per-kilowatt ratio drops, due primarily to limitations in oscillator tank-capacitor capabilities. As future developments in the capacitor field are made, this condition will be corrected or bettered. The curve of radio-frequency voltage shown in Fig. 5 represents the maximum usable radio-frequency voltage from the generator. This value is a function of the tube complement selected for each power rating and the plate potential used for the oscillator tubes. The available radio-frequency voltage increases as the rating of the generator increases due to the necessity of using larger tubes operating at higher plate voltage as the power goes up. With a constant kilovolt-ampere-per-kilowatt ratio and a gradually increasing tank voltage as the size of the radio-frequency generator increases, we have available larger values of tank current as the size of the generator increases. This is illustrated by the current curve of Fig. 5.

The only variable or adjustable characteristic of the radio-frequency generator is the available radio-frequency voltage. This voltage, of necessity, must be varied as the character of the load changes by using more or less of the generator tank inductance to maintain a given frequency. The result is that, in effect, we have a constant-current, variable-voltage, and high-internal-impedance generator.

The kilovolt-ampere-per-kilowatt curve shown in Fig. 5 is for full output from the radio-frequency generator. Quite often, full power capabilities are not required from the generator, with the result that the kilovolt-ampere-per-kilowatt ratio increases in direct proportion to the drop in power requirements. It becomes possible, by taking advantage of this characteristic, to supply power to excessively high kilovolt-ampere-per-kilowatt ratio loads.

The generally accepted frequency range for the radio-frequency generator for induction-heating use lies between 100 and 550 kilocycles. The upper limit of this range has been arbitrarily set, for two reasons. The frequencies between 550 and 1500 kilocycles are occupied by the broadcast stations of this country, and it has

been generally accepted as good practice to keep industrial generators from operating in this frequency range to eliminate the possibility of interference to broadcast reception. Except for special case-hardening problems where extremely shallow depth of penetration is necessary, the frequencies above 1500 kilocycles are normally used for dielectric heating rather than induction heating. This leaves 550 kilocycles as the normally accepted upper-frequency limit for induction heating.

For a given set of conditions, it is possible to raise the kilovolt-amperes in a radio-frequency generator by raising the frequency, because lower capacitive reactance and resultant higher generator current can be obtained as the frequency is increased. The majority of radio-frequency generators, therefore, operate at frequencies from 400 to 550 kilocycles to take advantage of this increase in kilovolt-amperes. This range of frequency is adequate for practically all types of induction-heating problems and provides the most economical design.

In all rotating-machine problems the load is adjusted to a point where efficiency and output satisfy the ratings of the generator. This same procedure is necessary for proper and efficient operation of the radio-frequency generator. The rotating-machine and spark-gap oscillator are both generators with low internal-impedance characteristics. The majority of induction-heating loads are also low-impedance, with the result that adjustment for proper efficiency and full power from the generator is relatively simple. The radio-frequency generator has an inherent high-impedance characteristic, and to apply this type of generator to the low-impedance induction-heating loads, it becomes necessary to obtain a suitable impedance match between the load and the radio-frequency generator.

In the case of the rotating machine, full power is obtained from the generator by power-factor-correction capacitors connected across the load or by use of step-

down transformers. In the case of the radio-frequency generator, the solution is handled in much the same manner. The usual method for taking power from a radio-frequency generator has been illustrated in Fig. 1. It is necessary first to arrive at a suitable coil design which will allow rated power to be taken from the generator with the current available from the generator. This is accomplished by suitable selection of ampere turns and spacing between the work and the coil. In general, the number of turns in the work coil is selected to give

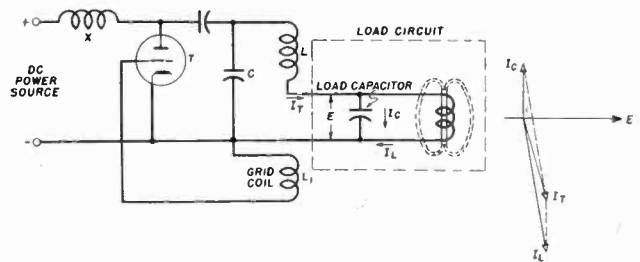

Fig. 6—Load-capacitor circuit.

the desired ampere turns. This subject will be discussed later. Many jobs are such that the impedance-match and ampere-turns requirements cannot be met, due to physical limitations. For instance, it is often physically impracticable to obtain a sufficient number of turns in the work coil, due to the shape of the piece to be heated. Then again, the shape of the material may restrict the proximity between work and the work coil. This latter condition is normally referred to as coupling. With close proximity between coil and work we have "tight" coupling; and when the coil is a considerable distance from the part to be heated we have "loose" coupling. To correct the condition where insufficient ampere turns are available to load the radio-frequency generator properly, there are two or three methods which may be used.

The first of these methods is similar to that used for capacitance coupling from a tank circuit into a resonant-antenna circuit; that is, we connect capacitance across the work coil as shown in Fig. 6. If the work coil plus this additional capacitor were chosen to become resonant at the oscillating frequency, the circuit would be functioning exactly the same as if the load circuit were an antenna system tuned to resonance. The connection of the capacitor across the work coil can also be compared with the use of power-factor-correction capacitors across the output of a rotating machine to correct the power factor as we are actually partially tuning the work circuit to resonance. Fig. 6 also illustrates the approximate phase relation of voltage and current that exists in this circuit. The extent to which capacitance may be added across the work coil to increase the kilovolt-amperes in the work circuit is limited to the kilovolt-ampere-per-kilowatt ratio in the work circuit which does not exceed approximately 80 per cent of the working

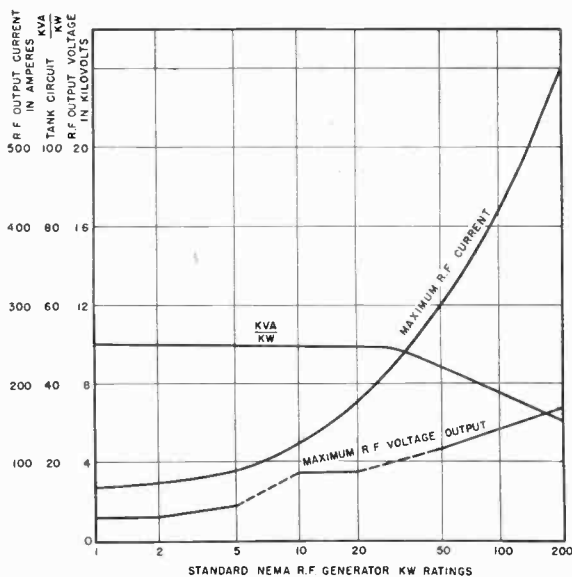

Fig. 5—Typical oscillator characteristics.

kilovolt-ampere-per-kilowatt ratio of the total generator-tank circuit. For average-type induction-heating loads, it is quite often possible to increase the work-circuit current from two to three times that of the tank circuit by this method before unstable operation results.

The second method which may be used to increase the load-circuit current is shown in Fig. 7. A transformer is placed in series with the generator oscillating circuit. This transformer is a step-down transformer with a

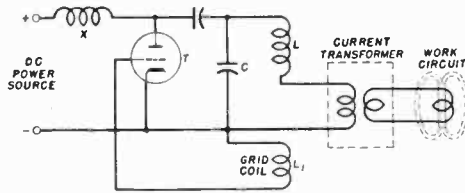

Fig. 7—Current-transformer circuit.

high-current, low-voltage secondary (low-impedance) to match the low impedance of a high-current load or work circuit. Because these transformers are operating at radio frequencies they are usually of the air-core type which means high leakage reactance with resultant poor efficiency. At machine frequencies and lower radio frequencies, iron-core transformers are used in special cases in order to obtain high-current concentrations. In general, the design of current transformers involves the same problems of turns ratio, leakage inductance, copper loss, and voltage insulation that are encountered in any radio-frequency-transformer design. Many commercial transformers are now on the market using oil or gas as a means of increasing voltage insulation.

The current transformer is ideal when the work circuit must necessarily be of very low impedance such as that obtained from a single-turn coil tightly coupled to the work. There are many jobs which fall within this category, and therefore it is quite common to find this type of impedance matching being used. If the impedance of the work circuit becomes the least bit high, due to long leads to the coil or multiturns in the coil, a current transformer becomes of little use. It is then necessary to resort to the method of connecting capacitance across the load circuit. A rule-of-thumb guide as to when a current transformer is desirable can be obtained from the load-circuit kilovolt-ampere-per-kilowatt ratio. If this ratio is in the order of 10 or less, and the current necessary in the work coil is from three to five times that available from the generator, the current transformer will provide the best impedance match and performance.

Still another method of impedance match can quite often be used to advantage when the impedance of the work circuit is low. It is possible to series two or more of the work circuits when the nature of the work permits the heating of more than one piece at a time. To do this it may be necessary to increase the heating time of an individual piece, but the effective heating time may be lower than for one piece because more than one piece is being heated simultaneously.

Fig. 8 shows this type of proposed connection. This is an especially useful method when the radio-frequency generator is of a higher rating than is necessary to perform the desired work.

Combinations of the above impedance-matching systems are, of course, possible, and will present themselves as the individual problems arise.

We now have the general characteristics of the radio-frequency generator roughly in mind, and we can proceed to study the application of this type of generator. The theory and calculations necessary to determine the work-circuit characteristics are given along with typical calculations which illustrate the use of the radio-frequency generator.

RADIO-FREQUENCY-GENERATOR APPLICATION

In general, when considering an induction-heating problem, we are confronted with finding the answers to the following questions: 1. What is the rating of the oscillator best suited for the job? 2. What extras in the form of power-factor correction or impedance matching are necessary? 3. What is the general design of the work coil?

The first step in calculation requires the finding of the power density (watts per cubic inch) required to accomplish the heating.

$$\text{Power density} = \frac{\text{thermal power in watts}}{\text{volume of metal in coil}}$$

$$\begin{aligned} \text{Thermal power} &= 1.76 \times 10^{-2} M C \Delta T \\ &= \text{kilowatts} \end{aligned} \tag{1}$$

where

M = rate of heating in pounds per minute

C = specific heat of material

ΔT = temperature rise in degrees Fahrenheit.

Power density is computed for a hollow cylinder on the basis of the volume of a solid cylinder of the same diameter. This is necessary, because, as far as eddy-cur-

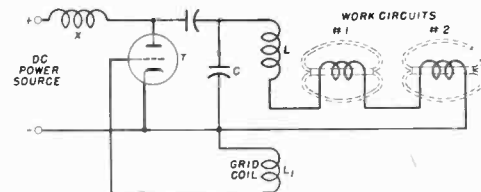

Fig. 8—Work circuits in series.

rent configurations and power input are concerned, hollow and solid shapes of materials behave identically. Skin effect limits the depth of penetration of currents into the work, with the result that the metal beneath this depth of penetration can have no electrical effect.

The second step in calculation is that of finding peak magnetizing force required. The following relationships give this quantity for several simple shapes into which nearly any problem in induction heating can be resolved:

Magnetic cylinder

$$H_0 = [(3.64PD \times d \times 10^3) / \sqrt{\rho f}]^{2/3} \tag{2}$$

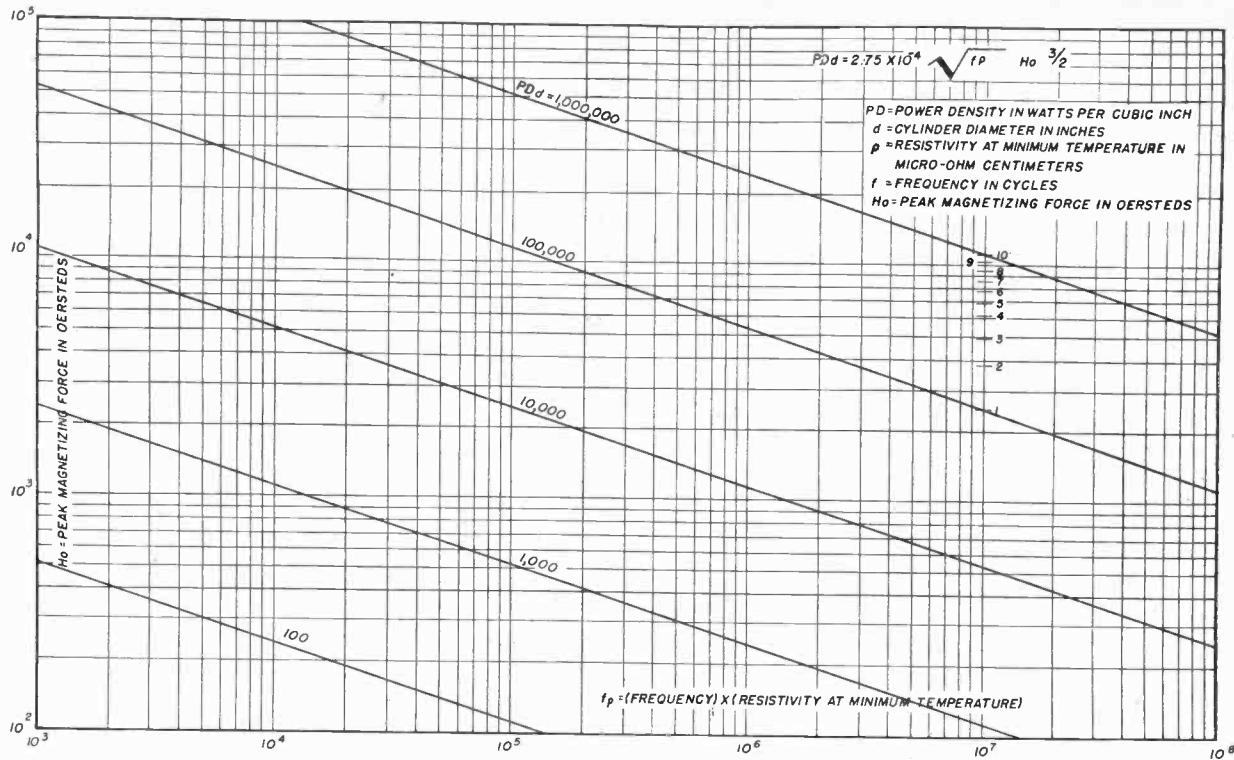

Fig. 9—Magnetizing force required for magnetic cylinder.

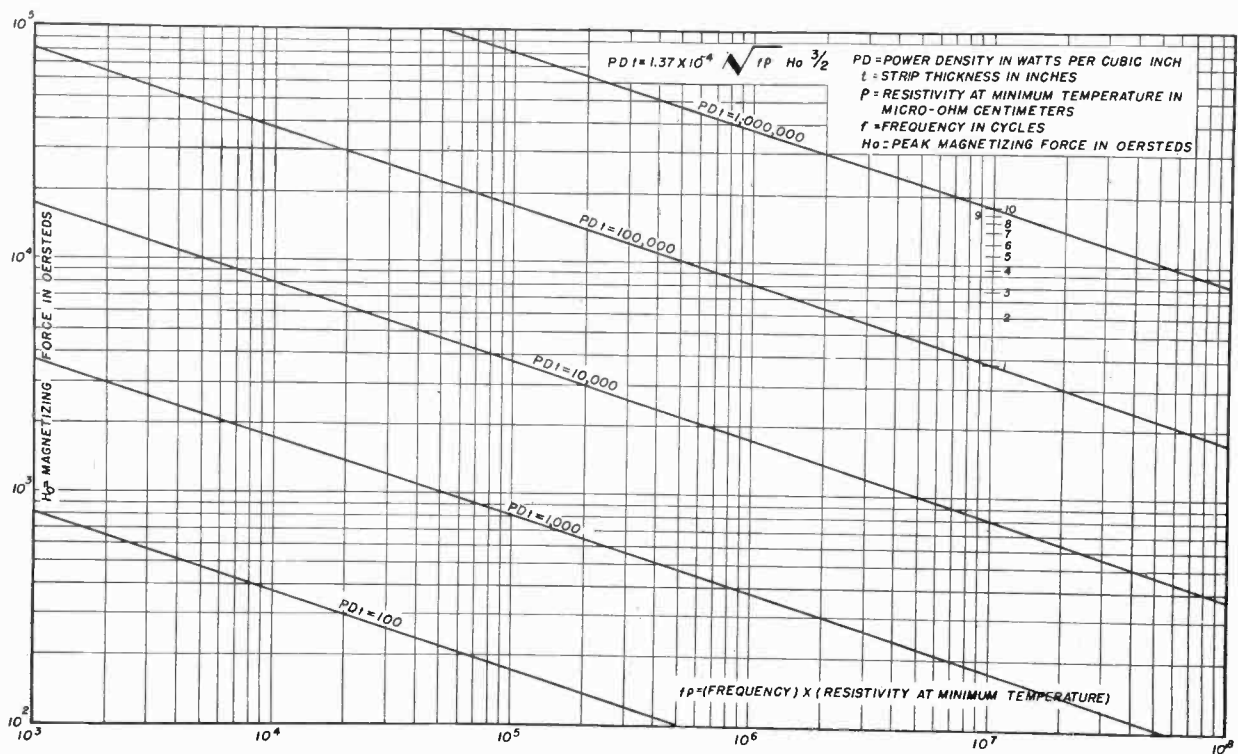

Fig. 10—Magnetizing force required for magnetic strip.

Magnetic strip

$$H_0 = [(7.3PD \times t \times 10^3) / \sqrt{\rho f}]^{2/3} \quad (3)$$

Nonmagnetic cylinder

$$H_0 = [(61.3PD \times d \times 10^4) / \sqrt{\rho f}]^{1/2} \quad (4)$$

Nonmagnetic strip

$$H_0 = [(1.23PD \times t \times 10^6) / \sqrt{\rho f}]^{1/2} \quad (5)$$

where

PD = power density in watts per cubic inch

t = strip thickness in inches

d = cylinder diameter in inches

H₀ = peak magnetizing force in oersteds

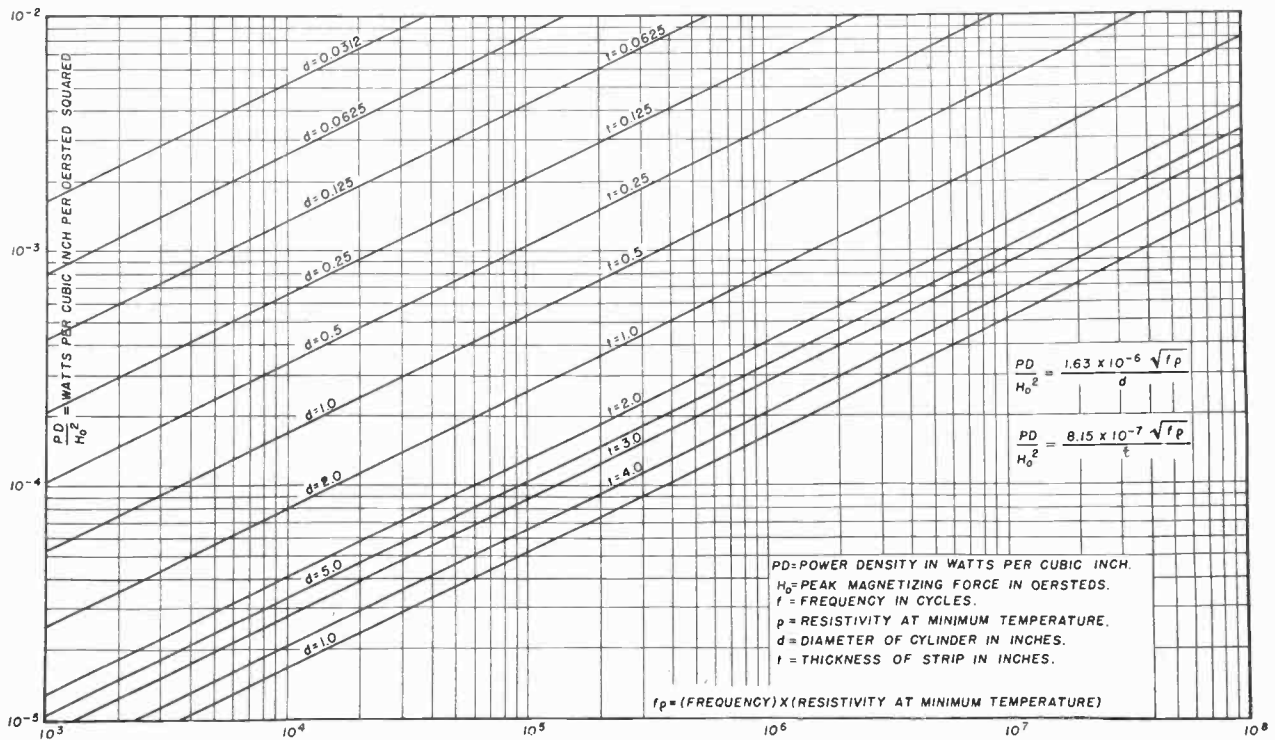

Fig. 11—Magnetizing force required for nonmagnetic materials.

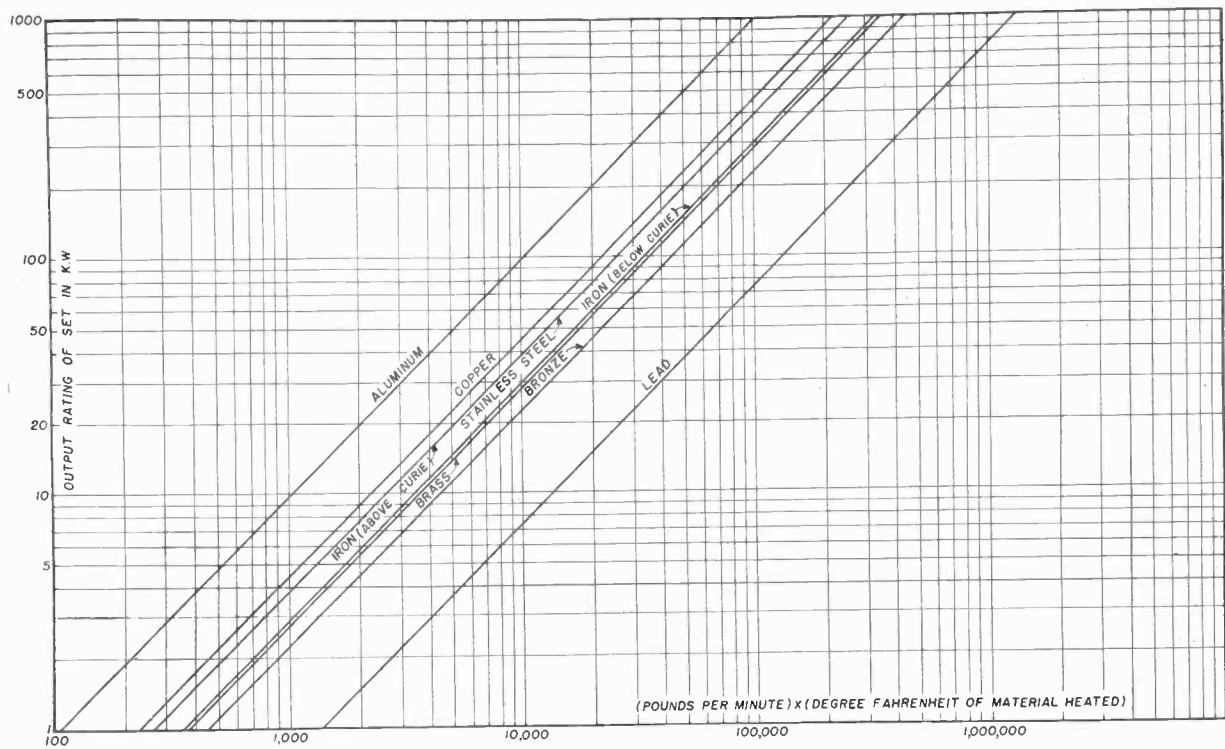

Fig. 12—Oscillator power capacity for radio-frequency heating requirements.

f = frequency in cycles

ρ = resistivity at minimum temperature in microhm-centimeters.

It will be noted that the resistivity was specified at minimum temperature. This is necessary to insure maximum power (H_0^2) into the work at the start of the heating cycle. As can be seen from the foregoing formula for

H_0 , the magnetizing force necessary for a given power density will drop as resistivity (ρ) increases with temperature.

Figs. 9 to 12 have been plotted for the magnetizing-force relationships, in order to assist in calculations.

The third step is that of determining voltage and current required in a coil to provide the required

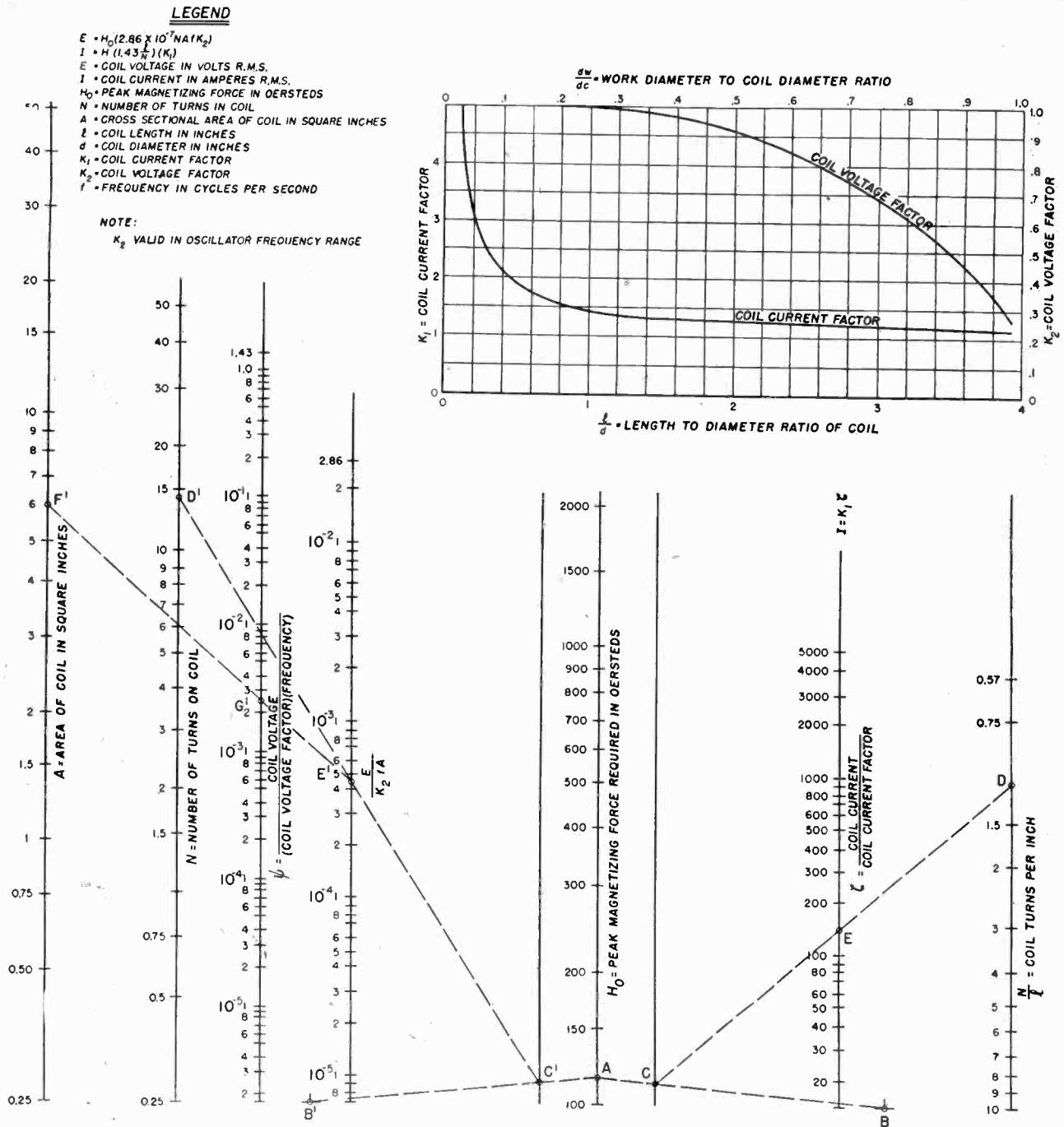

Fig. 13—Voltage and current of a solenoid as a function of peak magnetizing force.

magnetizing force. Coil dimensions must be assumed in correspondence with the conditions of the problem.

Voltage and current in terms of magnetizing force are given as

$$E = H_0(2.86 \times 10^{-7} f N A K_2) \tag{6}$$

$$I = H_0[1.43(l/N)K_1] \tag{7}$$

where

- E = coil voltage in volts root-mean-square
- I = coil current in amperes root-mean-square
- H_0 = peak magnetizing force in oersteds
- N = number of turns in coil
- A = cross-sectional coil area in square inches
- l = coil length in inches.

The constants K_1 and K_2 are factors by which coil current and coil voltage, respectively, are modified to correct for small length-to-diameter ratio of the coil and for the effect of metal in the field of the coil. These factors are based upon theoretical and empirical considerations and are plotted in Fig. 13, together with a nomograph for determining current and voltage using the foregoing relationships.

The coil-current factor K_1 is a function of the length-to-diameter ratio of the coil, and shows that, in order to reduce the current required for a given magnetizing force, this ratio should be as large as possible.

The coil-voltage factor K_2 is a function of the ratio of work-diameter-to-coil-diameter coupling and indicates

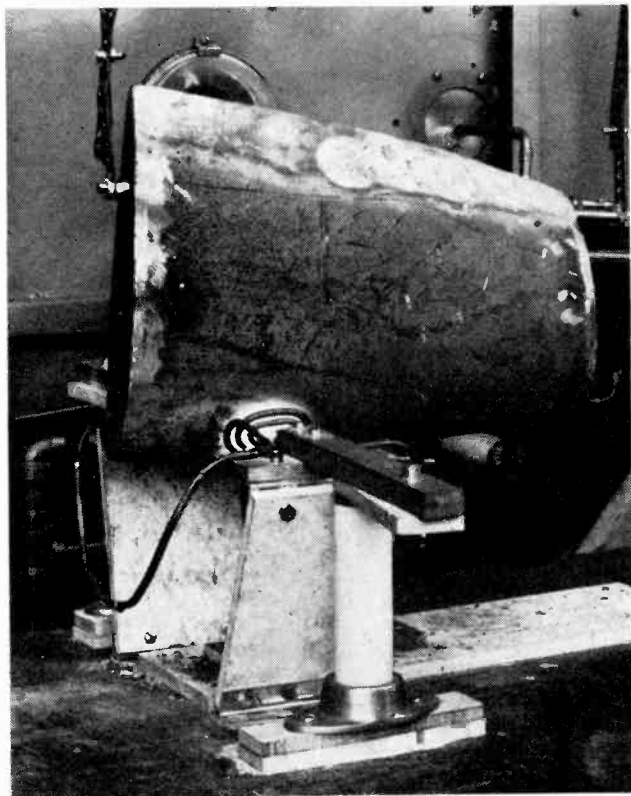

Fig. 14—Propeller-edge brazing at 450 kilocycles.

that at oscillator frequencies the coil voltage decreases as the diameter of the work is increased relative to that of the coil (tightly coupled). The effect is essentially the same for both magnetic and nonmagnetic cores at oscillator frequencies.

All that remains to complete the analysis is to determine the rating of the oscillator to be used. If current requirements are greater than can be provided by an oscillator of the correct power rating, impedance matching as described previously is necessary.

If we refer to Fig. 6, the rated oscillator current is shown as I_T . If the work coil L is partially tuned as indicated, the current in the tuning capacitor I_c will be very nearly 180 degrees out of phase with the coil current I_L . A work-circuit capacitor therefore is used with a reactance such that

$$I_c = I_L - I_T. \quad (8)$$

The total power rating which must be provided by the generator will be the sum of thermal power generated in the work and the I^2R coil loss.

Loss in the work coil is given¹ by the empirical formula

$$W_c = 1.40(d_c/d_w)\sqrt{(\rho_c/\rho_w)} \times W_w \quad (9)$$

where

W_c = coil loss in watts

W_w = power generated in work in watts

d_c = coil diameter

d_w = work diameter

¹ R. M. Baker, "Heating of nonmagnetic electric conductors by magnetic induction-longitudinal flux," *Trans. A.I.E.E. (Elec. Eng., June, 1944)*, vol. 63, pp. 273-278; June, 1944.

ρ_c = coil resistivity at working temperature
 ρ_w = work resistivity at minimum temperature.
 (Minimum temperature used to insure provision for maximum loss.)

A curve has been plotted in Fig. 12 from which total power required may be determined for several materials. These curves include coil losses encountered in normal heating problems, and can be used as a guide to generator power requirements.

Case hardening of the surface of a cylinder will be accomplished if the depth of current penetration is less than the depth of case desired, since a major portion of the heat input is generated within the depth of penetration, and if the rate of energy input is rapid enough, so that heat conduction to the interior of the work is minimized. As an approximation, the depth of penetration will be made always less than half the case thickness desired, and heat conduction will be depended upon for the remainder. The thermal problem of heat penetration into a cylinder under the conditions of case hardening is extremely complex. Simplifying assumptions therefore will be made for practical results. On the basis of experimental work, it has been found that a minimum power density of two kilowatts per square inch of surface area to be hardened is sufficient to cause a hardened case, if the heating cycle is short enough to prevent excessive conduction to the interior of the object to be heated. The power density required is dependent upon the type of hardening problem under consideration, and may vary from 4 to 10 kilowatts for normal applications, to 25 kilowatts or more per square inch for special thin case-hardening applications. Experimental work is required, in general, to determine the correct power.



Fig. 15—Internal-gear-tooth hardening at 450 kilocycles.

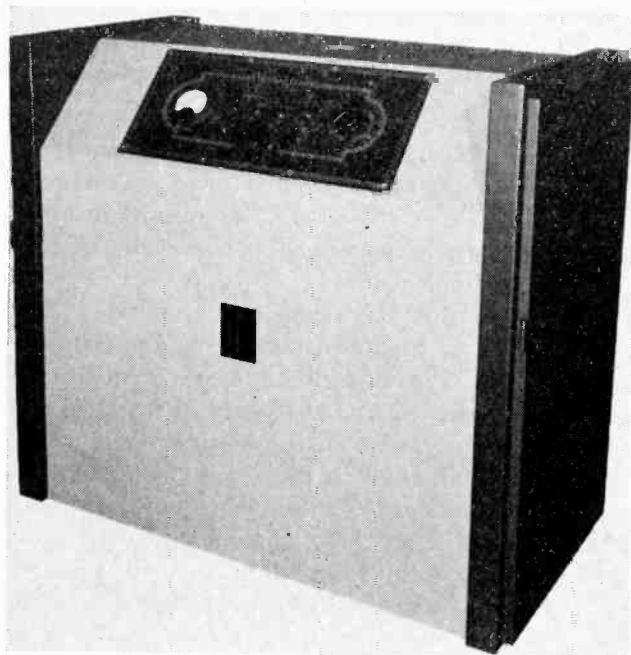

Fig. 16—A 2-kilowatt industrial radio-frequency generator.

It will be assumed further that the material remains magnetic to a temperature of 1300 degrees Fahrenheit, and that it must be raised to a final temperature of 1600 degrees Fahrenheit in order to produce a hardened case. If a frequency of 450 kilocycles and a resistivity of 20 microhm-centimeters at minimum temperature is used, it is found by an analysis shown in the appendix that 720 oersteds (50) is the proper value of magnetizing force to be used. Other values of final temperature, power density, frequency, and resistivity, of course, will require a similar mathematical procedure.

If the current and voltage requirements as calculated

fall within the range of the radio-frequency generator, using impedance matching where necessary, and the kilovolt-amperes-per-kilowatt ratio of the work circuit is 80 per cent or less than that of the generator, it can be assumed that the problem is solved. Considerable flexibility is provided in most applications where work-coil dimensions and turns can be varied and where combinations of impedance-matching systems can be used.

When it appears impracticable to do the job at hand with a generator of suitable rating, it may be possible that a rotating machine will perform the job, provided its frequency is above a minimum specified by the following relationships.

Solid magnetic or nonmagnetic cylinder

$$\mu f = 71(\rho/d^2). \tag{10}$$

Hollow magnetic cylinder

$$f = 0.129\sqrt{(PD) \times d \times \rho/t^3}. \tag{11}$$

Hollow nonmagnetic cylinder

$$f = 7.75\rho/t^2. \tag{12}$$

Magnetic or nonmagnetic strip

$$\mu f = 35.2(\rho/t^2). \tag{13}$$

Magnetic permeability at minimum frequency (in terms of μf of (10) and (13))

$$\mu = \sqrt{123\mu f/PD} \tag{14}$$

where

μ = magnetic permeability under specified conditions of (30)

f = minimum frequency in cycles

ρ = resistivity at maximum temperature in microhm-centimeters

t = wall thickness in inches (hollow-cylinder) strip thickness (in inches)

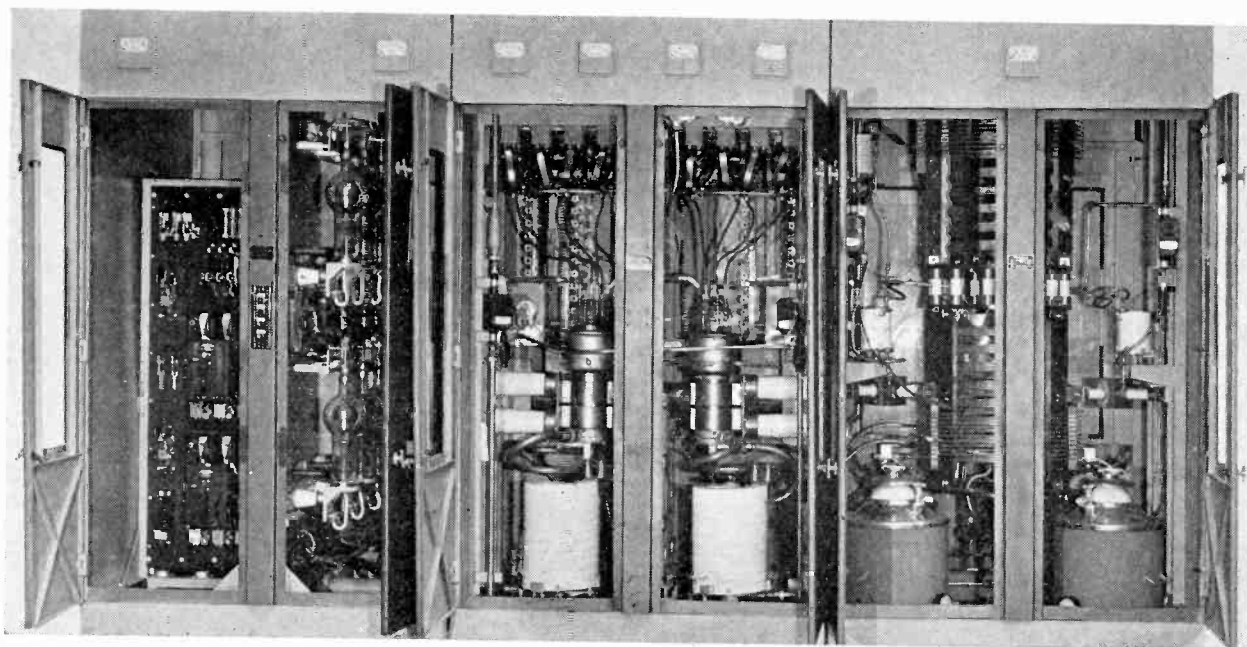

Fig. 17—A 200-kilowatt industrial radio-frequency generator.

d = outside diameter of cylinder in inches

PD = power density in watts per cubic inch.

The resistivity at maximum temperature is used in the equations for minimum frequency, because the largest value of this quantity will occur when the resistivity is a maximum. The hot resistivity is computed as

$$\rho_{\text{hot}} = \rho_{\text{cold}} (1 + \alpha \Delta t) \quad (15)$$

where

α = the temperature coefficient of resistivity

Δt = the temperature rise in degrees centigrade = the temperature rise in degrees Fahrenheit/1.8.

The following examples have been prepared to illustrate the procedure to follow in arriving at the answer to the three questions listed previously for various typical heating problems.

Example 1. Magnetic Strip

To illustrate the problem of heating a magnetic strip of steel, let us assume that we desire to fuse electroplated tin on the surface of a strip 2.5 inches wide and 0.12 inch thick. The temperature necessary to flow the tin is 550 degrees Fahrenheit, and we shall assume that the strip is traveling at a continuous rate of 15 feet per minute.

$\rho = 20$ microhm-centimeters (at minimum temperature).

A. Volume to be heated per minute = thickness \times width \times speed

$$= 0.12 \times 2.5 \times 12 \times 15 = 54 \text{ cubic inches per minute.}$$

B. Weight heated per minute = volume per minute \times pounds per cubic inch

$$= 54 \times 0.286 = 15.4 \text{ pounds per minute.}$$

C. Thermal power = $1.76 \times 10^{-2} \times 15.4 \times 0.12 \times (550 - 72)$

$$= 15.5 \text{ kilowatts.}$$

To determine a power density it is necessary to assume a coil length. The turns per inch and the total length must be of the proper magnitude so that current and voltage limitations are not exceeded. This must be done by a cut-and-try method. In some cases, coil length is fixed by conditions of the problem, so that the only variation possible is in the turns-per-inch ratio. In this case the coil length will be assumed to be 12 inches.

D. Volume of metal in coil (length = 12 inches) = $54/15$

$$= 3.6 \text{ cubic inches.}$$

E. Power density = $15,500/3.6 = 4300$ watts per cubic inch.

F. $PD \times t = 4300 \times 0.12 = 516$; $\rho f = 450,000 \times 20 = 9 \times 10^6$.

G. From Fig. 10, $H_0 = 116$.

H. Assume a coil

$l = 12$ inches (length); $N = 14$ (turns); $N/l = 14/12 = 1.17$; area = 4 inches \times 1.5 inches = 6 square inches.

In order to determine coil current and voltage from Fig. 13, the following procedure should be used:

I. Current

Locate $H_0 = 116$ (point A).

Draw AB (B is the same for all values of H_0).

Note point C and then locate $N/l = 1.17$ (point D).

Draw CD and locate point $E = 142$.

$I = K_1 \times (\text{point } E) = 1.20 \times 142 = 171$ amperes.

In order to apply the coil correction factor, l/d must be determined. As an approximation, d is taken as the so-called "effective diameter" of a rectangular coil, or that diameter which gives the same area as in the rectangular cross section.

Effective diameter

$$d_{\text{eff}} = \sqrt{A(\text{rectangular})/\pi/4} = \sqrt{(6 \times 4)/\pi}$$

$$= 2.76 \text{ inches; } l/d = 12/2.76 = 4.35.$$

$K_1 = 1.20$.

J. Voltage

Locate $H_0 = 116$ (point A).

Draw $A B'$ (B' is the same for all values of H_0).

Note point C' and then locate $N = 14$ (point D').

Draw $C'D'$ and note that $E' = 4.5 \times 10^{-4}$ (E'/fak_2).

Locate $A = 6$ (point F') and draw $E'F'$.

$\psi = E'/f_{k_2} = 2.7 \times 10^{-3}$ (point G'); $dw/dc \cong 0$; $K_2 = 1$.

$E = \psi K_2 f = 2.77 \times 10^{-3} \times 4.5 \times 10^5 \times 1 = 1250$ volts, coil voltage.

K. Rate of heating = pounds per minute $\times \Delta t = 15.4 \times (550 - 72) = 7360$.

From Fig. 12, total power required = 20,000 watts.

The curves in Fig. 12 give the approximate power required to heat a given load plus the heater-coil losses—a total of 20 kilowatts in this example.

L. Kilovolt-amperes per kilowatt for load circuit

$$(1.25 \times 171/20) = 10.7.$$

This value of kilovolt-ampere per kilowatt for the load circuit along with the 1250 volts and 171 amperes are all reasonable figures for a 20-kilowatt radio-frequency generator, and the coil assumption made to arrive at these figures is therefore entirely satisfactory.

Example 2. Nonmagnetic Strip

Assume that a 0.0625-inch-thick strip of stainless steel 15 inches wide is to be heated to a temperature of 720 degrees Fahrenheit. This is to be done in order to heat the material for a toughening drawing operation with a quick oil quench to follow immediately after the heating operation. It is assumed the strip will be traveling at a continuous rate of 2.5 feet per minute.

$\rho = 20$ microhm-centimeters at minimum temperature.

A. Volume to be heated = $0.0625 \times 15 \times 2.5 \times 12 = 28$ cubic inches per minute.

B. Weight heated per minute = $28 \times 0.286 = 8.0$ pounds per minute.

C. Thermal power = $1.76 \times 10^{-2} \times 8.0 \times 0.12 \times (720 - 72) = 10.8$ kilowatts.

D. Volume of metal per minute in coil (assume $l = 12$ inches) = $28/2.5 = 11.2$ cubic inches.

E. Power density = $10,800/11.2 = 965$ watts per cubic inch.

F. $\rho f = 450,000 \times 20 = 9 \times 10^6$.

G. From Fig. 11, $PD/H_0^2 = 3.9 \times 10^{-2}$ (by extrapolation)
 $H_0^2 = 965/3.9 \times 10^2 = 2.46 \times 10^4$; $H_0 = 157$ oersteds.

H. Assume a coil

$l = 12$ inches; $N = 12$; area = 18 inches \times 1.5 inches = 27 square inches.

From Fig. 13, $I/K_1 = 224$ $I = 224 \times 1.3 = 291$ amperes coil current.

$$D_{\text{eff}} = \sqrt{27 \times 4/\pi} = 5.86 \text{ inches}; \quad K_1 = 1.3;$$

$$\psi = 14.6 \times 10^{-3}$$

$dc/dw \cong 0$ $K_2 = 1$; $E = 14.6 \times 10^{-3} \times 4.5 \times 10^5 \times 1 = 6600$ volts, coil voltage.

I. Rate of heating = pounds per minute $\times \Delta t$
 $= 8.0 \times (720 - 72) = 5190$.

From Fig. 12, total power required = 20,000 watts.

J. Load circuit kilovolt-amperes per kilowatt = $6.6 \times 291/20 = 96$.

This is beyond the limits of a standard 20-kilowatt generator. Therefore, it is necessary to use a 50-kilowatt generator operating at reduced power to provide the high kilovolt-amperes-per-kilowatt ratio necessary to satisfy this load condition.

Example 3. Solid Magnetic Cylinder

Let us assume that, in order to anneal 0.25-inch steel wire before drawing it through a reducing die, it is required to heat the wire to a temperature of 1000 degrees Fahrenheit. A continuous production rate of 40 feet per minute is required.

$\rho = 20$ microhm-centimeter at minimum temperature.

A. Volume to be heated per minute = $(\pi/4)d^2l = \pi/4 \times (0.25)^2 \times 40 \times 12 = 23.5$ cubic inches per minute.

B. Weight to be heated per minute = $23.5 \times 0.286 = 6.74$ pounds per minute.

C. Thermal power = $1.76 \times 10^{-2} \times 6.74 \times 0.125 \times (1000 - 72) = 13.7$ kilowatts.

D. Volume of metal in coil (assume $l = 12$ inches) = $23.4/40 = 0.585$ cubic inch.

E. Power density = $13,700/0.585 = 23,400$ watts per cubic inch.

F. $f\rho = 9 \times 10^6$; $PD \times d = 23,400 \times 1/4 = 5850$.

G. From Fig. 9, $H_0 = 370$.

H. Assume a coil

$l = 12$ inches; $N = 48$; $d = 0.75$ inch.

From Fig. 13, $I/K_1 = 132$; $K_1 = 1$; $I = 132$ amperes, coil current.

$\psi = 2.24 \times 10^{-3}$; $dw/dc = 0.25/0.75 = 0.334$; $K_2 = 0.98$.

$E = 2.24 \times 10^{-3} \times 4.5 \times 10^5 \times 0.98 = 985$ volts, coil voltage.

I. Rate of heating = pounds per minute $\times \Delta t = 6.74 \times 928 = 6250$.

From Fig. 12, total power required = 18 kilowatts. A standard 20-kilowatt rating generator is therefore necessary. From Fig. 5, this rating of generator is capable of 175 amperes output. The aforementioned assumed coil design does not make full use of this output current; therefore, a change in coil design is necessary to match

properly the generator impedance and to utilize the full 175 amperes available.

J. Assume a coil

$l = 12$ inches; $N = 36$; $d = 0.75$ inch.

From Fig. 13, $I/K_1 = 175$ $K_1 = 1$; $I = 175$ amperes, coil current.

$\psi = 1.68 \times 10^{-3}$; $dw/dc = 0.25/0.75 = 0.334$; $K_2 = 0.98$;
 $E = 1.68 \times 10^{-3} \times 4.5 \times 10^5 \times 0.98 = 742$ volts.

K. Load circuit kilovolt-amperes per kilowatt

$$0.742 \times 175/18 = 7.2.$$

The current, voltage, and kilovolt-amperes-per-kilowatt ratio of the load circuit now agree with the characteristics of a standard 20-kilowatt generator, and we therefore have arrived at a suitable work-circuit design.

Example 4. Solid Nonmagnetic Cylinder

We shall assume that it is desired to heat four-inch lengths of one-half-inch-diameter stainless-steel rod to a temperature of 1600 degrees Fahrenheit in order to perform a forging operation. A production rate of 15 such ends per minute is desired, neglecting loading time. Induction heating is ideal for this application, since heating can be confined to the four-inch length at the end of the rod.

A. Volume to be heated per piece = $\pi/4 \times (0.5)^2 \times 4 = 0.785$ cubic inch.

B. Weight to be heated per piece = $0.785 \times 0.288 = 0.226$ pound per piece.

C. Rate of heating = 15 pieces per minute = $0.226 \times 15 = 3.39$ pounds per minute.

D. Thermal power = $1.76 \times 10^{-2} \times 3.39 \times 0.125 \times (1600 - 72) = 11.4$ kilowatts.

E. Power density = $11,400/0.785 = 14,550$ watts per cubic inch.

F. $f\rho = 450,000 \times 20 = 9 \times 10^6$.

G. From Fig. 11, $PD/H_0^2 = 9.8 \times 10^{-3}$

$H_0^2 = 14,550/9.8 \times 10^3 = 1.48 \times 10^6$; $H_0 = 1220$ oersteds.

This is a relatively high magnetizing force to be easily obtained from an oscillator.

In order to obtain more easily the required magnetizing force, three coils will be used in series, heating three separate rods simultaneously.

H. Power density per coil = $14,550/3 = 4850$ watts per cubic inch.

I. Magnetizing force per coil.

$H_0^2 = 4850/9.8 \times 10^3 = 49.5 \times 10^4$; $H_0 = 705$ oersteds per coil.

By the use of three coils, the magnetizing force per coil has been reduced. The rate of heating per coil will be one third the original rate using one coil, but the over-all rate of heating will remain the same. Fig. 12 is based upon a coil loss which is proportional to the thermal power supplied. To this approximation the coil losses will remain unchanged, as will the total power capacity required of the oscillator.

J. Assume a coil

$$l = 4 \text{ inches}; N = 23; N/l = 5.75; d = 0.75 \text{ inch.}$$

From Fig. 13, $I/K_1 = 175$; $l/d = 5.33$; $K_1 = 1.0$.

$$I = 175 \times 1.0 = 175 \text{ amperes}; \psi = 2.04 \times 10^{-3}.$$

$$dw/dc = 0.5/0.75 = 0.665; K_2 = 0.77.$$

$$E = 2.04 \times 10^{-3} \times 0.77 \times 4.50 \times 10^5 = 710 \text{ volts per coil.}$$

$$\text{Total voltage} = 710 \times 3 = 2130.$$

K. Rate of heating = $3.39 \times (1600 - 72) = 5200 = \text{pounds per minute} \times \Delta t$.

From Fig. 12, 20 kilowatts will be required to supply useful power plus losses.

$$L. \text{ Load circuit kilovolt-amperes per kilowatt} = 2.130 \times 175/20 = 18.6.$$

The voltage, current, and kilovolt-amperes-per-kilowatt ratio all satisfy the requirements of a standard 20-kilowatt generator, and the load has been made to match the generator perfectly by proper selection of the number of work coils and the proper number of turns in each coil.

Example 5. Nonmagnetic Hollow Cylinder

Assume that it is desired to heat a one-inch-diameter hollow brass tube with 0.05-inch wall thickness to a temperature of 322 degrees Fahrenheit, in order to flow an alloy coating which has been plated on the cylinder. A continuous rate of 25 feet per minute is required.

$$\rho = 8 \text{ microhm-centimeters (at minimum temperature).}$$

$$A. \text{ Volume to be heated per foot} = \pi/4 [(D_{o.d.})^2 - (D_{i.d.})^2] l = \pi/4 [1^2 - 0.9^2] \times 12 = 1.80 \text{ cubic inches per foot.}$$

$$B. \text{ Weight of metal per foot} = \text{volume per foot} \times \text{weight per cubic inch} = 1.80 \times 0.32 = 0.575 \text{ pounds per foot.}$$

$$C. \text{ Rate of heating} = 25 \times 0.575 = 14.4 \text{ pounds per minute.}$$

$$D. \text{ Thermal power} = 1.76 = 10^{-2} \times 14.4 \times 0.08 \times (322 - 72) = 5.05 \text{ kilowatts.}$$

$$E. \text{ Volume in coil of solid cylinder of same outside diameter (assuming a coil 12 inches long).}$$

$$V = \pi/4 \times (1)^2 \times 12 = 9.44 \text{ cubic inches.}$$

$$F. \text{ Power density} = 5050/9.44 = 535 \text{ watts per cubic inch.}$$

$$G. f\rho = 8 \times 4.5 \times 10^5 = 3.6 \times 10^6.$$

$$H. \text{ From Fig. 11, } PD/H_0^2 = 3.1 \times 10^{-3}.$$

$$H_0^2 = 535/3.1 \times 10^3 = 17.3 \times 10^4$$

$$H_0 = 415 \text{ oersteds.}$$

I. Assume a coil.

$$l = 12 \text{ inches}; d = 1.25 \text{ inches}; N = 42; N/l = 3.5; A = 1.23 \text{ square inches.}$$

From Fig. 13, $I/K_1 = 170$; $l/d = 9.6$; $K_1 = 1$; $I = 170$ amperes, coil current.

$$\psi = 61.4 \times 10^{-4}; dw/dc = 1.0/1.25 = 0.8; K_2 = 0.62.$$

$$E = 61.4 \times 10^{-4} \times 4.5 \times 10^5 \times 0.62 = 1710 \text{ volts, coil voltage.}$$

$$J. \text{ Rate of heating} = 14.4 \times (322 - 72) = 3600 = \text{pounds per minute} \times \Delta t.$$

From Fig. 12, total power required = 10,000 watts.

K. The current of 170 amperes is beyond that obtainable from the usual ten-kilowatt oscillator. If the maximum possible current is assumed to be 110 amperes, the work coil must be partially tuned in order to obtain the benefits of high-circulating currents.

$$I_c = I_L - I_i = 170 - 110 = 60.$$

$$\text{Capacitance required} = C = I_c/\omega E$$

$$= 60/(2\pi \times 450,000) \times 1710 = 0.0125 \text{ microfarad.}$$

$$\text{Kilovolt-amperes of capacitors} = 1710 \times 60 \times 10^{-3} = 103 \text{ kilovolt-amperes.}$$

$$L. \text{ Work circuit kilovolt-amperes per kilowatt} = 1710 \times 170/10,000 = 29.0.$$

M. Depth of penetration

$$\delta = 1.98 \sqrt{\rho/\mu f}.$$

Since δ is proportional to $\sqrt{\rho}$, the value of ρ at maximum temperature will be used in order to make certain that the depth of penetration is at all times less than the wall thickness. See (24) in the appendix for an explanation of the formula for depth of penetration and the terms used therein.

Resistivity at maximum temperature

$$\rho_{\text{hot}} = \rho_{\text{cold}} (1 + \alpha \Delta t)$$

where

Δt = temperature rise in degrees centigrade

α = temperature coefficient of resistivity

$$= 0.003 \text{ for brass}$$

$$\mu = 1$$

$$\rho_{\text{hot}} = 8 [1 + (0.003 \times 250/1.8)] = 11.3 \text{ microhm-centimeters}$$

$$\delta = 1.98 \sqrt{11.3/450,000} = 0.01 \text{ inch.}$$

The frequency is therefore of a high enough value so that the depth of penetration is less than half the wall thickness, as was required.

Alternate solutions are often desirable from the economic viewpoint. This application offers such an alternate solution. The foregoing figures indicate a generator current of 170 amperes which is a value obtainable from a 20-kilowatt generator without the aid of load capacitors or transformer. The power requirements were ten kilowatts, and therefore, by using two work circuits in series and a 20-kilowatt generator, the production rate can be doubled, and no accessories to the generator are necessary. The current, voltage (1710×2), and kilovolt-amperes-per-kilowatt ratio satisfy the characteristics of a 20-kilowatt generator.

Example 6. Magnetic Hollow Cylinder

It will be assumed that, in order to temper 0.25-inch-diameter steel tubing with 0.025-inch wall thickness, it is necessary to heat this tubing to a temperature of 1000 degrees Fahrenheit, while the tubing is moving at a continuous rate of 100 feet per minute.

$$\rho = 20 \text{ microhm-centimeters (at minimum temperature).}$$

$$A. \text{ Volume to be heated per foot} = \pi/4 [0.25^2 - 0.20^2] \times 12 = 0.212 \text{ cubic inch.}$$

B. Weight to be heated per foot = $0.212 \times 0.288 = 0.061$ pound per foot.

C. Rate of heating = $0.061 \times 100 = 6.1$ pounds per minute.

D. Thermal power = $1.76 \times 10^{-2} \times 6.1 \times 0.125 \times (1000 - 72) = 12.4$ kilowatts.

E. Volume in coil of solid cylinder of same outside diameter (assuming a coil 12 inches long).

$$V = (\pi/4) \times (1/4)^2 \times 12 = 0.59 \text{ cubic inch.}$$

F. Power density = $12,400/0.59 = 21,000$ watts per cubic inch.

G. $f\rho = 4.5 \times 10^5 \times 20 = 9 \times 10^6$; $PD \times d = 21,000 \times 0.25 = 5.25 \times 10^3$.

H. From Fig. 9, $H_0 = 344$ oersteds.

I. Assume a coil

$l = 12$ inches; $d = 0.8$ inch; $N = 36$; $N/l = 3$; $A = 0.5$ square inch.

From Fig. 13,

$l/d = 15$; $K_1 = 1$; $I/K_1 = 164$; $I = 164$ amperes, coil current.

$\psi = 1.80 \times 10^{-3}$; $dw/dc = 0.25/0.8 = 0.313$; $K_2 = 1$.

$E = 1.80 \times 10^{-3} \times 4.5 \times 10^5 \times 1 = 810$ volts, coil voltage.

J. Rate of heating = $6.1 \times (1000 - 72) = 5,650 =$ pounds per minute $\times \Delta t$.

From Fig. 12, total power required = 16 kilowatts.

K. Work circuit kilovolt-amperes per kilowatt = $810 \times 164/16,000 = 8.3$.

L. Depth of penetration

$$\delta = 1.98 \sqrt{\rho/\mu f}$$

$$\rho \text{ hot} = 20[1 + (0.003 \times 928/1.8)] = 50.6$$

$$\mu = 28,500/344 = 83.0$$

$$\delta = 1.98 \sqrt{50.6/450,000\mu}$$

$$\delta = 1.98 \sqrt{50.6/450,000 \times 83}$$

$$= 2.32 \times 10^{-3} \text{ inches.}$$

The depth of penetration is much less than the required half the wall thickness. Equations (30) and (37) in the appendix give the necessary explanation for the formulas for permeability and depth of penetration, respectively.

The foregoing figures satisfy the requirements of a 20-kilowatt generator, but they do not provide for full use of the power available from this 20-kilowatt unit. It would be desirable, therefore, to select a coil design to utilize the full rated current of 175 amperes and power of 20 kilowatts from a standard generator. The rate of production (100 feet per minute) thereby can be increased by the ratio 20/16 or to 125 feet per minute. Recalculation on this basis will give a coil design capable of fully loading the standard 20-kilowatt generator.

Example 7. Case Hardening

In this example we shall assume that a steel bearing 0.5 inch in diameter and one inch long is to be heated to a surface temperature of 1600 degrees Fahrenheit in order to case-harden to a depth of 0.03 inch.

A. Area to be hardened = $\pi dl = \pi \times 0.5 \times 1 = 1.57$ square inches.

B. Power required = 2 kilowatts per square inch = $1.57 \times 2 = 3.14$ kilowatts.

C. Volume of metal in coil = $\pi/4 \times (0.5)^2 \times 1 = 0.196$ cubic inch.

D. Power density = $3140/0.196 = 16,000$ watts per cubic inch.

E. $H_0 = 720$ (from analysis in appendix (50)).

F. Assume a coil

$N = 2$; $l = 1$ inch; $N/l = 2$; $d = 0.75$ inch; $A = \pi/4 \times 0.75^2 = 0.44$ square inch.

From Fig. 13,

$I/K_1 = 514$; $l/d = 1/0.75 = 1.34$; $K_1 = 1.35$.

$I = 1.35 \times 514 = 694$ amperes, coil current; $\psi = 1.81 \times 10^{-4}$.

$dw/dc = 0.5/0.75 = 0.665$; $K_2 = 0.78$; $E = 1.81 \times 10^{-4} \times 4.5 \times 10^5 \times 0.78 = 63.5$ volts, coil voltage.

G. Power loss in work coil (see (9))

$$W_c = 1.40(dc/dw)\sqrt{(\rho c/\rho w)W_w}; \quad W_c = 1.40 \times 0.75/0.5 \sqrt{2.1/20} \times 3.14 = 2.12 \text{ kilowatts.}$$

Total power required = $3.14 + 2.12 = 5.26$ kilowatts.

H. Load circuit kilovolt-amperes per kilowatt = $63.5 \times 694/5260 = 8.3$.

I. Depth of penetration

$$\delta = 1.98 \sqrt{\rho/\mu f} \quad \mu = 28,500/H_0 = 28,500/720 = 39.5.$$

Equations (30) and (37) in the appendix give the necessary explanation for the formulas for permeability and depth of penetration, respectively.

$$\rho \text{ hot} = 20[(1 + 0.003 \times 1528)/1.8] = 71.$$

$$\delta = 1.98 \sqrt{71/39.5 \times 450,000} = 3.96 \times 10^{-3} \text{ inches.}$$

The frequency used is therefore high enough so that the depth of penetration is less than half the depth of case desired.

The coil current is considerably beyond a value practically obtainable from an oscillator rated at five- or ten-kilowatt output. The load-circuit kilovolt-amperes-per-kilowatt ratio and the current requirements indicate that a current transformer is an ideal solution.

The total power requirements given in G do not include transformer losses. To accomplish this heating job, it is therefore necessary to use a ten-kilowatt generator to provide the relatively high current-transformer losses in addition to work-circuit power. There will be a margin of safety if a 10-kilowatt generator is employed, which by proper design of the work circuit can be used to increase the kilowatt per square inch into the work and thereby reduce the heating time.

APPENDIX

The theoretical basis from which the equations used were derived, together with the derivation of these equations, will be treated briefly in this section.

When any conductor is placed in a varying magnetic

field, currents are induced in the conductor as in a transformer secondary winding. Since the conductor has definite resistivity, heat is generated by the induced currents. This principle is known as induction heating. The correct frequency to be used depends upon the size and electrical properties of the piece to be heated. This frequency may vary from 60 cycles or less for large objects to several hundred kilocycles for case hardening and heating of small objects.

In general, magnetic properties make iron and steel below the Curie point much easier to heat than the other metals. The Curie point, approximately 1300 degrees Fahrenheit, is that temperature above which iron loses its magnetic properties. Materials of low resistivity, such as aluminum and copper, are more difficult to heat than the poorer conductors.

Nearly any problem in the induction-heating field can be resolved into that of heating either a cylinder or strip of magnetic or nonmagnetic material. If a hollow cylinder is to be heated, satisfactory results require that the depth of current penetration caused by "skin effect" be less than the wall thickness of the cylinder, which sets a lower limit to the frequency.

It has been shown² that power loss in a cylinder may be represented as

$$P = \frac{(H_0')^2 \rho m}{0.08\pi 2a} \times \left\{ \frac{\text{ber}(ma) \text{ber}'(ma) + \text{bei}(ma) \text{bei}'(ma)}{\text{ber}^2(ma) + \text{bei}^2(ma)} \right\} \text{ watts per cubic centimeter} \quad (16)$$

where

$$ma = a\sqrt{8\pi^2\mu f \times 10^{-9}/\rho} \quad (17)$$

f = frequency (cycles per second)
 ρ = resistivity (ohm-centimeters)
 a = radius of cylinder (centimeters)
 μ = permeability.

Let

$$G(ma) = \frac{1}{ma} \times \frac{\text{ber}(ma) \text{ber}'(ma) + \text{bei}(ma) \text{bei}'(ma)}{\text{ber}^2(ma) + \text{bei}^2(ma)} \quad (18)$$

Then

$$P = \frac{(H_0')^2 \rho m^2}{0.08\pi^2 ma} \times \frac{\text{ber}(ma) \text{ber}'(ma) + \text{bei}(ma) \text{bei}'(ma)}{\text{ber}^2(ma) + \text{bei}^2(ma)} = (H_0')^2 \rho \frac{(8\pi^2\mu f \times 10^{-9})}{0.08\pi^2 \rho} G(ma) = \mu(H_0')^2 f G(ma) \times 10^{-7} \text{ watts per cubic centimeter} \quad (19)$$

where H_0' = root-mean-square magnetizing force. If H_0 = peak magnetizing force, then $H_0 = \sqrt{2} H_0'$ and $P = 1/2\mu H_0^2 f G(ma) \times 10^{-7}$ watts per cubic centimeter. (20)

² N. W. McLachlan, "Bessel Functions for Engineers," Oxford University Press, New York, N. Y., 1943, chapter 9.

Power density will be maximum for a given frequency when the function $G(ma)$ is maximum. This occurs with a value of $(ma) \cong 3$. Operation is unstable with values of (ma) less than 3, and the minimum frequency is taken to be that frequency which makes $(ma) = 3$. This frequency is not critical and any frequency for which $(ma) \geq 3$, will be satisfactory, providing current and voltage limitations in the work coil are not exceeded. An increased frequency lowers the power factor of the coil, but increases the power-input-to-magnetizing-force ratio. The highest possible ratio is desired without exceeding current or voltage limitations. The function $G(ma)$ may be replaced with very little inaccuracy when

$$(ma) \geq 10 \text{ by} \quad G(ma) = 1/ma\sqrt{2} \quad (21)$$

and for practical purposes when $(ma) \geq 3$. Power density therefore simplifies to

$$P = (1/2ma\sqrt{2})\mu H_0^2 f \times 10^{-7} \text{ watts per cubic centimeter.} \quad (22)$$

For a coil long with respect to its diameter,

$$H_0 = (0.4\pi NI/l)\sqrt{2} \text{ oersteds} \quad (23)$$

where NI/l = ampere turns per centimeter of the coil. If the diameter of the coil is comparable to its length, the value given above for H_0 is modified by the factor K_1 , plotted in Fig. 11.

The same relationships are valid for a hollow cylinder, providing the depth of penetration of current is less than the wall thickness.

Effective depth of current penetration is given as

$$\delta = 5033\sqrt{\rho/\mu f} \text{ centimeters} \quad (24)$$

where ρ = resistivity in ohm-centimeters. The minimum frequency for hollow cylinder has been taken arbitrarily as twice the frequency which would produce a depth of penetration equal to the wall thickness.

The power input to a flat strip is given as

$$P = 1/2\mu H_0^2 f G(K_s t) \times 10^{-7} \text{ watts per cubic centimeter} \quad (25)$$

where

$$K_s t = t\sqrt{4\pi^2\mu f \times 10^{-9}/\rho} \quad (26)$$

t = thickness of strip (centimeters)

ρ = resistivity (ohm-centimeters).

$$G(K_s t) = \frac{1}{2K_s t} \frac{\sinh(K_s t) - \sin(K_s t)}{\cosh(K_s t) + \cos(K_s t)} \quad (27)$$

The function $G(K_s t)$ has a maximum value of $K_s t \cong 3$, as in the case of the cylinder. For practical purposes when

$$K_s t \geq 3 \quad (28)$$

$G(K_s t)$ may be replaced by $1/2K_s t$. In this case, the power-input equation reduces to

$$P = (1/4K_s t)\mu H_0^2 f \times 10^{-7} \text{ watts per cubic centimeter.} \quad (29)$$

These equations are valid for magnetic materials, provided that μ remains constant or varies according to some mathematical relationship. Since μ is ordinarily not constant and does not have a regular variation, approximation is necessary. If a constant value of μ ,

based on empirical and theoretical considerations and equal to

$$1.78\sqrt{B_m/H_0} \quad (30)$$

is used, where B_m is the saturation flux density of iron and is approximately equal to 16,000 gausses, the equation will give reasonably accurate results, for both strip and cylinder.

Equations (2) through (7) and (10) through (14) are derived as follows: General equation for power input to a cylinder

$$PD = 1/2\mu H_0^2 G(ma) f \times 10^{-7} \text{ watts per cubic centimeter} \\ = 8.2 \times 10^{-7} \mu f G(ma) H_0^2 \text{ watts per cubic inch} \quad (31)$$

$$ma = a\sqrt{8\pi^2 \mu f \times 10^{-9}/\rho} \\ = 0.356\sqrt{(\mu f/\rho)d} \quad (32)$$

where d = diameter of cylinder in inches
 ρ = resistivity in microhm-centimeters.

Let

$$G(ma) = 1/ma\sqrt{2} \\ PD = 8.2H_0^2 \mu f \sqrt{\rho} \times 10^{-7} / \sqrt{2} \times 0.356d\sqrt{\mu f} \\ = (16.3H_0^2/d)\sqrt{\mu f \rho} \times 10^{-7} \text{ watts per cubic inch.} \quad (33)$$

Power input to a magnetic cylinder

$$\mu = 1.78 \times 16,000/H_0 = 28,500/H_0.$$

$$PD = (16.3/d)\sqrt{\rho f \sqrt{(28,500/H_0)H_0^2}} \times 10^{-7} \\ = (2.75 \times 10^{-4}/d)\sqrt{\rho f} H_0^{3/2}. \quad (2)$$

Power input to a nonmagnetic cylinder ($\mu = 1$)

$$PD = (1.63/d)\sqrt{\rho f} H_0^2 \times 10^{-6}. \quad (4)$$

General equation for power input to a strip

$$PD = 1/2\mu H_0^2 f G(K_s t) \times 10^{-7} \text{ watts per cubic centimeter} \\ = 8.2 \times 10^{-7} \mu f G(K_s t) H_0^2 \text{ watts per cubic inch.} \quad (34)$$

$$K_s t = t\sqrt{4(\pi)^2 \mu f \times 10^{-9}/\rho} \\ = 0.505t\sqrt{\mu f/\rho} \quad (35)$$

where t = strip thickness in inches
 ρ = resistivity in microhm-centimeters.

Let

$$G(K_s t) = 1/2K_s t \\ PD = 8.2H_0^2 \mu f \sqrt{\rho} \times 10^{-7} / 2 \times 0.505t\sqrt{\mu f} \\ = 8.15H_0^2 \sqrt{\mu f \rho} \times 10^{-7} / t \text{ watts per cubic inch.} \quad (36)$$

Power input to a magnetic strip

$$\mu = 28,500/H_0$$

$$PD = 8.15/t\sqrt{f\rho}\sqrt{(28,500/H_0)H_0^2} \times 10^{-7} \\ = 1.37 \times 10^{-4}\sqrt{f\rho} H_0^{3/2}/t \text{ watts per cubic inch.} \quad (3)$$

Power input to a nonmagnetic strip ($\mu = 1$)

$$PD = 8.15 \times 10^{-7}\sqrt{f\rho} H_0^2/t \text{ watts per cubic inch.} \quad (5)$$

Minimum frequency for heating a solid cylinder

$$ma = 0.356d\sqrt{\mu f/\rho}.$$

$$\text{Let } ma = 3; \text{ then } 0.356\sqrt{\mu f/\rho} = 3; \mu f = 71\rho/d^2. \quad (10)$$

Minimum frequency for heating a strip

$$K_s t = 0.505t\sqrt{\mu f/\rho}.$$

$$\text{Let } K_s t = 3; \text{ then } 0.505t\sqrt{\mu f/\rho} = 3 \\ \mu f = 35.2(\rho/t^2). \quad (13)$$

Magnetic permeability at minimum frequency for steel cylinder or strip below Curie point

$$PD = 8.2 \times 10^{-7} \mu f G(ma) H_0^2 \\ = 8.2 \times 10^{-7} \mu f G(K_s t) H_0^2.$$

At minimum frequency

$$ma = 3 \\ K_s t = 3 \\ G(ma) = G(K_s t) = 0.186 \\ PD = 1.52 \times 10^{-7} \mu f H_0^2 \\ \mu = 28,500/H_0; \quad H_0 = 28,500/\mu \\ PD = 1.52 \times 10^{-7} (\mu f) \times (28,500/\mu)^2 \\ \mu = \sqrt{(123/PD)\mu f}. \quad (14)$$

Minimum frequency for heating a hollow magnetic cylinder

$$\delta = 5033\sqrt{\rho/\mu f} \text{ centimeters} \\ = 1.98\sqrt{\rho/\mu f} \text{ inches} \quad (37)$$

where ρ = resistivity in microhm-centimeters

$$\mu f = (1.98^2/\delta^2)\rho.$$

Let $\delta = t$ = wall thickness of cylinder.

Let

$$f^1 = 2f \\ f^1 = 1.98^2 \times 2\rho/\mu t^2; \quad \mu = 28,500/H_0 \\ = 1.98^2 \times 2\rho H_0/28,500 t^2 \quad (38)$$

$$PD = 2.75 \times 10^{-4}\sqrt{f^1 \rho} H_0^{3/2}/d \\ H_0 = [(3.64PD \times d \times 10^3)/\sqrt{f^1 \rho}]^{2/3} \quad (2)$$

$$f^1 = \frac{1.98^2 \times 2\rho \left[\frac{3.64PD \times d \times 10^3}{\sqrt{f^1 \rho}} \right]^{2/3}}{28,500 t^2} \\ f^1 = \frac{1.98^2 \times 2\rho \left[\frac{PD \times d \times 10^4}{2.75\sqrt{f^1 \rho}} \right]^{2/3}}{28,500 t^2} \\ f^1 = 0.129[(PD \times d \times \rho)/t^3]^{1/2}. \quad (11)$$

Minimum frequency for heating a hollow nonmagnetic cylinder

$$\delta = 1.98\sqrt{\rho/f}.$$

Let

$$\delta = t \\ f^1 = 2f \\ t^2 = 1.98^2(2\rho/2f) = 1.98^2(2\rho/f^1) \\ f^1 = (7.75\rho/t^2). \quad (12)$$

Magnetizing force for case hardening of a cylinder.

Let

$$E_1 = \text{energy input to work while it is magnetic} \\ E_2 = \text{energy input to work when it passes the Curie point} \\ E_0 = \text{total energy input to the work} \\ P_1 = \text{power input in watts while magnetic} \\ P_2 = \text{power input in watts when nonmagnetic} \\ t_1 = \text{time material is magnetic} \\ t_2 = \text{time material is nonmagnetic} \\ PD = (K_1 H_0^2 \sqrt{\mu f \rho})/d \text{ watts per cubic inch}$$

$$\begin{aligned}
P/A &= K_2 H_0^2 \sqrt{\mu f \rho} \text{ watts per square inch of surface area} \\
P_1/\pi dl &= K_2 H_0^2 \sqrt{\mu f \rho} \\
P_2/\pi dl &= K_2 H_0^2 \sqrt{f \rho} (\mu = 1) \\
P_1/P_2 &= \sqrt{\mu} \text{ (for } H_{01} = H_{02}) \quad (39) \\
E_1 &= (13/16)E_0 \\
E_2 &= (3/16)E_0 \quad (40) \\
E_0 &= 2(t_1 + t_2)\pi dl \text{ (2 kilowatts per square inch} \\
&\quad \times \text{area} \times \text{time)} \quad (41) \\
E_1 &= P_1 t_1 = (13/16) \times 2(t_1 + t_2)\pi dl \quad (42) \\
E_2 &= P_2 t_2 = (3/16) \times 2(t_1 + t_2)\pi dl \quad (43) \\
P_2 &= P_1/\sqrt{\mu}. \quad (44)
\end{aligned}$$

If we solve (39), (43), and (44),

$$\begin{aligned}
t_2/t_1 &= 3/13\sqrt{\mu} \quad (45) \\
P_1 t_1 + P_2 t_2 &= P_{\text{eff}}(t_1 + t_2) \quad (46) \\
P_1 t_1 + (P_1/\sqrt{\mu}) \times (3/13)\sqrt{\mu} t_1 &= (2t_1 + t_2)\pi dl \quad (47) \\
P_1 &= 1.63\pi dl [(3/13)\sqrt{\mu} + 1] \quad (48) \\
\frac{P_1}{\text{Volume}} = PD &= \frac{2.75 \times 10^{-7} \sqrt{f \rho} H_0^{3/2}}{d} = \frac{4P_1}{\pi d^2 l} \quad (49) \\
4 \times \left[\frac{1.63\pi dl (3/13\sqrt{\mu} + 1)}{\pi d^2 l} \right] &= \frac{2.75 \times 10^{-4} \sqrt{f \rho} H_0^{3/2}}{d}
\end{aligned}$$

Let

$$\begin{aligned}
f &= 450 \text{ kilocycles} \\
\rho &= 20 \text{ microhm-centimeters} \\
\sqrt{f \rho} &= 3 \times 10^3
\end{aligned}$$

$$\begin{aligned}
H_0^2 - 7.9 \times 10^3 \sqrt{H} - 3.08 \times 10^5 &= 0 \\
H_0 &= 720. \quad (50)
\end{aligned}$$

Coil voltage and current as a function of magnetizing force

$$\begin{aligned}
L &= (N\phi/1) \times 10^{-8} = (NHA/I) \times 10^{-8} \quad (51) \\
E &= \omega LI = \omega NH_0 A \times 10^{-8}
\end{aligned}$$

where H_0 = peak magnetizing force in oersteds

$$\omega = 2\pi f$$

$E = (H_0/\sqrt{2}) \times 2(\pi f N A \times 10^{-8})$, root-mean-square volts, for an air-core solenoid

where A = area in square centimeters

$$E = H_0(2.86 \times 10^{-7} f N A K_2) \quad (6)$$

where E = root-mean-square volts for coil with a metal core

A = area of coil in square inches

$$I = H_0 [(l/0.4\pi N) K_1]$$

where l = length of coil in centimeters

I = peak current in amperes

$$I = H_0(2.54l/0.4\pi\sqrt{2} N) K_1 = H_0 \times [1.43(l/N) K_1] \quad (7)$$

where I = root-mean-square current in amperes

l = length of coil in inches.

BIBLIOGRAPHY

- F. E. Terman, "Radio Engineers' Handbook," McGraw-Hill Book Company, Inc., New York, N. Y., 1943, section 6.
 C. P. Steinmetz, "Transient Phenomena and Oscillations," McGraw-Hill Book Company, Inc., New York, N. Y., 1920, chapters 6 and 7.

A 60-Kilowatt High-Frequency Transoceanic-Radiotelephone Amplifier*

C. F. P. ROSE†, SENIOR MEMBER, I.R.E.

Summary—Herein is described a high-frequency radio amplifier recently developed for the transoceanic-telephone facilities of the Bell System at Lawrenceville, N. J. In general, the amplifier is capable of delivering 60 kilowatts of peak envelope power when excited from a 2-kilowatt radio-frequency source. It is designed to operate as a "class B" amplifier for transmitting either single-channel double-sideband or twin-channel single-sideband types of transmission. Features are described which permit rapid frequency-changing technique from any preassigned frequency to another lying anywhere within the spectrum of 4.5 to 22 megacycles.

I. INTRODUCTION

THERE HAVE been increasing demands for transoceanic high-frequency two-way radiotelephone circuits since such a circuit was first initiated by the American Telephone and Telegraph Company in 1928. A step toward satisfying the early demands was taken in June, 1929, when two trans-

atlantic high-frequency transmitters were inaugurated at Lawrenceville, N. J.¹ By 1935 the system had expanded from transatlantic to transoceanic in scope. The overseas traffic carried by the high-frequency transmitting stations at Lawrenceville, Ocean Gate, N. J., and Dixon, California, was being handled with seven single-channel, double-sideband transmitter units. Experiments were conducted proving the merits of a single-sideband system as a replacement of the double-sideband type of transmission.² In 1938, newly installed input equipment for three transmitters provided transmission on either a double- or single-sideband basis.³ During 1939, the traffic capacity was augmented by modifications in the input equipment which permitted handling

¹ "Transatlantic short-wave radio," *Bell Lab. Rec.*, vol. 7, pp. 481-518; August, 1929.

² F. A. Polkinghorn and N. F. Schlaack, "A single-side-band short-wave system for transatlantic telephony," *Proc. I.R.E.*, vol. 23, pp. 701-718; July, 1935.

³ A. A. Oswald, "A short-wave single-side-band radiotelephone system," *Proc. I.R.E.*, vol. 26, pp. 1431-1454; December, 1938.

* Decimal classification: R355.7. Original manuscript received by the Institute, February 21, 1945.

† Bell Telephone Laboratories, Inc., New York, N. Y.

twin-channel single-sideband transmission, wherein the second channel was obtained by utilizing the other sideband.

Improvements in the input equipment comprising the Western Electric D-156000 radio transmitter embodied not only provision for twin-channel single-sideband and single-channel double-sideband transmission, but also minimized the operations required for changing frequencies dictated by diurnal variations in transmission paths.⁴ The existing two-stage radio-frequency power amplifier did not lend itself readily to modifications enabling rapid frequency-changing technique. Consequently, a program was followed for the development of a new high-power amplifier to be used in conjunction with the D-156000 radio transmitter. The program culminated in June, 1942, when the Western Electric D-158974 radio amplifier herein described was turned over to traffic at Lawrenceville, N. J.

II. SPECIFICATIONS AND REQUIREMENTS

In contrast with the amplifiers installed at Lawrenceville, in 1929, the design specifications for this equipment briefly encompassed the following:

1. The floor area required for the control unit, amplifier unit, and high-voltage rectifier unit should be reduced to a minimum. Toward this end rotating machinery must be eliminated except for the pumps and blowers for the water-cooling system, and the high-voltage rectifier shall employ mercury-vapor tubes instead of water-cooled high-vacuum tubes.
2. The costs for construction, operation, and maintenance must be minimized and only those improvements incorporated which insure better dependability, stability, simplicity, and quality of service.
3. The amplifier must meet the following requirements:
 - (a) It must deliver 60 kilowatts of peak envelope radio-frequency power into essentially a resistive load impedance lying anywhere within the range of 250 to 800 ohms.
 - (b) It must operate at any frequency within the range of 4.5 to 22 megacycles and be capable of continuous operation.
 - (c) The signal-to-distortion ratio must be equal to or greater than 25 decibels, and the signal-to-noise ratio at least 45 decibels, to satisfy the requirements for double-sideband transmission or single-sideband twin-channel operation.
 - (d) There must be provisions for rapid frequency changes; i.e., the time and personnel required to change from one frequency assignment to another must be reduced to a minimum.
 - (e) A safety system must prevent the personnel

⁴ K. L. King, "A twin-channel single-side-band radio transmitter," *Bell Lab. Rec.*, vol. 19, pp. 202-205; March, 1941.

from entering any compartment until all voltages have been removed and capacitors discharged.

III. DESCRIPTION

To minimize construction and maintenance costs, it was desirable to limit the amplifier to a single stage and locate as much of its power supply as possible outdoors. As shown in Fig. 1, the indoor equipment of the D-158974 radio amplifier comprises three units bolted together and all mounted on a common-channel-iron

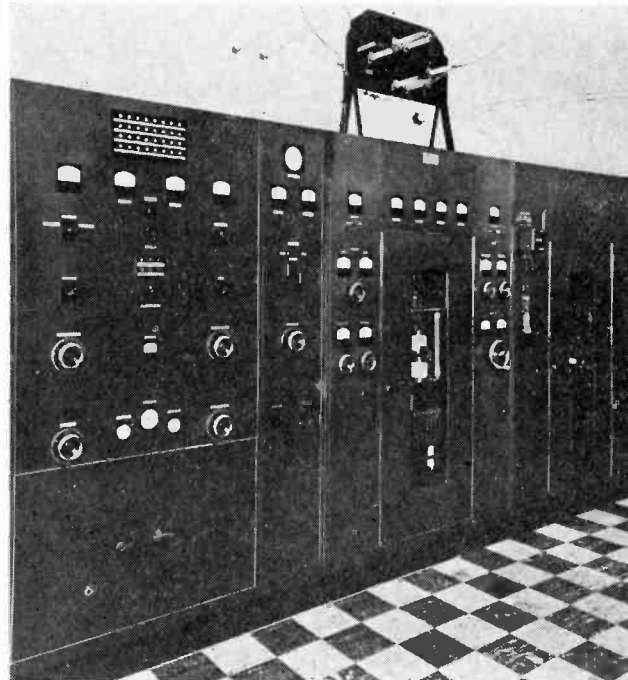

Fig. 1—Western Electric D-158974 radio amplifier.

base. These three units cover a floor space of 4 feet by 15 feet, as compared with at least triple this area previously required for comparable equipment. Each unit measures 4 feet deep, 5 feet wide, and 7 feet high. They are constructed of 1/16-inch sheet steel welded to a rectangular steel-tube frame which affords adequate shielding without resorting to the previous and more costly construction involving brass angle and aluminum sheet. The unit on the left houses the control switches and relays for the system, grid-bias rectifier and associated filter, filament controls, two porcelain coils for insulation in the water-cooling system, and indicating lamps for the entire system. The central unit houses the amplifier proper, which is discussed in detail later. The unit on the right houses the six Western Electric Type 255B mercury-vapor rectifier tubes connected in a three-phase, bridge-type, high-voltage rectifier circuit. The control for the high-voltage grounding switch is located in the upper left corner of this unit. This switch is mechanically connected to Cory interlocks in such a way as to prevent entrance to any compartment until all high voltage is removed and buses have been

grounded. A second line of protection is provided by means of door switches which will open the oil circuit breaker if a lock fails and a compartment door is opened. High voltage cannot be reapplied until all doors have been closed and the grounding switch removed from the grounded position.

All electrical connections, except to the antenna transmission line, enter through the floor. The two radio-frequency output leads pass through a pyrex

to the relatively low 2-kilowatt peak output of the Western Electric type D-156000 radio transmitter. Actually, with sufficient input power, the amplifier has a capacity of 80 to 100 kilowatts of radio-frequency peak envelope power. However, the output requirement of 60 kilowatts establishes a power gain of 15 decibels for a single-stage "class B" amplifier. This is somewhat more gain than that found in average practice, but it was satisfactorily realized after the development of a suit-

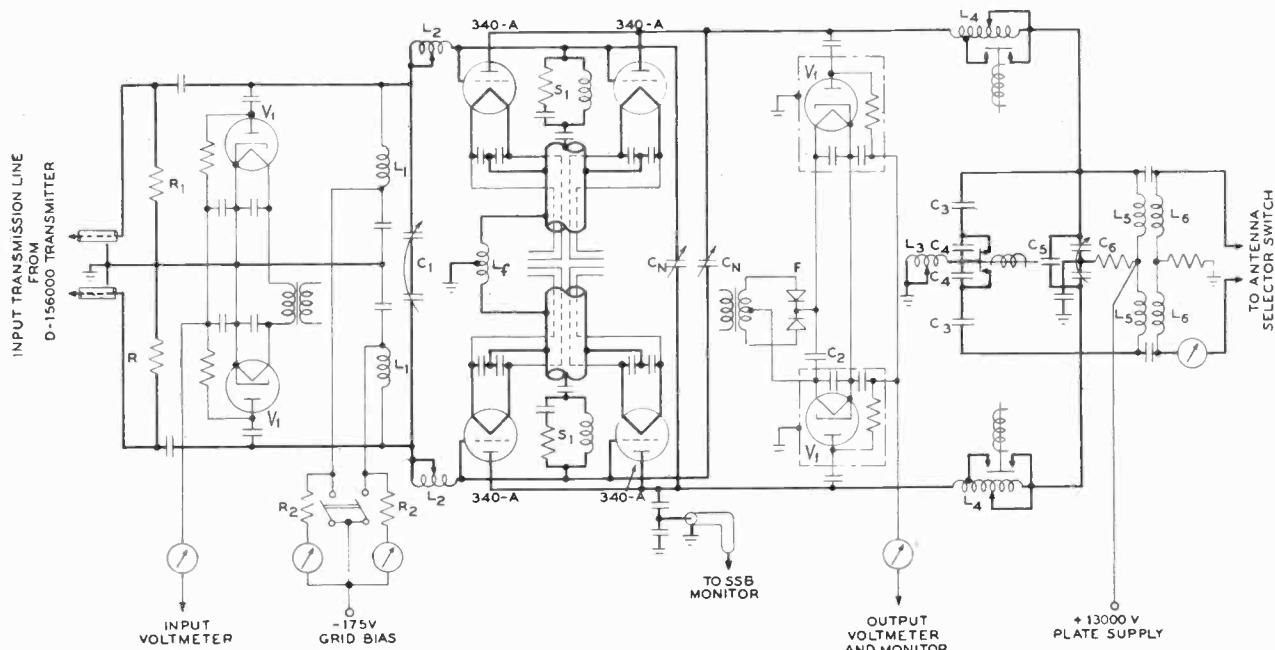

Fig. 2—Western Electric D-158974 radio amplifier, partial schematic.

glass panel in the top of the amplifier unit to an external antenna-transmission-line switch. Intercabinet wiring is run in conduit through the sides of the cabinets.

There are blowers in the control and rectifier compartments which circulate filtered air through all three compartments. The only other rotating machines in the system are the pumps and fans associated with the water-cooling system. These are located in other sections of the building and are normally unattended. A predetermined water temperature must be attained before the cooling fans operate. Thereafter, thermostats automatically control the number of fans required in accordance with the ambient temperature and the power dissipated.

The amplifier employs four Western Electric Company Type 340A single-ended, 25-kilowatt, water-cooled vacuum tubes connected in a push-pull bridge-neutralized circuit. The two tubes on one side of the circuit are connected in parallel. The operating characteristics for these tubes are similar to the vacuum tubes used in early models of Western Electric 50-kilowatt broadcast transmitters. Excessive heating of the copper-glass grid seal due to radio-frequency losses was eliminated by resorting to air cooling of the seal.

At first, a single-stage amplifier appeared impracticable because the basic radio-frequency supply was limited

able grid circuit employing a balanced pi-type network.

A schematic of the amplifier is given in Fig. 2. The grid circuit is tuned by means of two continuously variable series inductive elements designated as L_2 in the schematic. These inductances are known as Western Electric Type 13-A tuning coils. A roller, contacting progressive turns, short-circuits the unwanted turns as it advances on its shaft from one end of the coil to the other. A variable capacitance C_1 is used as the shunt element at the sending end of the network to accommodate varying grid input impedances resulting from frequency changes. Resistors R_1 also shunt the sending end of the network and serve a twofold purpose. They provide a termination for the 200-ohm balanced concentric input transmission line. In addition, they provide a swamping effect for the varying grid input resistance resulting from positive grid excitation.

Resistors R_2 are incorporated, which are normally short-circuited out, but for test purposes can be connected in series with the direct-current grid-bias path when the plate voltage is not applied. This permits using the amplifier tubes as peak voltmeters, thereby determining the voltage applied to the actual grid within the tube envelope. The ratio of this voltage to the voltage developed across the terminus of the coaxial input transmission line determines the voltage step up in the

grid circuit. For normal operation, a step up of approximately 2.2 is required. The push-pull peak voltage developed on the active grids at maximum peak envelope power approximates 2300 volts, and the grids in each bank of tubes are driven about 1000 volts positive.

Neutralization is accomplished by means of two oil-filled variable capacitors, C_N . These capacitors connect the plates in one bank of tubes to the grids of the other. However, an optimum amount of inductance L_f is added between the filaments of the tubes on opposite sides of the push-pull amplifier to perform a function similar to that described by other manufacturers.⁵ This provides greater stability and eliminates the necessity for changing the neutralizing capacitor settings to cover the frequency range. The value of this inductance is

The additional inductance L_f , inserted in the filament path, permits raising the radio-frequency filament voltage with respect to ground in an amount equal to that developed at its conjugate point located at the active grid. This was accomplished by threading the leads which carry the power for the filaments in each bank of two tubes within a copper pipe approximately 1 foot in length. The filament power leads are by-passed to the copper pipe at the end opposite the power supply. The other ends of the pipes, where the filament leads emerge, are connected together by means of a short conductor which provides the inductance L_f . An optimum point approximating the midpoint of this conductor is connected to ground.

In addition to the bridge type of neutralization in the

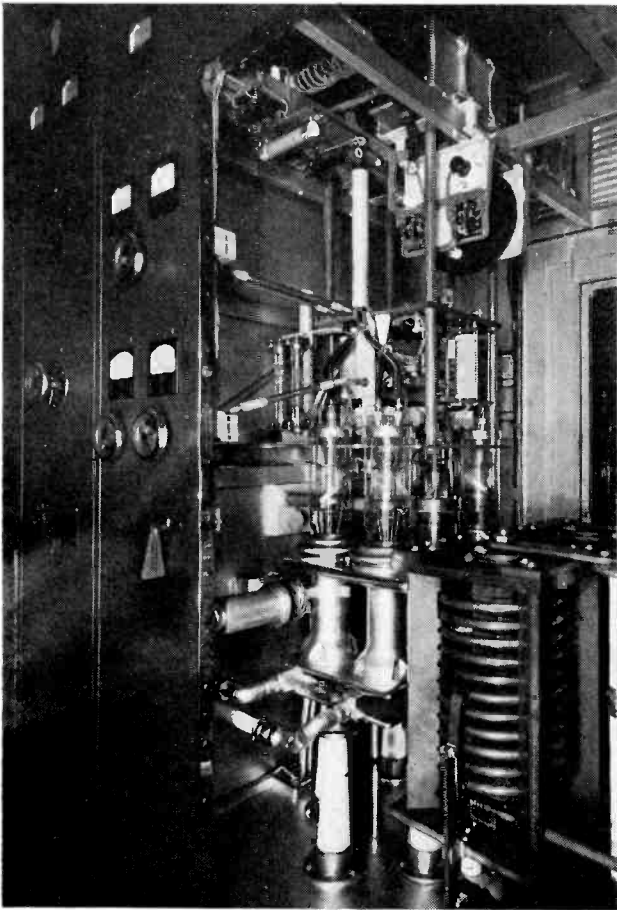

Fig. 3—Interior of radio amplifier.

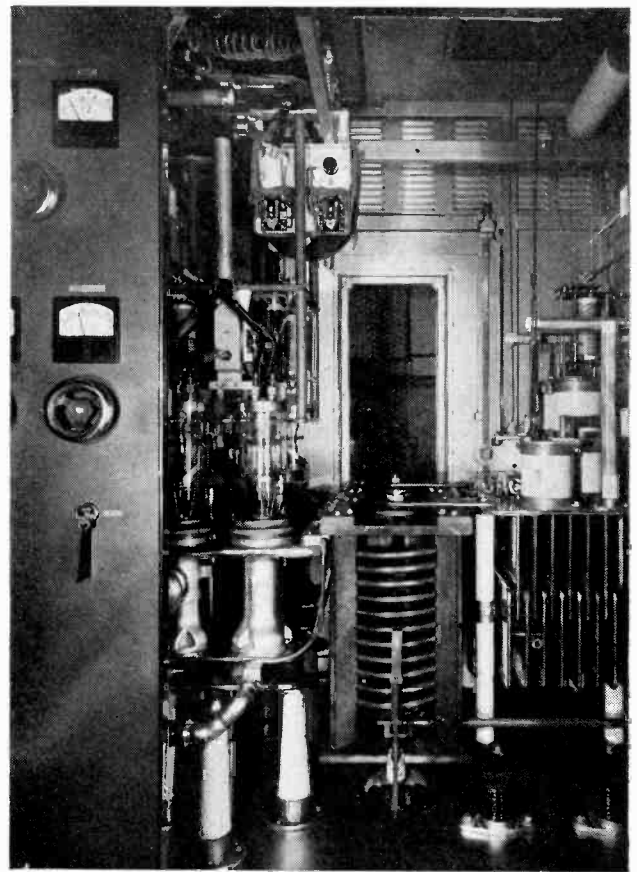

Fig. 4—Interior of radio amplifier.

dictated by the inherent plate-grid, plate-filament inter-electrode capacitance and the inherent grid inductance. The relationship requires that the ratio of plate-grid to plate-filament capacitance be equal to the ratio of total filament inductance to inherent grid inductance. This may be expressed $C_{pg}/C_{pf} = L_f/L_g$, wherein the subscripts p , f , and g refer to the plate, filament, and grid elements of the vacuum tubes.

⁵ P. J. H. A. Nordlohne, "The experimental short wave broadcasting station PCJ," *Phillips Transmitting News*, vol. 5, pp. 1-15; April, 1938.

amplifier, two suppression circuits are incorporated in the design. One is a 68-megacycle suppression circuit and the other is an harmonic suppression circuit.

The 68-megacycle suppression circuit S_1 is bridged from each grid circuit to its corresponding filament circuit. Its purpose is to eliminate spurious oscillations due to resonance within the bridge circuit. It is a high-pass filter series-resonated for 68 megacycles. A resistive component is capacitively coupled to this resonant circuit to broaden the characteristic impedance for the operating frequencies.

The harmonic-suppression circuit L_3, C_{3-4} is designed to suppress the second-harmonic voltage from each side of the output transmission line to ground. It consists of a capacitance bridged from each output lead to one terminal of a common variable inductance, the other terminal of which is connected to ground. Each capacitance comprises two series capacitors, C_3 and C_4 , one being short-circuited at the lower frequencies by a solenoid-operated switch.

The pi-type output circuit is tuned by means of continuously variable series-inductive elements L_4 , and coupling is provided by means of the capacitor C_6 . As in the case of the inductances used in the grid circuit, the unused end of each plate coil is short-circuited through the sliding contact in order to prevent parasitic voltages from being developed when only a few turns are actively in the circuit. An additional short circuit in the unused portion of the plate-tuning coils is necessary to overcome self-resonant conditions at frequencies within the operating spectrum. This is accomplished automatically by means of solenoid-operated switches. A commutator is mounted on the controls for these coils, which opens or closes the electrical circuit to the solenoids as the movable contact passes a given point on the coil.

The radio-frequency chokes L_6 , connected between the transmission line and ground, provide a short circuit for the plate voltage in the event that a transmission-line stopping capacitor fails, thereby preventing high direct-current voltage from being applied to the antenna. These chokes have very suitable characteristics over the frequency range of 4.5 to 22 megacycles. This is accomplished by using a large ratio of axial length to diameter.

The interior view, Fig. 3, is directed primarily toward the elements of the grid circuit. Particular features here illustrated are the glass-enclosed grid-loading resistors, the grid-tuning coils, the ducts carrying air for cooling the tube envelope at the grid seals, the configuration of elements concerning the filament circuit, the ceramic piping associated with the water-cooling system, and a plate-monitoring diode.

Fig. 4 shows the elements constituting the output circuit. The continuously variable feature of the plate tuning coils presented a special contact problem. For this reason the coils are water-cooled. They consist of eleven turns of $\frac{3}{4}$ -inch outside-diameter copper tubing having a mean diameter of 9.5 inches. The turns are held in position by four mycalex insulating supports that are fastened to the upper and lower insulating plates. The spacing of turns is more than sufficient to withstand an approximate maximum of 400 root-mean-square radio-frequency volts per turn. About one gallon of water per minute is by-passed around each bank of tubes to cool each plate tuning coil. To do this, both inlet and outlet water connections for either coil must be made at its associated plate assembly. This precludes a direct metallic water connection from the two ends of

the coil since it results in short-circuiting the coil. A radio-frequency isolating section of ceramic piping might be inserted in either the inlet or outlet water connection to a coil, but this becomes cumbersome. To avoid this, a copper tubing of $\frac{7}{8}$ -inch outside diameter is threaded inside the $\frac{3}{4}$ -inch outside-diameter copper-tubing helix. This design provides inlet and outlet water paths at the end of the coil which is electrically connected to the tube jackets. At the other end of the coil an internal re-entrant series water connection is provided between the inner and outer tubings. By this design, the cooling water flows in, around the $\frac{7}{8}$ -inch inner tubing, and out through it. Two 28-inch lengths of ceramic pipes are necessary for the inlet and outlet water paths supplying a tube bank and its associated plate-tuning coil. These insulating pipe sections provide radio-frequency insulation for the entire plate assembly, while the ceramic-hose coil in the control unit provides a high-resistance direct-current path from the plate assembly and coil to ground. The sliding contact, which is under pressure on each coil, will carry approximately 150 amperes of circulatory current. This contact rotates on the water-cooled axial shaft. A coaxial mycalex housing rotates the contact, and the axial thrust is derived from the pitch of the coil turns. The driving mechanism to each coil is adjustable through universal-jointed phenol shafting connected to the large hand wheel on the front of the cabinet. Differential gearing permits simultaneous adjustment of both coils when the hand wheel is in its normal position. When the hand wheel is pulled out, the shaft to the rear coil is disengaged and the front coil may be adjusted independently. This adjustment allows compensation for dissymmetries which may develop within the amplifier or in its external load circuit.

The output coupling capacitor C_6 , also shown in Fig. 4, is of unique mechanical design involving balanced construction. The two sets of stator plates are connected to the transmission line, while the common rotor plates are maintained at radio-frequency ground potential. These movable plates are counter-weighted, and raised or lowered by means of a flexible cable running over a drum and controlled by a hand wheel on the front of the cabinet. Arrangements are provided so that additional capacitance in the form of vacuum capacitors C_6 may be added in parallel to the coupling capacitor as required to cover the load-impedance range of 250 to 800 ohms.

The continuously variable tuning features of the grid and plate circuits expedite rapid frequency changes. Furthermore, the refinement in the bridge type of neutralizing circuit previously mentioned also facilitates rapid frequency changes since the neutralizing capacitors are essentially fixed as a function of frequency. The system permits frequency changes without the necessity of removing grid or plate direct-current supply voltages. With the former two-stage amplifier, two men required six minutes to change from one frequency assignment to another. Now, one man can make the change in three minutes. This represents not only a

saving in operating cost but also a decrease in lost circuit time.

Diodes V_1 are employed as peak voltmeters for measuring the voltages developed across the input and output transmission lines. The grid voltmeters are coupled to the circuit through large-capacitance stopping capacitors, while those in the output are coupled by means of capacitance dividers. The output rectifying devices serve as monitors whereby signal-to-noise and signal-to-distortion measurements may be made when using double-sideband transmission. They also provide a means for measuring signal-to-noise ratios for single-sideband transmission. In order that the noise in these monitors shall not interfere to any marked extent in amplifier-noise measurements, the cathodes of the tubes in the plate monitors are heated by direct current supplied from a small selenium rectifier F . In addition, some filtering action is obtained by an electrolytic capacitor C_2 connected across the heater elements.

The measurements of signal-to-noise and signal-to-distortion ratios meet the requirement of 45 decibels and 25 decibels, respectively. The term "signal," as herein used, refers to one of two frequencies of equal amplitude. Each frequency is adjusted to give half the permissible peak-sideband amplitude. The method by which these noise and distortion measurements are made is described in detail in Oswald's paper.³

IV. POWER SUPPLY

The filament current for the four amplifier tubes is supplied through four transformers arranged in two parallel-connected groups. Means are provided for adjusting and observing the three-phase wye and delta voltages applied to the primaries of the two groups of Scott-connected transformers. This allows the filament voltages to be adjusted independently, and at the same time insures quadrature phasing for the two tubes in a given bank of the push-pull circuit. If the wye voltages are unbalanced by greater than 4 per cent it manifests itself as an undesirable second-harmonic power-supply modulation. The secondaries of the transformer are accurately center-tapped to insure balanced voltages for each half of a filament with respect to ground, which minimizes the 60-cycle power-supply modulation. Series reactors are provided in the primary circuit to prevent the initial surge of current from rising above a specified value when power is applied to cold tubes. By means of a contactor, these reactors are short-circuited after the resistance of the tube filaments reaches a predetermined value.

The grid-bias voltage is supplied from a single-phase full-wave rectifier which uses two Western Electric Type 267B mercury-vapor rectifier tubes. The output voltage is controlled by means of a variac. When the voltage is changed, the load current is kept constant by

means of a variable load resistance which is connected mechanically to the control of the variac. The voltage may be adjusted over the range from -400 to $+200$ volts. This wide range in voltage is provided for testing new tubes, and for measuring the voltage-transformation ratios of the grid circuit. The grid bias for normal "class B" operation is -175 volts.

The power-supply equipment located outdoors is illustrated in Fig. 5. On this platform, as observed from left to right in the illustration, are the following pieces

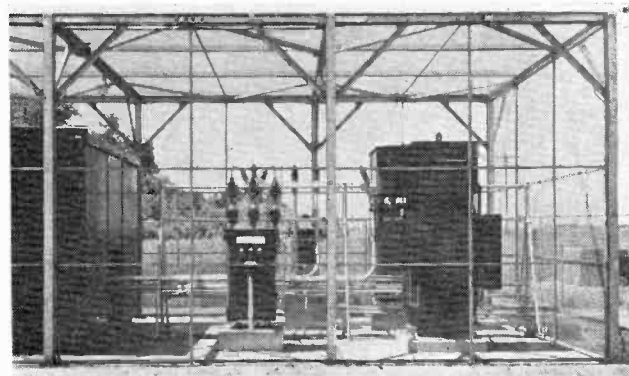

Fig. 5—Power-supply platform for D-158974 radio amplifier.

of equipment: switchhouses; 4160/230-volt three-phase low-voltage power-supply transformer; the high-voltage-rectifier filter coil; and the rectifier induction voltage regulator. The three-phase high-voltage-rectifier transformer is not visible in this view, but is located behind the induction voltage regulator. The phasing of the supply to this transformer is correctly orientated to give quadrature relationship between the rectifier plates and filament currents. Such orientation is desirable to obtain maximum filament life in the mercury-vapor tubes.

The primary power for the three-phase plate-supply transformer is controlled by means of an automatic three-phase induction voltage regulator and a remotely controlled oil circuit breaker. The automatic regulator normally is set to apply approximately 6000 volts to the amplifier. Subsequently, the voltage rises in about ten seconds to the normal operating value of 13,000 volts. The automatic features may also be disengaged so that the voltage may be raised and lowered manually. The installation is novel to the extent that the value of voltage at which automatic regulation takes place can be changed over a wide range from a remote point.

The following additional pieces of equipment are located in the switchhouses: the high-voltage oil circuit breaker; auxiliary control relays; the high-voltage rectifier-filter capacitors; and a power-factor-correction circuit. The power factor is unity when the full load of the amplifier is 104 kilowatts from the supply line.

Study of Ultra-High-Frequency Tubes by Dimensional Analysis*

G. J. LEHMANN†, SENIOR MEMBER, I.R.E., AND A. R. VALLARINO‡, ASSOCIATE, I.R.E.

Summary—The complete theory of the operation of ultra-high-frequency tubes being extremely difficult, it is shown that dimensional analysis in conjunction with experimental work is a powerful tool in this field.

If certain general assumptions are fulfilled, the properties of ultra-high-frequency oscillators can be expressed in terms of a dimensionless parameter $\varphi = (f \times d) / \sqrt{V}$.

The dependence of efficiency on frequency in an ultra-high-frequency oscillator is considered in the first part of this paper.

In the second part, combining the previous results with the Child-Langmuir equation, the relationship between the voltage, the dimensions of the tube, and the frequency are discussed when the efficiency is maintained constant.

I. INTRODUCTION

IT IS well known that the theoretical study of vacuum-tube operation at ultra-high frequencies is extremely difficult. In this field, Llewellyn's publications are of major importance. Although his theories are based on general hypotheses, his calculations may be used conveniently only for class A operation and small amplitudes. Although most of the problems pertaining to receiving tubes might be solved in this way, this is not the case for the transmission field, where the desirability of high efficiency leads to class B or C operation, generally resulting in large-amplitude oscillations.

Triodes may arbitrarily be classified into three modes of operation. Each mode is restricted to an ascending-frequency band.

First mode, relatively low frequency: In this case, the tube operation can be understood from its static characteristics. The oscillator efficiency is above 60 per cent.

Second mode, high frequency: The maximum efficiency decreases from about 60 per cent to 25 per cent. No complete theory is yet available for this mode of operation.

Third mode, extremely high frequency: In this case, the oscillator efficiency decreases from 25 per cent to 0 per cent, and the oscillations are of small amplitudes. Here Llewellyn's calculations are easily applied.

Our classification indicates that, in the second case, which is of major interest to the communications engineer, there is no published theory available. The only printed paper to our knowledge is that of Chao-Chen Wang.¹ In addition, even the concept of transit angle, so successfully introduced by Llewellyn, for class A,

* Decimal classification: R133. Original manuscript received by the Institute, June 1, 1944; revised manuscript received, March 5, 1945. Presented, New York Section, May 3, 1944.

† Formerly, Federal Telephone and Radio Laboratories, New York, N. Y.; now, Le Matériel Téléphonique, Lyon, France.

‡ Federal Telephone and Radio Laboratories, New York, N. Y.
¹ Chao-Chen Wang, "Large-signal high-frequency electronics of thermionic vacuum tubes," Proc. I.R.E., vol. 29, pp. 200-214; April, 1941.

loses its simple significance in the case of class B or C operation. This fact is the reason for the large discrepancies between the results of different authors who have tried to use it.

We, therefore, believe that dimensional analysis may be useful in consideration of the operation of triodes. First, it increases the value of a small number of tests which can be the basis for the study of families of similar tubes, and second, it introduces clearly defined dimensionless parameters which can be used instead of the transit angle.

The object of the present study is to establish the basic equations of dimensional analysis in the field of oscillating vacuum tubes. The theory applies to all types of vacuum tubes, with the exception of the magnetron. We have specifically in mind the case of the triode.

Before going into the subject, we want to say that, to our knowledge, work on the same general line has been carried out by David Sloan and F. W. Boggs, of the Westinghouse Research Laboratory.

II. HYPOTHESIS, CONDITIONS FOR VALIDITY OF RESULTS

We assume that the following conditions hold:

- The current emitted by thermionic surfaces is limited by space charge.
- Initial velocity of electrons is negligible. This presupposes that accelerating voltages are substantially greater than one volt.
- The maximum velocity attained does not require the use of relativity mechanics. This presupposes potentials less than 100,000 volts.
- Dimensions of the tube are small compared with wavelengths considered, which permits one to ignore the propagation time of electromagnetic waves inside the tube compared with the period of oscillation.
- The influence of magnetic fields on the motion of the electrons is negligible. The case of magnetrons will be the subject of a separate paper.

III. EQUATIONS OF THE PROBLEM

Within the framework of the preceding hypothesis, the motion of the electrons is governed by the two following laws:

Poisson's equation

$$\nabla^2 V = 4\pi\rho. \quad (1)$$

Fundamental equation of mechanics

$$m\vec{a} = -e\nabla V. \quad (2)$$

Poisson's equation gives the potential distributions within the tube. Two basic assumptions are made; one, that we have a space-charge-limited (unsaturated) cathode; and two, that the electrodes are all perfect conductors; i.e., they are equipotential surfaces. On this basis, the boundary conditions are linear in V , and the general solution is also linear in V ; i.e., the potential at any point in the field varies linearly with the potentials at the electrodes.

We apply, then, the methods of dimensional analysis to these two equations.^{2,3}

Let $|V|$ be the dimensional symbol for potential;
 $|L|$ be the dimensional symbol for length;
 $|T|$ be that for time;
 e/m be the ratio of charge-to-mass of an electron.

We may write (2) in dimensional symbols

$$(m/e) \cdot (\vec{a}/\nabla V) = \text{pure number.} \quad (2a)$$

In dimensional symbols $\vec{a} = |L|/|T|^2$, $\nabla V = |V|/|L|$. Note that $\nabla V = |V|/|L|$ is linear in V only because of the aforementioned assumptions.

Substituting the above symbols in (2a) we have

$$(m/e) |L|^2 \cdot |T|^{-2} \cdot |V|^{-1} = f(\theta_1, \theta_2, \dots, \theta_n). \quad (3)$$

The right-hand member is a differential equation involving only dimensionless quantities. Therefore, the first member is a dimensionless product Φ . From this we have the following theorem:

All calculations relative to electrodynamics in vacuum tubes contain physical quantities entirely in the form of the dimensionless product Φ .

We shall deduce some general and interesting properties from this theorem.

Consider a family of geometrically similar tubes. Take the cathode-to-plate distance d in centimeters as the unit of distance. For continuous oscillations, consider the period of oscillation as the unit of time, and write f for the frequency in megacycles per second. Finally, let V be the voltage of the fixed source of power as unity. We obtain

$$\varphi = fd/\sqrt{V} \quad (4)$$

φ being the square root of Φ , after removal of the factor e/m , constant for all vacuum tubes.

This dimensionless number will serve henceforth to characterize the mode of functioning of tubes.

IV. STUDY OF EFFICIENCY

To give an indication of the usefulness of this approach, we apply the method to the study of oscillator efficiency. This is a prime design consideration.

The inherent losses in the functioning of vacuum tubes result from the degradation of the kinetic energy of the electrons into heat at impact on the electrode surfaces. The result is that efficiency depends only on

the motion of the electrons, governed by the equations of the preceding section. Further, efficiency η is a dimensionless number. Therefore, it will be given by an equation in the form $\eta = u(\varphi, \theta_1, \theta_2, \dots, \theta_n)$.

The θ 's are dimensionless parameters containing φ and describing the conditions of adjustment of the oscillating circuit. To proceed further, we fall back on experience. This teaches us that for one value of φ there exists, in practice, only one adjustment giving optimum efficiency. In effect, what we are doing is so choosing the θ 's that η approaches its maximum value. We obtain, finally, the fundamental equation, the object of all our reasoning,

$$\eta_{\max} = u(\varphi). \quad (5)$$

One value of φ corresponds to a unique value of η_{\max} and conversely.

This property is utilized in the following manner:

For a family of tubes one draws experimentally the following curve $\eta_{\max} = u(\varphi)$.

This operation is particularly easy when a single tube possessing a known distance d is used. For example, one way of doing this is to adjust the oscillator to a fixed frequency and measure the efficiency as a function of plate voltage.

This curve, very easily obtained, permits us to predict the maximum efficiency of any tube of the family, used under the given conditions. We have to know merely the cathode-anode distance, the frequency of operation, and the plate voltage to find the maximum efficiency that can be realized for the specified conditions.

Our experience actually confirms the existence of a relation of the type (5), especially when applied to the same tube.

If one compares different tubes of the same family, because of the absence of complete geometric similarity, the resulting efficiency curves do not exactly coincide. For very different type tubes the curves are still close enough since all triodes have similar elements. Some exceptions appear, and emphasize the interest of the method in evaluating the progress made in development after the dimensional elements of the problem have been taken out.

It must be pointed out that the curves are giving the over-all efficiency, which is the tube efficiency multiplied by the circuit efficiency. When the circuit efficiency is poor, because of great ohmic losses in the conductors, the resulting curves are abnormally low. Therefore, this method leads to the discovery of over-all circuit and tube defects.

Fig. 1 shows the efficiency versus φ curves for three commercially available triodes; the 316A and 304A have similar geometry and result in similar curves.⁴

The RCA 887 has different geometry and shows a very different curve, which might be due to the circuit used for this determination.

² P. W. Bridgman, "Dimensional Analysis," Yale University Press, New Haven, Conn.

³ O. W. Eshbach, "Handbook of Engineering Fundamentals," John Wiley and Sons, Inc., New York, N. Y., 1936.

⁴ A. L. Samuel, "Extending the frequency range of the negative grid tube," *Jour. Appl. Phys.*, vol. 8, pp. 677-688; October, 1937.

In addition, the curve for an experimental tube is given, with points taken at voltages varying over a very wide range.

V. OTHER SIMILITUDE RELATIONS

As an example of the application of the preceding results, we shall establish three other relations useful in the study of ultra-high-frequency triodes.

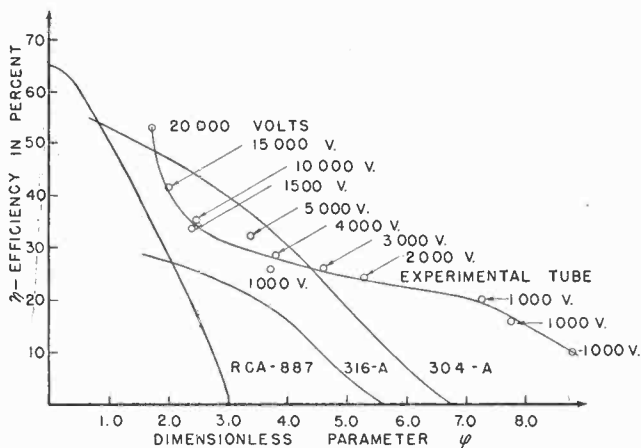

Fig. 1—Curves of efficiency versus ϕ . $\phi = (fd)/\sqrt{V}$, where ϕ is the dimensionless parameter, f is the frequency in megacycles per second, d is the cathode-anode distance in centimeters, and V is the plate potential in volts.

We propose to compare tubes of the same type, all operating with the same efficiency η , assuming, as said previously, that this efficiency is limited by the electronic inertia.

From the condition $\eta = \text{constant}$, we take $\phi = \text{constant}$; i.e., $(fd)/\sqrt{V} = \text{constant}$.

Let us now write the current density in terms of the space charge and the electron velocity, so that $A = \rho v$.

A = density of the current per unit area

ρ = density of the space charge

v = speed of the electrons.

Considerations of dimensional analysis, similar to the preceding one,⁵ bring us to the general Child-Langmuir law, under the form $A = (K\sqrt{e/m}) |V|^{3/2} / |L|^2$.

We will write this equation together with the preceding one (3), and by utilizing the notation used to define ϕ , we obtain

$$(e/m)V^{-1}d^2f^2 = K_1 \text{ dimensionless constant} \quad (6a)$$

$$\sqrt{e/m} V^{3/2} d^{-2} A^{-1} = K_2 \text{ dimensionless constant.} \quad (6b)$$

The first relation (6a) implies that we are comparing tubes operating with identical efficiencies; the second relation (6b) permits the elimination of one of the factors d or V by introducing the current density A . Our interest in this elimination comes from the fact that A may represent the maximum emission current imposed by the operation of the cathode, which, of course, plays

⁵ Irving Langmuir, "The effect of space charge and residual gases on thermionic currents in high vacuum," *Phys. Rev.*, vol. 2, series 2, pp. 450-486; December, 1913.

an essential part in every vacuum tube. Let us eliminate d and we have

$$(Vf^4)/A^2 = \text{constant.} \quad (7)$$

This relation shows that if we keep the efficiency η constant, and therefore the quantity ϕ , the maximum output plate voltage is $V = K_3(A^2/f^4)$.

This shows clearly that the useful plate voltage diminishes rapidly when frequency increases. The only remedy is to increase the emission A . Next let us eliminate V . We have

$$(df^3)/A = \text{constant.} \quad (8)$$

For the same conditions, this relation gives the value of anode-to-cathode distance $d = K_4(A/f^3)$.

We have, therefore, firmly established for a given type of cathode the $1/f^3$ law which governs the distances between electrodes in a high-frequency triode. This relation had been obtained previously by less satisfactory methods and is described in an unpublished work in the Federal Telephone and Radio Laboratories.

Such a relation leads rapidly to impossibly small dimensions for the tube when f increases, and shows the reason why a given type of electronic structure can only be used within narrow frequency limits. Here, again, the gain obtained by increasing A is evident.

Finally, let us establish a relation between useful power and frequency in assuming a similitude law in three dimensions. That is to say, if d is reduced by a given ratio we assume that all the other dimensions of the tubes are reduced by the same ratio.

We are always assuming that ϕ is kept constant, and that no question of heating comes into the picture.

The efficiency being constant, the power is proportional to the product of a current by a voltage chosen arbitrarily in the system. The H 's being constant, we have the voltage $V = H_1(A^2/f^4)$ from (7).

The current will become

$$I = A |L|^2 = H_2 A d^2 = H_3(A^3/f^6) \text{ from (8).}$$

Hence, the power will be

$$W = H_4(A^5/f^{10}). \quad (9)$$

We are giving this merely as an interesting relationship, since it does not correspond exactly to the actual conditions in which vacuum tubes are used. Nevertheless, it gives the reason why powers obtainable drop very quickly when f increases. Again we note the great advantage in increasing A , from improvement of the cathode. In actual conditions it is, of course, not necessary to reduce *all* dimensions in the same ratio, and the power will not decrease as fast as indicated by (9).

In order to avoid any misunderstanding, we shall state again that the three relations (7), (8), and (9) have been established for a constant value of efficiency; i.e., we always select f , d , and V , such that ϕ remains the same. Further, A is the current density resulting from the introduction of V and d in the Langmuir equation.

The equations (7), (8), and (9) are valid only when (6) is satisfied.

It is possible in certain cases to find the numerical value of the constants corresponding to certain types of tubes, and certain operating conditions. In this case, these calculations are extremely useful in designing tubes intended for a given problem.

Too limited a literature has been published on high-frequency vacuum tubes to allow us to furnish interesting numerical examples.

VI. CONCLUSION

In this short description, our main object has been to expose a line of approach toward the problem of ultra-high-frequency tubes, using a method which has proved extremely valuable in aerodynamics and fluid mechanics.

We should like, as a conclusion, to point out that the success of this method is based on a close co-ordination between theory and experiment. But, as is well known, this is the very basis of the science of physics.

Low-Frequency Compensation of Video-Frequency Amplifiers*

M. J. LARSEN†, ASSOCIATE, I.R.E.

Summary—The low-frequency response of a conventional multi-stage plate-compensated video amplifier is analyzed in terms of the distortion of a square wave as measured by a rounding of the wave form. Design criteria are derived to give control of the amount of rounding in the initial design of the amplifier.

Amplifier compensation effected by inclusion of a discrete impedance in the screen-grid circuit is discussed, and design formulae are derived. Comparisons of this type of compensation with that where compensation is effected exclusively in the plate circuit are made. The comparisons show that it is difficult to make a strong case favoring the adoption of screen compensation, except when direct coupling is utilized.

INTRODUCTION

IN VIDEO-FREQUENCY amplifiers the problem of holding phase-shift and amplitude characteristics within prescribed limits becomes increasingly difficult as the number of stages is increased. Departures from the optimum phase and amplitude characteristics in an amplifier operating at low frequencies result in inability of the amplifier to pass low-frequency square waves without the wave being rounded, tilted, or both. In many applications it is required that an amplifier be able to pass low-frequency square waves with a considerable degree of fidelity. This paper will critically examine certain amplifier circuits which are compensated to afford more or less perfect transmission of low-frequency square waves, and certain design and performance criteria will be derived. From a theoretical standpoint, screen compensation appears to be very attractive. The critical analysis given in the latter portion of the paper shows that the acceptance of screen compensation is limited by certain practical considerations.

The basic circuit to be considered is shown in Fig. 1. This is an equivalent alternating-current circuit representative of low-frequency conditions with the high-

frequency compensating features omitted. Fixed bias is assumed, as cathode compensation is not treated herein. A multistage amplifier will be assumed to be a number of stages of like form connected in cascade.

In testing a video-frequency amplifier for response to low frequencies a common testing procedure is to apply a low-frequency square wave and observe the wave form on an oscilloscope. Analyses will be made, therefore, so that design criteria are available in terms of measurements observable on the oscilloscope. Unless the circuit elements are suitably proportioned, the wave form will appear tilted, or rounded, or both. When tested stage by stage, the tilt is corrected readily by adjustment of the grid resistance R_g of Fig. 1, provided,

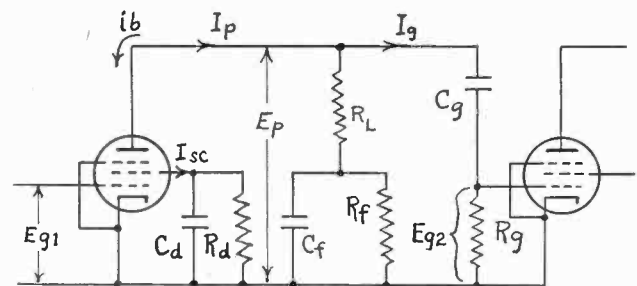

Fig. 1—Low-frequency alternating-current circuit of pentode stage for conventional video amplifier.

of course, that the other circuit elements have values within a range which will permit the adjustment.

After the tilt is adjusted, the wave form may appear rounded, as shown in Fig. 2. This rounding, when not excessive, may be considered to be caused chiefly by a fundamental component, somewhat enlarged, but in proper phase. The distorting effect of the higher odd harmonics of the square wave is minor both because of the lower reactance of the capacitances at the higher frequencies and because of the decreased amplitude of the higher harmonic components. This simplified way of considering the low-frequency square wave is not a

* Decimal classification: R363.1. Original manuscript received by the Institute, November 22, 1944; revised manuscript received, April 23, 1945.

† Stromberg-Carlson Company, Rochester, N. Y.

new approach, as it has been discussed by others, notably Preisman.^{1,2}

DERIVATION OF EXPRESSIONS FOR ROUNDING

From Fig. 2 it can be seen that it is convenient to express the rounding ratio of the square wave as the increase over the normal amplitude of the fundamental component divided by either the normal amplitude of the fundamental, or divided by the peak-to-peak ampli-

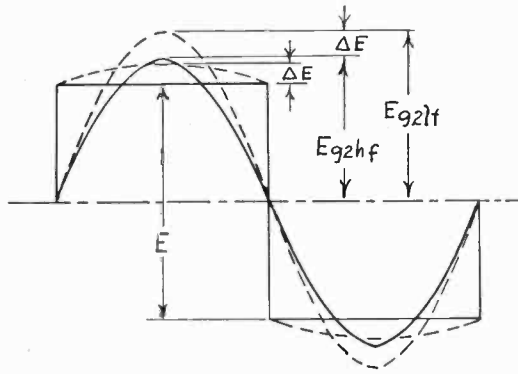

Fig. 2—A square wave showing rounding caused by an augmented fundamental component.

tude of the undistorted square wave. Upon considering one stage where E_{g1} is sinusoidal, the voltage E_{g2hf} appearing across the grid resistance of the second stage at low frequencies, where the capacitive reactances enter the calculations, may be shown to be

$$E_{g2hf} = - \{g_m E_{g1} r_{sc} R_g (R_L + Z_f)\} / Z_g (r_{sc} + Z_d) \quad (1)$$

where g_m is the grid-plate transconductance, r_{sc} is the dynamic screen resistance, and the other quantities are as referred to in Fig. 1. It is assumed in the derivation of (1) that the plate current is a function of control-grid and screen-grid voltages only, that relatively small signals are employed, and that the grid impedance made up of C_g and R_g is high enough to have negligible effect on the plate voltage. The derivation is not included as similar expressions have been derived previously. Edwards and Cherry³ derive a general expression which reduces readily to (1).

For convenience, (1) will be considered reduced to its real and quadrature components.

$$E_{g2hf} = A + jB. \quad (2)$$

Assuming that the fundamental component to be considered at frequency f_0 is adjusted so that it is in proper phase, that is, there is no tilt of the square wave, then

$$B_0 = 0 \quad (3)$$

and

$$E_{0g2hf} = A_0 \quad (4)$$

where the zero subscripts denote calculation at reference

frequency f_0 . At the higher frequencies where the capacitances act as virtual alternating-current short circuits, (1) reduces to

$$E_{g2hf} = -g_m E_{g1} R_L. \quad (5)$$

For conventional operation when the distortion per stage is not to be excessive, the following restrictions hold:

$$X_{0f}^2 \ll R_f^2; \quad X_{0d}^2 \ll R_d^2; \quad X_{0d}^2 \ll r_{sc}^2. \quad (6)$$

The rounding ratio of the square wave may be written

$$\Delta E / E_{g2hf} = (E_{0g2hf} - E_{g2hf}) / E_{g2hf}. \quad (7)$$

Substituting (4) and (5) into (7) while retaining restrictions (6) gives

$$\Delta E / E_{g2hf} = (X_{0f} / R_L) (X_{0f} / R_f + X_{0d} / r_{sc}) \quad (8)$$

where E_{g2hf} is the peak value of the alternating-current wave with the X 's = 0, or

$$\Delta E / E = (2X_{0f} / \pi R_L) (X_{0f} / R_f + X_{0d} / r_{sc}) \quad (9)$$

where E is the peak-to-peak value of the square wave; see Fig. 2. (Note that an analysis of a square wave shows the peak value of the fundamental to be $2E/\pi$.) The first term in the right-hand member of (9) is the rounding contributed by the plate circuit, while the second term is that contributed by the screen. A comparison of the relative contributions of the plate and the screen may be made by the following example. Assume

$$\begin{aligned} C_f &= 20 \text{ microfarads} & r_{sc} &= 20,000 \text{ ohms} \\ R_f &= 10,000 \text{ ohms} & R_d &= 56,000 \text{ ohms} \\ C_d &= 10 \text{ microfarads} & R &= 1000 \text{ ohms} \\ & & f_0 &= 20 \text{ cycles} \end{aligned}$$

Restrictions (6) are satisfied, so from (9) the rounding contributed by the plate is

$$2X_{0f}^2 / \pi R_L R_f = 1 \text{ per cent}$$

and that by the screen is

$$2X_{0f} X_{0d} / \pi R_L r_{sc} = 1 \text{ per cent.}$$

Thus, the total rounding is 2 per cent. Should a number of stages be employed, it is evident that it would be well to reduce the rounding by employing larger screen-filter capacitances and possibly larger plate capacitances.

DETERMINATION OF X_{0g}/R_g FOR ADJUSTED CONDITIONS

The commonly used approximate design ratio^{4,5} for determining C_g and R_g in terms of R_L and C_f is

$$R_g C_g = R_L C_f$$

or

$$X_g / R_g = X_{0f} / R_L. \quad (10)$$

This expression is entirely satisfactory for estimating R_g in practice, where often the nominal ratings of the circuit elements are not too close and a final readjustment of R_g becomes necessary in order to "square" the wave form, even though $R_f \gg X_f$, the condition under

¹ Albert Preisman, "Some notes on video amplifier design," *RCA Rev.*, vol. 2, pp. 421-432; April, 1938.

² Albert Preisman, "Low frequency square wave analysis," *Communications*, vol. 22, pp. 14-17, 20, 28, 35; March, 1942.

³ G. W. Edwards and E. C. Cherry, "Amplifier characteristics at low frequencies," *Jour. I.E.E.* (London), vol. 87, pp. 178-188; August, 1940.

⁴ H. Pender and K. McIlwain, "Electrical Engineers' Handbook, Electric Communication and Electronics," third edition, John Wiley and Sons, New York, N. Y., 1936, section 15, p. 33.

⁵ F. E. Terman, "Radio Engineers' Handbook," McGraw-Hill Book Company, New York, N. Y., 1943, p. 414.

which (10) is very nearly correct. Should it be feasible to determine the circuit elements more accurately, it is of interest to obtain the more accurate ratio

$$X_{0g}/R_g = \frac{X_{0f}/R_L - X_{0d}/r_{sc}}{1 + X_{0f}/R_L(X_{0f}/R_f + X_{0d}/r_{sc})} \quad (11)$$

As this is representative of the conditions that hold when the wave form has no tilt, it is the solution of (3) using restrictions (6) and dropping negligible terms.

Using the circuit values listed in the example above at a frequency f_0 of 20 cycles, the following comparison may be made:

$$X_{0g}/R_g = 0.40$$

for the approximate expression (10), while

$$X_{0g}/R_g = 0.35$$

for the more accurate expression (11). Using the same circuit constants, in each case, except R_g , it is seen that the more nearly accurate value for R_g is 14 per cent larger than that calculated on the basis of (10).

SOME PRACTICAL CONSIDERATIONS

Where the screen reactance X_d is high enough to cause considerable rounding, the dynamic screen resistance r_{sc} enters into the calculations for both rounding (9) and for adjustment (11). Because of the rather wide variation in screen resistance among different samples of tubes of a given type, replacement of tubes in a multistage video amplifier is likely to cause a noticeable tilt of the previously "squared" wave. Also, changes in operating voltages affect the screen resistance. Thus, it seems better to by-pass the screen with a sizable capacitance and thereby to minimize the effect of variations in screen resistance, as well as to reduce the rounding caused by the screen circuit.

In determining the circuit parameters, both R_d and R_f preferably are made high, limited chiefly by the permissible voltage drop. The load resistance R_L is determined by the high-frequency response required. R_g often is made as high as the tube and circuit operation

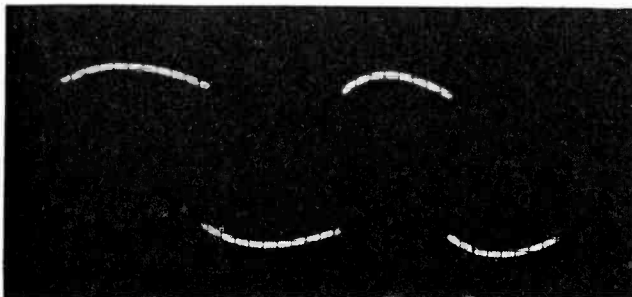

Fig. 3—Wave form showing 20 per cent rounding at output of third stage with square-wave input. The screen and plate circuits contribute equal amounts of distortion.

will allow, in order to avoid excessive sizes for the coupling capacitance C_p . The filter capacitances C_f and C_d are calculated in terms of rounding limitations by means of (9). The remaining calculation is the X_{0g}/R_g

ratio, (10) or (11), from which, of course, R_g and C_g are determined.

While the previous discussion relates to a single stage, the application to a series of stages is simple, provided the rounding or tilting per stage is not permitted to become excessive. The rounding, for instance, is directly proportional to the number of stages. Fig. 3 is an exaggerated experimental example showing 20 per cent rounding for three stages. The circuit constants are as follows:

$$\begin{aligned} f_0 &= 22 \text{ cycles} & r_{sc} &= 20,000 \text{ ohms} \\ C_f &= 10 \text{ microfarads} & R_d &= 56,000 \text{ ohms} \\ R_f &= 10,000 \text{ ohms} & R_L &= 1000 \text{ ohms} \\ & & C_d &= 5 \text{ microfarads} \end{aligned}$$

The rounding per stage calculated from (9) is $6\frac{2}{3}$ per cent, with contribution equally divided between plate and screen circuits. With a rigid screen, X_{0d} effectively zero, the rounding is cut to one half, as shown by Fig. 4.

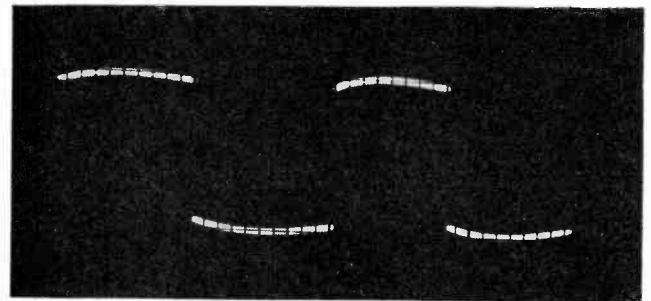

Fig. 4—Wave form showing 10 per cent rounding at output of third stage with square-wave input. The same circuit as for Fig. 3 is employed except that here the screen-filter reactance is effectively zero.

Tests cannot be tried always on a single stage because the effect may be too small to observe, yet the cumulative effect of a large number of stages may be severe. One per cent rounding in one stage, for example, may not be noticeable, but this would lead to ten per cent in ten stages which may be altogether excessive. A few preliminary calculations of the type discussed would predict the end result with reasonable accuracy.

SCREEN-COMPENSATION CONSIDERATIONS

While in general with insufficient capacitance in the screen filter the screen contributes to distortion, it is possible to choose the screen-filter parameters in a manner which will yield complete compensation at some specified reference frequency. To derive the appropriate expression for this screen-filter impedance, it is necessary to equate vectorially the low-frequency grid voltage with the high-frequency grid voltage, as the high-frequency conditions are representative of operation with no phase or amplitude shift introduced by the circuit elements. Thus, equating (1) with (5) at reference frequency f_0 gives

$$Z_{0d} = r_{sc} \{ (1 + Z_{0f}/R_L) / (1 - j\alpha_0) - 1 \} \quad (12)$$

where $\alpha_0 = X_{0g}/R_g$.

To aid in obtaining numerical results, the right-hand member of (12) may be resolved into the form

$$Z_{0d} = r_{sc}(a - jb) \tag{13}$$

where it can be shown that a and b are real and positive provided

$$\alpha_0 < \{(X_{0f}R_f^2)/[R_L(R_f^2 + X_{0f}^2) + X_{0f}^2R_f]\}.$$

It is assumed further that all of the restrictions (6) need not apply when (12) is satisfied, and consequently (9) and (11) are not valid in the present discussion. With the screen-filter impedance considered as R_d and X_{0d} in parallel, then, using (13),

$$R_d = r_{sc}(a^2 + b^2)/a \tag{14}$$

$$X_{0d} = r_{sc}(a^2 + b^2)/b. \tag{15}$$

Although perfect compensation is indicated at frequency f_0 for all values of α_0 that satisfy (12), there exists an amplitude and phase shift between f_0 and the higher frequencies where the X 's become negligible.

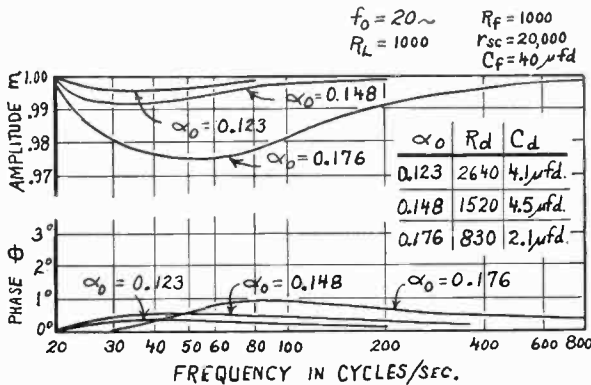

Fig. 5—Comparison of amplitude and phase variations with increase in frequency, assuming compensation operative at 20 cycles.

The calculated example of Fig. 5 shows a comparison of amplitude and phase variation with increase in frequency for three values of α_0 , assuming compensation at 20 cycles with circuit parameters as listed. The curves

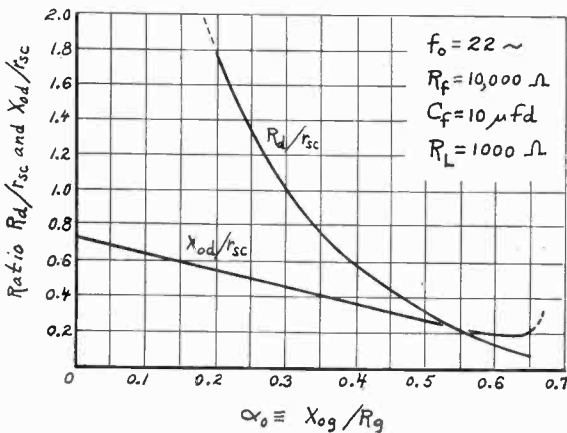

Fig. 6—Screen-filter values versus the grid-impedance ratio necessary to establish compensation when using the circuit constants listed. The circuit values are typical of a voltage-gain stage.

show that compensation improves throughout the frequency range as α_0 decreases. In fact, the compensation is perfect for $\alpha_0 = 0$, direct coupling, as is evident from (12) which reduces to

$$Z_{0d} = r_{sc}Z_{0f}/R_L \tag{16}$$

with both Z_{0d} and Z_{0f} composed of a resistance and capacitance in parallel, thus satisfying (16) at all frequencies.

Calculations for curves of the type shown in Fig. 5 are too tedious to warrant extension to numerous examples. The improvement in compensation as α_0 decreases can be observed experimentally, however, by viewing the output of a screen-compensated amplifier having a square-wave input. In Fig. 6, curves of R_d/r_{sc} and X_{0d}/r_{sc} taken from (14) and (15) are shown plotted versus α_0 for the three-stage amplifier which was used in obtaining the wave forms in Figs. 3 and 4. Fig. 7

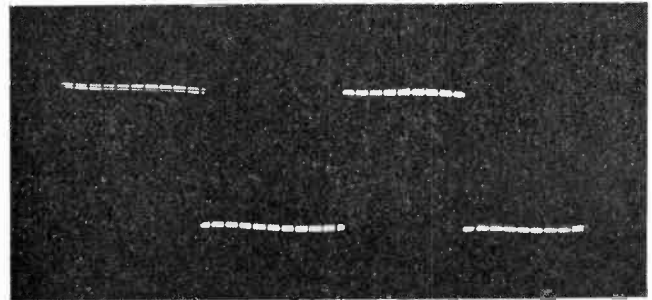

Fig. 7—Output wave form of three-stage amplifier using screen compensation with $f_0 = 22$ cycles, $\alpha_0 = 0.6$, and other values to correspond, as taken from Fig. 6.

shows the wave form taken with values corresponding to $\alpha_0 = 0.6$. The presence of phase and amplitude shift in the higher harmonics of the wave of Fig. 7 manifests itself in the irregularities which appear noticeably reduced in Fig. 8 where α_0 is reduced to 0.4.

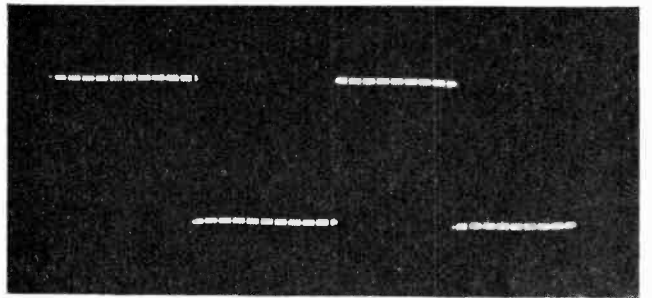

Fig. 8—Same as for Fig. 7 but with α_0 decreased to 0.4.

In case of a power stage the plate-filter resistance R_f must be limited to avoid excessive voltage drop. Without screen compensation, (9) dictates at low frequencies the use of a large plate-filter capacitance if the rounding is to be maintained at a low level. Curves of R_d/r_{sc} and X_{0d}/r_{sc} versus α_0 for screen compensation are shown in Fig. 9 for circuit values typical of a power stage. In this example X_{0d} has a very limited range, regardless of α_0 . Fig. 10 shows the output of a single 6AG7 stage, uncompensated, with rigid screen, having approximately 10 per cent rounding at 20 cycles with circuit parameters, as listed in Fig. 9. The screen-compensated wave form at 20 cycles with circuit parameters corresponding to an α_0 of 0.2 is shown in Fig. 11.

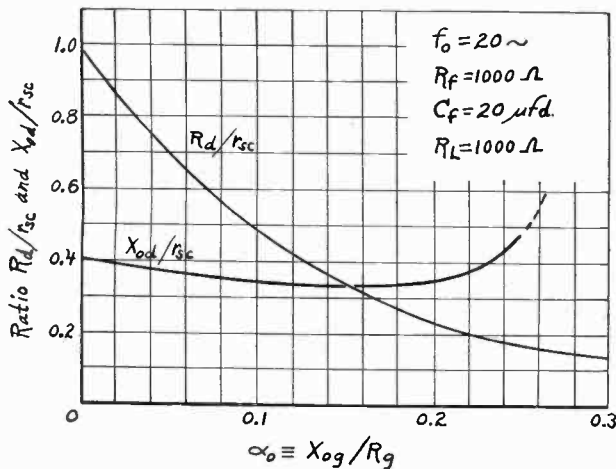

Fig. 9—Screen-filter values versus grid-impedance ratio necessary to establish compensation when using the circuit constants listed. The circuit values are representative of a power stage.

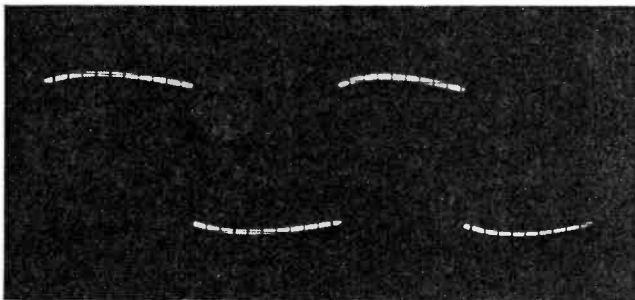

Fig. 10—Output wave form of a single 6AG7 stage with square-wave input, screen-filter reactance effectively zero, and other values as listed in Fig. 9.

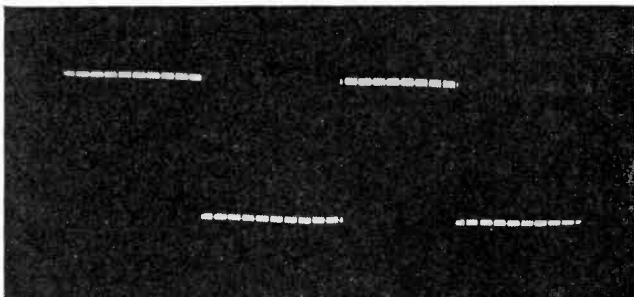

Fig. 11—Same amplifier as used for Fig. 10 but screen compensated with circuit parameters as shown in Fig. 9, using $\alpha_0 = 0.2$.

CRITICISM OF SCREEN COMPENSATION

It has been shown that under certain conditions complete compensation is attainable in the conventional circuit by using discrete screen-filter elements, that response between the reference frequency f_0 and the higher frequencies improves as α_0 is decreased, and that

perfect compensation is realized when α_0 is zero. It does not follow, however, that it is of great advantage to incorporate screen compensation in every circuit. Consider as an example the power stage operating under conditions illustrated by Figs. 9, 10, and 11. Using $C_f = 20$ microfarads, and, from (11), $X_{0g}/R_g = 0.36$, the rounding is 10 per cent without screen compensation. Employing screen compensation with $\alpha_0 = 0.2$ the rounding appears to be negligible. (Note that α_0 expresses the ratio X_{0g}/R_g when screen compensation is used.) With screen compensation, however, the lower X_{0g}/R_g ratio necessitates using a higher coupling capacitance C_c , assuming R_g to be fixed. If, then, this larger C_c is permissible without causing excessive leakage current, say, or excessive capacitance to ground at the high video frequencies because of greater physical size, a comparison may be made on the basis of equal X_{0g}/R_g ratios. Without screen compensation, using $X_{0g}/R_g = 0.2$, therefore, C_f would be approximately 40 microfarads which would reduce the rounding from 10 per cent to $2\frac{1}{2}$ per cent, as the rounding is proportional to the square of the capacitive reactance, assuming X_{0d} to be negligible. While this distortion is still somewhat more than when using screen compensation, the argument that using screen compensation permits using smaller coupling capacitances for a given distortion may not always be controlling.

In the case of direct coupling, on the other hand, when $\alpha_0 = 0$, screen compensation provides a means, alternative to cathode compensation, of correcting distortion introduced by the plate-filter circuit.

As evident from (14) and (15) the screen-filter parameters depend directly upon the dynamic screen resistance of the tube concerned. As the screen resistances often vary markedly from tube to tube and are subject to change with change in bias voltage or other operating voltages, the practical difficulties encountered in employing screen compensation are augmented. When all factors are considered, it becomes difficult to make a strong case favoring the adoption of screen compensation, particularly for multistage video amplifiers. For the direct-coupling application, however, usually one stage only is involved. Consequently, no accumulative distorting effects are produced and minor changes in operating voltage would have negligible distorting effect on the wave form.

ACKNOWLEDGMENT

The writer wishes to express his appreciation of the generous help given by A. E. Newlon and Myron Kantor in the preparation of this paper.

Books

"The Electrolytic Capacitor," by Alexander M. Georgiev
 Donald E. Gray 727
 "Transmission Lines, Antennas, and Wave Guides," by Cruft
 Laboratory War Training Staff W. D. Hershberger 727
 "Principles of Radio," by Keith Henney
 Ferdinand Hamburger, Jr. 727

The Design of Broad-Band Aircraft-Antenna Systems*

F. D. BENNETT†, P. D. COLEMAN†, AND A. S. MEIER†

Summary—A complete technique for the development of broad-band aircraft antennas at frequencies from 10 to 100 megacycles is described. The paper is divided into three sections concerned with (1) antenna-impedance measurement in aircraft, (2) design of reactance-matching sections for antenna, and (3) development of broad-band wire antennas for aircraft use.

Part I. Impedance Measurement: A coiled line and probe assembly, using commercial flexible cable, is described. The punctured line and tuned probe system operate in the same manner as the familiar high-frequency slotted lines. Because of slight losses on the line, corrections must be made to standing-wave ratio and voltage minimum position x_{min} . Both graphical and analytical methods for making these corrections are described. Comparison of coiled-line measurements with General Radio 916-A bridge measurements leads to the tentative conclusion that the system is accurate to ± 5 per cent. Subsequent engineering use corroborates this conclusion. Extension of the method to 200 megacycles by means of a tuned vacuum-tube-voltmeter probe is indicated. Measurement of standing-wave ratios higher than 15/1 have been made.

Part II. Impedance Matching: Because of the wide range of impedance values presented by any antenna termination over a range of frequencies, it is desirable to use reactance networks to match the antenna to the feed line. Four representations of antenna impedance are introduced—the impedance-frequency, admittance-frequency curves, and the impedance and admittance diagrams in the complex plane. With the help of these, a criterion for match is introduced; viz., that the standing-wave ratio on the line be equal to or less than two. The problem is then seen to be that of warping the antenna

curve into the $\rho=2$ circle on an admittance or impedance diagram. The geometrical effects of single reactance elements in series and shunt with the antenna are investigated. Two-element matching networks are discussed and “best-match” procedure outlined. It is observed that a “bazooka,” used to transform a balanced antenna to unbalanced feed line, can simultaneously be made to perform as a typical two-element matching section. It is concluded that high-impedance antennas can be matched more easily than low-impedance antennas, but that in any case the position of the antenna curve in the complex plane is more important than its initial bandwidth.

Part III. Broad-Band Fan Antenna: The use of conventional methods of broad-banding an antenna; i.e., expansion of the radiator to large lateral dimensions, is discussed and shown to be unfeasible for aircraft use at frequencies from 10 to 100 megacycles. Large conductors cannot be used because of the conspicuous target they present and the excessive amounts of wind drag involved. For these reasons, multiwire antennas were investigated. The two-wire V antenna is shown to have increasingly favorable broad-band characteristics up to flare angles of 50 to 60 degrees. With a suitable matching section, bandwidths as high as 30 per cent can be obtained.

Addition of a top wire closing the V gives rise to the prototype fan antenna. Antennas of the 3-, 4-, and 5-wire type are seen to have favorable broad-band properties, but the increment gained decreases with each successive wire. Two-element matching sections added to 3- and 4-wire antennas are shown to produce bandwidths of 32 to 45 per cent, which are adequate for most low-frequency applications. While the techniques described are very powerful at low frequencies, their use is not limited and may be extended successfully to much higher ranges.

PART I

A COILED LINE FOR AIRCRAFT-ANTENNA IMPEDANCE MEASUREMENT FROM 10 TO 80 MEGACYCLES

F. D. BENNETT

I. INTRODUCTION

THE DESIGN of aircraft-antenna systems is at present based to a large extent on experimental data concerning antenna impedance and pattern characteristics. This is so because modern, metal airplanes constitute very complicated grounds for the antennas to work against, and because aerodynamically suitable antennas are very often quite different in construction and essential dimensions from those used at identical frequencies in ground installations.

It is the purpose of this paper to describe a coiled-line impedance-measuring system which has been used in the design of aircraft antennas at Aircraft Radio Laboratories, Wright Field.

Any impedance-measuring system to be of use in aircraft tests must be compact, simple, rugged, and relatively insensitive to outside electrical disturbances. The system described here satisfies all these require-

ments to a high degree without sacrificing reasonable engineering accuracy.

The usual impedance bridges available for use in the part of the frequency range up to 50 megacycles (such as the General Radio 916-A bridge) are much too sensitive and delicate to lend themselves to the rigors of aircraft use. Their balance conditions are extremely sensitive to variations in grounding and to other external conditions not easily controlled; while the auxiliary apparatus, such as a precision signal generator and

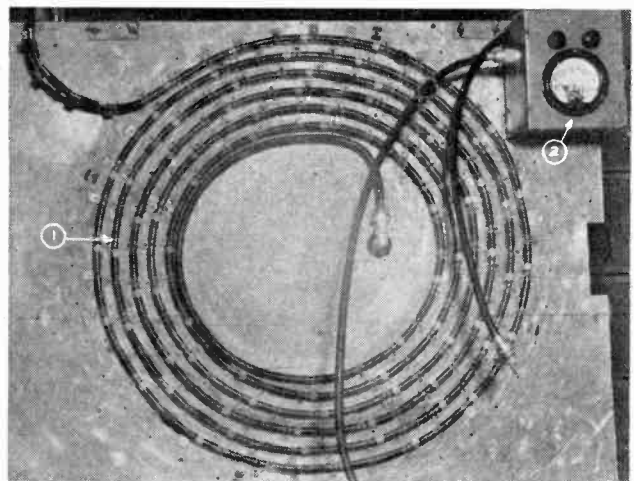

Fig. 1—Measuring line and probe assembly, showing (1) coiled line, and (2) probe box.

* Decimal classification: R525X R240. Original manuscript received by the Institute, February 13, 1945; revised manuscript received, July 2, 1945. Presented, Winter Technical Meeting, New York, N. Y., January 27, 1945.

† Wright Field, Dayton, Ohio.

sensitive receiver, is not adapted to use under conditions of extreme vibration and noise such as are encountered during flight.

Precision-slotted lines, using air or low-loss dielectric, are available at frequencies from 100 megacycles up, but even these are from four to six feet long, and involve sensitive detection systems not adapted to use in aircraft under flight conditions.

These difficulties have been overcome by use of a coiled low-loss cable and probe system wherein commercial 50-ohm cable, punctured at intervals to admit the probe, forms the counterpart of the slotted line; while a system of coupled resonant circuits and a line transformer comprise the high-impedance probe, equivalent in action to the crystal or bolometer probes commonly found in slotted-line equipment. Insensitivity to external electrical disturbances is assured through the use of a signal generator that delivers 10 watts power over the range of frequencies employed. This high power level has the further advantage that the power required to operate the probe is an insignificant fraction of the total power available, and consequent distortion of the standing wave by the probe is kept to a minimum.

II. DESCRIPTION OF THE LINE

The coiled line consists of about 20 meters of commercial low-loss coaxial cable of approximately 50 ohms characteristic impedance. RG-8/U cable or its equivalent is satisfactory. As may be seen in Fig. 1, the line is coiled in a tight spiral on an aluminum sheet $\frac{3}{8}$ -inch thick and approximately 30×40 inches in lateral dimensions. It is supported about $\frac{1}{2}$ inch from the aluminum plate by small strips of copper sheet that are cut

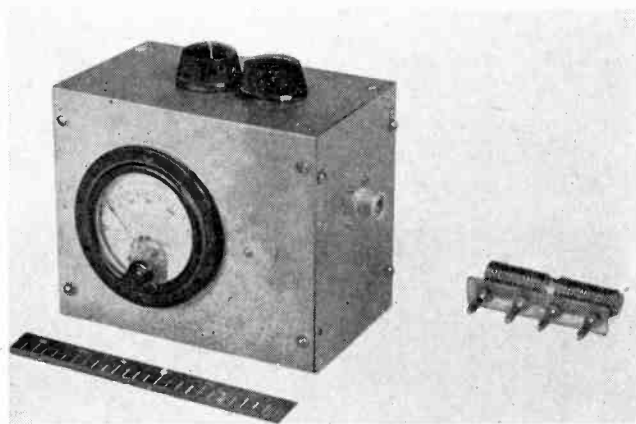

Fig. 2—Probe box and coil.

about $\frac{1}{2}$ inch wide, bolted tightly about the outer braids of the cable, and secured to the aluminum sheet with a bolt and elastic stop nut. A $\frac{1}{8}$ -inch hole is cut through the top of the copper strip encircling the cable and through the outer braid to the dielectric. A smaller hole through the dielectric to the center conductor allows one conductor of the probe to be touched to the center of the line while the other is grounded to the outer braid in the same operation. The probe holes are

spaced accurately 5 centimeters apart, and every other hole is numbered consecutively from the load; thus the number of the hole divided by 10 gives the distance in meters of the hole from the termination of the line. Type N or ultra-high-frequency connectors may be used on each end of the line, depending on which is more likely to be used in the antenna design.

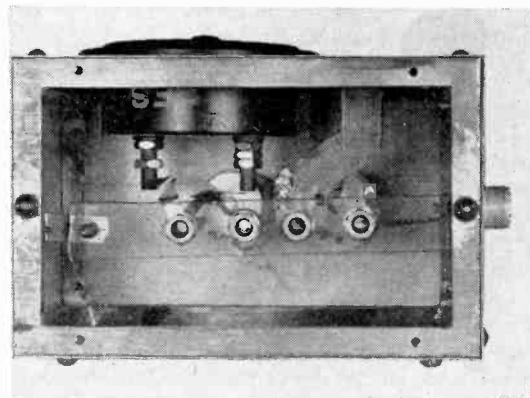

Fig. 3—Interior of probe box (bottom cover removed).

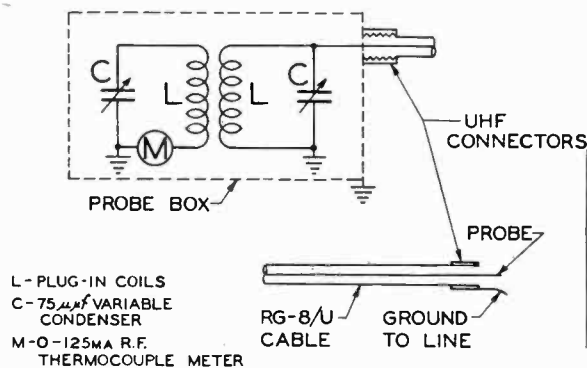

Fig. 4—Schematic diagram of probe assembly.

Figs. 2, 3, and 4 show the details of the probe box and cable used in obtaining relative voltages from the line. The probe assembly¹ consists of two resonant circuits coupled loosely together. The first is manually connected in parallel with the conductors of the line by means of a length of 50-ohm cable fitted with the probe tip and grounding strip. The probe tip may be a stiff copper wire used to extend the center conductor of an ultra-high-frequency plug, while the grounding strip can be easily constructed of a strip of copper or copper braid. Tuning the first circuit changes the impedance placed across the line by the probe tip; tuning the second circuit controls the current passing through the radio-frequency milliammeter, allowing adjustment to any desired value. By using several different pairs of tuning coils, the range from 10 to 80 megacycles may be covered.

Several interchangeable lengths of cable, each

¹ A high-impedance probe of this type was described to M. S. Wong, of Special Projects Laboratory, Aircraft Radio Laboratories, in 1941, by Andrew Alford, of Radio Research Laboratory, Harvard University.

equipped with a probe tip, must be provided in order to cover the frequency range. Each length will cover small bands of frequencies for which it transforms the impedance offered by the probe box to the highest possible value across the probe tips. When the first circuit is tuned to resonance, it offers a very high impedance to the probe cable. Because of the loose coupling and the fact that the meter circuit is usually considerably off resonance, the tuning of the meter circuit has small effect on the impedance offered by the first circuit. If the connectors and construction of the probe box could be neglected, the correct cable length would be one-half wavelength at each frequency. In practice, the length must be determined experimentally, and it turns out to be considerably shorter than one-half wavelength.

Of course, even under the best conditions of probe tuning, the introduction of the probe tip into the line distorts the voltage standing wave. When using a signal generator providing 10 watts power, the effect of the probe is usually negligible, and very good results may be obtained.

Before the coiled line can be used effectively, its characteristic impedance and relative velocity must be determined. These may be determined by making measurements of the line, open and short-circuited, with a radio-frequency bridge, at several frequencies in the range. Another method involves measuring the wavelength on the line directly and measuring the frequency by means of a heterodyne frequency meter, thus finding v/c . Determination of the capacitance per unit length of the line at a very low frequency (200 kilocycles), using a Q meter together with a standard capacitor, enables Z_0 to be calculated. For the line illustrated in Fig. 1, $Z_0 = 48.0 \pm 0.2$ ohms, and $v/c = 0.650 \pm 0.002$. The losses on the line cause Z_0 to be reactive to the extent of about 0.1 ohm, but for practical purposes this quantity can be neglected. Throughout the following work, Z_0 will be assumed real.

III. METHOD OF MEASUREMENT

In order to illustrate the method of using the coiled line, and the best procedure in adjusting the probe, a description of the general requirements and adjustments of a successful experimental arrangement will be given.

Whether the line is used with a ground screen in a laboratory or in measurements conducted during flight in an aircraft (Fig. 5), the aluminum line sheet must be securely mounted and grounded to screen or to the metal airframe at several points, with ground strips as short as possible. As the line is connected to the sheet all along its length by means of the copper supports and the grounded case of the probe box is connected with short straps to the sheet, sufficient grounding of the sheet automatically assures grounding of the rest of the line.

In tuning the probe, an auxiliary vacuum-tube voltmeter is very useful as a sentinel. The voltmeter should be connected across the line at a T connector between

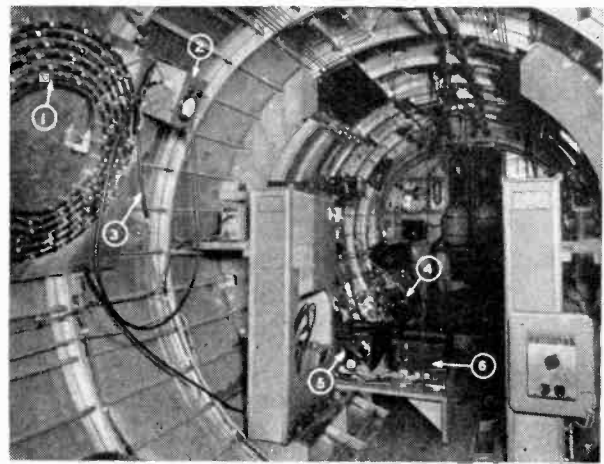

Fig. 5—Impedance-measuring equipment installed in an airplane. The circled numbers serve to locate the coiled line (1), probe box (2), probe cable (3), inverter (4), oscillator (5), and power supply (6).

generator and line. With the signal generator tuned to the desired frequency, the line should be probed for a voltage maximum, and the current through the probe meter adjusted to a medium value. At the voltage maximum, the probe should be moved rapidly in and out, making and breaking the connection. A flicker on the sentinel voltmeter will indicate that the presence of the probe is shifting the voltage wave along the line. The probe circuit should be tuned until the sentinel ceases to flicker, meanwhile adjusting the meter current so that the milliammeter stays on scale. Lack of flicker of the sentinel with the probe moving in and out is evidence that the probe has negligible effect on the standing wave. Data may now be taken.

Inability to tune the probe usually indicates the selection of the wrong probe cable, although in some instances instability in the signal generator will make good probe tuning impossible. When the probe is improperly tuned, an unsymmetrical voltage wave will be obtained. A check on either side of a voltage maximum or minimum will indicate whether the tuning is sufficiently good.

With the probe tuned, the data taken consists of probe milliammeter readings recorded against distance from the termination of the line; i.e., the number of the hole probed. Also, data for three maxima and three minima should be taken. Not all the holes need be probed, except in the vicinity of a maximum or a minimum. As will be seen later, more of the curve around a minimum is required than around a maximum.

IV. CALCULATION OF IMPEDANCE

If the coiled line were lossless, the only data needed in order to calculate the impedance terminating the line is the standing-wave ratio and the position of the first voltage minimum x_{\min} . Because of the small losses in the coaxial cables, corrections must be applied to the apparent values of both these quantities.

In Appendix I (equation numbers refer to the

Appendix) it is shown that the voltage maxima lie on the straight-line envelope

$$y_1 = \alpha(A - B)x + (A + B) \quad (16)$$

and the voltage minima on the straight-line envelope

$$y_2 = \alpha(A + B)x + (A - B) \quad (17)$$

where x is the distance along the coiled line measured from the termination, α is the attenuation constant in nepers per meter, A is the amplitude of the voltage wave traveling towards the termination, and B is the amplitude of the voltage wave reflected back toward the generator. In terms of these definitions, the standing-wave ratio $\rho = (A+B)/(A-B)$; and it is easily seen that the ratio of the intercepts of these lines gives exactly ρ .

Fig. 6 shows two typical voltage standing waves. The tangent lines to the minima and maxima have been drawn, the intercepts found, and the values of ρ obtained. The values of x_{min} have been located by joining the midpoints of three horizontal chords through the troughs. The vertical lines resulting pass through the voltage curve so near the true x_{min} position that for all $\rho \geq 1.3$ (see discussion in Appendix I) no correction need be made. Fig. 7 has been included to show how the impedance calculation is carried out by means of a standard transmission-line chart.²

In the event that a value of $\rho < 1.3$ is measured, it becomes necessary to correct x_{min} for the effects of attenuation. The analysis of Appendix I shows that cor-

rection may be made graphically if chords through the voltage troughs are drawn parallel to the line passing through the voltage minima. An analytical expression for the correction is also available as

$$C = (\alpha/\beta^2) [\rho/(\rho^2 - 1)] \quad (22)$$

where all the symbols are defined as before and in addition $\beta = (2\pi)/\lambda$. To apply the analytical correction it is necessary to know the value of α for the line at the frequency of measurement. This may easily be found from (16) and (17) utilizing the fact that slope of y_1 is $\alpha(A-B)$ and $(A-B)$ is the intercept of y_2 . Similarly, the slope of y_2 is $\alpha(A+B)$ and the intercept of y_1 is $(A+B)$. Both values of α should be calculated and the average taken; for a slight error in determination of either of the slopes can introduce large error³ into the value of α .

Figs. 8 and 9 show both the graphical and analytical methods of correction of x_{min} . The agreement is seen to be excellent.

V. ACCURACY OF THE SYSTEM

Possible sources of error and their approximate contributions may be listed as follows:

1. Error in standing-wave ratio due to inaccuracy in meter readings ± 0.5 to ± 10 per cent as ρ varies from 1/1 to 5/1: This error occurs because at lower values the

³ For a high standing-wave ratio $(A-B)$ approaches zero, and the value of α calculated from the slope of the upper envelope may be greatly in error. In this event the value from the lower envelope alone should be used.

² P. H. Smith, "An improved transmission line calculator," *Electronics*, vol. 17, pp. 130-133; January, 1944.

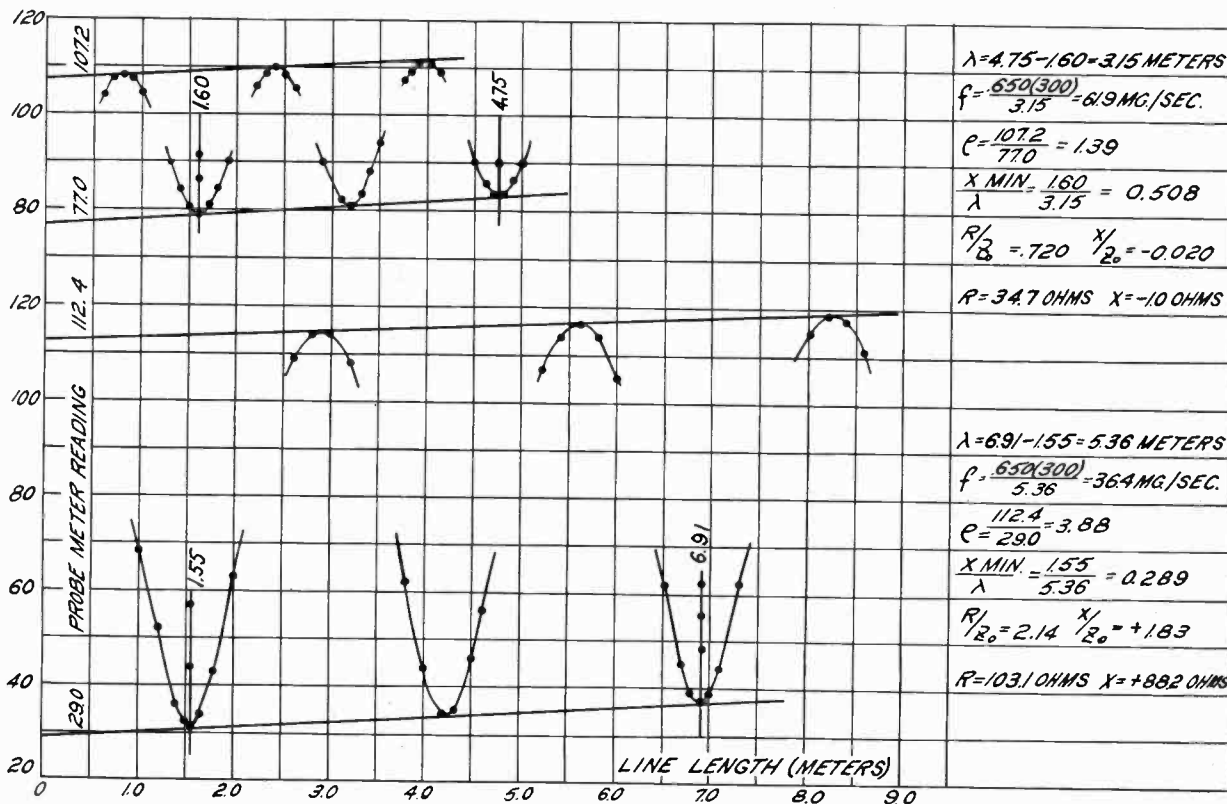
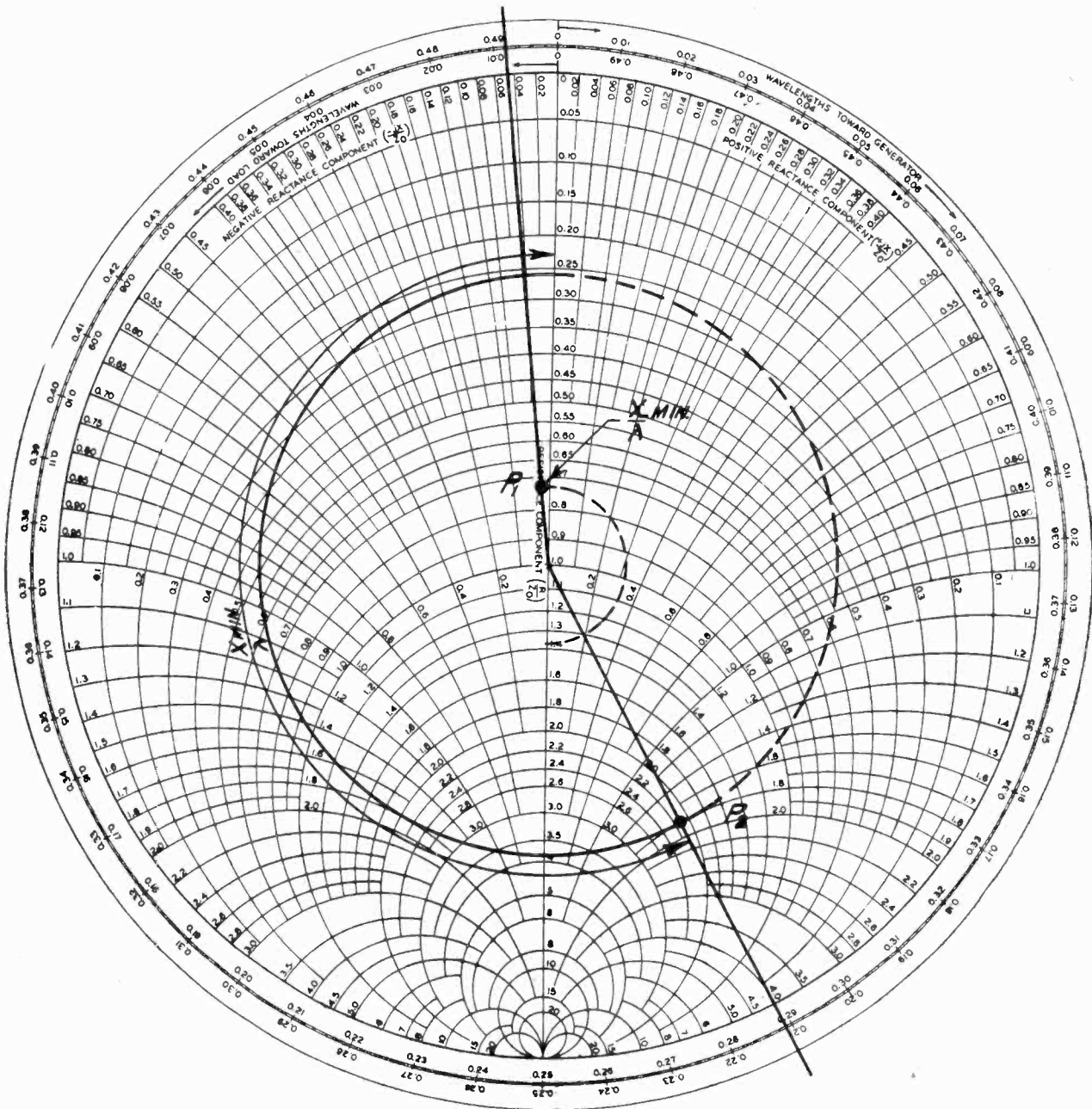

Fig. 6—Typical standing-wave curves taken with coiled line.



P₁ - IMPEDANCE (FIG. 6-TOP)

P₂ - IMPEDANCE (FIG. 6-BOTTOM)

Fig. 7—Impedance chart showing terminating-impedance calculations for curves in Fig. 6.

scale of the meter is crudely divided and divisions are closely spaced.

2. *Error in determination of $x_{min} \pm 1.0$ centimeters:* As x_{min} varies from zero up to 3 meters or more, the percentage error varies from very large values to less than one per cent. A glance at the chart will show that when x_{min} is very small the reactance is near zero and errors in x_{min} will cause very large percentage errors in reactance, possibly even causing it to change sign.

3. *Error in the determination of the wavelength on the*

line ± 2.0 centimeters: As no wavelengths less than 2 meters are encountered, this is one of the smallest errors, being always less than 1 per cent.

4. *Error in the determination of the line constants ± 0.2 ohm in characteristic impedance and ± 0.002 in relative velocity:* These result in percentage errors of ± 0.5 and ± 0.3 , respectively.

Trials with the chart will show that the errors in standing-wave ratio and x_{min} may, in critical cases where the standing-wave ratio is large, cause errors in

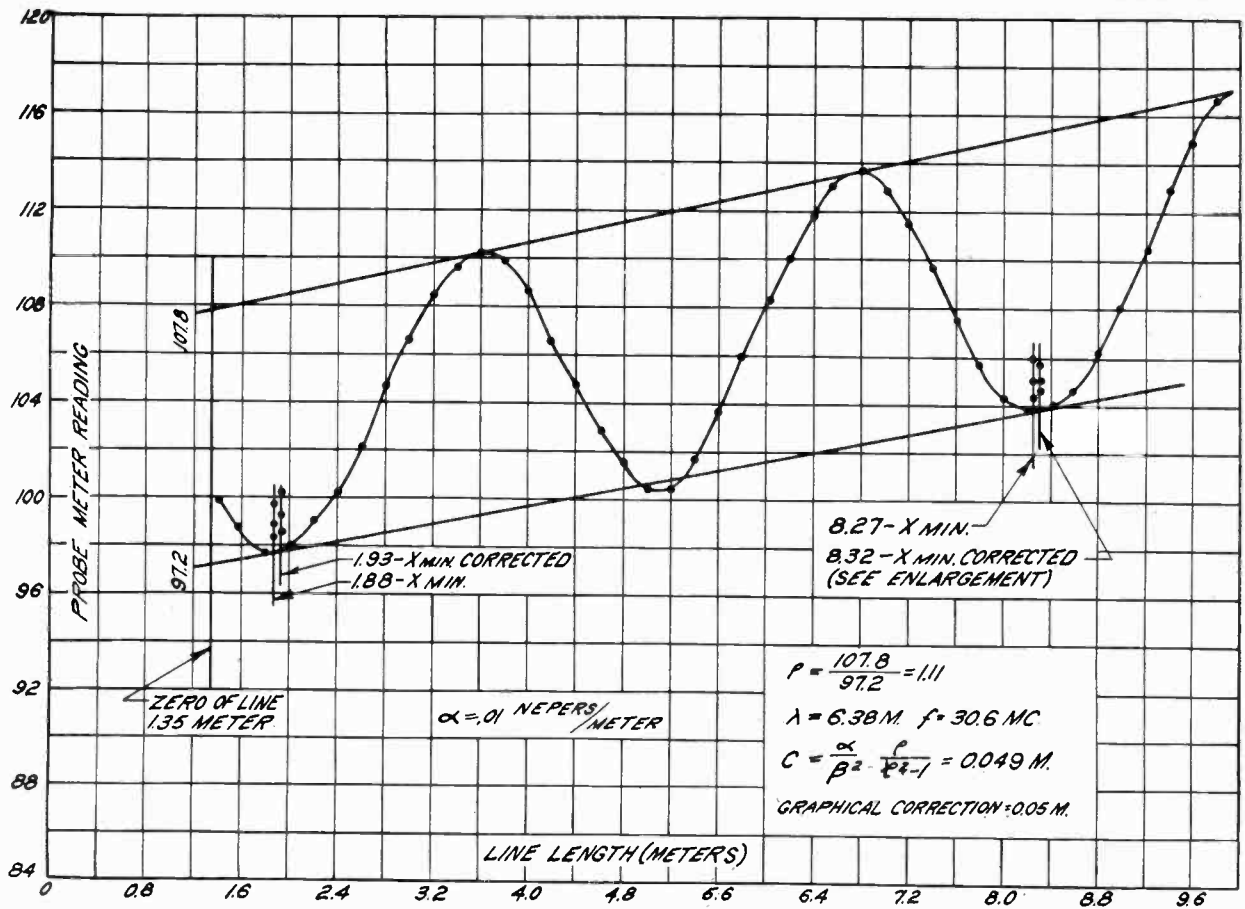

Fig. 8—Voltage curve showing effect of attenuation on the position of the voltage minimum.

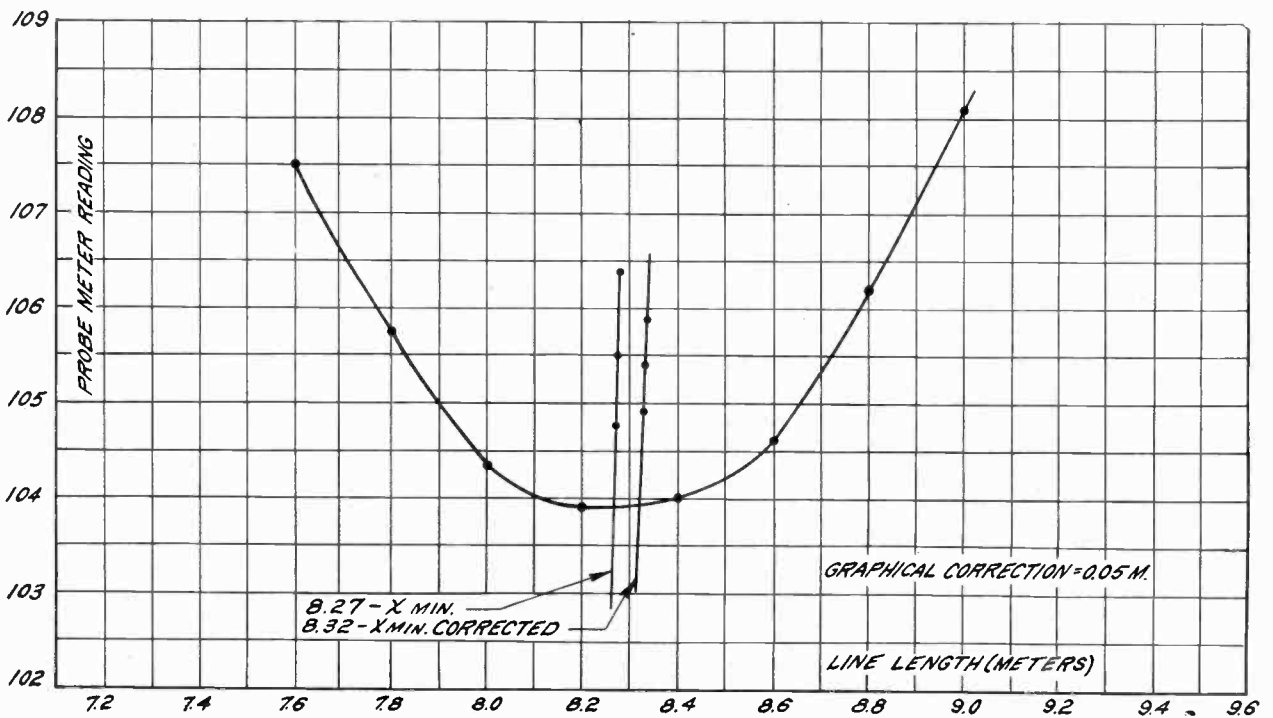

Fig. 9—Enlargement of voltage minimum showing effect of attenuation.

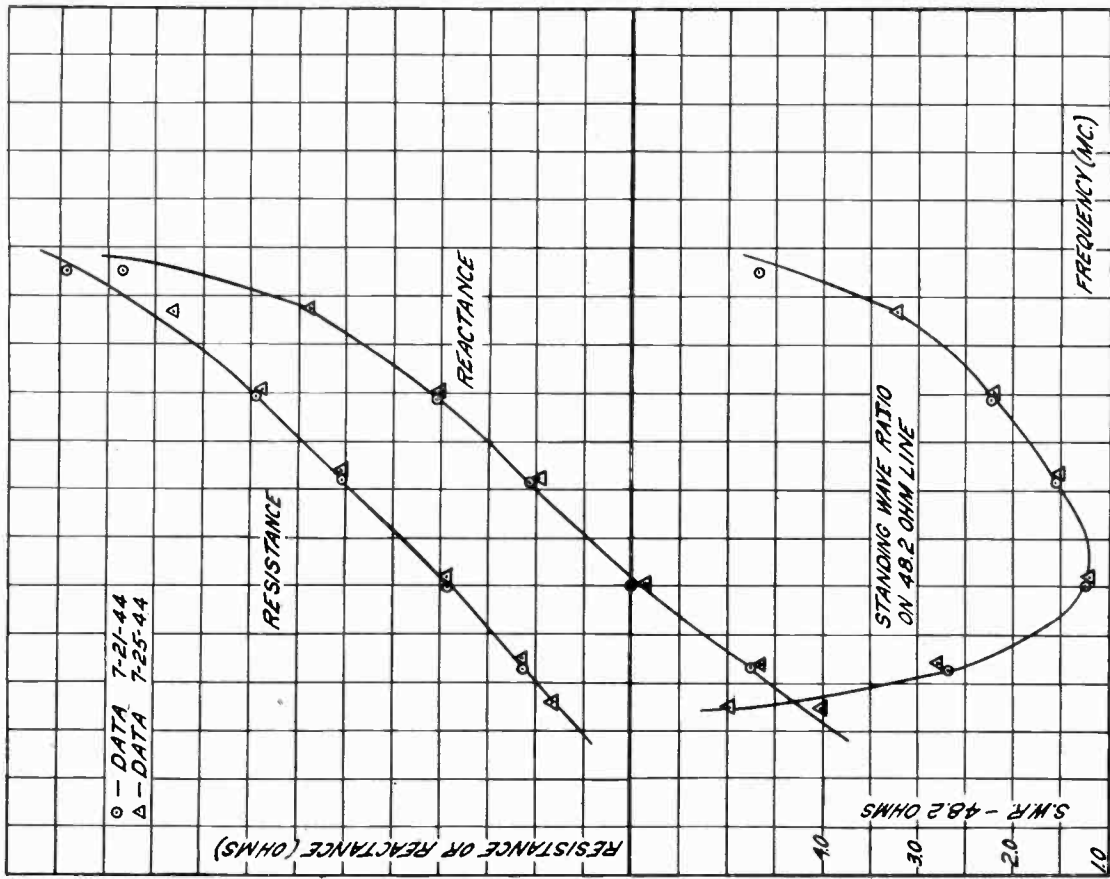

Fig. 11—Impedance measurements showing reproducibility of coiled-line data.

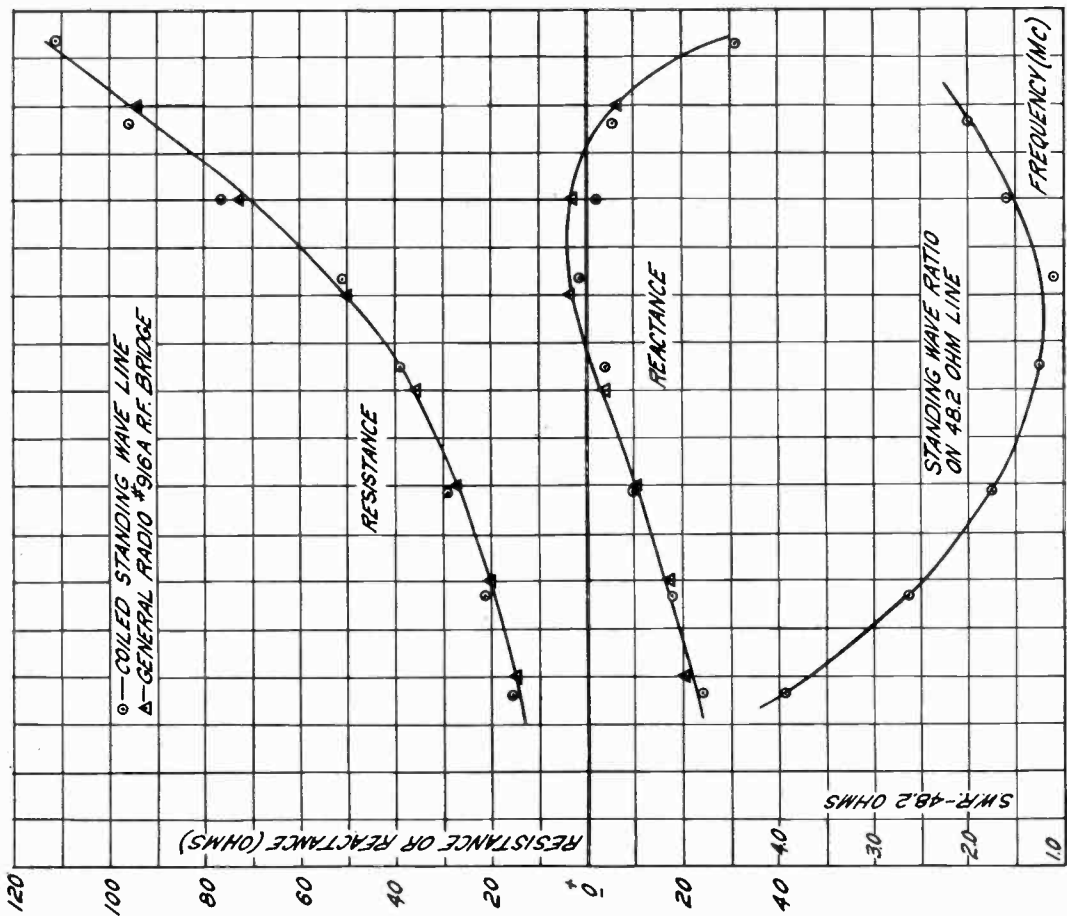

Fig. 10—Comparison of coiled-line and General Radio 916-A bridge measurements.

resistance of ± 10 to 20 per cent and errors in reactance near zero values of over ± 100 per cent, but in most cases all the errors combined will not total more than ± 5 per cent in either resistance or reactance.

In Fig. 10 is shown a comparison of impedance measurements of an antenna on a ground screen made with the standing-wave line and with the General Radio 916-A bridge. General Radio specifies an accuracy of ± 1 per cent or ± 0.1 ohm in resistance, and ± 2 per cent or ± 1.0 ohm in reactance in the range of the bridge.

These limits of accuracy presumably apply to a laboratory-bench setup. In antenna measurements on a ground screen, such conditions cannot be met, as connection to the antenna must be made through a length of cable (0.58 meter in this case) and use must be made of numerous grounding straps from the bridge equipment to the screen. While uncertainties due to the connecting cable were minimized by taking the impedance at its open end as the desired antenna impedance to be measured by both bridge and line, the ground-screen arrangement introduces sufficient other uncertainty to necessitate doubling the limits of error suggested by General Radio. We feel that the bridge measurements under these conditions cannot be better than ± 2 per cent or ± 0.2 ohm in resistance, and ± 4 per cent or ± 2.0 ohms in reactance.

If the mean of the bridge and line measurements be taken as a standard for purposes of comparison, inspection of the curve shows that the line measurements deviate no more than ± 5 per cent in resistance and ± 5 per cent in reactance, save at regions where the reactance values are near zero. For small reactance values, as has been mentioned before, normal errors of measure-

ment of x_{\min} and λ cause very large percentage errors in x_{\min} , and consequently in the reactance.

Fig. 11 shows the results of line measurements made on an aircraft antenna during consecutive ground tests made at an interval of three days. Over nearly all the range, the agreement between both resistance and reactance values is less than 5 per cent, while at the high-frequency end where the highest values of standing-wave ratio ρ are encountered, deviations of 7 per cent in reactance are noticeable. While part of the deviation at low standing-wave-ratio values is due to the increased uncertainty in the measurement of ρ , experience has shown that external conditions during the ground test, such as the position of neighboring aircraft and ground vehicles, can substantially affect the antenna impedance, especially at high values of resistance and reactance. Fig. 11 demonstrates the excellent reproducibility of the line measurements.

In order to show what results may be expected in the solution of a practical antenna problem with the line-measuring equipment, Fig. 12 has been included. In this problem, an antenna was measured on a B-17 aircraft in flight. From the initial data, a matching section for the antenna was calculated and a working model constructed with the aid of the 916-A bridge. The antenna and matching section was then measured on the B-17. Fig. 12 shows the comparison between the impedance calculated for the antenna with matching section and the impedance actually measured on the aircraft.

VI. EXTENSION OF THE METHOD

One of the most severe limitations on the coiled-line method described above is the use of a radio-frequency

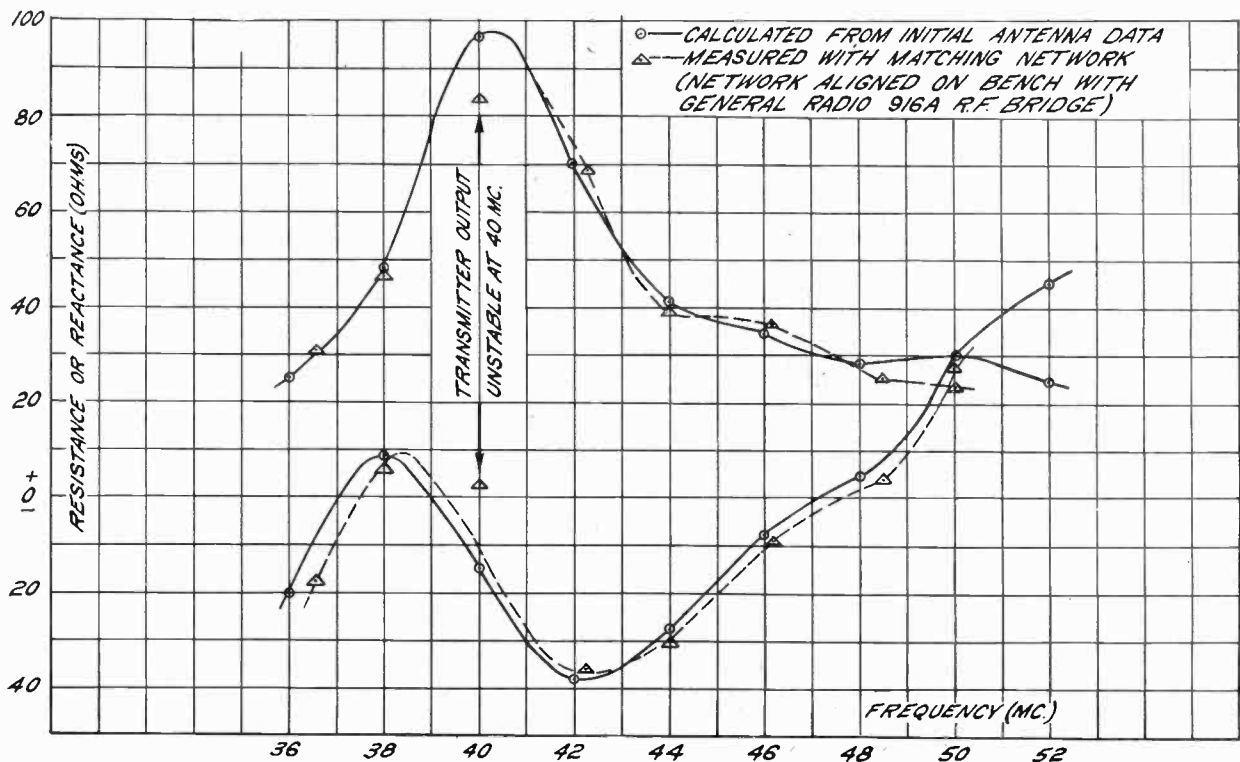

Fig. 12—Comparison of calculated matching section with experimentally observed impedance measured with coiled line.

milliammeter in the probe circuit, as the meter makes impossible the accurate measurement of standing-wave-ratio values higher than 6/1 because of the squared scale and crude division at low values.

This difficulty has been partially overcome by using a multiscale vacuum-tube voltmeter and a tunable series-line element with the probe cable connecting the meter to the coiled line. The tunable element or "line stretcher" is merely an adjustable length of 50-ohm line which allows accurate tuning of the probe so that the transformation due to the cable and stretcher together causes maximum impedance to appear at the probe tips. A General Radio 727-A voltmeter has been found extremely useful because of its high input impedance and its portability.

Using a coiled line with holes spaced at 2-centimeter intervals and the probe mounted as just described, measurements of ρ up to 15/1 are very easy in the range of 50 to 200 megacycles, and some measurements higher than 50/1 have been made. In all cases, excellent voltage curves were obtained and corrections carried out as before. While sufficient evidence has not yet been obtained to clear all objections, reactance values measured with this equipment are believed accurate to ± 5 per cent, and resistance values within ± 15 per cent.

VII. CONCLUSION

A coiled-line method of impedance measurement has been described. The method is applicable in the range 10 to 80 megacycles, which is not adequately covered by other impedance-measuring equipment.

The apparatus described is suitable for use in aircraft measurements during flight, and should find application in measurements made in tanks, ships, etc., where simplicity, compactness, stability, and rugged construction are at a premium.

Comparison of the method with standard radio-frequency bridge measurements leads to the conclusion that the accuracy of measurement is probably within ± 5 per cent in resistance and reactance. Successful engineering designs of aircraft antennas and matching sections confirm this estimate.

Indications are given that the method may be extended to cover the frequency range up to 200 megacycles and to measure standing-wave ratios as high as 50/1.

APPENDIX I

DERIVATION OF THE LINE AND CORRECTION FORMULAS

In this section a brief account will be given of the line theory necessary in the calculation of impedance from the data obtained by the measurement of the voltage standing wave on the coiled line.

It is proposed to justify (a) the fundamental formulas and the methods of calculation applicable to a lossless line; (b) the graphical methods for the correction of standing-wave ratio ρ for the effects of attenuation on the line; (c) an analytical method for the correction of the position of a voltage minimum for the

effects of attenuation; (d) the graphical method for accurate location of the minimum voltage positions on the line.

DERIVATION OF FUNDAMENTAL FORMULAS (Fig. 13)

Assuming a uniform line of real characteristic impedance Z_0 terminated in an impedance Z_A located at

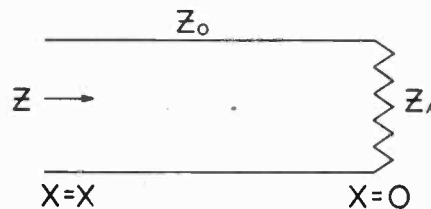

Fig. 13—Schematic diagram of transmission line.

$x=0$, and measuring x positive toward the generator, we can write the equations for voltage and current along the line in the following form:

$$\begin{aligned} E_a(x) &= A_1 e^{\gamma x} + B_1 e^{-\gamma x} \\ I_a(x) &= (1/Z_0) [A_1 e^{\gamma x} - B_1 e^{-\gamma x}] \end{aligned} \quad (1)$$

where $\gamma = \alpha + j\beta$ the complex propagation constant

$A_1 = A e^{i\theta_1}$, the complex amplitude of the wave traveling from the generator to the load

$B_1 = B e^{i\theta_2}$, the complex amplitude of the reflected wave

$$A \geq B \geq 0.$$

The subscript α indicates that the effect of the attenuation on the voltage and current functions is included. Subscript 0 will indicate lossless line.

The quantity obtained in standing-wave line measurements is proportional to the absolute value of the voltage. Considering a lossless line and letting $\theta_2 - \theta_1 = \psi$ we obtain from (1)

$$|E_0| = [A^2 + 2AB \cos(2\beta x - \psi) + B^2]^{1/2}. \quad (2)$$

Applying the condition for the location of the maxima and minima of the absolute voltage curve

$$d|E_0|/dx = 0 \quad (3)$$

results in the condition that

$$\sin(2\beta x - \psi) = 0 \quad (4)$$

which is satisfied for two sets of values of the argument

$$(2\beta x_{\max} - \psi) = 0, 2\pi, \dots, 2n\pi \quad (5)$$

$$(2\beta x_{\min} - \psi) = \pi, 3\pi, \dots, (2n+1)\pi.$$

Substitution of (5) into (2) gives, in turn,

$$\begin{aligned} |E_0|_{\max} &= A + B \\ |E_0|_{\min} &= A - B \end{aligned} \quad (6)$$

from which we may define the standing-wave ratio as

$$\rho = |E_0|_{\max} / |E_0|_{\min} = (A + B) / (A - B). \quad (7)$$

Returning to (1) and using the definition for impedance Z at point x on the lossless line,

$$\begin{aligned} Z(x) &= [E_0(x)] / [I_0(x)] \\ &= Z_0 [A + B e^{-i(2\beta x - \psi)}] / [A - B e^{-i(2\beta x - \psi)}]. \end{aligned} \quad (8)$$

At a voltage minimum where the second part of (5)

applies, (8) becomes

$$Z_{\min} = Z_0(A - B)/(A + B) = Z_0/\rho. \quad (9)$$

Thus, by measurement of the voltage standing-wave ratio and the position of x_{\min} on the line (usually the first minimum) sufficient data are obtained to determine the impedance at the end of the line; for the input impedance Z at a voltage minimum is given by (9). Using a transmission-line chart of the type developed by Smith,¹ one may set up the standing-wave ratio ρ on the real axis of the chart, rotate around the circle of constant ρ toward the load through $(x_{\min}/\lambda) + 0.25$, and read the load impedance Z_A from the circle.

CORRECTION OF THE STANDING-WAVE RATIO

The coiled line described in this paper has appreciable attenuation for which correction formulae will be derived. In the analysis of the corrections which follows, comparison will be drawn continually between the absolute-voltage standing wave on the line with attenuation and the absolute-voltage standing wave on the corresponding lossless line. For most purposes, the type of cable used in the construction of the coiled line may be considered lossless; however, when accurate measurements of impedance with such a line are desired, the effects of attenuation become very noticeable and corrections are necessary.

The absolute value of the voltage on the line with attenuation is found from (1) to be

$$|E_\alpha| = [A^2 e^{2\alpha x} + 2AB \cos(2\beta x - \psi) + B^2 e^{-2\alpha x}]^{1/2}. \quad (10)$$

For the purposes of this analysis it is useful to consider (10) as a function of the variables $|E_\alpha|$, x , and the parameter ψ .

Varying the parameter ψ generates the family of absolute-voltage curves of constant standing-wave ratio ρ . The physically equivalent situation is to cause Z_A to vary so that its representative point on the transmission-line chart moves around the circle of constant standing-wave ratio ρ ; x_{\min}/λ then varies continuously and consequently the x_{\min} on the line moves along the x direction.

Expressing (10) so that it can be represented as

$$F(|E_\alpha|, x, \psi) = 0 \quad (11)$$

the envelopes of the voltage curve may be found by eliminating ψ between (11) and

$$F_\psi'(|E_\alpha|, x, \psi) = 0. \quad (12)$$

Carrying out the differentiation in (12) yields

$$\sin(2\beta x - \psi) = 0 \quad (13)$$

which implies

$$\cos(2\beta x - \psi) = \pm 1. \quad (14)$$

Substituting (13) into (11) gives the two envelope curves, the first of which is tangent to the maxima, the second being tangent to the minima.

$$\begin{aligned} |E_\alpha|_1 &= Ae^{\alpha x} + Be^{-\alpha x} \\ |E_\alpha|_2 &= Ae^{\alpha x} - Be^{-\alpha x}. \end{aligned} \quad (15)$$

Comparison with (4), which applies to the lossless

line, shows the very important result that the maximum and minimum points of the voltage curve on the lossless line occur at the same abscissas as the tangencies of the attenuated voltage curve with its upper and lower envelopes.

At this point we wish to make use of the approximations $e^{\alpha x} = 1 + \alpha x$ and $e^{-\alpha x} = 1 - \alpha x$ in (15). The error incurred in these approximations is discussed in Appendix II, where it is shown that these approximations achieve the same result as taking the first two terms of the Taylor's series expansion of the envelope curves.

From the first of (15) we obtain

$$|E_\alpha|_1 = \alpha(A - B)x + (A + B) \quad (16)$$

a straight line of slope $\alpha(A - B)$ and intercept $(A + B)$; from the second

$$|E_\alpha|_2 = \alpha(A + B)x + (A - B) \quad (17)$$

a straight line of slope $\alpha(A + B)$ and intercept $(A - B)$.

As the ratio of the intercepts of (16) and (17) is exactly ρ , the standing-wave ratio we wish to find, a method of correction of the attenuated curve is clearly to draw the lines tangent to the maxima and minima of the attenuated curve and evaluate their intercepts.

If the slope of one line be taken with the intercept of the other, the value of α can be calculated. The two quantities obtained this way, when averaged, give a reasonably accurate value of the attenuation constant for the coiled line, providing the two slopes can be evaluated with comparable accuracy. At high standing-wave ratios, $\alpha(A - B)$ approaches zero and cannot be accurately measured.

In some experimental situations, a length of cable may be used to connect the impedance to the standing-wave line. Here, rather than extrapolate the envelope lines and risk a considerable graphical error in determining the intercepts, an analytical correction may be applied.

The lines (16) and (17), while not passing tangent to the precise maxima and minima of the attenuated curve, nevertheless constitute excellent approximations to these quantities. Defining

$$\begin{aligned} \rho(x) &= |E_\alpha|_{\max} / |E_\alpha|_{\min} \doteq |E_\alpha|_1 / |E_\alpha|_2 \\ &= [\alpha(A - B)x + (A + B)] / [\alpha(A + B)x + (A - B)] \end{aligned} \quad (18)$$

and using $\rho = (A + B)/(A - B)$ we find

$$\rho = [\rho(x) - \alpha x] / [1 - \alpha x \rho(x)]. \quad (19)$$

CORRECTION OF THE MINIMUM POSITION

The observation was made in the previous section that the minima of the unattenuated $|E_0|$ curve fall at exactly the positions of tangency of the lower envelope with the $|E_\alpha|$ curve. To obtain the correct value of x_{\min} , it would then be sufficient to determine the abscissa at which the lower envelope is tangent to the attenuated curve. This cannot be done accurately by inspection of the curve, so a more precise technique is necessary. A graphical method applicable to regions of the voltage minimum which closely approach a parabola may be

deduced from the property of conics: that the bisector of a family of parallel chords through the conic passes through the point of tangency of the line parallel to the chords; therefore, if the straight-line envelope to the voltage curve be drawn, three or more chords parallel to this line may be constructed in the lower part of the voltage trough. The line passing through the midpoints of these chords will intersect the curve at the x_{\min}^0 of the lossless curve.

The minimum of the $|E_\alpha|$ curve may be found similarly by constructing horizontal chords in the voltage trough. As this construction is easier than the previous one, it is desirable to have an analytical correction to apply that will enable determination of the x_{\min}^0 of the $|E_0|$ curve from that of $|E_\alpha|$.

Applying $d|E_\alpha|/dx=0$ to (10) we obtain as the condition for the maxima and minima

$$\sin(2\beta x - \psi) = [\alpha(A^2 e^{2\alpha x} - B^2 e^{-2\alpha x})] / [\beta 2AB]. \quad (20)$$

Using the approximations $e^{2\alpha x} = 1 + 2\alpha x$, $e^{-2\alpha x} = 1 - 2\alpha x$, and neglecting all terms in α^2 or higher, (20) becomes $\sin(2\beta x - \psi) = \alpha(A^2 - B^2) / (\beta 2AB)$ and if the definition $\rho = (A + B) / (A - B)$ be applied

$$\sin(2\beta x - \psi) = (\alpha/\beta) [2\rho / (\rho^2 - 1)]. \quad (21)$$

Since α is a very small quantity, the right side of (21) is ordinarily very small, and the condition is practically the same as (4) for the lossless line.

As it will be observed that for $\rho \rightarrow 1$ and $\rho \rightarrow \infty$ the right side of (21) approaches infinity and zero respectively, there are two critical values of ρ which must be found by analysis of the inequality.

$$(\alpha/\beta) [2\rho / (\rho^2 - 1)] - \delta \leq 0. \quad (22)$$

These critical values of ρ are: (a) ρ_m such that when $\rho < \rho_m$ no real values of x exist which satisfy (21). This corresponds to finding the limiting value of ρ for which (21) is less than or equal to 1. (b) ρ_b such that the approximation $\sin \theta \doteq \theta$ may be applied to (21) with an error of less than 1 per cent.

The inequality (22) is equivalent to

$$y = \rho^2 - [(2\alpha)/(\delta\beta)]\rho - 1 \geq 0 \quad (23)$$

which will be satisfied for values of ρ greater than the positive root of y . This limiting value is

$$\rho_L = [\alpha/(\delta\beta)] + \sqrt{\alpha^2/(\delta^2\beta^2) + 1}. \quad (24)$$

Using $\delta=1$ in (24) gives the value of ρ_m . Table I shows values of ρ_m for typical 50-ohm cable over a considerable range of frequencies.

TABLE I

f	α	β	ρ_m
10	0.0020	0.322	1.0062
50	0.0053	1.61	1.0033
100	0.0080	3.22	1.0025
150	0.010	4.83	1.0020

To obtain ρ_b , note that $\sin \theta \doteq \theta$ within 1 per cent when $\theta \leq 0.1$ radian which gives the value of $\delta=0.1$. As the ratio α/β decreases with increasing frequency, the largest value of ρ_b will obtain at $f=10$ megacycles. Thus

$\rho_b = 1.064$ at the lowest frequency of operation. Values of ρ as small as this are rarely encountered at any frequency; so the approximation of (b) holds for all ρ of interest in impedance measurement.

Applying the sine approximation to (21) and examining x_{\min} positions

$$(2\beta x_{\min} - \psi) = (2n + 1)\pi - (\alpha/\beta) [2\rho / (\rho^2 - 1)]. \quad (25)$$

Denoting the corresponding minimum on the lossless line by x_{\min}^0 and using the second of (5)

$$(2\beta x_{\min}^0 - \psi) = (2n + 1)\pi. \quad (26)$$

Eliminating ψ between these equations and solving for x_{\min}^0

$$x_{\min}^0 = x_{\min} + (\alpha/\beta^2) [\rho / (\rho^2 - 1)]. \quad (27)$$

Showing that the minimum position of the attenuated line may be corrected to give the minimum on the lossless line by addition of the correction factor.

$$C = (\alpha/\beta^2) [\rho / (\rho^2 - 1)]. \quad (28)$$

Finally, it is of interest to find the value ρ_B such that for $\rho \geq \rho_B$ the correction C is less than experimental error, about 1.0 centimeter.

Carrying out an analysis of (28) similar to that performed on (22), we find

$$\rho_B = \alpha / (2\beta^2 C) + \sqrt{1 + (\alpha / 2\beta^2 C)^2}. \quad (29)$$

Taking $C=0.01$ meter we obtain the values given in Table II.

TABLE II

f	α	β^2	ρ_B
10	0.0020	0.104	2.35
30	0.0038	0.924	1.23
50	0.0053	2.60	1.11
100	0.0080	10.4	1.04
150	0.010	23.2	1.02

A correction to x_{\min} must be applied when

$$\rho_b \leq \rho \leq \rho_B \quad (30)$$

which for the cable constants assumed in Tables I and II means

$$1.06 \leq \rho \leq 2.35$$

at the lowest frequency of operation of the line. The upper bound drops rapidly with frequency to values less than 1.3. No correction to x_{\min} is necessary for $\rho > \rho_B$ as the correction is smaller than the error in determining the position of x_{\min} . Below ρ_b the correction may not be applied as the approximations used in its derivation no longer hold; however, below this standing-wave ratio the terminating impedance is the same as the Z_0 of the line within experimental error.

APPENDIX II

DISCUSSION OF ERROR IN APPROXIMATING THE ENVELOPE FUNCTIONS

In this section we wish to determine the error in the envelope curves (15) introduced by approximating the functions by the first two terms of their series.

Taylor's expansion of a function about the point zero

$$f(h) = f(0) + \{ [hf'(0)] / 1! \} + \{ [h^2 f''(0)] / 2! \} + \dots + R_n$$

and $R_n = [h^n f^n(\theta h)]/n!$ where $0 < \theta < 1$ when applied to the first of (15) gives

$$|E_\alpha|_1 = (A + B) + \alpha x(A - B) + [(\alpha^2 x^2)/2!](Ae^{\theta\alpha x} + Be^{-\theta\alpha x}), \quad (31)$$

The remainder R_3 when divided by $|E_\alpha|_1$, gives the fractional error in the approximation and as

$$R_3 = [(\alpha^2 x^2)/2!](Ae^{\theta\alpha x} + Be^{-\theta\alpha x}) < [(\alpha^2 x^2)/2!](Ae^{\alpha x} + Be^{-\alpha x}) \quad (32)$$

the fractional error is bounded thus:

$$R_3/|E_\alpha|_1 \leq \alpha^2 x^2/2!. \quad (33)$$

A similar analysis shows the same result for the lower envelope.

We shall consider the approximation as sufficiently good providing

$$\begin{aligned} \alpha^2 x^2/2! &< 1/1000 \\ \alpha x &< 0.045. \end{aligned} \quad (34)$$

In Table III the distance along the line to which the approximation holds is worked out for a number of frequencies.

TABLE III

f	α	x	x/λ
10	0.002	22.5	1.2
20	0.003	15.0	1.5
80	0.007	6.4	2.6

It is rarely necessary to obtain data over more than $1\frac{1}{2}$ wavelengths; so the approximation holds over the useful lengths of the cable from 20 megacycles up. At frequencies as low as 10 megacycles the approximation no longer holds, but these fall well within the limit set by the requirement that $(\alpha^2 x^2)/2! < 1/500$ be true.

PART II

IMPEDANCE MATCHING

P. D. COLEMAN

I. INTRODUCTION

Power is usually supplied to a load impedance Z_A with a transmission line. For maximum efficiency and power transfer, the load impedance Z_A should match the line; i.e., Z_A should be the conjugate of the characteristic impedance of the line $Z_0 = (R_0 + jX_0)$. In the usual application, where the Z_0 of the line is taken to be real, this means that the load should be a constant resistance equal to R_0 .

If an antenna is fed by a transmission line, then it follows that the antenna impedance Z_A should match the line. However, this is very seldom the case, especially over a range of frequencies, so that it becomes necessary to transform the antenna impedance Z_A to R_0 by use of pure reactive networks for maximum power transfer. At a single frequency, a simple "T" section can easily be calculated to perform this transformation, but over a range of frequencies, the problem becomes more difficult. The antenna impedance Z_A will change with frequency as well as the elements of the "T" section, so that an impedance match will not be maintained.

It is the aim of this paper to discuss the design of simple one- and two-element networks for matching an arbitrary antenna impedance over a broad range of frequency to a cable of characteristic impedance R_0 . These networks are especially applicable to low-frequency aircraft antennas where physical size is limited. By their use, a given resonant antenna's bandwidth can be expanded two to three times with only two elements, and by the use of plug-in matching sections, frequency ranges of 2 to 1 below 100 megacycles can be realized.

The matching methods presented apply both to balanced and unbalanced antenna systems, and also to balanced antennas fed by unbalanced lines through the aid of a bazooka or balancing transformer. Where a bazooka is used, the matching methods are incorporated into the design, so that balancing and matching are achieved simultaneously.

II. METHOD OF ATTACK

A. Balanced and Unbalanced Systems

The pure reactive elements at one's disposal are, of course, coils, capacitors, and transmission lines; i.e., lumped and distributed parameter elements. Anyone who has analyzed a complex network soon discovers how complicated the algebra of the complex quantities becomes as the number of elements increases. In fact, the arithmetic often becomes so laborious and involved for the usual worker that he cannot see the forest for the trees. A combination analytical-and-graphical method of network analysis has been devised to avoid the complexity of a purely analytical approach and to give a clear, general, over-all picture of the solution to the problem.

From the transmission-line equation

$$Z_s/Z_0 = [(Z_A/Z_0) + j(\tan \theta)]/[1 + j(Z_A/Z_0) \tan \theta]$$

where Z_s and Z_A are the input and terminating impedances, Z_0 and θ are the characteristic impedance and electrical length of the line, it can be shown that the loci of impedances that will give constant standing-wave ratios are circles in the complex plane. Now in impedance matching, it is the usual practice to adopt a certain standing-wave ratio ρ as the mismatch limit allowable. Here the value of $\rho = 2$ is chosen, so that the criterion of match will be any impedances that fall on or in the circle for $\rho = 2$. In each of the figures, this 2-to-1 circle is drawn for reference.

The transmission-line equation has the same form for admittances as impedances, so that the criterion of match is the same for both types of representation.

The general graphical method that will be applied is as follows: A typical antenna impedance and admittance curve in the complex plane is investigated through the first resonant and antiresonant points. This will give an idea of the general characteristics of the impedances and admittances to be matched for one unfamiliar with antennas. Next, the effect of coils, capacitors, and lines,

both in series and parallel, is determined upon various portions of curves of these general shapes. The guiding principle applied is to try to move or collapse the given curve into the $\rho = 2$ circle. This same principle, however, should not be applied for combinations, as it is often desirable to set up the curve for the succeeding elements, rather than try to match into the circle with the first element.

Next, two-element combinations are illustrated. Most of these follow by intuition; however, a few may not be obvious. The rule of thumb here is to set up the antenna curve with the first element for the second as stated before; i.e., try to warp the antenna curve into a curve near that of the ideal load of the second element. By definition, an ideal load is the load in which the line or impedance element must be terminated to see R_0 looking into the input terminals.

It was intended to discuss three-element networks in this paper, but space will not permit.

B. Balanced Systems Fed with Unbalanced Lines by Means of a Bazooka

A coaxial-line bazooka (of the type represented in Fig. 14) achieves a balance-to-unbalance transformation

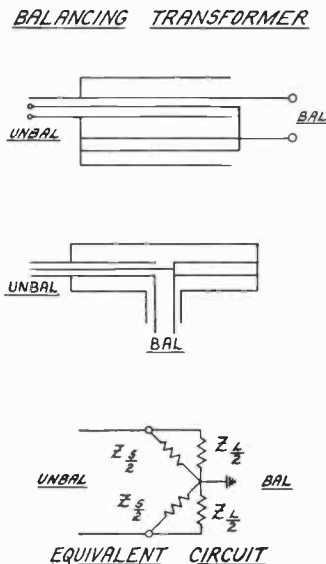

Fig. 14—Schematic drawing and circuit diagram of a broad-band balancing transformer.

by isolating the inner and outer conductors of the unbalanced coaxial line from ground by an insertion of quarter-wave stubs. This places a parallel circuit across the balanced load. Hence, in using a bazooka for both matching and balancing, the parallel circuit or stub must occur somewhere in the matching network. The guiding principle in balanced-to-unbalanced transformer-matching design is to arrange to have the balanced load changed by one or several impedance elements on the balanced side to a load impedance, such that it approximates the ideal load for the stubs. Adding the stubs will then both match the load and make the balancing transformation simultaneously. Or if the bal-

anced load is such that addition of the stubs will set up the impedance curve for a line on the unbalanced side, matching and balancing may be designed entirely inside the bazooka.

III. DISCUSSION OF CURVES

A. Antenna Curve

In Figs. 15, 16, 17, and 18, the impedance and admittance characteristics of a typical low-frequency broadband antenna are plotted versus relative frequency η . η is based upon the first resonant-frequency point of the antenna where it is taken equal to one. Two facts may be noted in Figs. 15 and 16: first, the antenna has a negative susceptance slope with respect to η around resonance; and second, a negative reactance slope with respect to η around antiresonance. This means, of course, that the susceptance or reactance in these regions may be cancelled wholly or partially by a properly chosen parallel or series-resonant circuit that could be added to the antenna. Furthermore, it might be observed that the slope of the resistive and reactive components of impedance with respect to η is greater around resonance than the slope of the conductive and susceptive components of admittance with respect to η around antiresonance.

Finally, in Figs. 17 and 18, it is noted that the portion of the antenna curve satisfying the matching criterion (points lying on or in the $\rho = 2$ circle) are the points from $\eta = 0.95$ to $\eta = 1.15$ approximately, or a bandwidth of some 20 per cent. The definition of percentage bandwidth is taken to be as follows: let η_1 and η_2 be the lower and upper frequencies, where the antenna curve enters and leaves the $\rho = 2$ circle. Then the percentage bandwidth is $[(\eta_2 - \eta_1)/\eta_1] \times 100$ per cent or $[(\Delta\eta)/\eta_1] \times 100$ per cent. For the example given, $\Delta\eta = 0.20$ and $\eta_1 = 0.95$.

B. Properties of Single Elements

1. Series capacitor

In Figs. 19 and 20, the effect of a series capacitor is given in both impedance and admittance diagrams. Here, just the portion of an antenna curve around resonance is considered, where in this case the impedance curve passes to the left of the $\rho = 2$ circle. A capacitor, of course, having a negative reactance, subtracts at each frequency a certain amount of reactance from that of the antenna leaving the resistance component unaffected. This has the effect in the impedance-diagram representation of moving the antenna curve down vertically into the $\rho = 2$ circle. In the admittance diagram, the effect is to rotate the entire curve counter-clockwise. Here, both the conductance and susceptance values are affected by the addition of the capacitor in series. It might be suspected that the maximum bandwidth could be obtained by moving the impedance curve so that it falls along a diameter; i.e., where the $\rho = 2$ circle would intercept the maximum arc. However, this is not the case, because of the spacing of the

Fig. 15
TYPICAL LOW FREQUENCY BROAD BAND ANTENNA

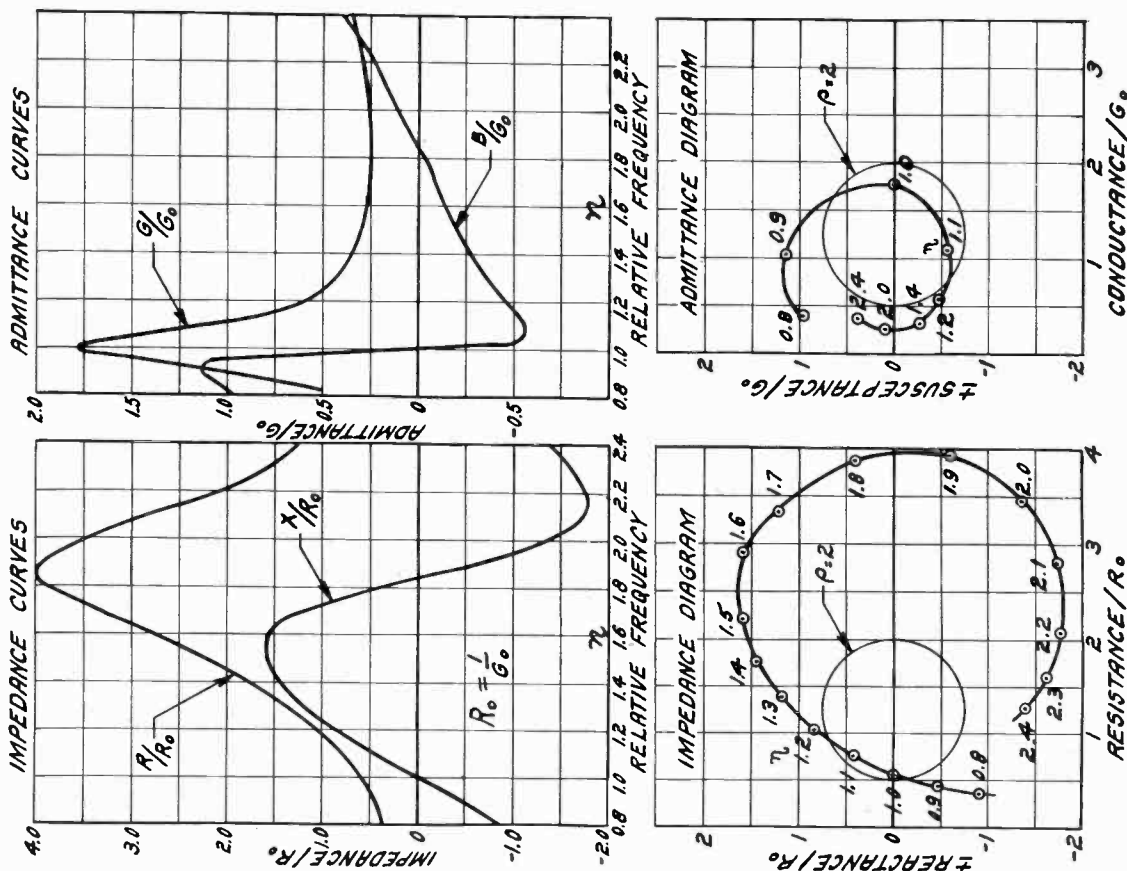

Fig. 17

Figs. 15-18—Impedance-admittance characteristics of a typical low-frequency antenna, illustrating the four types of representation of data.

Fig. 19

SERIES ELEMENT

CONDENSER

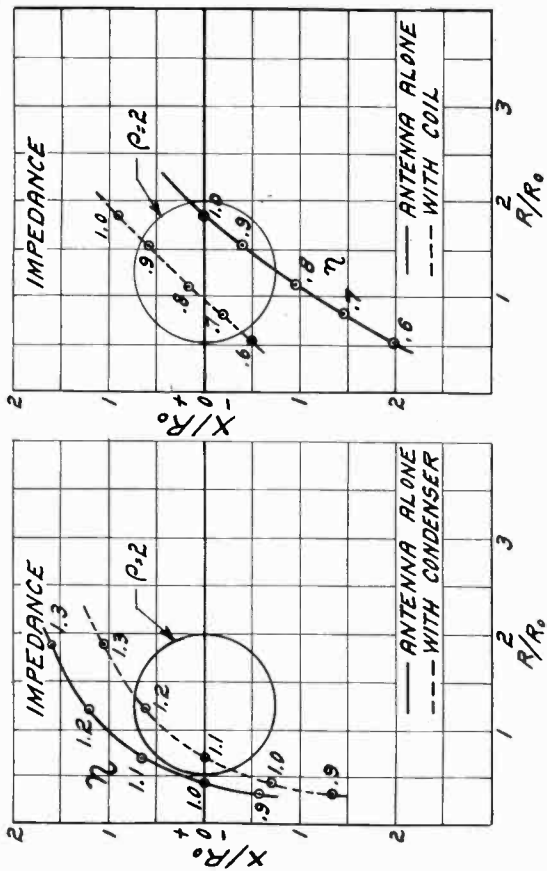

Fig. 22

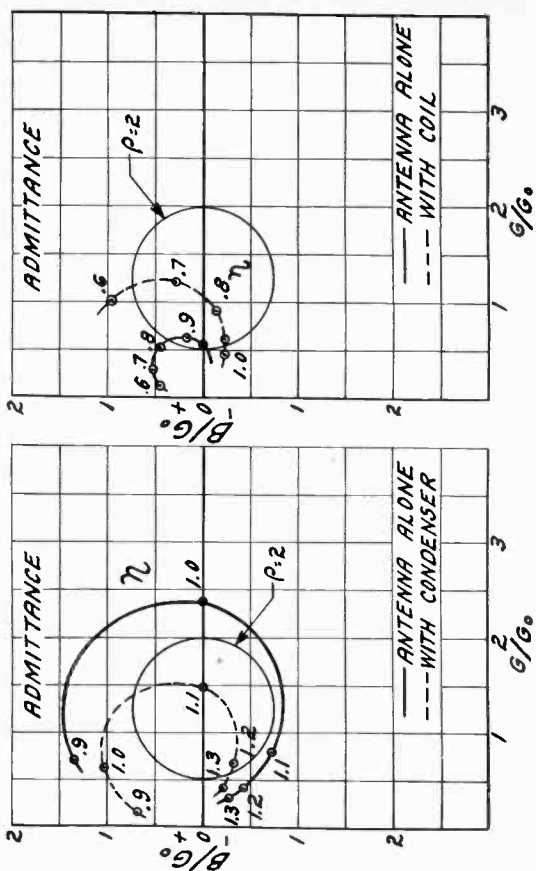

Fig. 20

Fig. 23

Figs. 19 and 20, 22 and 23—Transformation of antenna curve in complex plane by the addition of a capacitor or coil in series.

Fig. 25

SERIES QUARTER AND HALF WAVE LINES (QUARTER)

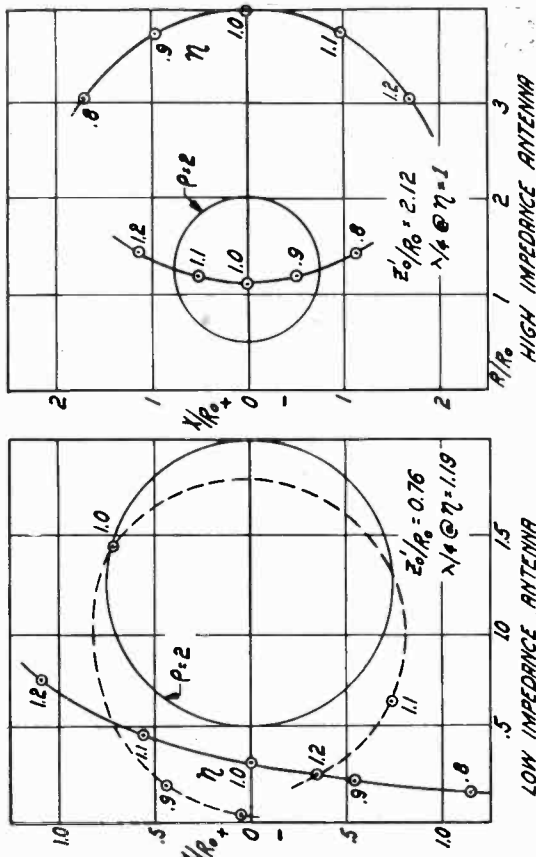

Fig. 24

(HALF)

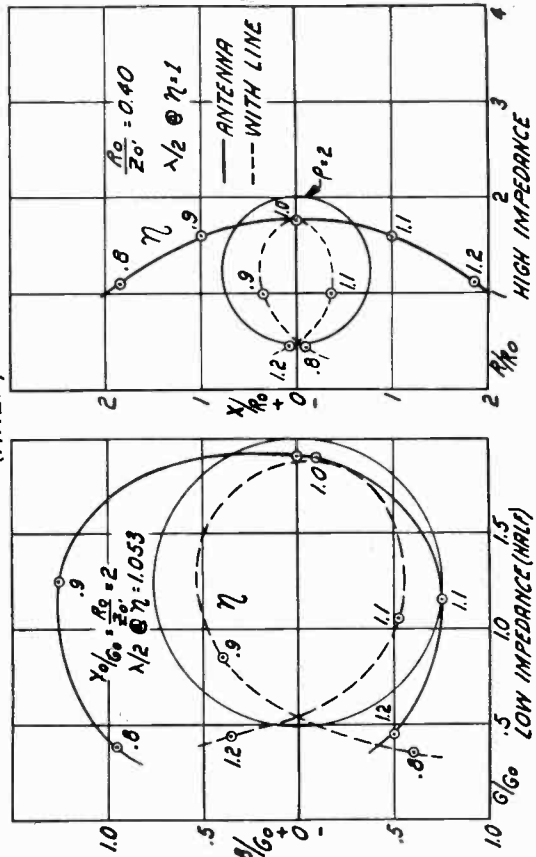
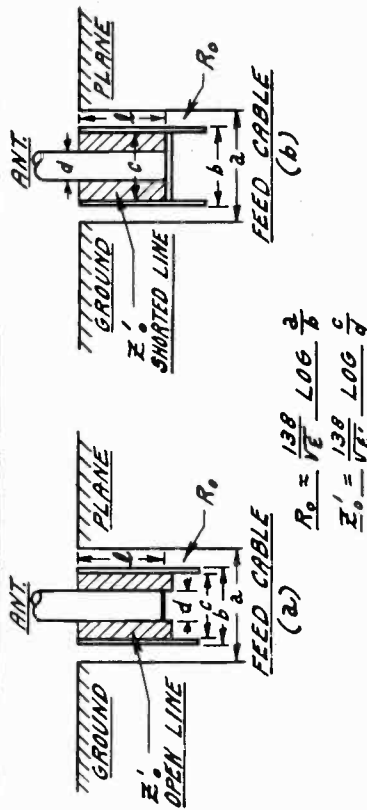

Fig. 28

Fig. 27

Figs. 24 and 25, 27 and 28—Effect on antenna curve in the complex plane of the addition of a series or tandem quarter- or half-wave line.

A. BUILT INTO INNER CONDUCTOR OF FEED CABLE



B. BUILT INTO ANTENNA

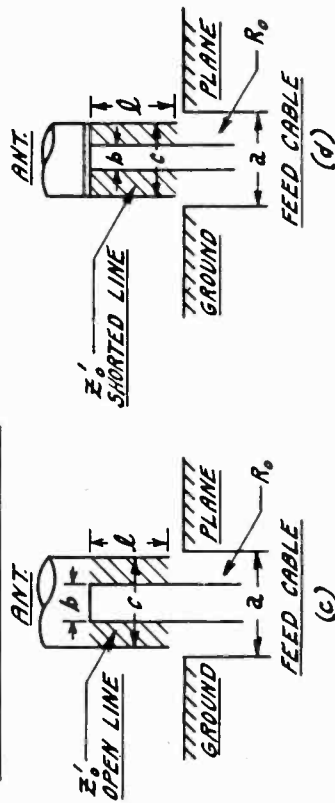

C. LUMPED CIRCUIT EQUIVALENT

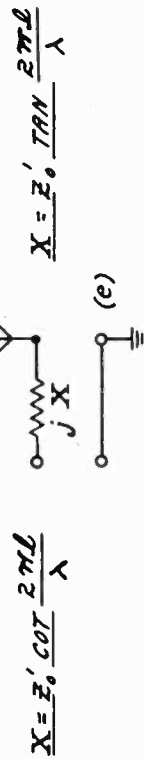

Fig. 21—Possible construction methods for series reactance element added to antenna.

frequency points. From the definition of bandwidth $\Delta\eta/\eta_1$, it is seen that $\Delta\eta$ inside the $\rho=2$ circle increases more slowly than η_1 , so that it is advantageous to place the curve slightly in the upper left-hand portion of the $\rho=2$ circle. As indicated, the bandwidth has been increased from 0 per cent to some 17 per cent by the capacitor, the frequency range being $\eta=1.05$ to $\eta=1.23$.

In Fig. 21, parts (a), (c), and (e) show the schematic construction and diagram of a series capacitor or electrically short, open-circuited, transmission line. Parts (a) and (c) show two possible methods of design, one inside the inner conductor⁴ of the feed cable R_0 , and the other inside the antenna itself.

If $Z_A = R_A + jX_A$ is the impedance of the antenna, then addition of the series impedance jX will result in the feed cable R_0 seeing a load impedance given by

$$Z_L = Z_A + jX = R_A + j(X_A + X) \quad (35)$$

where for an open-circuited line X is

$$X = -Z_0' \cot \theta = -Z_0' \cot 2\pi(l/\lambda). \quad (36)$$

For small electrical lengths

$$B = -1/X = \omega C(\text{eff}) = [\tan 2\pi(l/\lambda)]/Z_0' \\ \simeq \sqrt{L/C} \omega \sqrt{LC} l \quad (37)$$

or

$$C(\text{eff}) = (Cl) \quad (38)$$

where, of course, C is the electrostatic capacitance per unit length, and l the length of the line.

2. Series Coil

The effect of a coil is just the opposite to that of a capacitor, as can be seen from Figs. 22 and 23, in that it adds reactance to the antenna impedance. The coil works best when the impedance curve passes to the right of the $\rho=2$ circle, so that the curve can be moved up into the matching region. In this particular case, the original curve had a bandwidth of some 24 per cent, while with the coil the bandwidth has been increased to approximately 46 per cent. The reason for this large increase in bandwidth is that the lower-frequency part of the curve is being pushed into the $\rho=2$ circle, increasing $\Delta\eta$ and decreasing η_1 simultaneously.

In Fig. 21, parts (b), (d), and (e) show possible construction details of a series coil. These figures are identical to those for a series capacitor, except that the transmission line is short-circuited.

The load impedance for this case is then

$$Z_L = Z_A + jX = R_A + j(X_A + X) \quad (39)$$

where

$$X = Z_0' \tan \theta = Z_0' \tan 2\pi(l/\lambda). \quad (40)$$

For small electrical lengths

$$X = \omega L(\text{eff}) = \sqrt{L/C} \omega \sqrt{LC} \quad (41)$$

or

$$L(\text{eff}) = (Ll) \quad (42)$$

where L is the inductance per unit length and l the length of the line.

3. Series Quarter-Wave Lines

The properties of quarter-wave lines have been used extensively as spot frequencies, but have received relatively little attention over a range of frequencies. Figs. 24 and 25 give a rather representative picture of the behavior of quarter-wave lines on a resonant low-impedance antenna and a high-impedance antiresonant antenna. As can be seen, a quarter-wave line carries low impedances into high impedances, and vice versa. It may be noted that matching down produces greater bandwidth than matching up; i.e., it is more difficult to match a low impedance to a high constant resistance than a high impedance to a low constant resistance. This seems reasonable if one remembers that the low impedances shown here produce a much higher average standing-wave ratio on the cable R_0 than the high impedances. The crowding of the standing-wave ratio circles near the origin causes the impedances in this region to appear easily matched because of their nearness to the $\rho=2$ circle, but usually, their standing-wave ratios are much higher than impedances far to the right of the $\rho=2$ circle.

In Fig. 24, the cable of characteristic impedance $Z_0' = 0.76R_0$ was made a quarter wavelength long at $\eta=1.19$ instead of $\eta=1$, so that the resulting curve would be more symmetrical about the real axis. This is necessary because the original antenna curve was not symmetrical. If the antenna curve were symmetrical, as in Fig. 25, then the line can be chosen a quarter wavelength long at $\eta=1$.

In Fig. 26, parts (a) and (c) show the addition of a line of characteristic impedance Z_0' in series or tandem with the antenna. The antenna impedance Z_A is transformed through the line as given by the transmission-line formula (35). Z_{AA}' is then the impedance terminating the feed cable R_0 . In the example shown, the electrical length is near 90 degrees at the center of the frequency band, hence the term quarter-wave line.

4. Half-Wave Line

Figs. 27 and 28 give the typical behavior of a half-wave line when used with a resonant and antiresonant antenna. In the case of a resonant antenna (susceptance slope with respect to η negative), the characteristic impedance of the line is $Z_0' = R_0/2$; i.e., less than R_0 , while for an antiresonant antenna (reactance slope negative), $Z_0' = 2.5R_0$; i.e., greater than R_0 . Varying the characteristic impedance of the half-wave line causes the tie point to vary along the real axis. In the examples shown, the tie point was made near the $\rho=2$ circle for maximum bandwidth. Again, to take care of the slight dissymmetry of the antenna curve with respect to the real axis, the cable in Fig. 27 was made half wave at $\eta=1.053$. This caused the lower frequency points to bend downward more than the higher frequency points upward.

There is a remarkable resemblance in Fig. 27 of the half-wave line to a parallel-resonant circuit. A parallel circuit affects only the susceptance values of the antenna,

⁴ H. Salinger, "A coaxial filter for vestigial-sideband transmission in television," *PROC. I.R.E.*, vol. 29, pp. 115-120; March, 1941.

Fig. 30

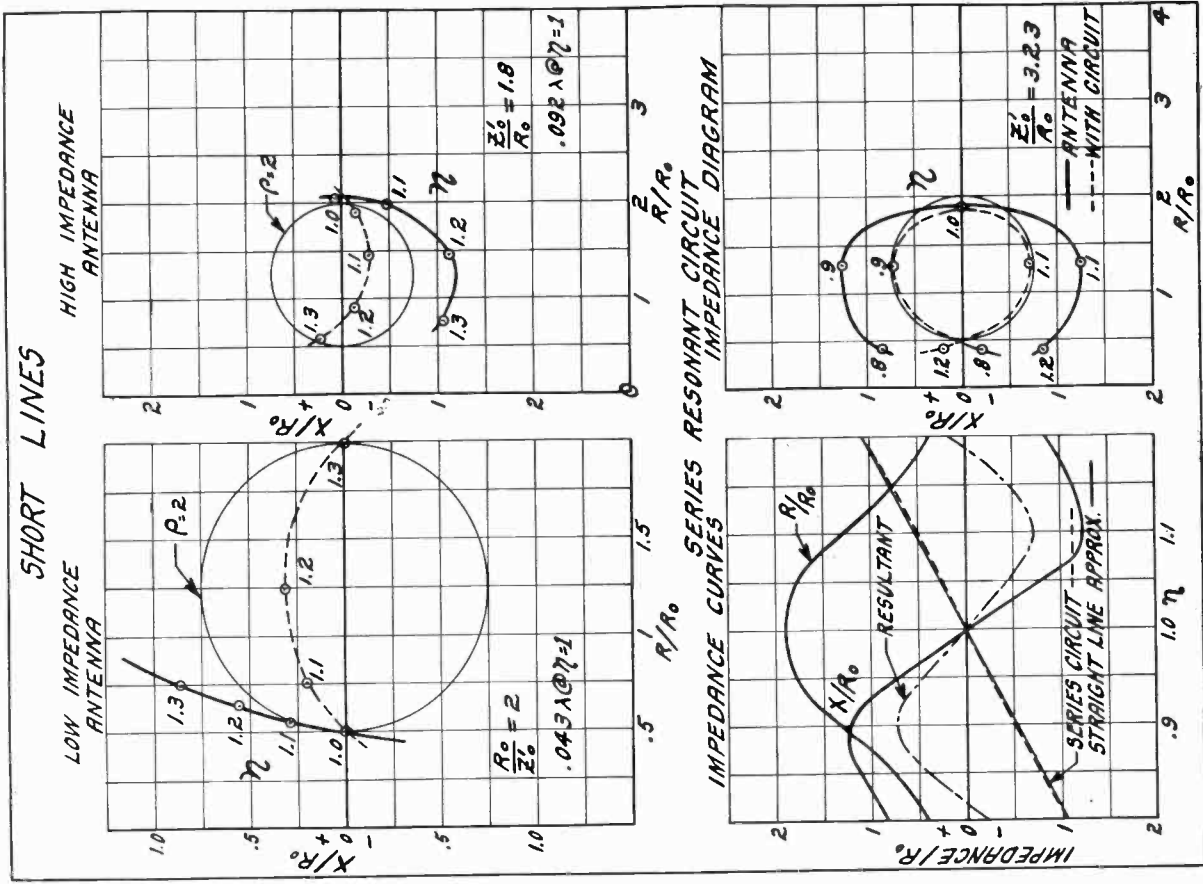

Fig. 29

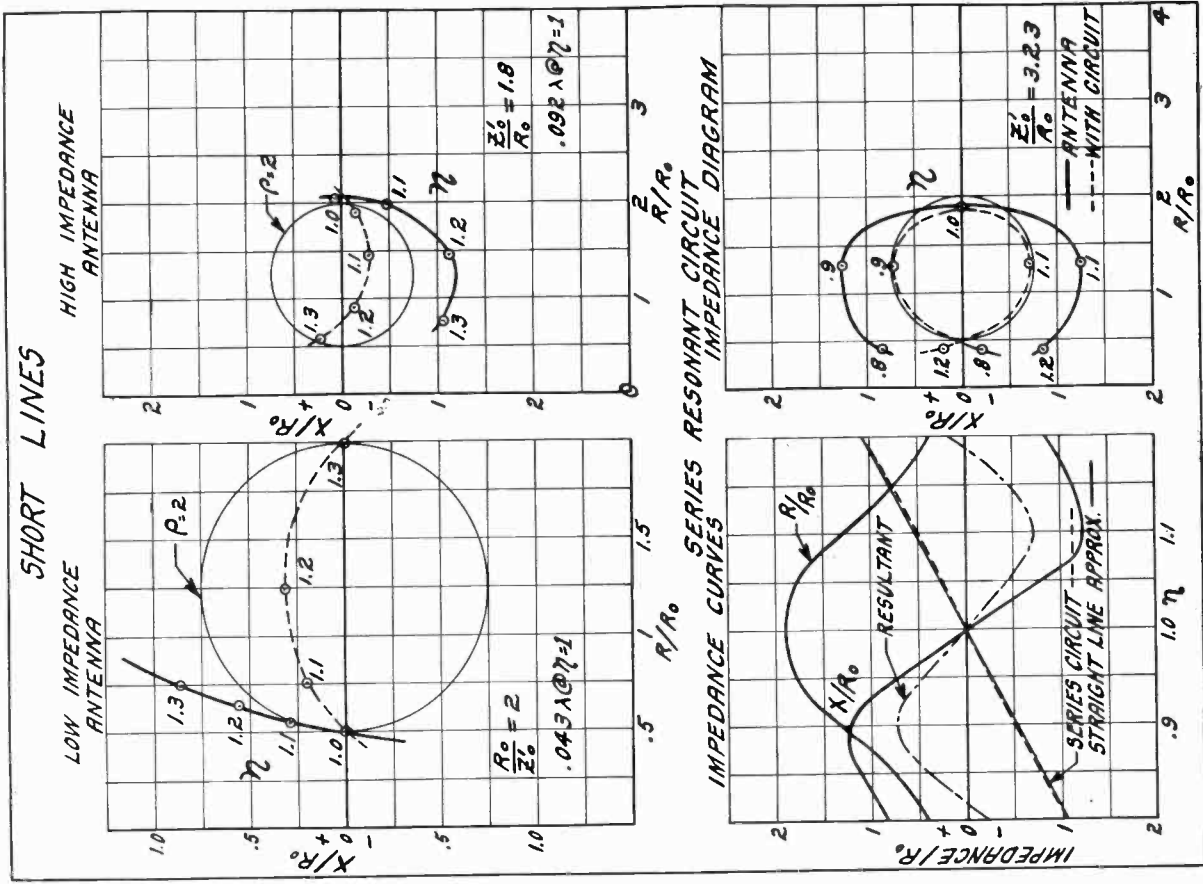

Fig. 32

Fig. 31

Figs. 29-32—Illustration of electrically short series line and series-resonant circuits effect on antenna curve.

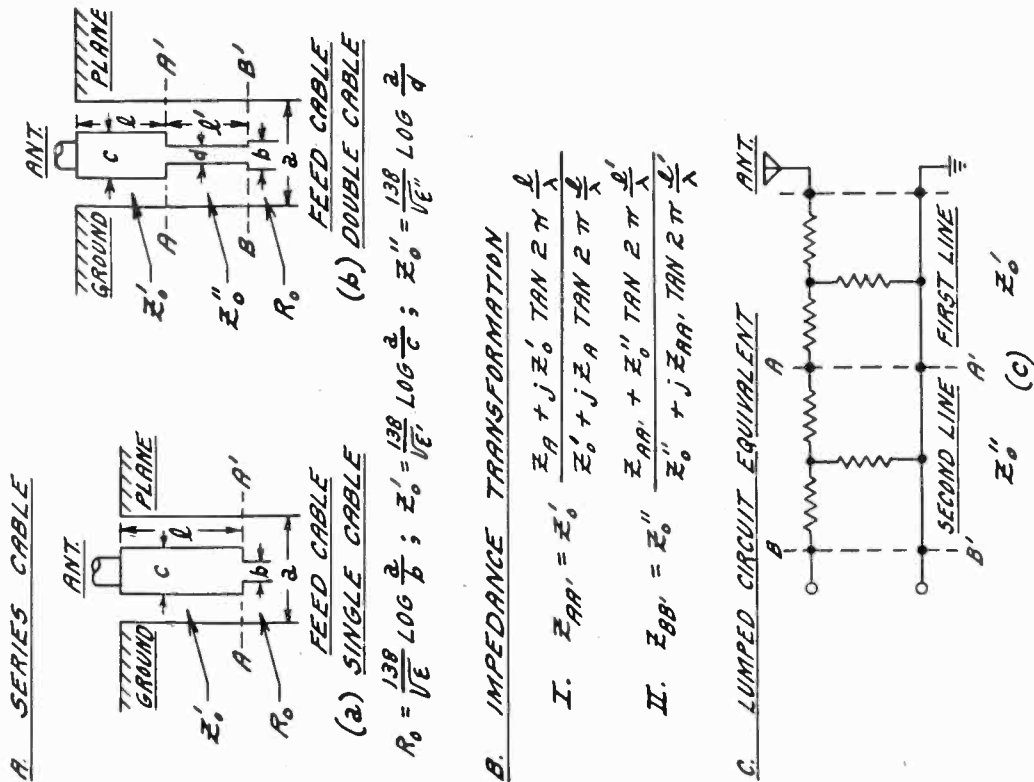

Fig. 26—Schematic drawing, impedance transformation, and circuit diagram of series cables added to antenna.

leaving the conductance values unchanged. In this case, the line cancels susceptance like a parallel circuit, while affecting the conductance values only slightly.

In Fig. 28, the half-wave line resembles a series-resonant circuit, in that reactance values are very strongly affected while resistance values remain rather constant. These facts will become more evident when parallel and series circuits are examined.

A half-wave line is connected to the antenna in the same fashion as the quarter-wave line, the only difference being that the electrical length is increased to 180 degrees.

5. Short Lines

Figs. 29 and 30 give two examples of the use of short lines; i.e., lines less than, say, 0.125λ long. Here the lines bend the antenna curve into the $\rho=2$ circle. They are especially useful when only a slight rotation of the antenna curve is needed to bring it into the $\rho=2$ circle. For those who are familiar with the circular form of an impedance chart, these short lines can be calculated rapidly by a little manipulation.

6. Series-Resonant Circuits

Figs. 31 and 32 show the use of a series-resonant circuit with an antiresonant antenna. In this case, the series circuit is a cable rather than a lumped circuit. Fig. 31 gives a very rapid method of determining the electrical length and characteristic impedance of this cable to be used. It is evident that, if the reactances of the two points for which the resistive component was 0.50 were cancelled to zero by a series circuit, the antenna curve would be partially collapsed into the $\rho=2$ circle and the maximum bandwidth obtainable with a single series element would result. Following this scheme, Fig. 31 illustrates the application of this method.

The values of the antenna's reactance are determined for the frequencies where the resistive component is 0.50. These two points must then be cancelled to zero, so that the series circuit must pass through the reactance points of the opposite sign. A straight line is then drawn through these second two points as a first approximation to the series circuit. The intersection of this line with the real axis then gives the resonant electrical length and the characteristic impedance can be determined from the slope by calculation. In this case where the antenna curve is symmetrical, the resonant electrical length is, of course, at $\eta=1$, while the characteristic impedance is seen by calculation to be $Z_0' = 3.23 R_0$. The dashed curve gives the true series-circuit curve for comparison with the straight line, while the dashed-dot curve gives the resulting, partially cancelled antenna's reactance curve.

A series-resonant circuit in series with the antenna is constructed in exactly the same manner as a series capacitor, coil, or short line. All that need be done is to increase the electrical length to 90 degrees in the case of an open-circuited line, or 180 degrees for a short-

circuited line. The impedance transformation is the same as given by (35), (36), and (40).

7. Parallel Coils and Capacitors

(a) *General Use:* Figs. 33 and 34 give the admittance counterpart of a series capacitor; i.e., a parallel coil. As is evident, the effect of a parallel coil in the admittance diagram is the same as a series capacitor in the impedance diagram, and vice versa. The same is true of a parallel capacitor and a series coil as given in Figs. 35 and 36. All techniques of choosing series coils, and capacitors in the impedance diagram apply to choosing parallel capacitors and coils in the admittance diagram.

In Fig. 37, parts (a), (b), (c), and (d) give possible schematic constructions and diagram of the addition of a parallel reactance to an antenna. As can be seen, this is the ordinary stub construction in impedance tuners, supported lines, etc.

Let Y_A be the admittance of the antenna, then the admittance transformation is

$$Y_L = Y_A + jB = G_A + j(B_A + B) \quad (43)$$

where

$$B = [\tan 2\pi(l/\lambda)]/Z_0' \text{ or } B = [-\cot 2\pi(l/\lambda)]/Z_0' \quad (44)$$

for the open and short-circuited stub line.

(b) *Bazooka Design:* If a balanced load is of the type given in Fig. 33, where by the cancellation of susceptance by a parallel coil or line element, the antenna curve can be moved into the matching circle, then this parallel coil or line element can be made the isolating stubs of the bazooka. In this case, it will mean that the stubs are less than a quarter wavelength long, and so the bazooka will be much shorter in physical length than usual.

8. Parallel-Resonant Circuit (Stub)

(a) *General Use:* Stubs have been used to match antennas for some time, but the broad-banding property of a single stub seems not to have been exploited. This circuit is the identical admittance counterpart of a series circuit, and is designed in exactly the same way. A resonant antenna has a negative susceptance slope with respect to frequency, which can be cancelled with a properly chosen circuit over a considerable range of frequencies. The most favorable antenna curve is one which has a resonant conductive component just less than 2, as shown in Fig. 38.

In the example shown, the antenna curve is not symmetrical, lying slightly more in the upper half of the complex plane than in the lower, so that the resonant electrical length of the stub will not be at $\eta=1$ as seen in Fig. 39. Here again a straight-line approximation is used for the parallel circuit in choosing the electrical length and characteristic impedance. The susceptances have been cancelled to zero for the points where the conductive component is 0.50, tying the admittance curve on the real axis.

(b) *Bazooka Design:* Parallel-circuit or stub matching of the type illustrated is ideally suited for bazooka matching and balancing of a balanced resonant antenna

Fig. 33

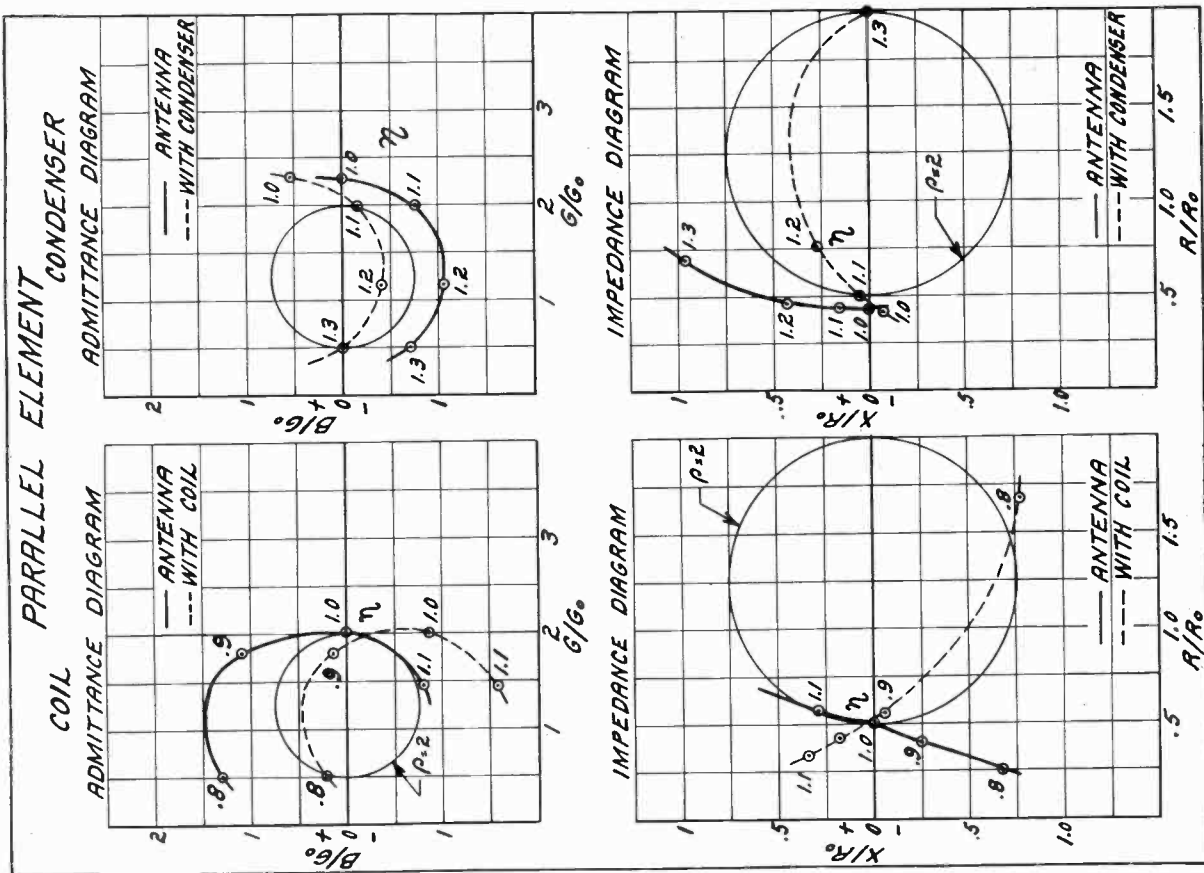
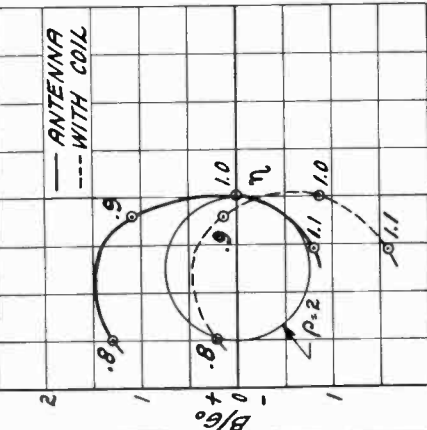

Fig. 33

PARALLEL ELEMENT
COIL

ADMITTANCE DIAGRAM



ADMITTANCE DIAGRAM

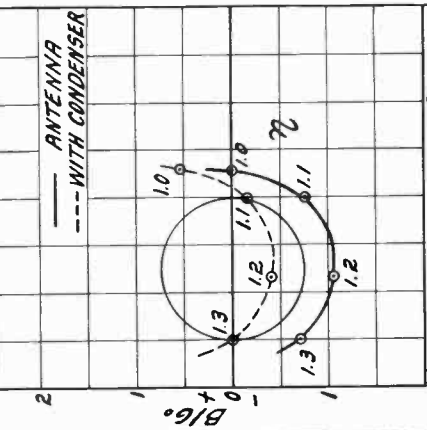

IMPEDANCE DIAGRAM

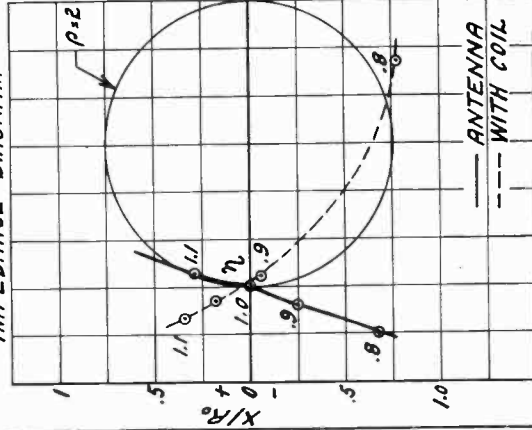

IMPEDANCE DIAGRAM

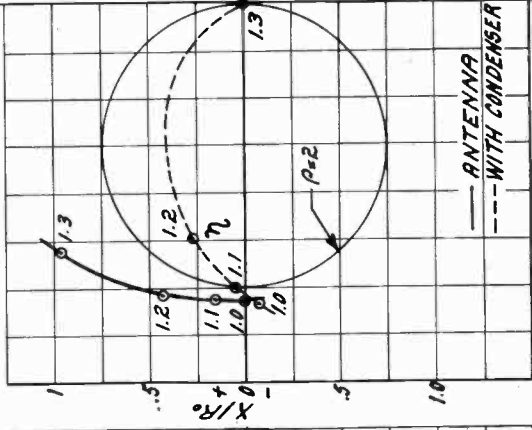
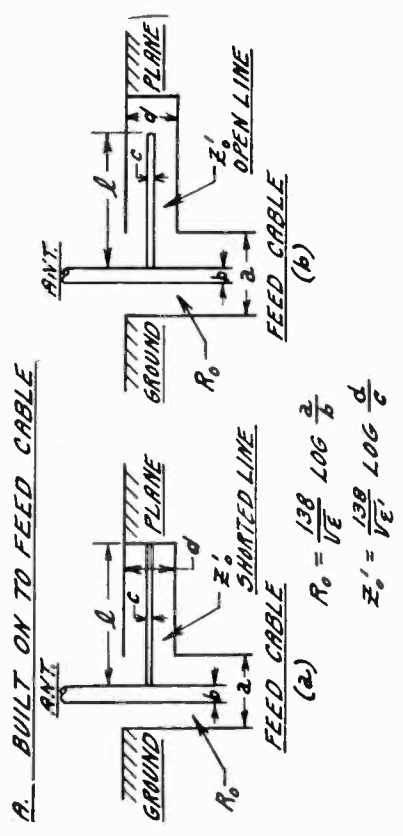

Fig. 34

Figs. 33-36—Transformation of antenna impedance-admittance curve by addition of parallel coil or capacitor.



$$R_0 = \frac{138}{\sqrt{\epsilon}} \log \frac{2}{b}$$

$$Z_0' = \frac{138}{\sqrt{\epsilon'}} \log \frac{d}{c}$$

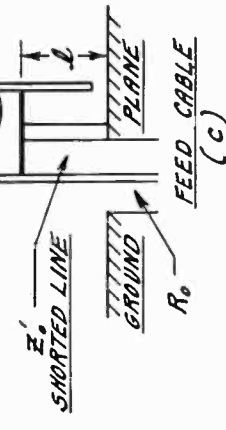

LUMPED CIRCUIT EQUIVALENT

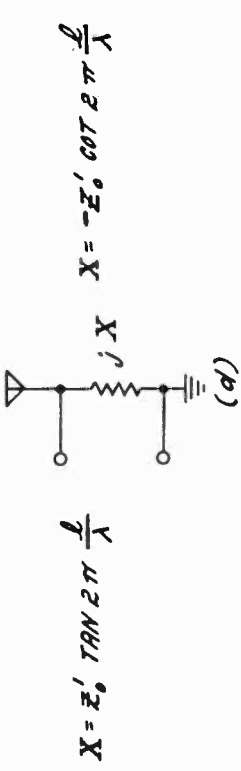

Fig. 37—Suggested construction of parallel reactance that may be added to antenna.

Fig. 41

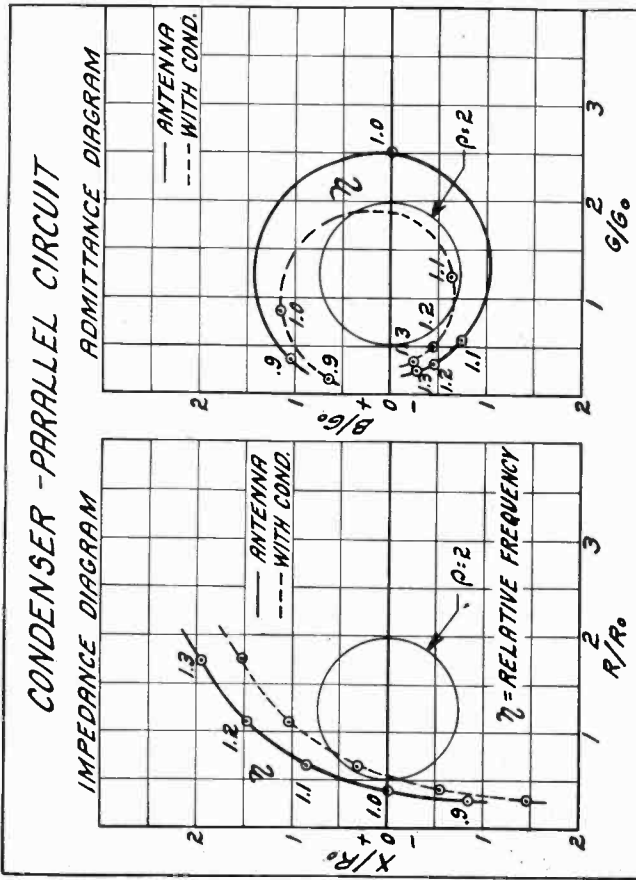

Fig. 40

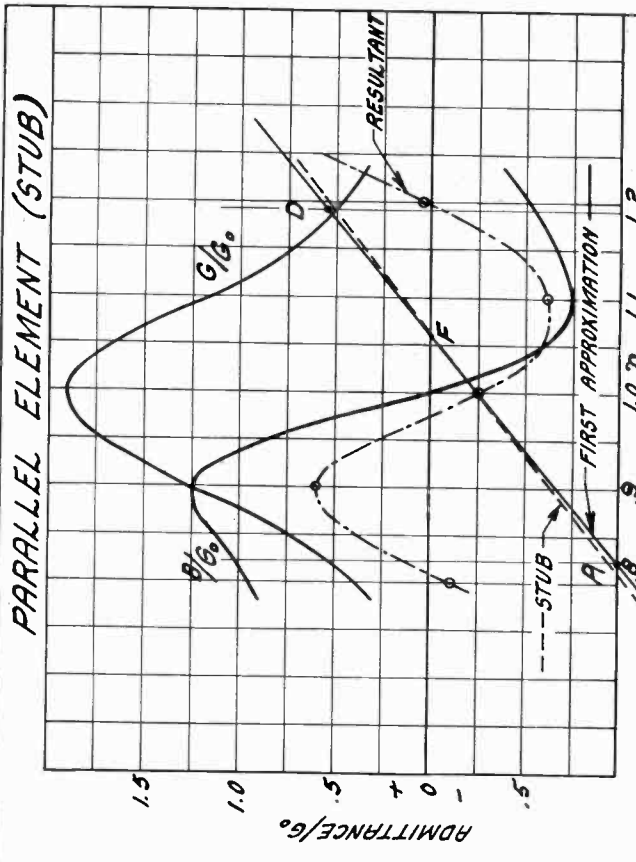

Fig. 39

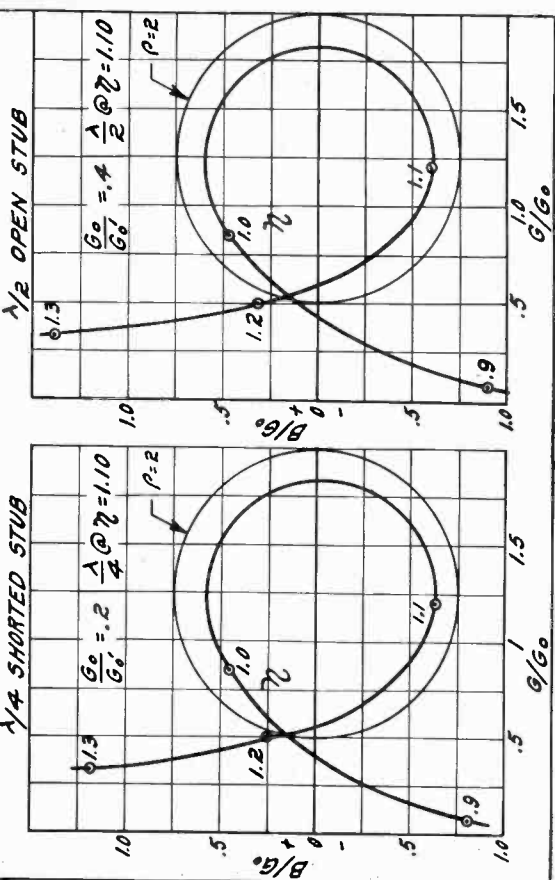

Fig. 42

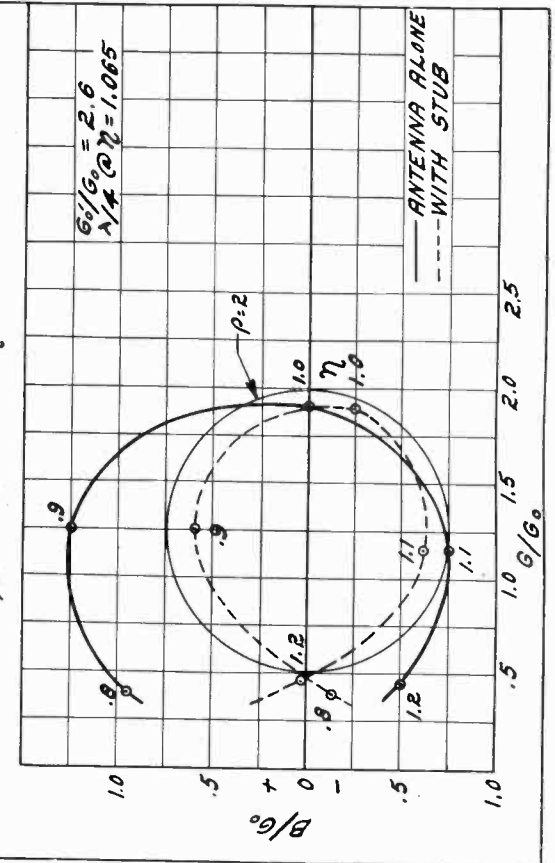

Fig. 38

Fig. 43

Figs. 40-43—Steps in synthesis of a two-element (series-capacitor parallel stub) network used to match a resonant antenna over a range of frequencies.

Figs. 38 and 39—Matching a resonant antenna over a range of frequencies by means of a stub or parallel-resonant circuit.

to an unbalanced line. Since the characteristic impedance of the stubs required to cancel susceptance is rather low, the usual problem of making the isolating stubs of the bazooka of high characteristic impedance is eliminated. The ideal antenna curve for this type of matching is one that has a broad admittance characteristic and a resonant conductance component slightly less than 2.

C. Two-Element Networks

1. Series Capacitor—Parallel Circuit (Stub)

(a) *General Use:* Figs. 40, 41, and 42 give the steps in synthesizing a series capacitor, parallel-circuit (stub) matching network. This particular antenna has a low resonant resistance so that it does not pass through any portion of the $\rho=2$ circle. By adding a capacitor, the curve is, of course, moved down toward the $\rho=2$ circle in the impedance diagram and rotated counterclockwise in the admittance diagram. The added capacitor is of such value that the curve is made to cut the real axis in the admittance diagram just inside the $\rho=2$ circle, and no value of conductive component is greater than 2. This sets up the curve for the addition of the parallel stub which, in turn, is chosen in the usual manner. The bandwidth here has been increased from 0 to some 24 per cent.

There is one rather objectional fact in Fig. 42, and that is the value of the characteristic impedance of the stub that is needed ($G_0=0.2G_0'$; $Z_0'=0.2R_0$). The value of Z_0' is rather small. If R_0 were 50 ohms, Z_0' would be only 10 ohms, a rather difficult line to be made flexible. This low characteristic-impedance problem can be overcome by making use of the electrical length of the cable. The slope of the susceptance curve of a transmission line is a function of both the characteristic impedance and electrical length. Instead of using a quarter-wave short-circuited line as the parallel circuit, a half-wave open-circuited line could be used just as well. Now by doubling the resonant electrical length, the effective characteristic impedance has also been doubled. This is illustrated in Fig. 43 where a half-wave open-circuited line of characteristic impedance $Z_0'=0.4R_0$ is used instead of a quarter-wave short-circuited line of characteristic impedance $Z_0'=0.2R_0$. It would then follow from the example given that the characteristic impedance of this line would be $0.4R_0$ or 20 ohms, a figure that can be easily realized in practice.

Fig. 44, parts (a) and (b), shows two possible constructions of a series-parallel impedance combination or L-section as seen in (c). The impedance and admittance transformations are given by the indicated equations.

2. Parallel Circuit (Stub)—Quarter-Wave Line

(a) *General Use:* This combination works well with an antenna whose resonant resistance is rather high; or in terms of admittance, whose resonant conductance is low, as can be seen from Figs. 45, 46, 47, and 48. The admittance curve then lies in the left-hand portion of the $\rho=2$ circle in the admittance diagram, as can be seen in Fig. 46. If a parallel circuit or stub be added in the

usual manner, the curve collapses as pictured in Fig. 47. Finally, if a quarter-wave line is attached in series, the curve is moved over into the center of the $\rho=2$ circle as given in Fig. 48. A little systematic trial and error will determine the best combination of stub and line for maximum bandwidth. Here, approximately 46 per cent is achieved by the combination.

Fig. 44, part (d), gives the schematic construction of this stub-tandem line combination along with a circuit diagram (e) and the admittance-transformation equations.

(b) *Bazooka Design:* This two-element-network combination is exactly the one found in the bazooka, so the method presented here is probably the most important from a compact network-design standpoint. A resonant balanced antenna is certain to have a high resonant resistance as compared to the characteristic impedance of an ordinary coaxial feed cable, so that the admittance curve will lie in a favorable portion of the complex plane for matching. The quarter-wave line used is placed, in this case, on the unbalanced side of the bazooka.

3. Parallel Circuit (Stub)—Half-Wave Line

(a) *General Use:* Figs. 49, 50, 51, and 52, give the method of synthesizing this combination. Here, it is desirable that the admittance curve lie in the right-hand portion of the $\rho=2$ circle. The parallel circuit is used to collapse the antenna admittance curve into the $\rho=2$ circle. This sets up the curve for a half-wave line which will then warp the ends of the curve back into the circle making a second tie at the right of the $\rho=2$ circle. As shown, the final bandwidth is well over 50 per cent.

(b) *Bazooka Design:* The physical arrangement for this combination is identical to the preceding stub—quarter-wave line method of matching. The length of line on the unbalanced side of the bazooka is simply increased from a quarter to a half wavelength.

4. Quarter—Quarter-Wave Lines:

This combination provides a very powerful method for matching antiresonant antennas. At first glance, the antenna curve given in Fig. 53 appears to be far from the $\rho=2$ circle. In Fig. 25, where a single quarter-wave line was added to an antiresonant antenna, only a very nominal bandwidth resulted. However, using the set-up idea again and not attempting to match into the $\rho=2$ circle at all with the first line, the addition of the second line gives more than the usual amount of bandwidth from a single line. This is seen in Fig. 54 where the resulting bandwidth is near 70 per cent.

5. Half—Half-Wave Lines:

Figs. 55 and 56 give the two steps used in determining the parameters of this pair of elements. In this case, the antenna curve is not symmetrical with respect to the real axis, so that the resulting curve after the addition of the two lines is an oddly wrapped affair. The scheme used is as follows: The first line ($Z_0' < R_0$) is picked such that the tie is well within the $\rho=2$ circle. Addition of the second line ($Z_0' > R_0$) ties the ends of the curve on the left, leaving the first tie loop just slightly expanded.

Fig. 46

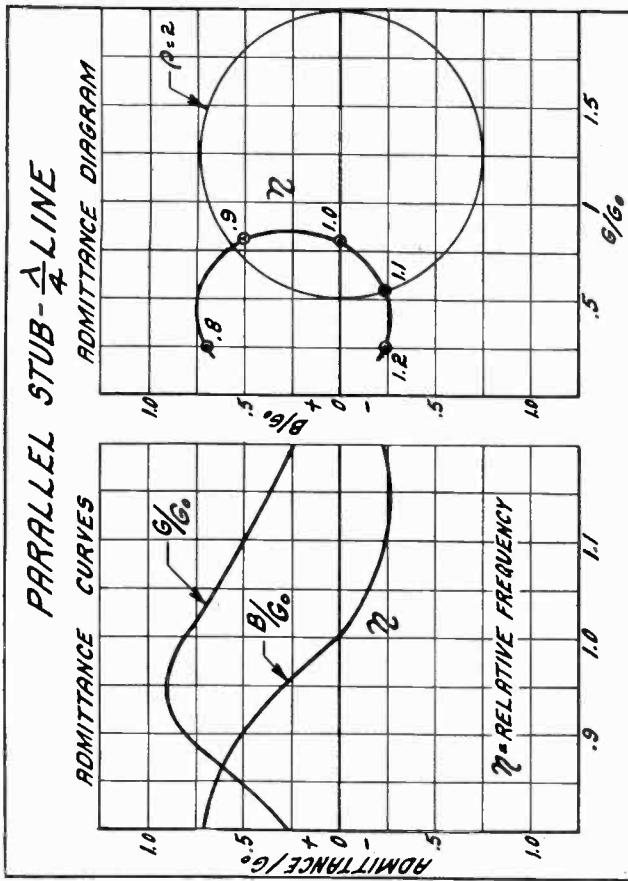

Fig. 45

Fig. 47

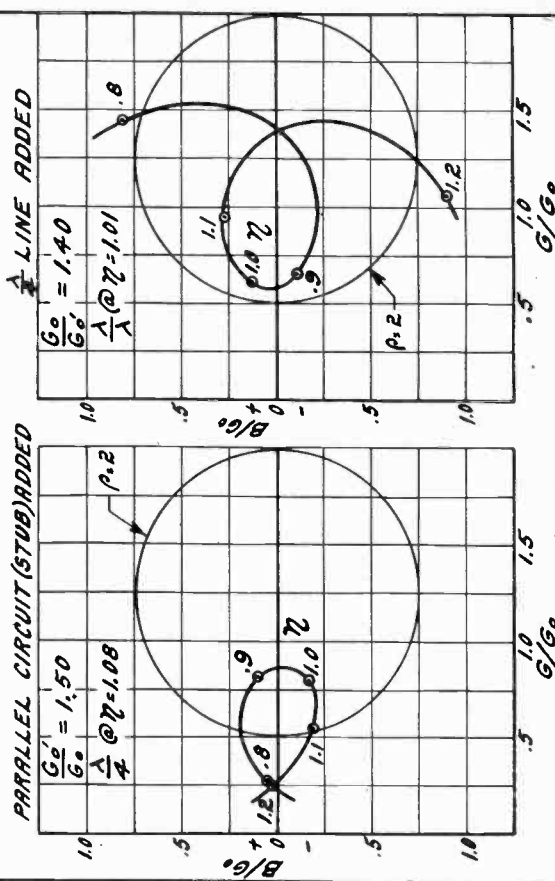
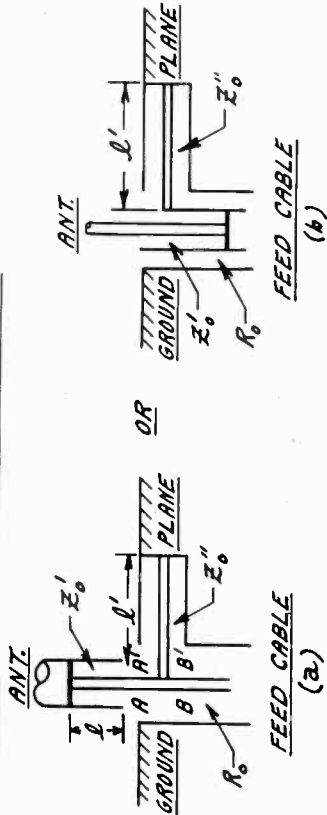

Fig. 48

Fig. 47

Figs. 45-48—Broad-band matching of a resonant antenna by means of a parallel stub—quarter-wave-line network.

A. SERIES - PARALLEL IMPEDANCE



$$Z_{AA'} = Z_A + jZ_0' \tan 2\pi \frac{l}{\lambda} = \frac{1}{Y_{AA'}}$$

$$Y_{BB'} = \frac{1}{Z_{BB'}} = Y_{AA'} - jY_0' \cot 2\pi \frac{l}{\lambda}$$

WHERE $Z_A =$ ANTENNA IMPEDANCE

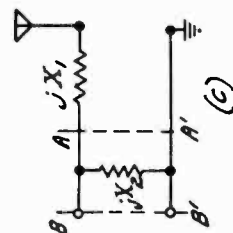

B. PARALLEL IMPEDANCE - SERIES LINE

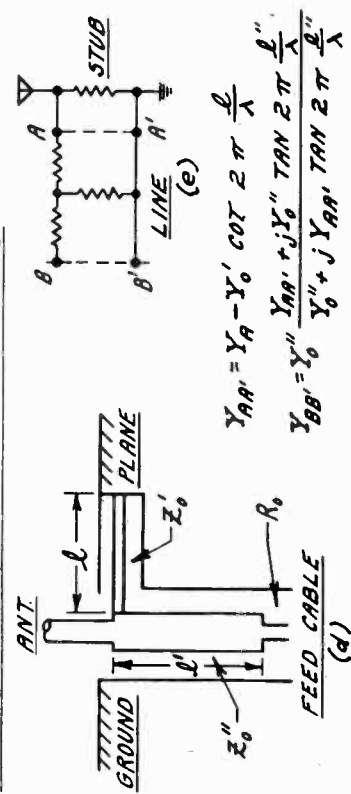

$$Y_{AA'} = Y_A - Y_0' \cot 2\pi \frac{l}{\lambda}$$

$$Y_{BB'} = Y_0'' \frac{Y_{AA'} + jY_0'' \tan 2\pi \frac{l}{\lambda}}{Y_0'' + jY_{AA'} \tan 2\pi \frac{l}{\lambda}}$$

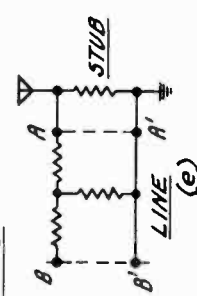

Fig. 44—Possible construction of several two-element networks.

Fig. 49

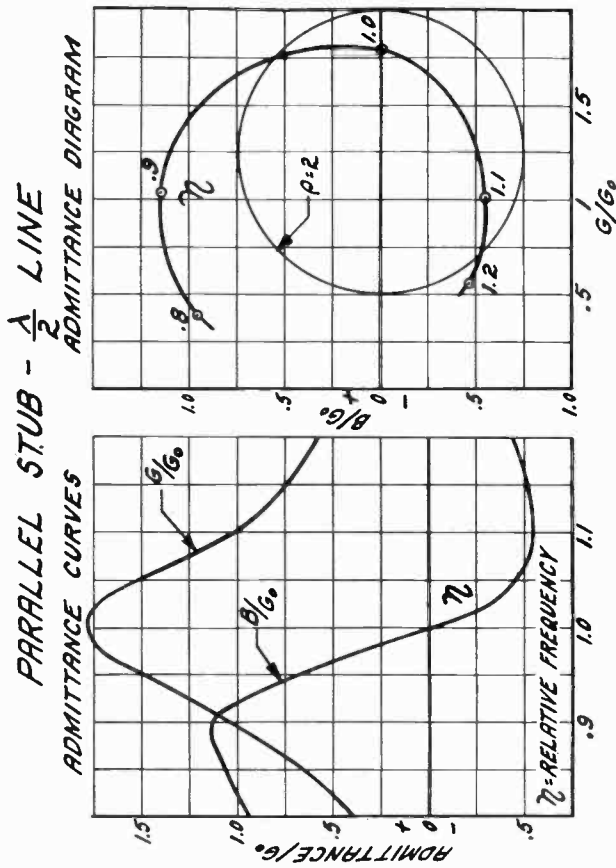

Fig. 53

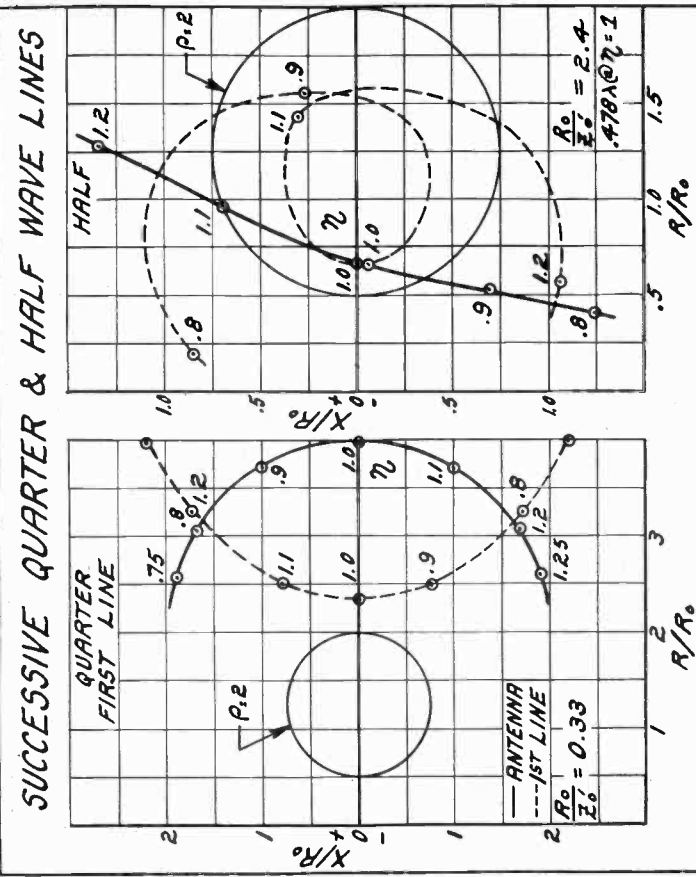

Fig. 55

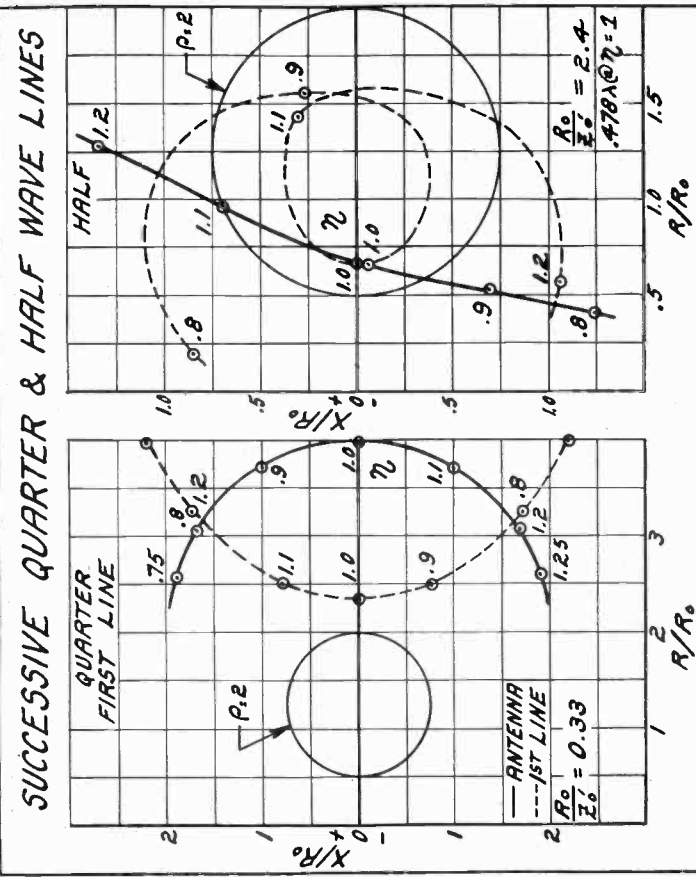
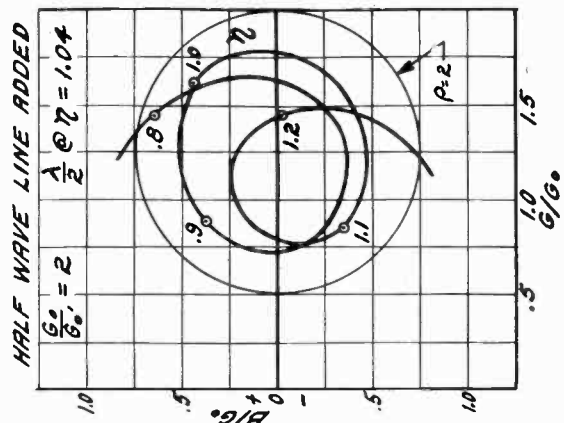
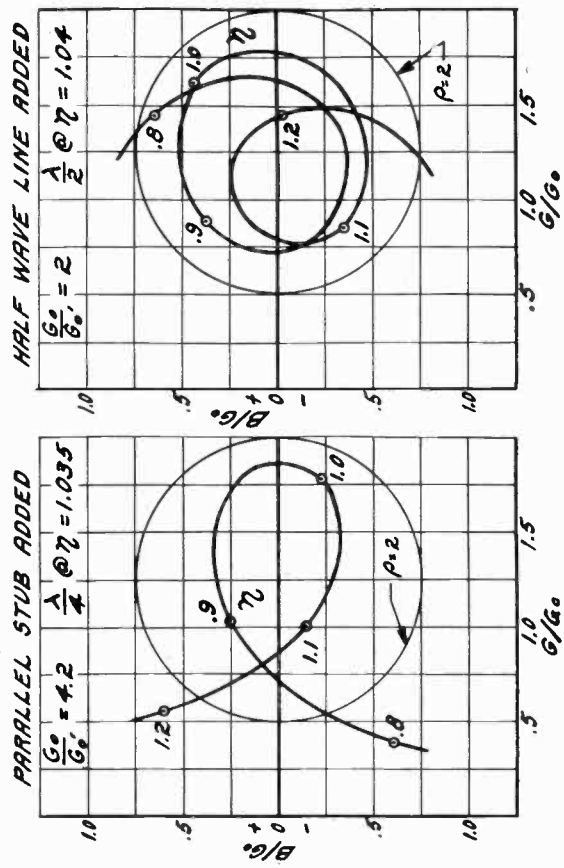

Fig. 49

Fig. 51

Fig. 54

Fig. 56



Figs. 49-52—Parallel stub—half-wave-line combination for matching a resonant antenna to feed cable over a wide range of frequencies.

Figs. 53-56—Matching an antiresonant antenna by means of successive quarter-wave lines, and matching a resonant antenna by means of successive half-wave lines.

2 WIRE "V" ANTENNA
25' x 35' GND. PLANE

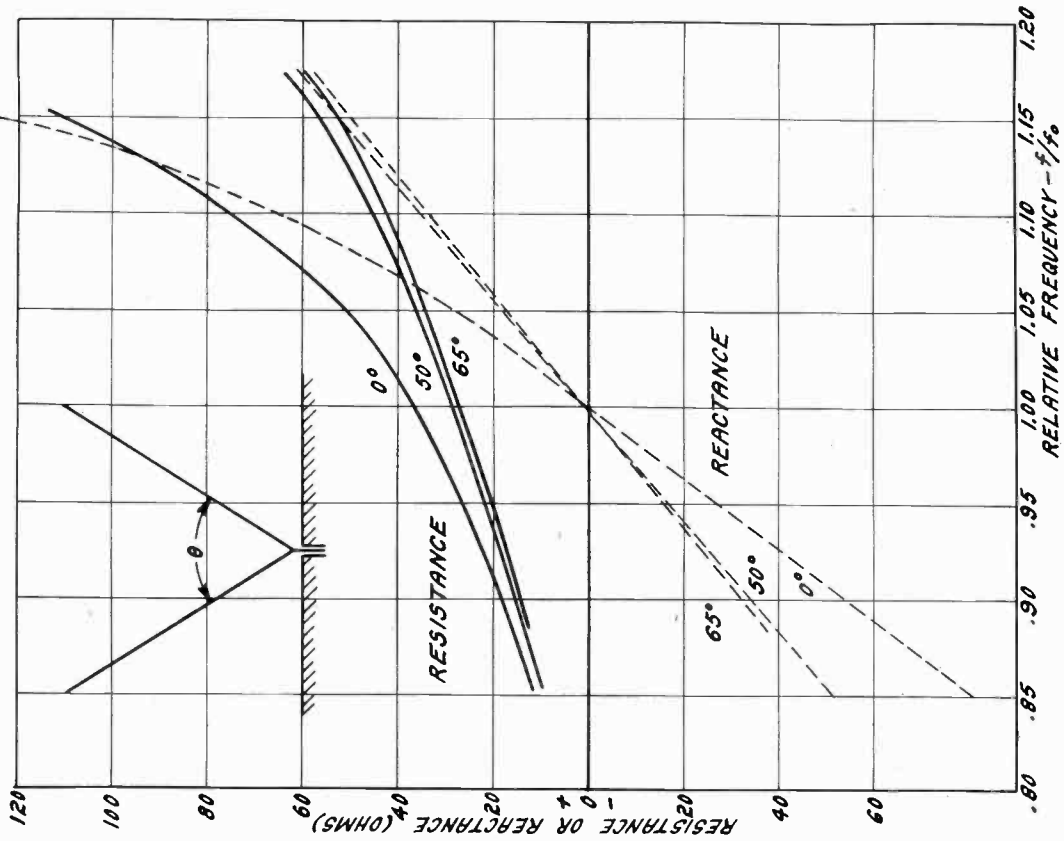

Fig. 61—Impedance of two-wire V antenna.

Fig. 57

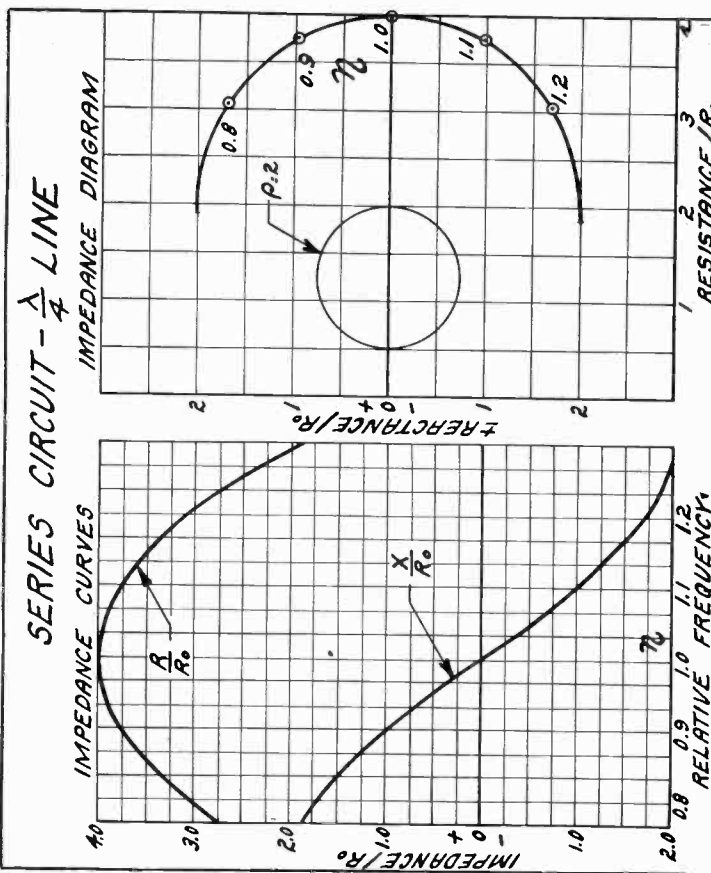

Fig. 58

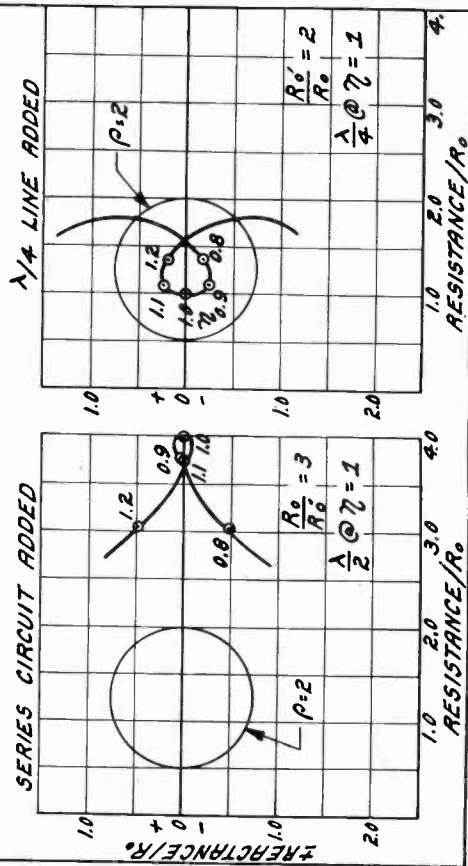

Fig. 59

Fig. 60

Figs. 57-60—Synthesis of a series circuit—quarter-wave-line network for matching an antiresonant antenna.

The method then reduces to one where the curve is alternately tied, first on the right, then on the left, and so on.

6. Series Circuit—Quarter-Wave Line:

As can be seen from Figs. 57, 58, 59, and 60, this network is the impedance analogue of the parallel-circuit quarter-wave line combination. Here the negative reactance slope with respect to frequency allows the antenna reactance to be cancelled with a series circuit, after which the resulting curve is moved into the $\rho = 2$ circle with a quarter-wave line. Since the antenna curve is less sharply resonant around antiresonance, a large resulting bandwidth is achieved.

IV. CONCLUSIONS

The two-element networks presented in this paper allowed a reasonably good antenna to be matched over a bandwidth of 35 per cent to 50 per cent with the mismatch limit not exceeding a standing-wave ratio of 2 to 1 on the given feed cable.

The position of the antenna curve with respect to the $\rho = 2$ circle and the spacing of the frequency points is a more important consideration in matching than the original bandwidth.

While the matching methods in this paper are applied to portions of the antenna curve around resonance and antiresonance, they apply equally well to curves in any position in the complex plane.

It is very desirable in two-element network matching to use the first element of the network to set up the antenna curve for the second element whenever possible.

High impedances (i.e., impedances to the right of the $\rho = 2$ circle in the impedance diagram) are more easily matched over a range of frequencies than low impedances.

Finally, the importance of the four types of graphical representation should be emphasized. They not only suggest the type of element to be added but furnish a very powerful guide in obtaining maximum bandwidth. By studying the effect of single elements graphically, combinations immediately suggest themselves. Perhaps the best method of synthesizing a matching network would be to use the graphical method in selecting the network combination, and then apply an analytical method to obtain the optimum values for the network parameters.

PART III. THE BROAD-BAND FAN ANTENNA

A. S. MEIER

I. INTRODUCTION

The development of a unique type of aircraft antenna, which is only in very limited use, has been selected to illustrate the practical applications of impedance measurement and matching techniques described in Parts I and II.

Measurement problems in the range of frequencies discussed in Part I involve lengths of 10 to 20 meters of

transmission line for determining impedance. Antenna-design problems at these frequencies are subject to similar difficulties when dealing with large physical dimensions and are particularly troublesome when aircraft dimensions become comparable to wavelength. The problem of broad-band antennas in this range becomes even more involved since a structure of large cross section is usually required to secure the necessary bandwidth, and any sizable antenna structure immediately creates a serious aerodynamic problem.

The term "broad-band" used with reference to antennas under discussion refers to bandwidths of 25 to 50 per cent, a 2:1 range in frequency being equivalent to 100 per cent bandwidth. Anyone dealing with high-frequency antennas would probably designate bandwidths of this magnitude as relatively narrow band, since high-frequency antennas having several times this bandwidth can be conveniently constructed with reasonably small physical dimensions. However, at the frequency range under consideration, such bandwidths are unrealizable in practice because of the large dimensions involved.

The broad-band development problem under consideration requires an antenna system for transmitting purposes, the specifications precluding the use of mechanical tuning devices and requiring an impedance match to a 50-ohm feed line within a 2:1 standing-wave ratio. This problem, based only on the desired electrical characteristics, appears to be straight-forward from an engineering standpoint. The conventional antenna meeting these electrical requirements would be one having a large cross section such as a cylinder, cone, or ellipse.⁵ Examination of the aerodynamic characteristics of such structures shows that the excessive air drag proves them impractical, and even a streamlined airfoil section of the required dimensions would result in an air drag of 75 to 100 pounds at modern aircraft speeds. The problem then becomes one of selecting an antenna with the necessary bandwidth qualities without unfavorable aerodynamic characteristics. At first glance, the electrical and aerodynamic specifications do not seem compatible, but a solution is presented which meets both requirements to a satisfactory degree.

Since structures of large dimensions are involved, the first step in simplifying the antenna structure is one of devising impedance-matching techniques to expand the useful bandwidth. The matching techniques outlined in Part II were devised for this purpose and prove extremely useful at the frequency range under consideration, where it is possible to improve the initial bandwidth by a factor of 2 or 3. The second step in securing the necessary bandwidth then becomes one of finding a suitable structure easily adapted to existing aircraft which has sufficiently broad resonance characteristics to meet bandwidth requirements when used with a matching network.

⁵ F. E. Terman, "Radio Engineers' Handbook," McGraw-Hill Book Company, New York 18, N. Y., 1943, paragraph 36, p. 863.

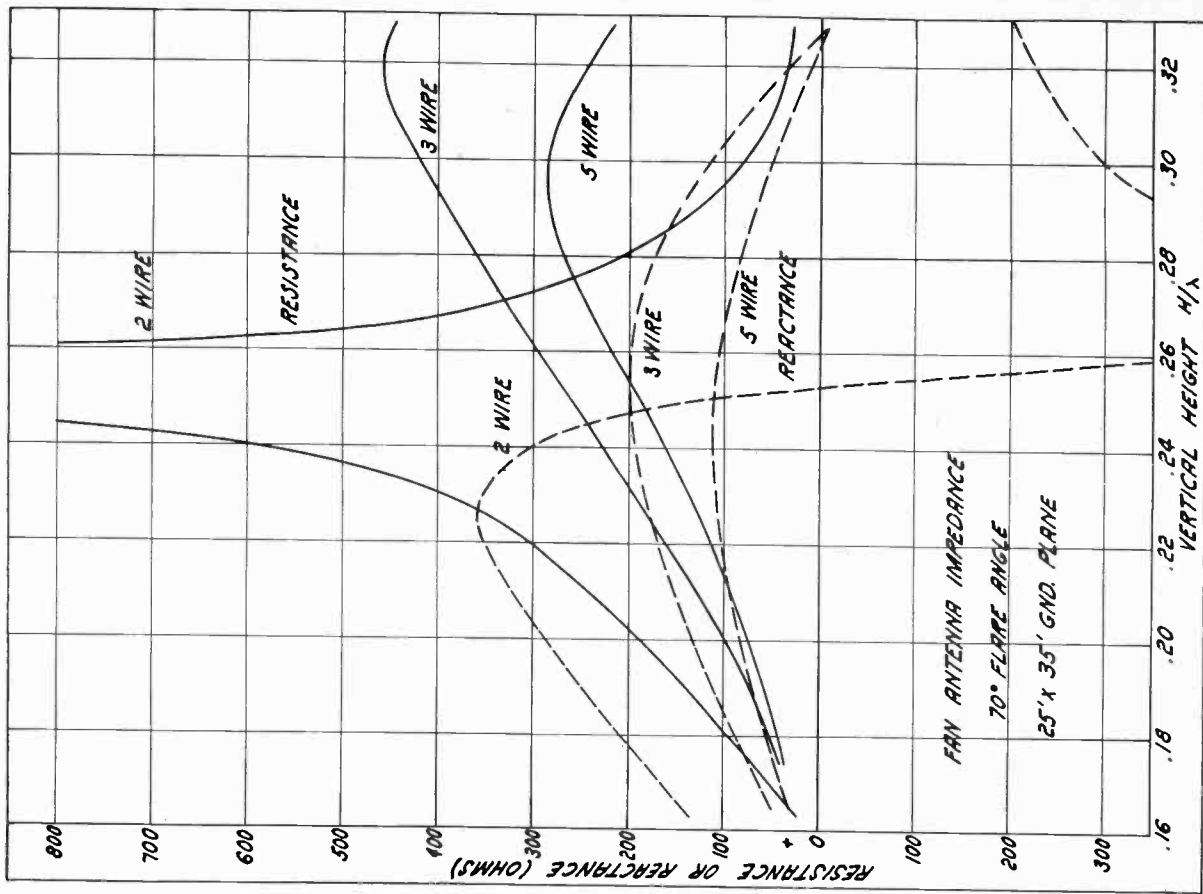

Fig. 63—Impedance of multiwire fan antenna.

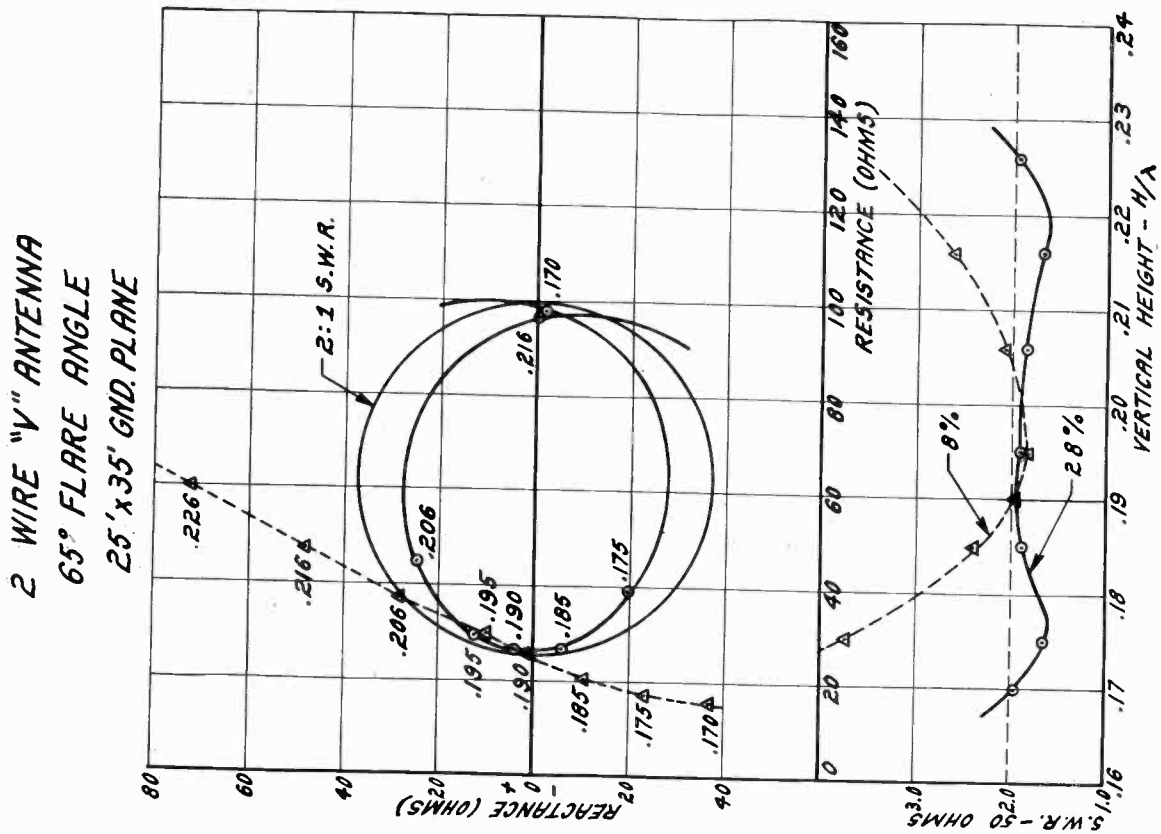

Fig. 62—Matched impedance of two-wire V antenna.

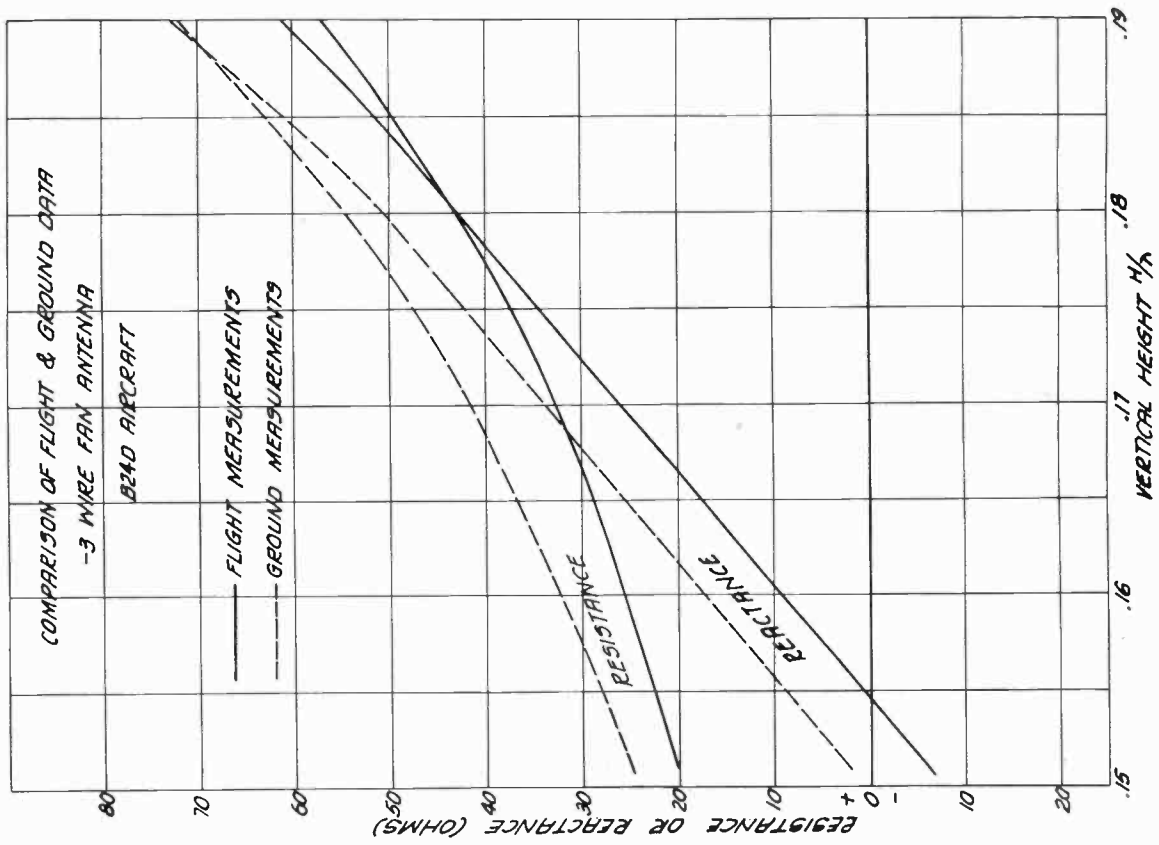

Fig. 67—Ground and flight impedance measurements—three-wire fan antenna.

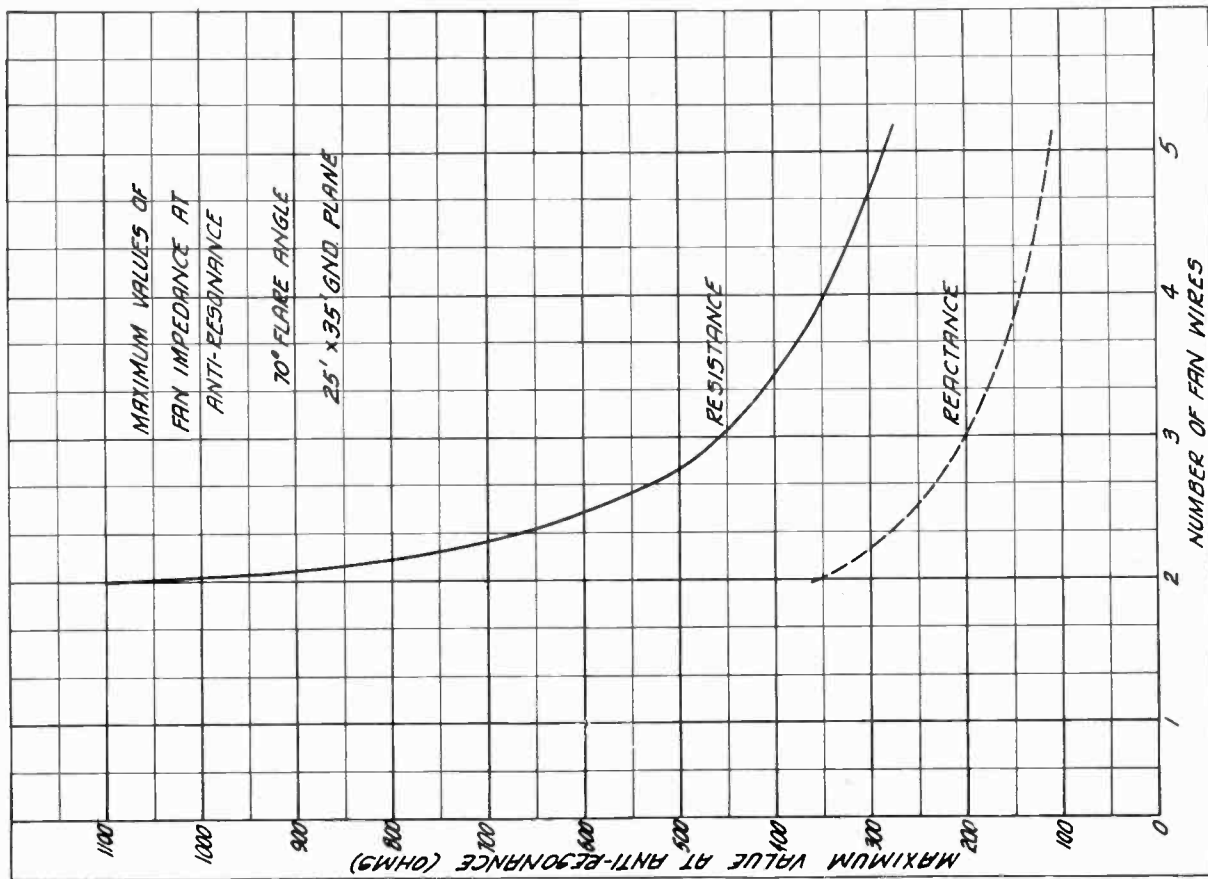

Fig. 64—Maximum impedance value of fan antennas near antiresonance.

II. V ANTENNA

A single wire and an appropriate matching network would be the most desirable antenna system from an aerodynamic standpoint, but unfortunately the impedance characteristics fall short of meeting bandwidth specifications, the application of matching techniques resulting in only 10 to 15 per cent bandwidth. A considerably greater bandwidth was found possible without an appreciable increase in air drag by use of the simple expedient of two wires instead of one in order to broaden the resonance characteristics.

Fig. 61 shows the impedance characteristics of the V antenna plotted on a relative frequency basis. Resistance and reactance are shown for flare angles of 0 degrees, 50 degrees, and 65 degrees for a symmetrical antenna normal to a flat ground plane. A double wire represented by $\theta = 0$ degrees is quite sharp in its resonant properties, and it is evident that considerable improvement is obtained by the use of two wires flared at an appropriate angle. The flare angle is not critical and there is a gradual transition as the angle is increased, with relatively little gain at the larger angles.

In Fig. 62, the dotted lines indicate the basic impedance of a V antenna consisting of two wires fed in phase and flared at an angle of 65 degrees. Application of a suitable matching network shown by the solid curves results in a final bandwidth of 28 per cent as compared to an initial bandwidth of only 8 per cent. Matching is accomplished by a parallel stub. In this case, the resonant resistance is ideal for the stub application and a substantial increase in useful bandwidth is possible using only a single element.

This type of antenna can be conveniently mounted on an aircraft, with the matching section located at the feed point inside the fuselage, and the air drag is not appreciably greater than that of a single wire which is ordinarily used for communication purposes. Requirements for modern high-speed aircraft can be met by this design for moderate bandwidths.

III. FAN ANTENNA

Greater bandwidths than that obtained from a two-wire system were required in several applications of special equipment for bombardment aircraft. A two-wire antenna, being a considerable improvement over a single wire, led to the impedance investigation of additional wires. Fig. 63 shows the characteristics of the fan type of antenna consisting of two to five wires. The two-wire fan has a very steep resonance curve, and by adding a third wire the resistance at antiresonance is reduced from approximately 1200 to 500 ohms, with a corresponding improvement in reactance. It will be noticed that further addition of wires results in a greater improvement, but the net gain per wire falls off quite rapidly as the number of wires is increased. To improve upon a five-wire antenna, several more wires must be added to improve substantially the characteristics shown.

Fig. 64, derived from the previous figure, shows the maximum resistance and reactance through antiresonance as a convenient yardstick of the bandwidth function, which shows that the gain falls off rapidly as the number of wires is increased. Extrapolating on the curve will approximate the relative improvement over the single wire, and almost as great an improvement results in going from a 2- to a 3-wire antenna. For all practical purposes it is not necessary to exceed 3 or 4 wires to meet any reasonable requirements, and relatively little gain is obtained at the expense of further complicating the antenna structure.

The fan antenna finally evolved for bomber-aircraft installation is shown in Fig. 65 and consists of three

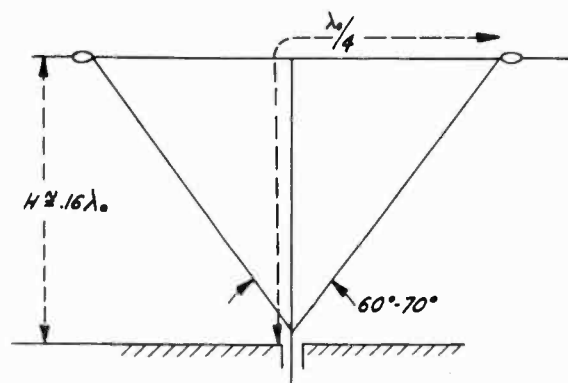

Fig. 65—Prototype three-wire fan antenna showing approximate dimensions.

radial wires supported by two insulators terminating a supporting cross wire. By fanning the wires, a reduction in vertical dimensions is attained, and control of impedance and pattern may be had by suitable orientation of the antenna on the aircraft. It will be noted that the height of the antenna is only approximately 16 per cent of the wavelength at the resonant frequency.

A typical fan installation is shown in Figs. 66A and 66B. Wire and insulators are standard Air Corps stock items which greatly simplify both installation and maintenance problems. The antenna is supported between the fuselage and vertical stabilizer, and in this particular application the antenna is inverted to improve the downward pattern.

Fig. 67 indicates ground and flight measurements of the antenna shown in the photograph. It is rather interesting to note the effect of the presence of the ground on the impedance characteristics which result in a uniform shift of frequency. Because of this correlation between ground and flight data, it was possible to make most of the initial adjustments of the antenna on the ground and only final checks were necessary in flight.

Fig. 68 indicates the impedance of the 3-wire fan antenna shown in Fig. 67. The initial curve, shown by the dotted lines, results in 10 per cent bandwidth. By addition of matching section the bandwidth is expanded to 32 per cent. Offhand, this does not seem to be much of an improvement over the results obtained from the two-

4 WIRE FAN ANTENNA
70° FLARE ANGLE
BITG AIRCRAFT

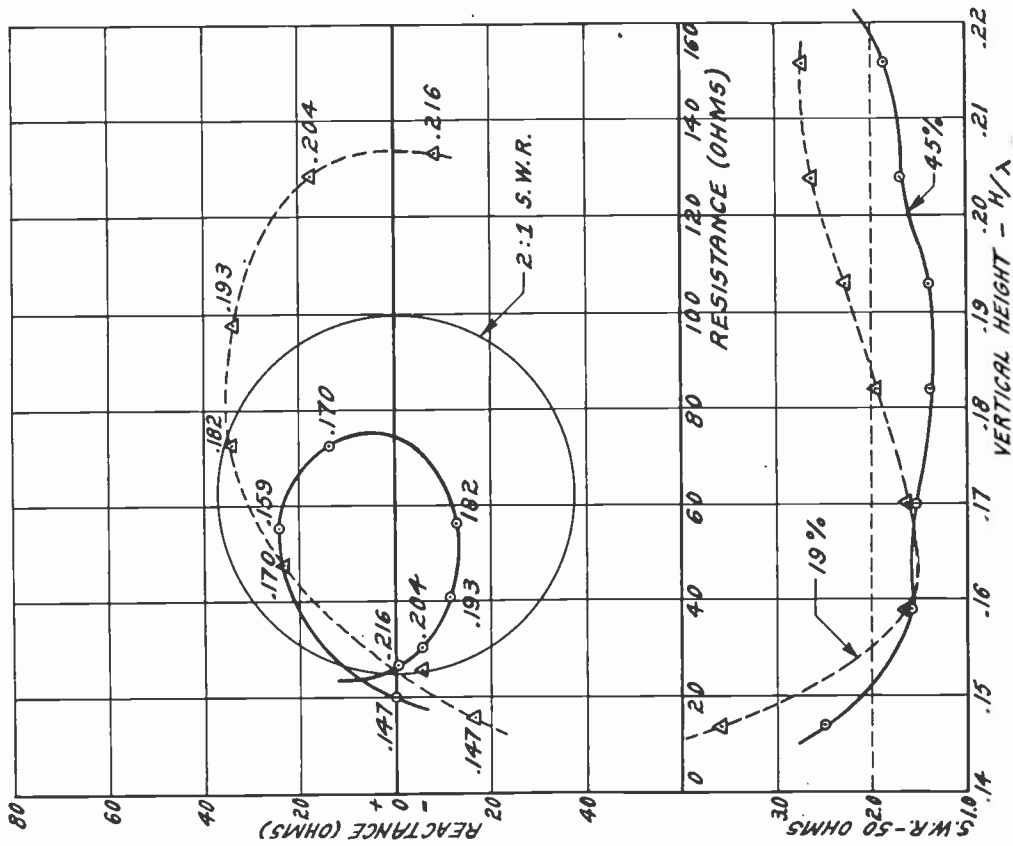

Fig. 69—Matched impedance of four-wire fan antenna.

3 WIRE FAN ANTENNA
65° FLARE ANGLE
B24D AIRCRAFT

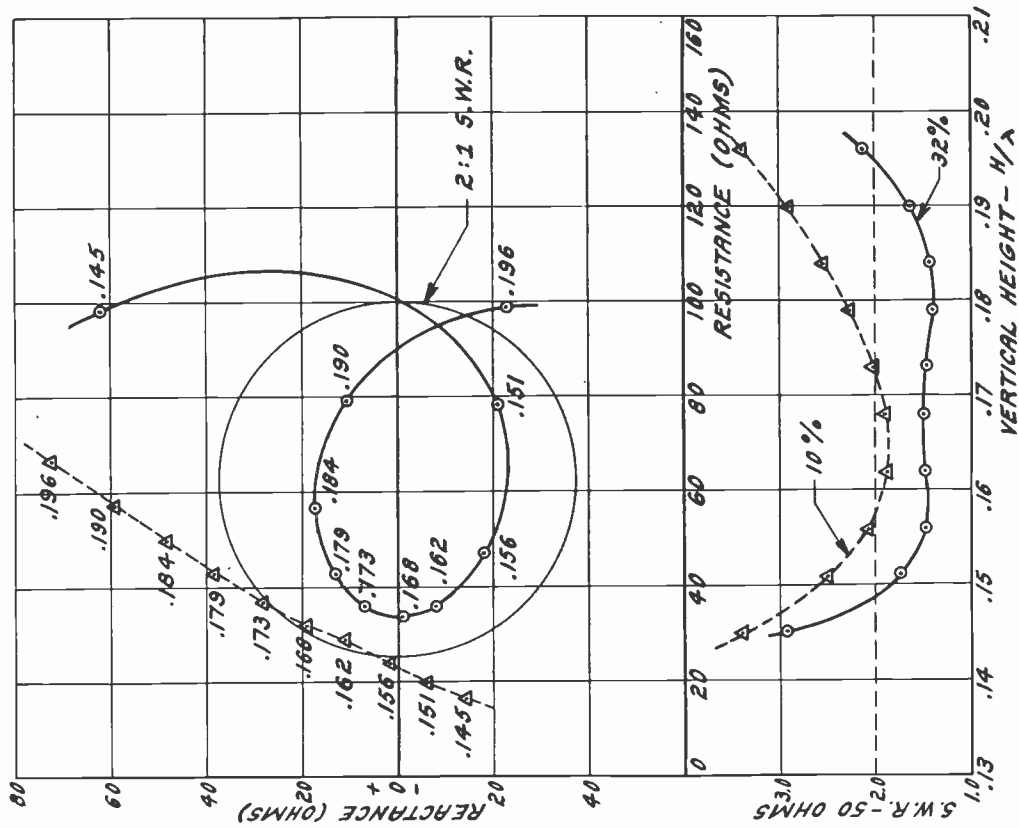

Fig. 68—Matched impedance of three-wire fan antenna.

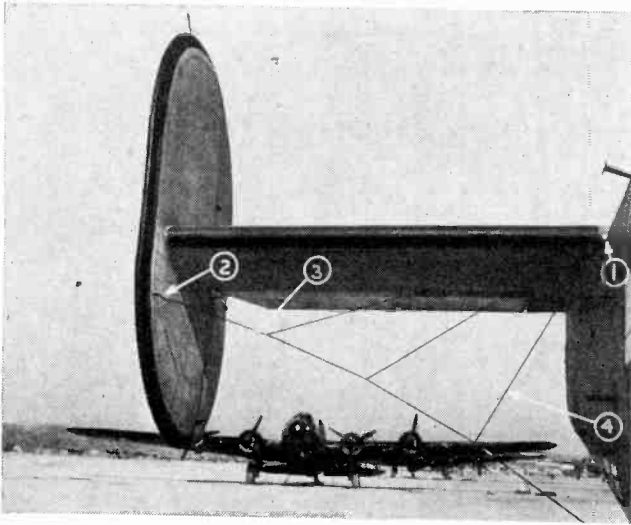

Fig. 66A—Installation of three-wire fan antenna. (1) insulator IN-84 lead-in, (2) spring tension unit, (3) insulator IN-88, and (4) wire W-106-A.

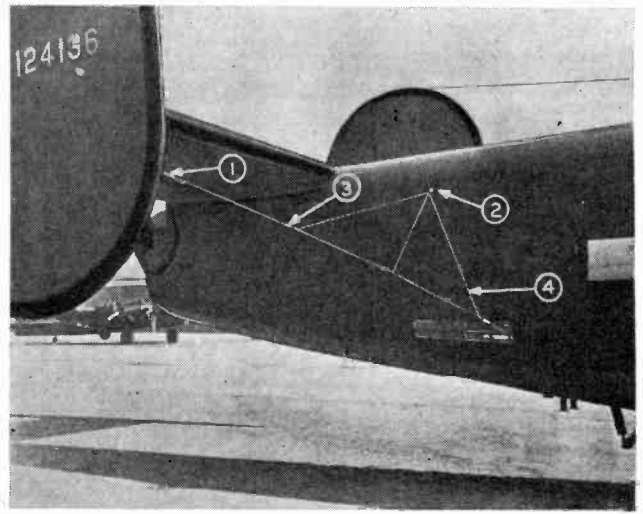

Fig. 66B—Another installation of three-wire fan antenna. (1) spring tension unit, (2) insulator IN-84 lead-in, (3) insulator IN-88, and (4) wire W-106-A.

wire V antenna, in which a 28 per cent band was realized. However, upon inspection of the standing-wave-ratio curve it is apparent that a much more favorable over-all standing-wave ratio is obtained in the case of the fan, and a 40 per cent bandwidth could have been easily realized if comparable standing-wave ratio standards were used. In this case a two-element matching network is used, a series capacitor to position the impedance curve with respect to the 2:1 standing-wave-ratio circle, and a parallel stub to effect a tie for optimum bandwidth.

Fig. 69 shows the antenna impedance of a 4-wire fan on a B-17G aircraft. A substantial bandwidth is obtained in expanding the basic band of 19 per cent to 45 per cent by use of matching techniques. The matching network used consists of three elements, a series capacitor, parallel stub, and series quarter-wave line. In this particular example, the location of the antenna materially improved the antenna impedance over that normally expected from flat ground-plane measurements. The shape of the fuselage and other aircraft structures influences the impedance to a considerable extent, and very careful consideration has to be given to the selection of a suitable mounting location, both in respect to pattern as well as impedance. In most instances of multiwire antennas, any great improvement over flat ground-plane characteristics is usually the exception rather than the rule. In this case, a bandwidth of more than 50 per cent could have been realized by extending the ends of the band at the expense of the center without exceeding a 2:1 standing-wave ratio over the band.

IV. CONCLUSIONS

It should be realized that the types of antenna systems discussed are not universally used on aircraft, es-

pecially where very great bandwidths are concerned. This development merely represents a special problem which required a workable solution, easily adapted to existing aircraft. At relatively low frequencies, it was shown that matching techniques play a very conspicuous part in improving the impedance characteristics of the antenna, permitting a considerable simplification in the fundamental antenna structure. If no attempt were made to compensate for the frequency variation of impedance by means of an auxiliary matching network, and if only the basic antenna were relied upon for acceptable impedance characteristics, a much larger and more cumbersome antenna structure would result, which would be unacceptable for use on modern aircraft.

The same general techniques of measurement, matching, and antenna design are not necessarily limited in frequency range or to aircraft applications, and are quite applicable in other ranges and applications not specifically discussed. The analysis and methods presented are relatively simple and straightforward, and may be of considerable use in solving problems involving many types of broad-band antenna systems.

ACKNOWLEDGMENT

The authors wish to make grateful acknowledgment of the assistance of the members of the Antenna Branch of Special Projects Laboratory in the preparation of this paper. In particular, they wish to acknowledge the contribution of Mr. Ming S. Wong to the early development of the coiled-line impedance-measuring technique.

To Colonel G. L. Haller and members of the administrative staff of the Special Projects Laboratory, and to Colonel W. G. Eaton of Aircraft Radio Laboratories, acknowledgment is made for much encouragement and assistance in bringing this work to publication.

Cathode-Coupled Wide-Band Amplifiers*

G. C. SZIKLAI†, SENIOR MEMBER, I.R.E., AND A. C. SCHROEDER†, ASSOCIATE, I.R.E.

Summary—A general analysis indicates that, in wide-band amplifiers, stable operation is possible with triodes in circuits using the cathode as a signal terminal. The amplification, however, is approximately equal only to the square root of that available with grounded-cathode amplifier, and therefore twice as many tube units are required to obtain the same amplification. In certain applications, however, the utility of such circuits outweighs the loss of gain.

A simple radio-frequency amplifier was designed for television receivers, using a cathode-input circuit. By combining a cathode-output and a cathode-input stage using one single twin-triode tube, a circuit was devised which compares favorably with pentode stages with respect to gain, stability, and economy, while it has far superior noise characteristics. The new circuit, called the "cathode-coupled twin-triode" amplifier, provides greater flexibility than conventional amplifier circuits, and can be used for radio-frequency, intermediate-frequency, video, converter, or detector services. Since the same tube type can also be used for synchronizing and deflection circuits, the number of tube types can be materially reduced, and greater standardization with further economical advantages may be obtained. An interesting application of the new circuit is a novel bidirectional amplifier.

I. INTRODUCTION

FOR APPROXIMATELY two decades, screen-grid tubes were used almost exclusively for amplification of high-frequency signals. The screen grid acting as a shield reduced the effect of the output circuit on the signal circuit, and provided a high-impedance output. When, with the advent of the video art, in the case of extremely wide-band amplifiers, the external circuits had lower impedances, the advantage of the high plate impedance became less significant. In the particular case of the cathode-output (cathode-follower) circuit, for instance, multigrid tubes were used as triodes purely for the reason that they had higher transconductance than the commercially available triodes.

As the operating frequencies of radio communication increased, the transit-time effect became more and more significant. In order to reduce the effect, the spacing of the tube electrodes was reduced, and it became increasingly difficult to align several grids in extremely close proximity. Thus, in lieu of the screen grid, the grid was used as a shield between the input and output, and in certain cases the cathode-input (grounded-grid or inverted) amplifiers provided superior results in performance and economy. As engineering knowledge about noise sources expanded, the multigrid tubes were avoided in stages where the signal was small.

It is the purpose of this report to give a comparative analysis of vacuum-tube circuits using multigrid and triode tubes in wide-band circuits. In the case of the triodes, circuits using the cathode as a signal electrode are emphasized, and a new cathode-coupled circuit is

introduced. This circuit surpasses the advantages of pentode circuits with respect to economy and stability, and possibly permits a broader tube-standardization program.

II. DEFINITIONS

As it appeared above, the nomenclature applied to the various amplifier circuits is not too well standardized. As compared with the conventional amplifier, in which the cathode is substantially grounded with respect to high-frequency current, two other configurations are possible when the cathode is not grounded. In the first, the cathode serves as output terminal, and is called the cathode follower, or grounded-plate amplifier. The second uses the cathode as the input terminal, and is called the inverted, or grounded-grid amplifier. In the present paper we propose to regard the cathode as the reference point, since it is the primary electrode of a vacuum tube (the source of electrons), and we shall use the terms of grounded-cathode (Fig. 1), cathode-output (Fig. 2), and cathode-input circuits (Fig. 3). For the circuit shown in Fig. 4, we adapted the term of "cathode-coupled twin-triode" stage. All circuits in which the cathode is not at ground, but serves as an input or output terminal, will be designated as cathode-coupled circuits against the conventional grounded-cathode amplifier.

III. WIDE-BAND GROUNDED-CATHODE AMPLIFIERS

The basic circuit, and its equivalent network, are shown in Fig. 1. This familiar circuit is designed such that, at frequencies of $f_0 \pm \Delta f/2$, the amplification is 0.707 times that of the amplification at f_0 , where f_0 is the resonant frequency and Δf is the bandwidth. If this stage is preceded by a similar stage, the amplification is then $A_{gc} = g_m / (\Delta\omega \sqrt{C_1 C_0})$ (see Appendix I (7)) where g_m is the transconductance, $\Delta\omega = 2\pi\Delta f$, C_1 is the input, and C_0 is the output capacitance. The grid-to-plate capacitance and other sources of feedback are assumed to be negligible. Since the last assumption is generally untrue, in order to reduce the grid-to-plate capacitance a screen is placed between the grid and the plate.¹ In this and the following equations, the value of $\Delta\omega = 2\pi\Delta f$ may be taken around any center frequency, and, accordingly, they are equally valid for video, intermediate-frequency, or radio-frequency amplifiers (see Appendix II). The formula given above is for a simple tuned circuit, as shown in Fig. 1. With a coupling circuit of more complex nature, greater gains may be obtained, as was shown by Wheeler.² For purposes of simple comparison, only the simple coupling circuit is considered here, but

* Decimal classification: R363.1. Original manuscript received by the Institute April 3, 1945; revised manuscript received, June 7, 1945.

† Radio Corporation of America, RCA Laboratories, Princeton, N. J.

¹ W. Shottky, United States Patent No. 1,537,708.

² H. A. Wheeler, "Wide-band amplifiers for television," Proc. I.R.E., vol. 27, pp. 429-438; July, 1939.

the same factors of improvement apply in all the cases when more complex coupling circuits are used.

IV. WIDE-BAND CATHODE-OUTPUT AMPLIFIERS

The basic circuit and its equivalent network are shown in Fig. 2. This circuit is shown in a form to work into a high-impedance circuit, such as the input of

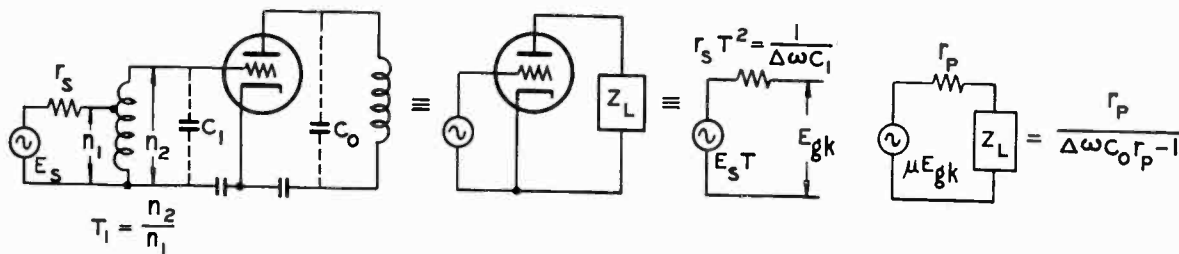

Fig. 1—Grounded-cathode amplifier circuit and equivalent network.

another similar stage. A circuit of this type was proposed in 1925 in order to reduce feedback in radio-frequency amplifiers.³ A more important application of this circuit became popular in recent years when it was applied to output loads of low impedance, such as transmission lines.⁴ This latter type of operation of this circuit has been frequently analyzed in the literature.^{5,6} It was shown that the input capacitance of the stage is reduced by a factor of $(1 - \text{amplification from grid to cathode})$ providing greater permissible impedance for the previous circuit. In general, the circuit behaves as if the tube

ing, although disclosed⁷ as early as 1927, became popular only during the last few years.⁸⁻¹⁰ If the stage operates from a source of matching impedance, as is the case when the source is predominantly resistive, the amplification is $A_{ei} = (1/2)\sqrt{\mu/[\Delta\omega C_0 r_p (\Delta\omega C_0 r_p - 1)]}$ (see Appendix I (23)). It may be observed again that the amplification is less than the square root of the amplifi-

cation of the grounded-cathode triode amplifier, thus requiring twice as many stages for the same over-all gain. When the signal sources is predominantly reactive, the expression changes to $A_{ei} = \sqrt{g_m/(\Delta\omega C_0)}$ (see Appendix I (26)).

While this amplifier has lower gain than the grounded-cathode amplifier, it finds its greatest utility as a radio-frequency stage between the antenna and the converter stage because of the fact that it is stable without the need of a screen grid or neutralization. This type of amplifier generates considerably lower noise currents

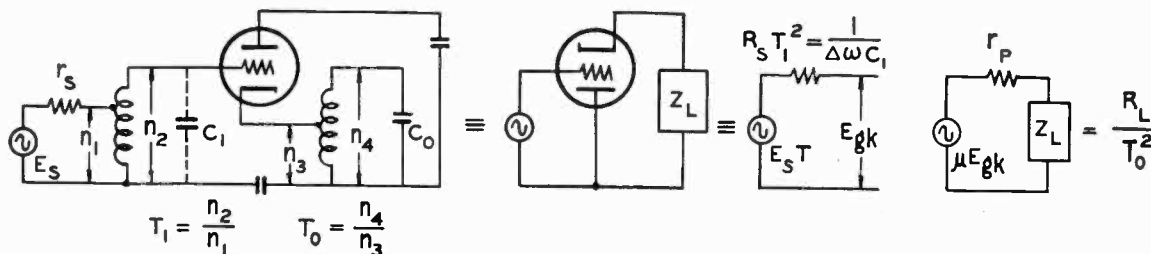

Fig. 2—Cathode-output amplifier and equivalent network.

had an amplification factor and plate resistance divided by $(\mu + 1)$. For our particular case the amplification is $A_{co} = \sqrt{g_m/(\Delta\omega C_1)}$ (see Appendix I (16)). This is (provided the stage is preceded by a similar stage) the square root of the amplification obtainable from a pentode with the same g_m and capacitances, thus indicating that two cathode-output stages in cascade are required to provide gain in the same order as that of one pentode stage.

V. WIDE-BAND CATHODE-INPUT AMPLIFIERS

The basic circuit and the equivalent network are shown in Fig. 3. In this circuit, the input and output circuits are shielded by the grid. This method of shield-

than a pentode would in the same service. It provides great improvement, for instance, in receiving television signals. Since the impedance appearing across the tube input for high g_m is low, $Z_1 = [r_p + (1/\Delta\omega C_0)]/(1 + \mu)$ the tuned circuit provides an adequately flat response over the whole television band, and therefore no tuning means is required for the antenna circuit for a six-channel receiver.

The circuit diagram of a simple cathode-input radio-frequency amplifier to be used with television receivers is shown in Fig. 5. Fig. 6 shows such an amplifier mounted in an RCA TRK-120 television receiver. Fig. 7

⁷ E. F. Alexanderson, United States Patent No. 1,896,534.

⁸ C. E. Strong, "The inverted amplifier," *Electronics*, vol. 13, pp. 14-56; July, 1940.

⁹ M. Dishal, "Theoretical gain and signal-to-noise ratio of the grounded-grid amplifier at ultra-high frequencies," *Proc. I.R.E.*, vol. 32, pp. 276-284; May, 1944.

¹⁰ M. C. Jones, "Grounded-grid radio-frequency voltage amplifiers," *Proc. I.R.E.*, vol. 32, pp. 423-429; July, 1944.

³ A. Winther, United States Patent No. 1,700,393.

⁴ A. D. Blumlein, United States Patent No. 2,178,985.

⁵ A. Preisman, "Some notes on video amplifier design," *RCA Rev.*, vol. 2, pp. 430-432; April, 1938.

⁶ A. A. Barco, "An iconoscope preamplifier," *RCA Rev.*, vol. 4, pp. 102-107; July, 1939.

shows the inside of the auxiliary chassis. This amplifier affords an additional amplification of 2 to 4, and a significant improvement of the signal-to-noise ratio. The heterodyne oscillator signal is substantially reduced in the antenna, thereby reducing radio-frequency interference between two receivers. Several of these simple

ground from the grid toward the cathode on the secondary of the input transformer, shown in Fig. 8. The limiting factor in this case will be found in the stability since the grid is a less effective shield, but with proper tapping of the coil, stable operation may be obtained. The circuit will behave as if the amplification factor of

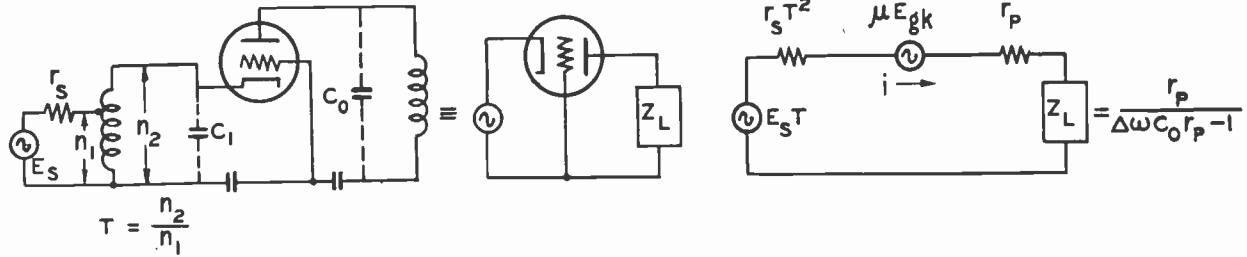

Fig. 3—Cathode-input amplifier and equivalent network.

amplifiers were made and attached to receivers in the Princeton area (approximately 45 miles from New York and Philadelphia), and considerable improvements were obtained in every case.

Since the antenna circuit feeding into the cathode is untuned, some thought has been given to the question of cross modulation in the cathode-input radio-frequency amplifier due to two strong carrier signals. Cross modulation is a function of the strength of the signals and the degree of curvature of the tube characteristic. In this amplifier, the magnitude of signal voltages ap-

the tube were increased by the transformer ratio of the cathode part of the coil to the total secondary.

These circuits are particularly suitable for antenna-plex systems as a consequence of the inherently good noise and wide-band characteristics.

VI. WIDE-BAND CATHODE-COUPLED AMPLIFIERS

As has been shown, the cathode-output circuit provides a comparatively high input-impedance circuit, with the additional advantage that this impedance is not changed materially by external potentials, such as

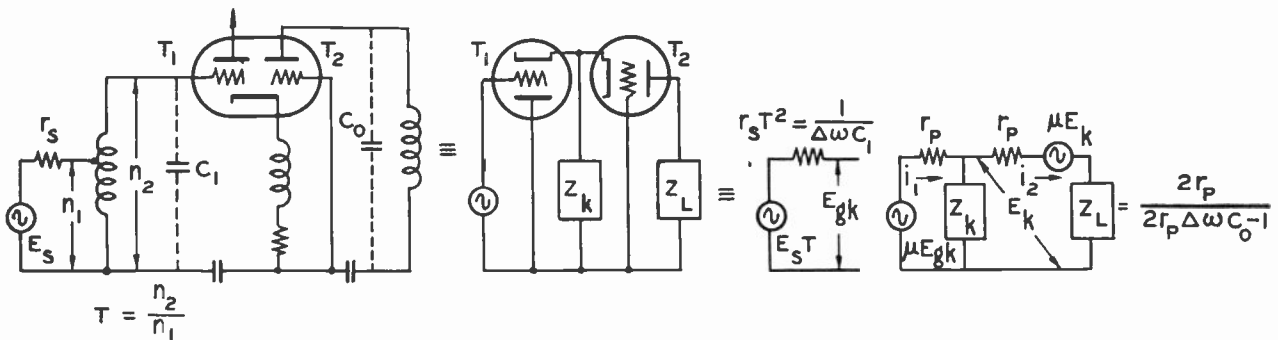

Fig. 4—Cathode-coupled twin amplifier and equivalent network.

pearing between grid and cathode is less than those in the antenna, since a 1:1 transformer is used for coupling, and the circuit is highly degenerative. These voltages are less than those appearing at the grid of a converter tube in television sets using a step-up transformer for coupling the antenna to the grid. The amplifier characteristics of a cathode-input amplifier are less curved because of the high degeneration of the cathode circuit. One is therefore led to the preliminary conclusion that cross modulation is less serious in the cathode-input amplifier than in the converter even though the grid of the latter is tuned. The tuned circuit in the converter is too broad to give sufficient adjacent-channel rejection.

In some cases the input loading is far in excess of that required to obtain the desired bandwidth. In such cases a compromise between the grounded-cathode and cathode-input amplifier may be obtained by moving the

grid bias, plate voltage, etc. It has been proposed to use such a stage in conjunction with a grounded-cathode amplifier,¹¹ but such a circuit, besides requiring the

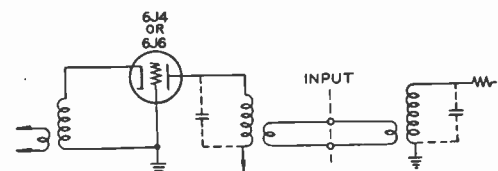

Fig. 5—Television radio-frequency amplifier circuit.

same number of circuit elements as two stages, uses a pentode tube as the grounded-cathode amplifier. In some cases this dual stage does not provide adequate stability, and also does not provide better noise

¹¹ P. Selgin, "The cathode driver as an R-F coupling stage," *Radio*, vol. 28, pp. 26-28; March, 1944.

characteristic than a pentode. By connecting a cathode-output and cathode-input stage together, as shown in Fig. 4, we obtain a high-gain wide-band amplifier stage.

The amplification of a wide-band amplifier of this type is $A_{cctt} = g_m / (2\Delta\omega\sqrt{C_1C_0})$ (see Appendix I (41)) which is favorably comparable to the gain obtained for grounded-cathode amplifiers, particularly since the input capacitance (C_1) is reduced by a factor of $1 - (1 + 2\Delta\omega C_0 r_p) / (4\Delta\omega C_0 r_p)$ (see Appendix I (46)).

The circuit is economical since a coil and a resistor (the coil preferably wound on the resistor) are the only coupling elements required between the two tube units. The resistor and by-pass capacitor customarily required in a screen supply are eliminated. Since the plate currents in the two triode units swing in opposite directions, subsequent similar stages have little influence on each other, due to varying load on the plate supply. By

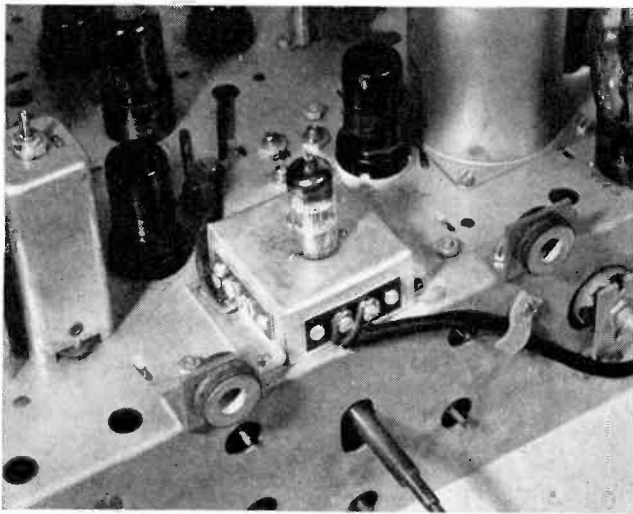

Fig. 6—Radio-frequency amplifier on RCA television-receiver chassis.

examining the circuit we may notice that the input and output signals are of the same polarity. Hence, when a cathode-coupled amplifier is used for video amplification, no attention need be given to the number of stages in order to obtain the proper polarity.

TABLE I
COMPARATIVE WIDE-BAND AMPLIFIER DATA

Tube Types		Circuit	Bandwidth 4 megacycles				Equivalent Root- Mean- Square Grid Noise μV	List Price \$
No.	Base		G_m μV	C_{0k} $\mu\mu f$	C_0 $\mu\mu f$	Amplifi- cation		
6AC7	Octal	Grounded- Cathode	9000	11.0	5.0	14.2	6.8	1.75
6AB7	Octal	Grounded- Cathode	5000	8.0	5.0	8.8	12.6	1.15
6AG5	Mini- ature	Grounded- Cathode	5000	6.5	1.8	17.6	10.4	2.15
6J6	Mini- ature	Cathode- Coupled	5300	2.2	1.6	10.4	7.5	1.85

A twin-triode tube with a common cathode may be manufactured more economically than a pentode of the same transconductance. While this point may be debatable at present, it can be shown that receivers could

be designed in which twin triodes were used in nearly all stages, and by reducing the tube types, the cost of the preferred-type tube could be reduced still further. Fig. 9 is a block diagram of a 16-tube television receiver in which 12 tubes are of the twin-triode type.

Table I shows the amplification obtainable from conventional high g_m pentodes in grounded-cathode circuits and from twin triodes in coupled-cathode wide-band amplifier circuits. To allow for the capacitances of tube sockets, wiring, etc., 2 micromicrofarads was added to the tube capacitances of each terminal, given in the tube handbook, for miniature tubes. Similarly, for octal metal tubes, 5 micromicrofarads was added. The bandwidth was assumed to be 4 megacycles, and the gain formulas given above were used. The input capacitance of the coupled stages was corrected for degeneration.

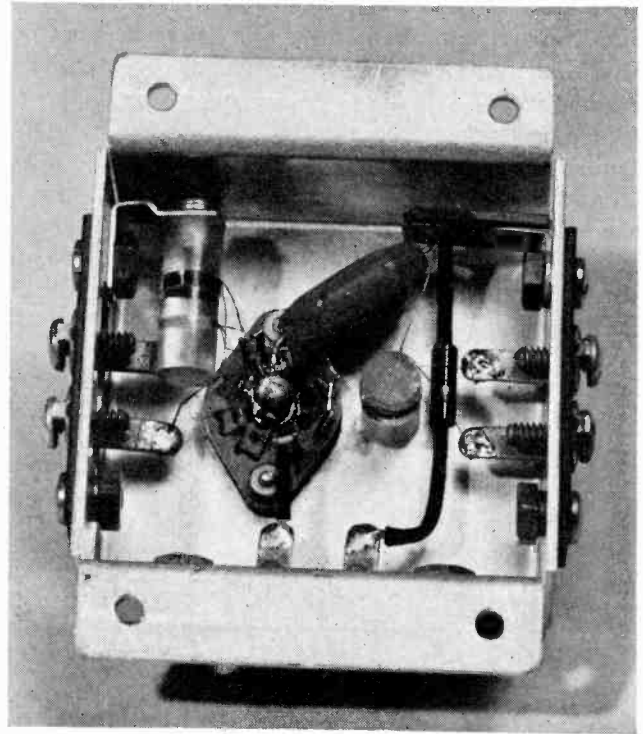

Fig. 7—Internal view of radio-frequency amplifier.

The tube-cost figures were also taken from the RCA Tube Handbook.

VII. SPECIAL CATHODE-COUPLED STAGES

On examination of Fig. 4, we may observe that the two grounded electrodes correspond to the input and output electrodes in the reverse direction. By injecting a signal of different frequency through a resonant circuit that appears substantially as a short circuit for the signal applied in the original direction to the grid of the second tube T_2 , and taking it off the plate of the first tube T_1 in the same manner, we obtain a bidirectional amplifier as shown in Fig. 10.

The terminals of the two signals are completely independent, and the capacitance of each will determine the

bandwidth and gain of its own signals. An amplifier of this type may be useful for bidirectional relay stations, reflex circuits, etc. Approximate calculations and experimental results indicate that with simple resonant circuits the two signals must be approximately twice their bandwidths apart. With a smaller frequency separation, the electrodes, which are supposed to be

with a 6J6 tube. The advantage of the bidirectional amplifier could be summed up by claiming a total amplification equal to the square of that of the unidirectional stage, or by claiming twice the bandwidth with the same gain.

The cathode-coupled stage can be used also as a frequency converter as shown in Fig. 13. The grid of T_2 is substantially grounded for all frequencies except for

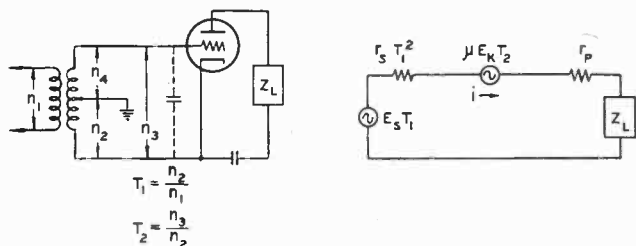

Fig. 8—Tapped cathode-input amplifier and equivalent network.

grounded, do not provide constant potentials, and, due to the regeneration, both pass bands are reduced. Further work on more complex circuits may permit the choice of closer signal frequencies.

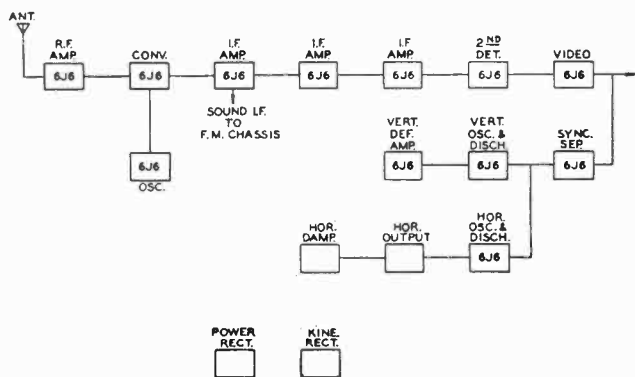

Fig. 9—Block diagram of television receiver using 6J6 tubes.

The experimental chassis containing a bidirectional cathode-coupled stage is shown in Fig. 11. The signals

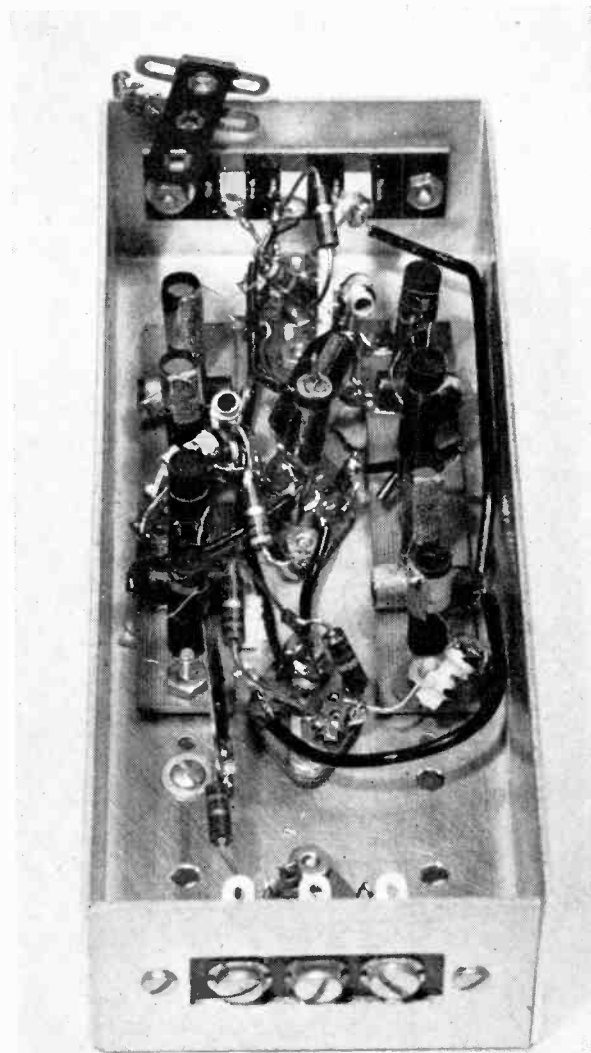

Fig. 11—Experimental bidirectional-amplifier stage.

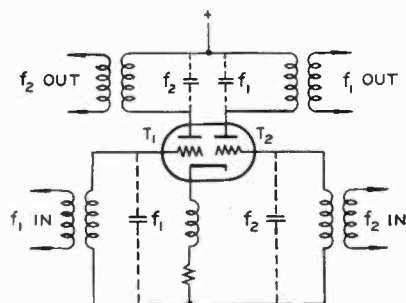

Fig. 10—Bidirectional-amplifier circuit.

applied were the frequency bands 8.5 to 13 megacycles and 24 to 28.5 megacycles. A gain of approximately 12 was obtained in both directions with a 6J6 tube. Fig. 12 shows a simple intermediate-frequency transformer construction for the frequency band 8.5 to 13 megacycles

the frequency of the tank circuit of the local oscillator. The local oscillator varies the transconductance of the tube, and therefore provides an intermediate-frequency output across the tuned circuit connected to the plate. The second tube T_2 acts as a cathode-output stage for the oscillator signal, and attenuates it by 6 decibels toward the antenna since it works into an impedance like its own. The first tube T_1 further attenuates this signal by providing a divider through its grid-cathode capacitance and the input impedance.

A simple cathode-coupled two-terminal oscillator circuit¹² is shown in Fig. 14. This is merely the twin-

¹² M. G. Crosby, United States Patent No. 2,269,417.

triode cathode-coupled amplifier described above, in which the output plate is coupled back to the input grid through some coupling impedance. The grid of the

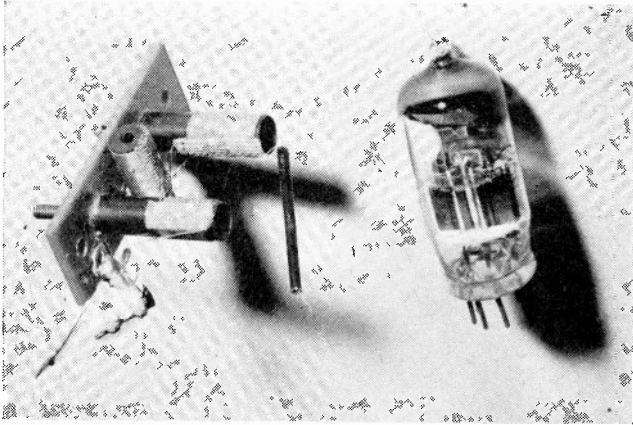

Fig. 12—Miniature intermediate-frequency transformer and tube.

cathode-input section T_2 is normally returned to ground. However, by properly biasing this grid, it is possible to obtain a frequency variation in excess of plus or minus 75 kilocycles about a mean frequency of 50 megacycles

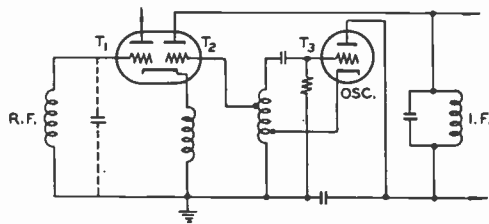

Fig. 13—Cathode-coupled frequency converter.

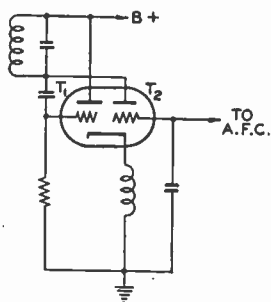

Fig. 14—Two-terminal oscillator.

with a 6J6 tube, with a bias variation of plus or minus one volt. In a television or frequency-modulation receiver this feature can be used to good advantage to provide vernier tuning or automatic frequency control without adding a reactance tube. In a frequency-modulation transmitter it may be possible to use this property to obtain direct frequency modulation of the oscillator.

Further applications of the cathode-coupled stage may include lock-in oscillators, reactance tubes, self-oscillating converters, etc. The economy and the

standardization possibilities of the circuit may well suit it for a large number of different applications.

APPENDIX I

DERIVATION OF GAIN FORMULAS FOR WIDE-BAND AMPLIFIERS

The grounded-cathode amplifier, with its equivalent network, is shown in Fig. 1. If we desire to maintain an amplification at a frequency $f = [\omega_0 \pm 1/(2\Delta\omega)]/2\pi$ that is approximately equal to 71 per cent of the amplification at resonance (see Appendix II)

$$r_s T^2 = 1/(\Delta\omega C_1) \quad (1)$$

provided we have unity coupling in our transformer. C_1 includes the capacitance in the primary divided by the square of the transformation ratio. The source resistance r_s may be a loading resistor, the surge impedance of a transmission line, the radiation resistance of an antenna, etc. The voltage applied to the grid is according to Thevenin's theorem

$$E_{gk} = E_s T. \quad (2)$$

The output of the tube is

$$E_o = E_{gk} [(\mu Z_L)/(r_p + Z_L)] \quad (3)$$

but since Z_L is determined by an external loading resistance which is in shunt with the plate resistance r_p according to the relation

$$(r_p Z_L)/(r_p + Z_L) = 1/(\Delta\omega C_o) \quad (4)$$

or

$$Z_L = r_p/(\Delta\omega C_o r_p - 1) \quad (5)$$

if (1) and (5) are substituted into (3), and both sides are divided by E_s , the amplification A is

$$A_{gc} = E_o/E_s = [1/(\sqrt{\Delta\omega C_1 r_s})][1/(\Delta\omega C_o r_p)]. \quad (6)$$

If the stage under consideration is preceded by a similar stage, we may set r_s equal to $1/(\Delta\omega C_o)$, in which case we obtain an over-all response of 0.5 at $f_o \pm (\Delta f/2)$, and by replacing μ/r_p by g_m , (6) will take the convenient form of

$$A_{gc} = g_m/(\Delta\omega \sqrt{C_1 C_o}) \quad (7)$$

a formula equally useful for triodes or pentodes if feedback can be neglected.

The equivalent noise resistance of the grounded-cathode amplifier is given by

$$R_{n \text{ equ}} = 2.2/g_m \quad (8)$$

while for the pentodes

$$R_{n \text{ equ}} = [2.2/(g_m(1 + \alpha))][1 + q\alpha(I_b/g_m)]. \quad (9)$$

$$\alpha = I_{c2}/I_b$$

I_b is the plate current, and I_{c2} is the screen current. The root-mean-square grid-noise input may be calculated then with the aid of the equation

$$\sqrt{e_{gn}^2} = 1.3 \times 10^{-10} \sqrt{R_{n \text{ equ}} \Delta f}. \quad (10)$$

The cathode-input amplifier, with its equivalent network, is shown in Fig. 2. Again for bandwidth considerations we make the assumption that $R_s T_1^2 = 1/(\Delta\omega C_1)$ (see (1)) and

$$[(r_p T_o^2)/(\mu + 1) + R_L]/[(r_p T_o^2)/(\mu + 1)R_L] = \Delta\omega C_o \quad (11)$$

where the input capacitance C_1 is equal to the sum of the reduced grid-cathode capacitance due to degeneration⁵ and the incidental capacitance to ground, while R_L is the equivalent parallel resistance of the losses in the output circuit. By rearranging (11),

$$R_L(\mu + 1)/T_o^2 = r_p(R_L\Delta\omega C_o - 1). \quad (12)$$

The amplification is

$$\begin{aligned} A_{co} &= T_o \left(\frac{\mu}{\mu + 1} \right) \left[\frac{R_L/T_o^2}{\frac{r_p}{\mu + 1} + \frac{R_L}{T_o^2}} \right] \\ &= T_o \left(\frac{\mu}{\mu + 1} \right) \left[\frac{\frac{R_L(\mu + 1)}{T_o^2}}{r_p + \frac{R_L(\mu + 1)}{T_o^2}} \right]. \end{aligned} \quad (13)$$

If we substitute from (12)

$$A_{co} = T_o \left(\frac{\mu}{\mu + 1} \right) \left(\frac{R_L\Delta\omega C_o - 1}{R_L\Delta\omega C_o} \right). \quad (14)$$

If $\mu \gg 1$ and we substitute for T_o from (12)

$$\begin{aligned} A_{co} &= \sqrt{\frac{\mu R_L}{(R_L\Delta\omega C_o - 1)r_p}} \left(\frac{R_L\Delta\omega C_o - 1}{R_L\Delta\omega C_o} \right) \\ &= \sqrt{\frac{\mu}{r_p}} \left(\frac{1}{\sqrt{\Delta\omega C_o}} - \frac{1}{\sqrt{R_L\Delta\omega C_o}} \right) \end{aligned} \quad (15)$$

if $\sqrt{R_L}$ is high we may replace μ/r_p by g_m , (15) will take the form

$$A_{co} = \sqrt{g_m/(\Delta\omega C_o)}. \quad (16)$$

Comparing (7) and (16), we may notice that the latter is in the order of the square root of the former, thus two cascade stages are required for amplification of the same order of magnitude. The equivalent noise resistance in this case is equal to that of the grounded-cathode amplifier.

The cathode-input amplifier, with its equivalent network, is shown in Fig. 3. This circuit may be analyzed in two ways. In one instance, the input impedance of the tube, which is usually very low, is matched to a predominantly resistive input, such as an antenna, a transmission line, etc. In the second case, the transformation ratio is reversed and the input impedance loads a tuned circuit to provide the required bandwidth.

In the first case, for optimum power transfer

$$r_s T^2 = (r_p + Z_L)/(\mu + 1) \approx (r_p + Z_L)/\mu. \quad (17)$$

From the equivalent network, it may be seen that

$$E_k \mu + E_s T = I(r_s T^2 + r_p + Z_L) \quad (18)$$

and

$$E_k = E_s T - I r_s T^2 \quad (19)$$

then

$$I = [(\mu + 1)E_s T]/[(\mu + 1)r_s T^2 + r_p + Z_L]. \quad (20)$$

If we multiply (20) with the plate load Z_L and divide through with E_s , we obtain

$$A_{ci} = E_o/E_s = [(\mu + 1)TZ_L]/[(\mu + 1)r_s T^2 + r_p + Z_L]. \quad (21)$$

If we substitute from (17) for T , we obtain

$$A_{ci} = [(\mu + 1)Z_L] / \left[\left(\frac{\mu + 1}{\mu} + 1 \right) \left(\sqrt{\mu r_s (r_p + Z_L)} \right) \right]. \quad (22)$$

If $\mu \gg 1$, equation (22), after substitution for Z_L from (5), takes the form

$$A_{ci} = (1/2) \sqrt{\mu / [\Delta\omega C_o r_s (\Delta\omega C_o r_p - 1)]}. \quad (23)$$

For the second case, when the cathode-input amplifier operates from a tap on a tuned circuit fed by a comparatively high impedance, such as another stage of amplifier,

$$T^2 = (\mu + 1)/(r_p \Delta\omega C_o) \approx \mu/(r_p \Delta\omega C_o). \quad (24)$$

If this value is substituted in the gain equation

$$A_{fi} = [(\mu + 1)Z_L]/[(r_p + Z_L)T] \quad (25)$$

if $\mu \gg 1$ yields the equation after substitution for Z_L from (5)

$$A_{ci} = \sqrt{g_m/(\Delta\omega C_o)}. \quad (26)$$

The equivalent noise input may be calculated from (8) with the aid of the equation

$$\sqrt{e_{kN}^2} = \left(\frac{1.3 \times 10^{-10} \sqrt{R_{n \text{ equ}} \Delta f}}{Z_L + r_p + R_1(\mu + 1)} \right) \mu R_1. \quad (27)$$

A compromise between the grounded-cathode and cathode-input amplifier may be obtained by connecting the ground to a tap on the input transformer, as shown in Fig. 8. From the equivalent network we may see that

$$E_s T_1 + \mu E_k T_2 = I(r_s T_1^2 + r_p + Z_L) \quad (28)$$

and

$$E_k = E_s T_1 = I r_s T_1^2. \quad (29)$$

If we solve for I , we obtain

$$I = [(\mu T_2 + 1)E_s T_1]/[(\mu T_2 + 1)r_s T_1^2 + r_p + Z_L] \quad (30)$$

which is the same as (20) except that in place of μ we have μT_2 , and, accordingly, we increased the amplification factor by T_2 .

The cathode-coupled twin-triode amplifier is shown in Fig. 4, with its equivalent network. From the equivalent network we may observe that

$$\begin{aligned} i_1 r_p + (i_1 - i_2)Z_k &= \mu E_{ok} = \mu(E_1 - E_k) \\ &= \mu E_1 - (i_1 - i_2)\mu Z_k \end{aligned} \quad (31)$$

and

$$(i_2 - i_1)Z_k + i_2(r_p + Z_L) = \mu E_k \quad (32)$$

from (31)

$$i_1[r_p + Z_k(\mu + 1)] - i_2[Z_k(\mu + 1)] = \mu E_1 \quad (33)$$

and from (32)

$$-i_1[Z_k(\mu + 1)] + i_2[r_p + Z_L + Z_k(\mu + 1)] = 0. \quad (34)$$

If (33) is divided through with $r_p + Z_k(\mu + 1)$, we have

$$i_1 - i_2[Z_k(\mu + 1)]/[r_p + Z_k(\mu + 1)] = (\mu E_1)/[r_p + Z_k(\mu + 1)] \quad (35)$$

and if (34) is divided through with $r_p + Z_k(\mu + 1)$, we have

$$-i_1 + i_2[r_p + Z_L + Z_k(\mu + 1)]/[Z_k(\mu + 1)] = 0. \quad (36)$$

If we add (35) and (36) we have

$$i_2 \left[\frac{r_p + Z_L + Z_k(\mu + 1)}{Z_k(\mu + 1)} - \frac{Z_k(\mu + 1)}{r_p + Z_k(\mu + 1)} \right] = \frac{\mu E_1}{r_p + Z_k(\mu + 1)}. \quad (37)$$

Thus the solution for the plate current of T_2 is

$$i_2 = \frac{\mu E_1 Z_k(\mu + 1)}{r_p^2 + Z_L r_p + 2Z_k r_p(\mu + 1) + Z_k Z_L(\mu + 1)}. \quad (38)$$

If we multiply through with Z_L and divide with E_1 , we obtain the amplification from grid number 1 to plate number 2

$$A_{CCTT} = \frac{\mu Z_L Z_k(\mu + 1)}{r_p^2 + r_p Z_L + 2Z_k r_p(\mu + 1) + Z_k Z_L(\mu + 1)}. \quad (39)$$

If Z_k is much larger than $(r_p + Z_L)/(2(\mu + 1))$, which is an easy condition to fulfill, (39) will take the form

$$A_{CCTT} = \mu Z_L / (2r_p + Z_L). \quad (40)$$

If we substitute $\Delta\omega C_0$ for $(2r_p + Z_L)/(2r_p Z_L)$ and multiply by the input-circuit transfer $\sqrt{C_o/C_i}$, where C_o is the output capacitance of the preceding stage factor (assumed to be equal to that of the stage under analysis) and C_i is the input capacitance corrected for degeneration, we have

$$A_{CCTT} = g_m / (2\Delta\omega \sqrt{C_i C_o}). \quad (41)$$

The grids of both tubes are at equal gain points with respect to their cathodes (in other words, the same gain is obtained from either grid to the output of the plate circuit, when the signal is applied between the grid and the cathode), and thus both tubes contribute equally to the total noise. The apparent noise generating resistances in either grid is equal to (8), and therefore the equivalent noise resistance between the input grid and cathode is

$$R_{n\text{ equ}} = 4.4/g_m \quad (42)$$

where g_m is the transconductance of one tube unit. The root-mean-square grid-noise equivalent may be determined with the aid of (10). The equivalent noise resistance of the cathode-coupled twin-triode amplifier is considerably better than that of a pentode amplifier, and therefore a great improvement can be obtained in the noise factor by using cathode-coupled amplifiers in the early stages of amplification. A particularly useful instance is when cathode-coupled intermediate-frequency amplifiers are used after low-gain frequency converters.

To evaluate C_i , we calculate from the equation

$$C_i = C_D + C_{gp} + C_{gk}(1 - A_1) \quad (43)$$

where C_D is the incidental (socket, wiring, coil, etc.) capacitance, C_{gp} is the grid-to-plate capacitance, and C_{gk} is the cathode-grid capacitance. A_1 is the amplification of the first tube only.

$$A_1 = \mu Z_k / [r_p + Z_k(\mu + 1)] = [\mu / (\mu + 1)] [(r_p + Z_p) / (2r_p + Z_p)]. \quad (44)$$

If $\mu \gg 1$ and we substitute

$$Z_p = 2r_p / (2r_p \Delta\omega C_0 - 1) \quad (45)$$

into (44) we have

$$A_1 = (2\Delta\omega C_0 r_p + 1) / (4\Delta\omega C_0 r_p). \quad (46)$$

APPENDIX II

The bandwidth in the present paper is considered as the frequency, or the separation between the frequencies, at which the amplification is reduced by a factor of $1/\sqrt{2}$ of the value at the frequency of maximum amplification. The gain is a direct function of the impedance of the output circuit; therefore we may examine the impedance, and particularly its absolute value, directly.

In the case of a simple resistance-capacitance circuit as shown in Fig. 15, the absolute value of the admittance at

$$|Y| = \frac{\sqrt{2}}{R} = \left| \frac{1}{R} + j\omega C \right|. \quad (47)$$

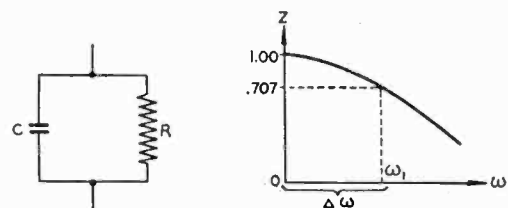

Fig. 15—Impedance characteristic of low-pass filter.

If we multiply by R and rationalize

$$\sqrt{2} = \sqrt{1 + \omega_1^2 C^2 R^2} \quad (48)$$

since $\Delta\omega = \omega_1 - 0$,

$$\Delta\omega = 1/(RC). \quad (49)$$

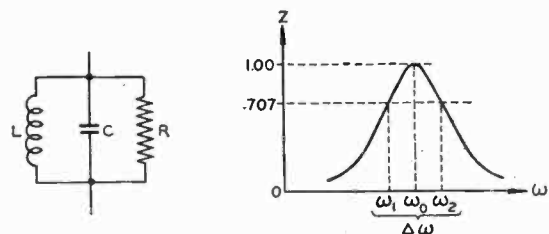

Fig. 16—Impedance characteristic of band-pass filter.

In the case of the band-pass analogy of this circuit, shown in Fig. 16, the admittance at the resonant frequency ω_0 is $1/R$, and at the frequencies ω_1 and ω_2 the absolute value of the admittance is

$$|Y| = \frac{\sqrt{2}}{R} = \left| \frac{1}{R} + j\omega_c C - \frac{j}{\omega} \right|. \quad (50)$$

If we multiply by R and rationalize, (50) becomes

$$\sqrt{2} = \sqrt{1 + \omega_c^2 C^2 R^2 [1 - (\omega_0^2/\omega_c^2)]^2} \quad (51)$$

where $\omega_0^2 = 1/LC$ and $\omega_c = \omega_1$, or ω_2 .

If (51) is squared, it yields

$$\text{or } \left. \begin{aligned} \omega_c RC [1 - (\omega_0^2/\omega_c^2)] &= 1 & \text{if } \omega_c > \omega_0 \\ \omega_c RC [1 - (\omega_0^2/\omega_c^2)] &= -1 & \text{if } \omega_c < \omega_0 \end{aligned} \right\} \quad (52)$$

If we rearrange (52), and solve the quadratic

$$\omega_c^2 \pm [1/RC]\omega_c - \omega_0^2 = 0 \quad (53)$$

$$\left. \begin{aligned} \omega_1 &= \frac{-[1/(RC)] \pm \sqrt{[1/(R^2C^2)] + 4\omega_0^2}}{2} \\ \omega_2 &= \frac{[1/(RC)] \pm \sqrt{[1/(R^2C^2)] + 4\omega_0^2}}{2} \end{aligned} \right\} \quad (54)$$

Since $\Delta\omega = \omega_2 - \omega_1$, $\Delta\omega = 1/RC$.

Band-Pass Bridged-T Network for Television Intermediate-Frequency Amplifiers*

G. C. SZIKLAI†, SENIOR MEMBER, I.R.E., AND A. C. SCHROEDER†, ASSOCIATE, I.R.E.

Summary—Bridged-T networks offer great economy in television intermediate-frequency amplifiers for sharp attenuation of the associated and adjacent sound channels.

A simple design method was obtained by the use of the equivalent lattice. By the same method, general formulas were obtained for the phase, attenuation, and delay characteristics. Two designs are given to illustrate the convenience of the method.

I. INTRODUCTION

THE ADVANTAGES of bridged-T coupling networks for the attenuation of a narrow-frequency band have been pointed out frequently in the literature.¹⁻⁵ The advantages are simplicity of physical construction and economy. Television intermediate-frequency amplifiers with sharp attenuation requirements, close to the pass band, may employ band-pass bridged-T networks advantageously. A particular advantage is the ease of resistance cancellation for the sound intermediate-frequency signal elimination. While formulas for the components of ladder-type band-pass filters are readily available,^{6,7} the components of a bridged-T network are usually determined from general network theory. This step is made in the present paper with the aid of the equivalent lattice network. The attenuation, phase, and delay characteristic equations are also derived by the same method.

* Decimal classification: R143. Original manuscript received by the Institute, April 3, 1945; revised manuscript received, June 7, 1945.

† Radio Corporation of America, RCA Laboratories, Princeton, N. J.

¹ A. C. Bartlett, "Extension of a property of artificial lines," *Phil. Mag.*, vol. 4, pp. 902-907; November, 1927.

² H. W. Bode, United States Patent No. 2,002,216, May, 1935.

³ V. D. Landon, "M derived band-pass filters with resistance cancellation," *RCA Rev.*, vol. 1, pp. 93-101; October, 1936.

⁴ W. N. Tuttle, "Bridged-T and parallel-T null circuits for measurements at radio frequencies," *Proc. I.R.E.*, vol. 28, pp. 23-29; January, 1940.

⁵ G. Builder, "Resistance balancing in wave filters," *A.W.A. Tech. Rev.*, vol. 3, pp. 83-100; 1938.

⁶ T. E. Shea, "Transmission Networks and Wave Filters," D. Van Nostrand Company, New York, N. Y., 1929.

⁷ J. E. Smith, "Simplified filter design," *RCA Press*.

II. THE LATTICE EQUIVALENCE

Considering the simple case of a symmetrical network, it is found to be equivalent to a lattice network with arms given by Bartlett's Theorem.¹ One pair of arms has a driving impedance equal to the terminal impedance of the network, with all arms short-circuited at the axis of symmetry, and the other arm is equal to the terminal impedance of either end with the network cut open at the axis of symmetry. The equivalence is illustrated in Fig. 1 for a bridged-T band-pass network,

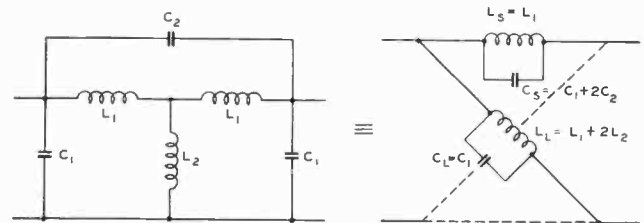

Fig. 1—Bridged-T band-pass filter and equivalent lattice network.

with the series arm of the lattice corresponding to the short-circuited midsection terminal impedance, and the lattice arm corresponding to the terminal impedance obtained by bisecting the network.

In any symmetrical lattice the attenuation⁸ is

$$E_1/E_0 = [(1 + jRB_S)(1 + jRB_L)] / (jRB_L - jRB_S) \quad (1)$$

where R is the resistance which terminates both input and output of the lattice, B_S is the susceptance of the series arm, and B_L is the susceptance of the lattice arm.

In the present case

$$B_S = C_S\omega - 1/(L_S\omega) = (C_S L_S \omega^2 - 1)/(L_S \omega).$$

If we call $C_S L_S = 1/\omega_S^2$

$$B_S = [(\omega/\omega_S)^2 - 1] / [L_S \omega]. \quad (2)$$

⁸ W. Cauer, "New theory and design of wave filters," *Physics*, vol. 2, pp. 242-268; April, 1932.

Similarly,

$$B_L = [(\omega/\omega_L)^2 - 1]/[L_L\omega]. \quad (3)$$

From (1) it is obvious that the attenuation goes to infinity when $B_L = B_S$. If ω_∞ is 2π times the frequency at which the attenuation goes to infinity, then from (2) and (3)

$$\begin{aligned} [(\omega_\infty/\omega_S)^2 - 1]/[L_S\omega_\infty] &= [(\omega_\infty/\omega_L)^2 - 1]/[L_L\omega_\infty] \\ \text{or } L_L/L_S &= [(\omega_\infty/\omega_L)^2 - 1]/[(\omega_\infty/\omega_S)^2 - 1] = m^2 \end{aligned} \quad (4)$$

where m is a design factor.

From Fig. 1, $L_s = L_1$; $L_L = L_1 + 2L_2$; $C_S = C_1 + 2C_2$; $C_L = C_1$.

$$\text{Therefore } m^2 = L_L/L_S = (L_1 + 2L_2)/L_1 \quad (5)$$

which says that m^2 must be greater than 1 in order for L_1 and L_2 to be physically realizable.

From (5),

$$L_2 = [L_1(m^2 - 1)]/2. \quad (6)$$

Also from (5), since

$$\begin{aligned} m^2 L_1 &= L_1 + 2L_2 = L_L = 1/(C_L\omega_L^2) = 1/(C_1\omega_L^2) \\ L_1 &= 1/(m^2 C_1\omega_L^2) \end{aligned} \quad (7)$$

and since

$$\begin{aligned} C_S &= 1/(L_S\omega_S^2) = 1/(L_1\omega_S^2) \text{ and } C_2 = (C_S - C_1)/2 \\ C_2 &= (1/2)[1/(L_1\omega_S^2) - C_1]. \end{aligned} \quad (8)$$

From the fact that

$$\begin{aligned} Z_0 &= \sqrt{Z_S Z_L} \\ &= \sqrt{- (L_S L_L \omega^2) / \{ [1 - (\omega/\omega_L)^2] [1 - (\omega/\omega_S)^2] \}} \\ Z_0 &= \sqrt{- [L_S L_L \omega^2 \omega_L^2 \omega_S^2] / [(\omega_L^2 - \omega^2)(\omega_S^2 - \omega^2)]} \end{aligned} \quad (9)$$

which is real only if

$$\omega_L^2 > \omega^2 > \omega_S^2$$

or

$$\omega_L^2 < \omega^2 < \omega_S^2$$

we see that ω_L and ω_S are the cutoff frequencies.

If we call 2π times the midband frequency $\omega_m = \sqrt{\omega_L \omega_S}$, the midband image impedance from (9) is

$$\begin{aligned} Z_{0m} &= \sqrt{- (L_S L_L \omega_m^2 \omega_L^2 \omega_S^2) / [(\omega_L^2 - \omega_m^2)(\omega_S^2 - \omega_m^2)]} \\ &= \sqrt{- (L_S L_L \omega_L^3 \omega_S^3) / \{ [\omega_L^2 - (\omega_L \omega_S)] [\omega_S^2 - (\omega_L \omega_S)] \}} \\ &= \sqrt{+ (L_S L_L \omega_L^2 \omega_S^2) / (\omega_L - \omega_S)^2} \\ &= [(\omega_L \omega_S) / (\omega_L - \omega_S)] (\sqrt{L_S L_L}) \end{aligned}$$

From (4) $L_L = m^2 L_S$.

Therefore $Z_{0m} = [(\omega_L \omega_S) / (\omega_L - \omega_S)] (m L_S)$

and since $L_S = L_1$

$$Z_{0m} = [(\omega_L \omega_S) / (\omega_L - \omega_S)] (m L_1). \quad (10)$$

Experience has shown that the network may be terminated by resistances up to three times this value in order to obtain adequate gain and still retain a satisfactory flatness of response in the pass band.

Equations (4), (6), (7), (8), and (10), are the only ones required for the design of the transformer, but further useful information may be obtained from the equivalent lattice network. It is obvious that perfect cancellation of the undesired signal is obtained when the phase angle

in the equivalent lattice arms are equal, which requirement will be fulfilled if the Q 's of L_1 and L_2 are equal, provided the losses in the capacitances are negligible. By checking the Q 's of these coils at the frequency to be attenuated, the resistor to be added in series with one of

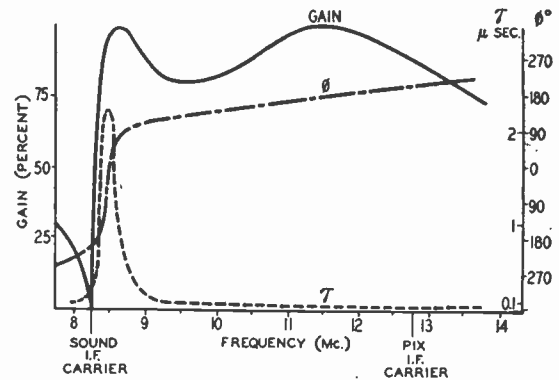

Fig. 2—Gain, phase, and time-delay characteristics of a television intermediate-frequency amplifier stage using a bridged-T network for attenuation of the associated sound channel.

the coils for resistance cancellation may easily be determined.

III. DESIGN PROCEDURE

Summarizing the design formulas in the order of use, (4) becomes

$$\begin{aligned} m^2 &= [(\omega_\infty/\omega_L)^2 - 1]/[(\omega_\infty/\omega_S)^2 - 1] \\ &= [(f_\infty/f_L)^2 - 1]/[(f_\infty/f_S)^2 - 1] \end{aligned}$$

remembering that $m > 1$, (7) becomes

$$L_1 = 1/(C_1 m^2 \omega_L^2) = 1/(4\pi^2 C_1 m^2 f_L^2)$$

(6) becomes $L_2 = [(m^2 - 1)/2] L_1$;

(8) becomes

$$C_2 = [1/(2L_1\omega_S^2)] - C_1/2 = (1/2)[1/(4\pi^2 L_1 f_S^2)] - C_1/2;$$

and (10) becomes

$$Z_{0m} = [(\omega_L \omega_S) / (\omega_L - \omega_S)] (m L_1) = 2\pi [(f_L f_S) / (f_L - f_S)] (m L_1).$$

Two typical designs are given in the following:

Example 1: Given

$$C_1 = 5 \text{ micromicrofarads}$$

$$f_S = 8.5 \text{ megacycles}$$

$$f_L = 11.5 \text{ megacycles}$$

$$f_\infty = 8.25 \text{ megacycles}$$

then

$$m = \sqrt{[1 - (8.25/11.5)^2] / [1 - (8.25/8.5)^2]} = 3$$

$$L_1 = 1/(4\pi^2 \times 11.5^2 \times 9 \times 5) = 4.3 \mu H$$

$$L_2 = 4L_1 = 17.2 \mu H$$

$$\begin{aligned} C_2 &= (1/2)[(10^{-6}/(4\pi^2 \times 8.5^2 \times 4.3)) - 5 \times 10^{-12}] \\ &= 38.5 \text{ micromicrofarads} \end{aligned}$$

$$Z_{0m} = (2\pi \times 4.3 \times 3)[(11.5 \times 8.5)/3] = 2620 \text{ ohms.}$$

The transmission and phase characteristics of this transformer are shown in Fig. 2 for a termination of 6800 ohms instead of the specified value of $Z_{0m} = 2620$ ohms.

Example 2: Given

- $C = 5$ micromicrofarads
- $f_s = 12.5$ megacycles
- $f_L = 8.5$ megacycles
- $f_\infty = 14.25$ megacycles

then

$$m = \sqrt{[1 - (14.25/8.5)^2] / [1 - (14.25/12.5)^2]} = 2.45$$

$$L_1 = 1 / (4\pi^2 \times 8.5^2 \times 2.45^2 \times 5) = 11.7 \mu H_v$$

$$L_2 = 2.5 \times L_1 = 29.3 \mu H_v$$

$$C_2 = (1/2) [(10^{-6} / (4\pi^2 \times 12.5^2 \times 11.7)) - 5 \times 10^{-12}] = 4.4 \text{ micromicrofarads}$$

$$Z_{0m} = (2\pi \times 11.7 \times 2.45) [(12.5 \times 8.5) / 4] = 4770 \text{ ohms.}$$

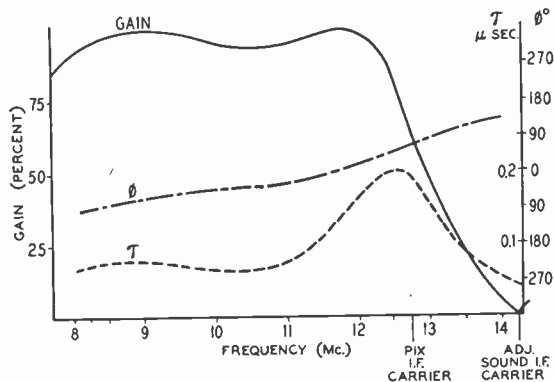

Fig. 3—Gain, phase, and time-delay characteristics of a television intermediate-frequency amplifier stage using a bridged-T network for attenuation of the adjacent sound channel.

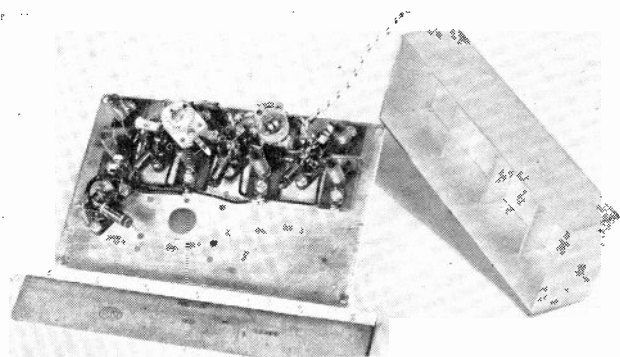

Fig. 4—Rear view of experimental intermediate-frequency chassis of Fig. 5.

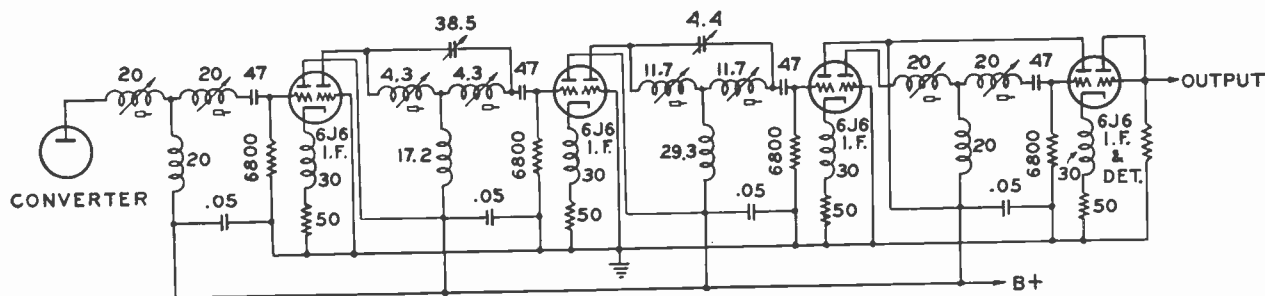

Fig. 5—Circuit of a complete television intermediate-frequency amplifier using bridged-T band-pass coupling networks.

The transmission and phase characteristics of this transformer are shown in Fig. 3 with 6800-ohm terminating resistances.

A three-stage intermediate-frequency amplifier, using 6J6 in cathode-coupled circuits,⁹ and incorporating one of each of the transformers designed above, is shown in Fig. 4, with its circuit shown in Fig. 5.

IV. ATTENUATION, PHASE, AND DELAY CHARACTERISTICS

The equivalent lattice section provides a simple and universal means for the exact calculation of the filter characteristics. The ratio of input to output voltages in (1) is

$$E_1/E_0 = [(1 + jRB_s)(1 + jRB_L)] / (jRB_L - jRB_s)$$

which may also be written

$$E_1/E_0 = [RB_L + RB_s - j(1 - RB_L RB_s)] / (RB_L - RB_s). \quad (11)$$

By first determining RB_L and RB_s , the attenuation (or gain) may be plotted from either (1) or (11). If a vector slide rule is used in the calculations, the phase angle is determined at the same time. However, the phase may also be determined from (1)

$$\phi = \tan^{-1} RB_s + \tan^{-1} RB_L - (\pi/2)$$

or from (11)

$$\phi = \tan^{-1} [-(1 - R^2 B_L B_s) / (R(B_L + B_s))]$$

which are equivalent.

The time delay

$$T = \frac{d\phi}{d\omega} = \frac{RL_s [(\omega/\omega_s)^2 + 1]}{1 + (RB_s)^2} + \frac{RL_L [(\omega/\omega_L)^2 + 1]}{1 + (RB_L)^2}$$

However, the time delay may be approximately determined if, in plotting phase angle ϕ , the points are taken close enough together since

$$T = \Delta\phi / \Delta\omega = \Delta\phi / 2\pi\Delta f.$$

⁹ G. C. Sziklai and A. C. Schroeder, "Cathode coupled wide-band amplifiers," PROC. I.R.E., this issue, pp. 701-709.

Electron Transit Time in Time-Varying Fields*

ARTHUR B. BRONWELL†, MEMBER, I.R.E.

Summary—The equations of electron acceleration, velocity, and displacement in time-varying fields are derived for the temperature-limited and the space-charge-limited diodes. These are written in a form making it possible to construct universal curves of electron displacement as a function of transit angle. Separate curves represent the direct-current and alternating-current components of electron displacement, the total displacement being obtained by adding the two components. The curves greatly expedite the solution of electron transit-time problems and aid in visualizing the physical processes at work.

INTRODUCTION

ELECTRONIC devices utilize the effects of electrons moving under the guiding influence of electric fields, magnetic fields, or combined electric and magnetic fields. The principles of electron dynamics, therefore, provide the foundation for a rigorous analysis of vacuum-tube performance. The equations of electron acceleration, velocity, and displacement are intimately related to the electrical quantities of potential, current, power, and impedance. The properties of electron tubes may be analyzed in terms of these fundamental relationships. This method of analysis has been developed by a number of authors¹⁻⁶ and has its principal application at frequencies where electron-transit-time effects are significant.

The equations of electron motion in superposed direct and alternating fields are derived here for the temperature-limited and space-charge-limited parallel-plane diodes. These equations contain direct-current and alternating-current terms resulting from the respective field components. The direct-current and alternating-current components of electron displacement are plotted as functions of transit angle. These are universal curves, applicable to all temperature-limited or space-charge-limited parallel-plane diodes. The electron-displacement curves for the space-charge-limited diode are based upon first-order approximations and are, therefore, restricted to small-signal applications. The method of approach is similar to that of the previous authors on the subject and some of their relationships are repeated here for reference purposes. Rationalized mks units are used.

* Decimal classification: R130×R332. Original manuscript received by the Institute, February 20, 1945; revised manuscript received, June 4, 1945.

† Northwestern University, Evanston, Illinois.

¹ W. E. Benham, "Theory of internal action of thermionic amplifiers, part 1," *Phil. Mag.*, vol. 5, pp. 641-651; March, 1928; part 2, *Phil. Mag. Supp.*, vol. 11, pp. 457-517; February, 1931.

² F. B. Llewellyn, "Electron inertia effects," Cambridge University Press, New York, N. Y., 1941.

³ F. B. Llewellyn, "Vacuum-tube electronics at ultra-high frequencies," *Proc. I.R.E.*, vol. 21, pp. 1532-1573; November, 1933.

⁴ J. Müller, "Elektronenschwingungen in Hochvakuum," *Hochfrequenz- und Elektroakustik*, vol. 41, pp. 156-167; May, 1933.

⁵ D. O. North, "Analysis of the effects of space charge on grid impedance," *Proc. I.R.E.*, vol. 24, pp. 108-136; January, 1936.

⁶ W. E. Benham, "A contribution to tube and amplifier theory," *Proc. I.R.E.*, vol. 26, pp. 1093-1170; September, 1938.

FUNDAMENTAL RELATIONSHIPS

A charge q in an electric field of intensity \bar{E} experiences a vector force $\bar{f} = q\bar{E}$. If the charge moves along a path s , Newton's second law of motion yields

$$\bar{f} = q\bar{E} = m(d^2\bar{s}/dt^2) \quad (1)$$

$$d^2\bar{s}/dt^2 = (q/m)\bar{E}. \quad (2)$$

Two successive integrations of (2) yield the electron velocity and displacement as a function of time. In the cases considered here, \bar{E} is a function of time and this substitution must be made before the integration can be completed. The integration constants are evaluated from known or assumed boundary conditions.

The electric-field distribution in space may be obtained from a solution of the divergence equation

$$\nabla \cdot \bar{E} = \rho/\epsilon \quad (3)$$

where ρ is the space-charge density and ϵ is the permittivity.

If the space-charge density ρ moves with a velocity \bar{v} , the current density at any point in the interelectrode space is

$$\bar{J} = \rho\bar{v} + \epsilon(\partial\bar{E}/\partial t). \quad (4)$$

The two terms on the right-hand side of (4) are the convection and displacement current densities, respectively.

The force acting upon a differential space charge $\rho d\tau$ is $\bar{f} = \rho\bar{E}d\tau$. The power transferred from the field to this differential space charge is force times velocity, or $d\dot{p} = \rho\bar{E} \cdot \bar{v}d\tau$. Integrating this over volume τ , we obtain the total power transfer

$$\dot{p} = \int_{\tau} \rho\bar{v} \cdot \bar{E}d\tau. \quad (5)$$

Let us now apply these relationships to the parallel-plane diode. Equation (3) then becomes

$$\partial E/\partial x = \rho/\epsilon. \quad (6)$$

Substituting ρ from (6) into (4), we obtain

$$J = \epsilon[(\partial E/\partial x)(dx/dt) + (\partial E/\partial t)] = \epsilon(dE/dt). \quad (7)$$

Thus, the current density is the time rate of change of electric flux density as we ride along with the electron. Further substitution of E from (2) in (7) yields

$$J = (\epsilon m/q)(d^3x/dt^3). \quad (8)$$

The average current density throughout the diode space (at a given instant of time) is

$$J_{av} = (1/\tau) \int_{\tau} Jd\tau. \quad (9)$$

In the parallel-plane diode, we have $d\tau = Adx$. If the separation distance between diode planes is d , equation (9) becomes

$$J_{av} = (1/d) \int_0^d Jdx. \quad (10)$$

The total current is the product of average current density times area. Substitution of (7) yields

$$i = J_{av}A = (A/d) \int_0^d J dx = (\epsilon A/d) \int_0^d (dE/dt) dx. \quad (11)$$

The power transfer from the field to the moving space charge is obtained by writing (5) for the parallel-plane diode, thus:

$$p = A \int_0^d \rho v E dx. \quad (12)$$

Finally, the potential at any point in the diode space is given by

$$V = - \int_0^x E dx. \quad (13)$$

If the diode potential contains direct-current and alternating-current components, the electric field in the diode space will likewise have superposed direct and alternating components. Equation (2) and successive integrations show that the electron acceleration, velocity, and displacement equations then contain direct and alternating terms, while (11) and (12) yield direct and alternating terms in the current and power-transfer equations. Having considered the general relationships, we now turn to the equations of electron motion in the time-varying fields.

TEMPERATURE-LIMITED DIODE

Consider an electron in motion in the temperature-limited diode of Fig. 1. The potential is assumed to have

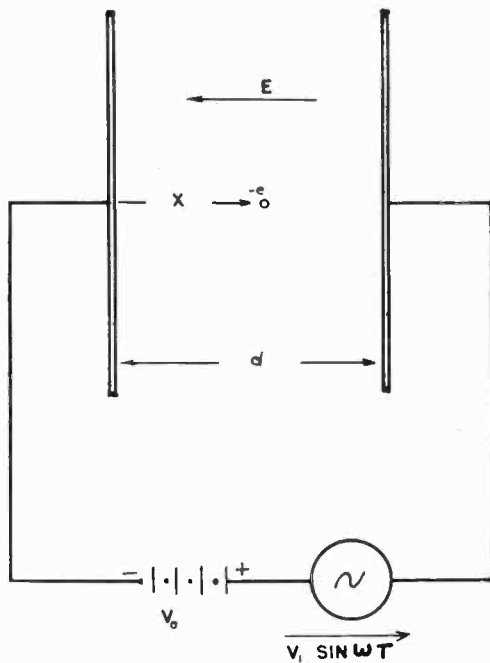

Fig. 1—Parallel-plane diode with superposed direct and alternating fields.

direct and alternating components represented by $V = V_0 + V_1 \sin \omega t$. Assuming that the space-charge density is sufficiently small so that it does not alter the field distribution, we have $E = -(1/d)(V_0 + V_1 \sin \omega t)$. The electron charge is taken as $q = -e$. Substitution for

E and q in (2) yields the equation of electron acceleration

$$d^2x/dt^2 = (e/md)(V_0 + V_1 \sin \omega t). \quad (14)$$

Two successive integrations of (14) yield the electron velocity and displacement. Assuming that the electron

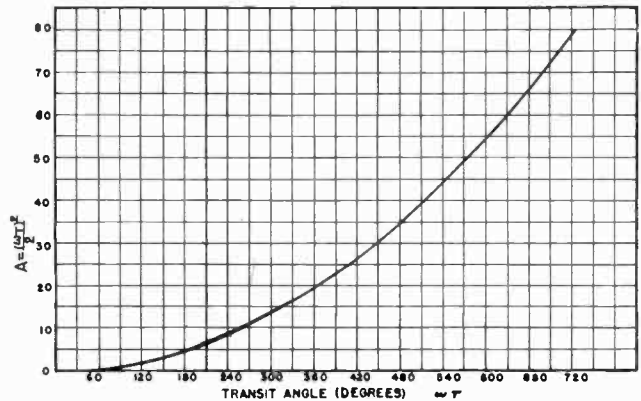
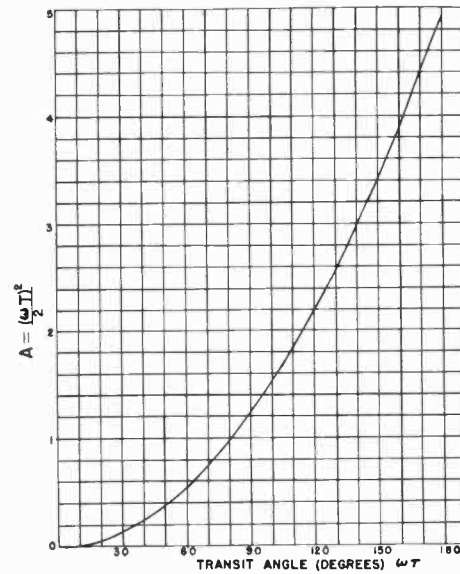

Fig. 2—Direct-current component of electron displacement parameter x/k as a function of transit angle for temperature-limited parallel-plane diode.

leaves the cathode at time t_0 and phase $\phi = \omega t_0$, we have $dx/dt = (e/md)[V_0(t-t_0) - V_1/\omega(\cos \omega t - \cos \omega t_0)] + v_0$ (15)
 $x = (e/md)[(V_0(t-t_0)^2/2) - (V_1/\omega^2)(\sin \omega t - \sin \omega t_0) + (V_1/\omega)(t-t_0) \cos \omega t_0] + v_0(t-t_0)$. (16)

Let T be the total time required for the electron to travel a distance x , thus $T = t - t_0$. Writing (16) in terms of T and t_0 gives the result

$$x/k = (\omega T)^2/2 + (V_1/V_0)[\cos \phi(\omega T - \sin \omega T) + \sin \phi(1 - \cos \omega T)] + v_0(\omega T)/\omega k. \quad (17)$$

$$x/k = A + (V_1/V_0)B + C \quad (18)$$

where

$$k = eV_0/\omega^2 md = 1.76 \times 10^{11}(V_0/\omega^2 d) \text{ (mks units)}$$

$$A = (\omega T)^2/2$$

$$B = \cos \phi(\omega T - \sin \omega T) + \sin \phi(1 - \cos \omega T)$$

$$C = v_0(\omega T)/\omega k. \quad (19)$$

⁷ The transit time T used here corresponds to $T + \delta$ used by Llewellyn, and others, where δ is the variation from the direct-current transit time.

The quantity ωT is the *transit angle* representing the number of radians of alternating potential during the electron transit time T . The term A in (18) is the electron displacement parameter x/k in a direct-current

and B from Figs. 2 and 3 and compute the value of C from (19). Substitution of these in (18) yields the electron displacement.

The reverse process; that is, finding the transit time corresponding to a given electron displacement, is a little more difficult. The value of x/k is first computed and the direct-current transit angle for this value of x/k is obtained from Fig. 2, as a first approximation. Values of transit angle in this vicinity are then assumed until one is found such that the values of A , B , and C satisfy (18).

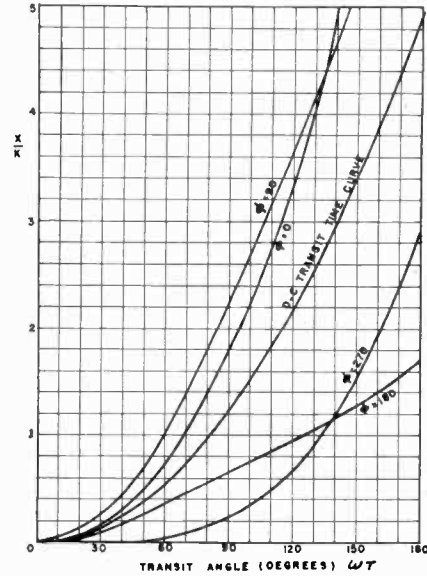
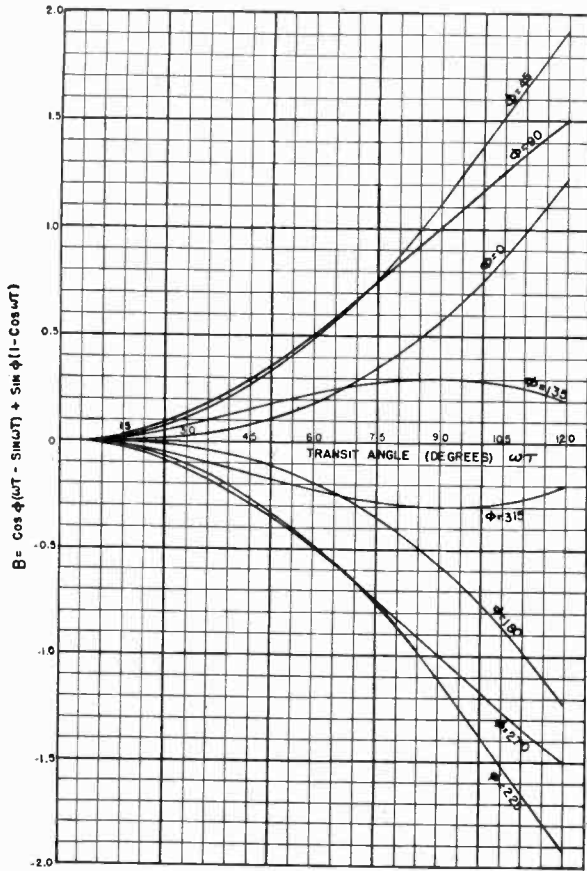

Fig. 4—Total transit angle for various values of ϕ , with $V_1/V_0=1$ and $v_0=0$.

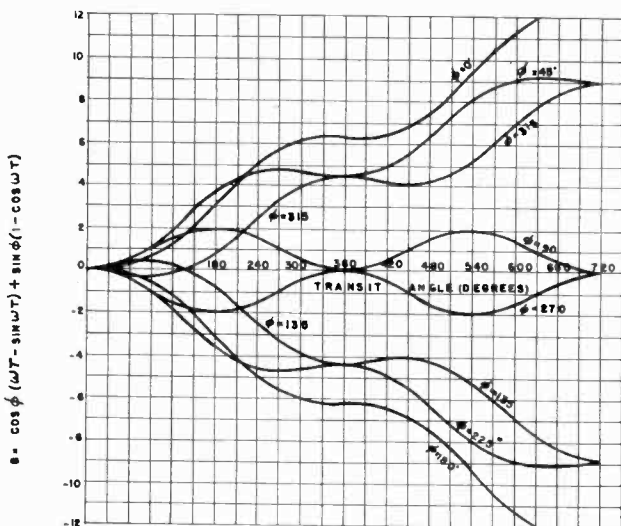

Fig. 3—Alternating component of x/k as a function of transit angle for temperature-limited parallel-plane diode.

field for zero initial velocity. This is the parabola plotted in Fig. 2. The term $(V_1/V_0)B$ is the alternating component of x/k as a function of time. This is plotted as a function of ωT for various values of ϕ in Fig. 3.

To find the electron displacement for a given transit angle, it is necessary merely to obtain the values of A

Fig. 4 shows the sum of the direct-current and alternating-current components of x/k for various departing phase angles for the ratio $(V_1/V_0)=1$. In general, the deviation of the total transit time from the direct-current transit time is less for large transit angles than for small transit angles. The reason for this is quite obvious when we realize that the alternating-current field alternately accelerates and retards the electron, while the direct-current field exerts a constant accelerating force in the same direction.

If the field has no direct-current component, we have $V_0=0$. In order to evaluate (17), it is first necessary to multiply both sides by V_0 , yielding the following:

$$x/k' = V_1 B + v_0(\omega T)/\omega k' \quad (20)$$

where

$$k' = e/\omega^2 m d = 1.76 \times 10^{11}/\omega^2 d \text{ (mks units).}$$

As an example, consider an electron moving in an alternating field between the parallel grids of a klystron oscillator. Assume that

- $d = 0.002$ meter
- $v_0 = 1.33 \times 10^7$ meters per second (corresponding to a direct-current accelerating potential of 500 volts)
- $V_1 = 300$ volts (crest of alternating voltage)
- $\omega = 18 \times 10^9$
- $\phi = 180$ degrees.

The value of x/k' is 7.35×10^3 . If there were no field between grids, the transit angle from (20) would be $\omega T = \omega x/v_0 = 2.7$ radians or 155 degrees. Assuming values of ωT in this vicinity and obtaining B from Fig. 3, we obtain the value of $\omega T = 175$ degrees or $T = 1.69 \times 10^{-10}$ seconds, which is found to satisfy (20) for the assumed conditions. It is interesting to observe that the transit angle is quite large, and the customary assumption of negligibly small transit angle, which is used to simplify the analysis of velocity modulation tubes, is seriously questionable.

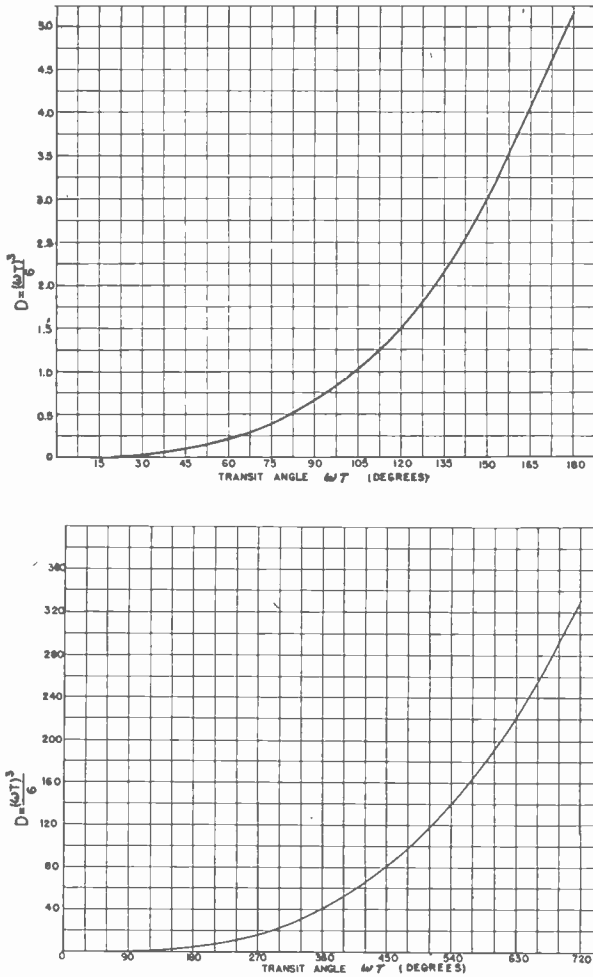

Fig. 5—Direct-current component of x/M for space-charge-limited parallel-plane diode.

SPACE-CHARGE-LIMITED DIODE

In the temperature-limited diode, a uniform field distribution in the diode was assumed. However, in the space-charge-limited diode, the electric intensity is a function of the space-charge distribution as given by (6), and the method of approach is different.

Again it is assumed that the potential has direct-current and alternating-current components. In general, the current is not a linear function of the voltage, and must be represented by a Fourier series. As an approximation for small-signal operation, the higher-order

terms in the series may be discarded, leaving only the first-order terms. Lewellyn has shown that the first-order correction to the direct-current transit time is a

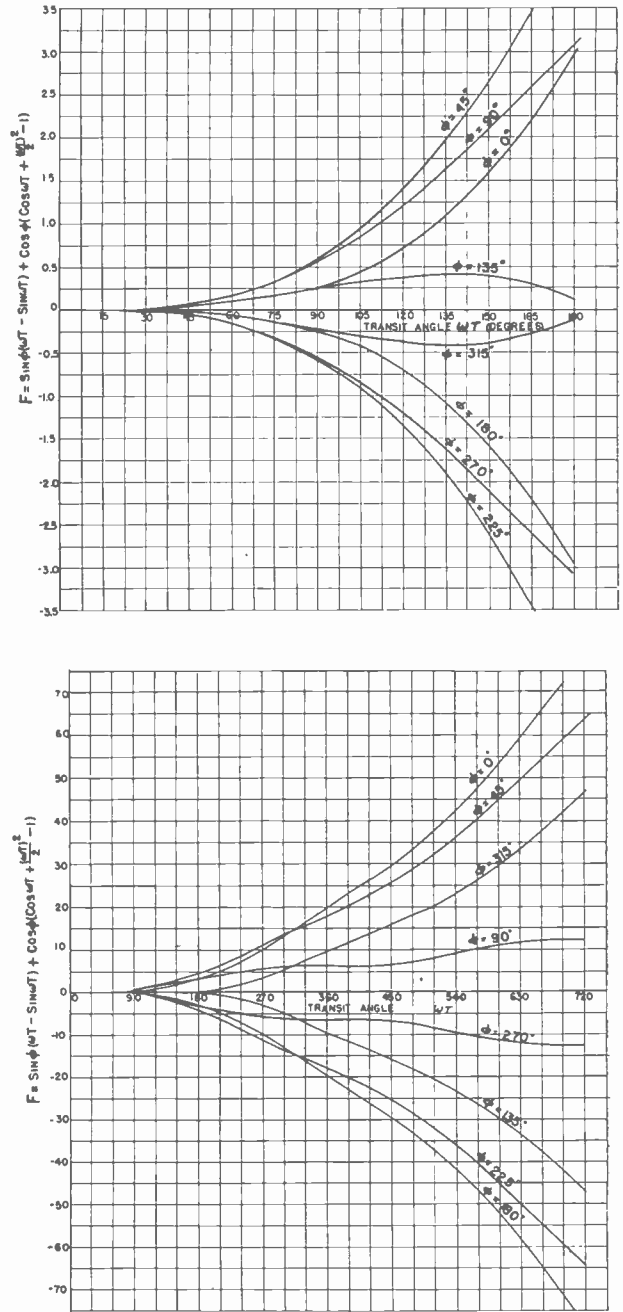

Fig. 6—Alternating-current component of x/M for space-charge-limited diode.

function only of the first-order alternating current.⁸ We therefore assume a current density of the form

$$J = J_0 + J_1 \sin \omega t \tag{21}$$

where J_0 is the direct-current component and J_1 is the amplitude of the alternating-current component.

Substituting (21) in (8), with $q = -e$, we have the equation of electron motion in terms of the current-density components

⁸ See paragraphs 18-20 of footnote reference 2.

$$d^3x/dt^3 = - (e/\epsilon m)[J_0 + J_1 \sin \omega t]. \quad (22)$$

A change of variable simplifies the mathematical analysis. Let $T = t - t_0$ and $d/dt = d/dT$, where T is again the transit time. Equation (22) then becomes

$$d^3x/dT^3 = - (e/\epsilon m)[J_0 + J_1 \sin(\omega T + \phi)] \quad (23)$$

where $\phi = \omega t_0$ is the phase angle of electron departure measured with respect to the alternating component of current. Successive integration yields the electron acceleration, velocity, and displacement equations, thus:

$$d^2x/dT^2 = - (e/\epsilon m)[J_0 T - (J_1/\omega) \cos(\omega T + \phi) + C_1] \quad (24)$$

$$dx/dT = - (e/\epsilon m)[(J_0 T^2/2) - (J_1/\omega^2) \sin(\omega T + \phi) + C_1 T + C_2] \quad (25)$$

$$x = - (e/\epsilon m)[(J_0 T^3/6) + (J_1/\omega^3) \cos(\omega T + \phi) + C_1 T^2/2 + C_2 T + C_3]. \quad (26)$$

It is assumed that at zero transit time ($T=0$) the electron leaves the cathode ($x=0$) with zero initial velocity. This permits an evaluation of the constants C_2 and C_3 in the above equations. For small-signal operation and complete space-charge-limited emission, it may be assumed that the off-cathode electric intensity is zero at all values of time. Consequently, the electron acceleration is zero when $T=0$, and the constant C_1 may be evaluated. Thus, if we set $x=0$, $dx/dT=0$, and $d^2x/dT^2=0$ when $T=0$, the constants are evaluated and (26) becomes

$$x/M = (\omega T)^3/6 + (J_1/J_0) \sin \phi (\omega T - \sin \omega T) + \cos \phi (\cos \omega T + (\omega T)^2/2 - 1) \quad (27)$$

$$x/M = D + (J_1/J_0)F \quad (28)$$

where

$$M = - (eJ_0/\omega^3 m \epsilon) = - 1.98 \times 10^{22} (J_0/\omega^3) \text{ (mks units)} \quad (29)$$

$$D = (\omega T)^3/6 \quad (30)$$

$$F = \sin \phi (\omega T - \sin \omega T) + \cos \phi [\cos \omega T + (\omega T)^2/2 - 1]. \quad (31)$$

According to the convention adopted here, the electron travels in the $+x$ direction and consequently the direct-current component of current density J_0 is negative. The term D in (28) is the value of x/M in a direct-current field with zero initial velocity. This is plotted in Fig. 5. The term F is the alternating-current component of x/M .

Curves of F as a function of ωT for various entering phase angles ϕ are shown in Fig. 6. The use of these curves in the determination of electron transit time in space-charge-limited diodes is the same as that previously described for the temperature-limited diode, except that the direct-current and alternating-current components of current density are required instead of the potentials. The current density may be taken as the total current divided by the diode area.

ACKNOWLEDGMENT

The author wishes to acknowledge gratefully the guidance of Professor W. G. Dow in a similar undertaking, and the assistance of Dr. R. E. Beam.

Attention Authors

PAPERS DESIRED FOR 1946 I.R.E. TECHNICAL MEETING

Outstanding papers on timely subjects are desired for the program of the I.R.E. Technical Meeting scheduled for January 23, 24, 25, and 26, 1946. All of the fields listed on the cover of the PROCEEDINGS should be included if the program is to be truly representative of the interests of the Institute. It will be possible to accept only a limited number of papers for the technical program. In order to receive consideration of your paper, the following rules should be followed:

1. The title and a brief abstract of the paper, similar to the summaries published at the beginning of articles in the PROCEEDINGS, but not more than 75 or 80 words in length, should be submitted as soon as possible. All abstracts must be received prior to November 10, 1945.

2. Correspondence should be sent to The Institute of Radio Engineers, 330 West 42nd Street, New York 18, New

York, marked to the attention of the Papers Committee, 1946 I.R.E. Technical Meeting.

3. Length of oral presentation should be limited to about 20 minutes. Extra time will be allowed for discussion.

4. Demonstration papers are desirable.

5. Authors are responsible for obtaining military clearance where required.

6. Submission of the papers for publication in the PROCEEDINGS of the I.R.E. is desired, but is not a necessary requirement for acceptance.

7. Papers published in any journal prior to the date of the Technical Meeting necessarily will be withdrawn from the program.

8. A condensed version or summary of the paper, including the most important illustrations, must be prepared by authors whose papers are accepted, and must be available by January 1, 1946.

Institute News and Radio Notes

Executive Committee

August 8 Meeting: At the Executive Committee meeting, held on August 8, 1945 the following were present: R. A. Heising, treasurer (acting chairman); G. W. Bailey, executive secretary; W. L. Barrow, E. F. Carter, W. H. Crew, assistant secretary; Alfred N. Goldsmith, editor; Haraden Pratt, and G. T. Royden (guest).

Correction: The spelling of the names of the following people serving on the Electroacoustics Committee should be corrected: B. D. Bower should be B. B. Bauer and H. F. Olsen should be H. F. Olson.

Membership

Approval was given to the 265 applications recommended by the Admissions Committee and listed on pages 34A-46A of the September, 1945, issue of the PROCEEDINGS.

Admissions Committee's Recommendations: Executive Secretary Bailey read the July 23 and August 2, 1945, letters from Mr. G. T. Royden, chairman of the Admissions Committee, concerning an interpretation of the Constitution regarding the procedure to be followed by the Admissions Committee when submitting its recommendations to the Board of Directors through the Executive Committee. The Executive Committee discussed the subject with Mr. Royden, who was present. Unanimous approval was given to the recommendation that there shall be handed to the Board full lists of persons approved for membership, not approved for membership on purely routine grounds, and not approved for membership on a broader or interpretation basis. Further, the report to the Executive Committee from the Admissions Committee shall give supporting data relative to each of the last-named cases, including information furnished by the references, so that the Executive Committee may consider such cases where appropriate.

Credit for Military Experience: Unanimous approval was given to the recommendation that the Admissions Committee may, at its discretion, interpret a specific number of years of military experience which includes technical activities as the partial or total equivalent of the corresponding number of years of engineering experience, and to an extent dependent on the technical quality and concentration of the applicant's work.

Editorial Department: Dr. Goldsmith presented the following matters, among others:

Papers Procurement Circularization: The membership of the Institute was circularized in relation to the preparation of new papers for the PROCEEDINGS. Between 150 and 200 persons indicated that they were already writing papers; an approximately equal number plan shortly to write papers; and a substantially equal number will write papers when security regulations permit. Thus, about 500 papers are in prospect (which indicates the correctness of the Board action in setting aside \$20,000 for the publication of

approximately one thousand extra pages of the PROCEEDINGS during the postwar period.) The tabulation of all the replies received from the membership has been carried out for the Papers Procurement Committee, and the results will be sent to the individual group and subgroup chairmen for appropriate follow-up.

Waves and Electrons: The first issue of a possible new Institute publication, WAVES AND ELECTRONS, has been printed and distributed in limited numbers.

Technical Committee Appointments: Unanimous approval was given to the appointment of technical-committee personnel.

Canadian I.R.E. Council: Approval of the Executive Committee was unanimously given to the use of the designation "Canadian I.R.E. Council."

Co-operation with Other Standardizing Groups: Unanimous approval was given to the suggestion that the I.R.E. Standards Committee and other technical committees co-operate with standardizing groups in other organizations to the end that standards adopted by all groups shall be identical or reasonably concordant.

Board of Directors Nomination Petitions

The following petition, signed by 45 voting members in good standing, arrived at the Institute office on August 13, 1945. The names of the signers are listed in the order in which they appear on the petition.

"To the Board of Directors:

"By this petition we, the undersigned voting members of I.R.E., nominate for membership on the Board of Directors for 1946 Mr. Virgil M. Graham, Williamsport, Pennsylvania.

L. E. West
W. S. Lovett
R. G. Petts
M. O. Schilling
P. W. Erickson
J. J. Wellendorf
H. L. Ratchford
H. E. Smithgall
F. L. Burroughs
W. P. Mueller
W. C. Freeman, Jr.
A. W. Keen
J. H. Seidner
C. B. Eckel
G. N. Mahaffey
J. R. Steen
H. E. Ackman
R. A. McNaughton
N. LaMont Kiser
R. F. Carlson
R. E. Palmateer
W. A. Dickinson
R. K. Gessford
W. H. Ottemiller, Jr.
M. I. Kahl
C. R. Smith
H. Melzer
W. A. Weiss
Edmund Kahl
Arthur V. Baldwin
R. A. Swan
Montoursville, Pa.
Williamsport, Pa.
Williamsport, Pa.
Williamsport, Pa.
Williamsport, Pa.
Williamsport, Pa.
Williamsport, Pa.
Williamsport, Pa.
Williamsport, Pa.
Williamsport, Pa.
Williamsport, Pa.
Williamsport, Pa.
Williamsport, Pa.
Williamsport, Pa.
Williamsport, Pa.
Williamsport, Pa.
Williamsport, Pa.
Williamsport, Pa.
Emporium, Pa.
Emporium, Pa.
Emporium, Pa.
Emporium, Pa.
Emporium, Pa.
Emporium, Pa.
Emporium, Pa.
Emporium, Pa.
Emporium, Pa.
Emporium, Pa.
Emporium, Pa.
Emporium, Pa.
Emporium, Pa.
Emporium, Pa.
Emporium, Pa.
Emporium, Pa.
Emporium, Pa.
Emporium, Pa.
Emporium, Pa.
Emporium, Pa.
Emporium, Pa.
Emporium, Pa.
Emporium, Pa.
Salem, Mass.

Herbert H. Chun
C. W. Reash
V. H. Campbell
W. R. Jones
G. L. Rishell
E. E. Overmier
Harvey J. Klumb
Maurice B. Huntington
William F. Bellow
Kenneth J. Gardner
Roy S. Anderson
Ken. L. Henderson
Howard H. Brauer
Harry E. Gordon
Salem, Mass.
Emporium, Pa.
Emporium, Pa.
Emporium, Pa.
Emporium, Pa.
Emporium, Pa.
Rochester, N. Y.
Rochester, N. Y.
Rochester, N. Y.
Rochester, N. Y.
Rochester, N. Y.
Rochester, N. Y.
Rochester, N. Y.
Rochester, N. Y.
Rochester, N. Y.

The following petition, signed by 51 voting members in good standing, arrived at the Institute office on August 13, 1945. The names of the signers are listed in the order in which they appear on the petition.

"To the Board of Directors:

"We, the undersigned voting members of The Institute of Radio Engineers, hereby nominate Mr. Royal V. Howard to the Board of Directors of The Institute of Radio Engineers, 1946-48, in accordance with Article VII, Section 1 of the Institute's Constitution.

Frederick Ireland
F. L. Hopper
Robert C. Moody
A. K. Jensen
Alan P. Chesney
C. F. Wolcott
W. W. Lindsay, Jr.
Allan A. Kees
F. R. Brace
A. E. Towne
F. P. Barnes
Hugh D. Farnsworth
D. I. Cone
Eldridge Buckingham
C. T. Anson
S. Andresen
James R. Grae
George E. Sleeper, Jr.
W. Noel Eldred
Ralph C. Shermund
Brunton Bauer
Gerhard R. Fisher
Robert I. Hatch
E. G. Danielson
Charles E. Walsh
Gilbert W. Cattell
Philip A. Ekstrand
V. Ford Greaves
Don C. Wallace
John M. Kaar
John F. Kramer
A. W. Moody
Francis S. Benson
Ernst H. Schreiber
C. R. Skinner
Paul F. Johnson
G. Stewart Paul
L. J. Black
W. W. Hanscon
H. J. Scott
Edward A. Schlueter
Wm. Aboussleman
Frank M. Kennedy
J. M. Baldwin
Arthur G. Forster
Gabriel M. Giannini
Edward L. Gove
S. S. Mackeown
Harry R. Lubcke
John K. Hilliard
Lester E. Reukema
Hollywood, Calif.
Pasadena, Calif.
North Hollywood, Calif.
Montrose, Calif.
Encino, Calif.
Beverly Hills, Calif.
West Los Angeles, Calif.
San Francisco, Calif.
Berkeley, Calif.
San Mateo, Calif.
San Francisco, Calif.
Berkeley, Calif.
San Francisco, Calif.
San Francisco, Calif.
El Cerrito, Calif.
Oakland, Calif.
San Mateo, Calif.
San Mateo, Calif.
Palo Alto, Calif.
Palo Alto, Calif.
San Francisco, Calif.
San Francisco, Calif.
San Anselmo, Calif.
Berkeley, Calif.
Vallejo, Calif.
San Francisco, Calif.
Long Beach, Calif.
Palo Alto, Calif.
San Francisco, Calif.
San Francisco, Calif.
San Francisco, Calif.
Los Angeles, Calif.
San Francisco, Calif.
Altadena, Calif.
Oakland, Calif.
Oakland, Calif.
San Francisco, Calif.
Berkeley, Calif.
Oakland, Calif.
North Hollywood, Calif.
Los Angeles, Calif.
Salt Lake City, Utah
Oakland, Calif.
West Los Angeles, Calif.
North Hollywood, Calif.
Pasadena, Calif.
Hollywood, Calif.
West Los Angeles, Calif.
Berkeley, Calif."

I.R.E. People



HARADEN PRATT

HARADEN PRATT

Haraden Pratt (A'14-M'17-F'29), vice-president and chief engineer of the American Cable and Radio Corporation, on July 26, 1945, was elected chairman of the Radio Technical Planning Board, one of the world's leading engineering groups concerned with the technical future of the radio industry and related services. Mr. Pratt will take office October 1, 1945. He succeeds Dr. W. G. R. Baker, vice-president, General Electric Company, who has been chairman since the RTPB was organized in September, 1943.

Long recognized as one of the leading contributors to radio, Mr. Pratt now assumes a position of even greater influence with an organization that is responsible in the United States for the scientific development of radio as applied to both communications and industry. The Radio Technical Planning Board is a nonprofit group, sponsored by The Institute of Radio Engineers, the Radio Manufacturers Association, the American Institute of Electrical Engineers, and a long list of major organizations in allied fields.



WILLIAM S. HALSTEAD

Mr. Pratt, in addition to his position with the American Cable and Radio Corporation, is vice-president and chief engineer, Mackay Radio and Telegraph Company, All America Cables and Radio, Inc., The Commercial Cable Company; vice-president, Federal Telephone and Radio Corporation, all associates of the International Telephone and Telegraph Corporation.

During a career which started on the Pacific Coast in 1906, Mr. Pratt has been a prominent figure in the growth of radio both here and abroad. He engineered the construction of some of the earliest and largest radio installations in the country, and has served with various divisions of the United States Government—the Bureau of Steam Engineering, Navy Department; and the Bureau of Standards, Department of Commerce. Mr. Pratt received his degree at the University of California, and joined the Federal Telegraph Company, a predecessor company of the Federal Telephone and Radio Corporation, in 1920. Eight years later he became chief engineer of Mackay Radio and soon thereafter was made vice-president.

In his international activities concerned with radio, Mr. Pratt was company representative at meetings of the International Radio Consultative Committee in Bucharest in 1937, and at the International Radio and Telegraph Conference in Cairo in 1938. He also served as United States Government technical adviser at the International Radio Conference at Washington in 1927, and on the Consultative Committee on Radio at Copenhagen in 1931.

At the time of his election to the chairmanship of the Radio Technical Planning Board today, Mr. Pratt was a delegate of The Institute of Radio Engineers to the RTPB and Chairman of the Panel on Radio Communications of that group.

Mr. Pratt is a past president of The Institute of Radio Engineers, Secretary of the I.R.E., and a member of its Board of Directors. In 1944 he was awarded the I.R.E. Medal of Honor.

WILLIAM S. HALSTEAD

William S. Halstead (M'38-SM'45), president of the Halstead company, will serve Farnsworth Television and Radio Corporation as consulting engineer on radio communications equipment and traffic control as well as on other phases of electronics. Farnsworth recently acquired all of the assets of the Halstead Traffic Communications Corporation, thus uniting two pioneering engineering organizations.

G. R. SHAW

G. R. Shaw (M'40-SM'43) recently was appointed chief engineer of the RCA Tube Division to be located at Harrison, N. J.

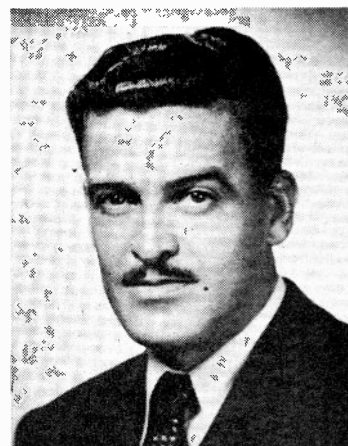

JOSEPH H. LANDELLS

JOSEPH H. LANDELLS

Joseph H. Landells (A'41) of San Francisco was named communications application engineer at San Francisco for the Westinghouse Electric Corporation on August 22, 1945. In his new post, Mr. Landells will be responsible for Westinghouse coverage of the communications industry and radio broadcast stations throughout the San Francisco Bay area.

A native of Winnepeg, Canada, Mr. Landells first joined Westinghouse at San Francisco in 1928 as an order interpreter. In 1930 he resigned to specialize in radio communications work. From early 1942 through the following year, he served as a co-ordinator on the Army's training program with the San Francisco Unified School District and as an instructor in radio engineering for evening classes at Stanford University. He joined the Marines in December, 1943, and served until May, 1945, as an instructor in electronics.



G. R. SHAW



HAROLD C. VANCE

HAROLD C. VANCE

Harold C. Vance (M'30), who has been appointed manager of the direct sales department of the RCA Tube Division, will supervise the sales of all tube types to commercial broadcasters, air lines, police, educational institutions, and industrial users.

He joined the RCA organization in 1930, as manager of commercial broadcast and police transmitter sales in the Middle Western states. In 1937 he was transferred to RCA Victor's Camden, N. J., headquarters to direct sales of facsimile, frequency modulation, and special commercial equipment. Shortly after Pearl Harbor, Mr. Vance was given a special assignment as manager of the Tube Division's Navy apparatus contract work. Later, when material for commercial tube construction became critical, he supervised the rebuilt tube activities which enabled many of the nation's broadcasters to maintain schedules despite acute tube shortages.

Mr. Vance is a graduate of Washington State College, where he received a degree in electrical engineering. While a student there he helped construct KWSC, which is operated by the school, and has been called the first educational station in the country.



RAYMOND C. FANCY

RAYMOND C. FANCY

Raymond C. Fancy (A'43-M'45), formerly with the radio engineering section of the Army Services Forces Headquarters, Sixth Service Command, Chicago, has been appointed to head a new division of Barnes and Reinecke, industrial designers and engineers, Chicago.

Mr. Fancy's war work included radio engineering on aircraft and radio range stations for the Army Air Forces, as well as design, development and inspection of radio materials and equipment for the Army Signal Corps and Army Engineers. He will be in charge of instruction manual and visual service aids production for his company. At one time associated with WCFL, CBS, and with WJJD as chief engineer, Mr. Fancy's most recent projects have been confined almost exclusively to writing and preparing instruction manuals on U. S. Navy panoramic radio equipment.



FRANCIS X. RETTENMEYER

The appointment of Francis X. Rettenmeyer (A'26-M'29-SM'43-F'44) as chief components engineer has been announced by the Federal Telephone and Radio Corporation, affiliate of the International Telephone and Telegraph Corporation. Mr. Rettenmeyer has been constructively active in the fields of radio receivers and wired-radio systems for power and telephone lines. His work will involve the engineering of selenium rectifiers, quartz crystals, transformers and coils, special-purpose and transmitting tubes, "Intelin" cables, and other components. He joined the Newark organization July 1, 1945.

Previously, Mr. Rettenmeyer had been for ten years chief receiver engineer and staff engineer for the RCA-Victor Division of the Radio Corporation of America, at Camden, N. J., his work covering the design and manufacturing in six plants of component parts, radio transmitters and receivers, and sound-motion-picture equipment. He also spent ten years with Bell Telephone Laboratories, where he was responsible for the design and development of all radio receivers, navigation equipment, mobile and fixed unattended station radio-communication equipment, ship-to-shore radio receivers and marine direction finders, power-line-carrier telephone equipment, and measuring equipment. He developed a wired-radio system to be used with the transmission of entertainment programs over power lines or telephone systems without interruption of the regular telephone service.

Born in Oklahoma and educated at the University of Colorado and Columbia in New York, Mr. Rettenmeyer first became interested in electrical engineering while serving in the Naval Aviation Section at San Diego, California during the first World War. Upon receiving his discharge he proceeded at once to the University of Colorado and emerged with a science degree in electrical engineering. This he later supplemented

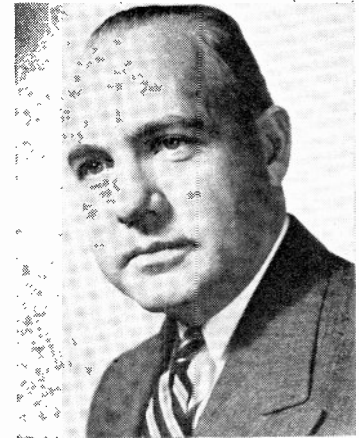

FRANCIS X. RETTENMEYER

with a Master's degree. Today he holds about thirty patents on radio and wire communication, and is the author of some thirty-five technical papers of note on radio and allied subjects. He is a Fellow of the Radio Club of America and a member of the Institute of Aeronautical Sciences, Franklin Institute, the National Aeronautics Association, Tau Beta Phi, and Eta Kappa Nu.



ROBERT CORENTHAL

First Lieutenant Robert Corenthal (A'41) has returned to the Terminal Radio Corporation, 85 Cortlandt Street, New York City, to resume his position as advertising manager and sales engineer, after three years as a pilot in the Army Air Forces.

Lieutenant Corenthal joined the Air Forces on June 4, 1942, and was stationed in this country at various Army airfields until sent overseas in February, 1944, as pilot of a Flying Fortress. He served in Africa and Italy in this capacity and participated in the first shuttle bombing missions to Russia. On his 42nd mission, the heavy bomber he was piloting was shot down August 28, 1944, over Austria. After parachuting to safety, he and his crew were captured and imprisoned



ROBERT CORENTHAL

in Germany, until liberated on April 29, 1945, by General Patton's Third Army.

Lieutenant Corenthal has been awarded the Distinguished Flying Cross, Air Medal with three Oak Leaf Clusters, Presidential Unit Citation, and wears Five Battle Stars on his European Theater campaign ribbon.

Previous to joining the Air Forces, Lieutenant Corenthal had been Terminal Radio Corporation's advertising manager for four years. During this time, he was well known in amateur radio and private flying circles.



C. E. WELSHER

C. E. Welsler (A'26) has been appointed field supervisor in the electronic apparatus section of the industrial department of the RCA Service Company. He will be responsible for the accumulation and distribution of technical data and training of field personnel in the electronic-heating field. Prior to his present assignment, he was a field specialist on electronic-heating equipment, and was earlier engaged in military electronic equipment installations at various Navy Yards, as a member of his organization's Government department.



JACK KAUFMAN

Jack Kaufman (A'30-SM'44) has been named head of the San Francisco office of the Aireon Manufacturing Corporation. This Company operates a large electronics division in Kansas City, Kansas, and a hydraulics division in Burbank. It also maintains a research laboratory at Greenwich, Connecticut. The new San Francisco office will serve railroads, mobile transportation, fishing fleets, and steamship companies on the Pacific Coast, and various foreign industries.

Mr. Kaufman, a graduate of the University of California in 1917, has been engaged for a number of years in electronics in San Francisco. He was formerly president of the pioneer firm of Heintz and Kaufman, Limited, and was executive vice president of Globe Wireless, Limited. He was president of the West Coast Electronic Manufacturers' Association, San Francisco Council, and was vice-president of the coastwide group of the same association. Until recently he was a member of the Industry Advisory Committee with the Board of War Communications.



NEW YORK SECTION RADIO PIONEERS' PARTY

Nostalgic reminiscences of the "good old days" of the early century, when "tubes" were only supporting cylinders for tuning coils and federal regulations applied to many things but not to radio, will be the order of the evening on November 8, when the New York Section of the I.R.E. holds its 1945 Radio Pioneers' Party at the Hotel Commodore. Louis G. Pacent, as general chairman, is directing the event.

On that night, radio engineers will take a complete holiday from the serious problems of their profession. To sustain this mood, planned entertainment in keeping with the theme of the evening party will be supplemented by impromptu skits and brief

In Appreciation

The Editorial Department of The Institute of Radio Engineers desires at this time to make public acknowledgment of its thanks to the authors of papers published in the PROCEEDINGS particularly during the recent years during which major difficulties have been experienced by all concerned. The authors, without exception, have proved most co-operative in acceding to the wartime requests necessarily made by the Editorial Department; and they have accepted all the economies and inconvenience which it was necessary for the PROCEEDINGS to put into effect in order to present the greatest quantity of highest caliber material to the membership within the provisions of Governmental regulations and restrictions.

The Editorial Department, while fully realizing the need for certain wartime measures, has been in complete sympathy with the authors and has recognized that, because of wartime limitations, papers frequently were not presented to our readers in the most impressive or clear manner. With the lifting of paper restrictions, we shall return, as promptly as possible, to a better grade of paper and a superior presentation of articles.

To our authors, we, in the Editorial Department, wish to express a hearty "Thank You" for your fine co-operation and for your patience and understanding of the difficult problems which we all have encountered.



addresses that will bring back recollections of the years from 1900 to 1925. There will be few if any serious talks, and those that find their way into the program will be of the early days and the men who were then making history.

One of the mementos of the occasion that will be treasured by those who attend will be a bound booklet containing a none-too-serious but strictly truthful history of wireless, together with a wealth of illustrations unearthed from dusty files, cartoons of veterans, and excerpts from pioneer magazines.

The banquet, which will be held in the Grand Ballroom of the Commodore, will be preceded by a cocktail party. Because of space limitations, attendance has been set at 1000 maximum.

Assisting Mr. Pacent in preparing for the Party are George Lewis, general vice chairman; Ralph R. Batcher, general secretary; Edward J. Content, general treasurer; and the following committee chairmen: Arrangements, Harry C. Gawler and John Q. A. Holloway; Entertainment, Roger M. Wise; Finance, George B. Hoadley; Prizes, Dorman D. Israel; Presentation, O. H. Caldwell; Refreshments, Paul F. Godley; Historical, George H. Clark; Press and Publications, E. L. Bragdon.

Further details of the Radio Pioneers' Party may be obtained from Mr. Batcher, Room 635, 480 Lexington Avenue, New York 17, N. Y.

ROCHESTER FALL MEETING

The tentative program for an informal Rochester Fall Meeting, to be held on November 12 and 13, 1945, in Rochester, New York, is given below. The committee in charge extends a cordial invitation to all interested engineers to attend this meeting, which promises to be of great interest.

PRELIMINARY PROGRAM 1945 ROCHESTER FALL MEETING

OF MEMBERS OF THE
RMA ENGINEERING DEPARTMENT AND OF
THE INSTITUTE OF RADIO ENGINEERS
The Sheraton Hotel, Rochester, New York
November 12 and 13, 1945

Monday, November 12

- 8:30 A.M. Registration
- 9:30 A.M. Technical Session (W. L. Everitt Presiding)
 - A Coaxial Modification of the Butterfly Circuit
 - E. E. Gross
 - General Radio Company
 - Germanium Crystals
 - Edward Cornelius
 - Sylvania Electric Prod., Inc.
- 12:30 P.M. Group Luncheon
- Committee Luncheons
- 2:00 P.M. Technical Session (J. E. Brown Presiding)
 - Microwave Radar
 - Donald G. Fink
 - McGraw-Hill Publishing Co.
 - High-Quality Sound Recording on Magnetic Wire
 - L. C. Holmes
 - Stromberg-Carlson Company
- 4:00 P.M. Committee Meetings
- 6:30 P.M. Group Dinner
- 8:15 P.M. General Session (George Town Presiding)
 - The Aurora and Geomagnetism
 - C. W. Gartlein
 - Department of Physics
 - Cornell University

Tuesday, November, 13

- 8:30 A.M. Registration
- 9:00 A.M. Technical Session (R. A. Hackbusch Presiding)
 - Report of RMA Eng. Dept.
 - L. C. F. Horle
 - RMA Data Bureau
 - Industry Standardization Work in Television
 - D. B. Smith
 - Philco Corporation
- 12:30 P.M. Group Luncheon
- Committee Luncheons
- 2:00 P.M. Technical Session (L. M. Clement Presiding)
 - Television—A Review of Technical Status
 - E. W. Engstrom
 - RCA Laboratories
 - War Influence on Acoustic Trends
 - Hugh S. Knowles
 - Jensen Radio Mfg. Co.
- 4:00 P.M. Committee Meetings
- 6:30 P.M. Stag Banquet
 - R. M. Brophy—Toastmaster
 - The Future of Radar
 - L. A. DuBridg
 - Radiation Laboratory
 - Massachusetts Inst. of Tech.

Short-Wave Radio Is Key to Postwar Progress

Optimistic forecasts of expanded postwar short-wave radio activities, in frequency modulation, television, international communications and high-frequency heating for industrial processing and manufacture, are made by Walter Evans (M'36-SM'43), vice-president in charge of radio, radar, and electronics activities of the Westinghouse Electric Corporation, Baltimore, Maryland.

The greatest single factor contributing to this advance, he said, will be the vastly improved "know how" acquired in this promising field during the industry's record war production.

"Every child understands that World War II is a great mechanized conflict," Mr. Evans explained, "but even a great many adults do not realize how completely it has become a war of electronics as well. Practically every phase of both offensive and defensive warfare, material tests, quality control, production-line manufacture, telephone and telegraph communication, radio, radar, and medical and surgical safeguards, depends upon electronics applications.

"We have made great progress in all of these fields, and since nearly all of them depend upon operation in the short-wave spectrum, one can easily see how lessons learned during the war give promise of rapid and, perhaps, spectacular progress after victory."

This forecast came on the twenty-first anniversary of the "coming of age" of short-wave communication, as Mr. Evans put it, pointing out that although the science had been known many years earlier, it was not until June, 1924, that it attained general acceptance among world radio authorities.

That recognition was won, he recalled, in a dramatic demonstration by the late Dr. Frank Conrad, assistant chief engineer of Westinghouse and one of a group of Americans attending a conference of international communications magnates meeting in London to consider a radio link between Europe and South America.

After lengthy discussions of an ultra-long-wave link, Dr. Conrad invited several delegates, among them a former ship's wireless operator, to his hotel room where, using the curtain rod as an antenna, he had the operator copy telegraph news sent by short-wave from Pittsburgh. Informed next day by the still-amazed operator-delegate of the sensational test, the conference shortly thereafter decided to build a short-wave link and out of this recognition came the general acceptance responsible for all modern short-wave radio.

Turning to war and postwar uses, Mr. Evans continued: "Without short wave we would have no radar, that near-magic development of the war which safeguards ships and planes from surprise attack and enables them to track down enemy craft; no static-free frequency-modulation radio; no television; no low-power long-distance communications; and no dielectric heating which today bonds plywood for PT boat hulls and serves a hundred other military and civilian uses.

"Each of these parts was known before the war and limited development was under way but it remained for the war's urgency



WALTER EVANS

to hasten their refinement and broaden their applications. Advances of two normal decades have been packed into a half dozen years of war and preparations for war and as a result VJ Day will find us with almost inexhaustible electronics 'know how' waiting to be harnessed to peacetime tasks."

Pointing out that electronics advances will bring not only the devices for better living, but by its widespread employment, purchasing power to afford and enjoy them, Mr. Evans declared:

"Frequency-modulation radio service, an accomplished fact before the war, will be expanded to bring this noiseless reception to listeners in every metropolitan center across the land. Inquiries in our industrial electronics division for frequency-modulation transmitters indicate widespread interest on the part of broadcasters, and our postwar transmitters and home receivers will include all the refinements developed in producing millions of these units for military planes and tanks.

"Our war-paced engineering and production of radar will yield proportionate advantage for television, its scientific first cousin. All answers for a completely satisfactory black-and-white television service already are at hand and war-learned lessons will speed development of improved color television."

Mr. Evans sees short wave playing an increasingly important part in world affairs after victory with international short-wave stations fostering mutual understanding and good will among nations.

"The war has taught us that these long-range stations, which know no barriers of geographical frontiers or racial prejudice, can become powerful adjuncts of every nation's State Department or Foreign Office. Hitler and Hirohito demonstrated their maximum abuse. It is up to postwar planners to shape this force to maximum good among nations.

"Operation will be improved because of our experiences in wartime communications. This nation's short-wave stations, including our own WBOS at Boston, have been and still are in the service of the Office of Inter-American Affairs and the Office of War Information. This government operation, we believe, should be and probably will be continued for some time after victory because of the importance of these stations in

shaping the mutual understanding and trust between nations without which there can be no lasting peace.

"However, Westinghouse is of the firm opinion that ultimate operation of these outlets must be left to private ownership, in the best American traditions; although a continuing, but temporary, over-all government supervision of programs seems desirable in the early years of restored private operation to guard against international incidents and misunderstandings."

High-frequency heating, the electronics science's newest contribution to better-quality-at-lower-cost manufacture, also will reflect war developments in its postwar applications, Mr. Evans said.

"Aided most by short-wave development will be its dielectric applications which have to do with nonconductor materials," he pointed out. "Already used to bond plywood, cure plastics, and dry nylon yarn, this newest tool of industry will find hundreds of new opportunities to improve production and reduce costs for postwar manufacturers.

"Also benefiting from the lessons of war production will be induction heating which is not dependent upon ultra-high-frequency operation. This wonder process which has been reflowing tin, at a saving of up to 65 per cent of this war-scarce material, will provide new and dependable manufacturing shortcuts in heat-treating metals, annealing electrical steels, brazing and welding and many other essential shop operations."

CHESTER W. CALDWELL

Chester W. Caldwell (M'41-SM'43), associate professor of electrical engineering at Purdue University, died suddenly at the age of 42 on June 6, 1945, following a heart attack suffered while he was conducting a class in electronics. Professor Caldwell was one of the leaders in the electronics field, and for the past two years had been in charge of extension work in electrical engineering in addition to his instructional and research duties.

He was born in Howard County, Indiana, on August 3, 1902, and took special work in education at Indiana University and Marion College before taking up the study of electrical engineering at Purdue. He was graduated with the degree of B.S. in electrical engineering in 1931, and in 1938 completed work for the Master's degree in electrical engineering.

During the last two years of his undergraduate days, he was named a research assistant of the Engineering Experiment Station at the University, specializing in television. Following his graduation, he accepted a position at the University of South Dakota, as head of the physics and electrical engineering departments.

In 1934, he returned to Purdue as an instructor, and was named assistant professor in 1938 and associate professor in 1941. He was the author of many authoritative technical articles and textbooks, largely in the field of electronics and radio. He was a member of Tau Beta Pi, Eta Kappa Nu, Sigma Xi, and the American Institute of Electrical Engineers.

Patents Available for License by Alien Property Custodian

A wealth of technical information about electronics has been made available to American manufacturers and research workers by the publication of abstracts of more than 45,000 alien patents now controlled by the Government. More than 3000 of these United States patents relate to radio. They were issued to inventors in Germany, Italy, Japan, and other enemy and enemy-occupied countries prior to the war, and most of them have now been made available for use by American citizens on a nonroyalty, nonexclusive-license basis.

A few of the most interesting patents are listed below.

Patent No.	Class	Title	Inventor	Assigned To
1,967,306	179-171	Testing Device for Modulated High Frequency	Karl Hallen	C. Lorenz A.G.
1,987,124	250-20	Tuning Control	Paul Muller	Siemens and Halske A.G.
2,157,677	250-11	Receiver for Observing Two Different Signals	Wilhelm Runge	Telefunken Gesellschaft
2,169,742	250-11	Receiving Apparatus for Direction Finding	Hans Scharlan	Telefunken Gesellschaft
2,221,105	178-44	Electric Filter	Rudolf Otto	Fides Gesellschaft
2,252,066	250-20	Interference-Responsive Circuit	George Dallos	United Incandescent Lamp and Electrical Company (Hungary)
2,234,806	178-6.8	Method of Electronoptically Enlarging Images	Martin Ploke	Zeiss Ikon A.G.
2,265,291	179-171	Broad-Band Amplifier	Ulrich Knick	Fernseh G.m.b.H.

The inventions disclosed in these patents deal with circuits, tubes, antennas, and equipment of all kinds including direction finding, television, and ultra-short-wave transmission and reception. Many of them had been assigned prior to the war to famous European manufacturing concerns such as Telefunken Gesellschaft, Siemens and Halske A. G., C. Lorenz A. G., Fernseh G.m.b.H., Gustave Ganz and Company, and Julius Pintsch. There are patents relating to radio transmission and reception, interference elimination, multiplex communication, microphones, headsets and loudspeakers, wave filters, amplifiers, tuning devices, capacitors, frequency modulation, and distortion-correction circuits.

Patents issued to German inventors constitute about two thirds of the total number,

but in certain fields, Italy is represented by a large number of inventions.

Abstracts of all of the vested patents are offered for sale by the Alien Property Custodian at nominal prices. These abstracts are arranged by United States Patent Office classes, and those containing patents relating to radio are listed below.

Class No.	Title	Class Abstract Price
116	Signals and Indicators	10¢
177	Electric Signaling	10¢
178	Telegraphy	50¢
179	Telephony	50¢
181	Acoustics	10¢
250	Radiant Energy	\$1.00
274	Sound Recording and Reproducing	10¢

Orders for abstracts may be sent to the Office of Alien Property Custodian, Field Building, Chicago 3, Illinois.

Complete sets of abstracts as well as copies of all vested patents are available for examination in any of the Alien Property Custodian Patent Libraries listed below.

Washington, D. C. National Press Bldg. 14th and F Sts.

Chicago 3, Ill. Field Bldg. 135 S. LaSalle St.

Kansas City, Mo. 4049 Pennsylvania Ave.

A copy of the "Index and Guide to Vested Alien Patents" may be had gratis by addressing any of these libraries.

Correspondence

Correspondence on both technical and nontechnical subjects from readers of the PROCEEDINGS OF THE I.R.E. is invited subject to the following conditions: All rights are reserved by the Institute. Statements in letters are expressly understood to be the individual opinion of the writer, and endorsement or recognition by the I.R.E. is not implied by publication. All letters are to be submitted as typewritten, double-spaced, original copies. Any illustrations are to be submitted as inked drawings. Captions are to be supplied for all illustrations.

Phase Inverter

The circuit shown below is a simple, direct approach to the problem of obtaining two equal and out-of-phase voltages for feeding a balanced circuit without using transformers. It consists of a cathode-follower circuit in which a resistance equal to the cathode resistance is inserted in the plate lead of the tube. Equal and out-of-phase voltages are then developed across the plate and cathode resistors when a signal is applied to the grid of the tube. Needless to say, this arrangement is best suited to triode-type vacuum tubes, since the screen-grid current cannot interfere with the equal-

ity of plate and cathode currents in a triode. Inasmuch as this is a circuit having almost total feedback, the output voltages are affected by tube characteristics only as a second-order effect, and even this does not

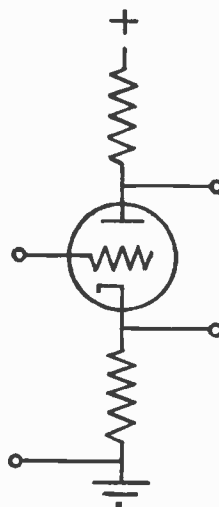

interfere with the equality or phase opposition of the two voltages generated. The circuit should prove useful for frequencies from zero up to the point where distributed capacitances affect the equality or phase of the two voltages. It should prove specially advantageous where it is desired to feed a balanced amplifier from an input one side of

which is grounded. This should prove useful for direct-current amplifiers in which the input phase-inverting stage frequently presents difficulty. The voltages developed across either resistor are given by the following equations:

$$V_0 = V(G_m R_1) / (1 + R_1 G_m + 2R_1 / R_p)$$

or

$$V_0 = V[(R_1 G) / (R_p + 2R_1 + R_1 G)]$$

where V_0 = voltage developed across resistor

V = input voltage

R_1 = resistance across which signal is developed, ohms

R_p = plate resistance of tube, ohms

G_m = transconductance of tube, ohms

G = gain of tube

D. L. DRUKEY
17 Outer Drive
Oak Ridge, Tenn.

I.R.E.—A.I.E.E. LECTURES

The New York Sections of the I.R.E. and A.I.E.E. have planned a series of lectures on the subject RADAR to be given during October and November in the Engineering Societies' Auditorium, 33 W. 39th Street, New York City. For further information, send a self-addressed stamped envelope to G. B. Hoadley, 85 Livingston Street, Brooklyn 2, New York, or to A.I.E.E. headquarters.

Tridimensional Equivalent Circuits

In the *General Electric Review*, no. 3, 1944, and PROCEEDINGS of the I.R.E. pp. 284-299; May, 1944, there is published a notable work by G. Kron, S. Ramo, J. R. Whinnery and McAllister on tridimensional equivalent circuits, used for approximate solution of the Maxwell equation.

In connection with the interest manifested in this problem in the United States we desire to call the attention of your writers to some work in this same field which has been published in the Soviet Union by my associates Professor Doctor of Technical Science L. P. Rutenmakher and Candidate in Technical Science Docent Yu. G. Tolstov.

1. L. P. Rutenmakher, "Artificial electric model of a multidimensional system." Address before Academy of Science U.S.S.R., vol. 31, no. 3., p. 198; 1940. In Russian and German languages.

2. L. P. Rutenmakher, "Electrical modeling of physical phenomena," *Electricity*, no. 5, 1940.

3. L. P. Rutenmakher, "Electrical modeling of physical phenomena for solution of boundary problems in mathematical physics," *Technical Physics*, vol. 12, nos. 2-5, p. 47; 1942.

4. L. P. Rutenmakher, "Electrical modeling—The Electro-Integrator." Book published by the Academy of Science U.S.S.R., (to be distributed in the United States for promoting cultural relations with foreign countries.)

5. Yu. G. Tolstov, "Use of the electrical modeling method for solving certain cases in underground hydraulics," *Technical Physics*, no. 10, 1942.

6. Yu. G. Tolstov, "Conformal transformation of doubly bounded fields with the aid of the electrical integrator." Report of the Academy of Science U.S.S.R., no. 7-8, 1944.

In these works is developed the theory of multiple-circuit electrical models, consisting of various combinations, for concentrating the parameters of electric circuits.

The distribution of current and potentials in these artificially assembled models of multidimensioned fields of different configurations gives an approximate representation of differential equations in mathematical physics of the elliptic, parabolic, and hyperbolic types, with an arbitrary number of independent co-ordinates for different boundary conditions.

Use of these models permits solutions of the equations of Maxwell, Fourier, Poisson, Laplace, Bigazh-Monichesky, and others.

With a specially designed electrical integrator, consisting chiefly of resistances and capacitors, solutions have been found for numerous cases in the fields of electrical engineering, thermodynamics, hydraulics, aerodynamics, and the like.

Solutions have also been found for general problems of arbitrary boundary conditions, spatial and time, and for solving non-homogenous equations.

By introducing special co-ordinates, not related to the spatial arrangement of elements of the model it has been possible to build models for "connected tridimensional and four-dimensional fields," "multiple-

leaved (laminar) surfaces," "Iman and other complex geometric forms," which are encountered in mathematical physics.

It has recently been possible to use mathematical apparatus with the Fredholm integral equations for analyzing the properties of multidimensioned models, and also to set up special models for solving integral equations of arbitrary types.

We attach much importance to the work of G. Kron and others as an indication of the rapid development of the problem of the electrical modeling of physical phenomena.

May the international co-operation between investigators, in the United States and the Soviet Union and others of the United Nations, which has been carried on under difficult conditions in wartime, continue to progress successfully in this field, which is now in the first stages of its development and has bright prospects.

G. M. Krijanovsky

Director of the Energy Institute of the Academy of Science U.S.S.R.—Moscow.
Active member of the Academy of Science U.S.S.R.

High-Frequency Error Curves for Adcock Radio Direction-Finder Arrays

When determining errors in a radio direction-finder station located in a new, untested location, it is helpful to know, for a given signal and observed bearing, just how much error is due to actual "site trouble" and how much is due to antenna-array error. If the antenna error is known, the exact magnitude of remaining site errors may then be considered and conclusions drawn accordingly.

The following method of measuring errors in Adcock antenna arrays may prove useful to some field engineers engaged in high-frequency direction-finding work.

It is well known that the average high-frequency crossed Adcock array, using a goniometer, is subject to a varying number of degrees error in certain directions, when taking bearings on different frequencies, the errors being due primarily to the physical spacing between the antennas.

Many engineers not too familiar with the problem figure intuitively that the ratio of North-South antenna pair pickup to East-West pickup is such that, if plotted out vectorially, would enable them to measure the bearing of the signal by noting the angle of the vector resultant. This view is useful to present the approximate operation and theory of the system, but to find the exact bearing that a given antenna array will produce for a signal from a given direction, we must figure the exact ratio of North-South pickup to East-West pickup and then find the resultant angle exactly. It will then be noted that this angle may be several degrees different than the true angle or bearing of the signal.

Some engineers have been known to believe that the crossed-Adcock system using a goniometer is unsuitable for use with frequencies so high as to make the greatest antenna spacing more than a half wavelength, but by using the method we will now discuss, it will be seen that a correction

curve may be drawn which will correct exactly all errors due to the spacing of the array; thus an array spaced a half-wavelength at perhaps 15 megacycles may be used effectively with good results up to about 20 megacycles.

Prior to drawing the curve, we must choose the frequency, have the antenna spacing in feet (S), and then, using the following data, find instrument bearings for the true bearings from 0 to 45 degrees, in steps of not more than 5 degrees. The two columns of "true" and "observed" bearings will then be all that is necessary for drawing the curve. It is only necessary to plot the error curve up to 45 degrees, as the same values and curve, inverted, may be used from 45 to 90 degrees, and the 0- to 90-degree curve is the same as the 90- to 180-, 180- to 270-, and the 270- to 360-degree curve. The four antennas, or towers making up the array will be assumed to be placed on true North, East, South, and West and will be abbreviated N, E, S, and W.

To find the instrument (antenna) bearing (O) of any true bearing (θ), we start by finding the maximum phase difference between the North and the South antenna, assuming the signal to be coming from true North,

$$\text{maximum phase difference (N-S) in degrees} = (S \cdot 109.73) / L$$

where S is the spacing N-S in feet and L is the wavelength in meters. The value 109.73, a constant henceforth called K , represents pi divided by the ratio of meters to feet (3.28).

Knowing the phase difference N-S for a signal from North, we can easily find the phase difference N-S when the signal is arriving from any other angle θ by

$$\text{actual phase difference N-S} = \cos \theta [(S \cdot K) / L]$$

and for the same signal and same bearing θ we may say

$$\text{actual phase difference E-W} = \sin \theta [(S \cdot K) / L].$$

We now have the phase difference in degrees for N-S and E-W for a wavelength L and a bearing θ . We know that the actual pickup varies from maximum when the antennas are spaced 180 degrees, to 0 when spaced 0 degrees, thus, assuming our wave to traverse the spacing S as a sine curve, we see that

$$\text{actual pickup (N-S)} = \sin \frac{1}{2} [(\cos \theta SK) / L] \quad (1)$$

$$\text{actual pickup (E-W)} = \sin \frac{1}{2} [(\sin \theta SK) / L]. \quad (2)$$

Knowing now the exact ratio of the N-S and E-W pickups, we see that the resultant of a vector using these figures will give us the approximate instrument reading. However, to be more exact we may say

tangent of the resultant angle

$$= \frac{\sin \frac{1}{2} (\cos \theta SK / L)}{\sin \frac{1}{2} (\sin \theta SK / L)} \quad (3)$$

But as we wish to find the bearing from North rather than the angle of our vector, we may say that the bearing of the resulting angle in (3) is equal to (90 degrees - θ) or, that the true bearing from North is the cotangent* of the resulting angle in (3). Using logs, our complete formula becomes

$$\log \cot O = \log \sin \frac{1}{2}(\cos \theta SK/L) - \log \sin \frac{1}{2}(\sin \theta SK/L). \quad (4)$$

Values of O for bearings θ in steps of 5 degrees from 0 to 45 degrees should be worked out and these values O used as points of the X axis in the graph of the curve. The number of degrees correction necessary to obtain θ is plotted up and down on the Y axis; the Y values will be (-) from 0 to 45 degrees and (+) from 45 to 90 degrees.

A bearing may be taken on the instrument, and the error Y in degrees applied from the corresponding instrument bearing on the X axis to obtain the true bearing

from North. This error may be appreciable, as is seen from the following problem:

Find the instrument reading O (disregarding site and other errors of course) for a true bearing of 15 degrees, the antenna spacing being 36 feet, and the wavelength $L=15$ meters.

Using (4), we find the answer to be 35 degrees, a 20-degree error. Of course the problem gave a high frequency for a 36-foot antenna spacing selected in order to illustrate the point, but all frequencies would have errors of several degrees shown on the curves.

If these antenna error curves are made up for all frequencies intended to be used

prior to making up the regular site calibration curves, by a comparison of the two curves it may be easier to see why the bearings from the radio direction-finder station sometimes appear so far in error and at other times appear to have no appreciable error. Thus other matters might be investigated which would reveal a large percentage or error that would ordinarily be chalked up to "site error."

JAMES HOLBROOK
70th AACG Group
APO 246
c/o Postmaster
San Francisco, Calif.

Emission-Limited Diode

In an emission-limited diode comprising two coaxial cylinders, the time required for an electron to pass from the cathode to the anode is

$$t_T = \frac{1.68 \times 10^{-8} R_2 M}{\sqrt{E_a}} \quad (1)$$

where

t_T = time in seconds required for an electron to pass from the cathode to the anode

R_2 = radius of anode in centimeters

E_a = potential difference in volts between cathode and anode

and where M is a factor given by the series

$$M = \left(2 \log \frac{R_2}{R_1} \right) - \frac{1}{3} \left(2 \log \frac{R_2}{R_1} \right)^2 - \frac{1}{3} \cdot \frac{1}{5} \left(2 \log \frac{R_2}{R_1} \right)^3 - \frac{1}{3} \cdot \frac{1}{5} \cdot \frac{1}{7} \left(2 \log \frac{R_2}{R_1} \right)^4 + \dots \quad (2)$$

where

R_1 = radius of cathode in centimeters.

The value of M may be determined directly from Fig. 1.

The time required for an electron to pass from the cathode to the grid in an emission-limited triode comprising coaxial cylindrical electrodes may be approximately determined from (1) if $(E_0 + E_p/\mu)$ is substituted for E_a and if the radius of the grid in centimeters is substituted for R_2 , E_0 and E_p being the potential in volts of the grid and plate, respectively, and μ being the amplification factor.

In the derivation of (1), the effects of space charge and relativistic change of mass were neglected.

In the derivation which follows, the additional symbols appear:

F = strength of electric field in statvolts per centimeter

K = a constant which is evaluated

s = distance in centimeters

E = difference in potential in statvolts between cathode and anode

a = acceleration in centimeters per second per second

e/m = ratio of the electric charge of an electron to the mass of an electron in statcoulombs per gram

t = time in seconds

C_1 = a constant of integration

C_2 = a constant of integration

Equation (1) may be derived as follows:

In a coaxial cylindrical diode operating under emission-limited conditions, if the effect of space charge is neglected, the potential gradient at any point between the electrodes varies inversely as the distance from that point to the common center of the electrodes; that is,

$$F = \frac{K}{R_1 + s} \quad (3)$$

The potential gradient is the potential increment per distance increment; that is, $F = dE/ds$. Substituting,

$$\frac{dE}{ds} = \frac{K}{R_1 + s} \quad (4)$$

The potential difference between the cathode and the anode is the sum of all the potential increments from zero to $(R_2 - R_1)$; therefore,

$$E = \int_0^{R_2 - R_1} \frac{K}{R_1 + s} ds \quad (5)$$

$$= K \log \frac{R_2}{R_1} \quad (6)$$

Rearranging terms,

$$K = \frac{E}{\log \frac{R_2}{R_1}} \quad (7)$$

Substituting in (3) from (7),

$$F = \frac{E}{(R_1 + s) \log \frac{R_2}{R_1}} \quad (8)$$

The acceleration of an electron in an electric field is

$$a = \frac{e}{m} F \quad (9)$$

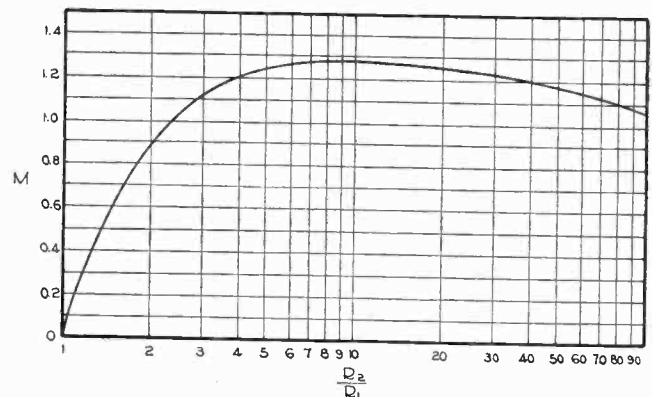

Putting $a = d^2s/dt^2$, and substituting the value of F from (8),

$$\frac{d^2s}{dt^2} = \frac{e}{m} \frac{E}{\log \frac{R_2}{R_1}} \cdot \frac{1}{R_1 + s} \quad (10)$$

A first integral of (10) is

$$\left(\frac{ds}{dt} \right)^2 = \frac{2e}{m} \frac{E}{\log \frac{R_2}{R_1}} \log(R_1 + s) + C_1 \quad (11)$$

Since $(ds/dt)^2$ is the velocity squared, and since the velocity is zero when s is zero.

$$C_1 = - \frac{2 \frac{e}{m} E \log R_1}{\log \frac{R_2}{R_1}} \quad (12)$$

Substituting in (11) from (12),

$$\left(\frac{ds}{dt} \right)^2 = \frac{2 \frac{e}{m} E}{\log \frac{R_2}{R_1}} \cdot \log \frac{R_1 + s}{R_1} \quad (13)$$

$$dt = \sqrt{\frac{\log \frac{R_2}{R_1}}{2 \frac{e}{m} E \log \frac{R_1 + s}{R_1}}} ds \quad (14)$$

Integrating,

$$t = \frac{(R_1 + s) \sqrt{\log \frac{R_2}{R_1}}}{\sqrt{2 \frac{e}{m} E}} \left[2 \left(\log \frac{R_1 + s}{R_1} \right)^{1/2} - 2 \cdot \frac{2}{3} \left(\log \frac{R_1 + s}{R_1} \right)^{3/2} + 2 \cdot \frac{2}{3} \cdot \frac{2}{5} \left(\log \frac{R_1 + s}{R_1} \right)^{5/2} - 2 \cdot \frac{2}{3} \cdot \frac{2}{5} \cdot \frac{2}{7} \left(\log \frac{R_1 + s}{R_1} \right)^{7/2} + \dots \right] + C_2 \quad (15)$$

When s is zero, t is zero; therefore, $C_2 = 0$. Substituting,

$$t = \frac{(R_1 + s) \sqrt{\log \frac{R_2}{R_1}}}{\sqrt{2 \frac{e}{m} E}} \left[2 \left(\log \frac{R_1 + s}{R_1} \right)^{1/2} \right]$$

$$- 2 \cdot \frac{2}{3} \left(\log \frac{R_1 + s}{R_1} \right)^{3/2} + 2 \cdot \frac{2}{3} \cdot \frac{2}{5} \left(\log \frac{R_1 + s}{R_1} \right)^{5/2} - 2 \cdot \frac{2}{3} \cdot \frac{2}{5} \cdot \frac{2}{7} \left(\log \frac{R_1 + s}{R_1} \right)^{7/2} + \dots \quad (16)$$

When an electron has completed a transit from cathode to anode, $s = R_2 - R_1$, and $t = t_T$. Substituting,

$$t_T = \frac{R_2 \sqrt{\log \frac{R_2}{R_1}}}{\sqrt{2 \frac{e}{m} E}} \left[2 \left(\log \frac{R_2}{R_1} \right)^{1/2} - 2 \cdot \frac{2}{3} \left(\log \frac{R_2}{R_1} \right)^{3/2} + 2 \cdot \frac{2}{3} \cdot \frac{2}{5} \left(\log \frac{R_2}{R_1} \right)^{5/2} - 2 \cdot \frac{2}{3} \cdot \frac{2}{5} \cdot \frac{2}{7} \left(\log \frac{R_2}{R_1} \right)^{7/2} + \dots \right] \quad (17)$$

Simplifying,

$$t_T = \frac{R_2}{\sqrt{2 \frac{e}{m} E}} \left[\left(2 \log \frac{R_2}{R_1} \right) - \frac{1}{3} \left(2 \log \frac{R_2}{R_1} \right)^2 + \frac{1}{3} \cdot \frac{1}{5} \left(2 \log \frac{R_2}{R_1} \right)^3 - \frac{1}{3} \cdot \frac{1}{5} \cdot \frac{1}{7} \left(2 \log \frac{R_2}{R_1} \right)^4 + \dots \right] \quad (18)$$

When the value for e/m is inserted, and when E is changed to practical units, (18) becomes (1).

VIRGIL M. BRITAIN
1204 N.W. 20 Avenue
Portland 9, Oregon

Institute Representatives on Other Bodies—1945

American Documentation Institute: J. H. Dellinger
Council of the American Association for the Advancement of Science: J. C. Jensen
Joint Co-ordination Committee on Radio Reception of the E.E.I., N.E.M.A., and R.M.A.: C. E. Brigham
National Research Council, Division of Engineering and Research: F. E. Terman
Radio Technical Planning Board: W. L. Barrow (D. B. Sinclair alternate)
U. R. S. I. (International Scientific Radio Union) Executive Committee: C. M. Jansky, Jr.
U. S. National Committee, Advisers on Electrical Measuring Instruments: Melville Eastham and H. L. Olesen
U. S. National Committee, Advisers on Symbols: L. E. Whittemore and J. W. Horton
U. S. National Committee of the International Electrotechnical Commission: H. M. Turner
ASA Standards Council: Alfred N. Goldsmith (H. P. Westman, alternate)
ASA Sectional Committee on Letter Symbols and Abbreviations for Science and Engineering: H. M. Turner
ASA Subcommittee on Letter Symbols for Radio Use: H. M. Turner
ASA Sectional Committee on National Electrical Safety Code, Subcommittee on Article 810, Radio Broadcast Reception Equipment: E. T. Dickey (Virgil M. Graham, alternate)
ASA Sectional Committee on Preferred Numbers: A. F. Van Dyck
ASA Sectional Committee on Radio: Alfred N. Goldsmith, chairman; Haraden Pratt, and L. E. Whittemore
ASA Sectional Committee on Radio-Electrical Co-ordination: J. V. L. Hogan, C. M. Jansky, Jr., and L. E. Whittemore

ASA Board of Directors: F. R. Lack
ASA Electrical Standards Committee: H. M. Turner (H. P. Westman, alternate)
ASA Sectional Committee on Acoustical Measurements and Terminology: E. D. Cook and H. F. Olson
ASA Sectional Committee on Definitions of Electrical Terms: Haraden Pratt
ASA Subcommittee on Vacuum Tubes: B. E. Shackelford
ASA Sectional Committee on Electric and Magnetic Magnitudes Units: J. H. Dellinger
ASA Sectional Committee on Electrical Installations on Shipboard: I. F. Byrnes
ASA Sectional Committee on Electrical Measuring Instruments: Wilson Aull, Jr.
ASA Sectional Committee on Graphical Symbols and Abbreviations for Use on Drawings: Austin Bailey (H. P. Westman, alternate)
ASA Subcommittee on Communication Symbols: H. M. Turner
ASA Sectional Committee on Specifications for Dry Cells and Batteries: H. M. Turner
ASA Sectional Committee on Standards for Drawings and Drafting Room Practices: Austin Bailey (H. P. Westman, alternate)
ASA Committee on Vacuum Tubes for Industrial Purposes: B. E. Shackelford
ASA War Committee on Radio: Alfred N. Goldsmith*
ASA War Standards Committee on Methods of Measuring Radio Noise: C. J. Franks and Garrard Mountjoy

* Also chairman of its Subcommittee on Insulating Material Specifications for the Military Services.

Institute Committees—1945

ADMISSIONS

G. T. Royden, *Chairman*
 F. A. Polkinghorn, *Vice-Chairman*
 R. D. Avery A. R. Hodges
 H. H. Beverage R. H. Langley
 R. M. Bowie Knox McIlwain
 J. L. Callahan A. R. Morton
 H. A. Chinn H. J. Reich
 J. D. Cobine C. E. Scholz
 E. D. Cook S. W. Seeley
 M. G. Crosby J. E. Shepherd
 Lloyd Espenschied M. E. Strieby
 T. T. Goldsmith, Jr. J. C. Stroebel
 F. D. Webster

AWARDS

W. C. White, *Chairman*
 Haraden Pratt, *Vice-Chairman*
 Austin Bailey E. W. Engstrom
 W. L. Barrow D. E. Harnett
 L. A. du Bridge Keith Henney
 J. V. L. Hogan

BOARD OF EDITORS

Alfred N. Goldsmith, *Chairman*
 R. R. Batcher Nathan Marchand
 R. S. Burnap E. D. McArthur
 P. S. Carter E. L. Nelson
 L. M. Clement H. F. Olson
 J. D. Cobine H. O. Peterson
 W. G. Dow G. W. Pickard
 E. W. Engstrom R. A. Powers
 W. L. Everitt Haraden Pratt
 W. G. H. Finch C. A. Priest
 G. W. Gilman C. J. Reich
 P. C. Goldmark V. W. Sherman
 A. W. Graf L. C. Smeby
 F. W. Grover E. C. Wente
 L. B. Headrick H. A. Wheeler
 C. M. Jansky, Jr. W. C. White
 H. S. Knowles L. E. Whittemore
 J. D. Kraus G. W. Willard
 D. G. Little William Wilson
 F. B. Llewellyn C. J. Young
 S. S. Mackeown V. K. Zworykin

CONSTITUTION AND LAWS

R. F. Guy, *Chairman*
 Austin Bailey R. A. Heising
 E. F. Carter F. E. Terman
 I. S. Coggeshall H. R. Zeamans

EXECUTIVE

W. L. Everitt, *Chairman*
 R. A. Heising, *Vice-Chairman*
 Haraden Pratt, *Secretary*
 S. L. Bailey E. F. Carter
 W. L. Barrow Alfred N. Goldsmith

INVESTMENTS

R. A. Heising, *Chairman*
 Fulton Cutting Haraden Pratt
 W. L. Everitt H. M. Turner
 H. R. Zeamans

EDUCATION

A. B. Bronwell, *Chairman*
 R. G. Anthes G. B. Hoadley
 W. E. Arcand F. H. Kirkpatrick
 R. E. Beam R. C. Manhart
 W. H. Campbell W. H. Radford
 C. C. Chambers H. J. Reich
 H. A. Chinn J. D. Ryder
 J. D. Cobine W. J. Seeley
 Melville Eastham F. R. Stansel
 G. H. Fett J. A. Stratton
 A. W. Graf W. O. Swinyard
 R. F. Guy G. R. Town
 Alan Hazeltine Ernst Weber
 L. N. Holland W. C. White
 F. S. Howes Irving Wolff
 G. A. Wootton

MEMBERSHIP

E. D. Cook, *Chairman*
 C. R. Barhydt L. B. Headrick
 C. M. Burrill L. G. Hector
 J. M. Clayton Albert Preisman
 R. I. Cole J. L. Reinartz
 J. M. Comer, Jr. Bernard Salzberg
 W. C. Copp R. B. Shanck
 W. H. Doherty J. C. Stroebel
 A. V. Eastman Sarkes Tarzian
 W. G. Eaton Bertram Trevor
 A. J. Ebel K. S. Van Dyke
 W. N. Eldred H. M. Wagner
 D. G. Fink Ernst Weber
 Samuel Gubin R. H. Williamson
 (Section Secretaries *Ex-officio*)

MEMBERSHIP SOLICITATION POLICY

F. B. Llewellyn, *Chairman*
 Alfred N. Goldsmith Keith Henney
 R. A. Heising L. C. F. Horle
 L. P. Wheeler

NOMINATIONS

J. V. L. Hogan, *Chairman*
 H. M. Turner, *Vice-Chairman*
 Beverly Dudley C. M. Jansky, Jr.
 O. B. Hanson R. C. Poulter
 W. C. White

PAPERS PROCUREMENT

Dorman D. Israel, *General Chairman*
 Edward T. Dickey, *Vice-General-Chairman*
 Howard Benner T. A. Hunter
 W. F. Bonner Jesse Marsten
 R. M. Bowie I. E. Mourmstseff
 A. B. Bronwell J. R. Nelson
 Madison Cawein H. F. Olson
 J. T. Cimorelli Walter Peek
 I. S. Coggeshall J. D. Reid
 J. I. Cornell D. B. Sinclair
 M. G. Crosby A. M. Skellett
 Alfred Crossley Karl Spangenberg
 Harry Diamond H. J. Tyzzer
 G. H. Floyd K. S. Van Dyke
 A. E. Harrison W. L. Webb
 W. C. White

PAPERS

F. B. Llewellyn, *Chairman*
 H. A. Affel Emil Labin
 W. L. Barrow F. R. Lack
 H. A. Chinn H. C. Leuteritz
 J. K. Clapp C. V. Litton
 I. S. Coggeshall Knox McIlwain
 S. B. Cohn H. R. Mimno
 E. J. Content I. E. Mourmstseff
 C. W. Corbett G. G. Muller
 M. G. Crosby A. F. Murray
 F. W. Cunningham J. R. Nelson
 R. B. Dome D. O. North
 E. B. Ferrell A. F. Pomeroy
 D. G. Fink J. R. Poppele
 H. S. Frazier Simon Ramo
 R. L. Freeman F. X. Rettenmeyer
 Stanford Goldman S. A. Schelkunoff
 F. W. Grover D. B. Sinclair
 O. B. Hanson Karl Spangenberg
 T. J. Henry Dayton Ulrey
 E. W. Herold A. P. Upton
 J. V. L. Hogan K. S. Van Dyke
 F. V. Hunt E. K. Van Tassel
 Harley Iams J. R. Whinnery
 L. F. Jones Irving Wolff
 J. G. Kreer, Jr. J. W. Wright
 H. R. Zeamans

PUBLIC RELATIONS

I. S. Coggeshall, *Chairman*
 F. W. Albertson (S. L. Bailey, Alter-
 G. W. Bailey nate)
 O. H. Caldwell E. K. Jett
 O. B. Hanson T. R. Kennedy, Jr.
 Keith Henney J. R. Poppele
 C. W. Horn A. F. Van Dyck
 C. M. Jansky, Jr. E. M. Webster
 L. P. Wheeler

SECTIONS

R. A. Heising, *Chairman*
 S. L. Bailey F. A. Polkinghorn
 E. D. Cook G. T. Royden
 Virgil M. Graham B. E. Shackelford
 R. V. L. Hartley W. O. Swinyard
 H. P. Westman
 (Section Chairmen *Ex-Officio*)

TELLERS

G. B. Hoadley, *Chairman*
 Edward J. Content, *Vice-Chairman*
 Trevor Clark

Books

The Electrolytic Capacitor, by Alexander M. Georgiev

Published (1945) by Murray Hill Books, Inc., 232 Madison Ave., New York 16, N. Y. 179 pages+12-page index+xii pages. 72 illustrations. $6\frac{1}{2} \times 9\frac{1}{4}$ inches. Price, \$3.00.

This is the author's first book and the third contribution in book form to the electrolytic capacitor art. It contains twenty-one short chapters averaging five to six pages of reading material exclusive of the numerous illustrations. The consecutive chapters gradually lead the reader through general capacitor information, comparison of capacitor types, the miscellaneous parts of an electrolytic capacitor used in the manufacture, the processing of these parts, routine and special tests, common troubles encountered during the manufacture or use, the design, and some of the more common uses and limitations of an electrolytic capacitor.

Considering the secrecy surrounding the industry and the lack of technical literature covering the manufacture of capacitors, this work represents a compilation of technical data and information which should prove valuable to a relatively large group of readers. Each chapter completely covers the general subject of that chapter, and appears to create a desire to proceed with the next chapter until the entire work is covered.

The scope of this book apparently is planned for a specific group of readers including engineers and technicians engaged in the manufacture of electrical equipment using electrolytic capacitors, and technicians engaged in the repairs or servicing of such electrical equipment.

This group of readers as well as others who desire a general knowledge of an electrolytic capacitor will find that this work thoroughly covers all of the general information which they desire and specifically will instruct them how to determine the quality and characteristics of electrolytic capacitors with simple test meters such as are generally available to this group.

The book is printed in a clear and easily readable type which does not distract from the thought of the author, but a more opaque or thicker page would add to the ease of reading as a number of the illustrations reflect through to the opposite page and make some of the reading difficult. It contains a seven-page glossary describing the relatively few technical terms which it has been necessary to use in the text so that even nontechnical readers will find the subject to be easily understandable.

Also included is a complete index as well as a list of illustrations which makes ready reference to any particular point of interest contained in the work.

Although the author has endeavored to describe the construction, manufacture, function, and testing of wet and dry electrolytic capacitors, and to explain the theories of the dielectric films employed on the surface of the plates or electrodes, he has condensed the material and technical data to such a point that a certain group of readers

will find it necessary to resort to the many references contained in the bibliography and to the numerous patents listed in order to obtain fully the details of manufacture, theory, and application of electrolytic capacitors. Such a condensation of technical data and information will leave this small group of readers with the impression that the subject has not been thoroughly covered but it is believed that the book will create a sufficient interest to cause this small group of readers to investigate the many references.

This book appears to be free of errors and in the opinion of this reviewer is a very practical up-to-date treatment of the subject.

D. E. GRAY
Cornell-Dubilier Electric Corp.
South Plainfield, N. J.

Transmission Lines, Antennas, and Wave Guides, by Cruft Laboratory War Training Staff

Published (1945) by the McGraw-Hill Book Co., Inc., 330 W. 42 Street, New York 18, New York. 338 pages+8-page index+xvi pages. 239 illustrations. 9×6 inches. Price, \$3.50.

This book presents the material given on transmission lines, antennas, wave guides, and wave propagation to the officers in the armed forces receiving preradar training at Harvard University, and it is written for undergraduate students rather than graduates.

The first chapter, 69 pages in length, deals with transmission lines and is the most satisfactory part of the book, both as regards coherence and completeness. The treatment begins with the "telegraph equations" and then proceeds to such topics as transmission-line constants, dissipationless lines, and impedance matching both by means of fractional wavelength transformers and single- and double-stub tuners. A section on circle diagrams shows how graphical calculations may be made on line problems. The student who masters this chapter and works a fair proportion of the 42 problems in the back of the book on lines will be able to cope with many of the engineering problems he will encounter in his later work on lines. Answers are given to about one half of the problems.

The second chapter of the book covering antennas leaves something to be desired. In view of the previous training of the preradar students and limited time available for their instruction, one can sympathize with the authors' self-imposed limitation of avoiding the use of the field equations in introducing the topic. The subject of radiation is introduced by the statement that "all electric charges exert forces on one another according to a law of retarded action at a distance." This statement with illustrations and variations sums up what the student presumably should know about electromagnetic theory. This section, in spite of the authors' pedagogical skill, is weak. The treatment includes a discussion of such topics as radiation resistance, coupled antennas, receiving antennas, and the directivity and gain of a variety of antennas and antenna arrays of technical

importance. A study of the 127 pages devoted to antennas and the 31 rather well-chosen problems, if supplemented by field experience, will no doubt give an individual a practical working knowledge of the subject, but will still leave him weak on fundamentals.

The difficulties in which the author of the sections on antennas and wave guides finds himself as a result of an inadequate presentation of the underlying theory are aggravated when the student is introduced to high-frequency circuit elements, in particular, resonant and nonresonant lines, wave guides, and cavity resonators. 67 pages are devoted to these topics. The descriptive material covering techniques is informative and well-selected, and includes brief descriptions of such devices as couplers for interconnecting wave guides and transmission lines, and the transformers and guide sections used in negotiating swivel joints in a wave-guide system. The theoretical material in this chapter is both wordy and incomplete.

The closing chapter of 20 pages on propagation is well written and presents a general survey of propagation as affected by frequency, transmission in both the lower atmosphere and the ionosphere, and abnormalities in propagation. The effect of the earth's magnetic field on propagation is not discussed.

W. D. HERSHBERGER
RCA Laboratories
Princeton, N. J.

Principles of Radio, by Keith Henney

Published (1945) by John Wiley and Sons, Inc., 440 Fourth Avenue, New York, New York. 522 pages+12-page index+viii pages. 317 illustrations. $8 \times 5\frac{1}{4}$ inches. Price, \$3.50.

This is the fifth edition of a well-known textbook of elementary radio. In this new edition the author has rearranged the subject material and has achieved an improvement in continuity and presentation. New material has been added in the last three chapters on Frequency Modulation, Ultra-High Frequency Phenomena, and Electronic Instruments. The material has been presented in the simple, readable form characteristic of the text and serves well to introduce the subject material to the uninitiated.

The elimination in this edition of the chapter on Radio-Frequency Amplifiers is considered unfortunate by this reviewer, while the omission of the chapter on Facsimile and Television in favor of the new added material appears to be well considered.

On the whole, this edition, like those preceding it, has certainly achieved the author's aim of introducing the material basic to radio communication particularly to the individual who must study without background and without teacher. The numerous problems throughout the text aid in serving the purpose of the text.

FERDINAND HAMBURGER, JR.
The Johns Hopkins University
Baltimore 18, Maryland

Contributors

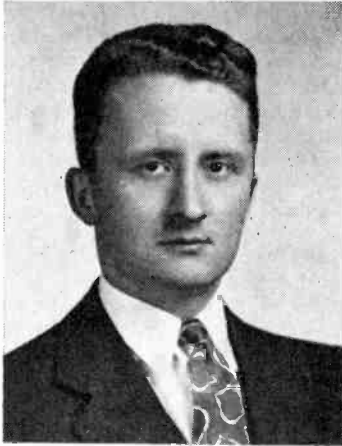

FREDERICK DEWEY BENNETT

Frederick Dewey Bennett was born in Miles City, Montana, on June 2, 1917. After receiving his B.A. degree from Oberlin College in 1937, he went to the Pennsylvania State College where he received his M.Sc. degree in 1939 and Ph.D. degree in physics in 1941. From 1941 to 1943 he taught in the physics department at the University of New Hampshire. During the summer of 1942, he was associated with the engineering staff of Pratt and Whitney Aircraft Company engaged in investigation of engine-cooling problems. Since 1943 he has been engaged in aircraft-antenna research and design at Special Projects Laboratory, Engineering Division, ATSC, Wright Field, Dayton, Ohio.

He is a member of the American Physical Society, Sigma Xi, and Phi Beta Kappa.

Arthur B. Bronwell (A'39-SM'43) was born in Chicago, Illinois, in 1909. He received the B.S. degree in electrical engineering in 1933, and the M.S. degree in 1936, from the Illinois Institute of Technology.



ARTHUR B. BRONWELL

This was followed by additional graduate work at the University of Michigan and Northwestern University.

He was employed by the Commonwealth Edison Company as substation operator while attending school, and later as engineer in fixed-capital evaluation. In 1937, he was appointed to the electrical engineering staff of Northwestern University and is now associate professor and director of communications and measurements instruction in the electrical engineering department.

Professor Bronwell was employed by the Bell Telephone Laboratories in the summer of 1941, and served as director of the Army Signal Corps School at Northwestern University.



E. FINLEY CARTER

He is chairman of the Committee on Education for The Institute of Radio Engineers, past chairman of the Chicago Section of The Institute of Radio Engineers, a member of the American Institute of Electrical Engineers, Society for the Promotion of Engineering Education, Sigma Xi, and Eta Kappa Nu.

E. Finley Carter (F'36) was born in Elgin, Texas, on July 1, 1901. He received the B.S. degree in electrical engineering from Rice Institute in 1922, and upon graduation became associated with the General Electric Company, engaged in radio development. In 1929 he became director of the radio division of the United Research Corporation in New York City, designing radios, circuits, and receivers.

Mr. Carter joined Sylvania Electric Products, Inc., as a consulting engineer in 1932, later becoming assistant chief engineer, and in 1941, was appointed to organize and head the industrial relations department of that organization, a position which he still holds.



PAUL D. COLEMAN

He is an Associate member of the American Institute of Electrical Engineers, a member of the American Radio Relay League, and of Tau Beta Pi, and is a member of the Board of Directors of The Institute of Radio Engineers.

Paul D. Coleman was born on June 4, 1918, at Stoystown, Pennsylvania. He received an A.B. degree from Susquehanna University in 1940, and an M.S. degree in 1942 from the Pennsylvania State College, where he was a graduate assistant in physics. Mr. Coleman has been employed since 1942 in the Antenna Branch of the Aircraft Radio Laboratory at Wright Field.

T. P. Kinn (A'36-SM'45) was born in El Paso, Texas, on January 12, 1907. He received the B.S. degree in electrical engineer-

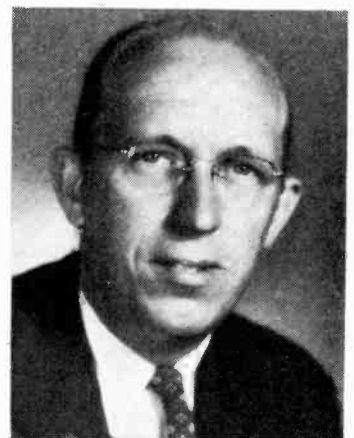

T. P. KINN



M. J. LARSEN

ing from the University of Colorado in 1928, and joined the Westinghouse Manufacturing Company staff as a radio design engineer in the same year. Since that time he has been active in the design of radio communication equipment, including marine, mobile, broadcasting, and aircraft for all types of services, devoting the major part of his time to work on military equipment.

During the 1930's Mr. Kinn was engaged in the development and application of radio frequency to induction and dielectric heating, and in 1941 he became section engineer in charge of active development and design of military communication and radar equipment. In 1944 he was made division engineer in charge of industrial electronic equipment, developing and promoting electronic equipment for industry, such as induction- and dielectric-heating equipment, precision-balancing equipment, mass spectrometer analytical equipment, and other electronic devices.

Mr. Kinn is a member of the American Institute of Electrical Engineers, and of panels 8 and 12 of the Radio Technical Planning Board.

M. J. Larsen (A'42) was born in 1909 at Spencer, Iowa. He received the B.S. degree in electrical engineering in 1933; the M.S.



G. J. LEHMANN

degree in 1934; and the Ph.D. degree in 1937, from the State University of Iowa. From 1928 to 1929 he was with the Northwestern Bell Telephone Company, and spent the summer of 1937 in the research department of the Central Commercial Company.

Dr. Larsen was instructor in electrical engineering from 1937 to 1940 at Michigan College of Mining and Technology. In 1940 he became assistant professor, a post which he held until 1943, when he became associated with the research department of Stromberg-Carlson Company, in Rochester, N. Y., where he has remained to date.

He is a member of Sigma Xi, Eta Kappa Nu, and the Society for Promotion of Engineering Education.

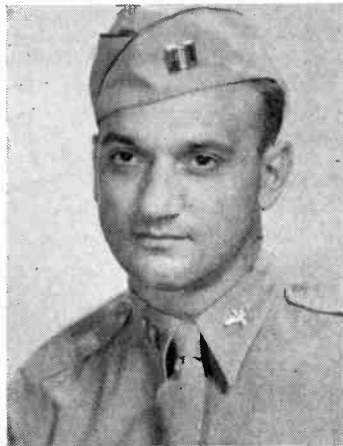

ALLEN S. MEIER

G. J. Lehmann (SM'44) was born in Paris, France, on April 6, 1909. After receiving his degree in engineering from the École Centrale, in 1931, he became associated with Sadir, a French company, building very-high-frequency communications and radio-navigation equipment, of which he was technical director in 1939.

After his release from the French Army in 1940, he joined the Lyon laboratory of Le Matériel Téléphonique. In 1943 he came to New York, and worked as research engineer with Federal Telephone and Radio Laboratories. He recently left the United States to rejoin Le Matériel Telephonique, in France.

In addition to research work, Mr. Lehmann has been teaching at the École Centrale since 1934, and in 1942 was appointed professor of direction finding and radio navigation at the École Supérieure d'Électricité.

Allen S. Meier was born on March 9, 1911, at Windsor, Connecticut. He received a B.S. degree in physics and mathematics in 1932 and an M.S. degree in physics in 1933 from Trinity College, Hartford, Connecticut. He was associated with the Pratt and Whitney Machine Tool Company and the Connecticut Mutual Insurance Company before service in the Army in 1940. After serving with the 704th Military Police Bn. and the 242nd Coast Artillery Corps, he was trans-



C. F. P. ROSE

ferred to the Signal Corps in 1942 and was assigned to the Radiation Laboratory of the Massachusetts Institute of Technology where he was engaged in research and development. Since December 1942, he has been branch officer of the Antenna Branch, Special Projects Laboratory, Aircraft Radio Laboratories at Wright Field, Ohio.

C. F. P. Rose (A'22-M'40) was born on September 19, 1901, in Montclair, New Jersey. He entered the radio research department of the Western Electric Company in December, 1920. He was graduated as a student assistant in 1924 and subsequently attended Columbia University Extension School. Since 1925, he has served as a member of the technical staff of the Bell Telephone Laboratories. Mr. Rose has been engaged in designing, developing, installing, and testing experimental and commercial short-wave transoceanic-radiotelephone transmitters for the Bell System in New Jersey, Argentina, and California. Since 1942, he has been engaged in developing special electronic equipment used by the Army.



A. C. SCHROEDER



G. C. SZIKLAI

A. C. Schroeder (A'38) was born in West New Brighton, Staten Island, N. Y., on February 28, 1915. He received the B.S. degree in electrical engineering from the Massachusetts Institute of Technology in 1937, and the M.S. degree from the same institution in the same year. He joined the Radio Corporation of America in 1937, and is now engaged in television research at the

RCA Laboratories in Princeton, New Jersey. He is a member of the American Association for the Advancement of Science.



G. C. Sziklai (A'41-M'43-SM'43) was born in Budapest, Hungary, on July 9, 1909. He received his absolutorium (equivalent to the M.S. degree) in 1930 from the Pazmany University of Budapest. He was an exchange student at the Technische Hochschule in Munich, Germany, in 1928. In 1931 he joined the Aerovox Corporation, where he became assistant chief engineer. He was the chief engineer of the Polymet Manufacturing Corporation from 1932 to 1935. During 1934, Mr. Sziklai spent a half year in Europe providing consultation to Electrical Component Manufacturers in London and Paris. From 1935 to 1939 he was on the research staff of the Micamold Radio Corporation. He joined the industry service division of the Radio Corporation of America in 1939, and later transferred to the Bloomington division of the same company. Since 1942, he has been in the television research section of the RCA Laboratories at Princeton, New Jersey. Mr. Sziklai is a member of the American Physical Society and Sigma Xi.



A. R. VALLARINO

A. R. Vallarino (S'43-A'44) was born in Panama City, Panama, on August 11, 1913. He was graduated in electrical engineering from Stanford University in 1939. Transferring his studies to electrical communications, Mr. Vallarino spent the next three years in graduate and research work at Stanford University.

In 1943 he joined the Federal Telephone and Radio Laboratories in New York City, where he worked as a research engineer.

THE EYES
HAVE IT

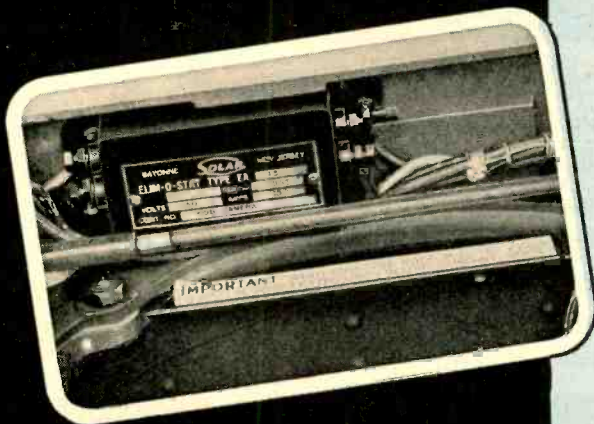

Quick as a wink the Fairchild Night Owl Camera records enemy movements intended to be hidden by darkness. Quick as a flash the radio of the photo-reconnaissance plane keeps touch with its base — and clearly — for Solar Elim-O-Stats are part of the electronic equipment of these highly perfected cameras. This is but one of many instances where Solar Elim-O-Stats are being used to absorb local interference and keep speech channels free. Let Solar advise you on radio-noise suppression.



WEST N. Y. BAYONNE
PLANT PLANT
A TOTAL OF NINE
ARMY-NAVY EXCELLENCE AWARDS

SOLAR MANUFACTURING CORP.
285 Madison Avenue • New York 17, N. Y.

Ⓢ 8013

KEN-RAD

METAL TUBES



Better Than Ever

Ken-Rad for years has aided manufacturers to build and market radio equipment which wins the user's confidence . . . Now, to tube quality already foremost, have been added great new research and manufacturing facilities . . . Ken-Rad Tubes therefore will serve *better than ever* builders of electronic equipment who value top performance and reliability.

Write for your copy of
"Essential Characteristics" the most complete digest of tube information available.

178-08-6650

KEN-RAD

DIVISION OF GENERAL ELECTRIC COMPANY

OWENSBORO, KENTUCKY

FINE POINTS MAKE FINE



PRODUCTS

**Immersion
Vacuum Test
OF
AMERTRAN
HERMETICALLY
SEALED
TRANSFORMERS**



EVERY UNIT GETS A BATH. The photographs above and to the left show one of the tests to which AmerTran Hermetically Sealed Transformers are subjected. All receive this test—not just random units.

NOT A BUBBLE SHOWING! Continuous inspection during and between manufacturing steps insures optimum performance and long life. The high dependability of AmerTran Hermetically Sealed Transformers is due to exceptionally rigid standards of manufacture and inspection.

NEW—OIL IMPREGNATION with bellows style case to permit complete sealing with provision for expansion.

OTHER FINE POINTS. Uniform characteristics correct terminations—vacuum impregnation with varnish or wax—vacuum filling with oil or wax—high mechanical strength—induction soldering—infra-red pre-heating—continuous inspection—42 years transformer manufacturing experience.

AMERICAN TRANSFORMER COMPANY
178 EMMET STREET • NEWARK 9, NEW JERSEY

AMERTRAN

MANUFACTURING SINCE 1901 AT NEWARK, N. J.

Pioneer Manufacturers of Transformers, Reactors and Rectifiers for Electronics and Power Transmission





Aerovox high-frequency capacitance bridge test of mica capacitors in heat chamber at right.

Block mica check for power factor. Every piece is checked before splitting and sorting according to thickness.



QUALITY PRODUCTION CONTROL from Alpha to Omega... step by step... with nothing taken for granted or left to chance... spells AEROVOX MICA CAPACITOR

Craftsmanship

● Mica capacitors are usually precision units. Capacitance tolerances may be tight. But even more important, critical characteristics such as power factor and "Q" must be met.

AEROVOX QUALITY CONTROL is exercised at every step in production. Incoming block mica is checked piece by piece for power factor and "Q." This proved invaluable

during the wartime mica shortage when new sources of supply had to be used. A spot check simply would not do.

Split micas are checked—electrically, visually, micrometrically. Mica assemblies are checked. Completed mica units are checked on the Q-meter. And since operating characteristics may change with operating temperatures, such units

are checked at given temperatures, by means of precision instruments of recognized accuracy, including Aerovox-designed and -built instruments.

It is this kind of production inspection, along with skilled craftsmanship and engineering "know-how," that accounts for the enviable reputation enjoyed by Aerovox mica capacitors.



Capacitors

INDIVIDUALLY TESTED

AEROVOX CORPORATION, NEW BEDFORD, MASS., U. S. A. SALES OFFICES IN ALL PRINCIPAL CITIES
 Export: 13 E. 40 ST., NEW YORK 16, N. Y. • Cable: 'ARLAB' • In Canada: AEROVOX CANADA LTD., HAMILTON, ONT.

Down to fundamentals...

IN TRANSFORMER DESIGN FOR POST-WAR

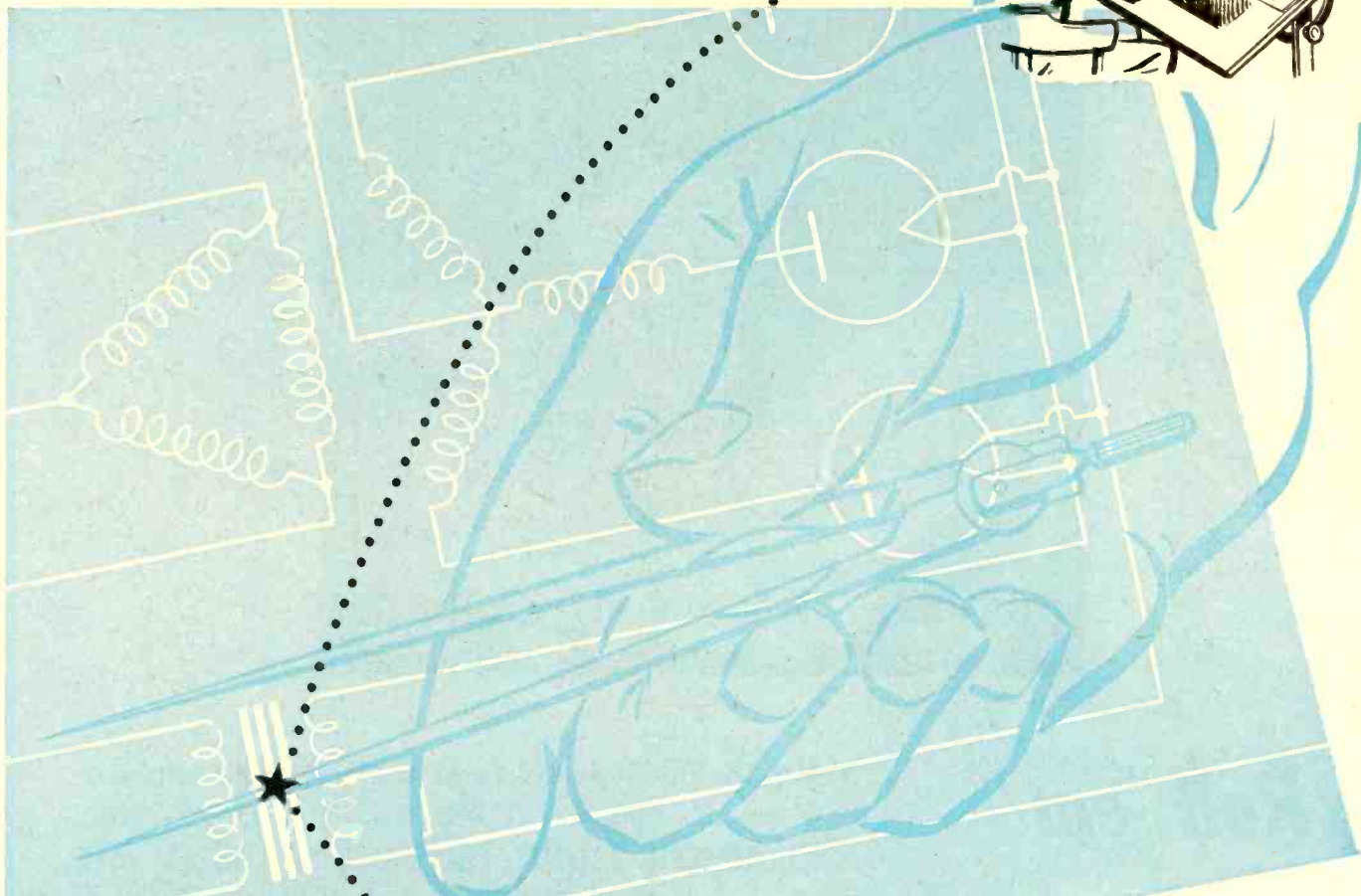

★ The product illustrated typifies N-Y-T compact designs incepted by N-Y-T for mobile, airborne and portable equipment.



A consideration of time and cost factors!

N-Y-T engineers are now in a position to extend close collaboration in the solution of transformer, choke and filter problems—from blueprint to finished product. They are prepared to design special components for specific applications and produce them promptly at low unit cost. This unique service is made possible by the specialized engineering and production facilities of N-Y-T. Our engineers are available for consultation.

Address inquiries to Dept. P.

NEW YORK TRANSFORMER CO
26 WAVERLY PLACE, NEW YORK 3, N. Y.



**Roll 'em
while they're
HOT, but . . .**



• • • the odds always favor the electronic engineer who chooses TURX for his DIELECTRIC HEATING UNIT FIXTURES. The tough rock hardness of TURX—the result of pyro-welding; the ease with which it can be machined and fabricated; its low loss performance under the most exacting conditions is rapidly bringing TURX to the front in the field of dielectric heating. For dies or structural supports this new and better glass-bonded mica will give you a new conception of just how effective glass-bonded mica insulation can really be.

Ask us to send you our catalogue. It's extremely interesting.

INTERNATIONAL PRODUCTS CORPORATION
High Frequency Electrical Insulation
BALTIMORE 18, MARYLAND

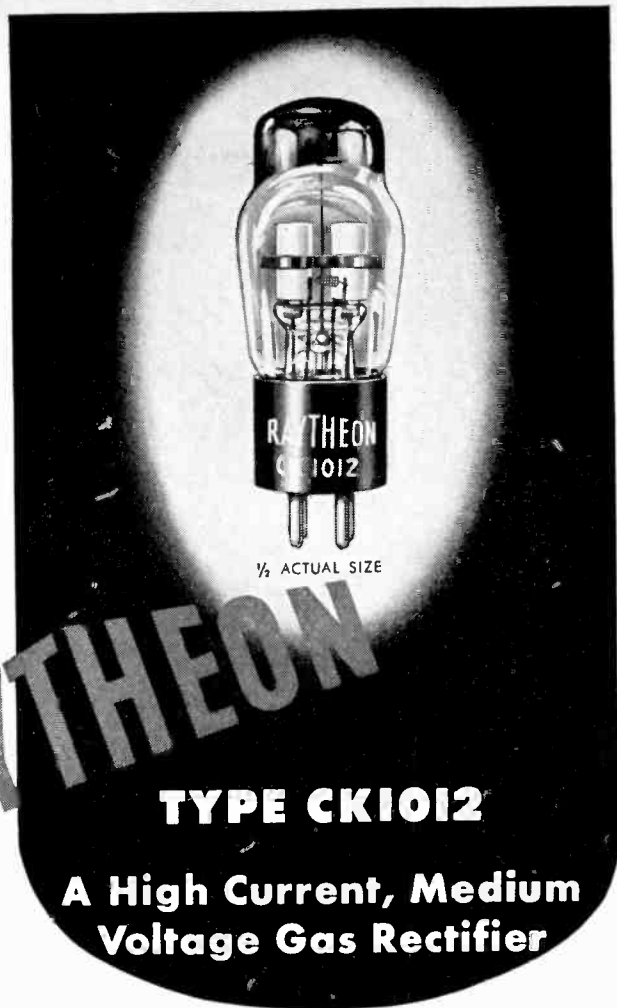

The Raytheon type CK1012 full wave gas rectifier was developed to supply the requirements at high rectification efficiency for those applications which require more power than is obtainable with conventional receiving tubes and yet cannot justify the size and expense of transmitting type tubes. In this category are the larger fm and television receivers and small fixed or mobile transmitters.

The CK1012 is contained in an ST-14 bulb, which is the size of a type 80. The emitter can be directly heated — or, under the proper conditions noted below, ionically heated for greater efficiency and elimination of heater windings.

The very rugged construction is ideal for mobile equipment, and the use of an inert gas allows it to operate over a wide range of ambient temperature. No preheating time is required, and consequently full output is obtainable almost instantly. Any tendency to generate noise in radio frequency applications can be minimized by proper filtering and shielding of the tube and associated wiring.

Whether or not CK1012 fits your requirements, it is an example of the advanced engineering and painstaking manufacture found in the entire Raytheon tube line. For best results, specify Raytheon High-Fidelity Tubes for your postwar products.

TYPE CK1012 RATINGS — FULL WAVE RECTIFIER SERVICE

	IONICALLY HEATED*	DIRECTLY HEATED	
Filament Voltage	0	1.75	volts
Filament Current	0	2.00	amp
Maximum Peak Inverse Voltage	1200	1200	volts
Average D.C. Voltage Drop	25	20	volts
Maximum D.C. Output Current	300	300	ma
Minimum D.C. Output Current	70	0	ma
Minimum Starting Peak Voltage	400	300	volts
Maximum Steady State Peak Anode current per anode	900	900	ma

*This condition is not recommended for rapid intermittent operation



All Four Divisions Have Been Awarded Army-Navy 'E' with Stars



DEVOTED TO RESEARCH AND THE MANUFACTURE OF TUBES AND EQUIPMENT FOR THE NEW ERA OF ELECTRONICS

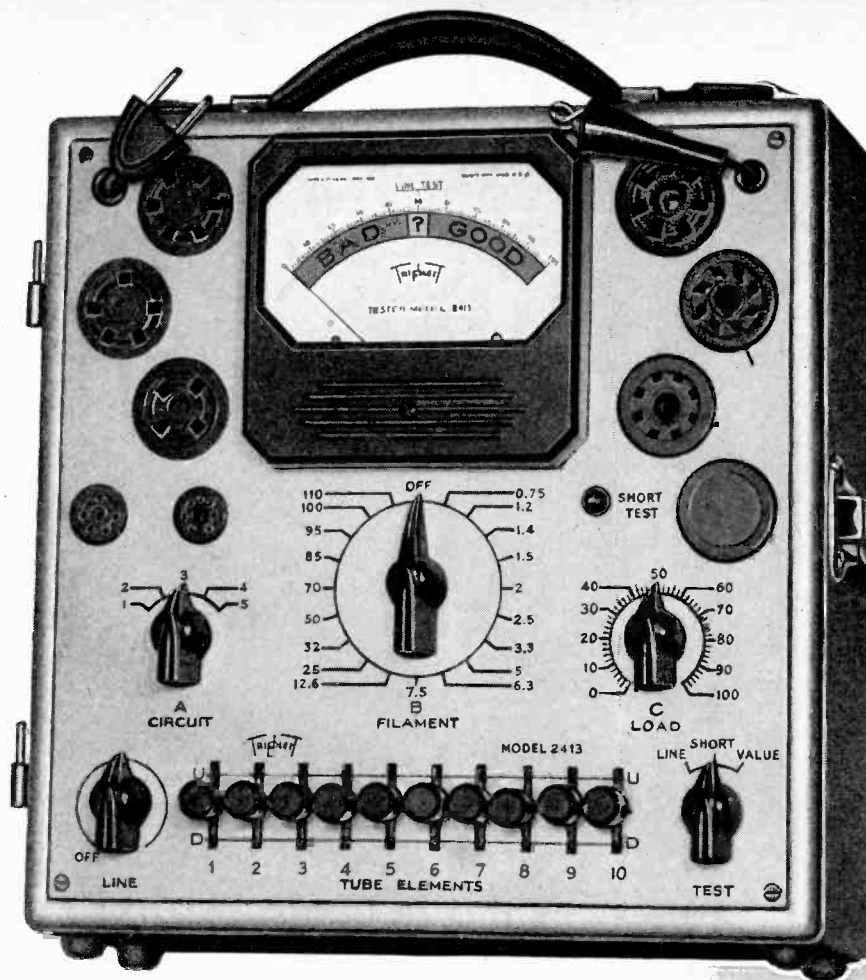

MODEL 2413

is another
member of the
NEW TRIPLETT
Square Line

The New Speed-Chek Tube Tester

MORE FLEXIBLE • FAR FASTER • MORE ACCURATE

Three-position lever switching makes this sensational new model one of the most flexible and speediest of all tube testers. Its multi-purpose test circuit provides for standardized VALUE test; SHORT AND OPEN element test and TRANSCONDUCTANCE comparison test. Large 4" square RED • DOT life-time guaranteed meter.

Simplicity of operation provides for the fastest settings ever developed for practical tube testing. Gives individual control of each tube element.

New SQUARE LINE series metal case 10" x 10" x 5½", striking two-tone hammered baked-on enamel finish. Detachable cover. Tube chart 8" x 9" with the simple settings marked in large easy to read type. Attractively priced. Write for details.

Additional Features

- Authoritative tests for tube value; shorts, open elements, and transconductance (mutual conductance) comparison for matching tubes.
- Flexible lever-switching gives individual control for each tube element; provides for roaming elements, dual cathode structures, multi-purpose tubes, etc.
- Line voltage adjustment control.
- Filament Voltages, 0.75 to 110 volts, through 19 steps.
- Sockets: One only each kind required socket plus one spare.
- Distinctive appearance with 4" meter makes impressive counter tester — also suitable for portable use.



Triplet

ELECTRICAL INSTRUMENT CO. BLUFFTON, OHIO



strength that is pre-destined

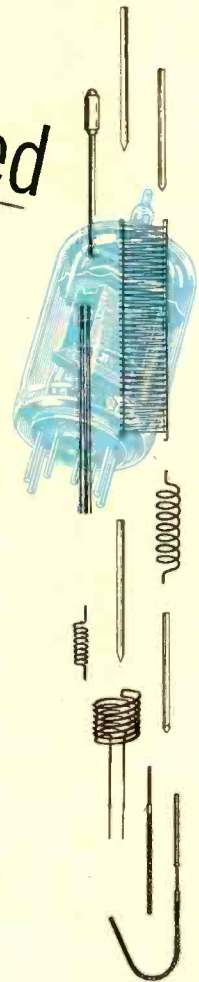
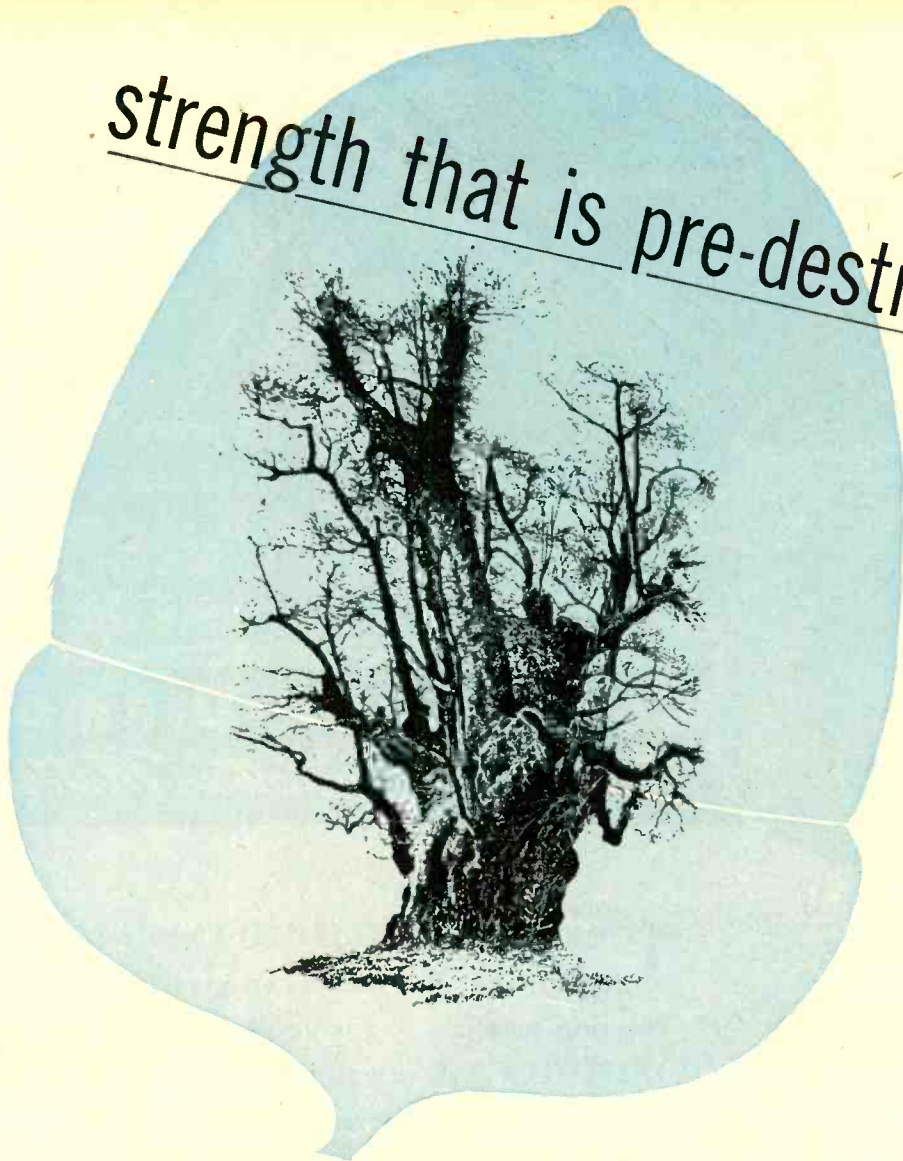

Callite Tungsten Heaters in these Tung-Sol Miniatures will weather whip and any vibration

The tiny Tung-Sol Tube type 6AK5, not much bigger than an acorn, has an enviable record in military equipment for its ability to stand abuse and remain efficient under adverse conditions.

Features, that contribute to the remarkable ruggedness of this miniature tube, are its unique plate construction, the method of anchoring the mount, and its Callite tungsten heater. These heaters are processed by Callite for Tung-Sol with the right

proportions of tungsten to give the required life and stability, plus the strength to withstand vibration and shock.

Through years of research in tungsten, molybdenum and special alloys, Callite has developed metallurgical components with the special qualities that facilitate tube-making and result in fine products. It will pay you to investigate our complete range of metallurgical specialities. Call on us for cooperation on designs and appli-

cations. Callite Tungsten Corporation, 544 Thirty-ninth Street, Union City, New Jersey. Branch Offices: Chicago, Cleveland.

Callite
tube components



HARD GLASS LEADS, WELDS, TUNGSTEN AND MOLYBDENUM WIRE, ROD AND SHEET, FORMED PARTS AND OTHER COMPONENTS FOR ELECTRON TUBES AND INCANDESCENT LAMPS.

FOR THE TOUGH JOBS

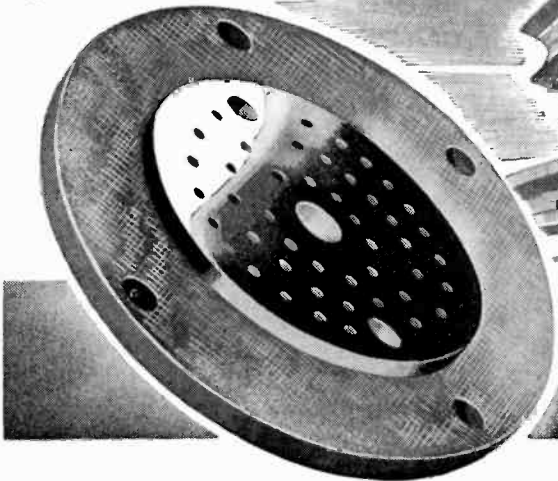

Continental-Diamond *Engineered Dielectric Materials*

A grade LE DILECTO laminated plastic insulating part used in rocket controls. Its insulating properties and dimensional accuracy must remain stable under terrific impact and vibration and regardless of temperature extremes.

THE ability of C-D DILECTO Electrical Insulation to take all a rocket can give . . . and still function perfectly . . . is good evidence that C-D DILECTO will serve well as electrical insulation in your present and future products.

C-D DILECTO is made in many standard grades to meet specific electrical, physical and thermal problems. Special grades can be developed to meet unusually exacting conditions. C-D DILECTO may be the solution to your "What Material?" problem.

KR-45

C-D PRODUCTS

The Plastics
DILECTO—A Laminated Phenolic.
CELORON—A Molded Phenolic.
DILECTENE—A Pure Resin Plastic Especially Suited to U-H-F Insulation.
HAVEG—Plastic Chemical Equipment, Pipe, Valves and Fittings.

The NON-Metallics
DIAMOND Vulcanized FIBRE
VULCOID—Resin Impregnated Vulcanized Fibre.

MICABOND—Built-Up Mica Electrical Insulation.

Standard and Special Forms
 Available in Standard Sheets, Rods and Tubes; and Parts Fabricated, Formed or Molded to Specifications.

Descriptive Literature
 Bulletin GF gives Comprehensive Data on all C-D Products. Individual Catalogs are also Available.

DISTRICT OFFICES
 NEW YORK 17 • CLEVELAND 14 • CHICAGO 11
 SPARTANBURG, S. C. • SALES OFFICES IN PRINCIPAL CITIES

•
 WEST COAST REPRESENTATIVES
 MARWOOD LTD., SAN FRANCISCO 3

•
 IN CANADA:
 DIAMOND STATE FIBRE CO. OF CANADA, LTD., TORONTO 8

Continental - Diamond FIBRE COMPANY

Established 1895.. Manufacturers of Laminated Plastics since 1911—NEWARK 48 • DELAWARE

THE AMPEREXTRA FACTOR IN DIELECTRIC HEATING

Dielectric heating has revolutionized the processing of plastics, textiles, rubber, drugs, foods, wood, paper and many other products. For dielectric heating equipment AmpereX has originated a number of electronic tube types especially suited for use as oscillators at high frequencies. Dependable operation and reserve capacity are the **AmpereXtra Factor** in this group of tubes — a Factor which will increase in importance in the highly competitive postwar years when goods must be delivered better, cheaper—and on time.

"WON'T GO CUCKOO"

... that is how one electronic heat generator manufacturer describes AmpereX tubes. If your equipment is right, AmpereX Special Application Engineering will help you make it better. Dependable operation is assured, replacements minimized, and greater value per dollar expended may be anticipated.



THE AMPEREX SPECIAL APPLICATION ENGINEERING DEPARTMENT

... AmpereX Special Application Engineers have nothing to sell. Their job is to work with you on the development of new equipment or the improvement of present products. Their time and knowledge is yours for the asking, without charge or obligation.



RESERVE CAPACITY

... the measure of tube life is in the reserve capacity of the tube. Because of novel design, AmpereX high frequency tubes may be used at plate voltages and plate power inputs sufficiently high to allow power outputs at maximum rated watts per tube.



AmpereX Type 235-R Transmitting Tube. Filament voltage, 14.5-15.0 volts. Filament current, 39.0 amperes. Amplification factor, 14.0. Grid to plate transconductance at 500 ma., 6500 micromhos. Direct interelectrode capacitance: grid to plate, 9.0 μf ; grid to filament, 10.0 μf ; plate to filament, 1.5 μf . List price, \$125.00.



AmpereX Type 889-R Transmitting Tube. Filament voltage, 11 volts. Filament current, 125 amperes. Amplification factor, 21. Direct interelectrode capacitance: grid to plate, 17.8 μf ; grid to filament, 19.5 μf ; plate to filament, 2.5 μf . List price, \$175.00.



AmpereX Type 889-R Transmitting Tube. Filament voltage, 11 volts. Filament current, 125 amperes. Amplification factor, 21. Direct interelectrode capacitance: grid to plate, 20.7 μf ; grid to filament, 19.5 μf ; plate to filament, 2.5 μf . List price, \$325.00.

AMPEREX

... the high performance tube

Many standard types of AmpereX tubes are now available through leading radio equipment distributors

AMPEREX ELECTRONIC CORPORATION

25 Washington St., Brooklyn 1, N. Y., Export Division: 13 E. 40th St., New York 16, N. Y., Cables: "Arlab"
Canadian Distributor: Rogers Majestic Ltd. • 622 Fleet Street West, Toronto

HOLD ON TO THE WAR BONDS YOU HAVE — AND KEEP BUYING MORE



New FOLDED UNIPOLE ANTENNA

Another Example of ANDREW Ingenuity in Engineering

Concentrating on electrical performance, Andrew engineers have designed a unique Folded Unipole Antenna which—according to comparative tests—easily outperforms other antennas at several times the price.

Used for transmitting and receiving at frequencies from 30 to 40 MC and for powers up to 5,000 watts, this antenna has proved so successful that similar models for higher frequencies are now being designed.

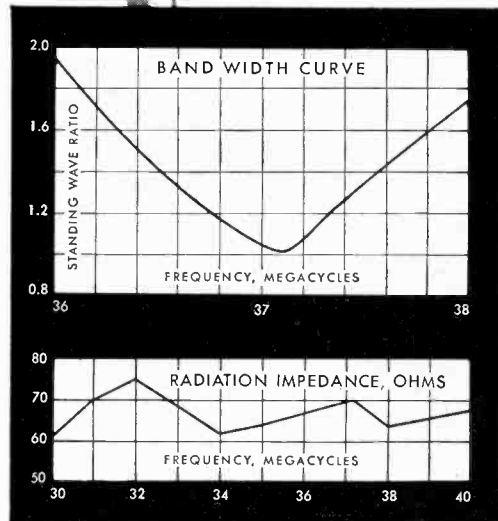

FEATURES:

- Light weight — only 15 pounds — simplifies installation.
- Lightning hazard minimized by grounded vertical element.
- "Slide trombone" calibration permits exact adjustment for any frequency between 30 and 40 MC, using only a wrench. Optimum performance for that frequency is guaranteed without "cut and try" methods.
- Proper termination of coaxial transmission line. Unlike other "70-ohm" antennas, the Folded Unipole actually provides a non-reactive impedance with a resistive component varying between 62 and 75 ohms (see lower curve).
- Excellent band width, ideal for FM (see upper curve).

Andrew Co. specializes in the solution of antenna problems. For designing, engineering and building of antenna equipment, consult Andrew Co.

ANDREW CO.
363 EAST 75th ST., CHICAGO 19, ILL.

WRITE FOR FULL INFORMATION



BOSTON

"Wartime Developments in Electronics," by W. L. Everitt, President, The Institute of Radio Engineers, Inc.; May 25, 1945. Election of Officers, May 25, 1945.

BUENOS AIRES

"Frequency-Modulation Transmitters," by A. Saenz, RCA Victor Argentina; June 1, 1945.

"Television," by J. P. Calvelo; Tel-Rad, S.A.; June 15, 1945.

"Acoustic Proof-Room—General Theory—Loudspeakers Tests' Instrumental," by R. Hastings; Ucoa, S. A.; July 6, 1945.

"Some Points of View on the International Radio-Conferences," by A. T. Cosentino; Pan-American Argentine; July 20, 1945.

CEDAR RAPIDS

"Frequency Ranges in Music and Speech," by Ralph Glover; Consulting Engineer; June 22, 1945.

DALLAS-Ft. WORTH

"An Informal Discussion of the RCA System of Television," by Wesley Turner, RCA Victor Division; July 13, 1945.

"Television Equipment Demonstration," by J. C. Skinner, Interstate Circuit, Inc.; July 13, 1945.

PORTLAND

"Frequency Modulation," by those present; August 8, 1945.

SAN DIEGO

"A 500-Cycle Aircraft-Landing System," by E. N. Dingley, U. S. Navy Radio and Sound Laboratory; August 21, 1945.

Election of Officers, August 21, 1945.

TORONTO

"Application of Radio to Railroad Signaling Systems," by W. S. Halstead, Halstead Traffic Communication Corp.; May 21, 1945.

Election of Officers, May 21, 1945.

WILLIAMSPORT

"Radio Relay Systems Development by the Radio Corporation of America," by H. O. Peterson, RCA Laboratories, Inc.; July 27, 1945.

"Industrial Radio-Frequency Transformers," by H. W. Parker, Sylvania Electric Products, Inc.; July 27, 1945.

"The Use of Sound Systems as a Production Tool," by A. G. Schifino, Stromberg-Carlson Company; July 28, 1945.



The following transfers and admissions were approved on September 5, 1945:

Transfer to Senior Member

- Bearden, J. A., Johns Hopkins University, Radiation Laboratory, Baltimore 18, Md.
 Bloomer, T. M., 605 Warwick Road, Baltimore 29, Md.
 Bonney, R. B., 343 Knollwood Ave., Douglaston, L.I., N.Y.
 Dickinson, W. A., Sylvania Electric Products, Inc., Emporium, Pa.
 Downs, G. W., California Institute of Technology, 137 South Lake Ave., Pasadena, Calif.
 Ingalls, C. E., 87 Simonds Road, Lexington 73, Mass.
 Johnson, W. C., School of Engineering, Princeton, N.J.

(Continued on page 46A)

Federal... **KNOWS** H-F Cable



Inside and Out

From inner conductor to outer covering . . . Federal really knows high-frequency transmission lines.

And this knowledge was not easily won. As the pioneer in the field Federal not only developed over 80% of all h-f cable types in use today . . . but developed most of the equipment needed to test them.

Attenuation, high-voltage, dielectric and balance testing equipment, velocity of propagation, braid-resistance and electri-

cal length meters . . . were all Federal-engineered to fit specific requirements.

That's why it's logical to turn to the acknowledged leader in the field for the finest in h-f cables, specialty-engineered harnesses and cable assemblies.

Where requirements are critical . . . for transmission lines with special characteristics . . . for custom-built and engineered harnesses and cable assemblies . . . take your high-frequency transmission problems to Federal.



Federal Telephone and Radio Corporation

Newark 1, N. J.



1,001 USES

Condensed Power for Years of Service

VERSATILITY and dependability were paramount when *Alliance* designed these efficient motors — *Multum in Parvo!* . . . They are ideal for operating fans, movie projectors, light home appliances, toys, switches, motion displays, control systems and many other applications . . . providing economical condensed power for years of service.

Alliance Precision

Our long established standards of precision manufacturing from highest grade materials are strictly adhered to in these models to insure long life without breakdowns.

EFFICIENT

Both the new Model "K" Motor and the Model "MS" are the shaded pole induction type — the last word in efficient small motor design. They can be produced in all standard voltages and frequencies with actual measured power outputs ranging upwards to 1/100 H. P. . . Alliance motors also can be furnished, in quantity, with variations to adapt them to specific applications.

DEPENDABLE

Both these models uphold the *Alliance* reputation for all 'round dependability. In the busy post-war period, there will be many "spots" where these Miniature Power Plants will fit requirements . . . Write now for further information.

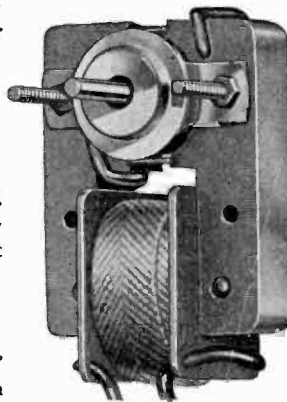

Model "MS" — Full Size
Motor Measures
1 3/4" x 2 x 3 1/8"

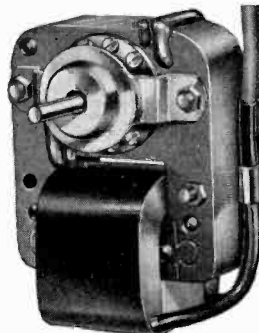

New Model "K" — Full Size
Motor Measures
2 1/8" x 2 3/8" x 3 1/8"

Remember Alliance!
—YOUR ALLY IN WAR AS IN PEACE

ALLIANCE

MANUFACTURING CO.

ALLIANCE . OHIO



(Continued from page 44A)

- Larsen, M. J., Stromberg-Carlson Co., Rochester 3, N.Y.
 Lewis, O. I., 128 E. Custis Ave., Alexandria, Va.
 McCanne, L., Stromberg-Carlson Co., Rochester 3, N.Y.
 Mueller, C. W., 17 Harold Ave., Princeton, N.J.
 Muller, J. H., 23 Johnstone Rd., Great Neck, L.I., N.Y.
 O'Brien, E. J., 960 Mamaroneck Ave., Mamaroneck N.Y.
 Phelan, T. H., 364 Concord Drive, Maywood, N.J.
 Ready, W. A., 85 Chestnut St., Weston, Mass.
 Young, C. J., RCA Laboratories, Princeton, N.J.

Admission to Senior Member

- Ferrar, R. C., P. O. Box 315, New Providence, N. J.
 Grignon, L. D., 1427 Warnall Ave., Los Angeles 24, Calif.
 Walker, H., 506 Overbrook Rd., Baltimore 12, Md.

Transfer to Member

- Anderson, I. H., 1709—3 Ave., S., Anoka, Minn.
 Baily, F. A. A., 2850 Willowdale Ave., Montreal, P.Q., Canada
 Bailey, F. M., General Electric Co., Bldg. 269, Schenectady, N. Y.
 Bartman, F. L., 174 N. Arlington Ave., East Orange, N. J.
 Berg, R. A., 138 Lexington Ave., Fair Haven, N. J.
 Brown, R. H., 1418 M St., N.W., Washington 5, D. C.
 Bullock, M. W., 1100 Idylwild Drive, Lincoln 3, Nebr.
 Evans, H. R., 1130 N. 9 St., Lafayette, Ind.
 Feindel, A., 292 N. Maple Ave., East Orange, N. J.
 Foster, J. D., 30 Burns Ave., Wyoming 15, Ohio
 Gaenzle, J. B., 301 E. Alleghany Ave., Emporium, Pa.
 Goldman, A., 565 W. 2 St., Dayton 2, Ohio
 Holling, K., "Lynwood," Prieststic Rd., Sutton in Ashfield, Notts., England
 Jensen, W., 1369 W. Iowa Ave., St. Paul 4, Minn.
 Jordan, A. D., 605 Jordan Ave., Montoursville, Pa.
 Kingsley, R. J., 180 Sanders Rd., Buffalo, N. Y.
 Knowles, D. J., RFD 2, Emporium, Pa.
 Lambert, R. L., Sylvania Electric Products, Inc., Emporium, Pa.
 Loeber, C. W., Federal Communications Commission, Washington 25, D. C.
 Mason, J. E., RFD 3, Box 1121, Bremerton, Wash.
 McKenzie, A. A., 350 Cabot St., Newtonville 60, Mass.
 McNaughten, N., International Div., Federal Communications Commission, Washington 25, D. C.
 Mendenhall, G. G., 1602 E. Garfield St., Seattle 2, Wash.
 Morley, H. B., 76 Forster St., Brighton 35, Mass.
 O'Brien, R. S., 12 Hilliard St., Cambridge 38, Mass.
 Peterson, A. W., 519 E. Alleghany Ave., Emporium, Pa.
 Porsch, A. W., Box 87, Emporium, Pa.
 Raymond, G. H., Upsal Manor, 13 E. Upsal St., Germantown, Philadelphia 19, Pa.
 Reitz, N. J., Sylvania Electric Products, Inc., Emporium, Pa.
 Roberts, S., 10 Avon St., Cambridge 38, Mass.
 Schnering, C. J., 1122—11 Ave., Huntington, W. Va.
 Sherburne, C. J., 3139 Wynwood Lane, Los Angeles 23, Calif.
 Soderman, R. A., c/o Radio Research Laboratory, 18 Divinity Ave., Cambridge 38, Mass.
 Switzenberg, E. A. F., c/o Western Electric Co., D-9813, 195 Broadway, New York 7, N. Y.
 Teomney, G. H., Jr., 88 Hart St., Lynbrook, N. Y.
 Wheeler, B. F., 500 Redman Ave., Haddonfield, N. J.
 Woodbury, W. F., 8 Alden Ave., Valley Stream, N. Y.

(Continued on page 48A)

Proceedings of the I.R.E. October, 1945

JUST ONE

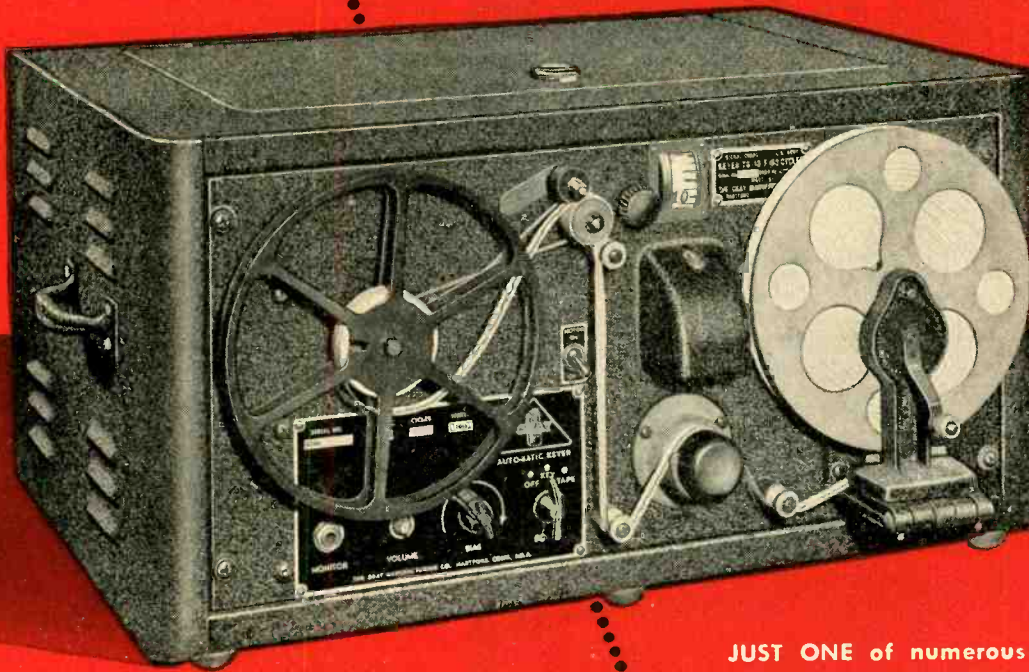

JUST ONE of numerous government radio and electronic items now available through the Hallicrafters Co., Chicago, agent for Reconstruction Finance Corporation.

This is a Keyer TG-10-F, an automatic unit for providing code practice signals from inked tape recordings. Excellent for group instruction, sufficient power to operate up to 300 pairs of head phones. Can be adapted as amplifier of 10 to 15 watts output for use with crystal mike or phono pick up. Completely checked and reconditioned by Hallicrafters engineers. Send coupon for further details and lists of other available items.

THESE VALUABLE ITEMS *Available Now*
or very soon. Write, wire or phone for further information

- head phones • test equipment • component parts • marine transmitters and receivers • code practice equipment • sound detecting equipment • vehicular operation police and command sets • radio beacons and airborne landing equipment

hallicrafters RADIO

HALLICRAFTERS CO., AGENT OF RFC UNDER CONTRACT SIA-3-24

WORLD'S LARGEST EXCLUSIVE MANUFACTURERS OF
SHORT WAVE RADIO COMMUNICATIONS EQUIPMENT

CLIP THIS COUPON NOW

RFC DEPARTMENT 107, HALLICRAFTERS
5025 West 65th Street • Chicago 38, Illinois

- Send further details and price on Keyer TG-10-F
 Send listings of other available items

Especially interested in.....

NAME.....

ADDRESS.....

CITY..... ZONE.....

STATE.....



(Continued from page 46A)

Wysocki, K., Hazeltine Electronics Corp., 58-25 Little Neck Pkwy., Little Neck, L.I., N. Y.

Admission to Member

- Abbott, W., Engineering Annex, Ames, Iowa
- Anderson, H. J., 1640 Wisconsin Ave., Flint 6, Mich.
- Borden, C. C. Sr., 33 Clinton Ave., New Providence, N. J.
- Bradley, J. C., 289 Carmita Ave., Rutherford, N. J.
- Britney, O. L., Rm. 244, Hunter Bldg., Ottawa, Ont., Canada
- Burgess, N. M., 15 Browning Ave., Toronto, Ont., Canada
- Chaney, H. L., Box 724, Red Bank, N. J.
- Chuang, Y. S., c/o T. W. A. Communication Dept., 14 W. 3 St., Kansas City, Mo.
- Collens, C. W., 53 Church St., Baldwin, N. Y.
- Crockett, J. G., 508 Devon Rd., Upper Darby P. O., Pa.
- Dobridge, R. W., 975 MacNaughton Rd., Town of Mt. Royal, Montreal 16, P. Q., Canada
- Farrar, C. L., 927 Chautauqua, Norman, Okla.
- Fleming, J. C., 1243 Westridge Rd., S.W., Atlanta, Ga.
- Forgue, S. V., RCA Laboratories, Princeton, N. J.
- Gregory, C. A., M.I.T. Harbor Bldg. School, 470 Atlantic Ave., Boston, Mass.
- Gross, T. A. O., Raytheon Manufacturing Co., Electronic Equipment Div., Waltham, Mass.
- Hanson, P. R., 28 Prince Ave., Winchester, Mass.
- Holt, R. B., 50 Trowbridge St., Cambridge 38, Mass.
- Johnson, L. E., Department of Chemistry and Electricity, U. S. Military Academy, West Point, N. Y.
- Knight, C. R., 230-2 St., Scotia 2, N. Y.
- Marshall, J. F., 720 Park Ave., Rochester 7, N. Y.
- Meeker, W. F., Stromberg-Carlson Co., 100 Carlson Rd., Rochester 3, N. Y.
- Mortada, I. O., "Immobilia" Bldg., 26A., Sharia Madabegh, Cairo, Egypt
- Slaymaker, F. H., 100 Carlson Rd., Rochester, N. Y.
- Somerville, G. A., 53 Broughton St., Edinburgh, Scotland, N. B.
- Sprows, P. H., 2 Victory Ave., Nafair, Navy Yard 55, S. C.
- Urick, R. J., U. S. Navy Radio and Sound Laboratory, San Diego 52, Calif.

Admission to Associate

- Albright, J. F., Box 666, Sylacauga, Ala.
- Alexander, F. C., 67 Broad St., New York 4, N. Y.
- Ashman, A. B., 225 E. 4 St., Cincinnati 2, Ohio
- Babcock, S. K., 3456 Glendale Blvd., Los Angeles 26, Calif.
- Baker, W. Y., 500 California St., Newtonville, Mass.
- Benis, B., 3810 Dorchester Rd., Baltimore 7, Md.
- Black, I. H., 114 Wurtemberg St., Ottawa, Canada
- Blow, A. W., 98 Beaumont St., Springfield 8, Mass.
- Bock, E. L., 172 Mystic Valley Pkwy., Arlington 74, Mass.
- Bolwig, A. C., Cia. Internacional de Radio, Bella Vista, F. C. P., Republica Argentina
- Boswell, I. I., The Laurels, North Crawley, Newport Pagnell, Bletchley, England
- Burke, F. T., 423 Catherine St., Elizabeth 4, N. J.
- Chubb, H. E., 1844 Capistrano St., San Digo 7, Calif.
- Clevenstine, W. M., 1512 Varnum St., N. W., Washington 11, D. C.
- Clough, R. F., 37-38-86 St. Jackson Heights, L. I., N. Y.
- Codish, S., 2685 Valentine Ave., New York 58, N. Y.
- Dalbey, W. O., 209 E. Henrietta St., Wooster, Ohio
- DeSimone, D. J., 147 Bedford Ave., Brooklyn, N. Y.
- Diamond, S., 1585 E. 14 St., Brooklyn, N. Y.
- Dinter, J. A., 19 Virginia Rd., Buffalo 21, N. Y.

(Continued on page 50A)



WAVE FILTERS

Precision Made for Specialized Applications

Engineering experience and manufacturing know-how combine to make Chicago Transformer unusually well qualified to design and produce all types of audio frequency filters for the most exacting requirements.

Also makers of . . .
 Power transformers for radio and other electronic circuits, vibrator power transformers, audio and filter reactors, instrument transformers, auto and control transformers, wave filters, fluorescent ballasts and ignition coils.

CHICAGO TRANSFORMER

DIVISION OF ESSEX WIRE CORPORATION
 3501 WEST ADDISON STREET
 CHICAGO, 18



NEW INSTANT-HEATING BEAM TETRODE

Ruggedized 2E25

FOR MOBILE OPERATION



Developed for Signal Corps portable, mobile, or emergency communications equipment, the 2E25 r.f. beam tetrode is easy on the battery. The thoriated tungsten filament permits simultaneous application of filament and plate potentials. Precious battery power is conserved during standby periods.

Completely shielded for r.f., the 2E25 requires no neutralization even at its maximum frequency of 100 megacycles. Other features are: low-loss octal base, plate connection to top cap, filament potential centered at 6.0 volts, and extremely rugged construction.

Consider the advantages of the 2E25 as an instant-heating replacement for the 6V6GT or 6L6G in older equipment, or for use in modern equipment such as the new Kaar mobile FM set illustrated. Remember, the versatility of the 2E25 beam tetrode simplifies the spares problem; this one type can power a whole transmitter—R.F. and A.F. Order your engineering samples today.

HYTRON 2E25

Instant-Heating 15-Watt R.F. Beam Tetrode
TENTATIVE ELECTRICAL DATA

Filament Potential	6.0 ± 5% ac or dc volts
Filament Current	0.80 amp.
Plate Potential	450 max. dc volts
Screen Potential	250 max. dc volts
Grid Potential	-125 max. dc volts
Plate Current	75 max. dc ma.
Plate Dissipation	15 max. watts
Screen Dissipation	4 max. watts
Grid Driving Power (Class C)	0.5 watt approx.
Power Output (Class C)	20 watts

AVERAGE DIRECT INTERELECTRODE CAPACITANCES

Grid to Plate (with external shielding)	0.18 max. mmfd
Input	8.5 mmfd
Output	6.0 mmfd

MECHANICAL DATA

Maximum Overall Length	4 ³ / ₁₆ inches
Maximum Diameter	1 ¹ / ₁₆ inches
Bulb	T-11
Cap.	Small metal
Base	7-pin med. short shell low-loss octal

The New 2E25 Supersedes and Replaces the HY65



New instant-heating mobile FM transmitter developed by Kaar Engineering Co. uses 7 Hytron 2E25 and 2 Hytron HY69 or HY1269.

WRITE TODAY to Dept. 14 for these:
New Hytron transmitting and special purpose tube catalog; 21 x 17 inch sheet illustrating Step-by-Step Assembly of Typical Hytron Tube.

OLDEST MANUFACTURER SPECIALIZING IN RADIO RECEIVING TUBES

HYTRON

RADIO AND ELECTRONICS CORP.

MAIN OFFICE: SALEM, MASSACHUSETTS



Two recent SHALLCROSS ENGINEERING DEVELOPMENTS

This convenient No. 759 Kilovoltmeter incorporates several features that make it ideal for either portable or fixed general use. A reversing switch makes it unnecessary to change the terminal connections should polarity be reversed. The built-in meter provides $\pm 2\%$ accuracy and binding posts are provided for an external meter if higher accuracy is required. The meter multiplier section is adjusted within 0.1% so that, when required, more accurate meters may be used with the external connection. This also permits the individual taps of the multiplier to be used as accurate high resistance standards.



New! 5-RANGE PORTABLE KILOVOLT METER

1, 2, 5, 10, 20 kilovolts DC at full scale.

Milliohmmeter No. 673-F is a new addition to the growing group of Shallcross direct reading resistance measuring test sets. Linear scales eliminate crowding of the higher resistance values at one end of the scale. Six scales have ranges of 0-0.5-1-5-10-50 and 100 ohms full scale, thus bridging the gap between the regular Shallcross Milliohmmeters that are extensively used for low resistance testing and the ordinary Ohmmeters used for relatively high resistance measurements. Separate connections are provided for current and potential to minimize the effect of lead and contact resistance when measuring low values. The instrument uses a single #6 dry cell battery carried in a compartment.

New! MEDIUM RANGE MILLIOHMMETER

Six scales: 0-0.5-1-5-10-50 and 100 ohms full scale

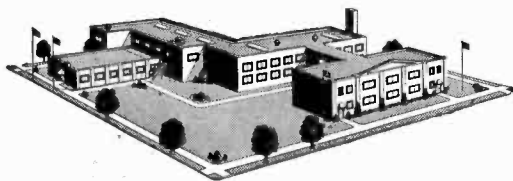

SHALLCROSS MFG. CO.

Engineers • Designers • Manufacturers

DEPT. IR-105, COLLINGDALE, PA.



(Continued from page 48A)

- Dunnegan, T. Jr., Industrial Command, Div. 12-I, U. S. Naval Repair Base, San Diego, Calif.
 Elliott, J. R., 1221—14 Ave. W., Calgary, Alberta, Canada
 Elphinstone, N. P., 1016 Boren Ave., Seattle 4, Wash.
 Evans, R. A., 2706—30 St. S. E., Washington 20, D. C.
 Firth, E., 1012 N. Coronado Terrace, Los Angeles, 26, Calif.
 Fortman, K. R., Michigan State Police, East Lansing, Mich.
 Galloway, N. D., 177 Balmoral Ave., Toronto, Ont., Canada
 Gardner, B. R., 3131 Wayne Ave., Dayton 10, Ohio
 Gares, L. F., 2800 William Penn Highway, Easton, Pa.
 Gissler, F. E., c/o Western Electric Co., Radio Div., 165 Broadway, New York, N. Y.
 Graham, D. A., 432 Lakewood St., Lynchburgh, Va.
 Greenblum, C., 274 Stockton St., Brooklyn, N. Y.
 Grib, B., 952 E. 32 St., Brooklyn 10, N. Y.
 Hallam, R. E., 602 McKewin Ave., Baltimore 18, Md.
 Hamilton, G. P., 420 Shawnee St., Bartlesville, Okla.
 Harwood, H. I., 299 Madison Ave., New York 17, N. Y.
 Hawkins, W. A., c/o R.M.O., Puget Sound Navy Yard, Bremerton, Wash.
 Henry, G. N., Jr., Lockbourne Air Base, Sqdn. A., Columbus 17, Ohio
 Hoadley, J. C., 11 Fairview Terrace, West Newton 65, Mass.
 Hultquist, J. F., 918 Winona St., Chicago 40, Ill.
 Hutchison, R. P., 2329 Bellevue Ave., Bettendorf, Iowa
 Iglesias, H. V., 25 de Mayo 793, Punta Alta, Buenos Aires, Argentina
 Jacobs, G. W., 1421 Chester St., South Bend Ind.
 Johnson, W., Box 2135, Seattle 11, Wash.
 Jones, M. C., 955 W. 4 St., Williamsport 30, Pa.
 Jones, N., c/o All America Cables and Radio Inc., Apartado Nal. 215, Cali, Colombia
 Kaplan, D., 41, Trumpeldor St., Tel-Aviv, Palestine
 Karanjia, K. F., Lower Patel, Del Lisle Rd., Bombay, India
 Karda, W. O., 1125 Bryant Ave., New York 59, N. Y.
 Kehoe, V. P., 47 Ardagh St., Toronto, Ont., Canada
 Kish, S. A., 2327—2 Ave., Seattle 1, Wash.
 Kubias, F. F., Box 771, Pasadena, Calif.
 Laxdal, H., Bollagata 9, Reykjavik, Iceland
 Lippert, G. R., 10013 Parkview Ave., Garfield Heights 5, Ohio
 Little, R. P., 4300 S. Capitol Terrace, S. W., Washington 20, D. C.
 Long, L. A., Radio Aviation, Box 157, Moncton, New Brunswick, Canada
 Long, R., c/o Putnam Trust Co., Greenwich, Conn.
 Lord, J. C. V., c/o Postmaster, San Francisco, Calif.
 Malone, F. M., 3871 Newark St., N. W., Washington 16, D. C.
 Marburger, W. G., 2308 Oakland Dr., Kalamazoo 40, Mich.
 Marshall, E. G., c/o William Innes, Castle Shannon, Pa.
 Martin, J. L., c/o Tasman Empire Airways Ltd., Box 457, Auckland, New Zealand
 Mather, J. A., 9 Sutherland Dr., Leaside, Ont., Toronto 12, Canada
 Maurer, C. D., 218—44—101 Ave., Queens Village, L. I., N. Y.
 Menanteaux, A. R., 504 W. 112 St., New York 17, N. Y.
 Mika, H. J., Cross St., Salem Depot, N. H.
 Miller, R. E., 2—4 St., Manhasset, L. I., N. Y.
 Moore, G. D., 1445 Ellis St., Wichita 9, Kansas
 Moulin, H. J., 3765 Market St., San Francisco 14, Calif.

(Continued on page 52A)

USE STANDARD PARTS—SAVE TIME AND MONEY

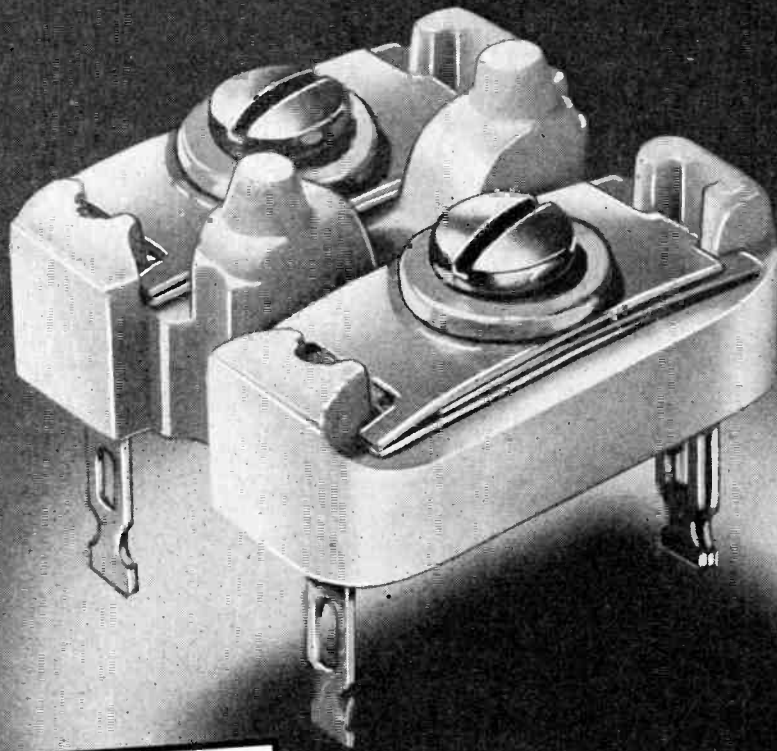

HELP!

*Automatic is delivering
Mass Production Coils and Trimmers
We Need Help*

*To integrate many war-borne developments
into civilian mass production.*

*We have permanent openings for men
who want to work hard and have imagination*

Radio Engineers - Mechanical Designers - Draftsmen

Write - Wire - Phone - Call in Person



AUTOMATIC
MANUFACTURING
CORPORATION

Harrison 6-6630

MASS PRODUCTION COILS & MICA TRIMMER CONDENSERS

300 PASSAIC AVE.

EAST NEWARK, N. J.

NEW!

A complete,
24 page
Illustrated
Manual

on *Permanent Magnets*

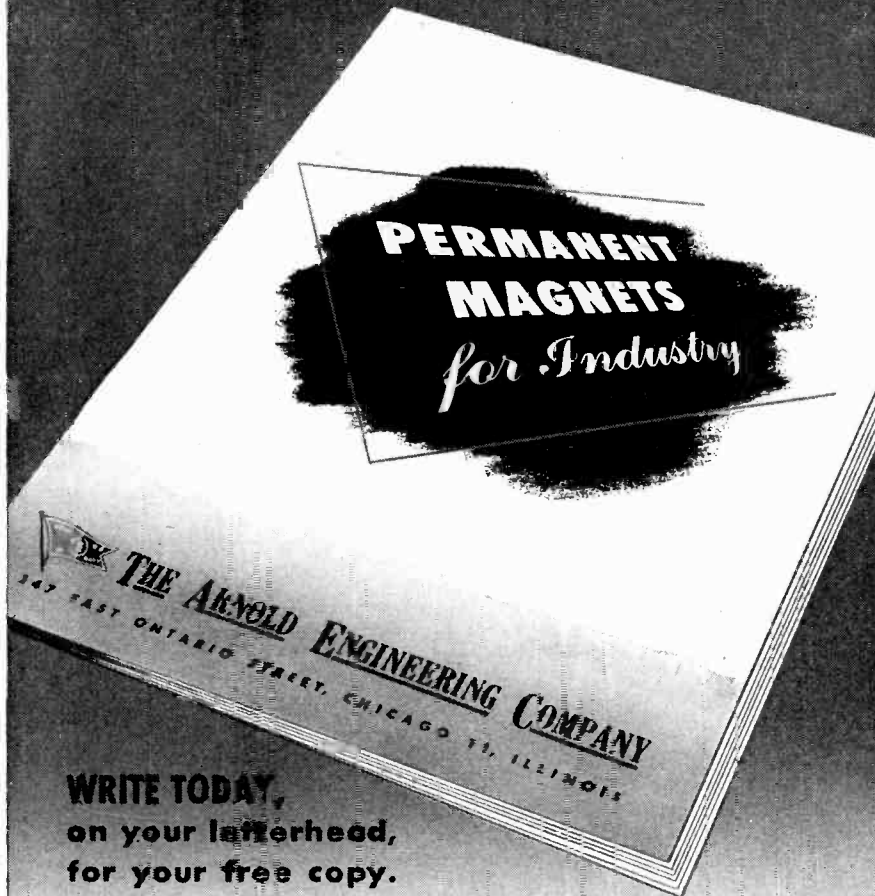

**WRITE TODAY,
on your letterhead,
for your free copy.**

This unusual Arnold manual on permanent magnets is the product of many months of careful research and planning.

It is devoted entirely to the consideration of the factors affecting the design, fabrication and application of Alnico permanent magnets. Written entirely by Arnold engineers, its purpose is to help engineers in industry to better utilize the magnetic and physical characteristics of the Alnico alloys in arriving at efficient design.

Write today, on your letterhead, for your free copy.



THE ARNOLD ENGINEERING COMPANY

147 EAST ONTARIO STREET, CHICAGO 11, ILLINOIS

Specialists in the Manufacture of ALNICO PERMANENT MAGNETS



(Continued from page 50A)

- Myhre, L. C., 99 Nimitz Dr., Dayton 3 Ohio
Nagata, W. S., 345-75 St., Brooklyn 9, N. Y.
Noland, J. W., 3411 Gold St., Omaha 5, Nebr.
Nordahl, H. E., 8010 N. Chautauqua Blvd., Portland 3, Ore.
North, R. C. Jr., 3242 E. 2 St., Wichita, Kansas
Norton, D. B., 8339-15 St., N.W., Seattle 7, Wash.
Nupp, W. D., 4010 Lasher Rd., Drexel Hill, Pa.
Nusbaum, A. S., 3902 Hilton Rd., Baltimore 15, Md.
O'Brien, A. F., c/o Federal Telephone and Radio Laboratories, 67 Broad St., New York, N. Y.
O'Buckley, J. P., 111 Cutler St., Allegan, Mich.
Oepkes, D. J., Riekstraat 2, Nymegen, Holland
Ossmann, E. A., 2100 E. Tremont Ave., New York 62, N. Y.
Parkinson, J. A., Railway Exchange Bldg., 80 E. Jackson St., Chicago 4, Ill.
Prache, P. M., 5 bis, Avenue des Etats Unis, Versailles, Seine & Oise, France
Radtke, W. H., 405 Welch Bldg., 244 California St., (SW Sector-PEA), San Francisco, Calif.
Richards, P. I., 49 Washington Ave., Cambridge 40, Mass.
Richmond, R. E., 1101 N. Burdick St., Kalamazoo 14, Mich.
Robillard, P. A., 9440 Berri St., Montreal 10, P. Q., Canada
Rohrer, C., Jr., 2000 Parkside Dr., Bremerton, Wash.
Ross, R. R., U. S. C. and G. Survey Ship Explorer, 400 Insurance Bldg., Seattle 4, Wash.
Ruel, O. J., 6301 Delmar Blvd., University City, Mo.
Sanchez, G. V., 60 Concordia St., Havana, Cuba
Sanchez, R. A., Estacion Radiotelegrafica de Chapultepec, Mexico, D. F.
Saunderson, H. D., 1015 N. St., N.W., Washington, D. C.
Schick, W., 1455 Jesup Ave., New York 52, N. Y.
Schreiner, R., 145-33-119 Ave., South Ozone Park, L. I., N. Y.
Shaw, G. J., 701 Belmont St., Belmont, Mass.
Shellabarger, J. N., 3229 El Cajon Blvd., San Diego 4, Calif.
Shellberg, S. G., Goodyear Tire and Rubber Co., Electrical Engineering Div., Akron 16, Ohio
Siff, R. G., 307 Livingston Terrace, S.E., Washington 20, D. C.
Slater, H. C., 8809 S. 12 Ave., Inglewood, Calif.
Srivastava, T. N., Govt. Telegraphs, Allahabad, India
Stambaugh, J. C., 3412 Albemarle Ave., Drexel Hill, Pa.
Stephenson, J. G., 41 Bowdoin St., Cambridge 38, Mass.
Stern, L. M., 3511 DeKalb Ave., Bronx 67, N. Y.
Stewart, R. F., 11 Fairview Ave., Winsted, Conn.
Suarez-Flamerich, O., "Villa Francis," Calle Cuello, La Campina, Caracas, Venezuela
Thomas, C. Y., RMS Staff, Treasure Island, San Francisco, Calif.
Tindall, L. T., Box 525-B, G.P.O., Sydney, New South Wales, Australia
Tompkins, G., 86 Beale St., Wollaston 70, Mass.
Tovell, H. O., 55 Browning, Toronto 6, Ont., Canada
Vallarino D., A., Casilla 1753, Santiago, De Chile
Wang, A., c/o I.T.A., 734-15 St., N.W., Washington 5, D. C.
Ward, F. L., 3550 Lorne Ave., Montreal, P.Q., Canada
Watt, C. W., Jr., 10 Dana St., Cambridge 38, Mass.
Weller, H. H., 2272-24 St., Santa Monica, Calif.
White, G. J., 69 Beresford Ave., Coventry, Warwickshire, England
Worrell, D. E., 1831 Sackett, Cuyahoga Falls, Ohio
Worster, M. C., 400 Elm Ave., Bogota, N. J.
Yates, C. F., 6216 Kraft Ave., N. Hollywood, Calif.

**What
you may
expect from
LITTON**

Vacuum Tube Baking Oven

- *Double wall stainless steel cylinder*
- *High temperature sheathed Calrod heaters*
- *Slide guide mounting brackets*
- *Lightweight*
- *Continuous operation at 500° C. with long life*
- *Short heating time*
- *Adaptable to nearly every design of power tube exhaust station*

These ovens are normally supplied with stainless steel bottoms and open tops. Tops are closed with asbestos mill board discs made simply by the user to fit his manifold requirements.

Send for Litton catalog on Molube Vapor Pump Media, High Vacuum Pumps and auxiliaries—Glass Working Fires, Machines and accessories—Spot Welder, Metal to Glass Seals and other special production items.

*"For Twelve Years the
Standard of the Industry"*

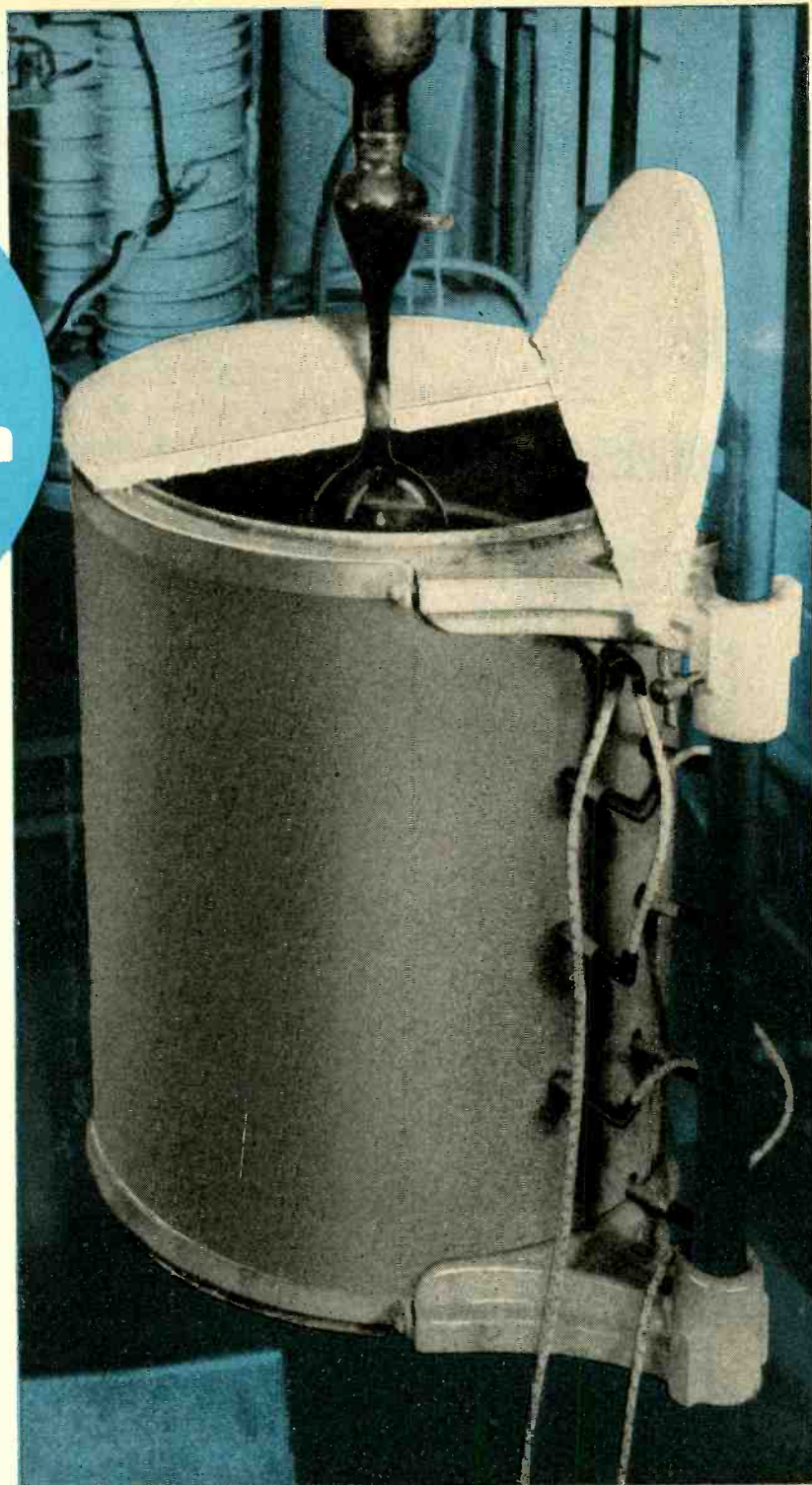

Litton



ENGINEERING LABORATORIES
REDWOOD CITY, CALIFORNIA, U. S. A.

Draftsmen Wanted

Also

Designers

Detailers

Tracers and

Engineers

We are one of the largest manufacturers of a wide variety of communication and electronic equipment in the world, fully prepared and ready to go ahead with a very ambitious, expansion program as quickly as we are permitted. There will be unlimited possibilities for creative, ambitious men to advance to key positions both in research development and production field.

At present, we are producing vital equipment for our fighting forces.

Good Starting Salaries

Exceptionally fine working conditions.

Apply Personnel Office
8 A.M. to 5 P.M.

**FEDERAL TELEPHONE &
RADIO CORP.**

the Mfg. unit of the International
Tel. & Tel. Corp.

591 Broad St., Newark, N.J.
WMC Rules Observed



The following positions of interest to I.R.E. members have been reported as open. Apply in writing, addressing reply to company mentioned or to Box No.

The Institute reserves the right to refuse any announcement without giving a reason for the refusal.

PROCEEDINGS of the I.R.E.

330 West 42nd Street, New York 18, N.Y.

RADIO ENGINEER

Several years experience on radio receivers and associated equipment desirable. Circuit development and mechanical design. Knowledge of production test procedure and test equipment. Opportunity in new division in established firm. Premier Crystal Laboratories, Inc., 63 Park Row, New York 7, N.Y.

ACOUSTICAL ENGINEER

Preferably with E.E. degree to work in the field of microphones, phones, and supersonics. Our employees know of this advertisement. Box 399.

CHIEF, OR SENIOR ENGINEER

New York television radio manufacturer, expanding very fast, requires man with several years thorough experience in design and production of home radio receivers. Not a temporary but a lifetime opportunity. Still have substantial military work; also very substantial home set orders throughout U.S.A. and abroad. Pay highest in the industry. U. S. Television Manufacturing Corp., 106 Seventh Ave., New York 11, N.Y.

TELEVISION ENGINEERS

Design experience in the development of television cameras, terminal equipment or transmitters. State experience and salary desired. Apply in person or in writing to Personnel Department, Raytheon Manufacturing Company, Inc., Communications Division, 60 E. 42nd St., New York 17, N.Y.

DESIGNING DRAFTSMEN AND CABINET BUYER

Designing Draftsmen with prewar experience in preparing production drawings of cabinets for home radios.

Cabinet Buyer experienced for wooden cabinets.

Pleasant working conditions in air conditioned office. Top salaries. Call or see Mr. C. N. Ehrlich, Chief Mechanical Engineer, Hamilton Radio Corp., 510 Sixth Ave., New York 11, N.Y.

SALES ENGINEER

For sale of new and interesting electronic device. Must have had previous sales experience in radio or other electronic equipment. A real opportunity for right man with large international organization. Write qualifications in detail to Box 409.

DIRECTOR OF ENGINEERING

Smaller firm with national organization and established postwar business in electronic, audio and electro-acoustic fields has opening for engineer in charge of development and design. Salary liberal. Must have engineering degree and practical experience. Design of audio and electro-acoustic systems. Replies confidential. State education, experience record, patents, etc. Photograph if available. Box 398.

GRADUATE ELECTRICAL ENGINEER

Having experience in the preparation and prosecution of U. S. patent applications, preferably in electrical fields including radio. Location New York City. Submit complete details, education, experience, and indicate salary expected. Box 392.

ELECTRICAL ENGINEERS

To be trained for patent work in the electronic fields, particularly radio. Location New York City vicinity. Submit complete details, education, experience, and salary requirements. Box 393.

(Continued on page 56A)

OPPORTUNITIES FOR RADIO ENGINEERS

High grade graduate engineers are needed immediately for communications equipment work with a record of outstanding ability and 5 or more years of design and product engineering experience.

Present activities include design and manufacture of high and medium power transmitters, frequency shifters, communication terminal equipment and other communication products.

INTERVIEWS WILL BE ARRANGED FOR QUALIFIED APPLICANTS. WRITE FOR OUR "QUALIFICATION RECORD" FORM.

**PRESS WIRELESS, INC.
HICKSVILLE, L.I.**

ATT: S. A. Barone, Chief Mfg. Engr.

Director of Engineering

Smaller firm with national organization and established postwar business in electronic, audio and electro-acoustic fields has opening for engineer in charge of development and design. Salary liberal. Must have engineering degree and practical experience. Design of audio and electro-acoustic systems.

Replies confidential. State education, experience record, patents, etc. Photograph if available. Box 398, Proceedings of I.R.E., 330 W. 42 St., New York, 18.

TESTIMONIAL TO PERFORMANCE!

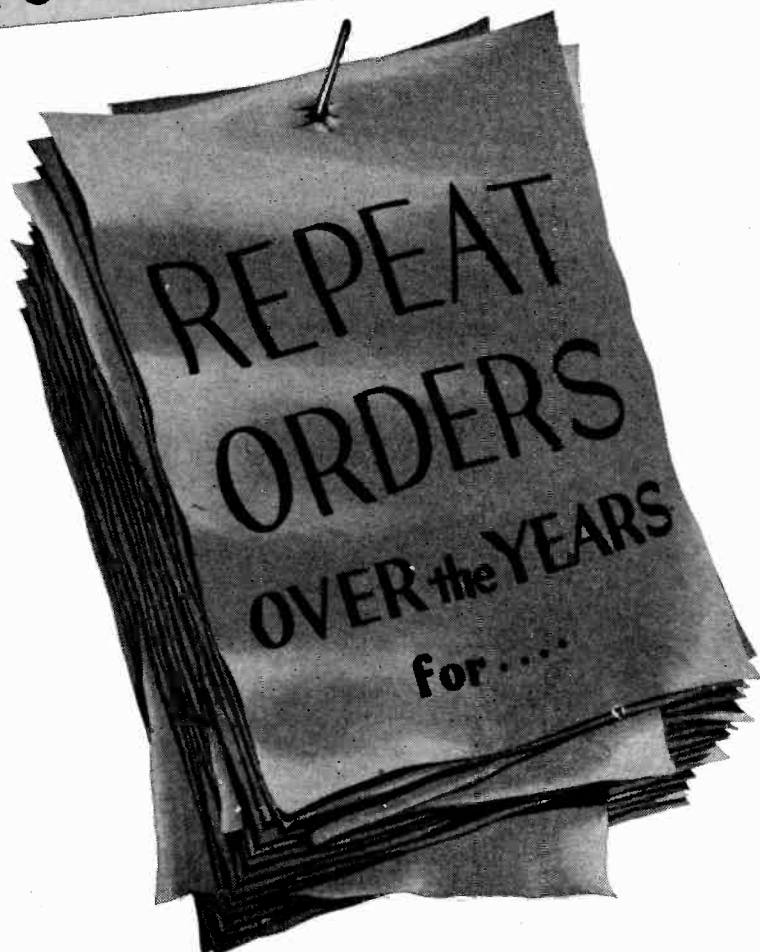

... THORDARSON TRANSFORMERS

The quality of a product and its performance over the years can best be judged by the repeat orders received. Repeat orders mean one thing above everything else . . . *customer satisfaction!*

For over 50 years, Thordarson has supplied transformers and other electronic products constantly to many of the most prominent manufacturers in industry. Yes, Thordarson has always enjoyed a large repeat order business.

At Thordarson . . . continuous research, progressive design and engineering are responsible for the development of the excellent transformers that have earned for Thordarson this reputation for fine performance.

Try Thordarson for your transformer requirements. Then you, too, will know why the many long-time users of Thordarson show their approval by repeat orders. New sales and distribution policies make Thordarson products available to everyone, everywhere.

500 WEST HURON ST., CHICAGO, ILL.



ORIGINATORS OF TRU-FIDELITY AMPLIFIERS

THORDARSON
ELECTRIC MANUFACTURING DIVISION
MAGUIRE INDUSTRIES, INCORPORATED

An important statement on

CARDWELL deliveries...

Almost all standard Cardwell Capacitors are now being made at our Plainville, Connecticut, plant. The splendid facilities of this newly acquired plant will permit us to produce greater quantities, and to considerably improve delivery schedules.

Now Ready!

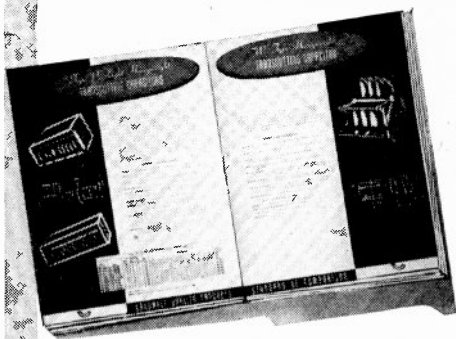

CARDWELL CATALOG NO. 46

... a valuable new edition, just off the press. Filled with descriptions, charts and photographs of standard Cardwell capacitors, accessories and precision instruments.

... a handy reference manual of unusual interest to engineers and purchasing agents working on present and postwar projects. Your copy will be sent immediately.



MAIL THIS COUPON TODAY

THE ALLEN D. CARDWELL MFG. CORP.
81 PROSPECT STREET
BROOKLYN 1, NEW YORK

Please send me a copy of the Cardwell Catalog #46.

NAME
FIRM NAME
ADDRESS
CITY STATE

THE ALLEN D. CARDWELL MANUFACTURING CORP.

Main Office: 81 Prospect St., Brooklyn 1, N. Y.
Factories: Plainville, Conn. — Brooklyn, N. Y.

Positions Open

(Continued from page 54A)

RADIO AND ELECTRONIC ENGINEERS

Pre-war company carrying on consulting and manufacturing business, requires engineers to develop special industrial electronic devices, wire and radio communication equipment for war use. Excellent post-war opportunity. Location New York City and Washington, D.C. Write qualifications in detail to Box 394.

ENGINEERS, PHYSICISTS, ANALYSTS

Needed for research, development, design, technical writing, supervision, testing, on electronic and mechanical problems, and as analysts, San Diego, California. Possible post-war future. Write giving personal history, education, experience, references, draft status, availability, to Personnel Manager, University of California Division of War Research, U. S. Navy Radio and Sound Laboratory, San Diego 52, California.

RADIO, ELECTRONIC AND TELEPHONE ENGINEERS, ELECTRONIC AND MECHANICAL DRAFTSMEN

Needed by one of the largest manufacturers of a wide variety of electronic and communications equipment in the World, fully prepared and ready with an ambitious postwar program. Write to Personnel Manager, Federal Telephone and Radio Corporation, 591 Broad Street, Newark, N.J.

AUDIO, ACOUSTICAL AND RECORDING ENGINEERS

The Columbia Broadcasting System, Inc. has permanent positions open in the General Engineering Department (in New York City) for the following graduate engineers:

AUDIO FREQUENCY ENGINEER who has creative ability and who is capable of designing broadcasting studio and program-distribution systems and equipment that is suitable for meeting the complex needs of network key-station operations and which, in addition, reflect advanced thinking and original ideas.

ACOUSTICAL ENGINEER primarily in the field of architectural acoustics, who is qualified to determine the acoustical properties of broadcasting and recording studios and to develop new methods and equipment for the measurement of these characteristics. A working knowledge of the acoustical problems associated with microphones and loudspeakers is also desirable.

RECORDING ENGINEER who is well versed in the theoretical and practical aspects of the electrical, mechanical and electro-mechanical problems of disc and magnetic recording and who is capable of designing, measuring and adjusting recording and reproducing systems, including the synthesis of the equalizer and filter networks associated with such equipment.

Applications and requests for interviews should be made in writing to W. B. Lodge, Director of Engineering, Columbia Broadcasting System, Inc., New York 22, N.Y.

PROJECT ENGINEERS

With design and development experience capable of assuming complete responsibility of a project and supervision of assistants. Post-war opportunity assured by civilian markets. Reply to Engineering Department, Hallicrafters Company, 2611 S. Indiana Ave., Chicago, Ill.

DESIGN ENGINEER

Experienced in mechanics and optics of motion picture cameras, projectors, and film scanning. Give details. Reply to John H. Martin, Columbia Broadcasting System, Inc., 485 Madison Avenue, New York 22, N.Y.

CUSTOMER ENGINEER

Graduate electronics engineer. Signal Corps experience preferable but not essential. Installation and maintenance radio printers and associated electronic equipment. An opportunity for post-war advancement with large international organization. Write qualifications in detail to Box 388.

SALES ENGINEER

Manufacturer of materials for radio components needs sales engineer with good technical background to appraise and work on technical details in the sales of their products. Headquarters New York. Box 402, Proceedings of the I.R.E., 330 West 42nd Street, New York 18, New York.

(Continued on page 64A)

ENGINEERS

*For Design Work
on Radio Receivers,
Audio Amplifiers,
Television*

Men with substantial experience wanted, preferably those having Degrees in Electrical or Communications Engineering. Write, giving details of experience and salary expected, to:

FRED RADIO CORPORATION

Makers of the Famous Freed-Eisemann Radio-Phonograph

200 Hudson Street
New York 13, N.Y.

Excellent Opening for Radio Sales Engineer

Leading national concern with headquarters in Southern California has opening for Sales engineer experienced in mobile radio communication systems. VHF and/or airline experience desirable. Graduate electrical or radio engineer preferred. Does not have to be a design engineer but should be able to analyze requirements and recommend proper equipment. Please state qualifications and salary desired. Enclose recent snapshot.

Box 405

Proceedings of the I.R.E.

330 West 42nd St.

New York 18, N.Y.



more efficient
...in miniature

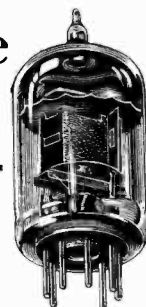

The early camera addict had to be both patient and rugged. He carried a bulky camera in one yellow stained hand and a case containing his plates, tripod and cloth in the other. He would laboriously "set up," struggle with focusing and try to keep subjects still for long time exposures. Compare the size of his equipment, his efforts and the results he obtained with those of the user of the modern camera.

Yet the pocket camera of today is no better example of greater efficiency in miniature than is the modern Electronic Tube. In most high frequency circuits TUNG-SOL miniatures function far better than the larger conventional tubes. Because of

shorter elements they are more rigid and their lesser mass makes them less prone to distortion as the result of vibration.

TUNG-SOL's principal interest in the Electronic industry is to produce tubes that make radio sets and other Electronic Equipment more effective and efficient. Their engineers are at your service to help plan circuits and select tubes. Consultation, of course, is confidential.

TUNG-SOL
vibration-tested
ELECTRONIC TUBES



TUNG-SOL LAMP WORKS INC., NEWARK 4, NEW JERSEY
Also Manufacturers of Miniature Incandescent Lamps, All-Glass Sealed Beam Headlight Lamps and Current Intermittors

Service Approved DYNAMOTORS

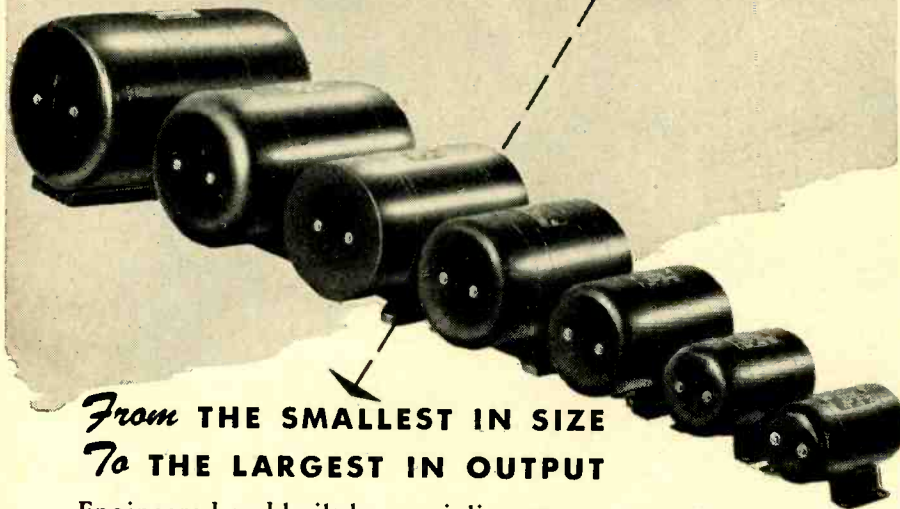

From **THE SMALLEST IN SIZE**
To **THE LARGEST IN OUTPUT**

Engineered and built by specialists, EICOR DYNAMOTORS have earned their fine reputation through years of exacting service. These dependable units furnish the necessary high voltage power for communications, direction finding, radio compass and other controls.

Our complete line of frame sizes makes possible the widest available range of dynamotor output ratings in the most compact sizes and weights. This assures the most economical size and weight for every need!

The experience and skill of Eicor Engineers are instantly available to help you on any problem involving Dynamotors, Motors, or Inverters.



Send for Helpful
DATA FOLDER

This handy folder gives useful data and information on EICOR Dynamotors, D. C. Motors, and other Rotary Electrical Equipment. Write for it!

SERIES NO.	MAX. OUTPUT WATTS	DIAMETER	LENGTH	WEIGHT
2300	10	2 ⁵ / ₁₆ in.	4 ⁷ / ₈ in.	2 ¹ / ₈ lbs.
2700	15	2 ³ / ₄ in.	4 ³ / ₄ in.	2 ³ / ₄ lbs.
3400	125	3 ¹ / ₁₆ in.	5 ⁵ / ₈ to 8 ¹ / ₂ in.	4 ¹ / ₂ to 7 ¹ / ₂ lbs.
4100	200	4 ¹ / ₁₆ in.	6 ¹ / ₂ to 7 ³ / ₈ in.	6 ³ / ₄ to 9 lbs.
4500	250	4 ¹ / ₂ in.	6 ¹ / ₂ to 8 in.	11 ¹ / ₂ to 13 ¹ / ₄ lbs.
5100	350	5 ¹ / ₈ in.	8 ¹ / ₂ to 10 in.	17 to 21 ¹ / ₂ lbs.
6100	500	6 ³ / ₁₆ in.	9 ⁵ / ₈ to 12 in.	28 to 36 lbs.

EICOR, INC. 1501 W. Congress St., Chicago, U. S. A.
DYNAMOTORS • D. C. MOTORS • POWER PLANTS • CONVERTERS
Export: Ad Auriema, 89 Broad St., New York, U. S. A. Cable: Auriema, New York

40 DEGREE

Vertical



AREA OF DISTRIBUTION

The new amazing Altec Lansing multi-cellular Duplex Speaker provides up to 800% increased area of quality sound distribution. In the vertical plane, the Duplex delivers a forty degree angle of distribution, or eight times the area distribution at high frequencies as compared to single unit speakers of comparable size. Another reason why the DUPLEX is the SPEAKER that REVOLUTIONIZES the methods of sound REPRODUCTION.

SEND FOR BULLETINS

ALTEC

LANSING CORPORATION

1210 TAFT BLDG., HOLLYWOOD 28, CALIF.
250 WEST 57 STREET, NEW YORK 19, N. Y.
IN CANADA: NORTHERN ELECTRIC CO.

Proceedings of the I.R.E. October, 1945

UP TO 42 Mc



DOWN TO 500 Kc

No-signal squelch circuit makes this general purpose KAAR RECEIVER IDEAL FOR STANDBY!

The KAAR KE-23A general purpose receiver has a wider than customary range, covering all of the radio communication bands from 500 Kc to 42 Mc. Unsurpassed for most types of emergency, commercial, and amateur operation, it is especially favored as a standby receiver.

A *no-signal squelch circuit*—normally not available in a general purpose receiver—automatically silences the speaker except

when a call or message is being received, thus eliminating background noise during standby periods. A threshold control on the panel determines the amount of carrier required to operate the receiver, or cuts out the squelch circuit when desired.

This nine tube receiver has a high degree of stability and its selectivity and sensitivity insure reception under the most difficult conditions.

The KE-23A, designed for 117 volt 60 cycle AC operation, is instantly converted to 6 volt DC by plugging in a KAAR 647X power pack at the back. Write today for additional information about this versatile KAAR receiver.

KAAR 
ENGINEERING CO.

PALO ALTO, CALIFORNIA

Export Agents: FRAZAR & HANSEN
301 Clay Street • San Francisco, California

FM TRANSMITTERS—50 and 100 watt mobile FM transmitters with instant-heating tubes for lower battery drain.

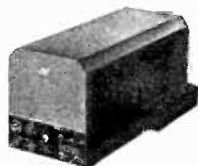

CRYSTALS—Low-drift quartz plates. Fundamental and harmonic types available in various holders.



AM TRANSMITTERS—Mobile, marine, and central station transmitters for medium and high frequencies. Instant heating, quickly serviced.

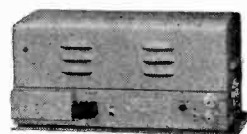

MICROPHONES—Type 4-C single button carbon. Superb voice quality, high output, moisture proof.



CONDENSERS—Many types of small variable air condensers available for tank circuit and antenna tuning.

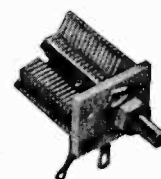

More Adaptable
**TO YOUR
 PARTICULAR NEEDS**

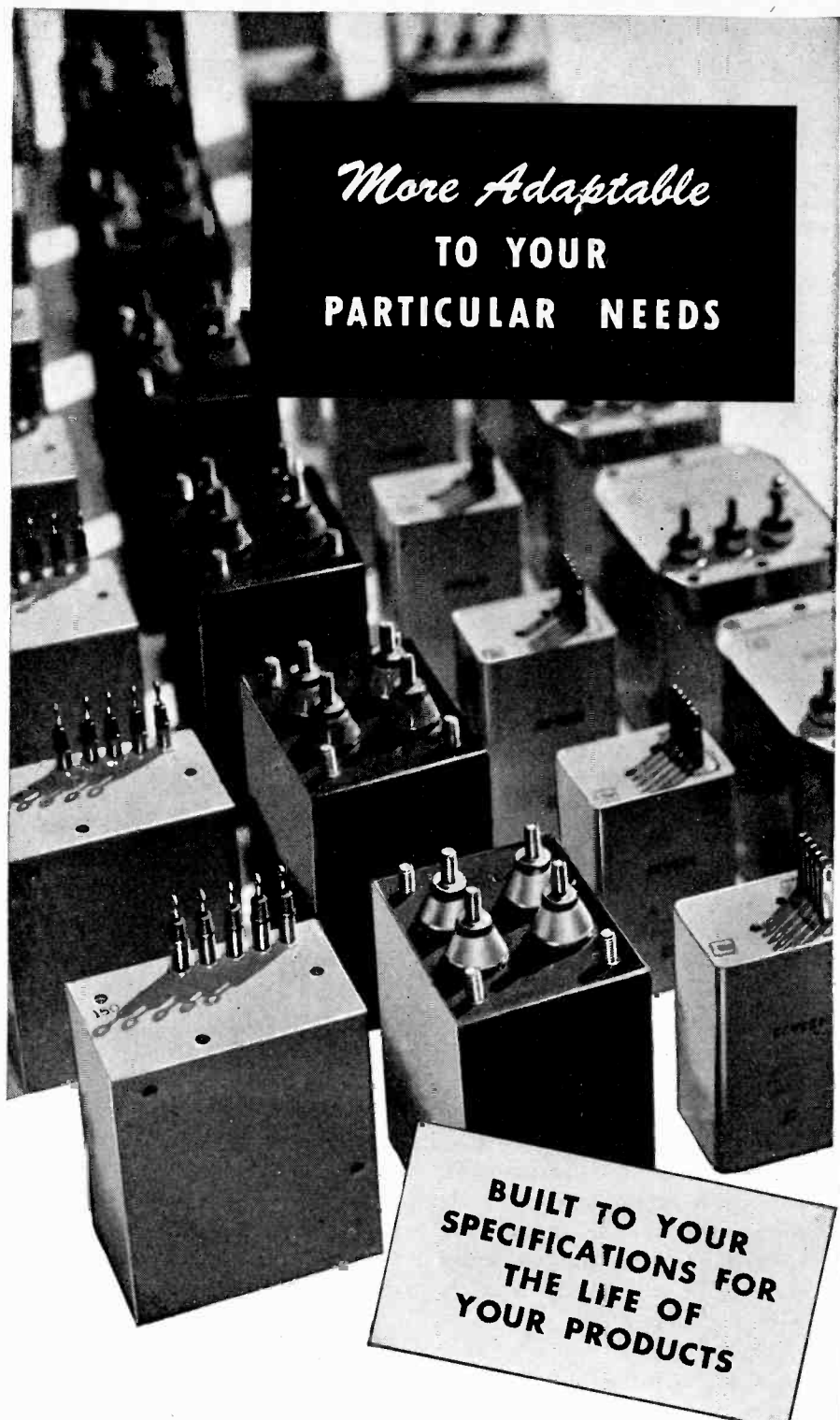

**BUILT TO YOUR
 SPECIFICATIONS FOR
 THE LIFE OF
 YOUR PRODUCTS**

THE know-how gained in engineering transformers to war's exacting specifications is now available to solve your peacetime transformer needs. Stancor engineers are ready to study and master the toughest problems you can set them. Production men trained to exacting standards, with modern equipment and precision winding machinery, assure that highest specifications will be met in the finished product.

When you have a transformer problem, think first of Stancor. Competent sales engineers are ready to satisfy your most exacting transformer requirements.



S T A N C O R
 STANDARD TRANSFORMER CORPORATION
 1500 NORTH HALSTED STREET CHICAGO 22, ILLINOIS

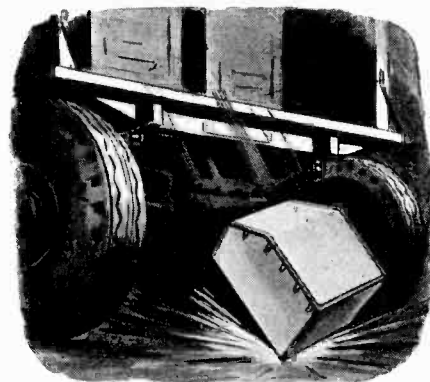

"DROP-TEST" PROVES
Skydyne

**CABINETS
 TWICE AS STRONG
 With Half the Weight**

From a 48-inch level—the height of the average truck—two chests containing 75 pounds of dead-weight were dropped to a concrete floor.

One chest was of fabricated plywood; the other, a Skydyne Cabinet of aluminum-balsa-aluminum "sandwich construction."

Each was dropped, fully loaded, four times . . . first on one corner and then another.

At the end of the experiment, the plywood case was smashed. In marked contrast, the Skydyne Cabinet came through intact. The weight of the Skydyne Cabinet itself was only half that of the plywood cabinet.

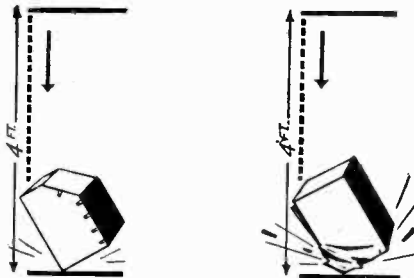

Such proved lightness and strength, however, are not the only reasons why thousands of Skydyne Cabinets are being used today to protect precision instruments in transit. Aluminum-faced Skydyne Cabinets are fungus resistant, water-tight, waterproof and rustproof as well . . . all highly important factors in tropical climates.

Nor is aluminum the only sheathing. Fibreglas, papreg and plywood can also be bonded with the balsa, cork or lightweight synthetic core and moulded to the most exacting specifications.

Skydyne construction is electrically shielded and is also resistant to heat, vibration and sound . . . a feature which suggests numerous applications now.

WRITE FOR OUR FREE BROCHURE
 describing the many advantages of
 using Skydyne Sandwich Construction

Skydyne Inc
 PORT JERVIS, NEW YORK

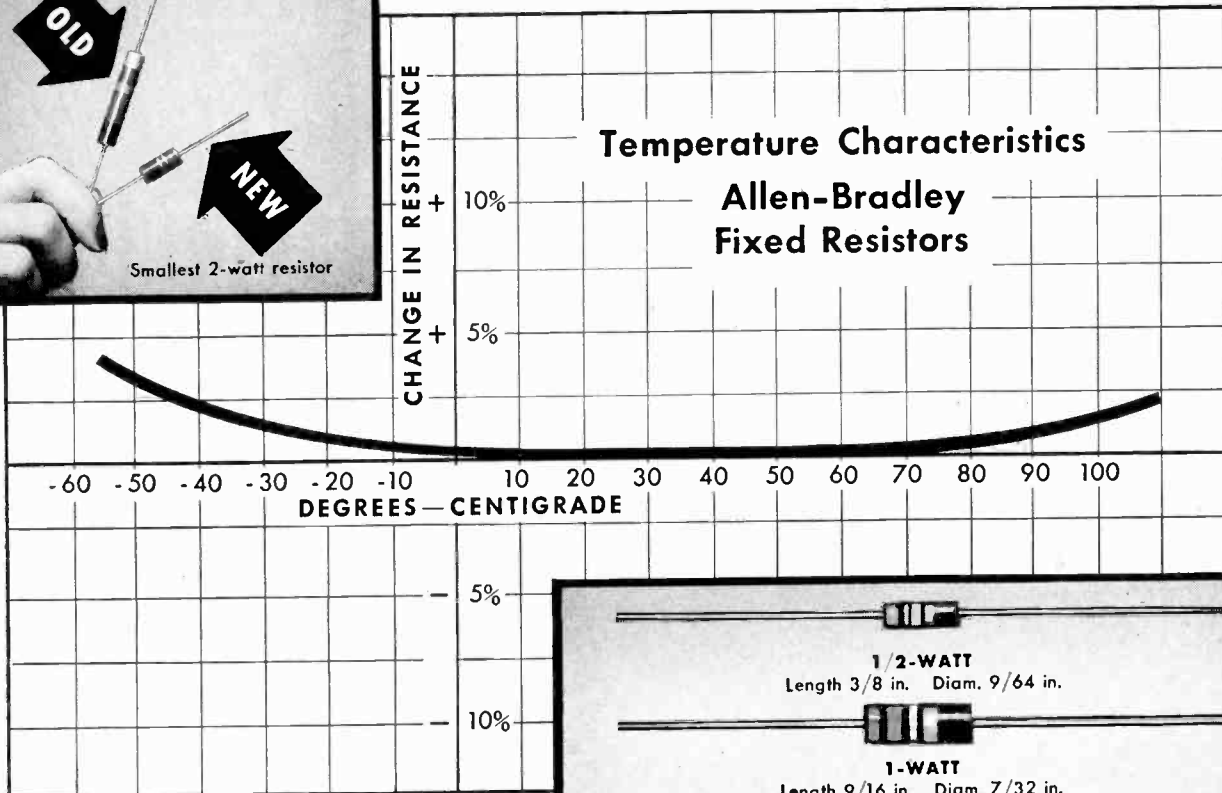
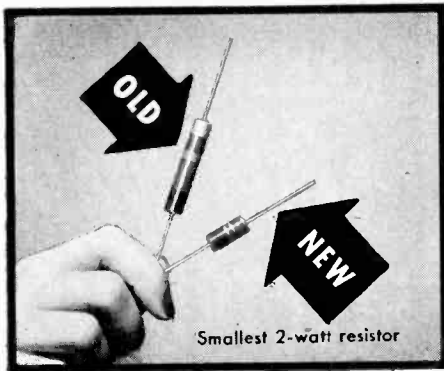

Allen-Bradley fixed resistors are offered in tolerances of 5, 10, and 20 per cent. All sizes of resistors are equipped with $1\frac{1}{2}$ -inch leads. (See diagram at right.)

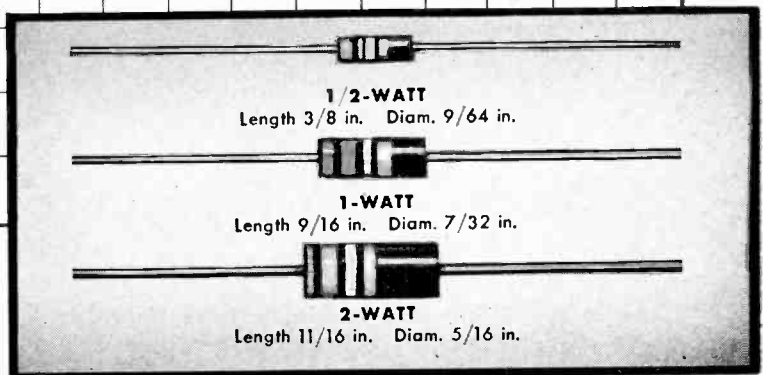

LESS THAN 5% CHANGE IN RESISTANCE

after 2000 hours (under full load at 70°C Ambient Temperature)

Allen-Bradley fixed resistors are not only small in size . . . they are capable of withstanding the most abusive service without harmful deterioration. For example, they can be used at full rating at an ambient temperature of 70 degrees Centigrade for 2,000 hours . . . and the change in resistance is actually less than 5 per cent. Such performance explains why A-B resistors are considered "tops" for war service.

These resistors will sustain an overload of ten times rating for several minutes without failing. Wax impregnation is unnecessary to pass salt water immersion tests. The $\frac{1}{2}$ -watt and 1-watt units are available in all RMA standard values from 10 ohms to 20 megohms. Two-watt units available from 10 ohms to 1 megohm. If dependability is a "must," specify Allen-Bradley resistors.

- Allen-Bradley Company, 114 W. Greenfield Ave., Milwaukee 4, Wis. •

ALLEN-BRADLEY
FIXED & ADJUSTABLE RADIO RESISTORS
 QUALITY

WHEN DEPENDABILITY AND PERFORMANCE ARE "MUST" . . . THE EXPERTS SPECIFY ALLEN-BRADLEY

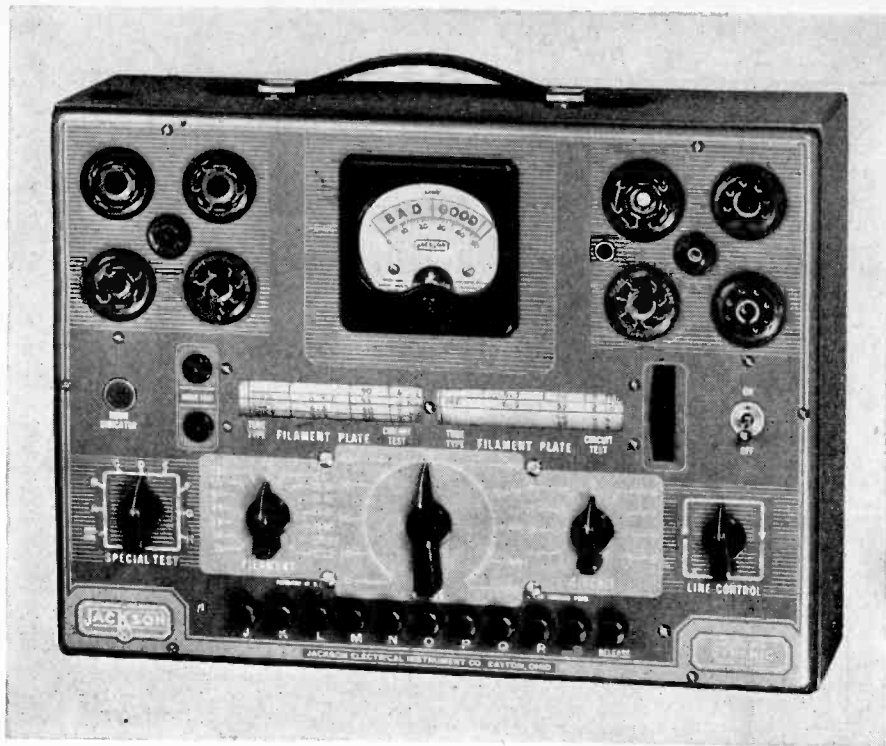

Model 636 Dynamic* Tube Tester

With Built In Rotary Tube Chart

Tops in design and performance including the latest Jackson patented switching circuits.

Modern in every feature of construction, appearance and operation.

Complete with every valuable feature. Up to date for all newest tube types.

SPECIFICATIONS

"Dynamic" Method of Test—Makes a better test on every tube. The "Dynamic" method is more accurate, frequently finding "poor" tubes which might pass for "good" in ordinary testers.

Tests All Tubes—All of the popular receiving types and television amplifiers, including *Bamtams*—*Loctals*—*Single Ended*—*High Voltage Filament Types* and *Minia-tures*. Provision for many more. The tester

is protected against obsolescence in every possible feature.

Roll Chart tube index—simplifies correct settings.

Full Range Filament Selection—marked directly in volts.

• • •

Bench Model 636-B (illustrated) is installed in welded steel cabinet. This instrument is also furnished (portable model 636) in a French grey leatherette case with removable lid—matched in dimensions and finish to other testing instruments in the Jackson line. It can be assembled with them in the Jackson Service Lab. Buy now with an eye ahead—on a *matched* Jackson testing set.

*TRADE MARK REG.

BUY WAR BONDS



AND STAMPS TODAY

JACKSON

Fine Electrical Testing Instruments

JACKSON ELECTRICAL INSTRUMENT COMPANY, DAYTON, OHIO

TRANSFORMERS FOR *POSTWAR* ELECTRONIC APPLICATIONS

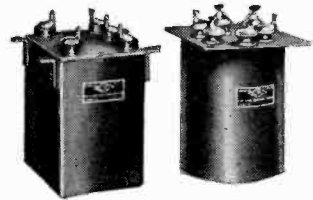

• Designed to meet your specifications, mechanically and electronically

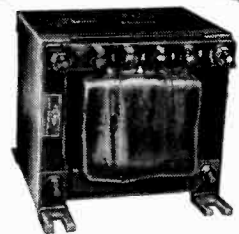

Open type, plastic impregnated transformers provide adequate weatherproofing for certain applications.



This special Radio Power transformer consists of primary winding, high voltage secondary winding and filament winding.

THE ACME ELECTRIC & MFG. CO.
CUBA, N. Y.

Acme  **Electric**
TRANSFORMERS

Proceedings of the I.R.E. October, 1945

*Enduring Accuracy
in Vital R.F. Applications*



OHMITE RESISTORS & CHOKES

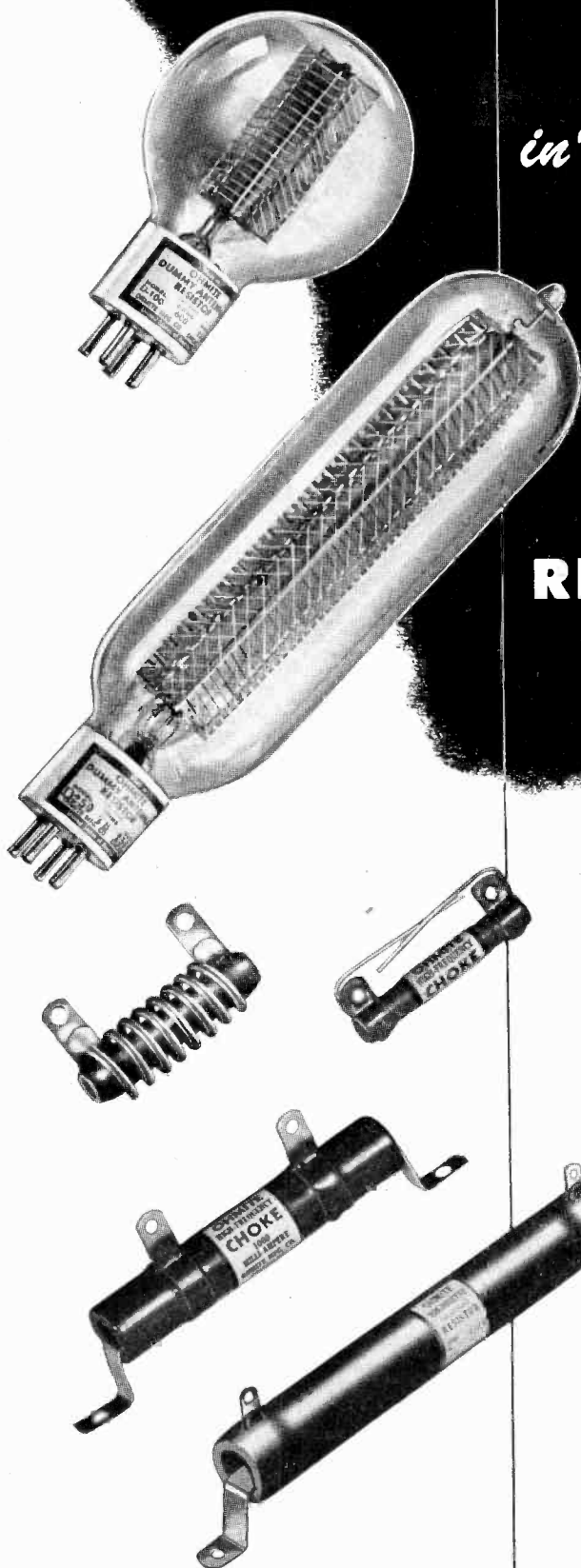

The unique characteristics of these Ohmite units have made them especially suitable for many r.f. applications. Proved by use before war came . . . they are performing vital functions today in the production and operation of critical equipment. Tomorrow—they will be more popular than ever!

GLASS-SEALED NON-INDUCTIVE DUMMY ANTENNA RESISTORS—for testing and measuring power output accurately. 100-watt and 250-watt sizes in variety of resistances.

R. F. PLATE CHOKES—single-layer wound on low power factor steatite cores, with moisture-proof coating. Built to carry 1000 M.A. 5 stock sizes from 2½ meters to 160 meters.

PARASITIC SUPPRESSOR—small, light, compact non-inductive resistor and choke, designed to prevent u.h.f. parasitic oscillations.

NON-INDUCTIVE VITREOUS ENAMELED POWER-SIZE RESISTORS—Useful in wide variety of radio frequency applications. 50-watt, 100-watt and 160-watt stock sizes in many resistances.

Ohmite Engineers are glad to assist you on any resistance-control problem.

OHMITE MANUFACTURING CO.
4860 FLOURNOY STREET • CHICAGO 44, U. S. A.

SEND FOR CATALOG No. 40
Write on company letterhead for helpful Catalog and Engineering Manual No. 40. Address Ohmite Mfg. Co., 4860 Flournoy Street, Chicago 44, Illinois.



Be Right with
OHMITE

RHEOSTATS • RESISTORS • TAP SWITCHES

Industrial Condenser Corporation's NEW HOME

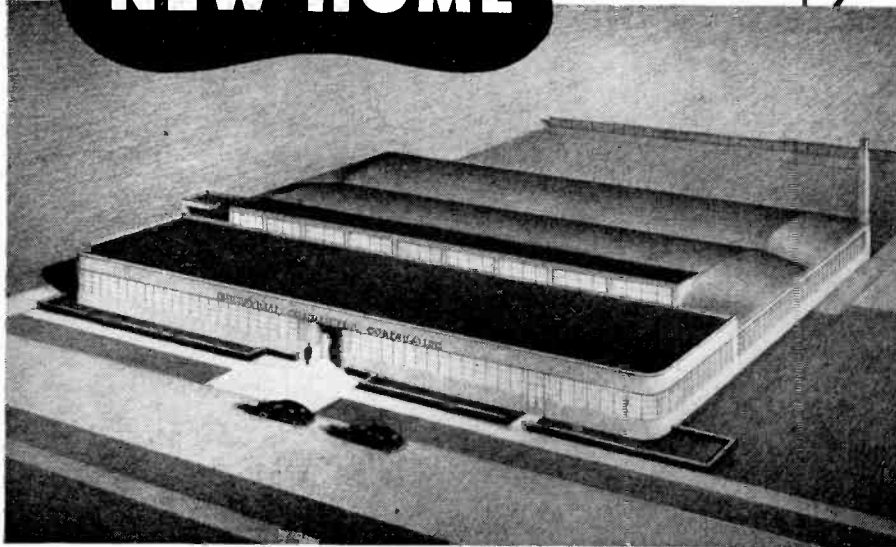

THE WORLD'S MOST MODERN CONDENSER PLANT with these outstanding features

- ★ 1,000,000 VOLT RESEARCH LABORATORY
- ★ VERY LATEST PRODUCTION EQUIPMENT
- ★ SPECIALIZED WAR-LEARNED TECHNIQUES

From this NEW ultra-modern factory come capacitors carefully engineered and accurately produced. Staffed by skilled engineers and backed by 16 years of technical progress, Industrial Condenser Corp. is supplying capacitors for every application. If your specifications call for Electrolytic, Paper, Oil, or Motor capacitors, look to Industrial Condenser Corporation.

INDUSTRIAL CONDENSER CORPORATION

3243-65 NORTH CALIFORNIA AVENUE, CHICAGO 18, U. S. A.

District Offices in Principal Cities

PAPER, OIL AND ELECTROLYTIC MOTOR CAPACITORS

Positions Open

(Continued from page 56A)

SEVERAL ENGINEERING POSITIONS

Progressive midwestern capacitor manufacturer has permanent key positions for top notch executive calibre men as follows:

Electrolytic Development Engineer

Capable of designing and supervising installation of equipment. To take complete charge of laboratory and supervise production quality control. Must have previous experience with etching and formation processes.

Electrical Engineer

Should have broad background of theory and practice in small electrical parts or equipment manufacturing. Position at present that of coordinating engineering problems of field sales with laboratory, engineering and manufacturing departments. Will have wide latitude of authority and report directly to management. To the right man, position will lead to that of Chief Electrical Engineer. Experience in capacitor field is advisable.

Electrical Engineer Power Factor Improvement

This key position for a new department requires an electrical engineer with specific experience in power factor improvement problems. Technical writing ability is important. The right man probably would have gained his experience with a public utility or manufacturer of heavy power equipment. He must be qualified to create and supervise an entire department for sales of capacitors used in power factor improvement. He will be given assistance of a competent staff of capacitor engineers but will be required to design and arrange for manufacture of associated power factor equipment. Sales experience will be helpful but not essential.

Applicants are requested to outline experience, education, present and previous earnings and salary requirements. All replies will be held in strictest confidence. Our own engineers know of this advertisement. Address Box 401, Proceedings of the I.R.E., 330 West 42nd Street, New York 18, New York.

ENGINEERS

Opportunities are offered by an expanding, progressive engineering organization to first-class Development, Communication and Radio Engineers with extensive prewar experience. Write: Maguire Industries, Inc., Electronics Division, Personnel Dept., 342 W. Putnam Ave., Greenwich, Conn.

FRANK MASSA

Electro-Acoustic Consultant

DEVELOPMENT PRODUCTION DESIGN
PATENT ADVISOR

ELECTRO-ACOUSTIC & ELECTRO-MECHANICAL
VIBRATING SYSTEMS

SUPERSONIC GENERATORS & RECEIVERS

3393 Dellwood Rd., Cleveland Heights 18, Ohio

M. F. M. Osborne Associates Consulting Physicists

Fluid Dynamics, Mechanics, Electronic Design, Electromagnetic and Acoustic Wave Propagation, Mathematical Analysis.

703 Albee Bldg., Washington 5, D.C.
ATLantic 9084

W. J. BROWN

Electronic & Radio Engineering Consultant

Electronic Industrial Applications, Commercial and Broadcasting Transmitter and Receiver Design, Test Equipment, etc.

23 years experience in electronic development

2879 Coleridge Rd., Cleveland Hts., Ohio
Fairmount 0030

STANLEY D. EILENBERGER

Consulting Engineer

INDUSTRIAL ELECTRONICS

Design—Development—Models

Complete Laboratory and Shop Facilities
6309-13—27th Ave.

Kenosha, Wis.

Telephone 2-4213

ERIE

Button Silver Mica Condensers

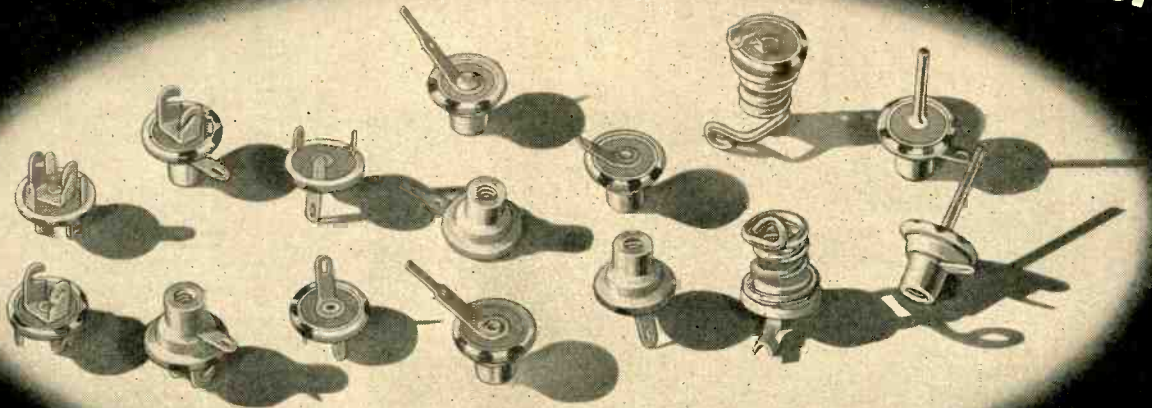

Now available up to 1000 MMF

THE compact ERIE Type 370 Button Silver Mica Condensers are now available with uniform nominal diameter of .447" in all capacities up to and including 1,000MMF. This higher capacity range greatly broadens the field of application for these popular units.

These condensers have proven to be ideal components for V.H.F. and U.H.F. applications where short ribbon-type leads, low series inductance, and compactness are requisite factors. Their efficiency and quality have been thoroughly established through practical service, in large quantities since 1941.

Illustrated above are several special and standard styles of type 370 Button Micas. In the interest of economical production 18 styles have been selected as standard units. The chart at the right gives the corresponding letter designations for the case and terminal styles of these standard units.

When ordering, case style should be specified first, by its corresponding letter, followed by terminal letter.

Complete technical information on ERIE Type 370 Button Micas will be sent to interested engineers on request.

CASE STYLE →		B	C	D	E	F	G
TERMINAL STYLE							
A	SINGLE L	370BA	370CA		370EA	370FA	
B	FEED-THRU L	370BB	370CB				
C	SINGLE U	370BC	370CC	370DC			
D	FEED-THRU U	370BD	370CD				
E	PILLAR				370EE	370FE	
F	LONG L				370EF	370FF	
G	WIRE LEAD						370GG
H	EYELET		370CH				



Electronics Division

ERIE RESISTOR CORP., ERIE, PA.

LONDON, ENGLAND • • TORONTO, CANADA



another Audio Development

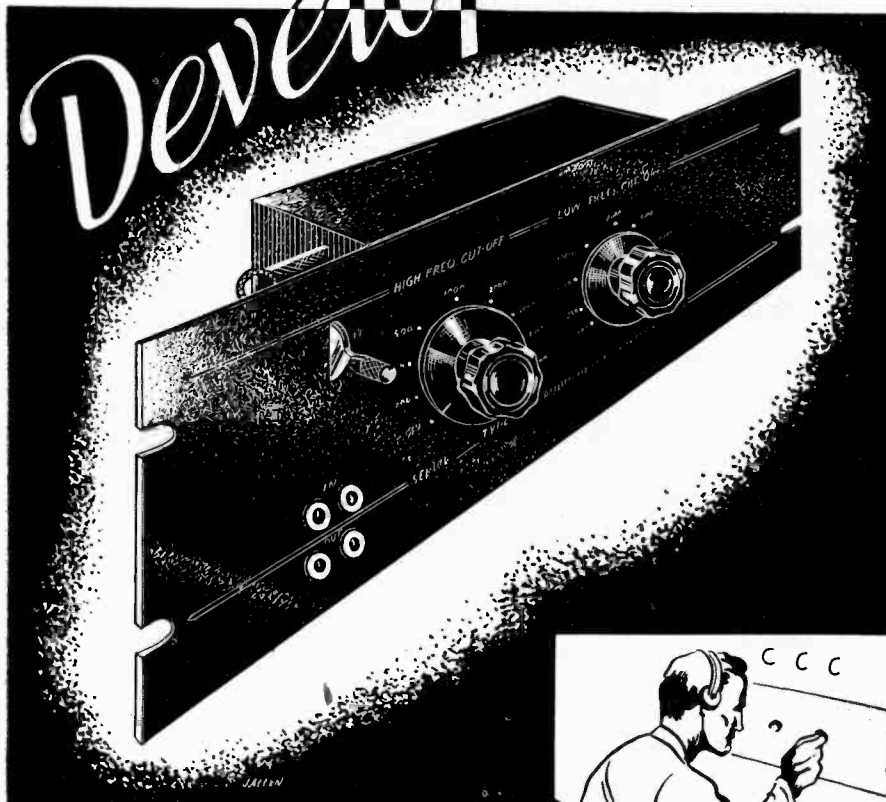

Our Variable SOUND EFFECTS FILTER

One of hundreds of basically different filter types produced by Audio Development, this unit has been designed principally for the use of broadcasting stations and recording studios. The filter consists of a single prototype low pass and a similar high pass filter section, each with eight different cut off frequencies. This permits the selection of a proper cut off frequency for any application.

Attenuation of at least 18 DB per octave is obtained for both high and low pass sections with the insertion loss in the pass band less than 1 DB. Coils are individually shielded to permit normal operating levels between -40 and +14 VU. Standard impedance is 600 ohms. Mounting facilities are provided within the unit for transformers, thereby permitting operation in systems of any impedance.



Quiet • POWERFUL
SM Fractional
H. P. Motor

The Home Power Servant also handles many other jobs efficiently, dependably



For quiet operation, dependable performance, long life, maximum power per ounce of weight and per inch of space, use SM Fractional H.P. Motors. Models from 1/10th to 1/200th H.P. Speeds of 3,000 to 20,000 R.P.M. Voltage from 6 to 220 AC-DC Large volume production to your exact specifications.

Small Motors, Inc.

DEPT. 31
1308 ELSTON AVE. • CHICAGO 22
Manufacturers of special small universal, fractional H. P. motors, dynamotors, shaded pole motors, heater motors, generators.
Design, Engineering, Production



DO YOU HAVE A FILTER PROBLEM?

Audio Development Co.
2833 13th Ave. S., Minneapolis, Minn.
"Audio Develops the Finest"

Anyway you look at them...

THEY'RE GREAT LITTLE METERS!

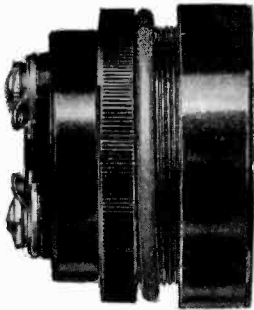

Side View

Front, side or back — inside and out — the 1½" Round Model 120 can do a whale of a job for you on a wide variety of applications.

External pivots provide maximum accuracy in mounting the moving element between the jewel bearings ... prevent rocking of pointer ... reduce side friction between jewels and pivots ... increase the life of bearing surfaces. Movements are designed to meet forthcoming JAN-I-6 specifications for 1½ inch instruments.

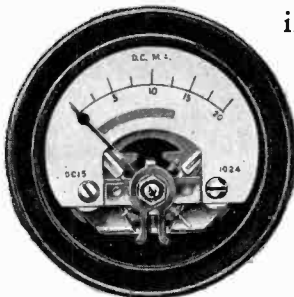

Front View

Built with fine precision, entirely self-contained ... with built-in resistors and shunts, this great little meter is also completely immersion-proof throughout. It has a special locking device for exerting pressure against rubber gaskets on either side of the glass. Watertight sealing includes terminal studs and a gasket back of the flange waterproofs the juncture between the meter and the panel. Installation is easy — a ring mounting eliminates mounting screws. The case is Black Anodized Aluminum.

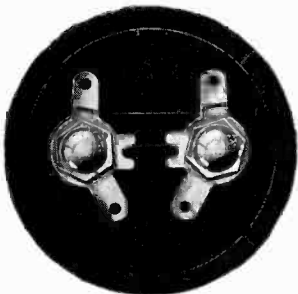

Back View

Model 112 has all the features of the Model 120 except that it has a square, bakelite case. Like the 120 it is available either as a D.C. or A.C. (rectifier) instrument. Write for latest catalog.



"Inside" View

BUY WAR BONDS



De JUR - AMSCO CORPORATION

GENERAL OFFICE: NORTHERN BLVD. AT 45th STREET, LONG ISLAND CITY 1, N. Y.

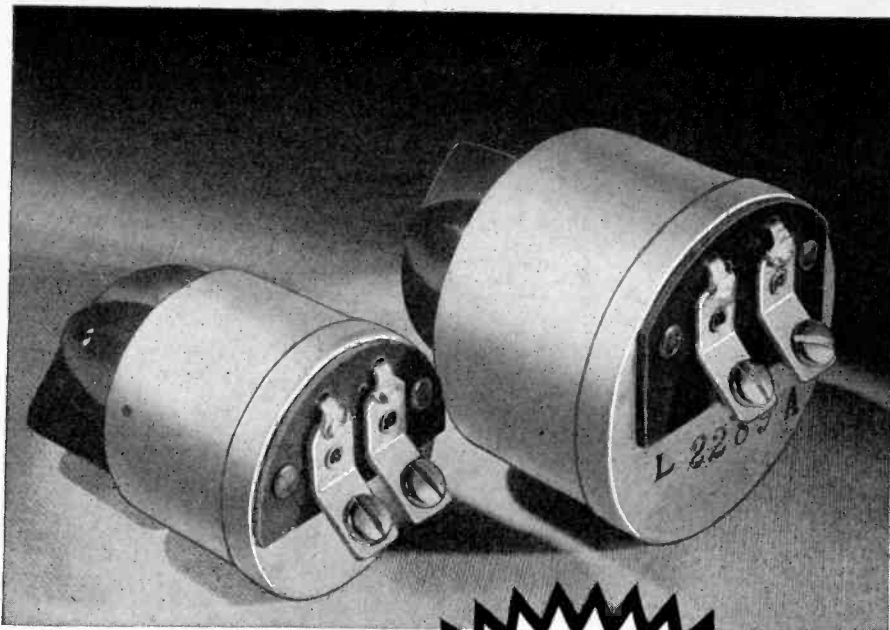

POWER Rheostats

★
Insulated metal core supports resistance winding. Winding imbedded in "Greenohm" cold-setting inorganic cement.

★
Normal current rating may be exceeded by 50% at any setting up to 1/3 total rotation, without damage.

★
Rotor design provides smoothest rotation and positive conduction at all settings.

★
1 to 5000 ohms in 25 watt;
1/2 to 10,000 ohms for 50-watt.

★
Detent action, hop-offs, special shafts, different terminals, etc. available on special order.

★ Hundreds of thousands of these Clarostat power rheostats are now in daily use. They are standard equipment in radio, electronic, aircraft and other wartime assemblies. Likewise in more and still more industrial equipment. They are proving that they "can take it"—and then some. No tougher controls are made.

The 25- and 50-watt units here shown are of the enclosed or protected type. Uncased units are also available, where the casing is not required. Wide choice of resistance values.

★ Write for details . . .

Controls and Resistors

CLAROSTAT MFG. CO., Inc. · 285-7 N. 6th St., Brooklyn, N. Y.

Immediate Delivery!
**WIDE RANGE
VACUUM TUBE
VOLTMETERS**



- High input impedance for both AC and DC measurements.
- Convenient, low capacity "Probe" especially adapted to high frequency radio use—100 megacycles and over.
- Self-regulating operation from power line; no batteries.
- Multiple voltage ranges — accurate and stable.

BULLETIN ON REQUEST

**ALFRED W. BARBER
LABORATORIES**

34-04 Francis Lewis Blvd. Flushing, N.Y.

Easy to Erect

MASTS AND TOWERS

Catalog will be sent to engineers and executives writing on their business letter-head.

Address Dept. AG
**HARCO
TOWER
INC.**
Elizabeth 4, N. J.

... this is the single unit* construction of
SHURE Super-Cardioid
Dynamic Microphones

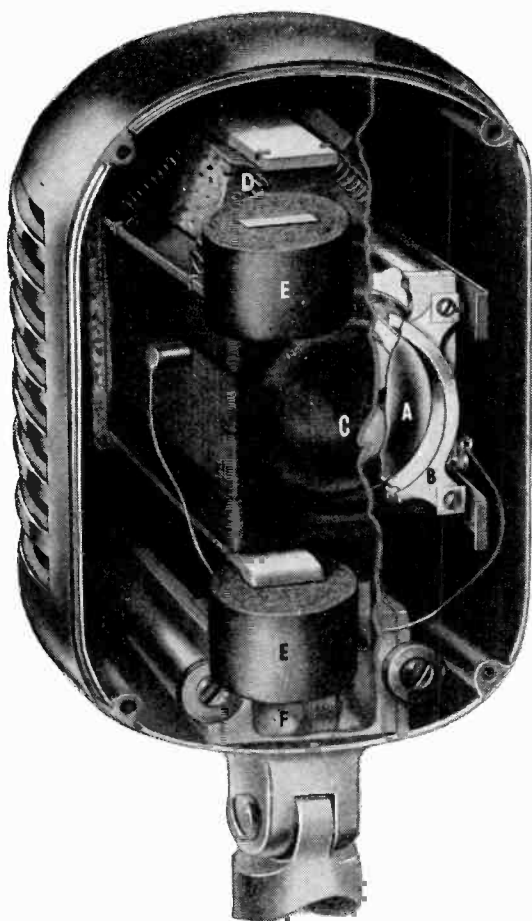

- (A) Single moving coil diaphragm.
- (B) Rugged 4 point moving coil suspension.
- (C) First wind and dust screen.
- (D) Spring mounted mechanism.
- (E) Shock absorbers.
- (F) High fidelity transformer.

* Using the "Uniphase" principle, an exclusive patented Shure development, this single unit construction is possible in a unidirectional Microphone. This eliminates the problems of matching two dissimilar units and results in compactness and ruggedness. Because only one unit is employed, all these advantages are available at less cost to you.



List Prices . . . Shure Super-Cardioid
 Dynamic Microphones

Models "556" Broadcast \$75

Models "55" Unidyne \$47 to \$49.50

SHURE BROTHERS

Designers and Manufacturers of Microphones and Acoustic Devices

225 West Huron Street, Chicago 10, Illinois • Cable Address: SHUREMICRO

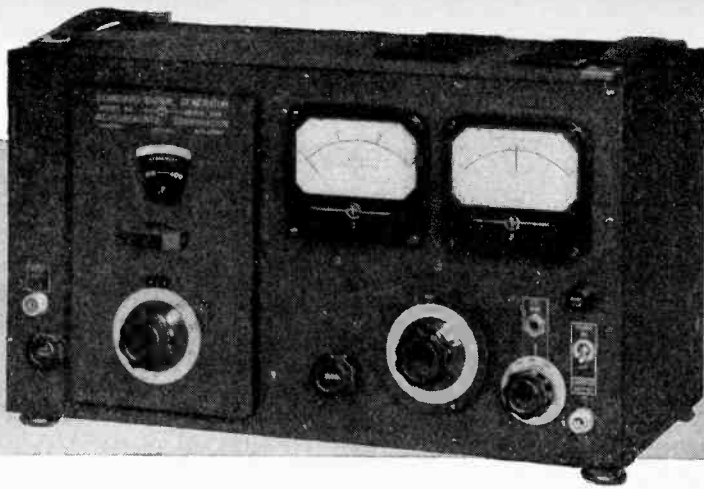

STANDARD SIGNAL GENERATOR Model 80

SPECIFICATIONS:

CARRIER FREQUENCY RANGE: 2 to 400 megacycles.
OUTPUT: 0.1 to 100,000 microvolts. 50 ohms output impedance.
MODULATION: A M 0 to 30% at 400 or 1000 cycles internal.
 Jack for external audio modulation.
 Video modulation jack for connection of external pulse generator.
POWER SUPPLY: 117 volts, 50-60 cycles.
DIMENSIONS: Width 19", Height 10 3/4", Depth 9 1/2".
WEIGHT: Approximately 35 lbs. **PRICE—\$465.00** f.o.b. Boonton.
 Suitable connection cables and matching pads can be supplied on order.

MEASUREMENTS CORPORATION
 BOONTON  **CORPORATION**
 NEW JERSEY

NEED SMALL BULBS and
 DEEP DRAWN PARTS
 to CLOSE TOLERANCES?

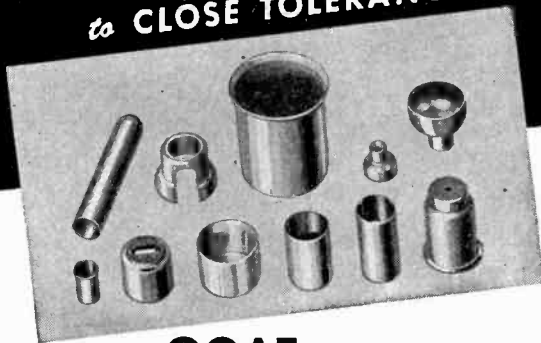

GOAT PRECISE-FORMED DEEP-DRAWN METAL PARTS

Improved Quality at Lower Cost!

Deep drawing, sizing and coining, in conjunction with quality control techniques devised by the Goat Company, make possible the economical production of small parts to tolerances unattainable a few years ago. The new method makes expensive annealing operations unnecessary. The use of these economically produced, precision parts reduces both material costs and assembly costs.

Send us your design prints for
 engineering recommendations



GOAT METAL STAMPINGS, INC.
 Affiliate of The Fred Goat Co., Inc.
 314 DEAN STREET BROOKLYN, N.Y.



Attention Associate Members!

Many Associate Members can qualify for higher membership grades and should certainly do so. Members are urged to keep membership grade up in pace with their present development.

An Associate over 24 years of age who is occupied as a radio engineer or scientist, and is in this active practice three years may qualify for Member Grade.

An Associate who has taught college radio or allied subjects for three years may qualify.

Some may possibly qualify for Senior Grade. But transfers can be made only upon your application. For fuller details request transfer application-form in writing or by using the coupon below.



Coupon

Institute of Radio Engineers
 330 W. 42nd St.
 New York 18, N.Y. 10-45

Please send me the Transfer
 Application Membership-Form.

Name

Address

Place

State

Present Grade

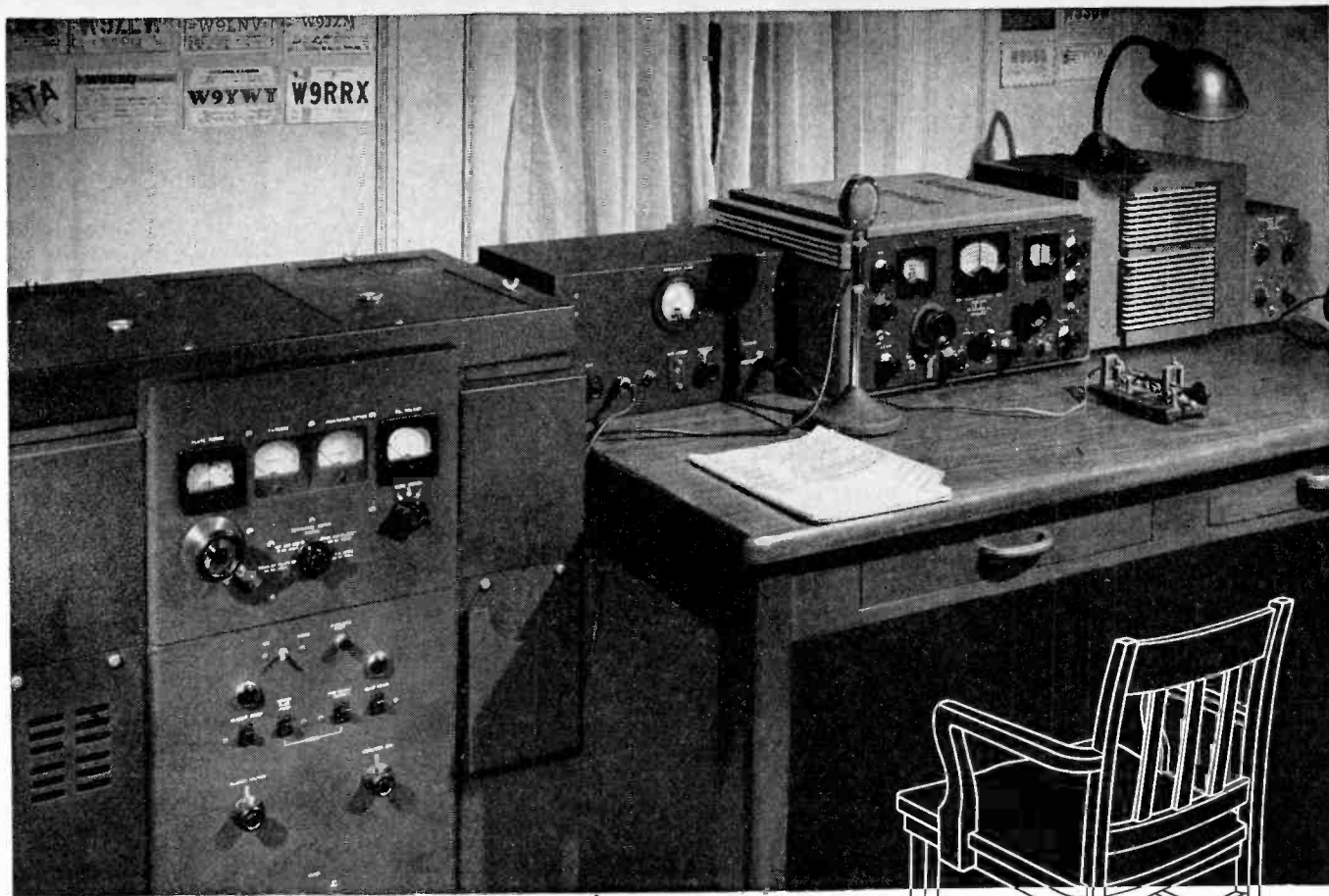

Pull up a chair!

Get a ringside seat at the ideal ham shack of tomorrow. The above picture was made at Hallicrafters Ham Shack on the Boulevard, in Chicago. But no picture can represent, no artist can paint what Hallicrafters has in store for the amateurs when the demands of war production are relaxed. Rugged, dependable, sensitive high frequency transmitters and receivers—like the HT-4 which went to war as the famous mobile radio station SCR-299 and the SX-28A, the great communications receiver—belong in the postwar picture of your ideal ham shack. Hallicrafters

equipment has been constantly refined and developed under the fire of war. In peace it will come closer than ever to meeting the exacting requirements of the radio amateur who has played such a prominent part in the progress of all radio and who assumed such a valuable role in war communications.

Even now you can "pull up a chair" in your ideal ham shack by sending for Hallicrafters 1945 Catalog . . . a fascinating piece of ham literature . . . detailed specifications on more than 20 models that are helping to win the radio war. Specify Catalog S-36A.

COPYRIGHT 1945 THE HALLICRAFTERS CO.

BUY A WAR BOND TODAY!



hallicrafters RADIO

THE HALLICRAFTERS CO., WORLD'S LARGEST EXCLUSIVE MANUFACTURERS OF SHORT WAVE RADIO COMMUNICATIONS EQUIPMENT, CHICAGO 16, U. S. A.



How to Keep a Signal... *"BUSY"*

"Land here!" "Patrol there!" "Base deflection—Right 321!" These are the "busy" signals of warfare. And it's the job of the Signal Corps to keep these vital communications crackling back and forth with a minimum of delay.

Their task is made easier because of the design and manufacturing skill behind the equipment in use today. *Look at the receiver cases of INSUROK*, molded to close tolerances by Richardson for the Rola Company, Inc., Cleveland, Ohio. These cases contain the delicate hearing mechanism of headsets made by Rola for use by our armed forces everywhere.

Notice the inserts, threads and holes in the cases illustrated. This is *precision molding*... all done in one operation... and is typical of the work we do daily with INSUROK for a wide variety of intricate industrial applications. If your product... present or planned... calls for the use of a moisture-resistant, lightweight, dielectrically and mechanically strong plastic part—write Richardson Plastics today for the full story about INSUROK—Molded and Laminated!

INSUROK *Precision Plastics*

The RICHARDSON COMPANY

MELROSE PARK, ILL. NEW BRUNSWICK, N. J. FOUNDED 1888 INDIANAPOLIS 1, IND. LOCKLAND, CINCINNATI 15, OHIO
 DETROIT OFFICE: 6-252 G. M. BUILDING, DETROIT 2, MICHIGAN NEW YORK OFFICE: 75 WEST STREET, NEW YORK 6, N. Y.
 CLEVELAND OFFICE: 326-7 PLYMOUTH BLDG., CLEVELAND 15, OHIO

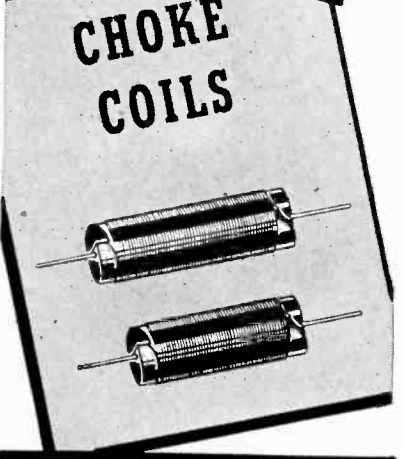
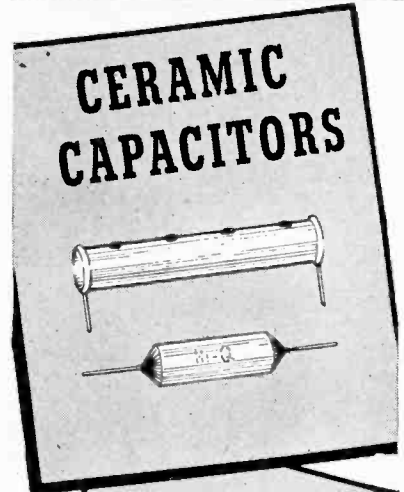

Projection Tubes for Home Television

Pioneering experience in the development of large screen television projection has given *Rauland* physicists and engineers the "know-how" necessary to produce projection tubes for home television receivers.

The *VISITRON R-6016* Front Surface Projection Tube with refractive optic . . . fluorescent screen of 4 inches . . . concave target to simplify lens . . . easy change of magnification . . . gives at least twice the light of a conventional projection tube of the same screen diameter . . . both tube and optic small enough to fit into a table cabinet . . . voltage requirement approximately 30 kilovolts.

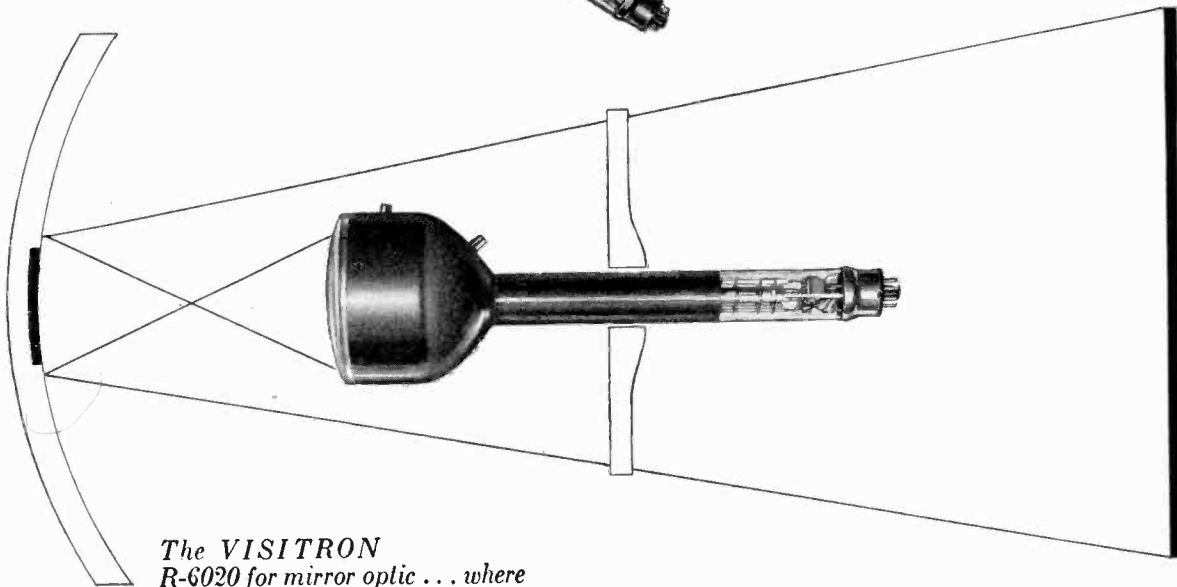
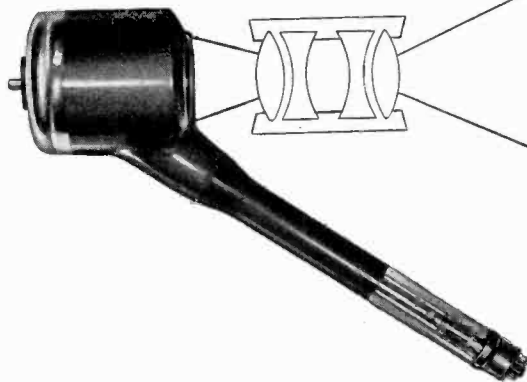

The *VISITRON R-6020* for mirror optic . . . where maximum light at lower anode voltage is desired . . . 5 inch diameter fluorescent screen.



Consult with *Rauland* about your television tube problems. We have the facilities to build projection tubes to special requirements.

RADIO · RADAR · SOUND

Rauland

COMMUNICATIONS · TELEVISION

Electroneering is our business

THE RAULAND CORPORATION • CHICAGO 41, ILLINOIS

How High?

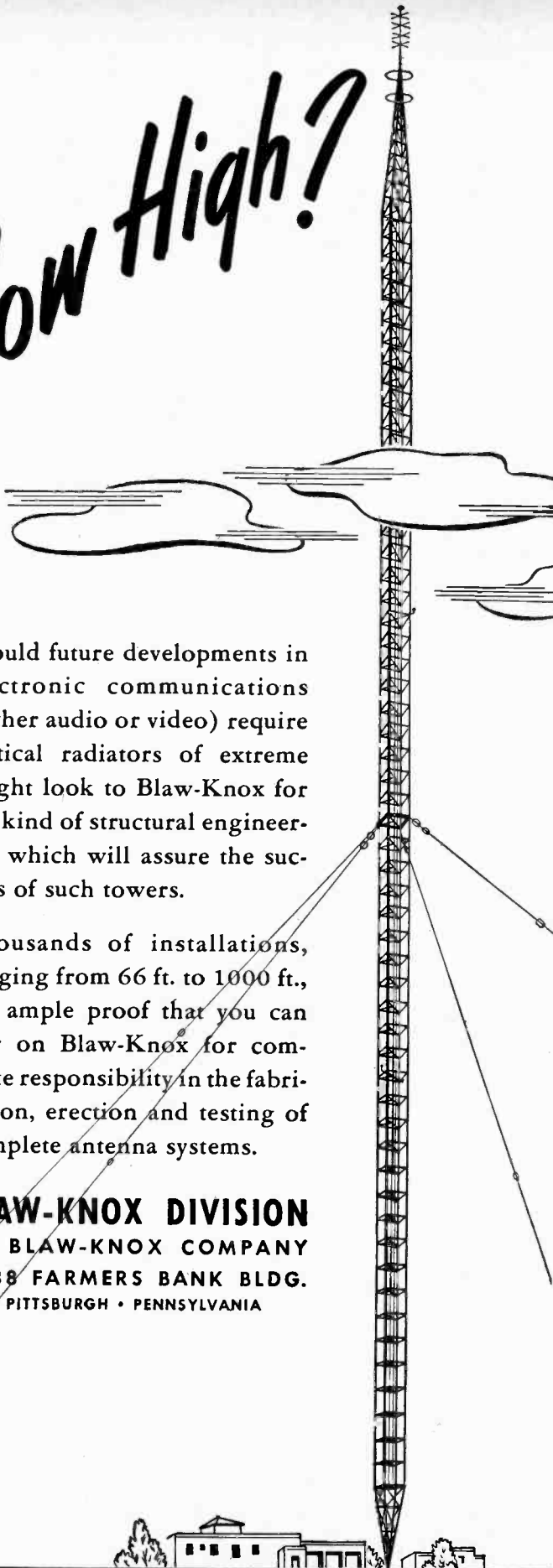

Should future developments in electronic communications (either audio or video) require vertical radiators of extreme height look to Blaw-Knox for the kind of structural engineering which will assure the success of such towers.

Thousands of installations, ranging from 66 ft. to 1000 ft., are ample proof that you can rely on Blaw-Knox for complete responsibility in the fabrication, erection and testing of complete antenna systems.

BLAW-KNOX DIVISION
 OF BLAW-KNOX COMPANY
 2038 FARMERS BANK BLDG.
 PITTSBURGH • PENNSYLVANIA

BLAW-KNOX VERTICAL RADIATORS

For your present and post war electronic instrumentation.

Actual

Size



— SERIES VW —

A new 15 ma., 1.5 volt sub-miniature vacuum tube with —peak inverse potential up to several thousand volts— Grid current less than 10-14 amperes — grid. resistance approximately 10^{16} ohms.

Available as . . .

- Electrometers
- Pentodes
- Tetrodes
- Triodes
- Diodes

. . . or to your specifications.

. . . and hand in hand with this tube development a new Victoreen Hi-Meg vacuum sealed resistor. Values from 1 megohm to 1,000,000 megohms.

1,000,000 Megohms

Actual size

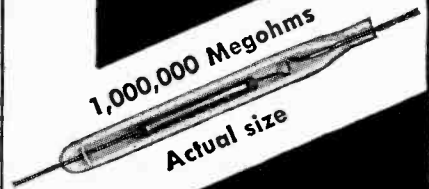

Meeting the needs of fine instrumentation with unusual stability.

Write for our technical brochure on tubes and resistors.

THE VICTOREEN INSTRUMENT CO.
 5806 HOUGH AVENUE
 CLEVELAND 3, OHIO

METAL ASSEMBLIES AND COMPONENTS FOR ELECTRONIC AND MECHANICAL DEVICES

●
ENGINEERING

●
DEVELOPING

●
FABRICATING

●
ELECTRO-FORMING

●
PLATING

●
FINISHING
●

BERNARD **R**ICE'S **S**ONS

I N C O R P O R A T E D

MANUFACTURERS OF QUALITY METAL PRODUCTS SINCE 1867

OFFICE: 325 FIFTH AVENUE, NEW YORK 16, N. Y.

WORKS: 139-145 NORTH TENTH STREET, BROOKLYN 11, N. Y.

★ *Now Available:*
CREI
Group Training

A Planned Program to
 Modernize the Technical
 Knowledge of Your
 Employees Through
 Training for Professional
 Self-Improvement

★ *Prepare your technical staff to meet the challenge of post-war radio-electronics technological demands.*

If your organization is going to engage in any phase of radio-electronics, your technical personnel must know FM—television—Ultra High Frequency Techniques, and all other phases of war-developed electronics technology; and, of course, a thorough and complete knowledge of the fundamentals of practical radio-electronics engineering.

The CREI "Employers' Plan" for group training will:

1. *Increase the technical abilities of your radio-electronics personnel.*
2. *Enable them to perform their duties more efficiently and in less time.*
3. *Increase the value of their services to your organization.*

No company time is required for this training . . . it is accomplished by spare-time, home study.

The CREI "Employers' Plan" is useful for the up-gradng of technical personnel in manufacturing, AM, FM, and television broadcasting, communications, industrial electronics, including the following:

Engineers	Testers
Engineering Aides	Technicians
Laboratory Assistants	Field Servicemen
Inspectors	Installers
	Maintenance Men

The CREI "Employers' Plan" for group training is, tailored to meet each individual organizations requirements.

Your request will promptly bring an outline of the plan, as now in use with other organizations, and intimate details will follow when your particular needs are known. No obligation or cost, of course.

CAPITOL RADIO
Engineering Institute

E. H. RIETZKE, President

Home Study Courses in Practical Radio-Electronics Engineering for Professional Self-Improvement

Dept. PR-10, 3224—16th St., N.W.
 WASHINGTON 10, D.C.

Contractors to the U. S. Navy—U. S. Coast Guard — Canadian Broadcasting Corp. Producers of Well-trained Technical Radiomen for Industry.

A
HARVEY
 Regulated Power Supply
106 PA . . .

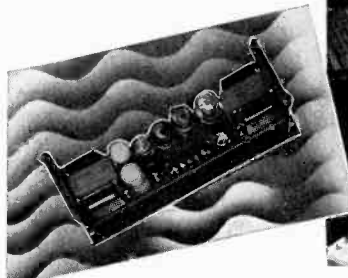

Helps RECORD A SUBTERRANEAN RESERVOIR'S REACTIONS

This Petroleum Reservoir Behavior Analyzer, developed by a major oil company, is used to analyze the behavior of petroleum reservoirs and predict the future performance of these reservoirs under arbitrarily assumed conditions of reservoir control.

A HARVEY Regulated Power Supply 106 PA plays an important role in its operation. To perform efficiently, the Analyzer must have a constant source of static-free regulated power. The HARVEY 106 PA has proven a dependable, controllable source of this power.

The HARVEY Regulated Power Supply 106 PA provides laboratory D.C. power between 200-300 volts. Operates from 115 volts A.C. . . . output remains constant even though line voltage varies between 95 and 115 volts. Ripple content is better than 10 MV . . . two separate filament voltages available, 6.3 volts, 5 amps. each . . . parallel operation possible making 6.3 volts at 10 amps. available.

Write for HARVEY Regulated Power Supply Bulletin H-25 today.

HARVEY RADIO LABORATORIES, INC.
 456 Concord Avenue, Cambridge 38, Massachusetts

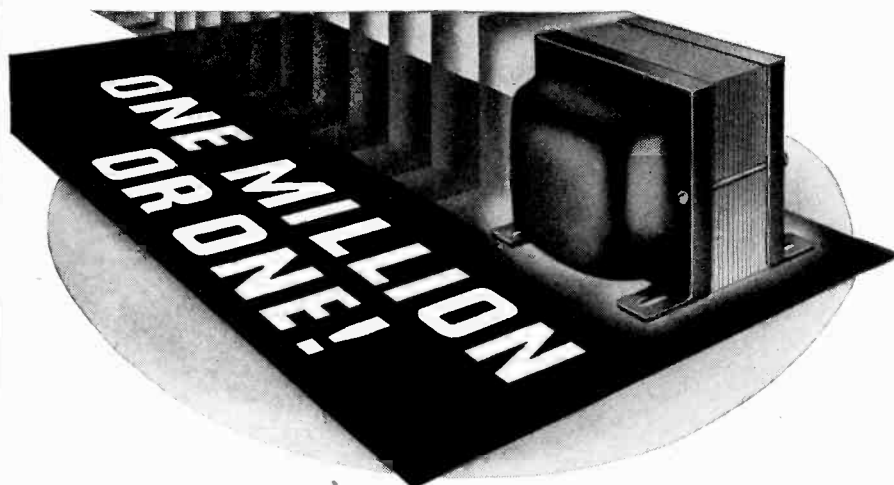

Electronic Engineering can supply—NOW—transformers in standard or special styles in
Any quantity . . .



Because there have been no conversion problems at Electronic Engineering, we are now producing and delivering the finest transformers with the same speed and skill as during the war. We are ready to serve your needs . . . with one million or one!

3223-9 WEST ARMITAGE AVE. • CHICAGO 47, ILLINOIS

Now, as before, expect quality leadership in Collins broadcast equipment

THE NEW COLLINS AM transmitters and remote amplifiers, now ready, reflect characteristically advanced Collins engineering.

Notable transmitter refinements include extremely high fidelity, and increased safety factors through the use of oversize components throughout.

The Collins 21A is a superb 5,000 watt transmitter, with reduced power operation at 1,000 watts also available. Its response curve is flat, within $\pm\frac{1}{2}$ db, from 30 to 10,000 cycles.

The Collins 20T is a 1,000 watt transmitter, of similar characteristics, equipped for reduced power operation at 500 watts if desired.

The Collins 300G is a 250 watt transmitter of equal fidelity, with reduced power operation at 100 watts available.

The Collins 12Y one channel remote amplifier is light, handy, simple and efficient. It is for unattended operation from a 115 volt a.c. power source.

The Collins 12Z four channel remote amplifier is a.c.-d.c. powered, the d.c. source being self-contained batteries which take the load automatically in case of a.c. line failure.

A complete line of Collins high-quality studio equipment is available for either AM or FM application.

An outstanding broadcasting station begins with outstanding equipment. We will be glad to know about your plans and submit complete recommendations. For additional detailed information, write the Collins Radio Company, Cedar Rapids, Iowa; 11 West 42nd Street, New York 18, N. Y. Collins equipment is sold in Canada by Collins-Fisher, Ltd., Montreal.

... FOR BROADCAST QUALITY, IT'S ...



JOB AHEAD

... as brilliant Sol through stubborn clouds
his dauntless will imposes"

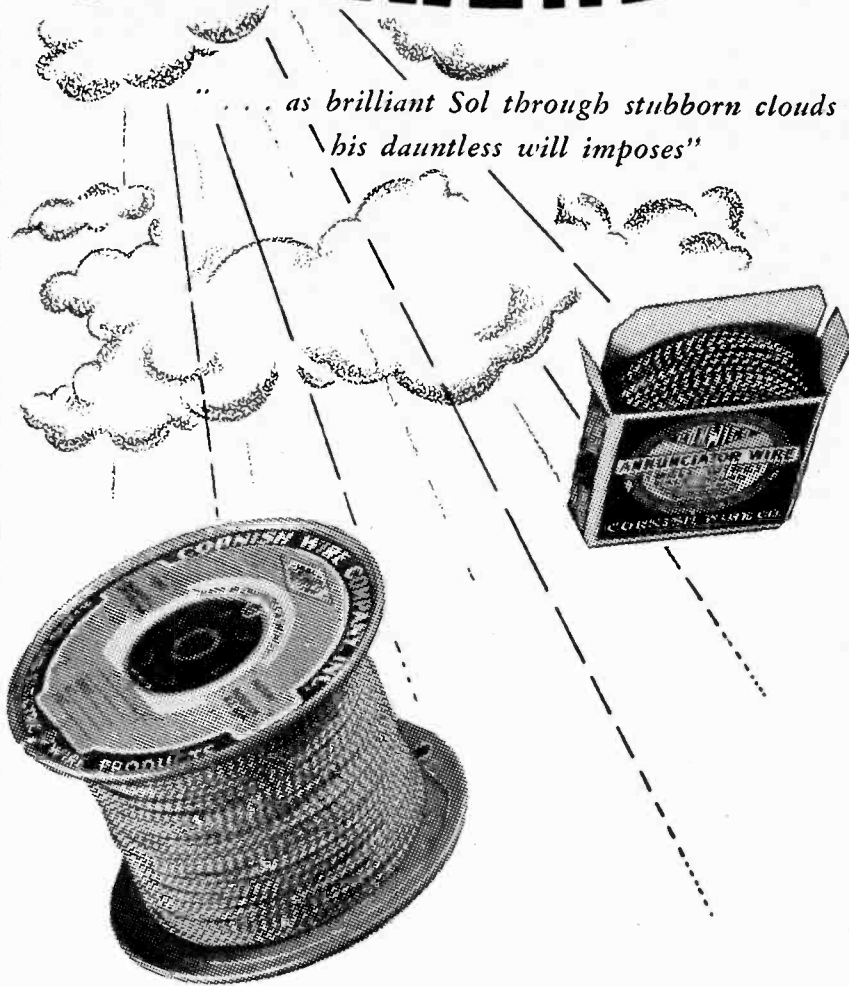

RECONVERSION to national peacetime economy is on the march . . . perhaps not as swift as you and we would like it. Vast displacements, inevitable as we "shift our gears", must be absorbed and neutralized . . . in short, there's a JOB ahead.

Each day supplies of famous CORWICO Wire, so important in the war and so important now, will be made available for civilian use.

Patience! We've moved mountains before

cornish
WIRE COMPANY, INC.
15 Park Row, New York City, New York
"Made by Engineers for Engineers"

EBY CRYSTAL SOCKET

(SIGNAL CORPS TYPE SO-200)

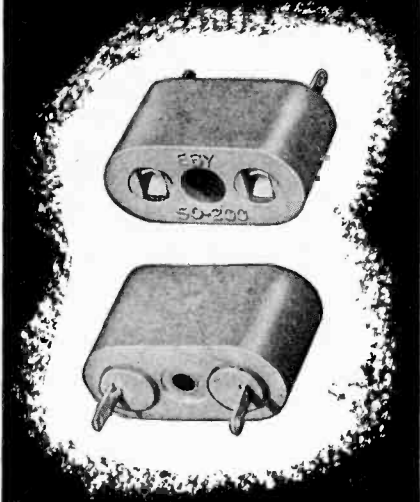

LONG-LIFE BERYLLIUM COPPER CONTACTS

Heat Treated for minimum drift and constant, fatigue-free pressure on the crystal holder prongs. 2 lb. insertion and withdrawal pressure reduces vibration hazards.

Silvered for maximum conductivity — contact resistance 0.005 ohms maximum.

INTERCHANGEABILITY

Designed for interchangeability — fits existing holders with .156 diameter solid prongs or .135 minimum diameter Banana pins on 3/4" centers (such as Signal Corps Types DC-34, DC-35 and FT-171-B).

LOW LOSS

Socket casting is molded from low-loss, mica-filled phenolic (as per Joint Army-Navy Spec. JAN-P-14, type designation E-4).

DELIVERY

Approximately 4 weeks from receipt of order.

Write today
for prices
and samples

HUGH H
EBY
INCORPORATED

HUGH H. EBY, INC.
18 W. CHELTEN AVE., PHILA. 44, PA.
Proceedings of the I.R.E. October, 1945



*Now... Leakage
Resistance Measurements
at Low Potentials!*

Because of its compactness and extreme high sensitivity, this direct reading instrument fills an important measurement gap in the production and servicing of a wide variety of components and electrical devices. Minute faults can be detected in advance . . . tests can be made without destructive breakdown. Test potential less than 50 Volts.

Here's what a few typical users say about Model 799:

"We use it for testing the leakage between windings in transformers, or from windings to core or case."

"We can test the leakage of low voltage paper and mica condensers with the 799, and without danger of damaging the dielectric."

"We test leakage resistance between individual wires in cable harnesses."

"Model 799 is also ideal for checking leakage due to moisture in fiber terminal strip."

For complete data on Model 799 Insulation Tester, communicate with the WESTON representative in your locality, or write... Weston Electrical Instrument Corporation, 617 Frelinghuysen Ave., Newark 5, N.J.



Weston

MODEL 799

INSULATION TESTER

• 10 BILLION Ohms •

will measure:

- ✓ Insulation Properties
- ✓ Resistance Leakage
- ✓ Conductivity of Insulating Materials
- ✓ Leakage due to Moisture Absorption
- ✓ Readings — .1 to 10,000 megohms

Weston Instruments

ALBANY • ATLANTA • BOSTON • BUFFALO • CHICAGO • CINCINNATI • CLEVELAND • DALLAS • DENVER • DETROIT • JACKSONVILLE • KNOXVILLE • LOS ANGELES • MERIDEN
MINNEAPOLIS • NEWARK • NEW ORLEANS • NEW YORK • PHILADELPHIA • PHOENIX • PITTSBURGH • ROCHESTER • SAN FRANCISCO • SEATTLE • ST. LOUIS • SYRACUSE,
In Canada, Northern Electric Co., Ltd., Powerlite Devices, Ltd.

HIGH GRADE PHOSPHORS

For more than thirty years, Patterson Luminescent Chemicals have been well known for exceptional quality. Today, these high-grade phosphors are being used by manufacturers of cathode ray tubes and by prominent universities and experimental laboratories.

At the modern Patterson plant, phosphors are produced under conditions that guarantee uniformity of emission, color and grain size. Complete facilities for large-scale production assure a plentiful supply to meet a wide variety of requirements. Patterson Screen Division of E. I. du Pont de Nemours & Co. (Inc.), Towanda, Pa.

Write for copy of a booklet on "Patterson Luminescent Chemicals."



Patterson Luminescent Chemicals



BETTER THINGS FOR BETTER LIVING
... THROUGH CHEMISTRY



AVAILABLE I.R.E. STANDARDS

	Price
Standards On Electronics: Definitions of Terms, Symbols, 1938. A Reprint (1943) of the like-named section of "Standards on Electronics, 1938." (viii + 8 pages, 8½ x 11 inches)	\$0.20
Standards On Electronics: Methods of Testing Vacuum Tubes, 1938. A Reprint (1943) of the like-named section of "Standards on Electronics, 1938." (viii + 18 pages, 8½ x 11 inches)	\$0.50
Standards On Transmitters and Antennas: Definitions of Terms, 1938. A Reprint (1942) of the like-named section of "Standards on Transmitters and Antennas, 1938." (vi + 8 pages, 8½ x 11 inches)	\$0.20
Standards On Transmitters and Antennas: Methods of Testing, 1938. A Reprint (1942) of the like-named section of "Standards on Transmitters and Antennas, 1938." (vi + 10 pages, 8½ x 11 inches)	\$0.50
Standards On Radio Receivers: Definitions of Terms, 1938. A Reprint (1942) of the like-named section of "Standards on Radio Receivers, 1938." (vi + 6 pages, 8½ x 11 inches)	\$0.20
Standards On Radio Receivers: Methods of Testing Broadcast Radio Receivers, 1938. A Reprint (1942) of the like-named section of "Standards on Radio Receivers, 1938." (vi + 20 pages, 8½ x 11 inches)	\$0.50
Standards On Radio Wave Propagation: Definitions of Terms, 1942. (vi + 8 pages, 8½ x 11 inches)	\$0.20
Standards On Radio Wave Propagation: Measuring Methods, 1942. Methods of Measuring Radio Field Intensity, Methods of Measuring Power Radiated from an Antenna, Methods of Measuring Noise Field Intensity. (vi + 16 pages, 8½ x 11 inches)	\$0.50
Standards on Radio Wave Propagation: Definitions of Terms Relating to Guided Waves, 1945. (iv + 4 pages, 8½ x 11 inches)	\$0.20
Standards on Facsimile: Definitions of Terms, 1942. (vi + 6 pages, 8½ x 11 inches)	\$0.20
Standards on Facsimile: Temporary Test Standards, 1943. (iv + 8 pages, 8½ x 11 inches)	\$0.20
Standards on Piezoelectric Crystals: Recommended Terminology, 1945. (iv + 4 pages, 8½ x 11 inches)	\$0.20
Normas Sobre Receptores de Radio, 1938.* A Spanish-language translation of "Standards on Radio Receivers, 1938," by the Buenos Aires Section of the Institute of Radio Engineers. (vii + 64 pages, 6 x 9 inches)	Two Argentine Pesos (Postpaid)

* Not carried in stock at I.R.E. Headquarters in New York. Obtainable only from Señor Domingo Arbó, Editor of Revista Telegrafica, Peru, 165, Buenos Aires, Argentina.

ASA STANDARDS

(Sponsored by the I.R.E.)

American Standard: Standard Vacuum-Tube Base and Socket Dimensions. (ASA C16.2-1939.) (8 pages, 7¼ x 10½ inches)	\$0.20
American Standard: Manufacturing Standards Applying to Broadcast Receivers. (ASA C16.3-1939.) (16 pages, 7¼ x 10½ inches)	\$0.20
American Standard: Loudspeaker Testing. (ASA C16.4-1942.) (12 pages, 7¼ x 10½ inches)	\$0.25
American Standard: Volume Measurements of Electrical Speech and Program Waves. (ASA C16.5-1942.) (8 pages, 7¼ x 10½ inches)	\$0.20

Prices are net and include postage to any country. Include remittance with order, and address:

THE INSTITUTE OF
RADIO ENGINEERS, Inc.
330 West 42nd Street, New York 18, N.Y.

WIRE SO FINE IT MUST BE *Magnified* TO BE SEEN



WOLLASTON PROCESS Wire as small as

$\frac{1}{100,000}$ OF AN INCH
IN DIAMETER

... available in Platinum
and some other Metals

.00001" is less than 1/30 the diameter of the smallest wire die commercially available. Yet our Wollaston Process wire (drawn in a silver jacket) closely meets your specifications for diameter, resistance and other characteristics.

This organization specializes in wire and ribbon of smaller than commercial sizes and closer than commercial tolerances. Write for List of Products.

SIGMUND COHN & CO.



44 GOLD STREET NEW YORK 7

SCOVILL PLUGGED A NEW TECHNIQUE

INTO RADIO TERMINAL JACKS

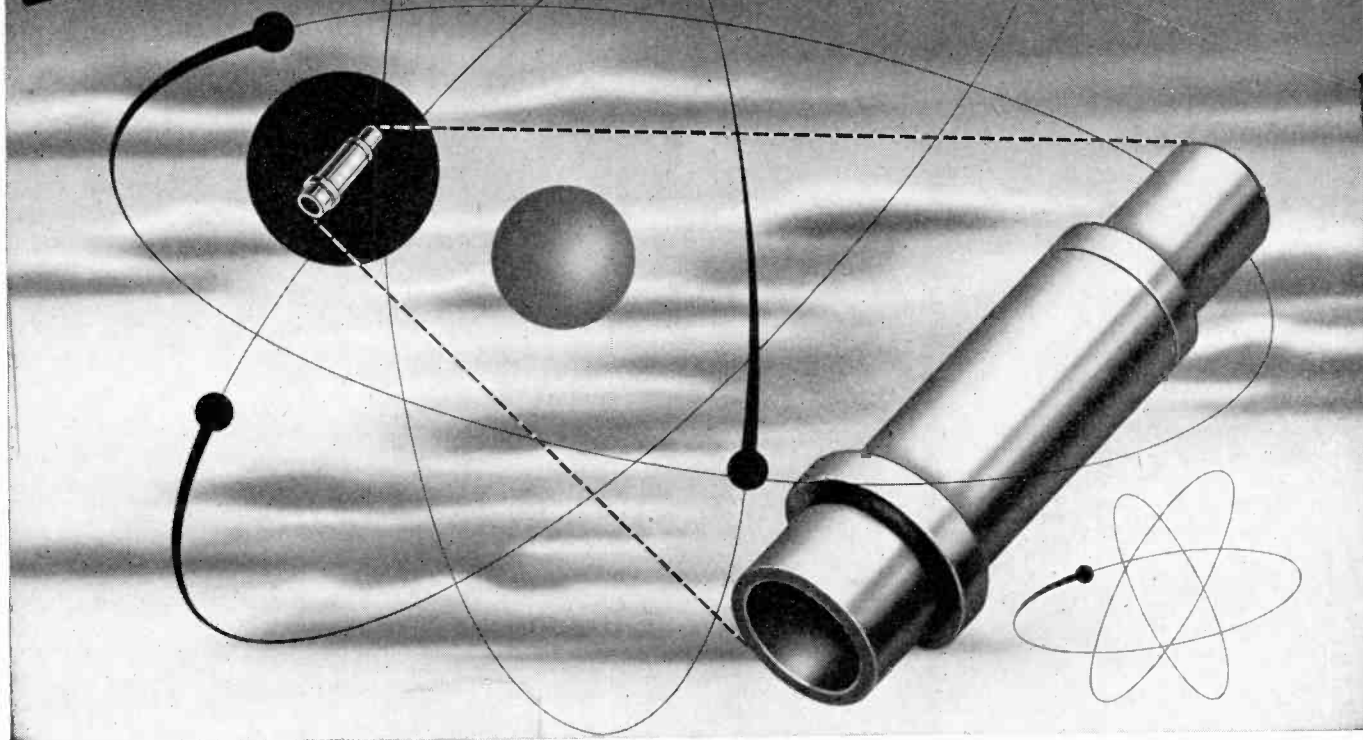

... and disconnected a tie-up



Terminal jacks for war-needed radios — screw-machined from rod stock — were lagging behind other parts. Expeditors called on Scovill to break the bottleneck.

Scovill did just that by shifting to high-speed stamping of sheet metal. This change in technique stepped up production greatly . . . cut down on scrap, always a problem in screw machine operations . . . turned out eminently satisfactory work . . . low-

ered costs by a substantial margin.

Scovill Electrōnents* may also save time and money for you

Maybe your small electronic components or large assemblies can benefit from Scovill's versatility in forging, drawing, stamping, heading, or machining all kinds of metals and Scovill's impartiality in choosing the one method that will make your Electrōnents* faster and better for less. For further details of Scovill's designing service and manufacturing

ability, send for literature. Use the coupon below and mail it today.

*Electrōnents = Electronic Components



Please send me a free copy of "Masters of Metal" booklet describing your facilities. I am interested in the ELECTRŌNENT* applications checked.

- | | | |
|--|--------------------------------------|--|
| <input type="checkbox"/> Batteries | <input type="checkbox"/> Dials | <input type="checkbox"/> Panels |
| <input type="checkbox"/> Record Changers | <input type="checkbox"/> Escutcheons | <input type="checkbox"/> Sockets |
| <input type="checkbox"/> Clips | <input type="checkbox"/> Jacks | <input type="checkbox"/> Stampings (misc.) |
| <input type="checkbox"/> Condensers | <input type="checkbox"/> Lugs | <input type="checkbox"/> Tubes |

Other applications.....

SCOVILL MANUFACTURING COMPANY

Electronic Division
26 Mill Street, Waterbury 91, Connecticut

Name

Company

Address

FREE!

The famous 64-page, fact-packed book that has stimulated thousands of men!



"Forging Ahead in Business" is a practical, thoughtfully-written book with "punch" and common sense on every page. It carries a message of vital importance to every man who wants to make more money, get a better job and improve his station in life.

Partial Contents:

- Law of Success
- Forging a Career
- Organized Knowledge
- Highway of Achievement
- Making Decisions
- Failure and Success

Noted Contributors

Among the prominent men who have contributed to the Institute's training plan, which is described in "Forging Ahead in Business," are: Thomas J. Watson, President, International Business Machines Corp.; Clifton Slusser, Vice President, Goodyear Tire & Rubber Co.; Frederick W. Pickard, Vice President and Director, E. I. du Pont de Nemours & Co.

Simply return the coupon below, and your FREE copy of "Forging Ahead in Business" will be mailed to you.

MAIL COUPON TODAY

ALEXANDER HAMILTON INSTITUTE
Dept. 329, 71 W. 23rd St., New York 10, N. Y.
In Canada:
54 Wellington Street, West, Toronto 1, Ont.

Please mail me, without cost, a copy of the 64-page book—"FORGING AHEAD IN BUSINESS."

Name.....
Firm Name.....
Business Address.....
Position.....
Home Address.....

Toroids..

by

DX

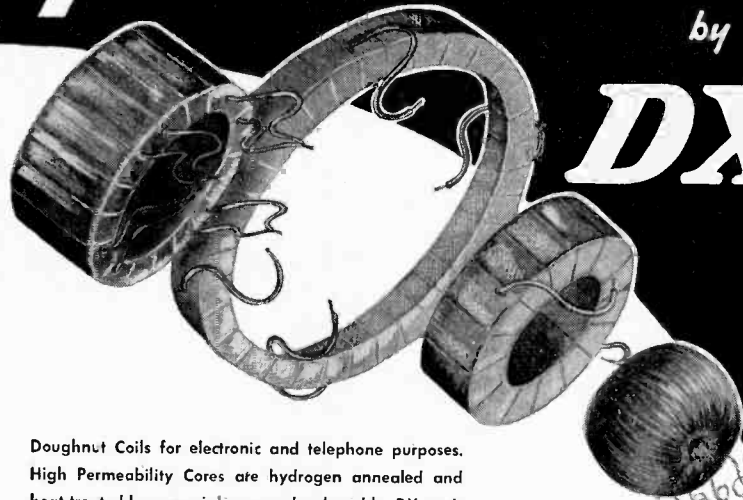

Doughnut Coils for electronic and telephone purposes. High Permeability Cores are hydrogen annealed and heat treated by a special process developed by DX engineers. Send us your "specs" today—ample production facilities for immediate delivery.

DX RADIO PRODUCTS CO.

GENERAL OFFICES 1200 N. CLAREMONT AVE., CHICAGO 22, ILL., U.S.A.



ATTENUATORS

by

TECH LABS

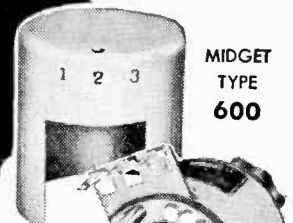

MIDGET TYPE 600

"Midget" model is especially designed for crowded apparatus or portable equipment.



STANDARD TYPE 700

- Solid silver contacts and stainless silver alloy wiper arms.
- Rotor hub pinned to shaft prevents unauthorized tampering and keeps wiper arms in perfect adjustment.
- Can be furnished in any practical impedance and db. loss per step upon request.
- TECH LABS can furnish a unit for every purpose.
- Write for bulletin No. 431.



Manufacturers of Precision Electrical Resistance Instruments
337 CENTRAL AVE. • JERSEY CITY 7, N. J.

Build longer life, better performance, into your products . . . with rugged, dependable SPERTI HERMETIC SEALS

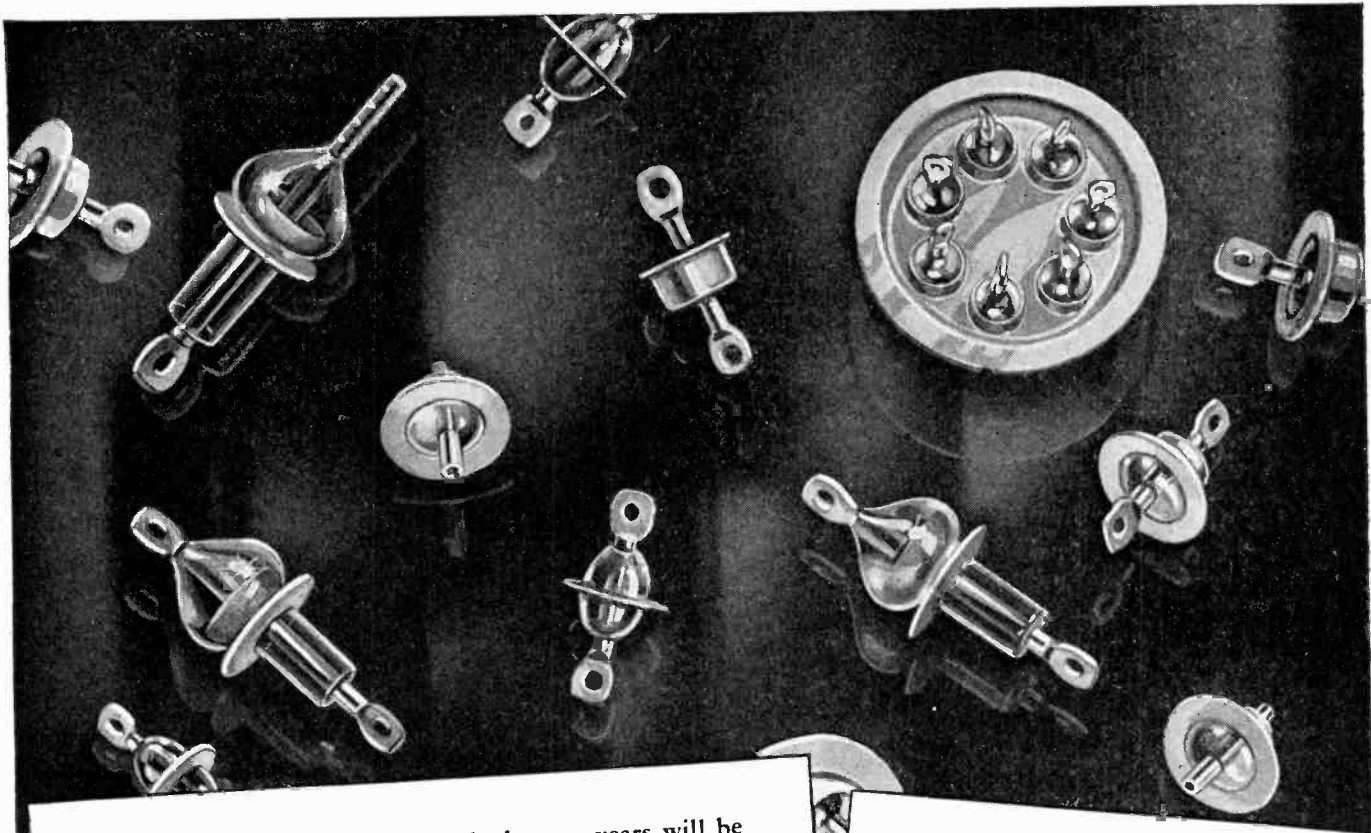

Buyers who have waited through the war years will be looking for big improvements in your products. You'll have to meet civilians' expectations . . . just as you have met military specifications.

You can do it by building longer life, better performance, more trouble-free operation into your products. That calls for Sperti Hermetic Seals, the rugged, dependable, war-proved seals that effectively shut out dust, moisture and deteriorating agents.

Sperti Hermetic Seals are durable, one-piece units, easily soldered-in at less expense. Because of Sperti's advanced manufacturing methods, plus exhaustive tests and inspections, you'll get "true" seals that cut down production delays and costly rejects in the inspection line.

WRITE, TODAY. Get the facts. Find out about the many product applications of Sperti Hermetic Seals and their performance advantages.

HERE'S WHY LEADING MANUFACTURERS CHOOSE SPERTI HERMETIC SEALS

Seal out dust, fungus, salt spray, sand atmosphere at high altitudes, etc.

Will add longer life to a product.

Will help reduce operational troubles.

Are one-piece, rugged units. Easily soldered-in at less expense.



Sperti

INCORPORATED • CINCINNATI 12, O.

RESEARCH • DEVELOPMENT • MANUFACTURING

Weigh a lot less!

Less subject to breakage!

Adaptable to any mounting style!

Exceptionally low dielectric loss!

TAP 'EM ANYWHERE!

If desired, many types of B & W Air Inductors can be supplied with every turn indented as illustrated. This permits quick, easy tapping at any point!

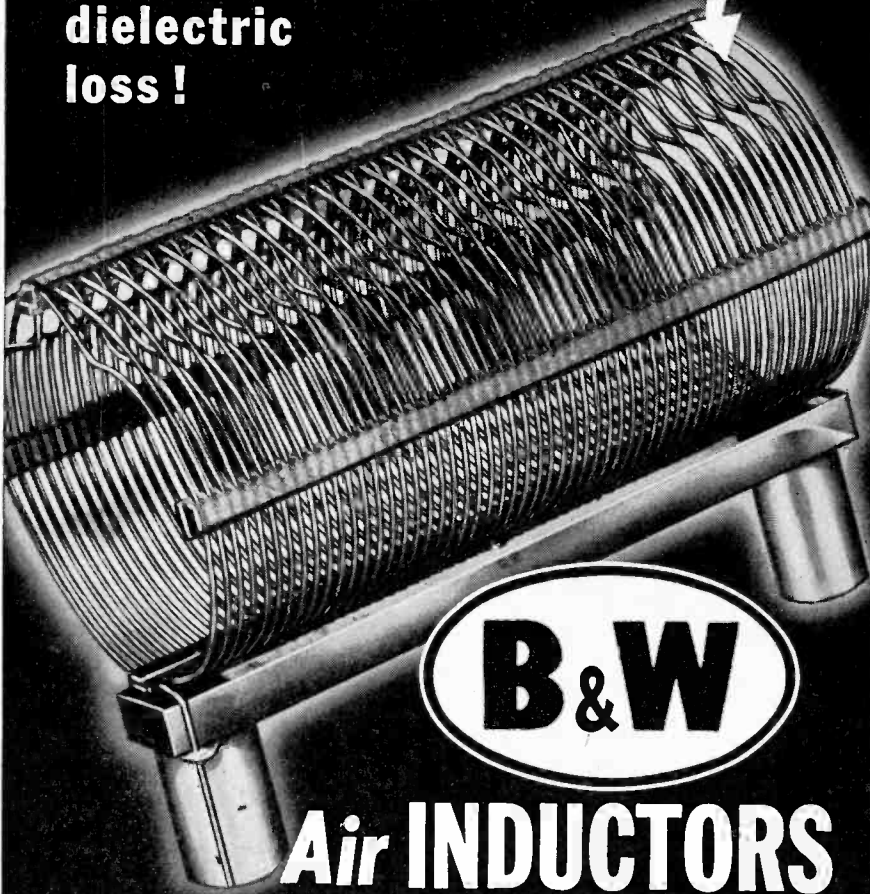

B & W

Air INDUCTORS

ALL SHAPES—ALL SIZES—for all jobs!

In the ten years since B & W discarded conventional winding forms and started winding many types of coils "on air", these unique inductors have proved their marked superiority for a wide variety of equipment. AIR INDUCTORS weigh much less—are infinitely more adaptable to difficult design

and mounting specifications. Unexcelled for plug-in services, there is little about them to break—and, if desired, they can be protected from rough services with bumper rings. Dielectric loss is exceptionally low—and they can be wound to an exacting, uniform pitch. Tell us your coil needs!



BARKER & WILLIAMSON

DEPT. IR-105, 235 FAIRFIELD AVE., UPPER DARBY, PA.

Export: LINDETEVES, INC., 10 Rockefeller Plaza, New York, N.Y., U.S.A.

CML SERVES THE ELECTRONIC INDUSTRY

Designed to meet the most rigorous specifications for precision, every CML unit is equipment of accredited performance.

1 ROTBRIDGE . . . This automatic inspector checks for proper wiring, correct resistance, capacity and inductance values in all types of electronic equipment.

2 MODEL 1100, MODEL 1110 . . . Voltage regulated power supply units; with extremely low noise level and excellent regulation.

3 MODEL 1420 GENERATOR . . . Furnishes test power over a wide frequency range; may also be employed in 3-phase circuits.

4 MODEL 1200 STROBOSCOPE . . . Stops motion within range of 600 to 600,000 R.P.M.

WRITE FOR DESCRIPTIVE BULLETINS

COMMUNICATION MEASUREMENTS LABORATORY
120 GREENWICH ST., NEW YORK 6, N. Y.

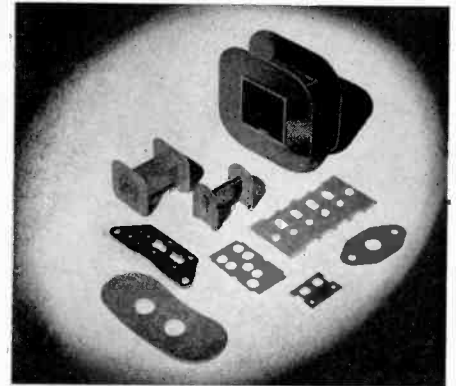

Serving the Radio Industry with dependable laminated plastics

NATIONAL VULCANIZED FIBRE

PHENOLITE
Laminated BAKELITE

—because of their lightness in weight, high dielectric strength, ready machinability, exceptional wearing and other qualities—are playing a vital part.



NATIONAL VULCANIZED FIBRE CO.

Offices in Principal Cities
WILMINGTON, DELAWARE

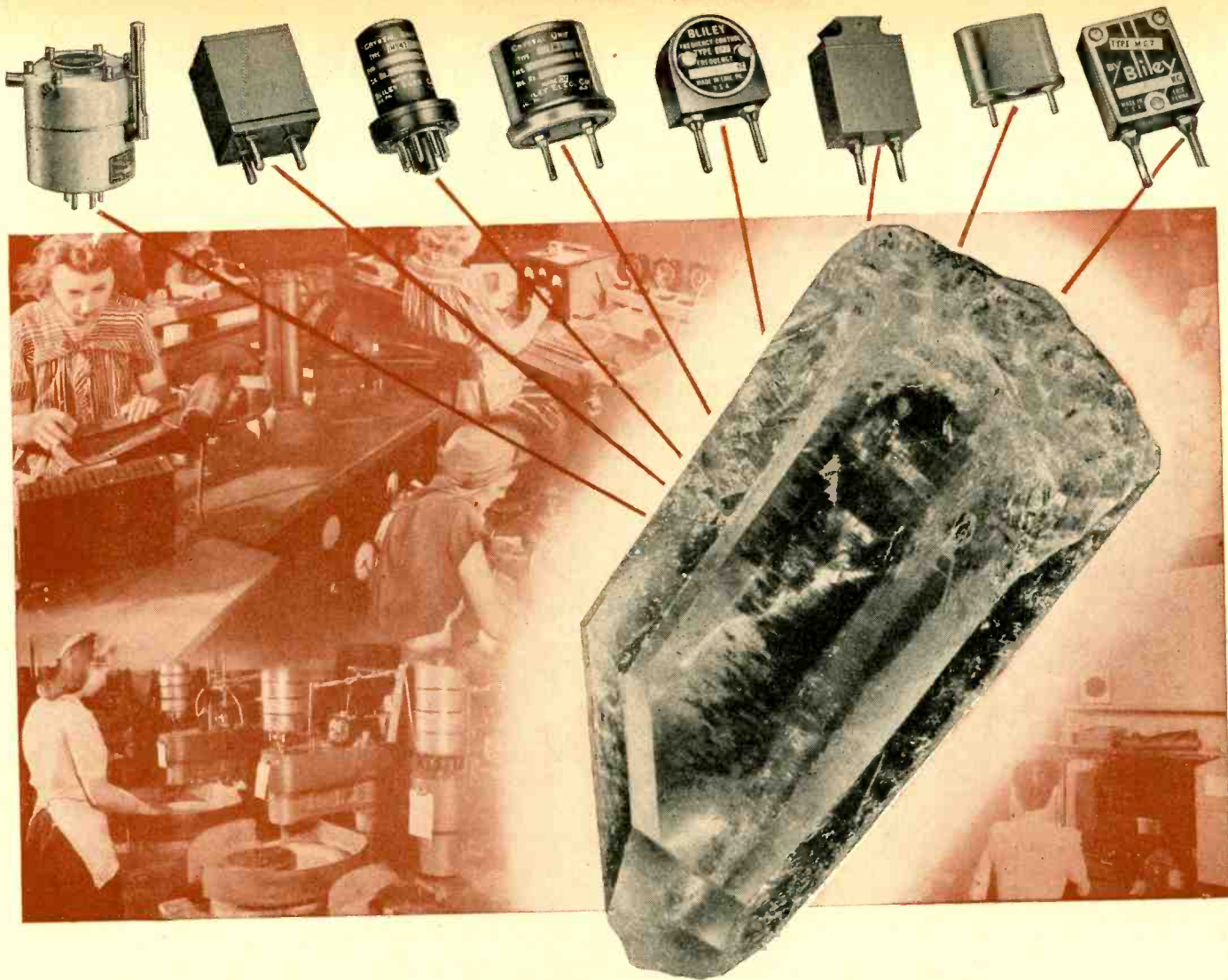

You name the application...

BLILEY has the crystals

Post VJ Day production of Bliley acid etched* crystals for FM receivers, Aircraft and Marine radios, Railroad communications equipment and many other applications is proceeding with the same skill and efficiency that marked our wartime operations.

Substantial quantities of these crystals are in the hands of foresighted manufacturers who planned in advance with Bliley engineers for frequency stabilization in their post-war models.

Now, more than ever before, you

need the versatile experience of Bliley engineers and craftsmen gained through more than 15 years of quartz crystal engineering exclusively. Whether your requirements are one crystal or a million, you can be sure of top quality—top design—and top performance—in Bliley crystals.

+ + +

*Acid etching quartz crystals to frequency is a patented Bliley process.



Another star has been added. Our 5th citation for outstanding achievement in producing materials essential to the war effort.

Bliley CRYSTALS

Radio Engineers —
write for temporary
Bulletin P.-26

BLILEY ELECTRIC COMPANY • UNION STATION BUILDING, ERIE, PENNSYLVANIA

Proceedings of the I.R.E.

October, 1945

85A

12,504 RADIO ENGINEERS

Who they are and where they work.

Just how can the advertising man define the radio engineer, identify and reach him?

It is true that a man's knowledge, training and work qualifies him as a radio-electronic engineer whether or not he calls himself one, or is so recognized. But most active radio engineers are mem-

bers of the Institute of Radio Engineers. They need the many important services of the I.R.E., including:

The helpful and informative section meetings held in 32 engineering centers each month.

The monthly magazine "PROCEEDINGS of the I.R.E."

And so we find 12,504 radio engineers and engineers in train-

ing, members of the I.R.E. as a unit, engaged in the following occupations

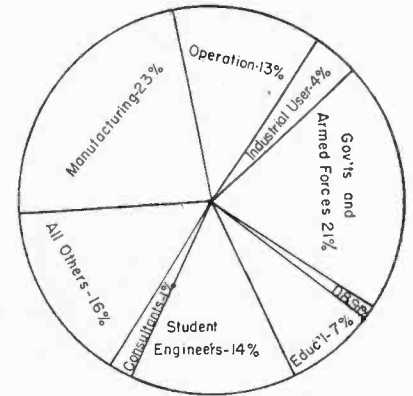

Who reads a Radio Engineering Journal?

The analysis of the December 31, A.B.C. Statement of the PROCEEDINGS of the I.R.E., giving the jobs of 14,138 subscribers, including 12,504 engineers, members of the I.R.E. A group of college students (engineers in training) is included in the following tabulation of occupations.

Radio Manufacturing	3190	23%
Operation & Broadcasting	1857	13%
Industrial Operations	534	4%
Armed Forces & Gov'ts	2981	21%
Distribution & Service	158	1%
Educators & Colleges, Etc.	1019	7%
Engineers in Training	1986	14%
Consulting Engineers	190	1%
All others	2223	16%

In a technical industry, the engineer is key man to your sales. His experience determines buying, and his research controls future designs. The PROCEEDINGS of the I.R.E. is his monthly textbook, up-to-date. Its research articles outline the future of radio-and-electronics and its advertising equips the engineer with usable product knowledge.

**"To SELL the Radio Industry,
TELL the Radio Engineers"**

You will readily see the importance of these men as a market. The radio-and-electronic industry is a technical one and only technicians are qualified buyers. Who really knows anything about buying a radio tube except a radio engineer?

During the war, membership in the I.R.E. has doubled. The chart below will show the growing importance in size alone of this easily reached group of engineers.

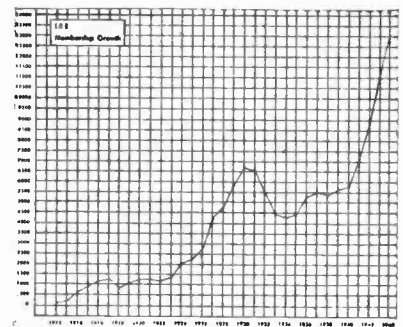

The post-war importance of radio engineers can hardly be over-estimated. Whatever course radio development takes, one thing is certain — "radio engineers" will be the men who guide these developments.

The advertising pages of the PROCEEDINGS of the I.R.E. will always be a direct method of reaching these engineers who make future radio-and-electronic markets.

A JOURNAL — of the Theory, Practice, and Applications of Electronics and Electrical Communication.

- Radio Communication • Sound Broadcasting • Television.
- Marine and Aerial Guidance.
- Tubes • Electron Optics • Radio-Frequency Measurements • Engineering Education • Sound and Picture Electrical Recording and Reproduction.
- Power and Manufacturing Applications of Radio-and-Electronic Technique • Industrial Electronic Control and Processes • Medical Electrical Research and Applications.



Proceedings of the I.R.E.

THE INSTITUTE OF RADIO ENGINEERS

Advertising Dept., 303 West 42nd St., New York 18, N. Y.





Avoid Moisture Damage in Over-Seas Packages

Simply put a few small bags of Jay Cee Silica Gel, like the ones above, inside your container . . . wrap or seal tightly . . . and ship over-seas without fear of damage from "in-the-package" moisture. Jay Cee Silica Gel is an ideal drying agent . . . has amazing power to absorb atmospheric moisture. Thus the air inside of containers is kept absolutely dry and delicate metal parts are protected from rust and corrosion.

Jay Cee Silica Gel is also used in pack-

ages of foods, fabrics, chemicals, and other products. Moreover, it has wide application in the air conditioning, refrigeration, and chemical industries. Jay Cee Silica Gel is clear white; passes a rigid section test; meets exacting Government specifications; is strictly a quality product.

JOBBER WANTED — There are excellent opportunities for jobbers to build profitable business on Jay Cee Silica Gel in a few territories. Write for details.

JOLIET CHEMICALS, LTD., INDUSTRY AVENUE, JOLIET, ILLINOIS



SILICA GEL

A superior dehydrant

Q METER

MODEL 160-A

Direct Reading

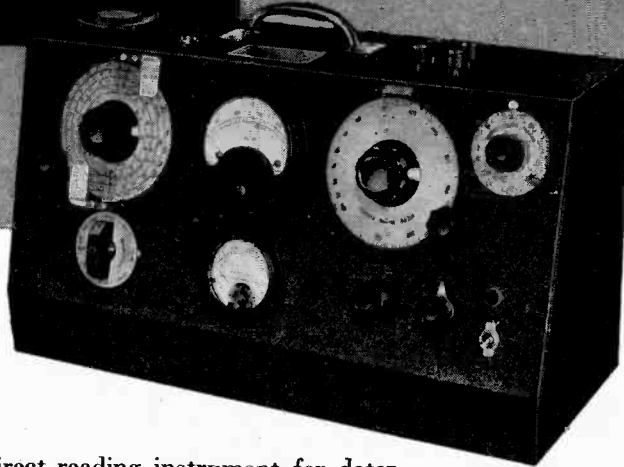

A dependable direct-reading instrument for determining the Q or the ratio of reactance to resistance, of coils. Used in design and production engineering of Radio and Electronic equipment. Condensers and other components readily measurable.

Determines effective inductance or capacitance



BOONTON RADIO

BOONTON, N. J.

Corporation



DESIGNERS AND MANUFACTURERS OF THE "Q" METER . . . QX-CHECKER . . . FREQUENCY MODULATED SIGNAL GENERATOR . . . BEAT FREQUENCY GENERATOR . . . AND OTHER DIRECT READING TEST INSTRUMENTS

Tone...

Always a Deciding Factor

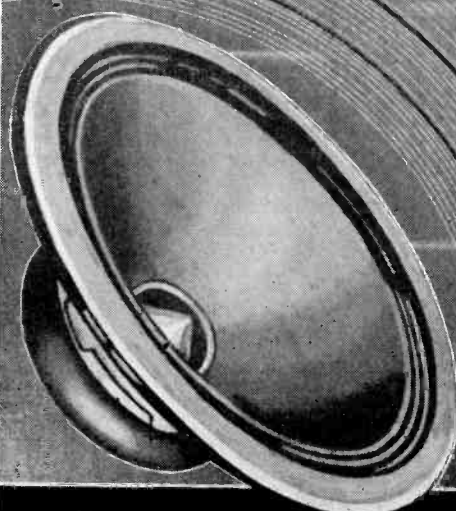

In the selection of any musical instrument, tone is of vital importance. Cinaudagraph Speaker Engineers have kept pace with every tone advancement — pioneered many new developments. That's why you'll want tomorrow's, better than ever, Cinaudagraph Speakers in every fine receiver — every quality sound unit.



Cinaudagraph Speakers, Inc.

3911 S. Michigan Ave., Chicago
Export Div., 13 E. 40th St., New York 10, N. Y.

"No Finer Speaker in all the World"

RADIO PARTS OF "TAYLOR LAMINATED PLASTICS"

THE VERSATILITY OF

Phenol Fibre, Vulcanized Fibre,

And Phenolastic Fibre

Gives radio engineers a

WIDE LATITUDE in the design

Of parts for post-war radios.

Dielectric qualities, strength-weight

Ratios, and the ability to

MASS-PRODUCE sheets, rods, tubes,

Or fabricated parts are

Bringing Taylor Engineers a

Constant stream of inquiries.

We'll welcome yours, too.

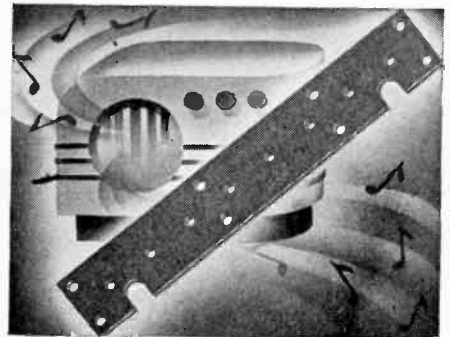

Almost quicker than the eye can follow, these radio terminal strips are sawed, drilled, and milled from sheets of Phenol Fibre having a fine weave cotton base. They are tough and moisture-resistant and have high electric properties. Whatever combination of qualities you require, it's a good bet that Taylor can give it to you.

TAYLOR FIBRE COMPANY

LAMINATED PLASTICS: PHENOL FIBRE-VULCANIZED FIBRE
Sheets, Rods, Tubes, and Fabricated Parts
NORRISTOWN, PENNSYLVANIA
OFFICES IN PRINCIPAL CITIES

Pacific Coast Headquarters:
544 S. SAN PEDRO STREET, LOS ANGELES

Proceedings of the I.R.E. October, 1945

3 D 23

$E_f = 6.3$ VOLTS.

$E_c = 250$ VOLTS.

I_p

250

200

150

100

50

0

$E_{c1} = +40V$

$E_{c1} = +30V$

$E_{c1} = +20V$

$E_{c1} = +10V$

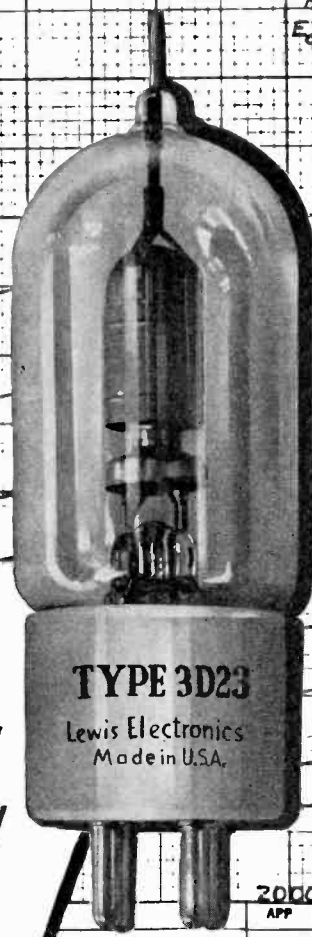

A remarkable new
TETRODE for fixed
or mobile operation!

- FILAMENT VOLTAGE, 6.3 AC or DC VOLTS
- FILAMENT CURRENT 3.0 AMPERES
- AMPLIFICATION FACTOR 65
- MUTUAL CONDUCTANCE 2,750
- PLATE DISSIPATION 35 WATTS
- MEDIUM 4 PIN CERAMIC BASE
- MAXIMUM POWER OUTPUT, 130 WATTS
- APPROX. DRIVING POWER . . . 4.5 WATTS

Inter-Electrode Capacities

- INPUT TO PLATE2 MMFD
- INPUT, 6.5 MMFD — OUTPUT, 1.8 MMFD

Licensed under R. C. A. Patents

Catalog Sheet and Tubes
Now Ready for
Distribution

ACTUAL SIZE

2000	DATE	PRINT	OF
APP			

Lewis at Los Gatos

A manufacturing organization . . . the pride of an entire community . . . with an electronic engineering background of 20 years experience! Plus a war-born performance record of meeting huge production demands and exacting technical requirements—on time and economically!

EQUIPPED and READY
to produce YOUR TUBES
under YOUR BRAND name!

Lewis ★

ELECTRONICS
LOS GATOS · CALIFORNIA

**Again
Available
Without
Priorities**

LINGO
VERTICAL TUBULAR
STEEL RADIATORS

Prompt Shipment
From Materials In Stock

Your post-war plans take a decided spurt now that Lingo Radiators are priority-free! Because of the limited amount of materials on hand, production must be concentrated now on radiators not exceeding 250 ft. in height. Regardless of whether you are ready to install now or not—order your Lingo Radiator now. It will be constructed on a first-come, first-served basis and delivered when you want it.

Place Your Order NOW!

Please include in your inquiries the radiator height required and approximate site, so that complete quotations can be made immediately, covering the radiator itself and its subsequent erection, when so desired.

JOHN E. LINGO & SON, INC.
EST. 1897 CAMDEN, NEW JERSEY

LINGO VERTICAL
TUBULAR STEEL
RADIATORS

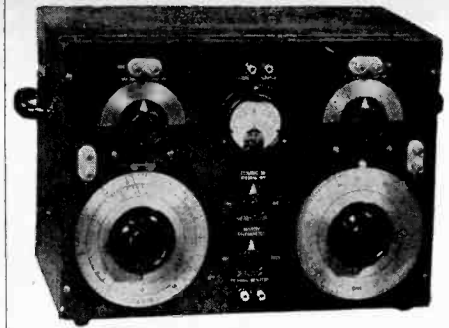

High Accuracy

In Measuring:

- * CAPACITANCE—RESISTANCE—INDUCTANCE
- * STORAGE FACTOR (Q) OF COILS
- * DISSIPATION FACTOR OF CONDENSERS

• MODEL 200-A IMPEDANCE BRIDGE is a portable, self contained instrument of highest quality used extensively by the Army, Navy, and many manufacturers.

The range of measurement for capacitance is 1 micro microfarad to 100 microfarads; for resistance, 1 milliohm to 1 megohm; for inductance, 1 microhenry to 100 microhenrys. The accuracy on the main decade is 1% for capacitance or resistance measurements and 2% for inductance tests.

Reading obtained from 6 inch direct reading dials. All controls and connections plainly marked and conveniently located on the panel. 35-page book gives methods for many types of measurements.

IMMEDIATE DELIVERIES

Our factory is in a position to make fast deliveries on Model 200-A and other products including precision mica condensers, binding posts, several types of AWS rheostat-potentiometers and decade and low capacity switches.

Brown Engineering Co.

4635 S. E. Hawthorne Blvd. Portland 15, Oregon

**Remler Appointed
as Agent for
R.F.C.**

... to handle and sell government owned electronic equipment released for civilian use.

Write for Bulletin 21 listing a wide variety of equipment covering entire electronic field.

Remler Co., Ltd. · 2101 Bryant St.
San Francisco 11, Calif.

REMLER

SINCE 1918

Communications · Electronics

Do Radio Engineers Know What You Make?



Now—A Radio Engineer's Directory

MARKET

Radio Engineers control the technical buying of a two-billion-dollar radio-electronic and radar market. These men alone are competent to do the specifying and purchasing of complicated radio tubes, components, and materials that only a trained and experienced engineer really understands.

More than 15,000 radio-and-electronic engineers and engineers in training, will receive and use the 1946 I.R.E. Yearbook. This membership roster and radio product index has a close personal relationship to each engineer because it lists the reader himself and his fellow members in the radio profession. It is his own property with a permanent place on his desk — at his fingertips, a reference to both friends and radio-product data he needs and wants.

FEATURES

- Complete membership list of The Institute of Radio Engineers.
- An alphabetical list of over 2000 firms serving the radio-electronic industry, with addresses, and —
- Names of the chief engineers of most of these firms, plus,
- Coding for 25 basic product classifications of each.
- Detailed product classifications (more than 100 headings) for all kinds of radio-electronic components and equipment listed for the firms advertising in the Yearbook.
- **PRODUCT ADVERTISING** of equipment and component-parts manufacturers, displaying and giving specifications for their products and providing engineering data.

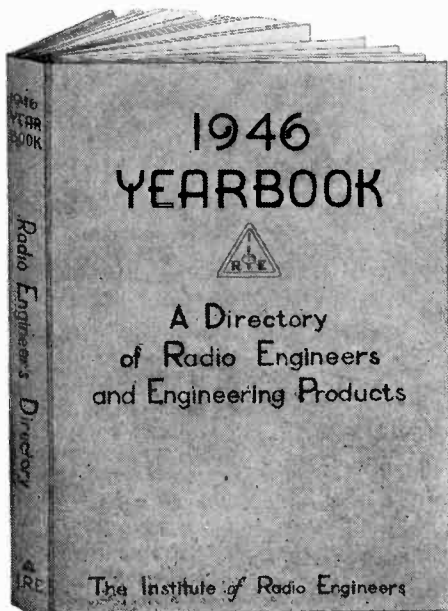

RATES			For "Proceedings of I.R.E. Contract Advertisers"	
Space	Rate	Size	6 Times	12 Times
1 page	\$250.	7" x 10"	\$225.	\$200.
2/3 page	180.	4 5/8" x 10"	160.	140.
1/3 page	100.	{ 2 1/4" x 10" { 4 5/8" x 4 7/8"	90.	80.
1/6 page	60.	{ 2 1/4" x 4 7/8" { 4 5/8" x 2 3/8"	55.	50.

Agency Discount 15%. Cash Discount 2% 10 days.

1946 I.R.E. YEARBOOK

THE INSTITUTE OF RADIO ENGINEERS

303 West 42nd Street, New York 18, N. Y.

ME. 3-5661

WILLIAM C. COPP — National Advertising Manager

SCOTT KINGWILL

DUNCAN A. SCOTT & COMPANY

Central States Representative

Pacific Coast Representative

35 E. Wacker Drive
Chicago 1

Mills Building
San Francisco 4

448 So. Hill Street
Los Angeles 13

I. R. E. YEARBOOK PRODUCT LISTINGS

Your firm will receive a free listing in an alphabetical Directory of Manufacturers serving the Radio and Electronic Industry in the 1946 I.R.E. Yearbook if you will make sure that we have the company name and address, name of your chief engineer, and data on your products. A questionnaire similar to these pages has been mailed to 3000 firms we have on record, but many firms have not yet answered. This listing will be a service to I.R.E. members and may bring business to your company, so will you help by checking off the information on the columns below and sending us the coupon with the proper product numbers at once? In that way you may be sure your firm is listed and correct data is shown. Thank you.

Check Your Product Here

- | | | |
|---|---|--|
| <p><input type="checkbox"/> 1. Aircraft Radio Equipment.</p> <p><input type="checkbox"/> 2. Airport Radio Equipment.</p> <p><input type="checkbox"/> 3. Amplifiers, Audio Frequency.</p> <p><input type="checkbox"/> 4. Antenna Phasing Equipment & Accessories.</p> <p><input type="checkbox"/> 5. Antennas:
 <input type="checkbox"/> A. Broadcast
 <input type="checkbox"/> B. Directional
 <input type="checkbox"/> C. Dummy
 <input type="checkbox"/> D. Police
 <input type="checkbox"/> E. Ultra High Frequency
 <input type="checkbox"/> F. Vertical</p> <p><input type="checkbox"/> 6. Antenna Accessories.</p> <p><input type="checkbox"/> 7. Attenuators.
 <input type="checkbox"/> Bakelite: see Moulded Products.
 <input type="checkbox"/> Binding Posts: see Hardware.</p> <p><input type="checkbox"/> 8. Blowers & Cooling Fans.</p> <p><input type="checkbox"/> 9. Books & Book Publishers.
 <input type="checkbox"/> Bridges: see Test Equipment.</p> <p><input type="checkbox"/> 10. Broadcasting Stations.
 <input type="checkbox"/> Bushings: see Hardware.</p> <p><input type="checkbox"/> 11. Cabinets.</p> <p><input type="checkbox"/> 12. Cables:
 <input type="checkbox"/> A. Co-axial
 <input type="checkbox"/> B. Microphone
 <input type="checkbox"/> C. Preformed Harnesses
 <input type="checkbox"/> D. Shielded
 <input type="checkbox"/> E. Ultra High Frequency</p> <p><input type="checkbox"/> 13. Capacitors:
 <input type="checkbox"/> A. Ceramic
 <input type="checkbox"/> B. Electrolytic
 <input type="checkbox"/> C. Fixed
 <input type="checkbox"/> D. Frequency Stabilizing; (variable temp. co-efficient)
 <input type="checkbox"/> E. Hermetically Sealed
 <input type="checkbox"/> F. Mica
 <input type="checkbox"/> G. Oil Filled
 <input type="checkbox"/> H. Paper
 <input type="checkbox"/> I. Vacuum
 <input type="checkbox"/> J. Variable Tuning</p> <p><input type="checkbox"/> 14. Ceramics:
 <input type="checkbox"/> A. Coil Forms
 <input type="checkbox"/> B. Mycalex
 <input type="checkbox"/> C. Rods
 <input type="checkbox"/> D. Sheets</p> <p><input type="checkbox"/> 15. Chassis.</p> <p><input type="checkbox"/> 16. Choke Coils:
 <input type="checkbox"/> A. Audio Frequency
 <input type="checkbox"/> B. Power
 <input type="checkbox"/> C. Radio Frequency
 <input type="checkbox"/> Coil Forms: see Ceramics.</p> <p><input type="checkbox"/> 17. Coils.
 <input type="checkbox"/> Condensers: see Capacitors.</p> <p><input type="checkbox"/> 18. Connectors.
 <input type="checkbox"/> Consoles: see Amplifiers.</p> | <p><input type="checkbox"/> 19. Consulting Engineers:
 <input type="checkbox"/> A. Acoustic
 <input type="checkbox"/> B. Electrical
 <input type="checkbox"/> C. Mechanical
 <input type="checkbox"/> D. Radio</p> <p><input type="checkbox"/> 20. Converters:
 <input type="checkbox"/> A. Frequency
 <input type="checkbox"/> B. Rotary: see Motor Generators</p> <p><input type="checkbox"/> 21. Core Materials:
 <input type="checkbox"/> A. Hipersil
 <input type="checkbox"/> B. Laminations
 <input type="checkbox"/> C. Powdered Iron</p> <p><input type="checkbox"/> 22. Crystals:
 <input type="checkbox"/> A. Oscillating Quartz
 <input type="checkbox"/> B. Piezo-electric</p> <p><input type="checkbox"/> 23. Custom Builders of Equipment.
 <input type="checkbox"/> Dials & Tuning Controls: see Hardware.
 <input type="checkbox"/> Discs, Recording: see Recording Equipment.</p> <p><input type="checkbox"/> 24. Distributors & Jobbers of Radio Equipment & Parts.</p> <p><input type="checkbox"/> 25. Drafting Equipment & Supplies.</p> <p><input type="checkbox"/> Dynamotors: see Motor Generators.</p> <p><input type="checkbox"/> 26. Electronic Control Equipment.
 <input type="checkbox"/> A. Air Conditioning Controls
 <input type="checkbox"/> B. Burglar Alarms & Protection Devices
 <input type="checkbox"/> C. Combustion & Smoke Control Equipment
 <input type="checkbox"/> D. Fire Prevention Equipment
 <input type="checkbox"/> E. Photo-electric Control Devices
 <input type="checkbox"/> F. Variable Speed Motor Controlling Equipment</p> <p><input type="checkbox"/> 27. Equalizers.</p> <p><input type="checkbox"/> 28. Facsimile Equipment.</p> <p><input type="checkbox"/> 29. Filters:
 <input type="checkbox"/> A. Band Pass
 <input type="checkbox"/> B. Noise Elimination
 <input type="checkbox"/> C. Rejection</p> <p><input type="checkbox"/> 30. Frequency Measuring Equipment:
 <input type="checkbox"/> A. Audio Frequency
 <input type="checkbox"/> B. Primary Standards
 <input type="checkbox"/> C. Radio Frequency
 <input type="checkbox"/> D. Secondary Standards</p> <p><input type="checkbox"/> 31. Frequency Measuring Services.</p> <p><input type="checkbox"/> 32. Fuses & Fuse Holders.
 <input type="checkbox"/> Generators:
 <input type="checkbox"/> A. Power: see Motor Generators
 <input type="checkbox"/> B. Signal: see Frequency Measuring Equipment, also Test Equipment</p> | <p><input type="checkbox"/> 33. Graphic Recorders.</p> <p><input type="checkbox"/> 34. Hardware:
 <input type="checkbox"/> A. Binding Posts
 <input type="checkbox"/> B. Bushings
 <input type="checkbox"/> C. Dials & Tuning Controls
 <input type="checkbox"/> D. Flexible Shafts
 <input type="checkbox"/> E. Lugs
 <input type="checkbox"/> F. Screws
 <input type="checkbox"/> G. Springs</p> <p><input type="checkbox"/> 35. Induction Heating Equipment.</p> <p><input type="checkbox"/> 36. Inductors.</p> <p><input type="checkbox"/> 37. Insulation:
 <input type="checkbox"/> A. Cloth
 <input type="checkbox"/> B. Glass Seals
 <input type="checkbox"/> C. Mica
 <input type="checkbox"/> D. Varnished Cambric: see also Ceramics</p> <p><input type="checkbox"/> 38. Jacks, Telephone.</p> <p><input type="checkbox"/> 39. Keys:
 <input type="checkbox"/> A. Switching
 <input type="checkbox"/> B. Telegraph</p> <p><input type="checkbox"/> Knobs: see Moulded Products.</p> <p><input type="checkbox"/> 40. Lacquers:
 <input type="checkbox"/> A. Finishing
 <input type="checkbox"/> B. Fungus Proofing
 <input type="checkbox"/> C. Protecting
 <input type="checkbox"/> D. Waterproofing</p> <p><input type="checkbox"/> 41. Loudspeakers.
 <input type="checkbox"/> Lugs: see Hardware.</p> <p><input type="checkbox"/> 42. Magnets:
 <input type="checkbox"/> A. Electro
 <input type="checkbox"/> B. Permanent</p> <p><input type="checkbox"/> Measuring Equipment: see Test Equipment.</p> <p><input type="checkbox"/> 43. Metals:
 <input type="checkbox"/> A. Copper
 <input type="checkbox"/> B. Ferrous
 <input type="checkbox"/> C. Non-ferrous
 <input type="checkbox"/> D. Precious & Rare</p> <p><input type="checkbox"/> 44. Meters:
 <input type="checkbox"/> A. Ammeters
 <input type="checkbox"/> B. Frequency Indicating
 <input type="checkbox"/> C. Power Level
 <input type="checkbox"/> D. Vacuum Tube Voltmeters
 <input type="checkbox"/> E. Voltmeters
 <input type="checkbox"/> F. Wattmeters</p> <p><input type="checkbox"/> Mica: see Insulations.</p> <p><input type="checkbox"/> 45. Microphones.</p> <p><input type="checkbox"/> 46. Monitoring Equipment:
 <input type="checkbox"/> A. Frequency
 <input type="checkbox"/> B. Modulation</p> <p><input type="checkbox"/> 47. Motor-Generators:
 <input type="checkbox"/> A. Dynamotors
 <input type="checkbox"/> B. Motor-Generators
 <input type="checkbox"/> C. Rotary Converters</p> <p><input type="checkbox"/> 48. Motors, very small.</p> <p><input type="checkbox"/> 49. Moulded Products:
 <input type="checkbox"/> A. Bakelite
 <input type="checkbox"/> B. Cabinets
 <input type="checkbox"/> C. Knobs, etc.
 <input type="checkbox"/> D. Plastics
 <input type="checkbox"/> Mycalex: see Ceramics.</p> |
|---|---|--|

I. R. E. YEARBOOK PRODUCT LISTINGS

Your firm will receive a free listing in an alphabetical Directory of Manufacturers serving the Radio and Electronic Industry in the 1946 I.R.E. Yearbook if you will make sure that we have the company name and address, name of your chief engineer, and data on your products. A questionnaire similar to these pages has been mailed to 3000 firms we have on record, but many firms have not yet answered. This listing will be a service to I.R.E. members and may bring business to your company, so will you help by checking off the information on the columns below and sending us the coupon with the proper product numbers at once? In that way you may be sure your firm is listed and correct data is shown. Thank you.

- 50. Oscillators:
 - A. Audio Frequency
 - B. Radio Frequency
 - C. Square Wave Generators
- 51. Oscillographs & Accessories.
- 52. Panels.
- 53. Phonograph Pick-ups.
- 54. Pilot Lights.
- 55. Plastics:
 - A. Raw Materials for moulding
 - B. Rods
 - C. Sheets
- 56. Plugs—Telephone.
- 57. Power Supplies.
- 58. Pumps, Vacuum.
- 59. Racks.
- 60. Radar: also see Aircraft & Airport Equipment.
- 61. Radio Receivers:
 - A. Broadcast
 - B. Communications
 - C. Fixed Frequency
 - D. Frequency Modulation
 - E. Special Purpose
 - F. Television
- 62. Record Changing Mechanisms.
- 63. Recording Equipment:
 - A. Blanks
 - B. Cutting Heads
 - C. Magnetic Wire Recorders
 - D. Needles
 - E. Turntables & Machines
- 64. Recording Services.
- 65. Rectifiers:
 - A. Metallic
 - B. Meter Rectifiers
 - C. Vacuum Tube, see Power Supplies
- Regulators, Voltage, see Voltage Regulators.
- 66. Relays:
 - A. Keying
 - B. Power
 - C. Stepping
 - D. Telephone Types
 - E. Time Delay
 - F. Vacuum Enclosed
- 67. Remote Controlling Equipment.
- 68. Resistors:
 - A. Fixed
 - B. Precision
 - C. Vacuum Sealed
 - D. Wire Wound
- Screws: see Hardware.
- Shafts: see Hardware.
- 69. Sockets:
 - A. Receiving Types
 - B. Transmitting Types

- 70. Solder:
 - A. Cored
 - B. Plain
- 71. Soundproofing Contractors and Equipment
- Speakers: see Loudspeakers.
- Springs: see Hardware.
- 72. Switches:
 - A. Circuit Breaking
 - B. Key
 - C. Power
 - D. Receiver Wave Band Changing
 - E. Rotary
 - F. Time Delay
 - G. Transmitter Wave Band Changing
- 73. Test Equipment.
 - A. Bridges
 - B. Capacitor Testers
 - C. Inductance Testers
 - D. "Q" Testers
 - E. Resistance Testers
 - F. Vacuum Tube Testing Equipment
 - G. Wave Form Analyzers & Distortion Testers
- 74. Transcription Libraries.
- 75. Transformers:
 - A. Audio Frequency
 - B. Hermetic Sealed Types
 - C. High Fidelity Audio Types
 - D. Power Components
 - E. Pulse Generating Types
 - F. Radio Frequency
- 76. Transmitters:
 - A. Amplitude Modulation
 - B. Communications
 - C. Frequency Modulation

- D. Police & Emergency Equipment
- E. Television
- F. Ultra High Frequency
- 77. Vacuum Tubes:
 - A. Cathode Ray
 - B. Geiger-Mueller
 - C. Industrial Types
 - D. Klystrons & Magnetrons
 - E. Receiving Types
 - F. Rectifying
 - G. Special Purpose & Phototubes
 - H. Television Types
 - I. Transmitting Types
 - J. Voltage Regulating
- Varnishes: see Lacquers.
- 78. Vibrators, Power Supply.
- 79. Voltage Regulators:
 - A. Automatic
 - B. Manually Controlled
- 80. Waxes & Sealing Compounds.
- 81. Wire:
 - A. Copper
 - B. Precious Metal

Product Classification If Not Included In List

.....

.....

.....

.....

.....

.....

.....

.....

.....

.....

.....

.....

.....

.....

PLEASE BE SURE TO SIGN QUESTIONNAIRE HERE

Firm Name

Chief Engineer

Address

Place Zone State

Product Classification Numbers and sub-letters:

.....

.....

.....

Mail today to: Industrial Research Division, Proceedings of the I.R.E., Room 707
303 West 42nd St., New York 18, N.Y.

ADVERTISERS' INDEX

Section Meetings	44A	Hugh E. Eby, Inc.	78A	National Carbon Company, Inc.	13A
Membership	44A	Eicor, Inc.	58A	National Co., Inc.	16A
Positions Open	54A	Stanley D. Eilenberger	64A	National Union Radio Corp.	21A
Acme Electric & Mfg. Co.	62A	Eitel-McCullough, Inc.	96A	National Vulcanized Fibre Co.	84A
Aerovox Corp.	36A	Electronic Engineering Co.	76A	New York Transformer Co.	37A
Aireon Mfg. Corp.	19A	Electrical Reactance Corp.	72A	North American Philips Co.	31A
Allen-Bradley Co.	61A	Erie Resistor Corp.	65A		
Alliance Mfg. Co.	46A			Ohmite Mfg. Co.	63A
Altec Lansing Corporation	58A	Federal Telephone & Radio Corp.	3A, 45A, 54A	M. F. M. Osborne	64A
American Lava Corp.	25A	Freed Radio Corp.	56A		
American Telephone & Telegraph Co.	14A, 15A			Press Wireless, Inc.	54A
American Transformer Co.	35A	General Aniline & Film Corp.	4A, 5A		
Amperex Electronic Corp.	43A	General Electric Co.	22A	Radio Corporation of America	32B, 32C
Andrew Co.	44A	General Instrument Corp.	32A	Rauland Corp.	73A
Arnold Engineering Co.	52A	General Radio Company	Cover IV	Raytheon Mfg. Co.	39A
Audio Development Co.	66A	Goat Metal Stampings, Inc.	70A	Remler Co., Ltd.	90A
Automatic Manufacturing Corporation	51A			Bernard Rice's Sons, Inc.	75A
		Hallicrafters Co.	47A, 71A	Richardson Company	72A
Alfred W. Barber Laboratories	68A	Alexander Hamilton Institute	82A		
Barker & Williamson	84A	Hammarlund Mfg. Co., Inc.	11A	Scovill Manufacturing Company	81A
Blaw-Knox Co.	26A, 74A	Harco Tower Inc.	68A	Shallcross Mfg. Co.	50A
Bliley Electric Co.	85A	Harvey Radio Laboratories, Inc.	76A	Shure Brothers	69A
Boonton Radio Corp.	88A	Heintz & Kaufman, Ltd.	12A	Skydyne, Inc.	60A
Brown Engineering Company	90A	Hewlett-Packard Co.	20A	Small Motors, Inc.	66A
W. J. Brown	64A	Hytron Radio & Electronics Corporation	49A	Solar Mfg. Co.	33A
				Sperry Gyroscope Co.	24A
Callite Tungsten Corp.	41A	Industrial Condenser Corp.	64A	Sperti, Inc.	83A
Capitol Radio Engineering Institute	76A	International Products Corporation	38A	Sprague Electric Co.	7A
Allen D. Cardwell Mfg. Corp.	56A	International Telephone & Telegraph Corp.	3A, 45A	Stackpole Carbon Co.	28A
Centralab	10A			Standard Transformer Corp.	60A
Chicago Transformer Corp.	48A	Jackson Electrical Instrument Co.	62A	Stupakoff Ceramic & Mfg. Co.	30A
Cinaudagraph Speakers, Inc.	88A	E. F. Johnson Co.	23A	Sylvania Electric Products Inc.	6A
Clarostat Mfg. Co., Inc.	68A	Joliet Chemicals, Ltd.	87A		
Sigmund Cohn & Co.	80A			Taylor Fibre Co.	88A
Collins Radio Co.	77A	Kaar Engineering Company	59A	Tech Laboratories	82A
Communication Measurements Laboratory	84A	Ken-Rad	34A	Thordarson Electrical Mfg. Co.	55A
Continental-Diamond Fibre Co.	42A			Triplett Electrical Instrument Co.	40A
Cornell-Dubilier Electric Corp.	Cover III	Lewis Electronics	89A	Tung-Sol Lamp Works, Inc.	57A
Corning Glass Works	1A	John E. Lingo & Sons, Inc.	90A		
Cornish Wire Co., Inc.	78A	Litton Engineering Labs.	53A	United Transformer Co.	Cover II
				Utah Radio Products Co.	17A
DeJur-Amsco Corp.	67A	Machlett Laboratories, Inc.	8A, 9A		
Tobe Deutschmann Corp.	95A	Maguire Industries, Inc.	55A	Victoreen Instrument Co.	74A
Allen B. DuMont Labs., Inc.	18A	Frank Massa	64A		
E. I. du Pont de Nemours & Co. (Inc.)	80A	Measurements Corp.	70A	Western Electric Co.	14A, 15A
DX Radio Products Co.	82A	Mycalex Corporation of America	29A	Westinghouse Electric Corp.	27A
				Weston Electrical Instrument Corp.	79A

HERE'S THE FORMULA FOR CAPACITOR SATISFACTION

$P_c + CQC = DP$

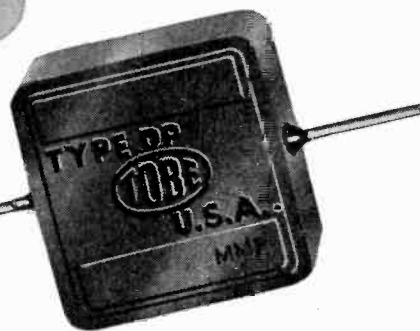

Productive capacity (P_c) plus continuous quality control (CQC) equals the dependable Tobe Type DP Oil-impregnated Molded Paper Capacitor, relied upon for performance in electronic and industrial apparatus.

This hermetically-sealed unit supersedes paper tubular capacitors where long life is essential. And where high capacitance must be provided in small space, it replaces mica capacitors.

From every standpoint — convenience, cost, and performance — Tobe DP capacitors merit your consideration in all your post-war designs.

Available in
CN35 and CN20
case sizes

Check these Features!

Capacitances: 1,000 to 50,000 mmfd.
Working voltages: 120 to 800 d-c
Power Factor = 0.004 to 0.006 at
1,000 cycles
Operating Frequencies: up to 40
megacycles
Shunt Resistance: 50,000 megohms
at 250° C.
Moisture Seal: meets all thermal cycle,
immersion, and humidity requirements
Working Temperatures: -55 to
+105° C.

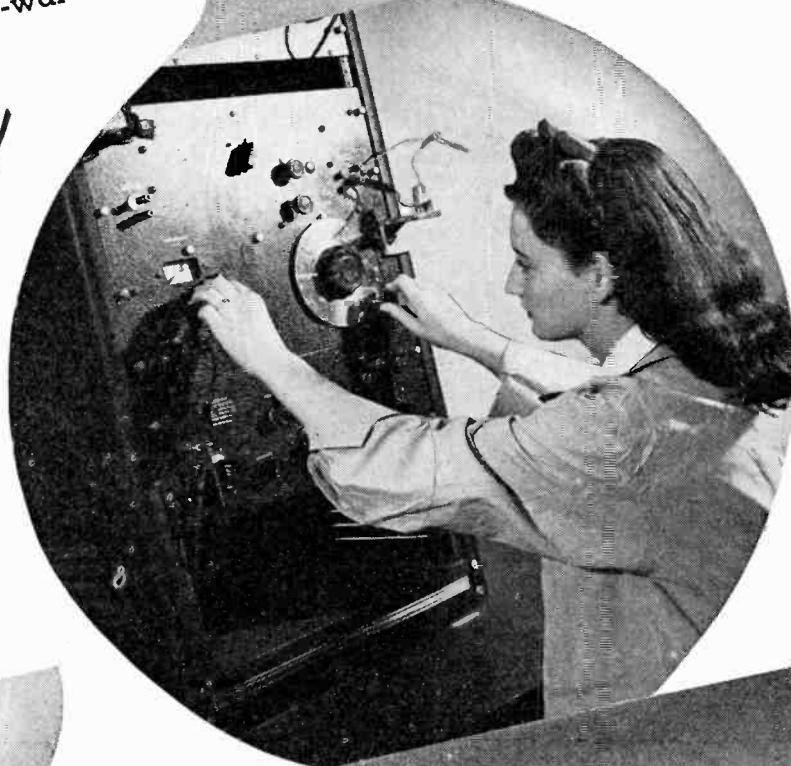

FIELD OFFICES IN NEW YORK CITY · CHICAGO · DETROIT · GLENDALE, CALIFORNIA

3 OUTSTANDING FEATURES OF THE NEW EIMAC 4-125A TETRODE

1 LOW DRIVING POWER

With but 2.5 watts driving power, the 4-125A will deliver 375 watts output at frequencies as high as 120 Mc. The low driving power requirement has been achieved without the use of excessive secondary emission. The control grid is specially processed to reduce both primary and secondary emission.

2 HIGH FREQUENCY PERFORMANCE

The Eimac 4-125A will deliver 200 watts output at 250 Mc. The performance curves below show the relationship between driving power and power output at frequencies up to 250 Mc.

FOLLOW THE LEADERS TO



EITEL-McCULLOUGH, Inc., 1085 San Mateo Avenue, San Bruno, Calif.
 Plants located at: San Bruno, California and Salt Lake City, Utah
 Export Agents: Frazer & Hansen, 301 Clay St., San Francisco 11, Calif., U. S. A.

3 LOW GRID-PLATE CAPACITANCE

The grid-plate capacitance of the 4-125A is only 0.03 *uufd.* This low value allows operation up to 100 Mc. without neutralization. Stability is further assured by the special grid processing which reduces secondary emission.

A technical bulletin on Eimac 4-125A Power Tetrode contains full specifications and detailed discussion of the tube's characteristics, circuit diagrams and constant current curves. Write for your copy today.

The Eimac 4-125A is the first of many new Eimac tubes that are on the way. Watch for future announcements.

ELECTRICAL CHARACTERISTICS	
Filament: Thoriated Tungsten	
Voltage	5.4 volts
Current	6.2 amperes
Plate Dissipation (Maximum)	125 watts
Direct Interelectrode Capacitances (Average)	
Grid Plate (Without Shielding, base grounded)	0.03 <i>uufd.</i>
Input	10.3 <i>uufd.</i>
Output	3.0 <i>uufd.</i>
Transconductance $\mu\mu$ = 50 ma., $E_b = 2500$ v., $E_{c2} = \pm 400$ v., 245C μ mhos	
1085	

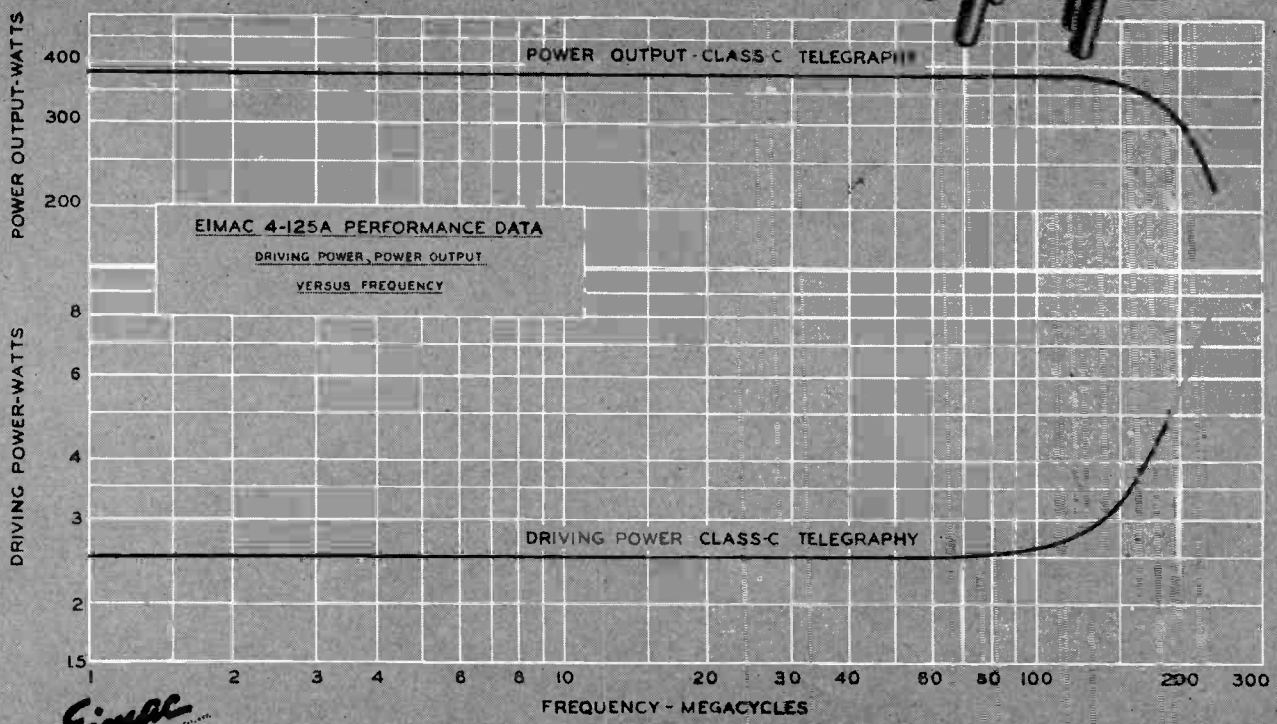
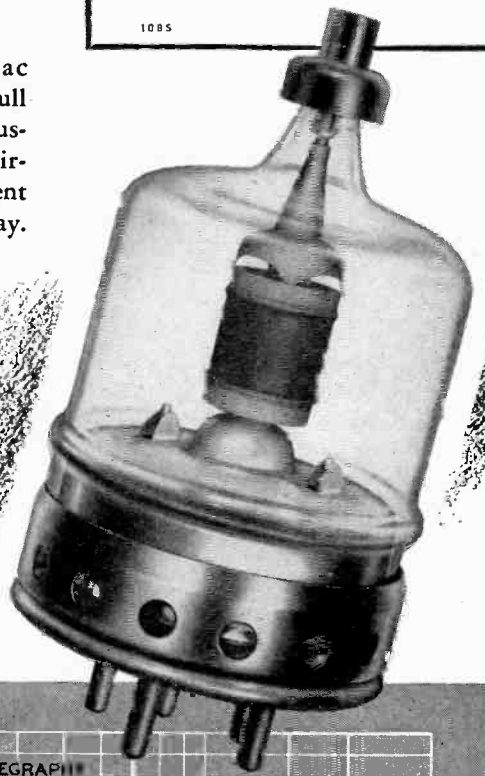

Eimac TUBES THE COUNTERSIGN OF DEPENDABILITY IN ANY ELECTRONIC EQUIPMENT

Only CORNELL-DUBILIER could make this CAPACITOR



When a real capacitor problem arises, engineers turn to Cornell-Dubilier *first*.

For example: A recent large installation was planned involving thousands of KVA. Capacitors were required to operate continuously under unusual conditions with a maximum rise of 20° C.

C-D engineers went to work. They made a more compact capacitor capable of meeting all specifications and at the same time cut costs in half.

The new units have been giving satisfactory service ever since their installation and more have been ordered by the same customer.

It is this special ability to tackle tough assignments and to come through with cost-cutting, "long-

life" solutions that you obtain when you call on Cornell-Dubilier.

We are constantly developing new, exclusive designs like this giant mica tank capacitor — watch for others! For cooperation on your capacitor applications or special designs, write Cornell-Dubilier Electric Corporation, South Plainfield, N. J. Other plants at New Bedford, Brookline, Worcester, Mass. and Providence, R. I.

CORNELL - DUBILIER CAPACITORS



MICA • DYKANOL • PAPER • ELECTROLYTICS



New and improved design of oil filled industrial oscillator mica capacitor. Types 97A and 97B can handle a high KVA in one compact unit

MORE VARIACS* NOW!

A portion of our greatly expanded VARIAC production has been released from war orders. VARIAC deliveries are improving daily. We hope that within a comparatively short time *all* models of the VARIAC can be shipped promptly upon receipt of your order.

In the meantime you'll find several weeks required for delivery of some models well worth the waiting . . . VARIACS are still the *original* continuously-adjustable autotransformer first introduced by General Radio . . . redesigned to meet all of the mechanical and electrical requirements for all types of service . . . assuring rugged construction, long life and the same manufacturing care that is given to the finest G-R laboratory instrument.

You may have to wait a little longer for VARIACS, but you'll be satisfied many times longer.



YOU CAN GET THESE FROM STOCK At the moment we have a small stock of the popular Types 100-Q and 100-R VARIACS and can ship immediately. These models are rated at 2,000 va. The Type 100-Q supplies continuously adjustable voltages from zero to either 115 or 135 volts from a 115-volt 60-cycle line with a maximum output of 18 amperes; the Type 100-R supplies a maximum of 230 or 270 volts from either a 230- or 115-volt line with a maximum current rating of 9 amperes from a 230-volt input, or 4.5 amperes when used on 115 volts. Price of either model: \$40.00.

VARIAC



MADE ONLY BY

*The trade name VARIAC is registered at the U. S. Patent Office. VARIACS are manufactured and sold only by General Radio Company under our U. S. Patent 2,009,013.

GENERAL RADIO COMPANY

Cambridge 39, Mass.

NEW YORK
CHICAGO
LOS ANGELES