

Proceedings



of the

I·R·E

A JOURNAL of the Theory, Practice, and Applications of Electronics and Electrical Communication

- Radio Communication • Sound Broadcasting • Television • Marine and Aerial Guidance •
- Tubes • Radio-Frequency Measurements • Engineering Education • Electron Optics •
- Sound and Picture Electrical Recording and Reproduction •
- Power and Manufacturing Applications of Radio-and-Electronic Technique •
- Industrial Electronic Control and Processes • Medical Electrical Research and Applications •

JULY, 1945

Volume 33 Number 7

South African
VICTORY LOAN



Professional Society Presentations

Wide-Range Tuned Circuits

Silicones

Acoustic Horns

Voltage Tripling and Quadrupling

Linear-Network Theory

Electron-Concentration Figure of
Merit

Regulated Power Supplies

Invest in the



VICTORY LOAN

The Institute of Radio Engineers

Why **AMPEREX**

**WATER AND AIR COOLED
TRANSMITTING AND RECTIFYING TUBES**



Colloquially speaking, we of *Amperex* have "broken our necks" to provide dependable service to our customers during these war years. This statement, we feel sure, will be supported by those who have made us their source of tube supply. Important to note is that the "Amperextra" of dependable service has been matched by the "Amperextra" of dependable quality. In commercial broadcasting — AM, FM, Television — in electro-medical apparatus, in communications systems, in industrial applications, *Amperex* tubes have delivered and still are delivering high efficiency over a longer period of time. The *Amperex* Application Engineering Department, another "Amperextra", will be glad to work with you on present or postwar problems. *This is Service.*

Many of our standard tube types are now available through leading radio equipment distributors.



AMPEREX ELECTRONIC CORPORATION

25 Washington St., Brooklyn 1, N.Y., Export Division: 13 E. 40th St., New York 16, N.Y., Cables: "Arlab"
Canadian Distributor: Rogers Electronic Tubes, Limited • 622 Fleet Street West, Toronto

W A S T E P A P E R I S V I T A L W A R E Q U I P M E N T . . . S A V E E V E R Y S C R A P

Micronics



Designing UHF and SHF equipment is in large part a matter of electromechanical precision. Our engineers aptly call it *micronics*.^{*} Micronics is an art at which we are adept. A part of our know-how stems from long experience in the design and manufacture of precision-machined hydraulic controls and actuators for military and commercial aircraft. It comes equally from the confidential basic design work our engineers have done in the field of micro-waves. And part comes from a pre-war background of experience in producing radio communication systems for a number of the country's major airlines. **Aireon's** micronic exactitude in all things electronic is a practice your engineers will appreciate—an aptitude our plants can translate into your precise wants. Your engineers and ours should talk it over.

Aireon

MANUFACTURING CORPORATION

Formerly AIRCRAFT ACCESSORIES CORPORATION

Radio and Electronics • Engineered Power Controls

NEW YORK • CHICAGO • KANSAS CITY • BURBANK

Proceedings of the I.R.E. July, 1945

1A

PROCEEDINGS of the I.R.E., July, 1945, vol. 33, no. 7. Published monthly by The Institute of Radio-Engineers, Inc., 330 West 42nd St., New York 18, N.Y. Price, \$1.00 per copy. Subscriptions: United States and Canada, \$10.00 a year; foreign countries, \$11.00 a year. Entered as second-class matter October 26, 1927, at the post office at Menasha, Wisconsin, under the Act of February 28, 1925, embodied in Paragraph 4, Section 538 of the Postal Laws and Regulations. Publication office, 450 Ahnaip Street, Menasha, Wisconsin.

Table of Contents will be found on page 32D.

Kovar, the alloy that seals to glass, available as wire, rod, tubing, strip or foil

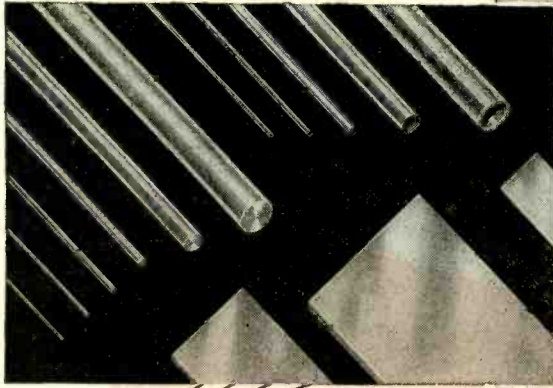

Solve Your Sealing Problems ...

with KOVAR*—Glass Hermetic Seals

ILLUSTRATED are some of the various forms in which Kovar—the alloy that seals to glass—are available from STUPAKOFF. Kovar—a cobalt, nickel, iron alloy, was developed specifically for sealing to hard glass and has been used commercially for that purpose since 1936.

Kovar forms a seal to hard glass through a heating process, in which the oxide of Kovar is dissolved into the glass. The result is a pressure and vacuum tight-seal, effective under all atmospheric conditions.

To manufacturers equipped for glass working, STUPAKOFF supplies Kovar as wire, rod, tubing, strip or fabricated into cups, eyelets, leads or special shapes.

Completed seals are available as terminals with single or multiple, solid or hollow electrodes which can be quickly and easily soldered to a metal container. STUPAKOFF also manufactures meter windows, gauge glasses, graded seals and seals for special applications.

STUPAKOFF engineers will be glad to assist in developing Kovar-glass hermetic seals for your product. The booklet "Kovar—The Ideal Alloy for Sealing to Glass," will be sent on request.

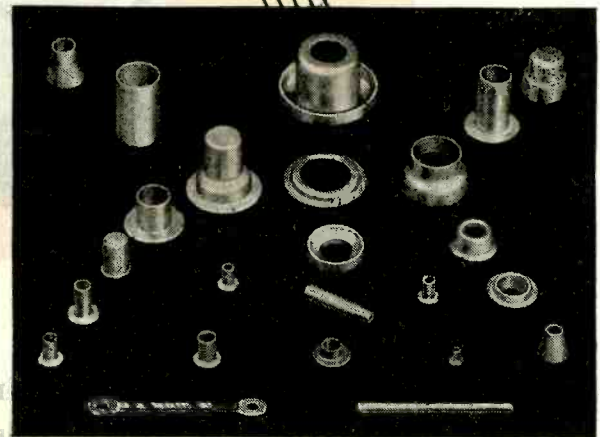

Kovar fabricated into cups, eyelets and special shapes

★ ★ Buy More Bonds ★ ★

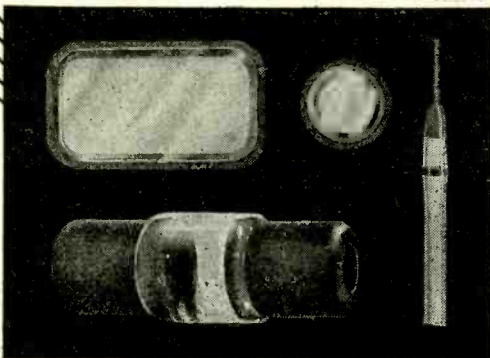

Kovar-Glass meter windows, gauge glasses, and special seals

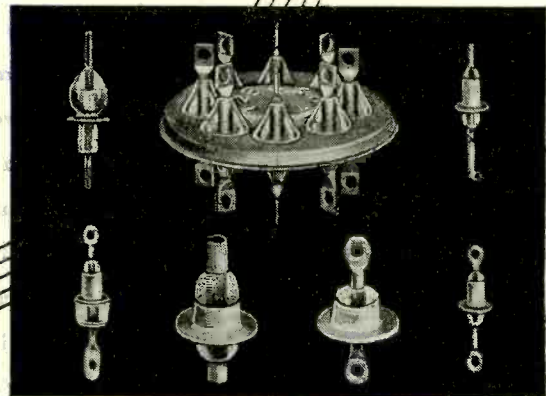

Complete Kovar-Glass terminals with single or multiple, solid or hollow electrodes

* TRADE MARK 337962 REGISTERED IN U. S. PATENT



STUPAKOFF CERAMIC AND MANUFACTURING CO., LATROBE, PA.

Products for the World of Electronics





THIS UNDERGROUND ENEMY!

"Electrolytic Corrosion" is his name.

He works slowly . . . quietly . . . continuously . . . and unobserved.

His prey is sub-surface cables, pipe lines and other metallic structures.

Unchecked, he can markedly shorten the life of buried equipment.

Yet, there is a way to protect your underground installations . . . use *Federal Cathodic Protection Rectifiers*.

These equipments, incorporating Federal Selenium Rectifiers to convert alternating current to direct current, send a steady current through the earth surrounding underground

metal structures, counteracting the natural forces of corrosive galvanic action.

Federal Cathodic Protection Rectifiers are now at work in all parts of the country . . . mounting silent, motionless guard over buried investments.

Stop deterioration of your equipment now. Put Federal Cathodic Protection Rectifiers to work for you . . . cost of operation is low . . . attention required is negligible.

Write us today for the FTR Technical Information Series booklet "Cathodic Protection and Applications of Selenium Rectifiers" . . . get the full story on this effective means of protection.



Federal Telephone and Radio Corporation



Newark 1, N. J.

DUPLICATING A GERMAN VACUUM TUBE IN 3 DAYS

Just behind the battlefield, a telephone system lay dead. The retreating enemy, hoping to return, had not blown it up, but had taken with them its vacuum tubes. To put it back to work, the General ordered 1000 new tubes — spot delivery.

A sample tube was flown back to the United States and brought to Bell Telephone Laboratories. It was of German design, different from any American tube in both dimensions and characteristics. Could it be duplicated soon? The job looked feasible. Within three days, try-out models were on their way to Europe. Three weeks later, Western Electric Company had made and delivered every tube. They were plugged in; vital communications sprang to life.

Vacuum tubes are an old story for Bell Laboratories scientists. Back in 1912 they made the first effective high vacuum tube. Three years later, they demonstrated the practical possibilities of tubes by making the first radio talk across the Atlantic, pointing the way to radio broadcasting. Since then, they have developed and utilized the vacuum tube wherever it promises better telephone communication — there are more than a million in your Bell Telephone System.

Today, Bell Telephone Laboratories is solving many of the toughest tube problems faced by the Armed Forces. When the war is over, it goes back to its regular job—keeping American telephone service the best in the world.



BELL TELEPHONE LABORATORIES

Exploring and inventing, devising and perfecting for our Armed Forces at war, and for continued improvements and economies in telephone service.

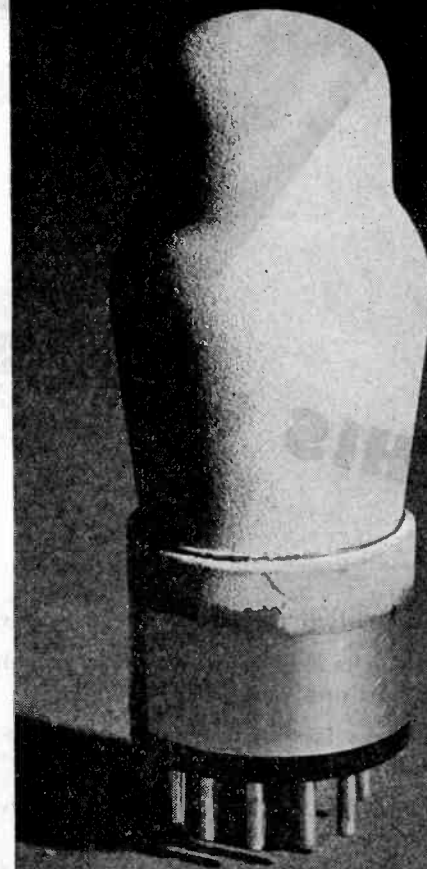

• This electrical replica of a heater-type pentode was made for use in German telephone repeaters.

STANDARD FOR COMPARISON



ALCO has been awarded for the fifth time the Army-Navy "E" Award for continued excellence in quantity and quality of essential war production.



IT is a fact that other materials offered as insulators for electronic and electrical use may be judged by the degree to which they approach

the combined properties of ALSiMAG Steatites. Study the Property Chart shown below. Whatever you are planning in the electronic or electrical field, the chances are ALSiMAG will do it better. Our specialized knowledge, and our engineering and research facilities are at your service. Let's work together.

AMERICAN LAVA CORPORATION
Chattanooga 5, Tennessee

43RD YEAR OF CERAMIC LEADERSHIP

MECHANICAL AND ELECTRICAL PROPERTIES OF ALSiMAG CERAMICS

ITEM	A.S.T.M. TEST NUMBER	UNIT	STEATITE							
			ALSiMAG A-35	ALSiMAG A-196	ALSiMAG 197	ALSiMAG 211	ALSiMAG 243			
Specific Gravity	—	—	2.5	2.6	2.6	2.7	2.8			
Density	—	lbs. per cu. in.	.090	.094	.094	.098	.101			
Volume	—	cu. in. per lb.	11.11	10.64	10.65	10.26	9.91			
Water Absorption	D116-42(A)	%	0—.05	0—.05	0—1	.08	0—.05			
Color	—	—	White	White	White	White	Buff			
Softening Temperature	C24-35	°C. °F.	1 450 2 642	1 440 2 624	1 445 2 633	1 400 2 552	1 440 2 624			
Resistance to Heat (Safe Limit for Constant Temperature)	—	°C. °F.	1 000 1 832	1 000 1 832	1 000 1 832	1 000 1 832	1 000 1 832			
Hardness	—	Mohs' Scale	7.5	7.5	7.5	7.5	7.5			
Linear Coefficient of Thermal Expansion 25-100°C. 25-600°C.	—	Per °C.	6.9x10 ⁻⁶ 8.7x10 ⁻⁶	7.3x10 ⁻⁶ 8.9x10 ⁻⁶	7.7x10 ⁻⁶ 10.4x10 ⁻⁶	7.3x10 ⁻⁶ 9.2x10 ⁻⁶	9.1x10 ⁻⁶ 10.4x10 ⁻⁶			
Tensile Strength	D116-42	lbs. per sq. in.	8 500	10 000	8 500	7 500	—			
Compressive Strength	D667-42T	lbs. per sq. in.	75 000	85 000	75 000	65 000	85 000			
Flexural Strength	D667-42T	lbs. per sq. in.	18 000	20 000	20 000	18 000	20 000			
Resistance to Impact (1/2" rod) Charpy D667-42T	—	inch-lbs.	4.5	5	1.8	2.0	—			
Thermal Conductivity (Approximate Values)	—	cal./sec./cm. per °C.	.006	.006	.006	.006	.008			
Dielectric Strength (step 60 cycles) Test discs 1/4" thick	D667-42T	volts per mil	225	240	210	240	240			
Volume Resistivity at Various Temperatures 25°C. 77°F. 100°C. 212°F. 300°C. 572°F. 500°C. 932°F. 700°C. 1 292°F. 900°C. 1 652°F.	—	Ohms per Centimeter Cube	> 10 ¹⁴	> 10 ¹⁴	> 10 ¹⁴	> 10 ¹⁴	> 10 ¹⁴			
			2.1x10 ¹²	1x10 ¹³	8.1x10 ¹³	> 10 ¹⁴	5.0x10 ¹³			
			6.0x10 ⁷	1.8x10 ⁹	2.5x10 ¹⁰	9.0x10 ¹²	7.0x10 ¹¹			
			3.2x10 ⁵	9.0x10 ⁶	8.8x10 ⁷	3.5x10 ¹⁰	1.2x10 ¹⁰			
			2.3x10 ⁴	5.0x10 ⁵	4.2x10 ⁶	4.8x10 ⁸	1.0x10 ⁸			
7.0x10 ³	7.0x10 ⁴	6.8x10 ⁵	2.5x10 ⁷	3.0x10 ⁶						
Te Value	—	°C. °F.	440 824	640 1 184	840 1 544	> 1 000 > 1 832	> 1 000 > 1 832			
			6.1 5.9 5.8	5.9 5.8 5.7	6.3 6.0 5.8	— 5.8 5.7	6.3 6.2 6.2			
Dielectric Constant { 60 Cycles 1 000 K. C. 10 M. C.	D667-42T	—	.015 .0035 .0030	.0022 .0021 .0015	.0020 .0012 .0010	— .0004 .0003	.0014 .0004 .00035			
			Loss Factor { 60 Cycles 1 000 K. C. 10 M. C.	D667-42T	—	.09 .021 .017	.013 .012 .008	.0126 .0072 .0058	— .0023 .0017	.0088 .0025 .0022
						Capacity Change Per °C.	—	parts per million	+ 160	+ 160

HOW hallicrafters EQUIPMENT COVERS THE SPECTRUM

MODEL SX-28A — from 550 kc to 42 Mc

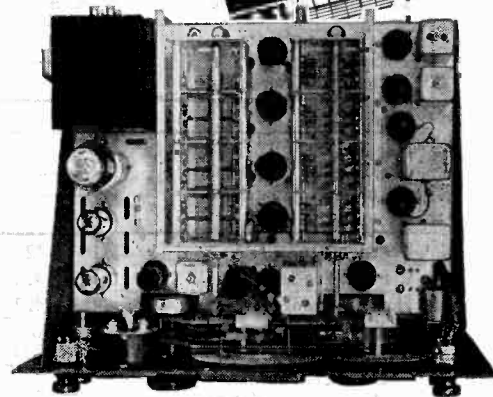

HALLICRAFTERS Super Skyrider, Model SX-28A, covers the busiest part of the radio spectrum — standard broadcast band, international short wave broadcast bands, long distance radio telegraph frequencies, and all the other vital services operating between 550 kilocycles and 42 megacycles. Designed primarily as a top flight communications receiver the SX-28A incorporates every feature which long experience has shown to be desirable in equipment of this type.

The traditional sensitivity and selectivity of the pre-war SX-28, ranking favorite with both amateur and professional operators, have been further improved in this new Super Skyrider by the use of "micro-set" permeability-tuned inductances in the RF section. The inductances, trimmer capacitors and associated components for each RF stage are mounted on small individual sub-chassis, easily removable for servicing.

Full temperature compensation and positive gear drive on both main and band-spread tuning dials make possible the accurate and permanent logging of stations. Circuit features include two RF stages, two IF stages, BFO, three stage Lamb-type noise limiter, etc. Six degrees of selectivity from BROAD IF (approximately 12 KC wide) for maximum fidelity to SHARP CRYSTAL for CW telegraphy are instantly available. Speaker terminals to match 500 or 5000 ohms are provided and the undistorted power output is 8 watts.

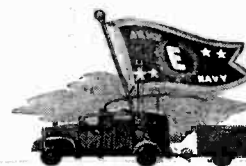

BUY A WAR BOND TODAY

hallicrafters RADIO

COPYRIGHT 1945 THE HALLICRAFTERS CO.

THE HALLICRAFTERS CO., CHICAGO 16, U.S.A., WORLD'S LARGEST EXCLUSIVE MANUFACTURERS OF SHORT WAVE RADIO COMMUNICATIONS EQUIPMENT

TRANSFORMER COMPONENTS

for every application

RADIO

Set components



Radio Filters

TELEPHONY

Loading Coils



Repeat Coils



Pulse Transformers



Mine Detection Components



Selective Amplifier Filters



Inter-phone Amplifier Components



DETECTION

AMPLIFICATION

Foremost Manufacturers of Transformers to the Electronic Industry



ALL PLANTS

May we cooperate with you on design savings for your applications... war or postwar?

United Transformer Corp.
150 VARICK STREET
EXPORT DIVISION: 13 EAST 40th STREET,
NEW YORK 13, N. Y.
NEW YORK 16, N. Y., CABLES: "ARLAB"

YOU CAN PROFIT FROM OUR KNOW-HOW ON
MICROPHONES

NO REJECTS WITH COMPONENTS BY AVIOMETER

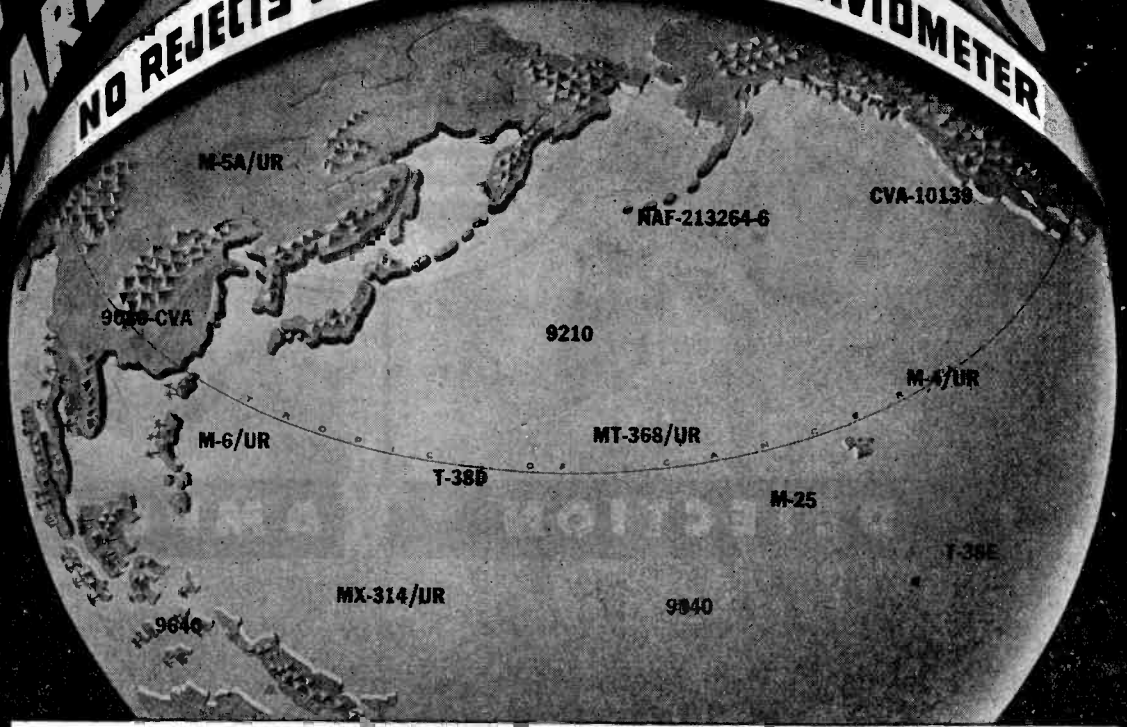

AVIOMETER

COMMUNICATION AND CONTROL INSTRUMENTS
370 WEST 35TH STREET NEW YORK 1, N. Y.

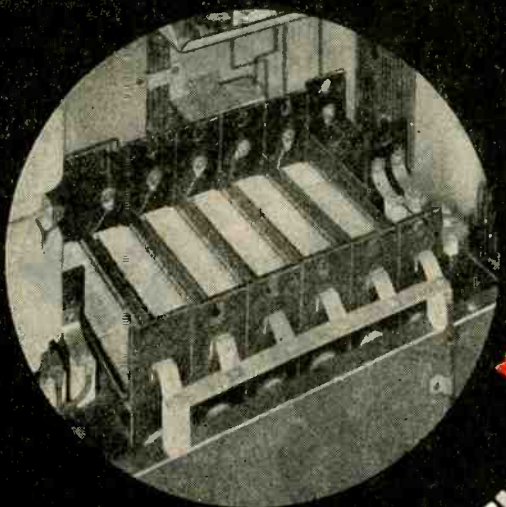

HERE'S ONE OF THE FEATURES OF PACKAGED DEPENDABILITY
 IN WESTINGHOUSE TRANSMITTERS



Dependability in transmitter performance is a package of many features . . . and one which contributes heavily to program continuity in Westinghouse 50-kw transmitters is the use of metal-plate rectifiers.

With virtually unlimited life, these surge-proof rectifiers have cut tube replacement to a new low, for only the power amplifier and modulator utilize tube rectifiers. Dependable performance is reinforced by quick tube transfer for emergency tube replacement.

Westinghouse 50,000-watt transmitters offer other advantages for clear channel service:

The smartly-styled Westinghouse 50-kw transmitters are built with 12 new, important design features. Ask your nearest Westinghouse office for the complete story.

Example: the equalized audio feedback system strengthens the naturally high fidelity of the audio and modulation circuits. No complicated circuit adjustments are needed.

Example: "De-ion" circuit breakers supply full overload and undervoltage protection, automatically reduce outage time.

Example: a tube life-meter provides a constant check on all tube life.

These basic advantages in faithful reproduction and solid dependability are features of the complete line of Westinghouse transmitters . . . 5, 10 and 50-kw AM, and 1, 3, 10 and 50-kw FM. You can get all the facts from your nearest Westinghouse office. Westinghouse Electric Corporation, P. O. Box 868, Pittsburgh 30, Pa.

J-08111

Westinghouse
 PLANTS IN 25 CITIES . . . OFFICES EVERYWHERE

Electronics at Work

XXV RADIO'S 25TH ANNIVERSARY KDKA

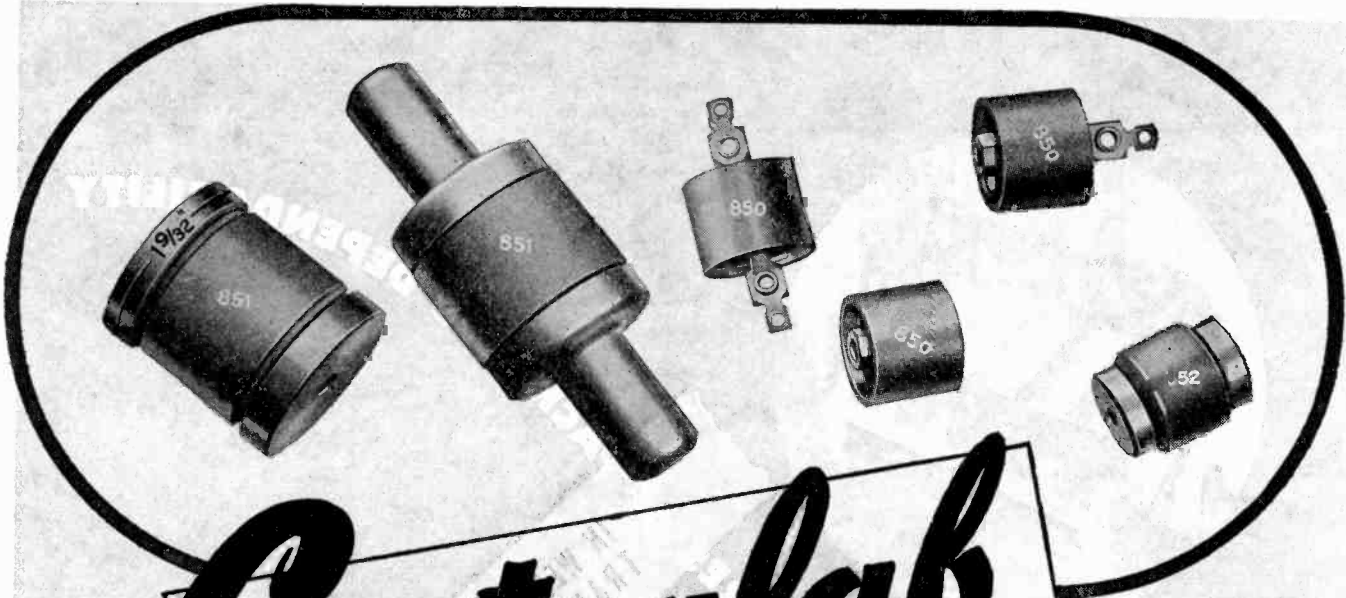

Centralab

CERAMIC CAPACITORS FOR HIGH VOLTAGE

Type 850, 851, and 852 shown above are double cup style ceramic capacitors engineered by Centralab for applications where high working voltages and loads are required. Capacities: 850 — 25 MMF, NPO to 100 MMF, N750; 851 — 25 MMF, NPO to 200 MMF, N750; 852 — 10 MMF, NPO to 853, 854 and 855 shown below are also double cup design and have accumulative capacities ranging from 2 MMF to 20 MMF in zero T. C. to MMF to 40 MMF in maximum negative T. C. (N750). Working voltages to 7500 D. C.

Send for Bulletin 721 and 814.



Centralab

Producers of: Variable Resistors • Selector Switches • Ceramic Capacitors, Fixed and Variable • Steatite Insulators • Button Type Silver Mica Capacitors.



YOURS!

Just write us, on your letterhead, for your copy of this valuable booklet on permanent magnets

● As a service to industry, The Arnold Engineering Company is "lending a hand" in the distribution of what Arnold engineers believe to be a very informative study on the subject of permanent magnets,

This 39-page book of permanent magnet theory, design data and references was published by the government. Arnold is pleased to make it available to you free of charge and without obligation. Write for it today!

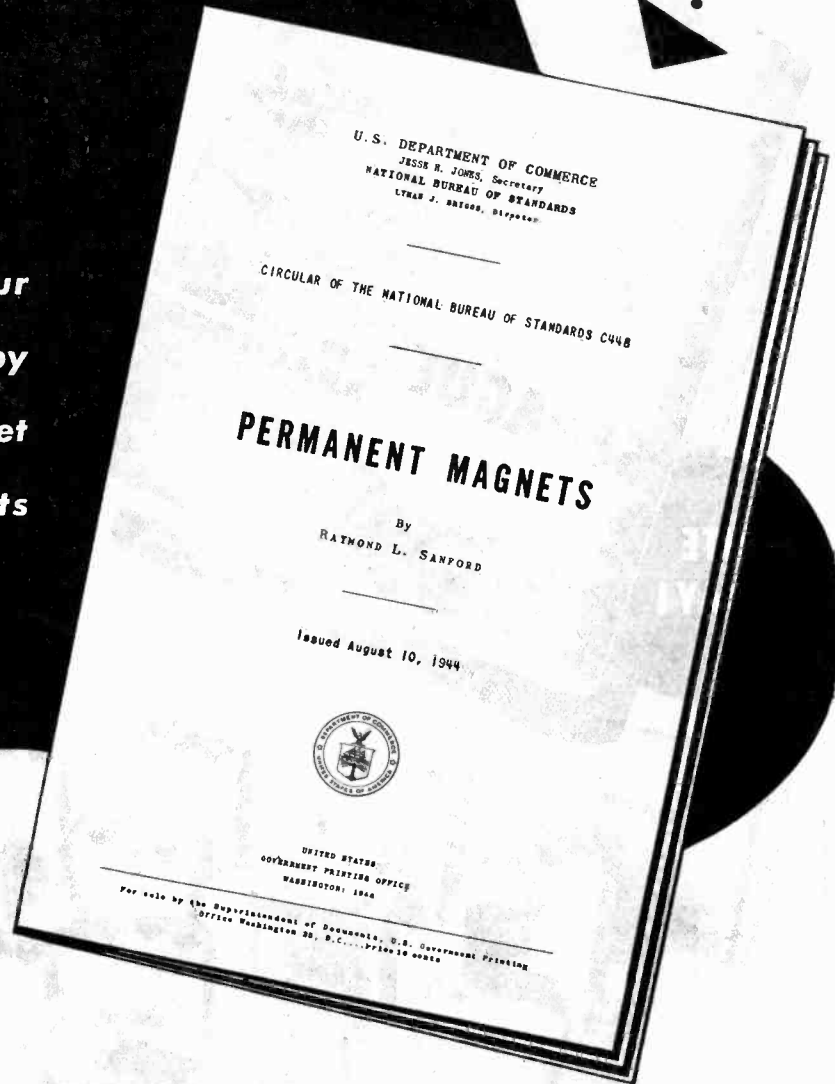

THE ARNOLD ENGINEERING COMPANY

147 EAST ONTARIO STREET, CHICAGO 11, ILLINOIS

Specialists in the Manufacture of ALNICO PERMANENT MAGNETS

HERE IS YOUR GUIDE

to modern paper dielectric capacitor selection and use

Months of painstaking work have gone into making this 56-page Sprague Catalog a complete guide to the design and engineering possibilities inherent in today's greatly enlarged line of Sprague Paper Dielectric Capacitors in hundreds of standard and special sizes and types.

Write for your copy today. You'll find it unsurpassed as a guide to the exact matching of up-to-the-minute Capacitor requirements!

SPRAGUE ELECTRIC CO.
North Adams, Massachusetts

**WRITE
TODAY!**



SPRAGUE

PIONEERS OF

ELECTRIC-ELECTRONIC PROGRESS

Presenting the...

DAVEN

WIRE-WOUND
SEALD-OHM

HERMETICALLY-SEALED PRECISION RESISTOR

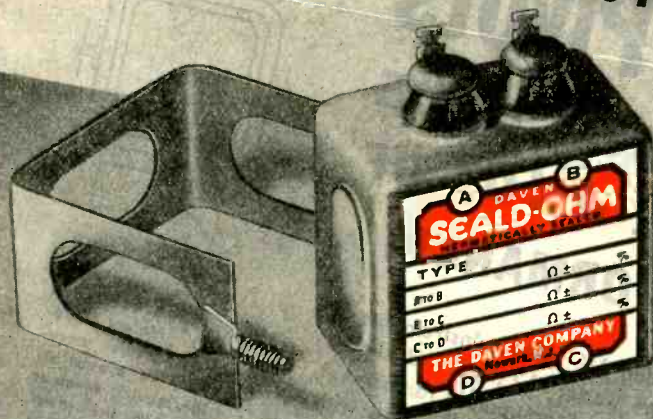

Totally unaffected by extremes of humidity and temperature, highly resistant to vibration and shock, with provision for rigid mounting... these were "specs" that could not be met by any resistor on the market. In response to a direct request, DAVEN, applying the know-how of over two decades of precision resistor engineering, carefully designed and built a new, completely hermetically-sealed resistor. DAVEN SEALD-OHMS squarely meet these specifications. This was proven by exhaustive tests conducted by a famous research laboratory.

ELECTRICAL DATA

RESISTOR WINDINGS: Either spool or mica-card type, depending upon engineering requirements. Non-inductively wound and carefully aged to remove strain before final calibration.

RESISTANCE RANGE: Any desired value may be had; maximum 1,600,000 ohms depending upon type of resistance wire employed.

TEMPERATURE CHARACTERISTICS: Four types of resistance wire of different characteristics are available.

ACCURACY: May be had to tolerance as close as $\pm 0.1\%$.

FREQUENCY CHARACTERISTICS: No appreciable effect over the audio range. This range may be exceeded to meet many other applications.

CIRCUIT COMBINATIONS: Resistors available with 2 terminals at one end or 2 terminals at two ends. A single four terminal unit is designed to take up to four separate spool-type resistors of different values and accuracies.

SEALD-OHMS are ruggedly constructed throughout, with special attention given to combining vibration and shock resistance. Their physical design enables the combining of several circuits within a single unit. A unique mounting bracket arrangement adds to the broad acceptability of these resistors. SEALD-OHMS are intended for use in any equipment subjected to humidity and temperature extremes. They fully meet both Army and Navy Specifications. Typical applications include as secondary standards, resistor elements in bridge networks, in voltage divider circuits, in attenuation boxes, etc.

MECHANICAL DATA

SHIELDING: Drawn brass, completely hermetically-sealed. Thermal-shock tested for faulty seals before shipment. Treated to withstand 200 hours salt spray test (f-13 AWS Spec C75.16-1944).

TERMINALS: Electrical connections are brought out through fused glass seals which are soldered in the resistor shield.

MOUNTING: A specially designed steel bracket with spade lugs welded to the sides is supplied with each unit. Cut-outs on this bracket engage with embossings on the side of the brass shielding to enable firm mounting of the unit in a vertical, inverted or horizontal position.

DIMENSIONS: 1-9/16" wide 1 1/2" high, 7/8" deep. Add terminal height, 9/16" Studs on mounting bracket, 1-11/16" between centers.

For additional information, write to THE DAVEN CO.,
191 Central Avenue, Newark 4, New Jersey

DAVEN **pioneer** maker of precision resistors



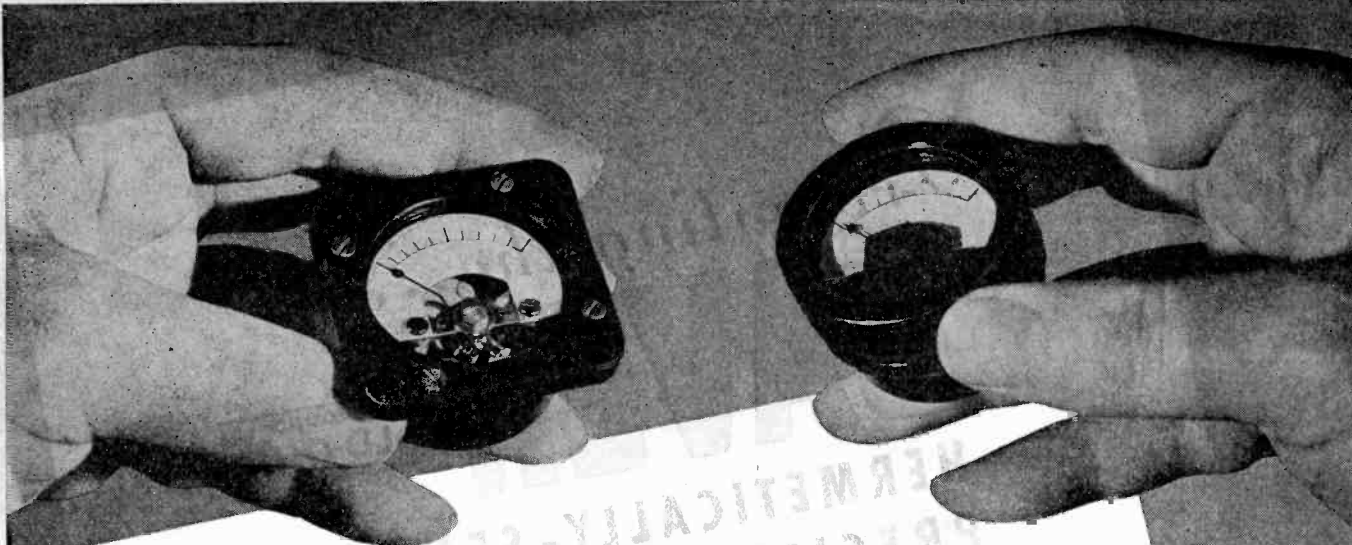

External Pivots

HELP THESE GREAT LITTLE METERS GIVE A LOT OF EXTRA PERFORMANCE!

These two hermetically sealed 1½" DeJur Instruments — the Model 120 (right) and the Model 112 (left) — designed to aid in the development of small equipment for present and post-war applications, combine miniature size with the accuracy resulting from external pivot design. External pivots used in both models, help provide better all-round performance because; external pivots provide maximum accuracy in mounting the moving element between the jewel bearings . . . prevent rocking of the pointer . . . reduce side friction between jewels and pivots . . . increase the life of bearing surfaces.

Alnico Magnets of the highest grade permit the use of high torque . . . afford instantaneous response under varying loads . . . insure stability . . . and provide protection against the damaging effect of surrounding magnetic fields.

Both Models are available either as D.C. or A.C. Instruments.

We are equipped to work with you on special models of all DeJur Products for present and postwar applications. Write for the latest DeJur catalog.

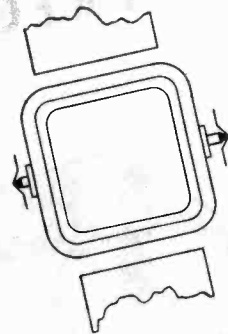

External pivots (above)—used in the design of DeJur 1½" Meters — provide greater accuracy in mounting the moving element between the jewel bearings. For this reason internal pivots (below) are not used in DeJur meters.

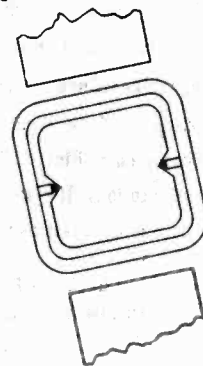

GIVE YOUR FULL SUPPORT TO THE SEVENTH WAR BOND DRIVE



De JUR - AMSCO CORPORATION

GENERAL OFFICE: NORTHERN BLVD. AT 45th STREET, LONG ISLAND CITY 1, N. Y.

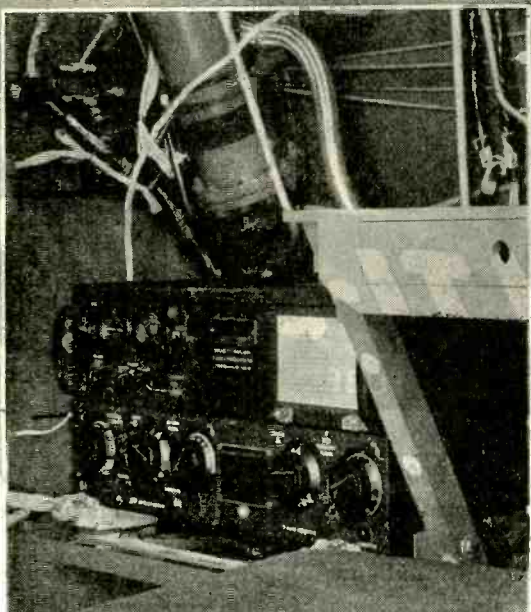
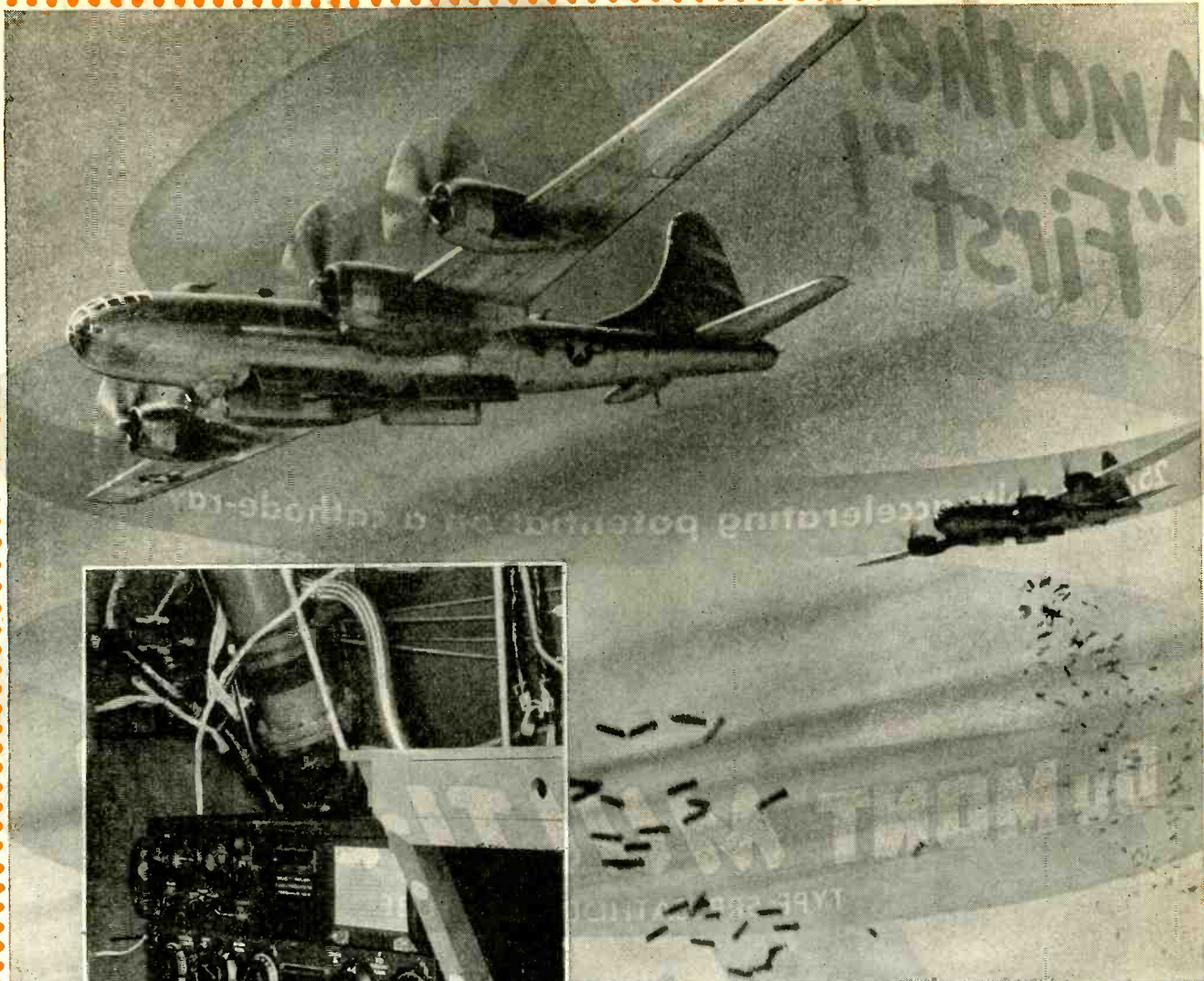

The Collins-designed transmitter as operator sees it from his station in a Superfortress. Boeing—Wichita Photo.

Superfortresses blast and roast Japs. Official photo U.S.A.A.F.

In the Boeing B-29 from the first

THE FIRST MESSAGE from the Army's first Boeing Superfortresses over Japan, on the Yawata mission of June 15, 1944, was transmitted by a Collins radio transmitter of the type shown above. From that time on, this transmitter has been standard equipment for all the Superforts, as it is also for the larger Naval aircraft.

As the Army and Navy demand increased, requirements exceeded the capacity of the extensive Collins facilities, and other manufacturers of radio equipment were drawn into the production program, aided by Collins engineers. Total deliveries have been very large.

Collins engineering and production have gained much valuable experience during the war in providing reliable radio communications under all operating conditions in practically every quarter of the globe. This experience will be available to commercial and personal users as soon as military requirements permit. Collins Radio Company, Cedar Rapids, Iowa; 11 West 42nd Street, New York 18, N. Y.



IN RADIO COMMUNICATIONS, IT'S . . .



**Another
"First"!**

25,000 volts accelerating potential on a cathode-ray tube...

DUMONT MULTI-BAND

TYPE 5RP CATHODE-RAY TUBE

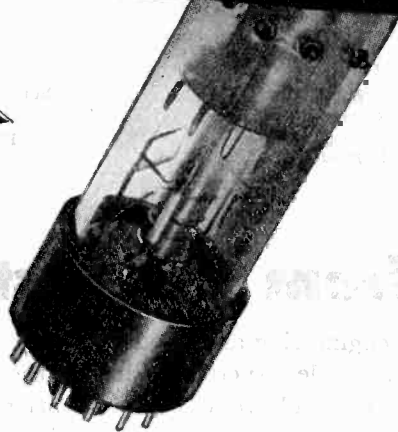

Cylindrical flat-face tube. Approximately the size of conventional 5-inch tubes. Deflection-plate leads brought out through neck instead of base. Shunt input capacities and cross-coupling effects reduced to minimum. Second anode and intensifier leads brought out through envelope to facilitate high-voltage operation.

▶ We repeat: 25,000 volts accelerating potential on a cathode-ray tube! That's front-page electronic news. Likewise cathode-ray history in the making.

The DuMont Multi-Band Tube (Type 5RP) permits recording at writing rates in excess of 2500 km/sec (using a 35 mm camera with f:1.9 lens) corresponding to sine wave transients at 10,000 megacycles!

This is a hot-cathode, permanently-sealed, high-vacuum tube. Subdivision of the intensifier element provides a controlled gradient allowing a total accelerating potential of 25,000 volts to be employed, with only slightly reduced deflection sensitivity. Greatly increased brightness with small spot size results in a writing rate far exceeding that heretofore obtainable.

Yes, DuMont pioneering continues.

▶ Literature on request.

© ALLEN B. DUMONT LABORATORIES, INC.

DUMONT

Precision Electronics & Television

ALLEN B. DUMONT LABORATORIES, INC., PASSAIC, NEW JERSEY



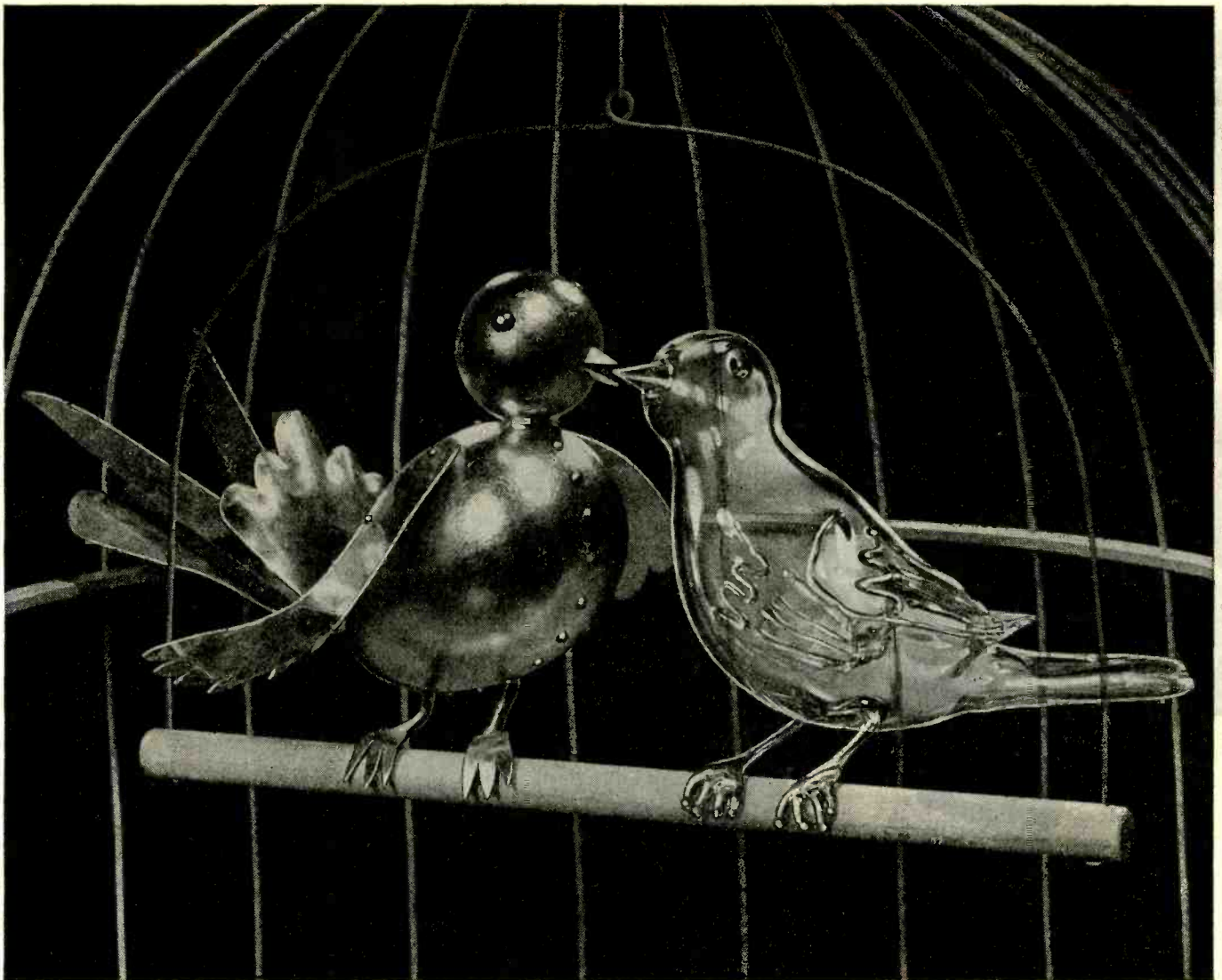

IT'S THE MATING SEASON FOR GLASS AND METAL . . .

thanks to Corning Metallizing!

CORNING has long been interested in the mating qualities of glass and metal. Out of this interest has developed a metallizing process which can be accurately controlled and which lasts.

Corning's metallizing process, combined with the excellent mechanical and dielectric properties of Corning's glasses, produces hermetic seals between glass components and metal by ordinary soldering methods or furnishes accurate and constant capacitances and inductances or electrostatic shielding.

Metallized glass as developed by Corning offers a wide variety of new applications in the field of electronics. Perhaps you have a problem where the union of glass and metal can help. Why not write us about it? Address Electronic Sales Department, P-7, Bulb and Tubing Division, Corning Glass Works, Corning, New York.

CORNING
— means —
Research in Glass

Electronic Glassware



"PYREX", "VYCOR" and "CORNING" are registered trade-marks and indicate manufacture by Corning Glass Works, Corning, N. Y.

SALT WATER MIKES

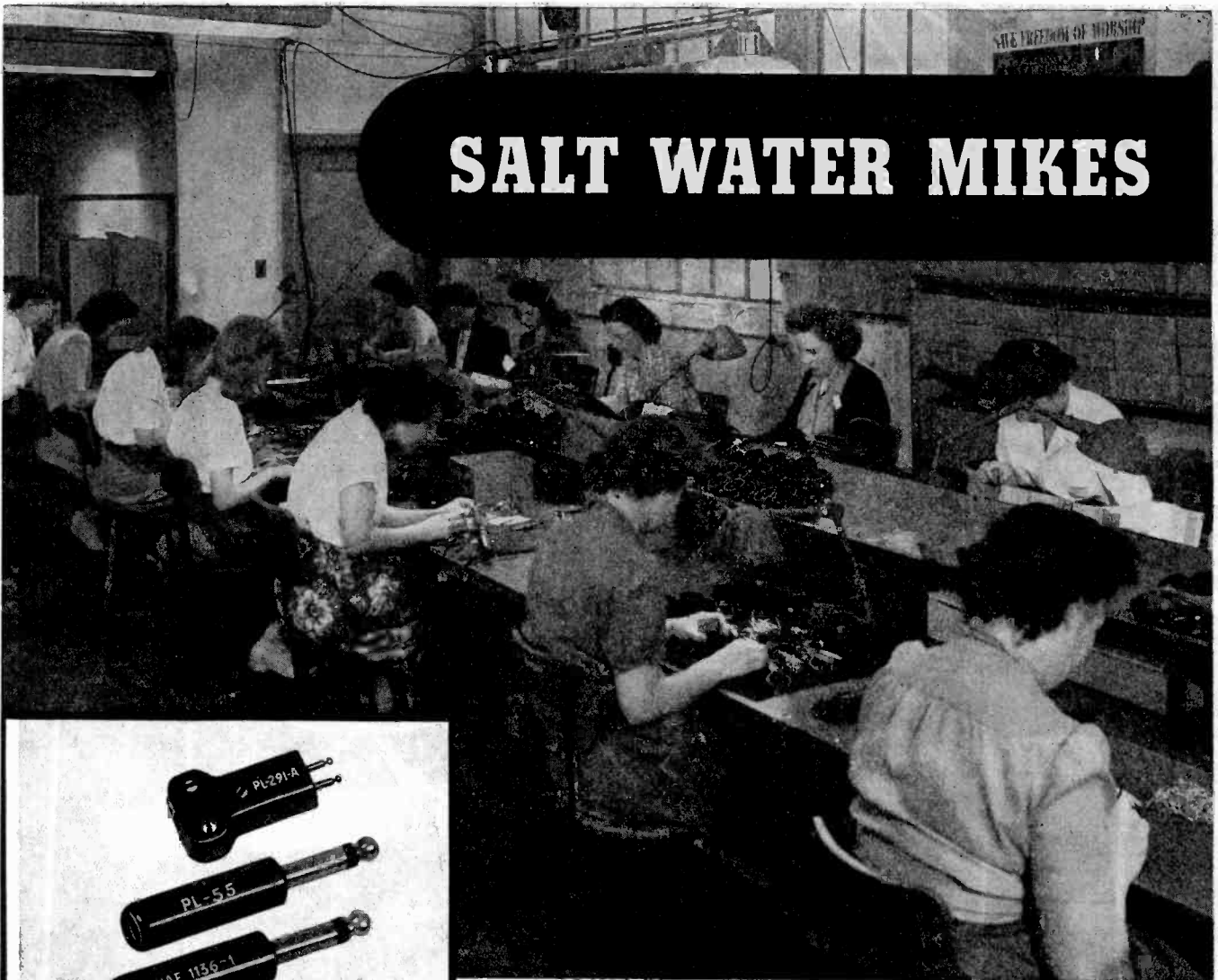

Marine microphone assembly. Plastic and metal parts designed, made and assembled by Remler to meet Navy and Merchant Marine specifications.

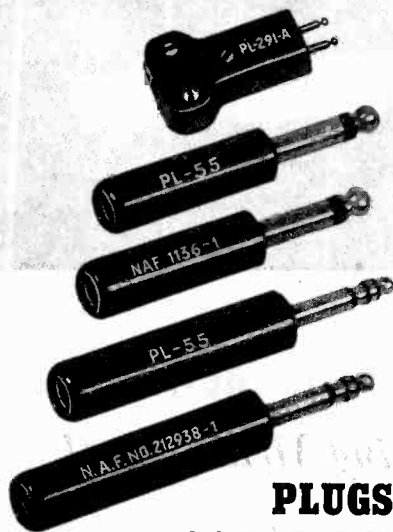

PLUGS & CONNECTORS

Signal Corps - Navy Specifications

Types:		PL			NAF	
50-A	61	74	114	150		
54	62	76	119	159		
55	63	77	120	160		1136-1
56	64	104	124	291-A		
58	65	108	125	354		No.
59	67	109	127			212938-1
60	68	112	149			

PLP		PLQ		PLS	
56	65	56	65	56	64
59	67	59	67	59	65
60	74	60	74	60	74
61	76	61	76	61	76
62	77	62	77	62	77
63	104	63	104	63	104
64		64			

OTHER DESIGNS TO ORDER

ONE REMLER ASSIGNMENT is the production of amplifying and transmitting systems for our Navy and Merchant Marine. Systems are complete—from shock-proof microphones, built to resist the corrosive action of salt air and water to transmitters and bull-horn speakers for baby Flat Tops. • Remler was organized in 1918 to manufacture ship wireless. Present activities in marine communications are a logical development of early activities in this field. The facilities and experience of this organization are at your disposal.

Further assignments in radio and electronics invited. Consult—

REMLER COMPANY, LTD. • 2101 Bryant St. • San Francisco, 10, Calif.

REMLER

SINCE 1918

Announcing & Communication Equipment



Famous Lighthouse Tubes

Disk-seal
parallel-plane
design

●
For use in the
ultra-high-
frequency
spectrum



TYPE 2C40
RECEIVING TUBE



TYPE GL-3C22
TRANSMITTING TUBE

Basic Ratings

For complete information on G-E lighthouse tubes and the story of their development, ask for Bulletin ETR-7, "The Lighthouse Tube".

	TYPE 2C40 (as local oscillator)	TYPE GL-3C22 (as power oscillator)
Filament voltage	6.3 v	6.3 v
Filament current	0.75 amp	2 amp
Max plate voltage	500 v	1,000 v
Max plate current	25 ma	150 ma
Max plate dissipation	6.5 w	125 w
Plate power output, typical operation	.075 w	50 w (at 600 mc)

● Developed by G-E engineers, the new Lighthouse Tubes have extended the top frequency limits, making possible outstanding performance in FM broadcasting, television, aviation and marine radio, and other fields. See your nearest G-E office or distributor, or write to *Electronics Department, General Electric, Schenectady 5, N. Y.*

GENERAL ELECTRIC

161-D7-8850

TRANSMITTING, RECEIVING, INDUSTRIAL, SPECIAL PURPOSE
TUBES • VACUUM SWITCHES AND CAPACITORS

You are cordially invited
to help write the "specs"
for this new
Gammatron Tube



Heintz and Kaufman Ltd.—first to design and produce such popular tube types as the 24, 24G, 54, and 257B—cordially invite you as a designer or manufacturer of electronic equipment to have a hand in the development of a new series of H & K "firsts." ☆ Our engineering staff welcomes your suggestions for additions to the Gammatron line. If you have a requirement not adequately met by existing tubes, please let us know so that our development program may be directed accordingly. ☆ It will be to our mutual benefit if you will take a few minutes now to set forth your suggestions, and thus participate in the designing of outstanding new Gammatrons.

HEINTZ AND KAUFMAN LTD.
SOUTH SAN FRANCISCO • CALIFORNIA

Gammatron Tubes

Export Agents: M. Simons & Son Co., Inc. 25 Warren Street, New York City, N. Y., U. S. A.



**BUY WAR
BONDS**

HERMASEAL

**HERMETICALLY SEALED TRANSFORMERS
—DEPENDABLE IN SEA WARFARE!**

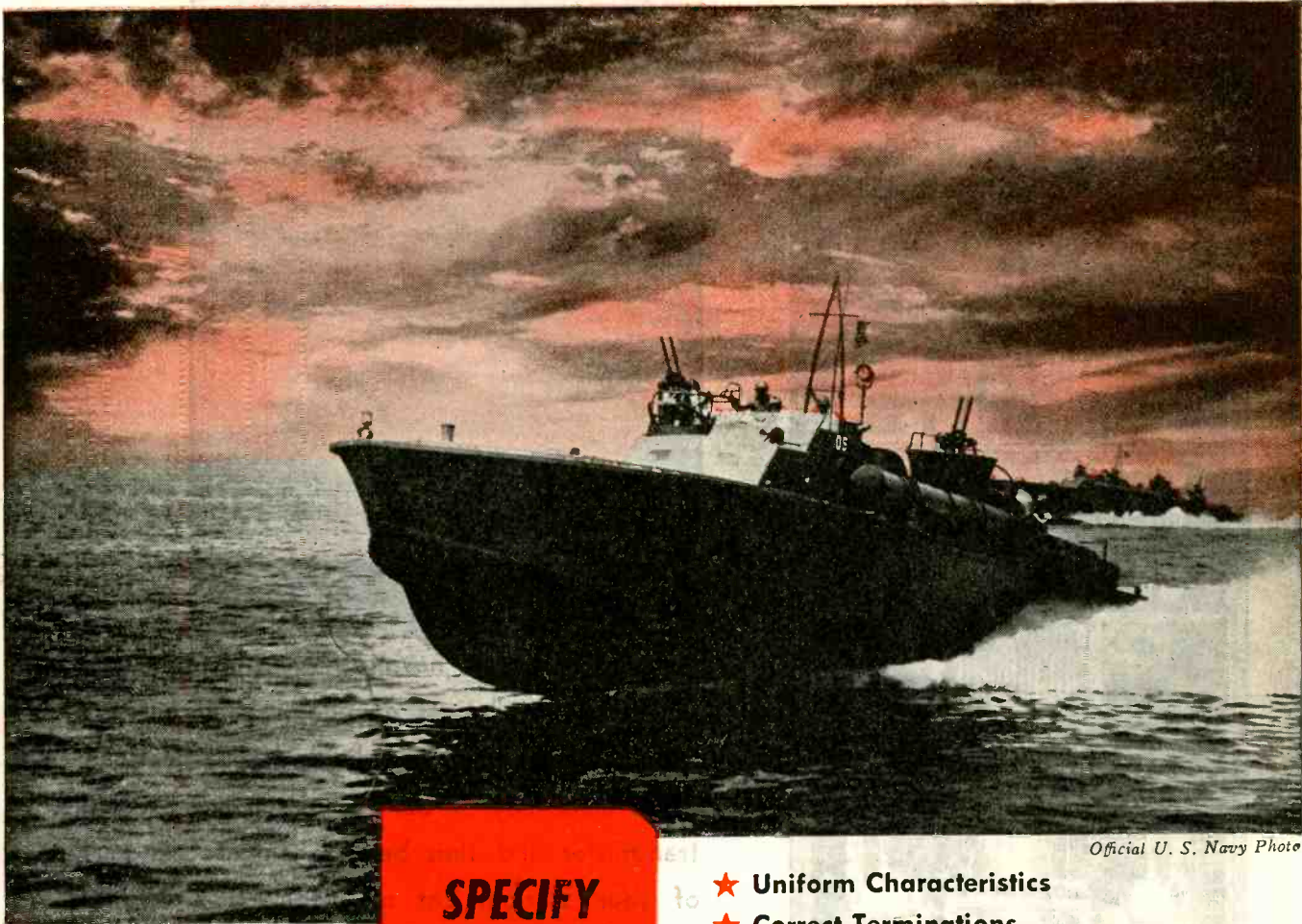

Official U. S. Navy Photo



HERMASEAL

**SPECIFY
HERMASEAL
AND GET
ALL
TEN**

- ★ Uniform Characteristics
- ★ Correct Terminations
- ★ Vacuum Immersion Test
- ★ Vacuum Impregnation—Varnish or Wax
- ★ Vacuum Filling—Oil or Wax*
- ★ Strong Mechanically
- ★ Soldered by Induction Heating
- ★ Infra-red Pre-heating
- ★ Continuous Inspection
- ★ 42 years Experience

HERMASEAL BY AMERTRAN

THE AMERICAN TRANSFORMER CO., 178 Emmet St., Newark 5, N. J.

AMERTRAN

MANUFACTURING SINCE 1901 AT NEWARK, N. J.

* May now be specified instead of compound filling.

Pioneer Manufacturers of Transformers, Reactors and Rectifiers for Electronics and Power Transmission

DIRECTIONAL ANTENNA EQUIPMENT

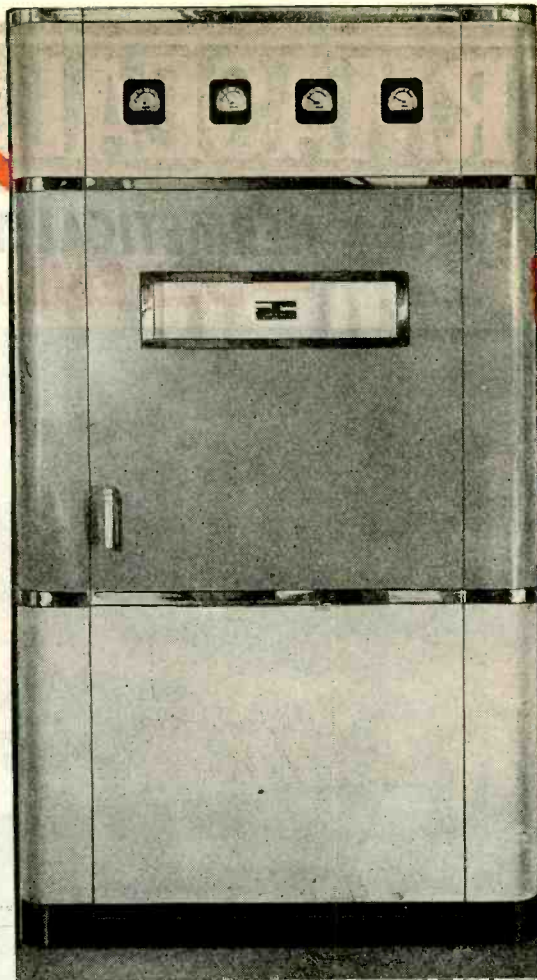
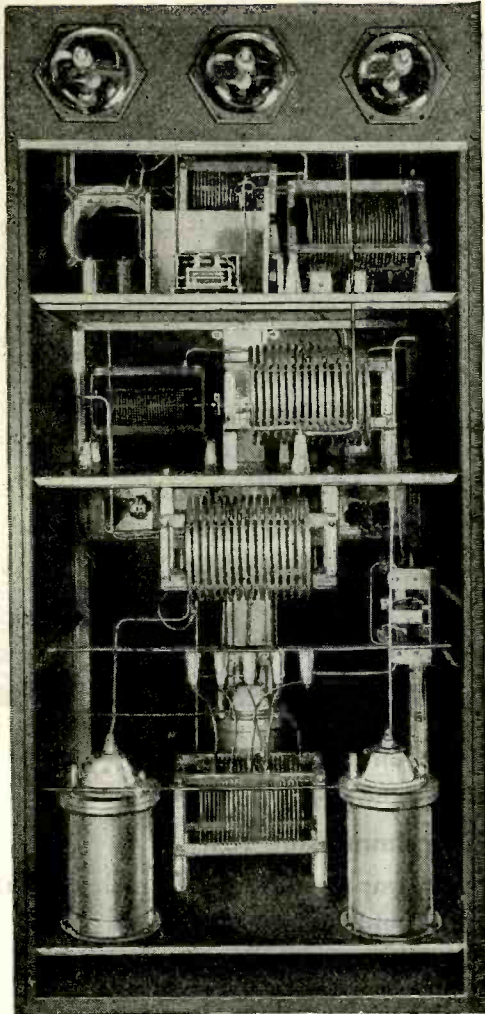

Johnson engineers have designed many highly successful installations of phasing and antenna coupling equipment to individual specifications. These units may be built to match any existing transmitter and thus become an integral part of your station. Let us help you and your consulting engineer plan your transmitting equipment for better market coverage. Orders received now will get first attention when priority restrictions are removed.

Here are two of the many installations of phasing equipment Johnson has furnished for Broadcast Stations, built to match existing equipment. Other items available from Johnson, made to individual specifications, are gas filled pressure condensers, coupling networks, tower lighting filters and special inductors.



JOHNSON

a famous name in Radio

**E. F.
JOHNSON
COMPANY**
WASECA, MINNESOTA

MYKROY
PERFECTED MICA CERAMIC INSULATION

DOESN'T CARBONIZE!

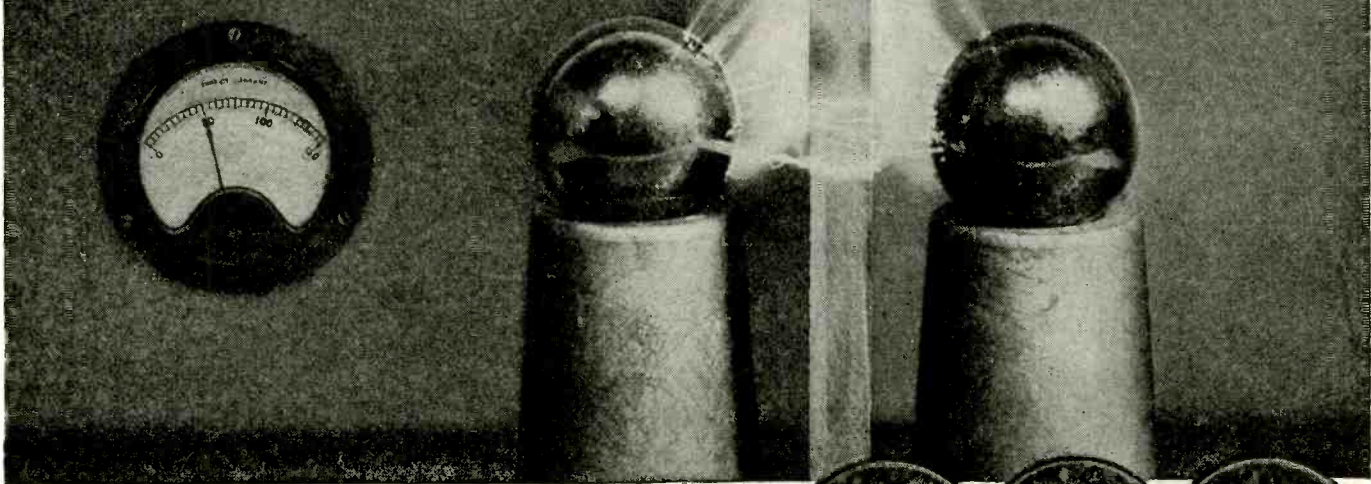

This high frequency insulation will not carbonize under arc, yet it possesses dielectric properties of the highest order. Made entirely of inorganic materials, Mykroy cannot char or turn to carbon even when exposed to continuous arcs and flashovers.

The sheet of Mykroy in the photo was exposed to a 50,000 volt arc after which it was sectioned and carefully examined for signs of damage. None were found . . . not even the slightest excoriations were present, hence no low resistance paths formed to support breakdown.

Engineers everywhere are turning more and more to Mykroy because the electrical characteristics of this perfected glass-bonded ceramic are of the highest order—and do not shift under any conditions short of actual destruction of the material itself. Furthermore Mykroy will not warp—holds its form permanently—molds to critical dimensions and is impervious to gas, oil and water. For more efficient insulation investigate Mykroy. Write for copies of the latest Mykroy Bulletins.

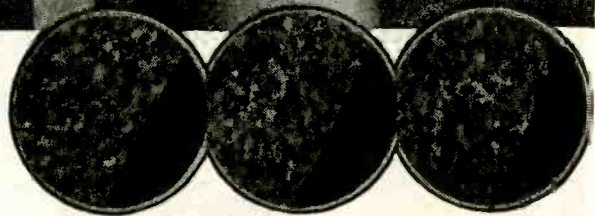

Cross sections of the test sheet made at the point of exposure to the 50,000 volt arc (magnified 10 times) show no trace of damage.

MECHANICAL PROPERTIES*

MODULUS OF RUPTURE.....18000-21000psi
HARDNESS
Mohs Scale 3-4 BHN, BHN 500 K9 Load, 63-74
IMPACT STRENGTH.....ASTM Charpy .34-.41 ft. lbs.
COMPRESSION STRENGTH.....42000 psi
SPECIFIC GRAVITY.....2.75-3.8
THERMAL EXPANSION.....0.00006 per Degree Fahr.
APPEARANCE.....Brownish Gray to Light Tan

ELECTRICAL PROPERTIES*

DIELECTRIC CONSTANT.....6.5-7
DIELECTRIC STRENGTH (1/8").....630 Volts per Mil
POWER FACTOR......001-.002 (Meets AWS L-4)

*THESE VALUES COVER THE VARIOUS GRADES OF MYKROY

- GRADE 8 Best for low loss requirements.
 - GRADE 38. Best for low loss combined with high mechanical strength.
 - GRADE 51. Best for molding applications.
- Special formulas compounded for special requirements.

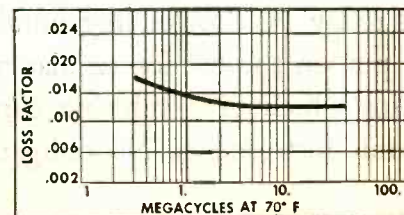

Based on Power Factor Measurements made by Boonton Radio Corp. on standard Mykroy stock.

MADE EXCLUSIVELY BY

ELECTRONIC MECHANICS
INC.

70 CLIFTON BLVD., CLIFTON, N. J.
CHICAGO 47; 1917 N. Springfield Ave., Tel. Albany 4310
EXPORT OFFICE: 89 Broad Street, New York 4, New York

MYKROY IS SUPPLIED IN SHEETS AND RODS — MACHINED OR MOLDED TO SPECIFICATIONS

MAKE ACCURATE TESTS
AND MEASUREMENTS

faster

WITH **hp** INSTRUMENTS



There is an *-hp-* Electronic

instrument for making most every important test or measurement in the field of radio and electronics. Their accuracy is unexcelled and their performance unequalled. Simplicity of operation makes for greater speed... saves you valuable time whether on the production line or in the laboratory. Get the facts about *-hp-* Instruments today. Ask for catalog number 17A. Also have your name put on the list for regular mailing of *-hp-* technical bulletins which give valuable current information about electronic instruments. No obligation, of course.

023

HEWLETT-PACKARD COMPANY

BOX 823 D, STATION A

PALO ALTO, CALIFORNIA

HERE'S A PARTIAL LIST OF TESTS AND MEASUREMENTS THAT CAN BE MADE WITH STANDARD **hp** INSTRUMENTS

- *Distortion Measurement*
- *Generate Standardized Voltages*
- *Measure Audio Frequencies*
- *Gain Measurement*
- *Voltage Measurement*
- *Measure Network Response*
- *Measure Wave Harmonics*
- *Acoustic Measurement*
- *Noise Analysis*
- *Measure Frequency Response*
- *Square Wave Measurement*
- *Establish Standard Frequencies*
- *Establish Standard Ratios by Attenuation*
- *Provide Voltage for Bridge Measurement*

Special instruments and combinations of instruments can be supplied to fill your needs. Let our engineers help solve your problem.



"HYTRON Tubes Are Good—SO WHAT!"

Sure, Hytron tubes are good — so what! All tubes made for Uncle Sam are good. They have to be, or he wouldn't accept them.

But Hytron goes further. Not satisfied just to meet Uncle Sam's JAN-1A specifications, it always sets factory testing specifications to tighter tolerances than the Services require. In this way, Hytron assures top quality

despite slight meter inaccuracies and the human element. When more uniform adherence to specifications can be attained, tests simulating actual equipment performance are added.

This same insistence on the best will continue after the war. Then, too, we shall say, "Hytron tubes are good — so what! They have to be good to be good enough for you."

OLDEST EXCLUSIVE MANUFACTURER OF RADIO RECEIVING TUBES

HYTRON
RADIO AND ELECTRONICS CORP.



MAIN OFFICE: SALEM, MASSACHUSETTS
PLANTS: SALEM, NEWBURYPORT, BEVERLY & LAWRENCE

BUY ANOTHER WAR BOND



HOW CLOSE are "close tolerances" in laminated plastics?

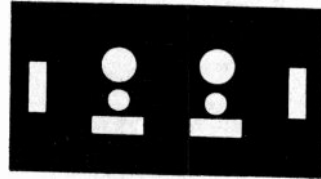
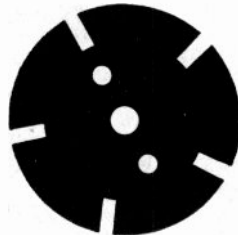

Ultimate "close tolerances" on holes in parts made from sheets

Exercising extreme care in the making of tools, and in the machining of the material; and with close individual inspection of finished parts, the following tolerances may be achieved when drilling or punching holes in Dilecto laminated plastics. These

are, however, the "ultimate" close tolerances which the plastic nature of Dilecto will allow regardless of any further care or time which might be given to making of tools and fabrication. To hold these tolerances costs are increased substantially.

DIAMETER OF HOLE	DRILLING	*REAMING	PUNCHING** 1/16 STOCK	PUNCHING** 3/32 STOCK
Up to 1/4"	-002 +003	-001 +001	-003 +003	-004 +004
1/4" to 1/2"	-002 +003	-0015 +0015	-004 +004	-005 +005
1/2" to 1"	-002 +005	-002 +002	-005 +005	-007 +007
1" to 2"	-010 +010	-0025 +0025	-006 +006	-008 +008

*Reaming is not recommended as a general practice on Phenolics and never on holes running parallel to the laminations. Holes over 1" are bored.

**Allow .003" per inch on hole center distances for shrinkage due to necessity to heat stock.

FOR DESIGN ENGINEERS . . . PRODUCTION AND BUYING EXECUTIVES

- When ordering Dilecto laminated plastics to be fabricated in your own shop . . . give full details of the fabricating problem so the most suitable form and grade of Dilecto will be furnished . . . when fabricated parts are ordered, B/P's should first be submitted for study by C-D Engineers . . . who can often suggest modifications which will result in lower production and die costs . . . for complete design data send for bulletin FP.



DISTRICT OFFICES: New York - Cleveland - Chicago - Spartanburg, S. C.
West Coast Rep., Marwood; Ltd., San Francisco - Sales Offices in principal cities

CK-44

Continental - Diamond FIBRE COMPANY

Established 1895 . . . Manufacturers of Laminated Plastics since 1911—NEWARK 48 • DELAWARE

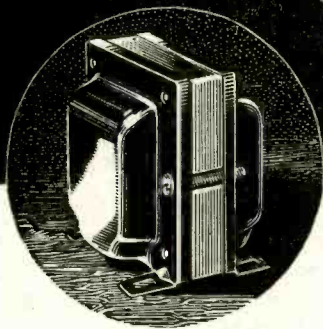

★ *This speaks for itself: Utah is its own transformer supplier for speakers, vibrators, wire recorders, etcetera.*

WHEN UTAH SAYS... "OK-SHIP"

It's like putting a big liner into water. Like a launching. Only here at Utah, we don't take time for celebration. Radio makers and electronics dealers appreciate the highly specialized product that has been manufactured... the way a skipper appreciates a fine craft. Radio listeners, like ships' passengers, take all this precision for granted.

Here at Utah our workers (assisted by

Utalins*) begin with nothing but the raw materials from which they make the tools that turn out Utah radio parts and electronic devices. At each step in manufacture... punch press, electroplating, welding, coil winding... from the beginning through to the finished product, Utah workers check, re-check, test and prove to Utah standards. When Utah says... "OK-SHIP" products of quality that stand up under every condition known to man leave to broadcast Utah performance around the world.

*Utah's Helpers

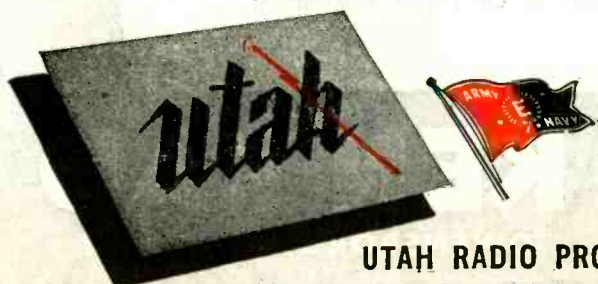

UTAH RADIO PRODUCTS COMPANY, 820 ORLEANS ST., CHICAGO 10, ILL.
 Utah Electronics (Canada) Ltd., 300 Chambly Road, Longueuil, Montreal (23) P.Q. • Ucoa Radio, S.A., Misiones 48, Buenos Aires

KEN-RAD

Little Giant MINIATURE TUBES



Better than ever

● Wherever compact power is essential, Ken-Rad Miniature Tubes are serving staunchly . . . Now this famous make of tubes, improved still further by important new research and manufacturing facilities, will meet better than ever the exacting specifications being laid down by designers, builders, and users of electronic equipment.

Write for your copy of "Essential Characteristics" the most complete digest of tube information available.

179-C2-8850

KEN-RAD

OWENSBORO, KENTUCKY

An Original **GUARDIAN** *Development*

designed for and in conjunction with
the Collins Radio Company



The New Vacuum Switch

KEYING RELAY

for High Frequency—High Voltage—
High Altitude Applications

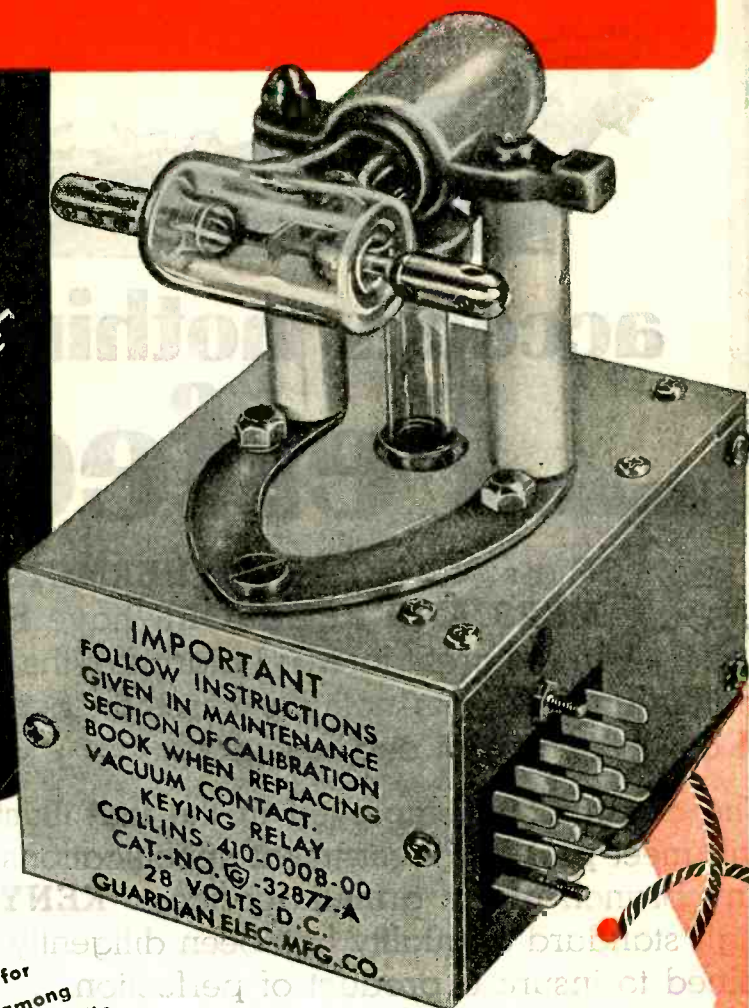

The confidential development of this vacuum switch keying relay involved design ingenuity and ability to produce immediate results. It called for cooperation and a meeting of minds among Guardian engineers and those of Collins Radio Co., the U. S. Navy, Spertl, and General Electric. Then quantity production and the responsibility of being the sole source of supply for many months followed successful development of the relay. The same confidential treatment, the same engineering ability on electrical control, the same production capacity is yours for the asking. Write.

GUARDIAN ELECTRIC
628-H W. WALNUT STREET
A COMPLETE LINE OF RELAYS SERVING AMERICAN INDUSTRY
CHICAGO 12, ILLINOIS

A request on your business
letterhead will bring you
Guardian's new catalog.



Your Navy

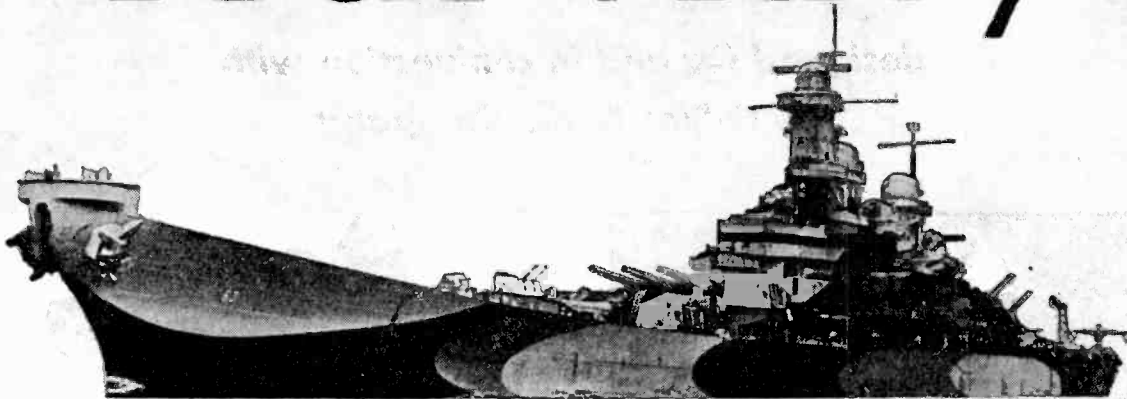

Official U. S. Navy Photo

accepts nothing less than Perfection



That's why **KENYON HERMETICALLY SEALED TRANSFORMERS AND REACTORS** have been selected to play their part in the great forward march of the world's greatest Navy which demands and accepts nothing less than perfection of all its personnel and resources.

The construction employed in the unit illustrated will meet present government specifications from any branch of the armed services. **KENYON'S** high standard of quality has been diligently maintained to insure a product of perfection.

Designs available employ both glass-to-metal and steatite-to-metal sealed terminals.

Overall dimensions and mounting dimensions conform to the **KENYON** T-line case except that the mounting is single ended at top or bottom. It may be necessary to increase case height.

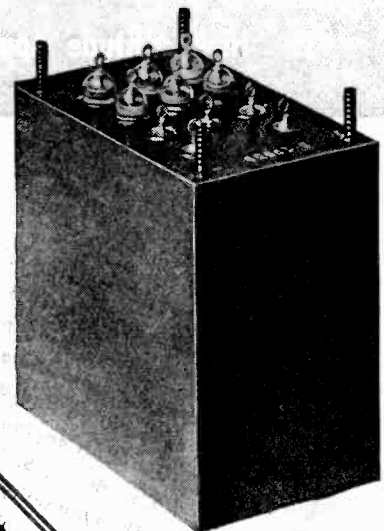

Manufactured for the Navy to their specifications RE 13A 553 B

THE MARK OF



EXCELLENCE

Inquiries invited. Write for our new 1945 illustrated catalogue

KENYON TRANSFORMER CO., Inc. 840 BARRY STREET
NEW YORK, U. S. A.

NATIONAL RECEIVERS ARE THE EARS OF THE FLEET

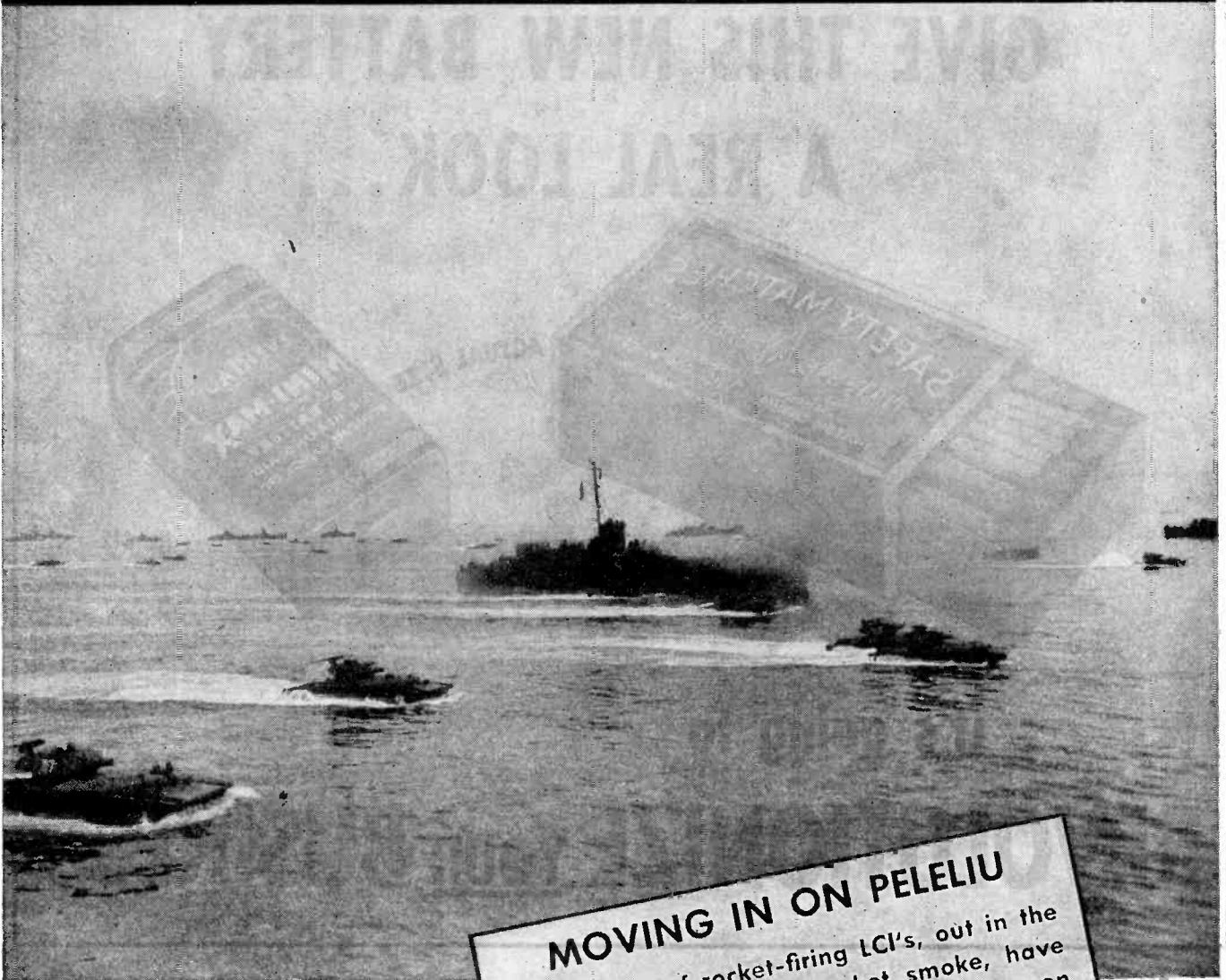

OFFICIAL U. S. NAVY PHOTOGRAPH

MOVING IN ON PELELIU

A flotilla of rocket-firing LCI's, out in the foreground clouded in rocket smoke, have smothered the Jap beach defenses. Cannon firing "Alligator" tanks plow through calm water, to blast the way for assault troops. This is D-day on Peleliu, and the Americans have come to stay.

Three out of four of the Navy's ships — landing craft or larger — are equipped with receivers designed by National.

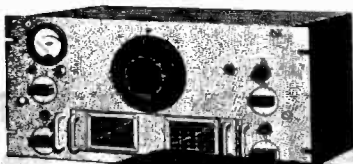

HRO

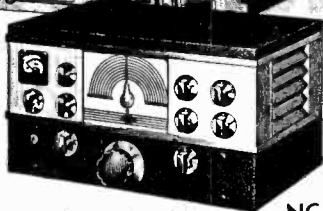

NC-200

NATIONAL COMPANY

MALDEN



MASS., U. S. A.

NATIONAL RECEIVERS ARE IN SERVICE THROUGHOUT THE WORLD

GIVE THIS NEW BATTERY A REAL LOOK...



ACTUAL SIZE



No. 412

This is "Eveready" "Mini-Max" "B" Battery No. 412. It furnishes 22½ volts, weighs 1¼ ounces. Dimensions are 2" by 1 1/32" by 23/32". Compare its size with that of an ordinary wooden match box.

it's going to

REVOLUTIONIZE YOUR BUSINESS

MEET the new "Eveready" "Mini-Max" midget "B" Battery. Embodying National Carbon Company's exclusive construction, it crams 22½ volts into a space smaller than any battery ever before conceived — approximately 2½ times smaller.

Think what it will mean in your business to have a 22½ volt battery "no bigger than a minute" and handy as a match box. It means that the portable radio business — nipped by the war just as it was getting a good start — will return with an even brighter future. It also means that radios can be made for the personal use of an individual. Made small enough to fit snugly in a vest pocket or a lady's handbag.

In this connection, we're cordially inviting America's engineers and designers to consult

with us. Bring your special problems to our engineers and our laboratories. We should like to cooperate with you in every way possible in order to speed the development of brilliant new battery uses for the good of the industry, right after the war.

EVEREADY
TRADE-MARKS

MINI-MAX

RADIO "B" BATTERIES

NATIONAL CARBON COMPANY, INC.
Unit of Union Carbide and Carbon Corporation

UCC

General Offices: NEW YORK, N. Y.
The trade-marks "Eveready" and "Mini-Max" distinguish products of National Carbon Company, Inc.

Buy More War Bonds

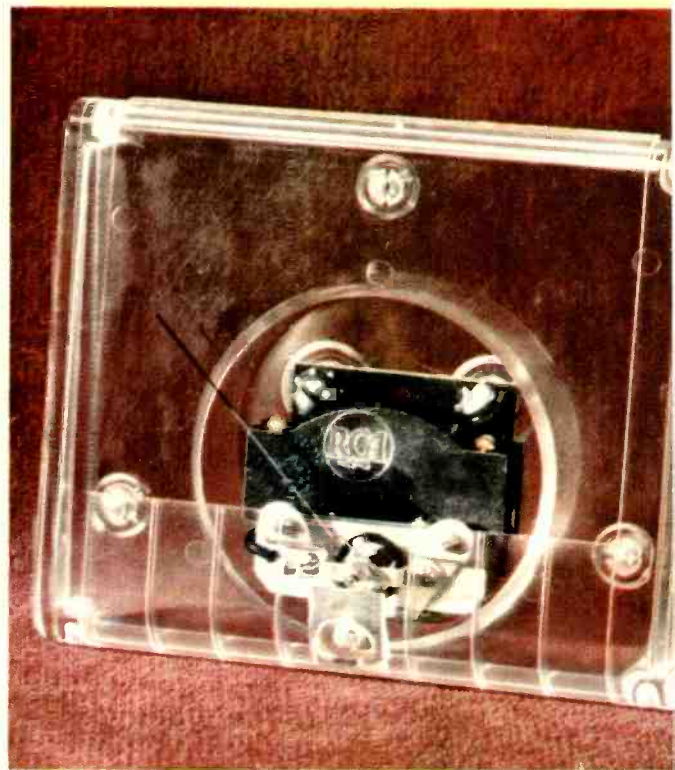

The entire meter case is molded of a clear plastic. There is no glass to loosen or break.

The New #195 VOLT OHMYST

NEW FEATURES:

1. A balanced diode rectifier providing readings over a very wide range of audio frequencies. (Flat from 20 to 100,000 cycles.)
2. Provision for alignment of f-m discriminators.

3. A new-type plastic meter case with one-piece crystal-clear front. Designed for easy reading of all scales.

WRITE FOR BULLETIN A special bulletin describing in detail the features of this new and improved VoltOhmyst is now being printed. Write for your copy today. Address Test and Measuring Equipment Section, Dept. BB124, Radio Corporation of America, Camden, N. J.



RADIO CORPORATION OF AMERICA

RCA VICTOR DIVISION • CAMDEN, N. J.

In Canada, RCA VICTOR COMPANY LIMITED, Montreal

NEITHER STRATOSPHERE COLD NOR DESERT HEAT AFFECT THE RCA-3B25

Xenon-Filled Rectifier Tube
Operates Efficiently Over
165°C Temperature Range

FOR applications in which ambient temperature varies widely, the 3B25 has important advantages over mercury-vapor-type tubes. No temperature-control devices are required, arc-back is minimized, and the tube drop remains constant at approximately 10 volts over the entire temperature range from -75°C to $+90^{\circ}\text{C}$.

The RCA-3B25 also will carry higher currents than high-vacuum tubes of the same size—and with much lower tube drop.

The Xenon filling permits operation of the tube mounted in any position. Since the 3B25 is ruggedly constructed to



withstand severe shock, it can be mounted near moving mechanisms without being adversely affected by vibration.

TECHNICAL DATA

In single-phase, full-wave operation, a pair of 3B25's will provide 1 ampere d-c output to the filter at 1270 volts. The tube is rated at 4500 peak inverse anode volts and an average anode current of 0.5 ampere.

General: Filament volts (a.c.), 2.5; filament current, 5.0 amperes; tube drop (approx.) 10 volts; overall length, $5\frac{7}{8}$ inches $\pm\frac{7}{16}$ inch; maximum diameter, $2\frac{1}{16}$ inches; cap, medium; base, medium 4-pin bayonet; mounts in any position.

Maximum Ratings (Absolute Values): Peak inverse anode volts (at 500 cycles or less), 4000; peak anode current, 2 amperes; average anode current, 0.5 ampere; surge anode current for maximum of 0.1 second, 20 amperes; ambient temperature range, -75°C to $+90^{\circ}\text{C}$.

For more complete data, send for free data-sheet on RCA-3B25. Address: RADIO CORPORATION OF AMERICA, Commercial Engineering Section, Dept. 62-31P, Harrison, New Jersey.

BUY WAR BONDS



62-6136-31

RADIO CORPORATION OF AMERICA

RCA VICTOR DIVISION • CAMDEN, NEW JERSEY

**THE FOUNTAINHEAD OF MODERN TUBE
DEVELOPMENT IS RCA**

BOARD OF DIRECTORS

1945

William L. Everitt
President

Hendrik J. van der Bijl
Vice-President

Raymond A. Heising
Treasurer

Haraden Pratt
Secretary

Alfred N. Goldsmith
Editor

Lynde P. Wheeler
Senior Past President

Hubert M. Turner
Junior Past President

1943-1945

Wilmer L. Barrow
F. B. Llewellyn

Harold A. Wheeler
1944-1946

Raymond F. Guy
Lawrence C. F. Horle
William C. White

1945-1947

Stuart L. Bailey
Keith Henney
Benjamin E. Shackelford

1945

E. Finley Carter
Lewis M. Clement
Ralph A. Hackbusch
Donald B. Sinclair
William O. Swinyard

Harold R. Zeamans
General Counsel

BOARD OF EDITORS

Alfred N. Goldsmith
Editor

Ralph R. Batcher
Robert S. Burnap
Philip S. Carter
Lewis M. Clement
William G. Dow
Elmer W. Engstrom
William L. Everitt

William G. H. Finch
George W. Gilman
Peter C. Goldmark
Frederick W. Grover

Lewis B. Headrick
C. M. Jansky, Jr.
Hugh S. Knowles
John D. Kraus

Donald G. Little
Frederick B. Llewellyn
Nathan Marchand
Samuel S. Mackeown
Edward L. Nelson
Harry F. Olson

Harold O. Peterson
Greenleaf W. Pickard
Ralph A. Powers

Haraden Pratt
Conan A. Priest
Herbert J. Reich
Peter C. Sandretto

Vernon W. Sherman
Lynne C. Smeby

E. C. Wente
Harold A. Wheeler
William C. White

Laurens E. Whittemore
Gerald W. Willard

William Willard
Charles J. Young
Vladimir K. Zworykin

Proceedings

of the I·R·E

Published Monthly by

The Institute of Radio Engineers, Inc.

VOLUME 33

July, 1945

NUMBER 7

Section Meetings.....	Next Page
Survival of the Technologically Fit.....	The Editor 421
William C. White.....	422
The Presentation of Technical Developments Before Professional Societies.....	William L. Everitt 423
Wide-Range Tuned Circuits and Oscillators for High Frequencies....	Eduard Karplus 426
Silicones—A New Class of High Polymers of Interest to the Radio Industry.....	Shailer L. Bass and T. A. Kauppi 441
A Note on Acoustic Horns.....	Paul W. Klipsch 447
Analyses of the Voltage-Tripling and -Quadrupling Rectifier Circuits..	D. L. Waidelich and H. A. K. Taskin 449
The Performance and Measurement of Mixers in Terms of Linear-Net-work Theory.....	L. C. Peterson and F. B. Llewellyn 458
A Figure of Merit for Electron-Concentrating Systems..	J. R. Pierce 476
Basic Theory and Design of Electronically Regulated Power Supplies	Anthony Abate 478
Corrections to	
"Transient Response," by Heinz E. Kallmann.....	482
"A Theoretical and Experimental Investigation of Tuned-Circuit Distortion in Frequency-Modulation Systems," by D. L. Jaffe..	482
Discussion on "Reflex Oscillators," by J. R. Pierce.....	483
E. U. Condon, A. E. Harrison, W. W. Hansen, J. R. Woodyard, and J. R. Pierce	
Corrections to "The Image Formation in Cathode-Ray Tubes and The Relation of Fluorescent Spot Size and Final Anode Voltage," by G. Liebmann.....	485
Institute News and Radio Notes.....	486
Board of Directors.....	486
Executive Committee.....	486
Correspondence:	
"Frequency and Phase Modulation," by D. L. Jaffe and D. Pollack.....	August Hund 487
.....	Bruce E. Montgomery 488
"Voltage-Regulator Operation," by W. R. Hill.....	488
.....	B. E. Noltingk 488
Contributors.....	489
Section Meetings.....	36A
Membership.....	38A
Positions Open.....	50A
Advertising Index.....	70A

Helen M. Stote, Associate Editor • William C. Copp, Advertising Manager

Responsibility for the contents of papers published in the PROCEEDINGS rests upon the authors. Statements made in papers are not binding on the Institute or its members.



Changes of address (with advance notice of fifteen days) and communications regarding subscriptions and payments should be mailed to the Secretary of the Institute, at 330 West 42nd Street, New York 18, N. Y. All rights of republication, including translation into foreign languages, are reserved by the Institute. Abstracts of papers, with mention of their source, may be printed. Requests for republication privileges should be addressed to The Institute of Radio Engineers.

Copyright, 1945, by The Institute of Radio Engineers, Inc.

PAPERS COMMITTEE

Frederick B. Llewellyn
Chairman

Herman A. Affel
Wilmer L. Barrow
Howard A. Chinn
James-K. Clapp
Ivan S. Coggeshall
Edward J. Content
Clifford W. Corbett
Murray G. Crosby

Frederick W. Cunningham

Robert B. Dome
Enoch B. Ferrell
Donald G. Fink
Howard S. Frazier
Robert L. Freeman
Stanford Goldman

Frederick W. Grover
O. B. Hanson

Thomas J. Henry
Edward W. Herold
John V. L. Hogan
Frederick V. Hunt

Harley Iams
Loren F. Jones
John G. Kreer, Jr.
Emil Labin

Frederick R. Lack
Hugo C. Leuteritz
Charles V. Litton
Knox McIlwain

Harry R. Mimno
Ilia E. Mourontseff
G. G. Muller

Albert F. Murray
Dwight O. North
Allen F. Pomeroy
Jack R. Poppele
Simon Ramo

Francis X. Rettenmeyer
Sergei A. Schelkunoff

Donald B. Sinclair
Dayton Ulrey
A. P. Upton

Karl S. Van Dyke
E. K. Van Tassel
John R. Whinnery
Irving Wolff

J. Warren Wright
Harold R. Zeamans

PAPERS

PROCUREMENT COMMITTEE

Dorman D. Israel
General Chairman

Edward T. Dickey
Vice General Chairman

GROUP CHAIRMEN

Arthur B. Bronwell
Nelson P. Case
Madison Cawein
Ivan S. Coggeshall

Murray G. Crosby
Alfred Crossley
Harry Diamond
Arthur E. Harrison

Theodore A. Hunter
James R. Nelson
Harry F. Olson
Donald B. Sinclair

Howard J. Tyzzer
Wilbur L. Webb
William C. White
Karl S. Van Dyke

George W. Bailey
Executive Secretary

William H. Crew
Assistant Secretary



THE INSTITUTE OF RADIO ENGINEERS

INCORPORATED



SECTIONS MEETINGS

ATLANTA
September 21

CHICAGO
September 21

CLEVELAND
September 20

DETROIT
September 21

LOS ANGELES
September 18

NEW YORK
September 5

PHILADELPHIA
September 6

PITTSBURGH
September 10

PORTLAND
September 10

WASHINGTON
September 10

SECTIONS

ATLANTA—Chairman, R. A. Holbrook; Secretary, Ivan M. Miles, State Engineering Experimental Station, Georgia School of Technology, Atlanta, Ga.

BALTIMORE—Chairman, W. L. Webb; Secretary, H. L. Spencer, Box 6760, Towson 4, Md.

BOSTON—Chairman, C. C. Harris; Secretary, Corwin Crosby, 16 Chauncy St., Cambridge, Mass.

BUENOS AIRES—Chairman, A. DiMarco; Secretary, H. Krahenbuhl, Transradio Internacional, San Martin 379 Buenos Aires, Argentina

BUFFALO-NIAGARA—Chairman, A. G. Skrivseth; Secretary, H. W. Staderman, 264 Loring Ave., Buffalo, N. Y.

CEDAR RAPIDS—Chairman, F. M. Davis; Secretary, J. A. Green, Collins Radio Co., 855—35th St., N.E., Cedar Rapids, Iowa

CHICAGO—Chairman, Cullen Moore; Secretary, L. E. Packard, General Radio Co., 920 S. Michigan Ave., Chicago 5, Ill.

CINCINNATI—Chairman, L. M. Clement; Secretary, J. F. Jordan, The Baldwin Co., 1801 Gilbert Ave., Cincinnati 2, Ohio

CLEVELAND—Chairman, H. B. Okeson; Secretary, A. J. Kres, 16911 Valleyview Ave., Cleveland 11, Ohio

CONNECTICUT VALLEY—Chairman, H. W. Sundius; Secretary, L. A. Reilly, 989 Roosevelt Ave., Springfield, Mass.

DALLAS-FORT WORTH—Chairman, J. D. Mathis; Secretary, B. B. Honeycutt, 9025 Roanoak, Dallas 18, Texas

DAYTON—Chairman, L. B. Hallman; Secretary, Joseph General, 411 E. Bruce Ave., Dayton 5, Ohio

DETROIT—Chairman, R. A. Powers; Secretary, R. R. Barnes, 1411 Harvard Ave., Berkley, Mich.

EMPORIUM—Chairman, W. A. Dickinson; Secretary, H. E. Ackman, West Creek, R. D. 2, Emporium, Pa.

INDIANAPOLIS—Chairman, W. W. Garstang; Secretary, J. T. Hood, 4816 N. Illinois St., Indianapolis, Ind.

KANSAS CITY—Chairman, R. N. White; Secretary, Mrs. G. L. Curtis, 6003 El Monte, Mission, Kansas.

LONDON—Chairman, G. A. Wootton; Secretary, Robert Wilton, No. 5 Radio School, Royal Canadian Air Force, Clinton, Ont., Canada

LOS ANGELES—Chairman, R. C. Moody; Secretary, R. G. Denechaud, Blue Network Co., 6285 Sunset Blvd., Hollywood 28, Calif.

MONTREAL—Chairman, L. A. W. East; Secretary, R. R. Desaulniers, Canadian Marconi Co., 2440 Trenton Rd., Town of Mt. Royal, Que., Canada

NEW YORK—Chairman, G. B. Hoadley; Secretary, J. T. Cimorelli, RCA Manufacturing Co., 415 S. Fifth St., Harrison, N. J.

OTTAWA—Chairman, W. A. Steel; Secretary, L. F. Millett, 33 Regent St., Ottawa, Ont., Canada

PHILADELPHIA—Chairman, D. B. Smith; Secretary, P. M. Craig, Philco Corp., Philadelphia 34, Pa.

PITTSBURGH—Chairman, T. C. Kenny; Secretary, R. K. Crooks, Box 2038; Pittsburgh 30, Pa.

PORTLAND—Chairman, Kenneth Johnson; Secretary, C. W. Lund, Route 4, Box 858, Portland, Ore.

ROCHESTER—Chairman, G. R. Town; Secretary, A. E. Newton, Research Dept., Stromberg-Carlson Co., Rochester 3, N. Y.

ST. LOUIS—Chairman, B. B. Miller; Secretary, C. H. Meyer, KFUD, 801 DeMun Ave., St. Louis, Mo.

SAN DIEGO—Chairman, F. A. Everest; Secretary, Clyde Tirrell, United States Navy, Radio and Sound Laboratory, San Diego 52, Calif.

SAN FRANCISCO—Chairman, David Packard; Secretary, William Barclay, Stanford University, Palo Alto, Calif.

SEATTLE—Chairman, G. L. Hoard; Secretary, K. A. Moore, 5102 Findlay St., Seattle 8, Wash.

TORONTO—Chairman, E. O. Swan; Secretary, Alexander Bow, Copper Wire Products, Ltd., 137 Roncesvalles Ave., Toronto, Ont., Canada

TWIN CITIES—Chairman, Ross Hilker; Secretary, Merle Ludwig, Minneapolis-Honeywell Regulator Co., Minneapolis, Minn.

WASHINGTON—Chairman, H. A. Burroughs; Secretary, L. C. Smeby, 4801 Connecticut Ave., N.W., Washington, D. C.

WILLIAMSPORT—Chairman, L. E. West; Secretary, F. L. Burroughs, 2030 Reed St., Williamsport 34, Pa.

Survival of the Technologically Fit

Engineers—and indeed all other citizens of modern nations—will be well advised to examine and encourage the major elements or forces which vitally aid the survival of national groups. Obvious among these are qualities of the mind, emotions, group spirit, and individual intuitions which do not readily yield to analytic examination or even to inspirational methods of study. But there is one factor concerning the urgent need for which there can be no doubt whatever, and that is technical mastery. Until such time as the nations shall have outlawed resorts to violence for the settlement of disputes—and none can say with certainty that that time is as yet at hand—victory will be to the strong. But strength in these times is not the strength of the individual man alone; it is also the integrated strength of a people in the realms of creation, construction, and utilization of their physical resources. And here we enter the particular realm of the engineer.

More and more, in an earth shrunken in space and time, the elements of communication and transportation play a striking part in the establishment of a superior position for any nation. They form the foundations of other forms of industrial production and the bases of military strategy and tactics. Communication and transportation are complicated fields of human endeavor where success is only to the intellectually swift and the bravely determined. That nation which is fortunate in the possession of large groups of trained research men, qualified development engineers, and skilled production men in these fields can gather confidence in its strength.

These ineluctable facts place a great responsibility as well as a splendid opportunity before the membership of The Institute of Radio Engineers. We must all regard ourselves not only as individual communication and electronic workers pursuing a path contributing to our professional careers but also in a real sense as one of the mainstays of our country. Thus we become crusaders for freedom of thought and for the opportunity of carrying out self-chosen cooperative measures. For that is the cause of those nations whose privileged citizens we are.

With great opportunities come as well certain obligations. Engineers in these days can contribute to the war effort not only by their activities in laboratory or shop or field but in other ways as well. We may foregather with our fellows in meetings where our mutual problems are discussed and we try earnestly to help each other toward their solutions. Contributions to technical committee work have a new significance in these days. The papers we prepare and publish are in a measure a friendly clasp of the hands of our fellows. And, in our few moments of respite from the daily demands on our time, we can and should think of plans for the days which will follow the victory of the cause to which we are giving our best efforts. Above all, when the stress of our activities grows apace and weariness threatens to claim us for its own, we may remember with pride and determination that our countries stand on firm ground, to the strength of which we contribute no slight part.

The Editor



William C. White

BOARD OF DIRECTORS - 1944

William Comings White was born in Brooklyn, New York, on March 24, 1890. He experimented with electrical devices as a youngster, constructed "wireless sets" as early as 1904, and was graduated in electrical engineering from Columbia University in 1912.

Later that year, he joined the staff of the research laboratory of the General Electric Company at Schenectady, N. Y., and in 1913 was assigned to research on electron tubes and their application, being active on the design, building, and operation of the first high-vacuum triode built by General Electric. He designed many of both the receiving and transmitting-type tubes used during the early years of broadcasting. He has continued with General Electric on electronic activities in several capacities and is now electronics engineer of its research laboratory. Under Mr. White's supervision were carried on such engineering developments as the thoriated-fila-

ment cathode; the screen-grid tube; the hot-cathode, mercury-vapor rectifier; the thyatron; metal receiving tubes; steel-envelope, sealed-off thyatrons, phanotrons, and ignitrons; and lighthouse tubes for the ultra-high frequencies.

A considerable number of patents and published papers in the PROCEEDINGS, as well as other technical journals, associate his name with the electron tube and its applications, particularly in the industrial field.

In 1915 Mr. White joined The Institute of Radio Engineers as an Associate, was transferred to Member in 1925, and elected a Fellow in 1940. He has served on various Institute Committees, was appointed to the Board of Directors for 1943, and is now serving as an elected director.

He is a member of the American Institute of Electrical Engineers, Sigma Xi, and Tau Beta Pi.

The Presentation of Technical Developments Before Professional Societies*

W. L. EVERITT†, FELLOW, I.R.E.

Summary—The professional man has an obligation to give wide dissemination to new discoveries and developments. This may be done by publication and by oral presentation before technical groups. The proper presentation of a paper requires the co-ordination of four groups or individuals. A check list of their duties is given which may be used as a reference in the planning of technical sessions.

THE NATURAL result of professional activities, particularly in science and engineering, is the development of new ideas and methods which are important, not only to the solution of a special problem but also to the general development of the art. It is not only the *privilege* but also the *obligation* of the professional man to make this knowledge available to other workers in his field and to the general public at the earliest possible time compatible with his own interest or that of his employer. Except when military security dictates otherwise, this information should be given as wide and early dissemination as possible, since its originator cannot know to whom and to what extent this new knowledge may be useful for the benefit of mankind.

It is to the advantage of the engineer and of his profession first to present publicly important developments and ideas of general utility in his field before a recognized professional society, where they may be discussed, developed, and perhaps questioned by his associates. By so doing, the engineer may be spared embarrassment or even discredit to himself or to his professional associates which sometimes follows premature disclosure to the public press.

The general dissemination of new technical ideas to the profession should be done in one or both of two ways:

- (1) By the presentation of a paper before a technical session of a professional society.
- (2) By the publication of a paper in the journal of a professional society or in a technical magazine.

It is preferable that both methods be used for many developments. If the presentation is before a technical session where the attendance necessarily is limited, it is desirable to submit a paper for publication consideration to the society which sponsored the session, so that all members may be informed. When both methods are used, the published paper should include material which is developed in the discussion at the technical session, including a correction of errors which the discussion may bring forth.

* Decimal classification: R060. Original manuscript received by the Institute, April 11, 1945.

† President, The Institute of Radio Engineers, Inc.

Papers which provoke oral *discussion* are the type which will give the most profit to the author, the society, and the public by presentation first before a technical session. The papers committee in charge of the session, together with the author, should examine proposed papers with this point in view. The author should also keep this in mind in preparing his presentation. Unless early release is essential, there is little profit to anyone merely in reading a paper before a group. Papers which require extended mathematical development, or detailed study to grasp their implications, are not suitable for presentation at technical sessions unless they can be briefed, and the important conclusions presented, so that the audience can participate in the discussion.

A strong distinction should be drawn between *reading* and *presenting* a paper before a technical session. The reading, word for word, of material which later is to be published, without adequate opportunity for discussion, as has been done all too often, is a waste of everyone's time and fulfills no useful purpose.

The proper presentation of a paper before a technical session requires the team action of at least four individuals or groups. They are usually

- (1) The Papers Committee
- (2) The Arrangements Committee
- (3) The Chairman of the Technical Session
- (4) The Author.

A mutual knowledge of the duties and responsibilities of each member is desirable to obtain team action.

The following suggestions are proposed for the duties of the team members in the conduct of technical sessions. While they are intended primarily for convention sessions, where there are a number of authors, most of the suggestions are applicable to section meetings. If you are a member of such a team, use this as a check list to be sure you are performing your functions.

Duties of the Papers Committee:

The Papers Committee, or an individual performing its functions, determines:

- (1) The general theme of the technical session (industrial electronics, radio antennas, etc.)
- (2) The time and date of the session
- (3) The length of the session
- (4) The chairman of the session (and contacts and secures him)
- (5) The number of papers
- (6) The time allotted to each paper

- (7) The proposed topics (examining them to be sure either that they can stimulate discussion, or that they should be presented to advance the date of release of the information).

The Papers Committee also

- (8) Contacts the author to obtain the paper

(Note: Items 7 and 8 may occur in either sequence.)

- (9) Handles all correspondence with the author, forwards suggestions as to the author's duties, determines from him what aids such as lanterns, blackboards, motion-picture projectors, power outlets, manual assistance, and the like he will require in his presentation.
- (10) Notifies the Arrangements Committee of the date and time, probable space required, and the requirements of the author in the way of lanterns, blackboards, and other supplies. Also indicates whether stenographic recording is desired.
- (11) Arranges for the introduction of the chairman, unless he is a section officer or otherwise acting in an official capacity so as to be known to the audience.

Duties of the Arrangements Committee:

The Arrangements Committee, or an individual performing its functions, arranges for:

- (1) The meeting place
- (2) The mailing of notices and other publicity (unless under the jurisdiction of a separate committee)
- (3) Janitor service
- (4) Projectors, blackboards, chalk, erasers, pointers, etc.
- (5) The lantern operator
- (6) Smooth control of the darkening of the room from the lantern operator's position by remote control, or by signaling to an attendant at the room-lighting switch
- (7) Means for signaling between the speaker and the lantern operator
- (8) A public-address system where (and only where) needed. (When provided, the public-address system should have a lapel microphone if at all possible.) Check that it is in proper operating condition and that the gain is set properly.
- (9) Contact with the chairman of the session to apprise him of the services provided and their operation, and to determine other services which may be desired. Inform him of any special conditions applying to the concluding of the session and vacating of the premises.
- (10) Power outlets for demonstrations
- (11) Assistance for bringing in and removing demonstration equipment

- (12) Shipping instructions for the disposal of demonstration equipment after the meeting
- (13) Chairs
- (14) Tables
- (15) Reading lights
- (16) Distribution of material which is to be passed out to the audience (and its collection if necessary)
- (17) Recording of attendance, if desired
- (18) Stenographic recording of discussion, if desired
- (19) Meeting of the speaker at section meetings, if he comes from out of town, and making sure that his time is occupied to fit his convenience. (Have this done by a friend of the speaker if possible.)

Duties of the Chairman of the Technical Session:

The Chairman:

- (1) Presides at the meeting and is responsible for the tempo and character of the whole session
- (2) Introduces speakers and outlines method of conducting discussion
- (3) Contacts authors, lantern, and light-control attendants in advance of the session to acquaint them with each other and with himself and to issue special instructions, including information on
 - (a) Facilities available
 - (b) Method of disposition of lantern slides
 - (c) Method of signaling operators
 - (d) Time schedule and method of adherence thereto
 - (e) Operation of public-address system
 - (f) Location of pointers, chalk, erasers, and any other supplies
 - (g) Method of conducting discussion
- (4) Ascertains from authors whether they know of members who will discuss papers
- (5) Receives information from members who have prepared discussions
- (6) Conducts business where such is scheduled
- (7) Is *responsible* for adherence to time schedule
- (8) Calls for discussion
- (9) Recognizes discussors in order, giving preference to those who have indicated preparation in advance. At conventions, he makes sure each speaker on the floor stands up and gives his name and business connection clearly. If he cannot be heard, the chairman should require him to come forward and face the audience and to use the public-address system if possible. Remember, a member of the audience in the center of the room has his back to half the audience.
- (10) Makes sure that questions from the audience are heard by all, and repeats them if necessary before the author replies
- (11) Confines discussion to the topic

- (12) Closes discussion when completed or at expiration of allotted time
- (13) When desirable, requests that discussions, containing comments which are important, be submitted in written form to the author and to the Editor of the PROCEEDINGS. Forwards to the Editor discussions which are available in written form at the time of the meeting.

Suggestions to the Author in the Presentation of a Paper before a Technical Session:

It is beyond the scope of this article to develop the rules for effective public speaking, as there have been many publications on this subject. However, it is believed that adherence to certain technical and almost mechanical rules will improve the presentation of any paper. The following suggestions apply. Remember that a stimulating discussion is beneficial to the author, the audience, and the society.

- (1) Prepare a draft of the paper in advance. Keep in mind that your mission is to teach rather than to demonstrate how much you know. Be sure the paper is presented from a professional viewpoint and not as an advertisement of your commercial connections. *Make it interesting.* Your efforts are wasted if the audience is bored.
- (2) Appear at the meeting sufficiently in advance of the scheduled time to meet and confer with the chairman.
- (3) *Do not read the paper.* Brief it and present it orally, emphasizing its high points, especially any items over which there may be controversy. Be sure the material is in logical sequence.
- (4) Speak clearly and distinctly, look at your audience, and evidence your interest in them and in your subject.
- (5) Show the relation of the development discussed to the progress of the art.
- (6) Distribute properly the time assigned to oral presentation, demonstration, and discussion.
- (7) Practice and time yourself beforehand.
- (8) Adhere to the time schedule. Expect the chairman to require you to do so. Use a watch which is constantly within your view. Modify your talk if you find you are running overtime.
- (9) Arrange for demonstrations if possible; they always provoke more interest.
- (10) Notify Papers Committee of lanterns, blackboards, power outlets, and other facilities you will need.
- (11) Provide adequate illustrations, preferably on standard 3¼- by 4-inch lantern slides. You may have to provide your own projector if non-standard slides are used. Be sure the thumb marks are properly placed, and the slides are in order with the thumb marks facing the operator and in the upper right-hand corner. Use a slide container which will keep all slides in order.
- (12) Use simplified block diagrams on slides where possible. Do not put too much detail on any slide; it is confusing in the short time during which it is shown. (This cannot apply to photographs of equipment.)
- (13) Make proper use of the public-address system. Keep at a constant distance from the microphone and in the same relative position at all times. Even if you have a powerful voice, it is disconcerting when the public-address system fades out due to increased separation of the speaker from the microphone, or due to the turning of the head.
- (14) Never turn your head away from the audience while you are talking, even to point out items on the projection screen, unless you are wearing a lapel microphone. If necessary, point to the screen and then turn and speak into the microphone or towards the audience.
- (15) Use the facilities provided to signal the lantern operator and point to the screen.
- (16) Give credit to others who serve as a source for your statements.
- (17) Make clear which statements you consider facts and which you consider conclusions or opinions.
- (18) In advance of the meeting, send copies of your manuscript to competent members who may attend the meeting. Ask them to come prepared to take part in the discussion. Do this particularly to individuals who may differ with you or oppose your views. Opposition may develop interest in your ideas and promote their acceptance if they are worth while, or save you from embarrassment later if you are in error. Notify the chairman of the meeting of any discussion you expect, and help him contact their source.
- (19) Rewrite your paper for publication, giving consideration to the points which were developed in the discussion. Send at least three copies to the Editor of the PROCEEDINGS as soon as possible.
- (20) Secure copies of the discussions in typewritten form, if possible. The chairman may assist you in this.

Again, and above all, *speak clearly and logically and adhere to the time schedule.*

Wide-Range Tuned Circuits and Oscillators for High Frequencies*

EDUARD KARPLUS†, FELLOW, I.R.E.

Summary—Tuned circuits for frequencies from 100 to 1000 megacycles are described, which combine the mechanical simplicity and compactness of low-frequency coil-capacitor circuits with electrical performance suitable for very-high-frequency and ultra-high-frequency applications. Tuning ranges of 4 to 1 are readily obtained, both with and without sliding contacts. Application of the circuits in negative-grid-triode oscillators is discussed.

INTRODUCTION

UP TO about 100 or 200 megacycles, resonant circuits are readily obtained with conventional capacitors and coils, tuning being accomplished by varying one or both of these elements. At higher frequencies it becomes increasingly difficult to make these conventional circuits behave properly and, for any given capacitor, there will be found an upper frequency limit beyond which satisfactory operation cannot be obtained.

Every variable capacitor has a certain amount of residual inductance. As the frequency is raised by decreasing the inductance of the coil, the residual inductance becomes larger and larger in comparison with the external inductance, until finally, when the external inductance has degenerated to a simple strap connecting the capacitor terminals, it may comprise nearly all the tuned-circuit inductance. The capacitor terminals are usually the only convenient points to which connections can be made, and the developed impedance at resonance between these points becomes very low.

At low frequencies the ohmic loss in the metallic structure of the capacitor is usually negligible compared to the dielectric losses and to the ohmic losses in the coil, and no particular effort is made to reduce it to the absolute minimum. As the frequency is raised, however, the tuned-circuit losses become more and more localized in the capacitor stack, until finally, when the terminals are strapped together, the circuit Q is largely determined by the condenser.

Another problem characteristic of high-frequency apparatus is concerned with sliding contacts. At low frequencies sliding contacts behave reasonably well. Low-frequency currents always follow the path of least resistance. At high frequencies, however, currents follow the path of least impedance no matter how high the contact resistance happens to be. In a two-finger contact, for instance, low-frequency currents will be distributed between the two fingers depending on their contact resistance and will shift between them as the two contact resistances vary. High-frequency current

will always flow through one finger only if the inductance of the second finger is appreciably larger. Multiple contacts, therefore, are no longer effective.

From an electrical standpoint a quarter-wave short-circuited coaxial line is an excellent resonant circuit. Because of the voltage and current distribution, the developed impedance at the terminals is necessarily the maximum that can be obtained. Because of the geometry, the current flows in simple paths of large superficial area, and the losses are held to a minimum. As a consequence, high Q 's can be realized and full advantage taken of them in developing high terminal impedance at resonance. A ratio of conductor diameters of 3.6 yields optimum Q for any given inner conductor diameter. For copper conductors and air dielectric Q is approximately $0.1D\sqrt{f}$ where D is the inside diameter of the outer conductor in inches and f the frequency in cycles per second. Such a line has approximately 75 ohms characteristic impedance and, for an inside diameter of 1 inch, has a Q of 1000 at 100 megacycles.

Unfortunately, constructional difficulties arise in the design of coaxial lines which tend to overbalance their excellent electrical characteristics. In a simple 100-megacycle quarter-wave resonator, for instance, a length of about 30 inches is necessary, with a plunger travel of 24 inches required for a frequency variation from 100 to 500 megacycles. If linear motion is used, a rack-and-pinion or lead-screw drive of expensive construction is necessary; if rotation along an arc is used, considerable waste of space results from the large area swept over by the arm carrying the plunger. The problem of changing the line length by accurately known amounts is further complicated by the need of avoiding excessive loss and erratic electrical variations. In some applications the changes required are small, and actual contact with the line conductors is not necessary, but sliding contacts are required if the tuning range is large.

The wide-range tuned circuits described in this paper were developed in an attempt to combine the simplicity and compactness of conventional low-frequency coil-capacitor circuits with good electrical performance in the frequency range from 100 to 1000 megacycles. The common features that distinguish them from coil-capacitor combinations are that the inductive element of a parallel tuned circuit is built integrally with the capacitive element and that two terminals are accessible that subtend a maximum of the total tuned-circuit impedance. The circuits differ among themselves principally in the arrangement of their terminals and in the methods by which wide tuning ranges are achieved.

* Decimal classification: R141.2×R355.9. Original manuscript received by the Institute, May 10, 1945. Presented, Boston Section, January 19, 1945.

† General Radio Company, Cambridge, Mass.

SLIDING-CONTACT-TYPE TUNING UNITS

The arrangement from which the development originally stemmed is shown in Fig. 1. This consists of a variable capacitor of conventional design, with a single turn of silver ribbon mounted coaxially with the shaft. One end of the ribbon is connected directly to the stator; a sliding contact mounted at the tip of the rotor

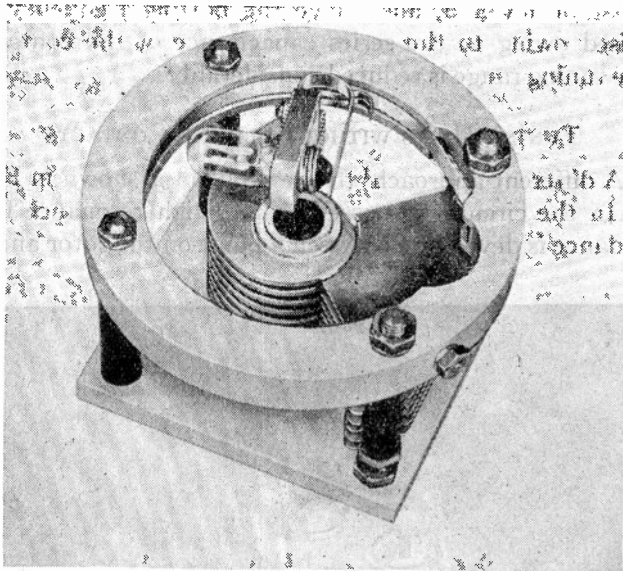

Fig. 1—55- to 400-megacycle wavemeter. Adaptation of conventional tuning capacitor.

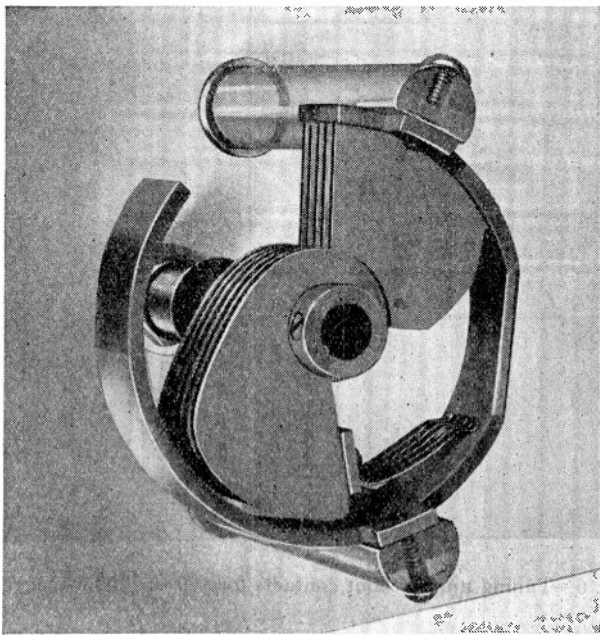

Fig. 2—Contact-type tuning unit for 60 to 660 megacycles.

bears on the ribbon and closes the circuit. When the capacitor plates are fully meshed, the entire loop is connected in circuit; when the capacitor plates are out of mesh, only a small portion is subtended. The inductance therefore varies in the same manner as the capacitance, and the tuning range is considerably greater than that obtainable with capacitance variation alone. In the

wavemeter shown, for instance, a 7-to-1 range from 55 to 400 megacycles is achieved.

Fig. 2 shows a circuit which has been designed to have lower losses in the metallic structure. In this version the inductance band is so mounted as to form the support for the stator plates, and the multiple-finger sliding contact is mounted on a bar that makes contact with the leading edges of all the rotor plates. This construction provides an individual current path to each plate, and a consequent reduction in losses and improvement in Q . The capacitance of this unit, which has an inside band diameter of $2\frac{1}{4}$ inches, and 4 and 5 plates on the stator and the rotor respectively, varies between 7.4 and 118 micromicrofarads, and the inductance between 7.8 and 59 centimeters, giving a frequency range of 60 to 660 megacycles. The law of inductance variation is fixed by the band configuration, but the capacitance variation can be controlled by shaping the capacitor plates to produce a desirable variation of frequency with angle. The plates shown in Fig. 2 give a logarithmic frequency scale, which gives constant fractional accuracy. Fig. 3 shows inductance, capacitance, and frequency variation plotted against dial rotation.

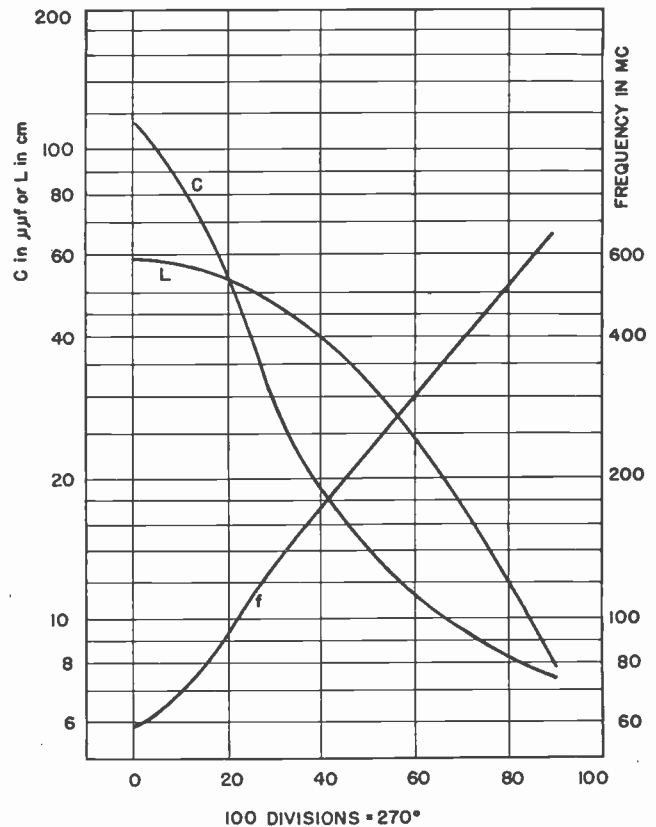

Fig. 3— L , C , and f variation of unit shown in Fig. 2.

A similar unit for higher frequencies is shown in Fig. 4. This assembly, which includes a crystal detector and coupling loop, is a wavemeter with a range of 250 to 1200 megacycles. The Q of this circuit, measured without shielding, is 450, 200, and 60 at frequencies of 250, 500, and 900 megacycles.

The unused part of the inductance band, projecting beyond the point of contact, is closely coupled to the tuned circuit and resonates at a high frequency. The end of the band is usually connected to the rotor to keep the resonant frequency outside the range of the tuned circuit. This connection can be seen in Fig. 4 and

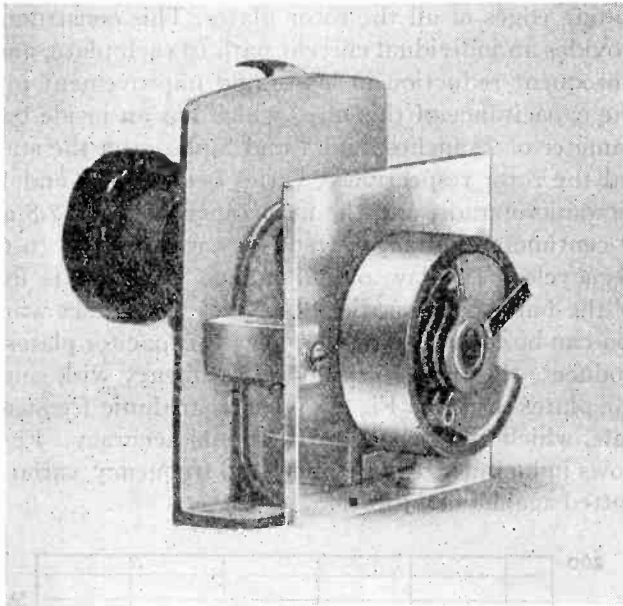

Fig. 4—250- to 1200-megacycle circuit. Coupling loop and block, containing crystal detector, are seen at bottom.

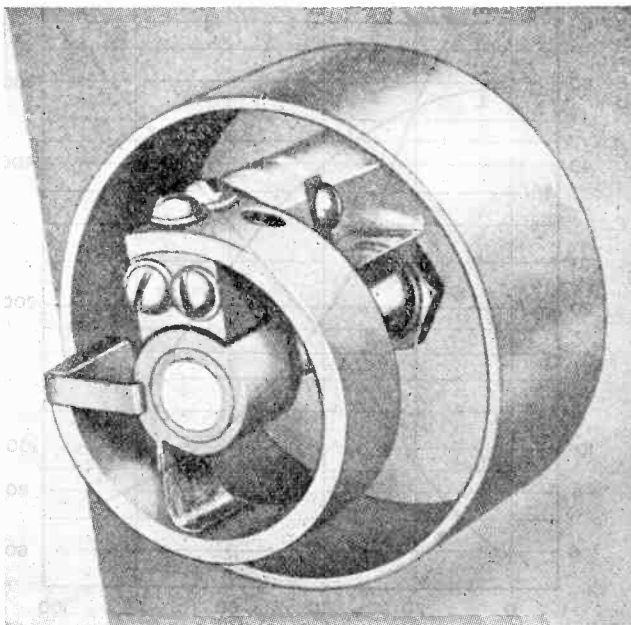

Fig. 5—400- to 1600-megacycle wavemeter. End of stator band connected to rotor.

also in Fig. 5, which shows a 400- to 1600-megacycle wavemeter of somewhat different design in which the capacitance is varied by an eccentric hub of the rotor.

Circuits of the type illustrated have found many practical uses where very wide tuning ranges are desirable. The sliding contacts, however, are disadvan-

tageous for applications involving requirements for low noise, long wear, and precise frequency setting since good sliding contacts for high frequencies are notoriously difficult to construct. To avoid these difficulties, the conductive contact can be replaced by a capacitive contact, but resonance effects can no longer be suppressed by short-circuiting the end of the band to the rotor. Consequently, the top frequency of the circuit must be lowered, and, since the bottom frequency is raised owing to the series capacitance of the contact, the tuning range is reduced considerably.

TUNING UNITS WITHOUT SLIDING CONTACTS

A different approach¹ to the problem is shown in Fig. 6. In the circuits discussed so far, high resonance impedance is developed between a point on the rotor and a

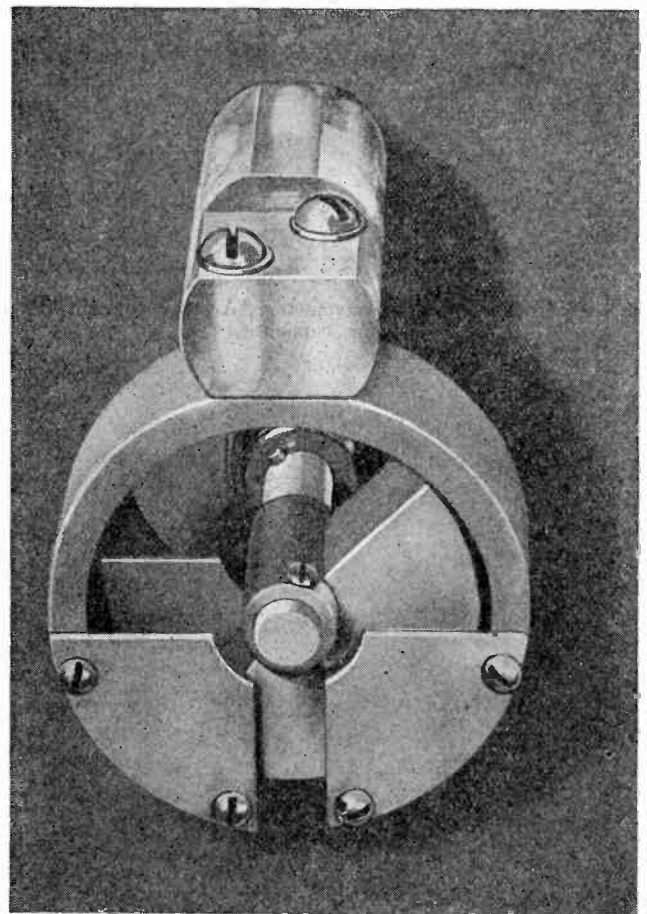

Fig. 6—Tuning unit without contacts for 400 to 1200 megacycles.

point on the stator. In the new circuit, the semi-butterfly circuit, so called because of its relation to the butterfly circuit discussed later, the highest impedance appears between two points on the stator.

In the unit shown a solid rotor forms an eddy-current shield in the magnetic field and a series-gap capacitor with the stator plates. When the rotor is completely meshed, the inductance is substantially that of the

¹ U. S. patent No. 2,367,681.

semi-circular band on which the stator plates are mounted, and the capacitance is a maximum; when the rotor is completely out of mesh, the inductance is reduced by the shielding effect of the rotor, which now blocks off nearly all the space previously traversed by the magnetic field, and the capacitance is a minimum. There is, therefore, a similar variation in both capacitance and inductance and an extension of range corresponding to that obtained with the sliding-contact units.

The plates of the semibutterfly circuit are shown in four different positions in Fig. 7. To change from the

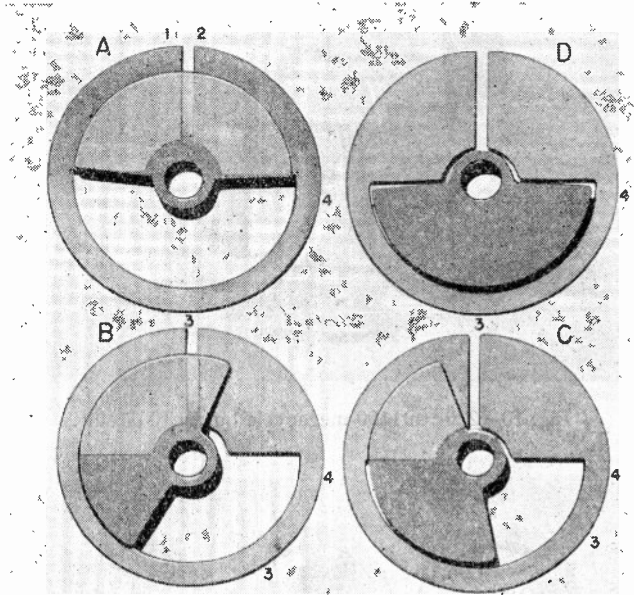

Fig. 7—Stator and rotor plates of semibutterfly circuit. Capacitance and inductance between points 1 and 2 on the stator are at maximum in A and at minimum in D.

lowest frequency position shown at A to the highest frequency position shown at D, the rotor is turned through 180 degrees. In position A the capacitance between points 1 and 2 on the two stator plates is a maximum. In position B the capacitance is almost a minimum and, as the rotor is turned, changes only slightly until position D is reached. The inductance between points 1 and 2 is likewise a maximum in position A and changes to minimum through positions B and C to position D. The change in inductance of the semicircular band is brought about as the rotor gradually fills up the opening of the inductance loop. In the final position D, lines of magnetic flux are restricted to the small gap between rotor and stator.

In this design, wide tuning range with simultaneous change of capacitance and inductance is obtained by rotation of a member that does not require any electrical connections. The rotor shaft can be made of insulating material, and the flow of radio-frequency currents through the bearings of this shaft is easily avoided.

A cross section of the unit of Fig. 6 is shown schematically in Fig. 8A. The rotor is a solid block. The stator

carries a pair of plates on each end of a circular band. The cross section of the band corresponds to the double-cross-hatched area. The obvious extension of this arrangement is to use several rotor and several stator plates, as in a variable air capacitor. This is illustrated in Fig. 8B, which shows a construction in which the inductance has also been increased by reducing the width of the inductance band. Fig. 8C illustrates a construction in which the capacitance and inductance are decreased by measures opposite to those employed in 8B, with a concomitant increase in frequency.

The resonant frequency of any of these circuits in the fully meshed position is changed most effectively by a change in size. Capacitance and inductance increase,

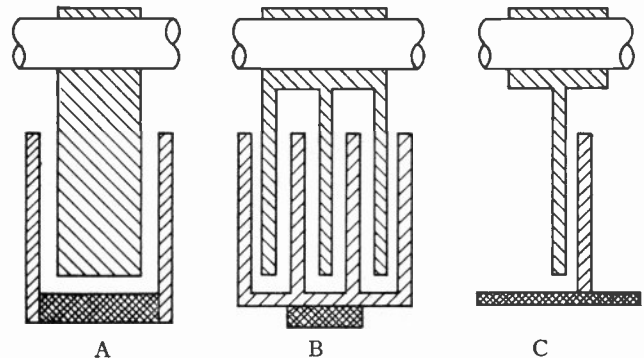

Fig. 8—Cross section of butterfly circuit with different types of design. The double-cross-hatched section represents the inductance band.

and frequency decreases, approximately as the square of the diameter. The resonant frequency in the unmeshed position, however, does not vary as rapidly, and the tuning range, therefore, tends to increase proportionately to the diameter.

The law of inductance variation is determined by the geometry. In general, the inductance variation will be considerably smaller than in the circuits with sliding contacts, and will be further reduced if the rotor plates are cut away to modify the frequency distribution. The reduction of tuning range, the price that has to be paid for a desirable frequency distribution, is therefore much greater in the butterfly circuit than in a conventional tuning condenser.

A further modification that yields a lower inductance-capacitance ratio is used in the 100- to 500-megacycle oscillator shown in Fig. 9. This circuit uses 120-degree sections for the stator plates and a 240-degree section for the rotor. The rotor turns through 120 degrees. The capacitance and inductance vary simultaneously throughout the angle of rotation.

It is important to keep in mind that these new tuning devices are two-terminal impedances only. The terminals are designated 1 and 2 in Fig. 7. No point on any of the circuits electrically maintains its position relative to these terminals over the tuning range, in the sense, for instance, of a tap on a coil with respect to the ends of the winding. In Fig. 7, the point 3, at which the

potential is midway between those of the terminals 1 and 2, is physically located midway between these points only in the two extreme positions A and D and shifts toward terminal 2 for intermediate settings. The potential of the rotor is midway between points 1 and 2 in position A and D but shifts toward that of terminal 1 for intermediate settings.

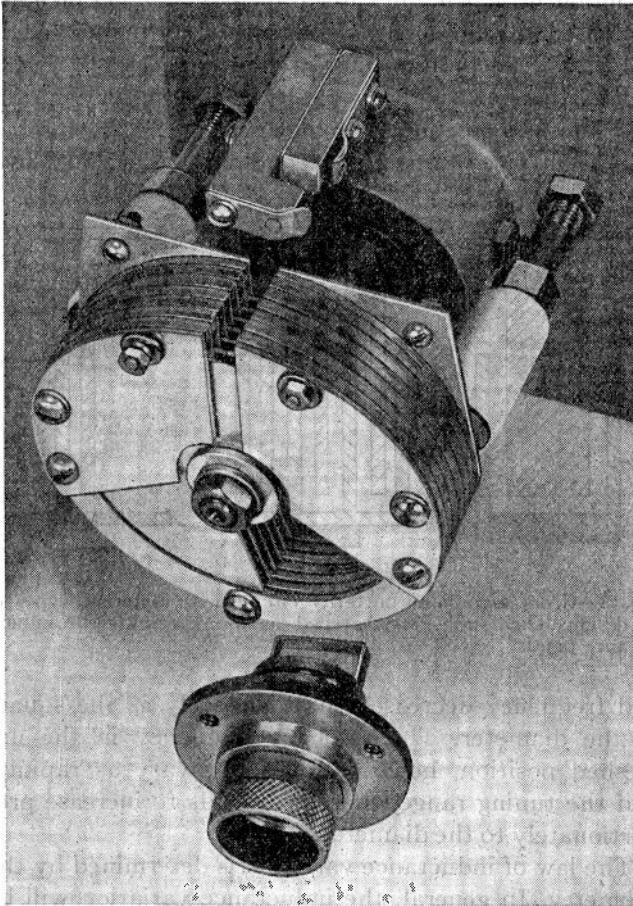

Fig. 9—100- to 500-megacycle oscillator. Inductive coupling to the load is varied by rotation of the coupling loop in lower part of the picture.

Any point of the circuit can be connected to ground, but it is convenient at times not to make any definite connections. This is often desirable in an oscillator circuit, for instance, where plate and grid of a tube are connected to the two terminals and where the cathode is grounded. The optimum method of coupling a load to a circuit depends upon the ground arrangement. If one terminal is grounded, electrostatic coupling is most convenient. When the circuit is left floating, electromagnetic coupling is more desirable. The only point where effective magnetic coupling over the entire tuning range can be obtained is shown as point 4 in Fig. 7. The oscillator shown in Fig. 9 uses this type of coupling. By rotating the coupling loop, the amount of coupling can be varied without disturbing the "floating-ground" condition of the oscillator.

THE BUTTERFLY CIRCUIT

A balanced version of the circuit just described is shown in Fig. 10. The new circuit, known as the butterfly circuit because of the shape of the rotor plates, may be thought of as a parallel combination of two of the previous circuits.

The rotor of the butterfly circuit is always symmetri-

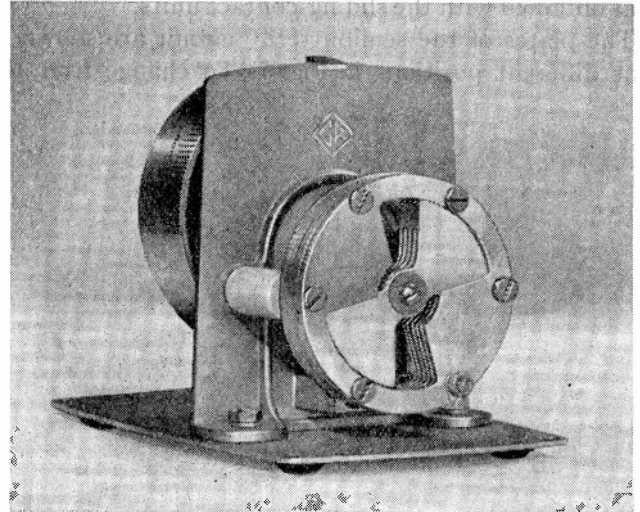

Fig. 10—220- to 1100-megacycle butterfly circuit.

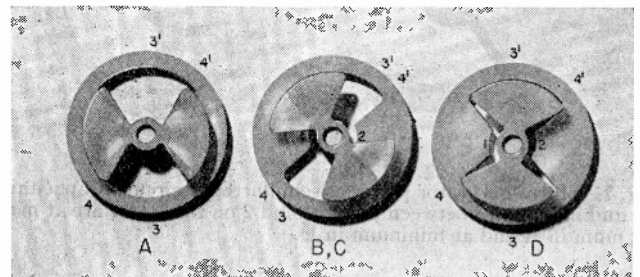

Fig. 11—Stator and rotor plates of butterfly circuit. Capacitance and inductance between points 1 and 2 on the stator are at maximum in A and at minimum in D.

cally located between the terminals and variation of its capacitance to ground during rotation does not affect the balance of the circuit. Mechanical stability under vibration or temperature variation is greatly improved by the elimination of the gap in the outer contour of the new circuit.

Figs. 11A, B, C, and D show rotor positions that correspond to the positions shown in Fig. 7, but the angle of rotation is now reduced to 90 degrees. Points 3 and 3' are the electrical midpoints between the terminals 1 and 2, and points 4 and 4' are the locations for magnetic coupling. The two bands in this circuit form parallel inductance paths and the inductance-capacitance ratio, therefore tends to be lower than for a comparable semibutterfly circuit. In other respects the circuits are similar and the discussions in the previous paragraphs can be directly applied for the butterfly circuit.

Fig. 12 is the close-up view of the 100- to 200-megacycle oscillator of a heterodyne frequency meter. The rotor plates are shaped to provide a logarithmic frequency distribution. The 958 acorn-type oscillator tube, seen in the rear, has its grid and plate connections made to extensions of the two stator sections, and the cathode is connected directly to the housing. Fig. 13 shows the smallest butterfly circuit built so far, together with an acorn tube and a Type 1N22 Detector. This circuit has a tuning range of 900 to 3000 megacycles.

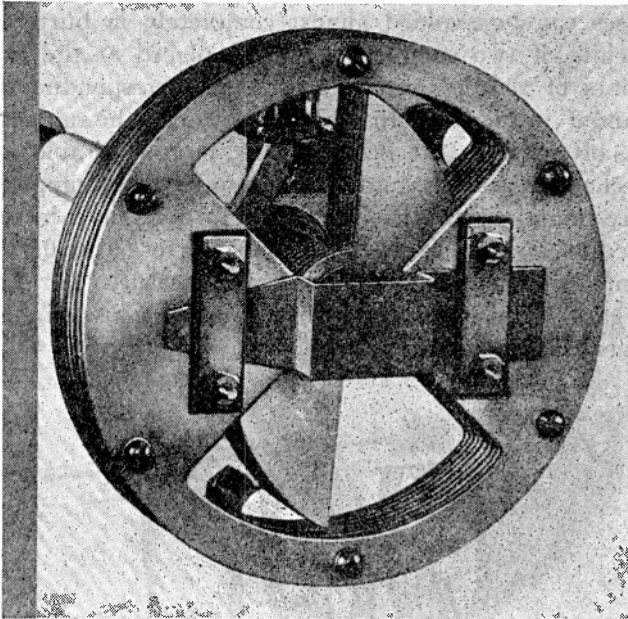

Fig. 12—100- to 200-megacycle butterfly circuit of heterodyne frequency meter.

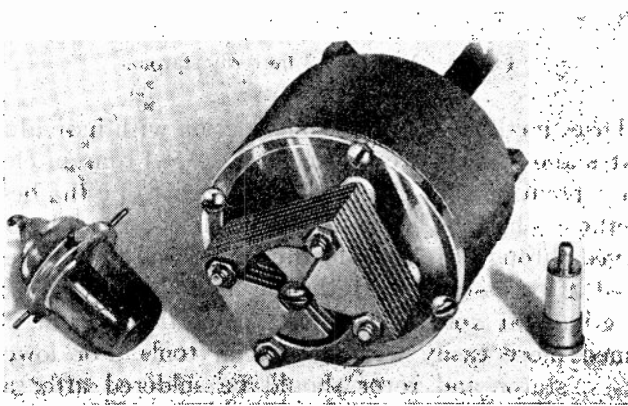

Fig. 13—900- to 3000-megacycle butterfly circuit. Acorn tube and 1N22 detector are shown for size.

DESIGN OF BUTTERFLY CIRCUITS

It was mentioned in the introduction that the equivalent Q of a resonant transmission line is of the order of $0.1D\sqrt{f}$. A quarter-wave line covering the range from 220 to 1100 megacycles would be about $13\frac{1}{2}$ inches long and might have a diameter of 2 inches. The theoretical Q would be 3000 at 220 megacycles and 6300 at 1000 megacycles. To cover this frequency range, the length

of the line must be varied over 10 inches. The circuit shown in Fig. 10, which has an outside diameter of $2\frac{1}{2}$ inches, exactly covers this range with a Q of 650 at 220 megacycles and of 300 at 1000 megacycles.

While the losses in butterfly circuits are generally higher than those of comparable concentric lines, values of Q can be obtained that are sufficient for many applications. The characteristics of the butterfly circuit shown in Fig. 10 are given in Table I, together with the

TABLE I

	Circuit of Fig. 10. Low-High	In General Low-High
Frequency	220-1100 megacycles	$1-n^2$
Inductance	0.011-0.0041 microhenry	$1-n^{-1}$
Capacitance	48-5 micromicrofarads	$1-n^{-3}$
Q	650-300	$1-n^{-1}$
$R = \omega L / Q$	0.023-0.095 ohm	$1-n^2$
$\sqrt{L/C}$	15.2-28.6 ohms	$1-n$
$Z = Q \sqrt{L/C}$	9800-8600 ohms	Constant

variation in these characteristics that can generally be obtained by varying design factors. In the third column, n is a factor between 1.5 and 3.5, depending on design and size, with the lower values applying for the smaller units.

The maximum inductance of butterfly circuits in the closed position can be computed by standard inductance formulas by taking $\frac{1}{8}$ of the inductance of the full ring and multiplying by a factor of 1.35 to allow for the contribution of the stator and rotor plates. For instance, $L = 1.35 \times \frac{1}{8} \times 0.01257r \ln(36r/(t+w) - 2) 10^{-6}$ henry or

$$L = 4.9r \log 4.9r/(t+w) \text{ centimeters.}$$

Another formula that gives fairly accurate results is

$$L = \frac{\pi^2}{6} r^2 - r_1^2 \left(\frac{1}{t+w} + \frac{1}{\sqrt{r^2 - r_1^2}} \right) \text{ centimeters}$$

where r is the inside radius of the band, r_1 is the outside radius of the rotor hub, and t and w the thickness and width of the band, all in centimeters. The minimum inductance depends to a great degree on the clearance between the circumferential rotor-plate edges and the inductance band, and on the clearance between the radial rotor-plate and stator-plate edges. This latter clearance cannot be reduced very far without adding capacitance and lowering the top frequency. In general, the ratio of maximum to minimum effective inductance will be between 1.5 and 3.5. The highest ratio actually obtained has been 4.6 in a circuit with a band diameter of $5\frac{1}{4}$ inches and $1/16$ -inch clearance between all adjacent stator and rotor edges. In this particular case the capacitance ratio of the 14-plate unit was 22 and the frequency range 47 to 470 megacycles.

Maximum and minimum capacitance of a butterfly circuit can be computed as in a variable air capacitor. Owing to the butterfly shape, capacitance ratios are considerably less than in well-designed conventional tuning condensers. Fig. 14 shows inductance, capacitance, and frequency plotted against dial rotation for

the 220- to 1100-megacycle butterfly circuit of Fig. 10.

One effect of changing the number of plates deserves special mention, although it has not been fully explored.

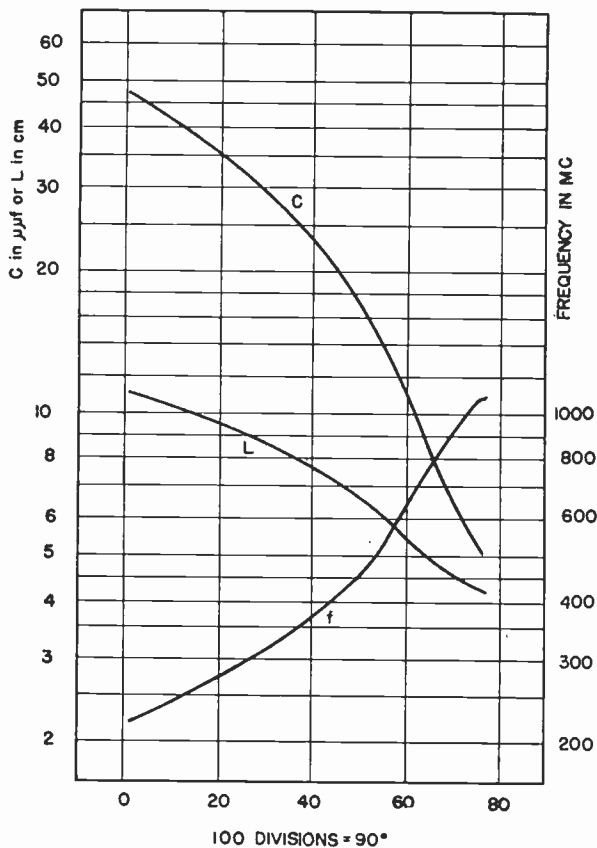

Fig. 14— L , C , and f variation of unit shown in Fig. 10.

As expected, the ratio of maximum to minimum capacitance increases with the addition of plates, and the inductance of the stator decreases owing to its increased width (designs where the band differs in width from the stator, as shown in Figs. 8B and 8C have only rarely been used in practice). For very few plates, however, the inductance can decrease more rapidly than the minimum capacitance increases, and a butterfly circuit with four plates, for instance, may have a lower low- and a higher high-frequency limit than with two plates. As further plates are added, the range is shifted to lower frequencies and the span slightly increased, but soon higher order modes of resonance begin to appear within the tuning range. These modes are seldom important in oscillator circuits, where oscillations generally occur only at the lowest-order mode, but they often cause undesirable spurious responses in wavemeter and other filter applications. It appears that these modes can be suppressed or at least can be shifted in frequency by the addition of short-circuiting connections across the radial plate edges of the four groups of plates. Two connections can be made at the inside of the stator and two at the outside of the rotor on the radial edges of the plates where they do not interfere with the rotation of the rotor. These connections can be seen clearly in Fig. 10.

The need for short-circuiting the plates ordinarily can be avoided by using a large unit with a few plates instead of a small unit with a large number of plates to cover the desired frequency range.

The equivalent series resistance of a butterfly circuit increases with frequency. The Q is therefore lowest at the high-frequency end where the Q of a transmission line is highest. The increase in equivalent resistance is due to the fact that the change of inductance in the butterfly circuit is caused by eddy currents in the rotor and not by a reduction of conductor length. Dielectric losses can be avoided almost completely in butterfly circuits, if two supports are used, placed at the two points of zero potential to ground, corresponding to 3 and 3' in Fig. 11A. In practice, however, the supports are often placed at other points, more desirable for mechanical reasons, and on large units three supports may be required. It is interesting to note that, in the circuit shown in Fig. 10, about one quarter of the 0.023-ohm equivalent series resistance, measured at 220 megacycles, is accounted for by the metallic losses in the silver-plated inductance band.

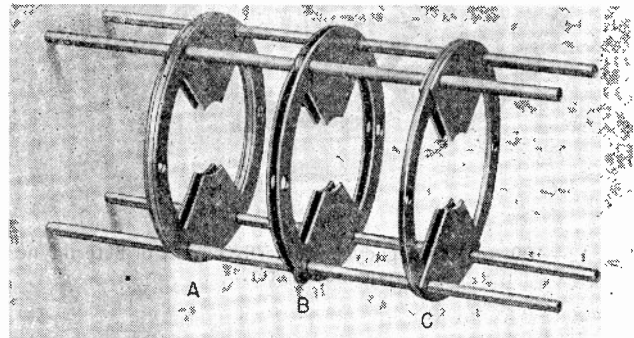

Fig. 15—Assembly of butterfly stators.

Three methods of stator construction with individual plates and spacers are shown in Fig. 15. From an electrical point of view, Method A appears to be the best. Method B has the advantage that the rotor can be observed through the slots in the stator and can be centered after assembly. Method C may be desirable in experimental work since it uses parts that can be obtained more easily without special tools. For lowest losses, stator and rotor should be soldered after assembly and plated with a material of high conductivity.

OSCILLATOR CIRCUITS

The various tuned circuits described so far have been considered as general tuning assemblies without particular reference to their application. Their important common characteristics when used as oscillators are their compactness and small physical size, and their general adaptability for ungrounded operation. These characteristics make them particularly useful in triode oscillators, in which they form resonant circuits between grid and plate, and the tube interelectrode

capacitances furnish the feedback necessary to sustain oscillation. This simple circuit is shown in Fig. 16.

In this circuit, the relative potentials of the grid and plate with respect to the cathode are determined by the net grid-cathode and plate-cathode capacitances. At low frequencies the capacitances to ground of the tuned circuit add directly to the interelectrode capacitances of the tube to form these net capacitances. At high frequencies, however, the lead inductances modify the effect of the capacitances external to the tube, and the feedback tends to change with frequency. The problem of maintaining favorable feedback conditions over wide ranges is difficult to solve as the resonant frequency of the oscillator tube is approached.

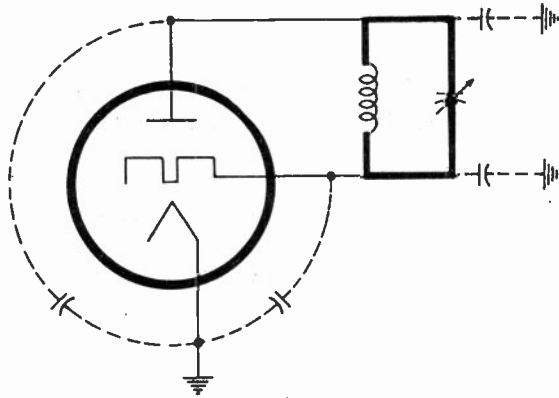

Fig. 16—Preferred circuit for wide-range oscillators.

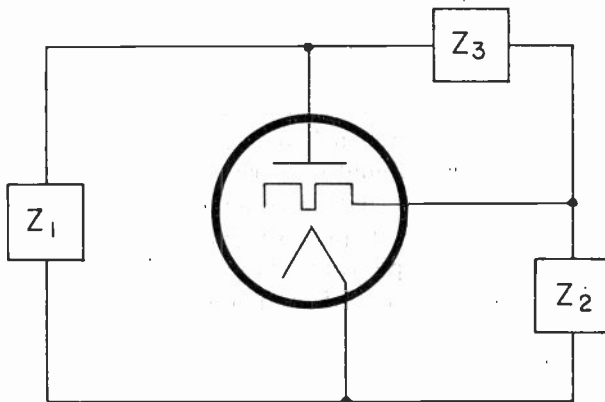

Fig. 17—Fundamental oscillator circuit.

A fundamental oscillator circuit is illustrated in Fig. 17. If the impedances Z_1 , Z_2 , and Z_3 are assumed to be pure reactances, jX_1 , jX_2 , and jX_3 , it can be shown readily that the conditions for oscillation are given by

$$X_1 + X_2 + X_3 = 0 \quad (1)$$

and

$$X_2 = X_1/\mu. \quad (2)$$

These relations show that the reactances between grid and cathode, and plate and cathode, must be of the same sign, and that, since series resonance occurs around the loop Z_1, Z_2, Z_3 , the reactance between grid and plate must be of opposite sign. Any oscillator that depends upon the normal use of the characteristics of conventional negative-grid tubes can, by suitable rearrange-

ment of its circuit, be shown to fit this representation, the Colpitts and Hartley circuits being the most obvious illustrations.

Other oscillator circuits can be drawn, of course, that represent more closely particular oscillators. Magnetic coupling between a plate and grid coil or common impedances in the lead wires to the tube electrodes are features that cannot be expressed in an obvious manner in the circuit shown in Fig. 17.

The circuit used with the butterfly and other wide-range oscillators has fixed capacitive grid-cathode and plate-cathode reactances and is similar to a Colpitts circuit, the tuned circuit operating below resonance to furnish the required inductive reactance. Z_3 is the only variable element.

The effect of losses is to modify the equations derived for pure reactances. As before, oscillations occur at the frequency for series resonance around the loop, but the tube now has to develop power to supply the circuit losses and so sustain oscillations.

To obtain stable oscillations, the tube should be coupled loosely to the circuit. To obtain large power output, impedance matching is required and proper adjustment of bias and feedback voltages. In high-frequency wide-range oscillators these considerations cannot be applied, as in low-frequency oscillators where circuit constants can be chosen at will. The problem is rather to obtain oscillations with available tubes and tuning units, and it has been found that best results are obtained at high frequencies if X_1 and X_2 are of the same order of magnitude. This corresponds to a tap near the center in a Colpitts circuit and to about equal plate-cathode and grid-cathode capacitances in the circuit of Fig. 16.

Many high-frequency triodes do have interelectrode-capacitance ratios that approximate unity, and these may be classed, for use with wide-range oscillators, as tubes having properly balanced interelectrode capacitances. At low frequencies, tubes that do not fall in this class can be made to operate satisfactorily by adding external capacitance. As the operating frequency is increased, lead inductances tend to resonate with the added capacitances. So long as the resonant frequencies of these external paths can be maintained well above the operating frequency of the oscillator, satisfactory operation over wide ranges can be obtained.

As the resonant frequency of the tube is approached, this condition cannot prevail. Oscillations still can be obtained at any one frequency by adding external reactances which will produce the desired capacitive reactance in combination with the reactance of the leads, but the required external reactance changes with frequency. Simple oscillators with a single variable element work over wide tuning ranges near the resonance frequency of a tube only if the tube has properly balanced electrode capacitances.

External capacitances are always present in a completed oscillator even if we do not add them intentionally.

They are shown in Fig 16 as the capacitances of the tuning unit to the surrounding housing, and their effect is usually to produce irregularities in the oscillation level, either regions where oscillations are weak or stop altogether, or regions where oscillations are unusually strong or motorboating occurs. Eliminating these irregularities is often a tedious process, and all possible precautions should be taken to prevent them. It has been found desirable to operate the tuned circuit without any direct connections to ground, to use an insulated rotor shaft, and to isolate the cathode of the oscillator tube from ground by a choke. This choke inserts a very high impedance in the cathode lead, which largely isolates the cathode from ground. The cathode then "floats" on the choke, and its potential with respect to grid and plate is almost entirely determined by the interelectrode capacitances. If these are properly balanced, excellent performance results at the highest frequencies, since a minimum of lead inductance is involved in the feedback paths. Further chokes are required to feed plate and grid of the tube, and all chokes may have to be damped by resistances. "Chokes" in high-frequency wide-range oscillators are usually coils wound with many turns, used beyond their resonant frequency where their reactances are capacitive.

If a completed oscillator operates uniformly over a wide tuning range with low output, it is found frequently that the efficiency can be increased at any one point in the tuning range, but only by making conditions worse at another point. It has been shown that this is caused by improper balance of electrode capacitances and that no simple remedy can be found. Such single-control oscillators will often furnish sufficient power for certain applications, and be more desirable than more complicated structures that require more than one adjustment for operation at high efficiency.

It has been suggested that push-pull-type oscillators might overcome the difficulty of unbalanced interelectrode capacitances, and might even be useful with well-balanced tubes. It appears that push-pull oscillators will not work where single-tube oscillators fail. Push-pull oscillators have a certain amount of symmetry that is not obtained in single-tube circuits, and the problem of feeding supply voltages to the tube electrodes is simplified, but all these details can be handled by proper design of a single-tube oscillator. So far as the balancing of plate and grid voltage of the individual tubes is concerned and the maintenance of proper phase relation within each tube, the second tube does not act differently from an external feedback condenser. In fact, the resonant frequency of the interconnecting circuit will usually be much lower than the resonant frequency of the equivalent balancing or feedback capacitor and its leads. It is obvious that push-pull circuits can be used in wide-range oscillators only at operating frequencies well below the resonant frequency of the interconnections. The chief advantage that results from push-pull

operation is, therefore, the additional power that can be generated.

OSCILLATOR TUBES

A wide variety of negative-grid tubes has been used

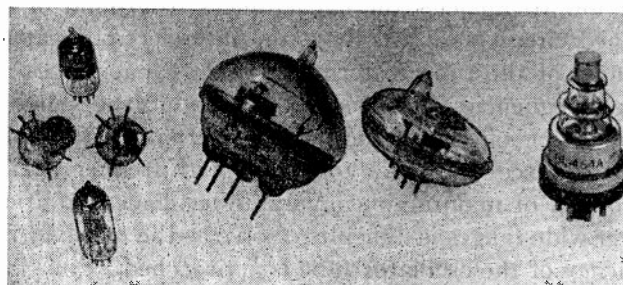

Fig. 18—Four types of triodes available for high-frequency oscillators.

with butterfly circuits, representative types of which are shown in Fig. 18 and listed in Table II.

TABLE II

Lighthouse or Disk-Seal Types	Doorknob Types	Miniature Types	Acorn Types
GE 446-A (2C40)	WE 316-A	6AK5 ²	955
GE 464-A (2C43)	WE 368-A	9002	958
	WE 703-A	6AG5	6F4
		6C4	
		6J4	
		6J6	

The first butterfly circuits developed for frequencies up to 1000 megacycles used the double-ended Western Electric Type 368-A triode and its successor, the single-ended Type 703-A. Both of these "doorknob" tubes have resonant frequencies² of about 1700 megacycles and are rated at 25 watts plate dissipation. For lower frequencies, up to 500 megacycles, another doorknob-type tube that was found to work well was the Western Electric Type 316-A, with a resonant frequency of 700 megacycles and 30-watt plate dissipation.

The doorknob-type tubes have thoriated filaments requiring from 3.5 to 4.5 amperes. For lower power applications the Radio Corporation of America acorn tubes have also been found to operate satisfactorily, and their low-power indirectly heated cathodes make it possible to avoid some of the problems of filament-type tubes. The Types 955 and 958 have resonant frequencies of about 700 megacycles and 2 watts plate dissipation.

More recently, miniature tubes with high resonant frequencies have been made available. They are similar to the acorn types except for the bulb and base. They have been used successfully in butterfly circuits up to 500 megacycles. Highest output is obtained with the 6C4, which is rated for 5 watts plate dissipation.

All these tubes have plate and grid terminals located close together, and short connections can be made to the high impedance points of a butterfly circuit, indicated as 1 and 2 in Figs. 7 and 11. It has been found

² Resonant frequency, as used here, is defined as the frequency at which the grid-plate circuit resonates when the tube terminals are connected by the shortest external path.

that, with these tubes, wide-range oscillators can be built with output frequencies as high as 70 or 80 per cent of the resonant frequency of the tubes.

The highest resonant frequencies are obtained at present in the General Electric disk-seal or lighthouse-type tubes. Plate dissipation of these tubes depends on the method of cooling, and is ordinarily over 6 watts. The tubes were built for use with coaxial lines, with which they function admirably well even beyond their resonant frequencies, but so far no circuit has been found where proper feedback can be maintained over a wide tuning range at high frequencies with a single tuning adjustment. The upper frequency limit of lighthouse-type tubes without adjustable feedback circuits is about 700 megacycles. This frequency, which is only about 35 per cent of the resonant frequency of the tube, is determined by the unusually low ratio of plate-cathode to grid-cathode interelectrode capacitance.

Coaxial-line oscillators generally used with these tubes do not depend for feedback on the electrode capacitances. They usually have two adjustable line sections connected between plate and cathode and grid and cathode of the tube, with capacitive or inductive coupling between them. The plate-cathode capacitance of the tube has purposely been reduced to an extremely small value. In practice the two adjustable line sections are sometimes connected by a cam arrangement and single-dial control is possible over limited frequency ranges.

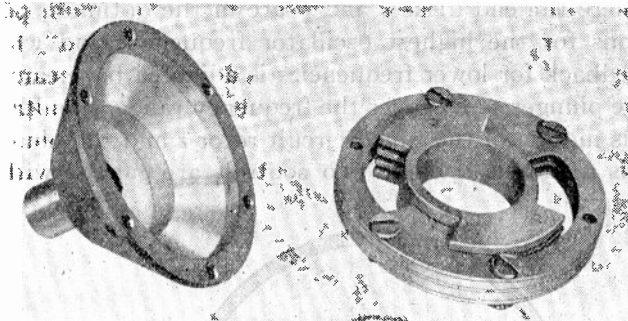

Fig. 19—Inverted butterfly circuit for 400 to 800 megacycles. In use, the circuit is mounted by 6 screws on the cone-shaped support shown at left.

Before the importance of the interelectrode-capacitance ratio in determining high-frequency performance in wide-range oscillators was fully appreciated, the problem of connecting the lighthouse tube to the butterfly circuit was believed to be of primary importance. The terminal arrangement of lighthouse tubes, as well as their electrode structure, was designed for use with coaxial transmission lines and gives the tube a shape that is not easily connected to the butterfly circuit. An attempt to build a more suitable tuning unit for use with lighthouse tubes led to the development of the inverted butterfly circuit shown in Fig. 19. Here the functions of the outer and inner tuning elements have been interchanged. In the butterfly, the circuit inductance

is incorporated in the outer ring. In the inverted butterfly, the center part of the inner element is enlarged and is used as the circuit inductance. The inductance of the outer element is short-circuited by the cone-shaped member shown at the left. A lighthouse tube can be inserted into the center hole of this unit, and very short connections made to plate and grid. Although lead inductances are minimized by the coaxial mounting, the upper frequency of oscillation is not appreciably higher than that obtained with the conventional butterfly.

COAXIAL BUTTERFLY

To make use of the excellent high-frequency performance of the lighthouse tube, a further variant of the butterfly circuit has been developed which has been named the coaxial butterfly.

Since lighthouse tubes are designed for use in coaxial lines, the new butterfly-type tuning circuit uses the elements of a coaxial line. The two extreme positions of the basic circuit are shown in Fig. 20. The coaxial butterfly consists of a coaxial line short-circuited at one

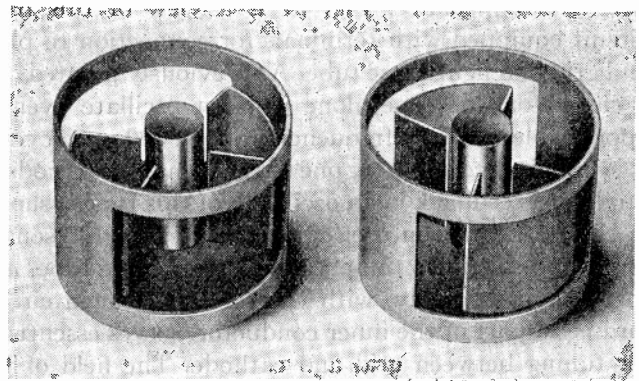

Fig. 20—Basic form of coaxial-butterfly circuit. High-frequency position is shown at left, low-frequency position at right.

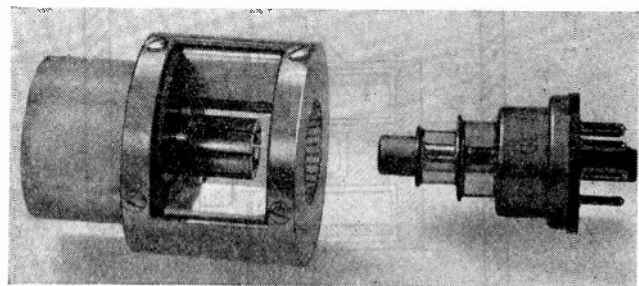

Fig. 21—Coaxial-butterfly circuit with terminals and oscillator tube.

end and open at the other. The outer conductor is not a full cylinder, two 120-degree sections of the line having been cut away. Rotating freely between the outer and inner conductors is the frequency-determining element consisting of two 60-degree sections.

The resonant frequency is changed by varying the characteristic impedance of the line. Because the tube constitutes a capacitive load, the length of line at

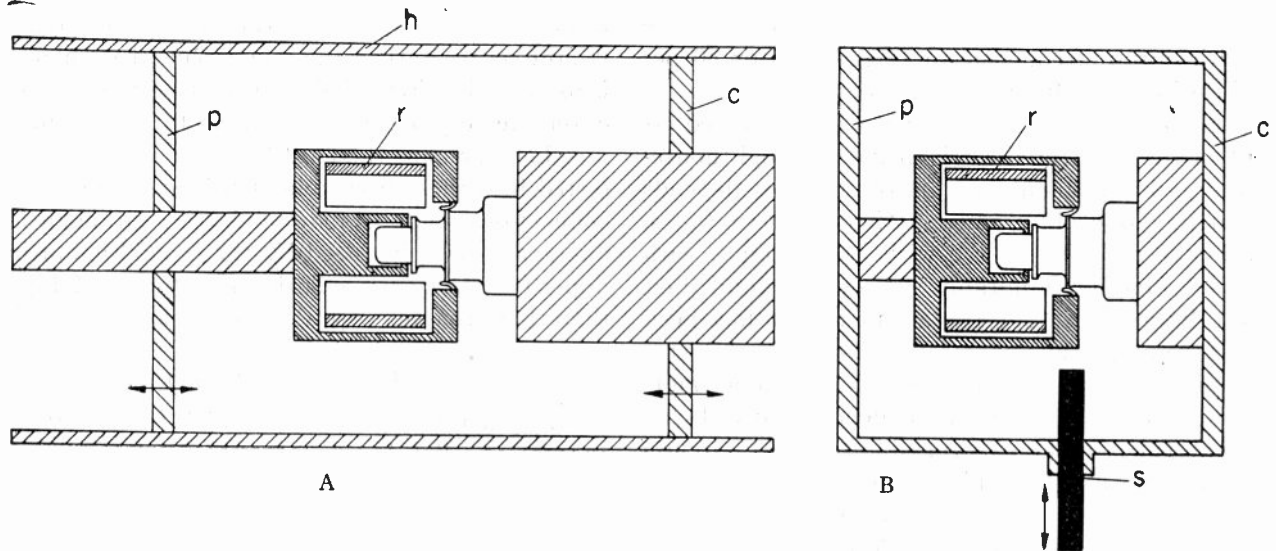

Fig. 22—Feedback circuits for coaxial oscillators using sliding contacts.

resonance is much less than a quarter wave. Under this condition, the effective input inductance of the line, and consequently the frequency, varies with the characteristic impedance. Fig. 21 is a view of this basic circuit equipped with terminals for connection to plate and grid of a lighthouse tube. As previously pointed out, a circuit of this type alone will not oscillate over an appreciable range at frequencies above 700 megacycles.

A circuit incorporating one of the common methods of producing feedback in an oscillator of this type is shown in Fig. 22A. The tuned circuit furnishes a high resonant impedance between the plate and grid of the tube, and the coaxial assembly, with the tube and tuned circuit forming a part of the inner conductor, serves essentially for tuning between grid and cathode. The field of the tuned circuit and the field of the coaxial assembly are

shorter build-up time can be obtained than are generally found in butterfly-circuit oscillators. This arrangement, however, calls for two adjustable elements in addition to the frequency-determining rotor, with two circular sliding contacts on each, and is not considered practical. Although this circuit will oscillate if only one of the two plungers is adjustable, high efficiency and short rise time cannot be obtained over a wide frequency range.

A simplification of the circuit is shown in Fig. 22B where the end disks *c* and *p* are in the optimum positions for the highest oscillator frequency, and where feedback for lower frequencies is adjusted by means of the plunger *s*. To cover the frequency range, simultaneous motion of the tuned-circuit rotor *r* and the plunger *s* is required. If these two controls are ganged with a

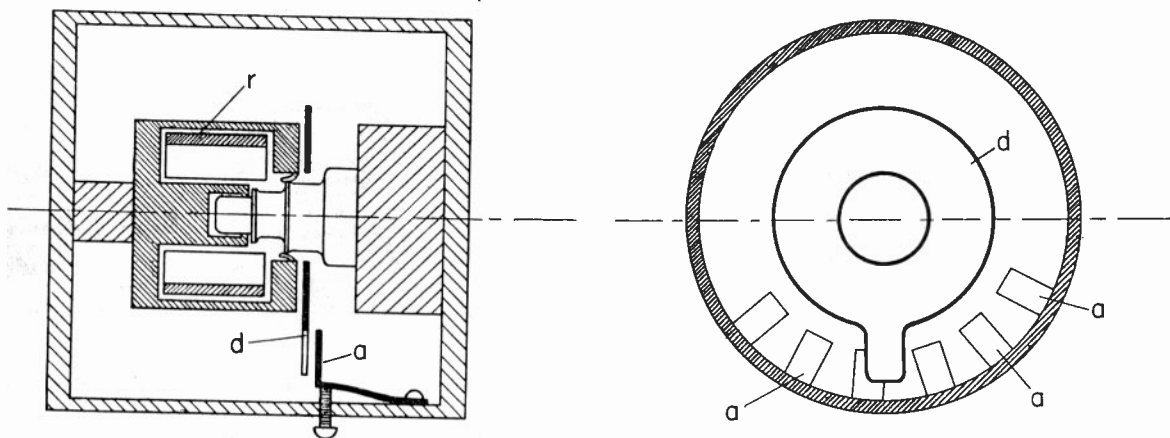

Fig. 23—Feedback circuit for coaxial-butterfly oscillator. Sliding contacts have been eliminated.

linked through the openings of the coaxial butterfly. Adjustment of feedback is obtained by moving the two disk-shaped plungers, *c* and *p*, within the cylindrical housing.

By the use of this circuit, not only can the upper frequency limit be raised but a higher efficiency and a

cam arrangement, oscillations over a wide frequency range can be obtained with good efficiency.

The final coaxial-butterfly oscillator design, illustrated in Fig. 23, is a further simplification. The plunger *s* which introduces capacitance between a point on the housing and a point on the tuning unit is replaced by

a series of adjustable plates *a*, which come successively in capacitive relationship to the disk *d* carried on the rotor element of the tuned circuit.

A cutaway view of a 1000- to 1300-megacycle oscillator of this kind is shown in Fig. 24. An output of one to two watts is obtained with an efficiency of about 30 per cent, and no sliding contacts are required. To obtain

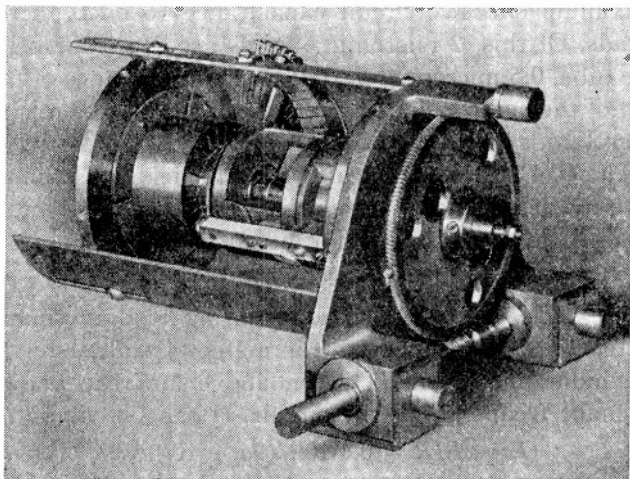

Fig. 24—Coaxial-butterfly circuit for 1000 to 1300 megacycles.

a predetermined frequency distribution, the outer line sections of the coaxial-butterfly circuit can be shaped. Part of the contour of one of these sections can be seen in Fig. 24.

Tuning ranges as high as 2 to 1 have been obtained in coaxial-butterfly circuits, but it has been found that feedback cannot be provided over these wide ranges by the simple arrangement shown in Fig. 23. It appears that the capacitance added between housing and tuned circuit should be distributed instead of being concentrated at a single point.

CYLINDER CIRCUIT

The problem of designing a circuit to make optimum use of the lighthouse tube has been aggravated by the difficulty of making short connections to tube terminals that were especially designed to fit coaxial lines. The same problem exists to some degree with all tubes, and a good deal of the thought that has gone into the design of wide-range tuned circuits has been expended in tailoring the mechanical shapes to fit available tubes.

Another tube that cannot be used to full advantage in butterfly circuits is the new Type 6F4 acorn triode. This tube has 2-watt plate dissipation and 1400-megacycle resonant frequency. This is about twice the resonant frequency of the older acorn tubes, which it resembles in appearance, except for the terminal arrangements. The grid is connected to 2 pins 180 degrees apart on the circular flange of the tube and the plate to 2 adjacent pins between them, across from heater and cathode.

High resonant impedance in the butterfly circuit is developed between two points on the stator. To take full

advantage of the high resonant frequency of the 6F4 tube, a tuning circuit is required in which high resonant impedance is developed in a way to provide unipotential connections to the two widely spaced grid terminals and to the two terminals of the plate. This requirement is fulfilled in the cylinder circuit shown in Fig. 25. In its simplest form the new circuit consists of two slotted

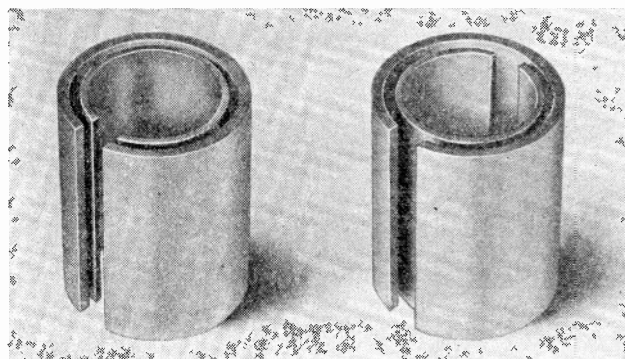

Fig. 25—Basic form of cylinder circuit. High-frequency position is shown at left, low-frequency position at right.

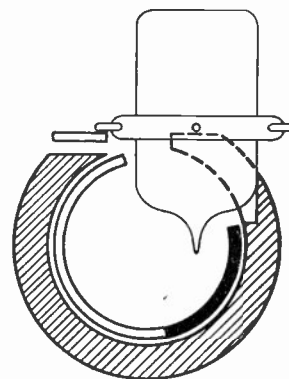

Fig. 26—Cross section of cylinder circuit, showing location of oscillator tube. Rotation of inner cylinder is restricted.

cylinders, one rotating inside the other. High resonant impedance is developed across the slot of the outer cylinder. The resonant frequency is at maximum in the position shown at left and at minimum in the position shown at right. The variation of resonant frequency is brought about by variation of capacitance across the slot, the inductance remaining practically constant.

Fig. 26 is a cross-sectional view of the basic circuit with the cylinder cut away to permit short connections to the oscillator tube. The tube is mounted on the outer cylinder with the two grid leads resting directly on one side of the slot and the two plate leads held above the other. The position of the tube limits the rotation of the inner cylinder to an angle of about 200 degrees. Fig. 27 shows a laboratory model of a cylinder oscillator with a range of 450 to 1050 megacycles.

The law of frequency variation is determined by the shape of the inner cylinder. An inner cylinder for logarithmic frequency variation is shown in the foreground of Fig. 27. The load is coupled to the circuit by a loop mounted on the housing. Fig. 28 shows a more

finished model of a cylinder oscillator, equipped with ball bearings and with a ceramic shaft. In another smaller model, a top frequency of 1200 megacycles has been obtained, which is 85 per cent of the resonant fre-

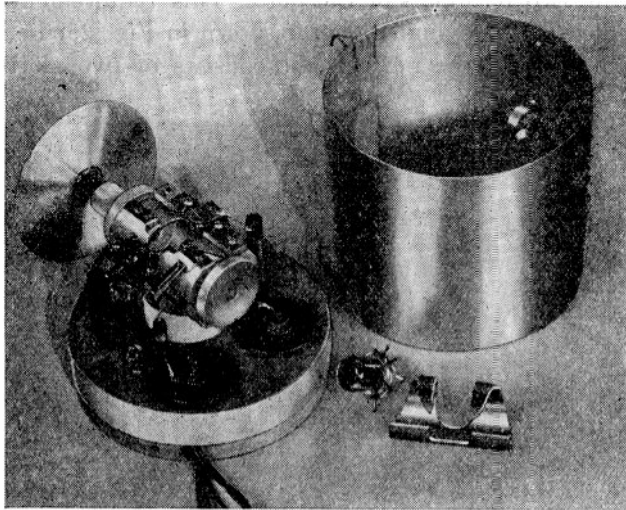

Fig. 27—450- to 1050-megacycle cylinder oscillator. The shield is 4 inches high with 4-inch diameter.

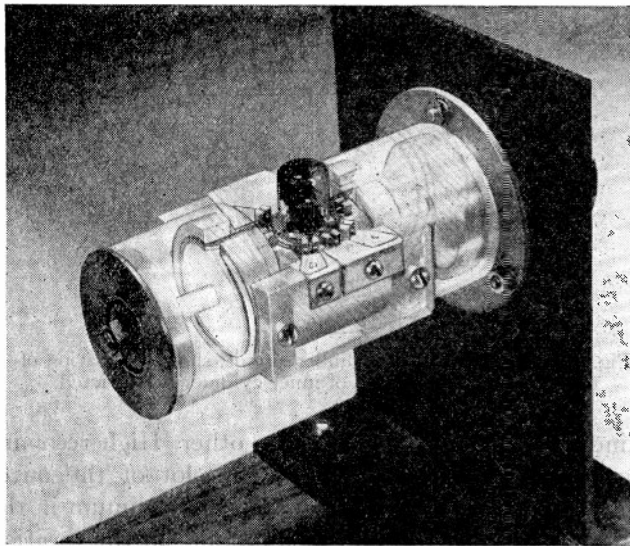

Fig. 28—More finished form of cylinder oscillator.

quency of the Type 6F4 tube. The frequency range obtainable in this type of circuit is largely determined by the spacing between the two cylinders. The model shown in Fig. 27 has an air gap of 1/64 inch.

The inductance of a cylinder in centimeters is given by the simplified current-sheet formula of Wheeler

$$L = 1000 \frac{a^2}{(9a + 10l)}$$

where a is the radius of the cylinder and l its length, both measured in inches. Applied to a cylinder circuit, a would be the inner radius of the outer cylinder, and corrections would have to be made for the hole where the tube is inserted, for skin effect and for the presence of the rotor. In the circuits shown these corrections tend to cancel.

Computation of the capacitance of a cylindrical condenser does not offer any difficulties, but an exact analysis of capacitance variation in a cylinder circuit is rather complicated if the inner cylinder is shaped to produce a desirable frequency variation.

In the circuit shown in Fig. 27, with 1-inch inside diameter and 2-inch length of the outer cylinder, the inductance is approximately 10 centimeters and the maximum effective circuit capacitance 16 micromicrofarads. Of this, 2 micromicrofarads are contributed by the tube, 0.5 micromicrofarad by the capacitance of the slot of the outer cylinder, and the remaining 13.5 micromicrofarads by the rotor.

The Q of a cylinder circuit without shielding is almost entirely determined by radiation. A common formula for radiation resistance is, for instance,

$$R = 31,200 (A/\lambda^2)^2$$

where A is the area of the radiating loop in square meters and λ the wavelength in meters. Combined with the inductance formula given above and the known resonant frequency of the circuit, Q can be computed

$$Q = \omega L/R = 0.4 \cdot 10^{12} / (9a + 10l) a^2 f^3$$

where a and l again are radius and length of the outer cylinder in inches and f the operating frequency in megacycles.

For the circuit shown in Fig. 25, this formula gives values of Q of 720, 130, and 60 for 450, 800, and 1050 megacycles. The measured values are almost the same, indicating that the circuit losses themselves are of a different order of magnitude. Radiation losses can be eliminated by enclosing the cylinder circuit with a conducting shield. The curves of Fig. 29 show the increase

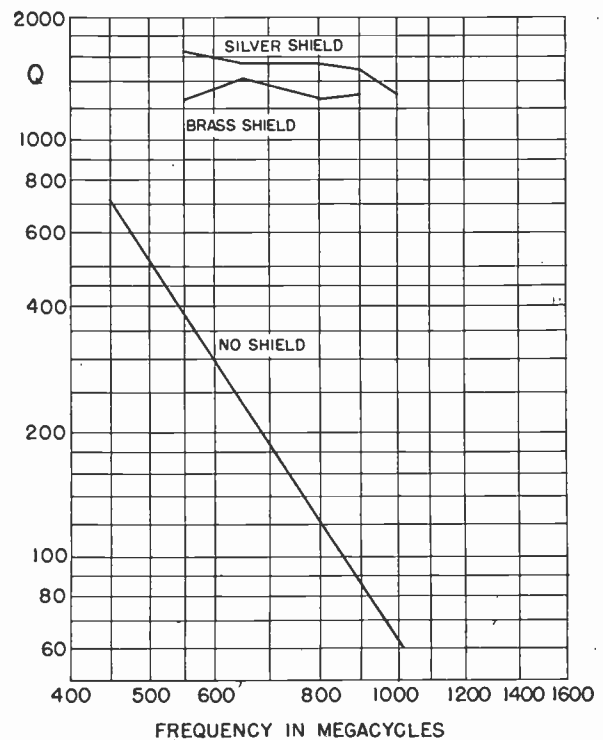

Fig. 29— Q of cylinder circuit shown in Fig. 25.

of Q observed with a cylindrical shield of 3-inch diameter and 4-inch length. The volume of this particular shield is 18 times the volume of the cylinder circuit, and Q is over 1400 over the entire tuning range. These values were obtained by coupling a standard-signal generator and a crystal detector to the cylinder circuit, and plotting the resonance curve. Owing to these high values of Q the oscillator shown in Fig. 27 oscillates uniformly over the entire tuning range with only 25 volts on the plate.

If the inner cylinder is removed completely, tuning is no longer possible, but resonance can be obtained at different frequencies by changing the width of the slot in the outer cylinder. Q has been measured under these conditions at 1000 megacycles on three cylinders of identical dimensions; one made of copper, one of brass, and a third one of brass with silver plating. The Q 's obtained are 3900 and 1800 for copper and brass, and 2600 for silver plating. The values for copper and brass are approximately in the ratio of the square roots of the respective conductivities, but the value for silver plating indicates that the resistivity of the silver layer produced by electrolytic plating is more than twice the resistivity of copper. The complete cylinder circuits that have been measured were all made of brass with silver plating.

CHOICE OF CIRCUIT

The coaxial-butterfly circuit is a special type designed to work with lighthouse tubes in an assembly that yields simultaneous variation of feedback and grid-plate tuning. High-efficiency operation at the highest frequencies can be obtained, but at the expense of a rather complicated mechanical design. The simpler butterfly and cylinder circuits, on the other hand, are adaptable to a wide variety of tubes and, as oscillators, yield moderate efficiency over wide ranges of frequencies. They are also useful in passive networks for numerous applications requiring selective circuits, such as antenna tuning, interstage coupling, wavemeters, and filters.

The tuning ranges obtainable with cylinder circuits are not so large so the ranges of butterfly circuits. In oscillator circuits, which have to work with available tubes, the choice of circuit may be determined by the terminal arrangement and the desired method of coupling. In filters and discriminators, low losses may be of outstanding importance. In general, shielded cylinder circuits will have lower losses than butterflies, particularly at the high-frequency end of the tuning range. In tuned circuits used as wavemeters and antenna tuners, spurious responses can be very bothersome. These are generally more prominent in butterflies than in cylinder circuits. They are most likely to occur in circuits with wide tuning ranges, and must be studied in each individual case. One example of such undesirable responses, or modes, has already been mentioned in connection with butterfly circuits and has been traced

to current paths through the stacks of rotor and stator plates. Most spurious responses cannot be eliminated completely, but their effects can be minimized by appropriate coupling. It should be remembered that all structures that allow current paths of approximately equal lengths along different directions will have spurious responses that are not harmonically related.

Practical considerations are often more important in the choice of circuits than small differences in electrical performance. Among those are mechanical stability and ease of manufacture. It is obvious, for instance, that the fully closed rings of a butterfly circuit, although larger for the same inductance, give better support to the stator than the open rings of the semibutterfly or the slotted cylinders of the cylinder circuit. The parallel-plate-type construction of the butterfly circuit makes wide tuning ranges possible if small air gaps are used, but to avoid backlash, good bearings and high accuracy in assembly are required. In this respect, the cylinder circuit has the advantage that axial movement of the rotor has only a second-order effect on frequency.

EXTENDED RANGES

While the various circuits described so far have all covered frequency ranges of the order of 2-to-1 to 4-to-1, and are therefore wide-range in the sense that a single low-frequency coil-capacitor combination is wide range, it has been general experience in instrument design that still wider ranges are desirable for versatility. At low frequencies the need for ranges wider than can be secured with a single coil-capacitor combination has been met by switching coils. At the higher frequencies it is likewise desirable to extend the ranges, even of butterfly circuits, and various switching systems have been evolved for this purpose.

Since the various wide-range circuits described have the inductance and capacitance built into the same unit, the problem of switching inductance is somewhat more difficult to solve than it is with conventional coil-capacitor circuits. If only a moderate extension of range is required, two circuits, each with its own tube, can be mounted with a common rotor shaft and can be switched on and off by energizing one tube or the other. An experimental signal generator for 50 to 1000 megacycles has been built this way, and all switching in the radio-frequency parts of the oscillators has been avoided.

If some efficiency or range at the highest output frequency can be sacrificed, a range-changing system that involves switching in the inductive part of the circuit can be used. In any multirange oscillator, difficulties arise at both the high- and low-frequency ranges but not in the middle ones. If a particular tube can be made to oscillate at 500 megacycles, it will work well with the same tuning capacitor, for instance, at 50, 5, and 0.5 megacycles, and difficulties will not arise until the impedance of the tuned circuit reaches unreasonably high values at low frequencies. To obtain this kind of operation, the inductance of the tuned circuit must be

changed in steps. The butterfly circuit, with its two inductance paths in parallel, does not lend itself very well to inductance switching, but the contact-type tuning circuits, the semibutterfly, and the cylinder oscillators are more suitable. Semibutterflies, for instance, have been arranged to cover frequency ranges of 40 to 500 megacycles by connecting a single-turn coil across a gap in the ring at the point marked 4 in Fig. 7, and



Fig. 30—Schematic diagram of range switching in a cylinder circuit.

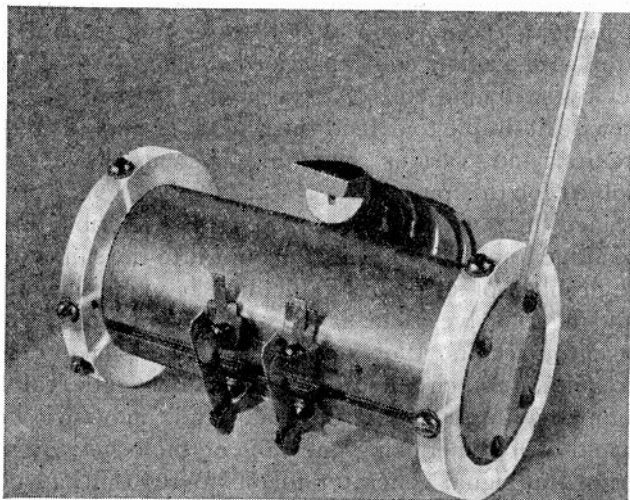

Fig. 31—Model of cylinder circuit, covering 6 to 500 megacycles in five ranges. Highest range "coil" is shown.

mounting a short-circuiting switch to open or close this gap. A switching system for a cylinder circuit is shown in Fig. 30. Fig. 31 is a view of a cylinder unit of this type designed to cover the frequency range from 6 to 500 megacycles in five ranges. The two short-circuiting straps in the range switch form the inductance of the highest range.

OSCILLATOR PERFORMANCE

It has been shown that simple, reliable oscillators can be built with generally available standard tubes that

give good electrical performance up to and slightly beyond 1000 megacycles.

The temperature coefficient of frequency of butterfly circuits is generally of the same order as the coefficient of linear expansion of the metal used; i.e., 15 to 20 parts per million per degree centigrade, if the plates are made of brass. The temperature coefficients of some of the other circuits are not determined by the material of the plates alone, but depend in addition on the process of manufacture and on design. This is obvious for a cylinder circuit where the expansion of the slotted cylinder with temperature depends on the mechanical stresses left after fabrication and on the method used in mounting.

The frequency stability with changing supply voltage is another important characteristic that determines the usefulness of an oscillator for many applications. This stability, which is usually expressed in parts per million, depends on the tuned circuit, the oscillator tube, and the interconnections between tube and circuit.

High Q of the tuned circuit makes it possible to obtain good stability, but it is easily demonstrated that it does not guarantee it. Losses in the tube elements and in the tube seals, and variations of the spacing of the tube elements with operating temperatures are increasingly more important as the resonant frequency of the tube is approached, since the tube then represents a larger part of the tuned circuit. When the impedances Z_1 , Z_2 , and Z_3 are determined according to Fig. 17 to enable the tube to replace circuit losses by drawing power from the plate supply, it becomes apparent that close coupling between tube and circuit is required for high output and that high output is incompatible with high stability. As we have seen, these impedances are not chosen at will in the simple wide-range oscillators discussed in this paper, and we find that stability is largely determined by the oscillator tube.

Frequency stability can be determined for small changes of heater and plate voltage or for large changes in plate voltage alone.

Small changes in supply voltage, of course, are taken at the operating point of the particular oscillator, and their effect is particularly important in battery-operated equipment. Table III shows the frequency change in

TABLE III

Frequency in Megacycles	20 Per Cent Change in Plate Supply	20 Per Cent Change in Filament Supply	20 Per Cent Change in Plate and Filament Supply
100	+30	-60	+20
150	+100	-70	+50
200	+200	-200	+50

parts per million for the local oscillator of the heterodyne frequency meter, shown in Fig. 12.

In power-operated equipment without voltage regulation, heater and plate-voltage changes due to line-voltage fluctuations occur simultaneously. Their effect on the oscillator shown in Fig. 9 can be seen in Table IV.

The frequency stability for a large change in plate-

TABLE IV

Operating Frequency in Megacycles	100	200	300	500
Frequency Change Due to 20 per cent Change in Line Voltage in Parts per Million	10	20	70	150

supply voltage has come to be regarded as a general performance criterion for oscillators and is important, in addition, when plate-voltage modulation is desired. The large change is understood to be a reduction of plate voltage to one half its normal value provided, of course, that the tube still oscillates under these conditions.

This change corresponds to 33 per cent plate-voltage modulation with depressed carrier amplitude, but the actual frequency modulation observed in a modulated oscillator will usually be less than the values indicated by the stability factor, since the temperature of the tube electrodes cannot follow the modulation frequency. Further data on stability factors for a 2-to-1 change in plate voltage alone are given in Table V. Stability factors for the 10-to-500-megacycle cylinder circuit with range switch are not shown at the lower frequencies, since they do not depend on the tube any more and can be reduced to very low values by circuit design.

TABLE V

Range of Oscillator in Megacycles	Tube	Resonant Frequency in Megacycles	Circuit	Operating Frequency in Megacycles	Stability Factor 10^{-6}
50-250	316-A	700	Semibutterfly	50	100
				100	250
				200	1000
				250	3000
250-1000	368-A	1900	2 butterfly circuits connected to 1 tube	250	200
				500	360
				800	850
				1000	1350
250-1000	703-A	1700	Butterfly	250	100
				500	250
				800	700
				1000	5000
1050-1350	464	—	Coaxial butterfly	1050	1400
				1200	1700
				1350	4000
				200	400
6-500	464	—	Cylinder circuit with range switch	500	1500
500-1000	6F4	1400	Cylinder circuit	500	180
				800	1200
				1000	7000

ACKNOWLEDGMENT

The writer wishes to acknowledge many contributions and helpful suggestions made by Dr. A. G. Peterson and Dr. D. B. Sinclair, and the valuable assistance of Mr. E. E. Gross, Jr., in designing the coaxial-butterfly circuit.

Silicones—A New Class of High Polymers of Interest to the Radio Industry*

SHAILER L. BASS† AND T. A. KAUPPI†

Summary—New dielectrics obtained from silica by modification with organic groups are described. These new organo-silicon-oxide polymers, commonly called silicones, have a higher order of heat stability than conventional organic insulating materials in the same physical forms. An outgrowth of research in glass by the Corning Glass Works and their Technical Glass Fellowship at the Mellon Institute, silicones went through a period of industrial development at the Dow Chemical Company and are now in large-scale production by Dow Corning Corporation at Midland, Michigan.

Silicone products include liquid dielectrics, electrical sealing compounds, insulating varnishes, and many other forms in which organic dielectrics have been known. The liquids are low-loss dielectrics over a wide frequency spectrum, and are used to waterproof ceramic surfaces to prevent surface leakage at high humidities. The sealing compounds are used to exclude moisture from disconnect junctions in aircraft-engine ignition systems and are similarly useful in radio components. The resins are natural complements to inorganic insulations like mica, fibrous glass, and asbestos to produce a new class of electrical insulation capable of withstanding long overloads at severe humidity conditions or high operating temperatures.

INTRODUCTION

MEMBERS of the radio industry have asked to hear about the development of silicones. This new, and perhaps even revolutionary, class of

high-polymeric substances includes many forms of insulating materials. All these silicone dielectrics are characterized by a higher order of heat stability than conventional organic materials and, in addition, certain liquid types have exceptionally low loss factors. These new materials are believed to be especially interesting now when service demands call increasingly upon radio technologists for better materials with greater performance.

Radio apparatus, like other kinds of electrical equipment, has depended upon two broad classes of dielectrics, organic and inorganic. The organic insulations are used in a variety of physical forms varying from molded plastics and wire coatings to potting compounds, cements, and liquid or wax impregnants. These organic insulations are essentially compounds of carbon and fulfill the needs for dielectrics at most temperature conditions met with in service. However, when the service requires stability at elevated temperatures, the organic dielectrics soon reach a temperature limit of effectiveness. One reason for this is the inherent instability of the carbon-to-carbon linkage. The rate of aging, determined by the time for the insulation to fail the test for a given physical property, such as flexibility, follows quite closely the rule of half the life for every rise of ten degrees centigrade in temperature. The eventual thermal

* Decimal classification: R281. Original manuscript received by the Institute, November 30, 1944; revised manuscript received, March 19, 1945. Presented, Rochester Fall Meeting, Rochester, N. Y., November 14, 1944.

† Dow Corning Corporation, Midland, Mich.

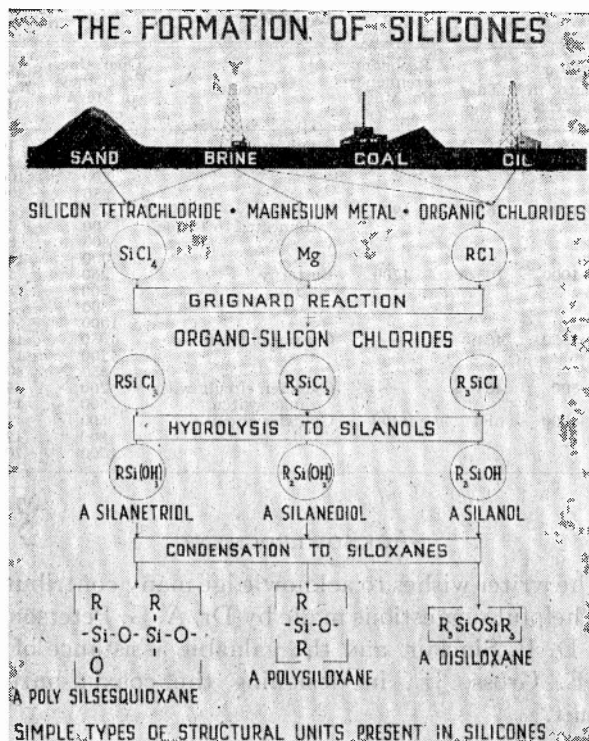

Fig. 1—Derivation of silicones from ultimate sources.

decomposition product of organic dielectrics is carbon. Thus, the end result of exposure of organic insulating materials to elevated temperatures is to change a dielectric to a conductor.

The inorganic spacing materials used are principally built upon a framework of silicon and oxygen atoms, the two most abundant elements in the earth's crust. They include such familiar materials as quartz, vitreous silica, glass, asbestos, mica, and the ceramics. As a class, all these materials are high polymers, large molecules whose molecular framework is essentially a structure of silicon atoms bound to each other through oxygen atoms. Their heat stability is due to the inherent stability of this silicon-oxygen-silicon bonding. However, these materials are limited in physical forms to comparatively hard, brittle solids.

There has long been a need for a new class of insulating materials which will have the ease of application of the organic products and a thermal stability approaching that of the inorganic materials. Dow Corning silicones, a new class of semi-inorganic high polymers based upon silicon and oxygen instead of carbon, are bridging the gap between the completely organic products on the one hand and the completely inorganic materials on the other. These new organo-silicon-oxide polymers reached their first commercial production in this country^{1,2} and are now available in a variety of physical forms. Silicone products include liquid dielectrics, lubricants, greases, resins, and varnishes; in fact, most of the forms of matter in which organic dielectrics are available.

¹ "Silicones," *Chem. and Eng. News*, vol. 22, p. 1134; July 10, 1944.

² *Chem. and Met. Eng.*, vol. 51, pp. 66, 138; July, 1944.

THE FORMATION OF SILICONES

Silicones are derived from sand, brine, coal, and oil as ultimate source materials. However, like certain of the organic high polymers which are said to come from coal, air, and water, their synthesis involves a number of steps and a considerable amount of industrial and chemical technology as indicated in Fig. 1. Sand provides the source of silicon and, when heated with coke from coal and chlorine from brine, forms silicon tetrachloride. Organic chlorides, made from hydrocarbons derived from coal and oil by treatment with chlorine from brine, are attached to silicon through the use of magnesium metal, also from brine.

By this modification of the Grignard reaction³ one or more chlorine atoms in silicon tetrachloride are replaced by a hydrocarbon radical as shown in Fig. 1 to produce a variety of organo-silicon chlorides. These are then treated with water to remove all the chlorine and by-

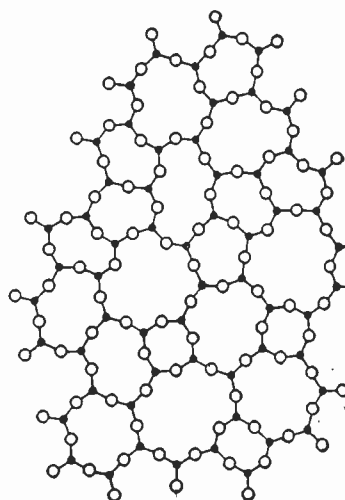

Fig. 2—The structure of vitreous silica, shown in two dimensions. Types of silicon-oxygen-silicon linkages. (From H. Moore, "Glasses, organic and inorganic," *Chem. and Ind.*, vol. 17, pp. 1027-1037; November, 1939.)

● = silicon

○ = oxygen

product magnesium chloride. The silanols so formed condense with each other to build up large molecules in a manner similar to the hardening of a silicic acid gel or the setting of a phenol-formaldehyde resin.

Thus, the tailoring of large silicone molecules to the requirements of specific uses involves having several building materials available and knowing how to put them together to produce high polymers having the requisite physical properties.

From the above method of formation, silicones may be defined as a class of condensation polymers in which the ultimate building units consist of organo-substituted silicon atoms linked to each other through oxygen atoms.

In general, silicones extend the range of service temperatures well beyond the limits of thermal stability of conventional organic materials in the same physical

³ F. S. Kipping, "Organic derivatives of silicon preparation of alkyl silicon chlorides," *Proc. Chem. Soc.*, vol. 20, pp. 15-16; January 1904.

form. Their heat resistance, their general inertness, and their good dielectric properties are due in large part to the fact that they are built upon interlacing structures of silicon and oxygen atoms similar to those existing in vitreous silica as shown in Fig. 2. Most of the structural types shown there can be duplicated in the silicones. Fig. 2 indicates not only the complexity of the possible structures but also that an infinite variety of structures are possible in large molecules built up of silicon and oxygen atoms.

HISTORICAL

Silicones as a new class of high polymeric materials resulted from fundamental research⁴ in the field of

TABLE I
DOW CORNING TYPE 500 FLUID PROPERTIES AND SPECIFICATIONS

Viscosity Grade in Centistokes at 25 Degrees Centigrade	Boiling Point		Freezing Point Degrees Centigrade	Flash Point Minimum Degrees Fahrenheit	Specific Gravity 25 Degrees Centigrade	Refractive Index at 25 Degrees Centigrade	Expansion Coefficient C X 10 ³ per Degree Centigrade 25 to 100 Degree Centigrade
	Temperature Degrees Centigrade	Pressure Millimeters Mercury					
0.65	99.5	760	-68	30	0.7606	1.3748	1.598
1.0	152	760	-86	100	0.8182	1.3822	1.451
1.5	192	760	-76	160	0.8516	1.3872	1.312
2.0	230	760	-84	195	0.8710	1.3902	1.247
3.0	70-100	0.5	-70	225	0.896	1.394	1.170
5.0	120-160	0.5	-70	270	0.918	1.397	1.095
10	>200	0.5	-67	350	0.940	1.399	1.035
20	>200	0.5	-60	520	0.950	1.400	1.025
50	>250	0.5	-55	540	0.955	1.402	1.000
100	>250	0.5	-55	600	0.966	1.403	0.994

Specifications: Same as for Dow Corning Type 200 Fluids, except that volatility limits apply only to viscosity grades of 20 centistokes upward.

polymer chemistry bounded by the glasses and silicates on the one hand and by the organic plastics on the other. Originally, interest in organo-silicon products was an outgrowth of research in glass.⁵ It was stimulated by the possibility of obtaining glass-like plastics or other materials useful with glass.

TABLE II
DOW CORNING TYPE 200 FLUID PROPERTIES AND SPECIFICATIONS

Viscosity Grade 25 Degrees in Centistokes at 25 Degrees Centigrade	Flash Point Minimum Degrees Fahrenheit	Specific Gravity at 25 Degrees Centigrade	Pounds per Gallon at 25 Degrees Centigrade	Refractive Index at 25 Degrees Centigrade	C X 10 ³ per Degree Centigrade Expansion Coefficient		Viscosity in Centistokes at		
					-25 to 0 Degrees Centigrade	25 to 100 Degrees Centigrade	-40 Degrees Fahrenheit	100 Degrees Fahrenheit	210 Degrees Fahrenheit
100	600	0.968	8.08	1.4030	0.926	0.969	650	82	32
200	615	0.971	8.10	1.4031	0.921	0.968	1300	160	65
350	625	0.972	8.11	1.4032	0.917	0.966	1950	260	135
500	625	0.972	8.11	1.4033	0.909	0.965	3300	370	190
1000	640	0.973	8.12	1.4035	0.900	0.963	6500	735	260

Specifications: Viscosity limits.....furnished within 5 per cent of rated viscosity at 24 degrees centigrade.
Heat stability.....less than 5 per cent viscosity increase after 96 hours at 160 degrees centigrade.
Volatility.....less than 2 per cent weight loss after 48 hours at 200 degrees centigrade.

The development of Fiberglas for electrical insulation provided the added impetus of a specific problem to be solved. Insulating resins and varnishes of a high order of heat resistance were needed before the greatest advantage could be taken of the thermal stability of fiberglas in electrical insulation. It soon became apparent that silicones were natural complements in their

⁴ By research groups under the leadership of Dr. J. F. Hyde, Corning Glass Works, and Dr. R. R. McGregor, Mellon Institute of Industrial Research.

⁵ Under the direction of Dr. E. C. Sullivan, in charge of research for Corning Glass Works.

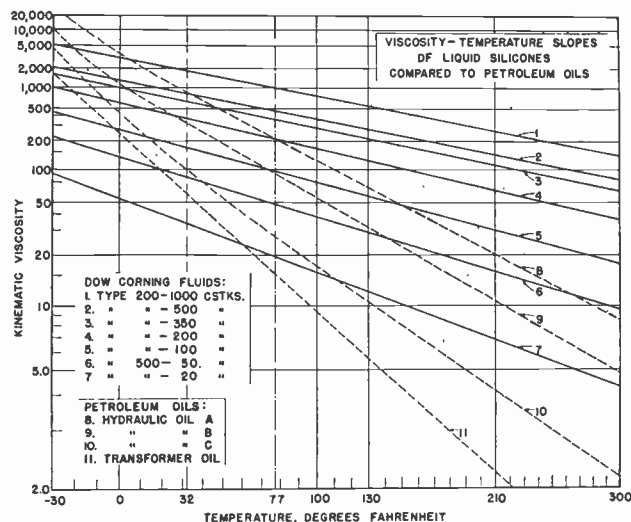

Fig. 3—Viscosity-temperature relations of liquid silicones compared to petroleum oils.

thermal stability to Fiberglas, mica, and asbestos in filling voids and excluding moisture from these materials. Increasing demand for new insulating varnishes and other silicone products resulted in the formation of the Dow Corning Corporation to manufacture them and develop their uses.

LIQUID SILICONES

During the search for glass-like silicone polymers, a series of water-white, odorless, inert liquid silicones was discovered and was one of the first families of silicone polymers to reach commercial production.⁶ Before the war, these new liquid silicones were laboratory curiosities chiefly interesting for their unusual combination of properties. They have since demonstrated their utility over conventional organic liquids in many engineering and technical applications. They are of especial interest

to the radio industry because of their exceptionally low dielectric loss over a broad frequency spectrum.

PHYSICAL PROPERTIES

Dow Corning liquid silicones fall into two groups based on the range of viscosity and service temperature to be covered. Fluids for use down to -55 degrees centigrade and below are listed in Table I for one type covering viscosity grades up to 100 centistokes. The viscosity grades above 20 centistokes are nonvolatile and useful

⁶ "Dow Corning Fluids," Dow Corning Corp., Midland Mich.

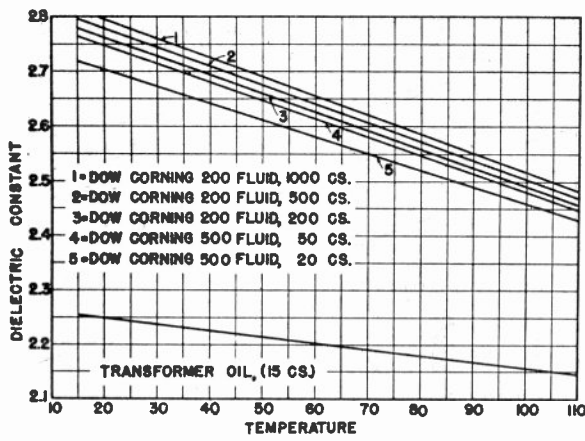

Fig. 4—Effect of temperature on dielectric constant of Dow Corning liquid silicones compared to typical transformer oil of petroleum origin.

as liquid dielectrics. Their temperature coefficient of viscosity is very low as shown by the curves of Fig. 3.

Fluids for use down to -40 degrees centigrade and up to 200 degrees centigrade are listed in Table II for another type of fluid silicones covering viscosity grades from 100 centistokes upward. All viscosity grades in this type are nonvolatile liquid dielectrics with an even lower rate of viscosity change with temperature than the lighter viscosity fluids of Table I. Their viscosity-temperature curves are compared to typical petroleum oils in Fig. 3.

The liquid silicones in Tables I and II are further characterized by their heat stability, their general inert-

TABLE III
DIELECTRIC PROPERTIES OF TYPICAL DOW CORNING FLUIDS (AT 25 DEGREES CENTIGRADE AND 50 PER CENT RELATIVE HUMIDITY)

Frequency Cycles	3 Centistokes, Type 500		350 Centistokes, Type 200	
	Dielectric Constant	Power Factor	Dielectric Constant	Power Factor
10 ²	2.412	<0.0001	2.74	<0.0001
10 ³	2.41	<0.0001	2.73	<0.0001
10 ⁴	2.405	<0.0002	2.72	<0.0002
10 ⁷	2.40	0.0002	2.71	0.0002
10 ⁸	2.39	0.0002	2.70	0.0006

ness, and oxidation resistance. They are noncorrosive to metals and are nonsolvents for rubber, synthetics, and other organic plastics. Their flash points are considerably higher than petroleum oils of equivalent viscosity and they will burn, when once ignited, to form silica, carbon dioxide, and water. Their surface tension is low, about 20 dynes per centimeter, and they readily wet clean, dry surfaces of glass, ceramics, and metals, making them water-repellent. They are insoluble in water and are unaffected by water, dilute acids, or salt solutions. They are soluble in most organic solvents including carbon tetrachloride and aromatic naphthas, but are insoluble in alcohol and acetone.

ELECTRICAL PROPERTIES

The dielectric constants of the nonvolatile types of Dow Corning fluids range from 2.7 to 2.8 at room temperature depending on the viscosity grade,⁷ as indicated

⁷ Electrical measurements are by courtesy of the Physical Research Laboratory, The Dow Chemical Company, Midland, Mich.

in Fig. 4. The rate of change of dielectric constant of these fluids with temperature at 1000 cycles is shown also in Fig. 4. The change is about that which would be expected from the expansion data from Tables I and II. The dielectric constant of liquid silicones changes very little with frequency as indicated in Table III.

The power factors of these fluids are unusually low, being less than 0.0001 at ordinary frequencies. They do not increase appreciably with increased frequency up to 10⁷ and 10⁸ cycles as the data of Table III shows. At higher frequencies, there is evidence of a more rapid rise in power factor. The power factors of Dow Corning fluids increase with temperature as shown in Fig. 5 but

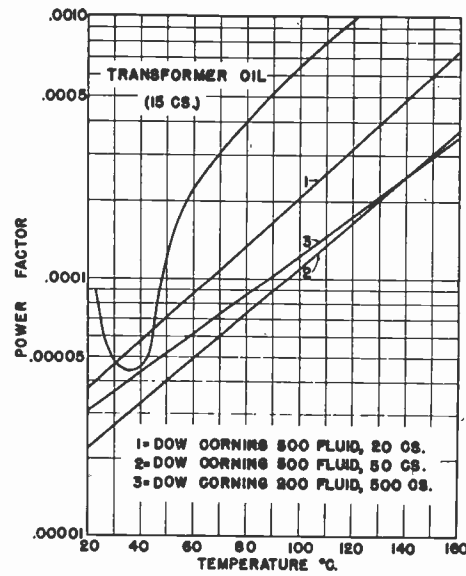

Fig. 5—Effect of temperature on power factor of Dow Corning liquid silicones compared to typical transformer oil of petroleum origin.

remain lower than a typical transformer oil.⁷ Their dielectric strength is 250 to 300 volts per mil at 100 mils. Their volume resistivity is in the order of 10¹⁴ and does not drop below 10¹² at 200 degrees centigrade. The low dissipation factors of these liquid silicones at elevated temperatures or at high frequencies, and their inertness to moisture, indicate them for use in liquid-filled condensers.

WATERPROOFING CERAMIC INSULATOR SURFACES

All liquids silicones tend to wet and adhere preferentially to siliceous surfaces and the nonvolatile higher viscosity types can be rather permanently absorbed. Use is being made of this property to produce water-repellent surfaces on glass and ceramic insulator forms. Ceramic articles to be treated should be scrupulously clean. Best results are obtained by treating the bodies directly as they are removed from the annealing ovens, preferably while still warm. After dipping in a solution of a nonvolatile liquid silicone in a nonflammable solvent, the articles are allowed to drain. They are then baked for two hours at 160 degrees centigrade to fix the silicone film on the surface of the insulators.

Articles so treated have a highly water-repellent

surface and when the insulator is exposed to high humidities under condensing conditions, the silicone film prevents the moisture from forming a continuous liquid film over the surface. This is shown by the two coil forms in Fig. 6. The water droplets on the surfaces of these forms have a very high angle of contact with the surface which is a measure of the quality of the non-wetting treatment. Measurements show that surface resistance of such insulators, when freshly treated, is infinite and stays at high values over long periods of time even under immersion in water.⁸

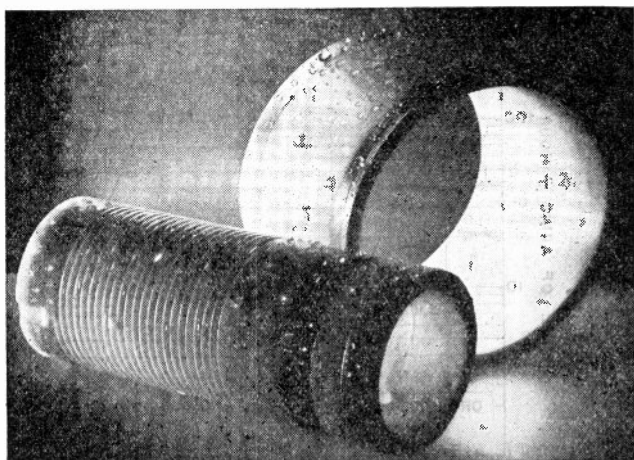

Fig. 6—Metal-banded glass-coil forms waterproofed by liquid-silicone treatment. On exposure to moisture-saturated atmosphere and measured with water condensed on the surface, the surface resistance stays above 10^{12} indefinitely. Surface resistance and power factor are not appreciably changed even after many days immersion in water.

A similar result can also be obtained by treating ceramics with organo-silicon chlorides either in the vapor stage⁹ or in solution in an inert solvent. Hydrolysis by moisture present on the surface of the article causes formation of a silicone-polymer layer on the surface by the mechanism previously illustrated in Fig. 1.

SILICONE GREASES

An electrical insulating and sealing compound has been developed and is in use as a heat-stable lubricant and moisture-proof seal for disconnect junctions in aircraft-engine ignition systems.¹⁰ It also acts to exclude air and prevent corona cutting of the insulation. As a lubricant, it permits easy wiring of ignition harnesses and is also useful on shafts and movable parts of radio components. It is a translucent, colorless grease in appearance and does not melt or harden over a temperature range from -40 degrees centigrade to over 200 degrees centigrade. It has no solvent effect on synthetic insulations or on rubber and tends to prevent the hardening of these insulations when heated in air. It

⁸ Unpublished work by O. K. Johannson and J. J. Torok, Corning Glass Works, Corning, N. Y.

⁹ F. J. Norton, *Gen. Elec. Rev.*, vol. 47, pp. 6-16; August, 1944. (See also U. S. Patent No. 2,306,222. W. I. Patnode to General Electric Company, Schenectady, N. Y.)

¹⁰ "Dow Corning No. 4 Ignition Sealing Compound," Dow Corning Corp., Midland, Mich., 1944.

provides no nutrient medium for microorganisms and tends to prevent their growth on organic insulation by excluding the necessary moisture.

HIGH-TEMPERATURE-SILICONE INSULATION

The life of electrical equipment depends primarily upon the insulating and spacing material used. The insulation should be able to withstand any temperature or exposure condition which the equipment is likely to meet, whether at normal or overload operation. In a great many environments, the essential purpose of the insulation is to keep out water. Many impregnating resins and varnishes will exclude water as long as they are not subjected to excessive thermal conditions. Due to the inherent instability of conventional organic insulating materials to heat, they eventually undergo thermal breakdown and become cracked or carbonized, thereby admitting water and conducting materials.

Thermal aging of insulation is recognized¹¹ as the basis for temperature limitations on the design of electrical machines. Insulation is classed into different orders of winding temperatures permitted for purposes of providing a standard according to the heat stability of the insulating materials used. For example, the replacement of cotton, paper, and other organic spacing materials by Fiberglas, asbestos, and mica, has resulted in a considerable increase in heat resistance of electrical machines. However, full advantage could not be taken of the heat-resistant properties of these inorganic insulations because of the temperature limitations of organic varnishes and impregnants. Some types of electrical machines have been built to withstand high temperatures by using inorganic spacing materials as the sole insulation. However, motors and other rotating equipment require heat-stable resinous dielectrics to fill in voids, to help hold conductors in place, to insure good heat transfer, and to exclude moisture.

The introduction of silicone varnishes with their greater thermal stability is making possible a new class of electrical insulation, insulation in a class by itself not only for heat resistance but also for moistureproofness and for its ability to withstand tough service conditions. Since there is no standard AIEE class designation for insulation in which silicone resins are used to fill voids and exclude moisture from equipment insulated with Fiberglas, mica, or asbestos, it has been suggested¹² that it be called "high-temperature-silicone" insulation.

A silicone varnish has been developed especially for use in high-temperature-silicone insulation.¹³ It is being used to produce insulating materials paralleling standard class B forms as illustrated in Fig. 7. It is used to bond Fiberglas or asbestos-served magnet wire, to

¹¹ "General Principles upon which Temperature Limits are Based in the Rating of Electrical Machinery and Apparatus," Amer. Inst. Elec. Eng. Stand.

¹² G. L. Moses, *West. Eng.*, vol. 4, pp. 138-141; September, 1944.

¹³ "Dow Corning Resins," Dow Corning Corp., Midland, Mich., July, 1944.

The new silicone varnishes should not be considered remedies for all insulating problems. However, if they fulfill the promises of test results, extensive use of high-temperature-silicone insulation can be expected not only on motors but also on air-cooled transformer coils and many other types of equipment.

THERMOSETTING SILICONE RESINS

Many types of electrical insulation constructions require thermosetting resins for use in their fabrication. These products include laminated board, coil forms, tubes, slot sticks, and laminated mica. Several types of silicone are under development for bonding Fiberglas and asbestos textiles to each other or to mica. These resins are supplied in solution and are used to coat or impregnate the product to be laminated. The resulting coated cloth or sheet can be laminated in the conventional press at temperatures of 230 to 250 degrees centigrade. A complete cure in the press requires about an hour, but the cycle may be shortened considerably by pressing the object for a shorter time and completing the curing by baking the laminate in an oven at 230 to 250 degrees centigrade. The thermosetting types of silicones so far developed for use as laminating resins, go through a thermoplastic stage in the same manner as conventional phenol formaldehyde. Similarity stops there since silicone resins convert to their ultimate heat-hardened condition much more slowly. In general, the properties of the finished piece depend to some extent on the rate of the final cure, and the resin is generally more flexible with longer curing times.

Many other types of silicone resins are under development. The industrial growth in and knowledge of organic high polymers following the last war together

with the demands of the present one have greatly stimulated research and industrial development in high-polymeric forms of organo-silicon products. As the chemistry of silicones unfolds and their manufacture

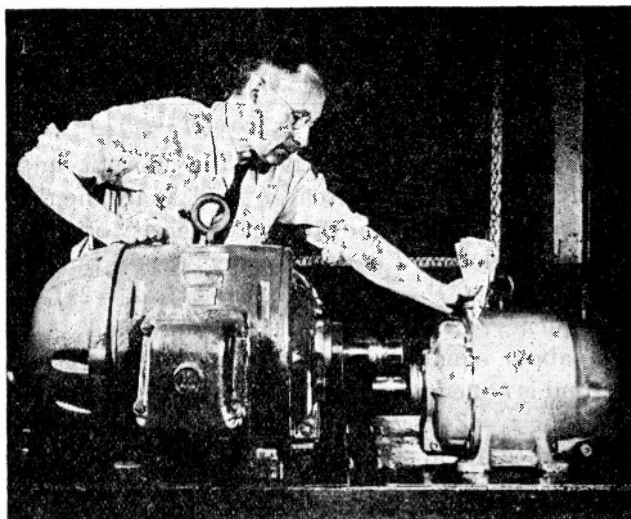

Courtesy Westinghouse Electric and Manufacturing Co.

Fig. 9—Designed and built with silicone insulation, the small motor at the right is half the size and weight of the conventionally designed, class-A motor at the left. Both produce 10 horsepower. The silicone-insulated motor operates at 175 degrees centigrade hot spot and will outlast the organic-insulated motor designed for 105 degrees centigrade in the hot spot by many years. Silicone resins are natural complements in their heat stability to the inorganic insulations. They fill voids and exclude moisture from mica, fibrous glass, and asbestos.

progresses, industry may expect to receive other forms of these new and unusual products including plastics, elastics, coatings, and oils all characterized by a stability to heat beyond the limit of previously available organic materials in the same physical form.

A Note on Acoustic Horns*

PAUL W. KLIPSCH†, MEMBER, I.R.E.

Summary—It has been the custom to illustrate the throat impedance of the exponential horn as exhibiting a sharp cutoff characteristic. That the horn can propagate sound below this cutoff frequency is recognized by practical workers.

The present note shows that this discrepancy between theory and practice is reconcilable. Equations based on accepted theory are used to compute the throat impedance below cutoff, and it is shown that both the resistive and reactive components of this impedance remain finite.

I. INTRODUCTION

THE FINITE exponential horn can radiate sound below its cutoff frequency, a fact which has long been recognized.¹ The present paper shows that the theory admits this fact. Existing mathematical

* Decimal classification: R365.2. Original manuscript received by the Institute, December 18, 1944; revised manuscript received, April 16, 1945.

† Hope, Arkansas.

¹ G. W. Stewart and R. B. Lindsay, "Acoustics," D. Van Nostrand Co., Inc., New York, N. Y., 1930, p. 146.

treatment is utilized to compute the finite resistive and reactive components of throat impedance below cutoff.

The exponential horn, first discussed by Webster,² acts as a transformer by means of which the acoustic impedance is changed as a function of the ratio of throat-to-mouth areas. Many workers have extended the theory. Excellent bibliographies may be found in recent works such as Olson.³

From the published curves of throat impedance, students are apt to conclude that the throat impedance of the exponential horn goes to zero at cutoff and remains zero below cutoff.

In discussing exponential connectors, however,

² A. G. Webster, "Acoustical impedance, and the theory of horns and of the phonograph," *Proc. Nat. Acad. Sci.*, vol. 5, pp. 275-282; 1919.

³ H. F. Olson, "Elements of Acoustical Engineering," D. Van Nostrand Co., Inc., New York, N. Y., 1940, pp. 91-97.

Olson^{4,5} shows that the throat, or small end, impedance approaches a finite value below cutoff. The same condition must hold for the horn.

II. THEORY

The impedance equation for the finite exponential horn as given by Olson^{6,7} is

$$Z_1 = \frac{\rho c \left[S_2 Z_2 [\cos(bl - \theta)] + j \rho c \sin bl \right]}{S_1 \left[j S_2 Z_2 \sin bl + \rho c [\cos(bl + \theta)] \right]} \quad (1)$$

where Z_1 and Z_2 are respectively the acoustic impedances at the mouth and throat, S_1 and S_2 are the throat and mouth areas, ρc is the product of density of medium and sound velocity, l is the horn length, $\theta = \tan^{-1} a/b$, $a = -\omega_0/c$, $b = \sqrt{k^2 - a^2}$, $k = \omega/c$, $\omega = 2\pi f$, $\omega_0 = 2\pi f_0$, f is the frequency, and f_0 the cutoff frequency.

The above equation is indeterminate at cutoff when $b=0$, and is not conveniently arranged for computation. By writing $z_1 = Z_1(S_1/\rho c)$, $z_2 = Z_2(S_2/\rho c)$ and performing some mathematical steps, the throat impedance may be expressed dimensionlessly:

$$z_1 = \frac{z_2 + z_2(a/b) \tan bl + j(k/b) \tan bl}{1 - (a/b) \tan bl + jz_2(k/b) \tan bl} \quad (2)$$

or, at values where $bl = n(\pi/2)$, $n=1, 3, 5$,

$$z_1 = [z_2(a/b) + j(k/b)] / [- (a/b) + jz_2(k/b)]. \quad (3)$$

At cutoff, where (2) and (3) become indeterminate and $b=0$, $\lim_{b \rightarrow 0} (\tan bl)/b = l$ and $k = -a$ may be used to give,

$$z_1 = (z_2 + z_2 a l - j a l) / (1 - a l - j z_2 a l). \quad (4)$$

In the above equations, z_1 is the throat impedance multiplied by $S_1/\rho c$, z_2 is the impedance imposed at the mouth multiplied by $S_2/\rho c$, and the other quantities are as defined following (1).

It is convenient to note that the following ratios may be used

$$\begin{aligned} a/b &= f_0/(f^2 - f_0^2)^{1/2} \\ k/b &= f/(f^2 - f_0^2)^{1/2} \end{aligned}$$

where f is the frequency and f_0 is the cutoff frequency, a/b is to be taken as *positive* and k/b as *negative* in the region *below* cutoff, and reversing both signs *above* cutoff.

The impedances z_1 and z_2 may be regarded as per-unit values in terms of the ultimate, characteristic, or surge impedances of the corresponding areas, so that at infinite frequency z_1 and z_2 become unity as Z_1 and Z_2 become respectively $\rho c/S_1$ and $\rho c/S_2$.

The impedance at the mouth is taken as that of a piston vibrating in a hole in an infinite baffle.⁸⁻¹⁰

⁴ H. F. Olson, "A horn consisting of manifold exponential sections," *Jour. Soc. Mot. Pic. Eng.*, vol. 30, pp. 511; 1938.

⁵ See sections 5.22 and 5.23 of footnote reference 3.

⁶ H. F. Olson, "Horn loudspeakers," *RCA Rev.*, vol. 1, pp. 68-83; July, 1937.

⁷ H. F. Olson, "A new high efficiency theater loudspeaker of the directional baffle type," *Jour. Acous. Soc. Amer.*, vol. 2, pp. 485-498; April, 1931.

⁸ Lord Rayleigh, "Theory of Sound," Macmillan and Co., London, England, 1898, vol. 2, pp. 162-169.

⁹ I. B. Crandall, "Theory of Vibrating System and Sound," D. Van Nostrand Co., Inc., New York, N. Y., 1926, pp. 143-149, and Fig. 19, facing p. 172.

¹⁰ See Fig. 5.1, pp. 82, of footnote reference 3 for graphical illustration.

III. COMPUTED PERFORMANCE OF HORN BELOW CUTOFF

To illustrate the action below cutoff, the throat impedance has been computed for a horn having a cutoff of 100 cycles, so that $m=0.0364$, $a=-0.0182$. The mouth area is taken as that of a circle 25 inches in diameter, the horn length is 22 inches, and the throat area that of a circle 4.7 inches diameter.

The throat impedance z_1 is shown in Fig. 1 wherein the heavy solid curve shows the resistive component, the dashed curve shows the reactive component, and the

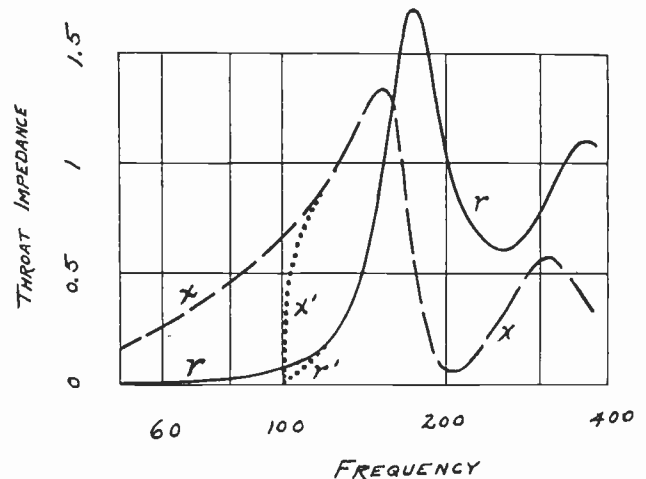

Fig. 1—Throat impedance of horn with cutoff frequency of 100 cycles. The impedance expressed in per-unit of the nominal surge impedance of the horn. Mouth area, 490 square inches; throat area, 17.5 square inches; horn length, 22 inches; solid curve r resistive component; dashed curve x reactive component; dotted curve r' resistive component as ordinarily illustrated; dotted curve x' reactive component as ordinarily illustrated.

dotted branches show the curves as usually depicted. Below cutoff, b becomes imaginary in which region the equation is evaluated using the relation $\tan jx = j \tanh x$.

IV. USE

Besides the theoretical aspect of rectifying the common belief likely to be held that the impedance is zero below cutoff, there are practical aspects pertaining to the design of loudspeakers.

The reactive component should, ideally, be offset by the driving-motor-diaphragm suspension stiffness and/or by an air chamber. In one practical design the combination of an air-chamber capacitance with suspension compliance was such that the total compliance was largely controlled by the air chamber. The air-chamber volume is shown to be of the order of¹¹

$$V = 2.9A_T \flat \quad (5)$$

where A_T is the throat area and \flat is the length¹² of horn within which the horn area doubles, referred to as the taper rate. Below cutoff it would be desirable to

¹¹ P. W. Klipsch, "A low frequency horn of small dimensions," *Jour. Acous. Soc. Amer.*, vol. 13, pp. 137-144; October, 1941. Equation (5) gives the air-chamber volume assuming infinite diaphragm suspension compliance. Remembering that the air-chamber and suspension compliances combine as capacitances in series, one can determine the volume which will combine with the suspension compliance to give a desired reactance.

¹² The symbol \flat is the Hebrew Lamedh.

maintain sufficient load on the diaphragm to limit its motion in case considerable electrical energy reaches the voice coil in this frequency range. Without load, the diaphragm motion would be reactance controlled. The positive throat reactance will resonate at some frequency with whatever compliance the system has. If the nonlinear suspension compliance contributes most of the mechanical capacitance, motion will be nonlinear, the harmonics of motion will be within the transmission-frequency range of the horn, and those harmonics will be reproduced efficiently. However, if the compliance is largely contributed by an air chamber, the acoustic reactance will be much more nearly linear with respect to amplitude, and the motion of the diaphragm will contain very small magnitudes of harmonics reproducible by the horn.

Furthermore, in the absence of suitable value of mechanical capacitance, damage to the diaphragm may result from large electrical input. By adding stiffness, (reciprocal of compliance), so that the mechanical reactance becomes small only at frequencies at which considerable resistive load exists, such damage may be avoided.

Thus, it is preferable to resonate the system somewhat above cutoff, or at least at some frequency at which the resistive component of throat impedance is sufficient to load the diaphragm and limit its motion to within the range of amplitude over which the suspension reactance is nearly linear. The several factors, such as behavior of the throat reactance below cutoff, the air-chamber capacitance, the nonlinearity of suspension of a given speaker, and the electrical power that the voice coil is likely to receive, can all be taken into consideration in the decision as to whether to alter any design elements or to add a high-pass filter to the electrical system to prevent overloading below cutoff.

Last, but perhaps not least, is the fact that the resistive component remains appreciable for a considerable range below cutoff, so that some useful contribution of sound energy is available in large-throat speakers. Failure to recognize this fact resulted in one of the discrepancies between predicted and measured performance in one experimental speaker.¹³ That discrepancy can be resolved by the present note.

¹³ P. W. Klipsch, "Improved low frequency horn," *Jour. Acous. Soc. Amer.*, vol. 14, pp. 179-182; January, 1943.

Analyses of the Voltage-Tripling and -Quadrupling Rectifier Circuits*

D. L. WAIDELICH†, SENIOR MEMBER, I.R.E., AND H. A. K. TASKIN‡

Summary—The analyses presented for both the voltage-tripling and quadrupling rectifier circuits have been made with the chief assumption being that of zero potential across the tubes when conducting. The characteristics obtained from the analyses and checked experimentally include those of the output direct voltage and the per cent ripple. These characteristics are useful in the design of the circuits and in predetermining their performance.

INTRODUCTION

IN THE PAST two decades several new voltage-multiplying rectifier circuits¹⁻³ have been developed, among which are the voltage tripler and the voltage quadrupler. Some of the characteristics of the tripler and quadrupler have been discussed by others,^{4,5} and

* Decimal classification: R366.3×R149. Original manuscript received by the Institute, September 15, 1944. This paper includes the material of a previous paper by H. A. K. Taskin, entitled "An analysis of a voltage-tripling rectifier circuit," together with additional new material descriptive of a voltage-quadrupling circuit. The work on which this paper is based was done at the University of Missouri.

† Naval Ordnance Laboratory, Washington, D. C.

‡ Surges Electric Company, Milwaukee, Wisconsin.

¹ H. Greinacher, "Über eine Methode, Wechselstrom mittels elektrischer Ventile und Kondensatoren in hochgespannten Gleichstrom umzuwandeln," *Zeit. für Phys.*, vol. 4, pp. 195-205; February, 1921.

² J. D. Cockroft and E. T. S. Walton, "Experiments with high velocity positive ions—further developments in the method of obtaining high velocity positive ions," *Proc. Royal Soc.*, series A, vol. 136, pp. 60-61; June, 1932.

³ A. Bouwers, "Roentgenapparaten," *Lab. N. V. Philips' Gloeilampenfabrieken*, No. 1080; March, 1936.

these papers give practical versions of these circuits suitable for use in radio-receiver power supplies. In general, the great advantage of these circuits is that the direct-voltage output is approximately three or four times the alternating-voltage input, thus either eliminating entirely the input transformer or greatly reducing its size. This advantage is particularly important at the present time. The disadvantage lies in the number of tubes and separate filament power supplies necessary. This disadvantage has been obviated to a large extent at the low voltages used in radio receiving sets by the use of tubes which consist of two diodes in one glass envelope, and by the use of cathodes indirectly heated by one common-filament power supply. In the design of these circuits a knowledge of the circuit operation and of the voltage and current characteristics is necessary. Some information in this direction is already available,^{1,5} but it is not complete enough for design work. The purpose of this paper is to present an analysis, in abbreviated form, of each of these multiplying circuits and to give the more general circuit characteristics obtained from this analysis. This analysis will follow somewhat

⁴ W. W. Garstang, "A new voltage quadrupler," *Electronics*, vol. 4, pp. 50-51; February, 1932.

⁵ D. L. Waidelich, "Voltage multiplier circuits," *Electronics*, vol. 14, pp. 28-29; May, 1941.

the type of analysis used in two previous papers^{6,7} and will assume that the tubes have no voltage drop when conducting. The modifications of these characteristics with the tube drop taken into consideration are taken up in a previous paper.⁸ Some of the calculated characteristics will be compared with experimental results.

These circuits are also interesting in that they have several different modes of operation depending upon the amount of load current taken from them. The change from one mode to another is characterized by a discontinuity in the firing-angle curves of the tubes in the circuit.

THE VOLTAGE TRIPLER

Analysis

The circuit of the tripler is that of Fig. 1, and for light loads the periods of conduction for each tube are indicated in Fig. 2(a). To begin the analysis, assume

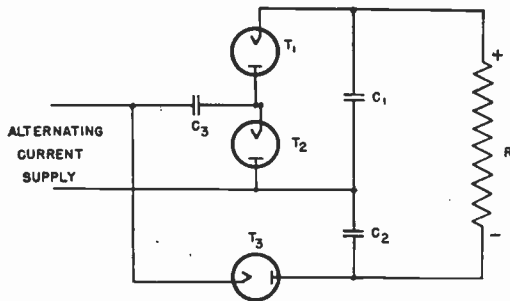

Fig. 1—The circuit diagram of the tripler circuit.

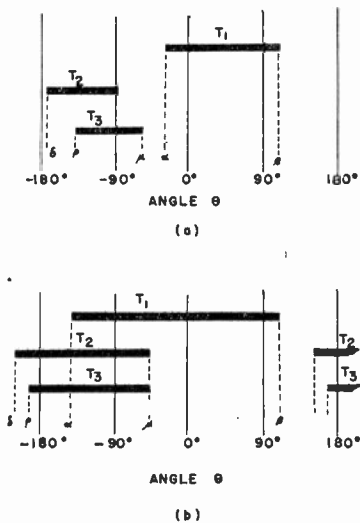

Fig. 2—The firing periods of the tubes (a) for Mode 1 (b) for Mode 2.

that the load resistor R is very large corresponding to light-load conditions. During each negative half cycle, tubes T_2 and T_3 conduct charging capacitors C_2 and C_3 almost to the maximum value E_m of the impressed al-

ternating-voltage supply. During the following positive half cycle, tube T_1 starts to conduct, and the alternating-voltage supply adds to the voltage across capacitor C_3 to charge capacitor C_1 . Capacitor C_1 will thus be charged nearly to $2E_m$, and capacitor C_3 nearly to E_m .

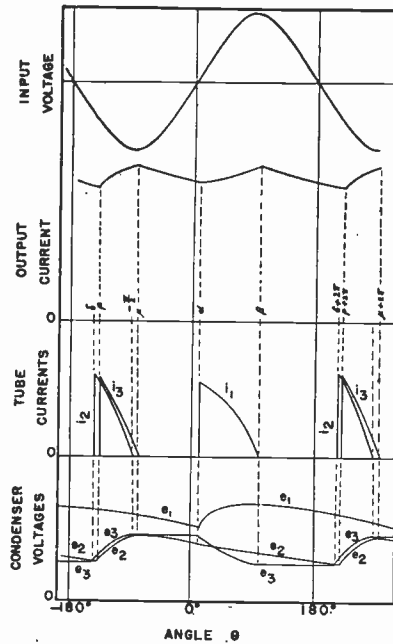

Fig. 3—Current and voltage wave forms for Mode 1.

The output voltage, which is the voltage across the capacitors C_1 and C_2 in series, will be nearly equal to $3E_m$, thus explaining the name, tripler. Under heavier loads the output voltage will be lowered, and the tubes will conduct during periods the length of which depends upon the magnitude of the load. The behavior of the tripler depends upon the conducting and stopping angles of the tubes, and the various expressions obtained for the operating characteristics of the circuit include also these angles of the tubes. The maximum value E_m of the impressed alternating voltage appears in the various expressions as a multiplying factor, while the other

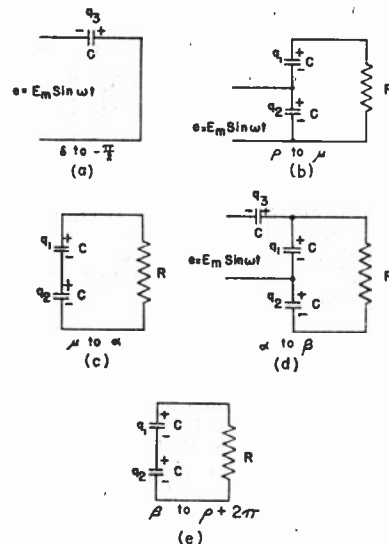

Fig. 4—The equivalent circuits for Mode 1.

⁶ D. L. Waidelech, "The full-wave voltage-doubling rectifier circuit," Proc. I.R.E., vol. 29, pp. 554-558; October, 1941.

⁷ D. L. Waidelech and C. H. Gleason, "The half-wave voltage-doubling rectifier circuit," Proc. I.R.E., vol. 30, pp. 535-541; December, 1942.

⁸ D. L. Waidelech and C. L. Shackelford, "Characteristics of voltage-multiplying rectifiers," Proc. I.R.E., vol. 32, pp. 470-476; August, 1944.

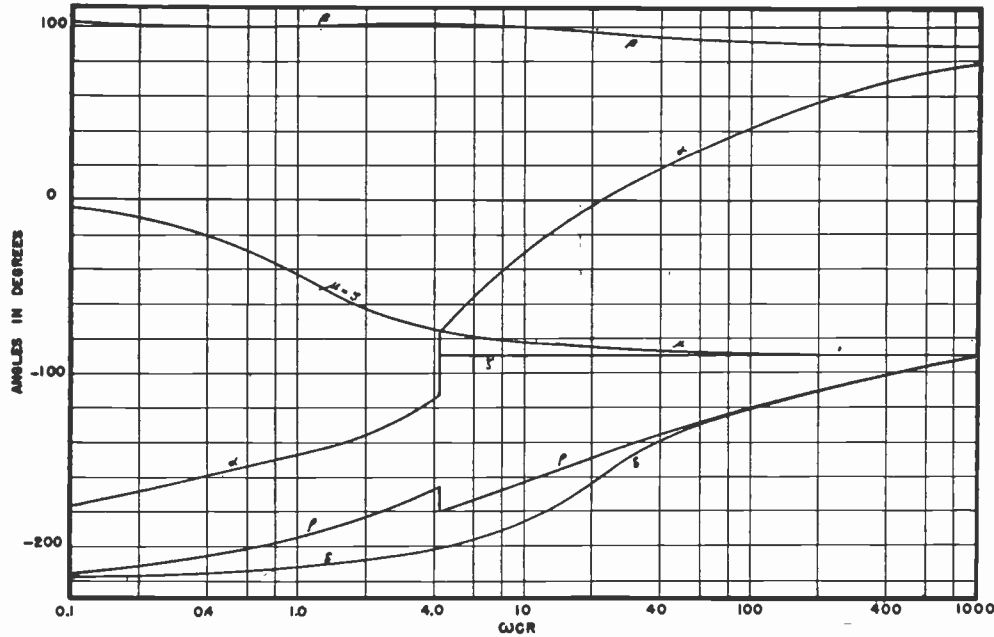

Fig. 5—The tube firing angles of the tripler.

variables are collected in the form of a single parameter ωCR , where $\omega/2\pi$ is the frequency of the alternating voltage, C is the capacitance of each capacitor, all of which are assumed equal, and R is the output load resistance.

The tripler has two modes of operation, each characterized by different arrangements of the firing and stopping angles of the tubes as shown in Figs. 2 (a) and 2 (b) respectively. The heavy lines of Fig. 2 indicate the time each tube is conducting, where the angle $\theta = \omega t$ is that of the applied alternating voltage $E_m \sin \omega t$. The operation of the circuit for large values of ωCR is called Mode 1 as indicated in Fig. 2 (a), while the operation of the circuit for small values of ωCR is designated as Mode 2, and is given in Fig. 2(b). The current and voltage wave forms for Mode 1 shown in Fig. 3 were obtained by calculation. Similar wave forms for Mode 2 may also be calculated, but are not shown here because Mode 2 is not nearly as important as the first mode of operation.

To make the mathematical analysis less difficult, the following assumptions were made: (1) the applied alternating voltage is sinusoidal and the source has zero impedance; (2) when conducting, the tube potential drop is zero, and when not conducting the tube resistance is infinite; (3) all capacitors are the same size and have zero power factor; and (4) the load is purely resistive in character.

The behavior of the tripler circuit can be represented by the operation in succession of a number of simpler circuits which simulate the circuit behavior during periodic intervals of each cycle depending on the firing of the associated tubes. Such circuits are shown in Fig. 4 for the first mode, and similar circuits have been used for the second mode. The analysis contained in Appendix II consists in showing how the firing angles were

obtained from the solution of the circuits shown in Fig. 4. The results obtained for various values of ωCR are plotted in Fig. 5. Referring to Fig. 5 it will be noted that the starting angle α of tube T_1 , the stopping angle ζ of tube T_2 , and the starting angle ρ of tube T_3 experience a sudden shift at ωCR equal to 4.21. This value of ωCR is the point of transition from the first mode of operation corresponding to values of ωCR from 4.21 to infinity (open-circuit); to the second mode of operation for values of ωCR from 4.21 to zero (short-circuit). Angle ζ , which is the angle at which tube T_2 stops conducting and is equal to -90 degrees in the first mode, becomes equal to angle μ , the stopping angle of tube T_3 , in the second mode of operation. In the first mode, tube T_1 is conducting when the other tubes are nonconductive. As the load increases (ωCR decreases) the starting angle α of T_1 decreases until it finally becomes equal to μ , the stopping angle of tube T_3 . This occurs at $\omega CR = 4.21$, which is the transition point between the two modes. For heavier loads than this, corresponding to Mode 2, all three of the tubes are firing simultaneously over part of each cycle. The tube angles approach the values of Table I at the open-circuit and short-circuit conditions.

TABLE I

Tube	Angle	Short Circuit	Open Circuit
		($\omega CR = 0$) degrees	($\omega CR = \infty$) degrees
T_1	α (start)	-180	+90
	β (stop)	+109.5	+90
T_2	δ (start)	-218.5	-90
	ζ (stop)	0	-90
T_3	ρ (start)	-218.5	-90
	μ (stop)	0	-90

Characteristics

The average output-voltage characteristic of the circuit is presented as the ratio of the average values of the

output unidirectional voltage to the maximum value of the input alternating voltage, E_{DC}/E_m . From the analysis this ratio appears to be dependent on ωCR alone and has been calculated for several values of ωCR for each mode. The results are shown in Fig. 6. It will be seen by

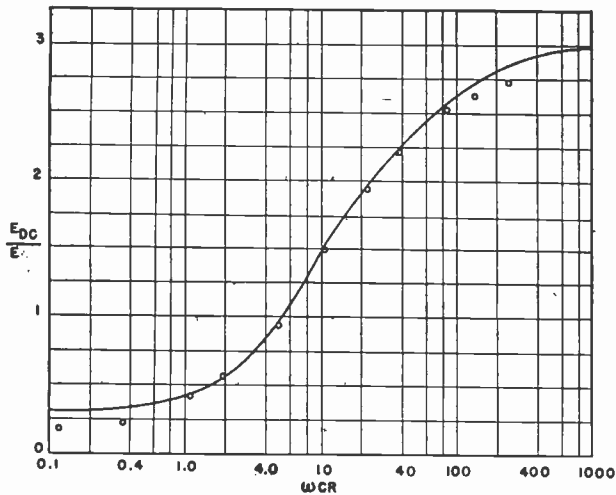

Fig. 6—The output-voltage characteristic of the tripler. Experimental values are shown as circles.

referring to this figure that, with an open-circuited load, this voltage ratio approaches 3, while with the load short-circuited it has a value $1/\pi$.

The per cent ripple designated by the symbol r is the ratio of the effective value of the ripple voltage to the average output voltage in per cent. Fig. 7, which has been obtained experimentally in a manner to be discussed presently, shows that at values of ωCR larger than 7.5 the most important ripple frequency is the one

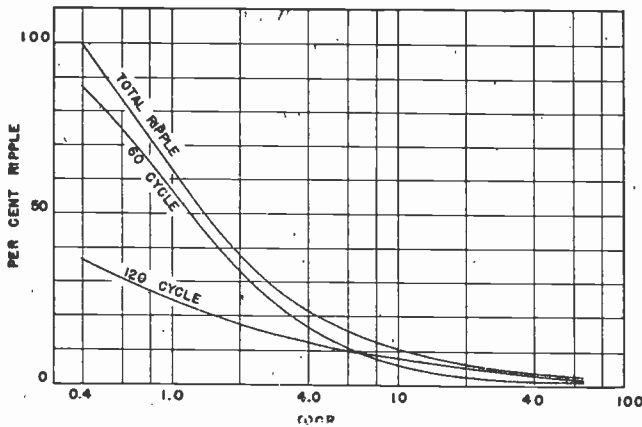

Fig. 7—Important ripple frequencies.

of twice the supply frequency, whereas for values of ωCR less than 7.5 the ripple having the same frequency as the supply is more important. The analysis gave expressions from which the ripple content can be calculated, and the results of these calculations are shown in Fig. 8. For values of ωCR above 25, that is, at fairly light loads, the per cent ripple is approximately $r = 71/\omega CR$.

For the design of tripler circuits it is necessary to know the average current, the maximum peak current, and the peak inverse voltages of the tubes for different conditions of operation. Since for each tube used the

average tube current is equal to the average output current, the average tube current may be obtained from Fig. 6.

Referring to Fig. 3 it will be seen that at high values of ωCR the maximum value of the current i_2 through tube T_2 is larger than the currents i_1 and i_3 of tubes T_1 and T_3 respectively. At small values of ωCR when the peak current i_2 through T_2 ceases to be the largest, the

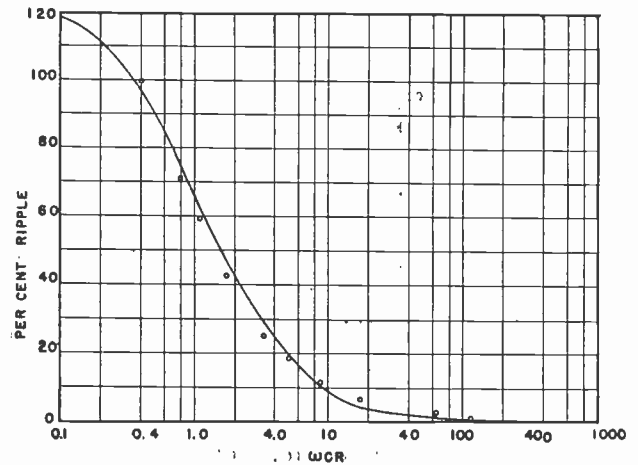

Fig. 8—Per cent ripple content in the output voltage. Experimental values are shown as circles.

peak tube-current characteristics are so close to one another that the characteristic for tube T_2 can be used for all three tubes. Since all the tubes used in this circuit are identical, only the characteristic for T_2 will be considered. The results for the maximum tube currents calculated from the analysis for several values of ωCR are plotted in Fig. 9. From this figure it will be seen that

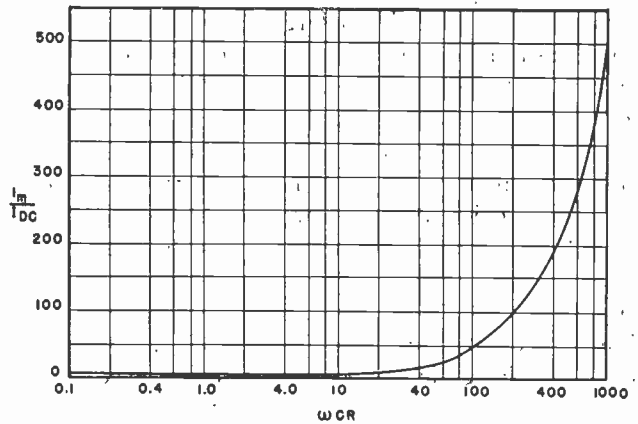

Fig. 9—The peak tube-current characteristic for the tripler.

the ratio of maximum tube current to average tube current i_m/I_{DC} decreases from very high values corresponding to large values of ωCR to less than ten at ωCR equal to ten, and has finally a value 2π corresponding to a short-circuited load.

It was found by calculation that the inverse peak voltages across tube T_3 is always larger than those across tubes T_1 and T_2 . In order to determine the maximum values of the inverse voltages across each tube, it was necessary to study the voltage variations across

the tubes for a whole cycle and then to select the maximum voltage. Fig. 10 shows the calculated ratio of maximum inverse voltage to the maximum value of the alternating-voltage supply, e_p/E_m .

Experimental Results

Following the analytical investigation, the results of which were discussed above, an actual tripler circuit, whose components were similar to those of the analytical one, was designed and investigated experimentally. The experimental results are discussed below. In Fig. 6 it will be seen that the experimental points for the ratio

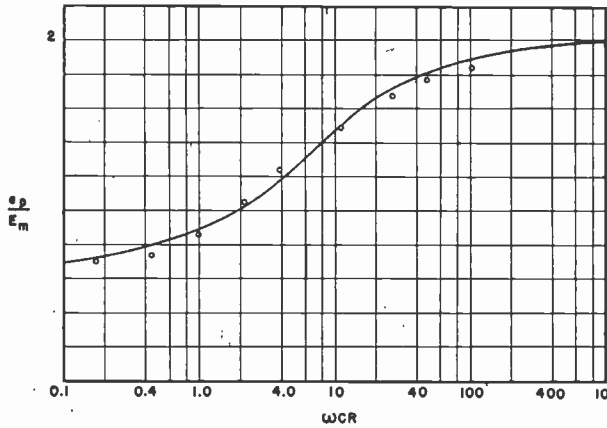

Fig. 10—The inverse peak voltage characteristic for the tripler. Experimental values are shown as circles.

E_{DC}/E_m are quite in agreement with the values given by the theoretical curve except near the two ends of the calculated curve. Experimental points approach zero at load values close to short circuit, and are lower than the calculated values at loads approaching open circuit. The cause of this discrepancy at small values of ωCR is due to the fact that the tube potential drops play an important part near short circuit. In the actual circuit it is possible to short-circuit the tripler and obtain finite values for the short-circuit current, whereas under the assumptions made, the short-circuit current is infinitely large. No satisfactory explanation of the discrepancy between theoretical and experimental values at high values of ωCR can be given at present. A probable cause is that in this region the tubes fire through very small time intervals which may not be long enough to cause complete ionization in the tubes. This will result in large tube potential drops and lowered output voltages. The experimental results for the per cent ripple and the maximum inverse voltage are indicated in Figs. 8 and 10. Again, similar slight discrepancies between theoretical and experimental results may be observed near the ends of these curves.

Design Considerations

The output-characteristic curve shown in Fig. 6 flattens out at very large values of ωCR , and this indicates a very good output-voltage regulation for lightly loaded tripler circuits. Under ordinary load conditions the

step part of the curve will more likely be closer to the region of operation.

From the calculated values of the capacitor voltages it can be shown that the voltages across capacitors C_2 and C_3 reverse during part of the cycle. This eliminates

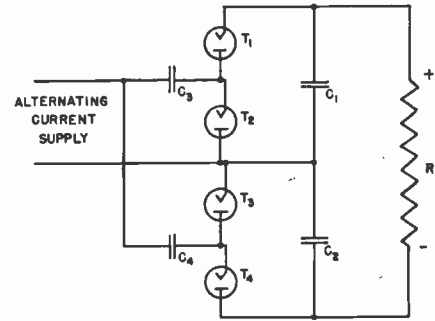

Fig. 11—The circuit diagram of the voltage quadrupler.

the possible use of polarized electrolytic capacitors for heavily loaded circuits or for circuits subject to short circuits. The voltage across capacitor C_3 reverses at a value of ωCR near 12 which may be within the useful portion of the characteristic curve.

THE VOLTAGE QUADRUPLER

Analysis

The circuit of the quadrupler is shown in Fig. 11. At light loads the quadrupler has one mode of operation that will be designated hereafter as Mode 1. For this

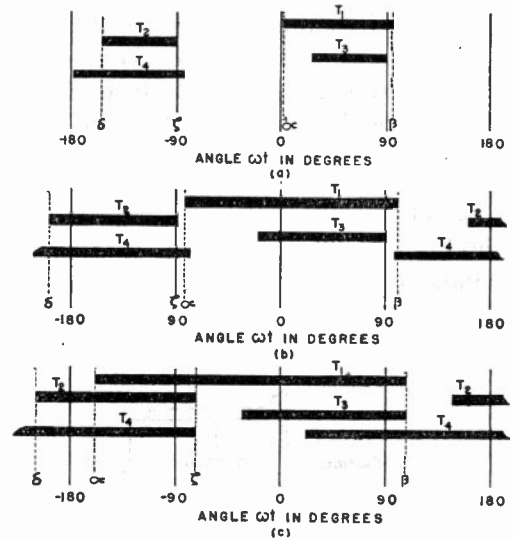

Fig. 12—The angles of firing for the various tubes. (a), (b), and (c) are for Modes 1, 2, and 3, respectively.

case, referring to Figs. 11 and 12 (a), it will be seen that tube T_2 starts to conduct at a time corresponding to angle $\omega t = \delta$ and stops at $\omega t = \zeta = -\pi/2$, where $\omega/2\pi$ is the supply frequency and t is the time in seconds. During this time the capacitor C_3 is charged to the peak value E_m of the alternating-voltage supply. For the following half cycle of time, tube T_1 starts to conduct at angle $\omega t = \alpha$ and stops conducting at $\omega t = \beta$. While T_1 is conducting, the alternating-voltage supply adds to the

voltage across capacitor C_3 to charge capacitor C_1 to approximately twice the maximum value E_m of the alternating-voltage supply. The conducting periods of tubes T_3 and T_4 are exactly 180 degrees out of phase with the periods of tubes T_2 and T_1 , respectively. This is illustrated in Fig. 12 (a). Since the voltages across capacitor C_1 and across capacitor C_2 are equal to approximately $2E_m$, the voltage across the load resistance R is also approximately $4E_m$, which explains the name quadrupler given to this circuit. Calculated current and

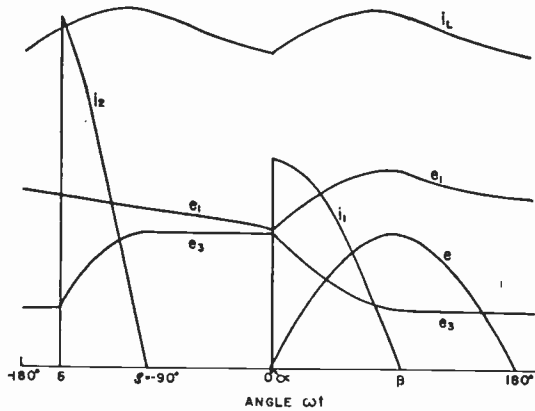

Fig. 13—The voltage and current wave forms for Mode 1.

voltage wave forms for this case are given in Fig. 13, but only 180 degrees of the alternating supply voltage is shown and is indicated by e . The load current i_L through the load resistor R is shown by the curve marked i_L , and the load voltage has exactly the same shape as i_L as long as the load is a pure resistance. The current i_1 through tube T_1 is shown by the curve marked i_1 , and the current i_2 through T_2 is similarly indicated by i_2 . The currents through tubes T_3 and T_4 are omitted, for clarity. They have respectively the same shape as those of T_2 and T_1 and are displaced from curves i_1 and i_2 by 180 degrees. The voltage of capacitor C_1 is e_1 and is so marked in Fig. 13. The voltage e_3 of capacitor C_3 is similarly indicated by e_3 , while the voltages of capacitors C_2 and C_4 are shifted from e_1 and e_3 respectively by 180 degrees. The load voltage is the sum of the voltages

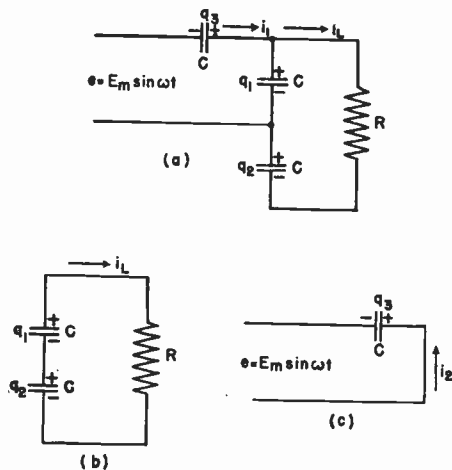

Fig. 14—The equivalent circuits for Mode 1.

of capacitors C_1 and C_2 . For convenience in plotting, the tube currents i_1 and i_2 are reduced in Fig. 13 to one tenth their actual values as compared with the load current i_L .

To simplify the analysis, similar assumptions to those made for the tripler are also made for the quadrupler. The equivalent circuits which successively simulate the behavior of this particular voltage multiplier for Mode 1 are shown in Fig. 14. The equivalent circuit while tube T_1 is conducting is that shown in Fig. 14 (a) for the interval corresponding to angular distance from α to β as illustrated in Fig. 12 (a). When neither tubes T_1 nor T_4 are conducting, i.e., during the interval corresponding to that from β to $(\alpha + 180)$ degrees, the equivalent circuit is like that of Fig. 14 (b). When tube T_2 is conducting from δ to ζ , the equivalent circuit is like the one shown in Fig. 14 (c), since capacitor C_3 is not connected to the load resistance R at that time.

The analysis for Mode 1 discussed above is carried out in part in Appendix III. The part of the analysis given consists in determining the angle α at which the tube T_1 starts to conduct, the angle β at which the tube stops conducting, and the angle $\gamma = \beta - \alpha$ which represents the length of time that the tube is conducting. The

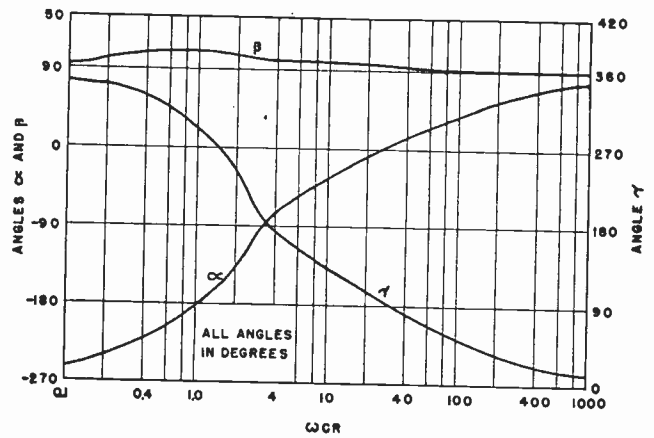

Fig. 15—Angles α , β , and γ for all three modes.

three corresponding angles, δ , ζ , and $\eta = \zeta - \delta$, for tube T_2 are also obtained. The analysis shows that each of the six angles depends only on the product ωCR . These angles have been calculated for several values of ωCR , and the results are plotted in Figs. 15 and 16. The analysis for Mode 1, however, holds only for values of ωCR from infinity to 3.694.

For lower values of ωCR (heavier loads) the quadrupler behaves differently. This mode of operation will be designated as Mode 2. The conducting periods of the various tubes are shown in Fig. 12 (b). It is seen that from angle α to angle $(\beta - 180)$ degrees both tubes T_1 and T_4 are conducting at the same time, whereas for Mode 1 this was not true. The current and voltage wave forms and equivalent circuits for this mode have not been presented here because this mode is much less important than Mode 1. This mode occurs only for values of ωCR from 3.694 to 3.133.

The third mode of operation, referred to as Mode 3, is valid from $\omega CR = 3.133$ to 0 which is short circuit, and the conducting periods of the tubes are shown in Fig. 12 (c). Three tubes, T_1 , T_2 , and T_4 , are now conducting simultaneously for the period corresponding to the angular distance from angle α to $(\beta - 180 \text{ degrees}) = \zeta$. Again, the wave forms and equivalent circuits are not shown. At $\omega CR = 3.133$, which is the boundary value between Modes 2 and 3, a discontinuity in tube angles ζ and η occurs for the same reasons as are given in the case of the tripler.

It is of interest to discuss both the change with load and the end values of the various tube angles. It may be seen in Fig. 15 that at light loads, i.e., large values of ωCR , both α and β are very close to 90 degrees, while γ is nearly zero degrees. As the load is increased, i.e., ωCR decreased, angle α decreases toward -270 degrees, β increases to a maximum of approximately 110 degrees and then decreases toward 90 degrees, while γ increases toward 360 degrees. At light loads both δ and ζ approach -90 degrees, and η is almost zero degrees. With

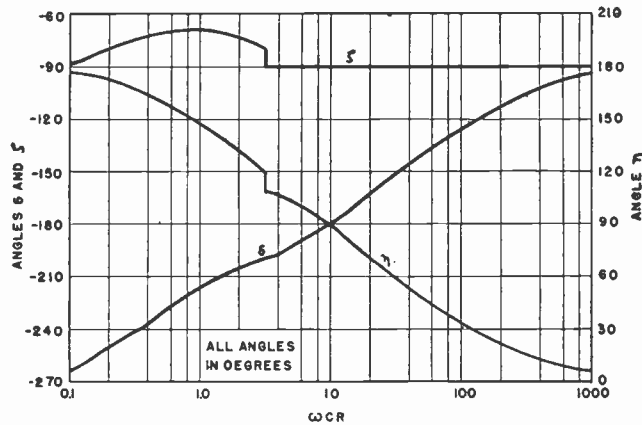

Fig. 16—Angles δ , ζ , and η for all three modes.

increased loads, δ decreases toward -270 degrees, while η approaches 180 degrees. Angle ζ remains equal to -90 degrees until $\omega CR = 3.133$, whereupon ζ jumps to approximately -78 degrees and is equal to $(\beta - 180 \text{ degrees})$ for all heavier loads. The jump in angle ζ occurs because for heavy loads both tubes T_1 and T_2 are firing at the same time and T_2 must then carry not only the charging current of capacitor C_3 but also the load current i_L .

Characteristics

The average output voltage for various loads is the most important characteristic of this circuit. The ratio of the average output voltage to the maximum value of the applied alternating voltage or E_{DC}/E_m may be shown to depend on ωCR alone, and has been calculated for several values of ωCR . The curve of Fig. 17 shows the relationship between E_{DC}/E_m and ωCR . It indicates that this ratio decreases from a maximum of four at light loads to zero at heavy loads.

The output voltage has a certain amount of ripple voltage, and the per cent ripple r as calculated is shown

in Fig. 18 from which it is seen that the per cent ripple increases from zero at light loads to a maximum of approximately 48.3 per cent at heavy loads. The value 48.3 per cent is also the maximum per cent ripple of a full-wave doubler. At light loads for the quadrupler $\omega CR > 25$ the per cent ripple is approximately $r = 111/\omega CR$. The ripple frequencies are even multiples of the supply frequency, as might be expected from the symmetry of the circuit.

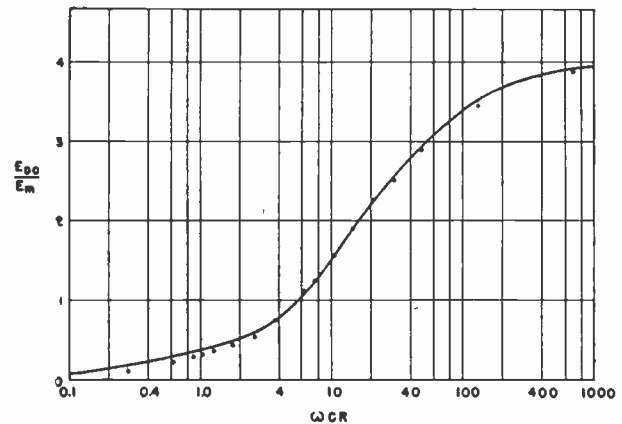

Fig. 17—The ratio of the average output voltage to the maximum value of the applied alternating voltage. Experimental values of this ratio are shown as circles.

The average current, maximum current, and peak inverse voltage of the tubes must be known for the selection of the proper tubes for this multiplying circuit. The average output current may be obtained from Fig. 17, and since the average tube current is equal to the average output current, the average tube current may thus also be obtained from Fig. 17. The maximum current for tubes T_1 and T_4 is always smaller than that for tubes T_2 and T_3 , and because the tubes used in this circuit are usually the same types, only the maximum current for tubes T_2 and T_3 is considered. The ratio of the maximum tube current to the average tube current i_m/I_{DC} as a function of ωCR is given in Fig. 19, from which it is seen that this ratio decreases from very large values at light loads toward 3.142 at heavy loads. The peak inverse voltage for tubes T_1 and T_4 is always smaller

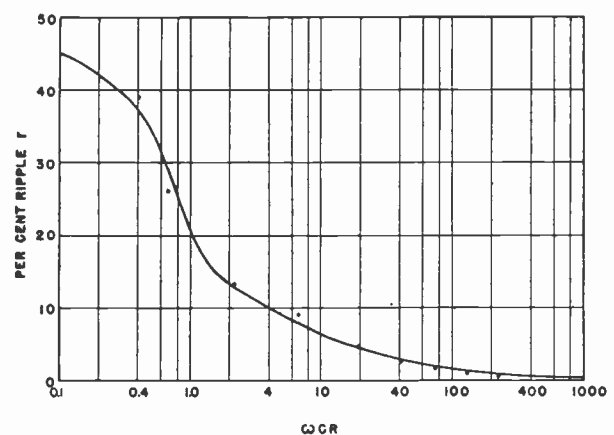

Fig. 18—The per cent ripple r with experimental values shown as circles.

than that for tubes T_2 and T_3 , and as in the case of the maximum tube currents, only the peak inverse voltage of tubes T_2 and T_3 is considered. The ratio of the inverse peak tube voltage to the maximum value of the alternating applied voltage e_p/E_m is shown as a function of ωCR in Fig. 19, from which it is seen that this ratio decreases from 2.0 at light loads to 0 at heavy loads.

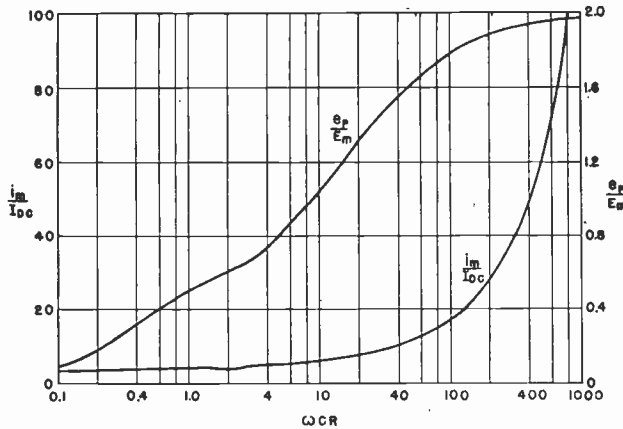

Fig. 19—The ratio of maximum tube current to average tube current i_m/I_{DC} and the ratio of inverse peak tube voltage to the maximum value of the applied alternating voltage e_p/E_m .

As a check on these calculated characteristics, some experimental results are also included, and are shown as the small circles in Figs. 17 and 18.

Capacitors

Capacitors C_1 and C_2 must withstand a voltage equal to $2E_m$, while capacitors C_3 and C_4 must withstand a voltage equal to E_m . From the analysis it was found that the voltage across the capacitors C_3 and C_4 reverses during part of each cycle if the quadrupler is loaded quite heavily. This occurs when δ is less than -180 degrees or when ωCR is less than 9.514. Polarized electrolytic capacitors should be used for C_3 and C_4 only when ωCR is greater than this value, while nonpolarized electrolytic capacitors may be used for any value of ωCR . It should be noted that the voltages across the capacitors C_1 and C_2 never reverse, and thus polarized electrolytic capacitors may be used for C_1 and C_2 for any value of ωCR .

Short-Circuit Operation

With the output short-circuited, tubes T_1 and T_4 are conducting all of the time while tubes T_2 and T_3 conduct alternately one half of each cycle. The output current on short-circuited load is found from the given analysis to be $I_{DC} = (2/\pi)\omega CE_m$, and these predicted short-circuit currents have been found to agree quite well with experimental values.

APPENDIX I

NOMENCLATURE

a. Symbols Common to the Analyses of Both the Tripler and the Quadrupler

$\omega/2\pi$ = frequency of the alternating-voltage supply

t = time in seconds

E_m = the maximum value of the alternating-voltage supply

e_1, e_2, e_3, e_4 = the instantaneous voltages across capacitors $C_1, C_2, C_3,$ and C_4 , respectively

i_1, i_2, i_3, i_4 = the instantaneous currents flowing through tubes $T_1, T_2, T_3,$ and T_4 , respectively

q_1, q_2, q_3, q_4 = the instantaneous charges on capacitors $C_1, C_2, C_3,$ and C_4 respectively

i_L = the current flowing through the load resistance R

R = the load resistance in ohms

C = the capacitance in farads of capacitors $C_1, C_2, C_3,$ and C_4

α = angle in radians at which the tube T_1 starts to conduct

β = angle in radians at which the tube T_1 stops conducting

δ = angle in radians at which the tube T_2 starts to conduct

ζ = angle in radians at which the tube T_2 stops conducting

E_{DC} = average output voltage across the load resistance R

r = per cent ripple

i_m = maximum tube current

$\lambda = \tan^{-1}(\omega CR), 0 \leq \lambda \leq (\pi/2)$

λ_1 = an angle such that $\tan \lambda_1 = (2/3) \tan \lambda, 0 \leq \lambda_1 \leq (\pi/2)$

$I_{DC} = E_{DC}/R$ = average direct current through the load resistance R

e = the instantaneous value of the alternating-voltage supply

e_p = peak inverse voltage that the tube must withstand

Subscripts

The instantaneous output current i_L is written at angle α , for example, as i_α and similarly for the other angles. The instantaneous charges such as q_1 use a somewhat similar notation and as an example, q_1 at angle β is written $q_{1\beta}$.

b. Additional Symbols Used in the Analysis of the Tripler Circuit

f_1, f_2, f_3, f_4 = functions of α, β, ρ, μ and λ defined in Appendix II.

$\theta = \omega t$

ρ = angle in radians at which the tube T_3 starts to conduct

μ = angle in radians at which the tube T_3 stops conducting.

$Z = \sqrt{R^2 + (1/\omega C)^2}$

c. Additional Symbols Used in the Analysis of the Quadrupler Circuit

$\gamma = \beta - \alpha$ = angle in radians during which the tube T_1 is conducting

$\eta = \zeta - \delta =$ angle in radians during which the tube T_2 is conducting

APPENDIX II

ANALYSIS OF THE TRIPLER CIRCUIT

MODE 1: $\infty \geq \omega CR \geq 4.21$

a. General Circuit Relations

The equations presented were obtained from the solution of the current and voltage equations pertaining to the equivalent circuits shown in Fig. 4. Using the equivalent circuit in Fig. 4 (b) which applies in the interval from angle $\omega t = \rho$ to $\omega t = \mu$, the current expressions become

$$i_L = -E_m/Z \cos(\theta - \lambda) + [i_p + E_m/Z \cos(\rho - \lambda)]e^{-(\theta-\rho)\cot\lambda} \quad (1)$$

$$i_3 = -2E_m/Z \cos(\theta - \lambda) + E_m/Z \tan \lambda \sin(\theta - \lambda) + [i_p + E_m/Z \cos(\rho - \lambda)]e^{-(\theta-\rho)\cot\lambda} \quad (2)$$

The relations holding at the end points ρ and μ are

$$E_m \sin \rho = (q_{1\rho}/C) - R i_p \quad (3)$$

$$i_\mu = -E_m/Z \cos(\mu - \lambda) + [i_p + E_m/Z \cos(\rho - \lambda)]e^{-(\mu-\rho)\cot\lambda} \quad (4)$$

$$i_\mu = E_m/R \tan \lambda \cos \mu \quad (5)$$

$$q_{1\mu} - q_{1\rho} = 1/\omega [E_m/Z(\sin \mu - \sin \rho)/\cos \lambda + \tan \lambda(i_\mu - i_p)] \quad (6)$$

Similar expressions were obtained from the other equivalent circuits for this mode.

b. Determination of the Firing Angles

The end-point equations, such as (3), (4), (5), and (6), were combined to result in four equations which could not be solved explicitly for the unknown angles α , β , μ , and ρ . These four equations are

$$f_1 = 2 \sin \alpha + 2 - 2 \sin \mu - \tan \lambda \cos \mu - (\tan \lambda \cos \mu)e^{-2(\alpha-\mu)\cot\lambda} \quad (7)$$

$$f_2 = \cos \beta \tan \lambda + 1/2 \sin \lambda_1 \cos(\beta - \lambda_1) + [2 \sin \alpha + 2 - 2 \sin \mu - \cos \mu \tan \lambda - 1/2 \sin \lambda_1 \cos(\alpha - \lambda_1)]e^{-(\beta-\alpha)\cot\lambda_1} \quad (8)$$

$$f_3 = \cos \mu \tan \lambda + \sin \alpha \cos(\mu - \lambda) - [1/3(\cos \beta \tan \lambda + 2 \sin \beta + 2 \cos \mu \tan \lambda + 4 \sin \mu - 6 \sin \rho + 2) + \sin \lambda \cos(\rho - \lambda)]e^{-(\mu-\rho)\cot\lambda} \quad (9)$$

$$f_4 = 1/3(\cos \beta \tan \lambda + 2 \sin \beta + 2 \cos \mu \tan \lambda + 4 \sin \mu - 6 \sin \rho + 2) + (\cos \beta \tan \lambda)e^{-2(\rho-\beta+2\pi)\cot\lambda} \quad (10)$$

In these equations the values of α , β , ρ , and μ that will make f_1 , f_2 , f_3 , and f_4 equal to zero for given values

of ωCR have to be determined by numerical solutions.⁹ The angle δ may be calculated from the values of the other firing angles.

The other characteristics of this circuit, such as the average output current, the per cent ripple, the peak tube currents, and the inverse peak voltages, may be obtained from the firing-angle values in a similar fashion to that used previously.^{6,7}

APPENDIX III

ANALYSIS OF THE QUADRUPLER CIRCUIT

MODE 1. $\infty \geq \omega CR \geq 3.694$

a. General Circuit Relations

The equivalent circuits of Fig. 14 were solved in a manner similar to that presented in Appendix II for the tripler.

b. Determination of the Firing Angles

The results of Part a may be incorporated in one equation which is

$$F(\gamma) = A_1^2 + B_1^2 - (A_1 B_2 - A_2 B_1)^2 = 0 \quad (11)$$

where

$$A_1 = \sin \lambda_1 - \sin(\gamma + \lambda_1)e^{-\gamma \cot \lambda_1}$$

$$B_1 = 3/\cos \lambda_1 [1 - e^{-2(\pi-\gamma)\cot\lambda} e^{-\gamma \cot \lambda_1}] + \cos \lambda_1 - \cos(\gamma + \lambda_1)e^{-\gamma \cot \lambda_1}$$

$$A_2 = 1/6(5 \cos \gamma + 1)$$

$$B_2 = \tan \lambda / 12 [1 + 5e^{-2(\pi-\gamma)\cot\lambda}] - 5/6 \sin \gamma.$$

For a given value of λ corresponding to $\omega CR = \tan \lambda$, the corresponding value of γ may be determined by solving $F(\gamma) = 0$ for its root. This root may be found by using an approximate numerical method of solution.⁹ The two angles α and β may then be calculated from $\beta = \tan^{-1}(-B_1/A_1)$ and $\alpha = \beta - \gamma$. The angle δ may be obtained from

$$\delta = \sin^{-1}(2/5 \cos \beta \tan \lambda + 4/5 \sin \beta - 1/5). \quad (12)$$

Thus, the five angles α , β , γ , δ , and η are functions of ωCR alone.

The analysis of Case I holds until $\gamma = \beta - \alpha = \pi$ or 180 degrees, and this can be shown to occur at $\omega CR = 3.694$. The range in which Mode 1 is valid is from $\omega CR = \infty$ to $\omega CR = 3.694$.

The other characteristics of this circuit may be obtained from the calculated values of the conduction angles of the tubes in a manner similar to that previously used.^{6,7}

⁹ D. L. Waidelich, "The numerical solution of equations," *Elec. Eng.*, vol. 60, pp. 480-481; October, 1941.

represented by the curve $C(t)$. Besides the high-level beating-oscillator voltage, a low-level signal, denoted by $S(t)$, is present. For generality the beating oscillator and the signal each may be thought of as expressed by the sum of a number of sine waves. In the case of the beating oscillator, these are in harmonic relation and therefore may be written in the form of a Fourier series in one variable. For the signal, this restriction is not necessary. The signal is taken to consist of a number of sinusoidal components comprised within a finite band of frequencies, and, as will become evident later, the linear relationship which applies between the input signal (usually a high-frequency one) and the output signal (usually an intermediate frequency) allows a single sinusoidal component to be taken as typical of the signal, both for input and for output.

To put these properties into the language of analysis, it will be noted that the current-voltage relationship of the single-valued curve of Fig. 1 may be written quite generally,

$$I = F(V). \tag{1}$$

With the beating oscillator $C(t)$ and the signal voltage $S(t)$ this becomes

$$I = F[C(t) + S(t)]. \tag{2}$$

It was stipulated in the beginning that the level of the beating-oscillator voltage was much greater than that of the signal. It results that (2) may be expanded into the Taylor series

$$I = F[C(t)] + F'[C(t)]S(t) + 1/2F''[C(t)]S^2(t) + \dots \tag{3}$$

and that, for the extremely small signals that are encountered in the use of actual mixers, only the first two terms in the above series need be retained. The first of these merely represents the currents flowing as a result of the beating oscillator alone, and contains only direct current and harmonics of the beating-oscillator frequencies, including the fundamental. In general, the signal frequencies differ from all of these, and consequently the currents which result from the signal are separable in frequency from those produced by the beating oscillator alone.

Thus, in the expression

$$I = F[C(t)] + F'[C(t)]S(t) \tag{4}$$

it is appropriate to follow the lead of Peterson and Hussey¹ and give the last term a fairly simple physical interpretation. Insofar as the signal is concerned, the nonlinear device behaves like a linear conductance $F'[C(t)]$ which, however, has the property of varying with time in accord with the effect of the beating oscillator. To illustrate, on Fig. 1 a typical point on the curve corresponds to the time t_0 of the beating-oscillator cycle. The signal voltage sweeps over a small segment $a-b$ of the characteristic, and for this small sweep the conductance to the signal is given by the slope of the $V-I$ characteristic at the point corresponding to t_0 . This slope is $F'(V)$ where for V it is necessary to insert the value of the beating-oscillator voltage at the time t_0 . This gives

$F'[C(t_0)]$ and expresses the value of the conductance at the instant t_0 in terms of the symbolism of (4).

Since $C(t)$ is a periodic function in practical applications, so also is the conductance $F'[C(t)]$. It can therefore be developed in a Fourier series whose coefficients depend upon the nonlinear characteristic and upon the beating-oscillator amplitude and wave shape, but not upon the signal.

It thus becomes possible in (4) to write the beating-oscillator voltage in the form of a Fourier series

$$F[C(t)] = \sum_{-\infty}^{\infty} B_n e^{inbt} \tag{5}$$

and thence to define the general conductance to the signal as $g(t)$ where $g(t)$ is given by a second Fourier series, namely

$$g(t) = F'[C(t)] = \sum_{-\infty}^{\infty} y_n e^{inbt} \tag{6}$$

where

$$y_n = 1/T \int_{-T/2}^{T/2} F'[C(t)] e^{-inbt} dt$$

and T is the period of the fundamental.

By inversion of the original relation (1) it is equally valid to express the impedance of the nonlinear device to a small signal in the form of the Fourier series

$$r(t) = \sum_{-\infty}^{\infty} z_n e^{inbt}. \tag{7}$$

The choice between (6) and (7) is usually a matter of convenience, for they merely express Ohm's law in the two forms $i = gv$ and $v = ri$.

Another noteworthy feature of (6) and (7) is that the Fourier coefficients are real numbers whenever the beating-oscillator input is an even function of time and are pure imaginaries whenever the beating-oscillator voltage is an odd function. In the general case, where the beating-oscillator input consists both of an even and an odd function, the Fourier coefficients are complex numbers, but are of such a character that y_{-n} is the complex conjugate of y_{+n} . Whenever the beating-oscillator input is a single sine wave, it is always possible to choose the time origin in such a way as to make all of the coefficients real. This simplifies the analysis, and, of course, does not change the result.

With these relations as a background, the effect may be found of impressing upon the mixer a generalized signal of the form

$$S(t) = \sum^p v_p e^{ip t} \tag{8}$$

where the summation is taken over the frequencies included in the impressed signal wave. Thus from (4), (6), and (8)

$$I = \sum_{n=-\infty}^{\infty} B_n e^{inbt} + \sum_{n=-\infty}^{\infty} y_n e^{inbt} \sum^p v_p e^{ip t}. \tag{9}$$

It is immediately evident that the resulting current may be written in the general form

$$I = \sum^q i_q e^{iq t} \tag{10}$$

where the summation is taken over all values of q corresponding to frequencies resulting from the right-hand side of (9). Thus, replacing the left-hand side of (9) by (10) and writing the double summation on the right-hand side in a somewhat different, but equivalent, form, we have

$$\sum^q i_q e^{jq t} = \sum_{n=-\infty}^{\infty} B_n e^{jnbt} + \sum_p \sum_{n=-\infty}^{\infty} y_n v_p e^{j(nb+p)t}. \quad (11)$$

Since this is true for all values of time, it follows that the sum of all terms involving the same frequency on the right-hand side must be equal to a term of that same frequency on the left. This fact allows the single equation (11) to be broken up into an infinite number of simpler equations, one for each frequency involved. Of these, a certain number correspond merely to the harmonics of the beating-oscillator frequency, and do not contain the signal. The ones which do contain the signal are then included in the following

$$\sum^q i_q e^{jq t} = \sum_p \sum_{n=-\infty}^{\infty} y_n v_p e^{j(nb+p)t} \quad (12)$$

where

$$q = nb + p. \quad (13)$$

Upon separating out the individual equations, and letting the input high-frequency signal be given by the special value of p for which

$$p = b + s \quad (14)$$

we can write the resulting equations in the form of an array with an infinite number of terms. Thus

\dots	v_{-3b+s}	v_{-2b+s}	v_{-b+s}	v_s	v_{b+s}	v_{2b+s}	\dots	
.
.	y_1	y_0	y_{-1}	y_{-2}	y_{-3}	y_{-4}	.	i_{-2b+s}
.	y_2	y_1	y_0	y_{-1}	y_{-2}	y_{-3}	.	i_{-b+s}
.	y_3	y_2	y_1	y_0	y_{-1}	y_{-2}	.	i_s
.	y_4	y_3	y_2	y_1	y_0	y_{-1}	.	i_{b+s}
.	y_5	y_4	y_3	y_2	y_1	y_0	.	i_{2b+s}
.

In any particular problem it is seldom necessary to deal with a very large number of these equations. Whenever no power is delivered or absorbed by the external circuit at a given frequency, it follows that either the current is zero, the voltage is zero, or they are in quadrature. As will be shown later, the same formal relations apply at the far terminals of a network hung onto the mixer. The quadrature relationship would require a purely reactive termination, and it becomes evident that this case may be avoided in practical applications where the final terminations comprise impedances only at specified input and output frequencies, being zero or infinite at all other frequencies. It then follows that the infinite set of equations expressed by (15) reduces to a finite number equal to the number of frequencies at which energy is either delivered to the mixer or absorbed

from the mixer by an external circuit. This number is the same as the number of frequencies at which the terminating impedance is different from zero or infinity.

Supposing these frequencies to be three in number, namely $b+s$, s , and $-b+s$, we have then

v_{-b+s}	v_s	v_{b+s}	
y_0	y_{-1}	y_{-2}	i_{-b+s}
y_1	y_0	y_{-1}	i_s
y_2	y_1	y_0	i_{b+s}

This begins to look like the array which specifies a linear passive network. It differs in that the array is not quite symmetrical about the main diagonal. However, as remarked before, whenever the beating oscillator impresses on the mixer a voltage that is an even function of time, all of the y coefficients become real, rather than complex or imaginary and hence, for this case, $y_n = g_n = y_{-n}$ so that (16) turns into the form

v_{-b+s}	v_s	v_{b+s}	
g_0	g_1	g_2	i_{-b+s}
g_1	g_0	g_1	i_s
g_2	g_1	g_0	i_{b+s}

This is entirely similar to the array which characterizes a passive linear network, and shows that insofar as any external measurements are concerned, the nonlinear resistive element behaves entirely like a passive network with three sets of terminals which stand in a 1-to-1 cor-

respondence with the three frequencies, $b+s$, s , and $-b+s$, at which there is energy transfer to or from the mixer. The general block diagram of Fig. 2 shows the

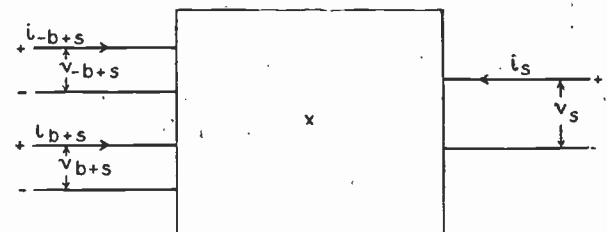

Fig. 2—Representation of a mixer as a linear 6-pole network.

three terminal pairs and illustrates the relative directions for voltage and current. In the case that a fixed impedance is connected across one of the three pairs of

terminals, the six-pole network of Fig. 2 may, of course, be reduced to a four-pole network having only two pairs of terminals. In relation to practical operation of mixers, this might occur when the external impedance to one of the three frequencies was made either zero or infinite. In such an event, and supposing that the frequency at which the external impedance was made zero were $-b+s$, then the array of (17) reduces to

$$\begin{array}{cc|c} v_s & v_{b+s} & \\ \hline g_0 & g_1 & i_s \\ g_1 & g_0 & i_{b+s} \end{array} \quad (18)$$

This is the form dealt with in much of the former literature on the subject and is illustrated in Fig. 3. It applies to cases where the input-signal frequency is $b+s$ and the intermediate-frequency output is s , while impedances in the external circuit at all other frequencies are zero.

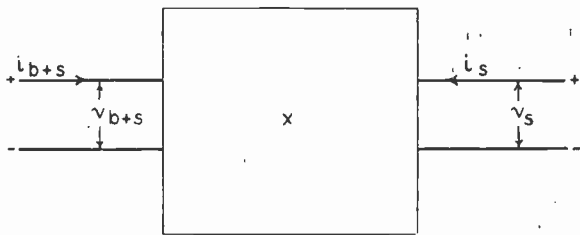

Fig. 3—Representation of a mixer as a linear 4-pole network.

As operated in many systems, however, the high-frequency band is so wide that with a signal input at $b+s$, the impedance at the $-b+s$ frequency cannot be disregarded. For example, when the beating-oscillator frequency is 10 megacycles and the intermediate frequency is 30 kilocycles, then the $b+s$ frequency of the input signal is 10.030 megacycles. The $b-s$ frequency is then 9.970 megacycles. It is obvious from practical considerations that, unless special action is taken to insure otherwise, the impedance at $b-s$ may be almost the same as at $b+s$. Hence, since the impedance at $-b+s$ is then the conjugate of that at $b-s$, it follows that the third equation in (17) cannot often be disregarded in high-frequency-mixer analysis.

Up to this point, it has been shown that the operation of resistive mixers may be formulated in terms of a set of linear equations; that the number of equations is equal to the number of frequencies at which energy is transferred to or from the mixer; that in certain cases the coefficients in the equations agree with those in equations describing a passive linear network; and that in many practical applications the network is a six-pole but in some cases reduces to a four-pole.

Nothing as yet has been said of the possibility of the existence of circuit reactance within the mixer terminals. The way of handling this situation involves application of the principles of linear-network theory, as indeed does the most general and expeditious way of progressing from the linear equations already derived to the performance properties of the actual mixer.

For this reason, the mixer itself will be left temporarily at this point and the general properties of the linear network will be outlined, after which a return will be made to the mixer.

PART II. PRINCIPLES OF LINEAR-NETWORK THEORY

For the immediate purpose of summarizing the pertinent principles of linear-network theory,⁶⁻¹⁰ consider the four-poles indicated schematically in Figs. 4 and 5. The

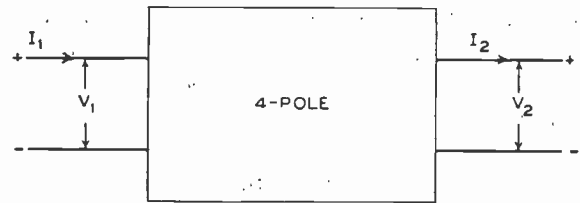

Fig. 4—Current-voltage relations for α coefficients.

four-pole portion of the two figures differs only in the direction of the assumed current I_2 with reference to the voltage across the terminals. In Fig. 4 the structure is set up in the most convenient way for analysis when it is driven at one end only, as at 1, and the other end terminates in a load impedance. In Fig. 5 the structure is set up in the most convenient way for analysis when the terminals are connected more generally to sources of electromotive force, E_1 and E_2 . The distinction between the assumed current directions is purely a matter of

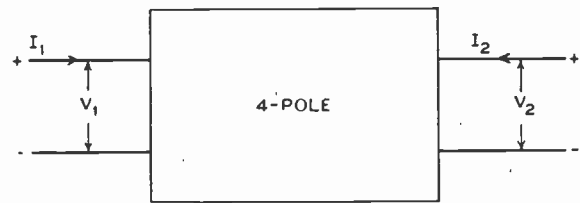

Fig. 5—Current-voltage relations for β coefficients.

convenience in order to avoid certain confusions with plus and minus signs which otherwise arise. In either case, the transmission of energy from left to right may be different from that from right to left in the general case, but, of course, becomes the same for passive networks.

In general, there are two equations which uniquely describe the relations between the currents and voltages at the terminal pairs in either Fig. 4 or Fig. 5. For the current directions in Fig. 4 they are most conveniently written in the form

$$\begin{aligned} V_1 &= \alpha_{11}V_2 + \alpha_{12}I_2 \\ I_1 &= \alpha_{21}V_2 + \alpha_{22}I_2 \end{aligned}$$

⁶ K. S. Johnson, "Transmission Circuits for Telephone Communication," D. Van Nostrand, New York, N. Y., 1925.

⁷ E. A. Guillemin, "Communication Networks," vol. II, John Wiley and Sons, New York, N. Y., 1935.

⁸ W. L. Everitt, "Communication Engineering," McGraw-Hill Book Company, New York 18, N. Y., 1937.

⁹ F. E. Terman, "Radio Engineers' Handbook," McGraw-Hill Book Company, New York 18, N. Y., 1943.

¹⁰ A. C. Bartlett, "The Theory of Electrical Artificial Lines and Filters," John Wiley and Sons, New York, N. Y., 1930.

or, for better visualization, as

$$\begin{array}{cc|c} V_2 & I_2 & \\ \hline \alpha_{11} & \alpha_{12} & V_1 \\ \alpha_{21} & \alpha_{22} & I_1 \end{array} \quad (19)$$

where the α coefficients depend upon the internal structure of the network only. The determinant

$$\Delta_\alpha = \begin{vmatrix} \alpha_{11} & \alpha_{12} \\ \alpha_{21} & \alpha_{22} \end{vmatrix} \quad (20)$$

has the value of unity when the network is passive, and this property in any network is indicative of the equal transmission of energy in either direction. For generality, however, this restriction will not be imposed at the present time.

For many purposes it is useful to transform (19) by solving for I_1 and I_2 instead of for V_1 and I_1 . The result is

$$\begin{aligned} (\alpha_{22}/\alpha_{12})V_1 - (\Delta_\alpha/\alpha_{12})V_2 &= I_1 \\ - (1/\alpha_{12})V_1 + (\alpha_{11}/\alpha_{12})V_2 &= -I_2. \end{aligned}$$

In this form, better symmetry is obtained by reversing I_2 , which brings us immediately to Fig. 5 and shows that, if we write for Fig. 5,

$$\begin{array}{cc|c} V_1 & V_2 & \\ \hline \beta_{11} & \beta_{12} & I_1 \\ \beta_{21} & \beta_{22} & I_2 \end{array} \quad (21)$$

and then take into account the fact that I_2 in Fig. 5 is equal to $-I_2$ in Fig. 4, we have

$$\begin{aligned} \beta_{11} &= \alpha_{22}/\alpha_{12} & \beta_{12} &= -\Delta_\alpha/\alpha_{12} \\ \beta_{21} &= -1/\alpha_{12} & \beta_{22} &= \alpha_{11}/\alpha_{12}. \end{aligned} \quad (22)$$

For reference, the converse relations are

$$\begin{aligned} \alpha_{11} &= -\beta_{22}/\beta_{21} & \alpha_{12} &= -1/\beta_{21} \\ \alpha_{21} &= -\Delta_\beta/\beta_{21} & \alpha_{22} &= -\beta_{11}/\beta_{21} \end{aligned} \quad (23)$$

where

$$\Delta_\beta = \begin{vmatrix} \beta_{11} & \beta_{12} \\ \beta_{21} & \beta_{22} \end{vmatrix}. \quad (24)$$

The systems of equations (19) or (21) are each by themselves sufficient to determine the performance of any linear structure with two pairs of terminals. The choice between them is entirely a matter of convenience. In the one case, the four α coefficients specify the structure, while in the other case the four β coefficients are used. The β 's may be derived from the α 's as given by (22) or vice versa as given by (23). The important thing to be emphasized at this juncture is that four independent parameters are sufficient to specify the performance of any linear structure, whether it be active or passive. When the structure is passive, only three of the coefficients are independent, and hence one may be eliminated. In the case of the α 's, the interrelation may be written

$$\Delta_\alpha = 1 \quad (25)$$

while for the β 's

$$\beta_{12} = \beta_{21} \quad (26)$$

for passive networks.

In general the performance of linear systems may be expressed equally well by other sets of four parameters rather than the α 's or the β 's. The new parameters may, of course, be derived from the old.

In communication engineering it is customary to use the so-called image parameters. These parameters are usually thought of only in connection with passive networks, but they can also be employed in the general linear network now under consideration. The image admittances Y_I and Y_{II} are defined as the admittances in which the four-pole network must be terminated in order that at either network terminal, the admittances seen in both directions shall be the same. Since in the general linear network the transmission loss may be different in the two directions, two image-transfer constants must be employed. They are defined as follows: The image-transfer constant θ_1 from input to output is one half the natural logarithm of the ratio of volt amperes flowing into terminals 1 and out of terminals 2 with the latter pair terminated in its image impedance. The image-transfer constant θ_2 from output to input is defined in a precisely similar way, namely, θ_2 is one half the natural logarithm of the ratio of volt amperes flowing into terminals 2 and out of terminals 1 with the latter pair terminated in its image impedance.

It is these four parameters which are used in most network analyses, and particularly in experimental and design applications. To find them in terms of the α coefficients, we first go to (19) and write $V_2 = I_2 Z_R$, where Z_R is a general impedance across the output. The impedance seen looking into the input terminals is then

$$Z_a = V_1/I_1 = (\alpha_{11}Z_R + \alpha_{12})/(\alpha_{21}Z_R + \alpha_{22}). \quad (27)$$

By a similar analysis, the impedance Z_b looking into the output terminals is found to be

$$Z_b = (\alpha_{22}Z_S + \alpha_{12})/(\alpha_{21}Z_S + \alpha_{11}) \quad (27a)$$

where Z_S is a general impedance across the input. To find the two image impedances, it is necessary only to put $Z_S = Z_I$ and $Z_R = Z_{II}$ and to solve (27) and (27a) simultaneously. The result is

$$Z_I = \sqrt{\alpha_{11}\alpha_{12}/\alpha_{21}\alpha_{22}} \quad (28)$$

$$Z_{II} = \sqrt{\alpha_{22}\alpha_{12}/\alpha_{21}\alpha_{11}}. \quad (28a)$$

These may be written in better form for measuring purposes by noting from (27) that, with the output terminals shorted, Z_a assumes the value

$$Z_{1S} = \alpha_{12}/\alpha_{22}$$

while with the output terminals open-circuited, Z_a assumes the value

$$Z_{10} = \alpha_{11}/\alpha_{21}.$$

Hence (28) may be written

$$Z_I = \sqrt{Z_{1S}Z_{10}}. \quad (29)$$

From similar short-circuit and open-circuit measurements at the output terminals, we have

$$Z_{II} = \sqrt{Z_{2S}Z_{20}}. \quad (29a)$$

To find the image transfer constant θ_1 we go to (19)

and (27), and find the ratio $V_1 I_1 / V_2 I_2$ when the structure is terminated in its image impedance. Thus

$${}_1L_2 = e^{2\theta_1} = \frac{V_1 I_1}{V_2 I_2} = \frac{I_1^2 Z_I}{I_2^2 Z_{II}} = [\sqrt{\alpha_{11}\alpha_{22}} + \sqrt{\alpha_{12}\alpha_{21}}]^2. \quad (30)$$

From a similar proceeding for transmission from output to input, we find

$$e^{2\theta_1} = \Delta_\alpha^2 e^{2\theta_2}. \quad (31)$$

Rather than to use θ_1 and θ_2 directly, it is more often convenient to deal with two other variables, namely

$$\theta = (\theta_1 + \theta_2)/2 \quad (32)$$

$$\phi = (\theta_1 - \theta_2)/2 \quad (33)$$

and it follows that

$$\tanh \theta = \sqrt{Z_{1S}/Z_{10}} = \sqrt{Z_{2S}/Z_{20}} \quad (34)$$

and

$$e^{\theta_1 - \theta_2} = \Delta_\alpha. \quad (35)$$

For passive networks, Δ_α is unity and $\theta_1 = \theta_2$.

Finally, the input impedance Z_a and the output impedance Z_b may be written in general as

$$Z_a = Z_I(Z_R/Z_{II} + \tanh \theta)/(1 + Z_R \tanh \theta/Z_{II}) \quad (36)$$

and

$$Z_b = Z_{II}(Z_S/Z_I + \tanh \theta)/(1 + Z_S \tanh \theta/Z_I) \quad (36a)$$

while the admittances are

$$Y_a = Y_I(Y_R/Y_{II} + \tanh \theta)/(1 + Y_R \tanh \theta/Y_{II}) \quad (37)$$

and

$$Y_b = Y_{II}(Y_S/Y_I + \tanh \theta)/(1 + Y_S/Y_I \tanh \theta). \quad (37a)$$

In terms of the β coefficients of (21) and with reference to Fig. 5, the image parameters become

$$\tanh \theta = \sqrt{1 - \beta_{12}\beta_{21}/\beta_{11}\beta_{22}} \quad (38)$$

$$Y_I = \beta_{11} \tanh \theta \quad (39)$$

$$Y_{II} = \beta_{22} \tanh \theta \quad (40)$$

and the loss from I to II is

$${}_1L_2 = (\beta_{12}/\beta_{21})(1 + \tanh \theta/1 - \tanh \theta) = (\beta_{12}/\beta_{21})e^{2\theta} \quad (41)$$

while, in the reverse direction

$${}_2L_1 = (\beta_{21}/\beta_{12})(1 + \tanh \theta/1 - \tanh \theta) = (\beta_{21}/\beta_{12})e^{2\theta}. \quad (42)$$

These relations summarize the most immediately useful formulas of linear-network theory. It follows that the objective of applying them to the analysis of mixers is to be able to find the image impedances or admittances and the image-transfer constants of the network containing the mixer and thus to know that when the image impedances form the terminating impedances for the mixer circuit, and when these image impedances are real, then the attenuation is given by the magnitude of $e^{2\theta_1}$. It also tells us that by tuning the circuit both at input and output terminals so as to make the image impedances real, as seen at the load terminals, the attenuation is reduced to the minimum value possible, which means that the circuit fits the mixer and allows it to perform to its best advantage. More than this, when the four image constants have been found, the performance of the mixer in any linear circuit whatever may be calculated.

The four image constants thus constitute the funda-

mental parameters of any linear network, active or passive, and are the basis for analyzing and describing its performance under whatever external circuit conditions and terminations may be imposed upon it.

PART III. COMBINATION OF MIXER EQUATIONS WITH LINEAR-NETWORK THEORY

High-Frequency Impedance at Signal Frequency Only

With the foregoing background from circuit theory, we are in a position to return once again to the mixer itself and to combine the relations obtained in Part I with the properties of linear systems as outlined in Part II. To show the connection in the simplest way, it will be appropriate to start with the simplest case, and to express in terms of theory the performance of the mixer with no reactance included between its available terminals, and with zero external impedance connected to them at all frequencies where the signal is concerned excepting for the signal input frequency $b+s$ and the intermediate output frequency s . The mixer equations are then given by (18). From these, the open-circuit and the short-circuit impedances may be found. Since they are more easily measured at the intermediate frequency than at the input-signal frequency, we proceed to express their values at that frequency, and find from (18), with i_{b+s} placed equal to $-V_{b+s}Y_{b+s}$ where Y_{b+s} is any general admittance attached to the high-frequency terminals:

$$v_s = i_s(g_0 + Y_{b+s})/\{g_0(g_0 + Y_{b+s}) - g_1^2\}$$

or, for the admittance at the s terminals

$$Y_a = \{g_0(g_0 + Y_{b+s}) - g_1^2\}/(g_0 + Y_{b+s}).$$

The short-circuit admittance obtained by allowing Y_{b+s} to become very large is thus

$$Y_{2S} = g_0 \quad (43)$$

and the open-circuit admittance (obtained by allowing Y_{b+s} to become very small) is

$$Y_{20} = g_0(1 - g_1^2/g_0^2). \quad (44)$$

From (43) and (44) together with (34) we have

$$\tanh \theta = \sqrt{Y_{20}/Y_{2S}} = \sqrt{1 - (g_1^2/g_0^2)}. \quad (45)$$

The loss in general would be subject to the limitation resulting from different values of transmission of the network in the two directions, giving different values of θ_1 and θ_2 in (31). However, in this case, the determinant of the coefficients of the mixer equations (18) is symmetrical, from which it follows that the mixer with external impedance at the signal and at the intermediate frequency, only, behaves like a passive network with transmission the same in the two directions. It results then that the loss in either direction is given by

$$L = e^{2\theta} = \frac{1 + \tanh \theta}{1 - \tanh \theta} = \frac{1 + \sqrt{1 - g_1^2/g_0^2}}{1 - \sqrt{1 - g_1^2/g_0^2}}. \quad (46)$$

In the limiting case $g_1 = g_0$ this has the interesting property that the loss can become unity. That would happen when the current flowing as a result of the

beating oscillator alone took the form of very short pulses or spikes so that the Fourier analysis of the instantaneous conductance gave the same values for the average g_0 and the fundamental component g_1 .

In regard to the image admittances into which the mixer must operate on its input and output terminals if the loss given by (46) is to be realized, we have the values for the intermediate-frequency terminals from (43) and (44) as follows:

$$Y_{II} = \sqrt{Y_{2s}Y_{20}} = g_0\sqrt{1 - g_1^2/g_0^2}. \quad (47)$$

The high-frequency image admittance is found by going back to (18) and solving for the open- and short-circuit admittances as seen from the high-frequency side. Without going through the details, we can see from inspection of (18) that the determinant of the coefficients is symmetrical with regard to both diagonals, and it follows that the high-frequency image admittance is the same as that for the intermediate frequency and hence is given by (47).

Since the mixer behaves as a linear passive network, it results that the diagram of the equivalent network may be derived from the equations. This has been done by Peterson and Hussey¹ and by others^{4,5} for this simple case as well as for more complicated ones. These networks are not repeated here, since the primary viewpoint is to bring out the fact that the entire mixer may be regarded as a network whose properties are derivable entirely from measurements at the available terminals, without the necessity of knowing its detailed internal configuration.

High-Frequency Impedance at Signal and Image Frequencies

With this simple example as a background, the application of the network theory to the somewhat more complicated case where the mixer is attached to external impedances not only at the signal and intermediate frequencies, but also at the signal-image frequency $-b+s$ is approached. The fundamental mixer equations are given in (17) for the purely resistive case where the beating oscillator is an even function of time. Here, again, the determinant is symmetrical about the main diagonal, from which it follows that transmission from the $b+s$ to the s frequency terminals is the same as transmission from the s to the $b+s$ terminals.

If we knew ahead of time what impedance was going to be connected to the $-b+s$ terminals, the present problem would differ from the preceding one in no respect, and it would merely be required to find the impedances looking into the s terminals when the $b+s$ terminals were first open- and then short-circuited. However, in practice the frequency $b-s$ is usually so close to the frequency $b+s$ that it is practically impossible to change the impedance at the one frequency without also changing it at the other. In fact, it is much nearer the actual operating condition of many mixers to suppose that the external impedances at these two fre-

quencies are equal to each other. Then, since we are still dealing with pure resistances only, it follows that the impedance at the conjugate or $-b+s$ frequency is likewise the same as at $b+s$.

For this case, then, it is noted that if the mixer were to be driven from the s terminals it would allow from (17) that the voltage v_{b+s} and the voltage v_{-b+s} would be equal to each other if the external impedances at the two were the same. In that event, the first and last columns of the array in (17) may be added, and the first row may be discarded as redundant, giving us

$$\begin{array}{cc|c} v_s & v_{b+s} & \\ \hline g_0 & 2g_1 & i_s \\ g_1 & g_0 + g_2 & i_{b+s} \end{array} \quad (48)$$

This determinant is not symmetrical, but it applies only to the case of transmission from the s terminals when the $b+s$ and $-b+s$ currents and voltages are equal. If then, from (48) the transmission in this direction from s to $b+s$ were found, it follows from the symmetry of (17) that transmission from $b+s$ to s would be the same. The latter case is the one of present interest and hence, from (48) the values of the open- and short-circuit admittances seen at the s terminals are written down. The result is

$$\begin{aligned} Y_{20} &= g_0[1 - 2g_1^2/g_0(g_0 + g_2)] \\ Y_{2s} &= g_0. \end{aligned}$$

Thence, as before

$$Y_{II} = \sqrt{Y_{20}Y_{2s}} = g_0\sqrt{1 - 2g_1^2/g_0(g_0 + g_2)} \quad (49)$$

$$\tanh \theta = \sqrt{1 - 2g_1^2/g_0(g_0 + g_2)}. \quad (50)$$

Before the loss can be found from this, account must be taken of the fact that the determinant of (48) is not symmetrical. However, it correctly gives the loss from s to $b+s$. By (41) it is

$$L_{b+s} = (2g_1/g_1) \cdot (1 + \tanh \theta / 1 - \tanh \theta) = 2e^{2\theta}$$

or, with insertion of the value of $\tanh \theta$, and since the loss in both directions is the same by virtue of the symmetry of (17)

$$L_{b+s} = 2 \frac{1 + \sqrt{1 - 2g_1^2/g_0(g_0 + g_2)}}{1 - \sqrt{1 - 2g_1^2/g_0(g_0 + g_2)}}. \quad (51)$$

From open- and short-circuit calculations, or directly from (40), the image admittance at the high-frequency terminals, both $b+s$ and $-b+s$ is

$$Y_I = (g_0 + g_2)\sqrt{1 - 2g_1^2/g_0(g_0 + g_2)}. \quad (52)$$

Comparison of Single- and Double-Sideband Cases

These expressions, (49), (52), and (51) for the two image admittances and the loss respectively in the case where the high-frequency impedances are the same both for the signal and for its image frequency, should be compared with the corresponding expressions (47) for both image admittances and (46) for the loss in the case where the admittance to the image frequency is zero. For brevity the latter will be called the "single-side-band"

case while the former will be called "double-sideband." In addition to the presence of a factor 2 in the double-sideband loss, the main differences in the corresponding expressions for loss and image admittance are that the quantity g_1^2/g_0^2 in the single-sideband case is replaced by $2g_1^2/g_0(g_0+g_2)$ in the double-sideband case and that, for the same loss, the high-frequency image admittance in the double-sideband case is higher than the intermediate-frequency image admittance, while in the single-sideband case they are the same.

In the single-sideband case it was pointed out that the transmission loss could approach unity (that is, zero decibels) in the limiting case when g_1 approached g_0 . In the double-sideband case, the lowest loss that can be secured is 2, (that is, 3 decibels) and this occurs in the limiting case when $g_2 = g_1 = g_0$.

This situation would lead one to expect that an effort should be made to reduce the impedance at the image frequency to as small a value as possible in order to decrease the mixer loss, but it turns out that, for normal mixers where g_1 and g_2 are considerably smaller than g_0 , the loss is actually less in many cases when the impedance at the image frequency is equal to that at the signal frequency. This normally happens when g_2 is quite small, and the effect may be evaluated by comparison of g_1^2/g_0^2 for the single-sideband case with $2g_1^2/g_0(g_0+g_2)$ for the double-sideband case. The latter expression may be written

$$(g_1^2/g_0^2)(2g_0/\overline{g_0 + g_2})$$

and in this form it becomes evident that the expression becomes greater than g_1^2/g_0^2 whenever g_2 is smaller than g_0 .

For a concrete illustration, assume that the nonlinear resistance is defined by the simple equation $I = KV^2$. Hence, $g = dI/dV = 2KV$. Next, let V consist of a positive-biasing voltage V_0 and the oscillator voltage, $B \cos bt$. The purpose of introducing the biasing voltage into the discussion is to allow us to use the simple expression $I = KV^2$ and yet avoid negative values of V where the slope of the $V-I$ curve (and hence g) is negative. The bias allows this to be accomplished so long as conditions are restricted to keep B always less than V_0 . Under such circumstances, then

$$g = 2KV_0 + 2KB \cos bt.$$

But from previous analysis

$$g = g_0 + 2g_1 \cos bt + 2g_2 \cos 2bt + \dots$$

It follows that $g_0 = 2KV_0$; $g_1 = KB$; $g_2 = 0$; and hence that

$$\begin{aligned} g_1^2/g_0^2 &= B^2/4V_0^2 \\ 2g_1^2/g_0(g_0 + g_2) &= B^2/2V_0^2. \end{aligned}$$

From (46) for the single-sideband case and (51) for the double, it follows that the respective losses when B becomes equal to V_0 are 11.5 decibels and 10.6 decibels, thus showing a 0.9-decibel margin of superiority for double-sideband operation in this specific example.

A still further reduction in the loss is obtained when the impedance at the image frequency is extremely high.

In the limiting case when this impedance becomes infinite, (17) may be used ($i_{-b+s} = 0$) to obtain

$$\tanh \theta = \sqrt{1 - (g_1^2/g_0^2)(1 - g_2/g_0)/(1 + g_2/g_0)(1 - g_1^2/g_0^2)}.$$

If the values of B and V_0 used above are inserted in the last expression and use is made of (41) ($\beta_{12} = \beta_{21}$) the loss becomes 9.9 decibels.

Effect of Parasitic Reactance and Resistance

Up to this point the analysis has been applied strictly to nonlinear resistances. At very high frequencies this restriction must be removed, for even though a simple nonlinear resistance is assumed to exist somewhere between the two available terminals of a mixer unit, the lead inductance, and the capacitance across the nonlinear element all contribute to modify the over-all performance. For example, Fig. 6 shows a very elementary concept of what may be expected in a diode mixer. The simple nonlinear resistance is indicated by R_1 . This is shunted by the capacitance C and the combination is in series with the inductance L_2 . Other mixers may be expected to exhibit other forms of parasitic elements. At low frequencies, the analysis may very well apply to a $V-I$ curve such as Fig. 1 measured across the available terminals $a-b$.

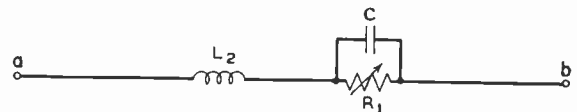

Fig. 6—Elementary diagram of a mixer.

At high frequencies, the simple nonlinear properties may easily exist for the resistance R_1 alone, but these cannot readily be measured directly nor can the effect of the parasitic elements C and L_2 be evaluated properly from the simple discussion which has preceded.

To accomplish the correct interpretation of the effect of these parasitic elements, or of even more complicated ones which may exist in actual applications, the fundamental starting point must be returned to once again, and the effect of the parasitics must be included specifically.

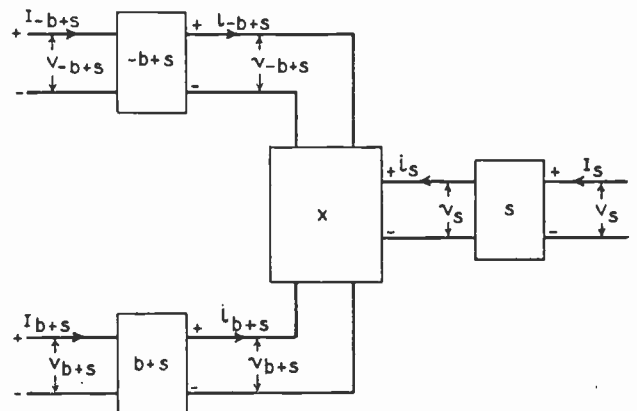

Fig. 7—Parasitic impedances included by connecting 4-poles to nonlinear resistance.

To do this, one very important assumption is made; namely, that whatever may be the actual internal structure of the device between the available terminals, it may be represented by a simple nonlinear resistance, together with a network of passive elements of greater or lesser complexity.¹¹ This assumption allows us to apply the general fundamental equation (12) to the simple nonlinear resistance and to effect a transformation out to the available terminals by means of the device illustrated in Fig. 7. Here the simple nonlinear resistance is represented at X . To it may be applied all of the foregoing analysis which showed that the nonlinear resistance behaves like a linear network with a pair of terminals for each frequency at which the connected external circuit exhibits a resistive impedance component. In the single-sideband case already dealt with there were two such frequencies, with correspondingly two pairs of terminals while in the double-sideband case there were three. In the general case there may be n of them, although in Fig. 7 only three are shown for illustration. These terminal pairs are attached directly to the network representing the simple nonlinear resistance. Between them and the available terminals, for each frequency involved there exist linear passive four-poles which represent at the various frequencies the effect of the parasitic impedances such as those shown in Fig. 6.

Combination of Four-Poles

To introduce these four-poles into (12) in a general way, it need be considered only that each four-pole may be dealt with according to the typical example of Fig. 4. In Fig. 7 the current and voltage at the available terminals are indicated by capital letters while those existing at the nonlinear element are indicated by lower-case letters, in accord with the notation in Part I. The relations between the two are merely the ordinary four-pole equations, which are expressed by (19). In order to be able to specify the various frequencies which will be involved in connection with the insertion of these four-pole equations into (12) the general α coefficients in (19) will be replaced by a new set, namely $\alpha, \beta, \gamma, \delta$, and as applied to Fig. 7, (19) becomes

$$\left. \begin{aligned} v &= \alpha V + \beta I \\ i &= \gamma V + \delta I \end{aligned} \right\} \alpha\delta - \beta\gamma = 1.$$

In place of (12) we have then

$$\sum (\gamma_q V_q + \delta_q I_q) e^{jq\omega t} = \sum_{n=-\infty}^{\infty} \sum_{p=-\infty}^{\infty} \gamma_n (\alpha_p V_p + \beta_p I_p) e^{j(nb+ps)\omega t} \quad (53)$$

where, as in (12), $q = nb + p$.

The separation of (53) into individual equations ultimately leads to a set which is formally representable by (15). The algebra involved is rather long, and will be given in outline form only. The process is to select a given frequency for q and then to find all of the combina-

tions of $nb + p$ which result in this frequency, where n can have integer values from $-\infty$ to $+\infty$, including zero. For example, with $q = s$ we have

$$\begin{aligned} \gamma_s V_s + \delta_s I_s = & \dots + y_2(\alpha_{-2b+s} V_{-2b+s} + \beta_{-2b+s} I_{-2b+s}) \\ & + y_1(\alpha_{-b+s} V_{-b+s} + \beta_{-b+s} I_{-b+s}) \\ & + y_0(\alpha_s V_s + \beta_s I_s) \\ & + y_{-1}(\alpha_{b+s} V_{b+s} + \beta_{b+s} I_{b+s}) \\ & + y_{-2}(\alpha_{2b+s} V_{2b+s} + \beta_{2b+s} I_{2b+s}) \\ & + \dots \end{aligned} \quad (54)$$

There will be analogous equations obtained by taking $q = b + s, -2b + s, b + s, 2b + s$, etc. In this infinite set of equations we may separate out those which correspond to frequencies at which energy is transmitted through the available terminals to or from the entire network. At all other frequencies either V is zero, I is zero, or they are in quadrature. Ruling out this quadrature case, as was done in arriving at (16) and considering only the three frequencies $-b + s, s$ and $b + s$ to be involved in energy transfer, we are left with three equations which correspond respectively to the effect of the three passive four-poles in Fig. 7, one for each of the three frequencies involved. The result may be written

V_{-b+s}	V_s	V_{b+s}	
Y_{11}	Y_{12}	Y_{13}	I_{-b+s}
Y_{21}	Y_{22}	Y_{23}	I_s
Y_{31}	Y_{32}	Y_{33}	I_{b+s}

(55)

where the Y 's are complicated functions calculated as follows. Let

$$\begin{aligned} \Delta_a &= \begin{vmatrix} a_{11} & a_{12} & a_{13} \\ a_{21} & a_{22} & a_{23} \\ a_{31} & a_{32} & a_{33} \end{vmatrix} \\ &= \begin{vmatrix} y_0\beta_{-b+s} - \delta_{-b+s} & y_{-1}\beta_s & y_{-2}\beta_{b+s} \\ y_1\beta_{-b+s} & y_0\beta_s - \delta_s & y_{-1}\beta_{b+s} \\ y_2\beta_{-b+s} & y_1\beta_s & y_0\beta_{b+s} - \delta_{b+s} \end{vmatrix} \end{aligned} \quad (56)$$

and let

A_{ij} be the minor of a_{ij} .

also let

$$\begin{aligned} \Delta_b &= \begin{vmatrix} b_{11} & b_{12} & b_{13} \\ b_{21} & b_{22} & b_{23} \\ b_{31} & b_{32} & b_{33} \end{vmatrix} \\ &= \begin{vmatrix} y_0\alpha_{-b+s} - \gamma_{-b+s} & y_{-1}\alpha_s & y_{-2}\alpha_{b+s} \\ y_1\alpha_{-b+s} & y_0\alpha_s - \gamma_s & y_{-1}\alpha_{b+s} \\ y_2\alpha_{-b+s} & y_1\alpha_s & y_0\alpha_{b+s} - \gamma_{b+s} \end{vmatrix}. \end{aligned} \quad (57)$$

Then

$$\begin{aligned} Y_{11} &= (-b_{11}A_{11} + b_{21}A_{21} - b_{31}A_{31}) \div \Delta_a \\ Y_{12} &= (-b_{12}A_{11} + b_{22}A_{21} - b_{32}A_{31}) \div \Delta_a \\ Y_{13} &= (-b_{13}A_{11} + b_{23}A_{21} - b_{33}A_{31}) \div \Delta_a \\ Y_{21} &= (+b_{11}A_{12} - b_{21}A_{22} + b_{31}A_{32}) \div \Delta_a \\ Y_{22} &= (+b_{12}A_{12} - b_{22}A_{22} + b_{32}A_{32}) \div \Delta_a \\ Y_{23} &= (+b_{13}A_{12} - b_{23}A_{22} + b_{33}A_{32}) \div \Delta_a \\ Y_{31} &= (-b_{11}A_{13} + b_{21}A_{23} - b_{31}A_{33}) \div \Delta_a \\ Y_{32} &= (-b_{12}A_{13} + b_{22}A_{23} - b_{32}A_{33}) \div \Delta_a \\ Y_{33} &= (-b_{13}A_{13} + b_{23}A_{23} - b_{33}A_{33}) \div \Delta_a. \end{aligned} \quad (58)$$

¹¹ A brief outline of the more general case when the nonlinear element consists of a nonlinear resistance in parallel with a nonlinear capacitance is given in Appendix II.

Despite the excessive length of these equations, and the fact that several useful results may be inferred from them without the necessity for carrying out the detailed calculations, it will be easier to draw these conclusions from their final, and general, forms. To this end, the calculations have been made, and the results are tabulated as follows:

TABLE I

Values of the General Coefficients in (55)

Let the subscript $(-)$ stand for $(-b+s)$ and the subscript $(+)$ stand for $(b+s)$. Then:

$$\begin{aligned} \Delta_a &= \beta_s \beta_{-} \beta_{+} [y_0(y_0^2 - 2y_1 y_{-1} - y_2 y_{-2}) + y_{-1}^2 y_2 + y_1^2 y_{-2}] \\ &\quad - \beta_s (\beta_{-} \delta_{+} + \beta_{+} \delta_{-}) (y_0^2 - y_1 y_{-1}) - \beta_{-} \beta_{+} \delta_s (y_0^2 - y_2 y_{-2}) \\ &\quad - (\beta_{-} \delta_s \delta_{+} + \beta_{+} \delta_s \delta_{-} + \beta_s \delta_{-} \delta_{+}) y_0 - \delta_s \delta_{-} \delta_{+} \\ Y_{11} \Delta_a &= -\alpha_{-} \beta_s \beta_{+} [y_0(y_0^2 - 2y_1 y_{-1} - y_2 y_{-2}) + y_1^2 y_{-2} + y_{-1}^2 y_2] \\ &\quad + \alpha_{-} \beta_s \delta_{+} (y_0^2 - y_1 y_{-1}) + \alpha_{-} \beta_{+} \delta_s (y_0^2 - y_2 y_{-2}) \\ &\quad - \alpha_{-} \delta_s \delta_{+} y_0 + ((\alpha_{-} \delta_{-} - 1) / \beta_{-}) [\beta_s \beta_{+} (y_0^2 - y_1 y_{-1}) \\ &\quad - (\beta_s \delta_{+} + \beta_{+} \delta_s) y_0 + \delta_s \delta_{+}] \\ Y_{12} \Delta_a &= \beta_{+} (y_0 y_{-1} - y_1 y_{-2}) - \delta_{+} y_{-1} \\ Y_{13} \Delta_a &= \beta_s (y_0 y_{-2} - y_{-1}^2) - \delta_s y_2 \\ Y_{21} \Delta_a &= \beta_{+} (y_0 y_1 - y_{-1} y_2) - \delta_{+} y_1 \\ Y_{22} \Delta_a &= -\alpha_{+} \beta_{-} \beta_{+} [y_0(y_0^2 - 2y_1 y_{-1} - y_2 y_{-2}) + y_{-1}^2 y_2 + y_1^2 y_{-2}] \\ &\quad + \alpha_{+} \beta_{-} \delta_{+} (y_0^2 - y_1 y_{-1}) + \alpha_{+} \beta_{+} \delta_{-} (y_0^2 - y_1 y_{-1}) \\ &\quad - \alpha_{+} \delta_{-} \delta_{+} y_0 - ((\alpha_{+} \delta_s - 1) / \beta_{+}) [\beta_{-} \beta_{+} (y_0^2 - y_2 y_{-2}) \\ &\quad - (\beta_{-} \delta_{+} + \beta_{+} \delta_{-}) y_0 + \delta_{-} \delta_{+}] \\ Y_{23} \Delta_a &= \beta_{-} (y_0 y_{-1} - y_1 y_{-2}) - \delta_{-} y_{-1} \\ Y_{31} \Delta_a &= \beta_s (y_0 y_2 - y_1^2) - \delta_s y_2 \\ Y_{32} \Delta_a &= \beta_{-} (y_0 y_1 - y_{-1} y_2) - \delta_{-} y_1 \\ Y_{33} \Delta_a &= -\alpha_{+} \beta_{-} \beta_{+} [y_0(y_0^2 - 2y_1 y_{-1} - y_2 y_{-2}) + y_{-1}^2 y_2 + y_1^2 y_{-2}] \\ &\quad + \alpha_{+} \beta_s \delta_{-} (y_0^2 - y_1 y_{-1}) + \alpha_{+} \beta_{-} \delta_s (y_0^2 - y_2 y_{-2}) \\ &\quad - \alpha_{+} \delta_s \delta_{-} y_0 + ((\alpha_{+} \delta_{+} - 1) / \beta_{+}) [\beta_s \beta_{-} (y_0^2 - y_1 y_{-1}) \\ &\quad - (\beta_s \delta_{-} + \beta_{-} \delta_s) y_0 + \delta_s \delta_{-}]. \end{aligned}$$

There exist a number of important interrelations between these coefficients, long as they are, that allow certain general conclusions to be drawn from them. For example, there is a hybrid sort of symmetry between Y_{11} and Y_{33} about Y_{22} as a fulcrum. Also, all of the remaining coefficients have a certain likeness of form. In the case when the parasitic impedances have the same values at $b+s$ and $b-s$, Y_{12} and Y_{32} are complex conjugate; and Y_{21} and Y_{23} are complex conjugate. In the more special case when the s frequency is low enough so that the corresponding coefficients α_s , β_s , δ_s are real, then in addition to the above, Δ_a is real; Y_{22} is real; Y_{11} and Y_{33} are complex conjugate; and Y_{13} and Y_{31} are complex conjugate. When, in addition to these restrictions, the beating-oscillator voltage is an even function of time, all of the y 's are real, and we have

$$\begin{aligned} Y_{12} &= Y_{21} \\ Y_{13} &= Y_{31} = G_{13} \\ Y_{23} &= Y_{32}. \end{aligned}$$

In the latter event, then, the array (55) reduces to

V_{-b+s}	V_s	V_{b+s}	
Y_{11}	Y_{12}	G_{13}	I_{-b+s}
Y_{12}	G_{22}	\bar{Y}_{12}	I_s
G_{13}	\bar{Y}_{12}	\bar{Y}_{11}	I_{b+s}

(59)

where the bar over a quantity indicates its complex conjugate. However, it must be pointed out that it is not in general sufficient for the beating-oscillator voltage at the available terminals to be a single-frequency sinusoid in order that the voltage across the nonlinear resistive element should be expressible as an even function of time. Any reactance at harmonic frequencies in the network facing the nonlinear element will produce phase shifts and in general destroy this simple relationship between fundamental and harmonic frequencies without which the voltage is no longer expressible as an even function of time.

For the special case of (59), the determinant, being symmetrical about the main diagonal, tells us that the mixer behaves like a passive network and that the loss in a signal going from the s to the $b+s$ terminals is the same as the loss in going in the reverse direction. This fact will be of material help in the analysis to follow, where it will be found to be relatively simple to find the loss in the direction from s to $b+s$, but hard to find the opposite by direct attack.

In finding the loss in going from s to $b+s$ the expedient used in the purely resistive case to obtain (48) cannot be employed unless Y_{11} and Y_{12} are real, for only then will V_{-b+s} and V_{b+s} be equal to each other when the system is driven from s , thus allowing the three equations of (59) to be reduced to two by equating V_{-b+s} and V_{b+s} as was done to obtain (48) from (17). This is shown by solving (59) for the open-circuit voltages at V_{-b+s} and V_{b+s} when the system is driven from s . The result is

$$V_{-b+s} = -I_s (\bar{Y}_{11} Y_{12} - \bar{Y}_{12} G_{13}) / \Delta_a \quad (60)$$

$$V_{b+s} = -I_s (Y_{11} \bar{Y}_{12} - Y_{12} G_{13}) / \Delta_a \quad (61)$$

These voltages are conjugate complex and become equal when Y_{11} and Y_{12} are real. This seems to be a simple requirement that might easily be satisfied in the laboratory but inspection of Table I shows that Y_{11} and Y_{12} involve the three quantities α , β , and δ at the high frequency. They will be equal in general only when α , β , and δ at the high frequency are individually real. This imposes three rather severe requirements, and makes it necessary to look for some alternative means, for getting at the loss rather than to strive further to find means for making V_{-b+s} and V_{b+s} equal when the system is driven from s .

For attacking this alternative means, it is just as simple to start out with the general relation given by (55) on which no restrictions have as yet been placed. The specific problem of greatest practical interest is to find the image parameters of a general network of the form of (55) under the conditions that the input signal is applied at the high-frequency $b+s$ terminals, while the output load is placed across the intermediate-frequency s terminals.

This seems straightforward enough, and in some applications would be so in fact. The complication enters when it is considered that, as mixers are often used, the

$-b+s$ terminals are attached to a load which is not independently under control. This happens because the $b+s$ and $b-s$ frequencies are often so close together that the impedance at $b-s$ is practically the same as at $b+s$ and consequently the impedance at $-b+s$ is the complex conjugate of that at $b+s$.

Loss Calculation

For the analysis, the start is made in what would be the usual way. That is, the s and the $b+s$ terminals are considered as constituting the four terminals of a general four-pole. In order to take care of the $-b+s$ terminals, it will be assumed that a general passive admittance termination Y_T is hung across them, and restrictions and departures from the straightforward analysis will be introduced as they become pertinent or necessary.

Thus, from Fig. 7 it is seen that

$$I_{-b+s} = -V_{-b+s}Y_T \tag{62}$$

and thence that V_{-b+s} in (55) may be eliminated, giving the set of four-pole equations

V_s	V_{b+s}	I_s	(63)
$Y_{22} - \frac{Y_{12}Y_{21}}{Y_{11} + Y_T}$	$Y_{23} - \frac{Y_{13}Y_{21}}{Y_{11} + Y_T}$		
$Y_{32} - \frac{Y_{12}Y_{31}}{Y_{11} + Y_T}$	$Y_{33} - \frac{Y_{13}Y_{31}}{Y_{11} + Y_T}$	I_{b+s}	

From these the open-circuit and short-circuit admittances may be written down at once. As before, letting A_{ij} represent the minor of V_{ij} in the determinant of (55), we have for the admittances looking into the $b+s$ terminals

$$Y_{open} = \frac{A_{22} + Y_{33}Y_T}{Y_{11} + Y_T} - \frac{A_{32} + Y_{23}Y_T}{Y_{11} + Y_T} \frac{A_{23} + Y_{32}Y_T}{A_{33} + Y_{22}Y_T} \tag{64}$$

$$Y_{short} = \frac{A_{22} + Y_{33}Y_T}{Y_{11} + Y_T} \tag{65}$$

The image admittance at the $b+s$ terminals is then

$$Y_{11} = \sqrt{Y_{open}Y_{short}} \tag{66}$$

and it would seem to be sufficient here to substitute (64) and (65). This procedure is, in fact, perfectly correct and gives a useful answer whenever Y_T is known. For the majority of mixers, however, Y_T is known only indirectly, since for the case where $b+s$ and $b-s$ are near together, it is the complex conjugate of Y_{II} itself, which is yet to be found.

Therefore, the next logical step would appear to be to substitute the conjugate \bar{Y}_{II} for Y_T in (64) and (65) and to proceed to solve (66) for Y_{II} . However, this direct approach leads to great difficulty and it is therefore expedient to use another method.

For a starting point, it may be noticed that (63) gives a certain amount of information as it stands. For instance, in reference to the relations given in Part II, it can be ascertained from (63) that the ratio of the loss

in a signal going from the $b+s$ terminals to the s terminals to the loss in a signal going in the opposite direction is given by

$$\frac{L_{(b+s) \text{ to } s}}{L_{s \text{ to } (b+s)}} = \left[\frac{Y_{11}Y_{32} - Y_{12}Y_{31} + Y_{32}Y_T}{Y_{11}Y_{23} - Y_{21}Y_{13} + Y_{23}Y_T} \right]^2 \tag{67}$$

This fact will be made use of subsequently. In the special cases when the beating-oscillator voltage is an even function of time the ratio of losses in (67) is unity.

Bartlett's Theorem

As a next step, use is made of Bartlett's bisection theorem. It was applied to mixer problems by Kruse² for finding image impedances. To use this scheme, it is assumed that the high-frequency terminals of the mixer under investigation are connected to the high-frequency terminals of a second, exactly similar, mixer. The di-

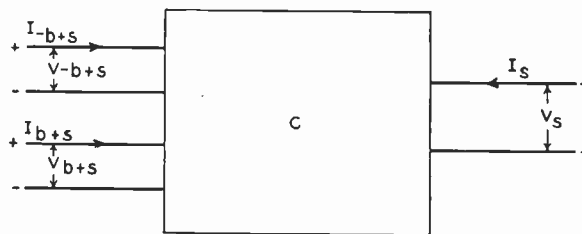

Fig. 8—Over-all 6-pole derived from Fig. 7.

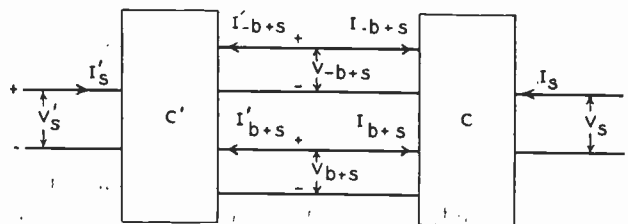

Fig. 9—Arrangement for application of Bartlett's theorem.

agram of Fig. 8 shows the mixer under consideration, and Fig. 9 shows how the two mixers C and C' would be connected together. In this arrangement it is evident from symmetry that the transmission of the system will be the same, whether it be driven from the s terminals or from the s' terminals. The plan of attack is to see whether the arrangement of Fig. 9 makes it possible to find the transmission loss in a signal going from the s to the $b+s$ terminals, and also to find the image impedances at $b+s$ and $-b+s$. If so, then the loss in going from $b+s$ to s may be found, either from (67) since Y_T would then be known, or from (64) and (65) by using the relations given in Part II.

In furtherance of this plan, equations of the form of (55) may be written for each of the two mixers C and C' . Where they join together, Fig. 9 shows that

$$\begin{aligned} I'_{-b+s} &= -I_{-b+s} \\ I'_{b+s} &= -I_{b+s} \end{aligned} \tag{68}$$

The two sets of equations may be set up for brevity as a single array, thus

V_{-b+s}	V_s	V_s'	V_{b+s}	
Y_{11}	Y_{12}	0	Y_{13}	I_{-b+s}
Y_{11}	0	Y_{12}	Y_{13}	$-I_{-b+s}$
Y_{21}	Y_{22}	0	Y_{23}	I_s
Y_{21}	0	Y_{22}	Y_{23}	I_s'
Y_{31}	Y_{32}	0	Y_{33}	I_{b+s}
Y_{31}	0	Y_{32}	Y_{33}	$-I_{b+s}$

(69)

Here are six equations involving eight quantities; that is, four voltages and four currents. Four of these quantities may therefore be eliminated, leaving two equations involving two voltages and two currents, which is just the right number for a set of four-pole equations. Thus if V_s' , I_s' , V_{-b+s} , and I_{-b+s} are eliminated, the resulting two equations involve V_s , I_s , and V_{b+s} , I_{b+s} and will give information about the transmission from s to $b+s$. They will also give information about the transmission from $b+s$ to s , but only under the conditions of Fig. 9 which, in general, does not allow the circuit to be opened and driven at the $b+s$ terminals without destroying the relationships of (68) under which (69) was derived. Great care must therefore be taken in interpreting the results to apply to the actual mixer driven at the $b+s$ terminals.

To effect the elimination of V_s' , I_s' , V_{-b+s} , and I_{-b+s} we return to (69).

By subtraction of the second from the first of these equations, there results

$$Y_{12}(V_s - V_s') = 2I_{-b+s} \tag{70}$$

Similarly, from the third and fourth

$$Y_{22}(V_s - V_s') = I_s - I_s' \tag{71}$$

and from the fifth and sixth

$$Y_{32}(V_s - V_s') = 2I_{b+s} \tag{72}$$

From these three equations are obtained

$$\begin{aligned} V_s' &= V_s - 2I_{b+s}/Y_{32} \\ I_s' &= I_s - 2I_{b+s}Y_{22}/Y_{32} \\ I_{-b+s} &= I_{b+s}Y_{12}/Y_{32} \end{aligned} \tag{73}$$

and hence, from adding the first and second equations of (69) and substituting (73)

$$\begin{aligned} V_{-b+s} &= (Y_{12}/Y_{11}Y_{32})I_{b+s} - (Y_{12}/Y_{11})V_s \\ &\quad - (Y_{13}/Y_{11})V_{b+s} \end{aligned} \tag{74}$$

Finally, by substitution of (73) and (74) into the third and fifth equations of (69) there are obtained the two equations in V_s , I_s , V_{b+s} , and I_{b+s} . In terms of the minors A_{ij} of (55) they may be written in the form

V_s	V_{b+s}	
Y_{22}	$\frac{Y_{21}A_{21} + Y_{23}A_{23}}{A_{23}}$	I_s
Y_{32}	$\frac{Y_{32}A_{22}}{A_{23}}$	I_{b+s}

(75)

These are the sought-for equations. They will correctly give the transmission from the s to the $b+s$ terminals, for with image-impedance termination through-

out, no reflection of energy is possible and the VI product at $b+s$ in Fig. 9 is the same as it would be when both $b+s$ and $-b+s$ are terminated in their image impedances rather than in the entire image network of the mixer C' .

On the other hand, (75) will not give the correct transmission from $b+s$ to s because the equations apply only to the entire configuration of Fig. 9 which has no available terminals at $b+s$. What they do give is the ratio of energy into the $b+s$ terminals of C in Fig. 9 to the energy out at the s terminals when the system is driven by a generator at the s' terminals. This generator sends energy into the $-b+s$ terminals as well as into $b+s$, and hence the resultant at s is greater than if energy had been applied only at the $b+s$ terminals with the $-b+s$ terminals connected to their passive image impedance rather than to the entire network.

The situation is far from hopeless, however, for the purpose of the system of Fig. 9 was to find the image impedances rather than the loss. In the configuration of Fig. 9, the ratio of current I_{b+s} to voltage V_{b+s} gives the admittance seen at the $b+s$ terminals. When this ratio is taken under the conditions that the driving generator is at s' and when s is terminated with an impedance equal to that of the generator at s' , then it follows from the symmetry of the figure that the I/V ratio existing at $b+s$ gives an admittance which is the same as is seen looking backwards toward the s' end from the $b+s$ terminals. It thus satisfies the requirements of an image impedance. Furthermore, its value under the conditions of image termination at s likewise coincides with that needed for image impedances in general.

From (75) and (40) its value is obtained by the normal rules for image admittances, namely,

$$\begin{aligned} Y_{II(b+s)} &= \sqrt{\frac{\beta_{22}}{\beta_{11}} \Delta_\beta} \\ &= \frac{Y_{32}A_{22}}{A_{23}} \sqrt{1 - \frac{Y_{21}A_{21} + Y_{23}A_{23}}{Y_{22}A_{22}}} \end{aligned} \tag{76}$$

For reference, the image admittance at the s terminals is also set down. Its value is

$$Y_{Is} = \sqrt{\frac{\beta_{11}}{\beta_{22}} \Delta_\beta} = Y_{22} \sqrt{1 - \frac{Y_{21}A_{21} + Y_{23}A_{23}}{Y_{22}A_{22}}} \tag{77}$$

and the loss from s to $b+s$ is

$${}_sL_{b+s} = e^{2\theta}(Y_{21}A_{21} + Y_{23}A_{23})/Y_{32}A_{23} \tag{78}$$

where

$$\tanh \theta = \sqrt{1 - (Y_{21}A_{21} + Y_{23}A_{23})/Y_{22}A_{22}} \tag{79}$$

With the above, we have the loss from the s to the $b+s$ terminals and the image admittance at $b+s$. According to (67) the loss from $b+s$ to s could therefore be found if the impedance Y_T at the $-b+s$ terminals were known. Now from Fig. 9 it is obvious that the same arguments may be applied between the s and the $-b+s$ terminals that were used above for s and $b+s$. Accordingly, $-b+s$ in Fig. 9 would have to be terminated

in an analogous way to $b+s$ in order for (76) correctly to remain an image impedance. Its value would be found by going to (69) and eliminating currents and voltages at $-b+s$ rather than at $b+s$ and then following through the analogous steps leading to (76). Rather than going through this long process, we can see from (69) and (55) that $b+s$ and $-b+s$ are interchanged if the following interchanges are made:

$$\begin{array}{ll} Y_{11} \text{ and } Y_{33} & Y_{13} \text{ and } Y_{31} \\ Y_{12} \text{ and } Y_{32} & Y_{21} \text{ and } Y_{23} \end{array} \quad (80)$$

Thence, from (76) the proper image impedance for $-b+s$ may be written

$$Y_{II(-b+s)} = \frac{Y_{12}A_{22}}{A_{21}} \sqrt{1 - \frac{Y_{21}A_{21} + Y_{23}A_{23}}{Y_{22}A_{22}}}. \quad (81)$$

The remaining question is whether (81) would give a value for Y_T in (67) which is in accord with useful applications. With reference to Table I for small values of s , it becomes evident that the relations given by (80) are merely those which satisfy the condition for the impedance at the $b-s$ frequency to be the same as at the $b+s$ frequency, so that the image impedance (81) is the complex conjugate of that given by (76). This means the arrangement of Fig. 9 automatically satisfies the common laboratory condition where the high-frequency impedance at $b+s$ is a broad-band circuit giving essentially the same impedance at the slightly different frequency $b-s$, and hence its conjugate at $-b+s$.

The result of substituting (81) and (78) into (67) gives the loss, which is

$$\begin{aligned} {}_{b+s}L_s &= \left[\frac{Y_{21}A_{21} + Y_{23}A_{23}}{Y_{32}A_{23}} e^{2\theta} \right] \\ &\quad \cdot \left[\frac{A_{21}A_{23} + Y_{32}Y_{12}A_{22} \tanh \theta}{A_{21}A_{32} + Y_{23}Y_{12}A_{22} \tanh \theta} \right]^2. \quad (82) \end{aligned}$$

Discussion

This seems to be the most general formulation for mixer loss that can be obtained by present methods. Its use in the general form lies mainly in the qualitative interpretations that may be drawn from it, and not in its applicability to numerical calculations. Primarily, it says that the formal shape of the general loss relation is similar to (51) for the purely resistive case, but it contains an additional factor represented by the second factor in brackets in (82). Moreover, the coefficient of the term involving $e^{2\theta}$ in the first bracket is not in general equal to the simple numerical factor 2 as in (51). For design and measuring applications, these differences are of special importance, and the attempt will be made here to point out their broad significance without, however, going into a detailed discussion at this time of the many ramifications to which they lead.

For this purpose, attention will be centered on the special case where the intermediate frequency is low enough so that the conditions leading to (50) are fulfilled. In this event, the second factor in brackets in (82)

becomes unity, and the value of $\tanh \theta$, given by the radical

$$\sqrt{1 - (Y_{21}A_{21} + Y_{23}A_{23})/Y_{22}A_{22}} \quad (83)$$

becomes real. The coefficient

$$\beta_{12}/\beta_{21} = (Y_{21}A_{21} + Y_{23}A_{23})/Y_{32}A_{23} \quad (84)$$

then represents the ratio of the actual loss of a double-sideband mixer to the value obtained by open- and short-circuit measurements. In the purely resistive case this ratio was 2.

Under the restrictions leading to (59) the ratio may be written

$$\beta_{12}/\beta_{21} = 1 + (Y_{12}A_{12}/\bar{Y}_{12}\bar{A}_{12})$$

which has the form

$$\beta_{12}/\beta_{21} = 1 + (a + jb)/(a - jb) = 2a/(a - jb) \quad (85)$$

where a and b merely represent the real and imaginary parts of $Y_{12}A_{12}$, respectively. The magnitude of this ratio is

$$|\beta_{12}/\beta_{21}| = 2(a/\sqrt{a^2 + b^2}) \quad (86)$$

and shows that the ratio is less than 2 whenever $Y_{12}A_{12}$ has an imaginary component.

The significant result of this lies in the fact that any attempt to measure loss by making impedance (or any other) measurements restricted to one pair of terminals only, is bound to involve the factor β_{12}/β_{21} . When this ratio is known, as it is in the resistive case, then the measurement of loss is complete. When it is not known, then additional measurements or information are required.

In the case of some mixers used in practice, the imaginary part of $Y_{12}A_{12}$ may sometimes differ appreciably from zero, and it may be shown that the addition of a reactive network such as a simple transmission line attached to the high-frequency terminals, and represented by the networks N and N' in Fig. 10, is not sufficient to insure that it can be made zero for the over-all system.

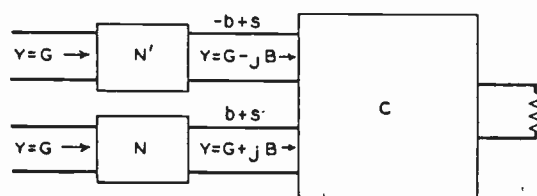

Fig. 10—Addition of purely reactive networks to tune a mixer.

It must be concluded, then, that while measurements at the intermediate-frequency terminals are sufficient to give the value of $\tanh \theta$, they are not sufficient to give the actual loss, which may be less than predicted by the formula of (51), so that we have to write ${}_{b+s}L_s \approx 2e^{2\theta}$.

The consequences of this relation will be more apparent in the next section, where measurements are discussed. There some estimates will be made of the expected deviation of the loss from the simple upper limit given by the factor 2 above.

PART IV. MEASUREMENT METHODS

In this section, a brief investigation is made of the theory of methods available for measuring the performance characteristics of mixers. For the most part, these methods are straightforward generalizations of those already in use for measuring the ordinary type of four-pole but have to be modified or extended to include the peculiar properties of the mixer-network equivalent.

In a general sense, the mixer performance is completely specified as soon as the four coefficients of the four-pole equations (19) or (21) are known. Actually, it is more useful to express the four coefficients in terms of the two image impedances and the two image transfer constants, though of the latter, only the loss from $b+s$

known values of Y_b attached to the opposite terminals, then we would have three equations which would be sufficient to determine β_{11} , β_{22} , and Δ .

For example, letting the three known values of Y_b be denoted respectively by Y_1' , Y_2' , and Y_3' and letting the corresponding measured values of Y_a be denoted by Y_1 , Y_2 , and Y_3 , without the primes, we have the three equations obtainable from (88) given by the array

β_{11}	β_{22}	Δ		
Y_1'	$-Y_1$	1	$Y_1 Y_1'$	(89)
Y_2'	$-Y_2$	1	$Y_2 Y_2'$	
Y_3'	$-Y_3$	1	$Y_3 Y_3'$	

The solution of these is

$$\left. \begin{aligned} \beta_{11} &= \frac{Y_1 Y_1' (Y_3 - Y_2) - Y_2 Y_2' (Y_3 - Y_1) + Y_3 Y_3' (Y_2 - Y_1)}{Y_1' (Y_3 - Y_2) - Y_2' (Y_3 - Y_1) + Y_3' (Y_2 - Y_1)} \\ \beta_{22} &= \frac{Y_1 Y_1' (Y_3' - Y_2') - Y_2 Y_2' (Y_3' - Y_1') + Y_3 Y_3' (Y_2' - Y_1')}{Y_1' (Y_3 - Y_2) - Y_2' (Y_3 - Y_1) + Y_3' (Y_2 - Y_1)} \\ \Delta &= \frac{Y_2' Y_3' Y_1 (Y_3 - Y_2) - Y_1' Y_3' Y_2 (Y_3 - Y_1) + Y_1' Y_2' Y_3 (Y_2 - Y_1)}{Y_1' (Y_3 - Y_2) - Y_2' (Y_3 - Y_1) + Y_3' (Y_2 - Y_1)} \end{aligned} \right\} \quad (90)$$

to s is of primary interest. Of course, as soon as the four-pole constants are known, the image impedances and transfer constants can immediately be found, and vice versa.

The measuring techniques, then, revolve essentially about the finding of these four-pole coefficients. They, or their equivalents, such as the image constants or the open- and short-circuit impedances, are the only quantities that express the inherent capabilities of the mixer itself, as distinguished from its particular environmental conditions. Moreover, when they are known, it is then possible to calculate the performance under various and sundry circuit conditions. Therefore, both from the standpoint of the manufacturer who needs a means of rating the quality of his product, and from that of the user, who needs a means of designing appropriate circuits around the unit, the four coefficients of the four-pole equations are the basis for building up a generally satisfactory measuring technique.

Impedance Method of Measuring Loss

To show how this may be accomplished, the four-pole equations in the form given by (21) are the most suitable. Assume that a known admittance Y_b is attached to the terminals at 2 in Fig. 5. From (21) the impedance looking into the terminals at 1 is then

$$Y_a = (Y_b \beta_{11} + \Delta) / (Y_b + \beta_{22}) \quad (87)$$

where $\Delta = \beta_{11} \beta_{22} - \beta_{12} \beta_{21}$. From rearrangement of (87) there results

$$\beta_{11} Y_b - \beta_{22} Y_a + \Delta = Y_a Y_b \quad (88)$$

In this form the equation is exhibited as a linear relation between β_{11} , β_{22} , and Δ with coefficients involving the external admittances Y_a and Y_b . It follows that if three successive measurements of Y_a were made with three

From these, three of the image constants may be obtained at once from the relations of Part I; namely,

$$\left. \begin{aligned} \tanh \theta &= \sqrt{\Delta / \beta_{11} \beta_{22}} \\ Y_I &= \beta_{11} \tanh \theta \\ Y_{II} &= \beta_{22} \tanh \theta \end{aligned} \right\} \quad (91)$$

The fourth, and missing, one cannot be found from impedance measurements alone. It is the one which relates β_{12} and β_{21} or θ_1 and θ_2 , and is unnecessary in passive circuits since they then are equal. In the mixer, as discussed in Part III, they are equal when there is energy transfer between the mixer and the external circuit at the frequencies only of the beating oscillator, the input signal and the output intermediate frequency. This is true in the so-called single-sideband case. In the double-sideband case, when no reactances are present within the mixer terminals and when the beating oscillator voltage is expressible as an even function of time, the ratio of β_{12}/β_{21} was shown to be equal to 2. The departure of the ratio from unity in the double-sideband resistive case is caused by the physical inability to change the impedance connected to the signal-frequency terminals without producing corresponding changes in the impedance effective across the image-frequency terminals, and is not occasioned by departure of the mixer performance from that of a passive linear network.

In the more general double-sideband case where parasitic reactances are allowed, but where the intermediate frequency is sufficiently low, and when the beating-oscillator voltage is expressible as an even function of time, the ratio was shown to be less than 2. Even in this case, relations of (90) are useful in leading to an upper limit for the loss and in giving the values of the impedances of the attached circuit required for best operation. For example, best power transfer to and from the

mixer, and hence the least loss, will be obtained when the image impedances are real. With parasitic reactances present within the mixer structure, this would necessitate the addition of external reactive structures N and N' in Fig. 10 in order to "tune out" the reactive impedances and hence minimize the over-all loss by making the image admittances real.

In any event, (90) gives a means of determining three of the network constants, and the method is merely to place three different, but known, impedances across one set of terminals, and to measure the impedance across the other set.

In high-frequency mixers, it is usually easier and more accurate to place the known impedances across the high-frequency terminals and measure the resulting impedance across the lower intermediate-frequency terminals than vice versa. One of the reasons for this is that the measurement of the resulting impedance does not then become entangled with the beating-oscillator voltage which is present on the high-frequency terminals and which is too near in frequency to the high-frequency signal to allow a ready separation to be made. On the other hand, the known impedances which are to be hung across the terminals can be measured before the beating oscillator is applied, since they are linear and hence do not change their values in the presence of the high-level beating oscillator. In fact, the beating oscillator itself provides a convenient signal source for making these measurements when its frequency is sufficiently close to that of the high-frequency signal to insure that the impedance being measured is essentially the same at both frequencies.

Since the maximum loss of a mixer has been shown to be derivable from a set of three impedance measurements, it becomes desirable to seek the most simple set of such measurements. The equations say that three known impedances are needed. They do not place any restrictions on how these shall be chosen, so long as they are different from each other. Two of the simplest terminating conditions are open circuit and short circuit. Aside from practical considerations of laboratory procedure, which will be discussed presently, this would seem to be a promising method of procedure.

In (90) the result would be obtained by placing $Y_1' = 0$ and $Y_2' = \infty$. These values give

$$\left. \begin{aligned} \beta_{11} &= Y_2 \\ \beta_{22} &= -Y_3'(Y_3 - Y_2)/(Y_3 - Y_1) \\ \Delta &= -Y_3'Y_1(Y_3 - Y_2)/(Y_3 - Y_1) \end{aligned} \right\} \quad (92)$$

This is a considerable simplification over (90), but even more important is the fact that with (92) we have

$$\tanh \theta = \sqrt{\Delta/\beta_{11}\beta_{22}} = \sqrt{Y_1/Y_2} \quad (93)$$

which involves neither Y_3 nor Y_3' . Hence, the determination of the image transfer constant θ requires only two impedance measurements when these are made respectively with the open- and the short-circuit termination.

The same thing is true of β_{11} and hence of the image admittance Y_I , for

$$Y_I = \beta_{11} \tanh \theta = \sqrt{Y_1 Y_2} \quad (94)$$

These results are not unexpected, since they were specifically stated in Part II, but their importance is such as to warrant repeating.

In the application to high-frequency mixers, a certain trouble arises from the fact that in order to carry out the open- and short-circuit measurements it is necessary to inject the beating-oscillator power first through a short circuit and then through an open circuit. To accomplish either of these in an absolutely exact sense is manifestly impossible when the short-circuit and the open-circuit impedances occur at signal frequencies close to that of the beating oscillator itself. However, the derivation of (92) from (90) shows that the open- and short-circuit requirements are not extremely severe in the sense that Y_1' and Y_2' have merely to be small enough, respectively, compared with the measured impedances Y_1 and Y_2 so that the one or the other may be disregarded in the appropriate places in (90). With these approximations, it becomes sufficient to introduce the beating-oscillator power through a very low or a very high impedance. It means, of course, the throwing away of a large amount of available beating-oscillator power, but except in those cases where the frequency is very high this may not be a serious disadvantage for the purpose of making absolute measurements, when in exchange the simplicity of the measurements is taken into account.

When the short- and open-circuit measurements are not possible, the value of $\tanh \theta$ can be found without using the long formulas of (90) whenever the image impedances can be found by some other method. For example, the circuit might be very carefully matched to resistive terminations on both input and output sides by observing adjustments required for maximum power transfer, or better still, and much more accurately, by observing the absence of standing waves on lines connected to the input and output terminals. The terminating admittances are then, of course, Y_I and Y_{II} themselves.

With knowledge of these two admittances, the value of $\tanh \theta$ may be derived from a single further measurement of input impedance with a known termination on the output side. From the first of (89) and with β_{11} and β_{22} expressed as $Y_I/\tanh \theta$ and $Y_{II}/\tanh \theta$, there results

$$\tanh \theta = (Y_2'Y_I - Y_2Y_{II})/(Y_2Y_2' - Y_IY_{II}) \quad (95)$$

With high-frequency mixers it requires a double-detection receiver to find the value of matching impedance on the high-frequency side because of the presence of the beating-oscillator voltage. When the mixer is matched to the high-level beating oscillator it is mismatched to a low-level signal superimposed on the beating oscillator, even though the two are of nearly the same frequency. The amount of mismatch is often not very great, and in

fact may be disregarded in a great many cases. The disadvantage is that there is no way of telling in advance just how great the mismatch actually is for any particular case. In the appendix will be found an estimate of the degree of mismatch for a particular set of cases.

It must be concluded in general that unless open- and short-circuit measurements are possible, the way to be sure of having an accurate measurement of $\tanh \theta$, and through it of the inherent loss of a mixer, is to make all three admittance measurements required by (90) and to go through the calculations indicated by that equation. When the circuits are tuned, and the terminations resistive, the loss is then given by

$$L = e^{2\theta} \quad (96)$$

for the single-sideband case and by

$$L \approx 2e^{2\theta} \quad (97)$$

for the double-sideband case.

In addition to the ways of measuring loss described above, two others are in common use and deserve mention from the analytical standpoint.

Double-Detection Method of Measuring Loss

In this method, the mixer is matched on input and output sides under operating conditions and direct measurements are made of the power from the high-frequency signal generator which is available at the high-frequency input terminals of the mixer, and of the intermediate-frequency power fed into the matched load. The ratio of the two powers gives the loss. From an analytical standpoint, there can be no question of the inherent correctness of the method. From a practical standpoint a number of difficulties have made it desirable to seek alternative methods that are more readily put into operation and which require less technical skill and precision apparatus in their application. For example, in addition to the requirement of accurate impedance matches on input and output sides, where the input match at the signal frequency becomes involved with the high-level beating oscillator voltage, the method requires the accurate determination of power, both at the signal frequency and at the intermediate frequency, where the power levels are too low to be measured directly. Hence, a system of carefully calibrated and controlled attenuators, amplifiers, and wattmeters must be employed. The final result is that, for accurate absolute-loss measurements, the method presents sufficient technical difficulties to make it desirable to find some simpler equivalent, which, from its comparative simplicity, will at once increase the accuracy and the reproducibility of the results.

Incremental Method of Measuring Loss

The other method in wide use eliminates some of the difficulties inherent in the direct method described above, but also involves others. In it the beating oscillator is applied to the input of the mixer, and a measured

small change in its available power is made. The resulting change in direct current from the mixer through a known resistance is noted. From these data, the loss may be calculated, provided that the known impedance is equal to the output image impedance, and provided that the beating oscillator is matched to the input in such a way that the match occurs for the small increment in beating-oscillator power rather than for the level of power actually used. Actually, this point is usually disregarded, since the mismatch is moderately small in many cases, as mentioned before and as calculated for certain particular conditions in the appendix. In practice, the high-level beating oscillator is often matched to the mixer input. This method involves high-frequency power measurements, and more important, involves accurate measurements of a small change in high-frequency power. It also requires, by other measurements, a knowledge of the image impedance at the intermediate-frequency terminals.

It is important to investigate from the linear circuit-theory standpoint whether this incremental method of measuring loss actually gives correct answers when parasitic reactances are present. Effectively the change in beating-oscillator power may be thought of as a modulation at a very low frequency giving two sidebands $b+s$ and $b-s$. (In one form of the incremental method, a low-frequency modulation of the order of 60 cycles per second is actually used in place of the direct change in beating oscillator power.) If only one sideband were present, the loss would be exactly that for the mixer discussed in the preceding pages, and hence would be given by the magnitude of

$$L = (V_+ I_+ / V_s I_s) = (\beta_{12} / \beta_{21}) e^{2\theta}$$

where V_+ and I_+ refer to the upper sideband $b+s$ and V_s and I_s refer to the intermediate frequency.

When both sidebands are impressed together, as in the incremental method, and when the mixer is tuned so as to present a resistive impedance, the change in beating-oscillator power represents the power sent into both sidebands, and hence is twice that in each. The resulting intermediate-frequency current and voltage will each be twice the values V_s and I_s used above, which they would have with only one sideband present. The intermediate-frequency power is therefore four times as great as though only one sideband had been impressed.

The high-frequency voltage across the mixer may be written

$$\begin{aligned} V &= B(1 + m \cos st) \cos bt \\ &= B \cos bt + (Bm/2) \cos (b+s)t \\ &\quad + (Bm/2) \cos (b-s)t. \end{aligned} \quad (98)$$

This voltage is supplied by a generator of internal admittance G_0 . The admittance of the mixer to the high-level beating oscillator is G_b , while for the low-level sidebands it is G_+ or G_- , which become equal to each other when the mixer input circuit is broadly tuned as in the

present example. The generator can therefore be thought of as producing an impressed current

$$I_0 = B(G_0 + G_b) \cos bt + (Bm/2)(G_0 + G_+) \cos (b + s)t + (Bm/2)(G_0 + G_+) \cos (b - s)t. \quad (99)$$

It is immediately evident from (98) and (99) that the modulation coefficient of this generator is not m , but m' , where

$$m' = m(G_0 + G_+)/(G_0 + G_b). \quad (100)$$

The total power into the mixer on each sideband is

$$1/2(Bm/2)^2 G_+$$

and the loss is given by

$$L = (1/2)(Bm/2)^2 G_+ / P_2 / 4 = (B^2 G_b / 2)(G_+ / G_b)(m^2 / P_2) \quad (101)$$

where $P_2 = 4V_s I_s$ is the intermediate-frequency power. The expression $B^2 G_b / 2$ is the power which the beating oscillator delivers into the mixer. It is related to the available power P_a of the beating oscillator by the reflection coefficient

$$4G_0 G_b / (G_0 + G_b)^2.$$

The loss may consequently be written

$$L = (P_a / P_2)(4G_0 G_b / (G_0 + G_b)^2)(G_+ / G_b)m^2 \quad (102)$$

or, in terms of the modulation coefficient m' of the beating oscillator, from (100)

$$L = (P_a / P_2)(4G_0 G_+ / (G_0 + G_+)^2)(m')^2. \quad (103)$$

This shows that the incremental method measures correctly when precautions are taken to insure that the mixer input circuit is tuned, that the conductance G_+ presented to the sidebands is the image conductance, that the modulation coefficient used in calculation is m' referred to the beating-oscillator available power and not to the power actually sent into the mixer, that due account is taken of the reflection coefficient in (103) above, and finally, that the output is properly terminated. When the beating oscillator is matched to the mixer conductance G_b , there may be a ratio of the order of 1.5 between G_0 and G_+ . In that event the reflection coefficient amounts to 24/25 or 0.2 decibel.

If the beating oscillator were matched to the sideband conductance G_+ rather than to G_b , this correction would not be necessary. Thus, for accurate work, the incremental method could be set up by attaching the proper intermediate-frequency impedance (as determined perhaps by the impedance method) and then adjusting a high-frequency lecher circuit for zero standing waves, not for the beating oscillator but for the signal.

The impedance to the signal may be measured either by impressing a high-frequency signal or by modulating the beating oscillator. In either event the pickup probe is connected to an auxiliary mixer to which an unmodulated beating oscillator is applied. The output of this auxiliary mixer is fed into an intermediate-frequency amplifier, whose output is then seen to be proportional to the signal standing waves but not to those of the beating oscillator.

Impedance Mismatch

The effect of impedance mismatch has been mentioned several times in the above paragraphs. While the effect is often small, nonetheless for accurate work it may be important. The following formulas show just how important. Let $p = Y_a / Y_I$, the ratio of the sending-end generator admittance to the corresponding image admittance; $q = Y_b / Y_{II}$, the ratio of the receiving-end load admittance to the corresponding image admittance. Then the ratio of available volt-amperes from the generator to the actual volt-amperes in the load is

$$\frac{L_a}{L} = \frac{(p + q)^2}{4pq} \left[\frac{1 + (1 + pq)/(p + q) \tanh \theta}{1 + \tanh \theta} \right]^2 \quad (104)$$

where the magnitude of

$$L = (\beta_{21} / \beta_{12}) e^{2\theta}$$

is the loss when both terminals are properly matched in impedance.

For a matched loss of four times (i.e., 6 decibels) and with $\beta_{21} / \beta_{12} = 2$ as in the double sideband mixer case, the value of $\tanh \theta$ works out to be 1/3. Then for a mismatch of two-to-one in admittance both at sending and receiving ends, so that $p = q = 2$, it is found from (104) that the loss is increased slightly, being

$$L_a = L(17/16)^2 = 1.129L$$

which is 0.5 decibel. On the other hand, with the same magnitudes, but when the two-to-one mismatch is in opposite directions so that $p = 1/q = 2$, we have

$$L_a = L(25/16)(19/20)^2 = 1.41L$$

which amounts to 1.5 decibel. Thus, while an impedance mismatch makes relatively little difference when both terminations are mismatched in the same direction, the same degree of mismatch makes quite an important difference when the mismatch goes in opposite directions.

General

When all is said and done, the technique of measuring and using mixers is one that requires the same careful analysis and attention to detail that is demanded in the design and use of filter networks. Since the analysis has been placed on the same basis as that of linear networks, the same broad principles and methods may be applied, but with the added complication that in the double-sideband case and, even in the single-sideband case, when the beating oscillator is not an even function of time, the equivalent four-pole does not act exactly like a passive network, but has different transmissions in the two directions.

ACKNOWLEDGMENT

To their many co-workers who have contributed constructively in discussing and criticizing this paper, the writers wish to express sincere appreciation.

APPENDIX I

THE RELATION BETWEEN IMPEDANCE PRESENTED TO INPUT SIGNAL AND TO BEATING OSCILLATOR

For purposes of this comparison, it will be necessary

to restrict conditions to simple cases in order to bring out the quantitative features. The broad results may, however, be generalized in a qualitative sense. The case to be considered is therefore the one in which the entire mixer can be taken as a simple nonlinear resistance at all frequencies. The resulting properties, insofar as the signal is concerned, are discussed in the foregoing memorandum, and it was found in (52) that the image admittance presented to the high-frequency signal is given by

$$Y_{II} = (g_0 + g_2)\sqrt{1 - (2g_1^2/g_0)(g_0 + g_2)}. \quad (105)$$

The point at hand is to find how this compares with the impedance seen facing the high level of the beating oscillator.

As in Part I, the mixer characteristic $V-I$ curve can be represented by $I = F(V)$. It is convenient to choose a more specific formulation, but one which is nonetheless quite general, and write

$$I = I_0 + I_1V + I_2V^2 + \dots$$

When, as is usually the case with mixers, there is no bias so that I_0 is zero, we can write

$$I = V[I_1 + I_2V + I_3V^2 + \dots] \quad (106)$$

which has the form

$$I = VG. \quad (107)$$

The voltage V can now be taken as the beating oscillator. In the present case it will be restricted to be a single sinusoid of frequency b with no harmonics, and may be written

$$V = B \cos bt. \quad (108)$$

Hence, from (106)

$$I = B \cos bt [I_1 + I_2B \cos bt + I_3B^2 \cos^2 bt + \dots] \quad (109)$$

or

$$I = B \cos bt \left[G_0 + \sum_1^{\infty} 2G_n \cos nbt \right]. \quad (110)$$

The fundamental component of this is

$$I_b = B \cos bt [G_0 + G_2]$$

and hence the conductance which the mixer presents to the beating oscillator is

$$G_b = G_0 + G_2. \quad (111)$$

To evaluate this, we have from (106) and (107)

$$G = I_1 + I_2V + I_3V^2 + \dots \quad (112)$$

whereas from (6) the conductance to the signal is

$$g = I_1 + 2I_2V + 3I_3V^2 + \dots \quad (113)$$

It is evident immediately from a comparison of these last two equations that the G 's pertinent to the beating oscillator do not bear a one-to-one equality to the g 's pertinent to the signal. Moreover, (111) for the beating oscillator is to be compared with (105) for the signal. For a more exact calculation, we can write the Fourier expressions

$$G_n = \frac{1}{T} \int_{-T/2}^{T/2} [I_1 + I_2B \cos bt + I_3B^2 \cos^2 bt + \dots] \cos nbt dt$$

$$g_n = \frac{1}{T} \int_{-T/2}^{T/2} [I_1 + 2I_2B \cos bt + 3I_3B^2 \cos^2 bt + \dots] \cos nbt dt.$$

In the special case where the $V-I$ characteristic of the mixer may be described by the conditions

$$\begin{aligned} I &= kV^m \quad \text{for } V > 0 \\ I &= 0 \quad \text{for } V < 0 \end{aligned} \quad (114)$$

we have, from the above

$$g_n = mG_n. \quad (115)$$

It follows from (105) and (115) that

$$Y_{II} = G_b m \sqrt{1 - (2g_1^2/g_0)(g_0 + g_2)}. \quad (116)$$

This applies in the double-sideband case. In the single-sideband case, from (47) and (111),

$$Y_{II} = G_b m (g_0/(g_0 + g_2)) \sqrt{1 - (g_1^2/g_0^2)}. \quad (117)$$

For interpretation, (116) may better be visualized in the form

$$g_{b+s} = Y_{II} = mG_b(L - 2)/(L + 2) \quad (118)$$

where L is the mixer loss and is a function of m . It is thus possible to plot a curve, such as the one shown in Fig. 11 in which the value of the exponent m is the abscissa, and both the loss and the ratio of signal conductance to beating-oscillator conductance are shown as ordinates. The interesting fact is that for better mixers, the signal conductance rises to 68 per cent of the beat-

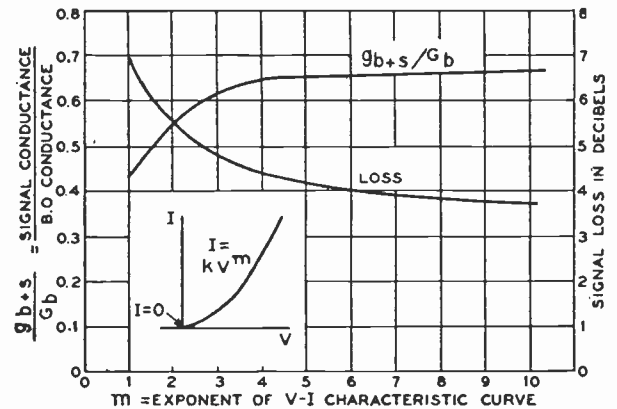

Fig. 11—Ratio of signal conductance to beating-oscillator conductance.

ing-oscillator conductance, while for the poorer ones the ratio decreases to about 43 per cent. The effect of a "tail" on the mixer's $V-I$ characteristic would be to increase the average conductances G_0 and g_0 by the same amount. This would tend to bring the effective conductances more nearly to equality, but would increase the loss at the same time.

APPENDIX II

EXTENSION TO NONLINEAR CAPACITANCE

The purpose of this appendix is to indicate how the theory can be extended to the case of a nonlinear

resistance shunted by a nonlinear capacitance. In Part II of the paper the capacitance in shunt with the nonlinear resistance was assumed to be a constant. Normally, this appears to be a good approximation; in some cases this capacitance may be variable. Let the nonlinear resistance be given by $I = F(V)$ and the charge on the nonlinear capacitance by $Q = Q(V)$. The total current flowing into the parallel combination is then

$$I = (dQ(V)/dt) + F(V) \quad (119)$$

or

$$I = (dQ(V)/dV)(dV/dt) + F(V). \quad (120)$$

Define the nonlinear capacitance as

$$K = dQ(V)/dV. \quad (121)$$

The capacitance so defined represents the slope of the curve $Q = Q(V)$. Equation (120) thus takes the form

$$I = K(V)(dV/dt) + F(V). \quad (122)$$

With the stipulation that the potential V is composed of a high-level beating-oscillator potential $C(t)$ and a low-level signal potential $S(t)$ (122) becomes

$$I = K[C(t)]C'(t) + F[C(t)] + S(t)\{F'[C(t)] + K'[C(t)]C'(t)\} + S'(t)K[C(t)]. \quad (123)$$

The first two terms represent the currents flowing as a result of the beating-oscillator potential alone and do not contain any signal-frequency components. To a first order of approximation the signal frequencies are contained in the last three terms. The first of them is produced by the action of the nonlinear resistance, while the last two are produced by the nonlinear capacitance. Since $C(t)$ is a periodic function, so also are $F'[C(t)]$, $K[C(t)]$, and $K'[C(t)]$. The terms multiplying $S(t)$ and $S'(t)$ can therefore be expanded into Fourier series the coefficients of which depend upon the nonlinear characteristics and upon the amplitude and wave shape of the beating-oscillator voltage, but are independent of the signal. By a process entirely similar to that in the text, one arrives at an array of the type (15) with the important difference that all the terms in the main diagonal are now complex and unequal.

A Figure of Merit for Electron-Concentrating Systems*

J. R. PIERCE†, ASSOCIATE, I.R.E.

Summary—Electron-concentrating systems are subject to certain limitations because of the thermal velocities of electrons leaving the cathode. A figure of merit is proposed for measuring the goodness of a device in this respect. This figure of merit is the ratio of the area of the aperture which, in an ideal system with the same important parameters as the actual system, would pass a given fraction of the cathode current to the area of the aperture which in the actual system does pass this fraction of the cathode current. Expressions are given for evaluating this figure of merit.

I. INTRODUCTION

IN ELECTRON-focusing devices, the thermal velocities of electrons leaving the cathode preclude concentration of the beam into an indefinitely small cross section. In actual devices, some measurable fraction of the cathode current is concentrated onto an area a measurable fraction of the size of the cathode area. In order to evaluate the over-all performance of the device, an expression is needed for comparing its performance conveniently with that of an ideal aberrationless device having the same important parameters.

One might suggest that the actual current density attained be compared with the "limiting current density," given later in (1). It can be shown that, in order to approach this "limiting" density closely, a large fraction of the cathode current must be eliminated by means of apertures. In many electron-beam devices it is necessary

or desirable to utilize a large fraction of the cathode current, and in this case even an aberrationless system, which should be counted as having a good figure of merit, would give much less than this limiting current density.

We might, on the other hand, try to take this into account by taking as a figure of merit the ratio of the fraction of the cathode current utilized in the actual system to the fraction which would be utilized in an aberrationless system having the same aperture sizes. However, if we increase all aperture sizes we can make the fraction of current utilized almost unity for any system, and hence make such a figure-of-merit unity. Reaming out the apertures would probably spoil the gun for its intended use.

Law¹ has proposed a figure of merit in which the beam current for which half the beam actually falls within a certain area is compared with the beam current for which half the beam would fall in the same area in an ideal aberrationless system. While this is not open to the objections cited above, it involves comparing the actual system with an ideal system having a different cathode diameter. Whether or not this is objectionable depends on one's point of view.

In this paper, a figure of merit is proposed which is obtained by dividing the beam area which could be obtained in an aberrationless system by that actually

* Decimal classification: R138. Original manuscript received by the Institute, January 9, 1945; revised manuscript received, March 16, 1945.

† Bell Telephone Laboratories, Inc., New York, N. Y.

¹ R. R. Law, "Factors governing performance of electron guns in television cathode-ray tubes," *PROC. I.R.E.*, vol. 30, pp. 103-105; February, 1942.

attained. A more precise definition of this figure of merit will be presented in the next section.

The proposed figure of merit is perhaps a little unfair if one assumes that cathode current is cheap, and by increasing the cathode current deliberately throws a lot away, perhaps for the purpose of relaxing mechanical requirements without sacrificing beam current. Still, the proposed figure of merit is intended to be a measure of electron-optical effectiveness rather than over-all engineering design.

II. EVALUATION OF FIGURE OF MERIT

For a point-focus beam, the current density at any point in the beam cannot exceed a limiting value.^{2,3}

$$j_m = j_0(1 + (11,600V/T)) \sin^2 \theta. \quad (1)$$

Here j_0 is cathode-current density, T is cathode temperature in degrees Kelvin, V is voltage with respect to the cathode, and θ is the half angle of a cone including all electron paths reaching the point in question. For instance, for the spot on the screen of a cathode-ray tube, $\tan \theta$ is half the diameter of the beam at the point where it leaves the final lens divided by the distance from that point to the screen. For electron guns, θ can be measured in various manners.

Now it was also shown that, for perfect focusing, the actual current density at a crossover or an image of the cathode cannot be greater⁴ than (2), (3)

$$j = (j_0/M^2)[1 - (1 - \beta^2)e^{-\beta^2\Phi/(1-\beta^2)}] \quad (2)$$

$$\Phi = 11,600V/T \quad (3)$$

$$\beta = M \sin \theta. \quad (4)$$

Here M is the ratio of crossover or image diameter to cathode diameter, or the magnification.

In terms of (1) and (2) the writer has defined two quantities pertaining to an ideal gun: the intensity efficiency or the ratio of actual current density to the limiting current density

$$E_i = j/j_m \quad (5)$$

and the current efficiency, or the fraction of the cathode current reaching the image.

$$E_c = jM^2/j_0. \quad (6)$$

E_i and E_c are, for a given value of V/T , functions of quantity β alone, and hence for a given value of V/T , E_i may be plotted versus E_c . It is found that for temperatures ordinarily encountered and for values of V greater than, say, 10 volts, the plot of E_i versus E_c is virtually independent of voltage and assumes the form shown in Fig. 1.

Now, assuming an aberrationless system, it is possible to solve for the magnification M by means of (1), (5), and (6). Let D_c be the diameter of the cathode and D_i be

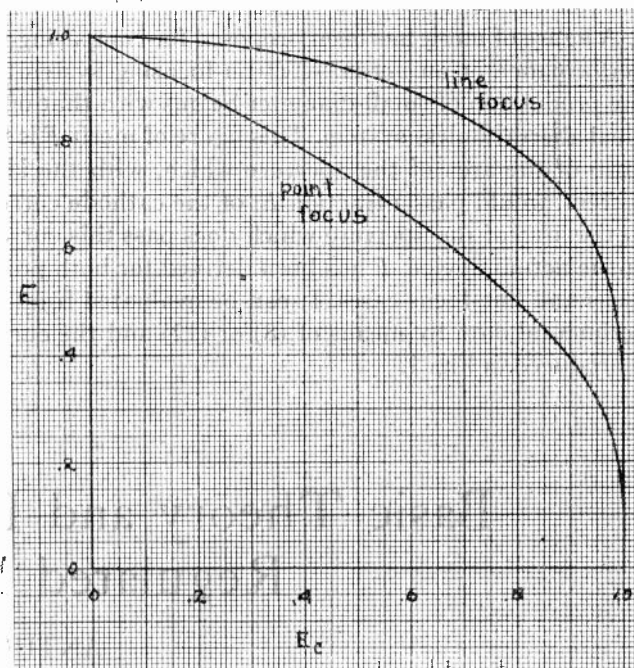

Fig. 1—Intensity efficiency versus current efficiency.

the diameter of the crossover or image. It is found that

$$D_i^2 = M^2 D_c^2 = D_c^2 (E_c/E_i) / (1 + 11,600V/T) \sin^2 \theta. \quad (7)$$

This is the size the crossover or image would have if there were no aberrations. Actually, the beam or image will have some diameter D . The figure of merit will be defined as

$$F = D_i^2/D^2 = (E_c/E_i)(D_c^2/D^2) / (1 + 11,600V/T) \sin^2 \theta. \quad (8)$$

Here D_c , D , V , T , θ , and E_c are experimental data. For most practical cases E_i can be obtained from the curve for E_i versus E_c in Fig. 1. For oxide-coated cathodes, $11,600/T$ is usually about 11.

F is the ratio of the area of the aperture which would pass a fraction E_c of the cathode current with perfect focusing to the area of the actual aperture which will pass this current in the actual device.

For line-focus beams, j_m and j are given³ by

$$j_m = j_0[(2/\pi^{1/2})\Phi^{1/2} + e^\Phi(1 - \text{erf } \Phi^{1/2})] \sin \theta \quad (9)$$

$$j = (j_0/M) [\text{erf } [\beta^2\Phi/(1 - \beta^2)]^{1/2} + \beta e^\Phi [1 - \text{erf } (\Phi/(1 - \beta^2))^{1/2}]] \quad (10)$$

$$\text{erf } X = (2/\pi^{1/2}) \int_0^X e^{-u^2} du. \quad (11)$$

In this case, θ is the half angle between a pair of planes including all electron paths. As before, for practical ranges of V and T , E_i versus E_c is virtually independent of V/T and the curve shown in the figure may be used.

The exact expression for the figure of merit F in the line-focus case is somewhat complicated. For the usual temperatures and V above, say, 10 volts we may use

$$F = (W_c/W)(E_c/E_i)(\pi^{1/2}/2) / (11,600V/T)^{1/2} \sin \theta. \quad (12)$$

Here W_c and W are the cathode and the beam widths, respectively.

² D. B. Langmuir, "Theoretical limitations of cathode-ray tubes," Proc. I.R.E., vol. 25, pp. 977-991; August, 1937.

³ J. R. Pierce, "Limiting current densities in electron beams," Jour. Appl. Phys., vol. 10, pp. 715-724; October, 1939.

⁴ Equations (1) and (2) do not include effects of electron collisions in the beam. Aberrations may, of course, be unavoidable. Thus (1) and (2) are not necessarily realizable in physical systems, but are limitations imposed by thermal velocities alone.

A figure of merit has been proposed for comparing the performance of an actual electron-focusing system for the production of small-diameter beams with that of an ideal aberrationless system. This figure of merit F is the ratio of the area of the aperture which, with the ideal system, would pass a fraction E_c of the cathode current to the area of the aperture which does pass this current in the actual device. F has been derived for both point-focus and line-focus cases. It can be evaluated from experimental data by means of (8) or (12) and the curves reproduced in Fig. 1.

In the fourth paragraph of this paper the writer has given his reason for not generalizing the figure of merit proposed by Law. Law's figure of merit as he presents it is specialized; he specifies that half of the total cathode current fall within the nominal spot diameter, making $E_c = 0.5$. For this value of current efficiency, the figure of merit proposed here is always 4 per cent greater than that proposed by Law. This is certainly an unobjectionable difference, and amounts practically to interchangeability of the two figures of merit for the case considered by Law.

Basic Theory and Design of Electronically Regulated Power Supplies*

ANTHONY ABATE†

Summary—Various types of electronic regulator circuits are discussed and an analysis is made of the degenerative or cathode-follower type, since it offers the most in flexibility and regulation. Equations are derived showing the theoretical output voltage, regulation characteristics, and output impedance for the basic circuit. Practical-design considerations evolved from these equations show the desirability of high-transconductance series-control tubes and high gain in the amplifier section.

A complete circuit is presented for a multiple-output regulator which, by combining regulated sections in opposition, covers the range from 0 to 500 volts. The design is such that a single rectifier and filter are supplying constant current throughout the selected range of output current. This effectively eliminates from consideration the usual regulation introduced by the latter components.

Curves are included showing actual regulation characteristics for several combinations of output voltage and current.

DURING THE past several years, electronically regulated power supplies have emerged from the laboratory into the field. Their inherent characteristics allowing smooth voltage control and extremely close regulation against line-voltage and load variations are advantageous in many production-testing installations such as those found in the manufacture of radio tubes. Furthermore, the output impedance can be reduced to a value of only a few ohms for all frequencies including direct current. This insures freedom from motor-boating in high-gain audio or direct-current amplifiers. The output ripple is also considerably reduced by the regulating action of the supply. The foregoing advantages will, in many instances, far outweigh the increased circuit complexity and the internal-power loss accompanying such a set. The purpose of this article is to set forth some of the basic theoretical and practical aspects of regulated-power-supply design.

A circuit will be presented which makes it possible to

* Decimal classification: R356.3. Original manuscript received by the Institute, September 22, 1944. Revised manuscript received, January 11, 1945.

† Raytheon Manufacturing Company, Newton, Massachusetts.

obtain simultaneously several different values of regulated output voltage from a single transformer and filter section. Each voltage can be adjusted continuously from 0 to 500 volts. A negative bias voltage is also available in addition to the positive values.

There are several fundamental principles of operation which can be utilized to secure voltage regulation through the use of electron tubes.

1. Regulators based on the bridge circuit for measuring transconductance.¹
2. Regulators based on the bridge circuit for measuring amplification factor.¹
3. Degenerative or cathode-follower types of regulators.²

These are sketched below in elemental form, together with Table I, which shows their salient features.

Since the degenerative scheme offers the most in flexibility and regulation, this article will be primarily concerned with exploiting its possibilities.

To improve the effectiveness of the degenerative circuit of Fig. 1(c), a straightforward direct-current amplifier is added as represented in Fig. 2 by VT2 which may be called the regulation amplifier. Its function is to minimize the change in output voltage E_0 by varying the grid bias on the series-control tube VT1. Thus in effect VT1 acts as a series rheostat which is automatically adjusted by VT2 so as to reduce the effect on E_0 when the input voltage E_i or the load resistance R_L is varied. The circuit then becomes the familiar regulator included in the RCA Application Note No. 96 issued in 1938 and discussed by Hunt and Hickman in their paper.²

If idealized tube characteristics are assumed, it is

¹ J. G. Brainerd, Glenn Koehler, Herbert J. Reich, and L. F. Woodruff, "Ultra-High-Frequency Techniques," D. Van Nostrand Company, Inc., New York, N. Y., 1942, pp. 72-75.

² F. V. Hunt and R. W. Hickman, "On electronic voltage stabilizers," *Rev. Sci. Instr.*, vol. 10, p. 6; January, 1939.

found that the output voltage for the circuit of Fig. 2 can be expressed by the following equation³

$$E_o = R_1 \left[\frac{E_i(R_2 + r_{p2}) + \mu_1\mu_2R_2E_c}{(R_2 + r_{p2})(R_1 + r_{p1}) + R_1R_2\mu_1(1 + A\mu_2)} \right] \quad (1)$$

A few judicious assumptions seem appropriate at this time, in order to reduce (1) to a more usable form. In practice $A\mu_2 \gg 1$ and $\mu_1\mu_2R_2E_c$ can be made considerably greater than $E_i(R_2 + r_{p2})$ with $R_1R_2\mu_1A\mu_2$ much larger than $(R_2 + r_{p2})(R_1 + r_{p1})$. Consequently, to the extent and range of operating conditions that the foregoing assumptions are valid, the output voltage reduces to

$$E_o \approx E_c/A \quad (2)$$

Equation (2) is an important design equation even though it is optimistic by predicting perfect regulation. It shows with good accuracy what the output voltage of the supply will be under different values of E_c and A , thus allowing the designer to cover a desired range of voltage with the R_c control.

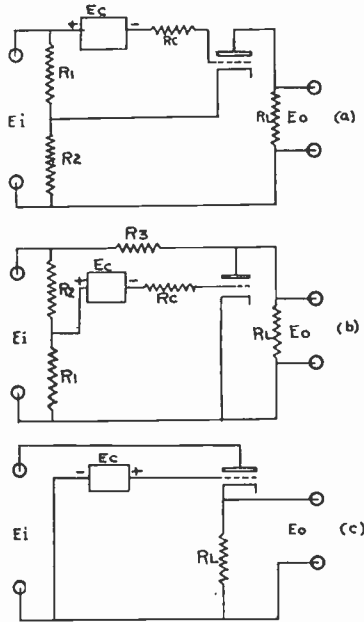

Fig. 1—Elementary regulator circuits. (a) Mu-bridge-derived regulator. E_o is constant when $R_2 = \mu R_1$. Application limited to small load currents. (b) Mutual-conductance-bridge-derived regulator. E_o is constant when $R_3 = (R_1 + R_2)/R_1g_m$. (c) Degenerative-type regulator.

There are several practical considerations determining range of operation over which the assumptions resulting in (2) are valid. It is obvious from Fig. 2 that output voltage is the difference between the input voltage and the drop across VT2 which in turn is a function of plate current and grid bias. The regulating action is accomplished when a small change in output voltage is amplified by VT2 and applied to the grid of VT1 so as to change its effective series resistance. Thus, if the output voltage tends to drop, VT2 is biased more negatively by the amount of such change. The consequent reduction in plate current reduces the voltage across R_2 supplying the negative grid bias for VT1. Consequently,

³ Derivation shown in Appendix A.

the series resistance of VT1 is lowered, and the output-voltage change is restricted to a small value. It now becomes apparent that one limit of regulation is reached when VT2 is biased to cutoff resulting in zero bias on VT1. With a given input voltage the maximum obtainable output voltage then becomes dependent upon the

TABLE I
CHARACTERISTICS OF ELECTRONIC VOLTAGE REGULATORS

Type	Output Voltage Control	Regulation Characteristics	
		$\frac{dE_o}{dE_i} \Big _{R_L=K}$	$\frac{dR_L}{dE_o} \Big _{E_i=K}$
g_m Bridge	Not readily controlled	$\frac{dE_o}{dE_i} = 0$ Over range of constant g_m	No Stabilization
$\mu\mu$ Bridge	Limited Control	$\frac{dE_o}{dE_i} = 0$ Over range of constant μ	No Stabilization
Degenerative	$E_o = \frac{R_L(E_i + E_c)}{R_p + R_L(1 + \mu)}$ Variable E_c can be used for control.	$\frac{dE_o}{dE_i} = \frac{R_L}{R_p + R_L(1 + \mu)}$	$\frac{dR_L}{dE_o} = \frac{R_p(E_c + E_i)}{[R_p + R_L(1 + \mu)]^2}$

desired maximum current and the zero-bias voltage required to maintain VT1 at that current. This information may be obtained from published tube characteristics.

It is interesting to note that when VT2 is biased to cutoff its r_p becomes infinite and (1) transcends from $E_o \approx E_c/A$ (perfect regulation) to $E_o = E_iR_1/(R_1 + r_{p1})$ (unregulated).

An additional limitation is encountered when an attempt is made to adjust E_o to a very low value. In this

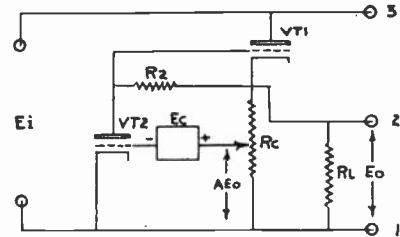

Fig. 2—Amplified degenerative regulator. E_i = The rectified and filtered direct voltage which is to be regulated. E_o = The regulated output voltage. E_c = The negative bias required for VT2. R_1 = Parallel resistance of load circuit comprising bleeders, control potentiometer, and load. $R_1 = R_cR_L/(R_c + R_L)$. R_c = Adjustment control for E_o . R_L = External load resistance. AE_o = Voltage from grid tap to negative; A representing a percentage of E_o .

case, a high voltage drop across VT1 is necessary. This entails a large negative grid bias when the output current amounts only to that of the bleeder. However, E_o must supply this bias, which is developed across R_2 , in addition to plate potential for VT2. Hence, it becomes impossible to reduce the output voltage below a certain value which is determined by E_i , bleeder load, VT1, and VT2 characteristics.

For an evaluation of the actual regulation that can be achieved from the circuit of Fig. 1, it is simply necessary to differentiate (1) with respect to E_i . The resultant differential then becomes

$$\frac{dE_o}{dE_i} = \frac{R_1(R_2 + r_{p2})}{[(R_2 + r_{p2})(R_1 + r_{p1}) + R_1R_2\mu_1(1 + A\mu_2)]}$$

Again assuming that $R_1R_2\mu_1A\mu_2$ is the predominating factor, we have $dE_o/dE_i \approx (R_2 + rp_2)/R_2\mu_1\mu_2A$. Since $\mu_2R_2/(R_2 + rp_2) =$ the gain associated with $VT_2 = G_2$. Then:

$$dE_o/dE_i \approx 1/AG_2\mu_1. \quad (3)$$

Equation (3) clearly illustrates the ripple and voltage-change attenuation that can be achieved by electronic regulation. It also indicates that the VT_2 tube should be capable of producing high gain, whereas VT_1 should have high μ and low R_p , and consequently high transconductance. The value of A should also be as nearly unity as possible since it directly affects the regulation. This can be done insofar as the alternating-current ripple is concerned by simply connecting a suitable condenser from the arm of R_c to the cathode of VT_1 . However, for direct-current changes it is necessary to vary the value of E_c rather than A in (2) for voltage control, if the greatest possible regulation is desired. This is obviously cumbersome and therefore, practical design is necessarily a compromise wherein E_c is held constant at some convenient value and E_o is varied by adjusting A in (2).

The regulation accompanying a change in load may be ascertained by differentiating (1) with respect to R_1 . Thus

$$\frac{dE_o}{dR_1} = \frac{(R_2 + rp_2)(R_1 + rp_1)[(R_2 + rp_2)E_i + \mu_1\mu_2R_2E_c]}{[(R_2 + rp_2)(R_1 + rp_1) + R_1R_2\mu_1(1 + A\mu_2)]^2} E_i = K.$$

Again assuming $\mu_1\mu_2R_2E_c \gg E_i(R_2 + rp_2)$

and $AR_1R_2\mu_1\mu_2 \gg (R_2 + rp_2)(R_1 + rp_1)$

we have

$$\frac{dE_o}{dR_1} \approx \frac{(R_2 + rp_2)(R_1 + rp_1)(\mu_1\mu_2R_2E_c)}{[(R_1R_2\mu_1\mu_2A)]^2}$$

Since

$$G_2 = \mu_2R_2/(R_2 + rp_2) \quad \text{and} \quad E_c/A = E_o$$

then,

$$dE_o/dR_1 \approx E_o(R_1 + rp_1)/A\mu_1G_2R_1^2. \quad (4)$$

Equation (4) also indicates that changes in load will have little effect on the output voltage in a well-designed supply.

It was mentioned in the introduction that a regulated power supply has very low output impedance. An analysis

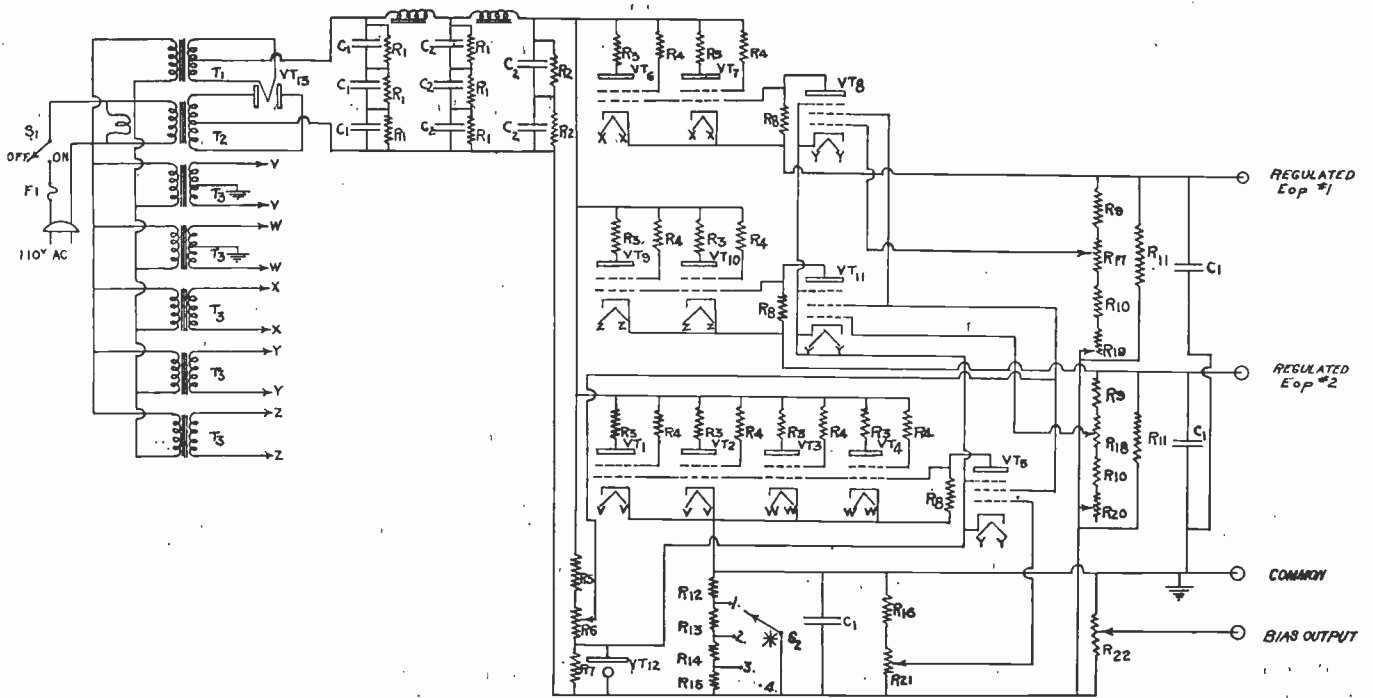

Fig. 3—Multiple-output regulated power supply.

- $C_1 = 20$ -microfarad electrolytic condensers.
- $C_2 = 8$ -microfarad electrolytic condensers.
- $F_1 = 5$ -ampere "littlefuse."
- L_1 and $L_2 = 15$ -henry 250-milliampere chokes.
- $R_1 = 0.5$ -megacycle 1-watt carbon resistor.
- $R_2 = 0.5$ -megacycle 1-watt carbon resistor.
- $R_3 = 100$ -ohm 1-watt carbon resistor.
- $R_4 = 1000$ -ohm 1-watt carbon resistor.
- $R_5 = 50,000$ -ohm 25-watt resistor.
- $R_6 = 5000$ -ohm 25-watt tapped resistor (Screen voltage; 50 volts approximate).
- $R_7 = 100,000$ -ohm 1 watt resistor.
- $R_8 = 1$ -megacycle 1-watt resistor.
- $R_9 = 125,000$ -ohm 2-watt carbon resistor.
- $R_{10} = 15,000$ -ohm 1-watt resistor.
- $R_{11} = 50,000$ -ohm 25-watt resistor.
- $R_{12} = 1000$ -ohm 100-watt resistor.
- $R_{13}, R_{14}, R_{15} = 500$ -ohm 25-watt resistor.

- $R_{16} = 10,000$ -ohm 25-watt resistor.
- $R_{17} = 50,000$ -ohm potentiometer control for E_{op} #1. ("Coarse.")
- $R_{18} = 50,000$ -ohm potentiometer control for E_{op} #2. ("Coarse.")
- $R_{19} = 5000$ -ohm potentiometer control for E_{op} #1. ("Fine.")
- $R_{20} = 5000$ -ohm potentiometer control for E_{op} #2. ("Fine.")
- $R_{21} = 5000$ -ohm 25-watt tapped resistor. (Set bias voltage to 200 volts.)
- $R_{22} = 10,000$ -ohm potentiometer control for bias voltage.
- $S_2 =$ Internal-load switch.
- $T_1 = 5.0$ -volt 4-ampere transformer.
- $T_2 = 2000$ -volt center-tapped transformer 300 milliamperes.
- $T_3 = 6.3$ -volt 3-ampere transformer.
- $VT_1, VT_2, VT_3, VT_4, VT_6, VT_7, VT_9, VT_{10} =$ Type 807 tubes.
- $VT_8, VT_8,$ and $VT_{11} =$ Type 6SJ7GT tubes.
- $VT_{12} =$ Type OA3/VR-75 tube.
- $VT_{13} =$ Type RK-60 tube.
- $*S_2$ Positions.
 - 1—200 milliamperes.
 - 2—150 milliamperes.
 - 3—100 milliamperes.
 - 4—50 milliamperes.

similar to the foregoing indicates that the impedance looking into the E_0 terminals is $Z_{12} = Z_1 r_{p1} / (Z_1 A G \mu_1 + r_{p1})$ where Z_1 is the impedance across terminals 1 and 2 when the tubes are inoperative; and

$$Z_{12} = r_{p1} / A G \mu_1 \quad \text{when } r_{p1} \ll Z_1 A G \mu_1. \quad (5)$$

Thus, with an $A G \mu_1$ factor of 100, a series-control tube having an r_p of 1000 ohms will result in 10-ohms output impedance which is constant for all frequencies including direct current.

A flexible power supply capable of delivering several independent values of regulated voltage from a single transformer and filter is shown in Fig. 3. With this unit it is possible to control voltage from either of two sections (more sections can be added if desired) between 0 and 500 volts. Each section is capable of regulating effectively from 0 to 100 milliamperes. The regulation and control down to zero volts is achieved by adjusting one regulated section comprising the tubes marked $VT_1, VT_2, VT_3, VT_4,$ and VT_5 to a low voltage approximating 200 volts above the power-supply negative. This section is loaded to the total maximum current that is desired at any given time from the output voltages. An internal-load range switch marked S_2 is incorporated for this purpose. It will be shown that this feature is desirable because it can be utilized to reduce the plate dissipation on the parallel series-control tubes $VT_1, VT_2, VT_3,$ and VT_4 when low currents are drawn from the outputs. One output section comprises tubes $VT_6, VT_7,$ and VT_8 . The second, tubes $VT_9, VT_{10},$ and VT_{11} . E_c for all sections is applied in the cathode circuit of the amplifier tubes $VT_5, VT_6,$ and VT_{11} from an OA3/VR-75 tube VT_{12} . Each output section is then designed to vary in voltage from that of the loaded section (200 volts) to 500 volts above that value, or 700 volts with respect to the power-supply negative.

If the positive of the low-voltage supply is grounded, the other sections individually will vary from 0 to 500 volts above ground. The total output currents then cannot exceed the internal load on the low-voltage section, because of the series arrangement. This is often a decided advantage, since the output voltage breaks rapidly if the current limit is exceeded, and the current meters are automatically protected in case of a short. The family of regulation curves shown in Figs. 4 and 5 clearly indicates this action. The actual negative point is below ground and can be used for a bias supply as shown. By virtue of the internal load, this supply becomes nearly a constant-current device insofar as the transformer, the rectifier, and the filter section are concerned. The current flowing through internal resistors $R_{12}, R_{13}, R_{14},$ and R_{15} divides between the various sections. With no external load, all the current flows through the low-voltage section. However, as the external current is increased, a division takes place wherein the current flowing through tubes $VT_1, VT_2, VT_3,$ and VT_4 is reduced by the amount that is drawn through tubes $VT_6, VT_7, VT_9,$ and VT_{10} . The voltage across

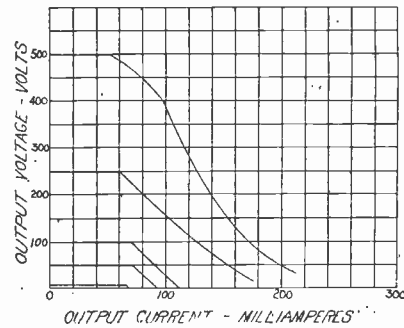

Fig. 4—Control characteristics of regulated power supply. Internal load = 50 milliamperes; one section.

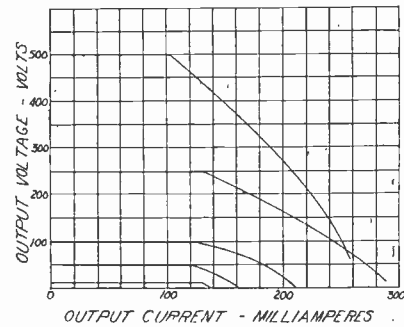

Fig. 5—Control characteristics of regulated power supply. Internal load = 100 milliamperes; one section.

the internal load remains constant until the limit of regulation is reached when the total output current equals the internal-current setting. There arise from this characteristic several advantages. First, the supply can be adjusted for a maximum output current, after which the voltage drops rapidly, thus offering protection to meters. Second, since the transformer, rectifier, and the filter section are supplying a constant current regardless of variations in load current, there is no regulation to consider within those components. The internal-power loss unloaded is high, but when power is drawn out the internal dissipation is reduced by the same amount of power. Therefore, the internal load current should be adjusted to a value only slightly higher than the maximum output desired at any given time. Fig. 6 shows the regulation obtained with changes in line voltage.

The main principles regarding the design of electronically regulated supplies may now be summarized as follows:

1. High-transconductance control tubes are desirable to reduce internal-power losses and improve the

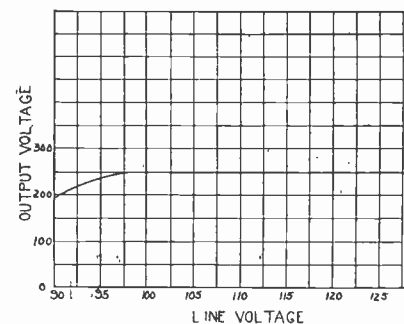

Fig. 6—Control characteristics of regulated power supply. $E_0 = 250$ volts; $I_0 = 100$ milliamperes; E -line = 115 volts.

regulation. Several tubes may be combined in parallel to achieve this end. Types 2A3, 6B4G, 6A3, triode-connected types 6L6, 6V6, and 807 offer good possibilities for this service.

2. A high-gain amplifier is required to obtain a maximum degree of regulation, low ripple, and low output impedance. This may be several stages of direct-current amplification when extreme regulation is necessary. Sharp-cutoff, high-transconductance pentodes like the 6SJ7, 6AK5, 6SH7, 6AC7, etc. are desirable if one stage is used.

3. The unregulated rectified voltage must always be great enough at the lowest encountered line voltage to supply the zero-bias drop in the series-control tube at the highest combination of desired output voltage and current. This is the absolute limit of regulation, and for good results the supply voltage should actually exceed this requirement.

4. A stable source of E_c must be incorporated since it directly affects the output voltage. Various possibilities include batteries and constant-drop devices, such as neon lamps and voltage-regulator tubes.

5. A suitable bleeder resistance is necessary to insure good regulation down to zero load current. Ten per cent of the maximum current at the maximum output voltage is a reasonable figure.

6. Since regulated supplies hold only to a maximum current and then break down rapidly, the peak current drawn must never exceed the maximum current rating. Hence, when it is desired to draw current in pulses of high peak value but nominal average values, a large condenser must be shunted across the supply output. This is represented by C_1 of Fig. 3.

APPENDIX

A. Derivation of Output-Voltage Equation

Assuming idealized tube characteristics, we have

For VT₁

$$ip_1 = (\mu_1 eg_1 + ep_1)/rp_1 \quad (6)$$

$$ip_1 = (-\mu_1 ip_2 R_2 + E_i - ip_1 R_1)/rp_1 \quad (7)$$

$$ip_1 = E_i - \mu_1 R_2 ip_2 / (R_1 + rp_1) \quad (8)$$

For VT₂

$$ip_2 = (\mu_2 eg_2 + ep_2)/rp_2 \quad (9)$$

$$ip_2 = (\mu_2 (A ip_1 R_1 - E_c) + ip_1 R_1 - ip_2 R_2)/rp_2 \quad (10)$$

$$ip_2 = (\mu_2 (A ip_1 R_1 - E_c) + ip_1 R_1)/(R_2 + rp_2) \quad (11)$$

Substituting the value of ip_2 from (11) in (8), we obtain

$$ip_1 = \frac{E_i(R_2 + rp_2) + \mu_1 \mu_2 R_2 E_c}{(R_2 + rp_2)(R_1 + rp_1) + R_1 R_2 \mu_1 (1 + A \mu_2)}$$

$$E_0 = ip_1 R_1$$

$$= R_1 \left[\frac{E_i(R_2 + rp_2) + \mu_1 \mu_2 R_2 E_c}{(R_2 + rp_2)(R_1 + rp_1) + R_1 R_2 \mu_1 (1 + A \mu_2)} \right] \quad (12)$$

Corrections

Heinz E. Kallmann, whose paper "Transient Response," appeared on pages 169-196 of the March, 1945, issue of the PROCEEDINGS, has brought the following corrections to the attention of the editor:

Page 181, second column, fourth line from the bottom: delete "37," write "38."

Page 184, first column, paragraph "The odd and even . . .,"

line 9: delete "(45)," write "(46)."

line 12: delete "(46)," write "(45)."

D. L. Jaffe, whose paper "A Theoretical and Experimental Investigation of Tuned-Circuit Distortion in Frequency-Modulation Systems" appeared in the May, 1945, issue of the PROCEEDINGS on pages 318 to 324, has brought to the attention of the editors the following corrections:

1. Page 318, lines 7, 8, and 9 of the Summary should read:

$\Delta W/2\pi$ = peak-frequency swing in cycles per second

$\lambda/2\pi$ = modulation frequency in cycles per second

$BW/2\pi$ = bandwidth in cycles per second measured at 3 decibels down. Double-tuned circuits critically coupled.

2. Page 318, line 19 of the Summary should read:

" . . . maximum per cent harmonic distortion is . . ."

3. Page 320, line 2 above Fig. 1 should read:

Page 186, second column, paragraph "Inasmuch . . .," line 6: delete "Figs. 48, 49, and 52," write "Figs. 48, 50, and 52."

line 7: delete "Fig. 46," write "Fig. 47."

Page 190, equation (62): delete " E_2/E_2 ," write " E_2/E_0 "; complete its last line to " $p = 1/(2Q_1)$ $q = 1/(2Q_2)$ "

Page 190, equation (64): write $T = (2\omega_0/\omega) \cdot \tan^{-1} . . .$

Page 191, second column, paragraph "Good responses . . .," line 3: delete "Fig. 54," write "Fig. 52."

" . . . where $BW/2\pi$ denotes the total bandwidth in cycles per second at 3.0 decibels down."

4. Equation (28) should read:

$$\Omega_0 = w_0 + \Delta w \sin \lambda t - \rho \lambda \frac{\cos \lambda t}{1 + \rho^2 \sin^2 \lambda t}$$

5. Equation (37) should read:

$$D_{n-\max} = \frac{2}{\sqrt{\left(\frac{\Delta w}{\lambda}\right)^2 + 1}} \cdot 100$$

6. Page 328, line 14 of Conclusions should read:

$BW/2\pi$ = bandwidth in cycles per second measured at 3 decibels down.

7. Page 330, Fig. 25 description should read:

$BW = 50$ kilocycles.

“Reflex Oscillators”*

J. R. PIERCE

E. U. Condon:¹ Dr. Pierce has given a valuable, clear presentation of the principles underlying the reflex klystron, a new type of tube which has found wide application in recent years. It was most interesting to see how well he could present the main properties without heavy theoretical calculations.

I am, however, moved to protest against the suggestion of any close resemblance between the old Barkhausen positive-grid oscillators and the modern reflex oscillators. Both are electronic-vacuum devices in which the working electrons reverse their direction of motion in operation; but the detailed operation of the two tubes is so different that their theory has very little in common. Moreover, it would be hard to trace a genetic connection between the two types in their historical development. Therefore, it seems to me that it is more conducive to clear thinking to contrast the two types, rather than to regard them as different forms of essentially the same thing, which is the impression which might be gained from a hasty reading of Dr. Pierce's paper.

A. E. Harrison:² Dr. Pierce's excellent article on reflex oscillators presents a very useful discussion of the principles of these tubes and their operating characteristics. Some question might be raised, however, as to the extension of the term “reflex oscillator” to Barkhausen tubes and the implication that a “modern reflex oscillator,” which is quite generally known as a reflex klystron, is a modified form of Barkhausen oscillator.

The definition given for a reflex oscillator under the heading, “General Description,” describes a reflex klystron accurately, but the analogy to a Barkhausen tube which follows is inexact. The usual explanation^{3,4} for the Barkhausen oscillator assumes that there is a radio-frequency field in all regions traversed by the electron beam, including the region between the positive grid and negative plate, and that electrons with certain phase continue to transfer energy to the alternating field until they are captured. The negative plate must be considered a part of the oscillating circuit, although the external circuit may be connected between the cathode and grid. These discrepancies between the explanation of the operation of a Barkhausen oscillator and the “reflex oscillator” defined in the paper make the analogy questionable.

In addition to the question of the validity of the analogy, nothing seems to be gained from the allusion. It does not contribute in any way to the theory which is described. The statement is made that the terminology of velocity modulation and bunching simplifies the explanation of reflex oscillators, and the paper includes Barkhausen tubes in this category. While it is true that a velocity-modulation analysis is quite useful in an explanation of reflex klystrons, the simplicity of such an analysis for a Barkhausen oscillator would seem doubtful. It should also be pointed out that velocity-modulation principles are more than merely a “new terminology”; the recognition and application of these principles has made possible the development of many new and useful tube types.

It seems difficult to justify the statement that reflex oscillators are not “entirely” new because there is a superficial resemblance between a reflex klystron and an older type of tube. The difficulty is easily avoided by not attempting to include Barkhausen tubes in the same classification with the reflex klystron. Historically, the tremendous development of reflex klystron tubes is an outgrowth of the development of velocity-modulation tubes. Noticing a resemblance to Barkhausen oscillators would appear to be an afterthought.

It is also noted that the amplitude characteristic in Fig. 8 is plotted as a function of frequency. This presentation of the characteristic is quite interesting, but should not be confused with the amplitude versus reflector-voltage (repeller-voltage) curves, a characteristic which is usually measured and does not have the cusp-like pattern.

W. W. Hansen:⁵ This article discusses oscillators of a class designated as reflex. Illustrations subdivide the class into “early” and “modern,” the former being a Barkhausen oscillator and the latter what is often called a reflex klystron.

It seems to me there is more difference between the two than that connoted by the words “early” and “modern”; perhaps even more than conceded by “new terminology.”

I would point out a number of differences between a reflex klystron (*K*) and what is commonly understood^{4,6,7} as a Barkhausen oscillator (*B*). I quite realize that legalistic exception can be taken to most of these differences, but suggest that reference to the literature mentioned above, and also to the article under

* PROC. I.R.E., vol. 33, pp. 112–118; February, 1945.

¹ Westinghouse Research Laboratories, East Pittsburgh, Pa.

² Sperry Gyroscope Co., Inc., Garden City, L. I., N. Y.

³ F. E. Terman, “Radio Engineers' Handbook,” McGraw-Hill Book Co., New York, N. Y., 1943, p. 521.

⁴ F. B. Llewellyn, “Electron Inertia Effects,” Cambridge University Press, New York, N. Y., 1943, pp. 96–98.

⁵ Sperry Gyroscope Co., Inc., Garden City, L. I., N. Y.

⁶ F. E. Terman, “Radio Engineering,” McGraw-Hill Book Company, New York, N. Y., 1937, p. 385.

⁷ A. F. Harvey, “High Frequency Thermionic Tubes,” John Wiley and Sons, New York, N. Y., 1943, p. 59.

discussion, will justify application of the phrase "commonly understood" to the following:

1. *B* has three electrodes, *K* has four.
2. *K* has an electron beam, *B* has not.
3. *B* has radio-frequency fields on either or both the cathode and reflector, *K* has not.
4. The electrons in *B* make many transits of the radio-frequency field, in *K* they make two.
5. The time between transits in *K* is $n + \frac{3}{4}$ cycles, in *B* it is $\frac{1}{2}$ cycle.
6. In *B* the frequency is stated to depend on voltage and electrode spacing, in *K* it depends almost entirely on the resonator.

J. R. Woodyard:⁸ There has recently appeared a valuable discussion of reflex oscillators by J. R. Pierce. Since this paper seems to have caused considerable controversy among those working in the field, it may be well to explain the significance of a few of the points discussed therein.

An erroneous impression might be obtained from reading the article in question, particularly by one who is not familiar with the subject. A Barkhausen oscillator is shown as an example of an "early" reflex oscillator, and a reflex klystron as a "modern" reflex oscillator, together with a statement about a new terminology, from which it might be inferred that the reflex klystron was developed from the Barkhausen oscillator. As a matter of fact, the development of the reflex klystron had nothing to do with the Barkhausen oscillator, but rather resulted from the idea of folding an ordinary two-resonator klystron back upon itself. It is true that there is a new terminology, but as so often happens, a new terminology has meant a new understanding of the principles involved, and in turn, new results.

As defined in the paper under discussion, a reflex oscillator is one in which an electron stream passes through a longitudinal radio-frequency electric field, through a retarding direct-current field which reverses its motion, and back through the radio-frequency field. This seems to cover just about everything in retarding-field oscillators. An author is, of course, privileged to define his terms, and this definition is perhaps as good as any, since it is sometimes useful to have a word which is comprehensive in meaning, and the name is suggestive of the process of "reflection" which the electrons undergo because of the retarding field.

Barkhausen oscillators are frequently operated with the tuned circuit between the grid and plate. Therefore we may assume that, in the author's definition, he did not intend that it should be necessary to have the retarding field in a separate space from the radio-frequency field. Also, nothing is said about transit time in the definition. We cannot interpret this as an oversight on the part of the author. Instead, we must assume that transit time was intentionally ignored, because one of the ways in which klystron and Barkhausen oscillators

differ is in transit time, and the differences between the two oscillators were ignored.

Since the transit time is unspecified in this definition, some low-frequency retarding-field oscillators qualify as reflex oscillators. Examples are the inverted-triode oscillator,^{9,10} and the so-called "transitron" oscillator of Brunetti.¹¹

An interesting analogy to the present situation occurred in 1935. In discussing the Barkhausen oscillator, F. B. Llewellyn¹² stated the following: "It is interesting to note that the same kind of analysis here used to illustrate the workings of the Barkhausen oscillator can be applied to the well-known feedback oscillators operating with negative grid and positive plate, and shows that the two are not very different from each other after all."

It frequently happens in the history of science that isolated discoveries are later linked up by further knowledge into an integrated structure, so that a continuous transition becomes possible between what were formerly thought to be unrelated ideas. Indeed, this is the normal and desirable procedure, and represents a real advance in knowledge.

J. R. Pierce:¹³ In discussing the discussions by Messrs. Condon, Hansen, Harrison, and Woodyard of my paper "Reflex Oscillators" I do not wish to have my earlier or my present remarks taken as implying that one particular device arose merely as a development of another. My interest is in grouping together, out of the broad field of devices by means of which high-frequency energy may be obtained from an electron stream, certain closely related devices. In this sense I believe it is a natural grouping to classify negative-plate Barkhausen tubes with the devices for which some others who have worked chiefly with klystrons may wish to reserve exclusively the name "reflex oscillator." Indeed, I am not the only person to have noticed the close similarity between Barkhausen tubes and reflex klystrons.¹⁴

That I see this similarity is not entirely because of my high opinion of the generality and usefulness of the concept of velocity modulation. While the velocity-modulation approach is not, in all cases, the most convenient mathematically, there is no question but that all longitudinal-field electronic problems can be formulated in terms of it. It happens to be especially convenient in explaining the electronics of Barkhausen tubes and reflex klystrons. While the functions of velocity modulation, drift action, and delivery of power were first physically segregated in an oscillator by Heil and

⁹ See footnote reference 6, 2nd Edition, year, p. 149.

¹⁰ R. L. Freeman and R. C. Hergenrother, "High-voltage rectified power supply using fractional-mu triode radio-frequency oscillator," *Proc. I.R.E.*, vol. 33, p. 55; January, 1945. (Abstract.)

¹¹ Cleo Brunetti, "The transitron oscillator," *Proc. I.R.E.*, vol. 27, pp. 88-94; February, 1939.

¹² F. B. Llewellyn, "The Barkhausen oscillators," *Bell Labs. Rec.*, vol. 13, p. 358; August, 1935.

¹³ Bell Telephone Laboratories, 463 West Street, New York, N. Y.

¹⁴ Robert I. Sarbacher and William A. Edson, "Hyper and Ultra-High Frequency Engineering," John Wiley and Sons, Inc., New York, N. Y., 1944, p. 603.

⁸ Sperry Gyroscope Co., Inc., Garden City, L. I., N. Y.

Heil¹⁵ in 1935, and the complete physical separation of these functions in a reflex oscillator was first shown by Hahn and Metcalf¹⁶ in 1939, it is no detraction from the valuable contributions of these workers and those of the Varians, Webster, and others, to point out that in negative-plate Barkhausen tubes (Barkhausen tubes were used with the plate very negative from the time of Barkhausen's first work, in 1920) the electron stream does become velocity modulated and bunched, and does deliver energy to the circuit. While multiple transits, which occur in some reflex klystrons as well as in Barkhausen tubes, figure prominently in the early theories about Barkhausen tubes, it is hard to say what part they actually play in the operation of these devices. In some of the latest theoretical work on negative-plate Barkhausen tubes, multiple transits are not considered.¹⁷⁻¹⁹

In Barkhausen tubes, the high-frequency excitation is applied sometimes between cathode and grid, sometimes between grid and anode, and sometimes to both regions. It occurs to me that operation in which the excitation is applied between the grid and reflecting plate as in the "resotank" is very closely analogous to that of the reflex oscillator as described by Hahn and Metcalf and in the Sperry Klystron Manual. Negative-plate Barkhausen tubes with the alternating-current field between the grid and plate are found to be most effective when the grid is small and cylindrical, fairly close to the cathode and the plate is large and cylindrical, much larger in diameter than the grid. What is the effect of these proportions? The alternating-current field is very intense near the grid, and a large fraction of the alternating voltage applied to the plate appears along a short part of the electron path near the grid. In other words, the

electron stream receives a strong velocity modulation just after leaving the grid, drifts in a retarding field where the alternating-current field is weak, and where, also, electron convection-current induces little current in the circuit, and finally the bunched stream returns and passes through the strong alternating-current field near the grid, inducing a strong current in the circuit and giving up energy. There are several optimum transit-times in the grid-plate region. We would expect these to be a little greater than $n + \frac{3}{4}$ cycles since the electron stream receives most of its velocity modulation, and the bunched stream gives up the most energy in a region near the grid whose "center of gravity" will be located a little way toward the plate. Kleinsteuber gives two optimum drift times of about 1.2 and 2.1 cycles. We see that, by making the grid small and cylindrical and the plate large and cylindrical, a partial segregation of the functions of velocity modulation, bunching, and energy exchange has been achieved, although the segregation is only partial and not complete as in the devices of Heil, Hahn and Metcalf, and the Varians.

I suppose I should comment on Dr. Hansen's six theses:

1. Yes.

2. The electron streams in my Figs. 1 and 3 do have different configurations. In some flat-grid Barkhausen tubes the electron stream had a different configuration from that shown in my Fig. 1.

3. Yes.

4. Electrons can make many transits in either *K* or *B*. In neither are multiple transits essential to operation¹⁷⁻¹⁸.

5. Barkhausen tubes actually operate with a variety of transit times. The $\frac{1}{2}$ -cycle transit time refers to a particular theory of operation. Other theories give other transit times, some much nearer to $n + \frac{3}{4}$ cycle, the optimum drift time predicted by simple theory for reflex klystrons.

6. This early conclusion appears to have been based on the effects of electronic tuning and the existence of many modes in early resonant circuits, such as they were. Later work on Barkhausen tubes leaves no doubt that the circuit plays a dominant role in controlling the frequency.

¹⁵ A. Arsenjewa Heil and O. Heil, "Eine neue Methode zur Erzeugung kurzer, ungedämpfter, elektromagnetischer Wellen grosser Intensität," vol. 95, pp. 752-762; July, 1935.

¹⁶ W. C. Hahn and G. E. Metcalf, "Velocity-modulated tubes," Proc. I.R.E., vol. 27, pp. 106-116; February, 1939. (Especially p. 109 and p. 113.)

¹⁷ C. J. Bakker and G. de Vries, "Amplification of small alternating tensions by an inductive action of the electrons in a radio valve," *Physica*, vol. 1, pp. 1045-1054, Oct.-Nov., 1934.

¹⁸ A. Allerding, W. Dällenbach, W. Kleinsteuber, "Der Resotank, ein neuer Generator für Mikrowellen," *Hochfrequenz und Elektroakustik*, vol. 51, pp. 96-99; March, 1938.

¹⁹ W. Kleinsteuber, "Das zylindrische Bremsfeld," *Hochfrequenz und Electroakustik*, vol. 61, pp. 38-47; February, 1943.

Corrections

G. Liebmann, whose paper "The Image Formation in Cathode-Ray Tubes and the Relation of Fluorescent Spot Size and Final Anode Voltage" appeared on pages 381 to 389 of the June, 1945, issue of the PROCEEDINGS, has brought the following errors to the attention of the editor:

On page 382, left-hand column, sixteenth line, the equation should read

$$n = 1/c \left[\left\{ (2e/m)E_A \right\}^{1/2} - (e/m)A \cos \chi \right]$$

On page 385, left-hand column, second paragraph from the bottom of the page, seventh and tenth lines, milliamperes should be changed to microamperes.

Institute News and Radio Notes

Board of Directors

May 2 Meeting: At the regular meeting of the Board of Directors, which was held on May 2, 1945, the following were present: W. L. Everitt, president; G. W. Bailey, executive secretary; S. L. Bailey, W. L. Barrow, Alfred N. Goldsmith, editor; R. F. Guy, R. A. Hackbusch, R. A. Heising treasurer; Keith Henney, L. C. F. Horle, F. B. Llewellyn, Haraden Pratt, secretary; B. E. Shackelford, D. B. Sinclair, W. O. Swinyard, H. M. Turner, H. A. Wheeler, and W. C. White.

Executive Committee: The actions of the Executive Committee, taken at its May 2, 1945, meeting, were ratified.

Committees and Appointments

Building-Fund: Chairman Shackelford of the Building-Fund Committee reported that 640 subscriptions for \$242,940.50 have been received. The total is divided as follows: 183 corporate gifts—\$214,552.50; 457 individual gifts—\$28,388.00.

Reports turned in by Sections (not including such Section members as Board members secured through Initial Gifts, and Section subscriptions mailed direct to the Building-Fund Office) are as follows: 250 subscriptions for \$10,782.00. Included in the individual gifts are: 58 members at large—\$1,208.50; 72 Student members—\$395.00; and 1 foreign member—\$20.00.

Member-at-large subscriptions are from 24 states; Student-member subscriptions are from 26 states.

Reports, none complete, have been received from the Boston, Chicago, Cincinnati, Cleveland, Dayton, Emporium, Washington, and Williamsport Sections.

Mr. Hackbusch, chairman of the Building-Fund-Campaign Organization for Canada, reported on the Canadian progress on the I.R.E. Fund, covering the Toronto, Montreal, and London Sections. Canadian subscriptions will be invested in Canadian War Bonds.

Canadian Building Fund: The appointment of F. H. R. Pounsett, J. R. Longstaffe, and R. A. Hackbusch as Administrators and Auditors of the funds contributed in Canada to the I.R.E. Building Fund for Canada was unanimously approved.

Constitution and Laws: Chairman Guy, of the Constitution and Laws Committee, reported on the following matters:

Amended Bylaw Section 41 (b): It was unanimously approved that the following wording be adopted for Bylaw Section 41:

"For Section maintenance, the Institute shall pay to each Section for each calendar year the following sum: Seventy-five cents per member for each member up to and including 700, and ninety cents per member for each member over 700, plus ten dollars per meeting for not more than ten meetings. Member means Fellows, Senior Members, Members, and Associates with mailing addresses within the territory of the Section on December 31 of the calendar year for which pay-

ment is made, and Meeting means meetings of the Section within the calendar year."

Proposed Modification of Sections 24 and 50: Adoption of the following Sections, as modified, was unanimously approved:

"**Sec. 24.** The Executive Committee shall direct and co-ordinate the work of all standing committees except Appointments, Awards, Constitution and Laws, Executive, Investments, Nominations, and Tellers, unless the Board of Directors directs otherwise."

"**Sec. 50.** The Executive Committee shall appoint all standing committees except the Appointments, Awards, Constitution and Laws, Executive, Investments, Nominations, and Tellers Committees."

Special Committee on Board Meetings:

Mr. H. A. Wheeler reported for the Committee on the proposed addition of seven directors, each representing a different region, these directors to be nominated by regional groups. A motion was approved that the Regional Group, proposed by Mr. Wheeler, be named "The Regional Council."

Sections

Dayton: It was unanimously approved that the request of the Dayton Section to affiliate with the Dayton Technical Societies Council be granted.

Sections' Charter: Unanimous approval was given to the recommendation of the Executive Committee that it shall be the policy of the Institute to issue instruments to all Sections authorizing the establishment of Sections, and that the form of said instrument shall be approved by the General Counsel and the Board.

Section Manual: The need for a new edition of the Section Manual was discussed. Dr. Heising will circularize the Sections and ask for suggestions.

1946 Winter Technical Meeting: S. L. Bailey reported that E. J. Content had been appointed Chairman of the 1946 Winter Technical Meeting. Unanimous approval was given to the proposal of holding a 1946 Winter Technical Meeting, and the Board authorized Mr. Bailey, as a representative of the Board and Executive Committee, to take up the matter with the Office of Defense Transportation at the proper time.

Executive Committee

May 2 Meeting: The Executive Committee meeting, held on May 2, 1945, was attended by W. L. Everitt, president; G. W. Bailey, executive secretary; S. L. Bailey, W. L. Barrow, Alfred N. Goldsmith, editor; R. A. Heising, treasurer; and Haraden Pratt, secretary.

Membership: The following transfers and applications for membership were unanimously approved: For transfer to Senior-Member grade, A. E. Abel, R. O. Bach, E. E. Burns, D. P. Earnshaw, C. E. Fay, G. L. Fernsler, J. J. Glauber, R. L. Haskins, H. J. Heindel, H. W. Holt, H. P. Kalmus, W. F. Kannenberg, A. P. King, T. P. Kinn,

H. T. Lyman, Jr., H. E. Mendenhall, P. C. Michel, R. D. Parker, J. G. R. Punched, S. D. Robertson, J. R. Schoenbaum, R. R. Scoville, S. Seely, J. W. Smith, S. C. Spielman, G. H. Timmings, J. W. Watson, and A. K. Wright; for admission to Senior-Member grade, W. R. Bennett, O. B. Cunningham, and H. H. Lowry; for transfer to Member grade, W. S. Bachman, A. S. Bainbridge, N. F. Barritt, F. I. Belov, L. Bond, C. H. Brereton, R. M. Cohen, J. F. Coghill, A. L. Crawford, Jr., R. B. Edwards, N. B. Frank, D. G. Geiger, G. E. Feiker, A. E. Glazer, G. C. Hopkins, K. C. Johnson, L. G. Killian, H. H. Kurth, S. H. Larson, D. R. MacQuivey, K. G. Morrison, N. R. Olding, K. Onder, J. M. Paterson, O. L. Prestholdt, G. A. Raynolds, J. E. Stacy, E. M. Strange, H. A. Tellman, D. C. Trafton, R. A. Vogeler, and T. M. Wilson; for admission to Member grade, I. J. Abend, A. H. Bennett, K. H. Blomberg, J. R. Boykin, G. O. Bradley, R. S. Conrad, J. M. Forman, W. T. Free-land, L. Friedman, O. H. Fulton, A. J. Grossman, G. J. Heinzelman, H. B. King, R. T. McFarland, M. E. Mohr, R. C. Paine, G. B. Ransom, G. L. Sansbury, G. R. Scott, E. F. Watson, and D. Westwood; Associate grade, 154; and Student grade, 55.

Committees: The following appointments were unanimously approved:

BOARD OF EDITORS

N. Marchand

MEMBERSHIP SOLICITATION POLICY

Appointment of a Committee of the Executive Committee for the purpose of preparing recommendations on the subject of membership organization generally, to be submitted by the Executive Committee to the meeting of the Board on June 6, was approved. The members of this Committee are to be:

G. W. Bailey, *Chairman*
E. D. Cook
Alfred N. Goldsmith
H. A. Heising
Haraden Pratt
G. T. Royden

PAPERS PROCUREMENT COMMITTEE; SUB-COMMITTEE ON ELECTRONICS IN INDUSTRY AND MISCELLANEOUS APPLICATIONS

W. C. White, *Chairman*
R. S. Burnap
J. M. Cagle
V. M. Graham
R. K. Honaman
C. J. Madsen

HIGH-FREQUENCY HEATING

G. L. Beers
T. P. Kinn
D. E. Watts
P. D. Zottu

INDUSTRIAL CONTROL

S. L. Burgwin
R. M. Serota
G. L. Rogers

MEASUREMENTS, TESTING, RECORDING,

PROCESS CONTROLS

C. T. Burke
H. D. Middel
Walter Richter
M. P. Vore

POWER CONVERSION

G. F. Jones
H. C. Steiner

MISCELLANEOUS

H. B. Marvin

Admissions-Committee Manual: Copies of the Manual were distributed to the members of the Executive Committee. Dr. Everitt discussed the Manual and suggested that it be presented to the Board for consideration.

Editorial Department: Dr. Goldsmith reported excellent returns from the membership survey on papers presently in preparation, and to be prepared when security regulations permit. He has received favorable reactions to the proposed new editorial reader-report form. The membership upgrading notice now being published is effective. A volume of letters containing technical questions from both members and non-members is being handled by the Editorial Department. The Norwegian Ministry for Reconstruction was granted permission to translate and distribute the Annual Progress Report for 1944 from the PROCEEDINGS.

Correspondence

Correspondence on both technical and nontechnical subjects from readers of the PROCEEDINGS OF THE I.R.E. is invited subject to the following conditions: All rights are reserved by the Institute. Statements in letters are expressly understood to be the individual opinion of the writer, and endorsement or recognition by the I.R.E. is not implied by publication. All letters are to be submitted as typewritten, double-spaced, original copies. Any illustrations are to be submitted as inked drawings. Captions are to be supplied for all illustrations.

Frequency and Phase Modulation

This reply to correspondence by D. L. Jaffe and D. Pollack, which appeared on pages 200-201 of the March, 1945, issue of the PROCEEDINGS is meant to be constructive, with statements which seem conservative. In order to avoid confusion, passages of the above correspondence are quoted literally between quotation marks. Encyclopedic definitions are:

- 1.) Module (Latin—modulus) is a measure to determine the relative proportions of the various parts of a system. The various parts refer to distinctive characteristic properties of a system.
- 2.) Module is applied in hydraulics to a contrivance for regulating the supply of water.
- 3.) Modulation in radio is the process wherein some definite characteristic of the carrier wave is varied in accordance with a voice wave or some other desired signal of intelligence.

To discuss details, let us start, as above correspondence, "with nothing that cannot be found in Chapter I of any alternating-current text" and omit, wherever possible, "mathematical junket."

Chapter I, then, tells us that an alternating current is defined by amplitude, frequency, and phase, respectively. They are the three characteristics of such a current. The phase enters, for example, when we use the concept and meaning of the power factor. No one reading Chapter I would ever think that the power factor has anything to do with frequency modulation, since the corresponding phase angle is found from the average reactance divided by resistance. When the phase is varied by some agency, this means, simply, that the power factor varies accordingly, and, with it, the useful power output. This is what is meant by phase modulation. If another characteristic, say, the frequency, is varied, but the phase, as well as the amplitude, is kept constant, we likewise alter or modulate a current and have frequency modulation. Altering or modulating the amplitude only gives us, then, what is meant by amplitude modulation.

4.) As far as the *cause* of altering (cause is *modulation*) is concerned, we have to distinguish between phase, frequency, and amplitude modulation. This meets the encyclopedic definition (3).

These distinctions are "not incorrect" and do not cause confusion since the three types of modulations; namely, phase, frequency, and amplitude modulation, respectively, are "not an unfortunate choice, even though it dates back in the 1920's." (It dates back a great deal further; I heard and read of such definitions as far back as 1907.)

5.) Inasmuch as a modulator brings about a desired type of modulation; that is, *causes* either altering of the phase (phase modulation), of the frequency (frequency modulation), of the amplitude (amplitude modulation), respectively, a distinction seems in order since it is logical and not "unfortunate."

To reply to other details of the above correspondence, the following is added:

As to "It is unfortunate that few people have attempted to arrive at the properties of modulated waves through the use of vectors and words," this is what is actually done on the first few and other pages of the book, "Frequency Modulation," and done in Fig. 3 on page 6, Fig. 6 on page 12, Fig. 19 on page 53, Fig. 20 on page 62, Fig. 22 on page 74 (this figure should tell something), Fig. 26 on page 91, Fig. 28 on page 105, Fig. 29 on page 108, and Fig. 30 on page 111.

Fig. 31, on page 6, and Fig. 6, on page 12, together with the text, express, for example, the same things that the above correspondence reveals by means of its Fig. 1. The mathematical inscripts give only additional details used at other places of the book and for the sake of comparing phase modulation of Fig. 3b with amplitude modulation of Fig. 3a by means of the vector PP_1 , which accounts for the modulation. The authors of the correspondence and the undersigned seem, therefore, to use the same language except that more details are given in the frequency-modulation book, as should be. The authors also seem to concur, as far as Fig. 3 of the correspondence is concerned, and Fig. 7 on page 13 of the frequency-modulation book, with more details given in Fig. 312 on page 369 and Fig. 317 on page 373 of the book, "High-Frequency Measurements."

As to: "We cannot emphasize this point—phase and frequency are interdependent—strongly enough. One cannot be changed without changing the other. Many writers, the undersigned is among them, have strayed because, while they surely know that phase and frequency are knotted solidly together, they sometimes ignore this principle," and, then, in the last paragraph of the correspondence, "Most writers are now ignoring the specious classical distinction between phase and frequency modulation, since both are *so close* to being the same thing, To maintain an *artificial* distinction is unnecessary, and frequency modulation, as it is now coming to be used, means *any type of angular-velocity* modulation." We disagree.

Statement (5) based on reasonings (4) is the answer to these quotations taken from the correspondence. As to details, why does the θ variation of Fig. 3 of the correspondence look like a triangle and not like the rectangular f variation of the same figure? (If phase modulation is the same as frequency modulation, a triangle can surely not change to a rectangular function.) Why is it, then, that the *experimental* curve of Fig. 21 on page 72 of the frequency-modulation book can give a method for completely canceling the modulation effect at a certain modulation frequency f in case of amplitude plus frequency modulation, but yields only a *minimum* for amplitude plus phase plus frequency modulation ("High-Frequency Measurements," Fig. 322, page 377, *experimental* curves)? Surely, phase modulation *cannot* be the same angular-velocity modulation as frequency modulation; otherwise, zero effect should occur at the particular modulation frequency. This is the reason why the theory leading to formula (46) on page 73 of the frequency-modulation book, and other analytical treatments, are given. Formula (46), then, confirms such experimental facts (we both seem to believe in actual facts) and also shows that a distinction between phase and frequency modulation exists.

The frequency-modulation book deals also with angular velocity-modulation concepts as can be seen on pages 10, 11, etc. On page 12, in connection with Fig. 6 of the frequency-modulation book, as well as at other places in the text, we find the statement—that the change in the rotational speed of the current vector accounts for an apparent (called *equivalent*) instantaneous, carrier-frequency change in case of phase modulation. This is what the authors of the correspondence call or take as *actual* frequency change. We disagree. If it were an actual change or close to it, the experimental curves for amplitude plus frequency modulation and amplitude plus phase modulation could be made to come *both* to a zero at a certain signal frequency f . In the frequency-modulation book, I use the name *indirect* frequency modulation for the well-known Armstrong system in order to distinguish it from phase modulation (*equivalent* frequency modulation) and *direct* frequency modulation (actual frequency modulation) as I have mentioned in several places in the text. The authors of the correspondence admit, in the second, last paragraph that we deal "neither with classical frequency modulation, nor classical phase modulation" in the

Armstrong system. We agree. In the frequency-modulation book, it is brought out that, in virtue of a pre-emphasized signal current at the modulator, we have in the Armstrong system all the features of direct frequency modulation. If there were no difference between phase and frequency modulation ("any angular velocity modulation will do"), or "both are so close the same," why is it, then, necessary to use pre-emphasis towards the higher signal frequencies of the Armstrong modulator?

I feel that we can agree now that no harm is done to distinguish between phase and frequency modulation, and that an analytical treatment may explain many things that are experimentally found and useful. It took a theoretical Maxwell to make an experimental Hertz, and it took a theoretical Hertz to explain his experiments and give us the well-known doublet theory. One of the authors of the correspondence used equations at one time to clear up the action of Armstrong's modulator in the April, 1938, issue of the PROCEEDINGS, on page 475, and with success to the readers. I was one of them. Let us have peace now.

AUGUST HUND

U. S. Navy Radio and Sound Laboratory
San Diego, California

D. L. Jaffe and Dale Pollack state the case for frequency modulation very well in their letter on Frequency and Phase Modulation on pages 200-201 of the March, 1945, PROCEEDINGS. However, if we accept the definition as they put it, phase modulation appears to be ruled out. I hope the following discussion will show why this is not so.

The receiving system was not considered by Jaffe and Pollack in their discussion. I wish to discuss it here. Specifically, let us consider the discriminator used in a frequency-modulation receiver. It is designed to produce a direct voltage that is directly proportional to the frequency deviation from the center frequency. The polarity of the voltage produced is determined by the direction of deviation from the center frequency. The alternating-current component of the modulation is coupled through a condenser to an audio amplifier and the result is used as desired.

Let us now replace the frequency discriminator by a phase discriminator. A phase discriminator is here meant to be a device designed to produce a direct voltage that is directly proportional to the phase deviation from the phase existing when no modulation is applied. The polarity of the voltage produced is determined by the direction of deviation from the no-modulation phase position.

Here, then, we have two receivers that can receive intelligence from the same transmitter and with proper audio system characteristics, their outputs will be identical. The two receivers are functioning differentl

Reprints Available

Reprints of Dr. Everitt's article, "The Presentation of Technical Developments Before Professional Societies," appearing on pages 423-426 of this issue of the PROCEEDINGS, will be available about August 15. These may be obtained by writing to the Executive Secretary of the I.R.E., Room 2000, 330 West 42d Street, New York 18, N. Y. All requests should be accompanied by a stamped, self-addressed envelope.

however, and it is quite probable that the transmission characteristics (as regards noise discrimination for instance) may be quite different.

Frequency modulation has demonstrated its usefulness and practicability beyond question. The fact that phase modulation as outlined above has no practical significance at present does not mean it will never have. It may not appear in exactly the form I have outlined, but the fact that such a system can exist is evident.

The purpose of the above discussion is to bring up a point that has received little or no attention. If it provokes further thought and discussion on the subject it will have fulfilled its purpose, and a clearer understanding of the intriguing subject of modulation will be the result.

BRUCE E. MONTGOMERY
United Air Lines
5959 South Cicero Avenue
Chicago 38, Illinois

Voltage-Regulator Operation

I have just read with interest the article entitled "Analysis of Voltage-Regulator Operation" by W. R. Hill, in your January, 1945, issue. This article provides a very useful study of the subject, but it seems to me that, in omitting all reference to F. L. Hogg's papers in *Wireless World* of November and December, 1943, the author has rather slighted the valuable contributions made there to this field. In Hogg's articles, while the mathematical details are not so full as in Hill's, the general question of voltage regulators is gone into, and a "perfect" regulator is described which is very similar to that of Hill's Fig. 5.

Though it will, very likely, have been pointed out before you receive this letter, it is, perhaps, also worth mentioning that there is a misprint in the transcription of your equation (26) from the Appendix.

B. E. NOLTINGK
42 Brookland Rise
London N. W., 11
England

Electric Power Distribution for Industrial Plants

The American Institute of Electrical Engineers has published a 109-page booklet entitled: "Electric Power Distribution for Industrial Plants." The material was developed by the AIEE Committee on Industrial Power Applications and released by the AIEE Standards Committee. It can be secured at \$1.00 per copy from the AIEE at 33 West 39th Street.

The report, which was prepared by forty electrical engineers "engaged in industry, in the manufacture of electrical equipment, and in the service of public utilities," represents viewpoints drawn from the aircraft, automobile, cable, chemical, copper, electrical equipment, factory insurance, mining, oil, photographic equipment, rubber, steel, and utility groups. While it contains a number of recommendations, it is stated that these are not intended to be either restrictive or mandatory and are not to be regarded as AIEE standards. The subject matter of the booklet is sufficiently indicated by the chapter headings which are "System Planning," "Primary Substations and Feeders," "Transformers, Primary Switchgear and Low-Voltage Feeder Protection," "Low-Voltage Feeders, Panelboards, Bus Distribution Systems and Load Circuits," "Fault Current Calculations," and "Wires and Cables." The book contains an unusual amount of directly usable information in tabular and text form and may be regarded as a thoroughly up-to-date handbook on the field which is covered. Communication and electronic engineers will find useful guidance from this publication in connection with the power supply of such equipment installations as may fall within their scope.

Summer Seminar of Williamsport Section

On July 27 and 28, 1945, the Williamsport Section of the Institute of Radio Engineers will hold its Second Annual Summer Seminar at the Hotel Lycoming in Williamsport, Pennsylvania.

The following technical program will be presented:

Friday, July 27

"Radio-Relay Systems Development by the Radio Corporation of America," by H. O. Peterson, R.C.A. Laboratories, Rocky Point, L. I., New York.
"Industrial Radio-Frequency Transformers," by H. W. Parker, Sylvania Electric Products, Inc., Kew Gardens, L. I., New York.

Saturday, July 28

"The Use of Sound Systems as a Production Tool," by A. G. Shifino, Stromberg-Carlson Company.

Contributors

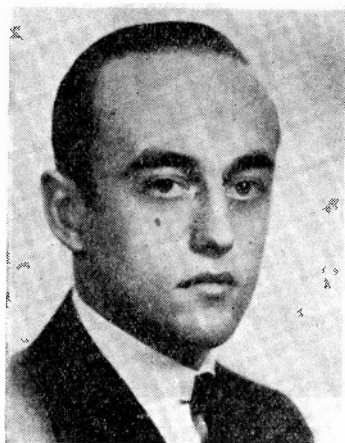

ANTHONY ABATE

Anthony Abate was born at Phillipsburg, New Jersey, on March 14, 1915. He received the B.S. degree in electrical engineering from Pennsylvania State College in 1936.

From 1936 to 1938 he conducted his own radio sales and service business, and from 1938 to 1940 was research assistant at Harvard University. Since 1940, Mr. Abate has been associated with the Raytheon Manufacturing Company as senior radio engineer in charge of the commercial engineering department of the measurements and applications division. His work involves special equipment design, measurements and ratings concerning electronic tubes, data preparation, and field problems.



Shailer L. Bass received the degree of Ph.D. in organic chemistry from Yale University in 1929. He was employed by the Dow Chemical Company as a group leader in organic research until 1936, when he joined the cellulose product development as a research-group leader on cellulose ethers. He has been associated with silicones since 1942, and is now research director for Dow Corning Corporation at Midland, Michigan. Dr. Bass is a member of the American Chemical Society, Phi Kappa Phi, and Sigma Xi.



SHAILER L. BASS

July, 1945

William L. Everitt (A'25-M'29-F'38) received the E.E. degree from Cornell University in 1922, the M.S. degree from the University of Michigan in 1926, and the Ph.D. degree from Ohio State University in 1933. He has taught electrical engineering at Cornell, Michigan, and Ohio State and has been in charge of the instruction in communications at the last institution since 1926. Since 1942, Dr. Everitt was on leave from Ohio State as director of operational research with the Signal Corps of the United States Army and is now head of the electrical engineering department of the University of Illinois. Dr. Everitt initiated and directed the annual Broadcast Engineering Conference at Ohio State. He is a Fellow of the American Institute of Electrical Engineers and a member of the National Defense Research Committee, Tau Beta Pi, Sigma Xi, and Eta Kappa Nu.



WILLIAM L. EVERITT



Eduard Karplus (A'31-F'38) was born in Moedling, Austria, on September 7, 1899. He received the degree of "Ingenieur" in the electrical engineering department of the Technische Hochschule of Vienna, Austria, in 1923. From 1923 to 1929 he was employed in the radio-frequency laboratories of the C. Lorenz A. G., Berlin, Germany, working on lightweight high-frequency communication equipment as used in the field, on cars, boats, and trains. In 1930 Mr. Karplus joined the engineering staff of the General Radio Company in Cambridge, Massachusetts. In this capacity he has been responsible for the development and design of many measuring instruments including the early models of cathode-ray oscillograph equipment and standard-signal generators. Mr. Karplus is the originator of the Variac, a continuously adjustable variable-ratio autotransformer, which was introduced in 1933. In recent years he has been working on tuned circuits, oscillators, and standard-signal generators for frequencies around 1000 megacycles. Mr. Karplus is a member of the American Institute of Electrical Engineers.



EDUARD KARPLUS



T. A. Kauppi was graduated from Brown University in 1933 with the degree of B.Sc. in chemistry. After a year with the Institute of Paper Chemistry, he joined the cellulose products division of the Dow Chemical Company and headed product-development work on cellulose ethers. He has been associated with silicones since 1943, and is now Manager of Product Development for Dow Corning Corporation at Midland, Michigan. He is an associate member of the American Institute of Electrical Engineers.



Paul W. Klipsch (A'34-M'44) was born on March 9, 1904, near Elkhart, Indiana. He received the B.S. degree in electrical engineering from New Mexico College of Agriculture and Mechanic Arts in 1926, and the degree of Engineer (in E.E.) from Stanford, in 1934. He was in the testing department of the General Electric Company from 1926 to 1928, and spent the next three years in electric-locomotive-maintenance work in Chile. From 1934 to 1941 he engaged in geophysical explorations, and from 1936 to 1941 he was development engineer with Subterrex, in Houston, Texas. He is a reserve officer and has been on active duty with the Ordnance Department since 1941. Since February

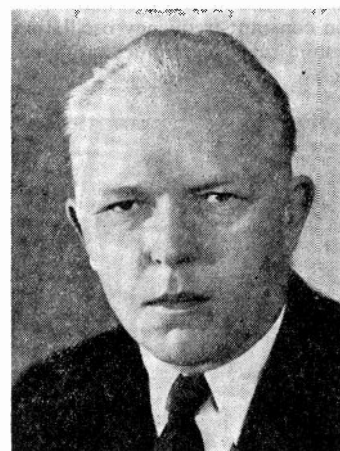

T. A. KAUPPI



PAUL W. KLIPSCH

1942, Major Klipsch has been in charge of the technical branch at Southwestern Proving Ground at Hope, Arkansas.

Major Klipsch has been intensively interested in acoustics since 1939, and his low-frequency horn has met with favor in several groups of engineers. He is a member of the American Institute of Electrical Engineers, Society of Motion Picture Engineers, Society of Exploration Geophysicists, Acoustical Society of America, Houston Engineers Club, Tau Beta Pi, and Sigma Xi.

Frederick B. Llewellyn (A'23-F'38) was born September 16, 1897, in New Orleans, Louisiana. Between 1915 and 1922 he spent a total of three years as a radio operator with the United States Navy and on ships of the merchant marine. In 1922 he was graduated from Stevens Institute of Technology with the degree of Mechanical Engineer, and in 1928 received the degree of Doctor of Philosophy in Physics from Columbia University. Joining the engineering department of the Western Electric Company in 1923, he was transferred to the Bell Telephone Laboratories when that company was formed in 1925 and has remained with them ever since. He has been primarily concerned with radio and circuit research which has extended to the analysis of the electronic behavior of vacuum tubes at high frequencies. Several papers by Dr. Llewellyn have appeared in the PROCEEDINGS and in 1936 he was awarded the Morris Liebmann prize for work on constant-frequency oscillators and on vacuum-tube electronics at high frequencies.



FREDERICK B. LLEWELLYN



L. C. PETERSON

L. C. Peterson (A'32) was born in Värberg, Sweden. He studied at Chalmers Technical University in Gothenberg and took further courses at the Technical Universities in Berlin and Dresden in Germany. After finishing these studies, Mr. Peterson took the test course at the General Electric Company in Schenectady. A year later he became a member of the development and research department of the American Telephone and Telegraph Company. In 1931 he transferred to the Bell Telephone Laboratories as a member of the Technical Staff. Here his work has been largely concerned with the analysis of circuits and with vacuum-tube performance at radio frequencies.

J. R. Pierce (S'35-A'38) was born at Des Moines, Iowa, on March 27, 1910. He received the B.S. degree in 1933 and the Ph.D. degree in 1936 from the California Institute of Technology. In 1936 Dr. Pierce became a member of the Technical Staff of the Bell Telephone Laboratories, where he is engaged in electronics research.

H. A. K. Taskin was born in 1918 at Istanbul, Turkey. He came to the United States in 1938, and received the M.S. degree in mechanical engineering from Harvard University in 1940, and the M.S. degree in electrical engineering from the University of Missouri in 1942. He was a teaching assist-



J. R. PIERCE

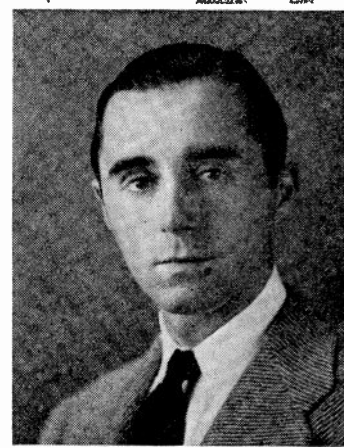

H. A. K. TASKIN

ant at the University of Missouri, and later, an instructor and assistant professor at Marquette Engineering School, in Milwaukee, Wisconsin. He has also done research work with the Kyle Corporation, of South Milwaukee, and is now a design engineer with the Surges Electric Company in Milwaukee.

Mr. Taskin is a member of the American Institute of Electrical Engineering, the American Society of Mechanical Engineers, the American Society of Metals, and the Society for the Promotion of Engineering Education.

D. L. Waidelich (S'37-A'39-SM'44) was born on May 3, 1915, at Allentown, Pa. He received the B.S. degree in electrical engineering in 1936, and the M.S. degree in 1938, from Lehigh University. He was teaching assistant at Lehigh University from 1936 to 1938, and instructor and assistant professor of electrical engineering at the University of Missouri from 1938 to 1944. In the summer of 1937 he worked with Bell Laboratories, Inc., in the field of electronics research, and in the summer of 1941 was a member of the electronic research staff of the Westinghouse Electric and Manufacturing Company, at Bloomfield, N. J.

Since 1944 Mr. Waidelich has been with the Naval Ordnance Laboratory in Washington, D. C., as an electrical engineer. He is a member of the American Institute of Electrical Engineers, the Society for the Promotion of Engineering Education, Sigma Xi, Tau Beta Pi, and Eta Kappa Nu.



D. L. WAIDELICH

HARVEY 206 PA

A Two-Range Source of Laboratory D.C. Power

The HARVEY Regulated Power Supply 206 PA is the latest contribution to the radio and electronics industries by HARVEY of CAMBRIDGE. It is designed to fill the need for a constant source of laboratory D.C. power between the ranges of 500 to 1000 volts.

The HARVEY 206 PA operates in *two ranges*: *Low range* — 500 to 700 volts at $\frac{1}{4}$ amp. . . . *High range* — 700 to 1000 volts at $\frac{1}{5}$ amp. . . . Regulation is 1% or better . . . Output is constant even though line voltage varies between 95 and 130 volts . . . Output is constant within 1% from no load to full load in each range.

These important factors plus many other safety and convenience features make the HARVEY 206 PA your best bet for operation with constant frequency oscillators, measurement equipment, pulse generators, amplifiers and other equipment requiring regulated D.C. voltage. *For details get in touch with HARVEY of CAMBRIDGE.*



HARVEY RADIO LABORATORIES, INC.

456 CONCORD AVENUE • CAMBRIDGE 38, MASSACHUSETTS

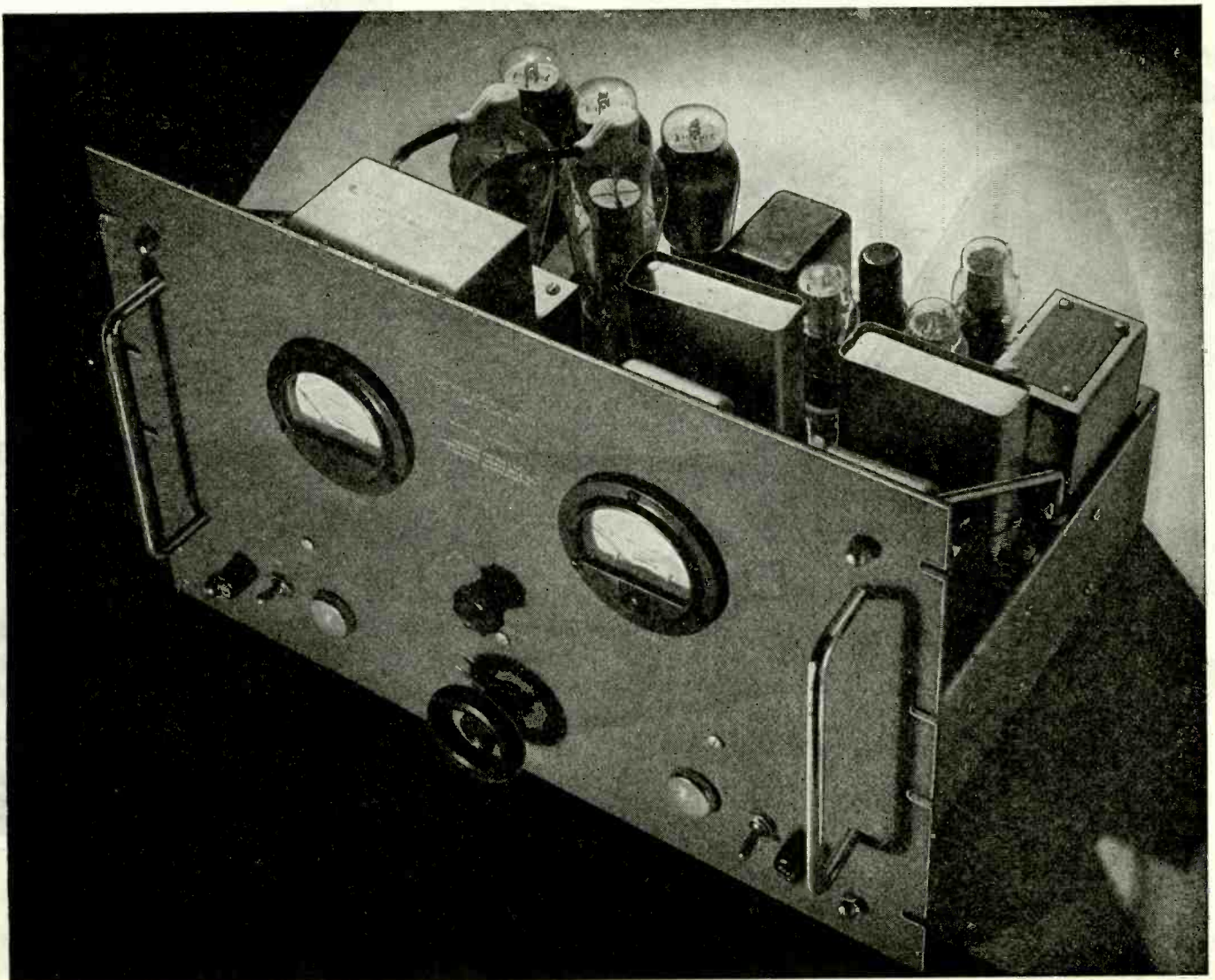

RADIO ALTIMETERS

DESIGNED by RCA

safeguard the planes that fly the "hump"

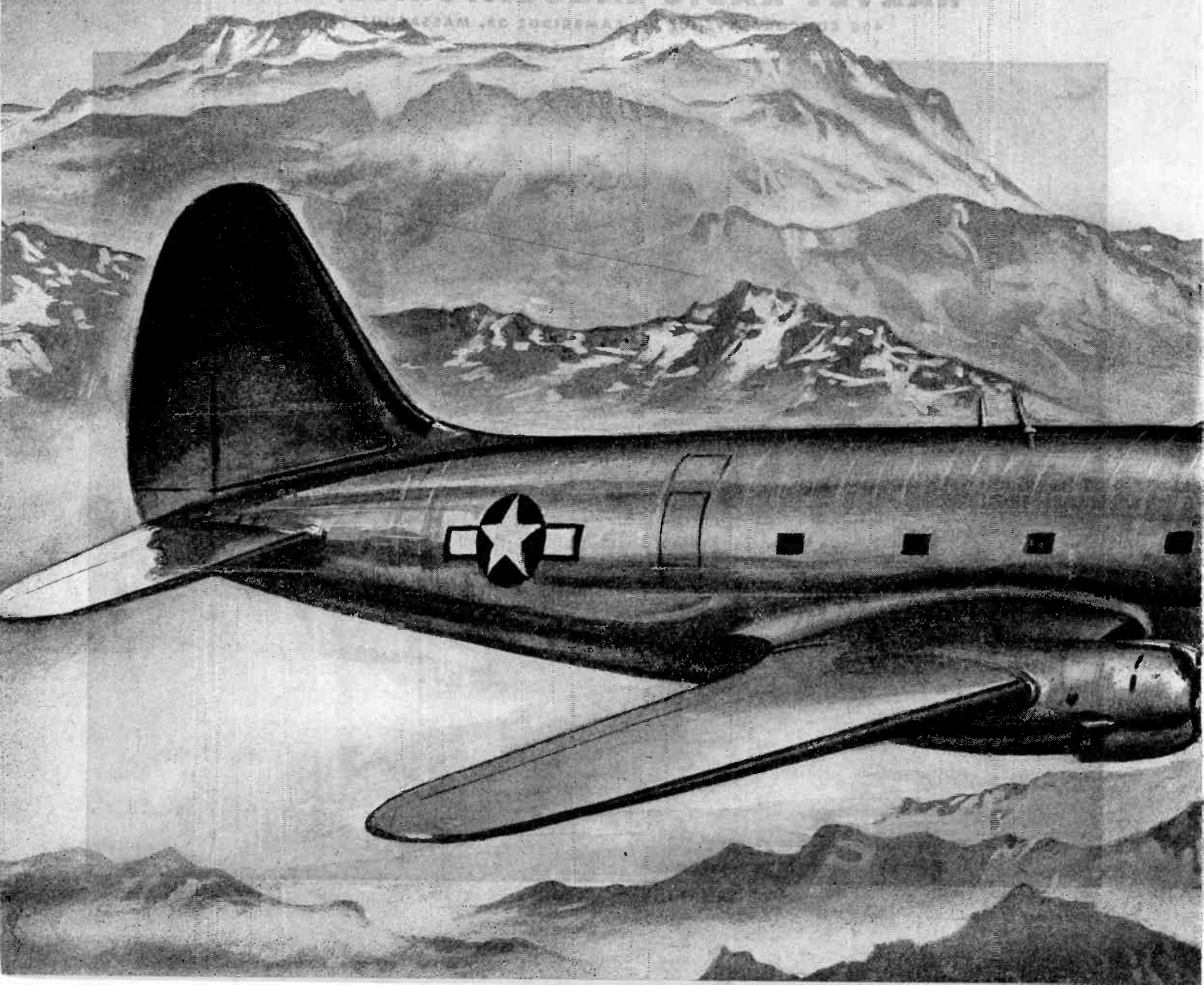

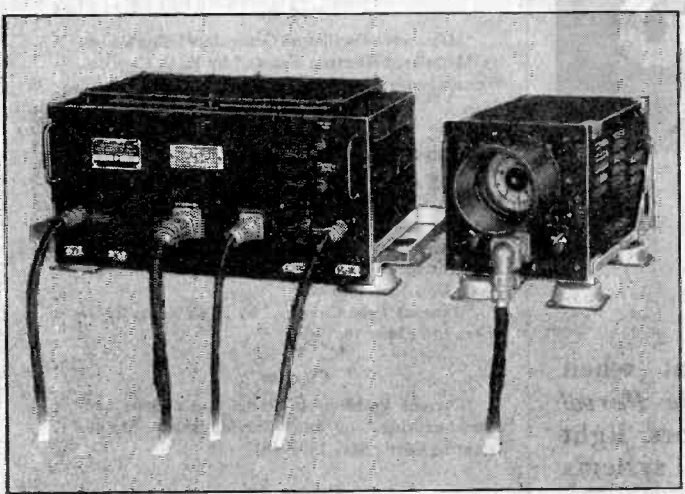

**RCA Radio Altimeters are used
on all the global routes
of the Air Transport Command**

FOR the past three years, the Air Transport Command has supplied the American Air Forces in China by flying supplies over the 20,000-foot peaks of the snow-clad Himalaya Mountains. This flying route with its 100-mile winds, severe downdrafts and cloud-hidden peaks is one of the most dangerous in the world—yet as high as three hundred trips a day must be made over it.

One of the instruments that help to maintain this ATC schedule is the high-altitude model of the RCA family of Radio Altimeters. This altimeter indicates the plane's clearance over cloud-hidden peaks and tells the pilots of the Air Transport Command when it is safe to let down through the overcast.

Thus, once again, RCA Research has made a major contribution to the safety of flying—a contribution that will be equally important in postwar commercial airline service. Remember, "When you think of Radio Altimeters, think of RCA."

Buy More War Bonds



RADIO CORPORATION OF AMERICA
RCA VICTOR DIVISION • CAMDEN, N. J.

1,001 USES

Condensed Power for Years of Service

VERSATILITY and dependability were paramount when *Alliance* designed these efficient motors — *Multum in Parvo!* . . . They are ideal for operating fans, movie projectors, light home appliances, toys, switches, motion displays, control systems and many other applications . . . providing economical condensed power for years of service.

Alliance Precision

Our long established standards of precision manufacturing from highest grade materials are strictly adhered to in these models to insure long life without breakdowns.

EFFICIENT

Both the new Model "K" Motor and the Model "MS" are the shaded pole induction type — the last word in efficient small motor design. They can be produced in all standard voltages and frequencies with actual measured power outputs ranging upwards to 1/100 H. P. . . Alliance motors also can be furnished, in quantity, with variations to adapt them to specific applications.

DEPENDABLE

Both these models uphold the *Alliance* reputation for all 'round dependability. In the busy post-war period, there will be many "spots" where these Miniature Power Plants will fit requirements . . . Write now for further information.



Remember Alliance!
—YOUR ALLY IN WAR AS IN PEACE

ALLIANCE
MANUFACTURING CO.
ALLIANCE . OHIO

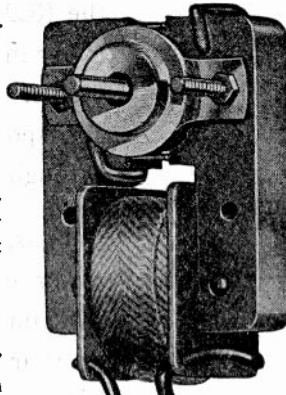

Model "MS" — Full Size
Motor Measures
1 3/4" x 2 x 3 3/8"

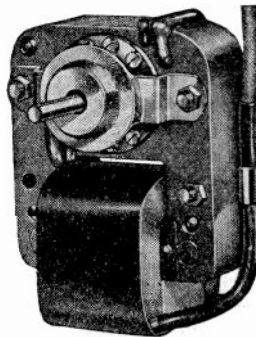

New Model "K" — Full Size
Motor Measures
2 1/8" x 2 3/8" x 3 3/8"



BOSTON

"Microwave-Oscillation Generators Using Velocity-Modulated Electron Beams," by E. U. Condon, Westinghouse Electric Corp.; April 27, 1945.

BUFFALO-NIAGARA

"Radio-Receiver Design and Measurements," by Byron Atwood, Colonial Radio Corp.; April 18, 1945.

CEDAR RAPIDS

"Management Problems of a Manufacturer of Engineering Products," by A. E. Thiessen, General Radio Co.; April 19, 1945.

"Unusual Tube Circuits," by E. L. Kent, C. G. Conn, Ltd.; May 18, 1945.

CHICAGO

"Current Problems in Radio Engineering and Manufacturing," by Paul Galvin, Galvin Manufacturing Corp.; May 18, 1945.

CINCINNATI

"Pulse Modulation," by G. F. Leydorf, Crosley Corp.; April 17, 1945.

DALLAS-FORT WORTH

"Aircraft Instrument Landing," by H. A. Smith, Civil Aeronautics Administration; April 6, 1945.

DAYTON

"Behind the Instrument Dial," by L. F. Parachini, Weston Electrical Instrument Co.; May 17, 1945.

EMPORIUM

"Telephone Service for Vehicles and Vessels in Urban Areas," by R. T. Griffith, Bell Telephone Company of Pennsylvania; May 16, 1945.

LONDON

Student Night; April 13, 1945.
"The Cathode-Ray Tube," by B. W. Graham, Sparton of Canada; April 26, 1945.

MONTREAL

"Ultra-High-Frequency Measurements" by D. B. Sinclair, General Radio Company; March 28, 1945.

"Mathematical Tools," by Faivel Panter, Canadian Marconi Company; April 11, 1945.

"The Application of Radio to Railroad Signaling Systems," by W. S. Halstead, Halstead Traffic Communications Corp.; May 9, 1945.

Election of Officers; May 9, 1945.
Inspection Tour of Traffic-Control Centre of the Canadian National Railways Central Station Terminal; May 23, 1945.

"Details of Operation of Traffic-Control Equipment," by E. J. Agnew, Union Switch and Signal Company of New York; May 23, 1945.

OTTAWA

"Ionosphere Focusing," by Wilbur Smith, Department of Transport, Canadian Government; February 27, 1945.

"The Magic of the Spectrum," by J. W. Bateman, Canadian General Electric Co.; April 17, 1945.

"The Application of Radio to Railroad Signaling Systems," by William Halstead, Halstead Traffic Communications Corp.; May 22, 1945.

Election of Officers; May 22, 1945.

PHILADELPHIA

"Wartime Developments in Electronics," by W. L. Everitt, President, The Institute of Radio Engineers, Inc.; May 3, 1945.

Election of Officers; May 3, 1945.

(Continued on page 38A)

**WESTINGHOUSE
CREATED THE**

Ignitron

**... it revolutionized welding and is now
finding new fields of usefulness**

The smooth, silent operation of resistance welding equipment is made possible by the ignitron tube—originated by Westinghouse. Ignitron tubes have broadened the field of welding to include projection welding. They have lowered costs, and increased speed and efficiency in all types of resistance welding operations. Westinghouse makes a complete line of ignitrons, the smallest of which is the WL-681/686 shown here.

But welding is only one field where ignitrons can be used. They are useful in timing operations requiring high peak currents for short durations, as X-Ray timers. They are useful in the field of motor speed control to govern the speed of medium horsepower motors. They may also be used in the field of frequency conversion and inversion.

In the WL-681/686, you have a small, light, compact tool of many applications and many adaptations of present applications. Write Lamp Division, Westinghouse Electric Corporation, Bloomfield, New Jersey.

**IGNITRON WL-681/686
for welding service**

Maximum welder demand . . . 300 kva
Maximum average current . . . 22.4 amp
per tube
Maximum RMS supply voltage 600 volts
Length+lead . . . 9.75+7 inches
Diameter . . . 2.13 inches

© 1945, Westinghouse Electric Corporation

Westinghouse

PLANTS IN 25 CITIES OFFICES EVERYWHERE

Electronic Tubes at Work

FOR SPECIALIZED
ELECTRONIC EQUIPMENT
RELY ON ANDREW CO.



The fine electronic instruments shown above are examples of the precision production that characterizes all ANDREW equipment. Designed and built by skilled engineers, ANDREW CO. electronic equipment is used the world over wherever specialized apparatus is needed.

1 TYPE 40A PHASE METER—This direct reading, precision instrument measures in degrees the phase angle between currents in radiating elements of a directional antenna system. It operates on a signal input of only 200 millivolts and may also be used for general laboratory work.

2 TYPE 291 HF OSCILLATOR—This portable battery operated oscillator is used for checking high frequency receivers, especially aircraft type. The frequency range is from 49 to 154 Mc. with modulation frequencies of 70, 90, 400, 1300 and 3000 cycles. This unit contains a collapsible whip antenna for checking receivers without direct connections, and provides 2 coaxial terminals for low and high level output.

3 TYPE 708 REMOTE ANTENNA AMMETER—This unit contains a diode rectifier with a DC micro-ammeter calibrated in RF amperes, and is used for indicating antenna current at a point remote from the antenna. This instrument is used by hundreds of broadcast stations.

4 TYPE 760 ANTENNA TUNING UNIT—This is used for coupling several antennas into a single receiver, or for coupling a single antenna into a number of receivers. Containing six RF amplifiers with an associated power supply, each amplifier stage in this unit has low impedance input and output circuits. These may be series connected for use with a single receiver or antenna. This equipment is especially useful where antennas are remotely located from receivers.

Send in your orders now so that you may receive early delivery as soon as military restrictions are lifted.

ANDREW CO.

363 East Seventy-fifth Street, Chicago 19, Illinois

SECTION MEETINGS

(Continued from page 36A)

PORTLAND

"Wartime Developments in Electronics," by W. L. Everitt, President, The Institute of Radio Engineers, Inc.; April 17, 1945.

ROCHESTER

"Multiplex Radio Link Across Chesapeake Bay," by N. F. Schlaack and C. R. Burrows, Bell Telephone Laboratories, Inc.; May 17, 1945.

SAN DIEGO

"Wartime Developments in Electronics," by W. L. Everitt, President, The Institute of Radio Engineers, Inc.; April 23, 1945.

"Television," by C. G. Pierce, General Electric Co.; May 21, 1945.

SEATTLE

"Industrial Electronic Development at Schenectady," by H. L. Palmer, General Electric Co.; May 18, 1945.

TORONTO

"Ultra-High-Frequency Measurements," by D. B. Sinclair, General Radio Co.; March 26, 1945.

"Quartz-Crystal Production," by L. W. Elliott, Canadian Marconi Co.; April 9, 1945.

"Signal Operations in the Field," by J. E. Andrews; 1st Divisional Signals, R.C.C.S.; April 9, 1945.

TWIN CITIES

"Television in Practice," by B. R. Hilker, Station KSTP; February 13, 1945.

"Minneapolis-Honeywell Electronic-Tube Regulator System for Aircraft," by Alfred Upton, Minneapolis-Honeywell Regulator Co.; May 8, 1945.

Election of Officers May 8, 1945.

WILLIAMSPORT

"Radio Plans for Postwar Private and Commercial Aviation," by T. B. Bourne, Civil Aeronautics Authority; May 2, 1945.

MEMBERSHIP

The following transfers and admissions were approved on June 6, 1945:

Transfer to Senior Member

- Albright, R. B., 460 E. Locust Ave., Philadelphia 44, Pa.
- Bach, J. R., Sparton of Canada, Ltd., Elm St., London, Ont., Canada
- Beal, R. R., 26 E. 93 St., New York 28, N. Y.
- Bleil, F. J., 21 S. Park Ave., Bay Shore, N. J.
- Dresser, W. R., 4 Edgewood Ave., Long Hill, RFD 4, Bridgeport, Conn.
- Fink, D. G., 1608 N. Queen St., Arlington, Va.
- Gilbert, W. E., 1020 E. Haines St., Philadelphia 38, Pa.
- Gray, T. S., Electrical Engineering Dept., Massachusetts Institute of Technology, Cambridge 39, Mass.
- Herber, J. C., Bell Telephone Laboratories, Inc., 463 West St., New York 14, N. Y.
- Hickman, R. W., Cruft Laboratory, Harvard University, Cambridge 38, Mass.
- Kuper, J. B. H., 17 Trull St., Cambridge 38, Mass.
- Lemmon, W. S., 590 Madison Ave., New York 22, N. Y.
- Litton, C. V., Box 749, Redwood City, Calif. (as of November 1, 1944)

(Continued on page 41A)

SELECTOR MECHANISMS



DEVELOPMENT INGENUITY

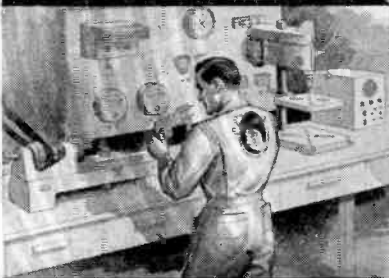

MANUFACTURING FACILITIES



DESIRE TO SERVE

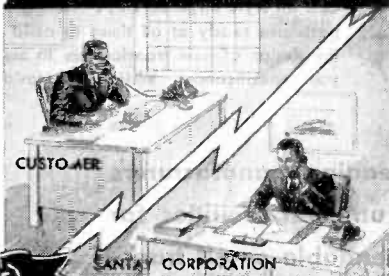

CUSTOMER

SANTAY CORPORATION

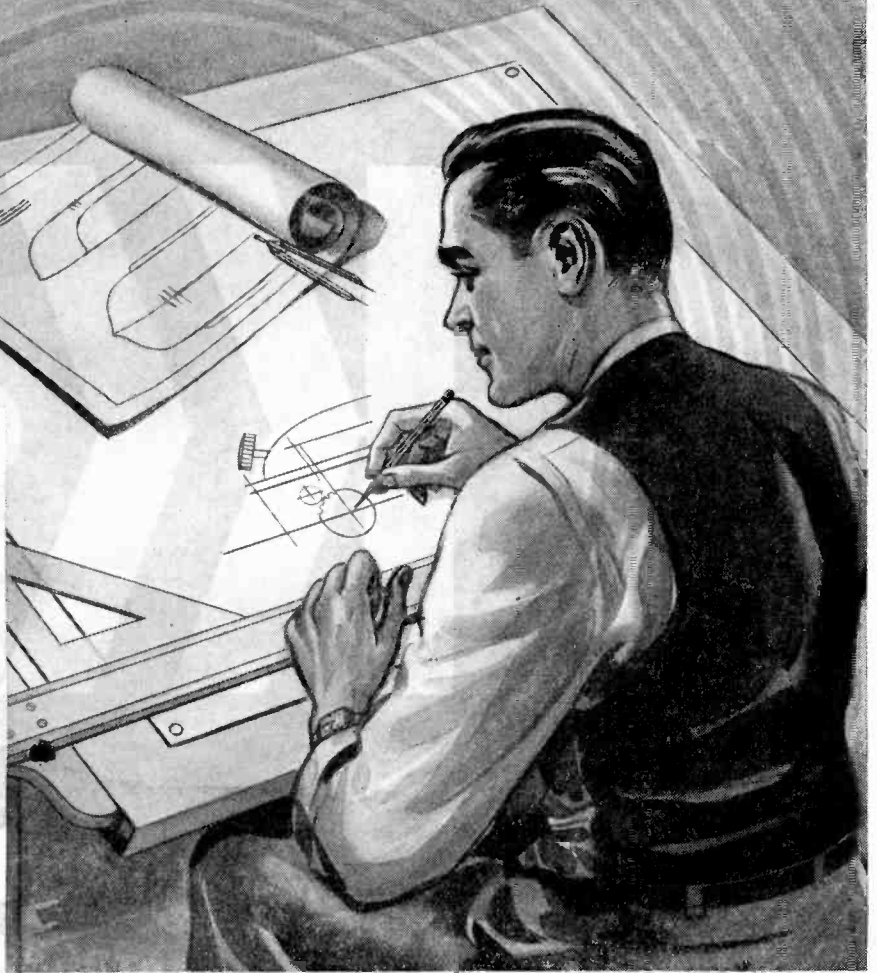

DESIGN ABILITY

Santay possesses design ability in its most tangible form. (1) the experience of its Engineering Staff in *conceiving*; (2) followed by *product design*, (3) nursing the early *production* through its *growing pains* and, (4) *field testing* a product in actual use.

Santay recognizes there is no substitute for good design; therefore, they continue to strengthen their Engineering Staff. Still finer designs may be expected from this outstanding producer of Selector Mechanisms.

INJECTION MOLDING AND METAL STAMPING • ELECTRO-MECHANICAL ASSEMBLIES

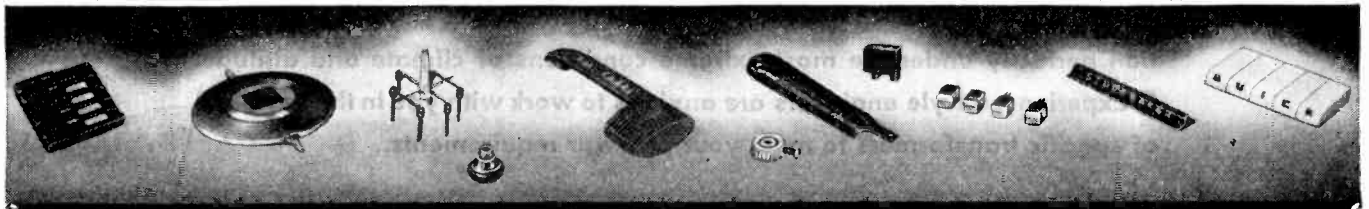

SANTAY CORPORATION, 358 NORTH CRAWFORD AVE., CHICAGO 24, ILLINOIS

REPRESENTATIVES: POTTER & DUGAN, INC., 29 WILKESON STREET, BUFFALO 2, NEW YORK • PAUL SEILER, 7779 CORTLAND AVENUE, DETROIT 4, MICHIGAN • QUEISSER BROS., 108 E. NINTH STREET, INDIANAPOLIS 2, INDIANA



transformers

FOR RADIO-RADAR-ELECTRONIC CONTROLS

Call on Kyle Engineers . . . Trained experts are ready at all times to assist in the design of new transformers to meet your specifications. Write Kyle today.

● Kyle Transformers are the product of one of the leading manufacturers of electric power distribution equipment. ☐ Kyle's unusual facilities for the design and manufacture of precisely built, dependable small transformers have been thoroughly proven in the service of wartime radio communications, radar detection and electronic controls. ☐ Specializing in hermetically sealed equipment of highest quality, Kyle transformers function perfectly under the most extreme conditions of climate and altitude. ☐ Experienced Kyle engineers are anxious to work with you in the design of specific transformers to meet your postwar requirements.



KYLE



CORPORATION

SOUTH MILWAUKEE, WISCONSIN



(Continued from page 38A)

- Malter, L., RCA Victor Division, Lancaster, Pa.
 Manderfeld, E. C., 2933 Ledgewood Dr., Los Angeles, Calif.
 McSweeney, R., 67 Broad St., New York 4, N. Y.
 Munro, G. H., Australian Scientific Liaison Office, Room 614, Dupont Circle Bldg., Washington 6, D. C.
 Rado, J. A., 58-25 Little Neck Pkwy., Little Neck, L. I., N. Y.
 Rau, D. S., 805 Elm St., Chevy Chase 15, Md.
 Rice, H. E., Sprague Electric Co., North Adams, Mass.
 Russell, J. B., Electrical Engineering Dept., Columbia University, New York 27, N. Y.
 Schor, F. W., 2432 Farwell St., Chicago 45, Ill.
 Thompson, M. L., High Road, Huntingdon Valley, Pa.
 Wood, J. A., Jr., 47 Wildwood St., Winchester, Mass.
 Woodward, J. D., 186 Yellow Springs Court S., Dayton 3, Ohio

Admission to Senior Member

- Byrne, J. F., 12 Carver Rd., Wellesley Hills 82, Mass.
 Coles, R. V., 1139 Connecticut Ave., N.W., Washington, D. C.
 Davies, R. H., 1785 Massachusetts Ave., N.W., Washington 6, D. C.
 Kock, W. E., Box 107, Red Bank, N. J.
 Phelps, G. H., 21 Holmehurst Ave., Catonsville 28, Md.

Transfer to Member

- Abraham, G., 2808 Erie St., S.E., Washington 20, D. C.
 Arnold, D. E., Oaklee Village Apts., Baltimore 29, Md.
 Bailey, R. E., Radio Corporation of America, 1-271, 501 N. LaSalle St., Indianapolis, Ind.
 Beggs, G. E., Jr., Leeds and Northrup Co., 4901 Stenton Ave., Philadelphia 44, Pa.
 Biedenbender, R., 5658 Lawndale Pl., Cincinnati, Ohio
 Brown, E. L., 1257 Eaton Ave., San Carlos, Calif.
 Campbell, V. C., 3 Livingston Ave., Scotia 2, N. Y.
 Carley, W. S., Electrical Engineering Dept., North Carolina State College, Raleigh, N. C.
 Carter, H. J., 1336 Kennedy St., N.W., Washington 11, D. C.
 Cave, E. L., 8725 Lock Bend Dr., Towson 4, Md.
 Copp, J. H., Transmitter Division, Engineering Bldg., A., General Electric Co., Thompson Rd., Syracuse 2, N. Y.
 Coroniti, S. C., 36 Berkley St., Johnson City, N. Y.
 Craig, G. F., 176 Hurd Ave., Stratford, Conn.
 Dimmer, R. P., Automatic Electric Co., 1033 W. Van Buren St., Chicago 7, Ill.
 Elston, G. F., 58 Sunset Ave., Bloomfield, N. J.
 Gaffney, F. J., 11 Cleveland Ave., Woburn, Mass.
 Glinski, G., Northern Electric Co., Ltd., Electronics Division, 1261 Shearer St., Montreal, P. Q., Canada
 Goeppinger, A. L., 109 Joliet St., S.W., Washington 20, D. C.
 Grandmont P. E., 83 N. Walnut St., E. Orange, N. J.
 Heisner, D. A., RFD 2, Lorain, Ohio
 Hobbs, C. F., 145 Lakeview Ave., Cambridge 38, Mass.
 Hoffman, K. B., Buffalo Broadcasting Corp., Rand Bldg., Buffalo 3, N. Y.
 Jones, R. H., Jr., Naval Training School, 470 Atlantic Ave., Boston 10, Mass.
 Kobilsky, M. J., Calle Garay 492, Piso 3, B, Buenos Aires, Argentina
 Koch, J. W., Radio Propagation Unit, Holabird Signal Depot, Baltimore 19, Md.

(Continued on page 42A)

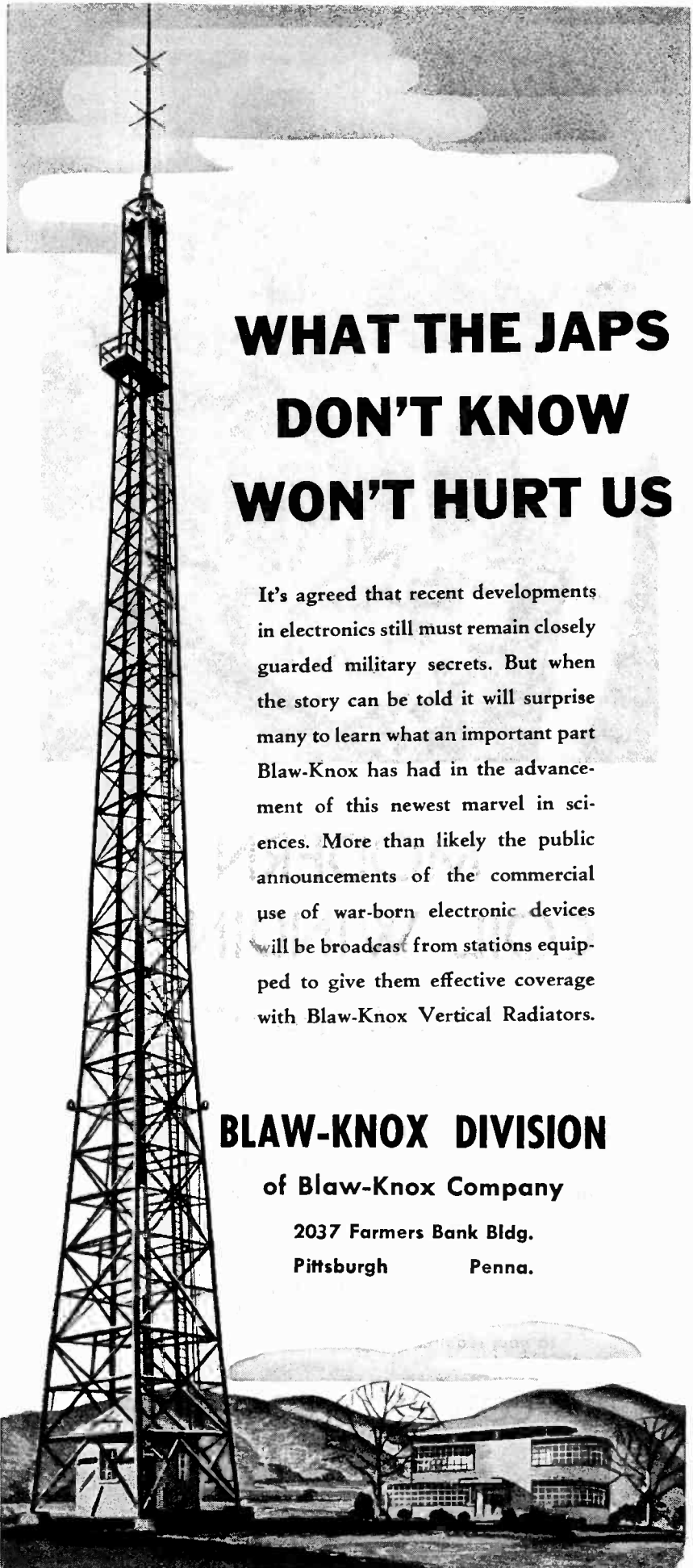

WHAT THE JAPS DON'T KNOW WON'T HURT US

It's agreed that recent developments in electronics still must remain closely guarded military secrets. But when the story can be told it will surprise many to learn what an important part Blaw-Knox has had in the advancement of this newest marvel in sciences. More than likely the public announcements of the commercial use of war-born electronic devices will be broadcast from stations equipped to give them effective coverage with Blaw-Knox Vertical Radiators.

BLAW-KNOX DIVISION

of Blaw-Knox Company

2037 Farmers Bank Bldg.
Pittsburgh Penna.

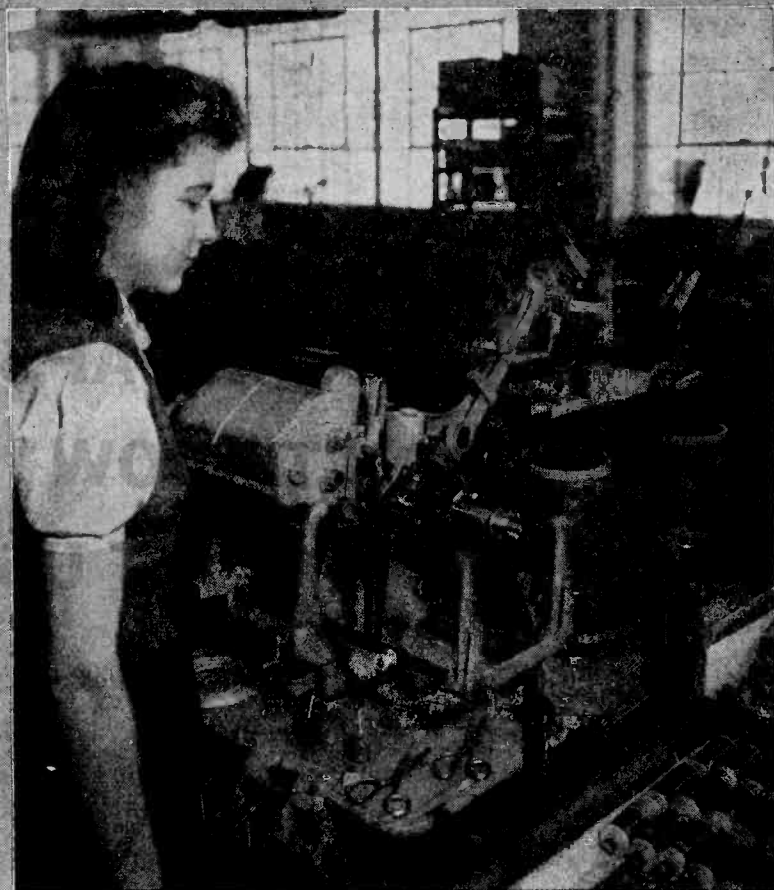

No. 3 of a Series

MODERN COIL WINDINGS

"with yarn"

This machine produces a coil of the familiar "cotton inter-weave" type where appearance or special applications require such construction. Glass or silk yarns are also used as a binder and insulator instead of cotton when their special qualities require it.

Our engineering department will be glad to recommend the type of winding best suited to your requirements.

COTO-COIL CO., INC.

COIL SPECIALISTS SINCE 1917

65 PAVILION AVE.

PROVIDENCE 5, R.I.



(Continued from page 41A)

- Kreager, P. H., 6905 Kenleigh Rd., Baltimore 12, Md.
 Lett, R. P., 340 Harvard St., Brookline, Mass.
 Lewis, C., 5 Highlands Ave., Bremerton, Wash.
 McNeil, B. T., Bell Telephone Co. of Canada, Montreal 1, P. Q., Canada
 Montgomery, W. D., Room 1008, 225 E. 4 St., Cincinnati 2, Ohio
 Naum, L. H., Krum Kill Rd., Slingerlands, N. Y.
 Owen, R. P., Allen B, DuMont Laboratories, 2 Main Ave., Passaic, N. J.
 Phatak, R. K., Purandare Park, 169, Vincent Rd., Bombay 14, India
 Rabb, J. W., Naval Research Laboratory, North Beach, Md.
 Richmond, A. E., P. O. Box 441, Portland 7, Ore.
 Rohner, A. J., 2903 Hiss Ave., Parkville, Baltimore 14, Md.
 Schwartz, H. H., 2210 Dorchester St., W., Montreal, P. Q., Canada
 Sherr, J. B., 21 W. Pennsylvania Ave., Towson 4, Md.
 Sturtevant, C. E., Bldg/269, General Electric Co., Schenectady, N. Y.
 White, R. N., 4800 Jefferson St., Kansas City 2, Mo.
 Werry, M. J., 86 Thurlow Rd., Homestead, Montreal 29, P. Q., Canada
 Yetter, E. W., 4901 Stenton Ave., Philadelphia 44, Pa.
 Zabel, L. W., 7901 Belleview St., Kansas City 5, Mo.

Admission to Member

- Ames, M. E., Jr., 7727 Fayette St., Philadelphia 38, Pa.
 Bacon, A. M., Kings Highway, Tappan, N. Y.
 Barney, H. L., 5 Pine Ave., Madison, N. J.
 Bessemer, L. E., 521-36 St., N.E., Cedar Rapids, Iowa
 Boak, I. S., 309 N. Broad St., Lancaster, Pa.
 Brotzman, E. S., 611 Lees Ave., Collingswood, N. J.
 Callahan, H. R., 4506 Georgia Ave., Washington 11, D. C.
 Capodanno, R. T., 238 Harrogate Rd., PennWynne, Pa.
 Carnes, W. T., Jr., 2815 W. 68 St., Mission, Kan.
 Chung, H., International Training Administration, Inc., 734-15 St., N.W., Washington 5, D. C.
 Chako, N., 6125 Kenwood Ave., Chicago 37, Ill.
 Clark, R. A., Jr., 5646 W. Race St., Chicago 44, Ill.
 Cole, W. P., 395 Belmont Ave., Newark 8, N. J.
 Cushman, R. W., 15 Everett St., Cambridge 38, Mass.
 Davis, M. F., Box 176, Delanson, N. Y.
 Edmonds, R. H., Dept. 5851, Philco Radio and Television Corp., Tioga and C Sts., Philadelphia 34, Pa.
 Fisher, F. S., Room 36, 204 Hospital St., Montreal, P. Q., Canada
 Glacé, K., 5213 N. Hope St., Philadelphia 20, Pa.
 Haines, R. K., 835 Cinnaminson Ave., Palmyra, N.J.
 Handel, N. E., 18 Chauncy St., Cambridge 38, Mass.
 Hannum, D. E., 2734 1/2 W. 42 St., Los Angeles 43, Calif.
 Harges, M. T., 22 Laurel Hill Rd., Southbridge, Mass.
 Hecht, B., 42 Washington Village, Asbury Park, N. J.
 Henninger, J. H., 4744 Meridian St., Philadelphia 36, Pa.
 Holshouser, D. F., 252 S. Railroad Ave., New Holland, Pa.
 Jacobs, H. N., 222-7 St., Garden City, L. I., N. Y.
 Kline, J., 116 Lenox Ave., East Orange, N. J.
 Kung, S., International Training Administration, Inc., 734-15 St., N.W., Washington 5, D. C.

(Continued on page 44A)

ONLY I C E VACUUM CAPACITORS
 give you the precise
 capacitance value
 you want

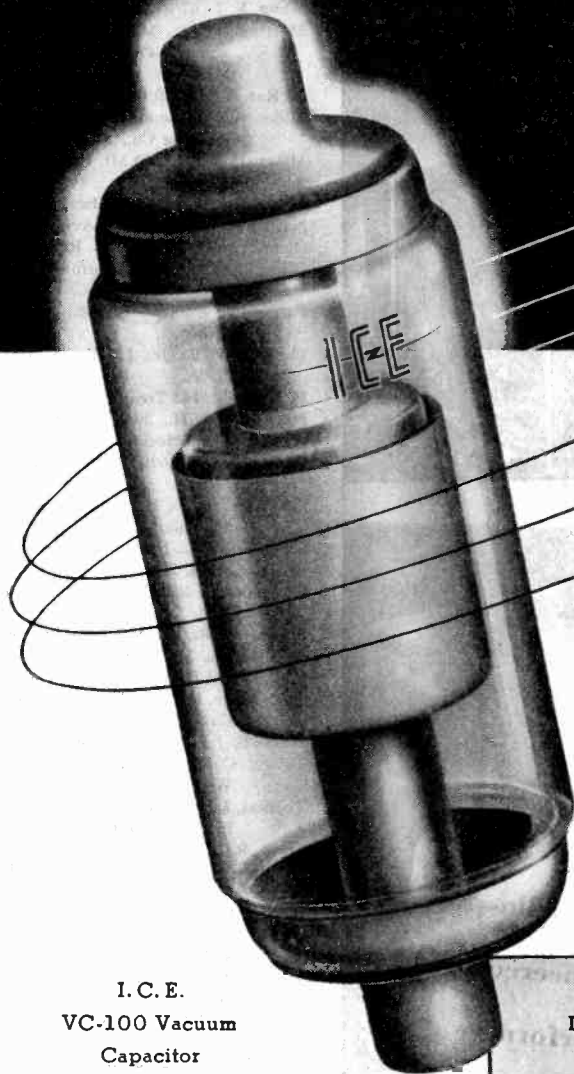

I. C. E.
 VC-100 Vacuum
 Capacitor

Now I. C. E. makes it possible for you to order vacuum capacitors with the correct capacitance value to meet requirements of your equipment. I. C. E. Vacuum Capacitors are now available in any value range from 6 to 110 mmfd. in steps of 1 mmfd.

I. C. E. Vacuum Capacitors Give You Close Tolerances

Beside offering you a wide range of capacitance values, I. C. E. Vacuum Capacitors are built to give you previously unobtainable tolerances.

I. C. E. PRECISION GRADE VACUUM CAPACITORS

Value Range	Accurate to
6 mmfd. to 25 mmfd.	±0.5 mmfd.
26 mmfd. to 60 mmfd.	±1.0 mmfd.
61 mmfd. to 110 mmfd.	±1.5 mmfd.

I. C. E. XX GRADE VACUUM CAPACITORS

Value Range	Accurate to
6 mmfd. to 25 mmfd.	±0.2 mmfd.
26 mmfd. to 60 mmfd.	±0.3 mmfd.
61 mmfd. to 110 mmfd.	±0.5 mmfd.

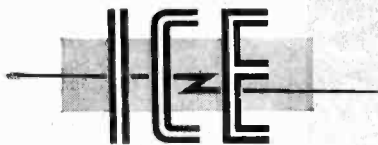

ELECTRONIC TUBES
 RESEARCH • DESIGN • PRODUCTION

Full Details in the New I. C. E. Catalog
 For full information on these outstanding I. C. E. Vacuum Capacitors, as well as other precision I. C. E. products, write today for the new I. C. E. Catalog.

INDUSTRIAL & COMMERCIAL ELECTRONICS

BELMONT, CALIFORNIA • NEW YORK CITY, N. Y.

WORLD FAMOUS OSCILLOSCOPES by DUMONT

Use Capacitors by
**INDUSTRIAL CONDENSER
CORP.**

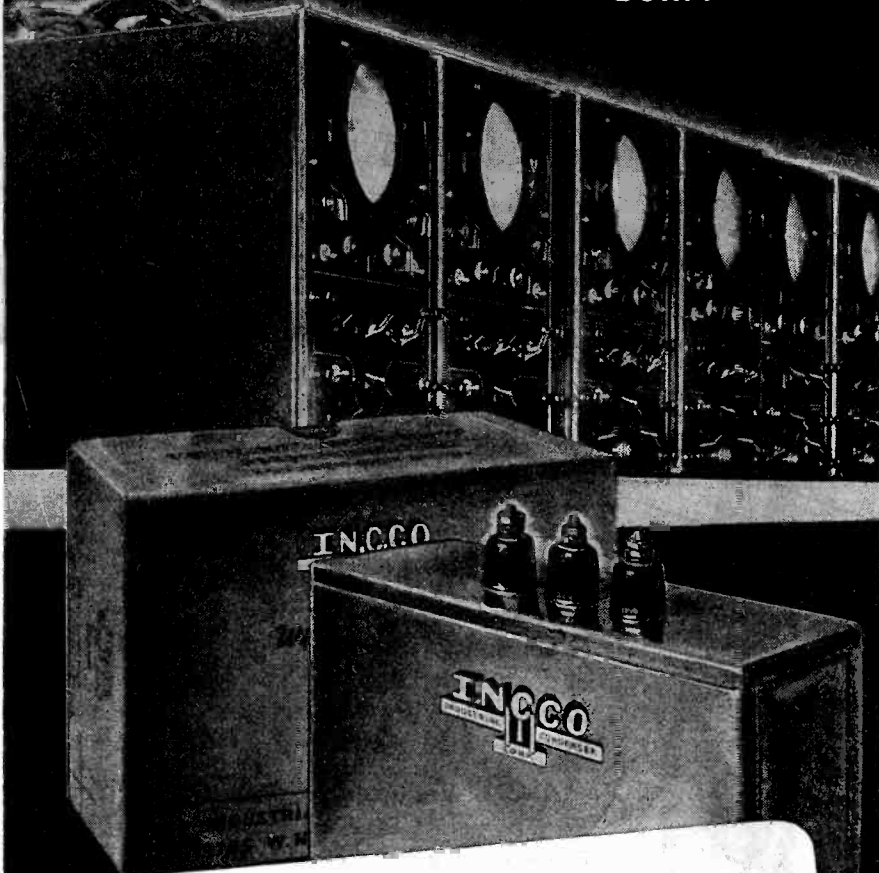

Capacitors used in Dumont's famous oscilloscopes are especially designed, engineered and manufactured for unusual performance under difficult operating conditions.

PAPER, OIL AND ELECTROLYTIC CAPACITORS

INDUSTRIAL CONDENSER CORPORATION

1725 W. NORTH AVE., CHICAGO 22, U. S. A.

DISTRICT OFFICES IN PRINCIPAL CITIES
QUICK DELIVERY FROM DISTRIBUTOR'S STOCKS



(Continued from page 42A)

- Langham, J. R., 2426 Harney Ct., San Diego 10, Calif.
- Lorber, J. F., 7 Laurel St., Marblehead, Mass.
- Maa, D. Y., Electrical Engineering Dept., National Tsinghua University, Kunming, China
- Mann, F. J., 67 Broad St., New York 4, N. Y.
- Mattingly, R. L., Massachusetts Institute of Technology, 470 Atlantic Ave., Boston 10, Mass.
- McRae, A. H., 939 Five Oaks Ave., Dayton 6, Ohio
- Miller, A. F., Communications Dept., The Atlantic Refining Co., Box 849, Port Arthur, Tex.
- Miller, E. G., Jr., 200 Mt. Pleasant Ave., Newark 4, N. J.
- Moskowitz, S., 3111 Broadway, New York 27, N. Y.
- Nathan, R., 2544 Calvert Ave., Detroit 6, Mich.
- Okun, A. M., 12 Broad St., Red Bank, N. J.
- Oosterling, H. J., 717 Morningside Dr., Towson 4, Md.
- Pappenfus, E., 1860 B Ave., N.E., Cedar Rapids, Iowa
- Phillips, W. E., Jr., 125 E. Main St., Port Jervis, N. Y.
- Pitts, W. L., 143 Treaty Rd., Drexel Hill, Pa.
- Pomerene, J. H., 263-89 Grand Central Pkwy., Little Neck, L. I., N. Y.
- Reisman, S. J., 629 Murdock Rd., Baltimore 12, Md.
- Schnitzer, B. E., 211 Cedar Rd., Hollywood, Philadelphia 11, Pa.
- Schuyler, W. E., Jr., National Press Bldg., Washington 4, D. C.
- Shulman, A., 2646 N. Spaulding Ave., Chicago 47, Ill.
- Simons, R. R., 812 N. Cuyler St., Oak Park, Ill.
- Smith, S. S., Maintenance Division, Holabird Signal Depot, Baltimore, Md.
- Strangways, D. H., 328 St. James St., London, Ont., Canada
- Sysko, S. J., 534 E. Johnson St., Philadelphia, Pa.
- Taylor, C. C., Bell Telephone Laboratories, 463 West St., New York 14, N. Y.
- Thomas, L. W., 3602 S. Dakota Ave., N.E., Washington 18, D. C.
- Trent, R. L., 463 West St., New York 14, N. Y.
- Wagner, F. R., 4111 Walnut St., Kansas City 2, Mo.
- Warner, H. K., 588 Linden Ave., Woodbridge, N. J.
- Watson, R. P., 229 Steinmetz Homes, Schenectady 4, N. Y.
- Westwood, S. A., P. O. Box 430, Rio de Janeiro, Brazil
- Zarky, B., 7346 N. Damen St., Chicago 45, Ill.

Admission to Associate

- Alseth, N. A., 2576 N. 1 St., Milwaukee 12, Wis.
- Anderson, R. E., Electronics Section, 610 Base Unit, Officers Club, Elgin Field, Fla.
- Andrews, J. C., 124 E. South St., South Bend, Ind.
- Anthony, G. E., 878 Gilbert St., Columbus 6, Ohio
- Bailey, T. J., Box 62, Elm Grove, Wis.
- Barlow, A. D., Beverly, West Va.
- Bearden, J. A., Radiation Laboratory, Johns Hopkins University, Homewood Campus, 34 and Charles Sts., Baltimore, Md.
- Bell, W. S., 1812-19 St., N.W., Washington, D. C.
- Bivins, W. P., 120 Colby Rd., North Quincy 71, Mass.
- Borden, E. L., 1310 E. Belevedere Ave., Baltimore 12, Md.
- Bouchey, S. H., 4612-48 St., N.W., Washington 16, D. C.
- Bratlie, O. J., 773 State St., Schenectady 7, N. Y.
- Brown, F. D., 1617 Northwick Rd., Baltimore 18, Md.
- Burack, H., 3618 W. 13 St., Chicago 23, Ill.
- Bush, G. B., 65 Beech Ave., Bethesda, Md.
- Campbell, C. C., 6926 Clinton Rd., Upper Darby, Pa.

(Continued on page 46A)

Complete

DUPLEX DETAILS



NOW AVAILABLE!

Fresh off the presses, a 12-page bulletin on the new, amazing Duplex Speaker is now available . . . jam-packed with engineering and technical data, performance curves, distribution characteristics. Details of the Dividing Network, A323 Amplifier and attractive cabinets also included.

**SEND FOR YOUR COPY
TODAY**

ALTEC

LANSING CORPORATION

1210 TAFT BLDG., HOLLYWOOD 28, CALIF.
250 WEST 57 STREET, NEW YORK 19, N. Y.
IN CANADA: NORTHERN ELECTRIC CO.

MOTOR DATA No. 125

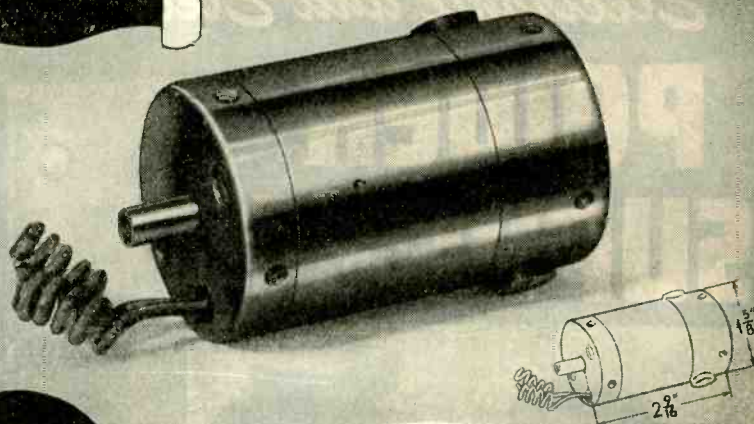

1600 FRAME MOTOR

Torque 4.5 in. oz. at 5800 RPM

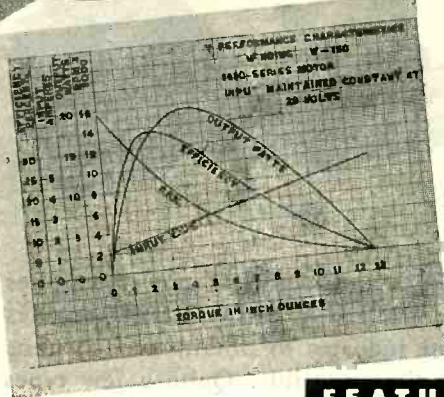

The power output of this precision motor is exceptionally high in proportion to its light weight and small size. Originally developed for numerous aircraft and portable applications, the characteristics of its performance can readily be modified for a variety of new uses.

FEATURES

- | | | | |
|-------------------------------|-------------------------------|-------------------|---|
| ↓ | ELECTRICAL | MECHANICAL | ↓ |
| Series or shunt wound | Completely enclosed | | |
| Unidirectional or reversible | Adaptable for any mounting | | |
| High starting torque | Laminated field poles | | |
| Low starting current | Stainless steel shaft | | |
| Low RF interference | Two precision ball bearings | | |
| Armature and field windings | Mica insulated commutator | | |
| Varnish impregnated and baked | Permanent end play adjustment | | |

1600 FRAME MOTORS		Series	Shunt
Watts Output, Int.	(max.)	22	
Watts Output, Con.	(max.)		5
Torque at 5500 RPM	(in. oz.)	3	
Torque at 5800 RPM	(in. oz.)	4.5	1
Lock Torque	(in. oz.)	12	3
Volts Input	(min.)	5	5
Volts Input	(max.)	32	32
Shaft Diameter	(max.)	.250"	.250"
Temperature Rise		50°C.	40°C.
Weight		12 oz.	12 oz.

EICOR INC. 1501 W. Congress St., Chicago, U. S. A.

DYNAMOTORS • D. C. MOTORS • POWER PLANTS • CONVERTERS

Export: Ad Auriema, 89 Broad St., New York, U. S. A. Cable: Auriema, New York

QUICK DELIVERY ON LEADING MAKES OF

Electronic and Electrical

POWER SUPPLIES

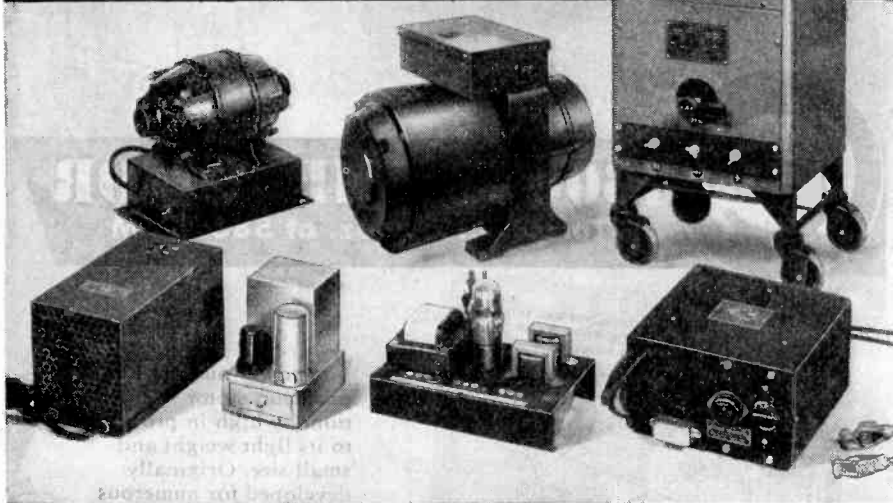

G.E.
MALLORY
ATR
ELECTRONIC LAB.
JANETTE
EICOR
PIONEER
KATO
G.T.C.
STANCOR
KNIGHT
ELECTRO PRODUCTS
WINDCHARGER

Helpful
**BUYING
GUIDE**
Available
on Request
Write for it!

MANY types and makes of power supplies are centralized at ALLIED. This enables government and industry to obtain needed units in the shortest time possible. Quite a few types are on hand for *rush delivery*.

Here you find Low Voltage High Current Supplies for aircraft, battery charging, plating, etc.; Vibrator and Rotary-Type Converters and Inverters for frequency changing and for converting A.C. to D.C. and D.C. to A.C.; Gas-Engine, Wind-Driven, and Motor-Driven Generators; Vibrapacks for mobile operation; Dry Batteries; and general utility Power Supplies. Also Dry Disc, Electronic and Vibrator Rectifiers.

*Save time and work... call ALLIED First!
Use our complete stock and procurement service.*

WRITE, WIRE, OR PHONE HAYMARKET 6800

ALLIED RADIO

CORPORATION

833 W. Jackson Blvd. • Dept. 3-G-5 • Chicago 7, Illinois

SUPPLIERS OF ELECTRONIC PARTS AND EQUIPMENT TO INDUSTRIAL AMERICA
Electronic Tubes, Rectifiers, Power Supplies, Intercommunicating Systems, Sound Systems, Photo-Cell Equipment, Batteries, Chargers, Converters, Generators, Supplies for Resistance Welders, Fuses, Test Instruments, Meters, Broadcast Station Equipment, Relays, Condensers, Capacitors, Resistors, Rheostats, Transformers, Switches, Coaxial Cable, Wire, Soldering Irons, Microphones, Speakers, Technical Books, etc.



(Continued from page 44A)

- Carpenter, R. E., 10388 Ilona St., Los Angeles, Calif.
Chalmers, D., Fife Mining School, Broad St., Cowdenbeath, Fife, Scotland
Chapman, W. E., Wolseley, Saskatchewan, Canada
Chase, N. C., 3509 McKenzie Ave., Los Angeles 32, Calif.
Chen, L. W., Copsewood Grange, Coventry, England
Chittick, C., 72 W. 113 St., New York 26, N. Y.
Clyce, T. E., 5009 Tulane Ave., Fort Worth 7, Tex.
Colton, F. S., 2552 N. High St., Columbus 2, Ohio
Conrad, E., 900 Gay Bldg., Madison 3, Wis.
Cooley, D. L., 7228 Tabor Ave., Philadelphia 11, Pa.
Coppell, F. K., 235 E. 22 St., New York 10, N. Y.
Cornell, L. L., 2215 Harvard Ave. N., Seattle 2, Wash.
Crane, R. R., 4305 Halley Terrace, S.E., Washington 20, D. C.
Davison, W. E., 861 Victoria Ave., St. Lambert, Montreal, P. Q., Canada
Decker, S. M., c/o Postmaster, San Francisco, Calif.
Dengate, C. D., 723 Wildell Rd., Drexel Hill, Pa.
Denning, L. S., c/o Fleet Post Office, New York, N. Y.
Dinnin, A. J., 80 St. George St., Toronto, Ont., Canada
Dolva, V. A., Box 253, Hawley, Minn.
Dunham, L. F., Baroda, Mich.
Emmerich, W. S., 3478 Dury Ave., Cincinnati 29, Ohio
Eng, D. Y., 218—20 Ave., Seattle 22, Wash.
Euler, K. C., Alturas, Calif.
Fawcett, H. G., 453 N. 31 St., Milwaukee 8, Wis.
Fay, P. J., 15 Roft St., Oswestry, England
Fedorkiw, M., 16 Admiral Rd., Toronto, Ont., Canada
Franklin, R. A., Submarine Signal Co., 160 State St., Boston 9, Mass.
Frيره, F. L., 102 Oaklee Village, Baltimore 29, Md.
Gallagher, L. C., 904 Pine St., Texarkana, Tex.
Garrison, W. H., Industrial Command, USN Repair Base 12-I Division, San Diego, Calif.
Goldberg, S. A., 15 W. 11 St., New York 11, N. Y.
Goodman, S., 523 N. Illinois, Belleville, Ill.
Gotsman, B., Magnetic Observatory, P. O. Box 32, Hermanus, C.P., South Africa
Graves, J. M., Alaska Communications System, Box 219, Anchorage, Alaska
Haas, M. H., 3212 West St., Ames, Iowa
Hachooagan, O., Ward 17, Veterans Administration, Wood, Wis.
Hahn, F. C., 2209 Blake Blvd., Cedar Rapids, Iowa
Hale, H., 4522 Brooklyn Ave., Seattle 5, Wash.
Hall, G. H., 88' London St., Peterboro, Ont., Canada
Haner, L. P., 105 Shepard Ave., Kenmore 17, N. Y.
Harris, F., High Frequency Laboratory, Ohio Rubber Co., Willoughby, Ohio
Heckman, W. E., 1523 Sewell Ave., Asbury Park, N. J.
Hensley, E. B., 1814 Spruce St., Philadelphia 3, Pa.
Highnam, K., 64, Shingrig Rd., Nelson, Glamorgan, England
Hillyer, F. R., 1126A Wilshire Blvd., Santa Monica, Calif.
Hilty, R. M., 87-35—168 St., Jamaica 3, L. I., N. Y.
Hodgson, R. W., 525 E. 99 St., Inglewood, Calif.
Holland, R. E., 225 N. Linn St., Iowa City, Iowa
Honig, W., Hotel Dauphin, Broadway and 67 St., New York 23, N. Y.
Huber, J. L., 511 N. Arch St., Montoursville, Pa.
Jacob, M. I., Oaklee Village, Baltimore 29, Md.
Jenny, H., Gladbachstrasse 99, Zurich 7, Switzerland
Jurek, W. M., 573—5 St., Brooklyn 15, N. Y.
Kane, I. M., 1775 E. 18 St., Brooklyn 29, N. Y.
Keller, J. E., 66 Marietta Dr., San Francisco 16, Calif.

(Continued on page 48A)



Jennings
RADIO
 VACUUM ELECTRONIC COMPONENTS
 VC 6-50 20 AMPS. CAPACITOR

Jennings
RADIO
 VACUUM ELECTRONIC COMPONENTS
 W 6-50 20 AMPS. CAPACITOR
 PATENT APPLIED FOR

Jennings
RADIO
 VACUUM ELECTRONIC COMPONENTS
 VC 50-250 60 AMPS. CAPACITOR

THESE PHOTOGRAPHS ARE REDUCED LESS THAN 1/2 ACTUAL SIZE

JENNINGS LEADERSHIP IN HIGH VOLTAGE VACUUM CAPACITORS

meets urgent need for newly designed electronic equipment

Jennings research laboratories are constantly developing new and major improvements to help serve the armed forces in their many fields of activity. They also serve the constantly grow-

ing demand for "the unusual" in capacitor usage in the newly designed heating equipment serving the American Electronic Industrial field. We welcome the opportunity to serve you.

Watch Jennings for new developments in the field of Vacuum Electronic Components

WRITE FOR BULLETIN IR

JENNINGS RADIO MANUFACTURING COMPANY • 1098 E. WILLIAM ST. • SAN JOSE 12, CALIFORNIA

**When all operations
are "In the Family"**

- Engineering-Design & Development
- Laboratory & Model Shop
- Tool & Die Making
- Coil Winding
- Impregnating
- Blanking & Annealing of Core Steel
- Fabrication of all Mounting Parts
- Complete Assembly
- Compound Filling
- Inspection & Testing

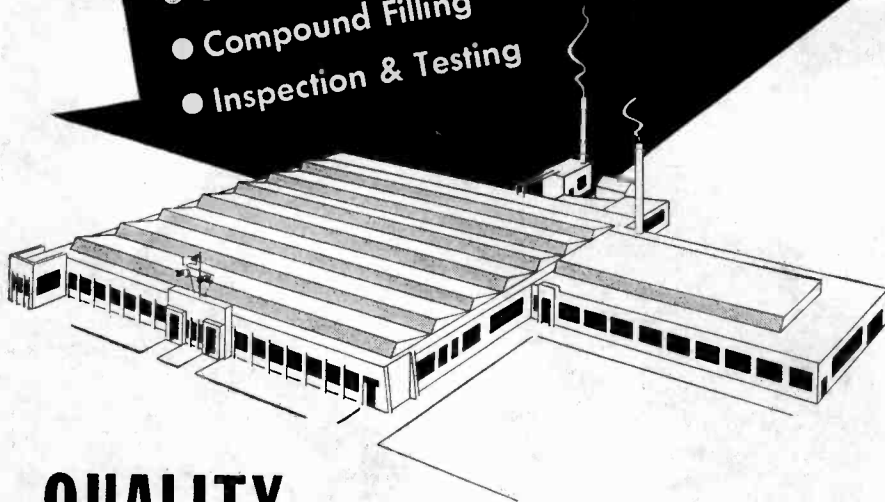

**QUALITY
CONTROL is at its best**

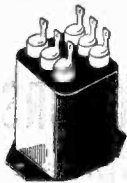

Because they are in immediate touch with every step in manufacture, Chicago Transformer's engineering and inspecting departments make Quality Control truly effective. Smooth flowing production is facilitated, and dependability and accuracy become performance characteristics of the finished product.

CHICAGO TRANSFORMER

DIVISION OF ESSEX WIRE CORPORATION

3501 WEST ADDISON STREET

CHICAGO, 18



TRADE MARK REG.



Membership

(Continued from page 46A)

- Kester, R. E., 3924 Riverside Dr., Dayton 5, Ohio
 Kitt, D., 1555 Rainier Ave., Bremerton, Wash.
 Knox, R. N., 1204 N. Dearborn St., Indianapolis 1, Ind.
 Knuth, H. G., Jr., 115-25—84 Ave., Richmond Hill 18, L. I., N. Y.
 Kulesha, K. J., 857 Mason Ave., Aurora, Ill.
 Laitinen, L. K., 226 E. Washington, Ft. Wayne 2, Ind.
 Lauritzen, I. L., 3162 Upas St., San Diego 3, Calif.
 LeBlang, E. D., 1411 Robbins St., Philadelphia 24, Pa.
 Lee, G. M., Massachusetts Institute of Technology, Cambridge, Mass.
 Lee, I. W., Jr., 5220—19 Ave., N.E., Seattle 5, Wash.
 Lee, R. C., 1817 E. 50 St., Seattle 5, Wash.
 Leighton, R. M., 4317—8 St., N.E., Seattle 5, Wash.
 Logan, H. E., 1041 Pleasant St., Oak Park, Ill.
 Lorant, L., 4115—46 St., Long Island City, L. I., N. Y.
 Loux, S., South Green St., Tuckerton, N. J.
 Lucas, D. T., 3672 N. Wells St., Ft. Wayne, Ind.
 Magee, W. L., 667 Teasdale Pl., Bronx 56, N. Y.
 Massell, E., 6612—102 St., Forest Hills, L. I., N. Y.
 May, L. U., Jr., 1508 Barrington Rd., Columbus 8, Ohio
 McDonald, E. D., 8210—2 Ave., Detroit 2, Mich.
 McGuigan, W. D., 420 Memorial Dr., Cambridge 39, Mass.
 Mooney, S. J., 236 W. Webster St., Ferndale 20, Mich.
 Moore, W. J., 1201 Sheridan St., N.W., Washington 11, D. C.
 Mussen, K. R., 2445 N. Myers St., Burbank, Calif.
 Niblo, P. B., c/o Fleet Post Office, San Francisco, Calif.
 Nichols, W. A., 337 Parkland Pl., S.E., Washington 20, D. C.
 Noga, J. J., 2122 W. Schiller St., Chicago, Ill.
 Olson, D. R., Michigan Bell Telephone Co., 1365 Cass Ave., Room 1508, Detroit 26, Mich.
 Owsiany, A. R., 735 Mills St., Kalamazoo 20, Mich.
 Parmer, P. R., 2516 Meadowbrook Court, S.E., Cedar Rapids, Iowa
 Payne, H. A., 6057—37 Ave., S.W., Seattle 6, Wash.
 Payson, E. C., Automotive Division, Ordnance Research and Development Ctr., Aberdeen Proving Ground, Md.
 Peterson, A. H., 3647 W. 62 St., Chicago 29, Ill.
 Peterson, H. L., Naval Training School, Bowdoin College, Brunswick, Me.
 Phlegar, C. L., Jr., Federal Drive, RFD 7, Anderson, Ind.
 Potts, E. B., 71 Van Ness Ave., Rutherford, N. J.
 Powell, F. S., 84 Gilpin Rd., Upper Darby, Pa.
 Powers, C. E., 101 Bill Ave., Groton, Conn.
 Preston, G. D., 58 Summer St., Malden 48, Mass.
 Reeves, W., Minerva Court, Chestnut and Garret Rd., Upper Darby, Pa.
 Retherford, R. C., Westinghouse Electric and Manufacturing Co., Research Dept., Bloomfield, N. J.
 Richard, N. J., 2937 N. Cramer St., Milwaukee 11, Wis.
 Rhodes, H. A., 5 Aldon Terrace, Bloomfield, N. J.
 Riker, M., National Lead Co., Titanium Division, Research Laboratory, South Amboy, N. J.
 Roberts, A. P., 903 Cherokee Ave., S.E., Atlanta, Ga.
 Roberts, W. G., 177 Elm Dr., Hove 4, Sussex, England
 Robinson, G. A., 1440 S. Lombard Ave., Berwyn, Ill.
 Robinson, J. E., 143 Bidwell Pkwy, Buffalo 9, N. Y.
 Romoser, P. E., 1118—8 St., Lorain, Ohio
 Rose, A., 2 Gloucester Drive N. 4, London, England
 Russell, W. W., 146 Poplar Ave., Elmhurst, Ill.
 Schoonover, W. L., 4 Savona Walk, Long Beach 3, Calif.
 Selsted, W. T., 1905 Berryman St., Berkeley 7, Calif.
 Sharp, V. E., P.O. Box 414, Orangeville, Ont., Canada

(Continued on page 69A)

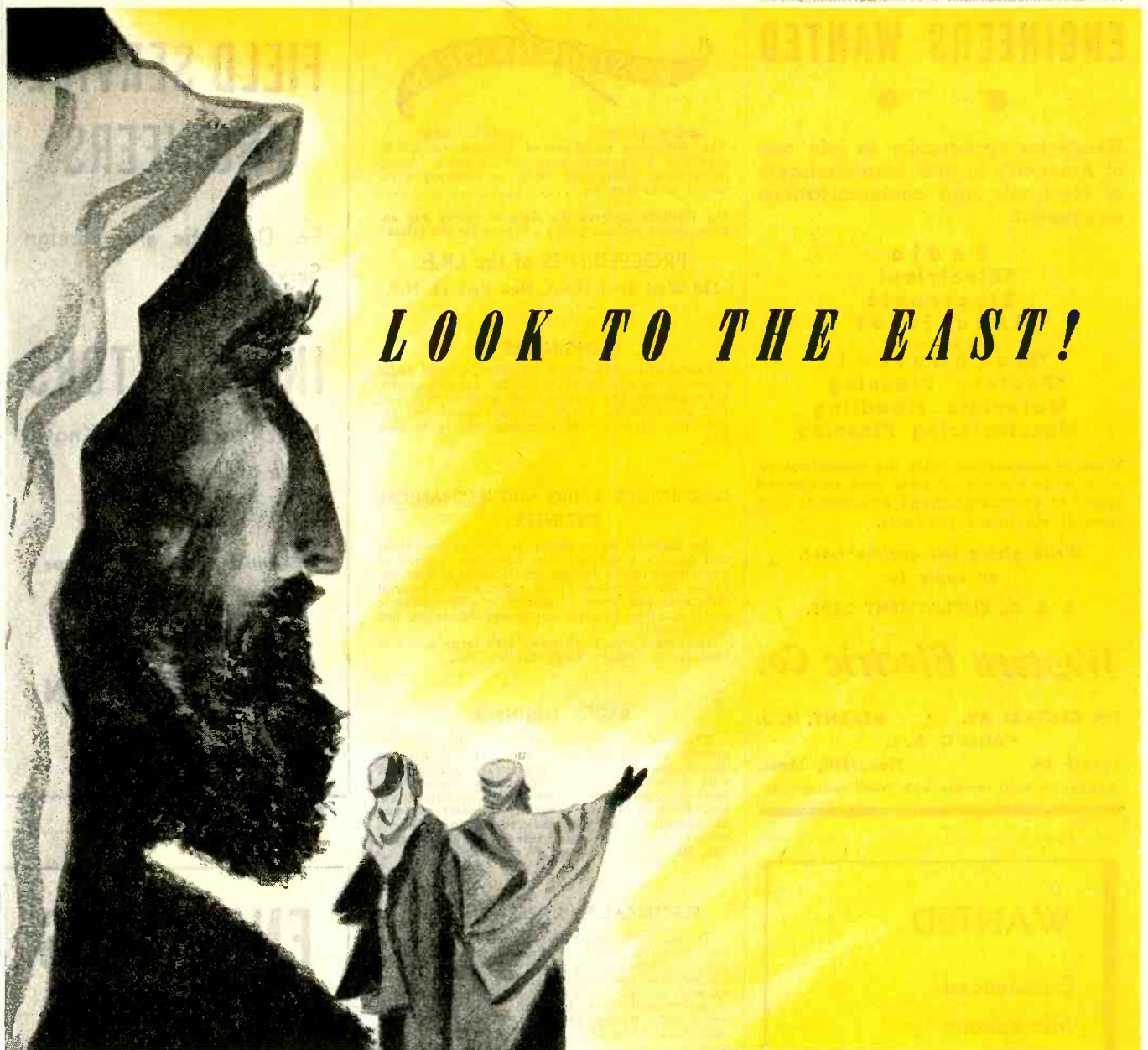

LOOK TO THE EAST!

For years, set manufacturers have looked to the East as an important source of radio components. We at G. I. have always enjoyed a large share of this business, namely; Condensers, Tuning Mechanisms, Actuators, and associated items.

As a matter of natural development, a few years back we launched the famed and successful G. I. RECORD CHANGER.

Now we have inaugurated a full line of quality SPEAKERS as part of an expanded peacetime program.

Yes, big things are brewing at G. I.—plans that will make us in the peacetime years ahead, eastern headquarters for a complete quality line of major radio components—in volume—thanks to the “know-how”, both physical and creative, vastly increased by the challenge of war needs.

GENERAL INSTRUMENT CORPORATION



829 NEWARK AVENUE • ELIZABETH 3, N. J.

ENGINEERS WANTED

Here's an opportunity to join one of America's largest manufacturers of electronic and communications equipment.

Radio
• Electrical
Electronic
Industrial
(Job evaluation)
• Mechanical
• Factory Planning
Materials Handling
Manufacturing Planning

Work in connection with the manufacture of a wide variety of new and advanced types of communications equipment and special electronic products.

Write giving full qualifications, or apply to:

R. L. D., EMPLOYMENT DEPT.

Western Electric Co.

100 CENTRAL AV. KEARNY, N. J.

• Also: C. A. L.

Locust St. Haverhill, Mass.

Applicants must comply with WMC regulations

WANTED

Experienced
Microphone
Engineer

One of America's leading microphone organizations is looking for a capable, experienced microphone engineer.

The man we have in mind is an E.E. Graduate, thoroughly grounded in microphone theory with practical experience in microphone research, development and application.

The position is permanent and offers real opportunity to a man with ability and initiative. We are not a war-baby, but a well-established concern with definite plans. Located in a clean, mid-west city of 60,000 with pleasant living conditions.

If you believe that you are the man we are looking for . . . and your record can prove it, write or call direct to our factory.

Attention: Mr. Evans
THE TURNER CO.
900 17th St. N.E.
Cedar Rapids, Iowa



The following positions of interest to I.R.E. members have been reported as open. Apply in writing, addressing reply to company mentioned or to Box No.

The Institute reserves the right to refuse any announcement without giving a reason for the refusal.

PROCEEDINGS of the I.R.E.

330 West 42nd Street, New York 18, N.Y.

ENGINEERS

Prominent midwestern manufacturer of radio transmitting equipment is looking for two graduate engineers for development work in AM and FM transmitters. Starting salary good and future for advancement excellent. Reply to Box 384.

ELECTRONICS, RADIO AND MECHANICAL ENGINEERS

An unusual opportunity is offered ambitious and capable engineers who have had qualifying experience in the design, development and preparation for manufacture of radio and industrial electronic equipment. Experience with dielectric and induction heating equipment desirable, but not essential.

Important war work now, with large post-war projects to follow. Reply to Box 385.

RADIO ENGINEER

Thoroughly experienced in ultra-high-frequency theory and technique, with or without patent law experience, preferably young, and with some knowledge of mechanical engineering, desired by established New York City patent law firm for employment presently or after the war as consultant and with view to becoming patent lawyer. State education, references, experience, age, and salary expected. Write Box 387.

ELECTRICAL ENGINEER—PHYSICIST

To take charge of development program involving selsyn and amplidyne controls for intricate instruments, radiation measurements, etc. Responsible position covering urgent war work as well as post-war problems. All inquiries held in strict confidence. Farrand Optical Company, Inc., 4401 Bronx Blvd., New York 66, N.Y. Attention: Chief Physicist.

RADIO ENGINEER

Graduate, 5 years experience laboratory design and construction, receivers and associated equipment. Premier Crystal Laboratories, Inc., 63 Park Row, New York, N.Y.

ELECTRICAL ENGINEERS OR MEN WITH TECHNICAL SALES EXPERIENCE

Well-established Chicago concern will hire qualified men for work as design engineers or sales engineers. Familiarity with application of transformers in electronic circuits required. Excellent opportunities. Write qualifications in detail to Box 374.

EXECUTIVE ELECTRICAL ENGINEERS

Experienced in sales, design and manufacture of oil-immersed distribution and power transformers. These positions offer excellent post-war opportunity with forty-year-old eastern pioneer transformer manufacturer. Write outlining full details to Box 375.

RADIO AND ELECTRONIC ENGINEER

Experienced on high-frequency receiver design and development. Excellent post-war opportunity. State age, experience and salary expected. Brooklyn plant. Box 376.

(Continued on page 52A)

FIELD SERVICE ENGINEERS

For Domestic and Foreign Service.

And

INSTRUCTORS

Must Possess Good Knowledge of Radio.

Essential workers need release

HAZELTINE CORPORATION

58-25 Little Neck Parkway
Little Neck, Long Island

ENGINEERS NEEDED

Opportunities for advancement are greater with a reputable company that is continually growing and expanding.

We need qualified engineers for permanent positions:

1. In our Radio Division to carry on research and development of Receivers, Transmitters, Direction Finders, F-M Equipment, Broadcast & Television Receivers, and specialized Aircraft & Marine Equipment.

2. To interpret & prepare Specifications, Instruction Books, & Engineering Estimates.

3. In our Railway Signal Division, to develop and install Carrier Current Equipment.

Write for application form and state condition of availability.

AIRPLANE & MARINE INSTRUMENTS, INC.
CLEARFIELD, PA.

Draftsmen Wanted

Also

Designers

Detailers

Tracers and

Engineers

We Offer

A Permanent Position
A Future with a Promise
of unlimited possibilities.

*We have no conversion problem!
There will be no lay offs or set back
when the war ends!*

We are one of the largest manufacturers of a wide variety of communication and electronic equipment in the world, fully prepared and ready to go ahead with a very ambitious, expansion program as quickly as we are permitted. There will be unlimited possibilities for creative, ambitious men to advance to key positions both in research development and production field.

At present, we are producing vital equipment for our fighting forces.

Good Starting Salaries
Exceptionally fine working conditions.

Apply Personnel Office
8 A.M. to 5 P.M.

FEDERAL TELEPHONE &
RADIO CORP.
the Mfg. unit of the International
Tel. & Tel. Corp.
591 Broad St., Newark, N.J.
WMC Rules Observed

**WRITE FOR YOUR
COPY TODAY!**



**Akra-Ohm
Resistors**
Accurate Fixed
Wire Wound
Types

*This New Bulletin
tells you what you
want to know about*
**ACCURATE FIXED
WIRE WOUND
RESISTORS**

**DIMENSIONAL SPECIFICATIONS • MOUNT-
ING AND TERMINAL DESIGNS • POWER
DISSIPATION • TEMPERATURE COEFFI-
CIENT OF RESISTANCE • MAXIMUM
RESISTANCE CHARTS • RESISTANCE
ALLOYS • MOISTURE AND FUNGUS
PROOFING • HERMETIC SEALING**

*Shallcross Types Designed to
Meet JAN-R 93 Specifications*

SHALLCROSS MFG. CO.

DEPT. R-75, COLLINGDALE, PA.

ENGINEERING • DESIGNING • MANUFACTURING

OPENINGS FOR
RADIO
ENGINEERS
ELECTRICAL
ENGINEERS
MECHANICAL
ENGINEERS

In the development and production of all types of radio receiving and low-power transmitting tubes. Excellent post-war opportunities with an established company in a field having unlimited post-war possibilities.

Apply in person or in writing to:

Personnel Manager

RAYTHEON
MANUFACTURING CO.
 Radio Receiving Tube Div.
 55 Chapel St., Newton, Mass.

ENGINEERS

*For Design Work
 on Radio Receivers,
 Audio Amplifiers,
 Television*

Men with substantial experience wanted, preferably those having Degrees in Electrical or Communications Engineering. Write, giving details of experience and salary expected, to:

FREED RADIO CORPORATION

Makers of the Famous Freed-Eisemann Radio-Phonograph

200 Hudson Street
 New York 13, N.Y.



(Continued from page 50A)

ENGINEERS

ELECTRONIC ENGINEER, with laboratory experience and familiarity with circuit design and development work. Job will be in connection with high frequency heating generators and other industrial applications of electronics. Graduate in electrical or radio engineering.

JUNIOR ENGINEER, preferably engineering graduate, with experience in radio engineering laboratory, factory or engineering department. Job will be in connection with H.F. and A.F. measurements, and general development work.

JUNIOR RADIO ENGINEER OR PHYSICIST, with good mathematical background. In replying give complete information as to experience, education, marital, draft status, and salary expected. Illinois Tool Works, 2501 North Keeler Avenue, Chicago 39, Ill.

RADIO AND ELECTRONIC ENGINEERS

For research and development in the field of radar, radio communications and electrical test equipment, good post-war opportunity, also openings available for draftsmen and junior designers. Allen D. Cardwell Manufacturing Corporation, 81 Prospect Street, Brooklyn, N.Y.

ASSISTANT CHIEF ENGINEER

Mid-west radio-electronics manufacturer, engaged exclusively on electronic war projects at present, requires experienced engineer to assume complete supervision of post-war development of household and auto radio receivers. Television receiver experience desirable but not essential. All inquiries confidential. Write Box 377.

SENIOR DEVELOPMENT ENGINEERS

Large mid-west manufacturer, now exclusively on war radio and radar work, has immediate openings for post-war radio and television development for three senior radio project engineers, two mechanical engineers and one engineer on specifications and standards. Confidential inquiries respected. Write Box 378.

RESEARCH ENGINEERS

Prominent radio and electronics manufacturer located in mid-west has immediate openings for three research men preferably with engineering background, on post-war problems in electrical and electronic fields. Confidential inquiries respected. Write Box 379.

ELECTRICAL ENGINEER

For research and development of automotive electrical systems. General knowledge of suppression of electrical interference to radio reception necessary. Give full particulars—background, experience and availability. Box 380.

RADIO ENGINEERS

Radio, Research and Development Engineers and Draftsman needed for key positions by manufacturer of diversified line of aircraft accessories, small motors, and aircraft radio who will be in the home radio field postwar. Salaries open. Full compliance with WMC regulations necessary. Confidential inquiries respected. Live in the midst of the best hunting and fishing in Michigan. Our employees know of this ad. Address Box 381.

PHYSICIST AND ELECTRICAL ENGINEER OR ENGINEERING PHYSICIST

Physicist qualified to supervise industrial and fundamental research in acoustics. Ph.D. with industrial experience preferred.

Also an electrical engineer or engineering physicist for research position in fundamental and applied electronics. Some industrial experience preferred. Write Armour Research Foundation, 35 West 33rd Street, Chicago 16, Illinois.

(Continued on page 56A)

OPPORTUNITIES
IN PRESENT AND
POSTWAR WORK

High grade graduate engineers are needed immediately for wartime and postwar work with a record of outstanding ability and five or more years of design and product engineering experience.

Present activities include design and manufacture of high and medium power transmitters, frequency shifters, other communication products for the Navy, and design and models for postwar use.

Interviews will be arranged for qualified applicants. Write for our "Qualification Record" form.

PRESS WIRELESS, INC.
HICKSVILLE, L.I.

ATT: S. A. Barone, Chief Mfg. Engr.

Micro-Wave
Design Engineers

An opportunity for radio engineers who have had extensive experience in the design of micro-wave apparatus. Their services are needed for long range development program for the government.

Broadcast Receiver
Designers

Still other radio engineers with experience are needed.

Mechanical Engineers for
telephone and radio work—

whose experience fits them to design electro mechanical devices for production are also needed.

While the above openings are for senior men, we do have opportunities for several junior engineers in these fields. Interested persons are invited to write giving full qualifications to the Engineering Personnel Manager.

War Manpower Commission rules will be observed.

STROMBERG-CARLSON CO.
ROCHESTER 3, N. Y.

LITTON MOLUBE

the best in High Vacuum

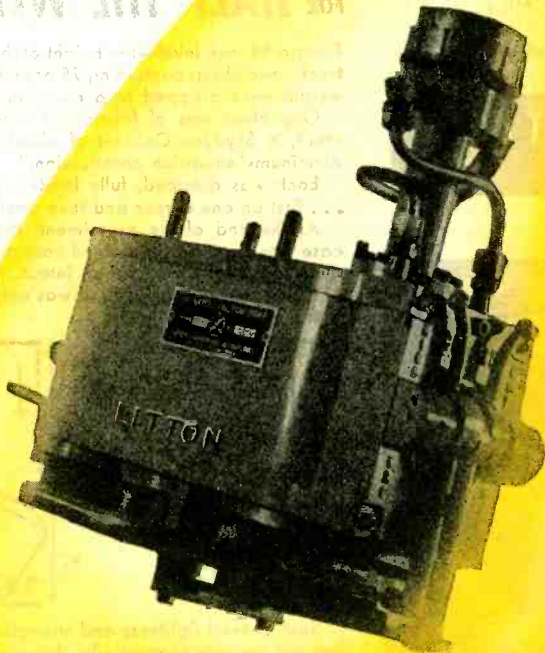

Litton Molube (Molecular Lubricant), a highly refined vapor pump medium, from carefully selected petroleum base, with high stability and extremely low vapor pressure, is now available in unlimited quantities for immediate delivery at prices that revise former operational economy.

Molube will operate advantageously in practically all equipment designed for organic media. Its complete sorption by activated charcoal makes it ideal for the attainment of ultimate vacuum, but it is equally adapted to ultra speed dynamic systems.

Literature on Litton Molube, High Vacuum Pumps and auxiliaries—glass working fires and machines, and accessories—metal glass seals and special products available on request.

*"For Twelve Years the
Standard of the Industry"*

Litton



ENGINEERING LABORATORIES
REDWOOD CITY, CALIFORNIA, U. S. A.

Laboratory Standards



PULSE GENERATOR

MODEL 79-B

SPECIFICATIONS:

- FREQUENCY:** continuously variable 60 to 100,000 cycles.
- PULSE WIDTH:** continuously variable 0.5 to 40 microseconds.
- OUTPUT VOLTAGE:** Approximately 150 volts positive.
- OUTPUT IMPEDANCE:** 6Y6G cathode follower with 1000 ohm load.
- R. F. MODULATOR:** Built-in carrier modulator applies pulse modulation to any r.f. carrier below 100 mc.
- MISCELLANEOUS:** Displaced sync output, individually calibrated frequency and pulse width dials, 117 volt, 40-60 cycles operation, size 14"x10"x 0", wt. 31 lbs.

Price: \$295.00 F.O.B. BOONTON

Immediate Delivery

MEASUREMENTS CORPORATION

BOONTON • NEW JERSEY

"Drop-test" proves

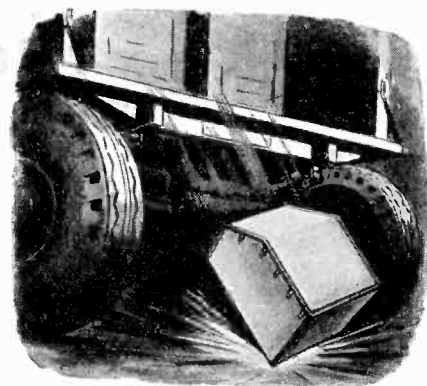

Skydyne

CABINETS

**TWICE AS STRONG
FOR HALF THE WEIGHT**

From a 48-inch level—the height of the average truck—two chests containing 75 pounds of dead-weight were dropped to a concrete floor.

One chest was of fabricated plywood; the other, a Skydyne Cabinet of aluminum-balsa-aluminum "sandwich construction."

Each was dropped, fully loaded, four times . . . first on one corner and then another.

At the end of the experiment, the plywood case was smashed. In marked contrast, the Skydyne Cabinet came through intact. The weight of the Skydyne Cabinet itself was only half that of the plywood cabinet.

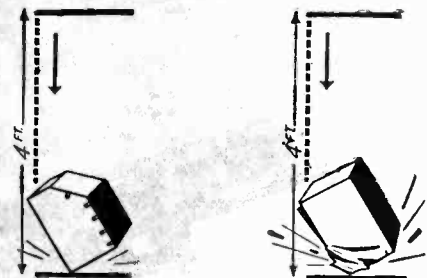

Such proved lightness and strength, however, are not the only reasons why thousands of Skydyne Cabinets are being used today to protect precision instruments in transit. Aluminum-faced Skydyne Cabinets are fungus resistant, water-tight, waterproof and rustproof as well . . . all highly important factors in tropical climates.

Nor is aluminum the only sheathing. Fibreglass, papreg and plywood can also be bonded with the balsa, cork or lightweight synthetic core and moulded to the most exacting specifications.

Skydyne construction is electrically shielded and is also resistant to heat, vibration and sound . . . a feature which suggests numerous applications now and after the war.

Get the whole story of Skydyne and learn how it will improve the appearance and serviceability of any product housing in which strength, light weight and special protection are essential. Write for our descriptive brochure.

Skydyne Inc

PORT JERVIS, NEW YORK

Transformer Engineers Devoted to



RESEARCH • DEVELOPMENT

● As leaders in the field of design and development of specialized transformers, Electronic Engineering Co. has established an enviable reputation for solving the most difficult transformer applications. With complete electronic laboratories and the finest engineering talent available, Electronic Engineering Co. is devoted exclusively to the production of specialized transformers for the armed forces.

ELECTRONIC ENGINEERING CO.

3223-9 WEST ARMITAGE AVE., CHICAGO 47, ILLINOIS

"SPECIALIZED TRANSFORMER ENGINEERS"

★

A forward-looking American manufacturer offers Advanced Careers to a few qualified engineers and scientists

★ ★ ★

Top salaries plus high royalty earnings

★ ★ ★

*Excellent laboratory in fine building
located in beautiful Southern New England community*

IN order to carry out a highly developed program of growth and expansion, we seek to augment the staff of our creative engineering laboratories with outstanding talent...and are prepared to do the things necessary to obtain it.

Applications are therefore invited from key engineers, research men and physicists experienced in industrial electronics, industrial control equipment, the design of automatic machines and allied fields. There are openings to satisfy the chief engineer, department head, project engineer, research engineer and the basic research scientist.

Salaries will at least equal those paid by other leading companies in the field, *but in addition, each candidate will receive a graduated percentage royalty on the sale of all products he develops. A portion of this royalty continues even if he later leaves the company.*

The conditions under which you will work are ideal. Our laboratory—housed in a splendid building—is well-equipped. You will be furnished with everything necessary to carry out the projects under your direction. The laboratory is located in one of the most charming residential communities of southern New England within commuting dis-

tance of New York—fine homes, excellent schools, modern shops and stores.

In order to receive fullest possible consideration, your application should present a detailed and comprehensive account of your experience and accomplishments, with particular emphasis on patents you may have obtained and contributions you have made to the origin or improvement of devices or techniques in your field.

The engagement of any candidate, of course, must be in accordance with War Manpower Commission and wage and salary regulations. If your present status precludes a change in position at this particular time, contractual arrangements can be made for you to join the staff at a later date.

We choose not to reveal the name of this corporation in this advertisement but every candidate interviewed will have the fullest opportunity of learning everything he wants to know about us. Further, your letter of application will be seen only by principals and will be held in the strictest confidence. All our staff knows of this advertisement.

Please address your letter to Box 383, Proceedings of the I.R.E., 330 West 42 St., New York 18.

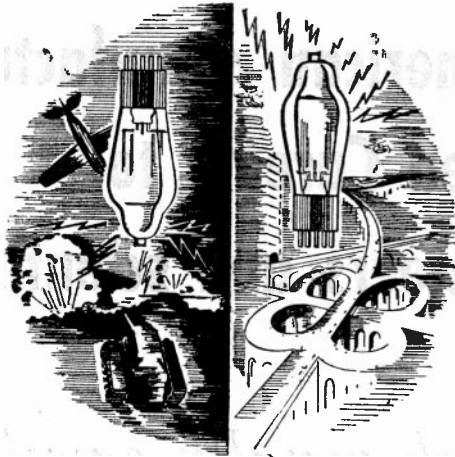

TODAY...and TOMORROW!

Today, the world over, many of the machines and devices of war are shaping the peaceful pursuits of tomorrow. Out of the holocaust of battle will emerge new horizons of human comfort, convenience and safety. The science of electronics marches on!

Today, and every day, Temple engineers and technicians are toiling on new problems, developing new products, improving old ones—dedicated to the task of insuring final Victory—and inspired, as well, to anticipate the peacetime demands of tomorrow.



Electronics Division

TEMPLE TONE
RADIO MFG. CORP.
 New London, Conn.



(Continued from page 52A)

COMMUNICATION OR RADIO ENGINEERS AND PHYSICISTS

A leading Eastern University is in immediate need of several communication or radio engineers and physicists for a war research project, the importance of which is certified by the armed services. This is an opportunity to make a real contribution to the successful and rapid completion of the Pacific War. The location is on an attractive campus and satisfactory salary arrangements can be made. Write to Box 370.

ELECTRONIC AND AUDIO ENGINEER

Electronic and audio engineer for key position in established manufacturing concern with its own laboratories and wide range of facilities. Liberal salary. Post-war opportunities assured by civilian markets. Design and production experience in audio frequency and R. F. fields desired. For confidential interview address Box 371 stating background and qualifications.

TRANSFORMER DESIGN ENGINEER

Transformer design engineer for one of the leading transformer manufacturers. Located in New York metropolitan area. If you are E.E. graduate and interested in becoming associated with a company which has real post-war possibilities write to Box 372 giving detailed information about yourself.

SALES MANAGER—PARTS JOBBER

Somewhere there is a radio parts salesman or sales engineer now working for a manufacturer's agent, jobber, or manufacturer of radio parts who has cut his eye teeth and is ready for a bigger job.

To such a man we offer a real post-war opportunity, with a hard hitting aggressive organization located in metropolitan area of New York. This company will have a quality line of parts and test equipment to be merchandised and sold through the electronic jobber. Salary and participating basis. If you have the necessary qualifications we want to hear from you. Write fully, in confidence to Box 373.

RESEARCH ENGINEERS

Several positions for Physicists, Analysts, and Electronic Engineers are open with the University of California Division of War Research. For further details write, giving personal history, education and qualifications, to Personnel Manager, University of California Division of War Research, U. S. Navy Radio & Sound Laboratory, San Diego 52, California.

THE OHIO STATE UNIVERSITY

Announces Westinghouse Educational Fellowships in Electron Optics
 A post-doctoral fellowship—\$3600 per year. Two pre-doctoral fellowships—\$1000 per year.
 Open to graduates in Physics, Mathematics or Electrical Engineering.
 Application forms may be secured from the Dean of the Graduate School, Ohio State University, Columbus 10, Ohio

Here is a Good Permanent Job

FOR A COMMUNICATIONS EXPERT

You may be interested in this permanent position with a long established, progressive Radio school. The job is open right now—but we will hold it for the right man, until he can be released from his war job.

To qualify for this position, you should be a college graduate with engineering and operating experience in Radio communications. Experience teaching Radio subjects will be an advantage—and experience in writing instruction manuals clearly, interestingly is essential.

Get in touch with us now. Let's see if we can come to a mutual understanding so you can start with us the day you are available.

Tell us all about yourself—your education and experience—your ambitions—your salary requirements. We will hold your letter in strict confidence.

WRITE BOX 382
PROCEEDINGS OF THE I.R.E.
330 West 42nd St.
New York 18, N.Y.

ACOUSTIC ENGINEER TO DEVELOP LOUD SPEAKERS

Familiar with laboratory and measurement devices for checking loud speaker characteristics.

Right hand man to chief engineer.

Permanent, post-war position with rapidly-growing loud speaker manufacturer located in New York City.

Salary commensurate with qualifications.

Submit complete resume.

Write to Box 353,
Cromwell Advertising Agency, Inc.
122 E. 42 St., New York 17

"TOPS" FOR DIELECTRIC HEATING...

*and other general
purpose rotary
coil uses*

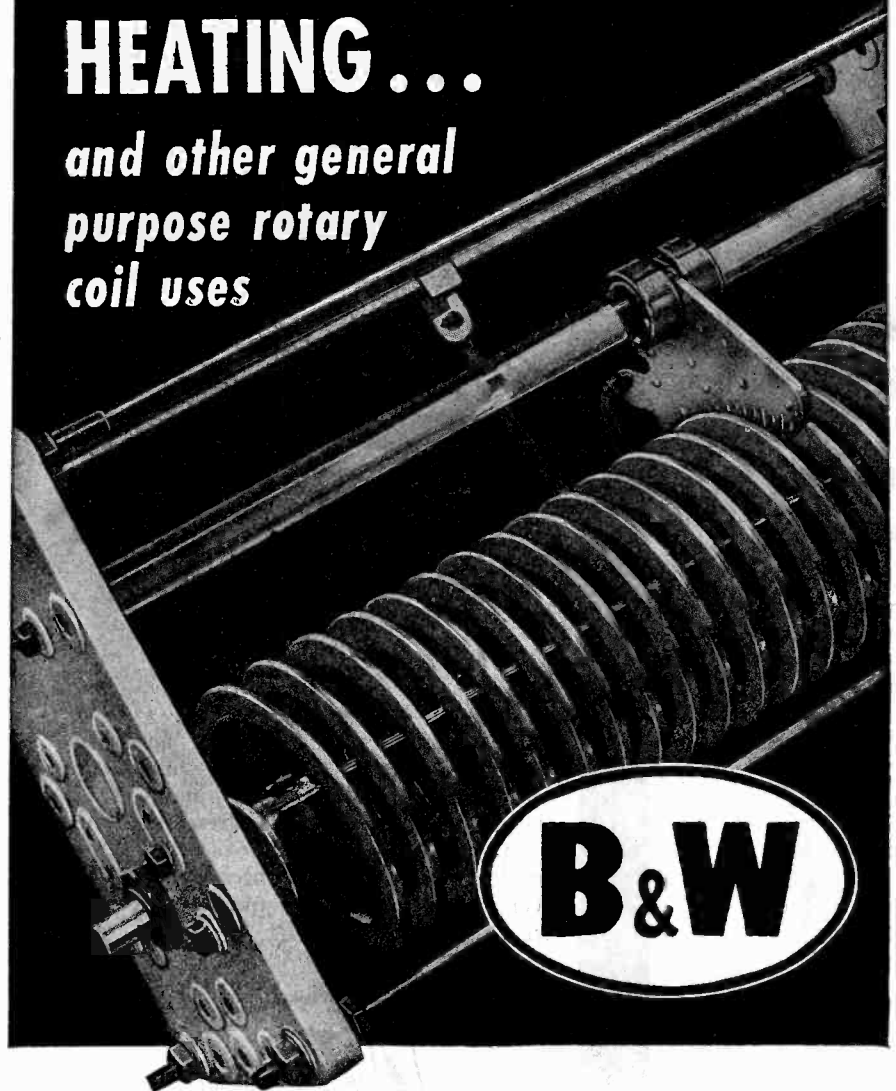

B & W has the answers to Inductor Coils of all types for Dielectric Heating uses! Many requirements can be matched by standard B & W heavy duty Air Inductors of which the big rotary coil illustrated above is

a typical example. Beyond these, more than a decade of specialized coil engineering experience is here at your disposal for the design of whatever type of special inductor your application may require.

CUSTOM AND PRODUCTION BUILT ELECTRONIC EQUIPMENT ASSEMBLIES



In addition to Air Inductors and Heavy-Duty Variable Capacitors, B & W offers specialized facilities for the design and production of custom-built electronic equipment such as special transmitters, test equipment, antenna tuning units, ultra-high frequency equipment, high voltage equipment, etc. Let us quote on your requirements.

BARKER & WILLIAMSON

AIR INDUCTORS • VARIABLE CONDENSERS • ELECTRONIC EQUIPMENT ASSEMBLIES

DEPT. IR-75, 235 FAIRFIELD AVENUE • UPPER DARBY, PA.

Export: LINDETEVES, INC., 10 Rockefeller Plaza, New York, N. Y., U. S. A.



TURNER *Microphones*

*A precision unit
for every job*

WHATEVER your need for accurate reproduction of voice, music or sound, there is a Turner Microphone especially adapted to your requirements. The complete Turner line includes dependable crystal and dynamic microphones for every communications purpose. A few are illustrated here.

211

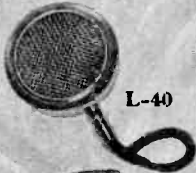

L-40



22X-D



33X-D



9X-D



99
999



Illustrated Turner catalog gives full details on all Turner Microphones for P.A., recording, sound system, commercial broadcast and amateur work. Get the full story of Turner performance and let Turner engineers help you select the units which meet your requirements. Write for catalog today.

The TURNER CO.



909 17th St. N.E., Cedar Rapids, Iowa

Crystals licensed under patents of the Brush Development Co.,



*Tapped
Controls*

★ Clarostat volume controls are obtainable with taps to meet usual requirements, in both standard and made-to-order values.

Twelve selected values, in resistance ranges from 250,000 ohms to 2 meg-ohms, with one or two taps, comprise the present standard line of composition-element tapped controls Type TCP. These standard numbers are listed in the Clarostat Interim Line (essential wartime servicing items). These midget controls are equipped with the original Ad-A-Switch feature. They facilitate replacement of standard tapped controls with the assurance that the total resistance value and tap satisfactorily match the original unit.



★ **Submit that problem . .**

If your problem has to do with resistors, controls or resistance devices, send it to us for engineering collaboration, recommendations, quotations.



CLAROSTAT MFG. CO., Inc. · 285-7 N. 6th St., Brooklyn, N. Y.

Proceedings of the I.R.E. July, 1945

IT'S NEW

A servo-type VOLTAGE CONTROL

SECO'S "POSITIONER" will enable you to remotely and accurately set the output voltage of a POWERSTAT variable transformer. Control wires between the "POSITIONER" and the motor operated POWERSTAT serve as an "electrical flexible shaft". This type of coupling means servo operation of the POWERSTAT variable transformer from a remotely located control dial.

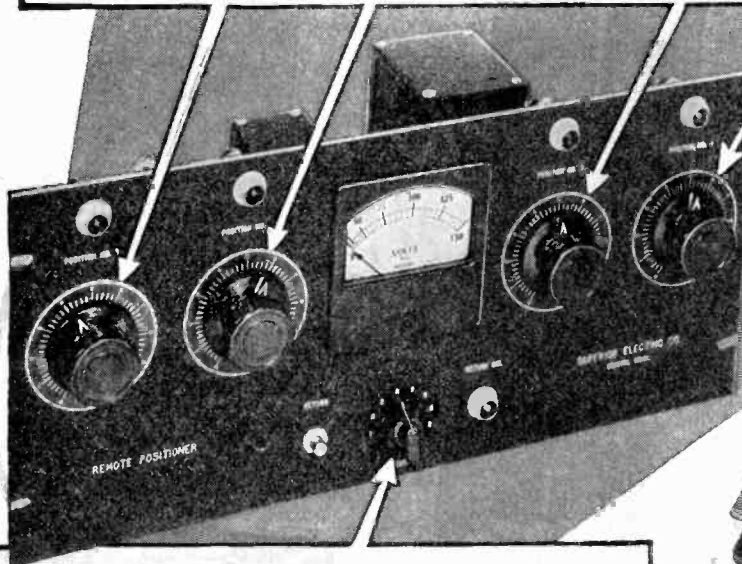

Manual, automatic or program selection of any one of a number of controls, makes for easy utilization of the POWERSTAT at any voltage or power level. The inherent accuracy of the control circuit makes it possible to return to preset levels with negligible error.

For maximum utilization of your equipment investigate the SECO "POSITIONER" and POWERSTAT Variable Transformer combination for... dielectric and induction heating, infra-red drying, photographic applications, and vacuum tube manufacture. Only SECO offers the motor-driven POWER-STAT Variable Transformer with SERVO control. SECO'S engineering staff will be pleased to assist with your applications.

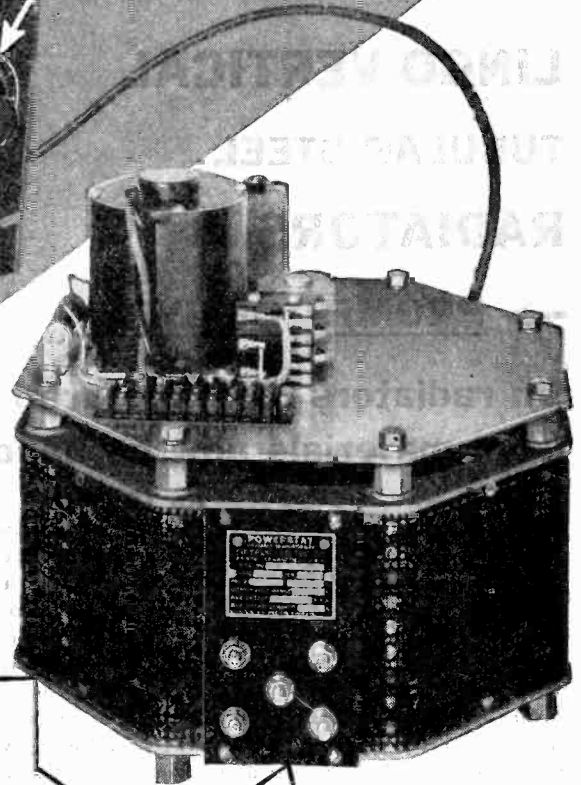

Send for
Bulletins ER

SUPERIOR ELECTRIC COMPANY
484 LAUREL STREET • **BRISTOL, CONNECTICUT**



FLASH!
Now Available Without Priorities

Place Your Order Now for

LINGO VERTICAL TUBULAR STEEL RADIATORS

→ PROMPT DELIVERY

On radiators manufactured from materials now on hand

Now, you can buy a LINGO Vertical Radiator without the use of priorities. Because of the limited amount of materials and components available, orders will have to be filled on a first-come, first-served basis. Until such materials are made available in greater quantities, production will have to be concentrated on radiators not exceeding 250 feet in height. If you are not ready to have the radiator installed at this time, we can arrange to manufacture and deliver the radiator to you with your option to have it installed and erected by us when you are ready. We urge you to act immediately and thus be assured of having your radiator on hand when you want it.

Please include in your inquiries the radiator height required and approximate site so that complete quotation can be made immediately covering the radiator itself and its subsequent erection when so desired.

JOHN E. LINGO & SON, INC.
Est. 1897
CAMDEN, NEW JERSEY

Performance Engineered TO THE Application

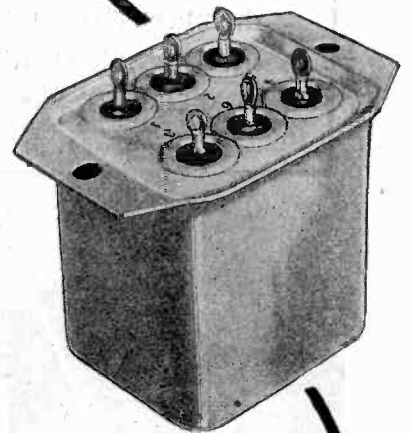

Hermetically sealed, output transformer. Terminals constructed of Pyrex glass with Kovar electrodes and metal collars. Designed and constructed to pass 5 cycle immersion test.

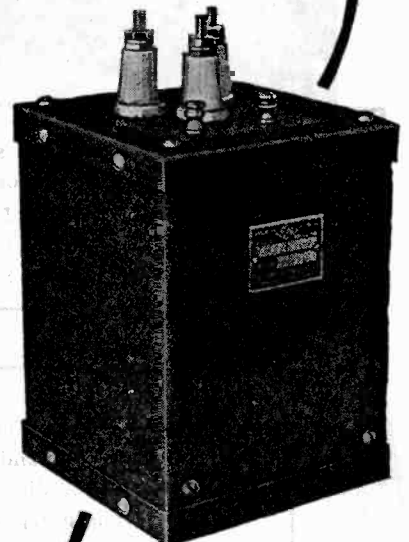

This type T-7029 Filament Transformer with H.V. insulators is one of many designs we have produced. Send your specifications.

THE ACME ELECTRIC & MFG. CO.
CUBA, NEW YORK • CLYDE, NEW YORK

Acme Electric
TRANSFORMERS

*Precision Methods
Followed*

BY SKILLED AND
TRAINED HANDS

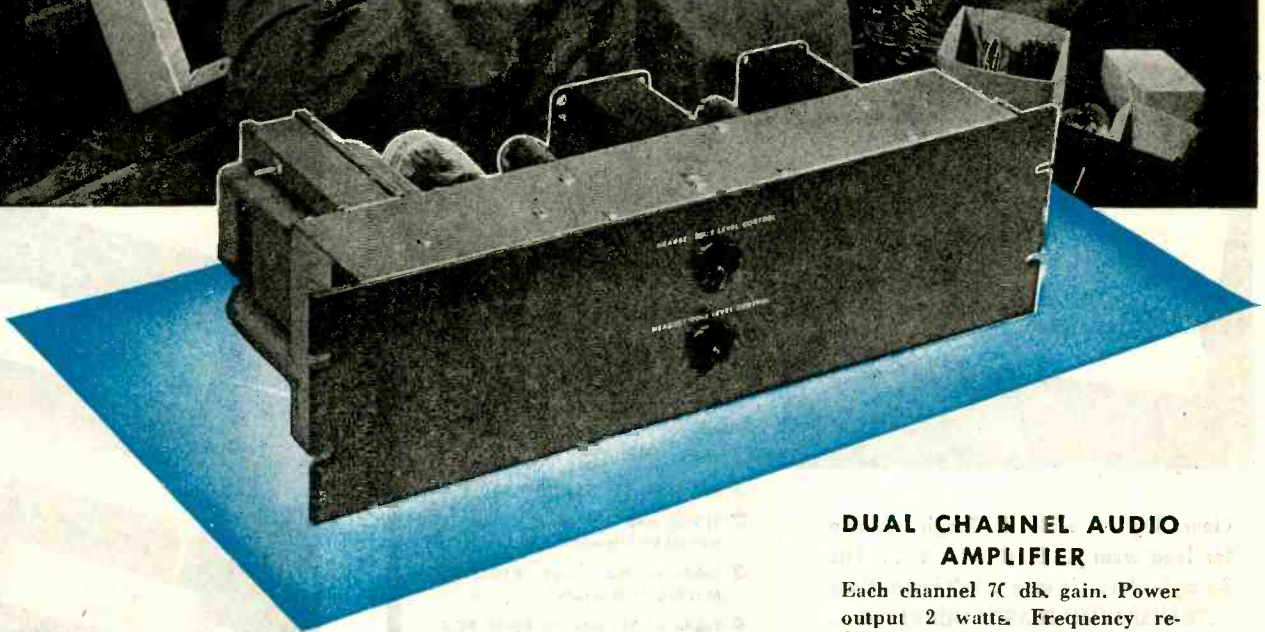
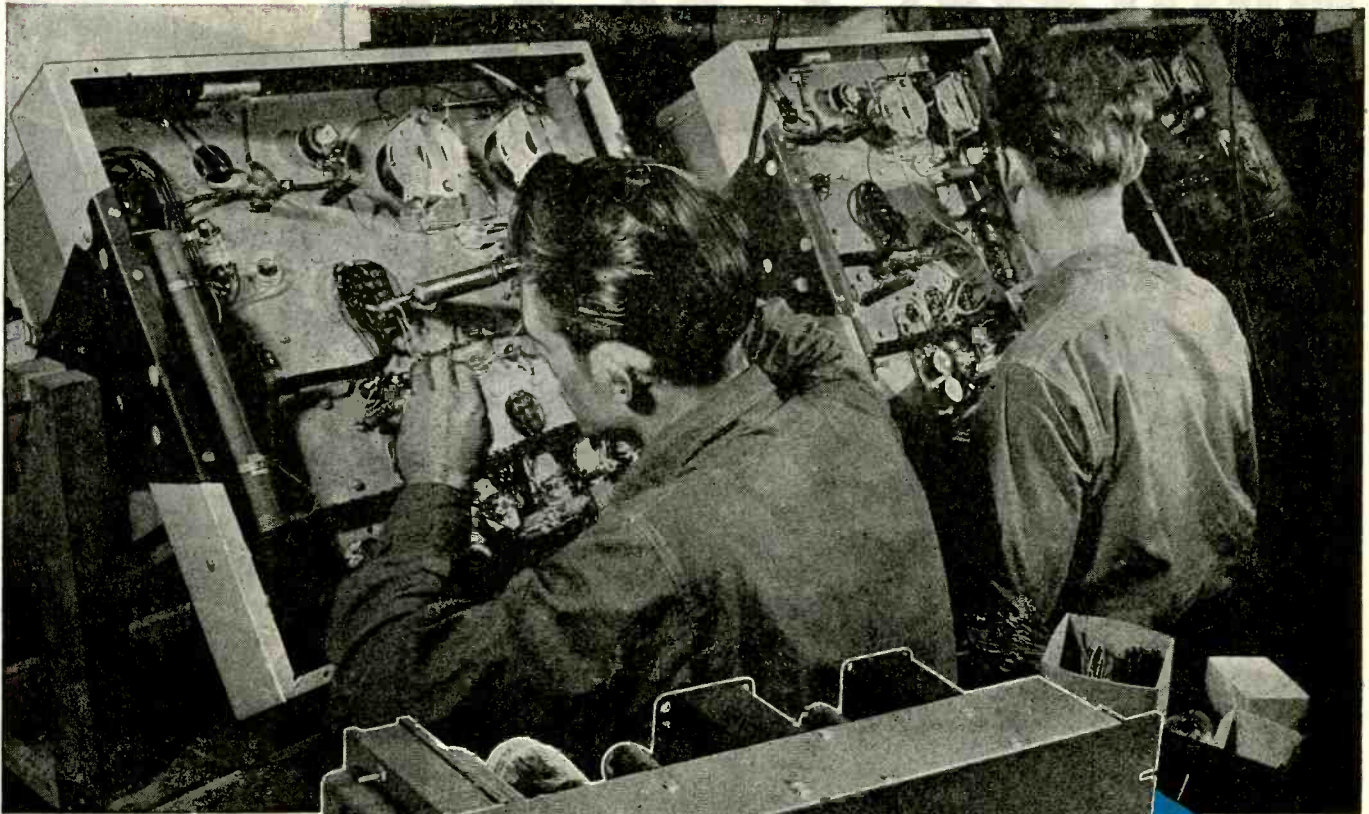

**DUAL CHANNEL AUDIO
AMPLIFIER**

Each channel 70 db gain. Power
output 2 watts. Frequency re-
sponse 200-7000 cycles.

For precision radio communications equipment, precision manufacturing is imperative. The equipment produced by Wilcox has reached a new standard of perfection for war-time communications and from this vast experience have come many new developments now being incorporated into post-war designs. Many items in this expanded and improved line are now available, subject to military priorities. Your inquiries invited.

WILCOX ELECTRIC COMPANY, INC.

Manufacturers of Radio Equipment

FOURTEENTH AND CHESTNUT

KANSAS CITY, MISSOURI



ENGINEERS! DRAFTSMEN! ACCOUNTANTS! STUDENTS!
ORDER TODAY! Sensational **NEW**

MULTI Slide Rule

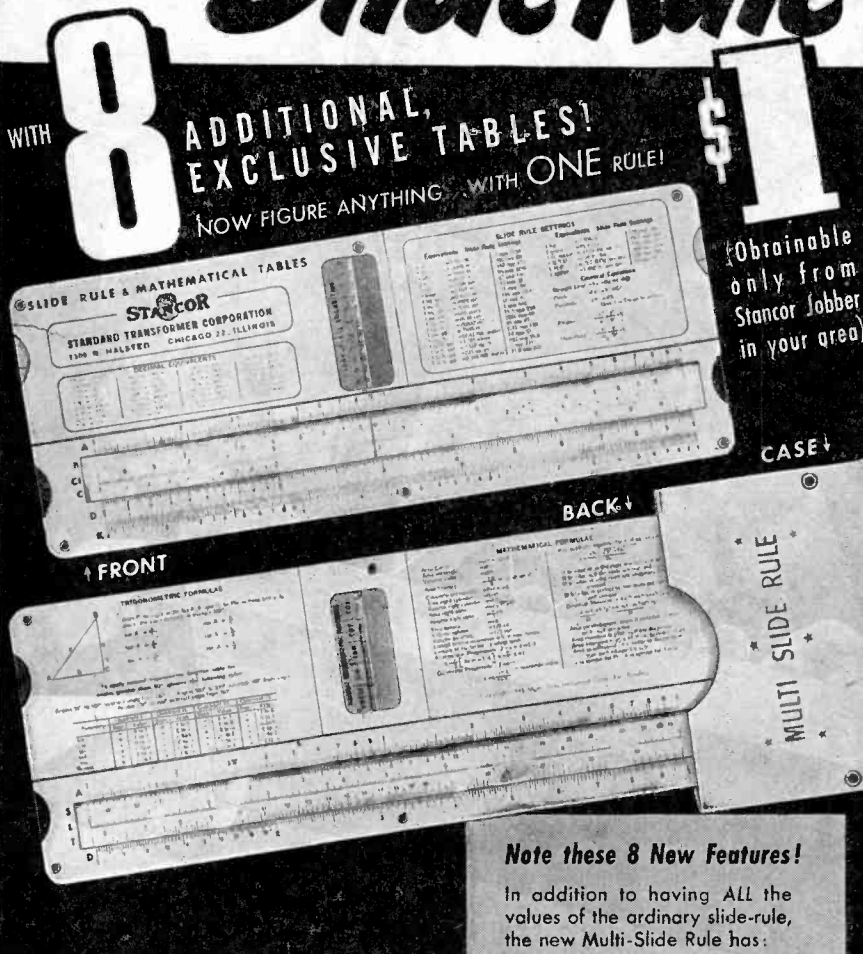

Clear, legible print... Tough, durable for long wear... Size 10" x 4"... Fits 3-ring binder... In case... Full instructions... **...TRANSPARENT PLASTIC INDICATOR...**

STANCOR now offers the entire electronic industry the new Multi-Slide Rule. First developed for our own use, it is today made available to all... Greatly simplifies calculation of unlimited range of problems... A genuine professional rule—not a toy. This rule is obtainable **ONLY THROUGH STANCOR JOBBERS. PLEASE DO NOT ORDER DIRECT.** See your local directory for the name of the Stancor jobber in your city or, write for his name. Price of Stancor Multi-Slide Rule: One Dollar!—America's biggest slide-rule bargain—a service to the trade by Stancor.

STANDARD TRANSFORMER CORPORATION
 1500 N. HALSTED ST. CHICAGO 22, ILL.

ORDER FROM YOUR JOBBER

Note these 8 New Features!

In addition to having ALL the values of the ordinary slide-rule, the new Multi-Slide Rule has:

- 1 Four-place LOGARITHM TABLE
- 2 SIGNS and LIMITS of VALUE assumed by trigonometric functions
- 3 Table of NATURAL TRIGONOMETRIC FUNCTIONS
- 4 Table of TRIGONOMETRIC FORMULAE
- 5 Table of SLIDE-RULE SETTINGS
- 6 Table of GENERAL EQUATIONS
- 7 Long list of common MATHEMATICAL FORMULAE
- 8 DECIMAL equivalents of a fraction

OFFERED AS A SERVICE TO THE TRADE BY

STANCOR

HI-Q
 A NEW NAME

FOR
 HIGH QUALITY
 CERAMIC
 CAPACITORS

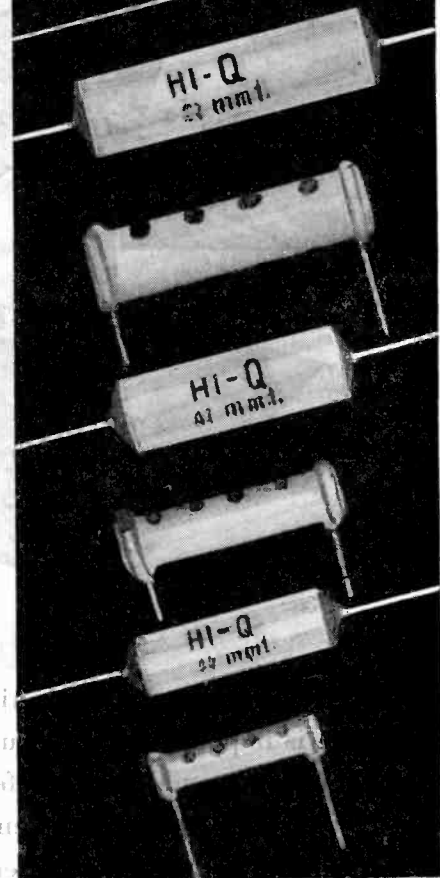

**ELECTRICAL
 REACTANCE
 CORPORATION**
 FRANKLINVILLE, N. Y.

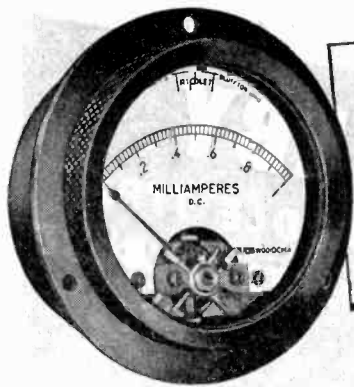

Introducing the
NEW TRIPLETT LINE
of
HERMETICALLY SEALED INSTRUMENTS

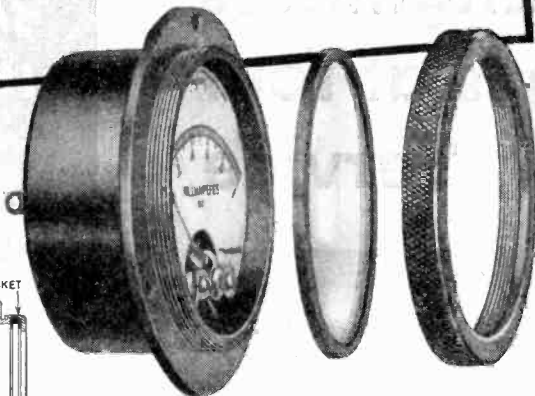

All the features of standard instruments retained. Withstand submersion tests at 30 feet. Comply with thermal shock, pressure and vibration tests. Resistant to corrosion. Conform to S.C. No. 71-3159 and A.W.S. C-39.2-1944 specifications. 1½", 2½" and 3½" metal cases with 1/16" thick walls, in standard ranges. D.C. moving coil, A.C. moving iron and thermocouple types. Write for circular.

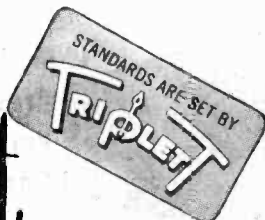
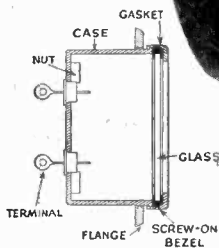

Triplet

ELECTRICAL INSTRUMENT CO. BLUFFTON, OHIO

CAPACITOR QUESTIONS Answered!

JUST OUT!

"THE ELECTROLYTIC CAPACITOR"

by Alexander M. Georgiev

Probably no Radio-Electronic component is more important than the Electrolytic Capacitor, and this new book by Alexander M. Georgiev who has devoted more than 15 years to Capacitor research and development answers all the many questions engineers, designers, servicemen and others have been asking about this subject. Abundant data is presented as to Electrolytic Capacitor constructional features—where, when and how to use them to obtain the best advantage in preference to non-electrolytic types—in short, everything you need to know in order to utilize, buy, specify, replace, or service Capacitors intelligently and efficiently. Contains over 200 pages and eighty illustrations including graphs, photomicrographs, oscillograms, etc. Just out in limited wartime edition—the first modern book to be written on this vital Radio-Electronic component! Order today while the supply lasts!

**WHAT TYPE?
WHY?
WHERE?**

\$3.00 (\$3.25 foreign)

ALL THE FACTS ON A LITTLE KNOWN SUBJECT

Electrolytic Capacitor Construction; Characteristics; Advantages; Applications; Operation at low and high voltages and frequencies; a-c or pulsating d-c; ambient conditions; wet versus dry; electrolytics versus non-electrolytics; behavior of various types; choosing the best type for a given application and operating conditions; servicing; testing; replacement and emergency repairs—and dozens of other subjects of foremost interest to all who design, handle, or service equipment incorporating capacitors.

ORDER NOW!

Technical Division, MURRAY HILL BOOKS, Inc., Dept. IRE 75, 232 Madison Ave., New York 16, N.Y.

Enclosed find \$..... for copies of Alexander M. Georgiev's "THE ELECTROLYTIC CAPACITOR" (Price \$3 each, \$3.25 foreign) or send C.O.D. (In U.S.A. only) for this amount plus postage.

Name

Address

City & Dist. No. State

Our New Booklet—
"MERIT SALUTES THE SIGNAL CORPS"
with illustrations in Four colors is now available
Please write for your copy

MERIT COIL & TRANSFORMER CORP.
TELEPHONE
4427 North Clark St. Long Beach 6311 CHICAGO 40, ILL.

"Our Staff of Acoustical Engineers is at Your Service"



**L. M. Heineman
President
Permoflux
Corporation**

Permoflux engineering is directly responsible for many history-making war communication improvements. Our dynamic headphones, speakers, microphones, midget transformers and other acoustical products have made notable contributions in performance, dependability and progressive design.

If in your development of communication equipment requiring acoustical components, you are interested in availing yourself of exceptional engineering, design and manufacturing talent, we invite you to turn over your problems to us. Our staff of competent acoustical engineering experts is ready and able to give you immediate cooperation.

TRADE MARK
PERMOFLUX
PERMOFLUX CORPORATION
4900 WEST GRAND AVE., CHICAGO 39, ILL.



PIONEER MANUFACTURERS OF PERMANENT MAGNET DYNAMIC TRANSDUCERS

EBY
SADDLE TYPE
MINIATURE TUBE
SOCKETS

AVAILABLE IN

GENERAL PURPOSE
PHENOLIC (EBY #8100) →



LOW LOSS PHENOLIC
(EBY #8082) →

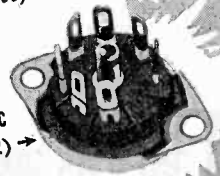

STEATITE
(EBY #8083) →

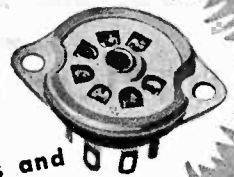

The castings and beryllium copper contacts are identical with JAN 5-28 Types SO 10M and SO 10C except that the shield base is replaced with a saddle. These EBY sockets meet the need for quality replacement of sockets of the saddle type. Write today for prices and samples.

LONG LIFE CONTACTS

The self-aligning beryllium copper contacts have been especially designed and Micro-processed to assure constant, even pressure on all parts of the socket pin without fatigue in contacts after continuous use.

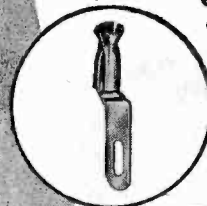

IF IT'S IN A CIRCUIT
... EBY COMPONENTS
AND SERVICES WILL
HELP YOU DO IT BETTER

HUGH H.
EBY
INCORPORATED
10 W. CHELTENAVE.
PHILADELPHIA, PA.



**A
GREAT PAST
LINKED TO**

**A
GREATER
FUTURE
1895 - 1945**

THORDARSON

*celebrates its 50th. Anniversary
by joining hands with*

MAGUIRE INDUSTRIES

Throughout the past half century, the name "THORDARSON" has been a synonym for highest quality in transformers and other electrical equipment.

Under the banner of Maguire Industries, this tradition of leadership will be maintained in even fuller measure.

Thordarson's new plans include outstanding improvements in present lines... new products and services to meet the expanding needs of the radio and electronic industries... vigorous and liberal merchandising policies... and a generally forward-looking viewpoint with regard to all of the industries we are privileged to serve.



A Subsidiary of Maguire Industries

THORDARSON
ELECTRIC MFG. COMPANY
500 WEST HURON STREET
CHICAGO 10, ILLINOIS

PHASE SHIFT DEVICES
 CARRIER SYSTEMS
 AUDIO SYSTEMS
 FILTER SYSTEMS
 SPECIAL BRIDGE CIRCUITS
 SUPERSONIC FREQUENCY COMPONENTS
 SUPERSONIC FREQUENCY SYSTEMS



MINDPOWER
at work!



Specialized mindpower — specialized techniques —
 at work creating *specialized* products for every appli-
 cation in the electronic and communications fields.
 Freed's exceptional record for meeting and exceeding
 the toughest requirements for transformers ordered
 by the Armed forces was made possible by exclusive
 laboratory facilities and manufacturing techniques
 which have developed new and important contribu-
 tions for peacetime use. If your problems require
 highly trained mindpower, Freed's facilities are avail-
 able to you.



FREED TRANSFORMER CO.

72D SPRING STREET
 NEW YORK 12, N. Y.

PREMAX

For
Police
 and other
Mobile Uses



PREMAX
ANTENNAS
 AND
MOUNTINGS

Premax Antennas, in either the solid metal "whip" types or the Tubular Metal Adjustable Types, are performing outstanding service on police, fire, forestry and other mobile units the world over.

Sturdy, rugged, yet light in weight, these Antennas in standard and special styles will answer practically every installation problem.

Send for
 Specifications
 and
 Prices

RADIO
ANTENNA

Premax Products

Division Chisholm-Ryder Co., Inc.
 4503 Highland Ave. Niagara Falls, N.Y.

Proceedings of the I.R.E. July, 1945



QX CHECKER

TYPE 110-A

A dependable

TEST AND MEASURING INSTRUMENT

The factory counterpart of the Q-Meter. Compares fundamental characteristics of inductance or capacitance and Q under production line conditions with a high degree of accuracy, yet quickly and simply. Insures uniform parts held within close tolerances. Frequency range 100 kc. to 25 mc.





BOONTON RADIO

BOONTON, N. J. *Corporation*

DESIGNERS AND MANUFACTURERS OF THE "Q" METER . . . QX-CHECKER . . . FREQUENCY MODULATED SIGNAL GENERATOR . . . BEAT FREQUENCY GENERATOR . . . AND OTHER DIRECT READING TEST INSTRUMENTS



METAL-TO-GLASS SEALS

Intricate glass work and tubes made to your specification

The Universal X-Ray plant specializes in the production of metal-to-glass seals. Intricate glass seals are made to customers' specifications for electronic tubes, transformers, resistors, capacitors, condensers, vibrators, switches, relays, instruments, gauges, meters, receivers, transmitters, and other scientific apparatus.

A strong metal-to-glass bond assures unflinching protection against rust, corrosion, and extreme climatic conditions in a vacuum-tight seal. Good deliveries can be made on volume orders. Submit your metal-to-glass seal problems to the Universal engineers for recommendations and estimates.

UNIVERSAL X-RAY PRODUCTS INC.

1800-KN, FRANCISCO AVENUE CHICAGO 47, ILLINOIS

WIRE, RIBBON and other METAL PRODUCTS

- Smaller than Commercial Sizes
- Closer than Commercial Tolerances

PLATINUM · RHODIUM · IRIIDIUM
PALLADIUM · RUTHENIUM
and ALLOYS

Commercial Purity and High Purity
WIRE, SHEET, FOIL, TUBING
Wire for Resistance Thermometers
Rhodium Electroplating Solutions
Platinum for Electronic Tubes
Rhodium First Surface Mirrors
Alloys for Contact Points
Wires for Detonator Fuses
Dental Metals and Alloys
Wires for Thermocouples
Tubing for Ink Devices
Wire for Pirani Gauges
Spark Plug Electrodes
Wollaston Wire
Duro Palladium

BASE METALS · RARE METALS
PRECIOUS METALS and ALLOYS

Galvanometer Suspension Strips
Platinum-Covered Grid Wire
Gold Covered Silver Wire
Gold Cyanide for Plating
Special Melts and Alloys
Gold Covered Grid Wire
Small Spring Ribbon
Electroplated Wires
Ribbon, All Metals
Molybdenum Ribbon
Tungsten Ribbon
Filament Ribbon
Filament Wire
Fuse Wire
Grid Wire

Write for List of Products and Data

SIGMUND COHN & CO.



44 GOLD STREET NEW YORK 7

The Little **GIANT**

FEDERAL'S *New* LEVER KEY

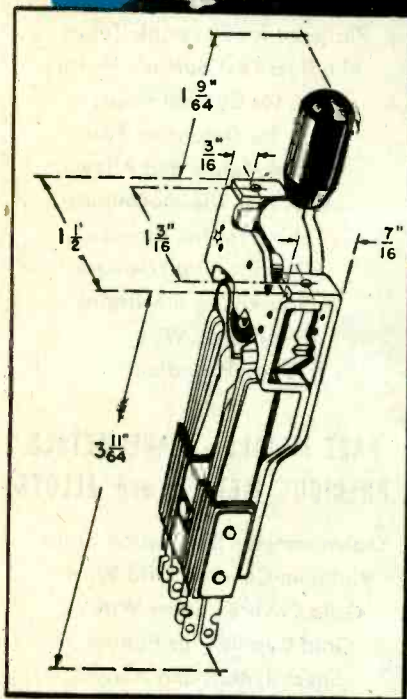
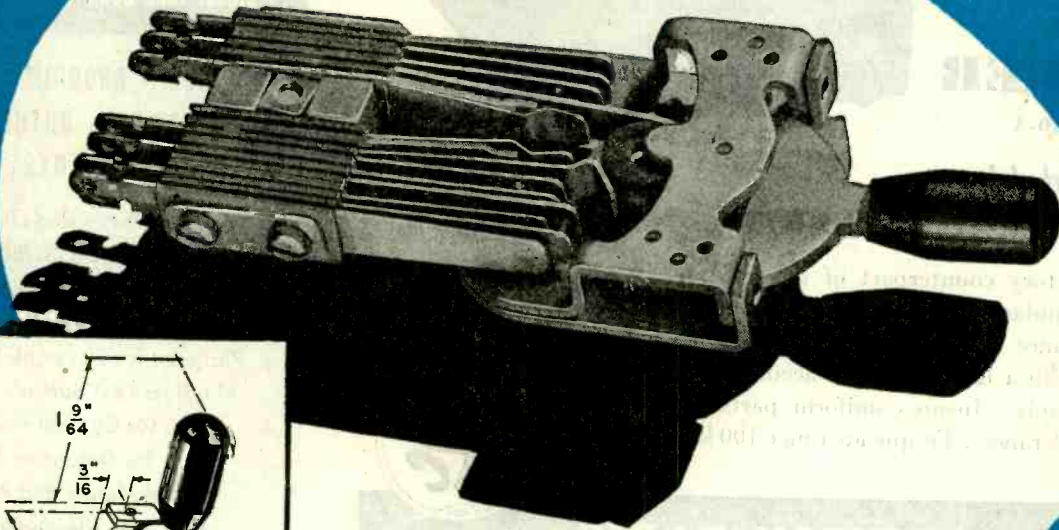

- Small Size— $\frac{5}{8}$ " horizontal mounting centers.
- Large Spring Capacity — 18 springs; over 500 possible combinations.
- Palladium Contacts . . . Nickel Silver Springs.
- High-Quality Phenol fibre Insulation.
- Universal Cam — 1 or 2 way — locking or non-locking.
- Free-Moving Roller . . . Positive Snappy Action.

Designed for finger-tip control of electronic and communications equipment where size is important, the FTR-810 Series Lever Key occupies less than half the horizontal mounting space required for older types.

And at the same time, its eighteen nickel-silver springs and low-resistance palladium cross-bar contacts permit more than five hundred possible switching combinations.

High-quality phenol fibre insulated throughout, the overall simplification in design has resulted in a more rugged, dependable lever key with a positive, snappy action that once set — stays set.

The universal cam has an unusually long bearing surface for smooth action and long life . . . for either locking or non-locking operation . . . one or two-way, simply by a change in position of the stop pins.

Here is another compact component by Federal with a wide variety of applications in control circuits, and another reason to see Federal first for electronic and communications equipment.



Federal Telephone and Radio Corporation



Newark 1,
New Jersey

Membership

(Continued from page 48A)

Shipley, W. W., Jr., U.S.N. Radio and Sound Laboratory, San Diego 7, Calif.
 Sigonowick, J., 406 Prospect Ave., Hackensack, N. J.
 Sive, F., P.O. Box 7919, Johannesburg, South Africa
 Smith, C. N., 3325 Nichols Ave., S.E., Washington 20, D. C.
 Spencer, C. H., 215 W. Walnut La., Philadelphia 44, Pa.
 Stanbery, J. F., 129B Hillcrest Ave., Collingswood, N. J.
 Stein, A. J., 73 Grand St., Reading, Mass.
 Stopps, R. E., Room 227, Hunter Bldg., Ottawa, Ont., Canada
 Stafford, C. I., 1774 N. Troy St., Arlington, Va.
 Ströman, C. F., Plant Engineering Agency, 17 and Sansom Sts., Philadelphia 3, Pa.
 Tarkoff, P. B., 2814 Keyworth Ave., Baltimore 15, Md.
 Thiel, W. L., 96 Westbury Blvd., Hempstead, L. I., N. Y.
 Thompson, E. J., 3834 Bailey Ave., Bronx 63, N. Y.
 Tompkins, H. E., Box 507, RFD 3, Media, Pa.
 Tucker, J. R., 13431—1 Ave., Seattle, Wash.
 Uzzell, W. C., 215-11—111 Ave., Queens Village 9, L. I., N. Y.
 Van de Vord, A., Jr., 312 E. Tioga St., Philadelphia 34, Pa.
 Van Deusen, R. K., 3126 Amherst Ave., Lorain, Ohio
 Veals, T. A., 802 Windermere Ave., Drexel Hill, Pa.
 Walborn, D. E., c/o Fleet Post Office, San Francisco, Calif.
 Walker, L. C., 8 Eastern Blvd., Baldwin, L. I., N. Y.
 Warner, V. S., 15044 Lamphere Rd., Detroit 23, Mich.
 Weis, C. F., 418 Stonemill Rd., Dayton 9, Ohio
 Wellemeier, H. A., Div. 12-I (Radio), USN Naval Repair Base, San Diego 36, Calif.
 Wells, G., 146 Hillcrest Ave., Montreal West, Montreal 28, Canada
 Welsh, W., 91 Lees Ave., Ottawa, Ont., Canada
 Wetter, A., 8R Plateau Pl., Greenbelt, Md.
 Wilkerson, J. A., 3747 N. Port Washington Ave., Milwaukee 12, Wis.
 Wood, G. W., Physics Dept., Louisiana State University, Baton Rouge 3, La.
 Yingling, R. A., 8133 Highland Pl., Munster, Ind.
 Young, P. D., 1105 S. 4 St., Columbus 6, Ohio
 Zagotta, A. C., 12240 Yale Ave., Chicago, Ill.
 Zee, D. M., 726 Cooper St., Camden, N. J.

M. F. M. Osborne Associates Consulting Physicists

Fluid Dynamics, Mechanics, Electronic Design, Electromagnetic and Acoustic Wave Propagation, Mathematical Analysis.
 703 Albee Bldg., Washington 5, D.C.
 Atlantic 9084

FRANK MASSA

Electro-Acoustic Consultant
 DEVELOPMENT PRODUCTION DESIGN
 PATENT ADVISOR
 ELECTRO-ACOUSTIC & ELECTRO-MECHANICAL
 VIBRATING SYSTEMS
 SUPERSONIC GENERATORS & RECEIVERS
 3393 Dellwood Rd., Cleveland Heights 18, Ohio

STANLEY D. EILENGERBER Consulting Engineer

INDUSTRIAL ELECTRONICS

Design—Development—Models

Complete Laboratory and Shop Facilities
 6309-13—27th Ave.
 Kenosha, Wis. Telephone 2-4213

NOW IT CAN BE TOLD!



Comco builds the smallest combat WALKIE-TALKIES

Comco Walkie-Talkies are not "war babies." They were first built for *civilian* use . . . for use by mounted policemen . . . *before* the war.

That's why Comco Walkie-Talkies for war boast so many practical superiorities. They are the smallest, most compact of all combat Walkie-Talkies. Their weight complete is *less than eight pounds!*

Comco has built thousands of these remarkably compact units for our fighting forces. And Comco is prepared to build peacetime Walkie-Talkies to meet a wide variety of needs, some of which are suggested in the column at the right.

Comco engineers and craftsmen, in the peacetime days ahead, will also produce many other types of radio and electronic equipment—all CUSTOMIZED for dependability and lasting satisfaction.

WRITE! Just a note on your company letterhead outlining your exact requirements. We'll give you the benefit of our specialized experience. We can supply a wide variety of CUSTOMIZED equipment on priority NOW. We are accepting non-priority orders for post-war delivery.

Customized

FOR MANY
POST-WAR USES



Fire Fighters



Railroading



Forest Service



Public Utilities

MANUFACTURERS OF RADIO & ELECTRONIC EQUIPMENT



COMMUNICATIONS COMPANY, Inc.

CORAL GABLES 34, FLORIDA

YOU WILL RECOMMEND THE NEW

Introduction to Practical Radio by

DURWARD J. TUCKER

BECAUSE this book teaches the indispensable fundamentals of radio in an *exceptionally thorough* manner. It gives the beginner that *complete mastery* of all the essential principles and their chief applications, including the mathematics constantly used in radio, that you know is necessary for radio engineering.

If you are training radio engineers, let us send you a free copy to examine. The price is \$3.00.

The Macmillan Co., 60 Fifth Ave.
New York 11

NO PRIORITY

For Harco Radio MASTS & TOWERS

Revocation of Order M-126 permits manufacturing from surplus inventories. We have adequate surplus stocks to make...

**IMMEDIATE
SHIPMENTS**

HARCO

CO. INC.

ELIZABETH 4, NEW JERSEY

Catalog mailed on request

INDEX

Section Meetings	36A
Membership	38A
Positions Open	50A

DISPLAY ADVERTISERS

Acme Electric & Mfg. Co.	60A
Aireon Mfg. Corp.	1A
Airplane & Marine Instruments, Inc.	50A
Alliance Mfg. Co.	36A
Allied Radio Corp.	46A
Altec Lansing Corp.	45A
American Lava Corp.	4A
American Tel. & Tel. Co.	4A
American Transformer Co.	21A
Amperex Electronic Corp.	Cover II
Andrew Company	38A
Arnold Engineering Co.	11A
Aviometer Corp.	8A
Barker & Williamson	57A
Blaw-Knox Company	41A
Boonton Radio Corp.	67A
Centralab	10A
Chicago Transformer	48A
Clarostat Mfg. Co.	58A
Sigmund Cohn & Co.	67A
Collins Radio Co.	15A
Communications Co., Inc.	69A
Continental-Diamond Fibre Co.	26A
Cornell-Dublier Electric Corp.	Cover III
Corning Glass Works	17A
Coto-Coil Company, Inc.	42A
Daven Company	13A
De-Jur-Amsco Corp.	14A
Tobe Deutschmann Corp.	71A
Allen B. DuMont Labs.	16A
Hugh H. Eby, Inc.	64A
Eicor Inc.	45A
Stanley D. Eilenberger	69A
Eitel-McCullough, Inc.	72A
Electrical Reactance Corp.	62A
Electronic Engineering Co.	54A
Electronic Mechanics, Inc.	23A
Federal Tel. & Radio Corp.	3A, 51A, 68A
Freed Radio Corp.	52A
Freed Transformer Co.	66A
General Electric Co.	19A
General Instrument Corp.	49A
General Radio Co.	Cover IV
Guardian Electric Mfg. Co.	29A
Hallcrafters Co.	6A
Harco Company, Inc.	70A
Harvey Radio Labs, Inc.	33A
Hazeltine Corp.	50A
Heintz & Kaufman, Ltd.	20A
Hewlett-Packard Co.	24A
Hytron Radio & Electronics Corp.	25A
Industrial & Commercial Electronics	43A
Industrial Condenser Corp.	44A
International Tel. & Tel. Corp.	3A, 51A, 68A
Jennings Radio Mfg. Co.	47A
E. F. Johnson Co.	22A
Ken-Rad Tube & Lamp Div.	28A
Kenyon Transformer Co., Inc.	30A
Kyle Corp.	40A
John E. Lingo & Son, Inc.	60A
Litton Engineering Labs.	53A
Macmillan Company	70A
Frank Massa	69A
Measurements Corp.	54A
Merit Coil & Transformer Co.	63A
Murray Hill Books, Inc., Tech. Div.	63A
National Carbon Co., Inc.	32A
National Company	31A
M.F.M. Osborne Associates	69A
Permoflux Corp.	64A
Premax Products	66A
Press Wireless, Inc.	52A
Radio Corp. of America	Facing 32A, Facing 32D, 34A, 35A
Rauland Corp.	70A
Raytheon Mfg. Co.	52A
Remier Co., Ltd.	18A
Santay Corp.	39A
Shallcross Mfg. Co.	51A
Skydyne, Inc.	54A
Sprague Electric Co.	12A
Standard Transformer Corp.	62A
Stromberg-Carlson Tel. Mfg. Co.	52A
Stupakoff Ceramic & Mfg. Co.	2A
Sun Radio & Electronics Co.	70A
Superior Electric Co.	59A
Templetone Radio Mfg. Corp.	56A
Thordarson Elec. Mfg. Co.	65A
Triplett Elec. Inst. Co.	63A
Turner Company	50A, 58A
United Transformer Corp.	7A
Universal X-Ray Products, Inc.	67A
Utah Radio Products Co.	27A
Western Electric Company	50A
Westinghouse Electric Corp.	9A, 37A
Wilcox Electric Co., Inc.	61A

You
CAN FIND
YOUR
RADIO
NEEDS
at
SUN RADIO



OVER 10,000
ITEMS IN STOCK
FOR IMMEDIATE
DELIVERY!

★
America's
most complete
Radio
Electronic Supply House

RADIO
PARTS
TUBES
ELECTRONIC
EQUIPMENT

FREE
800 Page
Buying Guide

Available solely to
authorized purchas-
ing agents and en-
gineers who write
to us on company
letterhead. Address
Box JR

★
PHONE
BR 47 1840

**SUN RADIO
& ELECTRONICS CO.**
212 Fulton Street, New York 7, N. Y.

Electroneering

... is the RAULAND
word for the finest
in electronics from
research through
engineering to the
finished product.

THE RAULAND CORPORATION
CHICAGO 41, ILLINOIS

Rauland

RADIO...RADAR...SOUND
COMMUNICATIONS...TELEVISION

Weigh the Advantages

of MOLDED OIL PAPER CAPACITORS



NOTE THESE FACTS

Molded oil-paper capacitors, first used as a "make-shift" for mica units, have now earned a place of their own in electronics—meriting their serious consideration in new product designs. With greater capacitance in any case size, properly processed molded paper capacitors have extremely low series resistance and can carry relatively large R.F. currents. Their high shunt resistance, maintained through the moisture-proof sealing of eli units, suits them to A.F. applications at all usual plate voltages.

CAPACITANCES: 1000 to 50000 mmfd.
 WORKING VOLTAGES: 120 to 800 v.d.c.
 SIZES: CN20 and CN35



FIELD OFFICES IN NEW YORK CITY • CHICAGO • DETROIT • GLENDALE, CALIFORNIA

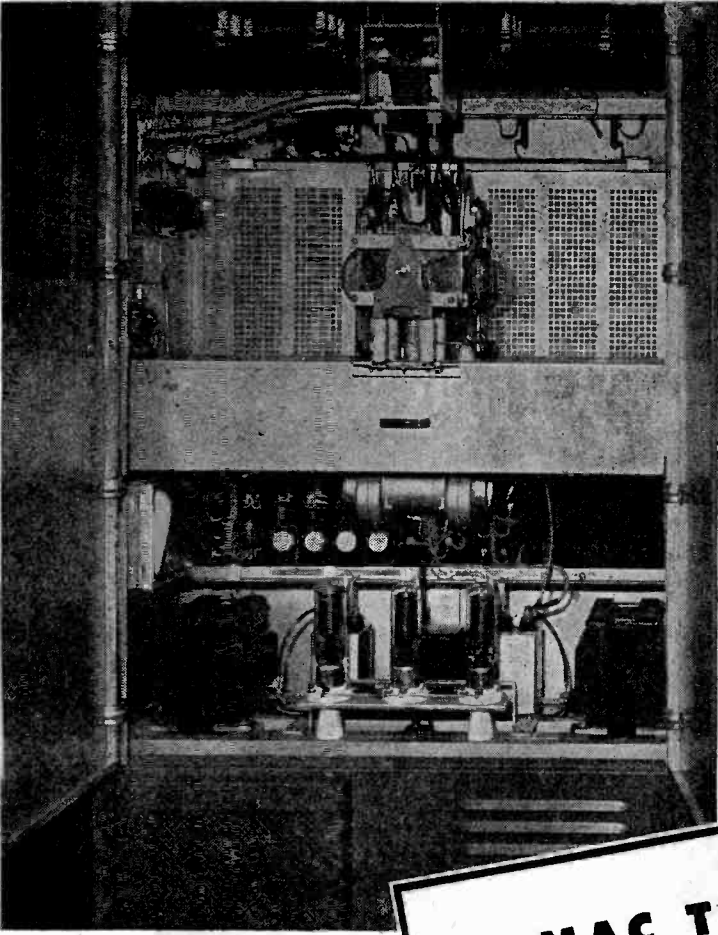

A pair of Eimac 1000-T's give 3 KW output in this Link-built FM transmitter for the emergency services.

Here's a 500 watt supersonic test generator for operation at 1 to 300 kc which uses Eimac 152-T tubes.

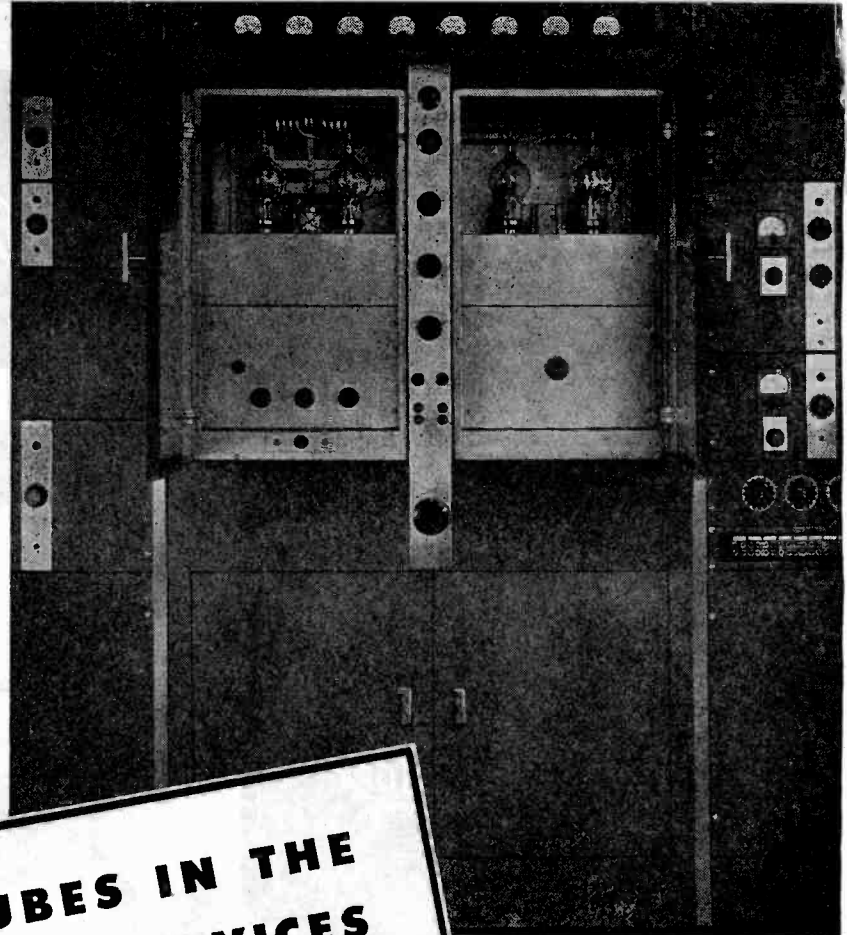

500 watt AM police transmitter for 30-40 Mc operation, built by Fred M. Link, using Eimac 250-TH tubes in the final.

**EIMAC TUBES IN THE
EMERGENCY SERVICES
WHERE DEPENDABLE
PERFORMANCE COUNTS!**

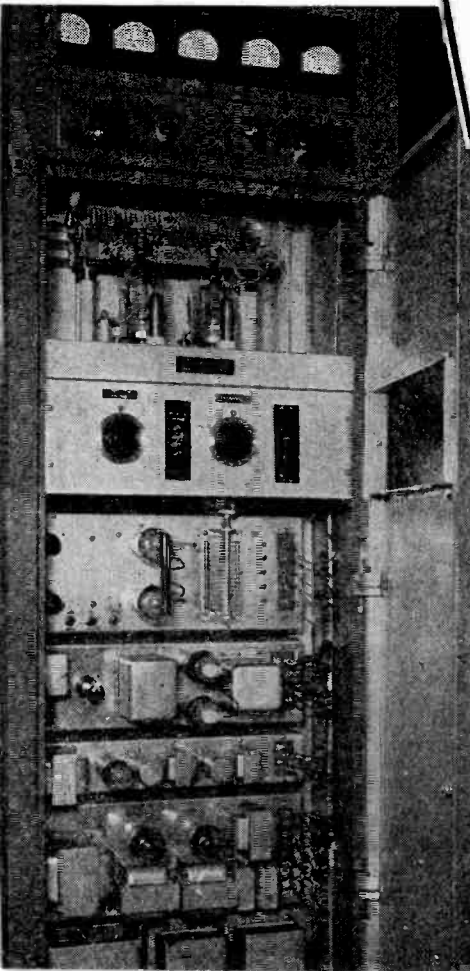

The transmitters shown on this page were developed and built for the emergency services — police, fire and transportation — by Link Radio Corporation of New York City. Recognition such as that enjoyed by the Link organization in this field is built upon sound engineering and the right choice of equipment components. That Eimac tubes occupy the important sockets in these vital transmitters is fitting acknowledgement of their inherently superior performance capabilities. That Fred M. Link specifies Eimac tubes is confirmation of the fact that Eimac tubes are first choice of leading electronic engineers throughout the world.

FOLLOW THE LEADERS TO

Get your copy of Electronic Telesis ... the sixty-four page booklet which gives the fundamentals of electronics. This little booklet will help electronic engineers explain the subject to laymen. It's yours for the asking ... no cost or obligation. Available in English and Spanish languages.



EITEL-McCULLOUGH, INC., 1033 San Mateo Ave., San Bruno, Calif.
Plants located at: San Bruno, California and Salt Lake City, Utah
Expert Agents: Frazer & Hansen
301 Clay Street, San Francisco 11, California, U. S. A.

checked by men who know



Here this Cornell-Dubilier series 50 capacitor is checked to make sure that the current and frequency ratings are correct.

This is one of many routine production tests to safeguard the quality and reliability of C-D Capacitors.

It is responsibility, not novelty, that makes C-D craftsmen so intent on the outcome of this test. This capacitor has a reputation to live up to . . . it must be capable of sustained performance, continuously, under heavy duty.

This preoccupation with the details that make for perfection has rated C-D capacitors the finest by men who know and use them. The name Cornell-Dubilier is their guarantee of better-than-specified quality. You, too, can depend on them.

If you have a capacitor problem, one of our basic innovations in design, engineering or manufacture may be the answer. Write to Cornell-Dubilier Electric Corporation, South Plainfield, N. J. Other Plants at New Bedford, Brookline, Worcester Mass. and Providence, R. I.

**CORNELL-DUBILIER
CAPACITORS**



MICA • DYKANOL • PAPER • ELECTROLYTICS

PRECISION to 0.000070 Inch!

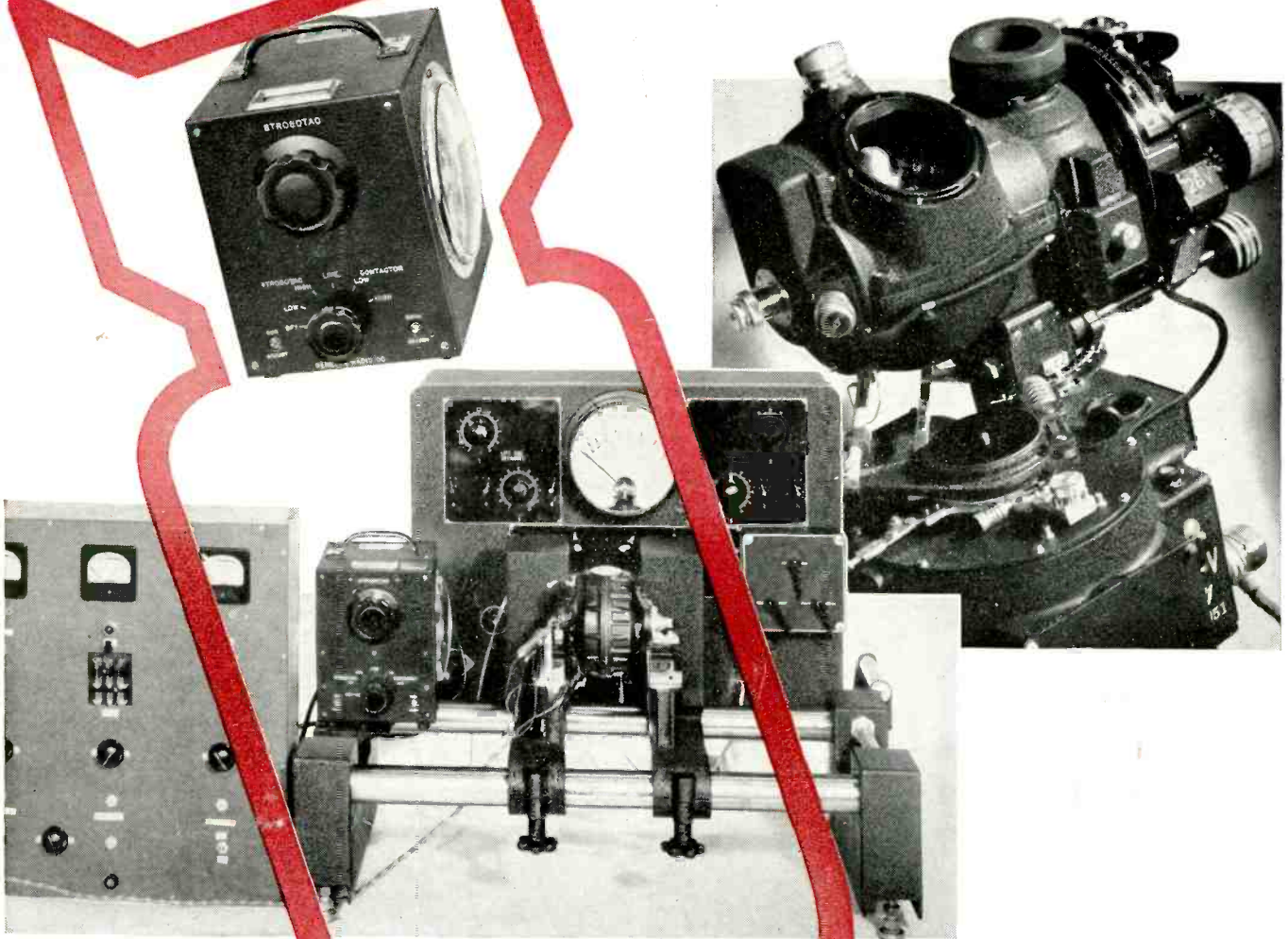

● One of the mechanical marvels of the war is the famed Norden Bombsight, until recently one of the most secret of military devices. Information on some of its general features has now been released by the Army.

This bombsight is probably the most precise instrument in the world, yet it is being built in mass production by the Victor Adding Machine Company and several other manufacturers.

The heart of the bombsight and its associated stabilizer are two gyros which have to be balanced to almost unheard-of accuracy. When inspected, the rotor must be centered to 70 millionths of an inch.

To obtain this accuracy, each gyro is carefully adjusted on the balancing machine shown in the illustration. This portable unit is manufactured by the Gisholt Machine Company. General Radio's STROBOTAC is a part of this machine.

The control equipment at the left includes an electronic speed regulator which maintains the gyro at the speed selected by the STROBOTAC. The equipment behind the gyro measures the amount of weight to be removed from the gyro rotor to give balance, while the STROBOTAC again is used to point out the angular position at which unbalance should be removed.

Gradually as the requirements of military security are relaxed, we hope that we can tell you of many other war uses for General Radio equipment.

In the meantime, possibly your interest in the STROBOTAC is associated with the war effort. STROBOTACS are available for top-priority war work. If you'd like detailed information about the STROBOTAC, ask for Bulletin 967



GENERAL RADIO COMPANY

Cambridge 39,
Massachusetts

90 West St., New York 6 920 S. Michigan Ave., Chicago 5 1000 N. Seward St., Los Angeles 38