

Proceedings



of the

I·R·E

A JOURNAL of the Theory, Practice, and Applications of Electronics and Electrical Communication

- Radio Communication • Sound Broadcasting • Television • Marine and Aerial Guidance •
- Tubes • Radio-Frequency Measurements • Engineering Education • Electron Optics •
- Sound and Picture Electrical Recording and Reproduction •
- Power and Manufacturing Applications of Radio-and-Electronic Technique •
- Industrial Electronic Control and Processes • Medical Electrical Research and Applications •



Galvin Manufacturing Corporation

"HANDIE-TALKIE"—RADIO VOICE OF COMBAT
Two-way portable radio maintains land and air contacts

MARCH, 1945

VOLUME 33

NUMBER 3

Radio Progress During 1944

Radio-Relay Systems

Transient Response

2.85) 4.220 (1.5
225
1.430
2.785

The Institute of Radio Engineers

Why



AMPEREX

WATER AND AIR COOLED
TRANSMITTING AND
RECTIFYING TUBES

In the production of *Amperex* tubes every construction step is carefully watched to insure greater operating efficiency and lower operating costs. Welding, for instance, is done in an inert or reducing atmosphere in specially designed apparatus. This "*Amperextra*" means that there is no oxidation of metal parts. As a consequence, there is much less liberation of gas later on in the life of the tube, and a more consistent *hard* vacuum is maintained.

More than 70% of all electro-medical apparatus in this country is equipped with *Amperex* tubes. More than 40% of the nation's broadcasting stations also specify our products as standard components. There's an *Amperex* type for every application in every field using transmitting and rectifying tubes. Your inquiries, for present or peacetime assignments, receive prompt attention.

AMPEREX

...the high
performance
tube



NOTE: Many of our standard tube types are now available through leading radio equipment distributors.

AMPEREX ELECTRONIC CORPORATION

79 WASHINGTON STREET BROOKLYN 1, N. Y.
Export Division: 13 E. 40th St., New York 16, N. Y., Cables: "Arlab"

NOW IS THE TIME WHEN YOUR DOLLARS COUNT

PLEASE SUPPORT THE RED CROSS WAR FUND

BOARD OF DIRECTORS

1945

William L. Everitt
President

Hendrik J. van der Bijl
Vice-President

Raymond A. Heising
Treasurer

Haraden Pratt
Secretary

Alfred N. Goldsmith
Editor

Lynde P. Wheeler
Senior Past President

Hubert M. Turner
Junior Past President

1943-1945

Wilmer L. Barrow
F. B. Llewellyn
Harold A. Wheeler

1944-1946

Raymond F. Guy
Lawrence C. F. Horle
William C. White

1945-1947

Stuart L. Bailey
Keith Henney
Benjamin E. Shackelford

1945

E. Finley Carter
Lewis M. Clement
Ralph A. Hackbusch
Donald B. Sinclair
William O. Swinyard

Harold R. Zeamans
General Counsel

BOARD OF EDITORS

Alfred N. Goldsmith
Editor

Ralph R. Batcher
Robert S. Burnap
Philip S. Carter
Lewis M. Clement
E. Maurice Deloraine

William G. Dow
Elmer W. Engstrom
William L. Everitt
George W. Gilman

Peter C. Goldmark
Frederick W. Grover
Lewis B. Headrick
C. M. Jansky, Jr.

John D. Kraus
Donald G. Little
Frederick B. Llewellyn

Samuel S. Mackeown
Edward L. Nelson
Harry F. Olson

Harold O. Peterson
Greenleaf W. Pickard
Ralph A. Powers

Haraden Pratt
Conan A. Priest
Herbert J. Reich

Peter C. Sandretto
V. W. Sherman
Lynne C. Smeby

E. C. Wente
Harold A. Wheeler
William C. White

Laurens E. Whittemore
Gerald W. Willard
William Wilson

Charles J. Young
Vladimir K. Zworykin

Proceedings

of the I·R·E

Published Monthly by

The Institute of Radio Engineers, Inc.

VOLUME 33

March, 1945

NUMBER 3

Section Meetings.....	Next Page
The Electronics Engineer.....	P. R. Mallory 141
Ivan Stoddard Coggeshall.....	142
Radio Progress During 1944.....	I.R.E. Technical Committee 143
Radio-Relay-Systems Development by the Radio Corporation of America.....	C. W. Hansell 156
Transient Response..	H. E. Kallmann, R. E. Spencer, and C. P. Singer 169
I.R.E. Building Fund.....	196
Institute News and Radio Notes.....	198
Board of Directors.....	198
Executive Committee.....	199
Cedar Rapids Section.....	200
Correspondence:	
"Frequency and Phase Modulation,".....	D. L. Jaffe and Dale Pollack 200
"Calculator for Directive Arrays".....	J. G. Rountree 202
"Quality-Control Engineering".....	George W. Purnell 202
"Balanced Amplifiers".....	Franklin Offner 202
Postwar Radio-and-Electronic Prospects.....	203
Radio-and-Electronic Wartime Achievements.....	203
Wartime Electronic Developments Hold Peacetime Promise...	204
Television as Service to the Public.....	204
Looking Ahead to Color and Ultra-High-Frequency Television.	205
Television Networks.....	205
I.R.E. People.....	206
Books:	
"Engineering Mathematics," by Harry Sohon.....	Frederick W. Grover 207
"Marine Radio Manual," Edited by M. H. Strichartz.....	C. B. Darcy 208
Reproduction of German Scientific and Technical Books.....	208
Contributors.....	209
Section Meetings.....	34A
Membership.....	38A
Positions Open.....	52A

Responsibility for the contents of papers published in the PROCEEDINGS rests upon the authors. Statements made in papers are not binding on the Institute or its members.



Entered as second-class matter October 26, 1927, at the post office at Menasha, Wisconsin, under the Act of February 28, 1925, embodied in Paragraph 4, Section 538 of the Postal Laws and Regulations. Publication office, 450 Ahnapp Street, Menasha, Wisconsin. Executive, editorial, and advertising offices, 330 West 42nd Street, New York 18, N. Y. Price, \$1.00 a copy. Subscriptions: United States and Canada, \$10.00 a year; foreign countries, \$11.00 a year. Changes of address (with advance notice of fifteen days) and communications regarding subscriptions and payments should be mailed to the Secretary of the Institute, at 330 West 42nd Street, New York 18, N. Y. All rights of republication, including translation into foreign languages, are reserved by the Institute. Abstracts of papers, with mention of their source, may be printed. Requests for republication privileges should be addressed to The Institute of Radio Engineers.

Copyright, 1945, by The Institute of Radio Engineers, Inc.

PAPERS COMMITTEE

Frederick B. Llewellyn
Chairman

Herman A. Affel
Wilmer L. Barrow
Howard A. Chinn
James K. Clapp
Ivan S. Coggeshall
Murray G. Crosby
Frederick W. Cunningham

Robert B. Dome
Enoch B. Ferrell
Donald G. Fink
H. S. Frazier
Stanford Goldman
Frederick W. Grover
O. B. Hanson
E. W. Herold

John V. L. Hogan
Frederick V. Hunt
Harley Iams
Loren F. Jones
John G. Kreer, Jr.
Emil Labin

Frederick R. Lack
Hugo C. Leuteritz
De Loss K. Martin
Knox McIlwain
Harry R. Mimno
Ilia E. Mouromtseff
G. G. Muller

Albert F. Murray
Dwight O. North
A. F. Pomeroy
Jack R. Popple
Simon Ramo
Francis X. Rettenmeyer

Sergei A. Schelkunoff
Donald B. Sinclair
Hubert M. Turner
Dayton Ulrey
Karl S. Van Dyke
E. K. Van Tassel
John R. Whinnery
Irving Wolf
J. Warren Wright
Harold R. Zeamans

PAPERS PROCUREMENT COMMITTEE

Dorman D. Israel
General Chairman

William L. Everitt
Vice Chairman

GROUP CHAIRMEN

Jesse E. Brown
Warren B. Burgess

Edward J. Content
Harry Diamond

Edward T. Dickey
J. Kelly Johnson

Carl J. Madsen
Dan H. Moore

James R. Nelson
Howard J. Tyzzer

William C. White

Helen M. Stote
Associate Editor

William C. Copp
Advertising Manager

William B. Cowilich
Assistant Secretary



THE INSTITUTE OF RADIO ENGINEERS

INCORPORATED



SECTIONS MEETINGS

ATLANTA
March 16

CHICAGO
March 16

CLEVELAND
March 22

DETROIT
March 16

LOS ANGELES
March 19

NEW YORK
April 4

PHILADELPHIA
April 5

PITTSBURGH
April 9

PORTLAND
April 9

WASHINGTON
April 9

SECTIONS

ATLANTA—Chairman, Walter Van Nostrand; Secretary, Ivan Miles, 554-14 St., N. W., Atlanta, Ga.

BALTIMORE—Chairman, W. I. Webb; Secretary, H. L. Spencer, Box 6760, Towson 4, Md.

BOSTON—Chairman, C. C. Harris; Secretary, Corwin Crosby, 16 Chauncy St., Cambridge, Mass.

BUENOS AIRES—Chairman, L. C. Simpson; Secretary, I. C. Grant, Venezuela 613, Buenos Aires, Argentina

BUFFALO-NIAGARA—Chairman, A. J. Dybowski; Secretary, H. G. Korts, 51 Kinsey Ave., Kenmore, N. Y.

CEDAR RAPIDS—Chairman, F. M. Davis; Secretary, J. A. Green, Collins Radio Co., 855-35th St., N.E., Cedar Rapids, Iowa

CHICAGO—Chairman, W. O. Swinyard; Secretary, A. W. Graf, 135 S. LaSalle St., Chicago 3, Ill.

CINCINNATI—Chairman, L. M. Clement; Secretary, J. F. Jordan, The Baldwin Co., 1801 Gilbert Ave., Cincinnati 2, Ohio

CLEVELAND—Chairman, H. B. O'Kesh; Secretary, A. J. Kress, 16911 Valley View Ave., Cleveland 11, Ohio

CONNECTICUT VALLEY—Chairman, R. E. Shea; Secretary, L. A. Reilly, 989 Roosevelt Ave., Springfield, Mass.

DALLAS-FORT WORTH—Chairman, J. D. Mathis; Secretary, B. B. Honeycutt, 9025 Roanoak, Dallas 18, Texas

DAYTON—Chairman, G. L. Haller; Secretary, Joseph General, 411 E. Bruce Ave., Dayton 5, Ohio

DETROIT—Chairman, R. A. Powers; Secretary, R. R. Barnes, 1411 Harvard Ave., Berkley, Mich.

EMPORIUM—Chairman, W. A. Dickinson; Secretary, H. E. Ackman, West Creek, R. D. 2, Emporium, Pa.

INDIANAPOLIS—Chairman, H. I. Metz; Secretary, J. D. Colvin, 328 E. 47 St., Indianapolis, Ind.

KANSAS CITY—Chairman, A. P. Stuhrman; Secretary, R. N. White, 4800 Jefferson St., Kansas City, Mo.

LONDON—Chairman, G. A. Woonton; Secretary, Robert Wilton, No. 5 Radio School, Royal Canadian Air Force, Clinton, Ont., Canada

LOS ANGELES—Chairman, R. C. Moody; Secretary, R. G. Denechaud, Blue Network Co., 6285 Sunset Blvd., Hollywood 28, Calif.

MONTREAL—Chairman, F. S. Howes; Secretary, J. A. Campbell, Northern Electric Co., Ltd., 1261 Shearer St., Montreal, Que., Canada

NEW YORK—Chairman, G. B. Hoadley; Secretary, J. T. Cimorelli, RCA Manufacturing Co., Harrison, N. J.

OTTAWA—Acting Secretary, L. F. Millett, 33 Regent St., Ottawa, Ont., Canada

PHILADELPHIA—Chairman, T. A. Smith; Secretary, P. M. Craig, Philco Corp., Philadelphia 34, Pa.

PITTSBURGH—Chairman, T. C. Kenny; Secretary, R. K. Crooks, Box 2038, Pittsburgh 30, Pa.

PORTLAND—Chairman, F. H. McCann; Secretary, Kenneth Johnson, 5212 N.E. 73 St., Portland, Ore.

ROCHESTER—Chairman, G. R. Town; Secretary, A. E. Newlon, Research Dept., Stromberg-Carlson Co., Rochester 3, N. Y.

ST. LOUIS—Chairman, N. B. Fowler; Secretary, C. H. Meyer, KFUE, 801 DeMun Ave., St. Louis, Mo.

SAN DIEGO—Chairman, E. B. Robinson; Secretary, Clyde Tirrell, United States Navy Radio and Sound Laboratory, San Diego 52, Calif.

SAN FRANCISCO—Chairman, David Packard; Secretary, William Barclay, Stanford University, Palo Alto, Calif.

SEATTLE—Chairman, G. L. Hoard; Secretary, K. A. Moore, 5102 Findley St., Seattle 8, Wash.

TORONTO—Chairman, E. O. Swan; Secretary, Alexander Bow, Copper Wire Products, Ltd., 137 Roncesvalles Ave., Toronto, Ont., Canada

TWIN CITIES—Chairman, H. S. McCartney; Secretary, C. W. Engelman, 4648 Chowen Ave. S., Minneapolis 10, Minn.

WASHINGTON—Chairman, H. A. Burroughs; Secretary, L. C. Smeby, 4801 Connecticut Ave., N.W., Washington, D. C.

WILLIAMSPORT—Chairman, H. E. Smithgall, Jr.; Secretary, K. E. Carl, Williamsport Technical Institute, Williamsport, Pa.

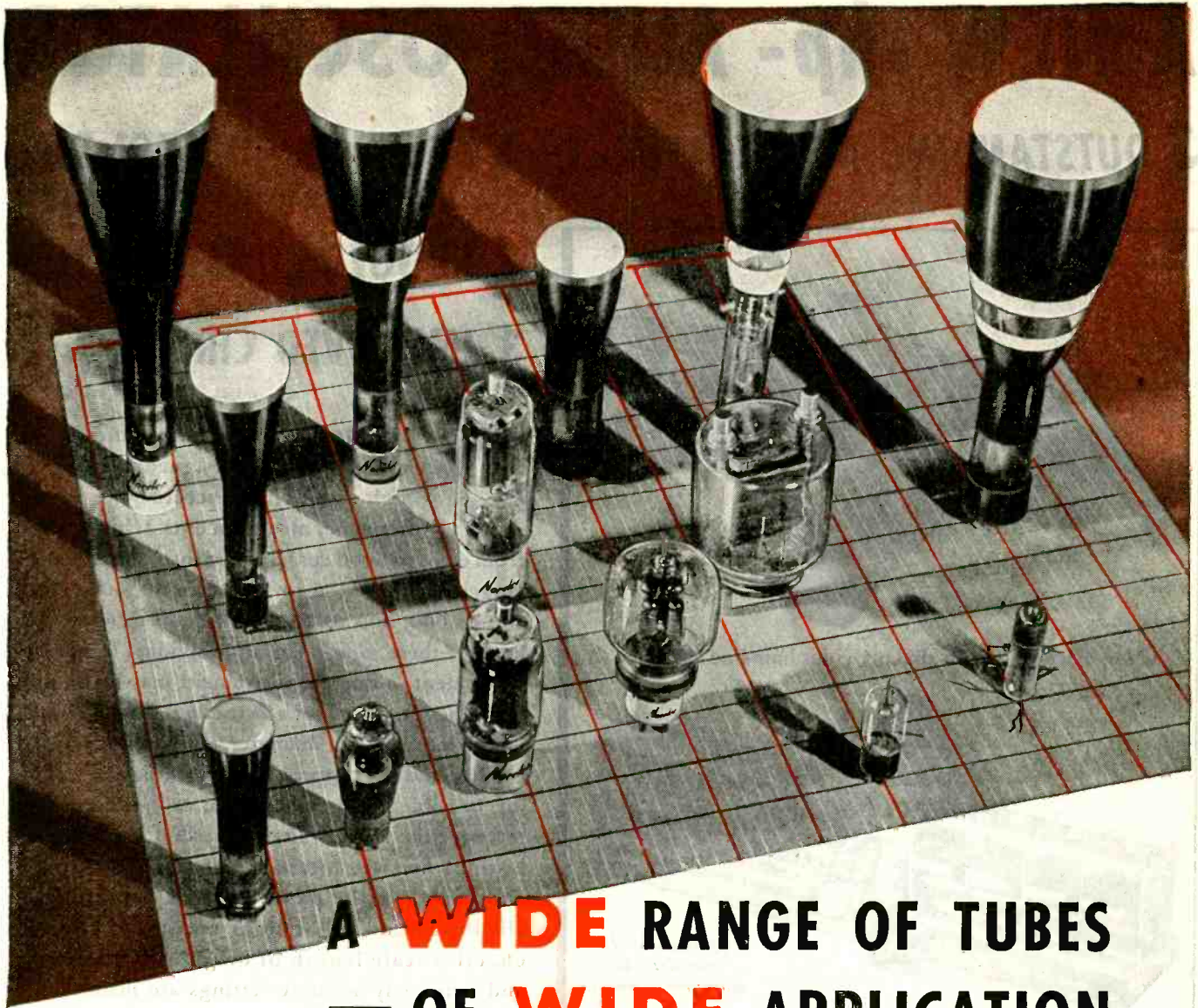

A **WIDE** RANGE OF TUBES — OF **WIDE** APPLICATION

THE enviable engineering tradition on which the foundation of the North American Philips Company, Inc., rests, is reflected in the superior quality and performance of electronic tubes bearing the NORELCO stamp. Contributing to the long life and uniform characteristics of these tubes are many exclusive manufacturing techniques and inspection methods developed over a long period.

Among the types we now manufacture—some of which are illustrated—are a number of special-purpose, cathode-ray and transmitting tubes for high and ultra-high frequency applications, r-f and a-f power amplifier tubes, and low- and high-power rectifiers. Although all the tubes we produce now go to the armed forces, we invite inquiries from prospective users. A list of the tube types we are especially equipped to produce will be sent on request.

In the North American Philips Company, there is gathered together a team of outstanding electronic engineers, coached by a group with world-wide experience resulting from fifty years of research and development in the electrical field. This new combination of technical talent has at its command many exclusive processes that insure electronic devices of the highest precision and quality. Today, North American Philips works for a United Nations Victory; tomorrow, its aim will be to serve industry.

OTHER PRODUCTS: In addition to the electronic tubes mentioned above we make Quartz Oscillator Plates; Searchray (X-ray) Apparatus, X-ray Diffraction Apparatus; Medical X-ray Equipment, Tubes and Accessories; Tungsten and Molybdenum products; Fine Wire; Diamond Dies.

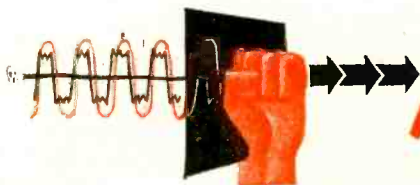

Norelco
Reg. U. S. Pat. Off.

When in New York, be sure to visit our Industrial Electronics Showroom.

**ELECTRONIC PRODUCTS by
NORTH AMERICAN PHILIPS COMPANY, INC.**

Dept. F-3, 100 East 42nd Street, New York 17, N.Y.

Factories in Dobbs Ferry, N.Y., Mount Vernon, N.Y. (Metalix Division); Lewiston, Maine (Elmet Division)

A NEW -hp- AUDIO OSCILLATOR

3 OUTSTANDING NEW FEATURES:

1. ACCURATE CONTROL DIAL
EASY TO READ • NO PARALLAX

2. RUGGED CONSTRUCTION

3. IMPROVED CIRCUIT

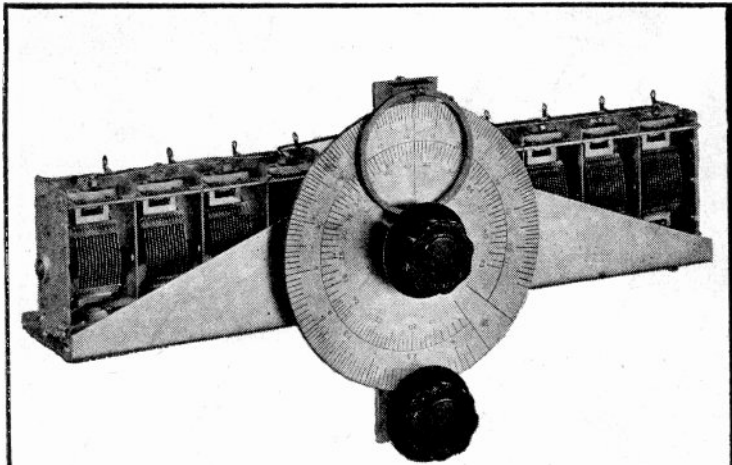

New friction driven dial provides hair-line accuracy

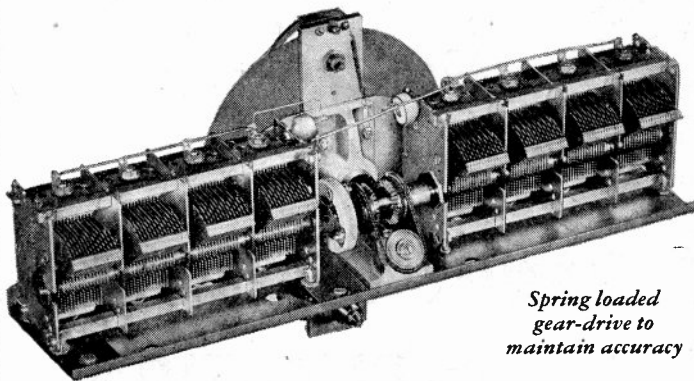

Spring loaded gear-drive to maintain accuracy

Rugged chassis construction on heavy cast frame

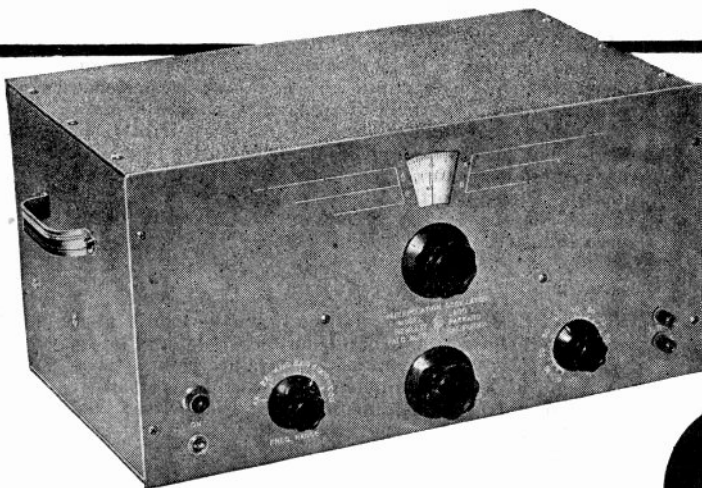

The Model 200-I is a resistance-tuned audio oscillator designed to provide high stability and accuracy for use in frequency measurements. It has a range from 6 cps to 6000 cps*, divided into six frequency ranges as follows: 6 to 20, 20 to 60, 60 to 200, 200 to 600, 600 to 2000 and 2000 to 6000 cps. Each of these ranges has an individual frequency adjustment so that the instrument may be set to a frequency standard such as the -hp- Model 100-B.

The large, 6-inch diameter, main frequency dial is calibrated over approximately 300 degrees, making possible a large number of calibrated points to cover the entire range. The dial itself rotates behind a fine wire locator which is visible through an opening in the panel. Parallax is completely eliminated and calibrations are spread over an effective scale length of nearly eight feet. Fast and extremely accurate settings are made easily with this dial. There are two manual controls: one direct action, and the second for vernier adjustments. An electronically regulated power supply is included to assure greatly improved stability.

The Model 200-I -hp- Audio Oscillator is but one among many new -hp- instruments which are to make public appearance as the cloak of military secrecy is removed. Preliminary technical information is available on this instrument now ... write for it! And watch for the early release of other new -hp- instruments.

**This frequency coverage was selected for interpolation work. Other frequency ranges can be supplied from 6 cps to 100 kc on special order.*



HEWLETT-PACKARD COMPANY
Box 930D Station A, Palo Alto, California

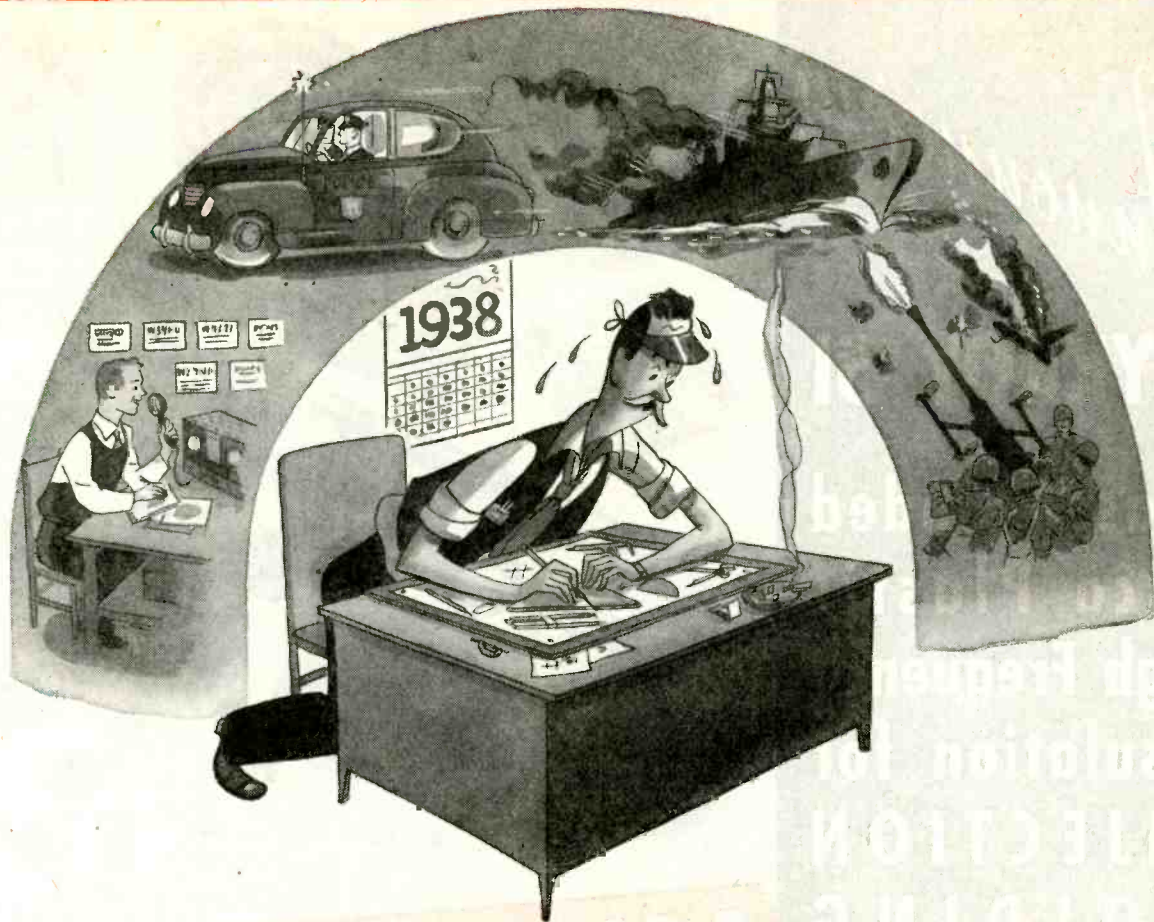

If you want the job done right —

A group of Hytron engineers decided in 1938 that to get those ideal tubes for "ham" radio — they must build them themselves. Combining years of experience in tube manufacture with exact knowledge of the tube characteristics desired, they went to work.

First they concentrated their efforts. Low and medium power types were most needed by the majority of hams. Hytron was equipped to make them. Gradually the engineers translated ideals into a comprehensive line—v-h-f triodes and pentodes, low and medium mu triodes, instant-heating r. f. beam tetrodes, and sub-miniatures.

Hams themselves, the engineers knew their brain children would be given the works. They built the tubes rugged; rated them conservatively. And did the amateur go for them! The v-h-f types — HY75, HY114B, HY615 — soon became accepted standards. Today's WERS operators use them almost exclusively.

Performance in the proving ground of amateur radio was the proof of the pudding. You will find Hytron transmitting and special purpose tubes in war and civilian jobs of all kinds. Like the BANTAM GT and BANTAM JR., they are popular because they are built right for the job.



OLDEST EXCLUSIVE MANUFACTURER OF RADIO RECEIVING TUBES

HYTRON
CORPORATION ELECTRONIC AND RADIO TUBES
SALEM AND NEWBURYPORT, MASS.



BUY ANOTHER WAR BOND

Announcing

MYKROY #51

**Glass-Bonded
Mica Plastic
High Frequency
Insulation for
INJECTION
MOLDING**

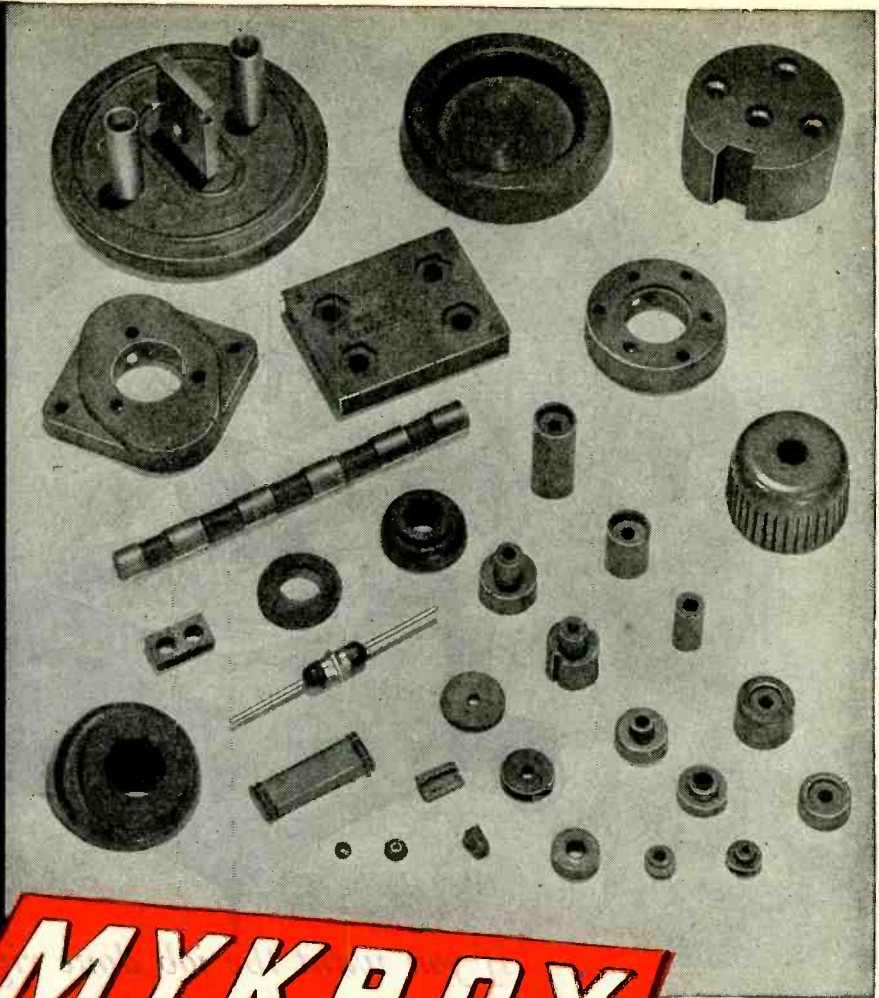

MYKROY
PERFECTED MICA CERAMIC INSULATION

THE perfection of MYKROY #51, glass-bonded mica ceramic insulation, which can be injection molded, and the processes developed for handling it rapidly and uniformly has opened a new field of applications. It is now possible to produce injection molded plastic ceramic parts of MYKROY having shrinkage characteristics of less than .001" per inch. In addition, parts molded from MYKROY #51 can be machined by grinding, drilling, tapping or cutting.

Electrical characteristics of MYKROY are of the highest order and do not shift under any normal conditions short of actual destruction of the material itself. This, plus

chemical and physical stability—high resistance to oil, gas and water—resistance to acute temperature changes—high coefficient of thermal expansion and excellent metal bonding properties, make it one of the best insulating materials ever developed for general and high frequency applications.

MYKROY #51 is already being molded into a large variety of parts for use throughout the entire Electronic and Electrical engineering field. It may be the answer to your own insulation problems. So ask for detailed information. Request a copy of the special MYKROY INJECTION MOLDING BULLETIN #103.



**WRITE FOR MYKROY
INJECTION MOLDING
BULLETIN #103**

A comprehensive manual containing complete working data including mold designing criteria.

**MYKROY SHEET
BULLETIN #102**

Contains full information about the largest size sheet (19 1/4" x 29 3/4") of perfected mica ceramic insulation now available.

MYKROY IS SUPPLIED IN SHEETS AND RODS . . . MACHINED OR MOLDED TO SPECIFICATIONS

MADE EXCLUSIVELY BY **ELECTRONIC MECHANICS INC.** 70 CLIFTON BOULEVARD • CLIFTON, NEW JERSEY
Chicago 47: 1917 NO. SPRINGFIELD AVENUE . . TEL. Albany 4310
Export Office: 89 Broad Street, New York 4, N. Y.



RUGGED-DEPENDABLE

... HOUR AFTER HOUR!

You can tell just by looking at it—this tube is built to l-a-s-t.

This new air-cooled Westinghouse Plotron No. WL473 is small, compact and designed especially for dielectric and induction heating. It is extremely economical in operation, having the lowest cost per R.F. kilowatt hour of any tube in its class on the market today.

For technical data or any other information on the Plotron No. WL473 or any Westinghouse Elec-

tronic Tube, consult your nearest Westinghouse Office or write to Westinghouse Electric & Manufacturing Company, Electronic Tube Division, Bloomfield, New Jersey.

Westinghouse

PLANTS IN 25 CITIES OFFICES EVERYWHERE

Quality Controlled Electronic Tubes



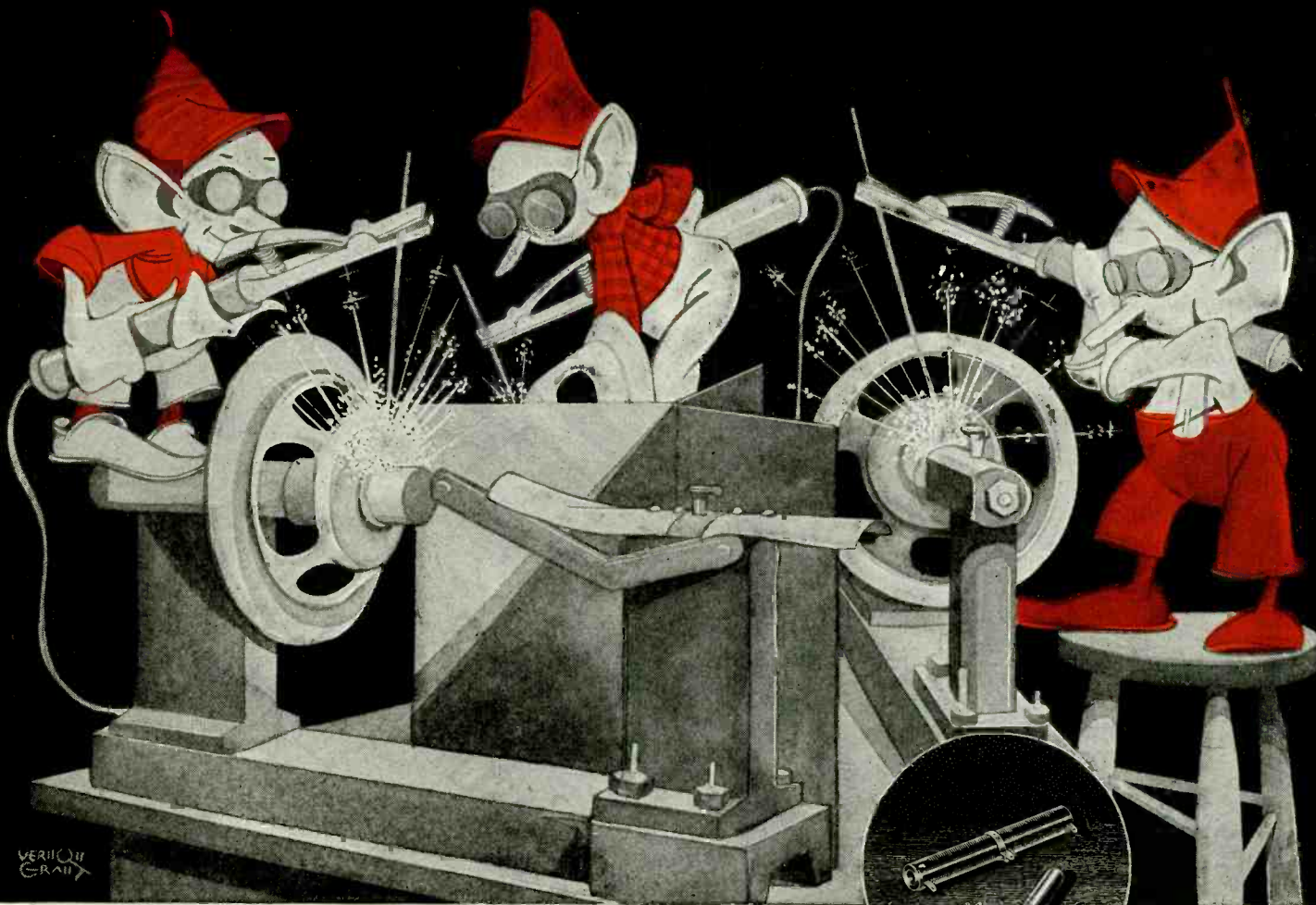

Vitreous enamel resistors, plugs, switches, and other component parts for electronic applications.

UTAH'S "PRECISION PLUS" MANUFACTURE ... SPEAKS FOR ITSELF!

Utalins* at work . . . welding . . . and proud as punch at the technique they've developed. They know welding is just one of several steps in the production of Utah's radio parts and electronic devices. But they give it that "precision plus" accuracy that Utah demands all the way.

Every phase of manufacture done in Utah's own factory is to perfection standards.

First comes the careful purchase of quality raw materials. Then Utalins make the tools that make the Utah products. The modern methods of production, the testing, the supervision, even the infinite care in shipping all add up to Utah's comprehensive process—an infallible system of manufacture that enables Utah—and you—to be proud of the finished products.

Utah products finally become hidden parts of your radio, and the world listens—with pleasure—as Utah performance speaks for itself!

**Utalins—Utah's helpers*



Utah Radio Products Co., 820 Orleans St., Chicago 10, Ill.
Utah Products (Canada) Ltd., 300 Chambly Rd., Longueuil, Montreal (23), P. Q.

ORIGINAL AWARD JULY 27, 1942

SECOND AWARD FEB. 13, 1943

THIRD AWARD SEPT. 25, 1943

FOURTH AWARD MAY 27, 1944

FIFTH AWARD DEC. 2, 1944

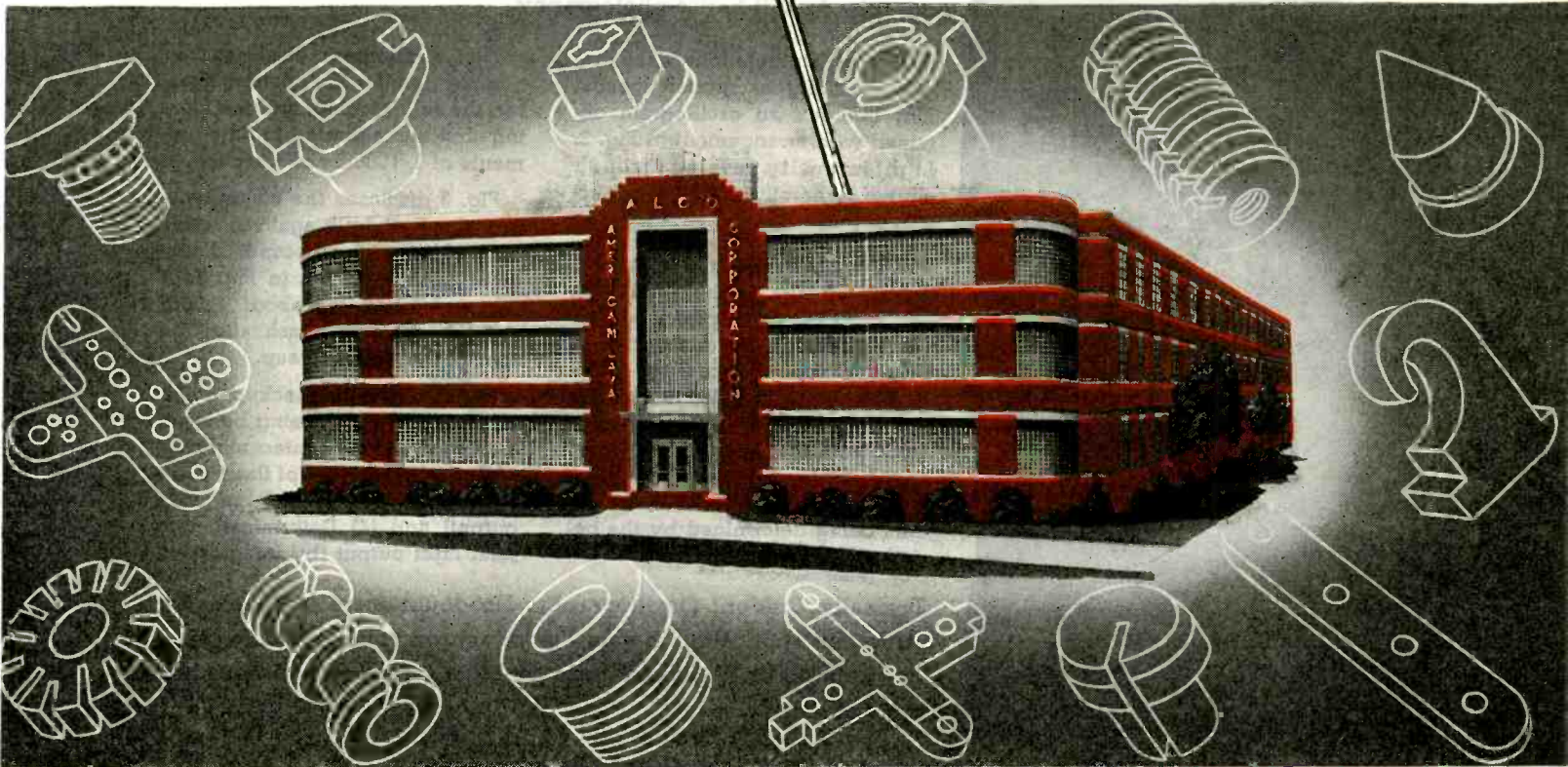

For the fifth consecutive time, the men and women of American Lava have earned the Army-Navy "E" Award "for continued excellence in quantity and quality of essential war production." All of us are very thankful that the necessary knowledge, experience and skill were available at American Lava to maintain the high standard of quality of ALSIMAG products, while meeting production schedules that once seemed incredible.

AMERICAN LAVA CORPORATION • Chattanooga 5, Tennessee
43RD YEAR OF CERAMIC LEADERSHIP

ALSIMAG

TRADE MARK REG. U. S. PAT. OFFICE

CERAMIC INSULATORS

For Use in:

- Electronic Devices
- Electrical Circuits and Appliances
- Gas and Oil Heating
- Automotive Equipment
- Chemical Processes



**PERFECT EXPOSURE BECAUSE
OF SHUTTERS AND FLASH-BULBS
CHECKED BY **DuMONT****

Oscillography

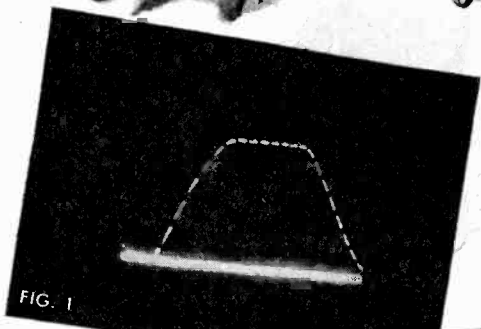

FIG. 1

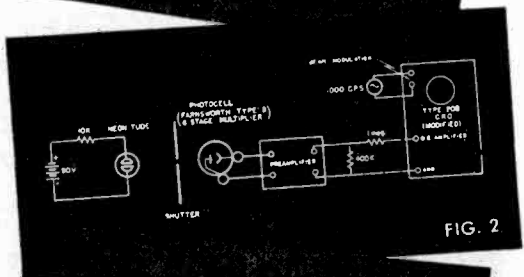

FIG. 2



FIG. 3

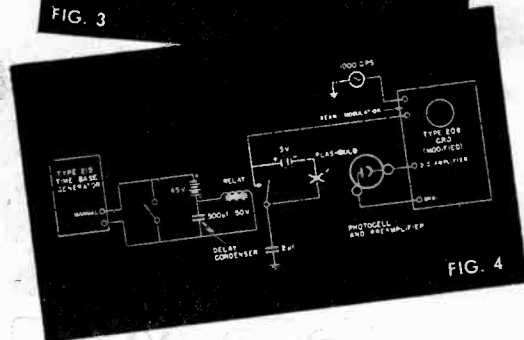

FIG. 4

Testing of photographic shutters; measurements of flash-bulb characteristics; calibration of lens diaphragm openings; comparison of transmission factor of lenses; opacity and density measurements—such are typical applications of versatile *DuMont Oscillography* to still better photography.

Typical of this technique is the precise checking of shutter speeds. Fig. 1 shows an oscillogram obtained with arrangement in Fig. 2. Light intensity passing through shutter is directly plotted as a function of time.

When shutter opens, light from neon lamp falls on photo-cell. Both cell and neon lamp operate on D.C. Output from photo-cell directly, or D.C. amplified if necessary, is applied to vertical deflection plates of cathode-ray tube. A timing wave modulates the cathode-ray beam, so that plot appears as dotted line, the distance between two adjacent dots being determined by the period of the timing wave.

Typically *DuMont Oscillography*. No doubt there is an equally important application in your laboratory, on your production line, or out in the field. Submit your problem for our suggestions and engineering help.

This oscillogram discloses the elapsed time for the opening shutter, the full opening, and the closing shutter, calibrated in time elements of 1/1000ths of a second.

Fig. 3 discloses the characteristics of a flash-bulb again in terms of 1/1000ths of a second. Equipment used is shown in Fig. 4. A relay, delayed for about 1/30th second, starts the flash after the start of the single sweep.

This flash-bulb checkup determines: (1) Time elapsing between closing of battery contact and start of flash; (2) Duration of flash itself; (3) Measurement of peak luminous output; and (4) Determination of total light output (by integration).

Write for Literature

ALLEN B. DUMONT LABORATORIES, INC.

DUMONT Precision Electronics & Television
 ALLEN B. DUMONT LABORATORIES, INC., PASSAIC, NEW JERSEY CABLE ADDRESS: WESPEXLIN, NEW YORK

Simplify TEST PROCEDURE

with these versatile
WESTON
Test Instruments

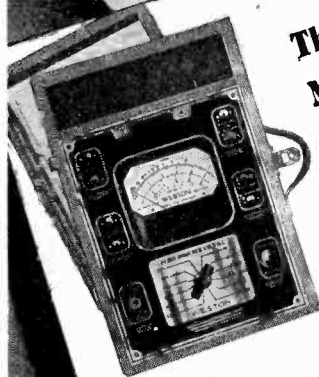

The Multi-Purpose, Super-Sensitive Analyzer (MODEL 772)

A compact and practical wide-purpose instrument with sensitivity of 20,000 ohms per volt, or 1000 ohms per volt, on dc ranges.

Ranges — all self-contained
Voltage, a-c and d-c — 0-1000/250/50/10/2.5.
Current, a-c and d-c — 0-10/1 amps. — 0-250/50/10/1 milli-amps. and 100 microamps.
Ohms — Full Scale — 30/3 megohms — 30,000/3000 ohms. Center Scale — 250,000/25,000/250/25 ohms.
Decibels — -14 to +2, -2 to +14, +12 to +28, +26 to +42, +38 to +54.
(Voltages up to 5000 dc available through use of external WESTON Televerter, Model 766.)

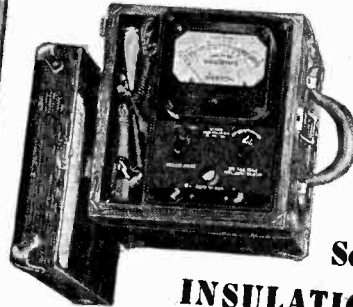

The Direct-Reading, Self-Contained INSULATION TESTER (MODEL 796)

This compact direct-reading resistance tester eliminates hand cranking and thus makes leakage testing a simple one-man job especially in unaccessible places. Tests up to 200 megohms at test potential of 350 to 500 volts d-c; although, the current at terminals is only a few microamperes. Operates from long life, light-weight batteries. There are no vibrators to replace. Ranges: 0-20-300 megohms full scale; 0-5-5' megohms center scale. Size 8" x 9 1/8" x 8".

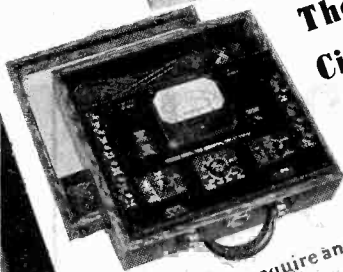

The Industrial Circuit Tester (MODEL 785)

Recognized as the most complete unit for routine maintenance tests, and for testing needs which require an ultra-sensitive instrument.

Ranges all self-contained
D-C VOLTAGE ... Six Full Scale Ranges of: 1/10/50/200/500/1000 volts (20,000 Ohms per volt).
A-C VOLTAGE ... Six Full Scale Ranges of: 5/15/30/150/300/750 (1,000 Ohms per volt).
D-C CURRENT ... Six Full Scale Ranges of: 50 Microamps ... 1/10/100 Milliamps. ... 1/10 mv. (Higher ranges, at half scale reading, with 100 external shunts).
A-C CURRENT ... Four Full Scale Ranges of: 5 1/5/10 Amperes. (Higher Ranges with external current Transformers.)
RESISTANCE ... Five Full Scale Ranges of: 3,000/30,000/300,000 Ohms ... 3/30 Megohms. Center Scale Values ... 25/250/2,500/25,000/250,000 Ohms. (Self-Contained Batteries)

With production currently running slightly ahead of war requirements, a limited number of the popular WESTON test instruments shown herewith are available and are offered subject to prior sale. Orders can be placed direct, or with the WESTON representative in your vicinity. Literature available from...WESTON Electrical Instrument Corporation, 578 Frelinghuysen Avenue, Newark 5, New Jersey.

WESTON

INSTRUMENTS

for POSITIVE HERMETIC SEALING



9820



9821



9822



9823

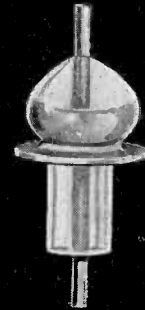

9824

PART No.	Average of Actual Test Flash Over or Breakdown Voltage R.M.S.	Recommended Maximum Use Voltage at Sea Level R.M.S.
9820	4,750	2,500
9821	6,900	5,000
9822	9,624	7,500
9823	9,300	7,500
9824	12,725	9,000

INSULATION RESISTANCE OVER 1,000,000 MEGOHMS

Actual Size Photograph

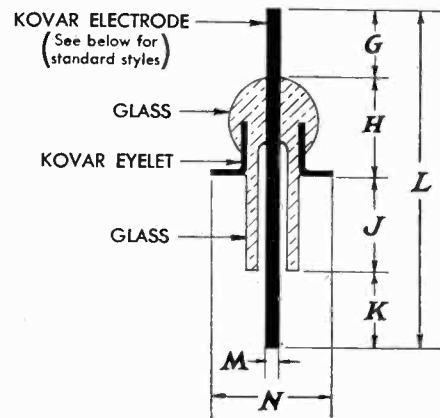

STANDARD SIZES (other sizes to your specifications)

PART	G	H	J	K	L	M	N
9820	$\frac{3}{16}$	$\frac{3}{16}$	$\frac{3}{16}$	$\frac{3}{16}$	$\frac{7}{8}$.040	.212
9821	$\frac{1}{4}$	$\frac{3}{8}$	$\frac{1}{4}$	$\frac{1}{4}$	$1\frac{1}{8}$.060	.340
9822	$\frac{1}{4}$	$1\frac{1}{2}$	$1\frac{1}{2}$	$\frac{1}{4}$	$1\frac{1}{4}$.080	.380
9823	$\frac{1}{4}$	$1\frac{1}{2}$	$1\frac{1}{2}$	$\frac{1}{4}$	$1\frac{1}{4}$.080	.500
9824	$\frac{3}{4}$	$1\frac{1}{2}$	$1\frac{1}{2}$	$\frac{1}{4}$	$1\frac{1}{2}$.080	.672

METAL-GLASS SEALS by STUPAKOFF

The series of Stupakoff metal-glass seals illustrated offers maximum electrical qualities consistent with space limitations and simplicity of design permitting mass production. They are suitable for operation at temperatures from -55°C to $+200^{\circ}\text{C}$, and are tested to meet thermal shock specifications of the services. The construction provides a hermetic seal with a long electrical leakage path, resistance to thermal shock and mechanical strength.

Such seals are made possible by the metal, Kovar, a cobalt, nickel, iron alloy which matches the expansion of certain hard glasses from -80°C to the annealing point of the glass (approx. $+450^{\circ}\text{C}$). Kovar forms a seal through a heating process in which the oxide of Kovar is dissolved into the glass to form a perfect bond—pressure and vacuum tight under extreme climatic conditions.

Stupakoff furnishes Kovar-glass seals with single or multiple electrodes in various styles. For those equipped for glass working, Stupakoff supplies Kovar as rod, sheet, wire, tubing or fabricated into cups, eyelets or special shapes.

Write Stupakoff today for assistance in developing hermetically sealed components for war applications. Samples and reprints of this advertisement may be obtained by writing department K-56.



STANDARD ELECTRODE STYLES
AVAILABLE IN COMBINATION
(EXCEPT B)

Do More Than Before—Buy EXTRA War Bonds



STUPAKOFF CERAMIC AND MANUFACTURING CO., LATROBE, PA.

Products for the World of Electronics



The Seal

THAT MEANS
PERFECT
HERMETIC SEALING

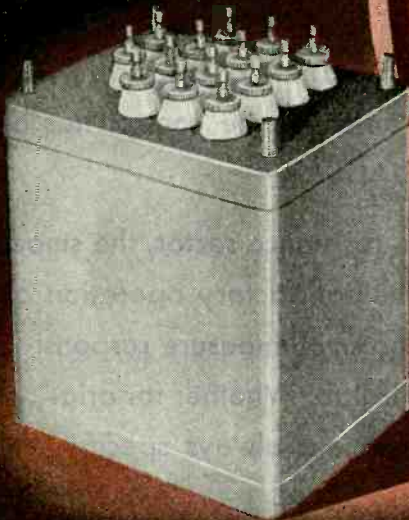

IMMERSION VACUUM TEST of each unit—not just random units—after final assembly, is standard procedure at AmerTran. Quality control of hermetic sealing is thus rigidly maintained.

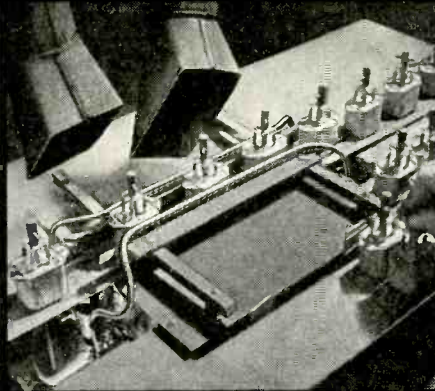

INDUCTION SOLDERING insures quality sealing of all case seams enabling the unit to withstand vibration and severe air pressure changes.

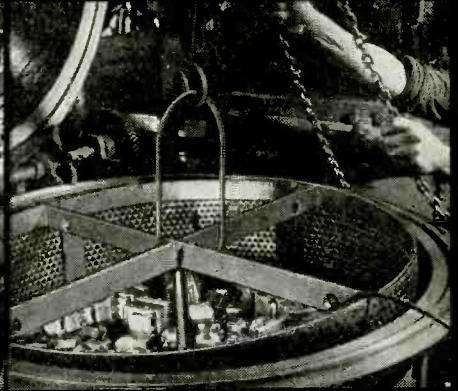

VACUUM IMPREGNATION with varnish removes moisture from coil and provides excellent turn, layer and section insulation, resulting in long trouble-free life.

Other Safeguards like infra-red preheating of cores and coils before compound filling, torque-gauging and resilient gaskets to protect ceramic terminals provide full protection against moisture, temperature changes, and pressures encountered in airborne service. Yet AmerTran Hermetically Sealed Transformers are designed to minimum weight and dimensions. Write for complete details.

THE AMERICAN TRANSFORMER CO., 178 Emmet St., Newark 5, N. J.



Pioneer Manufacturers of Transformers, Reactors and Rectifiers for Electronics and Power Transmission



Centralab STANDARD, MIDGET AND ELF Radiohms

● For more than two decades the name CENTRALAB on a volume control has been a synonym for QUALITY.

The long wall-type resistance sector, the smooth performance and the satisfactory operation of these controls are in no small measure responsible for the fame of Centralab. Whether for original equipment or replacement always specify

CENTRALAB Radiohms



Centralab

Division of GLOBE-UNION INC., Milwaukee

Producers of VARIABLE RESISTORS — SELECTOR SWITCHES — CERAMIC CAPACITORS,
FIXED AND VARIABLE — STEATITE INSULATORS — SILVER MICA CAPACITORS



After ADOLPH and TOJO are **Q·R·T**

The rig he left behind is due for a big change when GI Joe comes home. War experience has been an "eye opener" for him. From chassis to sky wire many pre-war Ham outfits will undergo a major alteration and amazing technical advances will be put into practice. Stimulated by training and experience gained in the armed services thousands of new enthusiasts will swell the ranks of amateur radio.

When the gang goes back on the air again,

CQ'ing, SS or DX; UNITED will be ready to serve the Amateur with war-perfected Transmitting Tubes.

Since 1934 UNITED has specialized in engineering, designing and building Transmitting Tubes that set the Quality Standard for the entire Radio Industry. When performance counts UNITED Tubes provide a maximum of electronic efficiency—plus a long and dependable life. Accept nothing less than UNITED quality for your own tube requirements.

Order direct or from your electronic parts jobber.

MASTERPIECE OF SKILLED HANDS

UNITED

ELECTRONICS COMPANY

NEWARK, 2



NEW JERSEY

Transmitting Tubes **EXCLUSIVELY** Since 1934

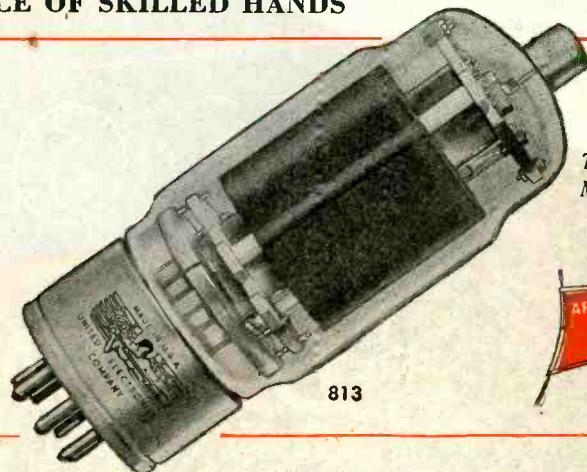

813

Buy
The Attack,
More Bonds
Back



DAVEN

ATTENUATION NETWORKS

Series 690

DAVEN Series 690 Attenuation Networks comprise 20 models, designed for general laboratory and production testing at audio frequency levels. DAVEN plug-in type Fixed Attenuators are employed for matching source and load impedances with the base impedance of the network. A high degree of flexibility is thus achieved with an absence of mis-match, reflection loss and switching noises.

MODEL VARIATIONS

- 2 MOUNTINGS: Portable and Rack Type
- 3 BASE IMPEDANCES: 500, 600 and 135 ohms
- 2 CIRCUITS: "T" and Balanced "H"
- 2 RANGES: 0-110DB, steps of 1DB (2 dials)
0-111DB, steps of 0.1DB (3 dials)

*Balanced "H" type may be used as an unbalanced network of one-half the base impedance.



OTHER SPECIFICATIONS

ACCURACY: Resistors calibrated within $\pm 1\%$

PLUG-IN PADS: Octal tube base, panel mounting, in wide range of impedances and losses.

FREQUENCY RANGE: 0-17,000 c.p.s.; at higher frequencies, slight reduction in accuracy.

OPERATION LEVEL: +20DB (0.6w) maximum input.

SIZE: 2 dial portable: 5"x10"x5"; 3 dial portable 6"x11 1/2"x5"; rack: 3 1/2"x19".

Daven Attenuation Standards, types 740 and 742 (resistor accuracy $\pm 1/2\%$), are designed for applications requiring greater accuracy. See your DAVEN Catalog or write for details.

PORTABLE TYPES

T	BAL "H"	DB RANGE	BASE Z
T-270-A	H-510-B	0-110	500
T-570-C	H-610-D	0-110	600
T-111	H-111	0-111	135
T-411	H-411	0-111	135

RACK TYPES

T	BAL "H"	DB RANGE	BASE Z
T-270-B	H-510-B	0-110	500
T-570-B	H-610-D	0-110	600
T-111-B	H-111	0-111	135
T-411-B	H-411	0-111	135



THE **DAVEN** COMPANY
191 CENTRAL AVENUE
NEWARK 4, NEW JERSEY

YOU CAN MAKE NO GREATER PERSONAL CONTRIBUTION TO THE WAR EFFORT THAN TO DONATE A PINT OF YOUR BLOOD TO THE RED CROSS



**JUST OFF
THE
PRESS!**

The new **ELECTRONIC ENGINEER'S REFERENCE MANUAL** now makes available to the practical engineer all the essential up-to-the-minute facts about electron tubes and related parts. More than 900 types of Receiving, Transmitting, Cathode-Ray and Photo Tubes are described—with physical specifications, characteristics, typical operat-

ing conditions, basing diagrams, war-time substitution chart and other data. All this and more in one handy quick-reference book of 146 pages that you can tuck in your pocket. Note ring binding which makes the pages lie flat when book is open. Price \$1.00. For copies write National Union Radio Corporation, Newark 2, New Jersey.

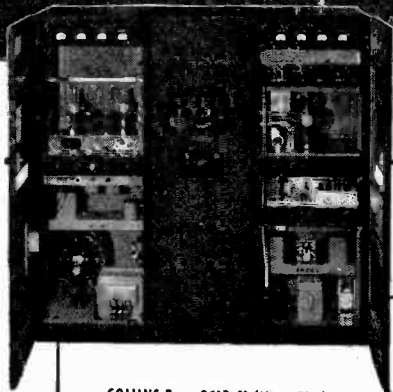
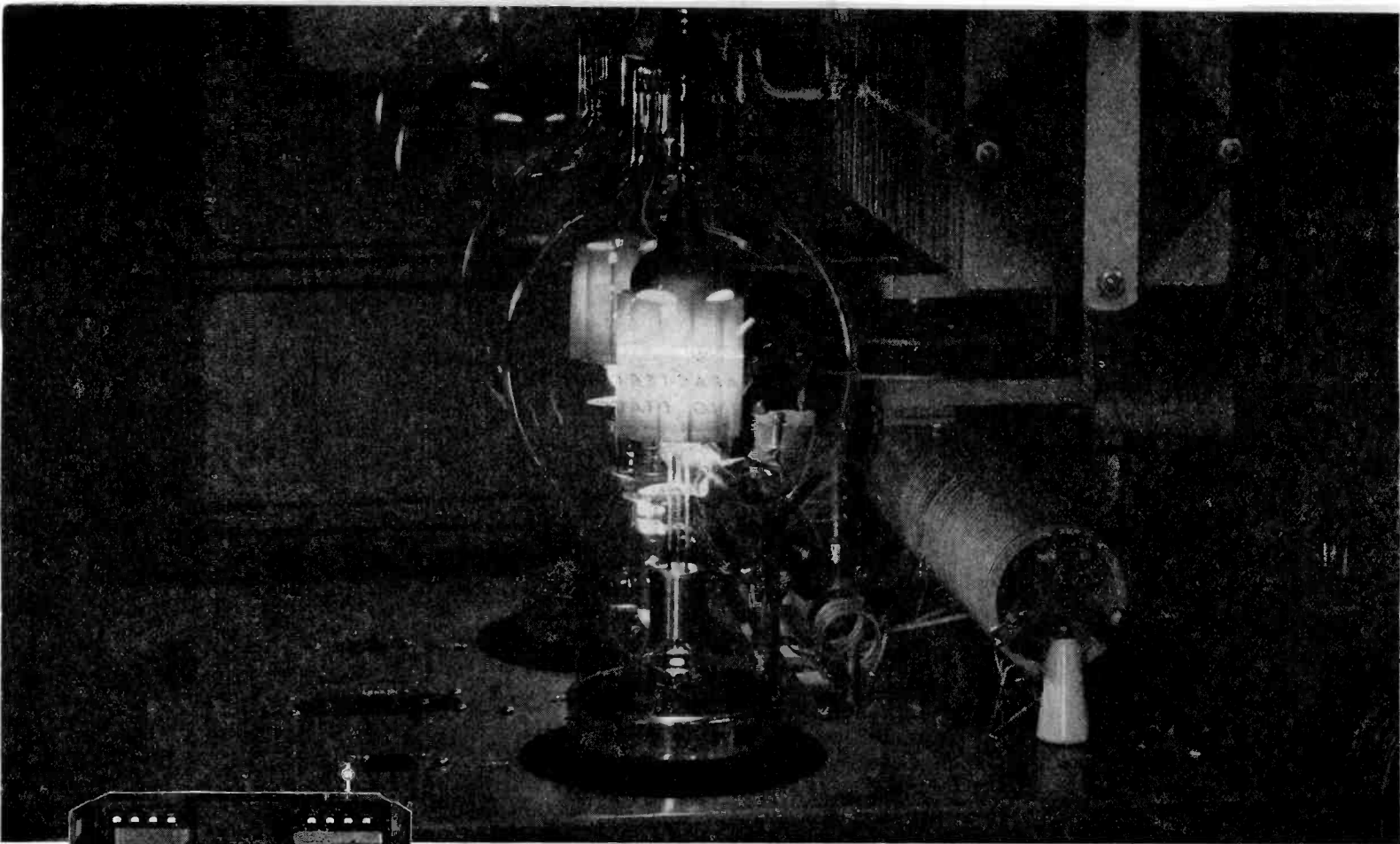

COLLINS Type 231D-11 (Navy TDH)
Multi-frequency transmitter

Output CW—5 KW; Output 'Phone—3 KW
100% modulated with a pair of Eimac 450TL
tubes in class "B" audio; continuous coverage
from 2 MC to 18.1 MC with 11 preset channels
in that range and complete manual coverage
throughout whole range. Capable of completely
unattended remote control operation and of A1,
A2 and A3 type emission. Audio characteristics:
plus or minus three DB from 150 to 3,500 cycles.
Total harmonic distortion less than 10%. The
transmitter can be terminated into a 50 to 1,200
pure resistive load at zero degrees phase angle. 70
to 850 ohm load at plus or minus 45 degrees and
100 to 600 ohms at plus or minus 60 degrees.



Write for your copy of
Electronic Telis—a 64
page booklet fully illus-
trated—covering funda-
mentals of Electronics
and many of its impor-
tant applications. Writ-
ten in layman's language.

COLLINS ENGINEERING AND EIMAC TUBES *achieve outstanding results*

This Collins type 231D-11 (Navy TDH) radio transmitter is an outstanding demonstration of the value of capable engineering coupled with the intelligent choice and use of vacuum tubes.

It is the latest of a series of Collins Autotune, quick shift transmitters which were originally introduced in 1939, and which use Eimac tubes in the important sockets. In the 231D-11, two Eimac 750TL tubes in parallel make up the power amplifier, while a pair of Eimac 450TL tubes in class "B" are used as modulators for voice and MCW emission.

Mr. F. M. Davis, General Manager of the Collins Engineering Division, says: "Eimac tubes have been found to be reliable, rugged and capable of withstanding the severe overloads encountered during equipment tests, without damage." Statements like this, coming from such men as Mr. Davis, offer proof that Eimac tubes are first choice of leading engineers throughout the world.

Follow the leaders to
Eimac
REG. U. S. PAT. OFF.
TUBES



Eimac has received
8 ARMY-NAVY "E" AWARDS
for production efficiency
San Bruno 5, Salt Lake City 3

EITEL-McCULLOUGH, Inc., 956 San Mateo Ave., San Bruno, Calif.
Plants located at: San Bruno, California and Salt Lake City, Utah
Export Agents: Frazer & Hansen, 301 Clay Street, San Francisco 11, California, U. S. A.

REPLACES THE HELPER OF THE FIELD



Plugs

FOR VICTORY

70 Types PLUGS & CONNECTORS SIGNAL CORPS • NAVY SPECIFICATIONS

Types :		PL		
50-A	61	74	114	150
54	62	76	119	159
55	63	77	120	160
56	64	104	124	291-A
58	65	108	125	354
59	67	109	127	
60	68	112	149	

PLP		PLQ		PLS	
56	65	56	65	56	64
59	67	59	67	59	65
60	74	60	74	60	74
61	76	61	76	61	76
62	77	62	77	62	77
63	104	63	104	63	104
64		64			

1136-1 **NAF** No. 212938-1

Other Designs to Order

Remler is equipped for the mass production of many types of radio and electronic devices from humble plugs and connectors to complete sound amplifying and transmitting systems. Ingenious production techniques contribute to Remler precision, reduce costs and speed up deliveries. • The Axis is on the run and final Victory is in sight. Let us help you finish the job.

Wire or telephone if we can be of assistance

REMLER COMPANY, LTD. • 2101 Bryant St. • San Francisco, 10, Calif.

REMLER

SINCE 1918

Announcing & Communication Equipment

NATIONAL RECEIVERS ARE THE EARS OF THE FLEET



OFFICIAL U. S. NAVY PHOTOGRAPH

Three out of four of the Navy's ships — landing craft or larger — are equipped with receivers designed by National.

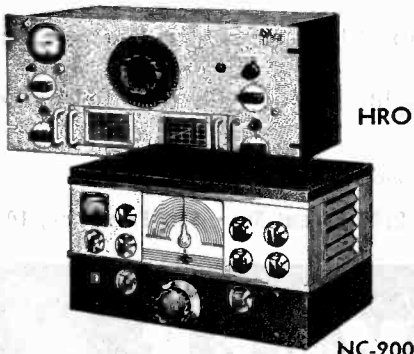

NATIONAL COMPANY

MALDEN MASS, U. S. A.



NATIONAL RECEIVERS ARE IN SERVICE THROUGHOUT THE WORLD

DO YOU NEED A CRYSTAL BALL ?

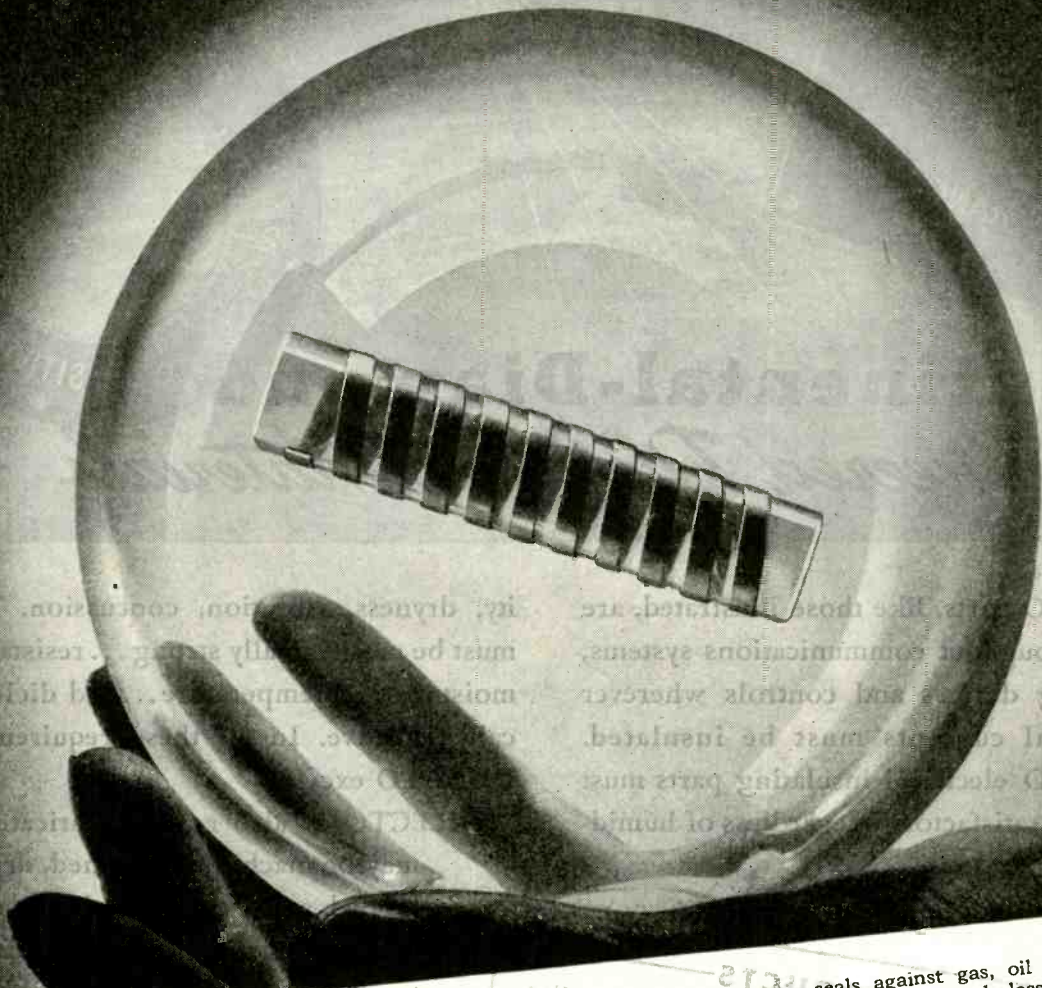

THERE are times in the lives of all good engineers when a crystal ball would come in mighty handy. We know because we've had many a problem where it looked like aid from the occult was the only solution. Instead, we found that sound engineering plus the outstanding physical properties of Corning's electrical glasses usually supplied the answers.

These same glass qualities are ready to help you produce better postwar electronic products. Which do you need?

1. High dielectric strength—high resistivity—low power factor—wide range of dielectric constants—low losses at all frequencies.

2. Permanent hermetic seals against gas, oil and water between glass and metal or glass and glass.

3. Commercial fabrication to the fine tolerances of precision metal working.

4. Corning's metallizing process produces metal areas of fixed and exact specification, permanently bonded to glass.

* * *

Write us about your problems. We'd be interested in seeing if glass can help you. Address Electronic Sales Dept., P-3, Bulb and Tubing Division, Corning Glass Works, Corning, N. Y.

CORNING
— means —
Research in Glass

Electronic Glassware



"PYREX", "VYCOR" and "CORNING" are registered trade-marks and indicate manufacture by Corning Glass Works, Corning, N. Y.



DILECTO parts, like those illustrated, are used throughout communications systems, detecting devices and controls wherever electrical currents must be insulated. DILECTO electrical insulating parts must function satisfactorily regardless of humid-

ity, dryness, vibration, concussion. They must be mechanically strong... resistant to moisture and temperature... and dielectrically effective. In all these requirements DILECTO excels.

DILECTO is also readily fabricated. It may be machined, punched, drilled, tapped, and even formed. It is made in many grades... each engineered to meet specific electrical or mechanical problems. DILECTO may be the answer to your "WHAT MATERIAL?" problem. Send for catalog "DO" which gives complete technical and physical data.

KB-44

C-D PRODUCTS

The Plastic's

DILECTO—A Laminated Phenolic.
CELORON—A Molded Phenolic.
DILECTENE—A Pure Resin Plastic Especially Suited to U-H-F Insulation.
HAVEG—Plastic Chemical Equipment, Pipe, Valves and Fittings.

The NON-Metallics

DIAMOND Vulcanized FIBRE
VULCOID—Resin Impregnated Vulcanized Fibre.

MICABOND—Built-Up Mica Electrical Insulation.

Standard and Special Forms

Available in Standard Sheets, Rods and Tubes; and Parts Fabricated, Formed or Molded to Specifications.

Descriptive Literature

Bulletin GF gives Comprehensive Data on all C-D Products. Individual Catalogs are also Available.

DISTRICT OFFICES

NEW YORK 17 • CLEVELAND 14 • CHICAGO 11
 SPARTANBURG, S. C. • SALES OFFICES IN PRINCIPAL CITIES

WEST COAST REPRESENTATIVES
 MARWOOD LTD., SAN FRANCISCO 3

IN CANADA:
 DIAMOND STATE FIBRE CO. OF CANADA, LTD., TORONTO 8

Continental - Diamond FIBRE COMPANY

Established 1895.. Manufacturers of Laminated Plastics since 1911—NEWARK 48 • DELAWARE



We sell battleships

WELL, not *real* battleships. But our products are built like 'em. And for good reason. Because our business is the manufacture of radio communications systems for the transportation field, the armed forces. The beating our equipment takes shouldn't happen to a dog. It pounds the rails, hits 4 G's—gets hot flashes, cold chills. But it lasts. And why

shouldn't it? It isn't built for polite society. It's made to give and take. And with precision. On trains, trucks, planes; on mountains, in jungles — wherever unfailing communication is a must. Your engineers and ours should get together. They'd talk the same language. And our factories can translate their conversation into what you want.

Aireon

MANUFACTURING CORPORATION

Formerly AIRCRAFT ACCESSORIES CORPORATION

Radio and Electronics • Engineered Power Controls

NEW YORK • CHICAGO • KANSAS CITY • BURBANK

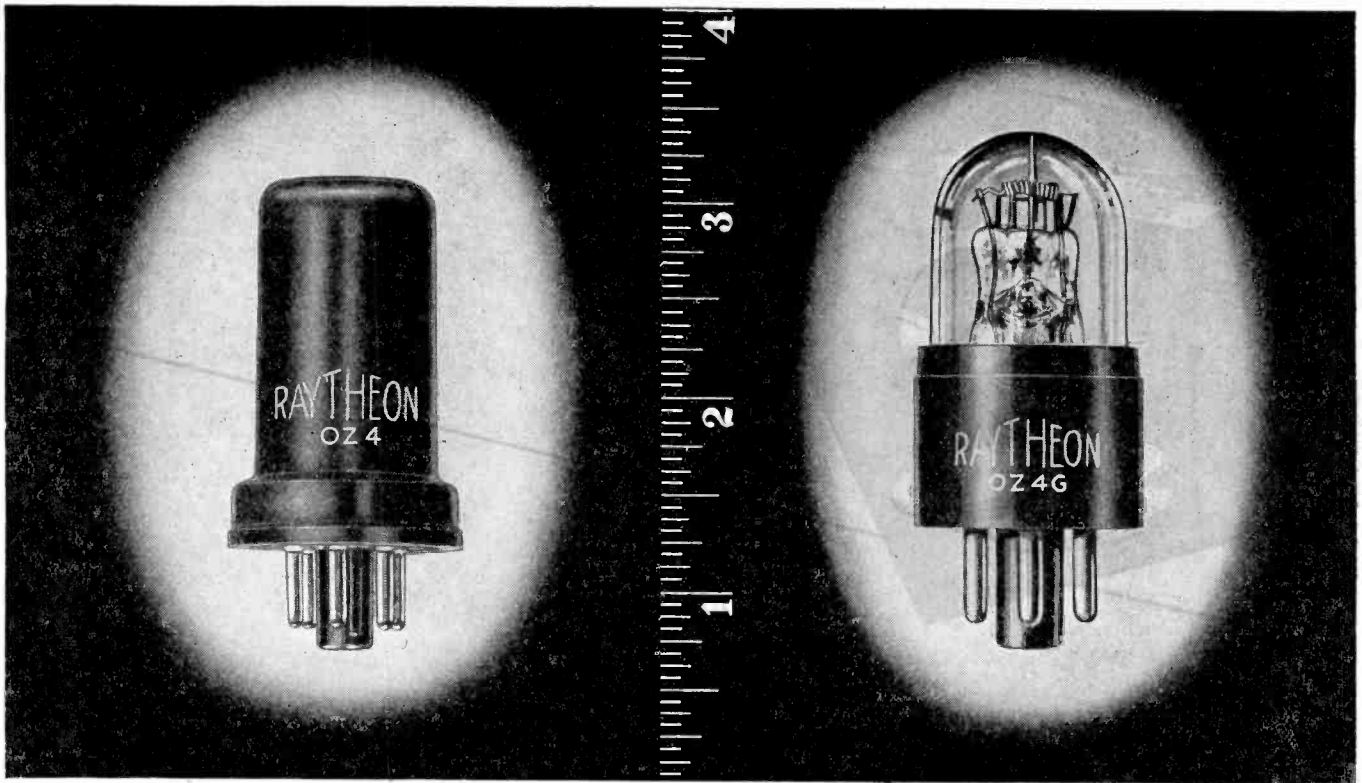

Increased Output from **RAYTHEON** OZ4 and OZ4G Tubes

Many manufacturers realize the advantages of small ionically heated cathode gas rectifiers which require no heater power, and yet operate with very low internal power losses. Convincing evidence is the widespread use of such tubes in automobile radios and other equipment where maximum performance must be obtained with minimum power input.

Millions of Raytheon OZ4 and OZ4G tubes have given reliable and efficient service in such equipment . . . service which will prompt engineers to incorporate them in numerous postwar products.

First developed by Raytheon as a refinement of the BH to obtain internal drops comparable to the larger directly heated cathode types, these tubes are now further improved to the point where the output rating has been increased from 75 ma to 90 ma when functioning as a full wave rectifier. Hence, it can be used to advantage in supplying the extra, "B" drain imposed by larger receivers or low-power mobile transmitters.

The OZ4 and OZ4G are examples of Raytheon's ability to design and produce better tubes . . . tubes which will be in great demand in the postwar radio and electronics industry.

Specifications of OZ4 & OZ4G

	OZ4	OZ4G
Maximum Overall Length	2-5/8 in.	2-5/8 in.
Maximum Seated Height	2-1/16 in.	2-1/16 in.
Maximum Diameter	1-5/16 in.	1-3/64 in.

Typical Operation Ratings as a Full Wave Condenser Input Rectifier

Heater Power	None
Minimum DC Output Current	30 ma
Maximum DC Output Current	90 ma
Maximum Peak Anode Current	270 ma
Minimum Starting Voltage— Peak (P to K)	320 volts
Average Dynamic Voltage Drop	24 volts
Maximum Peak Inverse Voltage	880 volts

RAYTHEON

RADIO RECEIVING TUBE DIVISION

Newton, Mass. • Los Angeles • New York • Chicago • Atlanta



All Four Divisions
Have Been Awarded
Army-Navy "E"
with Stars

Listen to
"MEET YOUR NAVY"
Every Saturday Night
ENTIRE BLUE NETWORK
Coast-to-Coast
181 Stations

DEVOTED TO RESEARCH AND THE MANUFACTURE OF TUBES AND EQUIPMENT FOR THE NEW ERA OF ELECTRONICS

A BASICALLY NEW IDEA IN TRANSMITTERS...

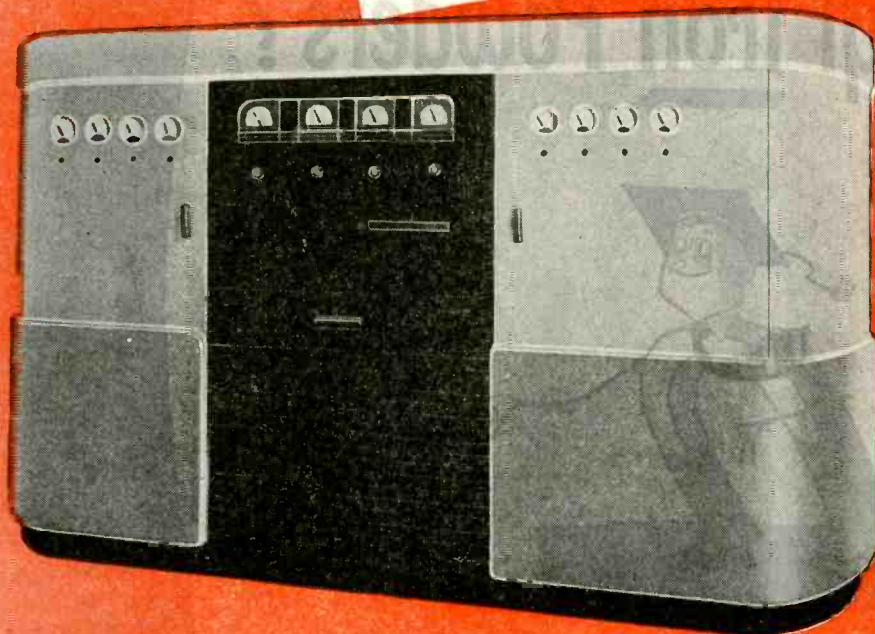

PLUS ALL THE EXTRAS OF SPECIAL WESTINGHOUSE RESEARCH FOR FM



*For harmonics up to 30 kc/s at ± 75 kc/s swing, distortion is less than 1.5% rms for modulating frequencies between 50 and 15,000 cps.

Here in a smartly-styled package is a basically new approach to FM transmitter design... combined with all the performance extras of special Westinghouse research for frequency modulation.

Built in 1, 3, 10 and 50 kw ratings, this new design provides direct generation of the modulated carrier by a simple and straightforward circuit. Frequency corrections are independent of critical tuning; Distortion is low.*

Metal-plate rectifiers—first introduced by Westinghouse for high-voltage, high-current AM applications—virtually eliminate outages caused by rectifier (tube) failures. Space and cooling requirements are reduced, operating costs are lowered.

Your nearest Westinghouse office has complete details of this new triumph in FM transmitter design in booklet B-3529. Or write Westinghouse Electric & Manufacturing Company, Radio Division, Baltimore, Maryland.

J-08103



Westinghouse
PLANTS IN 25 CITIES . . . OFFICES EVERYWHERE

Electronics at Work

XXV • RADIO'S 25TH ANNIVERSARY • KDKA

What are the uses of Carbonyl Iron Powders?



L Powder

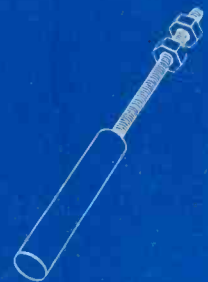

"L" Type Powder used in cores for permeability tuning.

The examples illustrated may suggest more specific applications of G.A.F. Carbonyl Iron Powders to many electrical design engineers. Other members of the profession, however, may desire a more detailed description of these powders. This is given below.

G.A.F. Carbonyl Iron Powders are obtained by thermal decomposition of iron penta-carbonyl. There are five different grades in production, which are designated as "L," "C," "E," "TH," and "SF" Powder. Each of these five types of iron powder is obtained by special process methods and has its special field of application.

The particles making up the powders "E," "TH," and "SF," are spherical with a characteristic structure of concentric shells. The particles of "L" and "C" are made up of homogenous spheres and agglomerates.

The chemical analysis, the weight-average particle size, the "tap density" (i.e. the density of the powder after a container is filled with loose powder has been tapped in a prescribed manner), and the apparent density or bulking factor as determined in a Scott Volumeter are given in the following table for the five different grades:

Grade	Chemical Analysis		% Nitrogen	Wt. Ave. diameter microns	Tap Density g/cm ³	Apparent Density g/cm ³
	% Carbon	% Oxygen				
L	0.005-0.03	0.1 -0.2	0.005-0.05	20	3.5-4.0	1.8-3.0
C	0.03 -0.12	0.1 -0.3	0.01 -0.1	10	4.4-4.7	2.5-3.0
E	0.65 -0.80	0.45-0.60	0.6 -0.7	8	4.4-4.7	2.5-3.5
TH	0.5 -0.6	0.5 -0.7	0.5 -0.6	5	4.4-4.7	2.5-3.5
SF	0.5 -0.6	0.7 -0.8	0.5 -0.6	3	4.7-4.8	2.5-3.5

Spectroscopic analysis shows that other elements, if any, are present in traces only.

Carbonyl Iron Powders are primarily useful as electromagnetic material over the entire communication frequency spectrum.

CARBONYL IRON POWDERS AND SOME OF THEIR PRESENT USES

The different grades of CARBONYL IRON POWDERS as seen in the microscope

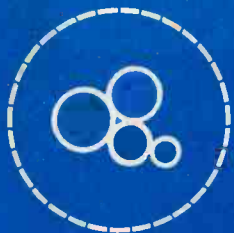

C Powder

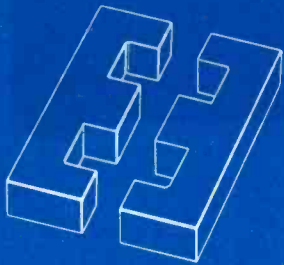

"C" Type Powder for E-cores in filter coils.



E Powder

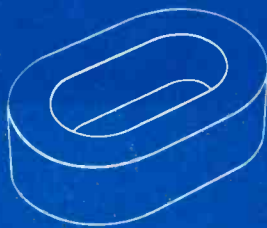

For antenna coils, "E" Type Powder used in cores.

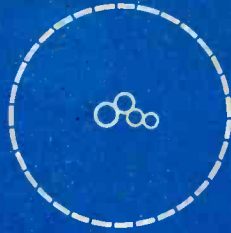

TH Powder



"TH" Type Powder is employed for cup shields in coils.

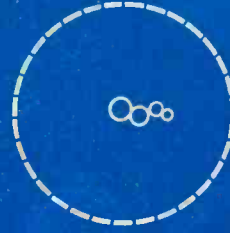

SF Powder



One use of "SF" Type Powder is in high frequency choke cores (with sealed-in leads).

Table 2 below gives relative Q values (quality factors) and effective permeabilities for the different grades of carbonyl iron powder. The values given in the table are derived from measurements on straight cylindrical cores placed in simple solenoidal coils. Although the

data were not obtained at optimum conditions, the Q values as expressed in percentage of the best core give an indication of the useful frequency ranges for the different powder grades.

"L" and "C" powders are also used as powder metal-

TABLE 2

Carbonyl Iron Grade	Effective Permeability at			Relative Quality Factor at		
	1 kc	10 kc	150 kc	200 kc	1 Mc	100 Mc
L	4.16	100	96	90	43	1
C	3.65	94	100	96	72	3
E	3.09	81	94	100	97	30
TH	2.97	81	93	98	100	54
SF	2.17	62	71	78	84	100

(Note: The actually measured Q values can be obtained by multiplying the rows respectively with: 0.78, 1.09, 1.25, 2.63, and 1.62.)

urgical material because of their low sintering temperatures, high tensile strengths, and other very desirable qualities. (Sintering begins below 500°C and tensile strengths reach 150,000 psi.)

Further information can be obtained from the Special Products Sales Dept., General Aniline & Film Corporation 435 Hudson Street, New York 14, N. Y.

G.A.F. CARBONYL IRON POWDERS

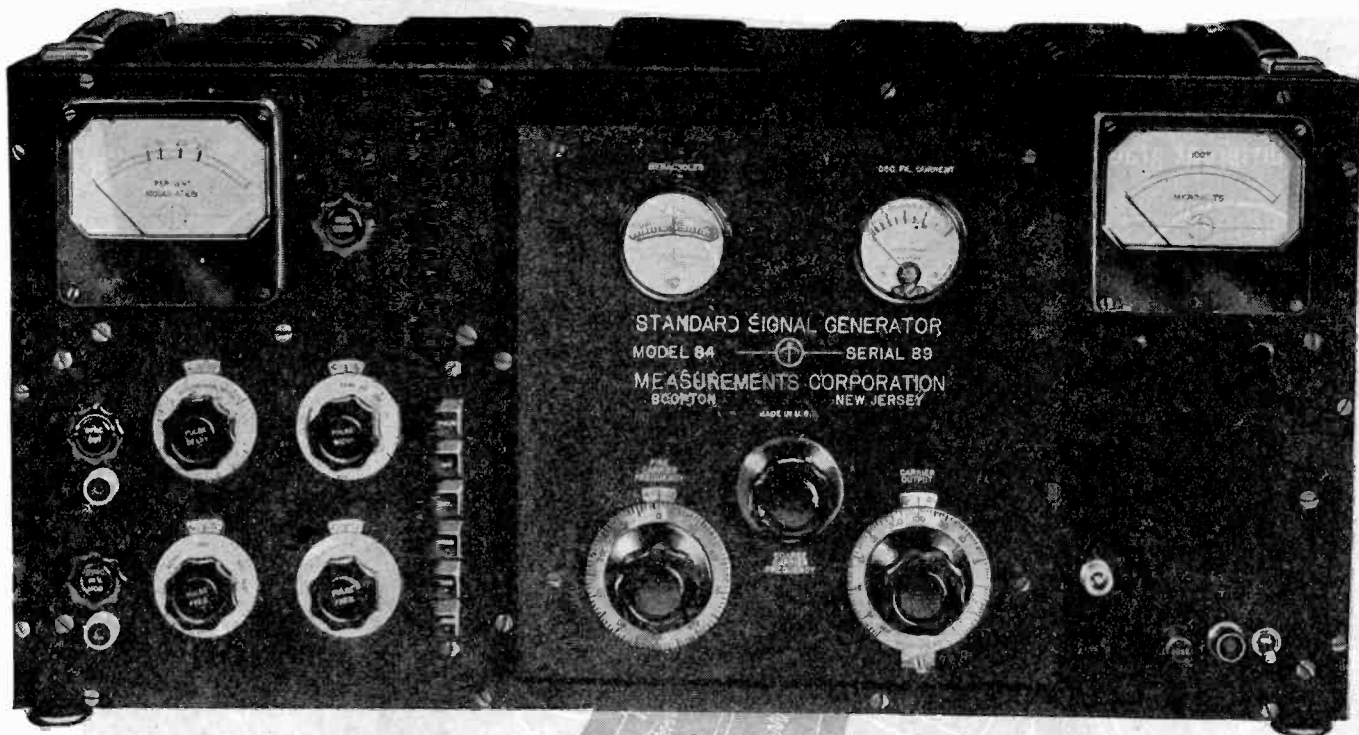

MODEL 84

U.H.F. STANDARD SIGNAL GENERATOR

SPECIFICATIONS

CARRIER FREQUENCY: 300 to 1000 megacycles.

OUTPUT VOLTAGE: 0.1 to 100,000 microvolts.

OUTPUT IMPEDANCE: 50 ohms.

MODULATION:

SINEWAVE: 0—30%, 400, 1000 or 2500 cycles.

PULSE: Repetition—60 to 100,000 cycles.

Width—1 to 50 microseconds.

Delay—0 to 50 microseconds.

Sync input—amplifier and control.

Sync output—either polarity.

DIMENSIONS: Width 26", Height 12", Depth 10".

WEIGHT: 125 pounds including external line voltage regulator.

MEASUREMENTS



CORPORATION

BOONTON,

NEW JERSEY

**DESIGN
ENGINEERS**

**CAN YOU USE A RESISTANCE MATERIAL
IN WHICH I varies as E^4 ?**

THYRITE

**MAY BE THE ANSWER TO SOME
OF YOUR CIRCUIT PROBLEMS**

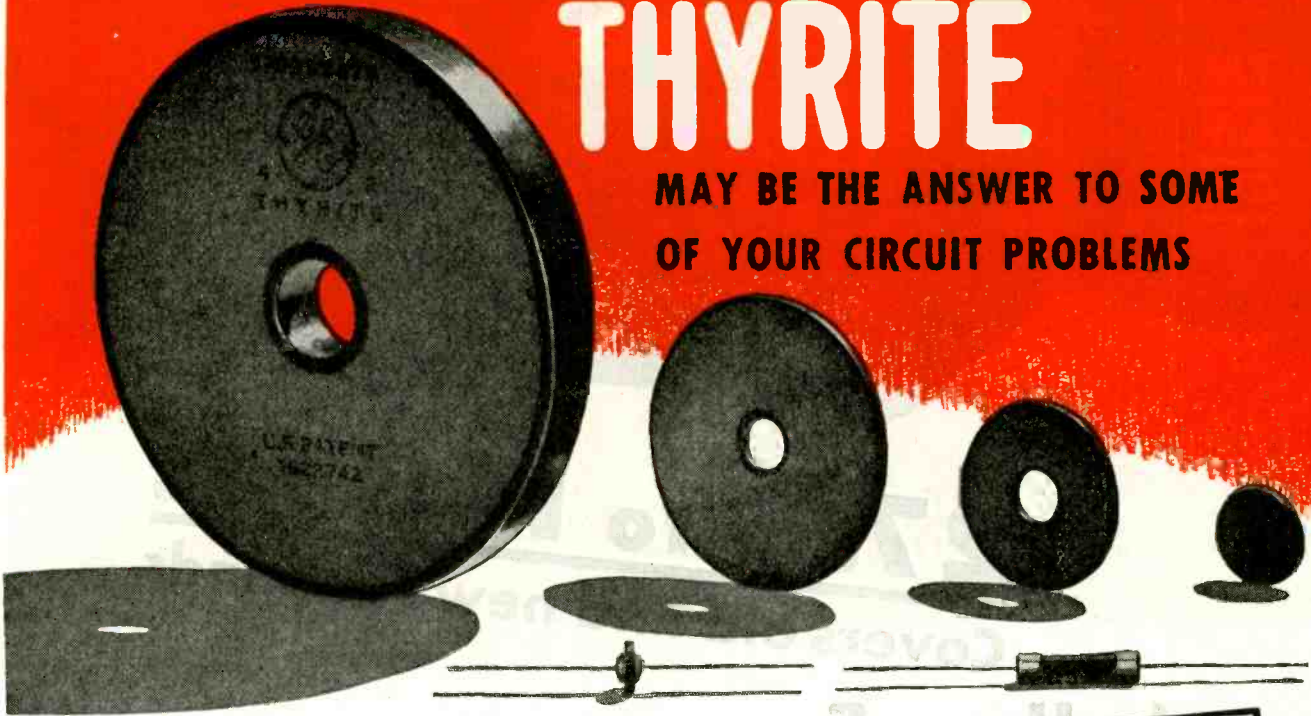

THYRITE* is a silicon-carbide ceramic material, dense and mechanically strong, having nonlinear resistance characteristics—the resistance varying as a power of the applied voltage. Its resistance characteristic is stable, and substantially independent of polarity or frequency. Thyrite has been used for many years in many important applications, including electronic. Thyrite can be produced in various shapes and sizes (those which can be successfully molded).

**Here are some of its
MANY APPLICATIONS**

- For protective purposes (to limit voltage surges)
- As a stabilizing influence on circuits supplied by rectifiers
- As a potentiometer (The division of voltage can be made substantially independent of load current)
- For the control of voltage-selective circuits, either independent of or in combination with electronic devices

*Reg. U.S. Pat. Off.

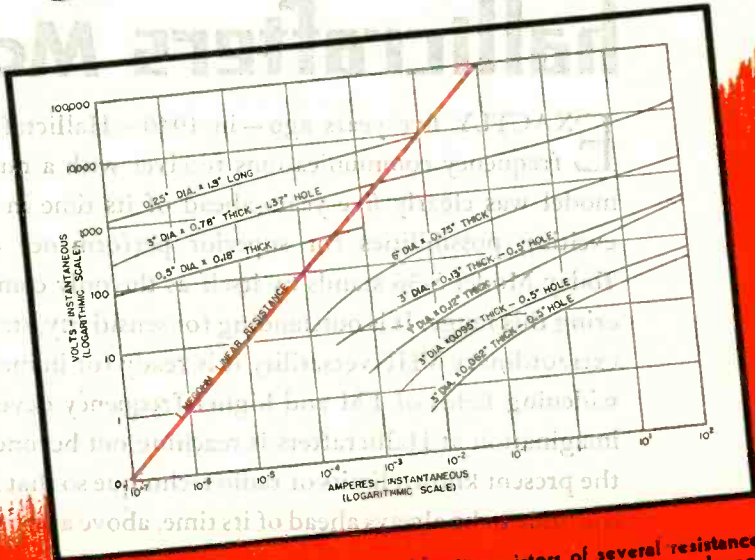

Typical volt-ampere characteristics of Thyrite resistors of several resistance levels and power ratings. Note that the nonlinear voltage-current characteristic extends over an extremely wide current range. Compare it with the characteristic (orange line) of a 1-megohm linear resistor.

The nearest G-E office can tell you what data should be submitted as a basis for a quotation. Or write direct to General Electric, Section 16-250, Pittsfield, Mass.

GENERAL  ELECTRIC

405-12-5600

5 YEARS AHEAD OF ITS TIME

FM
AM
CW



27.8 to 143 Mc

Covers old and new FM bands

hallicrafters Model S-36

EXACTLY five years ago—in 1940—Hallicrafters introduced a very high frequency communications receiver with a range of 27.8 to 143 Mc. This model was clearly five years ahead of its time in its anticipation of new and exciting possibilities for superior performance on the higher frequencies. Today Model S-36 stands by itself as the only commercially built receiver covering this range. It is outstanding for sensitivity, stability, high fidelity. With its extraordinary VHF versatility it is ready for immediate application in the ever widening fields of FM and higher frequency development work. Engineering imagination at Hallicrafters is reaching out beyond the next five years, beyond the present known limits of radio technique so that Hallicrafters equipment will continue to be always ahead of its time, above and beyond your best expectations.

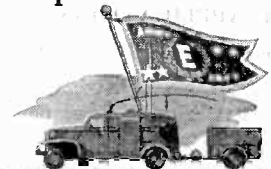

BUY A WAR BOND TODAY!

hallicrafters RADIO

THE HALLICRAFTERS COMPANY, MANUFACTURERS OF RADIO AND ELECTRONIC EQUIPMENT, CHICAGO 16, U. S. A.

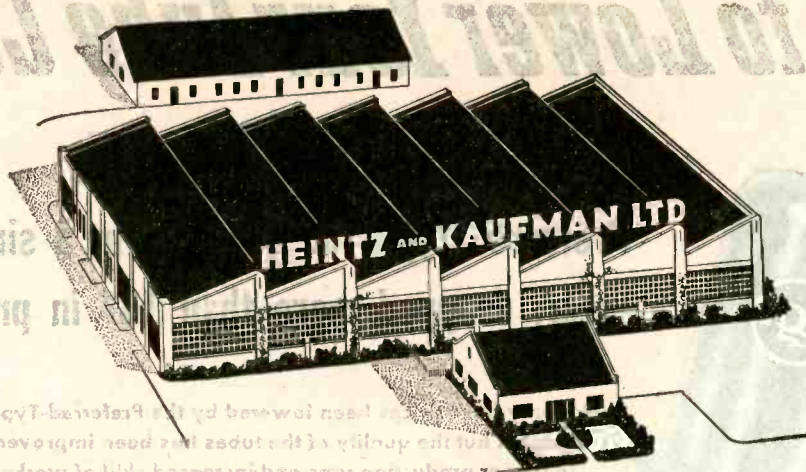

A STATEMENT OF POLICY TO THE EQUIPMENT MANUFACTURER CONCERNING *Gammatron Tubes*

WE at Heintz and Kaufman Ltd. believe that equipment manufacturers, many of whom are making their long-range plans now, will be interested in the policies for the standardization and stabilization of tube types which have been established for Gammatrons. These policies merit consideration when designing equipment either for military or civilian use.

Practically all tubes now sold to the Government must conform to specifications covering electrical standards and physical dimensions.

We are heartily in favor of the Signal Corps and Bureau of Ships joint standardization of electronic component parts. The good work of the Radio Manufacturers Association likewise deserves the highest commendation. We believe that the Joint Army and Navy

Specifications for Vacuum Tubes ("JAN specs") will be accepted voluntarily by tube manufacturers as post-war commercial standards, since they offer many advantages to the equipment manufacturer.

All H & K Gammatrons when again manufactured for commercial use will conform to the rigid physical and electrical specifications now required by "JAN specs."

Thus when you design equipment around Gammatron tubes you can be sure that neither electrical nor physical changes in these tubes will make redesign of equipment necessary, or replacement difficult.

We plan to tell you more about our standardization and development policies in future advertisements. So please be on the watch for them each month.



**BUY WAR
BONDS**

HEINTZ AND KAUFMAN LTD.

SOUTH SAN FRANCISCO • CALIFORNIA

Gammatron Tubes

How to Lower Your Tube Costs



Simply base your designs on RCA Preferred-Type Tubes which, in a single year, dropped more than 13% in price.

Not only have prices been lowered by the Preferred-Type Program but the quality of the tubes has been improved, due to longer production runs and increased skill of workers.

How the preferred-type idea started

Long before Pearl Harbor, RCA found that despite the hundreds of different receiving-tube types being manufactured, almost every possible-circuit requirement could be satisfied by a list of less than 50 tube types.

Moreover, by limiting the number of types being manufactured, it would be possible to realize tremendous savings in warehousing, distribution, test equipment, and other factors affecting cost.

The plan was promoted among equipment designers who, quick to see the advantages of fewer tube types, cooperated wholeheartedly to make the Preferred-Type Program a success.

When the war broke out, the Army and Navy adopted the Preferred-Type idea and established a list of their own, including many tubes already on RCA's Preferred-Type list. Military equipment was designed almost exclusively around Army-Navy Preferred-Type Tubes. This forward-looking policy simplified military tube stocks and insured speedy replacements on the fighting fronts.



Which RCA tubes are preferred types

By substantial indication of preference, designers themselves — not RCA — determine which tubes are Preferred Types.

Because the list of Preferred Types (metal, miniature and glass) is still rather fluid, it is advisable to check with us before your final decisions are made regarding any specific tube. Write to Department 62-28P, RCA, Harrison, N. J.



The fountain-head of modern Tube development is RCA.



62-40 214-28

RADIO CORPORATION OF AMERICA

RCA VICTOR DIVISION • CAMDEN, N. J.

The contacts between the leaders in the electronic and communication industry and the engineers in this field have become increasingly close under the stress of war conditions and promise to become even closer during the postwar period. Accordingly the thoughts of the industrialists are of primary interest and stimulation to the engineers, and are accordingly presented in these pages as guest editorials, in the form in which they are received. There follows such a message from the President of P. R. Mallory and Company, Incorporated.

The Editor

The Electronics Engineer

P. R. MALLORY

For more than thirty years my time, to a very large degree, has been spent in dealing with engineers—young and old alike.

For the most part these men have been identified with electronics and metallurgy and many of them have shown outstanding creative abilities.

Among them have been exceptional men and among them, too, have been men for whom I have developed the greatest respect as well as close bonds of friendship.

Therefore, I welcome this opportunity of briefly setting forth some of my views to the members of the I.R.E. at this time.

If there is one thing this war has demonstrated it is the resourcefulness and basic quality of the American engineer. The phenomenal record accomplished by industry is to a major degree the result of the even more phenomenal record of its engineers.

In every field of war equipment the engineer under intense pressure has created new devices—new answers to pressing problems—as they have arisen as a result of war experience. The record of all industries is replete with dramatic evidence of outstanding engineering accomplishment.

Perhaps in no field have these results been so outstanding as in the field of electronics—our youngest industry, manned largely by “young engineers”. These men, some of whom are veteran engineers of our radio industry and others only recently released from technical schools, have presented a fresh and dynamic approach to the new challenging problems of each day. Certainly no industry has left such an impress on so many different aspects of this global war—on the ground, in the air and under and on the sea.

You electronic engineers who read these words, know far better than do I the revolutionary results of these accomplishments. Suffice it to say here that they have altered in our favor the entire complexion of this war. They have given our forces a superiority of performance that has a profound effect on tactics and strategy.

Is it too much to anticipate that similarly they will greatly affect our peace time lives; that they will sustain this great new industry that already is an employer of hundreds of thousands of workers? I think not.

In peace, progress comes more slowly. However, modern scientific progress has accelerated the laws of change to a remarkable degree. Even before the stimulation of this war, changes were being effected in a few years which formerly would have required a generation.

In electronics we may look forward to a period of intense development and orderly and substantial accomplishments, affecting all phases of industry, transcending anything we can now visualize. Mr. James H. McGraw, Jr. recently stated, “The future of the electronics industry is limited only by man’s imagination.” George S. Armstrong and Co., Inc., in a recent booklet on the electronics industry, estimated the war growth of this industry as perhaps thirteen times its prewar volume. Of this at least a \$1,000,000,000 annual volume should be retained in the postwar era.

Surely this industry presents a challenging opportunity to engineers.

As a result of the war time accomplishments of our engineers I look for a new and enhanced respect for the engineering profession as a decisive factor in our industrial society. All too frequently in times past the engineer has felt himself at a disadvantage compared to the commercial man in recognition of their respective contributions to industry’s growth. Many reasons for this discrimination may be suggested. One unquestionably is that engineers are often trained to deal more with things than with men. This is a weakness that our engineering schools must strive to correct.

Never forget that this new recognition of engineering, won through splendid achievement, also presents its challenge. Engineers to hold their position must be broad-gauged, well-rounded men who not only understand mathematical but human equations as well.

The future opportunity for the well-balanced electronics engineer looks to me to be brilliant indeed. Nevertheless, it is still only an opportunity. Performance will be required to lift the unusual man above his fellow engineers. The field is wide open. The search of management for men who can accept responsibility is just as active as ever.



Ivan Stoddard Coggeshall

Ivan Stoddard Coggeshall, who recently completed his fourth year as appointed Director of the Institute, typifies those of its members whose engineering work has been in an "art allied with radio",—in his case, that of wire telegraphy. As general cable supervisor of The Western Union Telegraph Company, he is concerned with the traffic and electrical operation of that company's submarine cable system in the United States and abroad.

Born at Newport, Rhode Island, on September 30, 1896, he became an early wireless amateur. He attended Worcester Polytechnic Institute, leaving in 1917 to join Western Union. He served the United States Navy in World War I as Ensign in steam engineering. In 1937 he was commissioned Lieutenant-Commander, U.S.N.R., holding the post of executive officer of the Naval Communication Reserve radio network in the Third Naval District. He is at present a liaison officer between the Navy and the telegraph company, having had several assignments to active duty in the Navy Department during World War II. He also represents his company

on the Cable Committee of the Board of War Communications.

Mr. Coggeshall became an Associate of The Institute of Radio Engineers in 1926, transferred to Member grade in 1929, and was elected Fellow in 1943 for his services to the welfare of the Institute and the engineering profession. He has served on many I.R.E. standing committees, including the Executive Committee of the Board of Directors during 1942; and was chairman of the 1942 Convention and of the 1943 Winter Conferences. Mr. Coggeshall is vice-chairman of the Building-Fund Committee and is actively engaged in this work.

He is a Member of the American Institute of Electrical Engineers, a past-chairman of the Communication Group of its New York Section, and currently vice-chairman of the A.I.E.E. Committee on Communication. He has contributed to the technical literature of the telegraph; is a registered Professional Engineer of the State of New York; a Director of the Mexican Telegraph Company; and a member of Tau Beta Pi.

Radio Progress During 1944*

Introduction

AS IN 1943, the efforts of the radio industry were almost exclusively devoted to the development, production, and application of techniques, devices, and systems for the conduct of the war. While the details of technical activities of necessity continued to be shrouded in secrecy, the results of military operations reflected the tremendous contribution of the radio industry to the prosecution of the war.

The commercial radio services continued to function on a wartime basis or were suspended for the duration of the war. In general, man power and critical materials available for commercial services were reduced to those required for necessary operation and maintenance.

A limited amount of research and development directed toward new commercial services was authorized by the Federal Communications Commission in the United States but the attendant use of critical materials and man power was secondary to wartime needs. One of the services of prominence in postwar planning is point-to-point radio relaying, utilizing frequencies in the 1900 to 12,000 megacycle range.

During the year 1944, the radio industry in the United States had occasion to reconsider all existing frequency allocations and systems standards, and also to consider future allocations and standards for all new radio services. The year witnessed the intensive and thorough study of all phases of frequency allocation by the radio industry through the agency of the Radio Technical Planning Board, which had been formed under the joint sponsorship of the Radio Manufacturers Association and the Institute of Radio Engineers, and which substantially completed its organization during 1943. The Board was charged with the responsibility of studying all technical phases of radio and formulating technical recommendations for pertinent system standards and frequency allocations for the entire radio-frequency spectrum. It had prepared reports covering a large part of its program by October, 1944.

From September 28 to November 4, 1944, the Federal Communications Commission in the United States held hearings of vital interest to all existing and proposed radio services. The purpose of the hearings was to obtain technical data and recommendations on the subject of frequency allocations from all interested persons or organizations, as a prelude not only to domestic reallocation of all radio frequencies but also to the formulation of proposals for international treaties covering all radio frequencies of international interest. During these hearings, the Radio Technical Planning Board re-

* Decimal classification: R090. Original manuscript received by the Institute, January 11, 1945. This report is based on material from the 1944 Annual Review Committee of The Institute of Radio Engineers, as co-ordinated and edited by Laurens E. Whittemore, Keith Henney, and I. S. Coggeshall.

ported its findings and recommendations to the Commission. The technical decisions which result from these hearings are expected to have a considerable influence on future radio progress in the United States.

Transmitters

During 1944, the Standard Frequency Broadcast Service of the United States National Bureau of Standards was expanded to the following schedule:

2.5 megacycles 7 P.M. to 9 A.M., E.W.T.	1 kilowatt 440-cycle modulation
5 megacycles continuous	10 kilowatts 440- and 4000-cycle modulation
10 megacycles continuous	10 kilowatts 440- and 4000-cycle modulation
15 megacycles 7 A.M. to 7 P.M., E.W.T.	10 kilowatts 440- and 4000-cycle modulation

All transmissions include a 5-millisecond pulse at intervals of precisely 1 second, each consisting of five 1-millisecond pulses. This pulse is omitted on the 59th second of each minute. Audio-frequency transmission is interrupted for one minute beginning on the hour and each five minutes thereafter. The accuracy of all radio and audio frequencies is better than one part in 10,000,000. Instructions for reception and utilization of this service are available upon request, in the Bureau's Letter Circular, "Methods of using standard frequencies broadcast by radio."

- (1) National Bureau of Standards, "Standard frequency broadcast service," Proc. I.R.E., vol. 32, pp. 175-176; March, 1944. Revision of above material, Proc. I.R.E., vol. 32, pp. 493-494; August, 1944.

The probability of increased postwar application of grounded-grid, cathode-input amplifiers for medium or higher frequencies is reflected in performance analyses published in 1944. They show that, in addition to the greater stability obtainable from the cathode-input amplifier, compared with the grid-input type, a reduction in input noise is obtainable under prescribed conditions.

- (2) M. C. Jones, "Grounded-grid radio-frequency voltage amplifiers," Proc. I.R.E., vol. 32, pp. 423-429; July, 1944.
- (3) Milton Dishal, "Theoretical gain and signal-to-noise ratio of the grounded-grid amplifier at ultra-high frequencies," Proc. I.R.E., vol. 32, pp. 276-284; May, 1944.

A new station location or Z-marker antenna system was described which possesses marked advantages over presently used systems. It consists of two spaced-dipole arrays, crossed at right angles to each other and excited in quadrature time phase. The antenna is simple, sturdy, and stable under all weather conditions. The marker zone is narrower and the altitude range may be double that of existing equipment.

- (4) J. C. Hromada, "The development of a new station location or Z-marker antenna system," Proc. I.R.E., vol. 32, pp. 454-463; August, 1944.

TABLE I
RADIO BROADCAST STATIONS FOR WHICH LICENSES AND CONSTRUCTION PERMITS
ISSUED BY THE FEDERAL COMMUNICATIONS COMMISSION WERE
OUTSTANDING ON DECEMBER 31, 1944

Class of Broadcast Station	Number of Licenses	Number of Construction Permits
Standard	919	24
Commercial high-frequency (frequency-modulation)	46	7
Experimental high-frequency (including 1 station operating under "special authorization" and 2 stations operating under "temporary class 2" licenses)	5	0
Commercial television	6	3
Experimental television	10	10
International	31	5
Facsimile	3	0
Noncommercial educational	5	5
Developmental for frequency modulation and television	5	10

An increasingly large number of applications for construction permits for frequency-modulation broadcast stations continued to be submitted to the Federal Communication Commission as a result of the announcement of its policy to accept such applications for consideration when relaxation of wartime limitations makes it possible. All existing frequency-modulation broadcast stations have continued to operate, although such operation, in most cases, has been on restricted schedules. The interest shown in frequency modulation broadcasting during the war years is an indication that this service will rapidly expand in the postwar years.

Frequency Modulation

Curtailed publication of knowledge of developments in frequency modulation is, of course, to be expected in view of the war. This was especially true during the year 1944, in spite of the increased use of the frequency-modulation principle in matériel of war. Notwithstanding, there were some published contributions to the field relating to equipment and circuit developments.

A paper, published in 1943 but not reported in last year's Review, on the history and development of frequency modulation, should not go unnoticed. It pointed out that the first patent using the frequency-modulation principle as applied to code signals was filed in 1902. At that time the system employed a spark gap instead of the electronic tubes of the present, but the method of modulating a carrier frequency in accordance with a signal was essentially the same. That the field has not mushroomed can be observed in the number of patents issued to June 1, 1943, namely, 392, of which about 90 per cent were concerned with frequency modulation, and about 10 per cent with phase modulation. Complete listings of existing frequency-modulation stations, both commercial and experimental, and of stations planned for the near future, were included in this paper.

(5) Raymond F. Guy, "F-M and U-H-F," *Communications*, vol. 23, pp. 30, 32, 34-36; August, 1943.

Problems encountered in the design, development and operation of automatic and semiautomatic studio-to-transmitter links in the range above 260 megacycles were discussed in several papers. A feature of the transmitters employed in link service was drift compensation, whereby an upper harmonic of a crystal-controlled

frequency, was used in a control circuit, provided with a safety relay to shut down the transmitter if the frequency-stability network did not properly correct the frequency. Receivers designed for studio-link service were in general described as of fixed-frequency, crystal-controlled, and drift-compensated. The input stages usually employed "acorn" tubes. Antennas described were conventional, two horizontally polarized, colinear arrays.

(6) Paul Dillion, "A 337-Mc F-M studio-station link," *Electronics*, vol. 17, pp. 104-107; March, 1944.

(7) W. R. David, "F-M studio-to-transmitter links," *Communications*, vol. 23, pp. 15-19, 89; December, 1943.

The planning of an ultra-high-frequency communications system for mobile operation was considered in two papers, one concerned with a state-wide police system and the other with a transportation system. The planning of a complete communications program must include budget considerations, studies of methods of communications, fixed- and mobile-station problems, and maintenance. The three-year-old Massachusetts State Police System was described.

The streetcars and busses in Chicago are aided in smooth operation under emergency conditions by low-power mobile phase-modulated transmitters and receivers installed in some 50 cars. Receivers designed for this service make use of a squelch circuit, to block out noise and make the loudspeaker inoperative except when signals are received.

(8) John A. Doremus, "Planning a U-H-F communications system," *Electronics*, vol. 16, pp. 96-101, 178, 180; September, 1943.

(9) Beverly Dudley, "P-M communication system for Chicago surface lines," *Electronics*, vol. 17, pp. 102-106, 238, 240, 242, 244, 246, 248-249; January, 1944.

One of the first installations of frequency-modulation communication for power-line carrier work was completed this past year. This system used power-line carrier frequencies of from 50 kilocycles to 150 kilocycles, with each carrier channel about 6 kilocycles wide. The deviation ratio was 1:1 for 3000 cycles, with 100 per cent modulation. It was pointed out that the 3000-cycle shift of a 50-kilocycle carrier (6 per cent) is comparable with the 75-kilocycle shift about the 4.3-megacycle intermediate frequency (2 per cent) as usually used in the frequency-modulation broadcast receivers.

(10) "F-M Carrier telephony for 230-kv lines," *Electronics*, vol. 17, pp. 106-109; December, 1944.

In line with the above-mentioned application of frequency modulation was its use in transoceanic facsimile transmission. Using a frequency range of 1600 to 2000 cycles for the half-tone range, it was possible to obtain pictures with finer detail and better half-tone quality than those obtained by using earlier methods. Fading and multipath effects were minimized, since the use of a subcarrier frequency appeared as the equivalent of a linear amplitude-variation system which functioned independently of signal-level fluctuations. A paper was also published on the application of frequency modulation to wire-line telegraphy.

- (11) W. H. Bliss, "Use of subcarrier frequency modulation in communication systems," *Proc. I.R.E.*, vol. 31, pp. 419-423; August, 1943.
- (12) F. B. Bramhall, "Carrier telegraph systems," *Elec. Eng.*, vol. 63, pp. 283-286; August, 1944.

Circuit applications of frequency modulation were considered in several papers. One of these discussed the basic theory of a coupled-circuit frequency modulator using a condenser microphone to vary the reactance of an oscillator tank circuit, to operate at 40 megacycles. The variable reactance was transferred across an air-core transformer, resulting in a frequency change of 15 kilocycles. It was thought possible to secure a frequency shift of 80 kilocycles by this method.

The cathode-follower circuit was applied to a reactance-tube modulator. In this circuit the necessary phase shift to the grid of a reactance tube was obtained, since the output of the reactance tube was fed into a cathode follower, and then to the oscillator which was to be modulated.

A method for frequency-modulating a resistance-capacitance oscillator was treated. Here a tube acted as one of the frequency-controlling elements. This circuit was said to follow square-wave signals quite precisely; hence, it could be conveniently utilized in facsimile transmission. Design curves for the construction of such a modulator were given.

A synchronized oscillator used as a limiter in a receiver was described. Such an oscillator stage followed the intermediate-frequency amplifier and was synchronized to a subharmonic of the intermediate-frequency signal. This circuit resulted in improved voltage gain, adjacent-channel selectivity, and amplitude-limiting action. The theory of synchronized oscillators and the advantages of such system were outlined in the paper.

- (13) Elwin J. O'Brien, "A coupled-circuit frequency modulator," *Proc. I.R.E.*, vol. 32, pp. 348-350; June, 1944.
- (14) F. Butler, "Reactance-valve frequency modulator," *Wireless Eng.*, vol. 20, p. 539; November, 1943.
- (15) Maurice Artzt, "Frequency modulation of resistance-capacitance oscillators," *Proc. I.R.E.*, vol. 32, pp. 409-414; July, 1944.
- (16) C. W. Carnahan and H. P. Kalmus, "Synchronized oscillators as F-M receiver limiters," *Electronics*, vol. 17, pp. 108-111, 332, 334, 336, 338, 340, 342; August, 1944.

A phonograph pickup was described in which the needle itself formed part of a capacitor connected across the tank circuit of a conventional high-frequency oscillator. The "needle weight" could be reduced to $\frac{1}{2}$ to 1 ounce. Because of the construction of the pickup and the motion of the needle, there was automatic volume expansion, the amount of which could be regulated by the angle of the needle. The oscillator itself was mounted in the tone arm or pickup arm. Radiation took place from the oscillator tank circuit, the signal being picked up by a conventional frequency-modulation receiver tuned to some frequency not commercially used.

- (17) B. F. Miessner, "Frequency-modulation phonograph pickup," *Electronics*, vol. 17, pp. 132-133; November, 1944.

No review of frequency modulation would, of course, be complete without the mention of the work done by

Panel 5 of the Radio Technical Planning Board. One of the most important of their reports dealt with frequency standards of frequency allocation in the postwar world. Among its recommendations, the Panel proposed that: (1) frequency modulation is best suited for very-high-frequency broadcasting; (2) the frequency-modulation broadcast band should be from 41 to 56 megacycles including 75 channels; (3) each broadcast channel should have a width of 200 kilocycles, allowing 75 kilocycles as maximum frequency swing, with a 15-kilocycle maximum audio-frequency band width; and (4) horizontal polarization should be employed for antenna radiation.

- (18) Radio Technical Planning Board, Panel 6, "Report on standards and frequency allocations for postwar F-M broadcasting," *RTPB*; June 1, 1944.
- (19) "RTPB on F-M," *Electronics*, vol. 17, p. 125; November, 1944.
- (20) "A report on the FCC frequency allocation hearing," *Electronics*, vol. 17, pp. 92-97; December, 1944.

The following additional papers have appeared relating to frequency modulation:

- (21) G. Cudell, "Experiments with amplitude and frequency modulation," *Hochfrequenz. und Elektroakustik*, vol. 59, pp. 66-70; March, 1942.
- (22) B. Dudley, "Postwar FM and television," *Electronics*, vol. 16, pp. 94-97, 190-191; November, 1943.
- (23) K. R. Sturley, "The phase discriminator. Its use as frequency converter for FM reception," *Wireless Eng.*, vol. 21, pp. 72-78; February, 1944.
- (24) W. Stäblein, "Measurement of the characteristics of frequency-modulation oscillations," *Elek. Nach. Tech.*, vol. 20, No. 4, pp. 102-111; 1943; *Bull. Ass. Suisse Elec.*, vol. 35, pp. 100-102; February 23, 1944.
- (25) A. D. Mayo, Jr. and C. W. Sumner, "FM distortion in mountainous terrain," *QST*, vol. 28, pp. 34-36; March, 1944.
- (26) F. M. Colebrook, "A note on frequency modulation with particular reference to standard-signal generators," *Wireless Eng.*, vol. 21, pp. 112-115; March, 1944.
- (27) D. A. Bell, "Transient response in frequency modulation," *Phil. Mag.*, vol. 35, pp. 143-158; March, 1944.
- (28) A. Block, "Modulation theory," *Jour. I.E.E.* (London), vol. 91, part 3, pp. 31-42; March, 1944.
- (29) R. A. Gordon, "German VHF command set," *Electronics*, vol. 17, pp. 132-134, 300; April, 1944.
- (30) S. Helt, "F-M and A-M transmitter analysis," *Communications*, vol. 24, pp. 36, 85-88; July, 1944.

Radio Receivers

Radio engineers and manufacturers who, before the war, were concerned solely with broadcast receivers, have been engaged in the development and manufacture of all types of electronic equipment, in all frequency ranges, for the armed forces. These equipments are of sturdy mechanical design and have components of predominantly high quality. A great deal of attention has been given to the conversion and utilization of critical materials, to life tests, and to the protection of components from humidity, high and low temperatures, fungus, and rough handling.

- (31) R. Proskauer, "Fungus-proofing procedure," *Electronics*, vol. 17, pp. 92-93 and 224, 229, 232; June, 1944.
- (32) C. W. Martel and J. W. Greer, "Joint Army-Navy tube standardization program," *Proc. I.R.E.*, vol. 32, pp. 430-434; July, 1944.

Articles in the technical literature on receivers have reported some work which was largely under way before the war. Among the papers on ultra-high-frequency technique applicable to receivers, are the following:

- (33) E. W. Herold, "The operation of frequency converters and mixers for superheterodyne reception," *PROC. I.R.E.*, vol. 30, pp. 84-103; February, 1942.
- (34) B. Dudley, "U.H.F. technique, Part III, U.H.F. reception and receivers," *Electronics*, vol. 15, pp. 51-55; April, 1942. (Has extensive bibliography.)
- (35) E. W. Herold and L. Malter, "Some aspects of radio reception at ultra-high frequency," *PROC. I.R.E.*, vol. 31, Part I, pp. 423-438; August, 1943; Part II, pp. 491-500; September, 1943; Part III, pp. 501-510; September, 1943; Part IV, pp. 567-575; October, 1943; Part V, pp. 575-582; October, 1943.

Grounded-grid amplifiers for ultra-high-frequency postwar receivers are among the possibilities.

- (36) M. C. Jones, "Grounded-grid radio-frequency voltage amplifiers," *PROC. I.R.E.*, vol. 32, pp. 423-429; July, 1944.

The superregenerative receiver has had renewed attention, including possible application to frequency-modulation receivers.

- (37) H. P. Kalmus, "Some notes on superregeneration with particular emphasis on its possibilities for frequency modulation," *PROC. I.R.E.*, vol. 32, pp. 591-600; October, 1944.

Considerable attention has been paid to input systems of receivers, including transmission lines, wave guides, and antennas, and also the noise voltages in these systems.

- (38) R. King and C. W. Harrison, Jr., "The receiving antenna," *PROC. I.R.E.*, vol. 32, pp. 18-34; January, 1944.
- (39) C. W. Harrison, Jr., and R. King, "The receiving antenna in a plane-polarized field of arbitrary orientation," *PROC. I.R.E.*, vol. 32, pp. 35-49; January, 1944.
- (40) H. T. Friis, "Noise figures of radio receivers," *PROC. I.R.E.*, vol. 32, pp. 419-422; July, 1944.
- (41) C. W. Frick and S. W. Zimmerman, "Radio-noise filters applied to aircraft," *Trans. A.I.E.E. (Elec. Eng.)*, September, 1943, vol. 62, pp. 590-595; September, 1943.
- (42) Fred Foulon, "Radio noise elimination in all-metal aircraft," *Trans. A.I.E.E. (Elec. Eng.)*, vol. 62, pp. 877-891; 1943 (Supplement).
- (43) G. Weinstein, H. H. Howell, G. P. Lowe, and B. J. Winter, "Radio-noise elimination in military aircraft," *Trans. A.I.E.E. (Elec. Eng.)*, November, 1944, vol. 63, pp. 793-795; November, 1944.
- (44) T. B. Owen, "Very-high-frequency radio-noise elimination," *Trans. A.I.E.E. (Elec. Eng.)*, December, 1944, vol. 63, pp. 949-954; December, 1944.

Increase in the use of home receivers for frequency-modulated waves appears to be a major trend for the postwar period, although the exact frequency range in which expanded operation will take place is yet to be determined.

- (45) J. E. Brown, "Frequency-modulation and its postwar future," *Electronics*, vol. 17, pp. 94-99, 262; June, 1944.

Developments for receivers for frequency-modulated waves, which may be disclosed, include synchronized oscillators for eliminating amplitude modulation.

- (46) G. L. Beers, "RCA super-F-M uses locked-in oscillator," *Electronic Ind.*, vol. 3, pp. 76-78, 228, 230, 232, 234, 236; November, 1944; *PROC. I.R.E.*, vol. 32, pp. 730-737; December, 1944.

The demand for special receivers and communications systems for amplitude-modulated, frequency-modulated, and phase-modulated waves, applicable to railroads, busses, taxicabs, forest service, and other mobile and point-to-point applications, has increased.

- (47) H. K. Lawson and L. M. Belleville, "Mobile 30-40 Mc receiver for the U. S. Forest Service," *Electronics*, vol. 15, pp. 22-25, 98-99; January, 1942.
- (48) W. S. Halstead, "Electronic communication for trains," *Electronic Ind.*, vol. 17, pp. 102-107, 262, 264, 266, 268, 270, 272, 274; August, 1944.

- (49) L. O. Grondahl and P. N. Bossart, "Train communication," *Trans. A.I.E.E. (Elec. Eng.)*, July, 1943, vol. 62, pp. 493-500; July, 1943.

A great deal of work on standardization for postwar receivers has been done in the panel meetings of the radio Technical Planning Board.

- (50) W. R. G. Baker, "Planning tomorrow's electronic highways," *Gen. Elec. Rev.*, vol. 47, pp. 15-21; June, 1944.

Electronics

Advanced Developments

The advent of war greatly stimulated interest in certain aspects of electronics. A need for standardization soon became apparent, but the limitations imposed by military security made it impossible to care for this need through the usual I.R.E. committees. In 1943, a special subcommittee of the Electronics Committee, called the Subcommittee on Advanced Developments, was formed with membership restricted to men engaged in developments related to the needs of the Armed Forces of the United States. Approvals were obtained for the personnel and objectives of the Committee from the proper security officers of the United States Army and Navy and from the Vacuum-Tube Development Committee of the National Defense Research Committee. The Subcommittee on Advanced Developments was actively at work during 1944. While the results of its deliberations must remain unrevealed until security restrictions have been lifted, it can be stated that considerable progress was made toward the standardization of definitions, symbols, and test methods in the ultra-high-frequency electronic field.

Large High-Vacuum Tubes

Interesting descriptions of several developmental tubes for use in the upper ultra-high-frequency band are found in the 1944 literature, exclusively in translation from or in reference to foreign language literature. One such tube is a magnetron of a special design suitable for generating power of several hundred watts in the decimeter- and centimeter-wave band. Another tube is a metal triode for operation in the same frequency band, having a flat circular structure of electrodes very closely spaced and each constituting an integral part of the grid-anode or the grid-cathode transmission line. The third design is called "Resotank" and uses cavity resonators instead of Lecher transmission lines, tube electrodes also being integral parts of the cavity resonators.

- (51) N. F. Alekseev and D. D. Malairoff, "Generation of high-power oscillations with magnetrons in the centimeter band," *PROC. I.R.E.*, vol. 32, pp. 136-139; March, 1944.
- (52) N. D. Deviatkov, M. D. Gurevich, and N. K. Khokhlov, "A metal triode for ultra-high-frequency operation," *PROC. I.R.E.*, vol. 32, pp. 253-256; May, 1944.
- (53) W. Dallenbach, "On the first model type HB 14 of a 'Resotank,'" (Cavity resonator valve for a fixed wavelength of 14 centimeters), *Hochfrequenz. und Elektroakustik*, vol. 61, pp. 161-163; June, 1943. Abstract: *Wireless Eng.*, vol. 21, pp. 84-85; February, 1944.

Continuation of the strong trend toward improvement and development of high-frequency high-power

tubes for industrial heating of metal products was observed. At the present time, the high-frequency power used in industrial projects in the United States exceeds by far the total high-frequency power used in broadcast transmitters.

Power tubes capable of operating in the megacycle band up to several hundred megacycles with output power up to several kilowatts have been designed, and new tubes have been developed for uses in many important processes of heating dielectrics, such as plywood, rubber, plastics, etc., for bonding together, drying, or molding them.

In the field of broadcasting with both amplitude modulation and frequency modulation, there was a trend toward replacing water cooling by forced-air cooling on large tubes with external anodes.

In the ultra-high-frequency radio communication field, there was a tendency toward designing tetrodes, with outputs up to several kilowatts, which could be operated without neutralization up to 100 megacycles and which required extremely low driving power. Also, pentodes up to 350 watts with high "figures of merit" were developed for telephone communications systems using carrier-on-cable and carrier-over-coaxial lines. In addition 50- to 350-watt triodes and pentodes were built for ultra-high-frequency operation in multiplex radio communication systems, in which extremely high fidelity is of prime importance for prevention of inter-modulation.

- (54) S. B. Ingram, "Recent electronic-tube developments in telephone systems," presented the National Electronics Conference, Chicago, Ill., October, 1944.

Considerable important work was done in improving and developing materials and processes for building high-power tubes, especially their grids, with a view to reducing primary and also secondary emission under the most strenuous operating conditions.

Extensive study and experimenting were carried on toward improvement of emission from and increasing life of oxide-coated and thoriated-tungsten cathodes.

Small High-Vacuum Tubes

There was no material change in tube requirements during the year 1944. There was a trend to 28-volt plate and screen-grid operation in equipment with batteries with regulated supplies of this voltage. The Radio Manufacturers Association type 6AJ5 was introduced as a radio-frequency pentode particularly for this operation in addition to the previously announced 28D7 output tube. In addition, 28-volt ratings were established on several existing tube types.

- (55) W. R. Jones, "28-volt operation of radio tubes," presented, Rochester Fall Meeting, Rochester, N. Y., November 8, 1943. (*Sylvania News*, vol. 10, November, 1943.)
 (56) "High D-C voltages from a low-voltage oscillator," *Radio*, vol. 28, pp. 31-33; March, 1944.
 (57) C. R. Hammond, E. Kohler, and W. J. Lattin, "28-volt operation of receiving tubes," *Electronics*, vol. 17, pp. 116-119, 379; August, 1944.

Articles describing new tubes have begun to appear.

High-transconductance tubes with flat cathodes and flat grids were described. An electronic tube which commutates by magnetic beam deflection was also described.

- (58) "Lighthouse' tube," *Science News Letters*, vol. 46, p. 115; August 19, 1944.
 (59) E. F. Peterson and E. D. McArthur, "The lighthouse tube; pioneer ultra-high-frequency development," presented, National Electronics Conference, Chicago, Ill., October, 1944.
 (60) A. M. Skellet, "The magnetically-focused radial beam vacuum tube," *Bell Sys. Tech. Jour.*, vol. 23, pp. 190-202; April, 1944.

An analysis of the advantages of grounded-grid operation of amplifier tubes was published. Tubes with shielding especially arranged for such operation have been announced as the Radio Manufacturers Association types 708A and 6J4.

- (61) Milton Dishal, "Theoretical gain and signal-to-noise ratio of the grounded-grid amplifier at ultra-high frequencies," *PROC. I.R.E.*, vol. 32, pp. 276-284; May, 1944.

A fundamental contribution on vacuum-tube-network theory at high frequencies was published. Two articles were published giving new formulas on vacuum-tube design which should be more useful for the design of grids for closely spaced tubes than previously existing formulas.

- (62) F. B. Llewellyn and L. C. Peterson, "Vacuum-tube networks," *PROC. I.R.E.*, vol. 32, pp. 144-166; March, 1944.
 (63) H. Herne, "Valve amplification factor," *Wireless Eng.*, vol. 21, pp. 59-64; February, 1944.
 (64) F. W. Gundlach, "Calculation of grid control in electronic valves by means of an equivalent representation," *Arch. für Elektrotech.*, vol. 37, pp. 463-477; October 31, 1943. (Abstract: *Wireless Eng.*, vol. 21, p. 294; June, 1944.)

Cathode-Ray Tubes and Television Tubes

During the year 1944, a few new types of cathode-ray tubes were developed. Improvements were made in the performance, and production volume was increased for most of the tube types previously standardized. The Cathode-Ray-Tube Committee of the Radio Manufacturers Association in the United States continued its activity in industry coordination of standardization of test methods and recommendation for specifications to the Government.

The major improvements in cathode-ray tubes were sharper focus, higher light output, and higher deflection sensitivity. A number of important papers were published on electron-beam deflection, electron optics, improved electron microscopes, extended application of electron microscopes in varied fields of research where the high-resolution capabilities of this instrument provides important new information; also on new phosphors for cathode-ray tubes, improved oscilloscopes extending the field of application of cathode-ray tubes, and the use of reflection optics with cathode-ray tubes to provide larger and brighter television pictures. A comprehensive paper on negative ions in cathode-ray tubes was published in Europe in the latter part of 1943.

- (65) J. H. O. Harries, "Deflected electron beams," *Wireless Eng.*, pp. 267-277; June, 1944.
 (66) J. R. Pierce, "Limiting stable current in electron beams in the presence of ions," *Jour. Appl. Phys.*, vol. 15, pp. 721-726; October, 1944.
 (67) Kurt Schlesinger, "A mechanical theory of electron-image formation," *PROC. I.R.E.*, vol. 32, pp. 483-493; August, 1944.

- (68) H. W. Leverenz, "Phosphors versus the periodic system of the elements," *Proc. I.R.E.*, vol. 32, pp. 256-263; May, 1944.
- (69) L. Marton and R. G. E. Hutter, "Optical constants of a magnetic-type electron microscope," *Proc. I.R.E.*, vol. 32, pp. 546-552; September, 1944.
- (70) R. C. Williams and R. W. G. Wyckoff, "The thickness of electron microscopic object," *Jour. Appl. Phys.*, vol. 15, pp. 712-716; October, 1944.
- (71) V. K. Zworykin and J. Hillier, "A compact high resolving power electron microscope," *Jour. Appl. Phys.*, vol. 14, pp. 658-673; December, 1943.
- (72) L. Marton and R. G. E. Hutter, "The transmission type of electron microscope and its optics," *Proc. I.R.E.*, vol. 32, pp. 3-12; January, 1944.
- (73) Rudolph Feldt, "Photographing patterns on cathode-ray tubes," *Electronics*, vol. 17, pp. 130-137, 262, 264, 266; February, 1944.
- (74) C. S. Barrett, "The electron microscope in metallurgical research," *Jour. Appl. Phys.*, vol. 15, pp. 691-696; October, 1944.
- (75) E. H. Bartelink, "Wide band oscilloscope," *Electronics*, vol. 17, pp. 122-125; February, 1944.
- (76) H. Atwood, Jr. and R. P. Owen, "Oscilloscope for pulse studies," *Electronics*, vol. 17, pp. 110-114; December, 1944.
- (77) I. G. Maloff and D. W. Epstein, "Reflective optics in projection television," *Electronics*, vol. 17, pp. 98-105; December, 1944.
- (78) H. Schaefer and W. Walcher, "Negative ions in cathode-ray tubes and their relation to the mechanism of emission from oxide-coated cathodes," *Zeit. für Phys.*, vol. 121, pp. 679-701; October 1, 1943.
- (87) E. F. Christensen and M. M. Morack, "Operation of rectifiers under unbalanced conditions," *Trans. A.I.E.E. (Elec. Eng.)*, September, 1944), vol. 63, pp. 628-631; September, 1944.
- (88) H. L. Palmer and H. H. Leigh, "Inverter action on reversing of thyatron motor control," *Trans. A.I.E.E. (Elec. Eng.)*, April, 1944), vol. 63, pp. 175-184; April, 1944.
- (89) P. T. Chinn and E. E. Moyer, "A graphical analysis of the voltage and current wave forms of controlled rectifier circuits," *Trans. A.I.E.E. (Elec. Eng.)*, July, 1944), vol. 63, pp. 501-508; July, 1944.
- (90) W. C. White, "Mercury arc rectifier, brief early history," *Gen. Elec. Rev.*, pp. 9-13; June, 1944.

Television

As a result of the continued requirements of the Armed Forces for engineering and technical personnel, and for radio equipment, television activity remained at a relatively low level during 1944. All television broadcasters who were active in 1943 continued to provide limited program service during 1944; in some instances considerable increases in power output and other improvements in equipment were made. As in the preceding year, no new home television receivers were manufactured.

Published results of technical investigations in television during the year 1944 were very few. They included a study of field reception of the three television transmitters in the New York area with special emphasis on the multipath phenomena. There was also a short description of a new color-television cathode-ray picture tube in which either two or three separate color phosphors are excited by individual electron beams. Certain studies in wide-band amplifiers were also published. Finally, there was considerable interest in the use of Schmidt optical systems for projection television. These systems use a thin aspherical lens to correct the aberration of a large spherical mirror; and in recent applications, the correcting lenses have been of moulded plastic.

- (91) A. B. Dumont and T. T. Goldsmith, Jr., "Television broadcast coverage," *Proc. I.R.E.*, vol. 32, pp. 192-205; April, 1944.
- (92) "Baird telechrome," *Wireless World*, vol. 50, pp. 316-317; October, 1944.
- (93) "Electronic colour television," *Electronic Eng.*, vol. 17, pp. 140-141; September, 1944.
- (94) W. R. MacLean, "Ultimate bandwidths in high-gain, multi-stage video amplifiers," *Proc. I.R.E.*, vol. 32, pp. 12-15; January, 1944.
- (95) A. B. Bereskin, "Improved high-frequency compensation for wide-band amplifiers," *Proc. I.R.E.*, vol. 32, pp. 608-611; October, 1944.
- (96) D. Weighton, "Performance of coupled and staggered circuits in wide-band amplifiers," *Wireless Eng.*, vol. 21, pp. 468-477; October, 1944.
- (97) I. G. Maloff and D. W. Epstein, "Reflective optics in projection television," *Electronics*, vol. 17, pp. 98-105; December, 1944.

A television relay station was opened at Mount Rose, New Jersey, providing a high-frequency line-of-sight route between New York and Philadelphia over which television programs originating in New York were transmitted to a television station in Philadelphia from which they were rebroadcast.

Demonstrations were made of a flat-faced cathode-ray tube for television receivers having the following characteristics: (1) a plane surface to minimize reflections from stray light, (2) substantially increased useful area as compared with the size of the tube, (3) improved

Phototubes

During the past year there was little published in the field of phototubes which would indicate any major work devoted to the study of basic photoelectric effects. A few papers appeared continuing previous work on a caesium-antimony-type photosurface. There was considerable interest shown in the application of phototubes, particularly the electron multiplier, to scientific instruments such as the spectrograph where it would appear that phototubes may become a competitor of the photographic plate. Considerable effort has been devoted to the co-ordination of the various types of phototubes manufactured by the several companies. A method of defining the response of phototubes in terms of the spectral characteristics was established in which several different classes of spectral surfaces have been defined.

- (79) M. F. Hasler and H. W. Dietert, "Direct reading instrument for spectro-chemical analysis," *Jour. Opt. Soc. Amer.*, vol. 33, p. 687; December, 1943. (Abstract)
- (80) E. A. Boettner and G. P. Brewington, "The application of multiplier phototubes to quantitative spectrochemical analysis," *Jour. Opt. Soc. Amer.*, pp. 6-11; January, 1944.
- (81) R. J. Pfister, "Spectrophotometric experiments with an ultraviolet multiplier photo-tube," *Jour. Opt. Soc. Amer.*, vol. 33, p. 689; December, 1943. (Abstract)
- (82) "Photoelectric timer controls X-ray film exposure," *Electronics*, vol. 16, pp. 178, 180, 182, 184, 186; July, 1943.

Gas-Filled Tubes

The following significant papers relating to gas-filled tubes were published during the year 1944:

- (83) H. C. Steiner, J. L. Zehner, and H. E. Zuvers, "Pentode ignitron for electronic power converters," *Trans. A.I.E.E. (Elec. Eng.)*, October, 1944), vol. 63, pp. 693-697; October, 1944.
- (84) E. F. W. Alexanderson and E. L. Phillipi, "History and development of electronic power converter," *Trans. A.I.E.E. (Elec. Eng.)*, September, 1944), vol. 63, pp. 654-657; September, 1944.
- (85) H. L. Kellogg, C. C. Herskind, "The testing of mercury-arc rectifiers," *Trans. A.I.E.E. (Elec. Eng.)*, December, 1943), vol. 62, pp. 765-773; December, 1943.
- (86) C. C. Herskind, "Rectifier circuit duty," *Trans. A.I.E.E. (Elec. Eng.)*, March, 1944), vol. 63, pp. 123-128; March, 1944.

contrast as the result of limitation on the effect of stray light from the phosphor on the unlighted portions of the phosphor, and (4) a trap for filtering out the negative ions which are destructive to cathode-ray screens.

Probably the most important technical work in television during the year was that involved in the activity of the Radio Technical Planning Board. One of the Panels of the Board was charged with the responsibility of making recommendations with respect to both standards and frequency allocations for postwar television. In order to discharge this responsibility adequately, a large number of engineers and scientists from all parts of industry, as well as from various government research organizations, took part in the deliberations of the Panels.

The first major question facing the Panel was whether to recommend that commercial television should be released immediately after the war, which would require that it go ahead on substantially the present allocated channels, or to recommend that the existing television system should be scrapped in favor of new standards to be utilized in a higher portion of the radio-frequency spectrum. After considerable deliberation, it was decided to recommend that immediate commercialization of television should be encouraged on substantially the present channels and that some higher-frequency channels should be set aside for research and development and eventual commercialization, if and when standards could be adopted.

The Panel then reviewed the existing standards with a view to arriving at a single consistent system which would allow the maximum freedom of receiver design, and which would assure that the standards would be workable on all channels set aside for commercial operation. Various alternative standards were deleted and some minor changes were made so as to provide a single consistent set of standards for all transmitters. The Panel also proposed standards and frequency assignments for relay and network operations. The Panel recommended the use, for commercial operation, of a set of channels between 50 and approximately 300 megacycles. The recommendations of the Panel with respect to frequency allocations were then reviewed by the Frequency Allocation Panel of the Radio Technical Planning Board, which found it necessary to cut the frequency range of commercial channels to approximately 60 to 220 megacycles, and which suggested the possibility of geographical channel sharing between television and other services. The recommendations were presented to the Federal Communications Commission at the frequency allocation hearings held from September to November, 1944, referred to above.

The Television Broadcasters Association, organized in the United States early in the year, held its First Annual Conference in New York, in December, 1944. The conference sessions brought together many persons contributing to the technical, manufacturing, programming, and commercial aspects of television. Awards were made

in recognition of technical contributions to this field.

The following additional papers relating to television appeared during the year:

- (98) D. L. Shapiro, "The graphical design of cathode-output amplifiers," *Proc. I.R.E.*, vol. 32, pp. 263-268; May, 1944.
- (99) M. Dishal, "Theoretical gain and signal-to-noise ratio of the grounded-grid amplifier at ultra-high frequencies," *Proc. I.R.E.*, vol. 32, pp. 276-284; May, 1944.
- (100) I. G. Maloff, "Electron bombardment in television tubes," *Electronics*, vol. 17, pp. 108-111, 327-331; January, 1944.
- (101) E. H. Bartelink, "Wide-band oscilloscope," *Electronics*, vol. 17, pp. 122-125; February, 1944.
- (102) R. W. Crane, "Influence of feedback on source impedance," *Electronics*, vol. 17, pp. 122-123; September, 1944.
- (103) "Technical plan for post-war television," *Electronics*, vol. 17, pp. 92-97, 164, 168, 172; August, 1944.
- (104) H. A. Cook and H. Moss, "Visual alignment of wide-band I-F amplifiers," *Electronics*, vol. 17, pp. 130-133; October, 1944.
- (105) G. Parr, "Review of progress in colour television," *Jour. Telev. Soc.*, vol. 3, no. 10, pp. 251-256.
- (106) P. Nagy, "Some observations relating to reports of colour television in America," *Jour. Telev. Soc.*, vol. 3, no. 10, pp. 257-261.
- (107) B. J. Edwards, "A survey of the problems of post war television," *Jour. Telev. Soc.*, vol. 4, no. 1, pp. 10-12.
- (108) P. Nagy, "The signal converter and its application to television," *Jour. Telev. Soc.*, vol. 4, no. 2, pp. 26-35, discussion, pp. 35-36, 47-48.
- (109) L. H. Bedford, "Picture definition," *Jour. Telev. Soc.*, vol. 4, No. 2, pp. 37-40.
- (110) "Television without scanning" (Description of the Craig system of television), *Jour. Telev. Soc.*, vol. 4, no. 2, pp. 46-47.
- (111) "Standards for television," *Wireless World*, vol. 50, p. 1; January, 1944.
- (112) R. W. Hallows, "Television survey," *Wireless World*, vol. 50, pp. 166-169; June, 1944.
- (113) K. I. Jones and D. A. Bell, "U.H.F. and post-war broadcasting," *Electronic Eng.*, vol. 16, pp. 320-323; January, 1944.
- (114) N. Hendry, "Photography of cathode ray tube traces," *Electronic Eng.*, vol. 16, pp. 324-326; January, 1944.
- (115) J. M. A. Lenihan, "Pulse generation," *Electronic Eng.*, vol. 16, pp. 408-411; March, 1944.
- (116) W. Muller, "Using cathode coupling," *Electronic Ind.*, vol. 3, pp. 106-107, 196; August, 1944.
- (117) W. A. Stewart, "High speed time bases," *Electronic Ind.*, vol. 3, pp. 112-113, 176, 178, 180, 182, 184; August, 1944.
- (118) W. E. Moulie, "Simplified pulse generator," *Electronic Ind.*, vol. 3, pp. 84-85, 224; September, 1944.
- (119) W. Cooper, "Television production as viewed by a motion picture producer," *Jour. Soc. Mot. Pic. Eng.*, vol. 43, pp. 73-79; August, 1944.
- (120) W. C. Miner, "Television production as viewed by a radio broadcaster," *Jour. Soc. Mot. Pic. Eng.*, vol. 43, pp. 79-85; August, 1944.
- (121) R. E. Farnham, "Appraisal of illuminants for television studio lighting," *Jour. Soc. Mot. Pic. Eng.*, vol. 43, p. 378; disc., pp. 85-92; November, 1944.

Facsimile

The volume of radiophoto traffic increased greatly during 1944, as was well evidenced by the large number of pictures carried in the newspapers. These were received from all parts of the world over both government and commercial systems. The quantity of terminal equipment and operating facilities required for this expansion occupied the attention of both manufacturing and service companies, and consequently there was a limit to the amount of effort available for new developments. Nevertheless, there was a trend toward faster speed of transmission, as reflected by the success being obtained with 100 revolution-per-minute drum speeds on long-distance radio circuits. In general, this resulted from better modulation techniques; still further improvement may be expected in this direction.

The wirephoto companies maintained their national picture service for newspaper use. Also, the handling of messages by facsimile increased. Special telefacsimile circuits were set up between Oakland and San Francisco, and between Washington and New York, and equipment was furnished to the Signal Corps for use abroad. A considerable growth in this class of facsimile operation is expected in the postwar period.

The Armed Forces, in addition to their operation of radiophoto services, extended the other uses of both page and tape facsimile. In page operation, conventional direct-recording papers have been substituted for photographic methods where speed of handling was of primary importance, and where black-and-white recording was adequate. The Army Air Forces Weather Wing operated several facsimile wire networks for the dissemination of weather maps to Air Transport Command departure points. Weather maps were transmitted from a central control point every four hours to the satellites within the network. Duplicate copies of the facsimile map received at a satellite were made, so that a copy could be given to the pilot just prior to his departure. Tape facsimile was used chiefly in radio communication with military vehicles; it was used to a less extent as a substitute for printing telegraphs where only low-grade radio circuits are available.

In the laboratories there was an increased interest in electrolytic recording, and several machines were built which promise practical recording speeds many times faster than those now in use. The possibilities have been recognized for several purposes—police radio, for example—and postwar plans are being made in which special transmission circuits are proposed, such as radio relays, to accommodate the wide modulation band which will be required. Facsimile techniques were applied in several cases to the recording of data other than actual facsimile signals.

The co-operative work forming one of the Panels of the Radio Technical Planning Board dealt with the channel requirements of the various services and made a start toward standardizing the operating parameters of the terminal equipments and the modulation methods.

- (122) C. H. Hatch, "Radiophoto; pictures from foreign fronts are now seen in newspapers on the same day as shot," *Radio News*, vol. 31, p. 218; February, 1944.
- (123) F. W. Reichelderfer, "Weather maps for radio broadcast," *Radio News*, vol. 31, pp. 21-23; April, 1944.
- (124) M. Artzt, "Frequency modulation of resistance-capacitance oscillators," *PROC. I.R.E.*, vol. 32, pp. 409-414; July, 1944.
- (125) F. C. Collings and C. J. Young, "RCA facsimile equipment," *FM and Television*, vol. 4, pp. 18-22 and 75; July, 1944.
- (126) "Orders by air," *Business Week*, p. 32; August 26, 1944.
- (127) "Rock Island tests facsimile and carrier telephone on moving train," *Railroad Age*, vol. 117, p. 355; August 26, 1944.
- (128) Milton Alden, "Suiting facsimile designs to service needs," *FM and Television*, vol. 4, pp. 32-40; September, 1944.
- (129) R. M. Sprague, "Frequency-shift radiotelegraph and teletype system," *Electronics*, vol. 17, pp. 126-131; November, 1944.

Piezoelectricity

Recent fundamental research in piezoelectricity has centered mainly around the phosphates and arsenates

of potassium and ammonium. Crystals of these substances, together with Rochelle salt and a few salts isomorphous with Rochelle salt, are called the "Seignette-electrics." It has been known since the work of Busch at Zürich in 1938 that crystals of KH_2PO_4 , KH_2AsO_4 , $\text{NH}_4\text{H}_2\text{PO}_4$, and $\text{NH}_4\text{H}_2\text{AsO}_4$, have dielectric anomalies somewhat similar to those of Rochelle salt. In contrast to Rochelle salt, their abnormal behavior is found at liquid-air temperatures; moreover, these four crystals are all tetragonal, and the anomalies occur only when the electric field is parallel to the Z axis.

Following is a brief sketch of the results and conclusions arrived at by the Zürich investigators (see references to papers in the *Helvetica Physica Acta*). The upper Curie points are, approximately, for KH_2PO_4 , 122 degrees Kelvin; for KH_2AsO_4 , 96 degrees Kelvin; for $\text{NH}_4\text{H}_2\text{PO}_4$, 148 degrees Kelvin; and for $\text{NH}_4\text{H}_2\text{AsO}_4$, 216 degrees Kelvin. At these temperatures, just as with Rochelle salt, the dielectric constant rises to a very high value, while the coercive force approaches zero. There is a spontaneous polarization below the upper Curie point, but not above it. From experimental results on the spontaneous Kerr effect, hysteresis loops at different temperatures, and the dependence of the specific heats on temperature, the conclusion was reached that the spontaneous polarization persists at all temperatures below the upper Curie point. Whereas in Rochelle salt there is a lower Curie point, at which the spontaneous polarization and coercive force disappear while the dielectric constant rises to a sharp maximum, no such effect was observed with the phosphates and arsenates, nor was there an anomaly in the specific heat at any temperature below the upper Curie point, at least down to 7 degrees Kelvin; at the upper Curie point, the anomaly in the specific heat is very pronounced. It appears, therefore, that these salts do not have a second critical temperature that can properly be called a lower Curie point. Only for KH_2PO_4 have the piezoelectric constants been measured (by Lüdy). With regard to the specific heats, it should be stated that the most reliable values are probably those obtained by Stephenson and his associates. In fact, the values of the Curie temperatures for $\text{NH}_4\text{H}_2\text{PO}_4$ and $\text{NH}_4\text{H}_2\text{AsO}_4$ quoted above are based on their thermal measurements.

Observations were also made on potassium deuterium phosphate, KD_2PO_4 , in which H is replaced by heavy hydrogen, D. The results were similar to those with KH_2PO_4 , the most striking difference being a much higher Curie point, namely 213 degrees Kelvin.

In general it was found that these phosphates and arsenates have piezoelectric and elastic properties intermediate between those of quartz and Rochelle salt. They have much higher melting points than Rochelle salt, and the fact that at ordinary temperatures they are so far removed from their Curie points is an advantage that will be appreciated by all users of Rochelle salt. As the Zürich investigators pointed out, one or other of these salts is likely to find many practical uses. At present,

there seems to be no prospect, however, that cuts can be found with low temperature coefficients of frequency, or that resonators made from these salts will be as stable as those from quartz.

Noteworthy progress was made in the development of quartz plates and associated circuits for oscillators and filters. The low-frequency MT and NT cuts used for filters and oscillators were described by Mason and Sykes. The difficulty in making a quartz plate control an oscillating circuit while vibrating in a thickness mode at a very-high overtone was overcome by Mason and Fair. By placing the quartz in a bridge circuit between grid and filament, they obtained crystal-stabilized oscillations at frequencies as high as 197 megacycles per second.

Since the last annual report, five more chapters have appeared in the series of lectures by members of the staff at the Bell Telephone Laboratories on the technique of quartz and on the vibrational modes of this crystal. Somewhat related to the subjects treated in these lectures was a paper by Ekstein on free vibrations in anisotropic bodies, and one by Holton on the testing of quartz by an etch method.

REFERENCES

- (130) A. von Arx and W. Bantle, "Polarization and specific heat of KH_2PO_4 ," *Helv. Phys. Acta*, vol. 16 (No. 3), pp. 211-214; 1943.
- (131) A. von Arx and W. Bantle, "The converse piezoelectric effect in KH_2PO_4 ," *Helv. Phys. Acta*, vol. 16, no. 5, pp. 416-418; 1943.
- (132) W. Bantle, "The specific heat of Seignette-electric substances. Dielectric measurements on KD_2PO_4 crystals," *Helv. Phys. Acta*, vol. 15, no. 4, pp. 373-404; 1942.
- (133) W. Bantle, "Artificial crystals of KH_2PO_4 as frequency stabilizers," *Helv. Phys. Acta*, vol. 16, no. 3, pp. 207-209; 1943.
- (134) W. Bantle, G. Busch, B. Lauterburg, and P. Scherrer, "The spontaneous Kerr effect in KH_2PO_4 and KH_2AsO_4 crystals," *Helv. Phys. Acta*, vol. 15, no. 4, pp. 324-325; 1942.
- (135) W. Bantle and C. Cafilisch, "The piezoelectric effect of the KH_2PO_4 crystal, akin to Rochelle salt," *Helv. Phys. Acta*, vol. 16, no. 3, pp. 235-250; 1943.
- (136) W. Bantle and W. Lüdy, "The elastic properties of Seignette-electric substances," *Helv. Phys. Acta*, vol. 15, pp. 325-327; 1942.
- (137) W. Bantle, B. Matthias, and P. Scherrer, "The dependence of piezoelectric resonant frequencies of the Seignette-electrics on field strength," *Helv. Phys. Acta*, vol. 16, no. 3, pp. 209-211; 1943.
- (138) H. Ekstein, "Free vibrations of anisotropic bodies," *Phys. Rev.*, vol. 66, pp. 108-118; September 1 and 15, 1944.
- (139) R. M. C. Greenidge, "The mounting and fabrication of plated quartz crystal units," *Bell Sys. Tech. Jour.*, vol. 23, pp. 234-259; July, 1944.
- (140) G. J. Holton, "Rodometric examination of quartz crystals," *Electronics*, vol. 17, pp. 114-117, 252, 254; May, 1944.
- (141) W. Lüdy, "Effect of temperature on the dynamic-elastic behaviour of substances like Rochelle salt," *Helv. Phys. Acta*, vol. 15, no. 6, pp. 527-552; 1942.
- (142) W. P. Mason and R. A. Sykes, "Low frequency quartz-crystal cuts having low temperature coefficients," *Proc. I.R.E.*, vol. 32, pp. 208-215; April, 1944.
- (143) B. Matthias, "On the piezoelectric ΔE -effect in the Seignette-electrics," *Helv. Phys. Acta*, vol. 16, no. 2, pp. 99-135; 1943.
- (144) B. Matthias and P. Scherrer, "Crystal band pass filters," *Helv. Phys. Acta*, vol. 16, no. 5, pp. 432-434; 1943.
- (145) H. J. McSkimin, "Theoretical analysis of modes of vibration for isotropic rectangular plates having all surfaces free," *Bell Sys. Tech. Jour.*, vol. 23, pp. 151-177; April, 1944.
- (146) M. de Quervain and B. Zwicker, "Observations of the elementary electric domains in the Seignette-electrics," *Helv. Phys. Acta*, vol. 16, no. 3, pp. 216-218; 1943.
- (147) C. C. Stephenson and H. E. Adams, "The heat capacity of ammonium dihydrogen arsenate from 15 to 300°K. The anomaly at the Curie temperature," *Jour. Amer. Chem. Soc.*, vol. 66, pp. 1409-1412; August, 1944.
- (148) C. C. Stephenson and J. G. Hooley, "The heat capacity of potassium dihydrogen phosphate from 15 to 300°K. The anomaly at the Curie temperature," *Jour. Amer. Chem. Soc.*, vol. 66, pp. 1397-1401; August, 1944.
- (149) C. C. Stephenson and A. C. Zettlemoyer, "The heat capacity of KH_2AsO_4 from 15 to 300°K. The anomaly at the Curie temperature," *Jour. Amer. Chem. Soc.*, vol. 66, pp. 1402-1405; August, 1944.
- (150) C. C. Stephenson and A. C. Zettlemoyer, "The heat capacity of ammonium dihydrogen phosphate from 15 to 300°K. The anomaly at the Curie temperature," *Jour. Amer. Chem. Soc.*, vol. 66, pp. 1405-1408; August, 1944.
- (151) R. A. Sykes, "Modes of motion in quartz crystals, the effects of coupling and methods of design," *Bell Sys. Tech. Jour.*, vol. 23, pp. 52-96; January, 1944.
- (152) R. A. Sykes, "Principles of mounting quartz plates," *Bell. Sys. Tech. Jour.*, vol. 23, pp. 178-189; April, 1944.
- (153) S. Tolansky, "Topography of a quartz crystal face," *Nature*, vol. 153, pp. 195-196; February 12, 1944.
- (154) G. W. Willard, "Inspecting and determining the axis orientation of quartz crystals," *Bell. Lab. Rec.*, vol. 22, pp. 320-326; March, 1944.
- (155) G. W. Willard, "Use of the etch technique for determining orientation and twinning in quartz crystals," *Bell. Sys. Tech. Jour.*, vol. 23, pp. 11-51; January, 1944.
- (156) B. Zwicker and P. Scherrer, "Electro-optical behavior of KH_2PO_4 and KD_2PO_4 crystals," *Helv. Phys. Acta*, vol. 16, no. 3, pp. 214-216; 1943.

Electroacoustics

During 1944, as in the years immediately preceding it, the needs of the Armed Forces for electroacoustic devices designed specifically to meet their requirements, together with the limitations on the use of materials for instruments intended for nonmilitary applications, had a great influence on the trend of development in the field of electroacoustics.

Some new microphones and sound-reproducing devices and combinations thereof were announced as being available for commercial applications. These included office and factory announcing and intercommunicating systems, hearing aids, electric megaphones, outdoor announcing systems, etc. In general, they represented specific designs not involving new basic types or principles. Among them were those described in the following references:

- (157) H. F. Olson, "Polydirectional microphone," *Proc. I.R.E.*, vol. 32, pp. 77-82; February, 1944.
- (158) M. Bank, "Pin-pointing inter-tower communications," *Tel. and Tel. Age*, vol. 62, pp. 19, 28-29; March, 1944.
- (159) H. F. Olson, "The action of a direct radiator loudspeaker with a non-linear cone suspension system," *Jour. Acous. Soc. Amer.*, vol. 16, pp. 1-4, July, 1944. "New multi-cellular speaker," *Radio*, vol. 23, p. 60; August, 1944.
- (160) "Duo-directional sound reproducer announced by Executone, Inc.," *Steel*, vol. 114, p. 132; April 17, 1944.
- (161) J. B. Lansing, "The duplex speaker," *International Projectionist*, vol. 19, pp. 14-15, 30; October, 1944.
- (162) "Design of electronic megaphone," *Electronics*, vol. 17, pp. 200, 204, 209; May, 1944.
- (163) "Sound amplification by air modulation," *Electronic Ind.*, vol. 3, pp. 84-87, 228; November, 1944.
- (164) P. E. Sabine, "Acoustical amplification by hearing aids," *Jour. Acous. Soc. Amer.*, vol. 16, pp. 38-44; July, 1944.
- (165) R. W. Carlisle and A. B. Mundel, "Practical hearing aid measurements," *Jour. Acous. Soc. Amer.*, vol. 16, pp. 45-51; July, 1944.
- (166) F. M. Grossman and C. T. Molloy, "Acoustic sound filtration and hearing aids," *Jour. Acous. Soc. Amer.*, vol. 16, pp. 52-59; July, 1944.
- (167) W. W. Hanson, "Baffle effect of the human body on the response of a hearing aid," *Jour. Acous. Soc. Amer.*, vol. 16, pp. 60-62; July, 1944.

- (168) C. J. Le Bel, "Pressure and field response of the ear in hearing aid performance determination," *Jour. Acous. Soc. Amer.*, vol. 16, pp. 63-67; July, 1944.

A few of the electroacoustic devices designed for use by the armed forces were also described. These included those referred to in the following:

- (169) "Bell Telephone designs a 'salad bowl' speaker," *Radio and Telev. Weekly*, vol. 57, p. 16; May 3, 1944.
 (170) H. Gernsback, "Surrender speaker," *Radio Craft*, vol. 16, pp. 80, 128; November, 1944.

Several different recorder-reproducer equipments were announced. They were intended principally for recording speech sounds with the possibility of reproducing them directly after recording. Some of them were capable of an hour or more of continuous recording.

- (171) "Sound recording. Magnetic wire recorder," *Telephony*, vol. 126, pp. 20-21; June 10, 1944.
 (172) D. W. Aldons, "Magnetic recording," *Electrician*, vol. 133, pp. 138-140; August 18, 1944.
 (173) R. Blain, "Sound recording. Amertype recordgraph," *Telephony*, vol. 126, p. 22; February 19, 1944.
 (174) "Cellophane tape sound recorder capable of up to 8 hours of recording and automatic playback," *Communications*, vol. 24, pp. 85, 106; February, 1944.
 (175) M. C. Selby, "Investigation of magnetic tape recorders," *Electronics*, vol. 17, pp. 133-135, 302; May, 1944.

A paper appeared treating with the acoustic design and treatment of sound studios.

- (176) E. J. Content and L. Green, Jr., "Acoustical design and treatment for speech broadcasting studios," *Proc. I. R. E.*, vol. 32, pp. 72-77; February, 1944.

Information regarding the sound room at RCA's new laboratory also appeared:

- (177) H. F. Olson, "Acoustic laboratory in the new RCA laboratory," *Jour. Acous. Soc. Amer.*, vol. 15, pp. 96-102; October, 1943.
 (178) "Free field sound room," *Electronics*, vol. 17, pp. 148-150; April, 1944.

Although it is likely that information regarding some of the special electroacoustic devices developed for the Armed Forces will be withheld from the public even after hostilities cease, it is reasonable to assume that after the war a considerable amount of previously unavailable material will be released for publication, and that it will have a substantial influence on postwar designs and applications in the field of electroacoustics.

Radio Wave Propagation

With the impetus of the war, knowledge of radio wave propagation has increased enormously. While the publication of many of the most startling advances will necessarily be withheld until after the war, much new information has already become available in the published literature during the years 1942-1944.

Books

The following books contain sections which make available in compact form recent information on radio-wave propagation, including propagation in wave guides and by transmission lines:

- (179) J. G. Brainerd and others, "Ultra-High-Frequency Techniques," D. Van Nostrand Company, Inc., New York, N. Y.; 1942.
 (180) S. Ramo and J. R. Whinnery, "Fields and Waves in Modern Radio," John Wiley and Sons, New York, N. Y.; 1944.

- (181) R. I. Sarbacher and W. A. Edson, "Hyper and Ultra-High Frequency Engineering," John Wiley and Sons, New York, N. Y.; 1943.
 (182) S. A. Schelkunoff, "Electromagnetic Waves," D. Van Nostrand Company, Inc., New York, N. Y.; 1943.
 (183) J. C. Slater, "Microwave Transmission," McGraw-Hill Book Company, New York, N. Y., 1941.
 (184) T. W. Bennington, "Radio Waves and the Ionosphere," Iliffe and Sons, Ltd., London, England, 1943.
 (185) H. R. L. Lamont, "Wave Guides," Methuen and Co., London, England, 1942.

Ionosphere

Quantitative studies of the ionosphere were continued. With increasing ranges of experimental data available over a complete sunspot cycle, the theories of wave behavior in the various layers were improved. Thus for one layer, correlations were studied between geographical and geomagnetic latitude and critical frequency, time of occurrence of critical-frequency extremes, variation of layer heights and thickness, lack of correlation between ionization and sunrise, and time of day of maximum ionization. The titles of the papers listed below indicate the specific natures of the investigations.

- (186) N. Alam and S. R. Khastgir, "The dielectric constant of ionized air in a discharge tube in the range of wavelengths: 80 cm.-1500 cm.," *Indian Jour. Phys.*, vol. 17, pp. 204-215; August, 1943.
 (187) E. V. Appleton, "A simple method of demonstrating the circular polarization of ionospherically reflected radio waves," *Nature*, vol. 151, p. 250; February 27, 1943.
 (188) "Exploring the ionosphere. Progress over a complete eleven-year cycle," (Notes on lecture by Appleton) *Wireless World*, vol. 49, pp. 182-183; June, 1943.
 (189) W. Becker, "The oblique incidence of plane electromagnetic waves on the ionosphere," *Hochfrequenz. und Elektroakustik*, vol. 62, pp. 137-148; November, 1943.
 (190) T. W. Bennington, "Long-distance short-wave transmission. Simplified explanation of the behavior of obliquely incident waves," *Wireless World*, vol. 49, pp. 297-300; October, 1943.
 (191) H. G. Booker, "Height of maximum electron-density in the ionosphere," *Terr. Magnetism*, vol. 47, p. 173; June, 1942.
 (192) O. Burkard, "The seasonal height and ionization variations of the F₂ layer," *Hochfrequenz. und Elektroakustik*, vol. 60, pp. 87-96; October, 1942.
 (193) O. Burkard, "Reply to note of Michel" (Theory of the F₂ layer), *Hochfrequenz. und Elektroakustik*, vol. 62, p. 159; November, 1943.
 (194) S. P. Chakravarti, "A note on field strength of Delhi 3 and Delhi 4 at Calcutta during the solar eclipse of September 21, 1941," *Proc. I.R.E.*, vol. 31, pp. 269-270; June, 1943. Correction; *Proc. I.R.E.*, vol. 31, p. 643; November, 1943.
 (195) T. L. Eckersley, "Holes in the ionosphere and magnetic storms," *Nature*, vol. 150, p. 177; August 8, 1942. (Letter to the Editor.)
 (196) E. H. Felix, "The use of field-intensity measurements for commercial-coverage evaluation," *Proc. I.R.E.*, vol. 32, pp. 381-393; July, 1944.
 (197) K. Försterling, "On the propagation of electromagnetic waves in a magnetized medium, for vertical incidence," *Hochfrequenz. und Elektroakustik*, vol. 59, pp. 10-22; January, 1942.
 (198) J. Gauzit, "On the origin of the ionospheric E layer," *Comptes Rendus*, vol. 217, pp. 179-181; August, 1943.
 (199) S. N. Ghosh, "A comparison of the variations of night-sky luminescence and of region-F electron density at night," *Sci. and Culture* (Calcutta), vol. 9, pp. 170-172; October, 1943.
 (200) V. L. Ginsburg, "On the reflection of an electromagnetic impulse from the heaviside layer," *Jour. Phys. (U.S.S.R.)*, vol. 6, Nos. 3/4, pp. 167-174; 1942.
 (201) G. Goubau, "Reciprocity of wave propagation through magnetically doubly refracting media," *Hochfrequenz. und Elektroakustik*, vol. 60, pp. 155-160; December, 1942.
 (202) G. Leithäuser, "Intensity of the light of the night sky: magnetic disturbances: behavior of the F₂ layer," *Funktech. Monatshefte* (No. 3), pp. 29-33; March, 1942.
 (203) G. Michel, "On the theory of the F₂ layer: remark on Burkard's paper, 'The seasonal height and ionization variations of the F₂ layer,'" *Hochfrequenz. und Elektroakustik*, vol. 62, pp. 157-159; November, 1943.

- (204) R. Penndorf, "What do spectrum-analytical investigations say as the constitution of the upper atmosphere?" *Gerlands Beilräge z. Geophysik*, vol. 59, No. 2, pp. 175-190; 1942.
- (205) M. R. Rao, "Measurement of the angle of down-coming waves from Indian regional short-wave stations," *Indian Jour. Phys.*, vol. 16, pp. 347-367; December, 1942.
- (206) O. E. H. Rydbeck, "The reflection of electromagnetic waves from a parabolic friction-free ionized layer," *Jour. Appl. Phys.*, vol. 13, pp. 577-581; September, 1942.
- (207) O. E. H. Rydbeck, "Chalmers Ionospheric Observatory, Göteborg, Sweden," *Terr. Magnetism*, vol. 47, pp. 215-218; September, 1942.
- (208) O. E. H. Rydbeck, "Further notes on the electron density distribution of the upper ionosphere," *Phil. Mag.*, vol. 34, pp. 130-139; February, 1943.
- (209) A. Vassy and F. Vassy, "Temperature and origin of the D region of the ionosphere," *Comptes Rendus*, vol. 214, no. 6, p. 282; 1942.
- (210) K. Venkataraman, "Radio fade-outs in February and March, 1942," *Current Sci.*, vol. 11, pp. 185-186; May, 1942.
- (211) M. Waldmeier, "Simultaneous disturbances in the sun, in terrestrial magnetism, and in the ionosphere," *Naturwiss*, vol. 30, p. 260; April 24, 1942.
- (212) M. Waldmeier, "Ionospheric determination of UV-intensities of solar radiation in the region 700-900 Å," *Helv. Phys. Acta*, vol. 17, pp. 168-180; Month, 1944.
- (213) H. W. Wells, "Earth's magnetic field and actual heights in ionosphere," *Terr. Magnetism*, vol. 47, pp. 75-79; March, 1942.
- (214) H. W. Wells, "Effects of solar activity on the ionosphere and radio communications," *Proc. I.R.E.*, vol. 31, pp. 147-157; April, 1943.

Troposphere

Propagation studies in the troposphere on wavelengths ranging from 8 meters down to a few millimeters were reported in the papers listed. Topics surveyed include atmospheric bending of the direct wave; reflections from atmospheric discontinuities; air masses; fronts and occlusions; signal-strength decreases and increases associated with pressure, clouds, rain, and fog; relative magnitudes of cloud and ground scatter.

- (215) M. Adam, "The applications of centimetric electromagnetic waves," *Génie Civil*, vol. 119, pp. 56-59; January 31/February 7, 1942.
- (216) T. W. Bennington, "Wireless and weather. Exploration by ultra-short-wave reflections," *Wireless World*, vol. 50, pp. 146-149; May, 1944.
- (217) A. G. Clavier and V. Altovsky, "The simultaneous use of two new techniques in radio-communication. Centimeter electromagnetic waves and frequency modulation." (Includes discussion of "anormal" propagation.) *Bull. Soc. Franc. Elec.*, vol. 4, no. 35; March, 1944.
- (218) P. Dillon, "A 337-mc (frequency-modulated) studio-station link," *Electronics*, vol. 17, pp. 104-107; March, 1944.
- (219) F. C. C. Engineering Department, "Report on VHF field strength measurements, 1943-1944." Exhibit 4 at frequency allocation hearing, before Federal Communications Commission (Docket 6651), September 28, 1944.
- (220) T. L. Eckersley, G. Millington, and J. W. Cox, "Ground and cloud scatter of electromagnetic radiation," *Nature*, vol. 153, p. 341; March 18, 1944.
- (221) H. H. Klinger, "On undamped millimetric waves," *Funktech. Monatshefte*, no. 2, pp. 23-25; February, 1942.
- (222) M. McCaig, "The absorption of infra-red radiation by water-vapour and carbon-dioxide," *Phil. Mag.*, vol. 34, pp. 321-342; May, 1943.
- (223) R. L. Smith-Rose and A. C. Stickland, "A study of propagation over the ultra-short-wave radio link between Guernsey and England on wavelengths of 5 and 8 metres (60 and 37.5 Mc./s.)," *Jour. I.E.E.* (London), vol. 90, pt. 3, pp. 12-19; disc. pp. 20-25; March, 1943.

Effect of Ground Shape and Properties on Space Propagation

A number of papers on propagation over nonhomogeneous ground and over a ground-sea-air junction appeared. In the former, the theory and practice of measuring average ground characteristics and using

these results to compute attenuation by means of a generalized Sommerfeld-"numerical"-distance formula were developed. The advantages of horizontal polarization for transmission over hills were brought out.

- (224) J. Grosskopf, "On the Zenneck rotating field in the ground-wave field of a transmitter," *Hochfrequenz. und Elektroakustik*, vol. 59, pp. 72-78; March, 1942.
- (225) J. Grosskopf, "The radiation field of a vertical transmitting dipole over stratified ground," *Hochfrequenz. und Elektroakustik*, vol. 60, pp. 136-141; November, 1942.
- (226) J. Grosskopf, "The propagation of electromagnetic waves over inhomogeneous ground," *Hochfrequenz. und Elektroakustik*, vol. 62, pp. 103-110; October, 1943.
- (227) J. Grosskopf and K. Vogt, "On the measurement of ground conductivity," *Teleg.-Ferns-und Funk-Tech.*, vol. 31, pp. 22-23; January, 1942.
- (228) J. Grosskopf and K. Vogt, "The measurement of the electric rotating field in the near field of a transmitter," *Hochfrequenz. und Elektroakustik*, vol. 59, pp. 70-72; March, 1942.
- (229) J. Grosskopf and K. Vogt, "Propagation measurements over inhomogeneous ground," *Hochfrequenz. und Elektroakustik*, vol. 60, pp. 97-99; October, 1942.
- (230) J. Grosskopf and K. Vogt, "The relation between the 'effective' ground conductivity and the attenuation of propagation," *Hochfrequenz. und Elektroakustik*, vol. 62, pp. 14-15; July, 1943.
- (231) J. Grosskopf and K. Vogt, "The Zenneck rotating field in the neighbourhood of radiators," *Teleg.-Ferns-und Funk-Tech.*, vol. 32, pp. 102-104; May, 1943.
- (232) G. A. Grünberg, "Theory of the coastal refraction of electromagnetic waves," *Jour. Phys.* (U.S.S.R.), vol. 6, No. 5, p. 185; 1942.
- (233) G. A. Grünberg, "Suggestions for a theory of the coastal refraction," *Phys. Rev.*, vol. 63, pp. 185-189; March 1 and 15, 1943.
- (234) B. F. Howell, Jr., "Some effects of geologic structure on radio reception," *Geophysics*, vol. 8, pp. 165-176; 1943.
- (235) J. S. McPetrie and J. A. Saxton, "Diffraction of ultra-short radio waves," *Nature*, vol. 150, p. 292; September 5, 1942.
- (236) W. Pfister, "Remark on Grosskopf and Vogt's paper, 'The measurement of electrical conductivity for stratified ground,'" *Hochfrequenz. und Elektroakustik*, vol. 59, pp. 118-119; April, 1942.

Propagation of Radio Waves through the Earth

Studies of the electrical characteristics of various soils and rocks were extended not only because of their influence on radio wave propagation over their surfaces, but also because of direct interest in transmission through layers of earth. Several of the topics reported on were: frequency characteristics; "electrolytic-condenser" conditions in soils; the effect of rain on dry soils; attenuation of certain types of rock; and the elimination of interfacial reflections.

- (237) H. N. Evjen, "Utility of the electric methods in geophysical exploration," *Geophysics*, vol. 8, pp. 146-156; 1943.
- (238) V. Fritsch, "Some facts on the propagation of Hertzian waves in geological conductors," *Hochfrequenz. und Elektroakustik*, vol. 62, pp. 50-59; August, 1943.
- (239) E. Löb, "The dielectric constant and loss angle of dry and wet sand for centimetric waves," *Hochfrequenz. und Elektroakustik*, vol. 61, pp. 35-38; February, 1943.
- (240) H. Löwy, "Electric determination of film-volume and film density," *Phil. Mag.*, vol. 33, pp. 772-774; October, 1942.
- (241) J. S. McPetrie and J. A. Saxton, "The determination of the electrical properties of soil at a wavelength of 5 metres," *Jour. I.E.E.* (London), vol. 90, pt. 3, pp. 33-35; March, 1943.
- (242) D. Silverman and D. Sheffet, "Note on the transmission of radio waves through the earth," *Geophysics*, vol. 7, pp. 406-413; 1942.

General Theory and Experiments on Propagation in Various Media

Advances were made in general studies of electromagnetic waves in media with gradually varying parameters and with discontinuities. The lumped approximation to

distributed field problems in several dimensions was examined. Propagation in metals, and in moderately absorbing media, and the relative group velocities of radio and light waves were topics which received more attention.

- (243) A. Bronwell, "Transmission-line analogies of plane electromagnetic-wave reflections," *PROC. I.R.E.*, vol. 32, pp. 233-241; April, 1944.
- (244) W. Dällenbach, "The reciprocity theorem of the electromagnetic field," *Arch. für Elektrotech.*, vol. 36, pp. 153-165; March 31; correction p. 572; September 30, 1942.
- (245) P. Dive, "Ellipsoidal propagation of electromagnetic waves," *Comptes Rendus*, vol. 214, pp. 612-615; 1942.
- (246) J. Grosskopf and K. Vogt, "Polarization measurements in the field of a horizontal transmitting dipole," *Hochfrequenz. und Elektroakustik*, vol. 62, pp. 131-133; November, 1943.
- (247) F. J. Kerr, "Refractive indices of gases at high-radio frequencies," *Proc. Phys. Soc. (London)*, vol. 55, pp. 92-98; March 1, 1943.
- (248) G. Klages, "The dispersion of ultra-short waves in polar liquids with more than one relaxation time," *Phys. Zeit.*, vol. 43, pp. 151-166; May 20, 1942.
- (249) G. Kron, "Equivalent circuits to represent the electromagnetic field equations," *Phys. Rev.*, vol. 64, pp. 126-128; August 1 and 15, 1943.
- (250) G. Kron, "Equivalent circuit of the field equations of Maxwell -I," *Proc. I.R.E.*, vol. 32, pp. 289-299; May, 1944.
- (251) M. Kruger, "The theory of the spherical wave excited at a finite distance from a plane separating two media for finite indexes of refraction," *Zeit für Physik*, vol. 121, pp. 377-437; August 10, 1943.
- (252) B. Liebowitz, "Development of electromagnetic theory for non-homogeneous spaces," *Phys. Rev.*, vol. 64, pp. 294-301; November 1 and 15, 1943.
- (253) H. Ott, "Reflection and refraction of spherical waves; second-order effects," *Ann. der Phys.*, vol. 41, pp. 443-466; July 8, 1942.
- (254) M. E. Rose, "The specular reflection of plane wave pulses in media of continuously variable refractive properties," *Phys. Rev.*, vol. 63, pp. 111-120; February 1 and 15, 1943.
- (255) O. Schriever, "A clear presentation of the theory of the inhomogeneous plane wave," *Hochfrequenz. und Elektroakustik*, vol. 60, pp. 100-104; October, 1942.
- (256) R. L. Smith-Rose, "Research work on the speed of wireless waves," *Electrician*, vol. 129, pp. 415-418; October 16, 1942.
- (257) R. L. Smith-Rose, "The speed of travel of wireless waves." (Part of address before The Wireless Section of the British Institution of Electrical Engineers.) *Jour. I.E.E. (London)*, vol. 90, pt. 3, pp. 2-11; March, 1943.
- (258) H. A. Wheeler, "Formulas for the skin effect," *PROC. I.R.E.*, vol. 30, pp. 412-424; September, 1942.
- (259) J. R. Whinnery, "Skin effect formulas," *Electronics*, vol. 15, pp. 44-48; February, 1942.
- (260) J. R. Whinnery and S. Ramo, "A new approach to the solution of high-frequency field problems," *PROC. I.R.E.*, vol. 32, pp. 284-288; May, 1944.

Propagation of Astronomical Noise

Noise from stars continued to be of interest to radio engineers as well as to astronomers, as progress was made in this field.

- (261) V. Hardung, "Radio disturbances as astronomical research aids," *Bull. Ass. Suisse Elec.*, vol. 34, pp. 348-350; June 16; pp. 371-374; June 30, 1943.

Parallel-Wire Transmission Lines

Advances in this domain were principally concerned with a more precise and convenient treatment of higher-frequency effects. To bring out the approximations involved in the classical engineering approach, more emphasis was placed on starting with the Maxwell field equations. Interest also centered on the expression of characteristics in terms appropriate to higher-frequency measuring techniques.

- (262) A. Bloch, "Parallel transmission lines. The relation between their mutual inductance and mutual capacitances," *Wireless Eng.*, vol. 21, pp. 280-281; June, 1944.

- (263) F. M. Colebrook, "Transmission line theory in terms of propagation characteristics and reflection coefficients," *Wireless Eng.*, vol. 21, pp. 167-174; April, 1944.
- (264) E. U. Condon, "Principles of micro-wave radio," *Rev. Mod. Phys.*, vol. 14, pp. 341-389; October, 1942.
- (265) S. Frankel, "Characteristic impedance of parallel wires in rectangular troughs," *Proc. I.R.E.*, vol. 30, pp. 182-190; April, 1942.
- (266) M. Fuchs, "Intercoupled transmission lines at radio frequencies," *Elec. Commun.*, vol. 21, No. 4, pp. 248-256; 1944.
- (267) G. B. Hoadley, "An analysis of R-F transmission lines," *Communications*, vol. 23, pp. 22, 24-26, 28, 50, 52; February, 1943.
- (268) E. A. Laport, "Open-wire radio-frequency transmission lines," *Proc. I.R.E.*, vol. 31, pp. 271-280; June, 1943.
- (269) H. Meinke, "Electrically 'smooth' constructional elements of concentric lines at high frequencies," *Hochfrequenz. und Elektroakustik*, vol. 61, pp. 145-151; May, 1943.
- (270) R. F. Proctor, "High-frequency resistance of plated conductors," *Wireless Eng.*, vol. 20, pp. 56-65; February, 1943.
- (271) P. M. Smith, "An improved transmission line calculator," *Electronics*, vol. 17, pp. 130-133, 318, 320, 322, 324-325; January, 1944.
- (272) K. Spangenberg, "Propagation constant and characteristic impedance of high loss transmission lines," *Electronics*, vol. 15, pp. 57-58; August, 1942.

Coaxial Transmission Lines

More precise treatment of standard types of coaxial line; properties of ribbon inner-conductor lines; and more precise investigation of the effects of discontinuities and their spacing in coaxial lines were among the subjects reported.

- (273) H. B. Dwight, "Reactance and skin effect of concentric tubular conductors," *Trans. A.I.E.E. (Elec. Eng.)*, vol. 61, pp. 513-518; July, 1942.
- (274) C. C. Eaglesfield, "Characteristic impedance of transmission lines," *Wireless Eng.*, vol. 21, pp. 222-226; May, 1944.
- (275) W. Magnus and F. Oberhettinger, "The calculation of the characteristic impedance of a ribbon conductor in an outer conductor of circular or rectangular cross section," *Arch. für Elektrotech.*, vol. 37, pp. 380-390; 1943.
- (276) E. Müller, "The 'effective' dielectric properties of concentric lines with discontinuous dielectric," *Telegr.-Ferns.- und Funk-Tech.*, vol. 32, pp. 1-12; January, 1943.
- (277) J. R. Whinnery and H. W. Jamieson, "Equivalent circuits for discontinuities in transmission lines," *PROC. I.R.E.*, vol. 32, pp. 98-114; February, 1944.

Cylindrical Wave Guides

Many advances were published on the propagation of waves through the interior of hollow metal cylinders and, in addition, one paper reported new results on dielectric wave guides. One book, mentioned at the beginning of this report, put scattered information on these types of wave guide in a compact form. Of greatest interest, as evidenced by the amount of new work reported, has been the study of propagation in hollow metal cylinders containing one or more layers of dielectrics. Instructive comparison was made between the transmission properties of hollow metal cylinders and coaxial guides. More precise investigations of the transmission characteristics were reported for known types of hollow metal cylinders as well as for new types. Effects of bends, discontinuities and branching also received more careful treatment.

- (278) H. Buchholz, "The hollow conductor of circular-form cross-section with laminated dielectric insert," *Ann. der Phys.*, vol. 43, pp. 313-368; October 23, 1943.
- (279) V. I. Bunimovich, "The propagation of electromagnetic waves along parallel conducting planes," *Jour. Tech. Phys. (U.S.S.R.)*, vol. 10, pp. 1541-1550; 1940.
- (280) Chang-Pen Hsu, "Transmission theory of concentric lines," *Jour. Math. and Phys.*, vol. 21, pp. 43-51; March, 1942.

- (281) Chang-Pen Hsu, "Transmission theory of a cylindrical hollow tube guide," *Jour. Math. and Phys.*, vol. 21, pp. 23-42; March, 1942.
- (282) R. Courtel, "On the perturbation of proper-value problem by modification of the boundaries. Case of propagation of electromagnetic waves in cylindrical guides," *Comptes Rendus*, vol. 217, pp. 261-263; 1943.
- (283) H. T. Flint and L. Pincherle, "The impedance of hollow wave guides," *Proc. Phys. Soc. (London)*, vol. 55, pp. 329-338; July 1, 1943.
- (284) H. Gutton and J. Ortusi, "Measurement of the electric field in the interior of an electromagnetic guide," *Comptes Rendus*, vol. 217, pp. 18-20; July, 1943.
- (285) J. Kemp, "Wave guides in electrical communication," *Jour. I.E.E. (London)*, vol. 90, pt. 3, pp. 90-114; September, 1943.
- (286) E. Ledinegg, "The field-line diagram of the magnetic mode of oscillation in the cylindrical guide of circular cross section," *Hochfrequenz. und Elektroakustik*, vol. 62, pp. 38-44; August, 1943.
- (287) E. G. Linder, "Attenuation of electromagnetic fields in pipes smaller than the critical size," *Proc. I.R.E.*, vol. 30, pp. 554-556; December, 1942.
- (288) K. F. Lindman, "The propagation of electric waves through a metallic tube and between two parallel metallic plates," *Zeit. für Tech. Phys.*, vol. 23, no. 4, pp. 95-100; 1942.
- (289) L. Pincherle, "Reflexion and transmission by absorbing dielectrics of electromagnetic waves in hollow tubes," *Phil. Mag.*, vol. 34, pp. 521-532; August, 1943.
- (290) L. Pincherle, "Electromagnetic waves in metal tubes filled longitudinally with two dielectrics," *Phys. Rev.*, vol. 66, pp. 118-130; September 1 and 15, 1944.
- (291) K. Riess, "Electromagnetic waves in a bent pipe of rectangular cross section," *Quart. Appl. Math.*, vol. 1, pp. 328-333; January, 1944.
- (292) H. Samulon, "On the question of distortions in metallic wave guides," *Bull. Ass. Suisse Elec.*, vol. 33, pp. 518-522; September 23, 1942.
- (293) S. A. Schelkunoff, "Impedance concept in wave guides," *Quart. Appl. Math.*, vol. 2, pp. 1-15; April, 1944.
- (294) S. A. Schelkunoff, "On waves in bent pipes," *Quart. Appl. Math.*, vol. 2, pp. 171-172; July, 1944.
- (295) K. E. Slevogt, "On the propagation of ultra-short waves on a dielectric conductor," *Hochfrequenz. und Elektroakustik*, vol. 59, pp. 1-10; January, 1942.
- (296) G. C. Southworth, "Beyond the ultra-short waves," *Proc. I.R.E.*, vol. 31, pp. 319-330; July, 1943.
- (297) R. D. Spence and C. P. Wells, "The propagation of electromagnetic waves in parabolic pipes," *Phys. Rev.*, vol. 62, pp. 58-62; July 1 and 15, 1942.
- (298) E. M. Studentkov, "Propagation of electromagnetic waves in branched hollow-pipe lines," *Jour. Phys. (U.S.S.R.)*, vol. 8, pp. 308-309; 1943.

Nonuniform Guides

One contribution to the general theory of nonuniform lines appeared.

- (299) K. W. Wagner, "The theory of nonuniform lines," *Arch. für Elektrotech.*, vol. 36, pp. 69-96; February 28, 1942.

Tapered and Eccentric Coaxial Transmission Lines

Progress was made in the study of the propagation and admittance characteristics of various types of more elaborate coaxial lines. Several reports appeared on eccentric lines of square as well as circular cross section. Others were on tapered-characteristic coaxial cables, including the type in which the taper is produced by use of a spiral inner conductor of varying pitch.

- (300) W. J. Barclay and K. Spangenberg, "Graph of impedance of eccentric conductor cable," *Electronics*, vol. 15, p. 50; February, 1942.
- (301) G. H. Brown, "Impedance determinations of eccentric lines," *Electronics*, vol. 15, p. 49; February, 1942.
- (302) S. Frankel, "Characteristic functions of transmission lines," *Communications*, vol. 23, pp. 32, 34-35; March, 1943.
- (303) H. Kaden, "The design calculations for coaxial cable with spirally wound conductors," *Teleg.-Ferns.-und Funk-Techn.*, vol. 32, pp. 195-202; 1943.
- (304) E. Keutner, "High-frequency cable with varying characteristic impedance," *Zeit. für Fernmeldetechn.*, vol. 25, pp. 17-18; 1944.

Standards

Two I.R.E. Standards on Radio Wave Propagation, "Measuring Methods," and "Definitions of Terms," were issued as Part III of the July, 1942 (vol. 30), PROCEEDINGS. Progress was made on revision of these standards which will incorporate changes occasioned by recent advances in the subject. A set of standards on wave-guide terminology was approved and will soon be issued.

Symbols

Publication during 1944 of two Approved American Standards marked the culmination of several years' progress toward the standardization of the graphical symbols used in radio engineering. The adoption of compromise symbols in these standards eliminated the previous confusion resulting from the use of identical symbols by the radio engineer and the power engineer for different circuit components.

Continued work directed toward the general adoption of standard letter symbols for electrical quantities was carried on during the year by the engineering societies and associations.

American Standards Association, Standard Z32.5, "Graphical symbols for telephone, telegraph, and radio use," 1944.

American Standards Association, Standard Z32.10, "Graphical symbols for electronic devices," 1944.

Acknowledgment

This summary of progress generally covers, for the subjects dealt with, the period up to about the first of November, 1944. As in the case of recent annual reviews, it is limited to material which has appeared in various books and periodicals in the United States and certain other countries, and which appropriately can be published under present circumstances. The material has been prepared by members of the 1944 Annual Review Committee of the Institute of Radio Engineers, edited and co-ordinated by Laurens E. Whittemore, Keith Henney, and I. S. Coggeshall.

The other members of the Annual Review Committee for 1944 and the committees of the Institute of which they are chairmen are as follows:

Andrew Alford	Antennas
R. S. Burnap	Electronics
C. R. Burrows	Radio Wave Propagation
W. G. Cady	Piezoelectricity
C. C. Chambers	Frequency Modulation
L. F. Curtis	Radio Receivers
E. A. Guillemin	Circuits Committee
R. F. Guy	Radio Transmitters
I. J. Kaar	Television
G. G. Muller	Electroacoustics
E. W. Schafer	Symbols
H. A. Wheeler	Standards
C. J. Young	Facsimile

The chairmen of the above committees wish to acknowledge the assistance given them in many cases by individual members of the committees.

Radio-Relay-Systems Development by the Radio Corporation of America*

C. W. HANSELL†, SENIOR MEMBER, I.R.E.

Summary—Now that television is ready to provide a new American industry there is need for a nationwide network to distribute the programs. This network may handle many auxiliary services. Radio relays offer a promising means for establishing the network.

Twenty years of RCA radio-relay development made it possible, in 1940, to demonstrate a system for automatic relaying of the present standard television. It operated on frequencies near 500 megacycles, used frequency modulation with amplitude limiting in repeaters, and included a repeater retransmitting the waves on the same frequency as they were received.

The problems of relay-system design are reviewed and formulas, based on reasonable assumptions, are given for calculating the required repeater gain, the output power, and required antenna heights for various spacings between repeaters and for various frequencies. These indicate that the largest spacings for which adequate antenna height can be provided, and the highest frequencies up to some undetermined limit, result in least over-all repeater gain. Preliminary cost analysis indicates optimum repeater spacings will be 35 to 45 miles.

A striking characteristic of radio-relay systems is that they require much less repeater gain than existing coaxial-cable installations when both are adjusted to accommodate the present standard television modulation bands. This difference will be increased if the standards are raised.

Experimental data on cross couplings between antenna systems, an important factor in relay systems, and practical expedients for minimizing them are given.

It is proposed that minimum frequency bandwidths of 15 megacycles should be allowed for relay channels designed to carry the present standard television and it is pointed out that each band may be used over and over, not only in geographically separated areas but even for a number of channels in and out of the same city. This multiple use of frequency bands, and the great value to the public of television networks, justifies generous assignments of frequency space, and promises a great future for radio-relaying.

INTRODUCTION¹

IF TELEVISION and its auxiliary services are to expand rapidly, so as to provide a new American industry, and a source of large-scale employment after the war, we must have the means to carry programs from city to city over nationwide distributing networks.

For years forward-looking research, invention, and development have been directed toward making it possible to provide these networks, and the need to provide them is almost upon us.

Two lines of approach, one through development of coaxial cables and repeaters, and one through development of radio relays, have been followed. The present

* Decimal classification: R480×R583. Original manuscript received by the Institute, September 12, 1944. Presented, National Electronics Conference, October 5, 1944 (the Chicago Section of The Institute of Radio Engineers was one of the sponsors of the National Electronics Conference). This paper is an enlargement of material presented to Panel 9 of the Radio Technical Planning Board on March 16, 1944.

† RCA Laboratories, Rocky Point, L. I., New York.

¹ M. E. Streiby, "Coaxial cable system for television transmission," *Bell Sys. Tech. Jour.*, vol. 17, pp. 438-457; July, 1938.

paper is intended to outline work done by the Radio Corporation of America, on the development of radio-relay systems.

HISTORICAL

RCA has now been engaged in radio-relay development for more than 20 years. In the course of that development the radio carrier frequencies used have increased from 182 kilocycles to 500 megacycles and the modulation bands have increased from 2000 cycles to 4 megacycles. The type of service has comprised relaying of telegraph signals, international broadcast programs, facsimile, and television. It has included five years' experience with an unattended radio-relay system in commercial service between New York and Philadelphia.

1. 182-Kilocycle Relay for Transoceanic Telegraph Signals

In 1923 RCA began the development of a radio-relay station at Belfast, Maine. Its purpose was to intercept long-wave transoceanic telegraph signals at a location where directional reception would reduce interference from summer lightning storms and to relay the intercepted signals on another frequency to the Riverhead receiving station for transfer to New York. The relay transmitter was designed to handle several telegraph signals simultaneously. It used single-sideband modulation with a carrier at 182 kilocycles and provided peak power of a few kilowatts. This station was operated experimentally for about a year, until it was replaced with a commercial receiving station connected with New York through wire lines.

2. 3-Megacycle Relay for Transoceanic Broadcast Programs

In 1924 a supplementary relay transmitter was completed at Belfast to operate on frequencies near 3 megacycles, with a maximum power output of about 250 watts. This transmitter is of incidental-historical interest because it is believed to be the second transmitter in the world equipped for piezoelectric quartz-crystal frequency control, the first having been an assembly of units in the laboratory of Professor George H. Pierce at Harvard. It was the first crystal-controlled transmitter put to any practical use. It is also of interest because it relayed the first broadcast programs brought from London to New York for rebroadcasting here. For RCA it marked the beginning of short-wave equipment development and propagation tests which, in combination with the work of others, resulted in the present worldwide networks for international radio communication.²

² H. H. Beverage, C. W. Hansell, and H. O. Peterson, "Radio plant of R.C.A. Communications, Inc.," *Trans. A.I.E.E. (Elec. Eng.)*, March, 1933), vol. 52, pp. 75-82; March, 1933.

3. 80-Megacycle New York-to-Camden Television Relay³

In the meantime RCA and its associated companies carried forward a program of development designed to create a system of television. Eventually this program had made enough progress to justify the creation of an experimental television-broadcast station at the Empire State Building in New York City, and it had become apparent that television networks for carrying programs from city to city would be required.

In 1932 RCA and the National Broadcasting Company, in co-operation with General Electric and Westinghouse undertook the development of a relay station to carry experimental television from New York to Camden, New Jersey. It was demonstrated successfully in 1933. At that time television had reached the point where 120 lines per frame could be used, which required a modulation band of about 250,000 cycles.

The relay station was located at Arney's Mount, near Mount Holly, New Jersey. For reception of signals from the Empire State Building it used a broadside array of dipoles, with a reflector, mounted on a 165-foot steel tower, and for transmission used a resistance-terminated V antenna on 70-foot wooden poles. Most of the amplification in the repeater was done at an intermediate radio frequency so that modulation-frequency currents appeared at only one point in the transmitter.

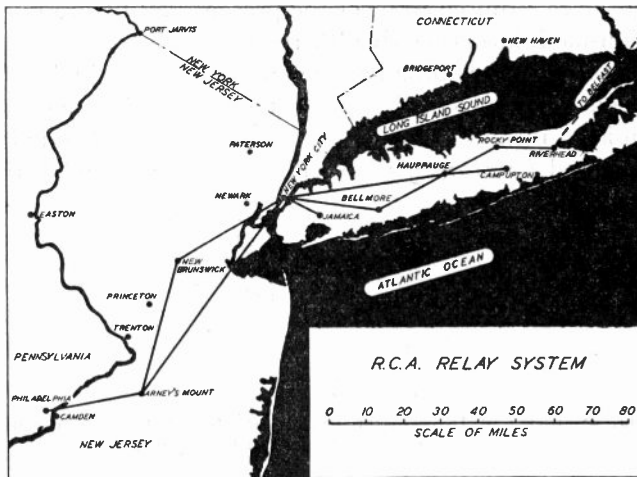

Fig. 1—Locations of radio-relay systems described in this paper.

The Arney's Mount repeater had only a short period of usefulness, for experimental purposes, because at about that time electronic methods of television were being field-tested, and the quality of the television images improved so rapidly with corresponding increases in bandwidth that the repeater very soon was entirely inadequate. It was foreseen that television relaying would have to be done at far higher frequencies than could be utilized at the time and that a long-range program of vacuum tube and equipment development would be necessary.

³ E. W. Engstrom, R. D. Kell, A. V. Bedford, M. A. Trainer, R. S. Holmes, W. L. Carlson, W. A. Tolson and Charles J. Young, "An experimental television system," *Proc. I.R.E.*, vol. 22, pp. 1241-1294; November, 1934.

4. 100-Megacycle Unattended Relay System between New York and Philadelphia^{4,5}

A long-range program of television-relay development was begun but, in the meantime, an unattended automatic radio-relay system for two-way multiplexed telegraph printer and facsimile communication between New York and Philadelphia was undertaken in 1934. This relay system used two repeaters, in each direction, one at Arney's Mount and one at the RCA transoceanic station at New Brunswick, New Jersey. It operated in a range of frequencies near 100 megacycles and provided for a modulation range up to 20,000 or 30,000 cycles.

The system was placed in operation in 1936 and was a regular part of RCA facilities on the circuits from New York to Philadelphia, Baltimore, and Washington until the Federal Communications Commission ordered it shut down soon after the beginning of the war. Its approximately 5 years of continuous unattended operation gave us some valuable experience and provided a service of greater reliability than had been obtained with cable pairs over the same circuit. It proved that radio relaying with fully automatic, unattended repeaters is practical.

5. 500-Megacycle Television-Relay Demonstrations⁶⁻⁹

By the end of 1939 enough progress had been made in the development of new vacuum tubes for use at very-high frequencies, and in the development of radio repeaters and relay stations that 450- to 500-megacycle experimental radio-relay stations had been established on Long Island, at Hauppauge, and at the Laboratory near the transoceanic transmitting station at Rocky Point. By means of these repeaters, television signals broadcast from the Empire State Building were picked up at Hauppauge and relayed automatically through Rocky Point to a terminal receiver in the Laboratory near the transoceanic receiving station at Riverhead. This relay system was designed to accommodate the full modulation bandwidth permitted by the present television standards.

It employed frequency modulation of the radio carrier current as a result of which the technical problems were simplified. It became possible to use simple amplitude limiting to control power levels in the system and the inherently nonlinear response characteristics of vacuum

⁴ H. H. Beverage, "The New York-Philadelphia ultra-high-frequency facsimile relay system," *RCA Rev.*, vol. 1, pp. 15-31; July, 1936.

⁵ J. Ernest Smith, Fred H. Kroger, and R. W. George, "Practical application of an ultra-high-frequency radio-relay circuit," *Proc. I.R.E.*, vol. 26, pp. 1311-1326; November, 1938.

⁶ Andrew V. Haeff and Leon S. Nergaard, "A wide-band inductive-output amplifier," *Proc. I.R.E.*, vol. 28, pp. 126-130; March, 1940.

⁷ H. M. Wagner and W. R. Ferris, "The orbital beam secondary-electron multiplier for ultra-high-frequency amplification," *Proc. I.R.E.*, vol. 29, pp. 598-602; November, 1941.

⁸ F. H. Kroger, Bertram Trevor, and J. Ernest Smith, "A 500-megacycle radio-relay distribution system for television," *RCA Rev.*, vol. 5, pp. 31-50; July, 1940.

⁹ I. G. Maloff and W. A. Tolson, "A résumé of the technical aspects of RCA theatre television," *RCA Rev.*, vol. 6, pp. 5-11; July, 1941.

tubes were reduced to a smaller factor in the production of distortion.

Late in 1940 a third relay station was established at the former site of NBC broadcast station WEAJ at Bellmore, Long Island, and a terminal receiving station was set up at the RCA Building in New York. This made it possible to relay from Hauppauge back into New York and many demonstrations of relaying were made, in 1940 and 1941, including demonstrations for the Federal Communications Commission and National Television System Committee.

These demonstrations should some day have much historic interest because they comprised all the elements of a complete television broadcast service including studio programs, programs brought from a distance by radio relay, and by coaxial cable, broadcasting of programs to home receivers, and showing of programs on a large screen in a theater.

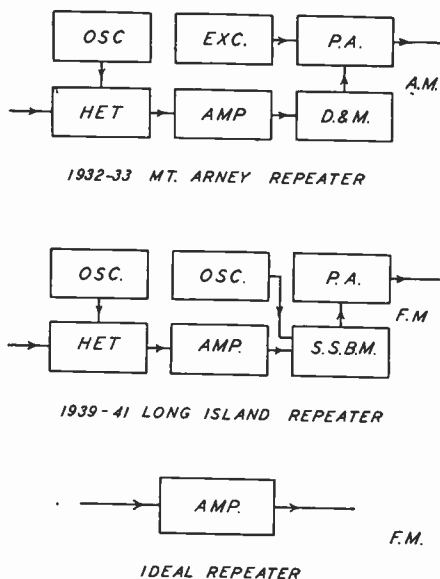

Fig. 2—Experimental repeaters and ideal repeater.

An important part of these tests was the demonstration of radio relaying with a repeater so designed and adjusted that the input and output carrier frequencies were equal.

PRESENT STATUS OF RADIO-RELAY DEVELOPMENT

Before the development of radio-relay systems suitable for television had been interrupted by the war, the initial and most difficult pioneering work had been accomplished and the technical basis laid for a great nation-wide system of radio relays capable of providing not only television networks but many other important services. Many detail problems, such as must be solved in establishing any new service, still remained, but it could be stated with confidence that there were no insuperable technical obstacles remaining to prevent the establishment of a successful radio-relay service.

The range of frequencies which will be used for relaying is so high that it has become possible to utilize each frequency channel over and over again, not only over cir-

cuits which are spaced apart geographically but even, with some limitations, for a number of circuits in and out of the same city. It is this possibility of using the same frequency band over and over again which justifies the assignment of wide-channel bands to television relay systems and which promises a great future for radio relays.

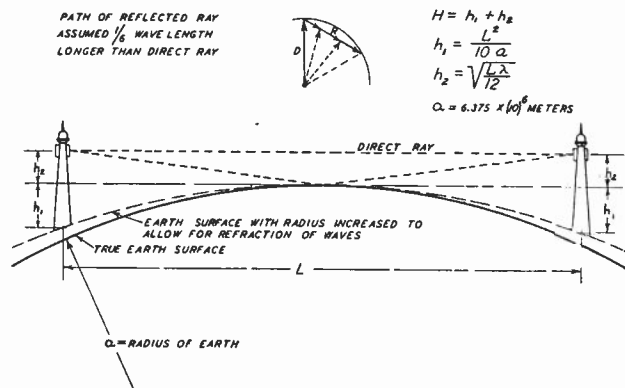

Fig. 3—Radio-relay space circuit, vector addition of direct and reflected waves for various efficiencies of reflection, and antenna heights for equivalent of free-space propagation.

A striking characteristic of properly designed radio-relay systems operated on frequencies above 500 megacycles is that they require much less amplification in a given distance than the concentric-cable systems, when both are required to meet the present and future television-modulation-bandwidth requirements.

As television broadcasting moves to the higher-frequency portions of the spectrum and as it becomes possible to include color, it is natural that the bandwidth required for transmission will be increased, and it then

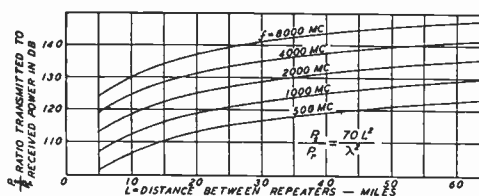

Fig. 4—Ratio of transmitted-to-received power for equivalent of short dipole antennas in free space.

seems probable that radio relaying will receive greater recognition as the most promising means, technically and economically, for the distribution of television programs.

A fortunate circumstance is that, in establishing a radio-relay system, a major portion of the cost is represented by sites and towers and that no developments which can be foreseen at present will destroy the value

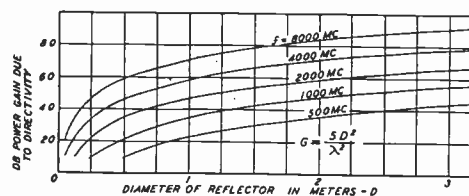

Fig. 5—Power gain per hop due to antenna directivity as compared with short dipoles.

of these investments. Instead, it is anticipated, future developments will make it possible to utilize higher radio frequencies and to provide more perfect reproduction of modulations without requiring substantial alterations in sites and towers.

Before the war the development of vacuum tubes and repeaters had been carried far enough to make it practical to utilize frequencies for television relaying in the range of about 300 to 1000 megacycles. It is anticipated

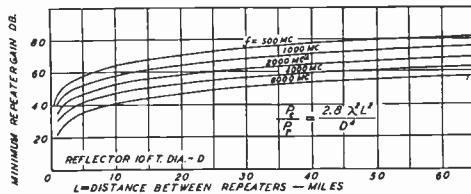

Fig. 6—Minimum power gain per repeater.

that, as soon as restraints due to the war are removed, the frequency range will be extended upward until, eventually, frequencies of 3000 megacycles or more may be used.

PHASE OR FREQUENCY MODULATION PREFERRED FOR RELAYING¹⁰⁻¹³

At the present time phase or frequency modulation of the radio carrier current by the video modulation frequencies is considered preferable to amplitude modulation. In practice a hybrid, or compromise, between phase and frequency modulation, obtainable by means of suitable pre-emphasis of the modulation currents in either a phase-modulated or a frequency-modulated terminal transmitter is preferred.

By using this hybrid type of modulation it is possible to strike some sort of optimum balance between the width of frequency band required for modulation side frequencies and the relative magnitude and frequency distribution of noise in the output of the relay system. This optimum balance may vary according to the character of the material transmitted so that the means to attain it should not be standardized but should be left to the agency operating the system.

When phase or frequency modulation is used in a radio-relay system it is possible to use simple amplitude limiting in each repeater as a means to overcome the effects of space-circuit variations. It is expected that this will make it unnecessary to employ pilot current channels with automatic level controls such as would be required in amplitude-modulated, or single-sideband-modulated systems.

Amplitude limiting makes it possible to operate the

¹⁰ Murray G. Crosby, "Communication by phase modulation," *Proc. I.R.E.*, vol. 27, pp. 126-136; February, 1939.

¹¹ Murray G. Crosby, "Frequency modulation noise characteristics," *Proc. I.R.E.*, vol. 25, pp. 472-514; April, 1937.

¹² Murray G. Crosby, "Frequency modulation propagation characteristics," *Proc. I.R.E.*, vol. 24, pp. 898-913; June, 1936.

¹³ Edwin H. Armstrong, "A method of reducing disturbances in radio signaling by a system of frequency modulation," *Proc. I.R.E.*, vol. 24, pp. 689-740; May, 1936.

high-power portions of repeaters as class C amplifiers, or equivalent, which is a condition tending toward high-power-conversion efficiency.

In the phase- or frequency-modulated system the inherently nonlinear amplitude-response characteristics of amplifiers become a smaller factor in determining modulation wave-form distortions and the characteristics of frequency-selective intertube coupling circuits become relatively more important. For this reason it is desirable to keep the number of the coupling circuits to a minimum by providing high gain per tube, provided the high gain can be obtained in a stable manner.

Fortunately, a good start toward providing high gain per tube has been made through the use of secondary-emission amplification to supplement the gain per tube obtainable by more conventional methods. In addition, the tube designers are making considerable progress in adapting tubes and circuits one to the other. Because of these and related developments the prospects for greatly improved repeaters, soon after the war, now seem to be good.

RELAY SYSTEM SIGNAL-TO-NOISE-RATIO REQUIREMENTS¹⁴⁻¹⁷

It is assumed that facsimile and television systems will be modulated by an electrical potential which differs from a reference value in proportion to the square root of brightness. Since brightness is a measure of radiated power, this assumption is that electrical power is made proportional to light power, when the reference value of potential is taken as zero. The resulting modulation characteristic is a fair approximation to the "approximately logarithmic" response characteristic suggested recently by the Television Panel of the Radio Technical Planning Board.

For message-type facsimile recording at a rate of one picture per frame, a reasonably satisfactory service can be provided if a brightness range of 20 to 1 is provided and brightness modulations due to relay system noise are held to an average value of about 1.5 per cent at the lowest brightness level. This corresponds, in an amplitude-modulated system, to a carrier-to-noise power ratio of 51.2 decibels.

In a frequency-modulated relay system, operated with a modulation index of 1, there is a 3-to-1 gain in ratio of signal power to noise power due to the noise-suppressing effect of frequency modulation. On the other hand there is a 2-to-1 power loss due to synchronizing pulses occupying a portion of the modulation characteristic. These two factors combined give a net gain of 1.5-to-1, or 1.8 decibels. We can, therefore, fulfill the operating specification stated in the previous paragraph with

¹⁴ Donald G. Fink, "Television Standards and Practice," McGraw-Hill Book Co., Inc., New York, N. Y., 1943.

¹⁵ Matthew Luckeish and Frank K. Moss, "The Science of Seeing," D. Van Nostrand Co., New York, N. Y., 1937.

¹⁶ Heinrich Kluver, "Visual Mechanisms," The Jacques Cattell Press, Lancaster, Pa., 1942.

¹⁷ E. E. Kenneth Mees, "The Theory of the Photographic Process," The Macmillan Company, New York, N. Y., 1944.

a carrier-to-noise power ratio of $51.2 - 1.8 = 49.4$, or say 50 decibels.

When it is desired to obtain an improved signal-to-noise ratio for the handling of higher-quality material it is possible to obtain the desired improvement by repeating the picture through any number of frames to form a single record in which the modulations due to noise are very largely averaged out into a nearly uniform minimum average power and brightness level. Much of the effect of this minimum average level upon the record can be eliminated by thresholding.

Fortunately, the noise requirements for television are less stringent than the assumed requirements for page-per-frame facsimile. In television the viewer cannot perceive individual successive images except perhaps for rare occasions when some object, not followed by the eyes, moves rapidly across the field. More generally the visual and mental mechanism causes the consciousness to combine the contributions of a considerable number of images.

If the contributions of all the successive images, attenuating with elapsed time, could be expressed in terms of an equivalent number of unattenuated images, then we might expect an averaging out of the effects of noise which would improve the image-to-noise power ratio in proportion to the equivalent number of unattenuated images. This averaging process is analogous to frequency selectivity in ordinary communications systems.

The equivalent number of images apparently can reach quite large values, depending upon the mental condition and attitude of the observer, the character of the pictures, and the degree to which interest and attention are centered on the program rather than on the technical perfection of reproduction.

In the absence of scientific-test results it seems fair to assume that, when still pictures are transmitted over a television system, the superposition of successive images results in a gain in image-to-noise ratio of 10 to 20 decibels.

If the foregoing reasoning is correct it seems that if a relay system is designed to provide a 50-decibel carrier-to-noise power ratio it will be quite adequate for television and will not make any significant contribution to noise in television-broadcast systems. This figure of 50 decibels will be assumed in what follows.

THE OVER-ALL PROBLEM OF TELEVISION RADIO RELAYING

One of the first problems in planning a television radio-relay system is to make a proper choice of the average spacing between repeaters and the consequent height of repeater-station towers. In this problem the factors of cost are in conflict with the factors of over-all technical performance and reliability of service.

Assuming that no less than a 500-mile relay system will be required to provide an acceptable range of service, a calculation has been made of the over-all technical requirements for a system of this length.

In making the calculations the following assumptions were made:

1. The over-all length of the system would be 500 miles. This is roughly the length of a system linking Boston, New York, Philadelphia, Baltimore, Washington and some of the smaller cities along the route.

2. Smooth spherical earth was assumed, keeping in mind the fact that rolling country would cause variations in repeater spacings and heights of towers, probably in a manner to increase the system requirements beyond the calculated requirements. To allow for bending or refraction of the waves around the curvature of the earth, it is customary to calculate the required heights of antennas using a formula which increases the earth's radius by 1.33. For the present calculation a more conservative factor of 1.25 was used, it being nor-

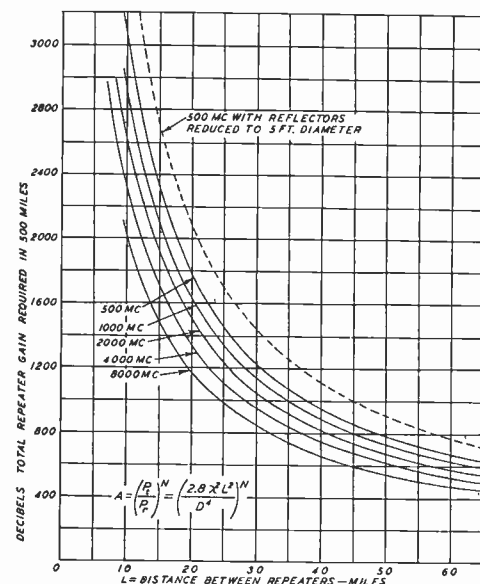

Fig. 7—Total repeater gain in 500 miles when using reflectors 10 feet in diameter.

mal minima rather than average signal strengths which are considered important.

3. It was assumed that antennas with reflectors 10 feet in diameter would be used and that they would be mounted at such a height that the direct ray of radiation and the ray reflected from the ground would lack 60 degrees of phase opposition. Any lower height would cause a rapid decrease in average received signal strength and a rapid increase in variations of the received signal strength. A greater height would add to the cost of towers. This assumption makes it possible to ignore variations in the percentage of power absorbed or reflected by the ground without introducing serious error.

4. It was assumed that the final noise level at the output end of a relay system would be the summation of the noise levels introduced at all the repeaters and would therefore be proportional to the number of repeaters used in the 500-mile distance.

5. It was assumed that all noise in the system would

be developed in the input ends of the repeaters themselves and that a 50-decibel over-all carrier-to-noise power ratio would be required in order that the relay system might not make a substantial contribution to the level of noise which can be observed in the viewer's receiver. It seems probable that repeater noise will be predominant except possibly for reception in cities where man-made noise reaches relatively high levels. Present experience seems to indicate that the noise generated in the head-end of receivers, or repeaters, is of the order of 30 times the power level produced by thermal agitation in the first input circuit. This ratio is not a constant for all frequencies nor for all periods of development, but will probably be representative of the state of the art as any new band of frequencies is opened up for radio-relay use. It is the ratio which is assumed here.

6. It was assumed that the effective frequency bandwidth of the system for determining carrier-to-noise

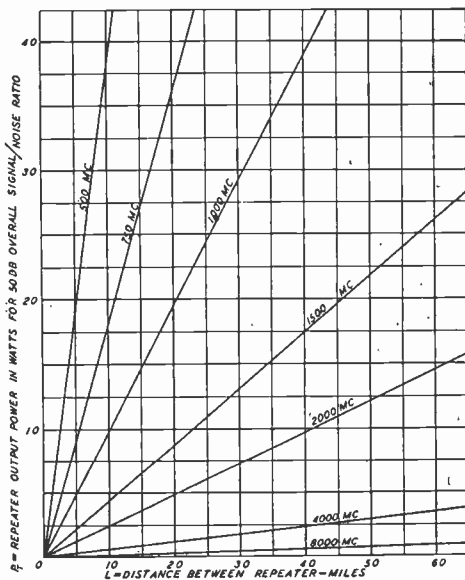

Fig. 8—Power output required from repeaters.
 $P_T = (2.8 \times 10^3 \lambda^3 L^2 NP_p) / D^4$.

ratio, to accommodate both modulation sidebands, would be 10 megacycles. This is believed to be a reasonable assumption, based upon the present television-broadcast standards. The actual total band occupied by a fully modulated carrier will be greater, perhaps 15 to 20 megacycles.

Based on the foregoing assumptions, calculations were made according to the following symbols and formulas:

LIST OF SYMBOLS

- a = radius of the earth in same units as λ .
 ($a = 6.375 \times (10)^6$ meters).
- A = total amplification power ratio for a whole relay system.
- B = effective frequency bandwidth of the relay system, in cycles per second. Normally this will be twice the band of modulation frequencies, all other

noise at higher modulation frequencies being presumed invisible on the television receiver screens.

- D = diameter of main parabolic reflector, in an antenna system of optimum design, in same units as λ .
- E = radiation field strength in volts per meter.
- G = power-gain ratio, due to directivity, as compared with a short capacitance-loaded dipole antenna.

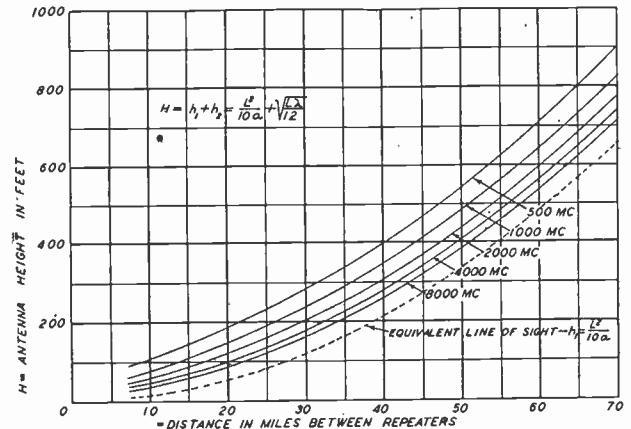

Fig. 9—Antenna heights to provide equivalent of free-space propagation.

- h_1 = antenna height required to give barely an equivalent line of sight between antennas at each end of a space circuit, taking into account refraction, assuming a smooth spherical earth.
- h_2 = additional antenna height required to give equivalent of free-space propagation between antennas at each end of a space circuit.
- $H = h_1 + h_2$ = total antenna height required to give equivalent of free-space propagation between antennas.
- I = current in a short capacitance-loaded dipole in amperes.
- λ = wavelength of the radio wave, in units consistent with other dimensions given in the formulas.
- L = distance between repeaters in same units as λ .
- N = number of space-circuit hops in a relay system.
- P_m = minimum theoretical thermal-agitation noise power, in watts, in first circuit of each repeater.
- P_n = practical equivalent noise level, in watts, in the input circuit of the terminal receiver required to match the accumulated noise of a relay system of N hops.
- P_p = practical equivalent noise level, in watts, required in input circuit of each repeater to give the actual noise in the system which is expected in practice.
- P_r = practical minimum required received power, in watts, after each hop, to provide a commercially acceptable relay system, assuming the noise to be substantially all repeater noise.
- P_T = practical minimum required transmitted power, in watts, required for each hop to provide a commercially acceptable relay system, assuming the

noise to be substantially all repeater noise, for any given set of assumed conditions.

R = radiation resistance of a short capacitance-loaded dipole antenna.

X = length of a short capacitance-loaded dipole in meters.

FORMULAS¹⁸⁻²⁰

1. $P_m = 0.8 \times (10)^{-20} B$ watt due to thermal agitation in each repeater-input circuit, at a temperature of 20 degrees centigrade. (Another $0.8 \times (10)^{-20} B$ appears as radiated power in the matched-antenna system.)
2. $P_p = 24 \times (10)^{-20} B$ watt due to all equipment causes, equivalent noise power in each repeater input circuit, at present stage of vacuum-tube development, in the frequency range from 500 to 4000 megacycles. At present the noise power level in good equipment is about 30 times the minimum thermal-agitation noise.
3. $P_n = NP_p$ watts in final receiver-input circuit of a relay system, after N hops, due to accumulation of noise from all repeaters.
4. $P_r = (10)^5 NP$ watts required to give a barely acceptable over-all signal-to-noise ratio in a radio-relay system of N hops. This assumes a 50-decibel signal-to-noise ratio in the relay system which is 10 to 20 decibels better than the minimum permissible at the final television-receiver screen.
5. $G = 5D^2/\lambda^2$ maximum obtainable gain due to directivity from an antenna system with a main parabolic reflector of D/λ wavelengths in diameter. The value of G must be squared to give total gain per hop if the same type of antenna is used for both transmitting and receiving.
6. $P_T/P_r = 70L^2/\lambda^2$ ratio of transmitted to received power for equivalent of free-space propagation between short dipole antennas.
7. $P_T/P_r = 2.8\lambda^2 L^2/D^4$ ratio of transmitted to received power for equivalent of free-space propagation between directional antennas with main reflectors D/λ wavelengths diameter.
8. $A = (P_T/P_r)^N = (2.8\lambda^2 L^2/D^4)^N$ the total amplification required in a relay system with a total length of LN/λ wavelengths.
9. $P_T = 2.8 \times (10)^5 \lambda^2 L^2 NP_p/D^4$ watts minimum acceptable power output from each repeater in a system of N hops, each L/λ wavelengths long, using antennas with reflectors D/λ diameter, where P_p is the equivalent noise power in the first circuit of each repeater.
10. $P_T = 6.72\lambda^2 L^2 BN/(10)^{14} D^4$ watts minimum acceptable power output from each repeater for giving
11. $P_T = 6.72\lambda^2 L^2 N/(10)^7 D^4$ watts required to keep a 50-decibel signal-to-equipment noise ratio in a practical relay system with a bandwidth of 10 megacycles (modulation band of 5 megacycles).
12. $h_1 = L^2/10a$ the antenna heights required to give equivalent clear line of sight over smooth spherical earth of radius a/λ wavelengths, using a factor of 1/1.25 to account for normal refraction. The value of (a) in the above formula is 3960 miles, 6,370,000 meters or 20,900,000 feet. (All factors to be in same unit of measure.)
13. $h_2 = \sqrt{L\lambda}/12$ additional height required to give equivalent of free-space propagation. This corresponds to 60 degrees from phase opposition for direct and reflected rays. Increasing h_2 by $\sqrt{3}$ will give phase addition of direct and reflected rays, a condition of maximum received signal strength where the received power can approach as a limit four times the received power for equivalent of free-space propagation.
14. $H = h_1 + h_2 = L^2/10a + \sqrt{L\lambda}/12$ total antenna height over smooth spherical earth to give equivalent of free-space propagation.
15. $E = 60XI/L\lambda$ field strength in volts per meter in the direction of maximum radiation from a short, capacitance-loaded, dipole antenna carrying a uniform current I over a length of conductor X .
16. $R = 789X/\lambda^2$ ohms, the radiation resistance of a short capacitance-loaded doublet antenna.
17. $P_T = I^2 R = 789X^2 I^2/\lambda^2$ the power radiated from a short capacitance-loaded doublet antenna.
18. $P_r = E^2 X^2/4R = E^2 \lambda^2/3156$ watts, the received power from an impedance-matched short capacitance-loaded dipole antenna in a radiation field of E volts per meter (all other dimensions also in meters).

SAMPLE CALCULATION

Assume that we have a 500-mile radio-relay system comprising 10 hops of 50 miles each. Each repeater will use receiving and transmitting antennas with reflectors which are 3 meters (about 10 feet) in diameter, mounted at a height required to give the equivalent of free-space propagation. The frequency will be assumed to be 1000 megacycles, corresponding to a wavelength of 0.3 meter and the bandwidth will be taken as 10 megacycles.

Expressed in symbols, with dimensions in meters:

$$\begin{aligned} N &= 10 & \lambda &= 0.3 \text{ meter} \\ D &= 3 \text{ meters} & B &= (10)^7 \text{ cycles} \\ L &= 50 \times 1610 = 80,500 \text{ meters} \end{aligned}$$

The minimum thermal-agitation noise power, at 20 degrees centigrade, effective in the first circuit of each repeater, assuming that the circuit is matched to the antenna system, and taking into account that half of

¹⁸ J. B. Johnson and F. B. Llewellyn, "Limits to amplification," *Trans. A.I.E.E. (Elec. Eng., November, 1941)*, vol. 53, pp. 1449-1454; November 1934.

¹⁹ "Valve and Circuit Noises," *Wireless World*, vol. 46, pp. 262-265; May 1940.

²⁰ F. E. Terman, "Radio Engineers' Handbook," McGraw-Hill Book Co., Inc., New York, N. Y., 1943.

the total thermal-agitation noise power is radiated, is $P_m = 0.8 \times (10)^{-20} \times (10)^7 = 0.8 \times (10)^{-13}$ watt.

According to the present state of the art, the actual effective noise power in each repeater will be about 14.8 decibels, or 30 times greater than the minimum thermal-agitation noise power. This raises the effective noise level in each repeater, as referred to the input circuit, to the practical value of $P_p = 30P_m = 24 \times (10)^{-13}$ watt.

Since there are 10 repeaters in cascade, and each adds its quota of noise power to the final signal-to-noise ratio, the final noise power accumulated and made effective in the terminal-receiver input circuit is $P_n = 10P_p = 24 \times (10)^{-12}$ watt.

The received power at each input circuit, required to give an over-all 50-decibel signal-to-noise ratio for the relay system is $P_r = (10)^5 P_n = 2.4 \times (10)^{-6}$ watt.

The ratio of transmitted to received power over each hop, if we assumed that short capacitance-loaded dipole antennas without reflectors were used, would be $P_T/P_r = 70 \times (80,500)^2 / (0.3)^2 = 5.05 \times (10)^{12}$, or 127 decibels.

If we use directional antennas for both transmission and reception, with maximum practical gain obtainable from parabolic reflectors, as compared with the short dipoles, the gain for each antenna will be about $G = 5 \times (3)^2 / \lambda^2 = 500$ in power, or 27 decibels.

This gain is effective at both ends of the circuit and provides a total gain of $G = 25 \times (10)^4$, or 54 decibels.

The directional-antenna gain reduces the gain required for transmission between short dipoles to $P_T/P_r = (5.05 \times (10)^{12}) / (25 \times (10)^4) = 20 \times (10)^8$, or 73 decibels.

This figure of $20 \times (10)^8$, or 73 decibels, is the required amplification gain per repeater in the system.

The total gain of the 10 repeaters in cascade is $A = (P_T/P_r)^{10} = [20 \times (10)^8]^{10} = (10)^{73}$ approximately, or 730 decibels.

The output power required from each repeater is $P_T = 20 \times (10)^8 \times 2.4 \times (10)^{-6} = 48$ watts.

The antenna height required to give the equivalent of free-space propagation is

$$H = (80,500)^2 / (10 \times 6.37 \times (10)^6) + \sqrt{(80,500 \times 0.3) / 12}$$

$$= 101.8 + 44.8 = 146.6 \text{ meters, or } 480.8 \text{ feet.}$$

SUMMARY OF CALCULATIONS

Calculations made from the formulas led to the results outlined in Tables I, II, and III. The data in all of these tables are based on the assumption that antenna heights are adjusted to give the equivalent of free-space propagation and that reflector diameters are 3 meters (10 feet) in diameter.

The data contained in the tables indicate that the total decibels power gain, or total amplification of all the repeaters in cascade, decreases rapidly as the spacing between repeaters is increased. Since the amount of re-

TABLE I
500-MEGACYCLE TELEVISION RADIO-RELAY SYSTEM

Repeater Spacing in Miles	Repeater Gain in Decibels	Repeater Power in Watts	Antenna Height in Feet
10	65	38.7	106.3
15	68.6	58	144.1
20	71	77.3	185.3
25	73	96.7	230.9
30	74.6	116	281.8
35	75	135.3	338
40	77.2	154.8	399.8
45	78.2	174	467.5
50	79	193.3	541.5
55	79.8	212.5	623
60	80.6	232	709.3
65	81.4	252	800.5
70	82	271	901.5
75	82.6	290	1005

TABLE II
1000-MEGACYCLE TELEVISION RADIO-RELAY SYSTEM

Repeater Spacing in Miles	Repeater Gain in Decibels	Repeater Power in Watts	Antenna Height in Feet
10	59	9.68	79.1
15	62.6	14.5	111.3
20	65.2	19.38	146.4
25	67	24.2	187.6
30	68.6	29.05	234
35	70	33.9	287.1
40	71	38.75	349
45	72.2	43.6	409.8
50	73	48.4	480.8
55	73.9	53.2	558.8
60	74.6	58.1	642.3
65	75.4	62.9	731
70	76	67.8	829.3
75	76.6	72.6	930.5

TABLE III
2000-MEGACYCLE TELEVISION RADIO-RELAY SYSTEM

Repeater Spacing in Miles	Repeater Gain in Decibels	Repeater Power in Watts	Antenna Height in Feet
10	53	2.41	59.8
15	56.6	3.62	87.1
20	59.2	4.825	119.4
25	61	6.03	157.1
30	62.6	7.25	200.9
35	64	8.45	250.9
40	65	9.65	306.6
45	66.2	10.9	368.8
50	67	12.1	437.5
55	67.9	13.3	513.8
60	68.6	14.5	595.2
65	69.4	15.7	681.8
70	70	16.9	778.3
75	70.6	18.1	877.5

peater equipment in cascade, the probability of failures in operation, and the undesirable distortions of the useful modulation, all increase more or less in proportion to the total required power gain in the system, it will be evident that excellence of technical performance favors a large spacing between repeaters.

Opposed to the use of large spacings between repeaters is the necessity to use higher output power and greater gain at each repeater, which increases the equipment and repeater-station-development difficulties. In addition, large spacing between repeaters requires the use of high and costly towers. A contributing factor of unknown future importance is the mutual hazard which high towers and airplanes provide for each other. This may result in a need for co-ordination and compromise in respect to regulations which at present appear to limit heights of radio structures without similarly limiting other structures, such as chimneys.

An attempt has been made to arrive at the relative cost per mile year for radio-relaying systems for several assumed radio frequencies and for various spacings

between repeaters. The costs have had to be based upon more or less arbitrary assumptions and cannot be accurate for determining actual costs, but are believed to be nearly correct for relative costs for various assumed conditions. They have led to the conclusion that, over ideal smooth spherical earth, if that were possible, repeater spacings in the range of 35 to 45 miles would provide minimum annual cost.

These cost studies indicate that the investment cost and annual cost per television channel can decrease quite rapidly as the number of channels provided over a given system is increased above the assumed minimum of one channel in each direction, operable simultaneously. This suggests that, whenever possible, each relay system should be designed to handle a number of channels in each direction.

As to choice of radio carrier frequency, it is quite evident that the highest possible frequency should be used up to some unknown limit where it is no longer possible to make effective use of a certain size of antenna, and where the space-circuit propagation becomes too variable. Before the war the highest frequencies which could be used were in the neighborhood of 500 megacycles, but it is possible that frequencies up to 3000 megacycles or more might be chosen if there were no equipment limitations.

At the present time it is a reasonable assumption that, except for unusual cases where natural obstacles require very long distances between repeaters, television relaying can be started soon after the end of the war in the range of 300 to 1500 megacycles.

Assuming that sufficient incentive, in the form of business opportunities for qualified organizations, is held out it may be anticipated that repeater development soon will extend the range of available frequencies up to, and perhaps beyond, 3000 megacycles.

COUPLINGS BETWEEN DIRECTIONAL ANTENNAS

Several years ago a series of measurements were made to determine the order of magnitude of the coupling be-

tween directional-antenna systems of the type which comprise simple dipole radiators in parabolic reflectors. These measurements are considered reliable only for determining order of magnitude, because there are many variations in conditions which can have an effect upon practical results. The results obtained may be summarized very briefly as follows:

1. Antennas Close Together Pointed in Same Direction

- (a) Radiators Either in Same Straight Line or with One Turned by 90 Degrees

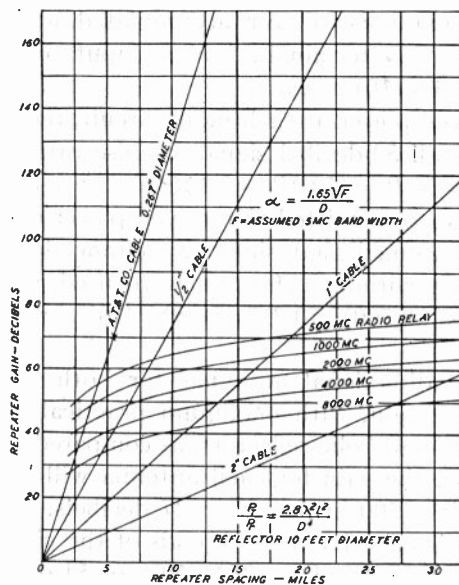

Fig. 11—Cable and radio-relay systems, gain per repeater required for various repeater spacings.

In this case the ratio of power transmitted from one antenna to power picked up by the other can be approximately $P_T/P_r = 60,000(D/\lambda)^4$.

- (b) Radiators Turned Parallel, at Right Angles to Line between Them

$$P_T/P_r = 600(D/\lambda)^4.$$

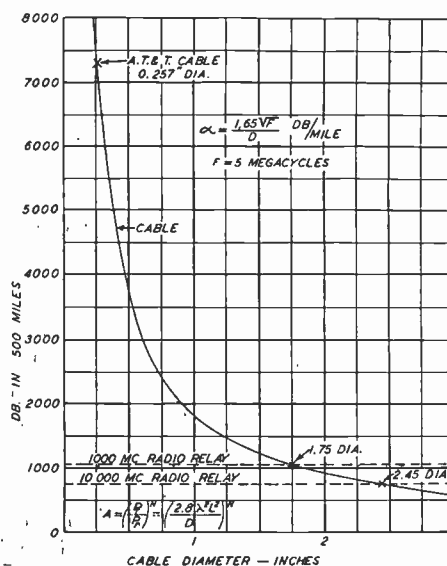

Fig. 12—Cable and radio-relay systems amplification required in 500 miles.

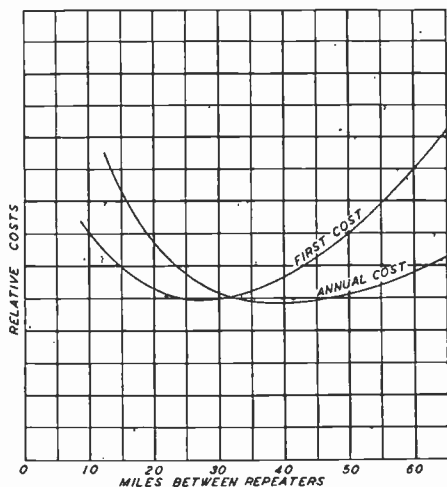

Fig. 10—Radio-relay relative costs.

2. Effect of Spacing between Reflectors

If the spacing between reflectors is increased from substantially zero to a distance between the closest points equal to the diameter, the cross coupling is reduced by about 10-to-1 in power for antennas with reflectors about 5 wavelengths in diameter. However, for radiators end to end, the change was not smooth but showed oscillations over a range of about 20 decibels upward from the values which would be given by the foregoing formula for P_T/P_r . These oscillations are undoubtedly due to passing through conditions which

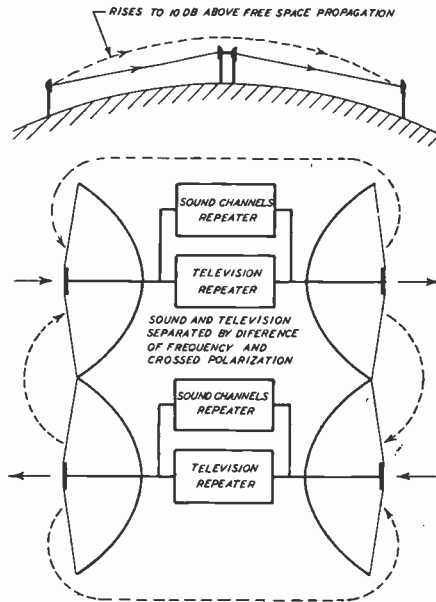

Fig. 13—Undesired coupling paths in radio-relay systems.

balance portions of the coupling paths against other portions.

No oscillations of feedback coupling with increasing spacing were observed when the dipoles in the reflectors

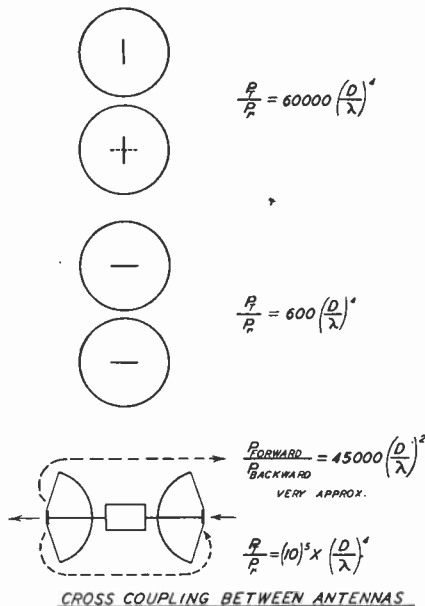

Fig. 14—Order of magnitude of ratio of transmitted power to power received over undesired coupling paths.

were set parallel to one another and at right angles to the line between them. In this case the energy fed across from one to the other falls off smoothly as the distance between reflectors is increased.

3. Ratio of Power Forward to Power Backward

From general theoretical considerations it might be expected that the ratio of power forward to power backward from an antenna system with a parabolic reflector would vary about in proportion to $(D/\lambda)^{2.5}$. However, in

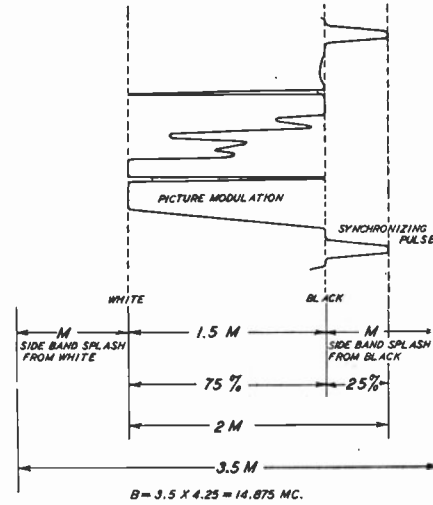

Fig. 15—Frequency range of frequency-modulation television modulated-carrier current.

practice, lack of symmetry of objects near the reflector, such as are caused by the supporting structure, and reflections backward from objects on the ground out in front are likely to cause a lower ratio.

For the present it seems safer and more realistic to say that our experience indicates, when reflectors 5 to 10 wavelengths in diameter are used, the ratio of power in the forward direction to power in the backward direction can be of the order of that obtained by using the following formula: $P_{forward}/P_{backward} = 45,000(D/\lambda)^2$.

4. Coupling between Radiators with Crossed Polarization, in Same Reflector

It is possible, theoretically, to place two radiators in the same reflector which are polarized at right angles, and which have couplings between them balanced out. Our experience would indicate that this expedient should not be relied upon to provide more than about 20 decibels of uncoupling between the radiators. Even this figure may prove to be too optimistic under conditions of snow and ice on the antenna system.

5. Artificial Balancing of Cross Couplings

It is theoretically possible, in any particular case, to introduce a balancing or neutralizing coupling to obtain a reduction in net coupling between antennas. In one trial of this we were able to reduce the coupling between two antenna systems from an initial value of 70 decibels to a final value of 85 decibels, a gain of 15 decibels. However, in wide-band service such balancing methods

may prove difficult and complicated because there probably will be a variety of component coupling paths of different length and time delay, each of which would require its own balancing path. In the experimental trial mentioned above it was found that there were a number of relatively short paths and other paths corresponding to distances down to the ground and back over the supporting structure, or out to near-by reflecting objects and back.

In any practical case it would seem that, if artificial balancing is used, it must be done with care to provide proper time delays and, at least until it is covered by

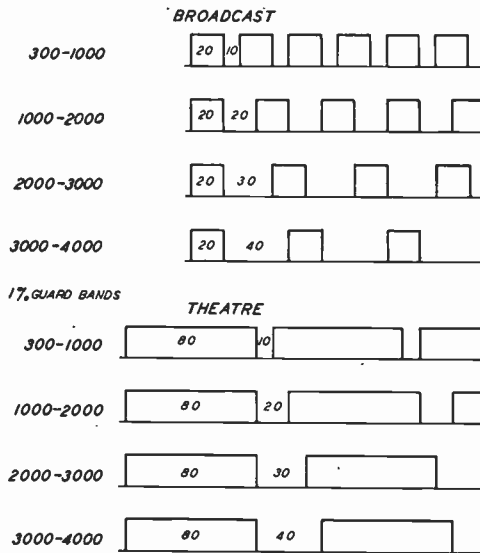

Fig. 16—Suggested minimum channel spacings for any one relay system—megacycles.

more experience, should not be relied upon for improvements of more than 10 to 20 decibels.

6. Polarization Discrimination over Long Distances

Insufficient information is available to indicate to what degree differences in polarization may be relied upon to discriminate between channels working in the same direction over the same space circuit. Our experience indicates only that such discrimination may be of substantial aid, but only tests for long periods over actual operating circuits can give us information as to how much discrimination can be relied on. As a conservative and very preliminary guess we might place the figure at about 10 decibels.

7. Coupling Between Antennas with Reflectors Pointed in Opposite Directions

The coupling between antennas in reflectors pointed in nearly opposite directions is more subject to the conditions under which they are mounted than is the coupling in the other cases considered. In general it should be possible, by using all the available technical expedients, to count on a reduction of coupling to about $P_T/P_r = (10)^5 \times (D/\lambda)^4$.

This would indicate that, by using reflectors 10 wavelengths or more in diameter it will generally be possible

to receive and retransmit without shift of carrier frequency in the repeater.

However, this matter of relaying without shift of carrier frequency, while it has been demonstrated in one of our relay experiments, is a matter which should receive more experimental development. All we can say with certainty at present is that we are confident that it can be done in most instances and that higher radio frequencies and large antennas will help to make it possible.

BANDWIDTHS REQUIRED FOR TELEVISION RELAYING INTENDED TO SERVE PRESENT STANDARD TELEVISION-BROADCAST STATIONS

The present television-broadcast standards provide for modulation frequencies ranging from 0 to about 4.25 megacycles.

In a relay system it is considered essential to transmit the zero or very low-frequency components of the modulation so that the synchronizing pulses may occupy a fixed range of the modulation characteristic. Otherwise, variations in image background level may modulate the wave form and amplitude of the synchronizing pulses in a manner to detract from the quality of reproduced images. This means that the highest frequency modulations of the frequency-modulated carrier current will be superimposed upon a carrier frequency which can vary between the values set for the black-and-white levels. This requires that the radio-frequency bandwidth be equal to twice the highest modulation frequency plus the range of frequency lying between the black-and-white levels.

According to the present standards, the difference between the black-and-white levels occupies about 75 per cent of the modulation characteristic. Therefore, if we so design the modulator that it can produce plus and minus 4.25 megacycles frequency deviation at any modulating frequency from 0 to 4.25 megacycles, then the minimum band required for a frequency-modulated radio-relay system, to match the present standards, will be $B = (2 \times 4.25) \times 1.75 = 14.9$ megacycles.

From this we may conclude that the nominal bandwidth allowed for a television-relay channel should be at least 15 megacycles.

In practice, a larger frequency band is desirable to permit some increase in quality and reduction in noise, to help guarantee that the relay system will not be a substantial factor in detracting from the quality of service from the broadcast stations which it serves.

It is therefore suggested that relay channels to serve the present standard television-broadcast stations should be allowed a nominal channel band of 20 megacycles.

BANDWIDTHS REQUIRED FOR RELAY SYSTEMS TO SERVE TELEVISION IN THEATERS

It now appears that future needs of theater television will call for an increase in the picture resolution

over that now considered standard for television broadcasting. This is particularly true where television programs may be interspersed with motion pictures, affording almost direct comparisons.

For some classes of theater television, it is, therefore, assumed that more scanning lines would be used and, for the purpose of the present analysis, a minimum bandwidth in a radio-relay system for theater television programs of 60 megacycles and a nominal bandwidth of 80 megacycles is assumed.

It may be noted that, if this bandwidth is available for theater television, it may be used also for carrying future color television to the home with the same or better definition than is provided by the present standard for black-and-white images.

GUARD BANDS BETWEEN CHANNELS WORKING IN THE SAME DIRECTION OVER THE SAME SYSTEM

In existing television-broadcast systems, operating near 50 megacycles, a frequency interval of 0.5 megacycle is allowed within which to provide cutoff with a filter, for preventing interference between vision and sound transmitters. This suggests that guard bands between channels, for single-hop relays, might be nominally 1 per cent of the carrier frequency.

In multiple-hop relays there tends to be an accumulation of the effects of cross coupling between channels, but perhaps this can be balanced off against the reduction in cross-coupling effects provided by use of frequency modulation and by the effects of expedients other than frequency selectivity, such as polarization discrimination. It therefore seems reasonable, until further data are available, to assume that guard bands between channels should be 1 per cent or more of the carrier frequency.

A suggested allowance for various ranges of frequency is shown in Table IV.

TABLE IV
CIRCUITS IN SAME DIRECTION OVER SAME RELAY PATH

Range in Megacycles	Megacycles Guard Band	Total Band Per Channel	
		Broadcast	Theater
300 to 1000	10	30	90
1000 to 2000	20	40	100
2000 to 3000	30	50	110
3000 to 4000	40	60	120

GUARDS BETWEEN CHANNEL WORKING IN OPPOSITE DIRECTIONS OVER THE SAME SYSTEM

For channels working in opposite directions the interference introduced at each repeater between channels is provided by the cross coupling between antennas pointing in the same direction, one of which is transmitting and the other receiving. This cross coupling, which has been given in a previous section, is determined by the approximate formula $P_T/P_r = 60,000(D/\lambda)^4$.

If this ratio is the same as the gain required in each repeater, our receiving conditions will be identical with those where two channels operate in the same direction.

Ordinarily, the gains per repeater may be on the order of 80 decibels or 100,000,000-to-1 in power. Therefore $P_T/P_r = 100,000,000 = 60,000(D/\lambda)^4$, or $D/\lambda = 6.4$.

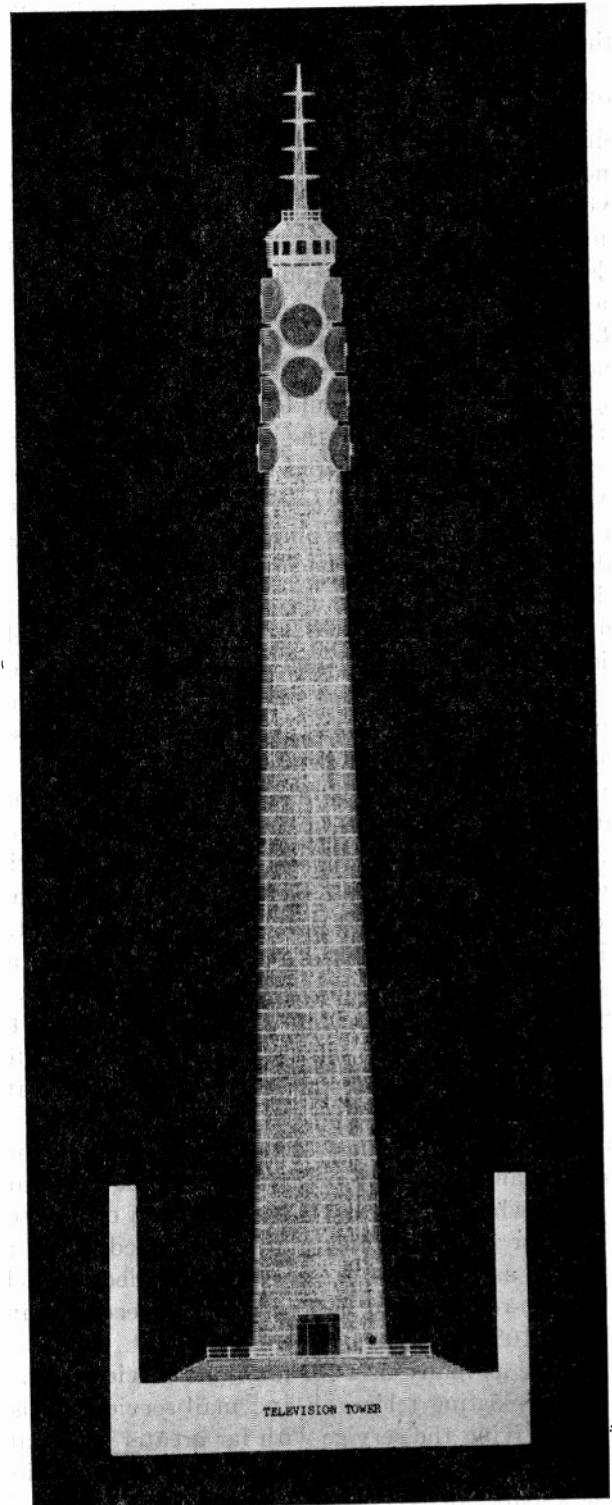

Fig. 17—Recommended design of television tower. It provides:
 1. Rigid mounting of antennas at any height and pointed in any direction.
 2. Housing for repeaters at antenna heights to save losses in transmission lines or wave guides.
 3. Means of access protected from wind, rain, ice, and snow.
 4. Observation platform for visitors.
 5. Cost comparable with less-desirable steel towers.
 6. Mounting for broadcast antennas when required.

From this we conclude that the spacing between channels going in opposite directions may be the same as that between channels going in the same direction provided the reflectors for the antennas are 6.5 wavelengths or more in diameter, in a system engineered as outlined in the early part of this paper.

PROBABLE FUTURE USES FOR RADIO-RELAY SYSTEMS

Since the only justification for investing large sums of money in radio-relay systems, and for becoming involved in the toils of technical development, business promotion, and government regulation, is the usefulness of the systems, it may be appropriate to consider what some of the uses may be.

Radio relays have such outstanding technical and economic advantages for the distribution of television that, eventually, they should be regarded as essential for this service. However, the costs for adequate radio-relay systems are substantial and, unless the costs of relay-station sites, towers, and facilities can be spread over a number of channels and services, they may be so burdensome as to delay the initial spread of television service.

In holding unit costs down it is essential that the relay stations be designed and utilized to provide several television channels, all utilizing the same towers. It is also essential that the investment and operating expenses be shared with as many secondary services as possible.

In general, relay stations will occupy the highest points and provide the highest towers in each community. They are, therefore, the natural choice for location of radio broadcast stations. By combining relaying and broadcasting, where this is possible, both can benefit.

High towers, occupying the highest points, are natural gathering places for pleasure seekers and the curious. In many cases, observation platforms at the top of the towers, television theaters, restaurants and other entertainment facilities may be provided to give a greater public service and to help in paying the costs.

One of the most natural secondary services, from a technical standpoint, will be that of facsimile communication, by which is meant the transmission of any sort of picture or message which is to be recorded at the receiving end as a copy of the original. An adequate television-radio-relay circuit has a potential speed of transmission of 108,000 pages per hour.

There are as many uses for facsimile service as there are for the existing telegraph and mail services. It is a means for giving the service with far greater speed and less effort. Soon, for example, it could provide a nationwide newspaper delivery faster than papers can now be printed. Newspaper publishers then will no longer be dependent upon the slow and inefficient type of delivery

service which was already in use when printing was invented.

There is another probably important use for future radio-relay systems which is closely related to the struggle just beginning to obtain the use of frequencies above 30 megacycles. It is that of providing radio services to airplanes.

As the number of airplanes in flight increases, the demands for radio service will increase to such a degree that it will be unreasonable to provide radio frequencies and facilities so that all of the airplanes flying over land may communicate by radio over long distances. Furthermore, as the speed and efficiency of airplanes has increased, it has become more unreasonable to provide either large protruding antennas, or powerful equipment, needed to operate on the frequencies required to reach large distances.

Looking ahead it seems inevitable that much of the communication with aircraft must be limited to short distances and carried out on higher frequencies with smaller equipment and without protruding antennas. This will require a large number of ground stations, spread out along the air routes. Substantially these same routes will be followed by the radio-relay systems, and the radio-relay stations are natural sites for airline radio ground stations.

The railroads, long-distance bus and truck lines, and portions of the traveling public have communications needs similar in character to those of the airlines, and radio-relay systems might very well contribute to the fulfillment of these needs.

Radio relays may, of course, be used for long-distance multiplex telephone communication, particularly for the distribution of sound broadcast programs. Sound accompanying television obviously should pass over the radio relays so that its handling may be properly coordinated and so that vision and sound will be subject to equal time delays.

Finally, there is a growing need for means to interconnect a variety of newly developed business machines so that manufacturing, transportation, and merchandising organizations, and the public they serve, may benefit from the advantages of decentralized and widespread operations, with centralized management and control.

With all the pent-up new needs, and the apparent ability of radio-relay systems to fill these needs, what is now needed most to make radio relaying a great new American industry is a more general understanding of its value; a well-defined and stable licensing policy; a relaxation of restraints which dampen the hope of expansion and profit and which discourage joint action by those in need of relay service; and a few good promoters who have caught the vision.

Transient Response*

HEINZ E. KALLMANN†, SENIOR MEMBER, I.R.E. AND ROLF E. SPENCER‡,
WITH MATHEMATICAL APPENDIX BY CHARLES P. SINGER‡

Summary—Numerous accurately calculated transient-response curves are presented, allowing comparison as well as design of single and cascaded stages of electrical and ideal networks. Transient response, taken as the criterion for the quality of television amplifiers, is valued according to (1) transition time T_r , from 0.1 to 0.9 of the final height, measured in radians of the nominal cutoff frequency; (2) amount (and duration and frequency) of the overshoot (or recoil) in per cent of height. To allow correlation with the amplitude and phase response, these are also plotted for many cases.

Section I deals with the transient response of single filters, proceeding from the shunt-peaking coil and the series-peaking coil (as representative for the staggered circuits and for band passes in carrier amplification) to filters without and with m -derived section. Their relative efficiency $H = CR/T_r$, and their overshoot are given for numerous values of $Q = 1/R\sqrt{L/C}$, thus supplying design data for many cases. It is shown which, if any, improvements are possible with complicated filters and that flat time response and steadily dropping amplitude response correspond to the most desirable transient response. The use of low-pass filters as carrier amplifiers is discussed.

Section II describes the deterioration of transients in cascades of equal or different, electrical or ideal, filter systems. It is shown that transients tend to take on certain ultimate shapes after passage through many stages of phase-true filters. A stretch modulus s is derived which gives the increase in T_r each time the number of stages is doubled; s is 1.41 for all filters in which the overshoot is small and neither rising nor decreasing in repetition; $s < 1.41$ for all filters in which the overshoot grows; $s > 1.41$ when the shape of the transient is progressively rounded. The total gain V_{total} is shown to pass through an early maximum and then to decrease if stages are added but the overall value of T_r is maintained. The amount of this loss caused by large numbers n of coupling circuits is plotted from $V_{total}/V_0^n = n^{-n/2}$. These considerable losses may be reduced by insertion of "cathode-follower" stages and by the use of staggered circuits in carrier amplification in preference to band-pass systems.

Section III describes a family of ideal transitions of uniform stretch, their even cases corresponding to ideal filters with flat time response and steadily dropping amplitude response, and representing the ultimate shapes of transients in filter cascades. These transitions maintain their shape when cascaded and stretch uniformly with a stretch modulus $s = n\sqrt{2}$ for the n th case. Their first member, $n = 2$, $s = 1.41$ is identical with the ERF function which has no overshoot, their last member $n = \infty$, $s = 1$, is the Si function, known as the transient response of the low-pass filter with infinitely sharp cutoff. Intermediate cases and their combinations supply a ready means to predict s from the cutoff steepness of the amplitude response if the time response is assumed to be corrected. The amplitude response of a television channel with which to obtain the most suitable shape of transient response for a given bandwidth is derived; the effects of further bandwidth trimming is shown.

In Section IV, various procedures are demonstrated to synthesize well-shaped transient-response curves by cascading simple electrical filters and, in more complicated cascades, by manipulating the time-delay response, e.g., by addition of a phase-correcting stage.

* Decimal classification: R143×R363.1. Original manuscript received by the Institute, June 4, 1940; revised manuscript received, July 11, 1944. Presented, Fourteenth Annual Convention, New York, N. Y., September 23, 1939.

† Radiation Laboratory, Massachusetts Institute of Technology, Cambridge 39, Massachusetts; formerly, Electric and Musical Industries, Ltd., Hayes, Middlesex, England.

‡ Electric and Musical Industries, Ltd., Hayes, Middlesex, England.

INTRODUCTION

THE criterion for the quality of a television amplifier is its transient response, but little is known about the factors which contribute to the steepness and shape of transients and about their deterioration in the passage through electrical filters. Such knowledge, including quantitative details, must form the basis of any efficient filter design.

In this paper, we have aimed at picturing the kinetics of transients in filters, i.e., the sudden discharge of energy into condensers, through coils and resistances, and we have only as a second line of attack resorted to Fourier analysis and the resulting amplitude response of the filters. All curves shown are based on calculations, most equations being worked out with the aid of Heaviside calculus. The analysis involved some very intricate mathematical problems, for the solution of which we are much indebted to C. P. Singer. A survey of the mathematical procedure is given in Appendix I. Some of the curves for two amplifier stages and all curves for more stages have been obtained by numerical point-to-point integration and differentiation; this process increases the possible error from 0.01 to about 0.02 (more, in a few particularly complex cases).

The transient-response curves for the various types of filters described are calculated on the assumption that the filters are in circuit between amplifying tubes, and that the rapidity of response required is so great that the tube-anode impedance may be neglected in comparison with the necessarily low load impedances. In these circumstances the tube may conveniently be regarded as a current generator, yielding a current $g_m V_g$, rather than as a voltage generator. All the filter-circuit diagrams are drawn with these assumptions; they all assume a current source feeding the input terminals, and the transient curves represent the voltage at the output terminals arising either from a unit (infinitely steep) step of current at the input terminals, or a unit-voltage step applied to the grid of a tube the anode of which is connected to the input terminals of the filter. The response is generally characterized by an initial time delay, and finite transition time, followed by transient oscillations which cause some overshoot above the final value and possibly continue to oscillate for a few cycles, with the angular frequency ω_r . The transition time is the most important characterization of a filter. To leave out of consideration the rarely important tailing at the beginning and at the end of the transition, the specific transition time T_r of a filter is here defined as the time within which its response rises from the value 0.1 to the value 0.9. For an ideally straight transition this would be 80

per cent of the total time of transition. If the transition follows the shape of a sine wave with a peak equal to unity the transition time T_r would be equivalent to 108 degrees of its period, i.e., 0.3 of a whole cycle.

The merits of the subsequent transient-response curves will be assessed (a) by the transition time T_r from 0.1 to 0.9 in radians of $\omega_0 t$; and (b) by the peak overshoot in per cent.

As in an amplifier of a certain gain, using a certain tube, the total capacitance (C_{total}) to ground as well as the total resistance (R_{total}) to ground are given, the unit of time is taken to be the time constant T_0 , equal to the product of C_{total} and R_{total} of a pure resistance-capacitance coupling. For example T_0 is 0.1 microsecond for a total capacitance of 50 micromicrofarads and R_{total} of 2000 ohms. The merit of a filter is expressed by $H = T_0/T_r$, increasing with decreasing T_r , and with increase in the C and R which are accommodated for a given value of T_r . If, in the following, a filter is characterized by $H = 0.5$, then this filter, built with C_{total} of 50 micromicrofarads and R_{total} of 2000 ohms will result in a transition time from 0.1 to 0.9 of 0.2 microsecond. Thus, any comparison of transient-response curves on the grounds of merit H is on the basis of equal T_0 , although the nominal cutoff frequencies of the couplings, considered as low-pass filters, may vary widely.

The correlation of the bandwidth of an amplifier with its transition time T_r is rather arbitrary. (See Section III.) Assuming again a sinusoidal transition and calling this sinusoidal oscillation the highest useful frequency $f_0 = \omega_0/2\pi$ of this filter, its transition time T_r would be 108 degrees = $0.3/f_0$ and $f_0 = 0.3/T_r$. A filter which would transform a square wave of unit height and of the angular frequency ω_0 into a sine wave of the same frequency and the same peak amplitude, attenuates the fundamental frequency ω_0 to $\pi/4 = 0.785$, because in a square wave of unit height is embodied a sine wave ω_0 of the peak value $4/\pi$.

I. TRANSIENT RESPONSE OF SINGLE FILTERS

In this section responses of simple couplings between tubes are considered. Many of these are evidently conventional low-pass filter sections. They are, however, calculated individually and on their own merits, since the treatment as ideal filters gives quite unreliable results, unless the filter is so long that terminations are effectively nonreflecting.

1. Series-Peaking Coil

In Fig. 1 a family of transient-response curves is shown for a simple circuit employing what is known as the "series-peaking coil." It cannot be realized in wide-band amplifiers because either the generator or the load, whichever is connected to the resistance, must be assumed to have no capacitance; but the circuit is important as producing the same effect as a carrier-frequency amplifier built with a pair of staggered circuits or a single band pass. (Appendix II, Section 1.)

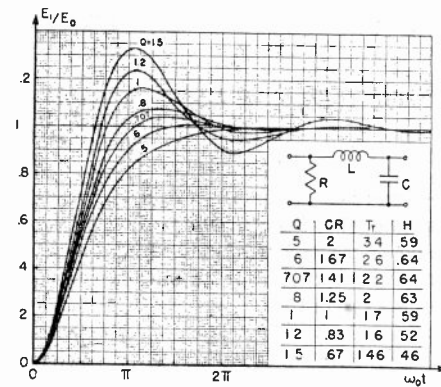

Fig. 1—Transient response of series-peaking coil circuit to a unit step of current.

The general equation for the transient response is (1) from which the curves of Fig. 1 were calculated. The

$$E_1/E_0 = 1 - \sqrt{\frac{4Q^2}{4Q^2 - 1}} \cdot e^{-\omega_0 t/2Q} \cdot \cos \left\{ \sqrt{\frac{4Q^2 - 1}{4Q^2}} \omega_0 t - \sin^{-1} \left(\frac{1}{2Q} \right) \right\} \quad (1)$$

shape of the curve depends mainly on the Q of the circuit, to be evaluated for this as for all other circuits

$$Q = 1/\omega_0 CR = \omega_0 L/R = (1/R)\sqrt{L/C}; Q\omega_0 t = T/T_0 \quad (1a)$$

from (1a). For the special case of $Q = 0.5$, equation (1) is to be replaced by (2).

$$E_1/E_0 = 1 - (1 + \omega_0 t)e^{-\omega_0 t} \quad (2)$$

The initial oscillation around a newly attained level is called transient oscillation, a fault which occurs in many video amplifiers. The amplitude of its first peak, the "overshoot" gives some measure of this fault. The frequency ω_r of this oscillation is always lower than ω_0 , equation (3). For comparison with the transient-

$$\omega_r = \omega_0 \sqrt{1 - (1/4Q^2)} \quad (3)$$

response curves the corresponding amplitude-response curves are plotted in Fig. 2, equation (4) and the time-

$$A = 1/\sqrt{1 + (1/Q^2 - 2)(\omega/\omega_0)^2 + (\omega/\omega_0)^4} \quad (4)$$

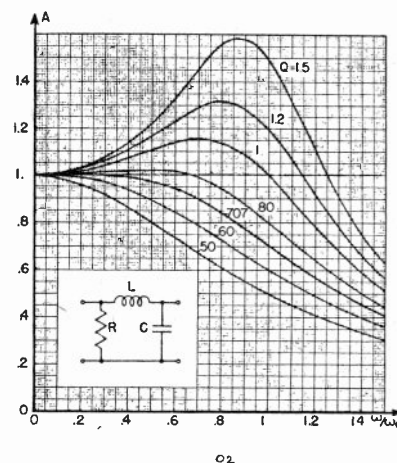

Fig. 2—Amplitude response of series-peaking coil circuit.

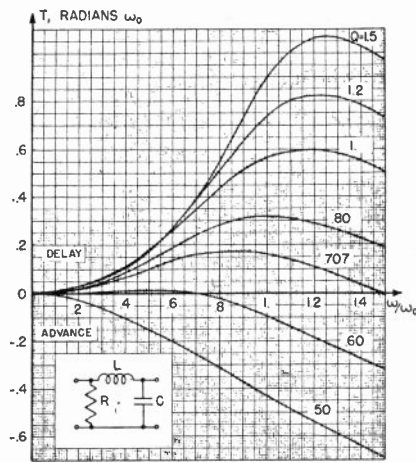

Fig. 3—Time-delay response of series-peaking coil circuit.

delay response in Fig. 3, equation (5). If any deduction

$T = (\omega_0/\omega) \tan^{-1} (1/[Q(\omega/\omega_0) - \omega_0/\omega]) - 1/Q$ (5) is to be drawn from the amplitude or the time-delay response as regards the transient response of the filter, then evidently a flat time-delay response ($Q=0.60$) seems to be of greater importance than a flat amplitude response ($Q=0.7$ to 0.8) in obtaining a well-shaped transient. The transition time T_r of this filter improves with higher values of Q , but these correspond to a smaller resistance and consequently smaller gain. The figure of merit H of the filter does not vary much in the range of interest, as is shown by the broken curve H versus Q in Fig. 4. The overshoot rises quickly as Q increases above 0.6 . Its value is plotted in Fig. 4, from equation (6).

$$E_1/E_0 - 1 = e^{-\pi/\sqrt{4Q^2-1}} \quad (6)$$

2. Shunt-Peaking Coil

Somewhat better transient response is obtained with the "shunt-peaking coil." The transient response of this circuit is shown in Fig. 5, equation (7). Its amplitude

$$E_1/E_0 = 1 - \sqrt{\frac{4Q^4}{4Q^2-1}} \cdot e^{-\omega_0 t/2Q} \cdot \cos \left\{ \sqrt{\frac{4Q^2-1}{4Q^2}} \omega_0 t + \sin^{-1} \left(\frac{2Q^2-1}{2Q^2} \right) \right\} \quad (7)$$

and time-delay-response curves are plotted in Figs. 6 and 7, equations (8), (9), and (9a) for the resistance-

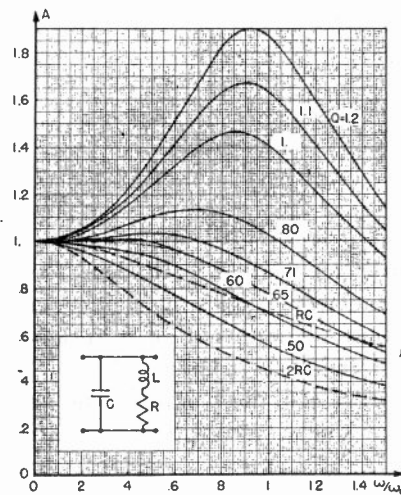

Fig. 6—Amplitude response of shunt-peaking coil circuit.

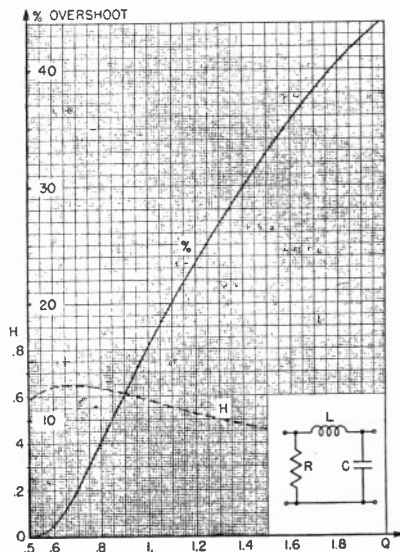

Fig. 4—Overshoot and figure of merit of series-peaking coil circuit.

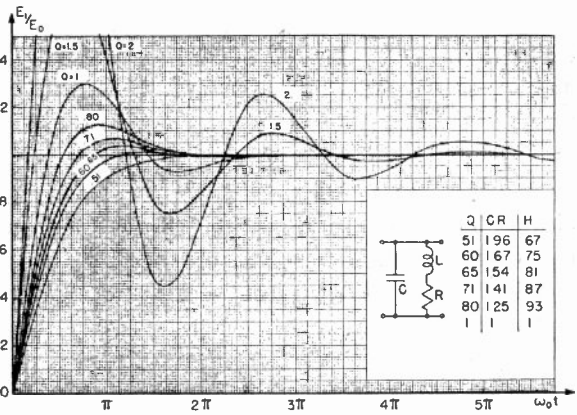

Fig. 5—Transient response of shunt-peaking coil circuit to a unit step of current.

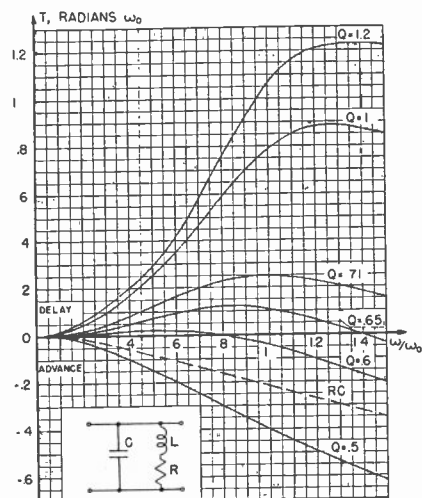

Fig. 7—Time-delay response of shunt-peaking coil circuit.

$$A = \sqrt{\{1 + (\omega/\omega_0)^2 Q^2\} / \{[1 - (\omega/\omega_0)^2]^2 + (\omega/\omega_0)^2 \cdot 1/Q^2\}} \quad (8)$$

$$T = (\omega_0/\omega) \tan^{-1} \{(\omega/\omega_0 Q)(1 - Q^2 + (\omega^2 Q^2/\omega_0^2)) - (1 - Q^2)/Q\} \quad (9)$$

$$T = (\omega_0/\omega) \tan^{-1} (\omega RC) - \omega_0 RC = (\omega_0/\omega) \tan^{-1} (\alpha \cdot \omega/\omega_0) - \alpha \quad (9a)$$

capacitance coupling. In this filter the voltage on the condenser starts rising immediately because it is not delayed by a coil as with the series-peaking circuit.

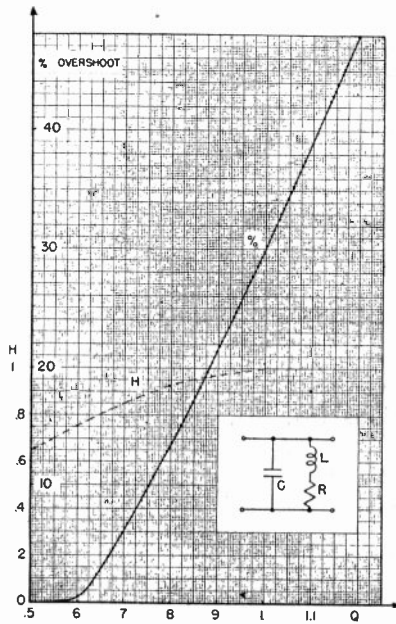

Fig. 8—Overshoot and figure of merit of shunt-peaking coil circuit.

Transition time as well as gain decrease with higher values of Q , the transition time being generally about 18 per cent better than that of a series-peaking coil. The overshoot increases quickly above 1 per cent for values of Q above 0.6, the height of the peak overshoot being shown in Fig. 8 according to equation (10). The

$$E_1/E_0 - 1 = Q \cdot e^{-[(\pi - \tan^{-1} \sqrt{4Q^2 - 1}) / \sqrt{4Q^2 - 1}]} \quad (10)$$

figure of merit H of the filter rises only slightly with increase of Q , as shown as a broken curve in Fig. 8. The

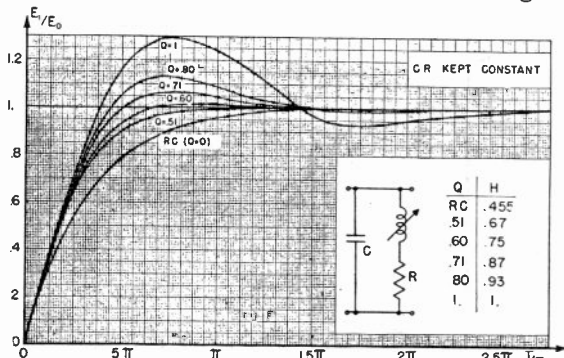

Fig. 9—Transient response to a unit step of current for equal gain, shunt-peaking coil circuit.

circuit is simple, easily produced, and its response does not vary much with small changes of its components; this is illustrated by Fig. 9, in which capacitance C as

well as resistance R are kept constant, and only inductance L is varied. The changes in the transient response are small, even for appreciable changes in inductance. In carrier-frequency amplification this filter finds its analogue in the "sucker circuit." (Appendix II, Section 2, Figs. 60(a), 60(b), and 60(c), equations (98) (99).)

3. Split Capacitances

The above circuits have all their capacitances lumped, whereas because of their superior amplitude characteristics the circuits with split capacitances are often thought to be preferable, since their nominal cutoff frequency is higher; yet the resulting transitions are often worse. Fig. 10 shows transient-response curves for two

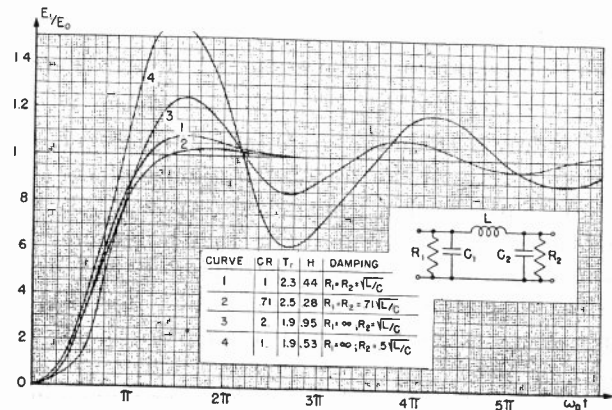

Fig. 10—Transient response to a unit step of current, of filter with two separate capacitances.

equal capacitances C , separated by a coil $2L$, and damped in various ways. Curve 1, equation (11) shows,

$$E_1/E_0 = 1 - e^{-\omega_0 t} - 1.15e^{-0.5\omega_0 t} \cdot \sin 0.86\omega_0 t \quad (11)$$

the case of orthodox matching on both ends with a resistance $R = \sqrt{L/C}$. This filter has an overshoot of 8 per cent and $H = 0.44$; that means that it has twice the transition time of a "shunt-peaked" filter $Q = 0.73$, which has the same overshoot, the same total capacitance, and the same gain. By reducing both the resistances to $0.71\sqrt{L/C}$ the overshoot decreases to 2.5 per cent, equation (12), and the gain to 0.71 of its former

$$E_1/E_0 = 1 - e^{-1.41\omega_0 t} - 2e^{-0.71\omega_0 t} \cdot \sin 0.71\omega_0 t \quad (12)$$

value. H is now 0.28; but a "shunt-peaking coil" with a $Q = 0.65$, $H = 0.8$ would, for 2.5 per cent overshoot, give nearly three times better transition time.

A filter of this type, but damped on one end only, gives much worse results. Curve 3 in Fig. 10, equation (13), shows the response of such a filter with two equal

$$E_1/E_0 = 1 - 0.8e^{-0.65\omega_0 t} - 0.67e^{-0.177\omega_0 t} \cdot \cos (0.86\omega_0 t - 72^\circ 40') \quad (13)$$

capacitances C and a coil $2L$, damped on one end by a resistance $R = L/C$. It has an overshoot of 25 per cent and is altogether only just as good as a "shunt-peaked" filter $Q = 0.93$ with 25 per cent overshoot. Reducing the value of R to $0.5\sqrt{L/C}$ makes things even worse, curve 4, equation (14), increasing the overshoot to 56 per

$$E_1/E_0 = 1 - 0.178e^{-1.76\omega_0 t} - 0.97e^{-0.123\omega_0 t} \cdot \cos(0.745\omega_0 t - 34^\circ) \quad (14)$$

cent, and being otherwise considerably inferior to a shunt-peaked circuit of 56 per cent overshoot. It can be shown quite generally for this type of filter that optimum damping of the overshoot is obtained, if the damping is evenly distributed between both ends, so that the products C and R at each end are just equal.

The physical explanation is found in that each resistance is simultaneously acting as a shunt damping for the nearer half section and as a series damping for the remote half section. The resistance should be small for the first, but large for the second purpose, and the use of equal time constants CR on both ends yields the optimum compromise.

The attempt to improve filters by splitting their capacitances in two having so far failed, it remained to observe the effect of splitting the capacitances in even smaller fragments. Fig. 11 shows the response of a low-

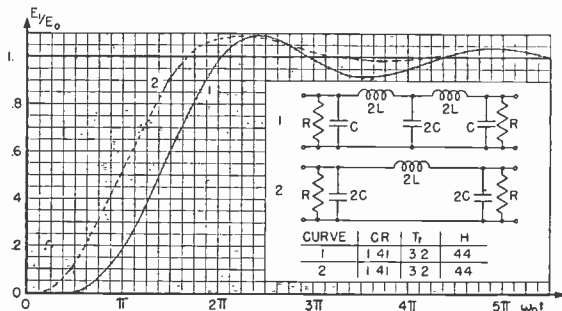

Fig. 11—Transient response to a unit step of current, of filter with three separate capacitances.

pass filter consisting of four equal half sections LC , damped at both ends, equation (15). It can be shown

$$E_1/E_0 = 1 - (1.36\omega_0 t + 0.14)e^{-0.71\omega_0 t} + 1.32e^{-1.1\omega_0 t} - 0.47e^{-0.16\omega_0 t} \cdot \cos(0.79\omega_0 t + 17^\circ 45') \quad (15)$$

that the value of $R=0.707\sqrt{L/C}$ gives the least overshoot which is still 9 per cent. For comparison the response of a low-pass filter built in two half sections like the filter 1 in Fig. 10 is shown as the dotted curve 2, stretched to accommodate the same total capacitance and the same resistance, giving therefore the same gain. The transition time and overshoot are exactly the same, $H=0.44$, and the only difference due to the further splitting of capacitances is that the transient oscillations are of somewhat higher frequency, but less well damped. A single shunt-peaking circuit with 8 per cent overshoot would be nearly twice as effective, $H=0.87$.

If we consider these particular types of circuits including split capacitances, we see that they carry resistance loads directly across capacitances, whereas this does not occur in the case of the series- and shunt-peaking filters. These particular split- and lumped-capacitance circuits may, in fact, be considered as examples of mid-shunt- and mid-series-terminated filters respectively. From some points of view it is unfair to compare examples from the different classes, but it must

be noticed that a lumped-capacitance (half-section) version of the mid-shunt-terminated filter would have no meaning, in that an inductance is left in series with a load of presumed infinite impedance. To make a fair comparison of the effect of splitting capacitances without changing the type of the termination, the good performance of the shunt-peaking circuits led us to apply the same form of termination to a low-pass filter with split capacitances. Curve 1 of Fig. 12 is the result of

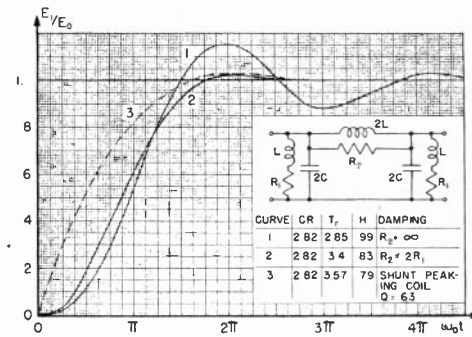

Fig. 12—Transient response to a unit step of current, of improved filter with two separate capacitances.

using two capacitances $2C$, separated by a coil $2L$ and each terminated by a resistance R in series with the optimum resistance $R=1.41\sqrt{L/C}$, equation (16). The overshoot

$$E_1/E_0 = 1 - (0.34\omega_0 t + 0.99)e^{-0.71\omega_0 t} + 0.07e^{-1.1\omega_0 t} - 0.53e^{-0.16\omega_0 t} \cdot \cos(0.79\omega_0 t + 82^\circ 30') \quad (16)$$

of 16 per cent is high, but can be damped out without loss in gain by a resistance $2R$ across the coil $2L$. The resulting filter is represented in curve 2 of Fig. 12, equation (17). This is a very straight curve with 2 per

$$E_1/E_0 = 1 - (0.31\omega_0 t + 1.05)e^{-0.71\omega_0 t} + 0.12e^{-1.0\omega_0 t} - 0.66e^{-0.39\omega_0 t} \cdot \cos(0.75\omega_0 t + 75^\circ) \quad (17)$$

cent overshoot, and is the first curve which has been found to be better than the shunt-peaking filter; the improvement is, however, very small, $H=0.83$. The competing shunt-peaked filter $Q=0.63$, $H=0.79$ is shown for comparison as a dotted line, curve 3. There is no reason to expect a better transition time by still further splitting the total capacitance. Indeed, the comparative behavior of these last-mentioned filters appears to allow the deduction of a few general rules:

(a) Splitting capacitances within a certain type of four-terminal filter does not appreciably increase the merit H , although it increases the frequency of the transient oscillations. The cutoff frequency of each half section is doubled for the same total capacitance, but the passage through several sections flattens the pulse by trickle feeding from one section to the next. It will be shown later on that T_r increases by about 1.41 each time the number of such sections, each with unchanged capacitance, is doubled, which nullifies the expected improvement. This holds true insofar as the coupling between the sections is negligible, and therefore, is not applicable to the extreme case of distributed inductance and capacitance of a real cable.

(b) Each oscillating circuit should have its own damping to hold down the overshoot.

(c) This damping should be prevented from action during the first half of the transition. Since the initial speed of transition in a low-pass section depends on the speed of rise of the charge in the condenser, this should not be delayed by diverting energy into shunting resistances. The easiest way to realize the delayed damping is to shunt the capacitance only by a resistance in series with an inductance (shunt-peaking coil).

(d) Series coils need damping, which is best done by parallel resistances.

(e) Connecting several equal sections in cascade delays the decay of the transient oscillations because the later sections are trickle-fed in the correct rhythm from the preceding ones, instead of being excited by a single kick. This shows in the equations as a coefficient $\omega_0 t$ to the amplitude of the transient oscillations, which tends to counteract the exponential decay.

(f) Large tolerances in components of simple filters are quite harmless, as can be seen in Fig. 9. The danger is not much increased in multisection filters, if all sections change their individual resonance by the same amount in the same sense; but random variations, such as would be likely to occur in quantity production, might easily upset the mutual phase and amplitude correction between the sections and deteriorate the response.

4. Capacitance-Terminated Filters

The remaining filters which, because of their well-corrected amplitude response, give promise of better efficiency, are those including an additional capacitance for loading at one end, and also in many cases containing an m -derived section.¹

The simplest case, having a total of $2C_0$ as load at the one end, is represented in Fig. 13, equation (18). This

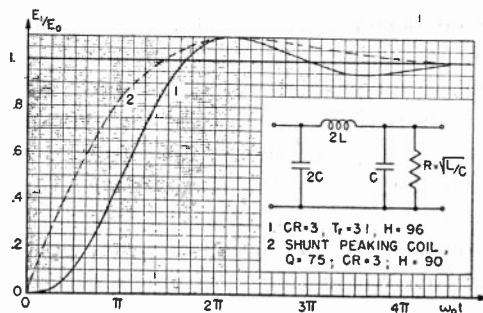

Fig. 13—Transient response to a unit step of current, of a capacitance-terminated filter.

$E_1/E_0 = 1 - e^{-0.5\omega_0 t} - 0.76e^{-0.25\omega_0 t} \cdot \sin(0.66\omega_0 t)$ (18)
 filter has 10 per cent overshoot but an $H=0.96$. It is slightly better than the competing "shunt-peaking coil" $Q=0.75$, $H=0.90$, which is plotted for comparison as the broken curve 2 stretched to accommodate the same total resistance and capacitances.

Further, and considerable, increase of H is obtained by the introduction of an m -derived section. Curves 1

¹ W. S. Percival, British Patent No. 490,525.

and 2 in Fig. 14 show the response of two filters which are calculated for a capacitance ratio of 18 micromicrofarads to .12 micromicrofarads; and a nominal cutoff

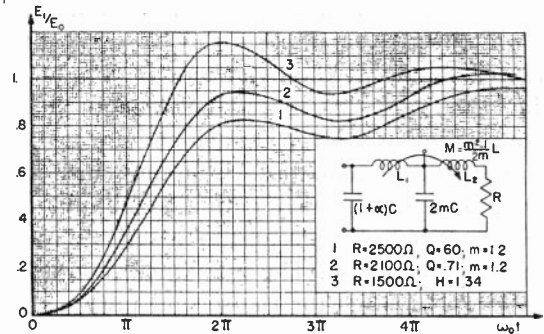

Fig. 14—Transient response to a unit step of current, of a filter with an m -derived terminating section.

frequency of 14.2 megacycles per second. They differ in the value of damping, the one, equation (19) having

$$E_1/E_0 = 1 - e^{-0.18\omega_0 t} - 0.25e^{-0.09\omega_0 t} \cdot \sin(0.72\omega_0 t)$$
 (19)

a resistance of 2500 ohms, corresponding to a Q of 0.60; the other, equation (20) having a resistance of 2100

$$E_1/E_0 = 1 + 0.03e^{-0.98\omega_0 t} - 1.02e^{-0.24\omega_0 t} - 0.28e^{-0.095\omega_0 t} \cdot \sin(0.72\omega_0 t + 1^\circ 30')$$
 (20)

ohms corresponding to a Q of 0.71. Both are characterized by a basically slow rise, which, however, is speeded up in the beginning by a properly timed oscillation; but this oscillation decays rather slowly and leads to a long delay near the end of the transition, before the curve reaches its final level. Curve 3, equation (21),

$$E_1/E_0 = 1 + 1.17e^{-0.38\omega_0 t} \cdot \cos(0.273\omega_0 t - 10^\circ) - 0.44e^{-0.16\omega_0 t} \cdot \cos(0.80\omega_0 t + 70^\circ)$$
 (21)

shows the response of a filter with the same capacitances, the same nominal cutoff frequency, and a resistance of 1500 ohms. The mutual inductance of this filter has been chosen according to the recommendations of

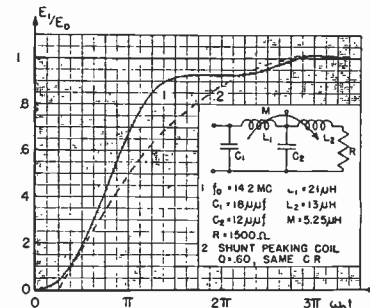

Fig. 15—Transient response to a unit step of current, of a filter with an m -derived terminating section.

British patent number 490,525, resulting in $H=1.34$; 16 per cent overshoot and long oscillations. Somewhat better results are given by a similar, but quite unorthodox filter, Fig. 15, equation (22). This uses the same

$$E_1/E_0 = 1 - 1.4e^{-0.46\omega_0 t} \cdot \cos(0.21\omega_0 t - 37^\circ) + 0.29e^{-0.29\omega_0 t} \cdot \cos(1.14\omega_0 t + 64^\circ)$$
 (22)

capacitances of 12+18 micromicrofarads, a resistance

of 1500 ohms, but coil values, found experimentally, of $L_1=21$ microhenries, $L_2=13$ microhenries, and $M=5.25$ microhenries. This response curve is of the same type but reaches its final level sooner. Because of the long delay near 0.9 of the final value, the curve does not lend itself to a just assessment by a single figure. The curve of the competing shunt-peaked filter is therefore plotted as a dotted line. It has a Q of 0.6, an $H=0.75$, and a 1 per cent overshoot. Its slope over most of the transition time is about 1.6 times inferior. Coil capacitances and damping resistances across one or both coils of this type of filter may somewhat affect its response. In fact, the losses of the coils are bound to damp the oscillation more than is visible in the plotted curve. But there is no reason to expect considerable changes in the shape or the speed of the transient response of this type of filter, i.e., a slow rise with a superimposed damped oscillation, which is timed to hold down its toe and to lift its top.

5. Low-Pass Filters as Carrier Amplifiers

Low-pass filters are sometimes used for the amplification of a carrier and both side bands. This case is not to be confused with that of the analogue band-pass filters for carrier amplification, as described in Appendix II, whose response is substantially symmetrical around the carrier frequency.

No simple conclusion can be drawn from the transient response of a low-pass filter regarding its merits as a carrier amplifier. As the filter type represented in Figs. 14 and 15 is sometimes used for this purpose it may serve as a suitable example of how to deal with such cases. Fig. 16, equations (23 and 24), shows the amplitude and time response of the filter underlying Fig. 15. Both the amplitude response and the time response of this filter appear to be reasonably steady in the range from $0.25 \omega_0$ to $0.75 \omega_0$. The frequency $0.50 \omega_0$ may thus be chosen as that of a carrier which is modulated with both sidebands up to a maximum modulation frequency $0.25 \omega_0$ and thus occupies the band from $0.25 \omega_0$ to $0.75 \omega_0$.

The assessment of merits of a filter for carrier amplification is exact only in the cases where the curve for the gain and the curve for the envelope time response are symmetrical around the carrier frequency, thus indicating exact equality of distortion of the upper and lower sideband. For slight assymetry it is, however, permissible with negligible error to take the average by lumping the amplitude and phase distortion, respectively, of the upper and the lower sideband.

The gain response in Fig. 16 varies in the frequency range occupied between 0.93 and 0.77, being 0.80 at the carrier frequency $0.50 \omega_0$. The gain of the upper and lower sideband may thus safely be lumped. The broken curve on Fig. 16 shows the resulting average gain \bar{A} of the modulation frequencies ω_m rising from 0.80 for zero frequency to 0.84 at $\omega_m=0.25 \omega_0$. This gain response may be considered as sufficiently flat.

A similar consideration applies to the envelope time response. It must be understood that in the case of carrier-frequency amplification the "envelope time response" is not identical with the "time response" of the filter as applicable for modulation-frequency amplification. The "time response" represents the time after which each frequency ω arrives at the output of the filter, relative to the time of arrival of zero frequency.

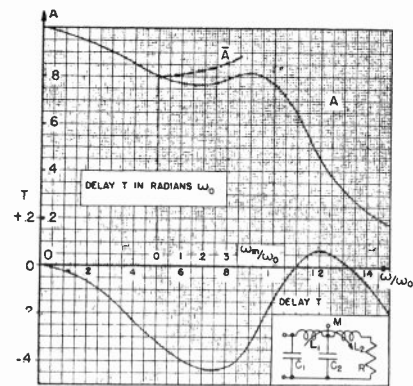

Fig. 16—Amplitude and time-delay response of a filter with an m -derived terminating section. Filter values as in Fig. 15.

This is plotted as time response in Fig. 16, equation (24). This time response is applicable if the filter is used for video frequencies, showing the amount of their respective advance or delay. But in carrier-frequency amplification matters are somewhat more complicated, in that the various modulation frequencies ω_m appear on the output as beats between the carrier frequency and the various sideband frequencies. These beats travel not with the velocity of the waves themselves, but with what is known as group velocity. The relative time of arrival of these beats at the output terminal of the filter is not described by $T = \phi/\omega$ but $T_m = d\phi/d\omega$. This envelope time delay T_m is plotted in Fig. 17, equation (25). Constant value (a horizontal line) would be the ideal envelope-time-response curve. And again, only when the response curve is symmetrical around the value of the carrier frequency, is the distortion identical for both sidebands and thus can be simply assessed. But

$$A = \sqrt{\frac{1 + 1.18(\omega/\omega_0)^2}{[1 - 6.14(\omega/\omega_0)^2 + 3.4(\omega/\omega_0)^4]^2 + [4 \cdot \omega/\omega_0 - 4.85(\omega/\omega_0)^3]^2}} \tag{23}$$

$$T = \omega_0/\omega \left\{ \tan^{-1} \frac{4 \cdot \omega/\omega_0 - 4.85(\omega/\omega_0)^3}{1 - 6.14(\omega/\omega_0)^2 + 3.4(\omega/\omega_0)^4} - \tan^{-1} (1.09 \cdot \omega/\omega_0) \right\} - 2.91 \tag{24}$$

$$\frac{d\phi}{d\omega} = \frac{4 + 10(\omega/\omega_0)^2 - 11.1(\omega/\omega_0)^4 + 16.5(\omega/\omega_0)^6}{[1 - 6.14(\omega/\omega_0)^2 + 3.4(\omega/\omega_0)^4]^2 + [4 \cdot \omega/\omega_0 - 4.85(\omega/\omega_0)^3]^2} - \frac{1.09}{1 + 1.18(\omega/\omega_0)^2} \tag{25}$$

good approximation is possible by taking the average between both sidebands under the following conditions:

(a) The amplitude response is assumed to be approximately flat; otherwise the time deviation of each frequency of the band from $0.25 \omega_0$ to $0.75 \omega_0$ should be multiplied with its amplitude response to weight the balance properly before lumping.

(b) It is assumed that the envelope time deviation of the modulation frequencies differs only slightly between

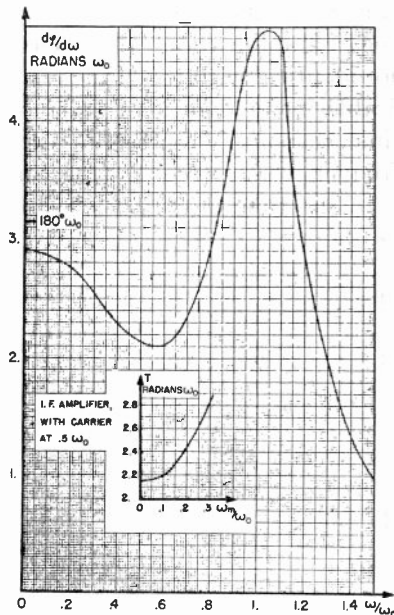

Fig. 17—Envelope time response of a filter with an m -derived terminating section.

both sidebands, so that the cosine of their phase difference is substantially equal to unity.

These conditions being satisfied in the case under consideration, the averaged envelope time response is plotted as an insert of Fig. 17. It shows a change of enveloped time delay from 2.15 radians ω_0 at zero frequency to 2.6 radians ω_0 at $\omega_m = 0.25 \omega_0$. Thus, the highest modulation frequency $\omega_m = 0.25 \omega_0$ is delayed against zero frequency by 0.45 radians ω_0 . For $\omega_m = 0.25 \omega_0$ this corresponds to 0.11 radians ω_m or 6.3 degrees of ω_m , a reasonably small time error.

The effects of higher degrees of asymmetry between the two sidebands are analyzed elsewhere.²

6. Pulse Response

A pulse of unit height and of the duration T may be considered as a succession of two equal and opposite unit step transients, following each other with the separation T . Thus the pulse response of a system always can be found simply by taking the difference of two identical transient responses with the time difference T . The resulting curve is generally more complicated than the component transient responses and thus lends itself less well to lucid interpretation.

² Heinz E. Kallmann, Rolf E. Spencer, and C. P. Singer, "Transient response of single-sideband systems," Proc. I.R.E., vol. 28, pp. 557-561; December, 1940.

II. TRANSIENT RESPONSE OF FILTER CASCADES

In the preceding section only single stages of wide-band amplifiers have been examined. In all cases it was assumed that an ideal transient has been fed to their input terminals. The present section deals with amplifiers of two or more equal or different stages. It is assumed that an ideal transient is fed to the input terminal of the first stage. The curves shown then represent the output voltage of the last filter under the assumption that there is no positive or negative reaction between any of the stages.

1. The Straight Transition, Cascaded

As a first example, it is assumed that each stage of the amplifier would produce from an ideal transient a straight transition according to curve 1 in Fig. 18. Such a filter would not easily be realizable, but provides a useful basis for discussion. If two equal stages, each having the transient-response curve 1, are cascaded, the output of the second stage assumes the shape of curve 2, Fig. 18. This curve consists of two exactly equal

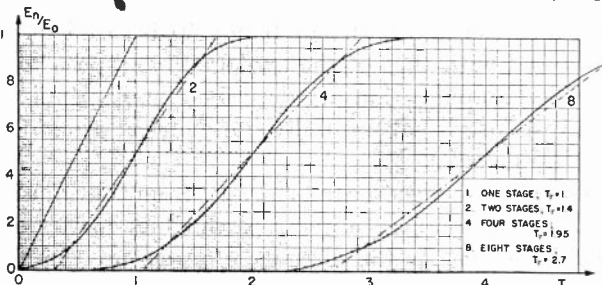

Fig. 18—Transient response of cascade of stages, each of which gives a straight transition to a unit step input.

parabolic parts joined at the center. At this point the curve reaches its maximum slope which is equal to the slope of the straight rise of a single stage, curve 1. It is easily understood that the second amplifier stage starts slowly, being fed initially from the first, not with the final voltage but with a small and steadily rising one. One might expect that the second stage continues straight and parallel to curve 1, once the value 0.5 is reached, since it has the right slope and the first stage has then reached its final level. But calculations as well as point-to-point integration of the energy transferred show otherwise. The physical difference lies in the potential energy stored in the magnetic field of the presumed coils of the filter 2, which is much greater after the sudden excitation by an ideal transient, than when it is built up by a pulse with finite transition time. The total transient occupies, after the second stage, twice as much time as after the first stage. Its average transition time is assessed by means of the straight line which intersects it at the values 0.1 and 0.9. The slope of this straight line is about 1.4 times less than that of the transient 1 after the first stage.

Curve 4 of Fig. 18 shows the transient after four equal stages, each having the transient response curve 1. The curve has remained symmetrical around the value

0.5 and has approximately kept its shape. Its total time of transition is now four times that of a single stage, but for nearly half of this time its departure from the original or its final value is quite negligible. Its average transition time is assessed by the straight line which intersects it at the values 0.1 and 0.9. Its slope is about half of that after the first stage.

Repeating the same process of doubling, and taking the response of eight equal stages in cascade, leads to curve 8 in Fig. 18, which again is symmetrical and of the same general shape as curves 2 and 4. Its total transition time is again stretched and is 8 times that of a single stage; its transition time from 0.1 to 0.9, however, is only about 2.7 times longer than that of a single stage. Indeed, the average transition times of the curves 2, 4, and 8 increase as the powers of 1.38, which value may be called the stretch modulus s for each doubling of stages. In this case its value is near enough to 1.41 to be represented by the value $\sqrt{2}$, the error being only 2 per cent per stage. In Fig. 19 all the curves 1, 2, 4, 8

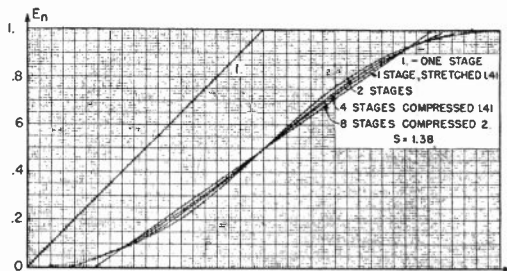

Fig. 19—Comparison of transient response of two, four, and eight identical stages with stretch modulus $s = \sqrt{2}$.

of Fig. 18 are superimposed on each other, taking the point 0.5 as common to all and the respective curves being stretched in the ratios 2.82, 2, 1.41, 1—. The figure shows how closely $\sqrt{2}$ represents the deterioration of such a transient response due to doubling the number of stages.

2. Unequal Transitions, Cascaded

It may now be assumed that two stages are cascaded, each of which has, taken singly, a straight transient response, but of different transition time. The first filter may have a transient response $E_1/E_0 = a \cdot t$; the second $E_2/E_0 = b \cdot t$ (Fig. 20). If the slope b is very high compared with a , the total response is evidently the same as that of the first stage alone. If b equals a , the resulting case is shown in Fig. 18 and is repeated in the curve 2 in Fig. 20, ($b_1 = a$). The resulting slope is in the average 0.71 times that of a , but no straight part of the curve is left. For cases of b smaller than a , curve 4 may serve as an example, ($b_2 = a/2$). These cases are represented by three separate equations (26, a, b, and c) of

$$\begin{aligned}
 \text{(a)} \quad 0 < t < 1/a: & \quad E_2/E_0 = abt^2/2 \\
 \text{(b)} \quad 1/a < t < 1/b: & \quad E_2/E_0 = bt - b/2a \\
 \text{(c)} \quad 1/b < t < (1/a + 1/b): & \quad \text{image of (a)} \quad (26)
 \end{aligned}$$

which (26a) describes the initial curved part, (26b) the straight central portion, and (26c) the final tailing.

The middle of the resulting transient response has remained a straight line of the same slope b as that of the second stage alone (indicated by a connecting arrow), and this line tails out at both ends in a parabolic curve to the point $t=0$ and the point $t=(1/a+1/b)$. Curves 5 and 6 in Fig. 20 illustrate that for $b=a/3$, and curves 7 and 8 for $b=a/4$. The influence of the tailing on the ends of the transition is soon negligible, and in the case

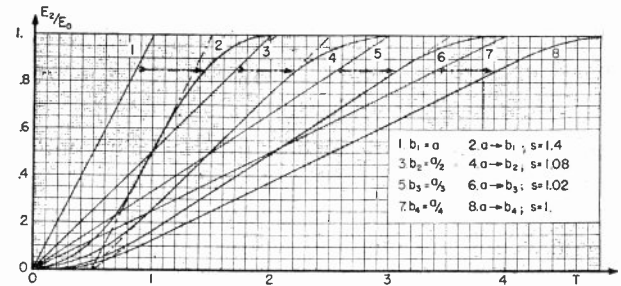

Fig. 20—Transient response of cascades of two different stages, each of which gives, alone, a straight transition to a unit-step input.

$b = a/3$ no longer affects the average transition time (from 0.1 to 0.9) to any noticeable extent.

Related to this subject is the question of how good the transient response of test equipment, such as an oscilloscope, must be in order not to increase noticeably the observed transition time. The error due to finite transition time of test equipment has been computed elsewhere³ for a transient shape as usually met in amplifiers. The curve plotted shows, for example, an error of 11 per cent if the test equipment has a transient response twice as fast as the unit under test.

It is striking how completely the sharp corners of a straight rise are worn away by adding a single stage of the same response. The explanation is found in the highly artificial conditions necessary to obtain such a response. The sharp corners prove the presence of high frequencies, but in this case their relative amplitudes are not such as to yield a steep rise. The amplitude

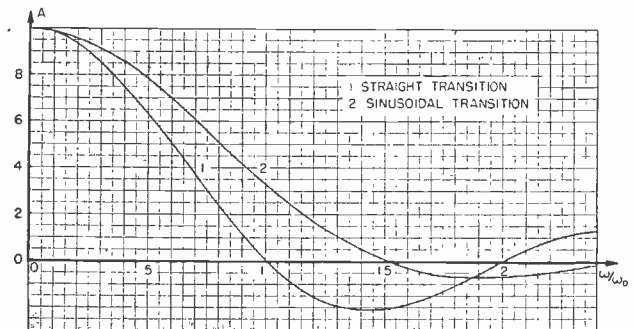

Fig. 21—Amplitude response corresponding to a straight, and to a sinusoidal, transition.

response of a filter producing such a trapezoidal oscillation from a square-topped one is shown as curve 1 in Fig. 21, equation (27). It extends far beyond the value

³ Heinz E. Kallmann, "Portable equipment for observing transient response of television apparatus," PROC. I.R.E., vol. 28, p. 359, Fig. 20; August, 1940.

$$A = \sin(\pi \cdot \omega / \omega_0) / (\pi \cdot \omega / \omega_0) \quad (27)$$

ω_0 , with alternating positive and negative sign. The amplitude relationship which produces the sharp corners is critical; it is destroyed after repetition.

3. The Sinusoidal Transition

A somewhat less extreme assumption is that of a filter giving a transient response of the shape of a half cycle of an undamped sine wave. This still is not easily realizable, but leads to simple mathematical expressions. Curve 2 of Fig. 21, equation (28), shows the

$$A = (1/1 - (2\omega/\omega_0)^2) \cdot \cos(\pi \cdot \omega / \omega_0) \quad (28)$$

amplitude response of such a filter which rounds off the edges of a square-topped oscillation so that its transient response follows a sine wave. Infinitely many harmonics are still required, with continually changing sign, but their amplitudes fall off faster. Accordingly, the change of shape of the transient response is much less pronounced, if two such stages are cascaded. Fig. 22

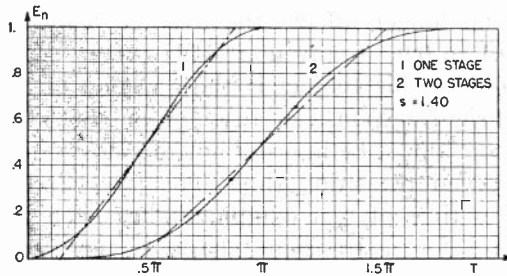

Fig. 22—Transient response of a cascade of two stages, each of which, alone, gives a sinusoidal transition to a unit-step input.

illustrates this. It shows the output of an ideal transient after the first and the second stage of an amplifier with assumedly sinusoidal transition, equation (29). The $E_2/E_0 = 1/4(1 - \cos T - (T/2) \sin T)$; $0 < T < \pi$ (29) change of shape is very slight, and the stretch modulus s is 1.40. Single points marked very near curve 2, were obtained by stretching curve 1 by $\sqrt{2}$ along the time axis.

As a test to what extent the deductions from the Figs. 18 and 19 are applicable in practice, several types of electrical filter have been examined in cascade.

$$E_2/E_0 = 1 - e^{-(1/2Q)\omega_0 t} \cdot \left\{ \frac{2Q^2\omega_0 t}{4-1/Q^2} \cdot \cos(\sqrt{1-1/4Q^2}\omega_0 t + \phi_1) + \frac{2Q\sqrt{9-2/Q^2}}{\sqrt{(4-1/Q^2)^3}} \cdot \cos(\sqrt{1-1/4Q^2}\omega_0 t + \phi_2) \right\} \quad (33)$$

$$\phi_1 = 3 \cos^{-1} \left(\frac{1}{2Q} \right) \quad \phi_2 = \phi_1 + \tan^{-1} \frac{1}{3Q\sqrt{4-1/Q^2}}$$

4. Cascades of Shunt-Peaking Coils

In curve 1 of Fig. 23, the transient response of a single "shunt-peaking filter" with a $Q=0.60$ is repeated from Fig. 5 as the curve 1. The response after a second stage of the same type is shown as curve 2, equation (30). The $E_2/E_0 = 1 - e^{-0.835\omega_0 t} \{ 0.585\omega_0 t \cdot \cos(0.55\omega_0 t + 100^\circ) + 1.67 \cos(0.55\omega_0 t + 126^\circ 30') \}$ (30)

general character of curve 1 is maintained, but the immediate rise at the beginning is lost. The stretch modulus s is found to be 1.4. Curve 4 shows the response after four equal stages. The tailing at the start

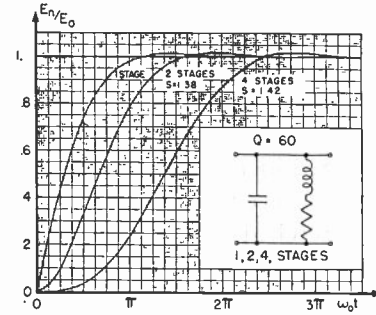

Fig. 23—Transient response of cascades of two and four stages of shunt-peaking coil circuits $Q=0.60$ to a unit step of current.

is more pronounced, but the general shape is maintained. The stretch modulus again is 1.4. Fig. 24, equation (31), shows the same series for one, two, and four stages of shunt-peaking filters $Q=0.71$. The stretch

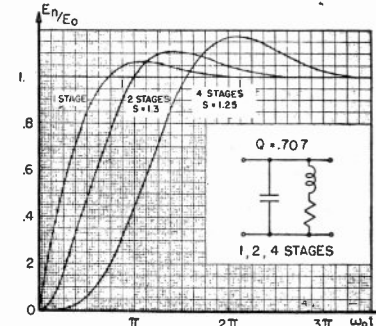

Fig. 24—Transient response of cascades of two and four stages of shunt-peaking coil circuits $Q=0.707$ to a unit step of current.

$$E_2/E_0 = 1 - e^{-0.71\omega_0 t} \cdot \{ 0.5\omega_0 t \cos(0.71\omega_0 t - 45^\circ) + 1.11 \cos(0.71\omega_0 t - 26^\circ 30') \} \quad (31)$$

modulus is only 1.3, but the amplitude of the transient oscillations rises with each repetition. Fig. 25 repeats the same for a $Q=1$, $s=1.25$, equation (32), general case equation (33). Fig. 26, equation (34), going to the other extreme,

$$E_2/E_0 = 1 - e^{-0.5\omega_0 t} \cdot \{ 0.67\omega_0 t \cdot \cos 0.866\omega_0 t + 1.02 \cos(0.866\omega_0 t + 11^\circ) \} \quad (32)$$

shows the response of two stages coupled by resistances only, both stages having the same time constant; $s=1.5$. Incidentally, its equation (34) is the same as

$$E_2/E_0 = 1 - (1+T) \cdot e^{-T} \quad T = t/R_1 C_1 = t/R_2 C_2 = t/T_0 \quad (34)$$

that for a single series-peaking coil with $Q=0.50$, equation (2).

5. Cascades of Equal and Different Series-Peaking Coils.

Similar curves are shown in Fig. 27 for one, two, (equation (35), general equation (36)) or four stages of $E_2/E_0 = 1 - e^{-0.835\omega_0 t} \cdot \{ 4.15 \cos(0.55\omega_0 t - 76^\circ) - 1.64\omega_0 t \cos(0.55\omega_0 t + 33^\circ 30') \}$ (35)

series-peaking filters $Q=0.60$, the stretch modulus being 1.42; and in Fig. 28, equation (37), for one and two such

$$E_2/E_0 = 1 - e^{-(1/2Q)\omega_0 t} \cdot \left\{ \frac{\cos(\sqrt{1 - 1/4Q^2}\omega_0 t - \phi_1)}{\cos \phi_1} - \frac{2\omega_0 t}{4 - 1/Q^2} \cos(\sqrt{1 - 1/4Q^2}\omega_0 t + \phi_2) \right\}$$

$$\tan \phi_1 = \frac{3/Q - 1/2Q^3}{(4 - 1/Q^2)\sqrt{1 - 1/4Q^2}} \quad \cos \phi_2 = 1/2Q \quad (36)$$

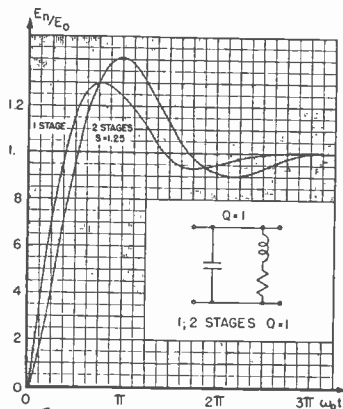

Fig. 25—Transient response of cascades of two and four stages of shunt-peaking coil circuits $Q=1$ to a unit step of current.

$$E_2/E_0 = 1 - e^{-0.71\omega_0 t} \cdot \{ 2.24 \cos(0.71\omega_0 t - 63^\circ 30') - \omega_0 t \cos(0.71\omega_0 t + 45^\circ) \} \quad (37)$$

filters with $Q=0.71$, the stretch modulus being 1.41.

Fig. 29 shows the combination of two stages with different Q in cascade, equation (38). The one has a Q of 0.63, the other of 0.80, equation (39). The total gain

$$E_2/E_0 = 1 - 1/[2(p - q)\sqrt{1 - p^2}] \cdot e^{-p\omega_0 t} \cdot \cos(\sqrt{1 - p^2}\omega_0 t + \phi_1) - 1/[2(q - p)\sqrt{1 - q^2}] \cdot e^{-q\omega_0 t} \cos(\sqrt{1 - q^2}\omega_0 t + \phi_2)$$

$$p = 1/2Q_1 \quad \phi_1 = \sin^{-1}(1 - 2p^2)$$

$$q = 1/2Q_2 \quad \phi_2 = \sin^{-1}(1 - 2q^2) \quad (38)$$

$$E_2/E_0 = 1 + 3.67e^{-0.63\omega_0 t} \cdot \cos(0.78\omega_0 t + 12^\circ 45') - 4.75e^{-0.80\omega_0 t} \cdot \cos(0.60\omega_0 t - 16^\circ 20') \quad (39)$$

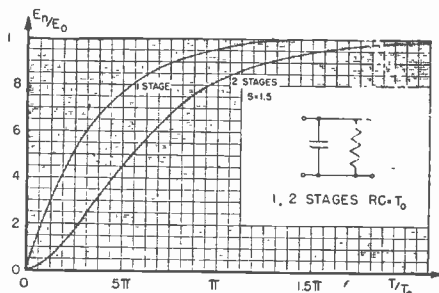

Fig. 26—Transient response of a cascade of two resistance-capacitance-filter coupled stages to a unit step of current.

is the same as that of two stages of $Q=0.71$, and so to a high degree is the resulting response.

6. The Butterworth System

Among the many possible cascades of series-peaking coils, those based on the Butterworth system are of special interest.⁴ This system prescribes the values of Q

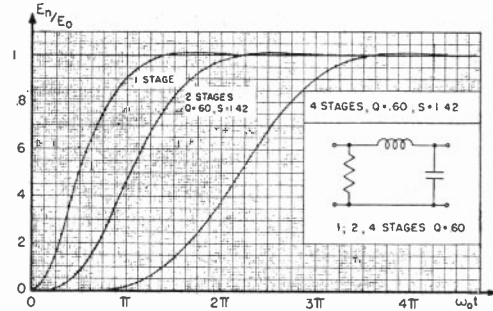

Fig. 27—Transient response of cascades of two and four stages of series-peaking coil circuits $Q=0.60$ to a unit step of current.

for each of any number of series-peaking coils in cascade, so that the over-all amplitude response of the resulting low-pass filter becomes as flat as possible. It is equally applicable to cascades of pairs of symmetrically staggered circuits or band passes for carrier amplification as explained in Appendix II, Section 1. Moreover, a series-peaking filter may be replaced by a cascade of a shunt-peaking filter and a stage with a matched re-

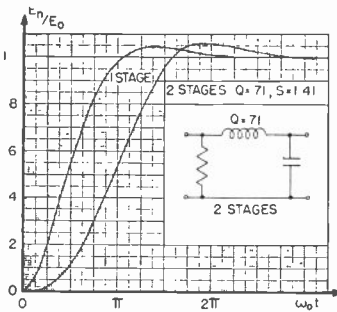

Fig. 28—Transient response of a cascade of two stages with series-peaking coil circuits $Q=0.71$ to a unit step of current.

sistance-capacitance coupling, according to Appendix IV. Thus this system serves very well in many cases where a flat amplitude response is desired.

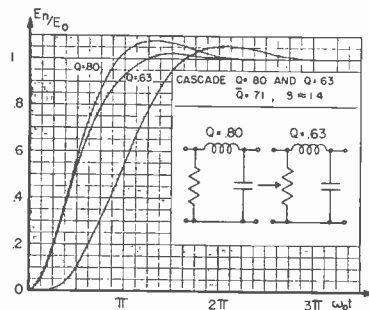

Fig. 29—Transient response of two stages with series-peaking coil circuits, the one $Q=0.63$, the other $Q=0.80$ to a unit step of current.

⁴ S. Butterworth, "On the theory of filter amplifiers," *Exp. Wireless and Wireless Eng.*, London, vol. 7, pp. 536-541; October, 1930.

The system prescribes equal nominal cutoff frequency ω_0 for all series-peaking coils; ω_0 is that frequency where the over-all gain has dropped to 0.707. The Q of each filter is then found from equation (40). The value de-

$$Q = 1/(2 \sin \pi r) \quad (40)$$

$$r = 1/2n; 3/2n; 5/2n \dots (n-1)/2n;$$

for even values of n (40a)

$$r = 1/2n; 3/2n; 5/2n \dots 1/2; \text{ for odd values of } n \quad (40b)$$

depends on the number n of the total number of reactances of all the "series-peaking coil" circuits (or the number of staggered circuits in carrier-frequency amplification). Odd values of n mean that one stage contains a pure resistance-capacitance coupling of the time constant $T = RC = 1/\omega_0$ (or that a single circuit $Q_s = \pi\nu/\omega_0$ is tuned to the carrier). Some values of Q , resulting from this formula are tabulated in Table I in Appendix

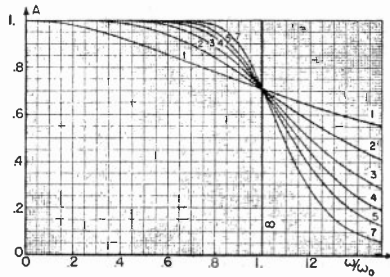

Fig. 30—Amplitude response of cascades according to Butterworth system.

III, which also gives the values of ω_r where the resonance peaks of the filters are to be expected, calculated from (3).

Fig. 30 shows the over-all amplitude response thus obtained. These curves can be calculated directly from equation (41). The over-all time-response curves in

$$A = 1/\sqrt{1 + (\omega/\omega_0)^{2n}} \quad (41)$$

Fig. 31, however, had to be found by summing up the responses of each single stage, calculated from equation (5). The curves are remarkably smooth, considering that they are built up from some very peaky com-

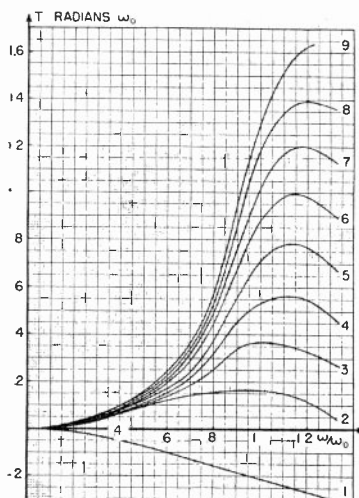

Fig. 31—Time-delay response of cascades according to Butterworth system.

ponents; but the time response is not so flat as appears desirable for good transient response. For example, the case $n=4$, equation (42) shows an overshoot of 10 per cent, Fig. 32.

$$E_2/E_0 = 1 + 0.99e^{-0.38\omega_0 t} \cdot \cos(0.925\omega_0 t + 45^\circ) - 2.42e^{-0.925\omega_0 t} \cdot \cos(0.38\omega_0 t - 45^\circ) \quad (42)$$

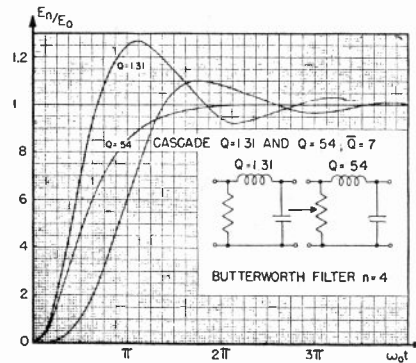

Fig. 32—Transient response of cascade $n=4$ of Butterworth system to a unit step of current.

In Fig. 33 some cases of the Butterworth system are collected, equations (43 and 44) for $n=3$, representing 1;

$$E_2/E_0 = 1 - \frac{1}{1 + 1/\alpha^2 - 1/\alpha Q} e^{-\omega_0 t/\alpha} - \frac{1}{\sqrt{1 - 1/4Q^2} \sqrt{1 + \alpha} - \alpha/Q} e^{-\omega_0 t/2Q} \cdot \cos(\sqrt{1 - 1/4Q^2} \omega_0 t + \phi)$$

$$\alpha = \omega_0 C_1 R_1 \quad Q = \frac{1}{\omega_0 C_2 R_2} = \frac{1}{R_2} \sqrt{L/C_2}$$

$$\phi = -\sin^{-1}(1/2Q) - \tan^{-1} \frac{\sqrt{1 - 1/4Q^2}}{1/\alpha - 1/2Q} \quad (43)$$

$$E_2/E_0 = 1 - e^{-\omega_0 t} - 1.15e^{-0.5\omega_0 t} \cdot \cos(0.866\omega_0 t - 90^\circ) \quad (44)$$

[identical with (11)]

1.5; 2; 3.5 low-pass filters (or 2; 3; 4; 7 staggered tuners for carrier-frequency amplification). This system is found to give an overshoot of approximately 10 per cent

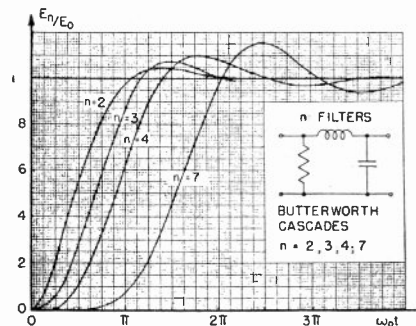

Fig. 33—Transient response of cascades $n=2, 3, 4, 7$, of Butterworth system to a unit step of current.

(excluding the case of $n=1$). It is, however, noteworthy that, for example, the case of $n=8$ (not shown) has slightly less gain than an amplifier with 4 equal series-peaking filters $Q=0.71$, chosen to give the same overshoot, the same total transition time, with the same

capacitances. From this it can be seen that nothing is gained and not much is lost if amplifiers are built from stages with different rather than with equal transition time. The Butterworth system may be regarded as a practical way to compensate the unsuitable transient response of an amplifier in which certain of the stages, for other reasons, have markedly low or high Q .

Although the Butterworth system is based on the use of series-peaking filters (or their carrier analogues) shunt-peaking filters can easily be accommodated in it. It has been stated that for any series-peaking circuit, there exists a cascade of a shunt-peaking circuit and a resistance-capacitance coupled stage (or their carrier analogues) which together will yield exactly the same response as the series-peaking circuit. This universally applicable conversion proves quite useful by giving further freedom in amplifier design. The necessary data are given in Appendix IV.

Faults in the transient response of a single stage, e.g., transient oscillations and slow approach to the final level, generally tend to aggravate on repetition. Figs. 34 and 35 show the disappointing transient re-

appreciable overshoot, this stretch modulus is so nearly equal to 1.41 that, even for the purpose of calculations, it is permissible to take the value of $\sqrt{2}$. This means that either the "bandwidth" of two equal stages in cascade is only 0.71 of that of a single one, or alternatively that, to maintain the undiminished "bandwidth" of the single stage, each of the two stages must be designed for 1.41 times the desired bandwidth. Each of the stages will then have only 0.71 of its original gain V_0 , and the system will have only half the gain of that expected as the product V_0^2 of the two original single stages.

Proceeding further, four stages in cascade would yield either a total gain V^4 with half of the original bandwidth, or the original bandwidth with the gain of each stage halved, resulting in a total gain of only $1/16 V_0^4$. The equation for the total gain V_{total} of an amplifier of undiminished bandwidth, built from n equal stages with the single gain V_0 is then $V_{total} = (V_0/\sqrt{n})^n$. It can be seen that the total gain has fallen to unity when $n = V_0^2$. The maximum gain for undiminished bandwidth is obtained with a number of stages n less than $V_0^2/2$. This is illustrated in Fig. 36. The horizontal axis

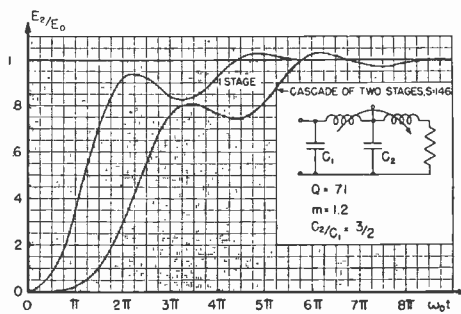

Fig. 34—Deterioration of transient response in a cascade of unsuitable stages.

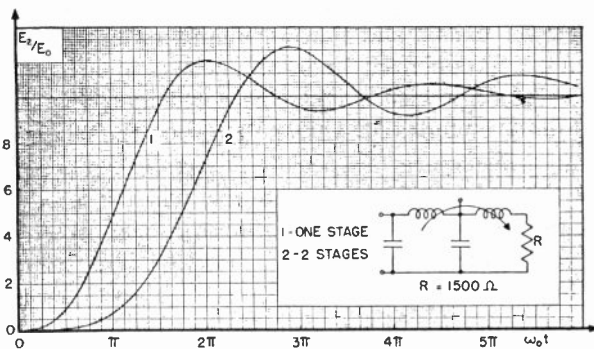

Fig. 35—Deterioration of transient response in a cascade of unsuitable stages.

sponses of two stages in cascade, each of which has the transient response of Fig. 14, curves 2 and 3, respectively.

7. Total Gain of Amplifier Cascades

Figs. 18, 19, 22, and 23 to 29 show that every time the number of these amplifier stages is doubled, the transition time T_r increases by a factor which varies slightly for different types of filters. But whenever there is no

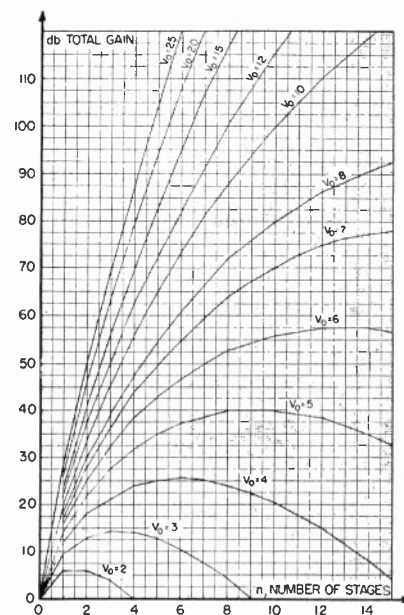

Fig. 36—Gain of amplifier cascades designed for equal over-all transition time, as a function of the number of stages.

indicates the total number of stages, the vertical axis the total gain in decibels. Various series of values are plotted, each for a different single-stage gain V_0 . Only the left-hand bottom corner of the diagram is shown. At $n = V_0^2$ each curve will have dropped to 0 decibels gain. For a $V_0 = 5$, this would happen at 25 stages, the gain, however, reaching its peak of 40 decibels at 8 stages. Higher gain cannot be obtained with stages of this quality; sacrifice of bandwidth would be necessary. Fig. 37 shows the same diagram in a more familiar arrangement. Total gain is plotted versus gain of a single stage, both in decibels. Straight lines are drawn for amplifiers of one to ten stages, with the slope n for n stages. The

interest of this diagram is centered in the position of the foot point of these straight lines. Its position depends on the number c of circuits used. It is, of course, at the

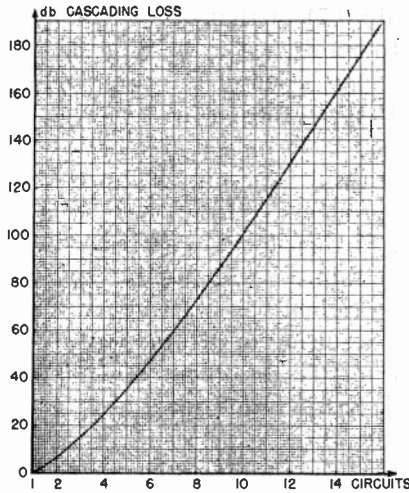

Fig. 37—Cascading loss in amplifiers.

origin for one single stage, moves downwards 6 decibels according to the factor 2 for two stages, as explained above, and so down in increasing steps. Its position on the vertical decibel scale represents the cascading loss U for c circuits, equation (45). It is plotted again in Fig. 37.

$$\text{Cascading loss } U = -10c \cdot \log_{10} c \quad (45)$$

To avoid the limitations indicated by Fig. 36, it is possible to use less circuits than tubes. An important example is a carrier-frequency amplifier with staggered resonant circuits. Each pair of such circuits corresponds in its response to a single band pass, i.e., to a single low-pass-filter section of the series-peaking type, so that the number c of circuits now differs from the number n of stages, e.g., $c = n/2$. In such cases the equation for the total gain assumes the more general form

$$V_{\text{total}}/V^n = c^{-n/2}; \quad \text{for } s = \sqrt{2}; \quad (46)$$

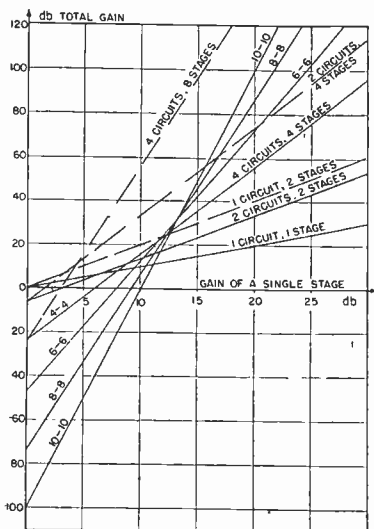

Fig. 38—Total gain of amplifier cascades designed for equal over-all transition time as a function of the gain per stage.

as exemplified by two cases plotted as broken lines in Fig. 38. It can be shown that for all cascades with tolerable overshoot, the advantage of a higher starting point for the broken line in Fig. 38 much more than recovers the loss in gain expected from comparison of a single pair of staggered tuners with two band-pass-coupled stages.

Another important example of this saving of circuits is the introduction of the cathode follower (impedance transformer tube). The deterioration of a transient in a cathode follower can be shown to be negligible at least in the positive direction. The value of the cathode follower, and of any similar load of negligible or negative input capacitance, consists in allowing an increased impedance in the circuits preceding it. If the total capacitance of that circuit is halved, the gain of the preceding amplifier can be doubled. In cascades of low-gain stages, this method is superior to adding another amplifier stage and incurring an increase in cascading loss, e.g., 15 decibels for the 11th stage.

III. IDEAL TRANSITIONS

1. Transitions of Uniform Stretch

The accuracy with which many transition curves preserve their general form when repeated, the only major modification being a factor of stretch in the time axis which was fairly common to all, led us to visualize the existence of a family of curves which would preserve their forms identically on repetition and which might have different stretch moduli.

These curves, if existing, would show an infinite tail in both directions, but this difference from practical cases since proved to be negligible.

These equations would probably not have been found without the mathematical ingenuity of C. P. Singer. He has proved analytically that such a family of transition curves exists, and that all members may be represented by exponential operators whose logarithms are all powers of p with a negative coefficient, $Z(p) = e^{-p^n}$. The family includes all values of n , but the cases when n is an integer are of special importance. These have to be treated by separate methods, when n is odd and even, but all have the common feature that the stretch modulus s is the n th root of 2; $s = (2)^{1/n}$. The value of s is 2 for $n=1$; 1.41 for $n=2$; 1.26 for $n=3$; and approaches unity for higher values of n .

The case where n is unity reduces to the distortionless network, such as a lossless cable, with constant amplitude and constant time delay at all frequencies. The transition is infinitely steep and the only meaning of $s=2$ is that the time delays of successive circuits are additive.

The second-order case reduces by chance to an expression embodying the probability integral ERF, equation (47). The shape of the transient is plotted in Fig. 39

$$\begin{aligned} E_2/E_1 &= 0.5 + 1/\sqrt{\pi} \int_0^{\omega_0 t/2} e^{-x^2} dx \\ &= 0.5 + 0.5 \text{ERF}(\omega_0 t/2) \quad s = \sqrt{2} \quad (47) \end{aligned}$$

together with a verification of the stretch modulus $s=1.41$. A sinusoidal transition plotted for comparison shows that the difference is negligible, except very close to 0 and 1, where the error is unimportant. Moreover, the amplitude response of this transition, which is plotted as curve 2 in Fig. 40, is not very different from

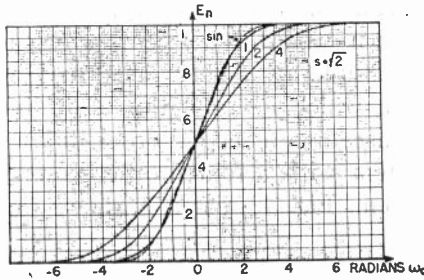

Fig. 39—Uniform-stretch transition, second order.

that of the sinusoidal transition, Fig. 21, curve 2, as regards content of higher harmonics. The second-order case is, furthermore, not very unlike a repeated straight rise, Fig. 18, and is quite generally representative of transitions with zero or negligible overshoot and approximately symmetrical shape (e.g., Figs. 23 and 27). This gives the mathematical verification that all filters giving this shape of transition can be expected to have a stretch modulus of approximately 1.41.

No further cases, with the exception of the infinite, reduce to known integrals. In general, the cases of odd integers represent filters whose amplitude response is unity to infinity, but whose phase twists steadily, reach-

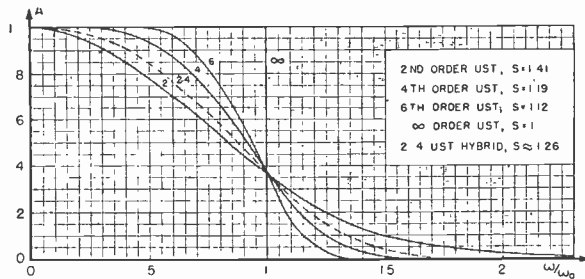

Fig. 40—Amplitude responses, corresponding to even orders of uniform-stretch transitions.

ing 90 degrees in the region of the nominal cutoff frequency. Their general equation is (48). The particular

$$E_2/E_1 = 0.5 + 1/\pi \int_0^\infty (1/y) \sin(\omega_0 t y - y^n) dy$$

$$s = \sqrt[n]{2}; \quad n = \text{odd integer} \quad (48)$$

$$E_2/E_1 = 0.5 + 1/\pi \int_0^\infty (1/y) \sin(\omega_0 t y - y^3) dy$$

$$s = \sqrt[3]{2} = 1.26 \quad (49)$$

case of $n=3$, equation (49) is plotted by numerical integration process in Fig. 41. In general, the odd cases are unsymmetrical transitions; they have considerable and maintained transient oscillations, which gradually diminish from 25 per cent overshoot for $n=3$ to 9 per cent in the infinite case. For $n=3$ the stretch modulus s

decreases to 1.26, a tendency which was observed in curves of similar shape (Figs. 24 and 25). However, its otherwise unsuitable shape is a typical result of

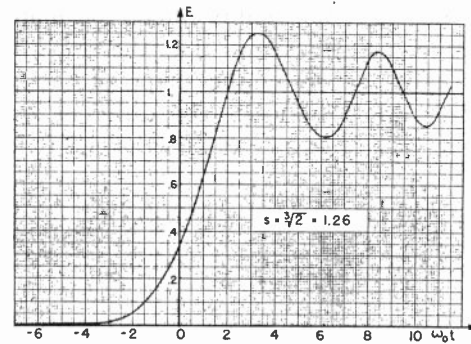

Fig. 41—Uniform-stretch transition, third order.

making the amplitude response very flat without regard for the phase response. Fig. 35 showed a remarkable success of this procedure and therefore closely resembled the curve of Fig. 41.

The general equation for the even cases is given as

$$E_2/E_1 = 0.5 + 1/\pi \int_0^\infty (e^{-y^n}/y) \sin(\gamma \omega_0 t) dy$$

$$s = \sqrt[n]{2}; \quad n = \text{even integer} \quad (50)$$

(50). All these cases represent filters with identically constant time delay and an amplitude response which, with higher orders, falls off more and more steeply at the cutoff frequency, Fig. 40.

There was no overshoot in the case of the second order, Fig. 39, but all others have a slight overshoot, which rises from 5 per cent for $n=4$, to 7 per cent for $n=6$, and to 9 per cent for the infinite case. The overshwing is followed by 0.5 per cent underswing for $n=4$, 1.5 per cent for $n=6$, rising to 4 per cent in the infinite case. The cases $n=4; 6; \infty$ are plotted in Fig. 42, equations (51), (52), and (53).

$$E_2/E_1 = 0.5 + 1/\pi \int_0^\infty (e^{-y^4}/y) \sin(\gamma \omega_0 t) dy$$

$$s = \sqrt[4]{2} = 1.19 \quad (51)$$

$$E_2/E_1 = 0.5 + 1/\pi \int_0^\infty (e^{-y^6}/y) \sin(\gamma \omega_0 t) dy;$$

$$s = \sqrt[6]{2} = 1.12 \quad (52)$$

$$E_2/E_1 = 0.5 + 1/\pi \int_0^{\omega_0 t} (\sin x/x) dx$$

$$= 0.5 + (1/\pi) \text{Si}(\omega_0 t); \quad s = 1 \quad (53)$$

All even cases are strictly symmetrical, an initial recoil of the transition corresponding to the overshoot. Such recoil is not observed on the more familiar filters but actually appears as soon as their phase response is improved. The amount of the recoil and overshoot is the same for any number of repetitions of such filters and is in all practical cases small enough, and decays so quickly, that it is easily compensated by a single filter $n=2$ (or the corresponding electronic focus of television cameras or cathode-ray tubes). The recoil is preceded,

and the overshoot is followed, by a very weak oscillation stretching to infinity. Its energy content is, however, so small that even consistent disregard of this oscillation does not noticeably affect the main part of the transition. Fig. 42 shows that the slope, the overshoot, and quite generally the shape of the transition do not alter much between the different even-order cases. There is, however, another reason left for trying

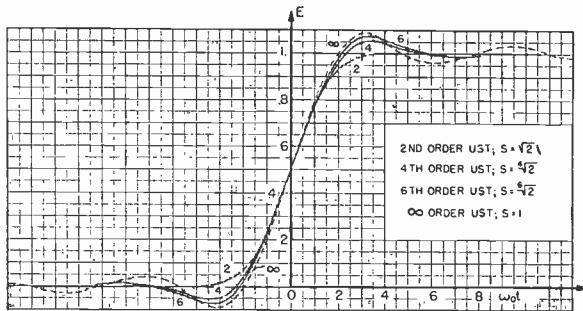

Fig. 42—Uniform-stretch transitions, fourth, sixth, and ∞ orders.

to improve the sharpness of cutoff of the amplitude response, Fig. 40, equation (54). The case $n=4$ has a

$$A = e^{-(\omega/\omega_0)^r} \tag{54}$$

stretch modulus $s=1.19$; the case $n=6$, a stretch modulus $s=1.12$; and the value of s keeps decreasing for higher orders in smaller and smaller steps down to $s=1$ for the infinite case.

The even cases clearly offer a much more attractive transient response than the odd cases. This emphasizes the necessity of treating the relative time delay as being of major importance in comparison with the amplitude response. Neither the odd nor the even cases can, of course, be exactly realized in practice, but a practical filter can be associated with the odd or the even family by determining whether the phase or the amplitude decays earlier.

The odd and the even families coalesce in the infinite case, which represents the ideal filter which is perfect over a stated band and deteriorates completely outside it. In such a filter the stretch modulus is unity, but since it requires the absence, or correction, of an infinite number of terms in the expansion of the operator, it is too far from practicability to be considered. However, insofar as filters can be made to approximate higher orders r the expression of (45) for the total gain of amplifier cascades may be modified to the general equations (55) and (55a) and a similar adjustment may be made to (46).

$$V_{\text{total}}/V_0^n = e^{-n/r}; \tag{55}$$

$$s = \sqrt[n]{2} \tag{55a}$$

Other transitions are represented by cases where n is not an integer, which cases would be even more awkward to calculate than the present ones. Their value n will be the higher, the sharper the cutoff of their amplitude response, and accordingly their stretch modulus will decrease.

2. Combinations of Uniform-Stretch Transitions

None of the uniform-stretch transitions described above has quite that shape which is most desirable for television, as straight a rise with as sharp corners as can be obtained with negligible overshoot. What overshoot is tolerable depends in television on what can be seen. The largest negligible contrast may, for practical purposes, be taken as about 2 per cent, which is thus the limit of permissible overshoot plus undershoot. An ideal transition which keeps within that limit can be produced by cascading a second order uniform-stretch-transition system with a fourth order uniform-stretch-transition system. Fig. 43, curve 3, shows the resulting

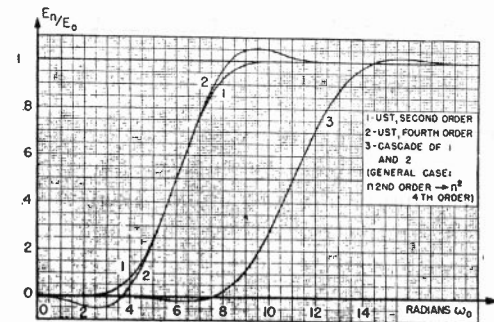

Fig. 43—Second- and fourth-order uniform-stretch transitions cascaded.

transition, which is symmetrical, reasonably straight, and has less than 2 per cent recoil and overshoot without further oscillation. This shape results whenever n stages second-order uniform-stretch transition are cascaded with n^2 stages of fourth-order uniform-stretch transition. Its amplitude response is between those of the parent curves, the broken curve 2-4 in Fig. 40, equation (56). It is not, with mathematical exactness,

$$A = e^{-0.5[(\omega/\omega_0)^2 + (\omega/\omega_0)^4]} \tag{56}$$

itself a transition of uniform stretch because its stretch modulus is not an exact constant. But the change of its shape in repetition is almost imperceptible and the stretch modulus thus found is with very good approximation $s=1.26$.

3. Relations Between the Shape of Transients and Amplitude and Time Response

The three main features of a transition are steepness, overshoot with transient oscillations, and symmetry. All those are closely linked to the amplitude and time response of the system. By defining the transient response of the system its amplitude and phase response are unambiguously defined, and vice versa. Thus, detailed knowledge of these relations will make it possible to shape the one to meet any requirement merely by manipulating the other.⁵

The amplitude and phase response corresponding to a certain transient response are found by Fourier analysis, based on the fact that any periodical function may be

⁵ Heinz E. Kallmann, "Transversal filters," Proc. I.R.E., vol. 28, pp. 302-310; July, 1940.

re-expressed as the sum of the sine waves, the lowest of which is of the same frequency as the analyzed function, and all other sine waves harmonics of the first. The analysis of a single transient is the limiting case of the Fourier analysis for extremely low or disappearing periodicity of the unknown function.

3a. *Effect of Phase Distortion*

The maximum steepness of a transition is obtained if and when all contributing sine waves reach their steepest rise simultaneously; that is, in the case of symmetrical transitions, in the center. The maximum steepness of sine waves of equal amplitude is proportional to their frequency. But the amplitude of the harmonics constituting the steepest finite transition, the unit step, is inversely proportional to frequency so that the resulting contribution to the steepness is the same for each harmonic. Any low-pass filter will still further reduce the amplitudes of the higher harmonics according to its amplitude response, and so reduce the maximum steepness of the transition. As the harmonics are evenly, i.e., with constant frequency separation, spread over the whole spectrum, it follows that the maximum steepness of a symmetrical transition is exactly proportional to the width of the contributing frequency band.

In a symmetrical transient, including the unit step itself, the point of inflexion of all component sine waves coincides with the middle of the transition, and no change of their relative amplitudes, due to pure amplitude distortion, can spoil this symmetry. Assymetry around the value 0.5 in a transient is always indicative of phase distortion. In fact, the degree of assymetry of the resulting transient is the easiest as well as the final criterion of whether the phase distortion in a certain television system is tolerable or excessive. Generally the higher contributing harmonics are delayed, which fact shows up as rounding at the beginning of the transition and corresponding overshoot at the end, perhaps followed by transient oscillations. Both these faults tend to grow worse in repetition, in accordance with the larger total phase distortion.

Whichever harmonic is missing, delayed or advanced, will contribute correspondingly less to the steepness in the center of the transition. The amount by which each harmonic fails to contribute is proportional to phase rather than time and for a given time delay is therefore greater for the higher harmonics.

Thus the phase-true transitions are to be sought as being the steepest for any given amplitude response. Small phase distortion, however, may not cause an appreciable increase in the transition time T , so soon as it shows up as rounding of the beginning and visible overshoot at the end of the transition. Attempts to suppress the latter, in a black-to-white transition, by reduced-contrast sensitivity in the white are of little use because they fail to cover the transient oscillations in the black, in a white-to-black transition.

Another misconception often met with is that a sim-

ple, e.g., resistance-capacitance-coupled, circuit will always be available to provide the necessary top cut to attenuate the frequency of the transient oscillations, and thereby to suppress them. Obviously, this means a waste of effort to secure high gain at these frequencies first and then to suppress them. This procedure compares with phase correction at these frequencies as does amputation of a broken limb with healing it by proper setting of the bones. "Top cutting" must necessarily deteriorate the steepness of the transition. Phase correction, on the other hand, saves as far as possible all the harmonics which contribute to the steepness of the transition by correction of their time delay.

3b. *Choice of Amplitude Response*

In no other way than stated above does phase distortion contribute to the shape of transition. Therefore, if phase correction of a system is assumed, the phase response may be taken as flat and only the correlation between the transient response on the one side and amplitude response on the other remain to be considered. That for similar shapes, the steepness of the one is proportional to the width of the other has already been stated. To state this more precisely, the maximum steepness of the transition is proportional to the integral of (i.e., the area under) the amplitude response. To obtain the steepest possible transient with the narrowest possible bandwidth is the main problem of every television amplifier, but only compromise solutions are possible.

The straight transitions, Fig. 18, curve 1, or perhaps the sinusoidal transition, Fig. 22, curve 1, are, of course, the most attractive. The amplitude response of these was shown in Fig. 21. Both are oscillatory, with ranges of negative (phase-reversed) gain. This feature, although it could be produced if necessary, does not correspond to practical electrical filters, the amplitude response of which generally drops steadily and asymptotically to zero.

If these oscillatory amplitude responses are excluded, the choice of symmetrical transitions reverts to the even order of the family of uniform-stretch transitions, the amplitude responses of which were shown in Fig. 40. In fact, this family of curves and their combinations has been found to be the best representatives of symmetrical transitions with monotonously dropping amplitude response, leaving no substantially different choice.

In this family the bandwidth economy rises with higher orders, being greatest in the case of the ∞ order, whose transition is shown as the dotted curve (∞) in Fig. 42, and whose rectangular amplitude response in Fig. 40, represents a low-pass filter with infinitely sharp cutoff. That, in this case, there are considerable transient oscillations at the cutoff frequency is quite plausible. The Fourier series of harmonics to represent a square-topped oscillation extends, dropping slowly, to infinity. If it is broken off at a certain frequency, the response will be deficient of all higher oscillations. Of these the next highest harmonic is the most prominent.

This would be required to "fill in" the bulk of transient oscillations, and the next higher some of the remaining oscillations, and so on.

From this consideration it is plausible that any sharp cutoff of the amplitude response must always be associated with transient oscillations at the cutoff frequency. To avoid these the cutoff must be gradual, and the extent of this requirement can immediately be found by comparing the two sets of curves in Figs. 42 and 40. The fourth-order uniform-stretch transition already exhibits an overshoot of more than 5 per cent, and it seems that only the second-order uniform-stretch transition and, especially, the hybrid of second- and fourth-order, Fig. 43, remain as representatives of desirable transient shapes in television.

3c. Effect of the Amplitude Response on the Stretch Modulus

Another factor, however, assumes importance in cases where, unlike television, the overshoot is of little importance, it being suppressed by limiting, as in telegraphy. The factor is the stretch modulus s , which has been shown to have considerable influence on the gain or useful bandwidth of long cascades. It has been shown that the stretch modulus decreases with higher order of the uniform-stretch-transition family, from 1.41 for the second order to unity for the infinitely sharp-cutting low-pass filter, equation (55a). From this equation it follows that the slope $dA/d\omega$ at the nominal cutoff frequency ω_0 of the amplitude response curve is directly proportional to r ; $dA/d\omega = -r/e$ for $\omega = \omega_0$. Consequently, a sharp cutoff of the amplitude response must be sought whenever a small value of stretch modulus is desired.

Now it can be shown for the cutoff of electrical-filter networks that the final slope (a straight line in logarithmic scale) is always proportional to the number of such reactances as are effective at the highest frequencies. This final slope, however, is reached only at such considerable attenuation (about 10 decibels per reactance) that it has very little influence on the shape of the transient response. This shape is determined rather by the sharpness of cutoff between full gain and an attenuation of 10 to 20 decibels, which range is most affected

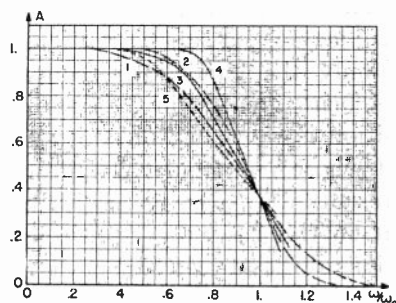

Fig. 44—Comparison of amplitude responses of ideal and electrical filters. Curve 1. Fourth order uniform-stretch transition. Curve 2. Sixth order uniform-stretch transition. Curve 3. Butterworth filter, $n=4$. Curve 4. Butterworth filter, $n=7$. Curve 5. Shunt-peaking circuit $Q=1$ and resistance-capacitance coupling $\alpha=1.5$.

by the design of the filter. Fig. 44 shows the amplitude response of some low-pass filters in comparison with those of uniform-stretch-transition curves repeated from Fig. 40. Curves 1 and 2 show the amplitude response of fourth- and sixth-order uniform-stretch transitions, respectively, the former having a stretch modulus of $s=1.19$; the latter of $s=1.12$. Curve 5 shows a slightly inferior combination of a single shunt-peaking filter and a resistance-capacitance-coupled stage (Fig. 49),

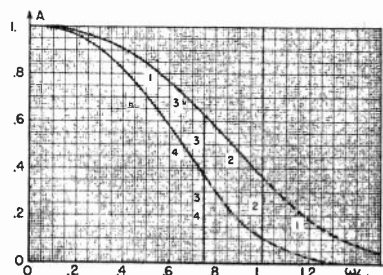

Fig. 45—Amplitude responses restricted by the width of a channel.

curves 3 and 4, shows the response of the Butterworth filters $n=4$, and $n=7$, which are already comparable or superior in steepness. As these filters require only 4 and 7 reactances respectively, it can be seen that not many reactances are required in a system for a very useful reduction in its stretch modulus.

Two assumptions are made when thus computing the stretch modulus from the sharpness of cutoff: (1) that the shape of the response curve of electrical filters is similar to that of the ideal transitions (which appears justifiable for the curves shown) and (2) (which is of greater importance) that there is no phase distortion throughout the amplified band.

Inasmuch as this condition is rarely fulfilled, the whole computation is reduced to a rather rough and always optimistic estimate of the stretch modulus. This will be exemplified by Figs. 47. to 52, where the actual stretch modulus, found from the transition curves in Figs. 48, 49, and 52, is 1.26 to 1.40, whereas the computation from the amplitude response shown in Figs. 46, 49 and 51, leads to the optimistic values 1.18 to 1.25. Cleaner conditions, however, lead to closer correspondence, see Figs. 56 and 57.

4. The Over-all Response of a Television Channel

The width of a video channel is limited by the television standards. This gives rise to the problem of finding the most suitably shaped transition that can be transmitted through a given channel. Since it is obvious from the preceding sections that the over-all time-delay distortion should be kept small, the problem reduces to the choice of the most suitable over-all amplitude response.

Restricting the choice to monotonously dropping amplitude responses leads to the family of even-order transitions of uniform stretch as representative for symmetrical transitions. The second- and fourth-order hybrid has been found best in bandwidth economy,

without excessive overshoot. It remains, then, to be determined where its amplitude response has fallen far enough to be broken off without serious harm to the transient response.

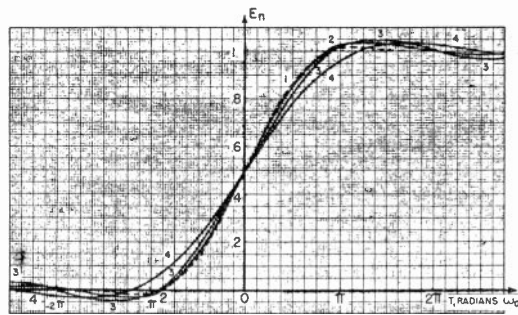

Fig. 46—Distortion of transient response due to restricted width of a channel.

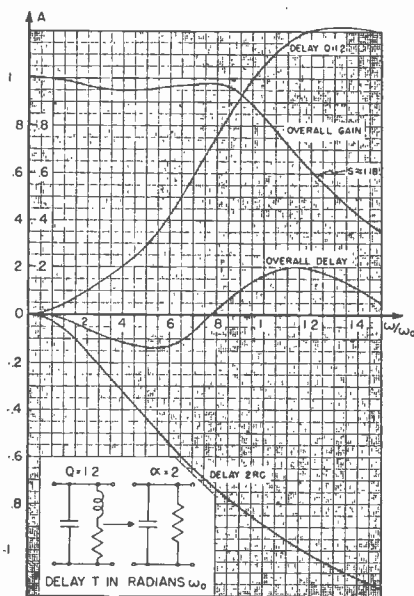

Fig. 47—Amplitude and time-delay response of a cascade of shunt-peaking coil circuit $Q=1.2$ and resistance-capacitance circuit $\alpha=2$.

The amplitude response of the second- and fourth-order uniform-stretch transition is shown again as curve 1 in Fig. 45, the transient response as the broken curve 1 in Fig. 46. It may be decided to suppress all frequencies above ω_0 , that is, to break off the amplitude response where it has dropped to 0.37 as shown by curve 2 in Fig. 45, equation (57). The corresponding experiment

$$A = e^{-0.5[(\omega/\omega_0)^2 + (\omega/\omega_0)^4 + (\omega/\omega_0)^6]} \quad (57)$$

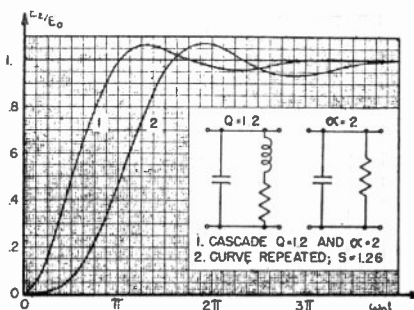

Fig. 48—Transient response of a cascade of shunt-peaking coil circuit $Q=1.2$ and resistance-capacitance circuit $\alpha=2$ to a unit step of current.

with transients is to cascade the second- and fourth-order uniform-stretch transition with an ∞ order uniform-stretch transition whose amplitude response cuts off sharply at ω_0 . The result is shown in Fig. 46 as curve 2. This has 3.5 per cent overshoot followed by 1 per cent underswing, and the transition time T_r has increased by 5 per cent. If this is considered tolerable, further trimming may be done by suppressing all frequencies

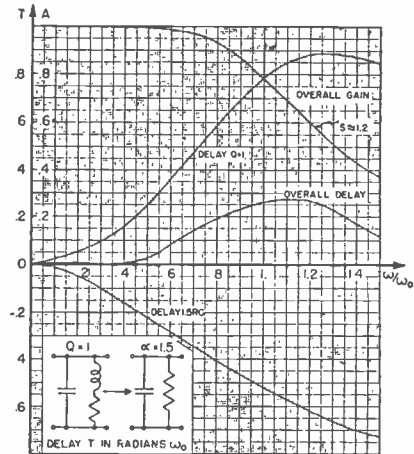

Fig. 49—Amplitude and time-delay response of a cascade of shunt-peaking coil circuit $Q=1.0$ and resistance-capacitance circuit $\alpha=1.5$.

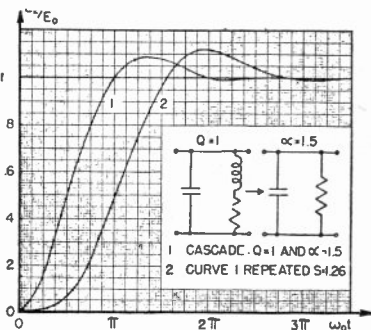

Fig. 50—Transient response of a cascade of shunt-peaking coil circuit $Q=1.0$ and resistance-capacitance circuit $\alpha=1.5$ to a unit step of current.

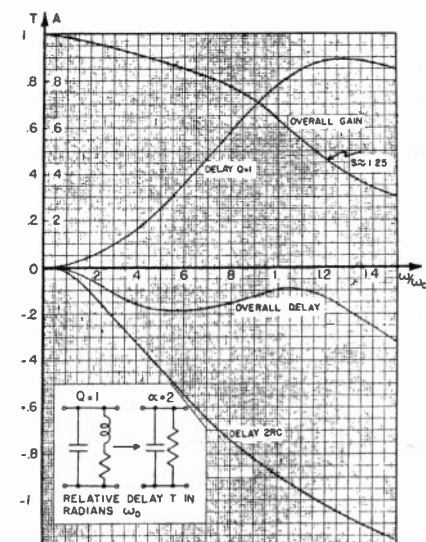

Fig. 51—Amplitude and time-delay response of a cascade of shunt-peaking coil circuit $Q=1.0$ and resistance-capacitance circuit $\alpha=2$.

above $0.75 \omega_0$, curve 3 in Fig. 45. The result is shown as curve 3 in Fig. 46. The overshoot has risen to about 5 per cent, followed by 3 per cent underswing, and the transition time T_r has increased about 17 per cent over that of curve 2. Thus, at the price of increasing the peak-to-peak amplitude of the first transient oscillation from 4.5 to 8 per cent the transition time has deteriorated 17 per cent for a reduction of 25 per cent in the required bandwidth, that is, an increase of 12 per cent in bandwidth economy. For comparison, curves 4 in Figs. 45 and 46 show the result of shrinking the bandwidth of curve 2 to $3/4$ and stretching the transition $4/3$. The smaller overshoot requires earlier and rounder turning of the transition near the corners, the difference between curves 3 and 4 in Fig. 46 residing in the difference between curves 3 and 4 of Fig. 45.

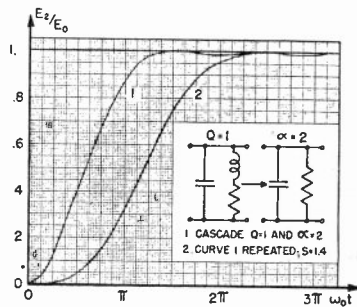

Fig. 52—Transient response of a cascade of shunt-peaking coil circuit $Q=1.0$ and resistance-capacitance circuit $\alpha=2$ to a unit step of current.

It may thus be concluded that, whenever overshoot is an important factor, the over-all amplitude response of a channel should follow approximately the shape of curve 2 or 4 in Fig. 45, cut at the frequency where it has dropped to 0.37. It may be noted that the amplitude response has dropped to 0.83 at one half that frequency.

What part of the drop in amplitude response is contributed by the transmitter and what by the receiver is a matter of agreement. It seems most reasonable, in order to make the receiver less costly and to improve the signal-to-noise ratio, that the amplitude response of the transmitter should be flat, and that of the receiver drop.

5. Transient Response of a Moving Electron Beam

In this connection it should be emphasized that the over-all response of a television system comprises not only the electrical filter, but all other frequency limitations as well, e.g., the finite thickness of a scanning spot in a cathode-ray tube. Fortunately, it is very easy to represent its effect, apart from the nonlinearity of the tube characteristics, in terms of transient or amplitude response.

It can be assumed⁶ that (1) each electron may contribute equally to the final brightness of the picture;

⁶ H. A. Wheeler and A. V. Loughren, "The fine structure of television images," Proc. I.R.E., vol. 26, pp. 540-575; May, 1938, have meanwhile published conclusions based on slightly different assumptions and leading to a value of $s=1.33$ of the transient response of the assumed shape of scanning spot.

(2) the brightness at the center of a scanning line is representative of the whole line thickness; and (3) the current density i , measured in a cross section through the center of the beam follows the bell shape of the probability curve $i=e^{-x^2}$. If a beam of this current distribution is moved over a certain point of the screen, each part of the curve will, in due course, contribute proportionally to its height at each point. At first there

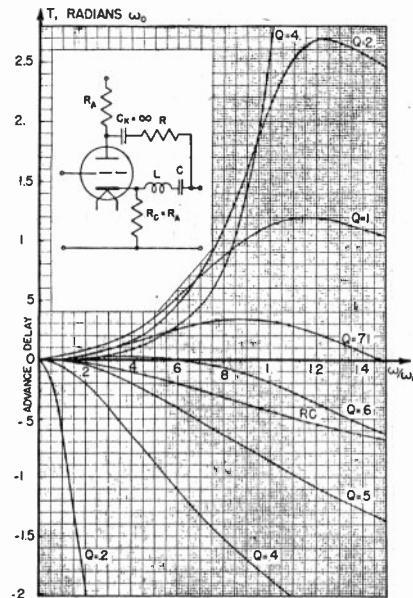

Fig. 53—Time-delay response of phase-corrector stage.

is what little effect is available from the advanced tail end, then the contributions rise with increasing rapidity until the top of the bell shape passes over; then follow decreasing contributions and tailing out symmetrical to that in the beginning. In short, the transient response of such a spot is the integral of the probability curve. This integral is the familiar ERF function, identical with the second-order uniform-stretch transition which has already been dealt with in Fig. 39. That means that the contribution of the size of the spot to the suppression of high frequencies is the same as that of a phase-true filter with the amplitude-response curve 2, as shown in Fig. 40. Only the units must be determined. A spot, the intensity of which has fallen to 0.5 at two points 3.3 radians ω_0 , e.g., 0.13

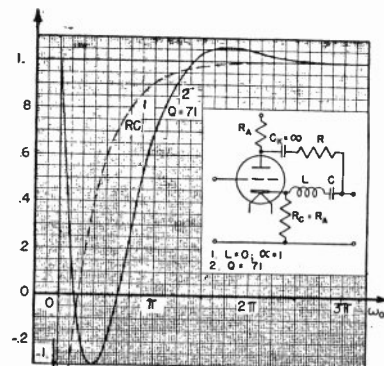

Fig. 54—Transient response of phase-corrector stage to a unit step.

microsecond apart, corresponds to a low-pass filter, curve 2 of Fig. 40, the response of which has dropped to $1/e=37$ per cent at ω_0 , e.g., 4 megacycles; the corresponding ERF (error function) transition in Fig. 39 then has a transition time from 0.10 to 0.90 of 0.144 microsecond. Thus the contribution of the size of the spot to the over-all response is generally quite considerable.

IV. SYNTHESIS OF PHASE-CORRECTED MULTISTAGE AMPLIFIERS

In the preceding section, statements have been made concerning possible and desirable shapes of transients. All of these conclusions were based on ideal transient shapes, with little regard for technical possibilities.

In this section are studied the possibilities of building electrical networks according to these recommendations, showing the allowable latitude in so doing. Principally, there are two ways of approaching the uniform-stretch transitions of the even orders in amplifier design. The one involves the use of phase-correcting networks to correct the coefficients of all terms in the expansion of the operator below that of the chosen order, and preferably of at least the next odd term beyond.

Alternatively, as phase correction is only necessary within the range of noticeable amplitude response, it appears promising to straighten the phase response of an amplifier by means of a few phase correctors until the whole transmitted frequency band has an approximately constant time delay. Both lines of approach will be demonstrated in this section, beginning with attempts to shape the transient response of simple filter combinations by suitably choosing their amplitude and phase response.

1. Combination of Shunt-Peaking Circuit and Resistance-Capacitance Coupling

If special phase-corrector circuits are to be avoided, the resistance-capacitance coupling is the simplest means to advance the higher frequencies, which, in the region near ω_0 , are generally retarded by other filters. The possibilities of such combinations were explored by cascading one resistance-capacitance-coupled stage with a shunt-peaking circuit, equation (58). The amplitude response of shunt-peaking circuits has been shown in

$$\frac{E_2}{E_0} = 1 + \frac{\alpha(\alpha - Q)}{1 + \alpha^2 - \alpha/Q} e^{-\omega_0 t/\alpha} + \frac{2Q^2}{\sqrt{4Q^2 - 1} \sqrt{1 + \alpha^2 - \alpha/Q}} e^{-\omega_0 t/2Q} \cdot \cos(\sqrt{1 - (1/4Q^2)} \omega_0 t + \phi) \quad (58)$$

$$\phi = \tan^{-1} \frac{2Q^2 - 1}{\sqrt{4Q^2 - 1}} - \tan^{-1} \frac{\alpha \sqrt{4Q^2 - 1}}{2Q - \alpha}$$

Fig. 6 and the corresponding time-delay response in Fig. 7. The resistance-capacitance coupling is described by the index α in terms of the nominal cutoff frequency ω_0 , whereby the value $\alpha=1$ indicates a resistance-

capacitance coupling with the time constant $T=RC=1$ radian of ω_0 ; larger values of α will indicate proportionally larger time constants; $\alpha=2$ means a resistance-capacitance coupling with a time constant of 2 radians of ω_0 .

For the first attempt a circuit $Q=1.2$ and a resistance-capacitance circuit $\alpha=2$ were cascaded. The over-all gain curve in Fig. 47 shows a substantially flat response up to about $0.9 \omega_0$. The time-response curves of the two stages have been plotted separately, that of $Q=1.2$ increasingly delaying the higher frequencies, that of 2 RC increasingly advancing them. The over-all time response (relative to the constant time delay T_0 of the zero frequency) varies between -0.14 and $+0.20$ radians ω_0 , a total of 20 degrees of the cutoff frequency ω_0 . The corresponding transient, as shown in Fig. 48, equa-

$$E_2/E_0 = 1 + 0.48e^{-0.5\omega_0 t} + 0.72e^{-0.417\omega_0 t} \cdot \cos(0.91\omega_0 t - 44^\circ) \quad (59)$$

tion (59), has an overshoot of 7 per cent with a slight tendency to rise and to grow longer in repetition.

Another combination is shown in Fig. 49, using a circuit $Q=1$, and a resistance-capacitance circuit with $\alpha=1.5$. The amplitude response is smooth but drops earlier. The time response is wholly on the side of delay and has a peak of $+0.28$ radian ω_0 . The corresponding transient response is shown in Fig. 50, equation (60),

$$E_2/E_0 = 1 + 0.43e^{-0.67\omega_0 t} + 0.87e^{-0.5\omega_0 t} \cdot \cos(0.865\omega_0 t - 49^\circ) \quad (60)$$

and has an overshoot of 9 per cent which grows to 12 per cent after one repetition.

A third combination is shown in Fig. 51, using the same $Q=1$ and a resistance-capacitance circuit with an $\alpha=2$. The amplitude response drop steadily, being only 0.63 at the cutoff frequency ω_0 . The over-all time response, however, varies only slightly. The transient response is shown in Fig. 52, equation (61). It is nearly

$$E_2/E_1 = 1 + 0.667e^{-0.5\omega_0 t} + 0.667e^{-0.5\omega_0 t} \cdot \cos(0.865\omega_0 t - 60^\circ) \quad (61)$$

symmetrical, has no overshoot, and a small and not growing undershoot of 1 per cent. It is the nearest simple approximation to the second-order uniform-stretch transition so far discovered.

None of these three combinations is notably advantageous with regard to accommodated capacitances, resulting gain, or transition time, if compared with a cascade of two equal shunt-peaking filters, Figs. 23 and 24. Neither have they much disadvantage, if for other reasons their use is desirable. It is worth noting, however, that the flat time response of Fig. 51 rather than the flat amplitude response Fig. 47 results in a well-shaped transient. Time deviations of approximately ± 10 degrees of the cutoff frequency are apparently sufficient to cause the asymmetry of the transition curve in Fig. 48. The choice of a resistance-capacitance circuit for "top correction" is thus rather more critical

$$\frac{E_2}{E_1} = 1 - \frac{\sqrt{1 - 4pq + 4q^2}}{8pq(p - q)\sqrt{1 - p^2}} e^{-p\omega_0 t} \cdot \cos(\sqrt{1 - p^2}\omega_0 t + \phi_1) - \frac{\sqrt{1 - 4pq + 4q^2}}{8pq(q - p)\sqrt{1 - q^2}} e^{-q\omega_0 t} \cdot \cos(\sqrt{1 - q^2}\omega_0 t + \phi_2) \tag{62}$$

$$\phi_1 = \sin^{-1}(1 - 2p^2) + \tan^{-1}(\sqrt{1 - p^2}/p) + \tan^{-1}[\sqrt{1 - p^2}/(2q - p)]$$

$$\phi_2 = \sin^{-1}(1 - 2q^2) + \tan^{-1}(\sqrt{1 - q^2}/q) + \tan^{-1}[\sqrt{1 - q^2}/(2p - q)]$$

$$= 1/2Q_1 \qquad q = 1/2Q_2$$

than a mere "top cut." For experiments in cascading stages with two different shunt-peaking coils, equation (62) may be helpful.

2. Phase-Corrector Circuits

The possibilities of correcting the time response of filters by the introduction of resistance-capacitance-coupled stages are limited. More elaborate filter systems can be built if special phase-corrector circuits are introduced, which improve the time response without any influence on the amplitude response. The tube circuit of Fig. 53 fulfills this condition. It comprises a grid-

$$T = 2\omega_0/\omega \cdot \tan^{-1} \frac{\omega/\omega_0}{Q[1 - (\omega/\omega_0)^2]} - 2/Q \tag{64}$$

curves may be selected, stretched if needed by different choice of the nominal cutoff frequency, and a very close compensation may be expected by this means for any reasonably steady time response of a given filter. Typical transient responses of such phase correctors are shown in Fig. 54, the dotted curve 1, equation (65),

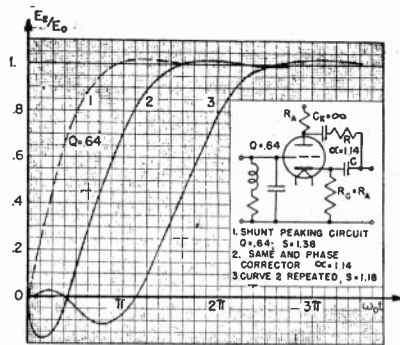

Fig. 55—Transient response of shunt-peaking coil circuit $Q=0.64$ with one phase correction to a unit step of current.

controlled tube, with a load resistance R_C in the cathode and an equal load resistance R_A in the anode, so that equal and opposite signals appear on cathode and anode. Both signals are fed to the output, the one via the resistance R (and the large insulating capacitor C_k), the other via the capacitor C and the inductance L , which are assumed to have a series resistance which is negligible compared with R . The circuit is better known without the inductance L and then produces a constant output amplitude for all frequencies with a steadily increasing advance of the higher frequencies, according to the nearly straight curve RC in Fig. 53, equation (63). Introduction of the inductance L does not affect

$$T = - (2/\omega CR) \cdot \tan^{-1}(\omega CR) + 2 \tag{63}$$

the flat amplitude response, but allows for more varied curvature of the time response,⁷ as shown in Fig. 53, equation (64). One or several of these time-response

⁷ The curves of Fig. 53 apply identically to the bridged- T phase-correcting network. For a discussion of this, see A. T. Starr, "Electrical Circuits and Wave Filters," second edition, J. Pitman and Sons, London, England, 1940, pp. 197-198.

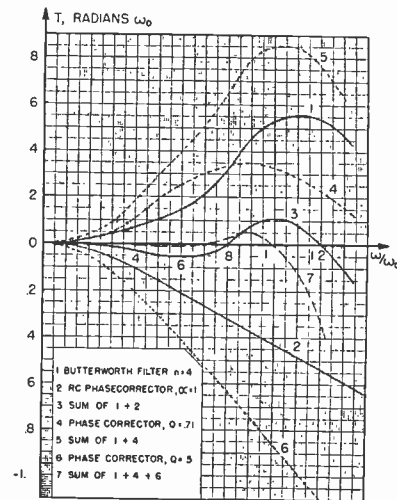

Fig. 56—Time-delay response of Butterworth filter $n=4$ with phase correction.

$$E_1/E_0 = 1 - 2e^{-T/RC} \tag{65}$$

representing the pure resistance-capacitance phase corrector; the curve 2, equations (66) and (67), a phase

$$E_1/E_0 = 1 - (4/\sqrt{4Q^2 - 1}) \cdot e^{-(1/2Q)\omega_0 t} \cdot \sin(\sqrt{1 - (1/4Q^2)}\omega_0 t) \tag{66}$$

$$E_1/E_0 = 1 - 4e^{-0.71\omega_0 t} \cdot \sin(0.71\omega_0 t) \tag{67}$$

corrector $Q=0.71$. The very sharp initial peak cannot, due to unavoidable stray reactances, be expected in practical cases.

Two procedures of phase correction have been mentioned in the beginning of this section. The one proceeds to correct the coefficients of successive terms (as many as correspond to the chosen order r of the uniform-stretch-transition family) in the expansion of the mathematical operator. This way is possible only if the operator is known. It is mathematically exact, but requires as many correctors for a simple filter as for any

large number of repeater stages. The shunt-peaking filter $Q=0.64$ has been chosen as an example, because it can be combined with a single resistance-capacitance phase corrector, $\alpha=1.14$, so that all the first three terms of the operator disappear. The transition of the filter $Q=0.64$ without phase corrector is shown as curve 1 in Fig. 55. After correction with the phase corrector

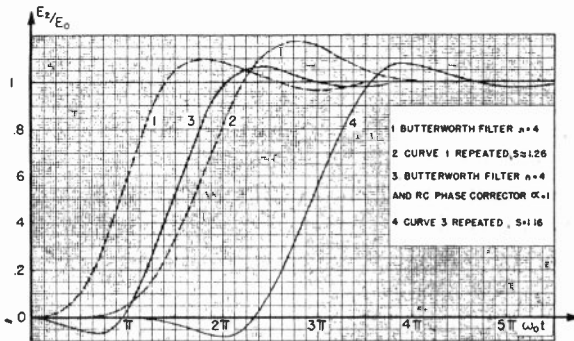

Fig. 57—Transient response of Butterworth filter $n=4$ with phase correction.

$\alpha=1.14$, the transition follows curve 2, equation (68).

$$E_2/E_0 = 1 - 1.04e^{-1.14\omega_0 t} - 2.9e^{-0.77\omega_0 t} \cdot \sin(0.63\omega_0 t - 1^\circ) \quad (68)$$

The step recoil due to the phase corrector is obvious. It decreases slowly on repetition, curve 3. Except perhaps for the improved stretch modulus, this experiment in phase correction does not show any advantage over the simple circuits, curve 1.

The other procedure, permitting of less exactitude, but appearing more efficient, obtains the time response of the filter cascade either by calculation or by measurement and compensates it as far as possible by the opposite and approximately equal time response of one or more phase correctors. Not many reactances are needed to equal the fourth- or sixth-order uniform-stretch transition in steepness of cutoff, Fig. 44. Thus, to test this procedure, the Butterworth filter $n=4$ was chosen. This filter is known to have a very smooth and flat amplitude response, and the phase response is plotted again in Fig. 56, curve 1. Two different attempts are shown to compensate the time-response deviations of the case $n=4$. The first attempt to compensate by trial and error uses only a single phase corrector of the simple resistance-capacitance type, equation (63), Fig. 56, curve 2. The resulting time response is represented by the fairly satisfactory curve 3, Fig. 56.

Another attempt was made to obtain still better results by using two phase correctors, the one having a $Q=0.71$, curve 4 of Fig. 56, and the other having a $Q=0.5$, curve 6. The first served to reduce the curvature of the uncorrected curve 1, thereby obtaining the straighter curve 5, which in turn is compensated by the straight curve 6 to give the final result curve 7. This is clearly a better time-response curve than curve 3, though the slight difference does not seem to justify the additional phase corrector. The improvement of the

transient response corresponding to the first attempt at phase correction is shown in Fig. 57, equation (69). The

$$E_2/E_0 = 1 - 1.50e^{-0.3827\omega_0 t} \cdot \cos(0.924\omega_0 t - 45^\circ) - 12.15e^{-0.924\omega_0 t} \cdot \cos(0.3827\omega_0 t + 45^\circ) + 10.68e^{-\omega_0 t} \quad (69)$$

filter $n=4$ before correction is represented by curve 1, and after correction by curve 3, which, with about equal recoil and overshoot, looks very nearly symmetrical. Apart from this, the curve 3 does not offer such an improvement over curve 1 as to justify the use of a phase corrector. This aspect is changed, however, if repetition is required. Curve 1 repeated turns into curve 2, with almost doubled overshoot and, nevertheless, 1.3 times increased transition time. Curve 2, however, by repetition becomes curve 4, with small increase of overshoot from 7 per cent to about 8 per cent, well-maintained symmetry, and an $s=1.16$. This stretch modulus agrees well with the expected average between 1.12 and 1.19, as the slope of the amplitude response is just about the average between that of the fourth-order and that of the sixth-order uniform-stretch transition, Fig. 44.

These examples seem to show that, once the various relations among amplitude response, time response, and transient response are clearly understood, a good transient response can often be produced merely by manipulation of the amplitude response and the time response. Sharp amplitude cutoff will cause transient oscillations, but is a condition for a low value of stretch modulus; small phase distortion will ensure a symmetrical transient shape with least overshoot. Whether a phase corrector is worth-while would depend on the requirements and on the number of stages.

Good responses lend themselves very well to combinations in cascades, as is illustrated in Fig. 58. The transient response of the combination Fig. 54 is repeated in Fig. 58, curve 1, that of the combination Fig.

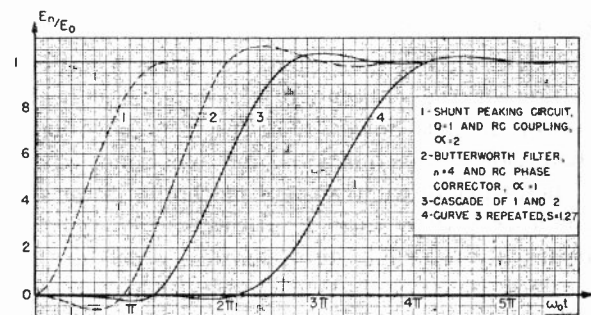

Fig. 58—Transient response of cascade of curve 3, Fig. 57, and curve 1, Fig. 52.

57 in curve 2. Cascading of both leads to curve 3 which is an intermediate shape between them and resembles that of the ideal transition in Fig. 43, curve 3. The resulting cascade repeated actually leads to the nearly unchanged shape, curve 4, $s=1.27$, also in close correspondence to the value 1.26 for the second- and fourth-order hybrid uniform-stretch transition desired.

APPENDIX I

BASIS OF MATHEMATICAL PROCEDURE

1. Heaviside Calculus

The mathematical treatment of physical filters in this paper is largely based on the principle that, if the vector ratio between the output and the input of a low-pass filter, adjusted to show unit gain at direct current, is expressed as the quotient of two series of ascending powers of $j \cdot \omega / \omega_0$, then the result of applying a unit step to the input of that filter is that of an operator of the same form in which $j \cdot \omega / \omega_0$ is replaced by $p = d/d(\omega_0 t)$. This operation produces a time curve which is a series of exponential terms whose indexes are the product of $\omega_0 t$ with the values of p at which the expression in the denominator vanishes. This gives a pure exponential component for each real root, and a damped oscillation for each conjugate pair of complex roots. Various expressions are available for arriving easily at the coefficients in numerical examples, both in the simple case and in the case of repeated roots, but though these have been used in preparing the examples it would be redundant to repeat them here.

In general, the denominator of the expression in p is of the order of the number of reactances in the filter. The numerator is commonly of lower order, and in general takes its order from the number of reactances which are not in the direct path from input to output. The numerator does not determine the exponents of the time curve, but enters into the determination of the coefficients, and, for example, may materially affect the phase of a component of damped oscillation. In the carrier-frequency analogue the order is generally determined by the number of resonant circuits which tune within the band which is being considered.

Complete generality of solution is possible only in the case of a quadratic, i.e., a half section of a standard filter. For higher orders numerical cases can be solved, but the effect of the variation of one particular impedance cannot be described in general terms unless a natural factorization of the denominator occurs. A considerable degree of insight, however, arises from observation of the behavior of the equations, and experience has shown that the utility of the transient method of filter analysis is not destroyed by these limitations.

Identically the same mathematical procedure is used in treating phase-correction circuits, which have their own individual transition curves. In these cases the numerator is usually of the same order in p as the denominator.

2. Mathematical Treatment of Cascaded Filters

The solution of problems involving feeding a filter, not with a unit step, but with the output from a preceding filter, varies with the knowledge of the form of the operator. If the operators are known, the solution depends on the principle that, within the known limits, the output is given by an operator which is the product

of the individual operators. If only the time functions are known, the superposition principle gives the resultant time function by mathematical integration. Finally, if no functions are known, and only the time plots are available, a process of mechanical integration and differentiation will yield the combined response, the process being based on the form

$$F_2(t) = \int_0^t a(t-T)b'(T)dT \quad (70)$$

of the Duhamel integral of the superposition theorem. The same principles apply in the combination of filters with phase-correction networks.

The result may be approximated by a numerical process which is simple but may grow tiresome in case of oscillatory responses. To cascade the responses $a(t)$ and $b(t)$ proceed as follows:

1. Divide both transient responses into evenly spaced time intervals, the same for both curves, beginning at their first significant departure from zero. The result will be the more exact, the smaller the intervals; 15 to 40 intervals were used for the curves of this paper.

2. Tabulate, and number consecutively, the average height in each interval for both curves; call these values $a_1, a_2, a_3, \dots, a_n$; and $b_1, b_2, b_3, \dots, b_n$.

3. Choose one of the curves, preferably the simpler one, say $a(t)$, and tabulate the differences between each two successive values: $a_1' = a_1 - 0$, $a_2' = a_2 - a_1$, $a_3' = a_3 - a_2, \dots, a_n' = a_n - a_{n-1}$.

4. Multiply each value $a_1', a_2', a_3', \dots, a_n'$ with each value $b_1, b_2, b_3, \dots, b_n$. Write in the first line: $\sum_1 = a_1' \cdot b_1$; in the second line: $\sum_2 = a_2' \cdot b_1 + a_1' \cdot b_2$; in the third line: $\sum_3 = a_3' \cdot b_1 + a_2' \cdot b_2 + a_1' \cdot b_3$, and so on to the last line: $\sum_n = a_n' \cdot b_1 + a_{n-1}' \cdot b_2 + a_{n-2}' \cdot b_3 \dots a_1' \cdot b_n$. The number of products thus rises by one for each successive line.

5. Add up all the products in each line, with attention to possible negative signs. The sums \sum_1 to \sum_n so obtained are then the ordinates of the resulting transient; they are spaced with the same time interval as was chosen for the two original responses.

The idea underlying this procedure is to represent the output of the first filter as a sequence of evenly spaced unit steps of the height $a_1', a_2', a_3' \dots$ and to feed each, when it emerges, to the second filter. The output of that is then the sum of n transient responses, each of the same shape $b(t)$ but of a height and delay corresponding to each unit step $a'(t)$.

3. Theory of Transition of Uniform Stretch⁸

Let $f_1(j\omega)$ be the frequency characteristic (output volts E_2 to input volts E_1) of a network, connected between grid and cathode of a tube of high impedance and negligible grid-plate capacitance; also let $f_2(j\omega)$ refer to another network, connected between the anode and the cathode of the same tube.

⁸ This section was prepared by Charles P. Singer.

Then applying to the input terminals of f_1 the Heaviside unit function, characterized by $F(t)=0$ for $t<0$; $F(t)=1$ for $t>0$ and writing $j\omega = p$, the instantaneous response E_2/E_1 at the output terminals of f_2 as a function of time is given by the Heaviside operator.

$$(1/\mu)(E_2/E_1) = \{f_1(p)f_2(p)\}1$$

where μ is the amplification factor of the tube. Now, let the two networks be identical, i.e., $f_1=f_2=f$; then the response becomes $E_2/(\mu E_1) = \{f(p)\}^2 1$ which is a function of time and will be denoted by $\alpha_2(t)$, so that

$$\alpha_2(t) = \{f(p)\}^2 1 \tag{71}$$

is the response across the output terminals of f_2 . In the same manner the response across the output terminals of f_1 (i.e., the input terminals of the tube) will be denoted by

$$\alpha_1(t) = \{f(p)\}1. \tag{72}$$

The problem is to find all possible forms of function $\alpha_1(t)$ which will satisfy the equation

$$\alpha_1(t) = \alpha_2(st). \tag{73}$$

In other words, the times for the voltage to reach the same value in $\alpha_1(t)$ and $\alpha_2(t)$ should have a constant ratio s , which will be defined as the "stretch modulus," Fig. 59.

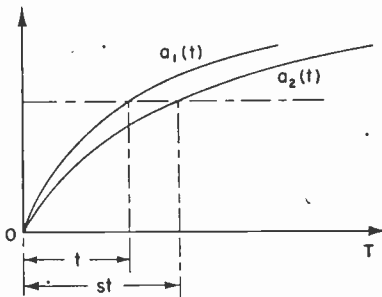

Fig. 59—Transition of uniform stretch, cascaded.

From the Heaviside calculus we know that

$$(1/p)^n = t^n/n! \tag{74}$$

which is true for all values of n , even when fractional or negative. Multiplying by s^n we obtain

$$(s/p)^n = (st)^n/n! \tag{75}$$

and so $f(p)$ must be of such form that $\{f(p)\}^2$ multiplies p by a constant. The only function that will satisfy this condition is

$$f(p) 1 = \{e \pm hp^n\}1 \tag{76}$$

for, squaring, we have

$$\{f(p)\}^2 1 = \{e \pm 2hp^n\}1 = \{e \pm h(2^{1/n}p)^n\}1$$

or by (75)

$$\{f(p)\}^2 1 = \alpha_2(t) = \alpha_1[t/(2^{1/n})].$$

Hence $\alpha_1(t/2^{1/n}) = \alpha_2(t)$ and writing

$$2^{1/n} = s \tag{77}$$

we have $\alpha_1(t/s) = \alpha_2(t)$ or $\alpha_1(t) = \alpha_2(st)$ which agrees with (73) and thus satisfies our problem. When n is an integer, there are two possible cases, according to whether n is even or odd. In the first case $f(p)$ will be real, in the second it will be imaginary.

Case I— n is even: For even n , the operator $f(p)$ is defined by

$$f(p) = e^{-h\omega^n} \tag{78}$$

and by the Fourier integral corresponding to (72) we have

$$\alpha_1(t) = \frac{1}{2\pi j} \int_{-\infty}^{\infty} \frac{e^{j\omega t}}{\omega} \cdot e^{-h\omega^n} \cdot d\omega \tag{79}$$

so that the corresponding frequency response is

$$g(\omega) = [1/(2\pi j\omega)] \cdot f(p) \tag{80}$$

and $f(p)$ has an amplitude, but no phase, spectrum.

The imaginary portion of (79) is a contour integral, the value of which is easily found to be 1/2, while the real portion furnishes

$$\frac{1}{2\pi} \int_{-\infty}^{\infty} e^{-h\omega^n} \frac{\sin \omega t}{\omega} \cdot d\omega$$

since the integrand is an even function in ω , we thus obtain

$$\alpha_1(t) = \frac{1}{2} + \frac{1}{\pi} \int_0^{\infty} e^{-h\omega^n} \frac{\sin \omega t}{\omega} \cdot d\omega. \tag{81}$$

The integral can be evaluated with the planimeter or by an infinite series; in one case, when $n=2$, it can be represented by a known function, as we shall see later.

If it is desired to evaluate the integral with the planimeter, it is best changed into the following form:

$$\alpha_1(T) = \frac{1}{2} + \frac{1}{\pi} \int_0^{\infty} e^{-y^n} \frac{\sin yT}{y} \cdot dy \tag{82}$$

where $h=1/\omega_0^n$; ω_0 =cutoff frequency; $y=\omega/\omega_0=\omega h^{1/n}$; $T=\omega_0 t$.

Denoting the variable portion of $\alpha_1(t)$ by $\bar{\alpha}_1(t)$, we see from (81) that $\bar{\alpha}_1(t)$ is an odd function in t and is therefore symmetric about the origin. Thus we have

$$\bar{\alpha}_1(t) = -\bar{\alpha}_1(-t). \tag{83}$$

Evaluation of the integral (81) by an infinite series: We have

$$\frac{\sin \omega t}{\omega} = t \sum_{m=0}^{\infty} (-1)^m \frac{(\omega t)^{2m}}{(2m+1)!}$$

and so we must find an integral of the form

$$I = \frac{t}{\pi} \int_0^{\infty} e^{-h\omega^n} \frac{(\omega t)^r}{(r+1)!} \cdot d\omega; \quad r = 2m.$$

Let

$$h\omega^n = u;$$

then

$$\omega = (u/h)^{1/n}$$

$$nh\omega^{n-1} \cdot d\omega = du$$

$$d\omega = [1/(nh)] \cdot (\mu/h)^{(1-n)/n} \cdot du$$

$$\omega^r \cdot d\omega = [1/(nh)] \cdot (u/h)^{(r+1)/n-1} \cdot du$$

$$I = \frac{t^{r+1}}{n\pi(r+1)! h^{(r+1)/n}} \int_0^{\infty} e^{-u} \cdot u^{(r+1)/n-1} \cdot du$$

and since $(r+1)/n > 0$

$$\int_0^{\infty} e^{-u} u^{(r+1)/n-1} \cdot du = \Gamma\left(\frac{r+1}{n}\right);$$

whence

$$\alpha_1(t) = 1/2 + 1/(n\pi) \{ (\Gamma(1/n)/(1! h^{1/n})t - (\Gamma(3/n)/(3! h^{3/n})t^3 + \dots) \}. \tag{84}$$

Case I— $n=2$: Here we have

$$\begin{aligned} \Gamma(1/2) &= \sqrt{\pi} \\ \Gamma(3/2) &= 1/2\sqrt{\pi} \\ \Gamma(5/2) &= (3.1)/(2.2)\sqrt{\pi} \text{ etc.} \end{aligned}$$

and so (84) reduces to

$$1/2 + 1/\sqrt{\pi} \{ z - z^3/(3.1!) + z^5/(5.2!) - \dots \},$$

where $z=t/2\sqrt{h}$. But this is the expansion of $1/2(1+\text{ERF } z)$, so that

$$\alpha_1(t)_{n=2} = 1/2 \{ 1 + \text{ERF } [t/2\sqrt{h}] \} \quad (85)$$

which function is nonoscillatory.

Case II— n is odd: Here it is necessary to define the operator $f(p)$ as follows:

$$f(p) = e^{-ih\omega^n} \quad (86)$$

so that

$$\alpha_1(t) = \frac{1}{2\pi j} \int_{-\infty}^{\infty} \frac{e^{j\omega t}}{\omega} \cdot e^{-ih\omega^n} \cdot d\omega \quad (87)$$

while the corresponding frequency response is

$$g(\omega) = 1/(2\pi j\omega)f(p)$$

or

$$g(\omega) = 1/(2\pi\omega) \{ \sin h\omega^n + j \cos h\omega^n \} \quad (88)$$

and $f(p)$ now has a phase, but no amplitude, spectrum.

The value of the imaginary portion of (87) is again $1/2$, while the real portion furnishes

$$\frac{1}{2\pi} \int_{-\infty}^{\infty} \frac{\sin(\omega t - h\omega^n)}{\omega} \cdot d\omega;$$

since the integrand is again an even function in ω , we obtain

$$\alpha_1(t) = \frac{1}{2} + \frac{1}{\pi} \int_0^{\infty} \frac{\sin(\omega t - h\omega^n)}{\omega} \cdot d\omega. \quad (89)$$

For $n>1$ there is no known function that will represent the integral (89) but this can again be evaluated with the planimeter, when the appropriate form (see 82) is

$$\alpha_1(T) = \frac{1}{2} + \frac{1}{\pi} \int_0^{\infty} \frac{\sin(yT - y^n)}{y} \cdot dy. \quad (90)$$

We can, however, obtain some information concerning the nature of the response curves by general reasoning. In the first place, it is clear from (89) that the integral is no longer symmetric about the origin, for

$$\bar{\alpha}_1(t) \neq -\bar{\alpha}_1(-t).$$

Furthermore, it follows from the form of the integral (89) that the function $\alpha_1(t)$ is oscillatory.

For the purpose of plotting, it is necessary to calculate the value of the integral for $t=0$. This can easily be done as follows:

Let $\omega^n=u$; then $n\omega^{n-1} \cdot d\omega=du$ and

$$\int_0^{\infty} \frac{\sin(h\omega^n)}{\omega} \cdot d\omega = \frac{1}{n} \int_0^{\infty} \frac{\sin(hu)}{u} \cdot du = \frac{\pi}{2n},$$

whence

$$\alpha_1(t=0) = 1/2(1 - 1/n). \quad (91)$$

Case III— n is infinite: This may be regarded as a lim-

iting case of (81). Hence the integral becomes

$$\lim_{n \rightarrow \infty} \left\{ \int_0^{\infty} e^{-h\omega^n} \cdot \frac{\sin(\omega t)}{\omega} \cdot d\omega \right\}.$$

But $\lim_{n \rightarrow \infty} e^{-h\omega^n} = \begin{cases} 1 & \text{for } \omega < 1 \\ 0 & \text{for } \omega > 1 \end{cases}$

and so we have to split the integral as follows:

$$\int_0^{\infty} = \int_0^1 + \int_1^{\infty}.$$

The second integral vanishes, whence

$$\alpha_1(t)_{n \rightarrow \infty} = \frac{1}{2} + \frac{1}{\pi} \int_0^1 \frac{\sin(\omega t)}{\omega} \cdot d\omega. \quad (92)$$

But $\int_0^1 \frac{\sin(\omega t)}{\omega} \cdot d\omega = \int_0^t \frac{\sin(\omega t)}{\omega t} \cdot d(\omega t)$

and so we have

$$\alpha_1(t)_{n \rightarrow \infty} = 1/2 + 1/\pi \text{ Si } (t). \quad (93)$$

Also, we again have $\bar{\alpha}_1(t) = -\bar{\alpha}_1(-t)$, i.e., the curve is symmetric about the origin.

APPENDIX II

CARRIER ANALOGUE OF LOW-PASS FILTERS

1. The Series-Peaking Circuit

The description of low-pass filters with "series-peaking coil" holds true for carrier-frequency amplifiers built with staggered circuits or with band passes, all these having the same amplitude, phase, and transient response for the modulation. Thus, in any cascade of amplifiers, any or all networks for video-frequency amplification may be replaced each by a corresponding network for carrier-frequency amplification and vice versa.

It is assumed that the carrier frequency is so high compared with the highest modulation frequency, that the amplitude- and phase-response curves can be taken as symmetrical. In that case (94), (95), (96), and (97) permit of simple conversion.

$$\begin{aligned} Q_s &= (2\pi\nu/\omega_0)Q_0; & 2\pi\nu \gg \omega_0; \\ Q_0 &= Q \text{ of corresponding low-pass filter} \end{aligned} \quad (94)$$

$$\omega_s = \pm \omega_0 \sqrt{(4Q_0^2 - 1)/4Q_0^2} \quad (95)$$

$$Q_b = (2\pi\nu/\omega_0)Q_0; & 2\pi\nu \gg \omega_0 \quad (96)$$

$$K = M/\sqrt{L_1 L_2} = 2\omega_0/(2\pi\nu)\sqrt{(4Q_0^2 - 1)/4Q_0^2} \quad (97)$$

$$K_0 = \text{critical coupling} = \omega_0/(\sqrt{2} \pi\nu) \quad (97a)$$

For slight assymetry due to a relatively low carrier frequency, the average sideband may be represented with good approximation as the geometric mean between the two sidebands; $\omega_0 \cong \sqrt{\omega_1 \omega_2}$.

For cases of considerable assymetry see Section I, part 5.

2. Sucker Circuit, the Carrier Analogue to the Shunt-Peaking Circuit

At a carrier frequency large compared with the highest modulation frequency the shunt-peaking circuit,

Fig. 60(a), has its exact analogue in the band-pass "sucker" circuit, Fig. 60(b). This consists, for example,

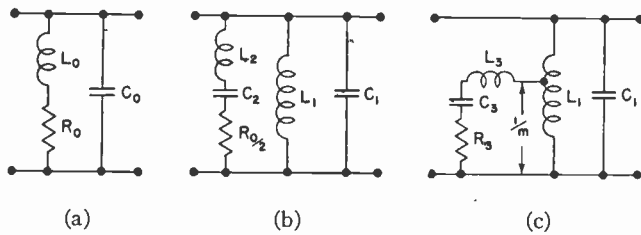

Fig. 60—The sucker circuit, the carrier-frequency analogue to the shunt-peaking coil circuit.

of a parallel-tuned circuit, tuned to the carrier frequency, shunted by a series-tuned circuit, which, too, is tuned to the carrier frequency and thus "sucks" out the peak of the resonance curve. The component values which are required for the conversion of any shunt-peaking circuit are given in (98a), (98b), (98c), and (98d) in the assumption that the value of shunt capaci-

$$C_1 = C_0 \tag{98a}$$

$$C_2 = (4f_0^2/\nu^2)C_0 \tag{98b}$$

$$L_1 = (f_0^2/\nu^2) \cdot L_0 \tag{98c}$$

$$L_2 = (1/4) \cdot L_0 \tag{98d}$$

tance is unaltered. Since these component values for the series circuit are inconvenient, the further transformation to (99a), (99b), and (99c) with the corresponding

$$C_3 = m^2C_2 = (4m^2f_0^2/\nu^2) \cdot C_0; \tag{99a}$$

$1/m$ = ratio of turns; neglecting leakage inductance

$$L_3 = (1/m^2)L_2 = (1/4m^2) \cdot L_0 \tag{99b}$$

$$R_3 = (1/2m^2)R_0 \tag{99c}$$

circuit Fig. 60(c), is desirable and has the additional advantage that, by suitable choice of turns ratio and couplings, the inductance L_3 can be assimilated as the leakage of L_1 .

In practice it may be impossible to avoid a resistance loading across the parallel resonant circuit. So long as this can be regarded as a minor damping on the circuit, its effect can be compensated by a reduction in the value of the series resistance.

APPENDIX III
BUTTERWORTH FILTER—STAGGER FREQUENCIES
AND DAMPINGS

TABLE I

n	ω_r/ω_0	Q_s
1	0	$RC = 1/\omega_0$
2	0.71	0.71
3	0.865 0	1.0 $RC = 1/\omega_0$
4	0.925 0.383	1.31 0.54
5	0.95 0.58 0	1.61 0.61 $RC = 1/\omega_0$
6	0.965 0.71 0.26	1.92 0.71 0.502
7	0.976 0.783 0.436 0	2.24 0.80 0.555 $RC = 1/\omega_0$
8	0.98 0.83 0.555 0.194	2.56 0.90 0.60 0.51
9	0.99 0.865 0.645 0.345 0	2.89 1.0 0.65 0.53 $RC = 1/\omega_0$

APPENDIX IV

CONVERSION OF SHUNT-PEAKING FILTER AND RESISTANCE-CAPACITANCE-COUPLED STAGE INTO EQUIVALENT-SERIES PEAKING FILTER

(1) Let the series-peaking circuit consist of the series resistance R_s , the inductance L_s , and the capacitance C_s .

(2) Let the components of a shunt-peaking circuit be the resistance R_p , the inductance L_p and capacitance C_p ; and let the amplifier stage containing this shunt-peaking circuit be cascaded with another stage coupled via the resistance R and the shunt capacitance C .

Then, for equal response of (1) and (2) it is required that:

$$L_s = L_p \quad R_s = R_p$$

$$C_s = C_p \quad L_s/R_s = L_p/R_p = CR.$$

I.R.E. Building Fund



POWEL CROSLY, JR.
Honorary Chairman, Campaign Executive Committee

To a confraternity like this Institute, an owned Home is an emblem, a torch held high, a beacon symbolic of establishment and permanence, a rallying point for lofty endeavor, a landmark for adventurous departures.

A symbol like that is created, not hired.

It was the fondest dream of the founders that one day I.R.E. should have its own home—R. H. MARRIOTT, with Albert N. Goldsmith and J. V. L. Hogan, a Founder of the Institute.

This campaign will bring to fruition two years of thinking and planning.—L. P. WHEELER, during whose administration as President the Building Fund was initiated.

The goal of "not less than \$500,000" is both imaginative and attainable. Men with their feet on the ground have a right to aspire to objectives heretofore out of reach—W. L. EVERITT, President of I.R.E. for 1945.

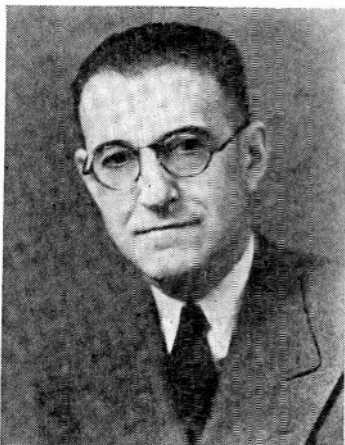

W. R. G. BAKER
Chairman, Initial Gifts Committee



AUSTIN BAILEY
Chairman, Sections Solicitations Committee



RALPH A. HACKBUSCH
Chairman, Canadian Council Building-Fund Committee

I have a great deal of interest in I.R.E.'s plans looking to the acquisition of adequate housing and will be glad to do anything I can to further the program—**FRANK B. JEWETT**, distinguished telephone engineer; Fellow, I.R.E.

I am gratified that the Building Fund of I.R.E. is flexible enough to permit the radio engineers' joining in a greater housing scheme of the whole engineering profession at a later time, if and when plans take shape—**GANO DUNN**, Fellow, I.R.E., Past-President A.I.E.E., Honorary Member, A.S.M.E.

A BROAD PROGRAM

THE souvenir program of the I.R.E. 1945 Winter Technical Meeting carried this significant editorial:

"The Building Fund campaign of I.R.E. may prove to be the most cohesive force working in the radio-and-electronic industry in 1945. . . . More engineers will hear about the Institute and discuss its virtues than ever before. Its members will more carefully than ever weigh the values to themselves of its tangibles and intangibles. . . . The corporations which typify the industry will apply to it their measuring-stick of net worth, in terms of its functions of constantly supplying them with replenishments of Ideas and Men-with-Ideas."

As the campaign has progressed since its midwinter launching, those words have been prophetic. Contributors, both corporate and individual, have recognized that when the Institute moves into its new home it represents but the first important step towards a Greater I.R.E.—that the momentum of the financial campaign itself, the stimulus of the challenge presented, the worth-whileness of the mutual effort, the thrill of recognition by friends of the profession, all will sweep the Institute and its membership on to measure up to the new opportunities which the electronic arts present. As Dr. L. P. Wheeler said in his address as retiring President a year ago: "At the present stage of its development the Institute may be thought of as having passed through its period of adolescence to the realization of mature powers, useful and used in large domains outside that of communications." This year, Professor Turner, in his valedictory: "This program of coming into our own is broader than any building fund. Numerically, a membership of 25,000 is within our grasp during the next few years."

PROGRESS REPORTED

The Directors, with their foreknowledge of campaign plans, had first opportunity to make individual sub-

scriptions. As reported by Dr. Everitt at the Annual Meeting: "They gave individually, in amounts ranging from \$500 down to \$100, with several of \$300 and \$250, and an average of \$217. The first two came from Washington, D. C. . . . While the Directors are men of parts they are not particularly men of means. The thing they *do* have is *interest* in the future of the Institute. Fortunately, interest is amenable to stimulation, so that it is something we can all work on. I hope that, as a result of present or stimulated interest, several individuals will be discovered during the course of our campaign who will make a thank-offering of a thousand dollars or more to the Institute for the part it has played in laying the foundation of personal fortunes. I believe that, likewise as a result of interest in I.R.E., hundreds of members, from Fellow to Associate, will match the Directors' range of gifts; and that other hundreds, who must be content to give less, will subscribe total sums the equivalent of a few dollars a month for one year, since ours is a nonrecurring need which must be satisfied within a year if at all."

Before a day had elapsed following Dr. Everitt's report on the Directors' solicitation, Mr. W. O. Swinyard, chairman of the Chicago Section of I.R.E., reported the first corporate gift of \$1000. Within a week, Dr. W. R. G. Baker's Initial Gifts Committee was reporting checks received in still higher brackets, and the campaign was well under way.

What helps Headquarters to function smoothly, directly helps the Sections. In addition, an adequate building available to members visiting New York City will be an asset to the membership in the United States and throughout the world—**L. M. CLEMENT**, Cincinnati Section; Director.

I.R.E. knows no more of international boundaries than radio itself. It deserves support everywhere—**R. A. HACKBUSCH**, Chairman, Canadian Council.

In my opinion the Building Fund is properly and legally safeguarded as to its application to the intended purposes—**H. R. ZEAMANS**, I.R.E. Legal Counsel.

Your campaign has been well timed. The industry is poised to take full advantage of a brilliant future—**MELVILLE EASTHAM**, radio pioneer, former Director and Treasurer, I.R.E.

Austin Bailey D. E. Harnett
 W. L. Barrow Keith Henney
 L. A. du Bridge J. V. L. Hogan
 E. W. Engstrom

Constitution and Laws: On recommendation of the Appointments Committee, the following members were appointed to the 1945 Constitution and Laws Committee:

R. F. Guy, *Chairman*
 Austin Bailey, R. A. Heising
 E. F. Carter F. E. Terman
 I. S. Coggeshall H. R. Zeamans

Nominations: The Appointments Committee recommendation of these members to serve on the 1945 Nominations Committee was approved:

J. V. L. Hogan, *Chairman*
 H. M. Turner, *Vice Chairman*
 Beverly Dudley C. M. Jansky, Jr.
 O. B. Hanson R. C. Poulter
 W. C. White

Tellers: The following members, recommended by the Appointments Committee, were appointed to the 1945 Tellers Committee:

G. B. Hoadley, *Chairman*
 Edward J. Content, *Vice Chairman*
 E. B. Boyce Trevor Clark

General Counsel: The reappointment of Harold R. Zeamans to serve as the Institute's General Counsel during 1945 was unanimously approved.

Investments: President Everitt and Professor Turner (alternate for Dr. Cutting) were appointed to the 1945 Investments Committee.

Technical Committee on Radio Receivers: Upon recommendation of the Executive Committee, J. A. Worcester was appointed to this technical committee.

Office Organization: President Everitt and Chairman S. L. Bailey of the Committee on Office Organization reported on the activities of the group and on the recommendation of the Executive Committee that George W. Bailey be invited to accept the Executive Secretaryship of the Institute.

The Executive Committee was authorized to issue the invitation to Mr. Bailey to accept this position.

Sections Committee Meeting: Chairman Heising distributed copies of the "Notice of Annual Meeting of the Committee on Sections," being held on January 24, 1945, as part of the 1945 Winter Technical Meeting, and reviewed the subjects on the agenda for that meeting. The Board members were invited to attend this annual meeting of the Sections' representatives.

Postwar Publication Fund: Upon the suggestion of Chairman Heising of the Investments Committee, it was moved to transfer the \$20,000, making up this fund, to the custody of the Investments Committee for the purpose of having the sum invested in United States Government securities bearing interest, such investments to be marked for the "Postwar Publication Fund" account.

American Standards Association: The quoted changes in Articles 2 and 5 of the ASA Constitution, explained in the December 27, 1944, circular from that association and recommended by the Executive Committee, were reported by Professor Turner and given unanimous approval:

"(1) To remove the limitation of the

work 'to those fields in which engineering methods apply' in order that the scope be broadened to handle any standard or standardization project which deserves national recognition regardless of what field it is in.

"(2) To include the consensus principle as one of the basic principles of the Association.

"(3) To authorize the Board to elect not more than three Members-at-Large to serve on the Board."

The corresponding letter-ballot will be sent to the ASA on that basis.

January 23 Meeting: The annual meeting of the Board of Directors, begun on January 10, 1945, was resumed on January 23, 1945, and the following were present: W. L. Everitt, president; G. W. Bailey (guest), W. L. Barrow, E. F. Carter, Alfred N. Goldsmith, editor; R. F. Guy, R. A. Heising, treasurer; Keith Henney, F. B. Llewellyn, B. E. Shackelford, D. B. Sinclair, W. O. Swinyard, H. M. Turner, H. A. Wheeler, L. P. Wheeler, W. C. White, H. R. Zeamans, general counsel (guest); and W. B. Cowilich, assistant secretary.

Office Organization: President Everitt announced that George W. Bailey had accepted the Executive Secretaryship of the Institute. Mr. Bailey will spend an initial period studying the problems of the Institute, and thereafter assume his full-time duties.

Readmission of Former Members: The following resolution was unanimously adopted:

"RESOLVED, that the Board of Directors readmit to the grade of membership previously held (or in the Associate grade if formerly a Junior) those former members (a) whose memberships terminated before or during 1944 and who pay either current dues or all dues in arrears, or (b) whose memberships terminate on April 30, 1945, and who pay dues for 1945 at a later date during 1945. The payment of a new entrance fee, if such would normally be required, is waived. Associates, who formerly had the privilege of voting, will be readmitted as non-voting Associates."

Sections

Williamsport: Mr. H. A. Wheeler reported on the January 3, 1945, letter from the Williamsport Section, proposing additional counties for its Section territory. Unanimous approval was given to having these counties in Pennsylvania included in the official Williamsport Section territory:

Pennsylvania Counties
 Bradford Lycoming Northumberland
 Clinton Mifflin Snyder
 Columbia Montour Sullivan
 Union

The approved counties are within a 60-mile radius of Williamsport.

Petitioned Constitutional Amendment: President Everitt reviewed this amendment relating to Article IV, which was submitted by a petition initiated by H. P. Westman, and which represents a second plan to increase membership dues. It was noted that at the last meeting the Constitution and Laws Committee was "empowered

to decide when the petitioned amendment shall be submitted to the voting membership before July 1, 1945." The following actions resulted from the discussion:

Endorsement: It was moved to endorse this proposed amendment of Article IV, submitted by petition and concerning a second plan to increase membership dues.

Sections Committee Meeting: It was decided to have the Board's endorsement of the indicated amendment reported and that amendment discussed at the annual Sections Committee meeting being held on January 24, 1945.

Section Rebates: The Constitution and Laws Committee was instructed to prepare an amendment to the Bylaws Committee for the purpose of increasing rebates to Sections by the amount of 25 cents a member in good standing (except Students), the increase to be retroactive to January 1, 1945.

1945 Budget: The Secretary was instructed to revise the 1945 budget to reflect the amount involved in the previous motion, relating to the increase in Section rebate.

Conferences and Meetings: Mr. H. A. Wheeler reviewed his October 13, 1944, report, "Future Co-operation Between IRE and National Electronics Conference in Chicago." The following actions followed the discussion of Mr. Wheeler's report:

Local Conferences and Meetings: It was moved that the Board adopt the policy of encouraging local conferences and meetings on specialized technical subjects under sponsorship of the Sections; that these conferences and meetings be held in strict concordance with the spirit of governmental regulations restricting travel; and, that the Institute headquarters co-operate with the Sections in arranging these conferences and meetings:

1945 Summer Convention: It was unanimously voted to cancel the Summer Convention, scheduled to be held in Montreal during June, 1945.

Traveling Lecture Series: Mr. Guy reviewed his letter of December 28, 1944, addressed to President Everitt, describing a plan for a traveling lecture series on television and frequency modulation for presentation among the Sections of the Institute. It was moved to refer the preliminary planning on the traveling lecture series proposed by Mr. Guy, to the Committee on Education, with instructions to proceed with putting the plan into effect as soon as it is feasible to do so. The Committee on Education was also instructed to work out the finances, including admission charges and the disposition of any profit that may result.

Executive Committee

January 9 meeting: The Executive Committee meeting, held on January 9, 1945, was attended by H. M. Turner, president; W. L. Everitt, president-elect; S. L. Bailey (guest), Alfred N. Goldsmith, editor; R. A. Heising, treasurer; F. B. Llewellyn, Haraden Pratt, secretary; H. A. Wheeler, and W. B. Cowilich, assistant secretary.

Membership: The following transfers and applications for membership were unanimously approved at the November 27, 1944, meeting: for transfer to Senior Member grade, L. L. Beranek, T. A. Cohen, H. S. Dawson, A. M. Gurewitsch, A. E. Harrison, A. P. Kauzmann, C. J. Penther, J. B. Schaefer, T. A. Smith, G. L. Tawney, W. P. West, and N. H. Young; for admission to Senior Member grade; C. S. Roys; for transfer to Member grade, Arthur Bloomer; T. M. Bloomer, W. W. L. Burnett, R. A. Dehn, A. P. Foster, T. A. Hunter, H. W. Jamieson, E. C. Karker, A. R. Keskinen, P. A. Kransz, Norman Lavoo, O. I. Lewis, W. R. Moody, L. E. Pepperberg, E. L. Petersen, A. G. Skrivseth, Karl Stiefel, and D. A. G. Waldock; for admission to Member grade, N. A. Abbott, H. G. Auckland, R. L. Carbre, E. W. Chapin, H. J. Donaldson, R. M. R. Gaarder, J. E. Hobson, O. C. Keil, Jr., R. D. Lambert, Jr., I. C. Pedersen, D. M. Ruggles, H. L. Shortt, Herbert Thorn, A. E. Tilley, W. M. Waffle, L. E. Willey, and I. F. Witt; Associate grade, 144; and Student grade, 70.

RTPB Secretaryship Expense: It was decided to have the Institute absorb the amount involved and to cancel the corresponding charge to RTPB; and to have a further report on the 1945 charges available at the end of the current year.

Standards Reports: Harold A. Wheeler, as chairman of the Standards Committee, reviewed the technical-committee reports, listed below, and stated that they are in order for immediate printing as separate publications and in sufficient quantities to provide copies to all members and subscribers and a surplus stock:

"Definitions of Guided Waves" (Submitted by Technical Committee on Radio Wave Propagation, Dr. C. R. Burrows, *Chairman*)

"Report of Technical Committee on Piezoelectric Crystals" (Professor W. G. Cady, *Chairman*)

The reports accordingly will be thus printed after approval of the proof thereof

Correct Membership Grade in the Institute

Every member of the I.R.E. should be in a suitable membership grade. Many members are qualified for grades higher than they now hold. It is fitting and proper that they should be transferred, upon application, to their correct grade.

Professional standing is partly expressed by the granted recognition of one's fellow engineers. Institute membership is expressive of that recognition. It is a professional obligation upon each I.R.E. member to take the place to which he is entitled and to receive the recognition he has earned. Application blanks for transfer, containing qualifications for each membership grade, may be obtained from the I.R.E., 330 West 42nd St., New York 18, N. Y.

by the chairmen of the technical committees involved, and Mr. H. A. Wheeler, as chairman of the Standards Committee.

Cedar Rapids Section

At the January 10, 1944, meeting of the Cedar Rapids Section, 52 people were in attendance. Mr. Rollins H. Mayer, chief engineer of The Turner Company, spoke on "The Noise-Cancellation Differential Dynamic Microphone," explaining some of the basic principles of the microphone and demonstrating their application in the design of the device.

Ballots for the election of permanent officers were distributed, and the results of the election were to be announced on January 22, 1945.

Correspondence

Correspondence on both technical and nontechnical subjects from readers of the PROCEEDINGS OF THE I.R.E. is invited, subject to the following conditions: All rights are reserved by the Institute. Statements in letters are expressly understood to be the individual opinion of the writer, and endorsement or recognition by the I.R.E. is not implied by publication. All letters are to be submitted as typewritten, double-spaced, original copies. Any illustrations are to be submitted as inked drawings. Captions are to be supplied for all illustrations.

Frequency and Phase Modulation

Dr. August Hund starts his letter¹ with "There seems to be still some confusion about frequency and phase modulation. . . ." We believe his letter contained unfortunate statements which will not reduce this confusion. In the following paragraphs we present, first, an explanation of the relationship between phase and frequency and, second, the distinction between types of modulated waves.

Previous discussions and analyses of types of modulated waves have utilized mathematics to a point where a physical picture of the processes involved was difficult to obtain. As a result, the interrelations between different kinds of modulation, while perfectly obvious to the mathematician, became obscured to the engineer attempting to study mathematicians' works. It is unfortunate that few people have attempted to arrive at the properties of modulated waves through the use of vectors and words. While the results obtained in such a manner may not be applied as glibly as the processes of integration or differentiation, the importance of such an application lies in the fact that a physical concept of what actually takes place in nature is obtained. While it certainly is true that, to handle complex modulation problems, mathematical processes have to be invoked, we believe that it is essential before starting on a

¹ Proc. I.R.E., vol. 32, pp. 572-573; September, 1944.

mathematical junket that such a physical picture—at least of the fundamental processes—be clearly kept in mind.

Let us proceed to examine phase and frequency by means of the familiar representation of alternating voltage and current by a rotating vector.

We are accustomed, in dealing with alternating-current phenomena, to consider the current (or voltage) as a vector rotating with an angular velocity of $2\pi f$ radians per second. Rotation in a counterclockwise direction is usually taken in a positive sense while rotation in a clockwise position is considered negative. Thus an angular shift in a counterclockwise direction of θ degrees is referred to as $+\theta$ degrees, while rotation of the vector clockwise θ degrees would be designated $-\theta$ degrees, as shown in Fig. 1. It would, of

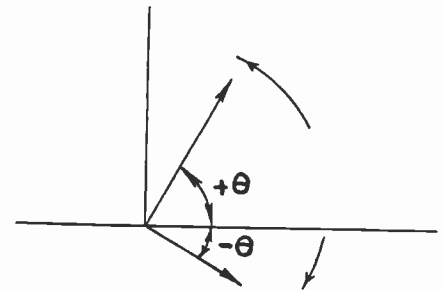

Fig. 1—Rotating vectors.

course, be awkward to represent and to observe a vector rotating at high speed. For convenience, therefore, it is customary to assume that the paper is rotating counterclockwise at some constant rate. This serves to slow down and, if possible, to stop the rotation of the vector, so that it may be studied more easily. If all the vectors under consideration have the same angular velocity, that is, they represent waves of equal and constant frequency and the paper is considered to be rotating in a counterclockwise direction with the same angular velocity as the vector, then any stationary line drawn on the paper will have identical angular velocity. So far we have discussed nothing that cannot be found in chapter 1 of any alternating-current text. We want next to make a point which is of importance in modulation theory, but which is not always emphasized.

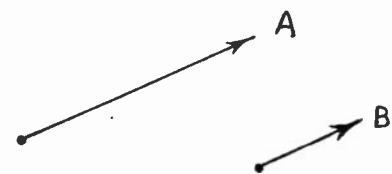

Fig. 2—Vectors of equal frequency.

Suppose we consider 2 vectors A and B (Fig. 2), representing alternating currents of frequency equal to one million cycles per second. Both of these vectors can be drawn on the same sheet of paper parallel to each other if we assume the phase of one with respect to the other to be zero. It should be stressed that both of these vectors are rotating counterclockwise with an angular velocity equal to $2\pi 10^6$ radians per second (that is, 10^6 revolutions per second since one

revolution is equivalent to 2π radians). Let us ask ourselves how can the phase of current B be advanced with respect to A ? In order for this to take place, it will be necessary for vector B to rotate faster than vector A in a counterclockwise direction. To increase the angular velocity, we must increase the frequency. Thus, we see in a qualitative way that in order to bring about a phase change a frequency change must take place,

of the change in phase is 1 cycle per second. In order that the phase advance 2π radians in $\frac{1}{2}$ second, vector B will have to rotate faster than vector A by 2 revolutions per second or, stating the same thing in terms of frequency, the frequency of B will have to be 2 cycles higher than that of A . In fact the frequency of B will have to be higher than that of A by this same 2 cycles per second at any time during this $\frac{1}{2}$ second. The

modulation. "Frequency modulation" does not mean that only the frequency of a wave is being changed, nor does "phase modulation" mean that only the phase of a wave is being changed. Fundamentally there are only two classes of modulated waves. First, there is the class in which the amplitude is modified by the modulating signal and second, the class in which the angular velocity of the wave is modified. (Sometimes a third class, consisting of combinations of these two classes, is added.)

We mention briefly the case of amplitude modulation. The frequency response of the audio system is never considered to alter the type of modulation. Amplitude modulation is amplitude modulation, whether the frequency response of the modulating circuit rises, falls off, or is flat.

Consider next the second class of modulated waves, the class in which the angular velocity is changed by the modulating signal. (We are at a loss to select a suitable name for this type of modulation—it has been called angular velocity modulation, generalized frequency modulation, generic frequency modulation, angle modulation—the prevalent and, we believe, best, usage calls it simply frequency modulation.) Some of the early writers on the subject felt that in this case the frequency response of the modulating circuit had a bearing on the characteristics of such waves. They gave different names, frequency and phase modulation, to two types of modulation, identical except for the frequency response of the modulating system. In frequency modulation, the frequency excursion is independent of the frequency of the modulating wave; in phase modulation, the frequency excursion is directly proportional to the modulating frequency. This is the sole distinction between the terms as they are classically used. In each case both the frequency and the phase of the wave are altered by the modulating wave, since, as we have seen, frequency cannot be changed without changing phase, and phase cannot be changed without changing frequency.

Present usage is fortunately tending to ignore these classical distinctions between frequency and phase modulation. This is because the most widely used angular velocity system, the Armstrong system, is neither classical frequency nor classical phase modulation. In the Armstrong system the higher modulating frequencies are pre-emphasized at the transmitter somewhat as shown in Fig. 4. For low notes the frequency deviation is independent of modulating frequency—classical frequency modulation—while for high notes the frequency deviation is directly proportional to modulating frequency, classical phase modulation.

Most writers are now ignoring the specious classical distinction between phase and frequency modulation, since both are so close to being the same thing. To maintain an artificial distinction is unnecessary and "frequency modulation" as it is now coming to be used, means any type of angular-velocity modulation. We hope that this trend will continue.

D. L. JAFFE and DALE POLLACK
Templetone Radio Manufacturing
Corporation
New London, Connecticut

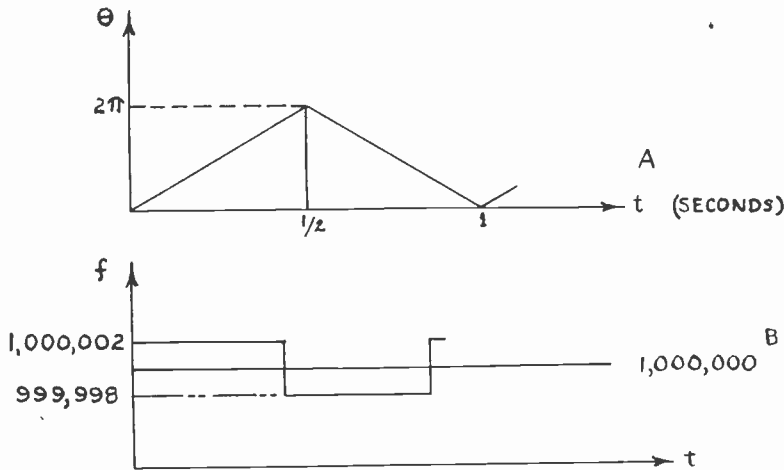

Fig. 3—Relation of frequency to phase deviation.

and inversely a frequency change must result in a phase change.

We cannot emphasize this point—phase and frequency are interdependent—strongly enough. One cannot be changed without changing the other. Many writers, Dr. Hund is among them, have strayed because, while they surely know that phase and frequency are knotted solidly together, they sometimes ignore this principle.

Let us apply this line of reasoning to a simple case of modulation. Consider the phase of current B , as represented by vector B , to be uniformly increasing at a rate of

angular velocity of B will have to be $2\pi \times 2$ radians per second greater than that of A . When vector B reverses itself and rotates clockwise 2π radians in $\frac{1}{2}$ second, the frequency of B relative to A will have to be 2 cycles per second less than 1,000,000. A plot of the frequency of vector B during this cycle of phase change is illustrated in Fig. 3B. Note that the frequency, Fig. 3B, is the slope of the phase-versus-time plot, Fig. 3A, that is, the frequency is proportional to the rate of change of phase. As a matter of fact, from the above, frequency is $1/2\pi$ times the rate of change of phase.

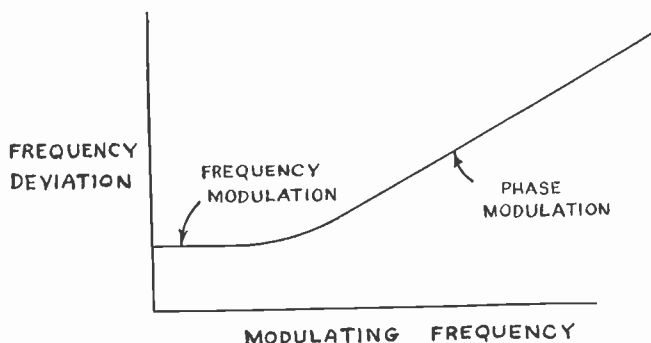

Fig. 4—Pre-emphasis curve.

2 revolutions each second (or, in fancier language, 4π radians per second). Then at the end of $\frac{1}{2}$ second, vector B will have moved in phase relative to A by one revolution (2π radians). Let us further assume that after vector B has made this one revolution its phase instantaneously reverses itself with the same angular velocity so that it resumes its original position at the end of 1 second.

In Fig. 3A there has been plotted phase as a function of time. The repetition rate

Now we come to the delicate subject of distinguishing frequency from phase modulation. Discussions on this distinction are reminiscent of the discussions which used to take place on the "physical reality of sidebands." We should like to start by giving the classical definitions, which are incorrectly stated by Dr. Hund. Much of the confusion arises from the unfortunate choice of the terms "frequency" and "phase" back in the 1920's to designate these two types of

Calculator for Directive Arrays

With regard to my paper,¹ some inquiries have been received regarding the scales which would have to be added in order to provide information on the vertical pattern, and it is thought that the following discussion may be in order:

The calculator, as described, solves the following formula for the horizontal pattern:

$$E_R = [ET_1^2 + ET_2^2 + 2ET_1ET_2 \cos(\alpha + kd \cos \phi)]^{1/2} \quad (1)$$

The formula commonly used for the solution of the pattern in both the horizontal and vertical directions is similar to

$$E_R = [ET_1^2 + ET_2^2 + 2ET_1ET_2 \cos(\alpha + kd \cos \theta \cos \phi)]^{1/2} \cdot f(\theta) \quad (2)$$

where E_R = resultant field vector

$ET_1 = 1$ = vector representing the field of T_1 , the tower producing the larger vector, if they are unequal

ET_2 = vector representing the field of tower T_2

α = phasing of T_2 with respect to T_1

kd = electrical spacing of towers

θ = vertical angle to the radiation vector, measured from the horizon

ϕ = horizontal angle from the line of towers to the radiation vector, measured from the T_2 end

$$f(\theta) = \frac{[\cos(A \sin \theta) - \cos A]}{[\cos \theta(1 - \cos A)]}$$

A = electrical height of towers

All angular measurements are in degrees.

In the calculator described and illustrated, scales for values of kd ranging from 360 to 45 degrees were provided on the fixed base, and the rotary runner was calibrated accordingly. The calculator may assist in developing the vertical-radiation pattern if additional scales of ϕ for values of kd from 45 to 0 degrees are added and the runner properly calibrated over this region. These calibration points would be determined in the same manner as those described in the above article. With these added scales, the term $[ET_1^2 + ET_2^2 + 2ET_1ET_2 \cos(\alpha + kd \cos \theta \cos \phi)]^{1/2}$ of (2), which we may call $f(E)$, may be solved as follows:

At any desired vertical angle θ , the value of $kd \cos \theta$ may be taken as a new value of spacing kd' . This value of kd' may be determined by setting the runner to the calibration point (on the kd scale) corresponding to the angle ϕ equal to θ , and measuring the central angle from the reference line to that calibration point. This measurement may be made by using the protractor scale inscribed on the outer edge of the rotary element ($\angle \alpha$ scale). Then the term $f(E)$ may be solved for this value of θ at all values of ϕ by proceeding as in the determination of the horizontal pattern, using the new value of spacing kd' . The value of E_R is then determined in each case by multiplying $f(E)$ by $f(\theta)$.

Scales could be provided for the solution of $f(\theta)$, but since this is a relatively simple slide-rule operation, it appears that no great saving of time would be made.

¹ J. G. Rountree, "A calculator for two-element directive arrays," *Proc. I.R.E.*, vol. 32, pp. 760-767; December, 1944.

Incidentally, a typographical error, apparently overlooked in the proofreading, appears near the bottom of the second column on page 763, where the term " E_2/ET_1 " appears. This should be " ET_2/ET_1 ."

J. G. ROUNTREE
P. O. Box 5238
Dallas 2, Texas

Quality-Control Engineering

This department which, although in its infancy, is gaining recognition in engineering and will in the future be a "must" to radio and parts manufacturers.

Quality-control engineering is made up of several departments, namely, inspectors, testing, statistics, and research. Therefore this department requires experience of a very broad nature. Since quality control works with production, the many problems that arise are corrected in assembly.

How it works:

1. Inspection

A mechanical inspection system is set up to inspect a percentage of the daily production; this may be in the nature of one unit from every ten units made. This of course depends upon the production rate and units being made. This inspection consists of the subassemblies, through to the final product, also the packing.

2. Testing

A complete over-all test of the final unit is made on a certain percentage of the daily production; their percentage depends of course on the type of unit and the rate of production. A visual check of the testing of subassemblies are made at various intervals. A check as to the performance of test equipment is made. When many tests of the same kind are made correlation of test equipment is of major importance. Quality control must have a complete set of equipment for making any needed tests on the particular items being produced. These should be standards.

3. Statistics

A complete report from quality-control inspection and testing is kept and put into graph form. These graphs show a picture of the quality of the products being produced. Should the quality decrease the trouble may be traced and remedied from the source.

4. Research

Continued research is made in an effort to increase the quality of the items, both mechanically and electrically. Results are recorded and sent to engineering.

Conclusion:

This department keeps everyone on the alert from incoming inspection to engineering because of its continued spot checks from any point; therefore, a high-quality unit is assured.

GEORGE W. PURNELL
Philco Radio Corporation
Sandusky, Ohio

Balanced Amplifiers

Several articles¹⁻⁵ have recently appeared on amplifiers employing cancellation of in-phase signals. These include differential input amplifiers; direct-current phase inverters; and resistance-capacitance-coupled push-pull amplifiers.

In any amplifier having three input terminals and/or three output terminals, the input voltages, e_1 and e_2 , may be written

$$e_1 = (e_1 - e_2)/2 + (e_1 + e_2)/2$$

$$e_2 = -(e_1 - e_2)/2 + (e_1 + e_2)/2$$

The first term in each case is the differential signal; the second, the "in-phase" signal. If the amplifier does not transmit the in-phase signal, while the amplification of the differential signals is μ_1 , μ_2 , the output voltages will be

$$E_1 = \mu_1(e_1 - e_2)/2$$

$$E_2 = -\mu_2(e_1 - e_2)/2$$

In a push-pull amplifier, $\mu_1 = \mu_2 = \mu$, and the differential output voltage is μ times the differential input. In a phase inverter, $e_2 = 0$, but $E_2 = -E_1 = -\mu e_1/2$. In a differential input amplifier, which is followed by single-ended stages, $\mu_2 = 0$, and $E_1 = \mu_1(e_1 - e_2)/2$.

Thus it is seen that all three types of amplifiers are merely special uses of in-phase signal degeneration. Perhaps the failure to recognize this fact may in part account for the frequent republishing, as original, of several of the circuits the writer developed for this purpose.^{6,7} These have been used in most of the equipment we have built since 1936, and because of their apparent wide usefulness were made available to many workers in biophysics in private communications, in advance of publication.

Thus the so-called "Toennies" differential input amplifier is merely an application of in-phase degeneration by use of a large cathode resistor, where μ_2 is made zero; i.e., one output terminal is disregarded.

However, some of the circuits recently published appear to be identical both in structure and function to those the writer has published, although no reference has been made thereto.

There are several aspects of in-phase degeneration which appear to be misunderstood. For example, some of the applications made do not appear to recognize the effect of small variations in components. The writer hopes to cover these points, as well as several new applications, in a forthcoming article.

FRANKLIN OFFNER
Offner Electronics, Inc.
Chicago, Ill.

¹ W. M. Rogers and H. O. Parrack, "Electronic apparatus for recording and measuring electrical potentials in nerve and muscle," *Proc. I.R.E.*, vol. 32, pp. 738-743; December, 1944.

² E. L. Ginzton, *Electronics*, p. 98; March, 1944.

³ Walther Richter, *Electronics*, p. 112; November, 1943.

⁴ Paul Traugott, *Electronics*, p. 132; August, 1943.

⁵ H. O. Rahm, *Electronics*, October, 1939.

⁶ S. N. Trevino and Franklin Offner, *Rev. Sci. Instr.*, vol. 11, p. 412; December, 1940.

⁷ Franklin Offner, *Rev. Sci. Instr.*, vol. 8, p. 20; January, 1937.

Postwar Radio-and-Electronic Prospects

Sounding the keynote at the opening of the first National Electronic Conference in Chicago on October 5, 1944, Ralph R. Beal, assistant to the vice-president in charge of RCA Laboratories, urgently pleaded that industrial research never relinquish the harmonious co-operation with the Army and Navy which has been so closely developed during the war. Our armor of science must be strong, said Mr. Beal. Science, which has helped in winning of the war, he added, must continue to assist in preserving the peace.

"If our armies, battleships, and bombers are equipped with the latest devices of science, no nation will be anxious to seek a fight," said Mr. Beal. "We know how destructive the weapons of science have been in this war. We know what the robot bomb has done; it makes us shudder to know what might happen were additional forces of science harnessed to its deadly wings. I can tell you, without revealing any military secrets, that based upon what I have seen developed for warfare in the science of radio-electronics alone, another war would be much more destructive.

"It is my urgent plea that our industrial-research laboratories continue to work hand-in-hand with our Army and Navy in peace as they have done so magnificently in war. Let us through science put new power behind the wings of the Dove of Peace. That is the new challenge; it is our DUTY. . . .

"We must be quick to recognize that if science can be so effective in war, it can be even more effective in peace. As soon as this war is won we must reconvert science from destruction to construction and by so doing rehabilitate the world and bring happiness and new comforts in living to every nation on earth."

Looking ahead, Mr. Beal predicted that radio-electronic triumphs achieved during the war by American research, science, and engineering are clues to revolutionary postwar developments in a wide variety of activities in which the progress and welfare of the nation depend. He said that research in electronics and vacuum-tube circuits is bringing into use the vast radio spectrum which lies in the frequency range from 30 to 30,000 megacycles. In his opinion, these staticless, nonfading microwaves "may well be the means of establishing a new epoch in domestic communications, and ultimately have a profound influence on communications throughout the world.

"The outlook is bright," he continued, "for radio communications services that can connect automobiles and other conveyances on land or water into telephone circuits and other communications services. It is within reason to predict that individual communication sets of the walkie-talkie type will come into wide use, and may also be connected into our national and world-wide telephone circuits."

Radio-and-electronics applications, he reported, have proved indispensable to aviation. He told of clearance- and height-measuring apparatus which informs the airman of the character of the terrain over which he is flying in darkness or stormy



Paying tribute to radio's wartime achievements, Army and Navy communications leaders attended the 25th anniversary dinner of the Radio Corporation of America at the Waldorf-Astoria in New York on December 1, 1944. Left to right: Brigadier General Frank E. Stoner, Chief of the Army Communications Service; Major General James A. Code, Assistant Chief Signal Officer, United States Army; Rear Admiral Joseph R. Redman, Director of Naval Communications; Brigadier General David Sarnoff, Fellow, I.R.E., and Past Secretary, I.R.E., President of RCA; and Major General H. C. Ingles, Chief Signal Officer, U. S. A.

weather; he forecast collision-prevention instruments which will indicate obstructions and give timely warnings. He predicted that electronic means would be utilized in controlling aircraft and for connecting the controls of planes into guiding radio systems which in the postwar era may enable automatic flying from one point to another.

Among other electronic developments having promise of great importance, Mr. Beal referred to radiothermics—the fast-growing industrial use of high-frequency power that generates heat. He foresaw it speeding industry and making possible many new products in the postwar period. He said that a great deal would be heard in the future about electronic industrial control.

Throughout his address, Mr. Beal stressed the importance of research and engineering in opening new frontiers which he described as vital to create employment and prosperity.

"Reward has come at last to man's inherent desire and striving to extend his sight beyond its normal limitations," said Mr. Beal. "Electronic television, now on the verge of becoming a great new industry and a service to the public, answers fully our expectations. It stands forth as a prime example of a major achievement of research and engineering. Into the development of this marvel of the age has gone more concentrated research than into any other modern development. Television involves fundamental discoveries dating back almost a century. It has tapped virtually all of the reservoirs of knowledge in radio, chemistry, physics, optics, and electronics.

"Every element, every component of the system has required exploration and pioneering. New principles had to be discovered in picture-pickup devices, electron optics, electronic amplifiers, radio transmitters, and transmitting tubes and antennas, and in methods for synchronizing the transmitted and received pictures. New parts of the radio spectrum had to be explored and harnessed.

Television today rests upon its own solid foundation of research. It encompasses many remarkable scientific advances, each of which in its own right rises as a monument to the progress of science."

Radio-and-Electronic Wartime Achievements

High tribute to radio's wartime achievements was voiced by speakers, and underscored by a message from President Roosevelt, at the twenty-fifth anniversary dinner of the Radio Corporation of America in New York on December 2, 1944. The speakers included Major General H. C. Ingles, Chief Signal Officer, United States Army; Rear Admiral Joseph R. Redman, Director of Naval Communications, and Colonel (now Brigadier General) David Sarnoff (A'12-M'14-F'17), President of the Radio Corporation of America.

Addressed to Colonel Sarnoff, the Presidential message included the following expressions:

"During these twenty-five years your company has played an important part in achieving pre-eminence for the United States in radio. I congratulate you personally for splendid leadership. Your organization throughout the years has created new wonders and brought into being new services in all phases of radio activity for the benefit of the American people and for people everywhere.

"I wish you and all members of the RCA family continued success in pioneering. With television as a new postwar industry of great promise in the fields of employment, entertainment, and education, I know that under your guidance and vision RCA will continue to contribute to the economic and cultural values created by radio.

"May the next twenty-five years see your fondest dreams in the fascinating world of radio come true."

General Sarnoff declared that America's entire radio industry deserved high praise for record-breaking achievements in supplying the fighting forces of the United Nations with the finest radio-electronic instruments of war, equipment so necessary to attain Victory in the increased tempo of battle on the farflung fighting fronts.

Addressing the gathering, Major General Harry C. Ingles, Chief Signal Officer, said:

"You have attached your President, Colonel David Sarnoff, to the Signal Corps from time to time as occasion demanded. Colonel Sarnoff's exceptionally meritorious conduct in the performance of outstanding services has gained him the Legion of Merit award, a decoration which he richly deserved. I can add nothing to the citation given to him by the War Department, which said, in part: 'Colonel Sarnoff's outstanding devotion to duty, his courage and great diplomacy in handling French citizens have aided materially in overcoming great difficulties.' I can assure you that Colonel Sarnoff's work in Europe was only one instance of his services to the Signal Corps and to the Nation."

Admiral Joseph R. Redman reported that advances in radio communications had made valuable contributions to the conduct of Naval warfare, and, looking to the future, asserted: "I envisage a remarkably efficient and modern international communications system. I can see great central switchboards on which terminate various circuits, each circuit operating through filters dividing it into many channels for all classes of service. I believe the Radio Corporation of America is alert to these future problems, just as it always has been in the past, and will not fail to retain its leadership in the international field of communications."

In response, General Sarnoff said in part,

"It has been America's good fortune to encourage the development of radio in every field of its activity," he asserted. "As a result, this country had a great radio industry to convert to the production of instruments of war. The entire industry deserves high tribute for its record-breaking accomplishments in supplying the finest radio-electronic apparatus to the United Nations.

"Ready to meet the impact of war, America had a world-wide communications system and a broadcasting system second to none. To operate these vastly expanded radio services, America has thousands of self-trained amateur and commercial operators who quickly enlisted. Today these young men are in the front lines of communication with the Signal Corps; they are in the Navy and Coast Guard, on warships, transports, and aircraft, while thousands of others are in the Merchant Marine. We salute the radio amateur as an effective contributor to America's wartime radio communications.

"The unprecedented part that broadcasting is playing in this war, in binding together the people of the United Nations, and in bringing in some light to countries darkened by dictatorships, can best be real-

ized when one is in the very vortex of it. I found myself in such a spot on D Day, June 6, 1944. At an undisclosed location in the United Kingdom, the news came in directly from the beaches of Normandy and that news was broadcast instantaneously to all the world. . . .

"Tomorrow holds the promise of television and of many other new electronic wonders which will aid our economy, help maintain employment, and broaden our cultural enjoyment. . . .

"Our road ahead is marked by great responsibility and golden opportunity," he concluded. "The achievements of radio during the past twenty-five years will be greatly surpassed during the next twenty-five years."

Wartime Electronic Developments Hold Peacetime Promise

Wartime electronic developments, now at work in military radar equipment, hold rich promise for more than a dozen major applications in postwar entertainment and industry, according to Walter Evans (M'36-SM'43), vice-president of the Westinghouse Electric and Manufacturing Company, in charge of all company radio activities.

Speaking before the Baltimore, Maryland, Association of Commerce Forum Discussion of Baltimore's Economic Future, Mr. Evans recently painted a bright picture of wartime developments in the electronics field which will serve peacetime America after victory. "Clearly," he declared, "there will be ample productive capacity to accommodate the most optimistic estimates."

He pointed out that in the case of the Westinghouse Radio Division alone the output of radio and allied electronics apparatus "has been stepped up 51 times since a state of emergency was first declared."

He recalled that scientific lessons learned in World War I were responsible, shortly after the close of that conflict, for introduction of the vacuum tube, which resulted in radio broadcast methods, talking movies, and other advancements which contributed much to the postwar economy of the 20's. Mr. Evans held out even brighter prospects for the part electronics will play after the present war.

Prominent in these developments will be television, of which Mr. Evans said: "It is our considered belief that all of the technical answers are on hand for a usable and acceptable television system. This includes the probability of a reasonably priced receiver, and a practical means of getting shows across the country by means of radio links, or one of the more recently developed types of metal conductors."

His list of other industrial applications for which electronics will provide the seven-league boots of accomplishment includes: moulding of plastics; annealing of electrical steels; bonding of plywood; brazing and welding; hardening and tempering of metals; inspection of sheet metal and cast-

ings for porosity; dynamic balancing; vibration fatigue tests for materials; remote power-line operation and metering; and high-speed X-ray inspection of forgings and castings. These applications, Mr. Evans said, are not mere dreams of accomplishments to come at some dim and distant day, but are "ready-for-use applications which have been proved in the miraculous war production attained by American industry."

Electronics, he explained, has come of age under the stresses of wartime production, but one little-known circumstance of this development is the fact that even before the war, engineers were rapidly becoming familiar with the marvels made possible by this new process.

"For example," Mr. Evans pointed out, "even in that day we were baking hams, kiln-drying lumber, curing plastics, drying movie films, dehydrating tobacco for export, killing vermin in grain, candy, and food-stuffs, and cementing shoes together with thermoheating—all by the use of electronics."

No appraisal of the future of America or the world, Mr. Evans said, can be even remotely accurate unless we take into consideration the vast fields opened by wartime electronics developments.

Television as Service to the Public

The stage is set and ready, technically, for the beginning of a regular television broadcasting service to the public, E. W. Engstrom (A'25-M'38-F'40), research director of RCA Laboratories, said in the keynote address at the First Annual Conference of the Television Broadcasters Association in New York on December 11, 1944.

The state of readiness of television, as he sees it, is evaluated "in cold engineering terms," and he added, "Those who feel that television is not ready and should, therefore, be delayed, must obviously not use the same clear spectacle lenses of engineering appraisal through which I so clearly see this situation."

"Now, as at earlier times, there are those who raise their voices in opposition, but today the industry in regard to television is as nearly united in its recommendations as it is practical to expect," said Mr. Engstrom. "Those who oppose, speak of the need of further improvement and refinement and of the necessity, therefore, to use channels in a higher-frequency portion of the radio spectrum.

"Although they do not say so, the end result of following their recommendations would be to delay television for a long time. I have been active in the research and engineering development of television for many years. I have participated in the planning and the co-ordination during the period of the growth of television from research status to its present-day maturity."

In substantiation of his views, Mr. Engstrom cited major advances in television research and development:

1. Research has been done on very

efficient reflective-type optics especially suited for television projection. These are now satisfactory in performance and low-cost manufacturing is assured. Thus we may expect that early postwar production of television receivers will include projection types of excellent performance with pictures adequately large for home use.

2. Major increases are indicated in sensitivity of the iconoscope or camera tube. Research on this had progressed to the point where substantial sensitivity gains were in sight when war called a halt to television work. The progress made gives promise of a solution to this important phase of television broadcasting. To be able to televise all scenes which may be seen directly will add immeasurably to the immediacy and spontaneity of television programs.

3. Progress has been made and experience has been obtained using cable and radio methods for joining stations together in networks. We may look forward to a growth of networks suitable for television programs to support the growth of television broadcast stations.

"When the presently assigned television channels were allocated by the Federal Communications Commission, radio manufacturers were able to supply transmitters for only a group of channels at the low-frequency end of the band," continued Mr. Engstrom. "The assignment of channels, however, spanned from 50 to 300 megacycles. Research began on transmitter tubes and apparatus, but again the war brought progress almost to a standstill. Now, however, the results of this 'slowed-up' research program are beginning to take tangible form. A development transmitter is now under test giving substantial output power up to 300 megacycles. Satisfactory picture transmission has been accomplished. Tests under full-scale field conditions in a metropolitan area are scheduled to begin soon.

"These major advances over and above general improvements in techniques brought about by war research, and again over and above an already excellent television status, prewar, promise a most favorable situation for television. Technically, the stage is set and ready.

"At the war's end we shall need all possible means of employment for those now engaged in manufacturing and for those who will return from the Armed Services," said Mr. Engstrom. "We need new things and principally those which will add to our standard of living.

"The making of television transmitters and receivers, the operation of the broadcast facilities, the making and the operation of the network facilities; these activities should help to solve the problem of employment for those now in war work and for those released from the Armed Services. Television, in its widespread application, will provide employment for very large numbers of people. We should make a determined effort to proceed with television on a broad scale, to proceed without handicaps. We need constructive planning and understanding co-operation on the part of all parties to make this effort successful," Mr. Engstrom concluded. "Television can render a service which the public wants and needs, and at the same time provide employment for many."

Looking Ahead to Color and Ultra-High-Frequency Television

At the first annual conference of the Television Broadcasters Association in New York on December 11, 1944, Dr. Peter C. Goldmark, director of engineering research and development of the Columbia Broadcasting System discussed the prospects for ultra-high-frequency television, both in monochrome and color. Among his remarks were the following:

"Much of what has been proposed by the Columbia Broadcasting System for ultra-high-frequency television had already been developed and tried before the war began. As an example, full color television was broadcast for the first time in August of 1940.¹ This was the first time color television had ever been broadcast. Further improvements and subsequent field tests in color television, with daily broadcasts over a period of almost one year, gave CBS and its associates the necessary knowledge and assurance to state that color television is here to stay.

"Wideband (10-megacycle) 525-line standards, that is, 31,500-kilocycle scanning frequency, were developed and tested in the CBS laboratories before the war, and some of the results were published in the PROCEEDINGS OF THE I.R.E. What was lacking at that time was the means of modulating and transmitting such wideband signals with adequate power, and efficient receivers at reasonable cost to receive such transmissions.

"Adequate power now can be produced in the proposed ultra-high-frequency band for television broadcasting (from 480 to 920 megacycles) to permit adequate coverage at those frequencies. Transmitting tubes and circuits have been developed to permit modulation with the previously mentioned 10-megacycle video band. A television transmitter to handle these new standards, that is, 735 lines black and white, or 525 lines in color, has been ordered from the Federal Telephone and Radio Corporation, to be delivered upon obtaining adequate priorities.

"This transmitter, together with a special antenna which is omnidirectional in a horizontal plane, and highly directional in a vertical plane, will be installed on top of the Chrysler Building in addition to the lower-frequency television transmitter now in operation.

"In collaboration with Zenith Radio Corporation, CBS plans to develop television receivers which will permit tuning over the entire ultra-high-frequency television spectrum and which will be capable of receiving both color and black-and-white transmissions.

"Television in the ultra-high-frequency band carries with it many advantages outside of the possibility of utilizing wider bands, and thus finer screens, and color. Specifically, it provides twenty-eight 16-megacycle channels in a single block, thus for the first time making nation-wide television service possible.

Dr. Goldmark continued his analysis along the following lines:

¹ By the CBS television transmitter atop the Chrysler Building.

"The all-important problem of multipath reception which now confronts service on the lower frequencies can be attacked in the ultra-high frequencies from an angle which gives hope of appreciably reducing, if not completely removing, this very serious condition. At present there are few installations known in the New York area where, with a single receiving antenna, all three of the existing television stations can be received without echoes or ghosts. In making the receiving antennas for the new ultra-high-frequency systems, experience gained in wartime research will be utilized to produce a highly directional, comparatively small array which automatically can be swung in two predetermined echo-free positions for each transmitter simply by tuning the receiver. Alternatively, a number of directional arrays can be switched remotely into the receiver circuit as the latter is switched from one transmitting station to the other.

"It is true that such antenna arrays as just described would cost more than the antennas used at present on lower-frequency television systems. However, the existing antennas are incapable of eliminating echoes. If one wanted to construct an antenna in the present bands with the same directivity as proposed in the ultra-high-frequency bands, the cost and the size would be far in excess of anything mentioned thus far.

"In conclusion it should be emphasized that ultra-high-frequency television is much nearer than most people realize. Without mentioning dates, it is safe to say that before the war is over its practicability will have been proved."

Television Networks

Syndication of television programs via networks will be a necessity in order that the high cost of quality programming may be divided among many stations, Raymond F. Guy (A'25-M'31-F'39), NBC radio facilities engineer, told 500 members of The Institute of Radio Engineers at a meeting held in Philadelphia on December 7, 1944. Other speakers at the meeting, held in the auditorium of the Franklin Institute, were Allen B. DuMont (M'30-F'31), president of the Allen B. DuMont Laboratories, Inc., and David B. Smith (A'35-SM'44), director of research of the Philco Corporation.

Supporting his contention, Mr. Guy pointed out that the American public is conditioned to good entertainment from motion pictures and that television will be expected to furnish program material of comparable stature. He recited instances where NBC prewar dramatic productions through WNBT had required forty hours of rehearsal for one hour of broadcasting. Fifteen hours of these rehearsals were conducted before the television cameras with substantially a full staff in attendance. He prophesied that the studio staff required to produce a studio dramatic production might consist of a producer, an assistant producer, a scene designer, two stagehands, a sound technician on the microphone boom and one on the control console, one person for make-up, three camera technicians, one technical director, one camera dolly operator, an electrician, and a

supervisor. In some productions, he added, especially made motion pictures (on location) were sandwiched in the production, requiring cameramen and projectionists. It was his opinion that affiliated network stations would find it very desirable to have a nucleus of first-rate network studio productions around which they could build their local programs, broadcast their news programs, local sporting events, and the like.

Coaxial cables or radio relays connecting radio stations, he suggested, might best be owned and operated by common carriers inasmuch as the facilities could be utilized during nontelevision time for other services, thereby keeping the facilities busy during the entire day with the attendant advantage of lower costs to individual users.

Mr. Guy cited plans of the American Telephone and Telegraph Company to build an extensive coaxial cable network which is

expected to be nationwide by 1948 to 1950. Using slides he showed the projected route of these circuits and illustrated how the present nucleus of nationwide networks is forming. The first transcontinental route will extend from Boston via New York, Washington, Charlotte, New Orleans, and Los Angeles to San Francisco with a number of branches. Circuits also will become available in the mid-West linking Washington, Cleveland, Pittsburgh, Chicago, St. Louis, Kansas City, Des Moines, etc. He discussed the possibility of radio relays now under development ultimately carrying the burden of television traffic, and reviewed present plans of the American Telephone and Telegraph Company to build an experimental network from New York to Boston utilizing frequencies from 1900 to 12,000 megacycles, and other similar projects under way.

Expressing the opinion that there is no

limit to what engineers can do, given sufficient time and money, he looked forward to the development of tubes and other devices which would make possible simple and economical long-distance radio relays. Assuming the development of such tubes and devices, Mr. Guy then illustrated his conception of such a relay utilizing frequency modulation and straight-through amplifiers at each relay point. The hypothetical relay utilized parabolic reflector antennas, a wavelength of 5 centimeters and a 4500-mile circuit with relays separated by approximately thirty miles. The cost of a two-way circuit over this distance he estimated at thirteen million dollars.

The speaker expressed his confidence in the further development of electronic devices that would make possible very satisfactory radio relays, meeting all requirements of the expanding television industry.

I.R.E. People

FREDERICK E. TERMAN

Frederick E. Terman, Fellow of the Institute and its Past President, has been appointed Dean of the Stanford University School of Engineering according to an announcement on December 25, 1944. Dr. Terman has been on leave from the University since 1942, to serve as head of the Government's Radio Research Laboratory at Cambridge, Massachusetts. He will assume his duties at Stanford University at such time in the future as his responsibilities to the present war project in which he is engaged are concluded.



FREDERICK E. TERMAN

GALVIN APPOINTMENTS

The Galvin Manufacturing (Motorola Radio) Corporation, of Chicago, has announced the appointments of William E. Cairnes (A'41) as chief engineer of the home radio division, and of Gus Wallin (A'42) as assistant chief engineer of the same division. Mr. Cairnes and Mr. Wallin have been with the organization for eight years and five years, respectively.



WILLIAM E. CAIRNES

Under the general direction of Don H. Mitchell (A'39), director of engineering, the new officials will be in full charge of design and production of the peacetime radio receivers of the company.

JOSEPH G. O'SHEA

Joseph G. O'Shea, Associate member of the I.R.E. since 1939, has received a commendation for meritorious civilian service signed by Lieutenant-General Brehon Somervell of the Army Service Forces and Major-General H. C. Ingles, Chief Signal Officer. The commendation reads: "For outstanding accomplishments while on temporary duty at Greenland for the purpose of rehabilitating the Army Airways Communications System facilities in the North Atlantic Ferrying Route, which involved the engineering and installation of point-to-point weather reporting and radio aids to aerial navigation; for completion of installations at the several stations under trying transportation and supply conditions in areas in which construction of this type of installation had no precedence, and for technical advice furnished the Greenland Base Command on requirements for radar protection."

T. B. JACOCKS

T. B. Jacocks (A'36) has been appointed manager of the Atlantic District for the General Electric Company, in addition to his present duties negotiating Government electronics contracts for the General Electric Company. Mr. Jacocks will be responsible for the sale of all electronics department products in Eastern Pennsylvania, Southern New Jersey, Delaware, Maryland, Virginia, Washington, D. C., and North Carolina.

Born in Tarboro, North Carolina, on July 5, 1902, Mr. Jacocks received the B.S. degree in electrical engineering in 1924, from the University of North Carolina, and upon graduation became associated with the General Electric Company. After a year of study in the test course, he was assigned to the engineering work of the radio department, where he remained until 1927, when he was transferred to the commercial division of the same department.

In 1931, Mr. Jacocks was sent to Washington, D.C., as a representative of the radio department, handling government and commercial radio equipment. For the past four years he has devoted his time exclusively to the negotiation of government electronics contracts.



GUS WALLIN



CLINTON R. HANNA

CLINTON R. HANNA

Clinton R. Hanna (M'28-SM'43) inventor of the tank-gun stabilizer which enables Allied tanks to fire accurately while in motion, has been appointed an associate director of the Westinghouse Research Laboratories it was announced by L. W. Chubb (M'21-F'40) director of research.

Mr. Hanna, who is also manager of the electromechanical department of the research laboratories has been associated with Westinghouse since 1922 in the development of new apparatus, and he has inventions covered by more than eighty patents in the United States and foreign countries. For his work in the development of the tank-gun stabilizer, he was awarded a Presidential Citation in 1942.

Mr. Hanna's work also includes the design of an automatic voltage regulator first used for the control of generators. Since its development in 1938, this device has been applied to motors, turbines, and other devices, including the tank-gun stabilizer, where automatic voltage control is required.

He also directed the development of one of the first successful methods of producing

talking motion pictures. Part of this work included the development of methods of noiseless recording. Prior to 1928, he was engaged in research on loudspeaker equipment and on power tubes for radio receiving sets. Later he investigated noise-measuring apparatus and methods for quieting equipment.

His work with gyroscopic controls, basis of the tank-gun stabilizer, goes back to 1936 when he developed a gyroscopic regulator for steel-mill-roll motors. This device assures that all the rolls run at the same speed, thus maintaining even tension in the steel sheet as it runs through them.

Mr. Hanna has reported on his technical experience in more than a score of papers for the technical journals. He is a Fellow of the Acoustical Society of America and the American Institute of Electrical Engineers. Born on December 17, 1899, in Indianapolis, Indiana, Mr. Hanna attended Purdue University where he was graduated in 1922 with the degree of bachelor of science in electrical engineering, receiving the professional degree of electrical engineer four years later.



WALTER R. JONES

The appointment of Walter R. Jones (A'26-M'32-SM'43) to the newly created post of general engineering manager for radio receiving tubes by Sylvania Electric Products, Inc., has been announced by Roger M. Wise, vice-president in charge of engineering. Mr. Jones, formerly manager of commercial engineering at Sylvania, joined the company in 1929 to set up a sales engineering laboratory. In his new capacity, Mr. Jones will have the direction of the engineering program for radio receiving tubes including the design and development, commercial engineering, chemical, mechanical, and standardizing sections. He is a Fellow of the Radio Club of America, and chairman of the Applications Subcommittee for Miniature Tubes for the War Production Board. He supervised creation of a series of charts on radio now used to train men in various electronic branches of the Armed Forces.



WALTER R. JONES



CHARLES W. TAYLOR

Charles W. Taylor (A'38), development and manufacturing engineer with fifteen years of diversified activity in the electronic field, has been named manager of RCA tube parts and machinery sales of the tube and equipment department of RCA Victor Division, Radio Corporation of America. Mr. Taylor will be located at the company's Harrison, New Jersey, electron-tube manufacturing plant.

Associated with RCA and its predecessor company since 1929, Mr. Taylor has a wide background of development and manufacturing experience. For three years he directed RCA's development and manufacture of cathode-ray tubes; for two years he was associated with the company's transmitting-tube laboratory; and for three years he was in receiving-tube-manufacturing production. He assisted in the preliminary planning for the new RCA plant at Lancaster, Pennsylvania, and was later assistant product manager for transmitting tubes at that plant for a year before returning to Harrison.

Mr. Taylor is a graduate of Purdue University with an engineering degree.

Books

Engineering Mathematics, by Harry Sohon

Published (1944) by D. Van Nostrand Company, Inc., 240 Fourth Avenue, New York, N. Y. 270 pages+8-page index+vi pages. 57 illustrations. 6½×9¼ inches. Price, \$3.50.

In his preface the author states that "this book is intended for engineering students who have completed the study of the elementary calculus and for graduate engineers seeking to bolster their present knowledge of mathematics. Its purpose is two fold. It is intended to strengthen the student in algebra and to provide him with certain mathematical tools which depend upon the calculus."

The choice of material in the book is admirably suited to the authors' purpose. The chapters of the book range from strictly algebraic subjects, such as determinants and the theory of equations to ordinary differential equations and the solution of Bessel's equation for round diaphragms and the evaluation of the skin effect in round conductors.

In the section on algebraic equations, especial attention is paid to the numerical evaluation of the roots by Horner's, Newton's, and Graeffe's methods.

Chapters are included on vector algebra and vector calculus. In connection with the conventional development of Fourier series, the author has developed an original method for making an approximate analysis of an experimental curve which differs from the

usual schedules of analysis from n measured points.

Throughout the book, the material is clearly and concisely presented. Numerous problems are presented with each chapter for testing the student's understanding of the subject. Answers to the problems are given in a section at the end of the book.

In the opinion of this reviewer, the author has produced a readable and interesting textbook. Considered from the standpoint of the graduate engineer, the book should be of value as a source for reference and a review of methods of attack for the solution of new problems.

FREDERICK W. GROVER
Union College
Schenectady, N. Y.

Marine Radio Manual, Edited by M. H. Strichartz.

Published (1944) by Cornell Maritime Press, 241 W. 23 St., New York 11, N. Y. 505 pages+12-page index+x pages. 35 figures. 7½×5½ inches. Price, \$4.00.

As stated by the Honorable Schuyler Otis Bland, Chairman of the House Committee on Merchant Marine and Fisheries, in a Foreword to the above publication, "Marine Radio Manual" is a valuable contribution toward furthering the present high standard of efficiency in the art of radio communication.

In compiling and editing numerous data contained in the manual, Mr. Strichartz has ably covered the subject of maritime radiotelegraph communication from the operator's viewpoint, drawing on his actual seagoing experience and that of other radiomen with years of service in the art.

Written in the language of the seagoing operator and covering all phases of operating routine, this manual is an excellent brushup for the old-time operator. Both the radio operator making his first trip to sea and the operator with years of sea experience may make the manual part of their equipment with the assurance that information contained therein will be of the utmost help in the efficient performance of their duties.

To the new operator the manual is of great value, as it provides the answers to many questions which come up in his daily routine on shipboard. By giving both a word and picture description of the various forms used in radio communications, the author provides an offset to the lack of commercial operating experience, which has so often hampered the new man in the past.

C. B. DARCY
Radiomarine Corporation of America
New York, N. Y.

Reproductions of German Scientific and Technical Books

A group of facsimile reproductions of recent German scientific and technical books has been prepared under the auspices of the Alien Property Custodian, and published by J. W. Edwards, Ann Arbor, Michigan. Of possible interest to workers in various portions of the radio field are the following individual titles:

CERAMICS

Herman Salmang, "Die physikalischen und chemischen Grundlagen der Keramik." Springer, Berlin, 1933. viii+229 pages. \$5.75.

CONDENSERS (ELECTRICITY)

Electric Capacitance; Dielectrics

Georg Straimer, "Der Kondensator in der Fernmeldetechnik." Hirzel, Leipzig, 1939. x+229 pages. (Physik und Technik der Gegenwart. Abt. Fernmeldetechnik. Bd. 6). \$6.00.

Electrolytes—Conductivity

Adolf Güntherschulze and Hans Betz, "Elektrolyt-Kondensatoren. Ihre Entwicklung, wissenschaftliche Grundlage, Herstellung, Messung und Verwendung." Krayn, Berlin, 1937. 178 pages. \$6.00.

ELECTRIC AMPLIFIERS

Hans Bartels, "Grundlagen der Verstärkertechnik." Hirzel, Leipzig, 1942. xii+258 pages. \$6.25.

ELECTRIC CONTACTORS

Ragnar Holm, "Die technische Physik der elektrischen Kontakte." Springer, Berlin, 1941. x+337 pages. \$9.00.

ELECTRIC-CURRENT RECTIFIERS

Karl Maier, "Trockengleichrichter. Theorie, Aufbau und Anwendung." Oldenbourg, München, 1938. 313 pages. \$7.20.

Walter Schilling, "Die Wechselrichter und Umrichter, ihre Berechnung und Arbeitsweise." Oldenbourg, München, 1940. 160 pages. \$4.00.

ELECTRIC CURRENTS

Alternating

Fritz Vilbig, "Lehrbuch der Hochfrequenztechnik. Mit 801 Abbildungen." Akademische Verlagsgesellschaft, Leipzig, 1937. xix+775 pages. \$14.25.

Alternating; Geology, Prospecting

Volker Fritsch, "Messverfahren der Funknutzung." Oldenbourg, München, 1943. 220 pages. \$5.75.

Measuring

Herbert Lennartz, "Praktische Messgeräte für Hoch- und Niederfrequenz." Weidmann, Berlin, 1944. ix+239 pages. \$3.50.

ELECTRIC DISCHARGES THROUGH GASES: ELECTRONICS

Joachim Dosse and G. Mierdel, "Der elektrische Strom im Hochvakuum und in Gasen; Einführung in die physikalischen Grundlagen." Hirzel, Leipzig, 1943. xii+352 pages. (Physik und Technik der Gegenwart. Abt. Fernmeldetechnik Bd. 12). \$9.00.

ELECTRIC INSULATORS

Paul Böning, "Elektrische Isolierstoffe. Ihr Verhalten auf Grund der Ionenadsorption an inneren Grenzflächen." Vieweg, Braunschweig, 1938. vi+134 pages. \$3.00.

ELECTRIC MEASUREMENTS

Otto Zinke, "Hochfrequenz-Messtechnik." Hirzel, Leipzig, 1938. xii+233 pages. \$6.20.

Measuring Instruments

Paul Martin Pfier, "Elektrische Messung mechanischer Größen." 2. erweiterte Aufl. Springer, Berlin, 1943. vi+259 pages. \$6.50.

ELECTRIC WAVES

Hans Erich Hollmann, "Physik und Technik der ultrakurzen Wellen." Springer, Berlin, 1936. v. 1: \$8.75; v. 2: \$7.20; set, \$13.50.

Otto Groos, "Einführung in Theorie und Technik der Dezimeterwellen." Hirzel, Leipzig, 1937. v. 1: x+188 pages. \$4.65.

Heinz Richter, "Elektrische Kippschwingungen; Wesen und Technik." Hirzel, Leipzig, 1943. x+154 pages. \$3.50.

Vacuum Tubes

"Bucherei der Hochfrequenztechnik," Leipzig, Akad. Verlagsgesellschaft, 1940. \$32.25. v. 1: Bruno Beckmann, "Die Ausbreitung der elektromagnetischen Wellen." x+286 pages. \$9.65.

v. 2: Horst Rothe, "Grundlagen und Kennlinien der Elektronenröhren." xiv+325 pages. \$9.50.

v. 3: Horst Rothe, "Elektronenröhren als Anfangsstufenverstärker." xiii+303 pages. \$8.60.

v. 4: Horst Rothe, "Elektronenröhren als End- und Sendverstärker." x+141 pages. \$4.50.

ELECTRON EMISSION

Hajo Bruining, "Die Sekundär-Elektronen-Emission fester Körper." Springer, Berlin, 1942. vii+126 pages. (Technische Physik in Einzeldarstellungen. Bd. 5.) \$4.00.

ELECTRON EMISSION OF SOLIDS

Hajo Bruining, "Die Sekundär-Elektronen-Emission fester Körper." Springer, Berlin, 1942. xii+126 pages. (Technische Physik in Einzeldarstellungen, Bd. 5.) \$6.00.

ELECTRON MICROSCOPE

Baron Manfred von Ardenne, "Elektronen-Übermikroskopie. Mit einem Titelbild, einer photographischen Tafel und 404 Abbildungen." Springer, Berlin, 1940. xvi+393 pages. \$13.00.

ELECTRON TUBES

Horst Rothe, "Elektronenröhren als Schwingungserzeuger und Gleichrichter." Leipzig, Akad. Verlagsges., 1941. x+210 pages. \$3.00.

ELECTRONS; VACUUM TUBES

Carl Ramsauer, ed., "Das freie Elektron in Physik und Technik." Springer, Berlin, 1940. vii+270 pages. \$9.55.

GUMS AND RESINS, SYNTHETIC

Johannes Scheiber, "Chemie und Technologie der künstlichen Harze." Wissenschaftl. Stuttgart. Verlagsges., 1943. xix+828 pages. \$18.50.

HIGH-FREQUENCY TECHNIC

Fritz Vilbig and J. Zenneck, "Fort-schritte der Hochfrequenztechnik." 2. Aufl. Leipzig, Akad. Verlagsges., 1941. xii+656 pages. \$23.00.

HYDROGEN-ION CONCENTRATION; ELECTRIC MEASUREMENTS

Frans Fuhrmann, "Elektrometrische pH-Messung mit kleinen Lösungsmengen." Springer, Wien, 1941. vi+133 pages. \$3.00.

OPTICS

Electronic

Ernst Brüche, "Geometrische Elektronenoptik. Grundlagen und Anwendungen. Mit einem Titelbild und 403 Abbildungen." Springer, Berlin, 1934. xi+332 pages. \$8.00.

Johannes Picht, "Einführung in die Theorie der Elektronenoptik." Barth, Leipzig, 1939. viii+197 pages. \$4.50.

Electrons: Optical Instruments

Ernst Brüche, "Elektronengeräte. Prinzipien und Systematik." Springer, Berlin, 1941. xiv+447 pages. \$15.85.

PHOTOELECTRIC CELLS

Helmuth Simon and R. Suhrmann, "Lichtelektrische Zellen und ihre Anwendung." Springer, Berlin, 1932. vii+373 pages. \$11.00.

PHOTOGRAPHY

"Handbuch der wissenschaftlichen und angewandten Photographie." Springer, Wien.

v. 1: "Das photographische Objektiv," 1932, ix+399 pages. \$15.00.

v. 2: "Die photographische Kamera und ihr Zubehör," 1931. ix+590 pages. \$21.60.

PYRO- AND PIEZOELECTRICITY: QUARTZ

Adolf Scheibe, "Piezoelektrizität de Quarzes." Steinkopff, Dresden, 1938. xii+236 pages. (Wissenschaftliche Forschungsberichte. Naturwiss. Reihe. Bd. 45). \$5.75.

RADIATION

Maurice Deribere, "Les Applications pratiques de la luminescence; fluorescence, phosphorescence, lumiere noire." Dunod, Paris, 1938. xiv+263 pages. \$5.00.

RADIO

Hans Günther (i.e. Walter de Haas), "Schule des Funktechnikers. Ein Hilfsbuch für der Beruf mit besonderer Berücksichtigung der Rundfunk- und Fernsehtechnik." Frankh, Stuttgart, 1941. v. 1: viii+341 pages; v. 2: 342 pages; v. 3: 352 pages. \$17.50.

Amplifiers; Receivers

Maximilian J. O. Strutt, "Verstärker und Empfänger." Springer, Berlin, 1943. xiv+384 pages. (Lehrbuch der drahtlosen Nachrichtentechnik. Bd. 4) \$11.50.

Antennas

Helmut Brückmann, "Antennen; ihre Theorie und Technik." Hirzel, Leipzig, 1939. xiv+339 pages. (Physik und Technik der Gegenwart. Abt. Fernmeldtechnik, 5.) \$8.40.

Apparatus and Supplies; Electric Filters

Richard Feldtkeller, "Einführung in die Theorie der Rundfunk-Siebschaltungen." Hirzel, Leipzig, 1940. 168 pages. (Physik und Technik der Gegenwart Bd. 7.) \$3.75.

TELEGRAPH; TELEPHONE; RADIO

Richard Feldtkeller, "Einführung in die Vierpoltheorie der elektrischen Nachrichtentechnik." 3., verb. Aufl. Hirzel, Leipzig, 1943. xi+169 pages. (Physik und Technik der Gegenwart. Abt. Fernmeldetechnik. Bd. 2). \$3.75.

Wireless; Radio; Television

"Lehrbuch der Drahtlosen Nachrichtentechnik." Springer, Berlin, 1940. 2 vols. \$16.75.

TELEVISION

Fritz Schröter, "Fernsehen. Die neuere Entwicklung insbesondere der deutschen Fernsehtechnik. Vorträge von M. von Ardenne, E. Brüche u.a." Springer, Berlin, 1937. vi+260 pages. \$8.40.

VACUUM

Günther Mönch, "Vacuumtechnik im Laboratorium." Wagner, Weimar, 1937. 218 pages. \$5.00.

VACUUM TUBES

Maximilian Julius Otto Strutt, "Moderne Mehrgitter-Elektronenröhren. Bau, Arbeitsweise, Eigenschaften, elektrophysi-kalische Grundlagen." 2. verm. und verb. Aufl., Springer, Berlin, 1940. viii+283 pages. \$5.00.

VACUUM TUBES; METALS

Werner Espe and M. Knoll, "Werkstoffkunde der Hochvakuumtechnik. Eigenschaften, Verarbeitung und Verwendungstechnik der Werkstoffe für Hochvakuumröhren und gasgefüllte Entladungsgefäße." Springer, Berlin, 1936. viii+386 pages. \$15.75.

Contributors

Clarence Weston Hansell (A '26-M'29-SM'43) was born on January 20, 1898 at Medaryville, Indiana. He received the B.S. degree in electrical engineering from Purdue University, in 1919. In the summer of 1918,



CLARENCE WESTON HANSELL

he took the operations training course of the Commonwealth Edison Company in Chicago. In the fall of 1918, he was enrolled in the Student Army Training Corps of the U. S. Army, stationed at Purdue University.



HEINZ E. KALLMANN



From June 1919 to May 1920, he was employed in the test training course of the General Electric Company at Schenectady, N. Y., and during this time was in charge of factory tests on Alexanderson high-frequency alternators. From May to September, 1920, he was in the radio-engineering department of the General Electric Company, engaged in testing and placing in service equipment in RCA transoceanic radio stations.

From September, 1920, until 1929 he was employed by the Radio Corporation of America and was engaged in the develop-

ment, design, and placing in service of radio transmitting equipment. This work was continued in R.C.A. Communications, Inc., when that company was formed in 1929.

In 1925, Mr. Hansell founded the RCA radio-transmission laboratory at Rocky Point, Long Island, and has continued as active head of the laboratory since that time. The laboratory has carried on pioneer work in the development and application of equipment to operate at higher and higher frequencies.

Mr. Hansell was a recipient of a National Modern Pioneers Joint Award of the National Association of Manufacturers in 1940. He is a member of the American Institute of Electrical Engineers, Franklin Institute, Electrochemical Society, and the American Association for the Advancement of Science.



Heinz E. Kallmann (A'38) was born on March 10, 1904, at Berlin, Germany. He received his Ph.D. degree from the University of Goettingen in 1929. From 1929 to 1934, Dr. Kallmann was a research engineer in the laboratories of the C. Lorenz A. G., and from 1934 to 1939 he was an engineer in the research and design department of Electric and Musical Industries, Ltd. Since 1939, Dr. Kallmann has been a consultant in New York City. During 1940, he was a member of the New York Laboratory Staff of Scophony Television, Ltd. In



R. E. SPENCER



1943, he joined the staff of the Radiation Laboratory, Massachusetts Institute of Technology.



Rolf Edmund Spencer was born at Sutton, Surrey, England, on April 19, 1908. He received the B.A. degree in mathematics from Oxford University in 1929, and since that date Mr. Spencer has been a member of the designs department of the Electric and Musical Industries, Ltd., at Hayes, Middlesex, England.





YOU SHOULD HAVE THIS CATALOG ON HAND!

It contains complete information on the new line of C.T.C. Terminal Lugs that are proving to be the best, fastest, most economical route to firm, swift soldering terminal posts. There's the interesting facts about an Ultra-High Frequency I-F Transformer that's no bigger than your thumb and complete information on C.T.C. X-ray Oriented Crystals which are setting new standards of performance and long life.

You may find the information in the Catalog very useful to you in connection with present or projected components. Write for it today. Ask for C.T.C. Catalog Number 100. No obligation, of course.

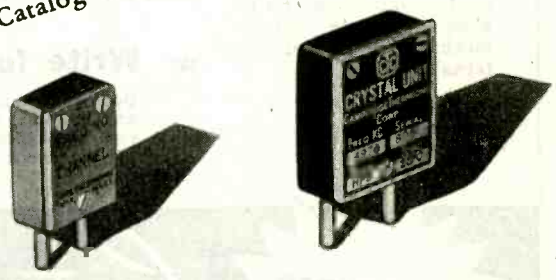

CAMBRIDGE THERMIONIC CORPORATION
456 CONCORD AVENUE · CAMBRIDGE 38, MASSACHUSETTS

POWER RESISTOR DECADE BOX



Covers resistance range of 1 ohm to 999,999 ohms.

★

Each decade dissipates up to 225 watts. Green-ohms (wire-wound cement-coated power resistors) used throughout. Glass insulated wiring.

★

Six decade switches on sloping panel.

★

Maximum current per decade: 5, 1.5, .5, .15, .05 and .005 amp.

★

Attractive frosted-gray metal case. Etched black-and-aluminum panel. Dual binding posts for left- and right-hand duty.

★

Grille at bottom and louvres at side for adequate ventilation. Baffle plate protects switch mechanism against internal heat.

★

13" long, 8½" deep, 5¾" high. Weight, 11 lbs.

★ Since its introduction several years ago, the Clarostat Power Resistor Decade Box has become a "must" among busy engineers, laboratory workers, maintenance men and others. Especially so during the hustle and bustle of war work.

Definitely in a class by itself. There's nothing else just like it. Note that it is a *power resistor* decade box. That means the introduction of the correct resistance value for any circuit or application for use under actual working conditions, at the mere twist of the knobs. The resistance which provides the correct operating conditions is then read directly off the dials. No calculations required. No guesswork. No time-consuming routine. No wonder the Clarostat Power Resistor Decade Box pays for itself in short order.

★ Write for literature . . .

Descriptive bulletin sent on request. Likewise literature on controls or resistors in which you are particularly interested. Let us quote on your requirements.

CLAROSTAT



Controls and Resistors

CLAROSTAT MFG. CO., Inc. - 285-7 N. 6th St., Brooklyn, N. Y.



ATLANTA

"The Manufacture of Quartz Crystals for the Armed Services," by J. B. Peebles, Pan-Electronics Laboratories, Inc.; September 29, 1944.

"War Department Battle Films," by T. B. Sawyer, United States Army; October 27, 1944.

Discussion on Postwar Engineering Education; November 24, 1944.

BUFFALO-NIAGARA

"The Air Plane," by H. W. Tompkins, Curtiss Wright Corporation; January 17, 1945.

CEDAR RAPIDS

"The Noise-Cancellation Differential Dynamic Microphones," by R. H. Mayer, The Turner Company; January 10, 1945.

CHICAGO

"The Engineer's Place in the Scheme of Things," by R. H. Herrick, Automatic Electric Company; J. E. Brown, Zenith Radio Corporation; A. B. Bronwell, Northwestern University; and J. E. Hobson, Illinois Institute of Technology; November 17, 1944.

"Factors Influencing Fidelity in Home Radio and Record Reproduction," by R. P. Glover, Consulting Engineer; B. B. Bauer, Shure Brothers; and H. S. Knowles, Jensen Radio Corporation; December 15, 1944.

"Electromagnetic Measurements with Strain Gages," by C. M. Hathaway, Hathaway Instrument Company; December 15, 1944.

"Television Developments," by D. E. Foster, Majestic Radio and Television Corporation; January 19, 1945.

"Television Distribution Systems," by C. W. Hansell, RCA Laboratories; January 19, 1945.

CINCINNATI

"Elimination of Radio Interference in Engine Ignition Systems," by F. L. Wedig, Crosley Corporation; January 17, 1945.

CLEVELAND

"1584 Miles per Hour Flown Remote-Controlled," by R. T. Crowell; September 28, 1944.

"Some Present Applications of Radio-Frequency Oscillators to Field of Induction Heating," by J. B. Wadhams, Ohio Crankshaft Company; October 26, 1944.

"Magnetic-Tape Transient Recorder," by H. B. Shaper, Brush Development Corporation; November 30, 1944.

DALLAS-FORT WORTH

"Radio-Frequency Induction and Dielectric Heating," by R. L. Bieseke, Jr., Southern Methodist University; January 15, 1945.

Election of Officers; January 15, 1945.

DAYTON

"Radio Plans for Postwar Aviation," by Don Stewart, Civil Aeronautics Administration; January 18, 1945.

DETROIT

Discussion of Induction Heating of Conducting and Nonconducting Materials, by Howard Boltz, Detroit Edison Company; January 19, 1945.

EMPORIUM

"Molecular Processes in Gas-Discharge Tubes," by J. G. Winans, University of Wisconsin; January 15, 1945.

(Continued on page 36A)

\$1,000 EDITORIAL AWARDS

☞ To encourage, through publication, the widest possible dissemination of electronic engineering information of the greatest practical value, Caldwell-Clements, Inc., Publisher of **ELECTRONIC INDUSTRIES**, announces Awards totalling \$1000 for articles or papers having to do with the application of electronic principles.

☞ Three Awards will be made—a First Award of \$600, a Second Award of \$300 and a Third Award of \$100—for articles or papers of outstanding significance that are published in the Editorial columns of **ELECTRONIC INDUSTRIES** during the remainder of the year 1945.

☞ Complete particulars of the Award offer will be found in the March issue of **ELECTRONIC INDUSTRIES**. Correspondence with regard to the subject is welcomed by the Editors.

CALDWELL-CLEMENTS, INC.

Publisher—**ELECTRONIC INDUSTRIES**

480 LEXINGTON AVENUE NEW YORK 17, N.Y.

LINGO

VERTICAL TUBULAR STEEL RADIATORS

**... NOW
available
promptly
to stations
with
necessary
priority**

We are ready now to serve you again, if you have the proper priority to purchase new equipment. In planning your modernization program, be sure to investigate the exclusive and superior features of the Lingo Vertical Tubular Steel Radiator. They are available in standard heights—100 to 500 feet. Orders placed now can be delivered within a few weeks. Write at once for details.

Lingo also produces tubular steel poles for the support of FM, Television and other UHF antennas.

Our staff will be pleased to provide you with the complete story as it applies in your own case. In writing, please give location, power, frequency of station, and indicate radiator height desired.

JOHN E. LINGO & SON, INC.
Est. 1897 Camden, New Jersey



(Continued from page 34A)

INDIANAPOLIS

"Unpublicized Facts About Frequency-Modulation Broadcasting," by Sarkes Tarzian, Consulting Engineer; December 29, 1944.

KANSAS CITY

"Frequency-Modulation Antennas," by M. W. Scheldorf, General Electric Company; January 15, 1945.

LONDON

"Radio Links Over Land," by S. T. Fisher, Rogers Electronic Tubes; January 11, 1945.

NEW YORK

"Radio-Relay Systems," by C. W. Hansell, RCA Transmission Laboratory; January 3, 1945.

"Electronics and Electronic-Tube Development," by J. E. Mourontseff, Westinghouse Electric and Manufacturing Company; January 3, 1945.

"Train Communication," by J. L. Niesse, New York Central System; January 9, 1945.

"Train Communication," by C. N. Kimball, Aircraft Accessories Corporation; January 9, 1945.

"Trends in Receiving-Tube Design and Application," by Louis Martin, Radio Corporation of America, January 10, 1945.

"The Lighthouse Tube," by E. F. Petersen, General Electric Company; January 10, 1945.

"Application of Circuit Theory to the Design of Servo Mechanisms," by A. C. Hall, Massachusetts Institute of Technology; January 17, 1945.

ROCHESTER

"Postwar Radio," by R. H. Manson, Stromberg-Carlson Company, January 16, 1945.

"Wave Concepts in Electricity," by J. R. Whinnery, General Electric Company; January 18, 1945.

SAN DIEGO

"Ultra-High-Frequency Propagation Phenomena," by August Hund, United States Navy Radio and Sound Laboratory; January 18, 1945.

SEATTLE

"Engineering Education," discussion led by F. B. Mossman and A. V. Eastman; December 15, 1944.

Election of Officers; December 15, 1944.

"Recent Developments in the Study of Electric Arcs," by C. K. Stedman, Boeing Aircraft Company; January 11, 1945.

TORONTO

"Radio Links for Long-Distance Telephone Service," by S. T. Fisher, Rogers Electronic Tubes, Ltd.; November 30, 1944.

TWIN CITIES

"Measurements in Disk Recording," by C. J. Le Bel, Audio Devices; January 9, 1945.

WASHINGTON

"The Lighthouse Tube," by E. F. Peterson, General Electric Company; January 8, 1945.

WILLIAMSPORT

"The Suppressed Carrier Modulator as a Frequency Translator," by F. B. Bramhall, Western Union Telegraph Company; January 5, 1945.

IRC PRESENTS



THE NEW FRW FLAT WIRE WOUND RESISTORS

Flat as a flounder, efficient as a standard tubular wire wound . . . and available right now for essential uses . . . the new Type FRW packs a wealth of features to recommend it for many limited-space applications.

Five standard sizes, covering the 0.1 to 22,000 ohm range, are now being built to JAN-R-26 specifications for RW20, RW21, RW22, RW23 and RW24 requirements.

Non-magnetic mounting brackets extending through the resistor allow easy and economical mounting, aid in uniform heat distribution along the entire length of the resistor, and serve as conductors to transfer internal heat to the chassis.

FRW's may be mounted vertically or horizontally, either singly or "stacked." Although light in weight, they have exceptional mechanical strength and withstand severe vibration. They reflect in every detail IRC's traditional high quality.

INTERNATIONAL RESISTANCE CO.

For more complete details write for FRW engineering data bulletin, now in preparation.

Dept. 10-C

401 NORTH BROAD STREET, PHILADELPHIA 8, PA.

IRC makes more types of resistance units, in more shapes, for more applications than any other manufacturer in the world.



AN 3155
Rheostat

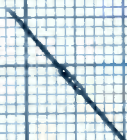

BTR—1/4 watt
Insulated Resistor

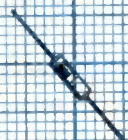

BTA—1 watt
Insulated Resistor

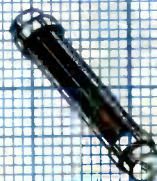

Grade 1—Class 1
Resistors



Type FRW
Resistor



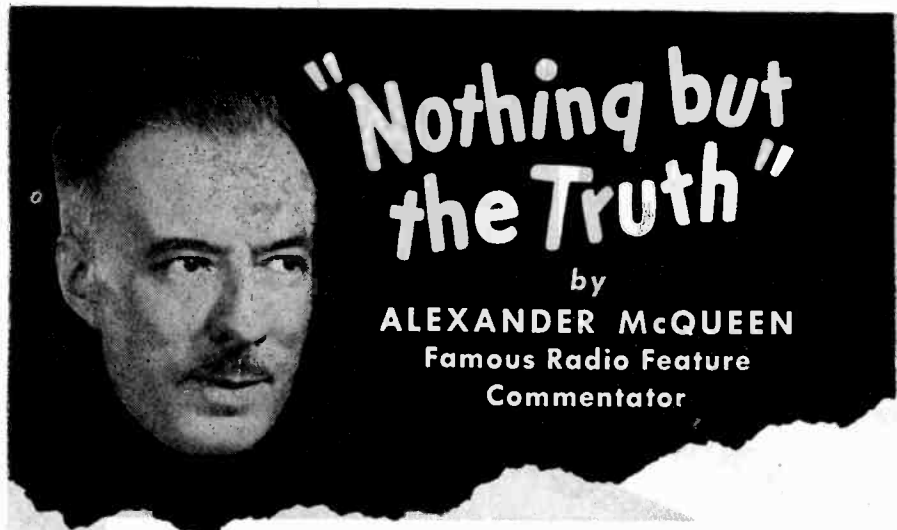

"Nothing but the Truth"

by
ALEXANDER McQUEEN
Famous Radio Feature
Commentator

A Monarch Fact Story

HOW DID TESTING START?



The women of ancient Rome were forbidden to drink wine while their husbands were away. To check on their abstinence, it was the custom for the husband, upon his return, to "taste" the lips of each woman in the household. Originally this was called "tasting" but eventually it became known as "TESTING"

... and that's
"NOTHING BUT THE TRUTH"

... BUT TODAY

For the exacting measurements and tests required in all phases of radio and electronics, engineers prefer

MONARCH

MEASURING • TESTING • CALIBRATING

Equipment

... and that's "nothing but the truth"



2014 N. MAJOR AVE. • CHICAGO 39, ILL.



The following admissions and transfers were approved on February 6, 1945:

Transfer to Senior Member

- Bates, J. F., 2440 Lakeview Ave., Chicago, Ill.
- DeCola, R., 21 N. Lincoln Ave., Park Ridge, Ill.
- Gellerup, D. W., WTMJ, 720 E. Capitol Dr., Milwaukee, Wis.
- Henderson, R. A., 901 Eldridge Ave., West Collingswood, N. J.
- Herrfeld, F. P., Box No. 271, New London, Conn.
- Jones, C. B., 2321 Grandview Ave., Cleveland, Ohio
- Melloh, A. W., 863 D Ave., Coronado, Calif.
- Smith, W. M., 79 Ashbrook Ave., Springfield, Mass.
- Schoenfeld, E., c/o RCA Laboratories, 711 Fifth Ave., New York, N. Y.
- Stodola, E. K., Box 215B, RFD No. 2, Neptune, N. J.
- Tiedemann, D. P., 1261 Shearer St., Montreal, Que., Canada

Admission to Senior Member

- Booker, H. G., Flat 2, Combermere Ave. Rd., Great Malvern, England
- Bradley, W. E., 219 N. Swarthmore Ave., Swarthmore, Pa.
- Breit, G., Ballistic Research Laboratory, Aberdeen Proving Ground, Md.
- Hahn, W. C., R.D. 2, Spring Rd., Scotia, N. Y.
- Samuelson, R. E., 7320 Bennett Ave., Chicago, Ill.
- Searby, N. H., Ferranti, Ltd., Moston, Manchester, England
- Slepian, J., Westinghouse Electric and Manufacturing Company, East Pittsburgh, Pa.

Transfer to Member

- Anderson, A. E., 413 Ludlow Ave., Spring Lake, N. J.
- Brooke, E. F., 2316 Livingston Ave., Bexley, Ohio
- Clark, W. R., 197 Oceanport Ave., Long Branch, N. J.
- Coil, N. B., Bowdoin College, Brunswick, Me.
- Davis, J. W., 4717 Dartford Ave., Baltimore, Md.
- Elliott, T. A., 5406 Belmont Ave., Dallas, Texas
- Fancy, R. C., 2316 Sherman Ave., Evanston, Ill.
- Guyer, E. M., 7 W. Fourth St., Corning, N. Y.
- Herrmann, F. W., 4224 Drew Ave., S., Minneapolis, Minn.
- Hudson, W. E., 334 E. Broadway, Louisville, Ky.
- Klein, W. S., 4510 Russell Ave., Los Angeles, Calif.
- Ley, Gordon S., 202 Huron Rd., Catonsville, Md.
- McLennan, M. A., 2217 N. Main St., Dayton, Ohio
- Nunner, R. J., 4014 Brooklyn Ave., Seattle, Wash.
- Ottemiller, W. H., Jr., Box 221, Emporium, Pa.
- Perkins, T. B., RCA Victor Division, Harrison, N. J.
- Pettit, J. M., Radio Research Laboratory, Harvard University, Cambridge, Mass.
- Prehn, L. D., 30 Old Glebe Rd., Arlington, Va.
- Ross, E. O., 1649 Touhy Ave., Chicago, Ill.
- Seifert, F. F., Signal Corps Standard Agency, 12 Broad St., Red Bank, N. J.
- Sheppard, H. S., 195 Broadway, New York, N. Y.
- Spencer, H. L., 21 W. Pennsylvania Ave., Towson, Md.
- Suffield, F. G., 2636 N. Charles St., Baltimore, Md.
- Tapp, J. E., 115 E. 12th St., Long Beach, Calif.
- Whiteman, R. A., 6600 N. Bosworth Ave., Chicago, Ill.
- Wischmeyer, C. R., Rice Institute, Box 1892, Houston, Texas

Admission to Member

- Bowler, G. E., 53 Chesbrough Rd., W. Roxbury, Mass.
- Burley, P. B., 135 E. 11th Place, Chicago, Ill.

(Continued on page 42A)

OHMITE RESISTORS

Many Types and Sizes
Assure the Right Resistor
for Each Control Job

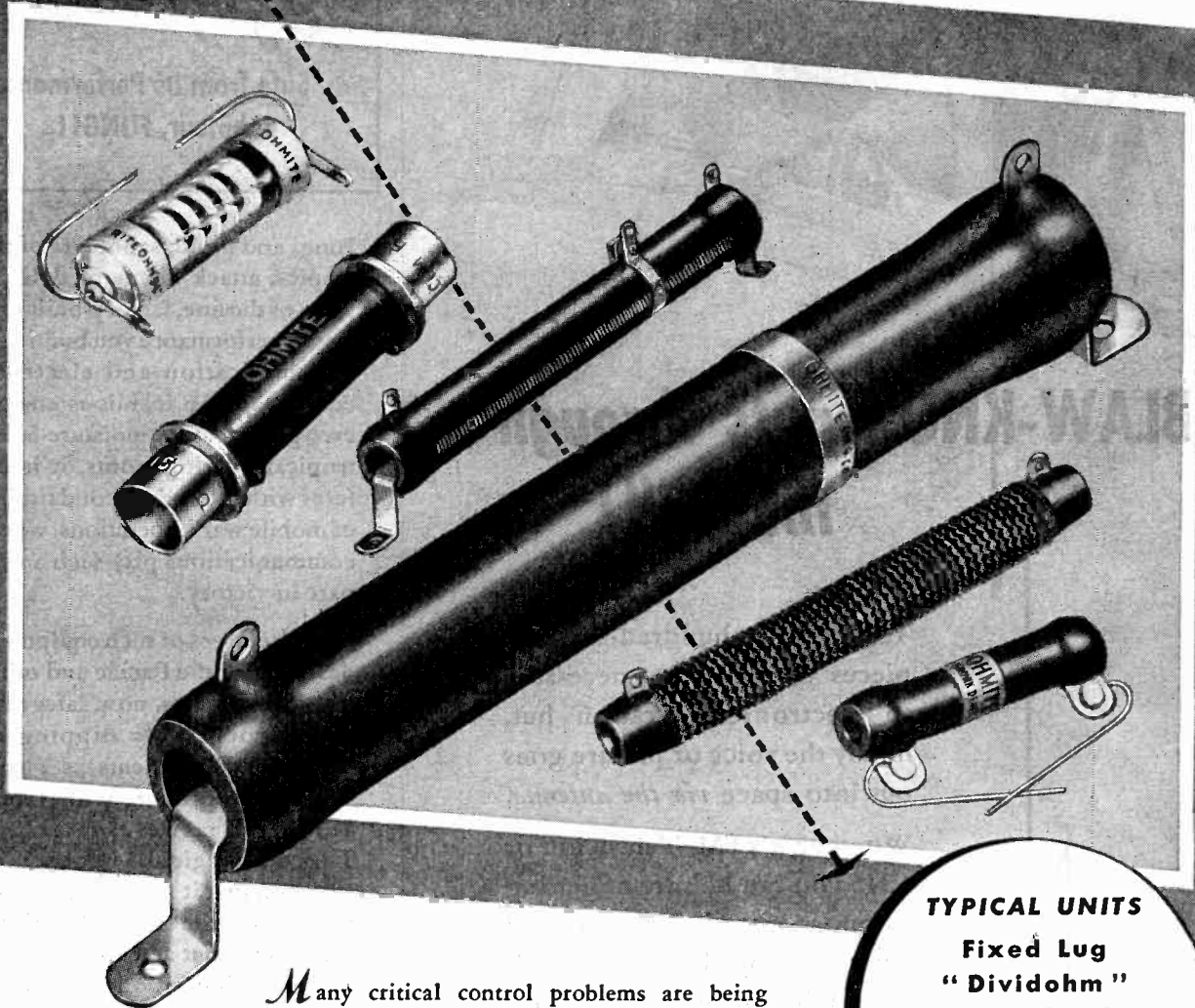

Many critical control problems are being readily and successfully solved with Ohmite Resistors. That's because the extensive range of Ohmite types and sizes makes possible an almost endless variety of regular or special units to meet each need best.

Ohmite core sizes range from 2½" diameter by 20" long to ¼" diameter by 1" long. Wide selection of stock units are available.

These rugged resistors have proved their worth under toughest operating conditions, in every field of action. Ohmite engineers are glad to help on today's and tomorrow's control problems.

OHMITE MANUFACTURING COMPANY
4860 Flournoy Street • Chicago 44, U.S.A.

TYPICAL UNITS

Fixed Lug
"Dividohm"
Wire Lead
"Corrib"
Ferrule
Edison Base
Precision
Bracket
Non-Inductive
Tapped
Cartridge
Strip

Be Right with **OHMITE**
RHEOSTATS • RESISTORS • TAP SWITCHES

Send for Catalog and Engineering Manual No. 40

Write on company letterhead for this complete, helpful guide on resistors, rheostats, tap switches. Address OHMITE, 4860 Flournoy, Chicago 44.





BLAW-KNOX puts through the Call!

There are a hundred-and-one pieces of apparatus necessary to electronic operation but, finally the voice or picture goes out into space *via the antenna*.

Whether it's FM, Television or VHF you can be sure of getting the most out of your power and equipment by "Putting the Call Through" on Blaw-Knox Vertical Radiators.

BLAW-KNOX DIVISION
of Blaw-Knox Company

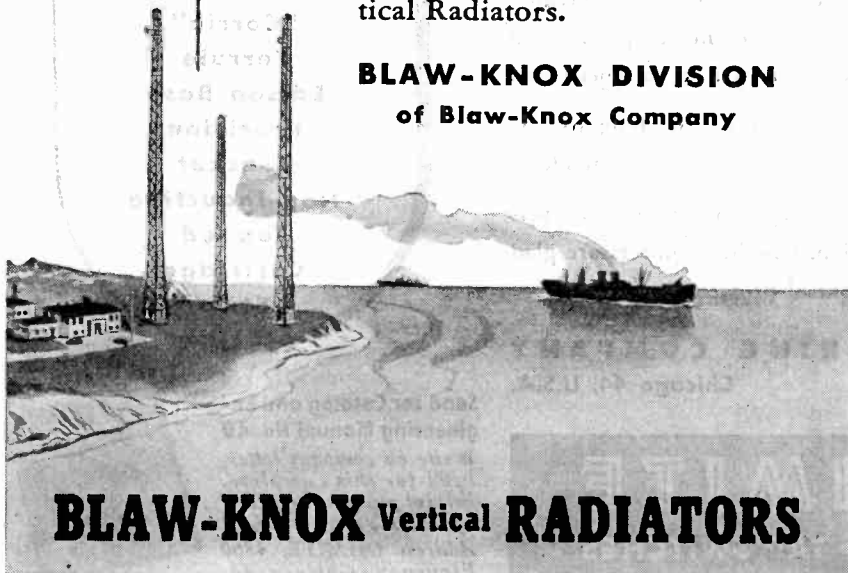

BLAW-KNOX Vertical RADIATORS

TROPICALIZED
*Communication
Equipment*

...Safe from its Performance
Saboteur, FUNGI!

Fungi and mold, saboteurs of the tropics, attack the many delicate parts of the fine, factory-built precision performance you build into communication and electrical equipment. An insidious enemy, ever-present at the moisture-laden tropical fighting fronts, it interferes with the split-second timing of mobile war's operations, where communications play such a vital part in victory.

Manufacturers of such equipment destined for the Pacific and other tropical climates, now safeguard their products by dipping or brushing components as a *post-assembly* procedure with Tropicalized Q-Max A-27 H.F. Lacquer. This anti-fungicidal lacquer is so effective, that it not only prevents infection of the surface by microorganisms, but actually provides a zone of inhibition around the coated areas as well.

Write for complete details about this factory-mixed fungicide-and-lacquer combination that comes in a convenient container—marked Tropicalized, for sure identification, on the Q-Max label.

Communication
PRODUCTS COMPANY, INC.

346 BERGEN AVE., JERSEY CITY, N. J.

Q-MAX CHEMICAL DIVISION

Coaxial Transmission Line & Fittings • Sterling Switches • Auto Dryaire • Antenna & Radiating Systems • Tropicalized Q-Max A-27 H.F. Lacquer

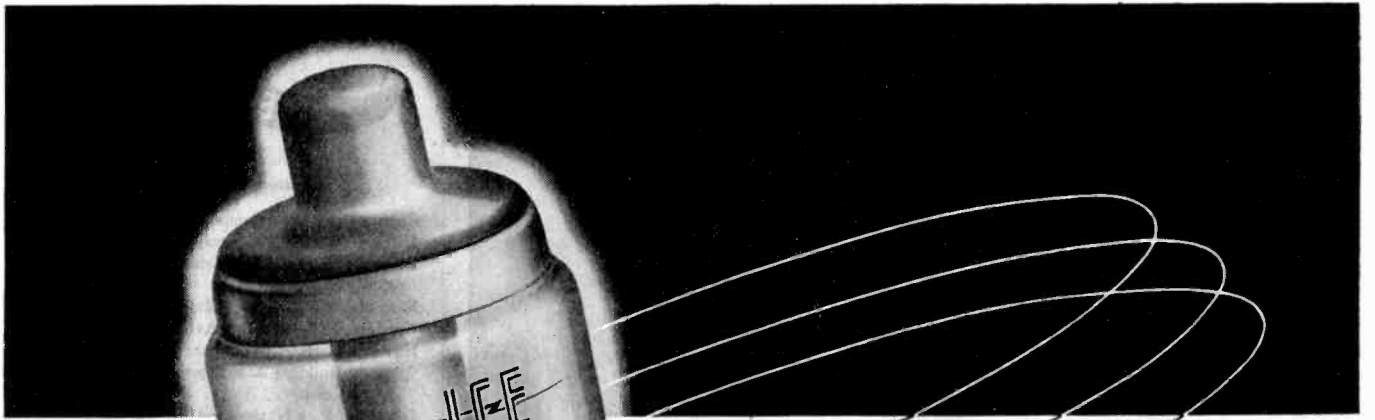

I. C. E.
VC-100 VACUUM
CONDENSOR

I. C. E. HAS THE ANSWER TO YOUR MICROMICROFARAD PROBLEM

You don't have to build equipment to suit the capacity of any particular condenser. I. C. E.'s advanced research now makes available to you reliable vacuum condensers in capacities ranging from 10 to 110 micromicrofarads ... in steps of one micromicrofarad. I. C. E. precision assures accuracy of one micromicrofarad, plus or minus. Standard condensers available in sizes VC-12 ... VC-25 ... VC-50 and VC-100.

Order your requirements today

Send for this Complete Catalog

A new catalog, fully illustrated, describes in detail I. C. E. vacuum condensers as well as other high precision vacuum equipment. Write for your free copy today.

Research on Your Other Problems

The I. C. E. research laboratory is ready to serve you in the development and designing of tubes and other vacuum units required by electronic equipment you are now designing. Write Engineering Department today.



ELECTRONIC TUBES
RESEARCH • DESIGN • PRODUCTION

INDUSTRIAL & COMMERCIAL ELECTRONICS
BELMONT, CALIFORNIA



**Make a "date"
WITH STANCOR NOW!**

If you are streamlining for the highly competitive markets we all shall face later on, do not injure your future with a mediocre transformer... Consider Stancor Transformers, fabricated to perfection, bearing an enviable record of performance here and abroad.

Stancor is still on a 24-hour victory schedule, but our engineering laboratory may give you an "early date" for a joint discussion on how Stancor Transformers may play an important part in making your units "front row" in your field.

STANDARD TRANSFORMER CORPORATION, 1500 NORTH HALSTED ST., CHICAGO 22, ILLINOIS

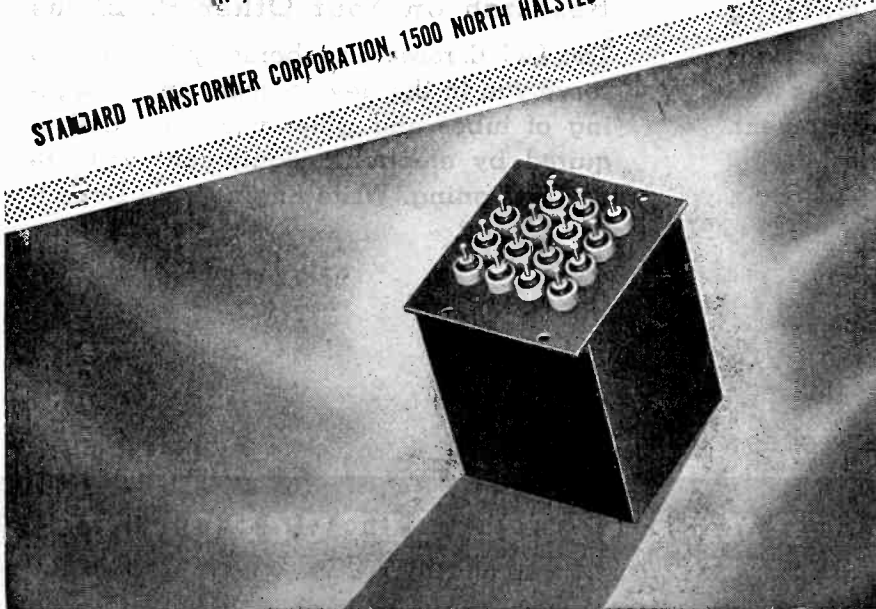

(Continued from page 38A)

- Cahan, L. C., 2860 Ocean Ave., Brooklyn, N. Y.
 Dilks, U. C. S., 503 Conway Ave., Narberth, Pa.
 Dunham, S. B., 2195 Grand Blvd., Schenectady, N. Y.
 Florance, H. C., 629 S. Fillmore St., Arlington, Va.
 Gardner, K. J., 111 East Ave., Rochester, N. Y.
 Hawes, B. K., Jr., General Electric Company, Building 33E, Boston Ave., Bridgeport 2, Conn.
 Jacob, W. P., 1 Nameaug Ave., New London, Conn.
 McClellan, C. E., 11 Enjay Ave., Baltimore, Md.
 McNaney, J. T., 1636 Ralworth Rd., Baltimore, Md.
 Millar, C. H., Radio Branch, National Research Council, Sussex St., Ottawa, Ont., Canada
 Moody, A. W., General Electric Company, 235 Montgomery St., San Francisco, Calif.
 Radmacher, D. S., Box 128, Route No. 1, Wantagh, N. Y.
 Ross, E. H., Galvin Manufacturing Corporation, 4545 Augusta Blvd., Chicago, Ill.
 Schick, H. G., 2207 Eighth Ave., Los Angeles, Calif.
 Shostak, A., 3056 S. Abingdon, Arlington, Va.
 Sturtevant, H., Route 6, Box 1160, Portland, Ore.
 Virgadamo, F., 167 Hicks St., Brooklyn, N. Y.
 Warrick, H. H., 5801 Kensington Pl., Seattle, Wash.
 Winter, L. L., 1280 W. 73 St., Box No. 6087, Cleveland, Ohio
 Yarbrough, H. B., Aircraft Radio Laboratory, Wright Field, Dayton, Ohio

Admission to Associate

- Abbott, E., 1775 Townsend Ave., Bronx, N. Y.
 Abrams, J. N., 803 Lenox Rd., Brooklyn, N. Y.
 Albrough, E. H., 89 Thames St., Ingersoll, Ont., Canada
 Allen, R. M., 2843 Hope St., Walnut Park, Calif.
 Andrews, E. G., 114 Kenneth Ave., Baldwin, L. I., N. Y.
 Appleton, F., Box 96, P. O. Rossland, B. C., Canada
 Babeaux, A. G., 915 Volante St., Arcadia, Calif.
 Baker, S. E., Jr., 1108 Market St., Seattle, Wash.
 Barotta, P. J., 191 Mallory Ave., Jersey City, N. J.
 Bekkar, B. N., 1226 Madison Pk., Chicago, Ill.
 Bennett, P. C., 731 Chatsworth Ave., Pittsburgh, Pa.
 Berry, F. R., 8034 Manila, Detroit, Mich.
 Bertin, E. P., 210 S. Main St., Muncy, Pa.
 Bigley, D. L., 836-54 St., Oakland, Calif.
 Black, D. R., 33 Lorraine St., Hartford, Conn.
 Blaquiere, B. E., Valparaiso Technical Institute, Valparaiso, Ind.
 Bradford, D. C., 41 Beekman St., Bloomfield, N. J.
 Bright, J. E., 939 Queen's Ave., London, Ont., Canada
 Brown, J. H., 623 E. Cedar, Saguin, Texas
 Brown, L. L., 405 Dickinson St., Springfield, Mass.
 Buckler, D. R., National Airlines, Inc., Jacksonville, Fla.
 Burkhard, F. J., 363 Melville Ave., Palo Alto, Calif.
 Carney, C. W., P. O. Box 111, Dayton, Ohio
 Carter, H. A., 1174 Cherry St., Winnetka, Ill.
 Catherman, E. E., 220 E. Allegheny Ave., Emporium, Pa.
 Cesar, E. M., Sr., 525 E. 145 St., Bronx, N. Y.
 Child, D. E., 106 S. Main St., Putnam, Conn.
 Cleckner, D. C., 172 W. Lane Ave., Columbus, Ohio
 Conroe, A. H., 136 Montague St., Brooklyn, N. Y.
 Cooke, L. G., 1595 Greenwich St., San Francisco, Calif.
 Curtis, G. L., 6003 El Monte, Mission, Kans.
 Dakin, O. C., 240 Sutherland Dr., Toronto, Ont., Canada
 Dawe, P. G. M., 27 Townsend Ave., Southgate, London, England
 Deltour, B., 2070 N. Faircooks Ave., Pasadena, Calif.
 Denney, J. M., 200 Mt. Pleasant Ave., Newark, N. J.

(Continued on page 46A)

KNOW-HOW BEGINS AT HOME

SPECIAL tools, ingenious manufacturing devices, and elaborate test equipment which makes delicate measurements almost as easy as telling the time . . . these things seem to interest our visitors particularly. We are always proud to point out that most of these aids to swift, precise production were developed by our own men and women.

There's a world of skill and experience at Con-

necticut Telephone & Electric Division . . . born of nearly fifty years of practice and progress. This know-how isn't confined to our engineering departments, either. Some of our most useful suggestions come straight from the production lines.

Purchasers of C. T. & E. products benefit from this skill and ingenuity . . . in better, more advanced devices, produced faster, for less.

CATHODE RAY SCREEN TESTER

Tests a telephone or radio headset for response over the entire range of audible sound in a matter of seconds, and charts the results on a television-type screen. Developed for our own use by our own people, this instrument has been a priceless aid in maintaining high quality and quantity in war production for the U. S. Signal Corps and Air Corps.

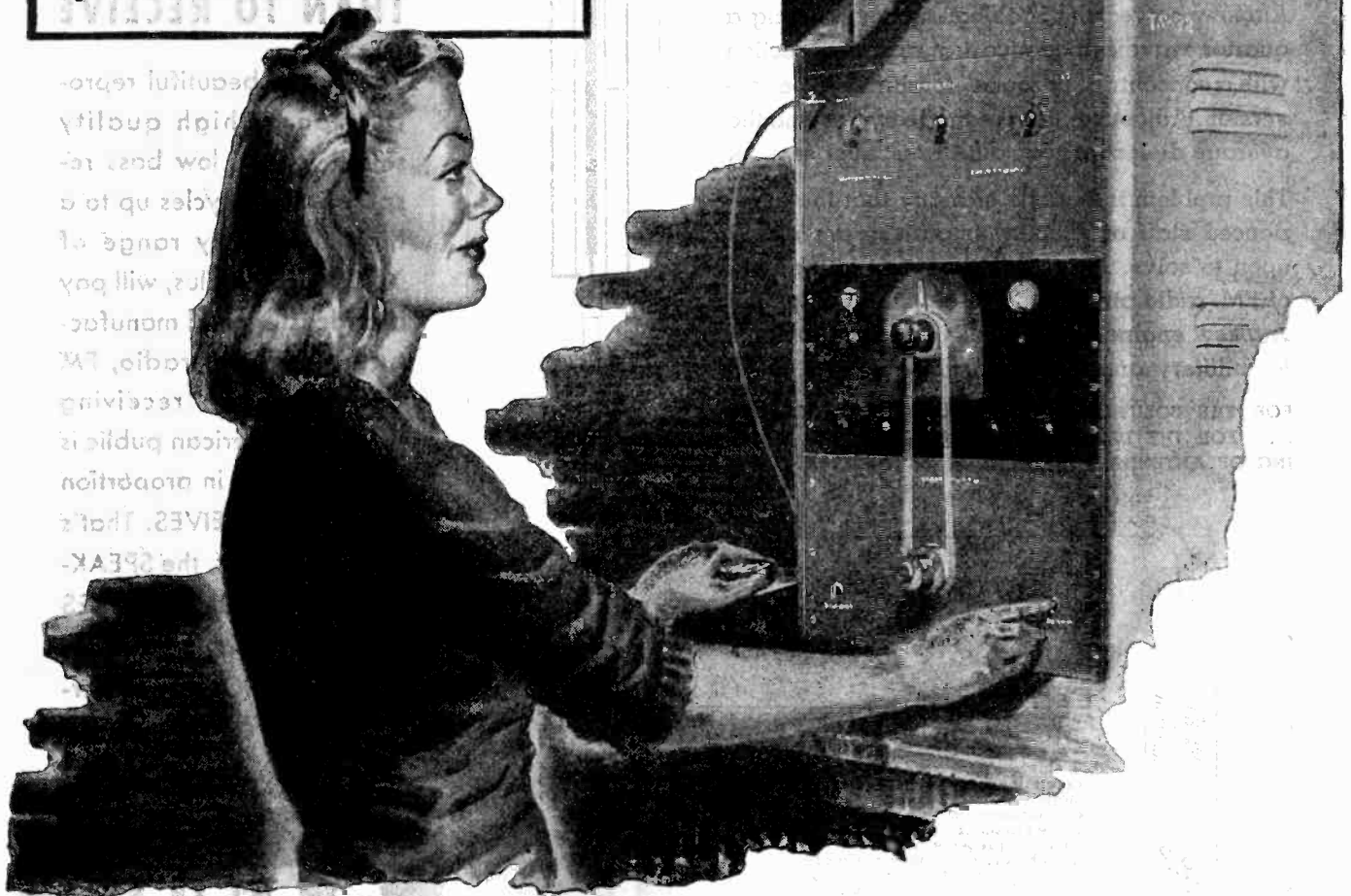

CONNECTICUT TELEPHONE & ELECTRIC DIVISION
GREAT AMERICAN INDUSTRIES, INC. • MERIDEN, CONN.

TELEPHONIC SYSTEMS • SIGNALLING EQUIPMENT • ELECTRONIC DEVICES • ELECTRICAL EQUIPMENT
HOSPITAL AND SCHOOL COMMUNICATIONS AND SIGNALLING SYSTEMS • IGNITION SYSTEMS

An ANDREW SOLUTION to an ANTENNA PROBLEM

 Faced with a difficult antenna problem, E. H. Andresen, Chief Engineer of Chicago's Board of Education Station WBEZ, called on ANDREW engineers for a solution. The problem was that of coupling a 70-ohm unbalanced coaxial transmission line to the much smaller balanced impedance of the antenna. Uncertainty of the exact value of the antenna impedance made the problem difficult, and called for some kind of an adjustable coupling device.

ANDREW solved the problem by constructing a quarter wave impedance transforming section with a concentric "bazooka" for the balance conversion. Adjustments were made by varying the average dielectric constant in resonant section.

This problem is but one of many that the experienced staff of ANDREW engineers are called upon to solve. As qualified experts in the field of FM, radio and television antenna equipment ANDREW engineers have solved many problems for military and broadcast engineers.

FOR THE SOLUTION OF YOUR ANTENNA PROBLEMS . . . FOR THE DESIGNING, ENGINEERING, AND BUILDING OF ANTENNA EQUIPMENT . . . CONSULT ANDREW

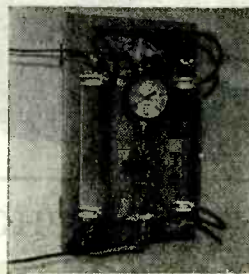
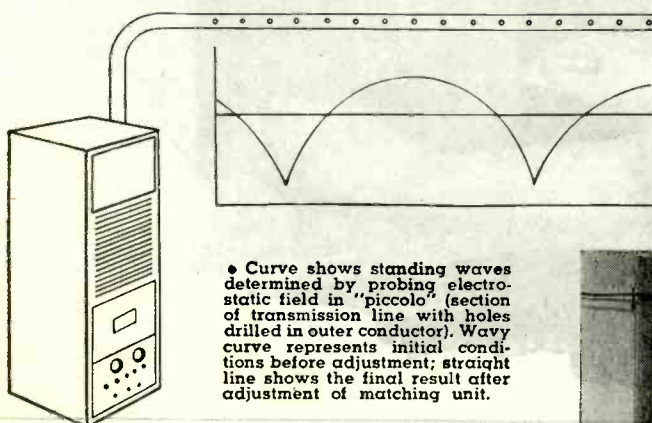

• Twin-barreled dehydrating unit especially designed for WBEZ by ANDREW engineers. Design permits leaving one cartridge in service while the other cartridge is being recharged.

ANDREW CO.



363 East 75th Street, Chicago 19, Illinois

IT IS BETTER
TO

Give

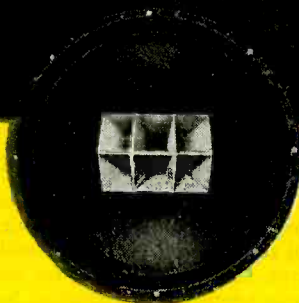

THAN TO RECEIVE

To GIVE a beautiful reproduction of high quality sound from a low bass response of 40 cycles up to a high frequency range of 15,000 cycles plus, will pay broadcasters and manufacturers of home radio, FM and Television receiving sets. The American public is willing to give in proportion to what it RECEIVES. That's why the Duplex, the SPEAKER that REVOLUTIONIZES the methods of sound REPRODUCTION, was perfected.

SEND FOR BULLETINS

ALTEC
LANSING CORPORATION

1210 TAFT BLDG., HOLLYWOOD 28, CALIF.

Proceedings of the I.R.E. March, 1945

To build BIG tubes takes BIG experience

G-E "know-how" is your safeguard when
buying heavy-duty, high-power amplifiers

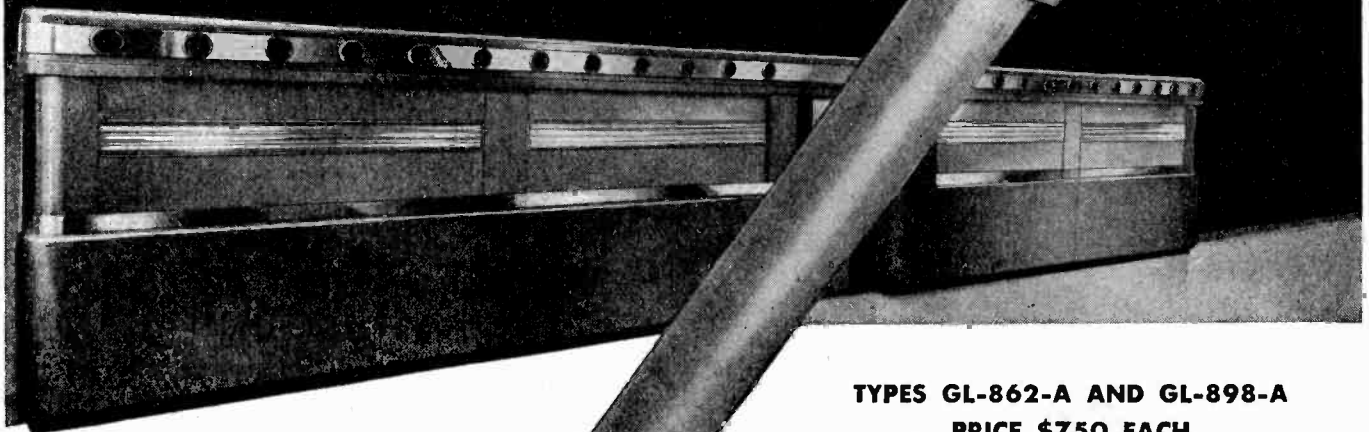

The modern 50-kw broadcast station requires powerful tubes like the water-cooled husky at the right. These large triodes represent a substantial investment—must be dependable, fully efficient.



TYPES GL-862-A AND GL-898-A PRICE \$750 EACH

These 3-electrode, water-cooled power tubes, for use as radio-frequency amplifiers, oscillators, or Class B modulators, also are widely employed industrially in high-frequency heating. They will dissipate 50 to 100 kw, depending on the type of service. Filament voltage for both tubes is 33 v; current is 207 amp. for 862-A, and 70 amp for each of the three filament sections of 898-A. Maximum plate ratings for both tubes in Class C service are 20,000 v and 10 amp. Frequency at maximum ratings, 1.6 megacycles.

The water-cooled transmitting tube with tungsten filament and copper anode was pioneered by G-E in 1919—one of an impressive group of General Electric electronic "firsts." Since that time the record has been one of continuous development and progress. At one time 500 to 1,000 hours was the average life of a high-power transmitting tube. Today this term is but a fraction of what may be expected in period of service.

Numerous technical improvements have punctuated the years since these large tubes were developed. Some of the most significant apply to the current models GL-862-A and

GL-898-A as against their predecessors. One such important advancement is the self-supporting filament and grid structure, which obviates the need of internal insulators, as well as helps do away with the problem of "transients" such as temporary over-voltage. GL-862-A and GL-898-A also are much easier to "break in." Despite improvements of this nature constantly being introduced, new G-E production methods and equipment made possible by large demand have brought about substantial cost savings, by reason of which the price of these tubes recently has been lowered from \$1,650

to \$750—a drop of more than one-half!

Telephone your nearest G-E office or distributor for information on high-power transmitting tubes or any other type included in the complete G-E line. Prices, ratings, performance charts, and other descriptive data will be furnished you promptly. Or write direct to *Electronics Dept., General Electric, Schenectady 5, N. Y.*

Hear the G-E radio programs: "The World Today" news, Monday through Friday, 6:45 p. m., EWT, CBS. "The G-E All-Girl Orchestra," Sunday 10 p. m., EWT, NBC. "The G-E House Party," Monday through Friday 4 p. m., EWT, CBS.

GENERAL  ELECTRIC
101-D3-6880

Shallcross Akra-Ohm ACCURATE FIXED WIRE- WOUND RESISTORS

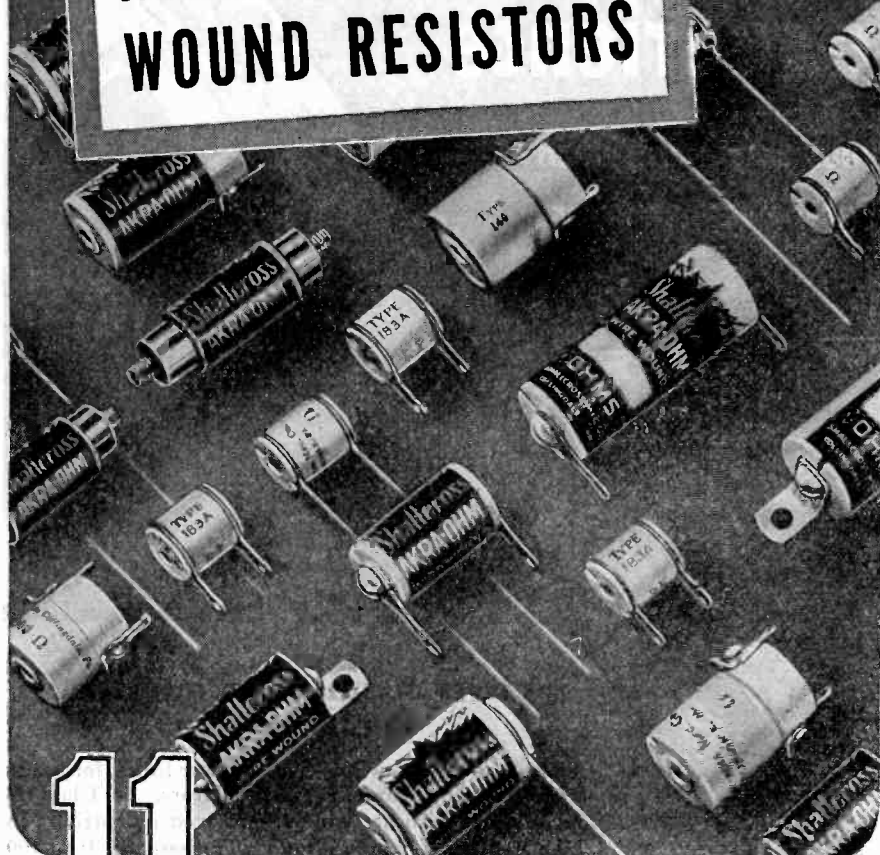

11

BASIC TYPES...DOZENS OF ADAPTATIONS TO MEET ANY NEED

For many years, Shallcross has devoted 100% of its extensive resistor engineering and production facilities exclusively to accurate fixed wire-wound types. This has resulted in bringing to the field of electronics 11 basic time-tested types. These types can be readily adapted to meet all engineering needs as to terminal, mounting and other physical requirements. Special processing with materials found exclusively at Shallcross provides a complete selection of resistors which retain their accuracy and stability even under the most severe conditions of temperature, humidity and fungus.

INSTRUMENT TYPE RESISTORS

Designed to dissipate 1 watt and having a tolerance of 0.25% (or less if required) Shallcross bifilar wound Types 245 and 7525 are ideal for wide variety of precision instrument applications. When you have need of Accurate Fixed Wire-wound Resistors write for the complete Shallcross Akra-Ohm Catalog!

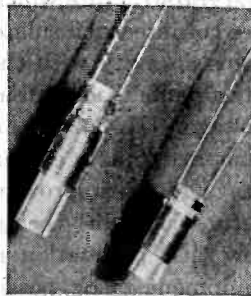

SHALLCROSS MFG. CO.

DEPT. IR-35, COLLINGDALE, PA.

ENGINEERING • DESIGNING • MANUFACTURING



(Continued from page 42A)

- DeWolf, J. B., JR., 239 Nassau St., Princeton, N. J.
- DiMattia, A. L., 3 Winford Way, Medford, Mass.
- DiVito, F., 256 Withers St., Brooklyn, N. Y.
- DiElsi, F. J., 102 Lafayette St., New Haven, Conn.
- Doney, L. M., Sylvania Electric Products, Inc., Emporium, Pa.
- Doherty, E. J., Walsingham, 43 Colyton Rd., Honor Oak, London, England
- Duke, H., 409 N. Arden Blvd., Los Angeles, Calif.
- Durrant, R. E., 148 Dereham Rd., Norwich, Norfolk, England
- Easterday, M. R., 415 N. Kensington, Kansas City, Mo.
- Eckert, J. F., Jr., 639 Fanshawe St., Philadelphia, Pa.
- Elliott, C. I., 31 Lewis Rd., Belmont, Mass.
- Ettenberg, Morris, 615 E. 12 St., Brooklyn, N. Y.
- Fabb, N. R., 147 Gorevale Ave., Toronto, Ont., Canada
- Fanta, F., Jr., 1846 Grove Ave., Berwyn, Ill.
- Farago, J., Jr., 625 Jackson Ave., New York, N. Y.
- Fisch, O., 3800 San Pablo Ave., Oakland, Calif.
- Foster, D., 335 Beech Ave., Wyoming, Ohio
- Finger, L. C., 9946 Belleterre, Detroit, Mich.
- Freier, J. B., 1416 Nelson Ave., New York, N. Y.
- Frum, A., Federal Telephone and Radio Laboratories, 67 Broad St., New York, N. Y.
- Fuqua, H. G., 1431 Curie Way, Baltimore, Md.
- Furanna, A. L., 732 Wellington St., London, Ont., Canada
- Gaffney, M. P., Jr., 1632 T St., S.E., Washington, D. C.
- Gartner, C. L., 125 Knicker Bocker Ave., Springdale, Conn.
- Giguere, E. F., 45 Prospect Pl., New York, N. Y.
- Goldblatt, R., 17 The Curve, Observatory, Johannesburg, South Africa
- Golden, D. R., 1081 S. Cloverdale Ave., Los Angeles, Calif.
- Grayson, E. L., 616 E. 40 St., Indianapolis, Ind.
- Green, B. I., Naval Research Laboratory, Receivers Section, Washington, D. C.
- Gregory, C. M., 1291 Commonwealth Ave., Allston, Mass.
- Griemsmann, J. W. E., 90-64 Francis Lewis Blvd., Queens Village L. I. N. Y.
- Guasco, D. Y., N.A.F.-Radio Division, Columbus, Ohio
- Gumbart, H. E., 72 Catherine St., Corning, N. Y.
- Hagen, E. L., 5194 Perry St., Denver, Colo.
- Hagler, D. L., 50 Follen St., Cambridge, Mass.
- Hahley, R. J., 4525 AAF (BU), Robins Field, Ga.
- Hansen, D. K., Section B, Flight 2, BMC Np. 1, 3501 AAF Base Unit, Boca Raton, Fla.
- Hanson, R. L., Big Bethel Radio Station, Box 683, Langley Field, Va.
- Harrison, R. P., Electronic Field Service Group, Naval Research Laboratory, Washington, D. C.
- Hart, T. J., 4121 West Ave., Los Angeles 40, Calif.
- Hafvey, H. C., Box No. 22, Port Washington, L. I., N. Y.
- Hayward, J. R., 54 Balmoral Ave., N., Hamilton, Ont., Canada
- Henderson, G. G., 316 11A St., N.W., Calgary, Alberta, Canada
- Hertmann, P. J., 295 Broad St., Carlstadt, N. J.
- Hinckley, G. A., 14 Chestnut Pl., Jamaica Plain, Mass.
- Hixenbaugh, G. P., Radio Station WMT, Cedar Rapids, Iowa
- Hlipala, N., 88-36 Elmhurst Ave., Elmhurst, L. I., N. Y.
- Hoag, O., 52 Roosevelt St., Garden City, L. I., N. Y.
- Hoagland, J. H., Fleet Post Office, San Francisco, Calif.
- Hopkins, J. J., 10122 Greenock Rd., Silver Spring, Md.

(Continued on page 48A)

★ *This New Cetron High
Current Thyatron brings
 New Efficiency to
 Industrial Operations*

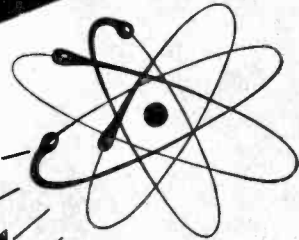

CETRON

CE-304

In the Cetron CE-304 tube shown here, Continental Electric Company engineers have reached a new high in concentrating super-efficiency in the smallest possible space.

CE-304 is a mercury vapor filled tube with a peak current rating of 125 amperes and an average current rating of 12.5 amperes DC. This high current thyatron-type tube is designed to be particularly useful in welding control and motor control applications.

CE-304 uses industrial type 4-pin base; is sturdily constructed. Patented filament design gives exceptionally high output with minimum of cathode power.

CE-304 is built to give long life in all sorts of industrial and other applications where dependability is an important consideration.

Write for
 Bulletin No. 119



CONTINENTAL
ELECTRIC COMPANY GENERAL

★ CHICAGO OFFICE, 933 Merchandise Mart
 NEW YORK OFFICE, 265 West 14th Street

MIRACLE of

Design!

"World's Smallest Transformer"

If you have a space or weight saving problem you'll want to know all about this remarkable new midget transformer—how it was developed by Permoflux engineers with new materials and manufacturing methods—how it was made small enough to be incorporated directly into the cases of earphones and hand-held microphones.

You'll be interested too, in knowing about its many application possibilities and about its outstanding operating efficiency and uniform response characteristics. This transformer can be produced to meet your own special design requirements.

Permoflux welcomes inquiry from design engineers about this new midget transformer. Write for our complete technical catalog listing Permoflux transformers, speakers, headphones and other acoustical devices.

BUY WAR BONDS FOR VICTORY!

TRADE MARK
PERMOFLUX

PERMOFLUX CORPORATION
4900 WEST GRAND AVE., CHICAGO 39, ILL.

PIONEER MANUFACTURERS OF PERMANENT MAGNET DYNAMIC TRANSDUCERS



(Continued from page 46A)

Hopkins, W. L., 70 E 45 St., New York, N. Y.
Hornsby, P. L., 402 Neville St., Hanford, Calif.
Hubbard, T. P., Jr., 624 S. Clinton, Iowa City, Iowa
Hull, R., 226 W. Herman Ave., Dayton, Ohio
Hund, E., Co. 2218, U.S.N.T.C., Great Lakes, Ill.
Hungerford, R. S., 13561 Stahelin, Detroit 23, Mich.
Jackson, W. J., 150-44 Freeborn St., Jamaica, L. I., N. Y.
Jacobs, W. T., 2720 Cudahy St., Walnut Park, Calif.
Johnson, W. H., Jr., 100 E. Manoa Rd., Brookline, Upper Darby P. O., Pa.
Kaiser, E. H., 1809A N. 21 St., Milwaukee, Wis.
Killian, L. H., 2179 Valentine Ave., New York, N. Y.
Kodera, C. F., 52 Clark St., Brooklyn, N. Y.
Kucera, R. J., 821-18 St., S.E., Cedar Rapids, Iowa
Kulp, A., 4732 W. Congress St., Chicago, Ill.
Lalonde, R. P., 3910 Mentana St., Montreal, Que., Canada
Lambert, T. M., Tufts College, Medford, Mass.
Lee, J. J., Jr., 64 Dana St., Cambridge, Mass.
Liang, D. Y. H., 3698 E. Willis St., Detroit, Mich.
Leicester, E. J., Parkcroft, 42 Ridgeway, Hayes, Bromley, Kent, England
Loewenthal, M., 186 Commonwealth Ave., Boston, Mass.
Lyons, B. P., 136 DeSoto Way, San Bruno, Calif.
Mann, F. E., Box 795, Sonoma, Calif.
Marshall, G. E., 631 S. Norton Ave., Los Angeles, Calif.
Martinez, C. I., 11 Metropolitan Oval, New York, N. Y.
Masters, W. S., 1039 Bird Ave., Birmingham, Mich.
Mattson, C. L., Box 1456, Atlanta, Ga.
McAllister, D. E., 315 N.E. 66 Ave., Portland, Ore.
McBurney, A. R., A-7 C.S.T.C., R.C. Signals, M.P.O. 302, Barriefield, Ont., Canada
McCauley, C. E., 131 W. 52 St., Bayonne, N. J.
McFee, J. L., Hazeltine Corporation, Little Neck, L. I., N. Y.
McLaughlin, W. A., 345 Edmonton St., London, Ont., Canada
Meiners, W. H., 4920 Thurston Rd., Fort Worth, Texas
Miller, D. C., P.O. 1663, Santa Fe, N. M.
Miller, L. E., 442 N. Sandusky St., Delaware, Ohio
Miller, W. B., 1618 Rockwood St., Los Angeles, Calif.
Molla, J. J., Submarine Signal Company, c/o E. A. Grey, 160 State St., Boston, Mass.
Montgomery, V. A., Box 114, 40 Stelzear St., Riviere Du Loup Station, Quebec, Canada
Morgan, R. E., 1068 Parkwood Blvd., Schenectady, N. Y.
Morrow, G., 2366 Grand Concourse, Bronx, N. Y.
Morse, R. L., 4521-15 St., N.E., Seattle, Washington
Meuller, H., 100 Thayer St., New York, N. Y.
Meuller, P. L., 2511 Hollins St., Baltimore, Md.
Murray, L. H., 166 W. 87 St., New York, N. Y.
Neuman, G. J., 516 W. 169 St., New York, N. Y.
Newton, A., 67 E. Seventh St., New York, N. Y.
Olds, H. R., 1612 Main St., Beech Grove, Ind.
Olsen, O. C., 617 North Ave., Dayton, Ohio
Parisi, F. E., Education Department, Mo. Nine, Navy Pier, Chicago, Ill.
Peters, E. F., 3842 Alvarado Ave., Stockton, Calif.
Peterson, O. L., 2829 Forest View Ave., Baltimore, Md.
Petry, C. B., 27-14 Morlot Ave., Fairlawn, N. J.
Pfeifer, R., 5103 San Rafael Ave., Los Angeles, Calif.
Pierce, E. R., Civil Aeronautics Administration, Summit, Alaska
Pizor, I., 645 West End Ave., New York, N. Y.
Puttick, A. W., 974 St. John, Lincoln Park, Mich.

(Continued on page 62A)

EQUALIZERS

by

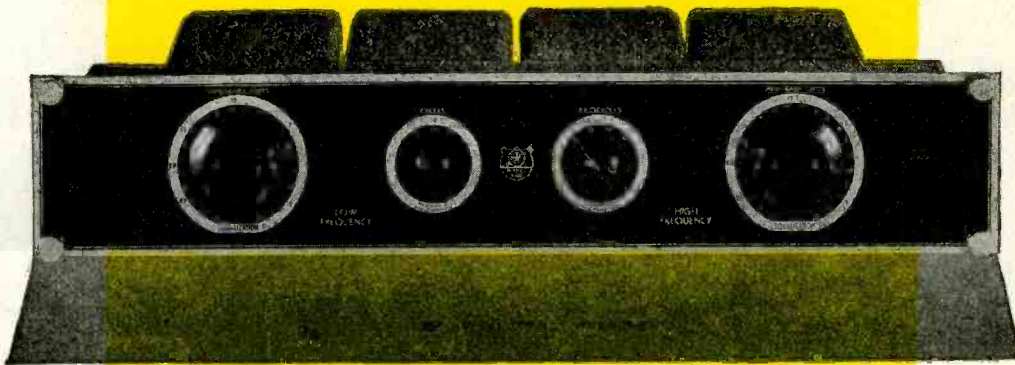

3AX . . . THE UNIVERSAL EQUALIZER FOR BROADCAST AND RECORDING SERVICE. PROVIDES ADJUSTABLE EQUALIZATION AT 25, 50, OR 100 CYCLES FOR LOW END, AND AT 4000, 6000, 8000, OR 10,000 CYCLES AT HIGH END. CALIBRATED CONTROLS READ DIRECTLY IN DB EQUALIZATION AND FREQUENCY SETTING. THE INSERTION LOSS EFFECTED BY THE EQUALIZER IS COMPENSATED THROUGH SPECIAL COMPENSATING PADS, SO THAT IT IS CONSTANT REGARDLESS OF SETTING. RAPID CHANGE IN TONE COLOR CAN BE OBTAINED WITH NEGLIGIBLE CHANGE IN VOLUME.

4C . . . AN IDEAL SOUND EFFECTS FILTER FOR BROADCAST AND RECORDING SERVICE. LOW PASS FILTER FREQUENCIES OF 100, 250, 500, 1000, 2000, 3000, 4000, AND 5000 CYCLES ARE PROVIDED. IDENTICAL HIGH PASS FILTER FREQUENCIES ARE PROVIDED. THIS UNIT EMPLOYS NOISELESS SWITCHING, AND A SUFFICIENTLY WIDE RANGE OF FREQUENCIES TO TAKE CARE OF ANY TYPE OF TONE COLOR REQUIRED.

MAY WE COOPERATE WITH YOU ON DESIGN SAVINGS FOR YOUR APPLICATION . . . WAR OR POSTWAR?



United Transformer Co.
150 VARICK STREET NEW YORK 13, N. Y.

EXPORT DIVISION: 13 EAST 40th STREET, NEW YORK 16, N. Y., CABLES: "ARLAB"

RADIO ALTIME

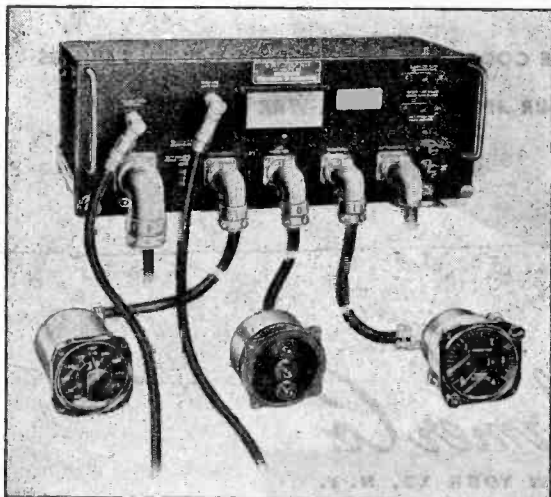
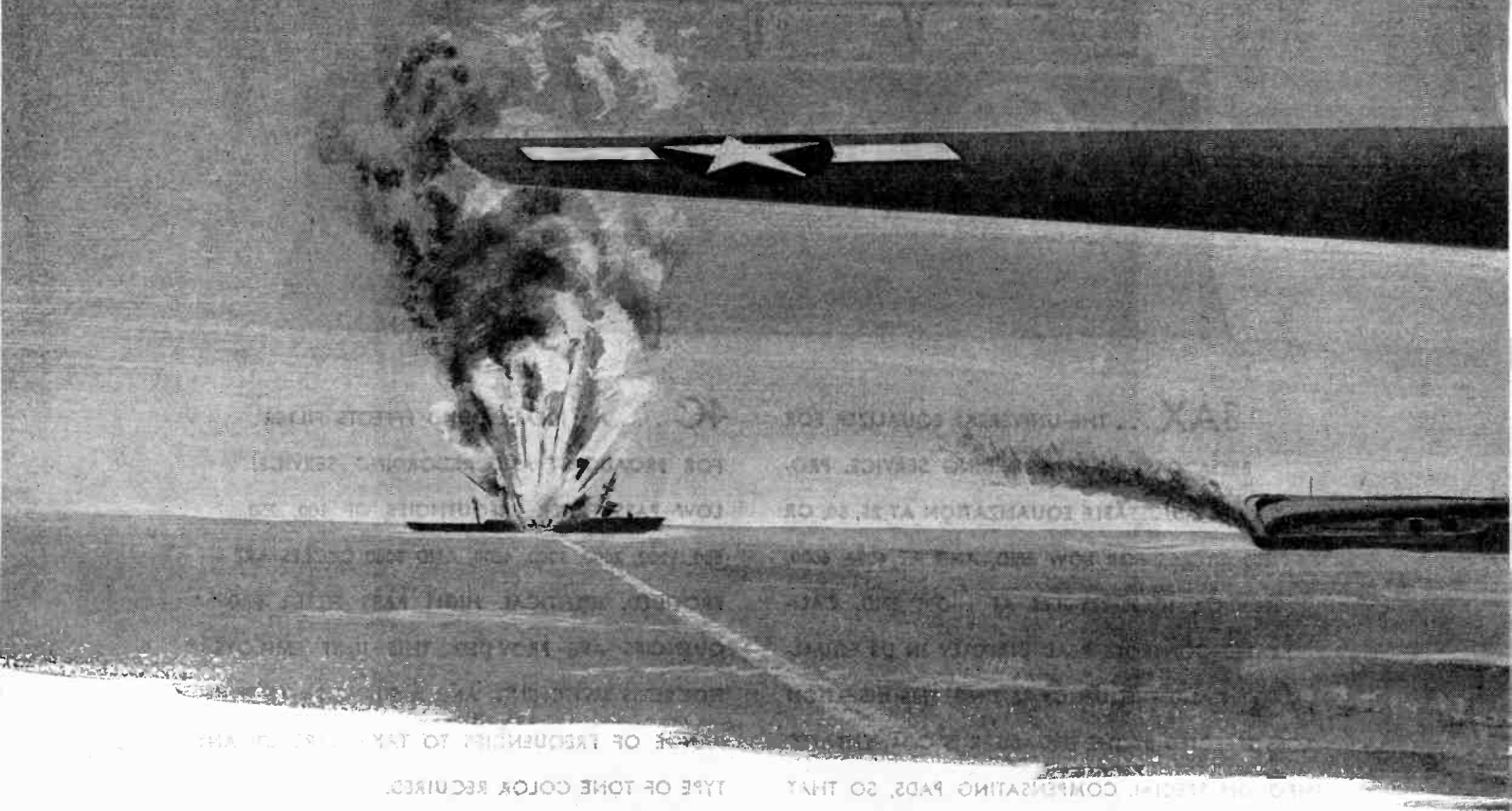

Two years before Pearl Harbor, RCA research engineers began the development of a new kind of radio altimeter—an altimeter which was destined to become of major importance in the successful operation of U. S. Naval aircraft against the Japanese fleet.

Rushed into mass production at RCA and other manufacturers' plants, this newly designed RCA altimeter was delivered in time to see action in the Battle of Midway.

Since that time ALL of the Radio altimeters used in Army, Navy and British aircraft have been designed and first produced by RCA. Thus, five years of continuous altimeter research have built, at RCA, an outstanding reserve of engineering experience in this new field.

Other dramatic stories of RCA aviation radio contributions will soon be told. And, in RCA laboratories, there are still more developments which will help to solve the urgent problems of peacetime commercial aviation.

TERS by RCA



BUY
MORE
WAR
BONDS



RADIO CORPORATION OF AMERICA

RCA VICTOR DIVISION • CAMDEN, N. J.

K A U T Z

INSTRUMENT ENGINEER WANTED

Engineer needed to develop and apply electronic instruments for measuring vibrations, strains, pressures and temperatures. Experience with electro-mechanical devices desirable. Position of permanent nature and at present concerned with measurement of aircraft and engine characteristics on projects of war urgency. Apply in writing stating education, experience and salary expected.

Persons now utilized at highest skill in essential industry need not apply as all hiring is done in accordance with Hartford area stabilization plan.

**PRATT & WHITNEY AIRCRAFT
INSTALLATION
ENGINEERING DEPARTMENT
EAST HARTFORD 8, CONNECTICUT**

OPPORTUNITY NOW FOR TECHNICAL ENGINEERS

In Expanding Organization
with Post War Future

Progressive company located near San Francisco has splendid openings for Engineers with a degree from a recognized college in physics, electrical or mechanical engineering who have specialized in electronics or allied fields.

Write, stating qualifications, education, draft status and salary requirements. Applicants now employed should submit a detailed resume of their experience together with an evaluation of their present duties.

DALMO VICTOR
1414 El Camino Real
San Carlos, California



The following positions of interest to I.R.E. members have been reported as open. Apply in writing, addressing reply to company mentioned or to Box No.

The Institute reserves the right to refuse any announcement without giving a reason for the refusal.

PROCEEDINGS of the I.R.E.

330 West 42nd Street, New York 18, N.Y.

ELECTRONIC ENGINEERS, PRODUCTION MANAGER

New York corporation is interested in adding Junior and Senior Engineers with design and development experience, and a Production Manager with electronic and mechanical experience.

Salaries, based on experience and capacity, range up to \$100 a week for Junior Engineers, and \$10,000 a year for Senior Engineers and Production Manager. Address reply to Box 368.

ELECTRONIC ENGINEER

An engineer is required to head a department of industrial electronics in consulting engineering firm. Must have had experience in this field. Salary as well as a share in the profits. Please write to Box 342 giving detailed information on education and experience.

ENGINEERS FOR INDUSTRIAL ELECTRONICS

Experienced engineers wanted for design and application engineering of electronics to industry in a consulting engineering firm. Position offers unusual opportunity to qualified, reliable and responsible man. Present work will be on war contracts. Write to Box 343.

ACOUSTICAL ENGINEER

Acoustical and electronic engineer for development work on electronic musical instruments.

Also electronic technician and an electronic draftsman. Permanent positions in a research and development laboratory. Write Supersonics, Inc., 231 East 47th Street, New York 17, N.Y.

SALES ENGINEER

Manufacturers-representatives' company in New England needs a sales engineer, preferably one residing in Connecticut, with good technical background, pleasant personality, and keen judgment in appraising and working out technical details. Past experience in selling not necessary.

Work involved includes calling on industrial accounts in New England, and discussing engineering matters and working out solutions of technical problems between customers and manufacturers.

Position represents an immediate opportunity with postwar future and pays well. Send replies to Box 369.

OPPORTUNITIES IN PRESENT AND POST-WAR WORK

Senior and Junior graduate engineers with one or more years radio experience wanted by an expanding manufacturing division of an established communication company.

Present activities include high- and medium-power transmitters, frequency shifters, other communication products for the Navy and designs and models for post-war use.

Engineers with practical experience also required for radio communication plant installation and test in foreign countries.

Phone, call or write stating experience, education, present salary, etc. Press Wireless, Inc., Hicksville, L.I., N.Y.; Attention of S. A. Barone, Chief Mfg. Engr.

TELEVISION TECHNICIANS

The Television Laboratories of the Columbia Broadcasting System, in New York, need television technicians. Men having had definite experience in the television field, transmitters, or receivers, preferred. Excellent opportunity for

(Continued on page 54A)

SENIOR ELECTRONIC ENGINEERS

Preferably graduates of communication engineering courses are required for designing, receiving-type electronic equipment covering all frequency ranges, and other specialized electronic apparatus. Design experience necessary and knowledge of production is desirable. Excellent post-war opportunities. Salary open. Requirements urgent. Proof of citizenship and certificate of availability are necessary.

Write giving detailed qualifications and if satisfactory, interview will be arranged at our expense.

SUBMARINE SIGNAL CO.

Dept. 420
175 State St. Boston, Mass.

Micro-Wave Design Engineers

An opportunity for radio engineers who have had extensive experience in the design of micro-wave apparatus. Their services are needed for long range development program for the government.

Broadcast Receiver Designers

Still other radio engineers with experience are needed.

Mechanical Engineers for telephone and radio work—

whose experience fits them to design electro mechanical devices for production are also needed.

• While the above openings are for senior men, we do have opportunities for several junior engineers in these fields. Interested persons are invited to write giving full qualifications to the Engineering Personnel Manager.

War Manpower Commission rules will be observed.

STROMBERG-CARLSON CO.
ROCHESTER 3, N. Y.



**Experience to solve
transformer
problems
of America**



The illustrated unit typifies the many compact designs invented by N-Y-T for mobile, airborne and portable equipment.

A bitter pill for humanity is the realization that progress transcends ordinary development in time of war. Dually destroying — by death dealing devices, and advancing — by knowledge gained, the future is molded by mankind itself.

A ray of optimism and hope is the re-interpretation of warborne research for peacetime betterments.

Already new techniques, new materials and new processes have added greatly to transformer efficiency. N-Y-T engineers have played an important part in these developments.

To you engaged in the fulfillment of America's future — through product or equipment utilization of transformers, solenoids or filters—a cordial invitation is extended for near-future collaboration.

**NEW YORK
TRANSFORMER
COMPANY**



26 WAVERLY PLACE
NEW YORK 3, N. Y.

Unsurpassed QUALITY

• The Industrial Condenser Corporation manufactures a complete line of Oil-filled, Electrolytic, Wax and Special Mica Capacitors for all industrial, communications and signalling applications up to 250,000 volts working. Complete laboratory and engineering facilities available for solution and design of capacitor problems for special applications.

An Industrial Condenser for every industrial application.

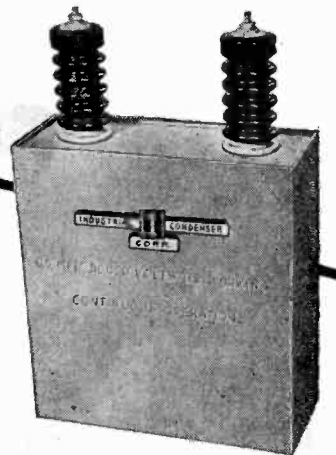

**.5 MFD. 50,000 VOLTS
DC WORKING**

(Illustrated above)...28 inches high, weight 175 pounds, built by Industrial Condenser Corporation to meet Navy specifications. Oil-filled, oil impregnated. Built for 24 hour continuous operation and total submersion in salt water.

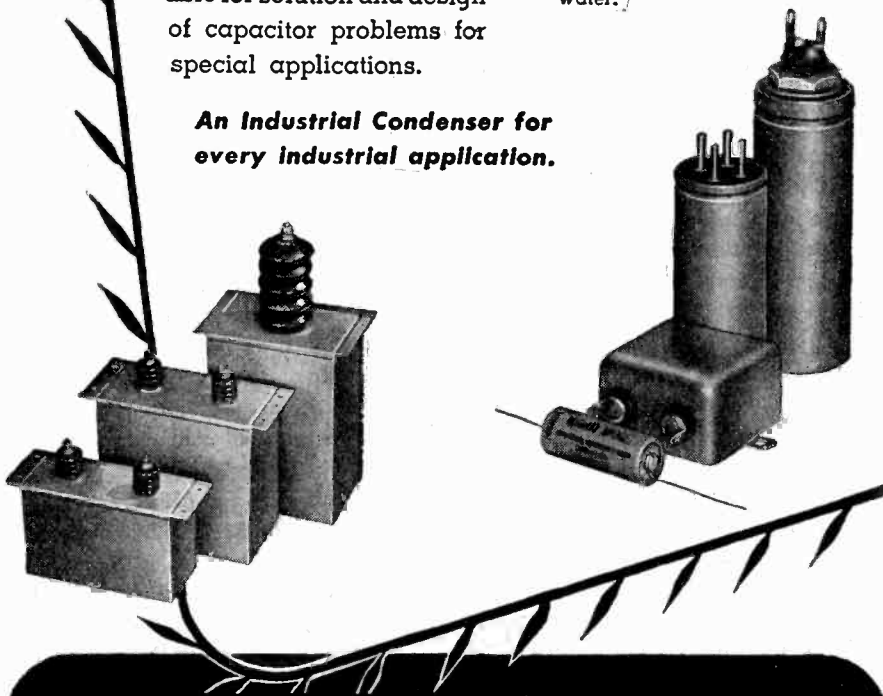

PAPER, OIL AND ELECTROLYTIC CAPACITORS

**INDUSTRIAL
CONDENSER
CORPORATION**

3243-65 NORTH CALIFORNIA AVE., CHICAGO 18, U.S.A.

DISTRICT OFFICES IN PRINCIPAL CITIES



A Present and a Future for Experienced Design Engineers

The Collins Radio Company has always been a pioneering organization—an *engineer's* engineering and manufacturing outfit.

It was the pioneering urge that led us to introduce professional standards of design and performance in transmitters and receivers for radio hams in the early thirties . . .

To plan and build special radio equipment that stood up to the rough-and-tumble of Admiral Richard E. Byrd's second expedition to Little America . . .

To take high quality broadcast equipment out of the laboratory and make it economically practicable for any broadcasting station . . .

To meet the individual requirements of some of the great airlines with specially engineered communication equipment, including the ingenious Collins Autotune.

To be prepared on December 7, 1941, to go into production of airborne and ground based radio gear of highly advanced design for the Armed Forces—the result of research and development looking years ahead.

We are looking far ahead today in the field of high quality radio communication equipment. Our post-war plans, well advanced, offer a very substantial opportunity for additional

junior and senior assistant design engineers with at least three years of practical mechanical design and drafting experience; and for design engineers with five to ten years of experience. Our work involves the production of small, intricate mechanical and electrical mechanisms.

This is a splendid opening for men and women who are able to make neat, accurate parts drawings with complete specifications, assembly drawings and layouts, who will assume responsibility, and who have knowledge of general standard shop and field practices.

Cedar Rapids is a human, wholesome city of about 65,000. People enjoy living here. And people enjoy working, without being distracted by weather variations, in the modern controlled-conditions Collins plant.

If you feel that you could fit happily and capably into this organization, write us fully. Tell us about your education, experience, age, desired compensation and draft status. W.M.C. regulations, of course, must apply.

Address E. H. Reinschmidt,
Superintendent of Design,
Collins Radio Company,
Cedar Rapids, Iowa.



(Continued from page 52A)

well qualified applicants. Our staff knows of this advertisement and replies will be kept confidential. Write, giving all details, to CBS Television Engineering Department, 485 Madison Avenue, New York 22, New York.

ENGINEERS

A Midwestern manufacturer of radio transmitters and associated equipment has openings for several junior project engineers qualified to supervise or assist development of transmitters, speech input systems, control apparatus, and similar items. Salary average \$2500 per year. Give full details first letter. Address Box 365.

ELECTRICAL ENGINEER FOR ELECTRONIC RESEARCH

An unusual opportunity for a man who has a knowledge of hot and cold cathode tubes and tube applications in amplifiers, multivibrators, triggers, and switching circuits. Permanent position in laboratory of established manufacturer, doing research and development work, both present and post war. Salary open and commensurate with experience, initiative, and ability. Include complete details of education, experience, and WMC availability with reply to Box 366.

ELECTRICAL OR RADIO ENGINEER

Should have general experience in Electrical or Radio Measurements. Graduate engineer (radio or electrical) from recognized engineering school, desirable. Long-established radio-electrical components manufacturer in New England, doing war work at present. Postwar future for right man. Give detailed outline of experience, etc., salary requirements. Address Box 367.

ELECTRONIC ENGINEERS AND DRAFTSMEN

The services are required of several electronic equipment design engineers capable of supervising the system layout of electronic and electro-mechanical devices.

Also, several draftsmen are needed with experience in electronic schematics, circuit layouts, and wiring diagrams, or with considerable experience in other related electrical fields.

Write giving full qualifications to the Personnel Department, Curtiss-Wright Corp., Development Division, 88 Llewellyn Ave., Bloomfield, N.J.

CONSULTING ENGINEERS

For laboratory with adequate facilities, to take on the design of R.F. precision measuring instruments on a contract basis. Send reply to Box 359.

ELECTRONICS ENGINEERS

Development engineers on television and ultra-high-frequency tubes. Technician on tubes. Radio engineers on special applications.

Write full details to Box 363.

ELECTRONIC ENGINEER

Radio or electronic engineer for design and development of Army and Navy electronic equipment. Position offers excellent opportunity with well established and expanding company in Connecticut, employing over one hundred personnel. The company's big post-war program in the industrial electronics, radio, and aircraft communications fields assures engineering personnel a continued opportunity for advancement. Address reply to Box 364.

RADIO ENGINEERS, SUPERVISORS AND TECHNICIANS

Chief Radio Engineers, Transmitter and Studio Supervisors and Technicians between thirty and forty-five years of age are needed at once in important war work in the Pacific to construct and operate radio stations. These positions are with the United States Government, with good salaries and subsistence, and for the duration plus six months. Interested persons with actual broadcast experience should write, giving details of radio work, to Box 356.

(Continued on page 56A)



KAAR 50 and 100 WATT INSTANT HEATING MOBILE OR FIXED RADIOTELEPHONES

A new series of KAAR radiotelephones, offering improved performance and greater convenience, is now available to police and fire departments, public utilities, sheriffs' offices, railroads, the forestry service, and similar users of radiotelephone communication. Designed with the needs of these services in mind, this series provides instant heating tubes, single channel or five channel operation, and crystal controlled or tunable receivers. Notice how compact this equipment is, and how it is immediately accessible for tuning or servicing, although the cabinet itself may be permanently secured to a shelf, wall, vehicle, or vessel.

SERIES 46 • 50 WATT KAAR RADIOTELEPHONE

A five channel transmitter with power output of 50 watts. All five channels are independently tuned, and any one may be instantly selected by turning a knob on the front panel. Standard frequency range is from 1600 to 6000 Kc. Furnished with companion tunable or fixed tuned crystal-controlled receiver as desired. Power supply (8" x 8" x 17") is a separate unit, interconnected by a 12-foot cable. Available for operation on 117 volts 60 cycle A. C., 12, 32 and 110 volts D. C.

SERIES 96 • 100 WATT KAAR RADIOTELEPHONE (NOT ILLUSTRATED)

Five channel instant-heating transmitter, with an output of 100 watts and having a standard frequency range from 1600 to 6000 Kc. The companion receiver may be of the tunable or fixed tuned crystal-controlled type as desired. R. F. ammeter and plate milliammeter are mounted on front panel. This 100 watt radiotelephone, including transmitter and receiver, is only 19½" high, 22" wide, 14¾" deep. Furnished with separate power supply (8" high, 16" wide, and 17" deep). Available for operation on 117 volt 60 cycle A.C., 32 or 110 volt D.C. circuits.



KAAR ENGINEERING CO.
PALO ALTO • CALIFORNIA

Export Agents: FRAZAR & HANSEN, San Francisco

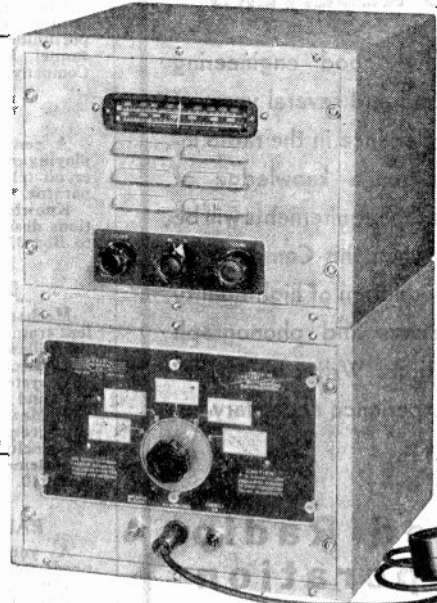

COMPARE THE ADVANTAGES

...and you will get a KAAR 46!

- ★ **INSTANT HEATING TUBES**... Stand-by current is zero—yet there is no waiting for tubes to warm up before sending a message! Reduces drain on batteries... extremely important in mobile or marine operation.
- ★ **FIVE CHANNEL TRANSMISSION**... Any one of five channels from 1600 to 6000 Kc can be instantly selected by turning the large knob on the panel.
- ★ **CARRY ONLY 1 SPARE TUBE**... For simplicity of replacement there is only one type of tube used in these Kaar transmitters. (For 117 volt AC operation, 5R4GY rectifier tubes are also employed.)
- ★ **REMOVABLE PANEL**... By removing six finger-tight lugs, the front panel of the transmitter may be lifted away, exposing all tuning controls. This allows complete tune-up to be made in a short time without moving the set.
- ★ **SIMPLE TO SERVICE**... When four screws are released, transmitter slides out like a letter file to simplify tube replacement.
- ★ **FITS MOST ANYWHERE**... Transmitter may be placed above or below the receiver, or on either side of it. Transmitter and receiver units are each 10" high, 13" wide, 13" deep. This equipment is easy to install.
- ★ **REASONABLY PRICED**... Although Kaar instant-heating radiotelephones offer all these features for convenience and simplicity, they are competitively priced. Your inquiries are cordially invited.

ENGINEERS

TO SERVE AS PROJECT LEADERS ON TRANSMITTERS AND RECEIVERS

Must have good engineering background and several years of broad experience in the radio industry. Also, a knowledge of civilian radio requirements will be valuable when this Company resumes production of high-quality FM receivers and phonograph combinations. Write, giving details of experience and salary expected, to:

Freed Radio Corporation

200 HUDSON STREET NEW YORK CITY

Wanted ENGINEERS

- Radio
- *Electrical
- Electronic
- *Mechanical
- *Factory Planning
- Materials Handling
- Manufacturing Planning

Work in connection with the manufacture of a wide variety of new and advanced types of communications equipment and special electronic products.

Apply (or write), giving full qualifications, to:

R.L.D.
EMPLOYMENT DEPT.

Western Electric Co.

100 CENTRAL AVE., KEARNY, N.J.

*Also: C.A.L.
Locust St., Haverhill, Mass.

Applicants must comply with WMC regulations

POSITIONS OPEN

(Continued from page 54A)

RADIO, ELECTRICAL AND MECHANICAL ENGINEERS

In the development and production of all types of radio-receiving and low-power transmitting tubes. Excellent post-war opportunities with an established company in a field of opportunities. Apply in person, or write to Personnel Manager of Raytheon Manufacturing Company, 55 Chapel Street, Newton, Mass.

DESIGNER

A central New England manufacturer employing over 1000 people needs draftsman-designer on telephone and signaling (mechanical) apparatus.

Knowledge of die-casting and plastic applications desirable. WMC regulations prevail. Write to Box 339.

DEVELOPMENT ENGINEERS

Mechanical and electrical. Graduate or equivalent training. Required for development work in the following branches:

1. Electro-mechanical devices, communication systems. Must be interested in development and familiar with magnetic circuits.
2. Measuring and control instruments. Background should be in electrical engineering, including electronics.

Statement of availability required. Address Box 340.

RADIO-ELECTRONIC ENGINEERS

A young progressive radio-electronic firm needs top-flight men for these key positions: Development engineers.

Project engineers.
Engaged 100% in war work, with excellent post-war future and possibilities. Our staff knows of these openings. Write in confidence to Box 352.

FIELD SERVICE ENGINEERS

FOR DOMESTIC AND
FOREIGN SERVICE
MUST POSSESS GOOD
KNOWLEDGE OF
RADIO

Essential workers need release

HAZELTINE CORPORATION

50-25 Little Neck Parkway
Little Neck, Long Island

WANTED: DESIGN ENGINEERS WITH TELEVISION BACKGROUND FOR GOOD POSITIONS

Here's the dual angle you've been seeking! Join this growing outfit with four Southern New England plants in full-time war work until Victory—then stay as a key man in our big peacetime program of Home Radio and Television. Experience in Television since 1938 preferred.

MAGUIRE INDUSTRIES, INC.

ELECTRONICS DIVISION

342 W. PUTNAM AVE.

GREENWICH, CONN.

RADIO ENGINEERS

Three promising positions are open to men who want to be associated with a progressive company of established reputation and accomplishments. At present there are openings for one senior engineer and two junior engineers. Desire men for work on military projects now who, will be adaptable to postwar engineering. Prefer men with experience in radio receiver or television laboratory, and with college education in communication engineering.

Address your communication to

MAJESTIC RADIO & TELEVISION CORP.

2600 W. 50th Street, Chicago 32, Illinois

a NEW

Industrial

POWER TUBE

by Federal

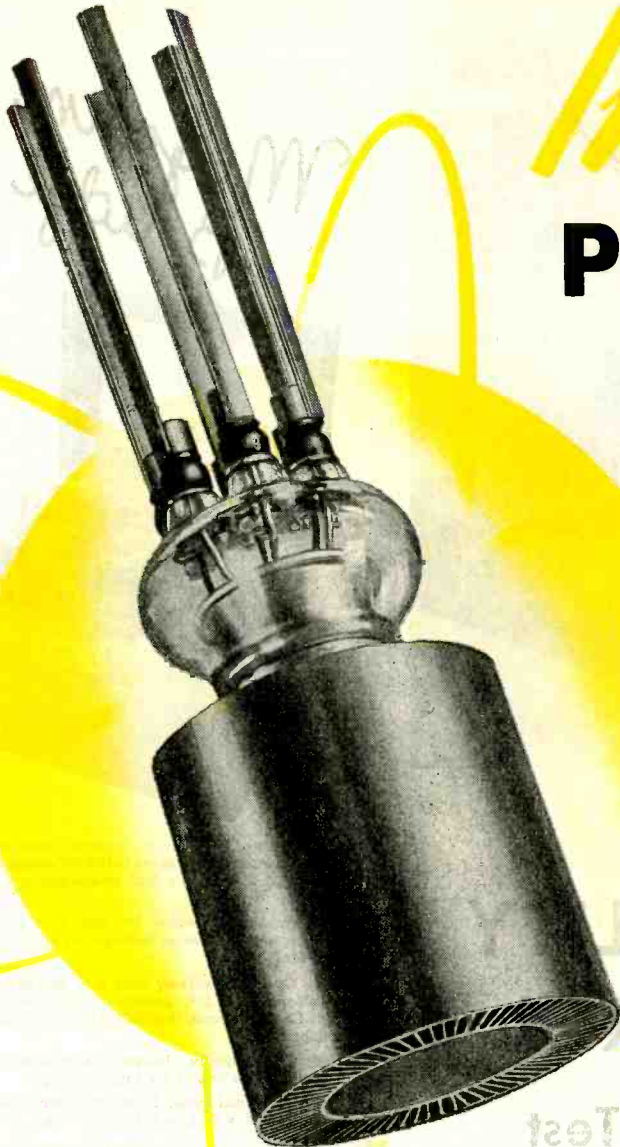

Federal presents a new and rugged power tube that fills an immediate demand — a power tube that has been specially designed for industrial use in high-frequency heating equipment, both dielectric and induction.

Really built to withstand the constant jars, shocks, and vibration commonly encountered in manufacturing operations, this heavy-duty vacuum tube is very conservatively rated, and will stand up under extremely hard usage.

Widely spaced, unusually sturdy filament and grid elements, without internal ceramic insulation, give this tube a ruggedness that makes it the logical choice for dependability in the design of industrial heating equipment.

For industrial power tubes, and also for rectifier and transmitting tubes, see Federal first... because "Federal always has made better tubes."



TECHNICAL DATA FOR TYPE F-5303

Filament Voltage	11.0 volts
Filament Current	27.5 amps.
Maximum Ratings for Maximum Frequency of 50 Mcs.	
DC Plate Voltage	3500. volts
DC Plate Current	1.0 amp.
Plate Dissipation	1200 watts
Overall Height	app. 7"
Maximum Diameter	3 3/4"
Supplied with 6 flexible copper leads, 2 on each terminal.	
Type of Cooling	Forced-air
(Also supplied for water-cooling, type F-5302.)	

Federal Telephone and Radio Corporation



Newark 1,
New Jersey

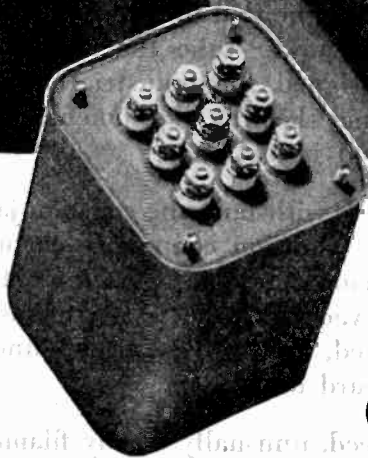
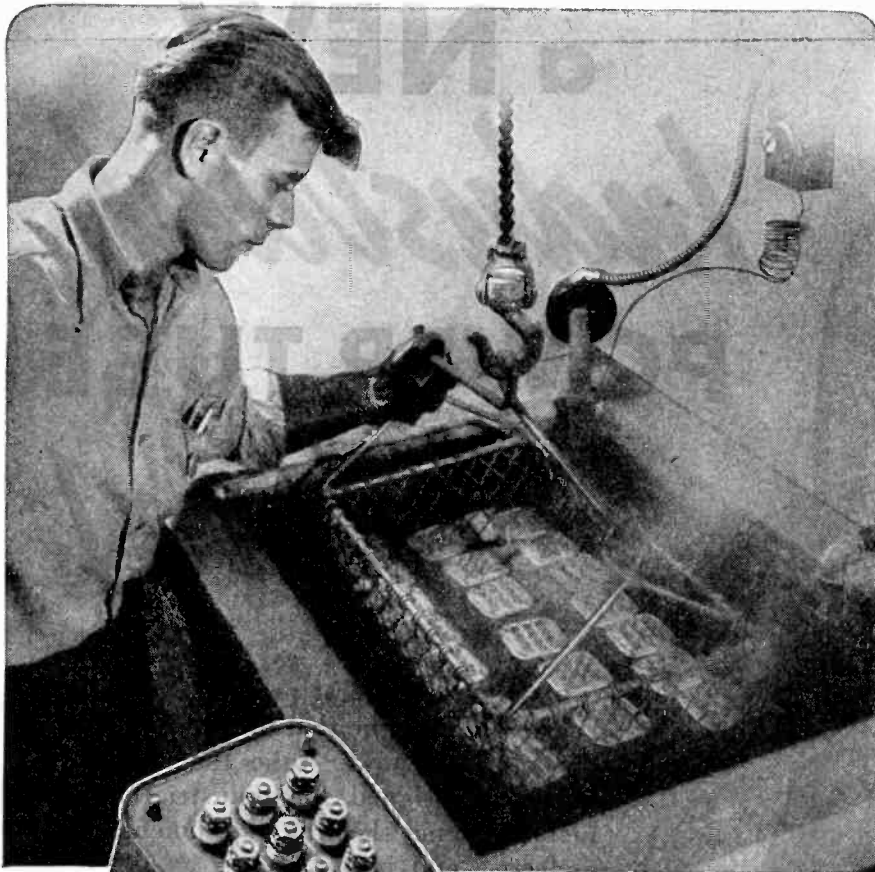

QUALITY CONTROL

The Bubble Test

As a final check, every Hermetically Sealed Chicago Transformer is bubble tested by immersion in hot water at $+190^{\circ} F$ for over two minutes.

This concluding test, applied before packaging, assures that no Transformer with detectable flaws in case or bushing seals can be shipped to enter service.



CHICAGO TRANSFORMER



DIVISION OF ESSEX WIRE CORPORATION
3501 WEST ADDISON STREET
CHICAGO, 18



for **ACCURATE** yet
INSTANTANEOUS
READINGS . . .

*Megohm
Bridge*



- In four models for various resistance ranges from 100,000 ohms to 100,000 megohms and with 250 or 500 v. D.C. bridge source voltage.
- Accurate to within 5% from 1 to 15 on scale, and as close as readable on remainder of scale.
- Operating entirely from A.C. power line. Self-contained D.C. supply for electron tube and bridge circuit. Unaffected by line-voltage fluctuations.
- Automatically charges condensers and high-voltage cables for rapid testing.
- Hardwood case. Slide-hinge removable cover. 8" l. x 7" h. x 5 1/4" d. 6 1/4 lbs.

• Type MB Megohm Bridge is a rapid, accurate instrument for routine insulation tests. Compact. Portable. Simple operation: non-laboratory workers can secure accurate, instantaneous results. Electron-ray null indicator replaces usual delicate galvanometer. Invaluable for testing electrical and electronic equipment insulation, leakage in cables and wiring, moisture content, etc. Typically an "Industrial Instrument."

• **Write for Bulletin**

Industrial

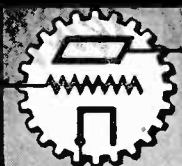

Instruments:

PLANT and OFFICES:

17 POLLOCK AVENUE

JERSEY CITY 5, N. J.

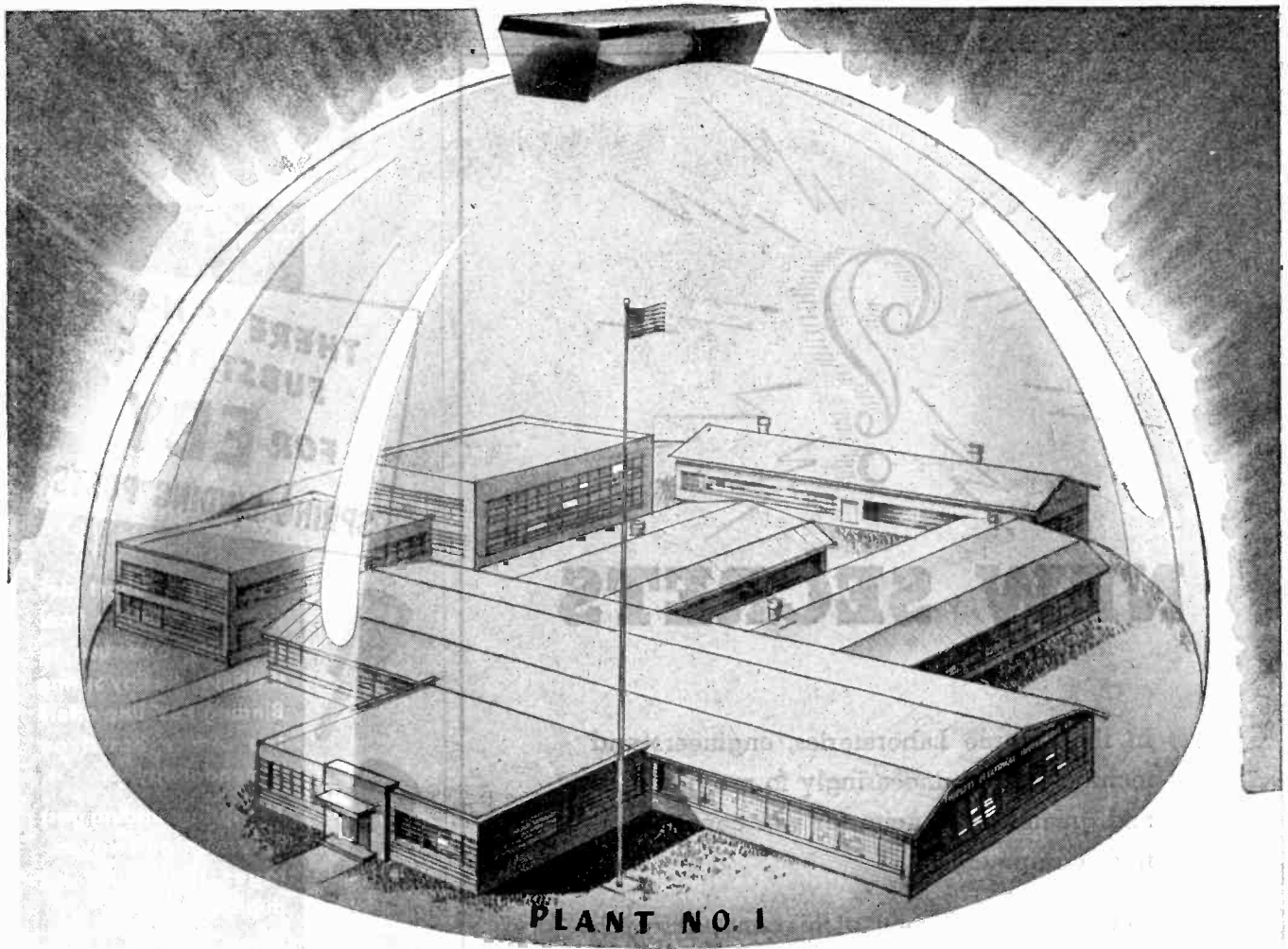

"DUSTLESSTOWN, OHIO"

● It's the little things that loom biggest in the manufacture of delicate electrical measuring instruments. Little things like specks of dust or breath condensation can play havoc with accuracy. That's why Triplett Instruments are made in spotless manufacturing departments; why the air is washed clean, de-humidified and

temperature-controlled; why every step in their mass production is protected. As a result Triplett Instruments perform better, last longer and render greater service value.

Extra Care in our work puts Extra Value in your Triplett Instrument.



Triplett



ELECTRICAL INSTRUMENT CO. BLUFFTON, OHIO



NEW SECRETS

In the Temple Laboratories, engineers and technicians toil unceasingly to provide new and greater efficiencies for war communications equipment.

Needless to say that out of this constant search for betterment comes further discovery, further knowledge — new secrets of development in the limitless field of electronics.

Temple engineering skill and inventiveness, fostered still further by the stress and strain of war, will contribute richly indeed to the electronic world of the future.



Electronics Division

**TEMPLE TONE
RADIO MFG. CORP.**

New London, Conn.

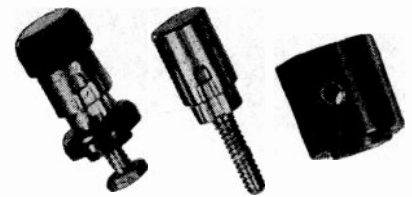

**THERE IS NO
SUBSTITUTE
FOR EBY
SPRING BINDING POSTS**

From the product designer through to final assembly and use in the field, the Eby Spring Binding Post line offers top service based on dependability.

The spring binding post offers unique advantages that can't be duplicated:

1. No screw cap to tighten or come loose with vibration.
2. Constant, even pressure on the wire at all times in all positions.
3. Easy one-hand feeding of wire into the post.
4. Corrosion-resistant, long-life springs.
5. Complete range of sizes, stem lengths, and accessories for every application.

Replace with Eby Spring Binding Posts — Write today.

HUGH H.

EBY

INCORPORATED
18 W. CHELTENAVE.
PHILADELPHIA, PA.



RADIO AND ELECTRONIC EQUIPMENT

Customized

FOR DEPENDABLE PERFORMANCE



Designed and built by seasoned engineers and skilled craftsmen in limited volume, COMCO Electronic Equipment in every way measures up to highest custom standards.

A VERSATILE LINE

Transmitters and Receivers are CUSTOMIZED for fine quality and superior operating characteristics.

- Aeronautical Ground Stations
- Airport Traffic Control Towers
- Commercial and Private Aircraft
- Police, Fire and Public Safety
- Marine Communications

WRITE! Complete details on request.

COMMUNICATIONS
COMPANY, INC.
CORAL GABLES 34, FLORIDA

BLUE PRINT to SERVICE

ON URGENTLY REQUIRED
RADIO PARTS · TUBES
ELECTRONIC EQUIPMENT

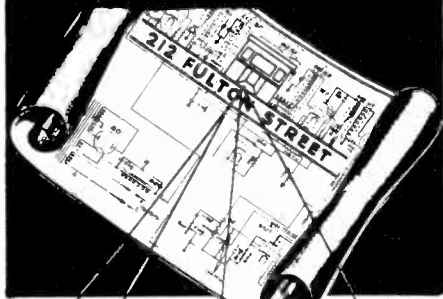

PHONE
BARclay 7
1840

TELETYPE
Direct fast wire
service to our
premises.
Code - RGY-New York

Free 800 Page
Catalog
Available to purchasing
agents and engineers
who write on company
letterhead.
Address Box

★ OVER 10,000 ITEMS IN STOCK
FOR IMMEDIATE DELIVERY!

America's most complete
Radio · Electronic Supply House

**SUN RADIO
& ELECTRONICS CO.**
212 Fulton Street, New York 7, N. Y.

1,001 USES

Condensed Power for Years of Service

VERSATILITY and dependability were paramount when *Alliance* designed these efficient motors — *Multum in Parvo!* . . . They are ideal for operating fans, movie projectors, light home appliances, toys, switches, motion displays, control systems and many other applications . . . providing economical condensed power for years of service.

Alliance Precision

Our long established standards of precision manufacturing from highest grade materials are strictly adhered to in these models to insure long life without breakdowns.

EFFICIENT

Both the new Model "K" Motor and the Model "MS" are the shaded pole induction type — the last word in efficient small motor design. They can be produced in all standard voltages and frequencies with actual measured power outputs ranging upwards to 1/100 H. P. . . Alliance motors also can be furnished, in quantity, with variations to adapt them to specific applications.

DEPENDABLE

Both these models uphold the *Alliance* reputation for all 'round dependability. In the busy post-war period, there will be many "spots" where these Miniature Power Plants will fit requirements . . . Write now for further information.

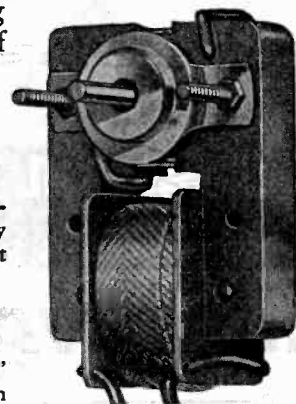

Model "MS" — Full Size
Motor Measures
1 3/4" x 2 x 3 1/8"

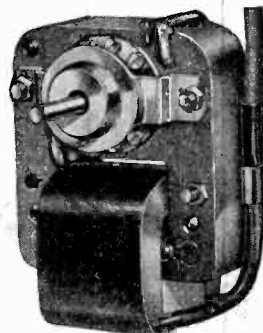

New Model "K" — Full Size
Motor Measures
2 1/8" x 2 3/8" x 3 1/4"

Remember Alliance!
—YOUR ALLY IN WAR AS IN PEACE

A ALLIANCE MANUFACTURING CO. ALLIANCE . OHIO

When the Going Is Hardest
MERIT TRANSFORMERS
 are in the thick of the fight, standing up to the most exacting demands and doing their part to maintain vital communications and operating controls.

MERIT COIL & TRANSFORMER CORP.
 TELEPHONE
 4427 North Clark St. Long Beach 6311 CHICAGO 40, ILL.

HIGH VACUUM GAUGES

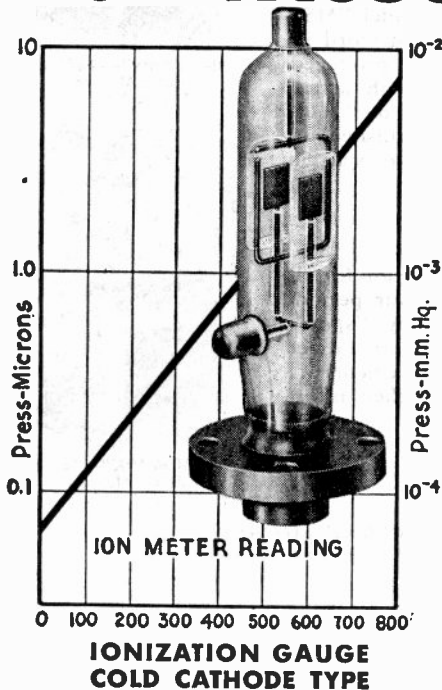

Measures high vacuums with galvanometer down to 10^{-4} mm. Hg. in electron microscopes and other high vacuum apparatus. Utilizes discharge current between electrodes in magnetic field. Extremely sensitive and accurate.

The Universal line includes two types of vacuum gauges of special interest to users of electron microscopes—the Universal highly sensitive cold cathode ionization gauge and the rugged Universal thermocouple gauge.

Both gauges are standard equipment on R. C. A. electron microscopes—and can be supplied for other high vacuum work.

Universal offers a complete production service in special glass and tube work—including metal-to-glass seals of all types and sizes. Your problems will receive our immediate and courteous consideration.

THERMO-COUPLE GAUGE

Measures low pressure levels with millivoltmeter which indicates variation in thermocouple voltage due to changes in vacuum. Ideal for systems requiring rapid verification of high vacuums. Heater and instrument terminals fit standard 8-prong tube socket.

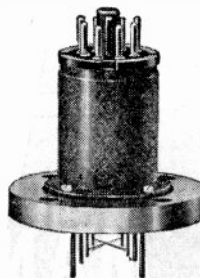

UNIVERSAL X-RAY PRODUCTS INC.
 1800-K N. FRANCISCO AVENUE • CHICAGO 47, ILLINOIS

Membership

(Continued from page 48A)

- Rasnack, J. J., Jr., 692 Pleasant Ridge Ave., Bexley Ohio
- Reynard, A. I., 54 King St., Dorchester 22, Mass.
- Rich, E. M., 104 Hards Lane, Lawrence, L. I., N. Y.
- Richards, J. A. K., 4829 N. Bernard St., Chicago, Ill.
- Roller, E. R., 246 Marcy St., Southbridge, Mass.
- Roach, W. E., c/o Postmaster, New Orleans, La.
- Rose, M., S.A.B.E.N.A., Leopoldville, Belgian Congo, West Africa
- Safford, E. L., Jr., 1206 Butterfield, Mesa Terrace, El Paso, Texas
- Schaerf, M., 36 Blvd. Nordau, Tel-Aviv, Palestine
- Scheneman, E. E., 3916 Ridgewood Ave., Baltimore, Md.
- Schultz, C. J., 6440 N. Nordica Ave., Chicago, Ill.
- Scott, D. R., 1050 Page Mill Rd., Palo Alto, Calif.
- Seagraves, W. P., 406 Chamberlain St., Raleigh, N. C.
- Shelton, T. J., Jr., Box 1263, Miami Springs, Fla.
- Shinn, E. N., Federal Communications Commission, Box 31, Laurel, Md.
- Shoemaker, H. L., 114 E. Market St., Iowa City, Iowa
- Small, B. I., 30 Wendell St., Cambridge, Mass.
- South, V. W., 3800 San Pablo Ave., Oakland, Calif.
- Sprung, J., 254 W. 31 St., New York, N. Y.
- Stahl, J., 202 North Dr., San Antonio, Texas
- Stewart, A. A., 1523 Greenfield Ave., Los Angeles, Calif.
- Stier, M. P., 202 Mountain Ave., Ridgewood, N. J.
- Stockton, L. W., 2765 Devonshire, Redwood City, Calif.
- Strother, F. P., 4020 Pillsbury St., Minneapolis, Minn.
- Sutton, J. R., 202 Northridge Rd., Columbus 2, Ohio
- Taich, L., 5709 Ethelbert Ave., Baltimore, Md.
- Taylor, G. E., 563 Twin Oaks Ave., Chula Vista, Calif.
- Tekosky, M. G., Y.M.C.A., Box 731, Paterson, N. J.
- Tepper, C. W., 2701 Norton St., Rochester, N. Y.
- Thibodeau, J. E., 113 AAF Base Unit (Air Insp.), AAB, Charleston, S. C.
- Thomas, W. J., The Hut, Cosmo Manufacturing Company, Ltd., Brimsdown, Middlesex, England
- Tyrrell, L. L., 56 W. Kinney St., Newark, N. J.
- Uhrig, R. B., 1644 Baltimore Ave., Kansas City, Mo.
- Uhrich, W. J., 2528 Broadway, New York, N. Y.
- Ulrich, E. C. W., Summit Ave., Tappan, N. Y.
- Van Felt, D., 1088 Morris Court, San Jose, Calif.
- Varadaraj, K., 69 Kingsway, Secunderabad, Decan, India
- Waddell, J. F., 2029 Durant Ave., Berkeley, Calif.
- Wagner, D. W., Franklinville, N. Y.
- Warner, J. L., 2434 Brambleton Rd., Baltimore, Md.
- Weaver, K. G., 120 Stoy Ave., Westmont, N. J.
- Weeks, R. L., Box 1947, Sacramento, Calif.
- Weinschel, B. O., 365 E. 21 St., Brooklyn, N. Y.
- Wels, W. G., Box 2701, Stanford University, Calif.
- Whittemore, J. D., Jr., 131 S. Harrison St., East Orange, N. J.
- Wight, R. W., 6601 Romaine St., Los Angeles, Calif.
- Wightman, E. E., Fleet Post Office, New York, N. Y.
- Wikolaski, W., 5112 Maxwell St., Detroit, Mich.
- Woods, A. R., 4 Grove Close, Hayes Common, Bromley, Kent, England
- Woods, C. W., 290 Margarita Ave., Palo Alto, Calif.
- Zimmer, E. W., 58-25 Little Neck Pkwy., Little Neck, L. I., N. Y.
- Zupnick, I. N., 768 Linden Blvd., Brooklyn 3, N. Y.

M. F. M. Osborne Associates Consulting Physicists

Mathematical Analysis of Physical Problems, Higher Mathematics, Approximations, Electronic Design, Fluid Dynamics, Mechanics, Electromagnetic and Acoustic Wave Propagation, Literature Surveys, Reports.
 703 Albee Bldg., Washington 5, D.C.
 Telephone District 2415

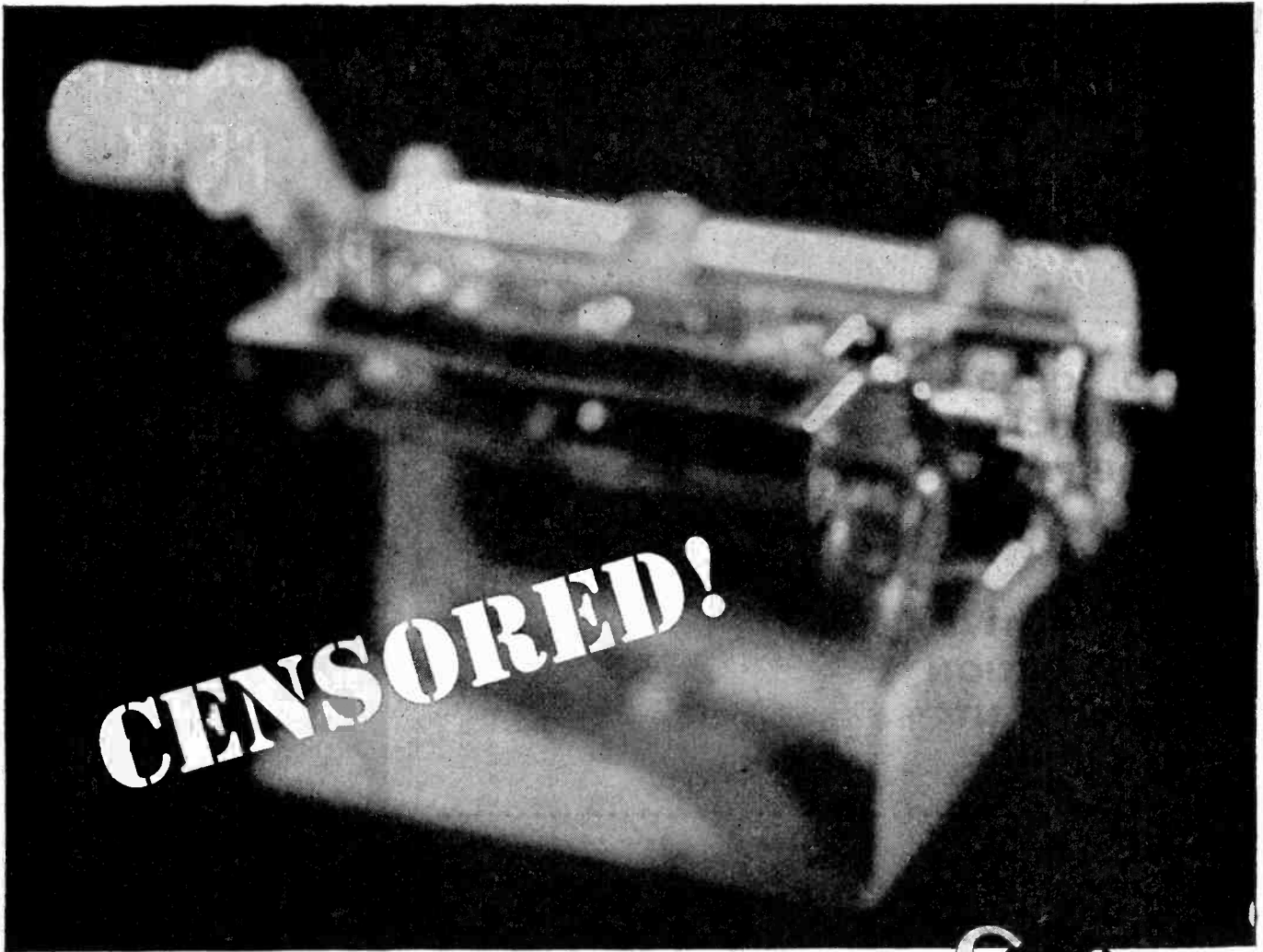

SANTAY wanted to bring the camera into focus, but the Armed Services said, "Censored"! However, here's another example of Santay's ability to make simple or intricate SELECTOR MECHANISMS.

Santay possesses the four important factors in producing simple or intricate SELECTOR MECHANISMS; (1) design ability, (2) development ingenuity, (3) manufacturing facilities, and (4) the desire to serve. In addition, Santay possesses twenty-five years experience in designing and making tools for the metal working industry.

Santay continues to produce SELECTOR MECHANISMS now as they will in times of peace. Should you have a product in which a mechanical assembly of any kind is involved, may we suggest you investigate this skilled precision craftsmanship!



INJECTION MOLDING • METAL STAMPING • ELECTRO-MECHANICAL ASSEMBLIES

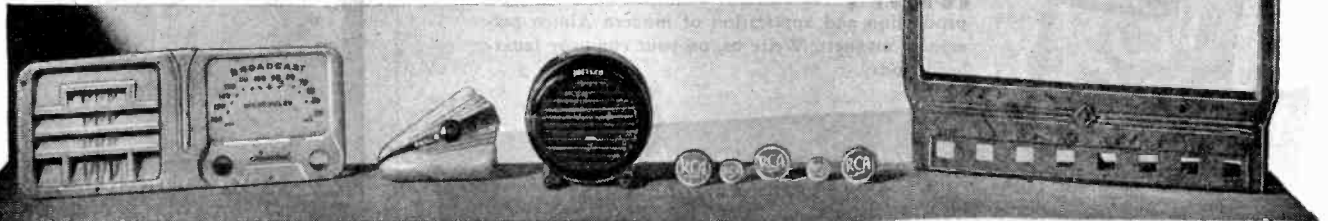

SANTAY CORPORATION 358 NORTH CRAWFORD AVE., CHICAGO 24, ILLINOIS

FORMERLY SINKO TOOL & MANUFACTURING CO.

REPRESENTATIVES: POTTER & DUGAN, INC., 29 WILKESON STREET, BUFFALO 2, NEW YORK • PAUL SEILER, 7779 CORLAND AVENUE, DETROIT 4, MICHIGAN • QUEISSER BROS., 108 E. NINTH STREET, INDIANAPOLIS 2, INDIANA

BETTER PERMANENT MAGNETS

for:

**RADIO, SOUND and
COMMUNICATIONS
EQUIPMENT**

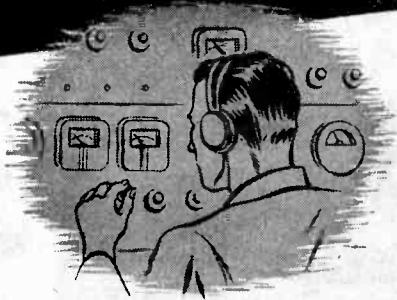

**AUTOMOTIVE
and AVIATION
EQUIPMENT**

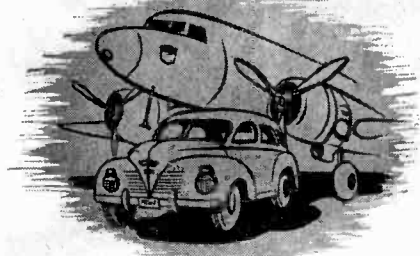

INSTRUMENTS

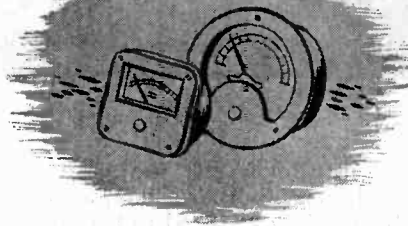

However advanced your own product-development work may be . . . however new or revolutionary the permanent magnets you require . . . Arnold engineers can be of considerable assistance to you in supplying the proper permanent magnets *in volume*. They're precision-built entirely in our own plant, under the closest metallurgical, mechanical and magnetic control to assure peak efficiency at the lowest cost.



NEW! Get your copy of this valuable, up-to-the-minute manual on the design, production and application of modern Alnico permanent magnets. Write us, on your company letterhead, today.

Specialists in the manufacture of
ALNICO PERMANENT MAGNETS

THE ARNOLD ENGINEERING COMPANY

147 EAST ONTARIO STREET, CHICAGO 11, ILLINOIS

DESIGNED FOR PEAK PERFORMANCE

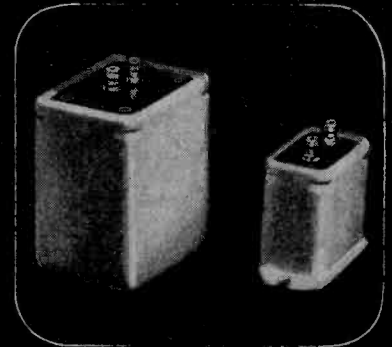

**SEALED, ALUMINUM CASE
AIR-BORNE TRANSFORMERS**

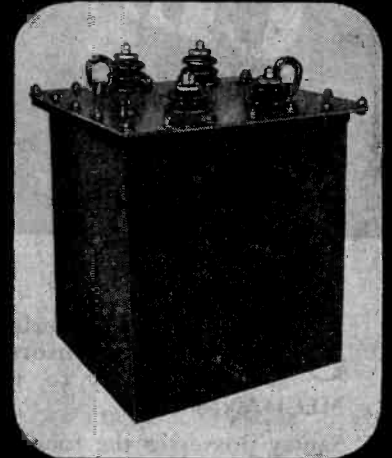

**OIL-COOLED, PLATE SUPPLY
TRANSFORMERS**

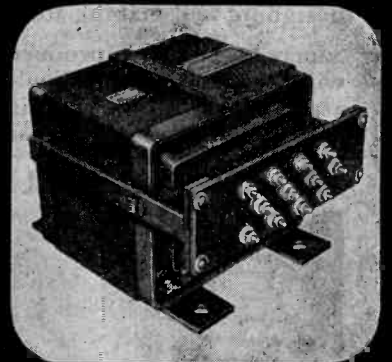

**AIR-COOLED TRANSFORMERS
WITH 10 VOLT SEC. TAPS**

THE ACME ELECTRIC & MFG. CO.
CUBA, NEW YORK • CLYDE, NEW YORK

Acme Electric
TRANSFORMERS

E-L DEVELOPS HIGH DEGREE OF VOLTAGE REGULATION IN VIBRATOR POWER SUPPLIES

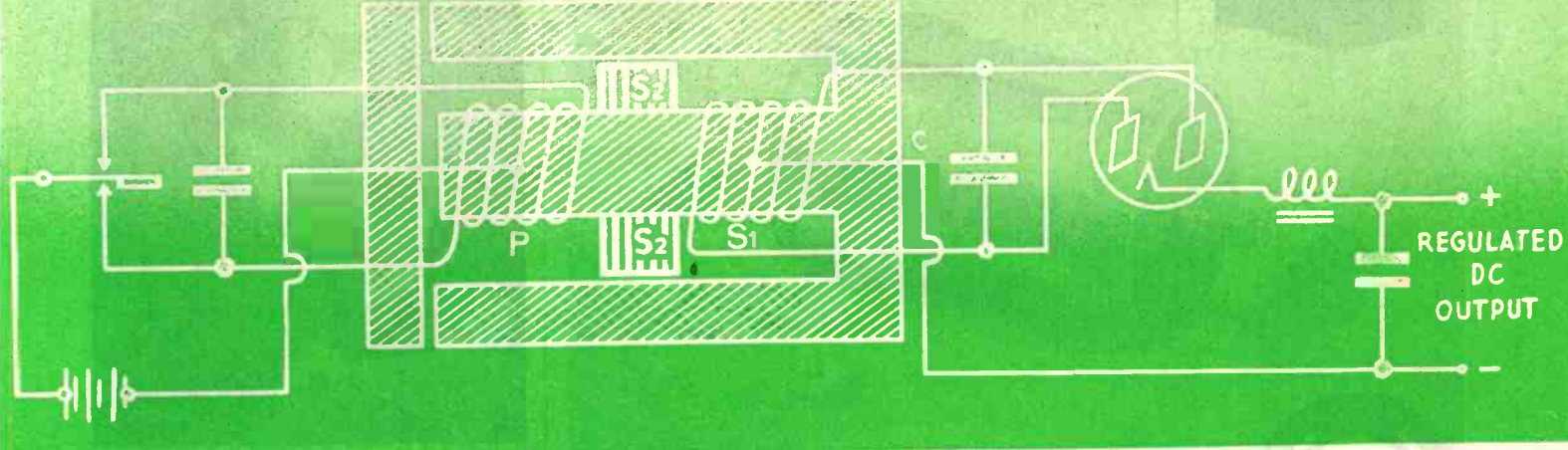

One of the most serious and annoying problems faced by radio and electrical engineers has been fluctuating output voltages due to varying input voltages. Now, Electronic Laboratories has solved this problem by using a high-efficiency, regulated type transformer system applied to vibrator operation for DC systems.

This type of transformer, as shown above, consists of primary and secondary windings having a linear magnetic leakage path between them. The tank condenser, C, is connected across the secondary winding.

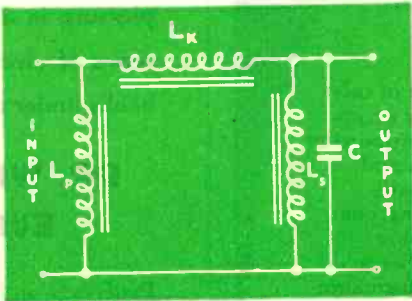

Fig. 1

The equivalent circuit diagram is shown at the right (see fig. 1). L_k represents the leakage inductance provided by the magnetic shunts. L_p and L_s are primary and secondary inductances respectively, L_s working at the saturated portion of its curve.

The net voltage across the output terminals is the vectorial sum of the equivalent voltage input and the drop across the reactance L_k . This drop is due to the condenser current (additive) and the inductive current drawn by the saturable reactor L_s (subtractive). In operation, when the input voltage rises, there is a proportional increase in condenser current. Also, due to the non-linear characteristics of L_s , there is a more than proportional increase in the inductive current. The next effect is an increase in the inductive (subtractive) drop in the reactor L_k . Thus, the voltage across the output terminals tends to remain substantially the same. When the input voltage goes down, the inductive drop on L_k will fall at a faster rate than the capacitive drop due to C, for reasons explained above. This results in a net gain in capacitance or additive drop which prevents the output voltage from decreasing with the input voltage.

To insure absolutely flat regulation, coils wound on the primary are connected to buck a small percentage of the voltage of the secondary as shown by the accompanying schematic (see fig. 2). The bucking voltage, being a linear quantity, can be made to compensate exactly for the small rise in voltage across L_s as it swings through its saturation curve.

An important feature of this system is its excellent load regulation. The output will tend to remain constant with load, since the reactive energy stored in the secondary circuit can be made large compared to the actual energy delivered at the output. This method of regulation is particularly suited to battery-operated power supplies, because it is a *high-efficiency* regulator and not a *losser*, as available heretofore. In addition, the output wave form approaches a sine wave, which is especially desirable in certain applications. Also, any number of output voltages and currents, both AC and DC, can be obtained from the secondary circuit of a single transformer.

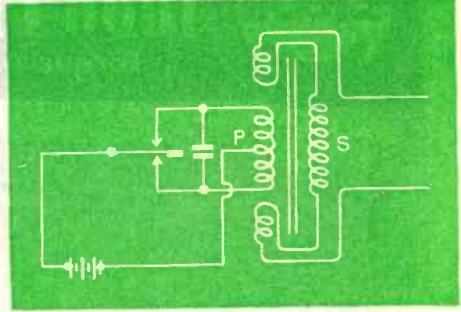

Fig. 2

E-L Vibrator Power Supplies have wide application in many fields: Radio, electrical, electronic, marine, aviation and railroad. Their high efficiency and versatility with multiple inputs and outputs, enable them to meet many power supply needs. They may be designed to provide any wave form required for specific equipment. . . . Economy is assured because of long, efficient service with minimum maintenance. E-L Engineering Service is available to discuss your power supply problem and to design a vibrator power supply to meet specific voltage, power, size and weight requirements.

E-L STANDARD POWER SUPPLY

Model 1566

This typical E-L unit, with voltage regulation, is used to supply the necessary voltages for the Signal Corps Model BC-100 Walkie Talkie Transmitter-Receiver, from a 6, 12, or 24 volt storage battery.

- Input Voltages: 6, 12 and 24 volts DC.
- Output Voltages: 140 volts DC at 0—55 ma. . . . 90 volts DC at 30 ma. . . . 45 volts DC at 250—550 ma.
- Regulation: Output voltages are held constant within 5% over the entire range of load changes listed above, as well as over input voltage variations, as for example, 5.7 volts to 7.5 volts.



Electronic

LABORATORIES INC.

INDIANAPOLIS



MOTOR DATA
No. 125

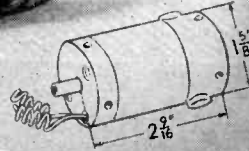
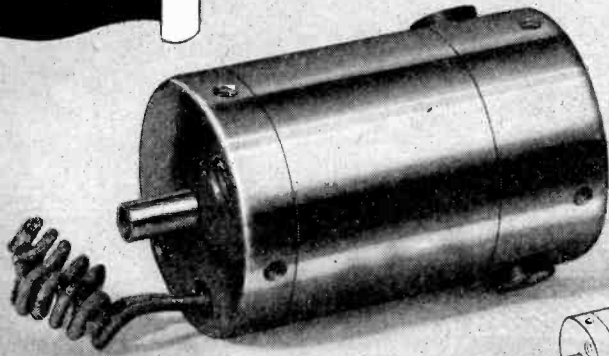

1600 FRAME MOTOR
Torque 4.5 in. oz. at 5800 RPM

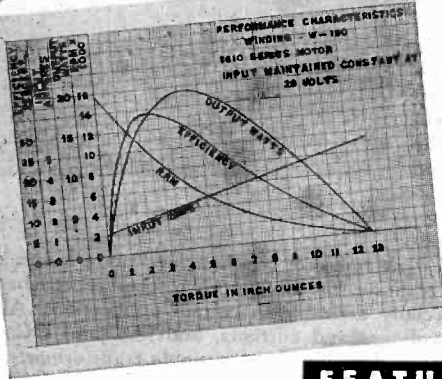

The power output of this precision motor is exceptionally high in proportion to its light weight and small size. Originally developed for numerous aircraft and portable applications, the characteristics of its performance can readily be modified for a variety of new uses.

FEATURES

- | | | | |
|-------------------------------|-------------------------------|-------------------|---|
| ↙ | ELECTRICAL | MECHANICAL | ↘ |
| Series or shunt wound | Completely enclosed | | |
| Unidirectional or reversible | Adaptable for any mounting | | |
| High starting torque | Laminated field poles | | |
| Low starting current | Stainless steel shaft | | |
| Low RF interference | Two precision ball bearings | | |
| Armature and field windings | Mica insulated commutator | | |
| Varnish impregnated and baked | Permanent end play adjustment | | |

1600 FRAME MOTORS		Series	Shunt
Watts Output, Int.	(max.)	22	
Watts Output, Con.	(max.)		5
Torque at 8500 RPM	(in. oz.)	3	
Torque at 5800 RPM	(in. oz.)	4.5	1
Lock Torque	(in. oz.)	12	3
Volts Input	(min.)	5	5
Volts Input	(max.)	32	32
Shaft Diameter	(max.)	.250"	.250"
Temperature Rise		50°C.	40°C.
Weight		12 oz.	12 oz.

EICOR INC. 1501 W. Congress St., Chicago, U.S.A.
DYNAMOTORS • D. C. MOTORS • POWER PLANTS • CONVERTERS
Export: Ad Auriema, 89 Broad St., New York, U.S.A. Cable: Auriema, New York



Signal Corps Photo

PRENTICE-HALL takes pleasure in announcing a new series of electrical engineering books under the editorship of

DR. WILLIAM L. EVERITT

Professor and Head of the Department of Electrical Engineering at the University of Illinois, on leave with the U. S. Army as Director of the Operational Research Staff, Office of the Chief Signal Officer, and President of the Institute of Radio Engineers.

Dr. Everitt's series will include both texts for college courses in Electrical Engineering and a wide range of professional books in the electrical field.

PRENTICE-HALL, INC.
70 FIFTH AVENUE
NEW YORK 11

HEAVY-DUTY OIL-FILLED CAPACITORS

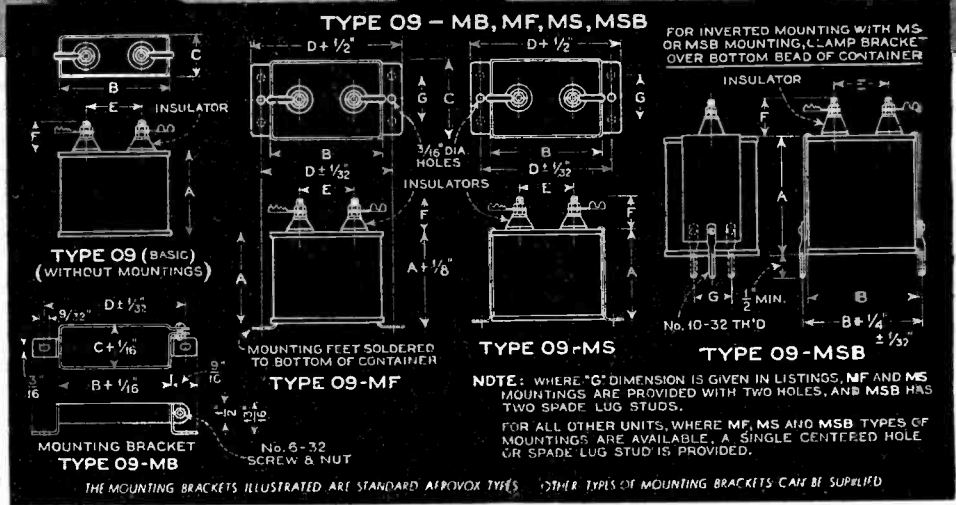
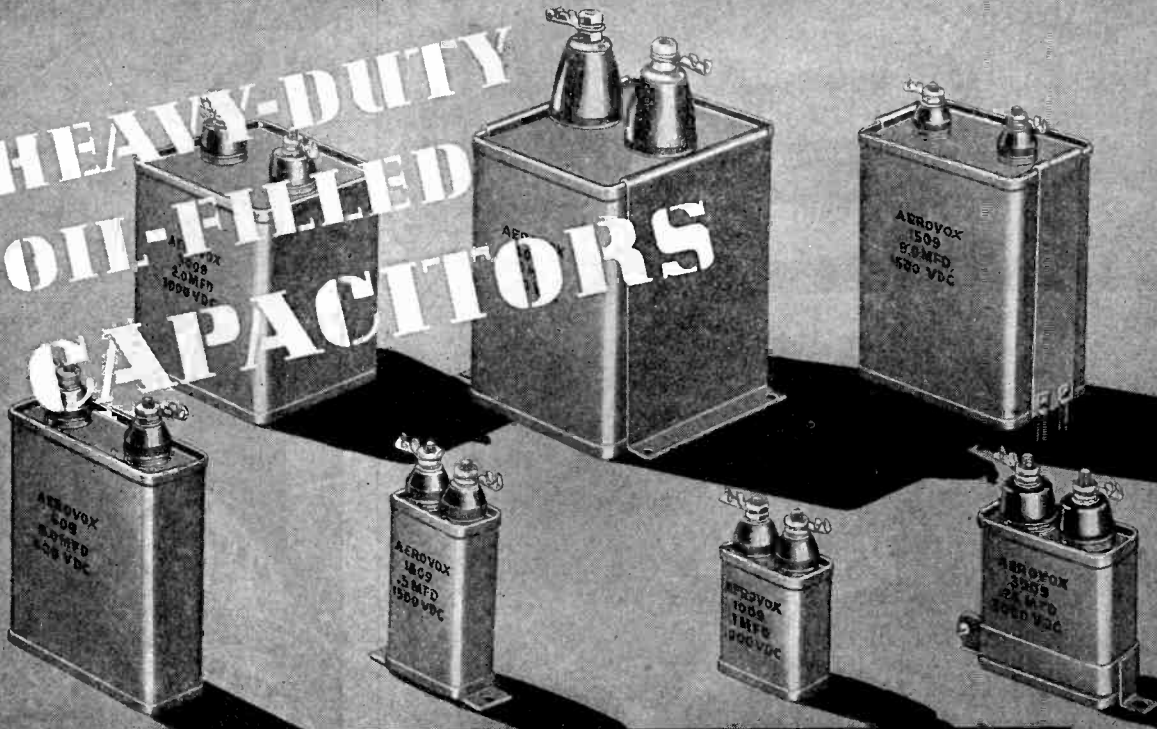

• **VERSATILITY**—with economy of chassis space and assembly operations a prime factor—distinguishes Aerovox Type 09 oil-filled capacitors. Although mass-produced, this type is available in such an outstanding range of voltage and capacitance ratings, as well as mountings, that it is virtually custom-made for most high-voltage heavy-duty applications.

Note particularly the choice of mounting means. Mounting means brackets shown in drawing are Aerovox standard; other types can be supplied. Voltage ratings from 600 to 7500 D.C.W. Widest

selection of capacitance values. Impregnants and fills available are HYVOL (Vegetable) or HYVOL M (mineral oil). The exclusive Aerovox terminal construction means units that pass the standard immersion tests required by various Governmental services. Terminal assembly is non-removable, an integral part of the capacitor.

These capacitors provide maximum capacitance at minimum cost. Widely used for continuous-service in transmitters, amplifiers, rectifier filters and similar applications.

• Literature on Request

AEROVOX

Capacitors

INDIVIDUALLY TESTED

AEROVOX CORPORATION, NEW BEDFORD, MASS., U. S. A.

SALES OFFICES IN ALL PRINCIPAL CITIES

Export: 13 E. 40 ST., NEW YORK 16, N. Y. • Cable: 'ARLAB' • In Canada: AEROVOX CANADA LTD., HAMILTON, ONT.

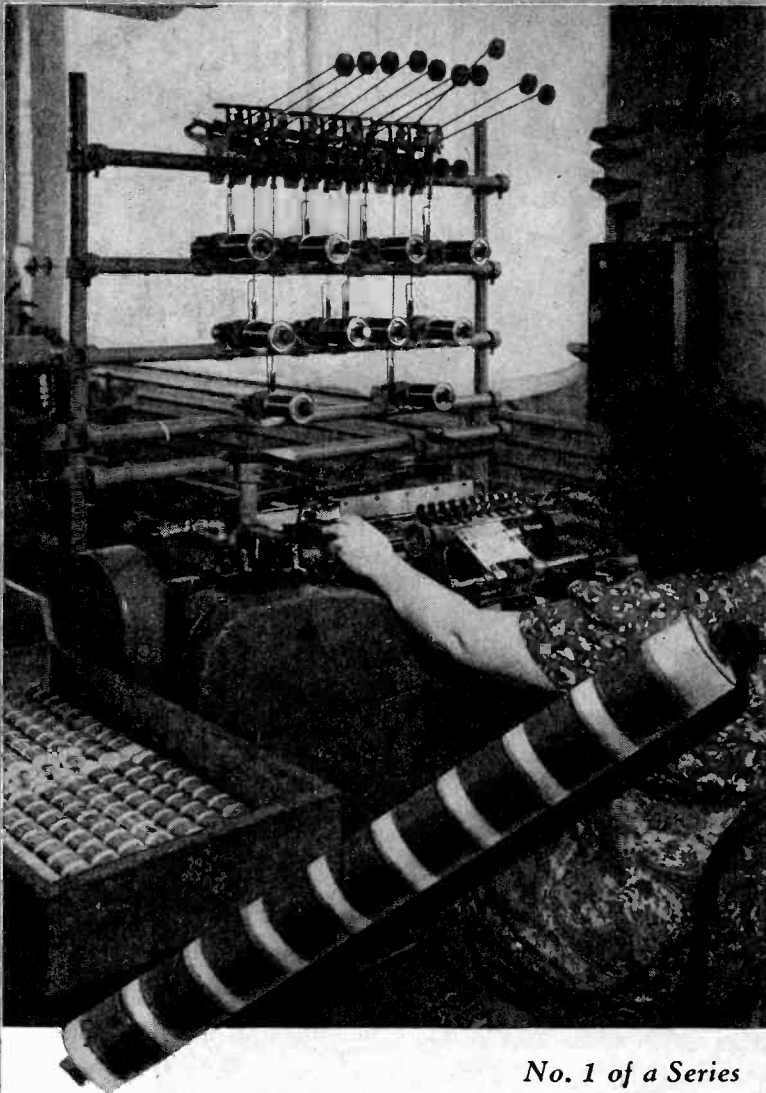

No. 1 of a Series

COTO CLOSE-UPS

Back of each COTO coil winding lies engineering skill . . . expert craftsmanship and "know how" . . . and much highly specialized equipment. All play their parts in assuring correct coil function and production costs in line with your requirements.

Modern Coil Winding in Multiple Groups

Nine coils are shown being wound simultaneously with .0007" thick cellulose film interleaved between layers of wire.

Machines are automatic and versatile . . . capable of handling a range of wire from #18 to #42 and acetate film or paper insulation from .0007" to .005" thick . . . at high speed.

These modern facilities are available now for war components and essential rated requirements.

COTO-COIL CO., INC.

65 Pavilion Ave., Providence 5, R.I.

COIL SPECIALISTS SINCE 1917



Permax Antenna In Allied Service

It is the combination of Permax experience and leadership, with the vision to meet the needs . . . that puts Permax Antennas on every fighting front . . . on land and sea.

Write for special detailed information on Antennas to suit your particular needs.

RADIO ANTENNA

Permax Products

Division Chisholm-Ryder Co., Inc.
4503 Highland Ave. Niagara Falls, N.Y.

Proceedings of the I.R.E. March, 1945



RADIO COMPONENTS EXCLUSIVELY!

No, we don't claim to be a "Jack of all trades"! Our line is, and has been—for more than two decades—radio components.

When Uncle Sam sounded the SOS for highest-standard, precision instruments in our specialized field we were ready to turn them out, and ship them out, in mass quantities to the far horizons of the war fronts of the world. This job still claims our all-out attention.

But we will be in a strategic position when reconversion time comes. For we shall return without undue effort or interruption to the production of our original line of variable condensers, tuning units, actuators and record changers. There'll be innovations and improvements, of course—and new items, too, such as our recently announced SPEAKER line—all obviously and logically in our specialized realm of radio components.

We still have capacity for urgent war assignments.

GENERAL INSTRUMENT

CORPORATION

829 NEWARK AVENUE
ELIZABETH 3, N. J.



FAST, RELIABLE SOURCE FOR
Leading Makes of
**INDUSTRIAL ELECTRONIC
 INSTRUMENTS**

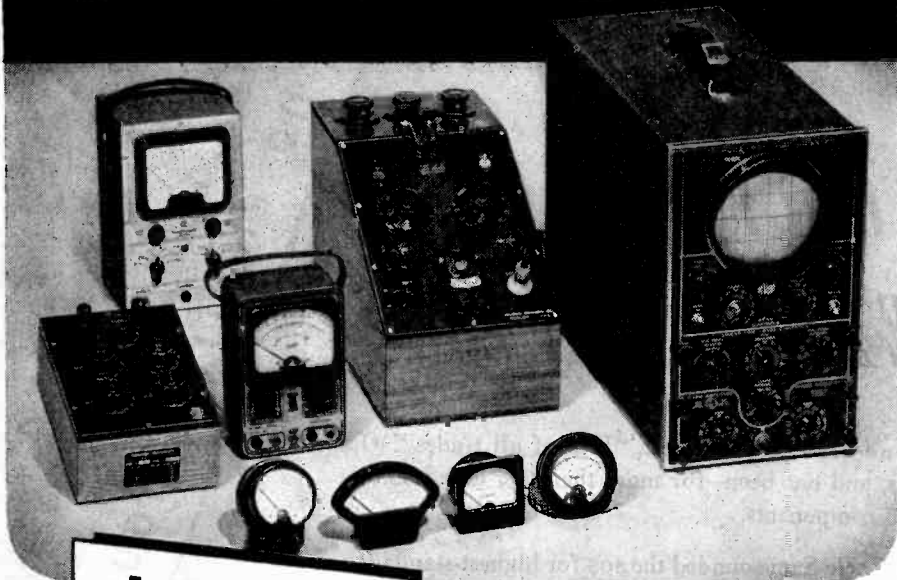

**For Measurement,
 Inspection,
 Testing and Control**

- TUBE TESTERS
- OSCILLOSCOPES
- CAPACITY DECADES
- RESISTANCE DECADES
- WHEATSTONE BRIDGES
- RESISTANCE LIMIT BRIDGES
- WEIN CAPACITY BRIDGES
- SIGNAL GENERATORS
- PANEL METERS
- VACUUM TUBE VOLTMETERS
- VOLT-OHM-MILLIAMMETERS

Helpful
**BUYING
 GUIDE**
 Available
 on Request
 Write for it!

Allied's concentration of leading makes *under one roof* means you can obtain the type of instrument you want . . . *in the shortest time possible*. This specialized service to industry, government, and research laboratories simplifies procurement . . . increases efficiency . . . saves hours, days, and effort. Such well known makes as RCA, Dumont, G.E., Industrial Instruments, Hickok, Radio City, Triplett and others. Many on hand for immediate delivery.

EVERYTHING IN ELECTRONICS AND RADIO

It's faster, simpler to get all your electronic and radio supplies from this one central source. We carry the largest and most complete stocks of parts and equipment under one roof . . . ready for immediate shipment. Besides, our procurement experts are in constant contact with all leading manufacturers to speed supplies.

*Save time and work . . . Call Allied First!
 Write, Wire or Phone Haymarket 6800*

ALLIED RADIO

C O R P O R A T I O N

833 W. Jackson Blvd. Dept. 3-C-5 Chicago 7, Illinois

SUPPLIERS OF ELECTRONIC PARTS AND EQUIPMENT TO INDUSTRIAL AMERICA

Electronic Tubes, Rectifiers, Power Supplies, Intercommunicating Systems, Sound Systems, Photo-Cell Equipment, Batteries, Chargers, Converters, Generators, Supplies for Resistance Welders, Fuses, Test Instruments, Meters, Broadcast Station Equipment, Relays, Condensers, Capacitors, Resistors, Rheostats, Transformers, Switches, Coaxial Cable, Wire, Soldering Irons, Microphones, Speakers, Technical Books, etc.

Specialists . .

in
 FEATHER
 EDGING

COPPER
 MACHINE
 PARTS

ON RADIO
 TUBES

Why Not Try Us?



We also do plastic injection molding up to 6 ounces.

ARPIN PRODUCTS, Inc.
 422 Alden St. Orange, N.J.

**WIRE, RIBBON and
 Other Metal Products**

★ *Smaller than Commercial Sizes;
 closer than Commercial Tolerances*

An organization devoted to the research, development and production of wire and ribbon and similar products of Platinum and other Precious Metals, as well as Rare and Base Metals . . . This metallurgical plant is completely equipped with alloying, melting and working facilities for precision production. Equipment and staff permit specialization in smaller than commercial sizes and closer than commercial tolerances for the most exacting technical requirements.

SIGMUND COHN & CO.
 44 Gold Street • New York 7, N. Y.



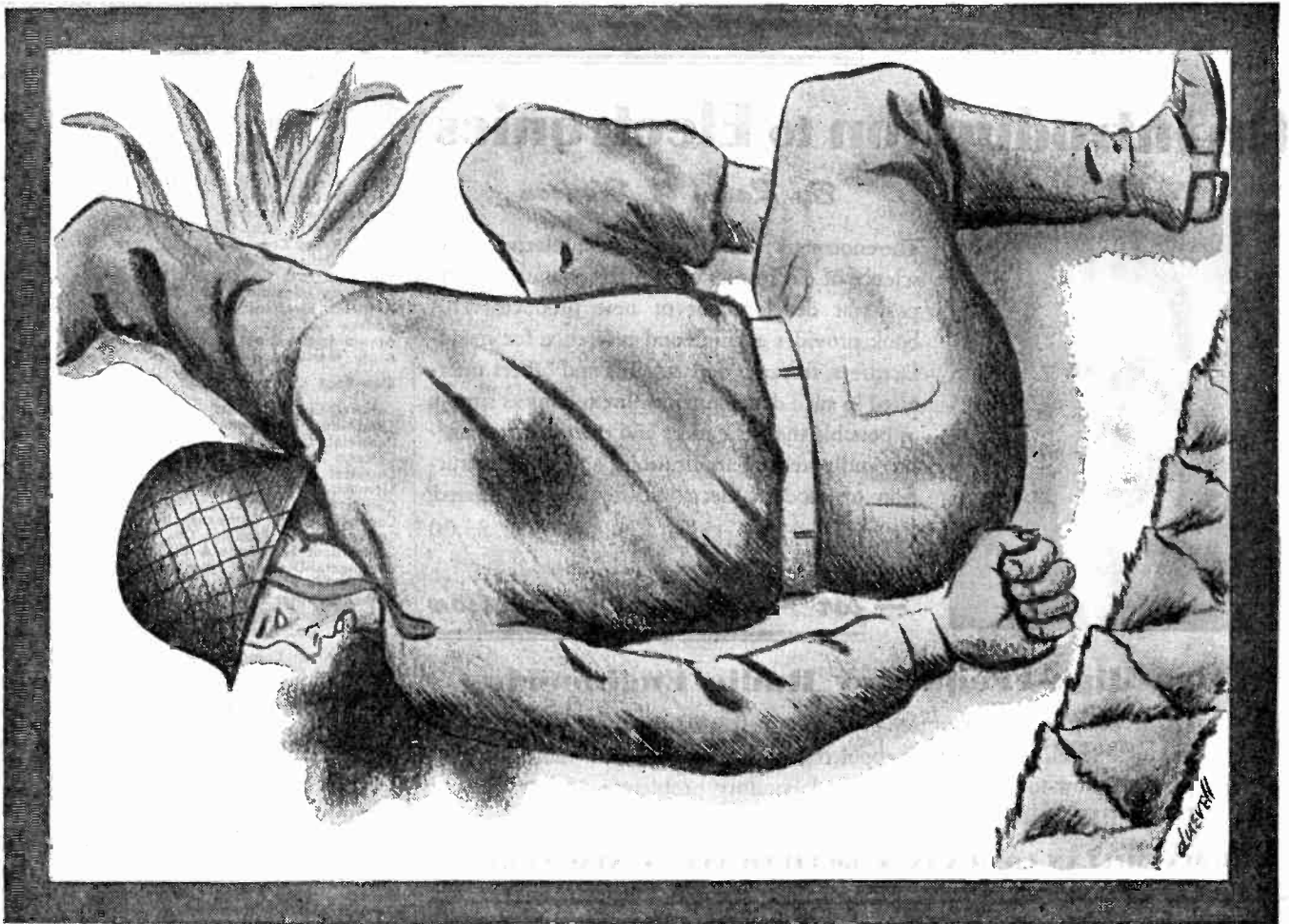

Portrait of a man who no longer cares about the cigarette shortage, the meat shortage... or gas shortage!

It's just a question of time when all shortages will be replaced by plenty — thanks to this boy and to millions like him.

*Give them a helping hand.
Buy Bonds — Donate Blood.*

We, the management and employees alike, at Kenyon, are building better transformers than we ever built before — and building them faster for the armed forces.



THE MARK OF EXCELLENCE

KENYON TRANSFORMER CO., Inc. 840 BARRY STREET
NEW YORK, U. S. A.

— for Post-War Planning

An Introduction to Electronics

By Ralph G. Hudson



The enormous potentialities of the relatively new science of electronics offer many avenues for the post-war development of new products. This book provides a guide and reference for manufacturers, research departments and others interested in such developments. It explains as simply as possible the basic ideas and theories, the existing and potential applications, and the construction of modern electronic devices. Illustrated.

\$3.00

— for Practical Instruction

Ultra-High-Frequency Radio Engineering

By W. L. Emery. "Exceptionally good for courses at the undergraduate level," say teachers about this new book. Contains much practical how-to-do-it information; laboratory problems; 2-color illus. \$3.25

THE MACMILLAN COMPANY • 60 FIFTH AVE. • NEW YORK 11

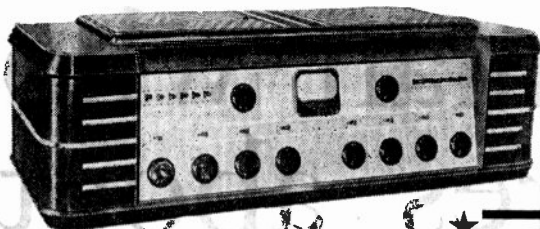

Model 30 DeLuxe Speech Input Console for use as main studio control unit for stations up to 50,000 watts.

ONLY GATES OFFERS YOU THIS CHOICE of SPEECH INPUT CONSOLES

Here are two popular examples of how Gates equipment is engineered for efficiency and economy to meet the requirements of every type of station. These two popular studio control units meet every demand for use as a main studio control unit, as sub-studio control equipment, for auditorium pick-ups and for large broadcasts such as symphonies, conventions, etc. You'll find these Gates units in service all over the world . . . time-proved by dependable service in more than 100 U.S. broadcasting stations ranging from 250 to 50,000 watts.

Wartime restrictions do not allow the sale of new broadcasting equipment without priority, therefore, this equipment is presented merely to acquaint you with Gates' current developments.

Ask About Our Priority Plan for Prompt Delivery When Gates Equipment Is Again Available.

Gates
RADIO COMPANY
Quincy, Illinois, U. S. A.

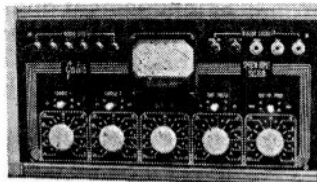

Model 51-CS Studiette Speech Input Console for smaller stations and sub-studio operation.

INDEX

Section Meetings	34A
Membership	38A
Positions Open	52A

DISPLAY ADVERTISERS

Acme Electric & Manufacturing Co.	64A
Aerovox Corporation	67A
Aireon Manufacturing Corp.	23A
Alliance Mfg. Co.	61A
Allied Radio Corp.	70A
Altec Lansing Corp.	44A
American Lava Corp.	9A
American Transformer Co.	13A
Amperex Electronic Corp.	Cover II
Andrew Co.	44A
Arnold Engineering Co.	64A
Arpin Manufacturing Co.	70A
Blaw-Knox Company	40A
Caldwell-Clements Inc.	35A
Cambridge Thermionic Corp.	33A
Centralab	14A
Chicago Transformer Corp.	58A
Clarostat Mfg. Co., Inc.	34A
Sigmund Cohn & Co.	70A
Collins Radio Co.	54A
Communications Company, Inc.	61A
Communication Products Co., Inc.	40A
Connecticut Telephone & Elec. Div.	43A
Continental-Diamond Fibre Co.	22A
Continental Electric Co.	47A
Cornell-Dubilier Electric Corp.	Cover III
Corning Glass Works	21A
Coto-Coil Co., Inc.	68A
Dalmo Victor Company	52A
The Daven Company	16A
Tobe Deutschmann Corp.	73A
Allen B. Dumont Labs., Inc.	10A
Hugh H. Eby Incorporated	60A
Eicor Inc.	66A
Eitel-McCullough, Inc.	18A
Electronic Industries	35A
Electronic Laboratories, Inc.	65A
Electronic Mechanics, Inc.	6A
Federal Telephone & Radio Corp.	57A
Freed Radio Corporation	56A
Gates Radio Co.	72A
General Aniline & Film Corporation	26A, 27A
General Electric Company	29A, 45A
General Instrument Corp.	69A
General Radio Co.	Cover IV
Halicrafters Company	30A
Hazeltine Corp.	56A
Heintz & Kaufman Ltd.	31A
Hewlett-Packard Co.	4A
Hytron Corp.	5A
Industrial & Commercial Electronics	41A
Industrial Condenser Corp.	53A
Industrial Instruments	58A
International Resistance Co.	37A
International Tel. & Tel.	57A
Kaar Engineering Co.	55A
Kenyon Transformer Co.	71A
John E. Lingo & Son, Inc.	36A
Macmillan Co.	72A
Maguire Industries, Inc.	56A
Majestic Radio & Television Corp.	56A
Measurements Corp.	28A
Merit Coil & Transformer Corp.	62A
Monarch Mfg. Co.	38A
National Company	20A
National Union Radio Corp.	17A
New York Transformer Co.	53A
North American Philips Co., Inc.	3A
Ohmit Mfg. Co.	39A
M. F. M. Osborne Associates	62A
Permotlux Corporation	48A
Pratt & Whitney Aircraft	52A
Premax Products	68A
Prentice-Hall Inc.	66A
Radio Corp. of America	32A, 50A, 51A
Rauland Corp.	74A
Raytheon Mfg. Co.	24A
Remler Co., Ltd.	19A
Santay Corp.	63A
Shallcross Mfg. Co.	46A
Standard Transformer Corp.	42A
Stromberg-Carlson Co.	52A
Stupakoff Ceramic & Mfg. Co.	12A
Submarine Signal Co.	52A
Sun Radio & Electronics Co.	61A
Templetone Radio Mfg. Corp.	60A
Triplett Electrical Instrument Co.	59A
United Electronics Co.	15A
United Transformer Co.	49A
Universal X-Ray Products Inc.	62A
Utah Radio Products Co.	8A
Weston Electrical Instrument Corp.	11A
Western Electric Co.	56A
Westinghouse Electric & Mfg. Co.	7A, 25A

To fulfill Long Life
is the goal of every
Tobe Capacitor
even under extreme
temperature conditions



Long Life and Tobe are
interchangeable trademarks



SPECIFICATIONS OF JUST ONE TYPE OF THE MANY TOBE OIL-IMPREGNATED
AND OIL-FILLED PAPER CAPACITORS . . .

OD*-CAPACITORS

RATINGS:		GROUND TEST 2,500 Volts DC	
600 VDC	Single Units	.05, 0.1, .25 Mfd.	OPERATING TEMPERATURE 55°F. to 185°F.
	Dual Units	.05, 0.1, "	
	Triple Units	.05, 0.1, "	
1,000 VDC	Single Units	.05, 0.1 Mfd.	SHUNT RESISTANCE: .05 to 0.1 Mfd.—20,000 Megohms .25 Mfd. —12,000 Megohms
	Dual Units	.05, 0.1 "	
	Triple Units	.05 "	
STANDARD CAPACITANCE TOLERANCE plus or minus 20.%**		POWER FACTOR 1,000 cycles—.002 to .005	
TEST VOLTAGE twice DC rating		CONTAINER SIZE: Width 9/16"; length 1-11/16"; height 1-17/32"	
		MOUNTING HOLE CENTERS 2-1/8"	

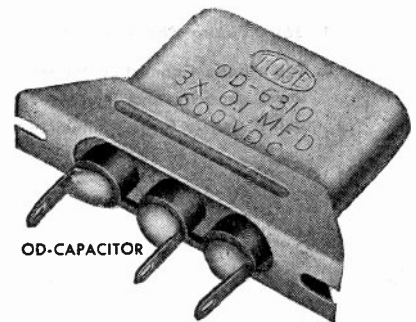

OD-CAPACITOR

*Data sheets showing complete code number for units having a specific capacitance value and voltage ratings available on request. **Other tolerances available.

Illustration shows capacitor with bottom terminals. Capacitors also available with top terminals.

A SMALL PART IN VICTORY TODAY — A BIG PART IN INDUSTRY TOMORROW

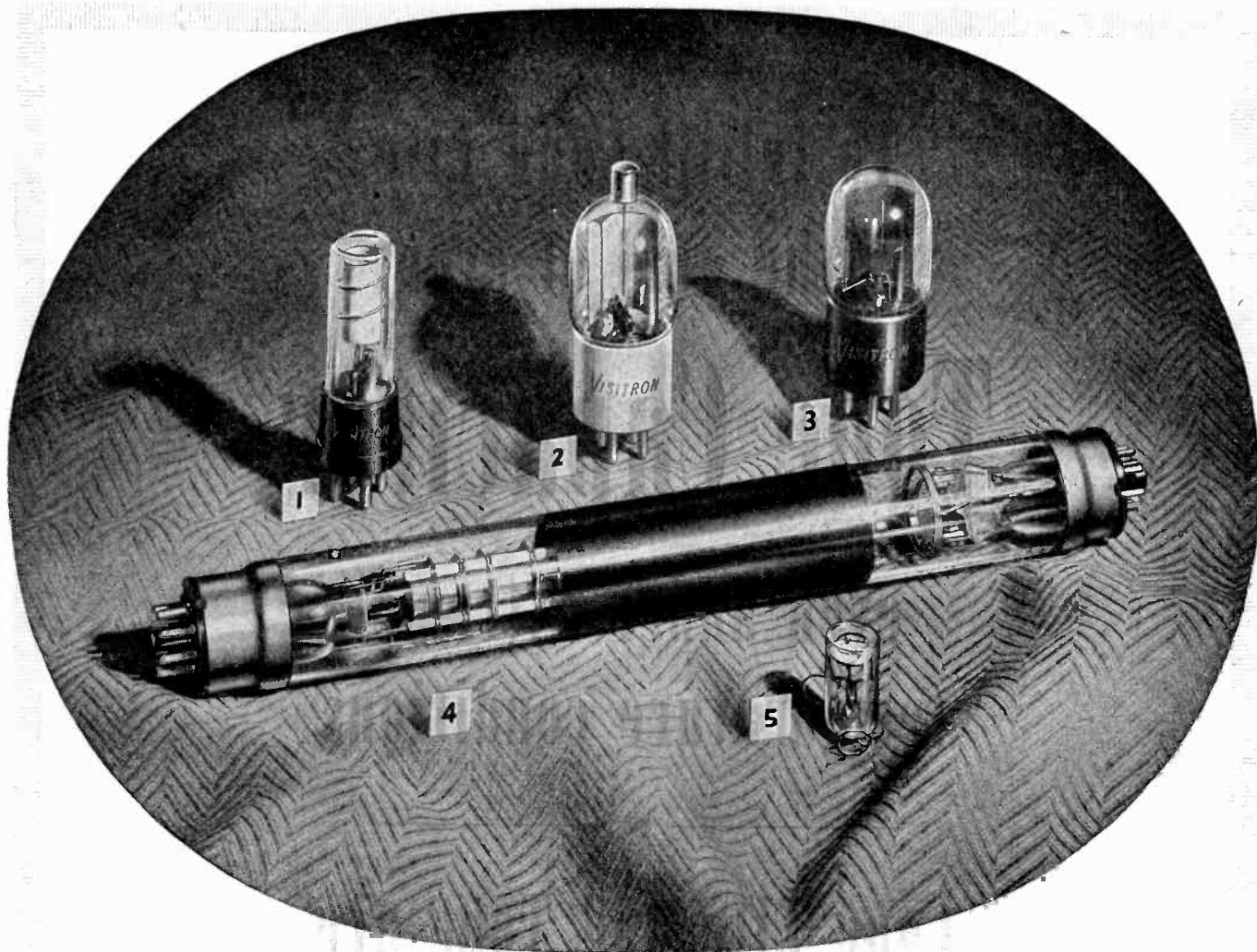

Name Your Problem

Don't be "stumped" by a seemingly unobtainable tube. Usually such problems are successfully solved by RAULAND specially-designed tubes having characteristics that meet special requirements.

Your quest may call for a single tube or thousands. In either case the RAULAND organization will produce them. • RAULAND tube engineers are men of long experience, widely recognized for achievement, who have opened the way to a broader electronic progress through their creation of tubes which have solved many, varied applications.

THE ILLUSTRATION:

1. 360° Pickup Phototube, having universal application.
2. Top Anode Connection Phototube with ceramic base to lower capacity and increase leakage path, with special guard ring to further minimize leakage.
3. Exceptionally High Blue-Sensitive Phototube. (Typical application is in high temperature photo-control).
4. Electronic Beam Tube for negative feedback control devices.
5. Space-Saving Midget End-View Phototube (size $1\frac{1}{8}'' \times 1\frac{1}{16}''$).

RADIO • RADAR • SOUND •

Rauland

COMMUNICATIONS • TELEVISION

Electroneering is our business

THE RAULAND CORPORATION • CHICAGO 41, ILLINOIS

Buy War Bonds and Stamps! Rauland employees are still investing 10% of their salaries in War Bonds

NEW OSCILLATOR



100 to 500 Mc

THIS NEW oscillator, designed for use as a general-purpose laboratory instrument, uses the new Butterfly Circuit which obviates the difficulty of sliding contacts in any part of the circuit and provides a source of ultra-high-frequency power sufficient for most laboratory measurement needs.

Some of its features are:

- Dial calibrated directly in megacycles with an accuracy of 1 per cent
- Vernier dial with 100 divisions, covering the tuning range in 10 turns
- Output through a coaxial jack to which is attached a pick-up loop to provide variable coupling to the oscillator
- Output of one-half watt with the power supply furnished
- Output up to one watt at the highest frequency with a 450-volt power supply, provided certain precautions are taken in the operation of the oscillator
- The Type 857-P1 Power Supply furnishes a plate voltage of 350 volts and filament supply of 2.5 volts for the W. E. Type 316-A tube used in the oscillator
- Electron-ray tube incorporated in the power supply to show oscillator grid current

Type 857-A Oscillator with Type 857-P1 Power Supply \$250.00

We are in limited production now for high priority war orders; reservation orders for later deliveries are being accepted.

A complete description appears in the G-R Experimenter for November, 1944. If you do not have a copy, write for Bulletin 931.

GENERAL RADIO COMPANY Cambridge 39, Massachusetts
NEW YORK CHICAGO LOS ANGELES