

Proceedings



of the

I · R · E

A Journal

of the Theory, Practice, and Applications of
Electronics and Electrical Communication

Radio Communication • Sound Broadcasting • Television
Marine and Aerial Guidance • Engineering Education
Power and Manufacturing Applications of Radio-and-Electronic Technique
Industrial Electronic Control and Processes • Tubes • Electron Optics
Medical Electrical Research and Applications • Radio-Frequency Measurements
Sound and Picture Electrical Recording and Reproduction

1945 WINTER TECHNICAL MEETING

JANUARY, 1945

VOLUME 33

NUMBER 1



HUBERT M. TURNER
President, 1944



WILLIAM L. EVERITT
President, 1945

Graduate Engineering Study
Electronic Research
Industrial Heating
Quartz-Crystal Units
Velocity-Modulation Bunching
F-M Duplex Operation
Universal-Coil Winding
Voltage-Regulator Operation
Coaxial-Cable Attenuation

The Institute of Radio Engineers

Why

AMPEREX

WATER AND AIR COOLED TRANSMITTING AND RECTIFYING TUBES



AMPEREX

... the high performance tube



The ILLINOIS TOOL WORKS has made tremendous strides in the design and development of dielectric heating equipment for such applications as moulding bakelite, heating pre-forms, joining thermoplastics, etc. AMPEREX tubes are used in all such equipment produced by this well-known concern.

With the ILLINOIS TOOL WORKS, as with many other leading concerns working with electronic tubes, it's the "Amperextra" of longer life and low-cost efficiency that has made our products a first and exclusive choice. AMPEREX pioneered in the field of tubes for industrial applications. We are familiar with the needs of industry, and we have the tubes to meet all requirements. Consult AMPEREX for assistance with your present or postwar problems.

IMPORTANT! AMPEREX tubes are now available through leading radio equipment distributors. This new arrangement may save valuable time for busy engineers by enabling them to obtain many of our standard tube types from their local supply sources.

AMPEREX ELECTRONIC CORPORATION

79 WASHINGTON STREET BROOKLYN 1, N. Y.

Export Division: 13 E. 40th St., New York 16, N. Y., Cables: "Arlab"

THE WAR ISN'T OVER YET...BUY AND HOLD MORE WAR BONDS

BOARD OF DIRECTORS
1944

Hubert M. Turner
President
Ralph A. Hackbusch
Vice-President
Raymond A. Heising
Treasurer
Haraden Pratt
Secretary
Alfred N. Goldsmith
Editor
Arthur F. Van Dyck
Senior Past President
Lynde P. Wheeler
Junior Past President

1942-1944

Adolph B. Chamberlain
William L. Everitt
Browder J. Thompson

1943-1945

Wilmer L. Barrow
Frederick B. Llewellyn
Harold A. Wheeler

1944-1946

Raymond F. Guy
Lawrence C. F. Horle
William C. White

1944

Stuart L. Bailey
E. Finley Carter
Ivan S. Coggeshall
Charles B. Jolliffe
Herbert J. Reich

Harold R. Zeamans
General Counsel

BOARD OF EDITORS

Alfred N. Goldsmith
Editor
Ralph R. Batcher
Robert S. Burnap
Philip S. Carter
Lewis M. Clement
E. Maurice Deloraine
William G. Dow
Elmer W. Engstrom
William L. Everitt
George W. Gilman
Peter C. Goldmark
Frederick W. Grover
Lewis B. Headrick
C. M. Jansky, Jr.
John D. Kraus
Donald G. Little
Frederick B. Llewellyn
Samuel S. Mackeown
Edward L. Nelson
Harry F. Olson
Harold O. Peterson
Greenleaf W. Pickard
Ralph A. Powers
Haraden Pratt
Conan A. Priest
Herbert J. Reich
Peter C. Sandretto
V. W. Sherman
Lynne C. Smeby
E. C. Wente
Harold A. Wheeler
William C. White
Laurens E. Whittemore
Gerald W. Willard
William Wilson
Charles J. Young
Vladimir K. Zworykin

Proceedings of the I·R·E

Published Monthly by

The Institute of Radio Engineers, Inc.

VOLUME 33

January, 1945

NUMBER I

Section Meetings	Next Page
The Challenge to Engineers	Walter E. Poor 1
Adolph Bernard Chamberlain	2
Concurrent Graduate Study—Its Place in Postwar Engineering Education	F. R. Stansel 3
Electronic Research Opens New Frontiers	Ralph R. Beal 5
The Use of Radio Frequencies to Obtain High-Power Concentrations for Industrial-Heating Applications	Wesley M. Roberds 9
The Standardization of Quartz-Crystal Units	Karl S. Van Dyke 15
Graphical Methods for Analysis of Velocity-Modulation Bunching	Arthur E. Harrison 20
A Stabilized Narrow-Band Frequency-Modulation System for Duplex Working	E. E. Suckling 33
On the Winding of the Universal Coil	A. W. Simon 35
Analysis of Voltage-Regulator Operation	W. R. Hill, Jr. 38
A Method of Measuring Attenuation of Short Lengths of Coaxial Cable	Chandler Stewart, Jr. 46
Institute News and Radio Notes	
1945 Winter Technical Meeting	49
Board of Directors	61
Executive Committee	61
I.R.E. Board Sets Goal of Building Fund at \$500,000	62
Rochester Fall Meeting	64
I.R.E. People	65
Correspondence:	
"Frequency and Phase Modulation," by Harry Stockman and Gunnar Hok	66
"A Circuit Study," by Braulio Dueño	66
"Proposed Changes to Bylaws," by R. E. Stark	67
Books:	
"International Telecommunications," by Osborne Mance and J. E. Wheeler	Haraden Pratt 67
"Sampling Inspection Tables—Single and Double Sampling," by Harold F. Dodge and Harry G. Romig	F. X. Rettenmeyer 68
"Die Beziehungen zwischen Nutzsprungung und Störspannung," by Erwin Huber	H. A. Affel 68
"Instrument Flying and Radio Navigation," by Holland L. Redfield	H. C. Leuteritz 68
"Electronics Today and Tomorrow," by John Mills	V. K. Zworykin 69
Contributors	69
Section Meetings	34
Membership	36
Index	72

Responsibility for the contents of papers published in the PROCEEDINGS rests upon the authors. Statements made in papers are not binding on the Institute or its members.



Entered as second-class matter October 26, 1927, at the post office at Menasha, Wisconsin, under the Act of February 28, 1925, embodied in Paragraph 4, Section 538 of the Postal Laws and Regulations. Publication office, 450 Ahnapp Street, Menasha, Wisconsin. Executive, editorial, and advertising offices, 330 West 42nd Street, New York 18, N. Y. Price, \$1.00 a copy. Subscriptions: United States and Canada, \$10.00 a year; foreign countries, \$11.00 a year. Changes of address (with advance notice of fifteen days) and communications regarding subscriptions and payments should be mailed to the Secretary of the Institute, at 330 West 42nd Street, New York 18, N. Y. All rights of republication, including translation into foreign languages, are reserved by the Institute. Abstracts of papers, with mention of their source, may be printed. Requests for republication privileges should be addressed to The Institute, of Radio Engineers.

Copyright, 1945, by The Institute of Radio Engineers, Inc.

PAPERS COMMITTEE

Frederick B. Llewellyn
Chairman
Herman A. Affel
Wilmer L. Barrow
Howard A. Chinn
James K. Clapp
Ivan S. Coggeshall
Murray G. Crosby
Frederick W. Cunningham
Robert B. Dome
Enoch B. Ferrell
Donald G. Fink
H. S. Frazier
Stanford Goldman
Frederick W. Grover
O. B. Hanson
E. W. Herold
John V. L. Hogan
Frederick V. Hunt
Harley Iams
Loren F. Jones
John G. Kreer, Jr.
Emil Labin
Frederick R. Lack
Hugo C. Leuteritz
De Loss K. Martin
Knox McIlwain
Harry R. Mimno
Ilia E. Mouromtseff
G. G. Muller
Albert F. Murray
Dwight O. North
A. F. Pomeroy
Jack R. Poppele
Simon Ramo
Francis X. Rettenmeyer
Sergei A. Schelkunoff
Donald B. Sinclair
Hubert M. Turner
Dayton Ulrey
Karl S. Van Dyke
E. K. Van Tassel
John R. Whinnery
Irving Wolf
J. Warren Wright
Harold R. Zeamans

**PAPERS
PROCUREMENT
COMMITTEE**

Dorman D. Israel
General Chairman
William L. Everitt
Vice Chairman
GROUP CHAIRMEN
Jesse E. Brown
Warren B. Burgess
Edward J. Content
Harry Diamond
Edward T. Dickey
J. Kelly Johnson
Carl J. Madsen
Dan H. Moore
James R. Nelson
Howard J. Tyzzer
William C. White

Helen M. Stote
Associate Editor
William C. Copp
Advertising Manager
William B. Cowilich
Assistant Secretary



THE INSTITUTE OF RADIO ENGINEERS

INCORPORATED



1945 WINTER TECHNICAL MEETING
NEW YORK, JANUARY 24, 25, 26, AND 27, 1945

SECTIONS MEETINGS

ATLANTA January 19	CHICAGO January 19	CLEVELAND January 25	DETROIT January 19	LOS ANGELES January 16
NEW YORK February 7	PHILADELPHIA February 1	PITTSBURGH February 12	PORTLAND February 12	WASHINGTON February 12

SECTIONS

- ATLANTA**—Chairman, Walter Van Nostrand; Secretary, Ivan Miles, 554-14 St., N. W., Atlanta, Ga.
- BALTIMORE**—Chairman, W. L. Webb; Secretary, H. L. Spencer, Box 6760, Towson 4, Md.
- BOSTON**—Chairman, C. C. Harris; Secretary, Corwin Crosby, 16 Chauncy St., Cambridge, Mass.
- BUENOS AIRES**—Chairman, L. C. Simpson; Secretary, I. C. Grant, Venezuela 613, Buenos Aires, Argentina
- BUFFALO-NIAGARA**—Chairman, A. J. Dybowski; Secretary, H. G. Korts, 51 Kinsey Ave., Kenmore, N. Y.
- CEDAR RAPIDS**—Temporary Chairman, T. A. Hunter; Temporary Secretary, J. A. Green, Collins Radio Co., 855-35th St., N.E., Cedar Rapids, Iowa
- CHICAGO**—Chairman, W. O. Swinyard; Secretary, A. W. Graf, 135 S. LaSalle St., Chicago 3, Ill.
- CINCINNATI**—Chairman, J. L. Hollis; Secretary, R. S. Butts, Box 1403, Cincinnati 2, Ohio
- CLEVELAND**—Chairman, A. S. Nace; Secretary, L. L. Stoffel, 1095 Kenneth Dr., Lakewood, Ohio
- CONNECTICUT VALLEY**—Chairman, R. E. Shea; Secretary, L. A. Reilly, 989 Roosevelt Ave., Springfield, Mass.
- DALLAS-FORT WORTH**—Chairman, D. J. Tucker; Secretary, P. C. Barnes, WFAA-WBAP, Grapevine, Texas
- DAYTON**—Chairman, G. L. Haller; Secretary, Joseph General, 1319 Superior Ave., Dayton 7, Ohio
- DETROIT**—Chairman, R. A. Powers; Secretary, R. R. Barnes, 1411 Harvard Ave., Berkeley, Mich.
- EMPORIUM**—Chairman, W. A. Dickinson; Secretary, H. E. Achman, West Creek, R. D. 2, Emporium, Pa.
- INDIANAPOLIS**—Chairman, H. I. Metz; Secretary, J. D. Colvin, 328 E. 47 St., Indianapolis, Ind.
- KANSAS CITY**—Chairman, A. P. Stuhrman; Secretary, R. N. White, 4800 Jefferson St., Kansas City, Mo.
- LONDON**—Temporary Secretary, R. Wilton; Royal Canadian Air Force, Clinton, Ont., Canada
- LOS ANGELES**—Chairman, L. W. Howard; Secretary, Frederick Ireland, 1000 N. Seward St., Hollywood 38, Calif.
- MONTREAL**—Chairman, F. S. Howes; Secretary, J. A. Campbell, Northern Electric Co., Ltd., 1261 Shearer St., Montreal, Que., Canada
- NEW YORK**—Chairman, Lloyd Espenschied; Secretary, J. E. Shepherd, 111 Courtenay Rd., Hempstead, L. I., N. Y.
- OTTAWA**—Acting Secretary, L. F. Millett, 33 Regent St., Ottawa, Ont., Canada
- PHILADELPHIA**—Chairman, T. A. Smith; Secretary, P. M. Craig, Philco Corp., Philadelphia 34, Pa.
- PITTSBURGH**—Chairman, T. C. Kenny; Secretary, R. K. Crooks, Box 2038, Pittsburgh 30, Pa.
- PORTLAND**—Chairman, W. A. Cutting; Secretary, W. E. Richardson, 5960 S.W. Brugger, Portland, Ore.
- ROCHESTER**—Chairman, G. R. Town; Secretary, Harold Goldberg, Stromberg-Carlson Co., Rochester 3, N. Y.
- ST. LOUIS**—Chairman, N. B. Fowler; Secretary, C. H. Meyer, KFUE, 801 DeMun Ave., St. Louis, Mo.
- SAN FRANCISCO**—Chairman, David Packard; Secretary, William Barclay, Stanford University, Palo Alto, Calif.
- SEATTLE**—Chairman, F. B. Mossman; Secretary, E. H. Smith, Apt. K, 1620-14 Ave., Seattle 22, Wash.
- TORONTO**—Chairman, E. O. Swan; Secretary, Alexander Bow, Copper Wire Products, Ltd., 137 Roncesvalles Ave., Toronto, Ont., Canada
- TWIN CITIES**—Chairman, H. S. McCartney; Secretary, C. W. Engelman, 4648 Chowden Ave. S., Minneapolis 10, Minn.
- WASHINGTON**—Chairman, H. A. Burroughs; Secretary, L. C. Smeby, 4801 Connecticut Ave., N.W., Washington, D. C.
- WILLIAMSPORT**—Chairman, H. E. Smithgall, Jr.; Secretary, K. E. Carl, Williamsport Technical Institute, Williamsport, Pa.

SYNCHRONIZATION OF VIBRATORS FOR PARALLEL OPERATION

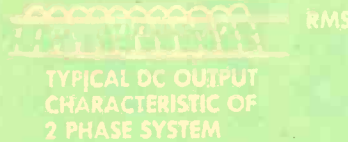
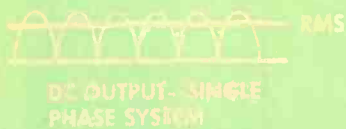
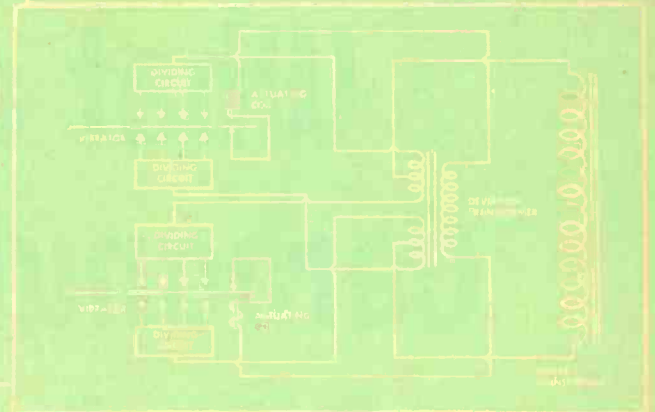
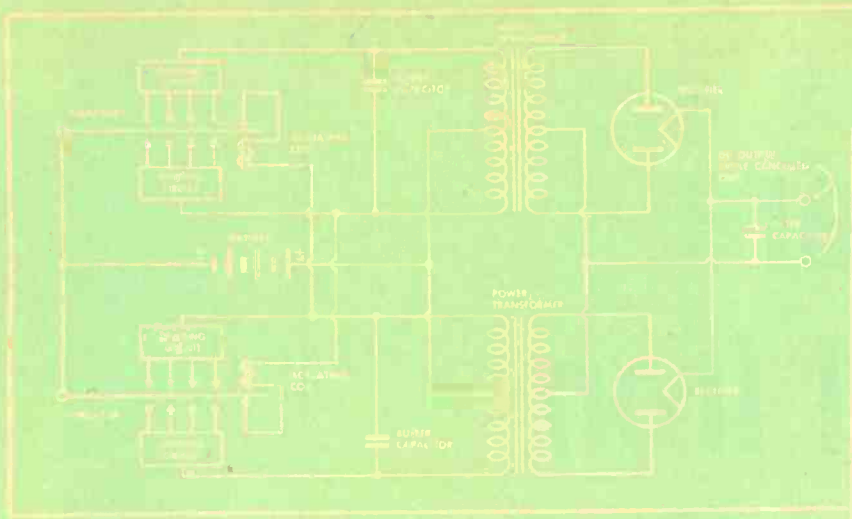

Typical E-L single-phase and two-phase circuits of dual vibrators which permit power outputs in excess of 1,000 watts.

While improvements in circuit technique developed by Electronic Laboratories have allowed commutation of currents up to 25 to 30 amperes, recent requirements for increased power have necessitated introduction of dual vibrator circuits thereby doubling the output of E-L Power Supplies. Both in-phase and two-phase systems are available permitting output powers in excess of 1000 watts.

Parallel Operation—Single-Phase—A.C. Output

In units furnishing A.C. power as output, the vibrators must operate in phase. This operation is secured by means of modulating voltage obtained from a secondary placed on a current dividing reactor, which insures the division of the current between the two vibrators. The primary is center-tapped with the center tap feeding the power transformer, while the ends connect to power contacts on the same side of the respective vibrators. If one vibrator makes contact before the other there will be a voltage induced in the secondary of the transformer. This induced voltage is applied to the actuating coil of the other vibrator in such a way as to be in phase and thereby cause it to increase its frequency and decrease that of the higher frequency vibrator. When the vibrators reach the same frequency it is obvious there will be no modulating voltage. The time constant of the current division network is such as to take care of small time differentials. The circuit has the further advantage of allowing the use of one large power transformer which gives higher efficiency than can be secured by using two smaller ones.

Parallel Operations—Two-Phase—D.C. Output

In vibrator power units which have a filtered D.C. output the advantages of a two-phase system are obvious in the reduction of the filter network required to secure a given A.C. ripple on the output.

To correct any possible frequency deviations, Electronic Laboratories' engineers have cross-modulated the D.C. voltage applied to the respective actuating coils with an A.C. voltage secured from the opposite transformer primary. The A.C. voltage is of such a value that the alternate in-and out-of-phase relationship effectively forces the vibrators to assume the same frequency. The 90° phase relationship essential to insure low ripple outputs from associated rectifiers is secured by the action of the modulating voltage, inasmuch as the vibrator having the higher natural frequency will make contact first upon the application of the input voltages. This causes the effective voltage on the actuating coil of the lower frequency vibrator to be $E_{dc} + E_{ac}$ (E_{ac} is the modulating voltage received from the transformer winding associated with the higher frequency vibrator). When the lower frequency vibrator actually makes contact, the phase of the A.C. modulation is such that the effective voltage applied to the higher frequency vibrator is $E_{dc} - E_{ac}$, thus causing a reduction in its frequency until synchronism is obtained with the lower frequency vibrator and contact is broken. It then functions in the normal manner. The cycle then repeats itself and maintains the 90° phase shift.

The E-L unit, shown below is a typical Vibrator Power Supply used in the operation of communication equipment. With a 12 volt D.C. input, it develops 500 watts power output. Dimensions 20x20x8½ in.



Electronic

LABORATORIES INC.

INDIANAPOLIS

VIBRATOR POWER SUPPLIES FOR LIGHTING, COMMUNICATIONS AND ELECTRIC MOTOR OPERATION . ELECTRIC, ELECTRONIC AND OTHER EQUIPMENT

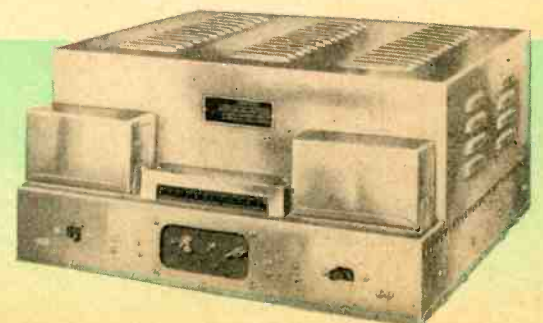

What are Carbonyl Iron Powders?

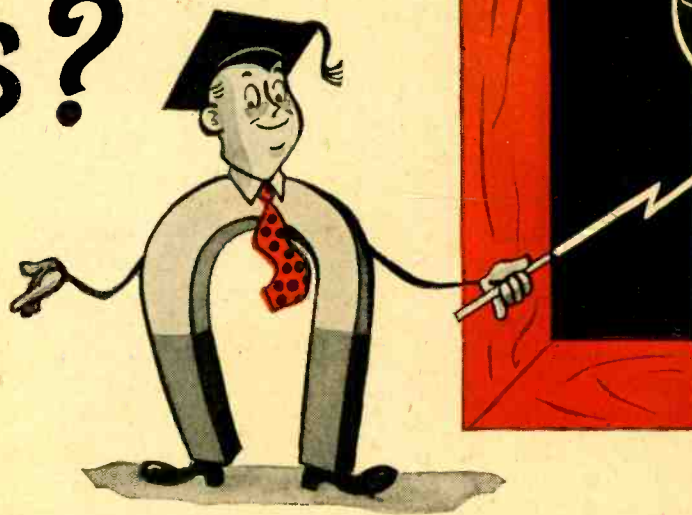

ABOVE you see the fundamental characteristics found only in G.A.F. Carbonyl Iron Powders. The text below outlines kinds of powders, chemical and physical analysis, including "Q" value, and suggested uses.

G.A.F. Carbonyl Iron Powders are obtained by thermal decomposition of iron penta-carbonyl. There are five different grades in production, which are designated as "L," "C," "E," "TH," and "SF" Powder.

The particles making up the powders "E," "TH," and "SF" are spherical with a characteristic structure of increasingly larger shells. The particles of "L" and "C" are made up of homogenous spheres and agglomerates.

The chemical analysis, the weight-average particle size, the "tap density," and the apparent density as determined in a Scott Volumeter are given in the following table for the five different grades:

TABLE 1

Grade	Chemical Analysis		% Nitrogen	Wt. Ave. diameter microns	Tap Density g/cm ³	Apparent Density g/cm ³
	% Carbon	% Oxygen				
L	0.005—0.03	0.1 —0.2	0.005—0.05	20	3.5—4.0	1.8—3.0
C	0.03 —0.12	0.1 —0.3	0.01 —0.1	10	4.4—4.7	2.5—3.0
E	0.65 —0.80	0.45—0.60	0.6 —0.7	8	4.4—4.7	2.5—3.5
TH	0.5 —0.6	0.5 —0.7	0.5 —0.6	5	4.4—4.7	2.5—3.5
SF	0.5 —0.6	0.7 —0.8	0.5 —0.6	3	4.7—4.8	2.5—3.5

With reference to the chemical analysis shown above, it should be noted that spectroscopic analysis shows the rest to be iron with other elements present in traces only.

Carbonyl Iron Powders are primarily useful as elec-

tromagnetic material over the entire communication frequency spectrum.

Table 2 at right gives relative Q values (quality factors) and effective permeabilities for the different grades

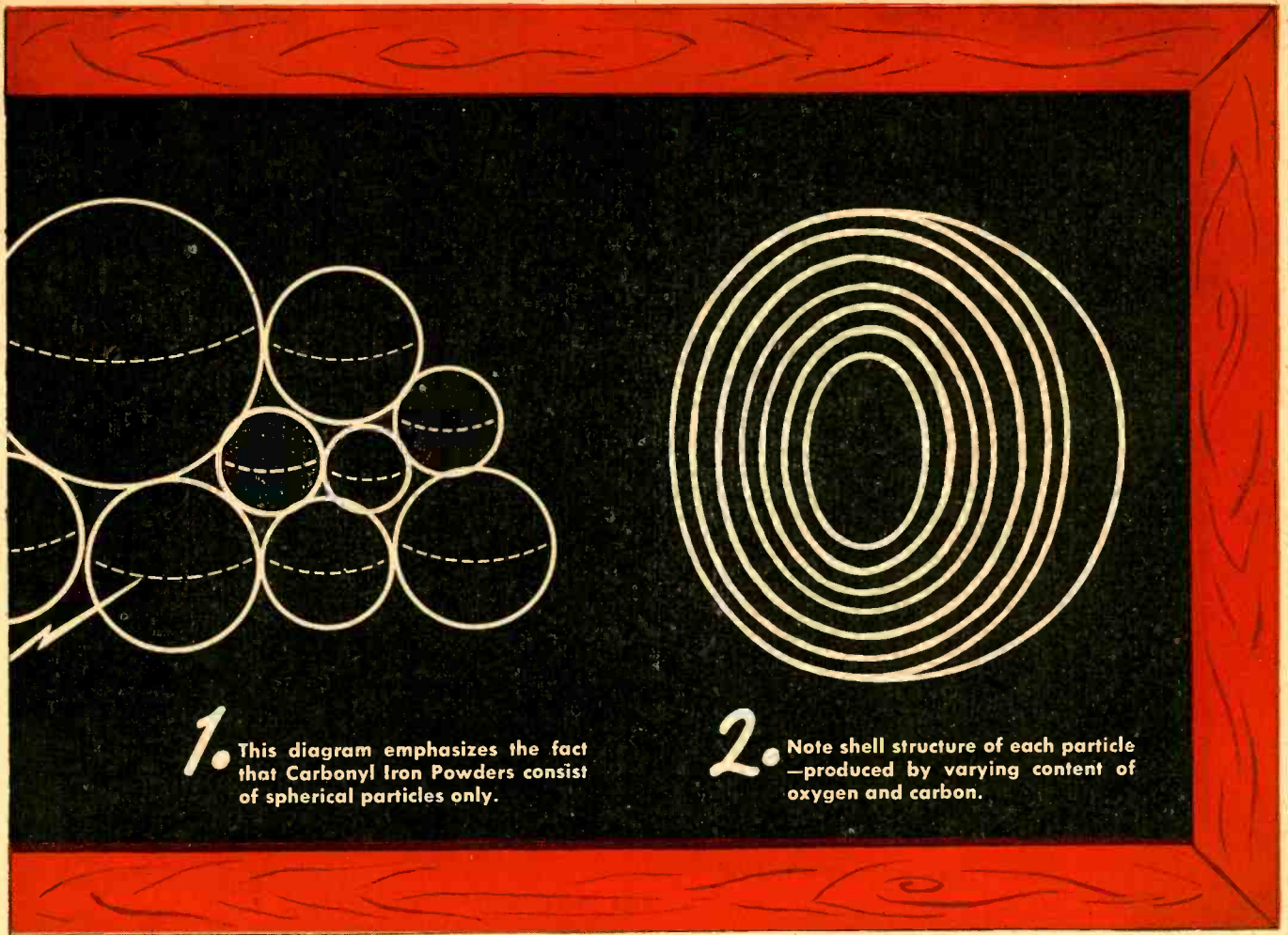

1. This diagram emphasizes the fact that Carbonyl Iron Powders consist of spherical particles only.

2. Note shell structure of each particle —produced by varying content of oxygen and carbon.

of carbonyl iron powder. The values given in the table are derived from measurements on straight cylindrical cores placed in simple solenoidal coils. Although the data were not obtained at optimum conditions, the Q

values as expressed in percentage of the best core give an indication of the useful frequency ranges for the different powder grades.

TABLE 2

Carbonyl Iron Grade	Effective Permeability at 1 kc	Relative Quality Factor at				
		10 kc	150 kc	200 kc	1 Mc	100 Mc
L	4.16	100	96	90	43	1
C	3.65	94	100	98	72	3
E	3.09	81	94	100	97	30
TH	2.97	81	93	98	100	54
SF	2.17	62	71	78	84	100

(Note: The actually measured Q values can be obtained by multiplying the rows respectively with: 0.78, 1.09, 1.25, 2.63, and 1.62.)

“L” and “C” powders are also used as powder metallurgical material because of their low sintering temperatures, high tensile strengths, and other very desirable qualities. (Sintering begins below 500°C and tensile

strengths reach 150,000 psi.)

Further information can be obtained from the Special Products Sales Dept., General Aniline and Film Corporation, 437 Hudson Street, New York 14, N. Y.

G.A.F. CARBONYL IRON POWDERS



Radio in the

The BC-348 Receiver—Designed by RCA

Centered on the B-29 radio operator's table is the RCA-designed BC-348 long-range aircraft receiver. This is the receiver which keeps the crew in touch with its base on the thousand-mile bombing runs over Japan. It is one of the equipments which is responsible for the remarkable success of these new bombers.

Conceived by the Signal Corps before Pearl Harbor, the BC-348 was designed and put in production by RCA in time to be installed on practically every important bomber now used by the Army Air Forces. Its outstanding sensitivity, selectivity, image rejection, operating convenience and rugged construction made it the logical choice for the B-29's of the 20th Air Force.

Many other aviation equipments have been designed by the engineers of RCA since the BC-348. When security permits, these contributions to aviation radio progress will make peacetime aviation safer, faster and more efficient.

1919-1944 • 25 Years of Progress in Radio and Electronics



RADIO CORPORATION OF AMERICA

RCA VICTOR DIVISION • CAMDEN, NEW JERSEY

BUY MORE WAR BONDS



Superfortress

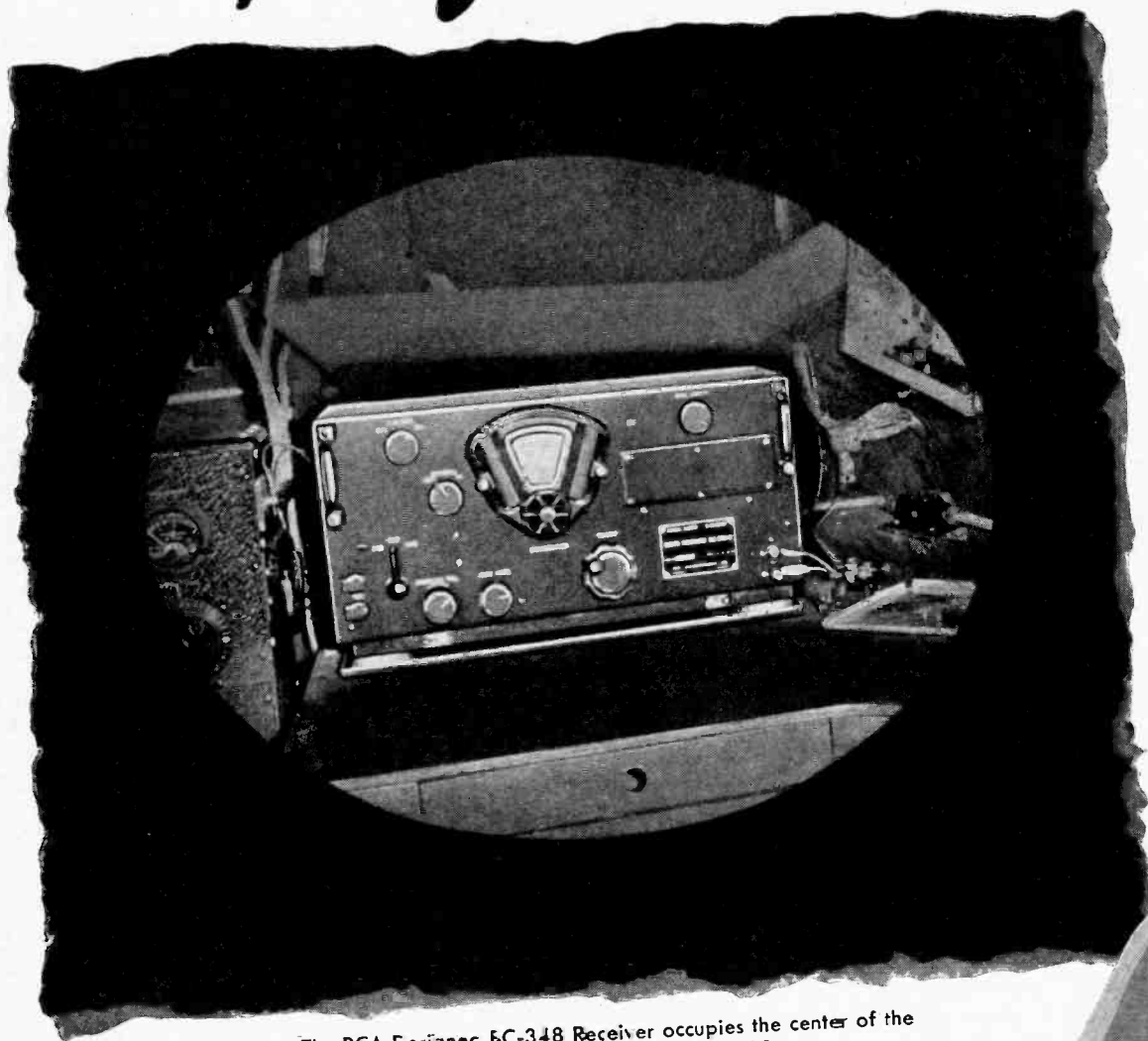

The RCA-Designec BC-348 Receiver occupies the center of the radio operator's table in the B-29.



GRAND

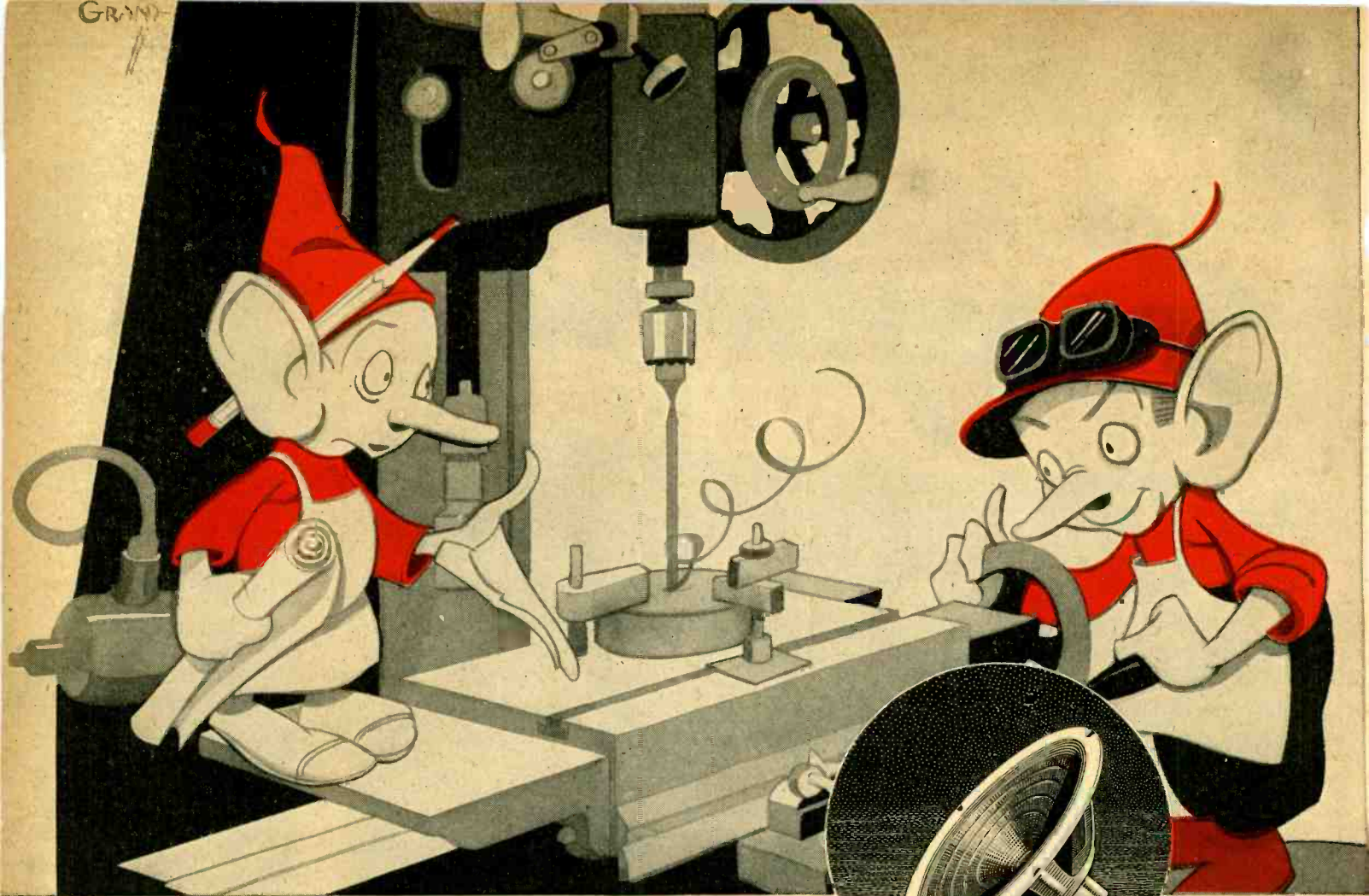

THE UNBROKEN CIRCUIT

A machine like that shown above may look like a complicated and perplexing mass of metal to you, but not to Utalins*.

They visualize the precision of the resulting tools . . . made in Utah's own factory to Utah's undeviating standards. They know these tools will play a major part in creating the quality products that make possible the modern electronic circuit.

And Utalins* know the performance of these products! For Utah's process is absolutely com-

prehensive . . . the making of tools is only the first step. It is followed by the close supervision and painstaking testing of all steps of manufacture, from raw material to finished product . . . *the unbroken circuit.*

When finally these products become an integral part of an electronic device, those listening—as well as those working in the many phases of electronic development—can recognize the quality of the products

that emanate from Utah's self-contained plant.

UTAH SPEAKERS:
More than 20 million Utah speakers have been made for radio, and public address systems.

*Utalins—Utah's helpers.



IT ALL DEPENDS ON

WHERE YOU PUT THE BRUSH

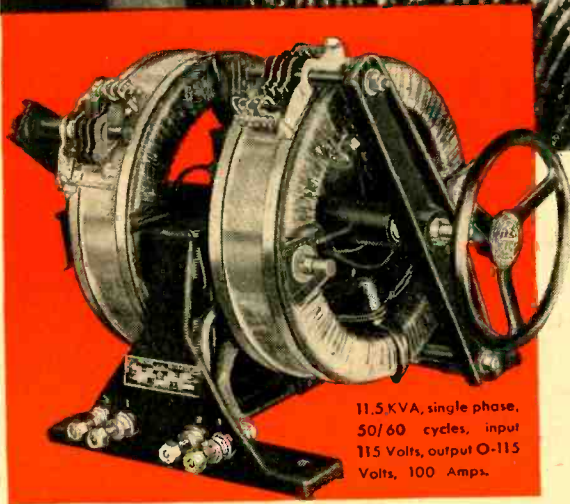
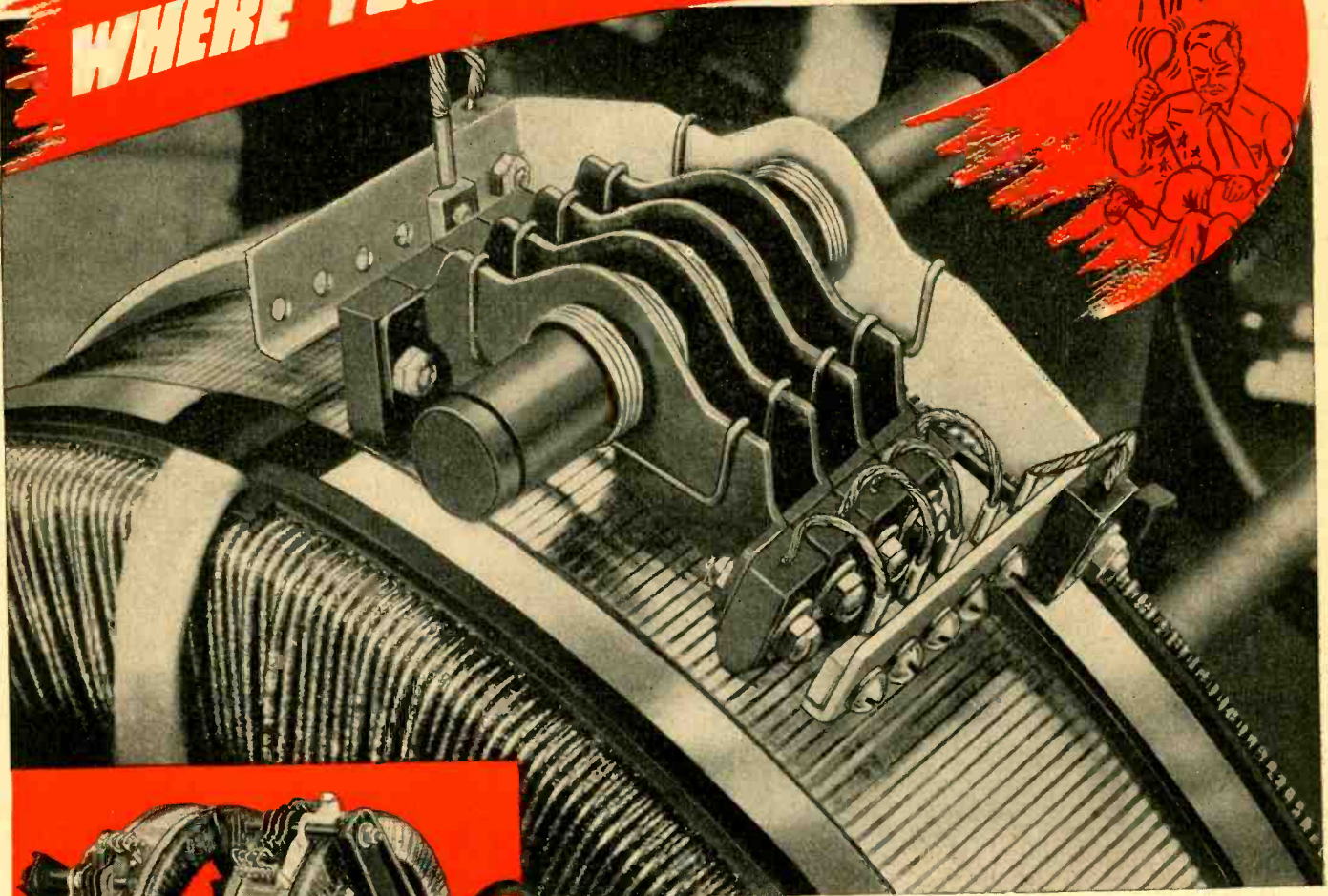

11.5KVA, single phase,
50/60 cycles, input
115 Volts, output 0-115
Volts, 100 Amps.

Topside or bottom—a hair brush can be applied effectively at either place according to the result desired. But the commutator brush on an a.c. voltage regulator is different. Only **one** place will do for best results and that is where the Transtat's brush track is.

Instead of on the commonly used flat annular section, where brush area is limited, the Transtat brush rides on the curved outside surface of the coil. There, the uniformly laid wires permit grinding smooth, perfectly parallel, evenly spaced commutator segments. That means arc-less, prac-

tically stepless control without circuit interruption. This position allows room for the long, sturdy Transtat brushes with their larger heat dissipating surfaces and lower current density per contact area . . . cooler running, longer lasting brushes.

Being transformer type regulators, Transtats will not distort wave form or alter power factor. Their varnish-impregnated cores and coils cannot loosen in service. The balanced collector arms maintain brush setting in any position. For continuous a.c. voltage regulation in testing, heating, plating, light control, speed control and in radio transmitters and other electronic apparatus they are unexcelled. Write for bulletin 51-2.

AMERICAN TRANSFORMER COMPANY • 178 Emmet Street, Newark 5, N. J.

AMERTRAN

MANUFACTURING SINCE 1901 AT NEWARK, N. J.

Pioneer Manufacturers of Transformers, Reactors and Rectifiers for Electronics and Power Transmission



NATIONAL RECEIVERS ARE THE EARS OF THE FLEET



OFFICIAL U. S. NAVY PHOTOGRAPH
FROM FREDERICK LEWIS

EACH LST
HAS TWO
NATIONAL
RECEIVERS



NATIONAL COMPANY

MALDEN  MASS, U. S. A.

NATIONAL RECEIVERS ARE IN SERVICE THROUGHOUT THE WORLD

IRC is ready with...

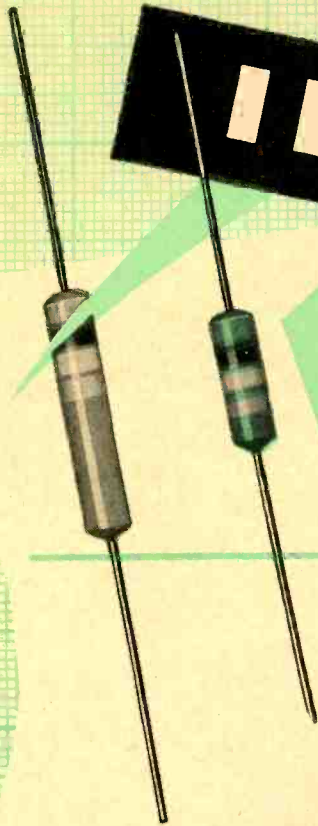

THE NEW **BTA**
RESISTOR

Lowest Temperature Rise

Like all BT Resistors, the operating temperature of the new BTA is lower than other resistors of comparative size!

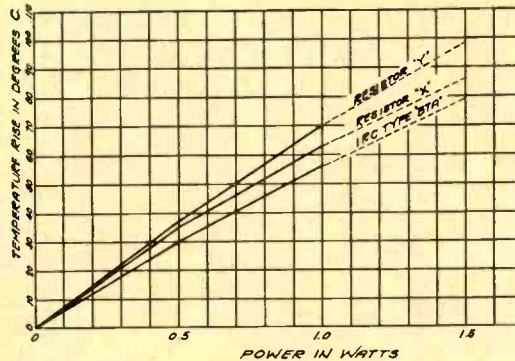

Only the extreme pressure of essential war production has delayed our release of this small one-watt AWS RC 30 type *insulated* resistor.

You'll find the BTA insulated resistor a worthy and important addition to the BT family. Built to meet American War Standards specifications, the BTA is only 0.718 inches long and 0.250 inches in diameter. Wattage rating, 1 Watt at 40° C ambient. Voltage rating, 500 volts. Minimum range, 330 ohms. Maximum range, Standard: 20 megohms.

Write today for comprehensive bulletin containing engineering data and charts.



INTERNATIONAL RESISTANCE CO.

401 NORTH BROAD STREET

PHILADELPHIA 8, PA.

IRC makes more types of resistance units, in more shapes, for more applications than any other manufacturer in the world.



AN 3155
Rheostat

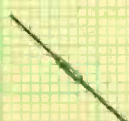

BTR—1/4 watt
Insulated Resistor



BTA—1 watt
Insulated Resistor

COMING... COMING... COMING... COMING...



ALSiMAG

TRADE MARK REGISTERED U. S. PATENT OFFICE

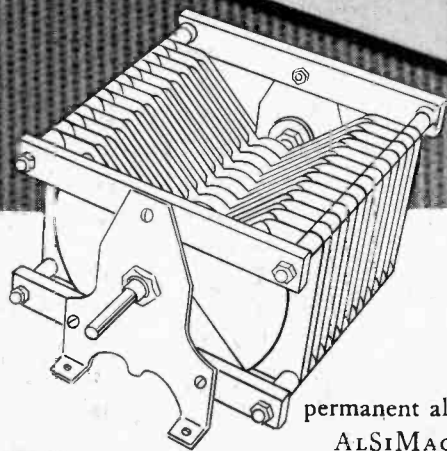

PERMANENT RIGIDITY

ALSiMAG Steatite Ceramics are unsurpassed for lending permanent rigidity—permanent alignment and accurate spacing of elements in electrical circuits.

ALSiMAG Insulators are permanent materials. They are strong, hard, *inflexible*—do not distort by loading, nor do they shrink with time. Impervious to heat up to 1000° C. Highly resistant to thermal shock. Non-corrodible. Do not absorb moisture.

If stability is a requirement of your electronic and electrical apparatus, investigate the strength and permanent rigidity of ALSiMAG. Send us a blueprint or a sample. Let us prove that ALSiMAG is best suited to your requirements.

AMERICAN LAVA CORPORATION, CHATTANOOGA 5, TENNESSEE



ALCO has been awarded for the fifth time the Army-Navy "E" Award for "continued excellence in quantity and quality of essential war production."

A knack for making difficult tubes

NORTH AMERICAN PHILIPS is one of the few producers of electronic tubes successfully manufacturing the type 833-A transmitting triode tube in quantity. The assembly alone calls for unusual skill and resourcefulness on the part of our engineers and craftsmen, and specially designed equipment.

Due to the unique design of the 833-A, the plate is supported from its own terminal post at the top of the glass envelope and the remaining elements from the base or stem. The tube must therefore be assembled in two sections and accurately joined on a glass lathe. Bonding of the metal grid and plate terminal posts to the glass flares is done by r-f induction heating, which is confined to the sealing points only. This operation, illustrated, is completed in a matter of seconds.

The ability to produce such difficult tube types is the result of experience gained by an organization with a background of over half a century of research and development in the electrical field. That is one of the reasons why

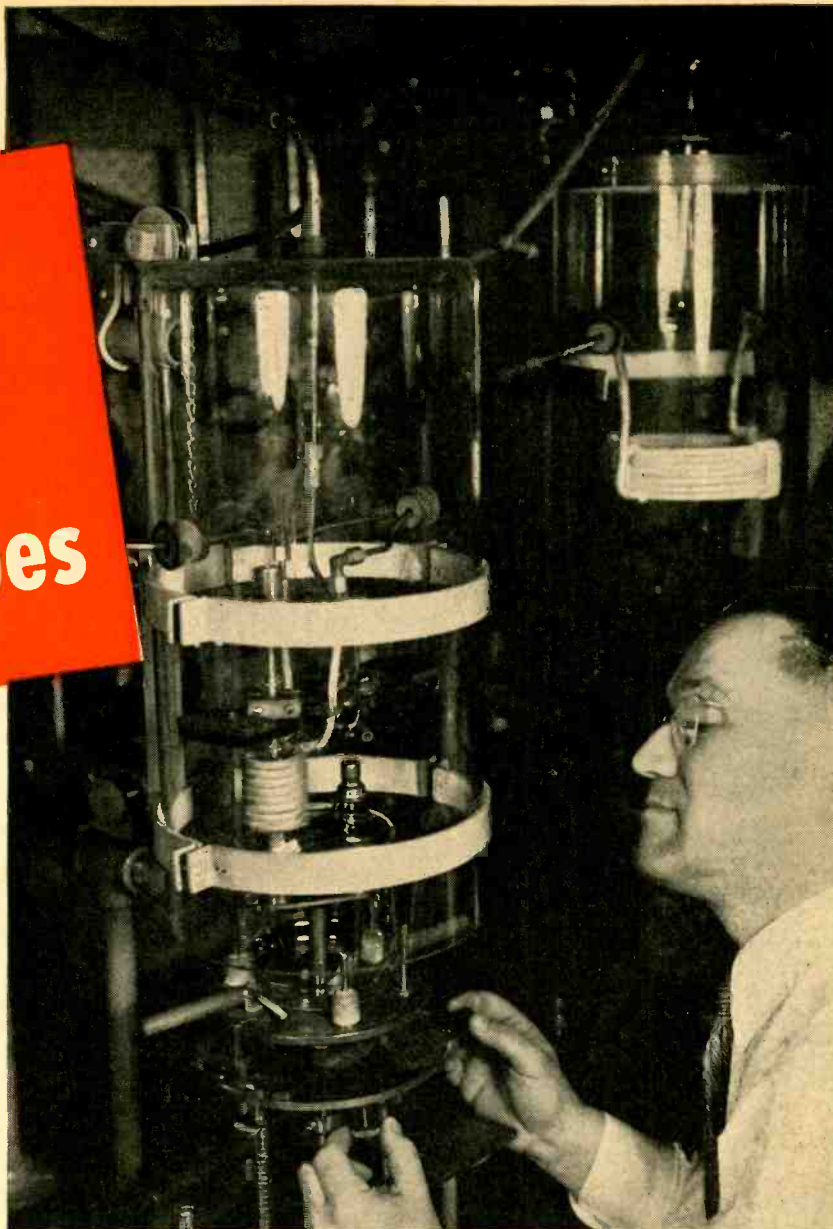

The metal plate and grid terminal posts of an 833-A being bonded to the glass envelope by means of radio-frequency heating in a nitrogen atmosphere.

manufacturers look to North American Philips as a reliable source of electronic tubes for their postwar requirements.

Although all the NORELCO tubes we produce now go to the armed forces, we invite inquiries from prospective users. A list of the tube types we are especially equipped to produce will be sent on request.

Write today for interesting booklet, describing the background of North American Philips in the science of electronics.

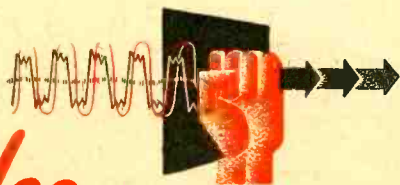

Norelco Electronic Products by
Reg. U. S. Pat. Off.

NORELCO PRODUCTS: Quartz Oscillator Plates; Amplifier, Transmitting, Rectifier and Cathode Ray Tubes; Searchray (Industrial X-ray) Apparatus; X-ray Diffraction Apparatus; Medical X-ray Equipment, Tubes and Accessories; Tungsten and Molybdenum products; Fine Wire; Diamond Dies. • When in New York, be sure to visit our Industrial Electronics Showroom.

NORTH AMERICAN PHILIPS COMPANY, INC.

Dept. F-1, 100 East 42nd Street, New York 17, N. Y.
Factories in Dobbs Ferry, N. Y.; Mount Vernon, N. Y. (Metalix Div.); Lewiston, Me. (Elmet Div.)

This SOLA CONSTANT VOLTAGE TRANSFORMER

has an important postwar future in

YOUR

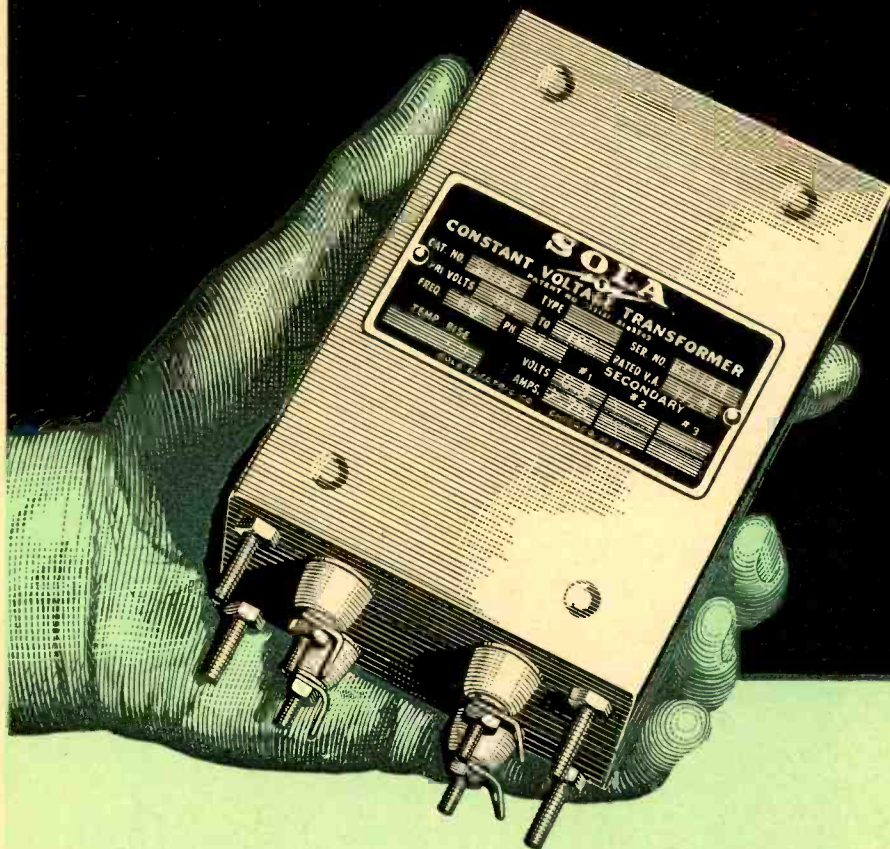

HEATING CONTROLS •
REFRIGERATION CON-
TROLS • TELEVISION
SETS • F-M RADIO •
VACUUM TUBE VOLT-
METERS • ELECTRON-
IC GAUGING AND IN-
SPECTION EQUIPMENT
• PHOTO-METRIC IN-
STRUMENTS... there are
other applications of course

Here is a SOLA Constant Voltage Transformer that should be a built-in part of your equipment—

First: because it will stabilize output voltage at your rated requirements regardless of line voltage fluctuations as great as ± 12 to 15 %.

Second: because its small, compact size is ideal for chassis mounting.

Third: because of its low, economical cost.

Fourth: because of the saving that can be made through the elimination of other components.

Fifth: because a majority of anticipated service calls can be eliminated from your cost calculations.

Sixth: because the users of your product will get greater satisfaction from trouble-free service.

This particular transformer is rated at 6.3 volts, 17VA output and is designed primarily for the stabilization of vacuum tube filament and heater voltages. Other voltages and capacities for chassis mounting can be supplied on the same low cost, economical basis to meet your exact requirements.

Constant Voltage Transformers

To Manufacturers:

Complete specification details covering this new Constant Voltage Transformer will be furnished at your request.

Ask for Spec. No. KCV-103

Transformers for: Constant Voltage • Cold Cathode Lighting • Mercury Lamps • Series Lighting • Fluorescent Lighting • X-Ray Equipment • Luminous Tube Signs • Oil Burner Ignition • Radio • Power • Controls • Signal Systems • Door Bells and Chimes • etc. SOLA ELECTRIC CO., 2525 Clybourn Ave., Chicago 14, Ill.

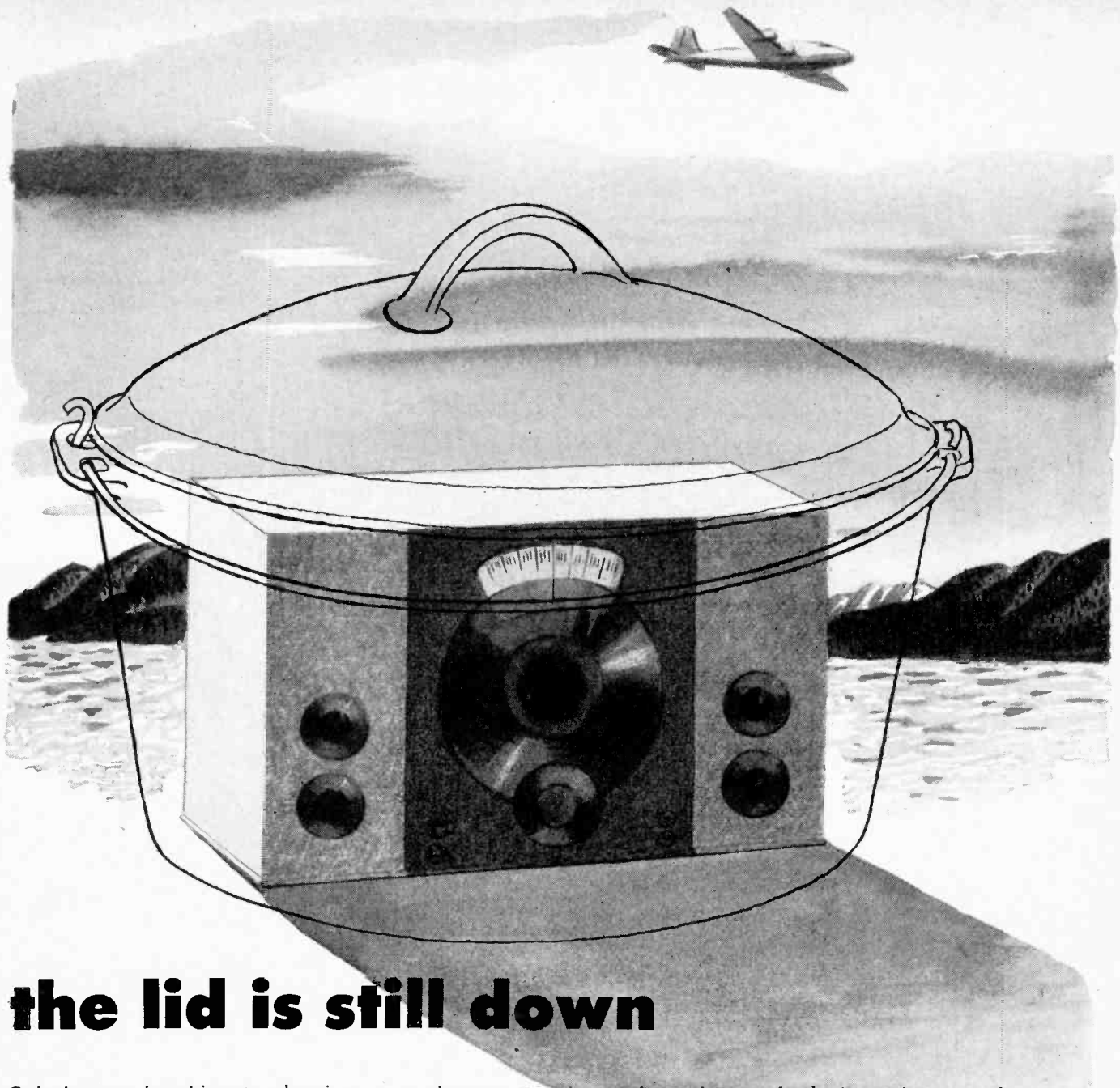

the lid is still down

Only the most hazy hints may be given as to what you can expect in the way of more accurate, highly specialized electronic instruments when military secrecy is removed.

Into the past two years, a normal ten years of technological progress has been crammed. Out of it will come electronic instruments of amazing accuracy and of such rugged construction as to defy mechanical error. *-hp-* engineering has contributed much to these advancements. Some of the new *-hp-* instruments which are today doing combat service will set new standards in your laboratory and plant tomorrow.

If you are interested in radio broadcasting, television or frequency modulation . . . carrier current work, industrial heat-

ing or electronic controls, *-hp-* has an important date on your calendar of plans . . . a real stake in your future. Even though vital technical data cannot be released publicly today it is a practical idea for you to make known your requirements now so that much time may be saved in ultimately obtaining the solution to your problem. Among new instruments already perfected you may find just what is required. *-hp-* engineers are at your service without cost or obligation.

Direct Canadian inquiries to Atlas Radio Corp., 560 King St. West, Toronto 2, Canada.

HEWLETT-PACKARD COMPANY
 Box 929D Station A, Palo Alto, California

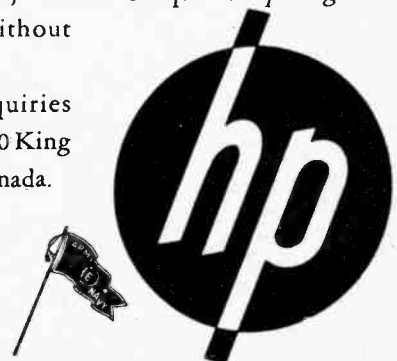



After ADOLPH and TOJO are **Q·R·T**

The rig he left behind is due for a big change when GI Joe comes home. War experience has been an "eye opener" for him. From chassis to sky wire many pre-war Ham outfits will undergo a major alteration and amazing technical advances will be put into practice. Stimulated by training and experience gained in the armed services thousands of new enthusiasts will swell the ranks of amateur radio.

When the gang goes back on the air again,

CQ'ing, SS or DX; UNITED will be ready to serve the Amateur with war-perfected Transmitting Tubes.

Since 1934 UNITED has specialized in engineering, designing and building Transmitting Tubes that set the Quality Standard for the entire Radio Industry. When performance counts UNITED Tubes provide a maximum of electronic efficiency—plus a long and dependable life. Accept nothing less than UNITED quality for your own tube requirements.

Order direct or from your electronic parts jobber.

MASTERPIECE OF SKILLED HANDS

UNITED

ELECTRONICS COMPANY

NEWARK, 2



NEW JERSEY

Transmitting Tubes EXCLUSIVELY Since 1934

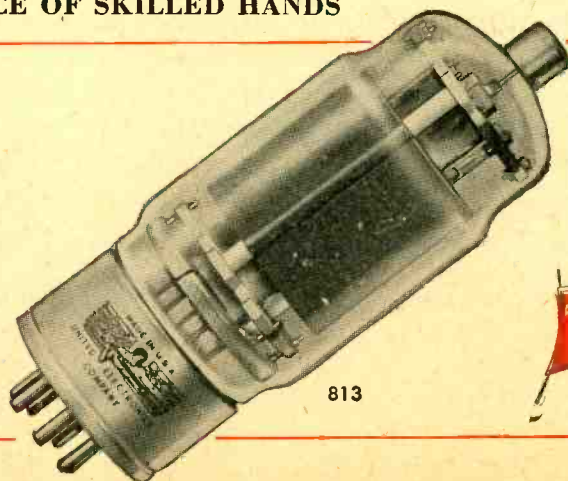

813



wherever a tube is used . . .

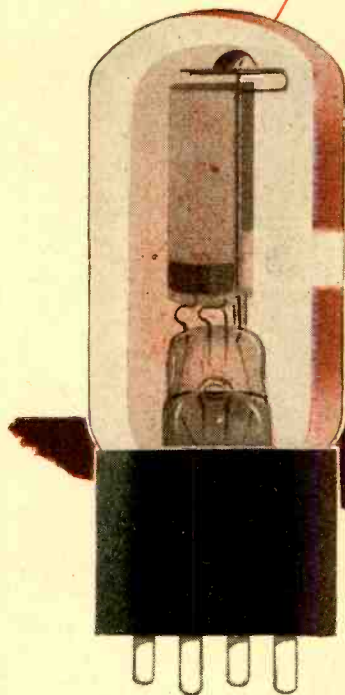

for example:

COMBUSTION CONTROL

An abnormal increase in the density of smoke passing through a boiler breeching means a reduction of heat, loss of efficiency, increase in fuel consumption, and probably violation of smoke control ordinances. The electronically operated Worner Combustion Supervisor detects such conditions, turns in an audible or visible alarm, and sets in motion the mechanism that will bring about efficient combustion.

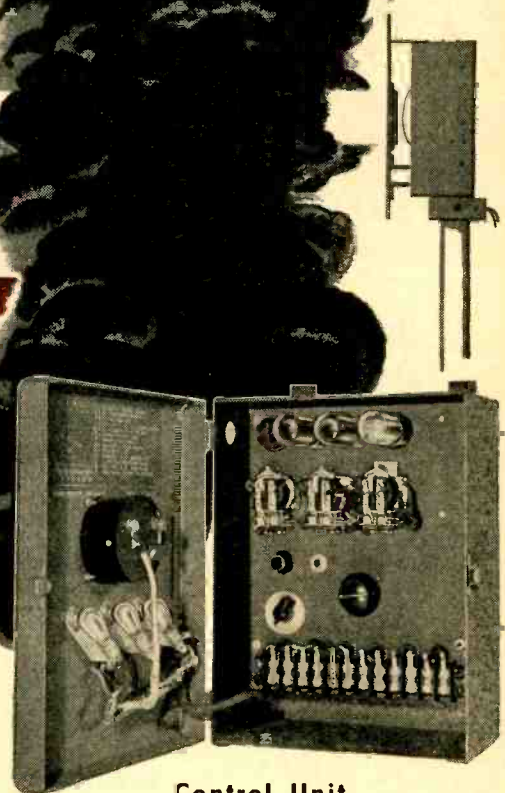

Control Unit

THERE'S A JOB FOR *Relays* BY GUARDIAN

The "Combustion Control Supervisor," made by Worner Electronic Devices of Chicago, is a photo-cell system that responds to any predetermined degree of smoke density. To avoid "false alarms" resulting from momentary puffs of smoke, it is equipped with a time delay feature.

Worner's specified that the three relays used in this system must be sensitive but not delicate; that they require no adjustment; and that they meet Underwriter's requirements.

Guardian engineers developed the Series 155 D.C. relay as the answer to these specifications. This is a compact, sturdy, easily mounted unit with constant spring tension on the contacts. It is widely used on remote selection devices and other low voltage applications. Copper slug time delays up to .05 seconds on attract and 0.15 seconds on release are available. Coils for operation on any voltage up to 230 volts D.C. For further information write for Series 155 bulletin.

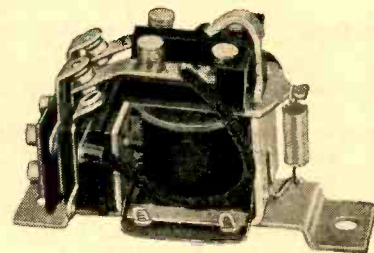

Series 155 D.C. Relay

Consult Guardian whenever a tube is used—however—Relays by Guardian are NOT limited to tube applications, but are used wherever automatic control is desired for making, breaking, or changing the characteristics of electrical circuits.

GUARDIAN ELECTRIC

1628-A W. WALNUT STREET

CHICAGO 12, ILLINOIS

A COMPLETE LINE OF RELAYS SERVING AMERICAN WAR INDUSTRY

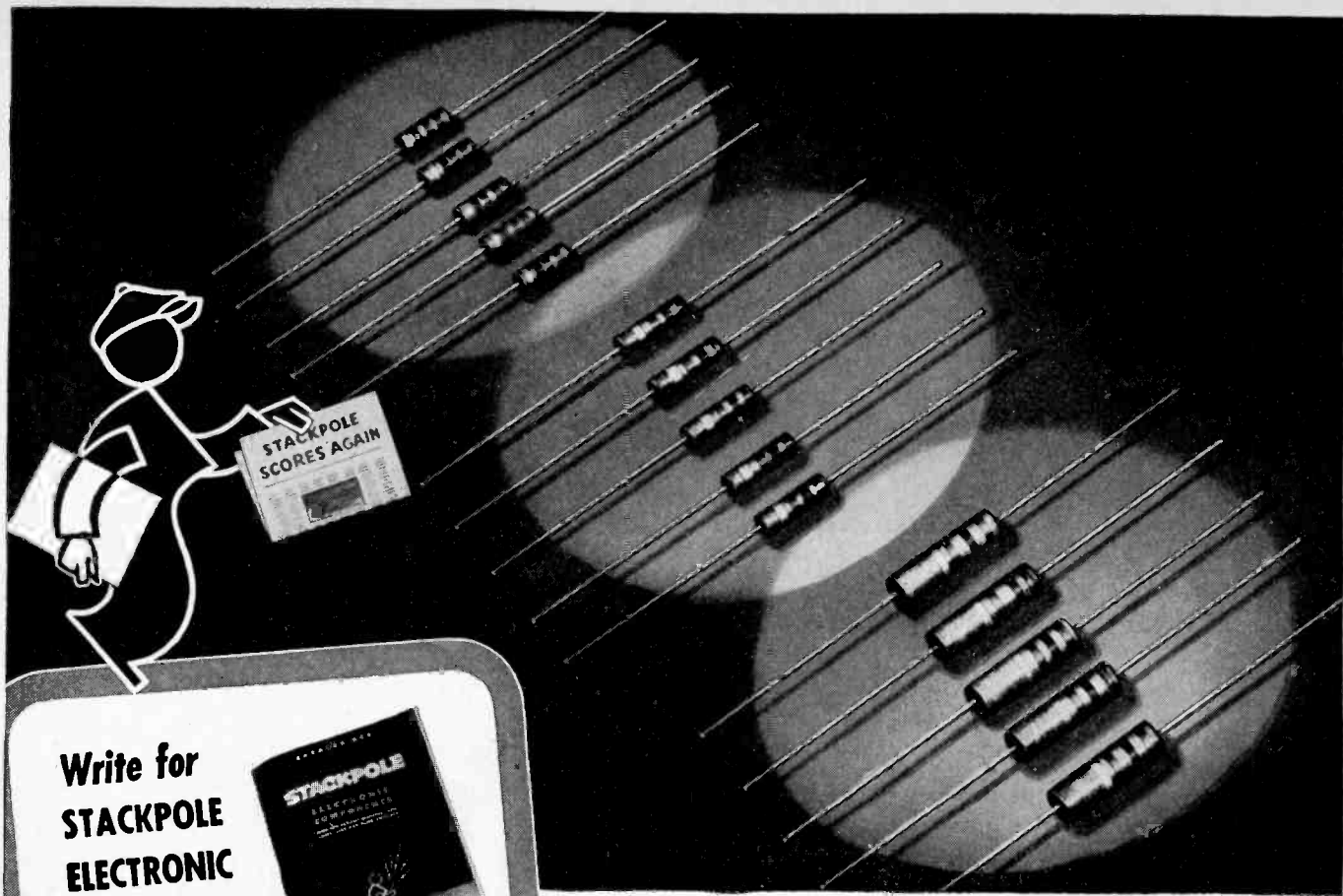

**Write for
STACKPOLE
ELECTRONIC
COMPONENTS
Catalog**

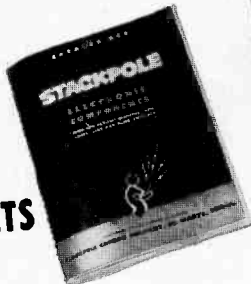

Whether for today's needs or post-war engineering, write today for your copy of this 36-page Catalog RC 6 replete with helpful engineering data.

**FIXED AND
VARIABLE
RESISTORS
IRON CORES
LINE, SLIDE,
ROTARY
ACTION
SWITCHES**

OTHER STACKPOLE PRODUCTS

- BRUSHES and CONTACTS
(All carbon, graphite, metal and composition types)
- RARE METAL CONTACTS
- WELDING CARBON PRODUCTS • BEARINGS
- BRAZING BLOCKS • ANODES
- ELECTRODES • CARBON PILES
- PACKING, PISTON, and SEAL RINGS
- RHEOSTAT PLATES and DISCS
- SPECTROGRAPHITE NO. 1
- CARBON and MOLDED METAL POWDER SPECIALTIES

INSULATED RESISTORS

*Designed to Match War
Standards Specifications*

Integrally molded in one operation under laboratory controlled production standards, Stackpole Type CM Resistors in $\frac{1}{3}$ -watt (RC-10); $\frac{1}{2}$ -watt (RC-21); and 1-watt (RC-30) sizes have been specifically designed to meet the newly issued Army-Navy specifications. The construction of these new resistors is such that they offer an exceptional degree of stability under load—the average change being less than 5% after 1000 hours under test at full load. In addition to having highly satisfactory humidity characteristics well within today's exacting requirements, Stackpole Type CM Insulated Resistors meet up-to-the-minute salt water immersion specifications.

Samples to any required tolerance on request.

STACKPOLE

STACKPOLE CARBON COMPANY, ST. MARYS, PA.

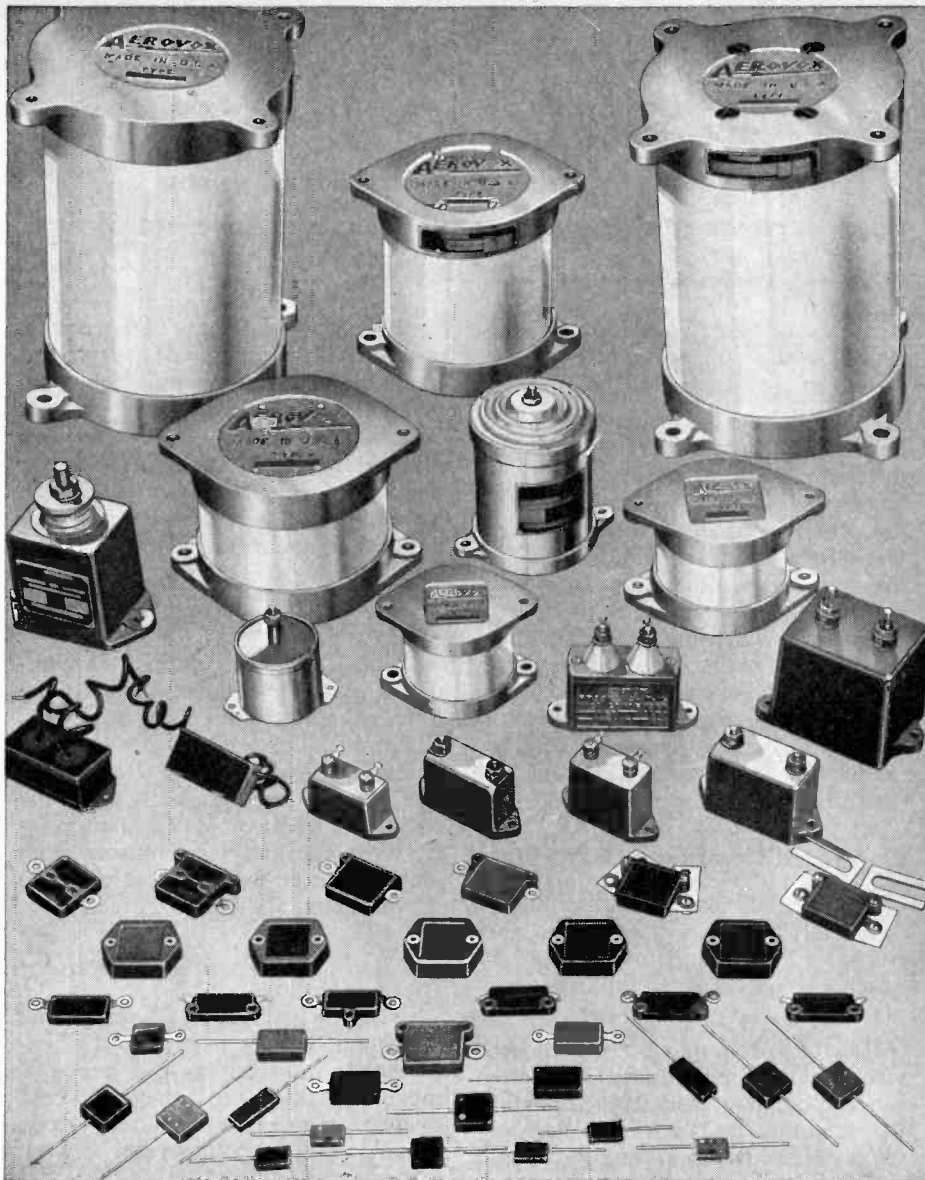

**THERE'S A
TYPE FITTED
PRECISELY TO
YOUR NEEDS...**

**AEROVOX
MICA**
Capacitors

SPECIFY AEROVOX

Be sure you have the Aerovox Capacitor Manual in your working library, for general guidance. And for final insurance covering satisfactory results, just specify Aerovox Capacitors.

● Aerovox selection ranges from tiny "postage-stamp" molded-in-bakelite units to giant porcelain-cased stack-mounting units. These many varied types are standard with Aerovox—in daily production—available at quantity-production prices.

The following factors are suggested in guiding your selection:

Electrical: (a) Capacitance and tolerance; (b) D.C. voltage rating; (c) Current-carrying capacity and frequency characteristics; (d) Allowable temperature rise and maximum operating temperature; (e) Special characteristics such as temperature coefficient, retrace, etc.; (f) Special operating condi-

tions such as high humidity, altitude, extreme temperatures, etc. *Mechanical:* (g) Basic type; (h) Terminals; (i) Case; (j) Mounting holes; (k) Name-plate data.

Yes, Aerovox expects you to select that type best fitting your particular requirements in every way. And Aerovox is ready to help you make the proper selection. Remember, Aerovox Application Engineering—that "know-how" second to none in the industry—can make all the difference between disastrous makeshifts and the most satisfactory results.



INDIVIDUALLY TESTED

AEROVOX CORPORATION, NEW BEDFORD, MASS., U. S. A.

SALES OFFICES IN ALL PRINCIPAL CITIES

Export: 13 E. 40 St., New York 16, N. Y. • Cable: 'ARLAB' • In Canada: AEROVOX CANADA LTD., HAMILTON, ONT.

BELL TELEPHONE LABORATORIES

*Exploring and inventing, devising and perfecting for our Armed Forces
at war and for continued improvements and economies in your telephone service*

RESearch, in the Bell Telephone System, has always been an expanding activity, growing with the scientific knowledge of the times and contributing to that knowledge. Upon it have been based important inventions and developments.

The telephone, itself, was invented in the laboratory where Alexander Graham Bell was carrying on researches in speech and hearing and laying the foundation for the electrical transmission of speech. As time went on the telephone research program expanded to cover every science which gives any promise of improved telephony and every engineering art which applies to the development, construction, installation and operation of telephone facilities.

These researches and development studies now cover electrical communication of speech—both by wire and by radio—the transmission of pictures (television)—and many important projects for war.

There Is No End to Progress

Every new research gives rise to new inventions and to new lines for development and design. New inventions indicate new lines for more research. Research and development work, invention and design go hand in hand. In the early years, this work was carried in part by the American Telephone and Telegraph Company and in part by the Western Electric Company, the manufacturing unit of the Bell System.

For many years, however, this work has been assigned to a specialized unit, Bell Telephone Laboratories, Incorporated. Theirs is the responsibility for the technical future of the industry. They carry their developments from the first faint glimmerings which basic researches disclose to the final design of equipment and the preparation of specifications for its manufacture. And after manufacture and installation, they follow their products in operation; and continue development work to devise still more perfect

equipment, less expensive, more convenient and of longer useful life.

These policies and procedures of Bell Telephone Laboratories are distinguished by two characteristics. In the first place the Laboratories design for service. The consideration is not the profit of a manufacturer through first sales and replacement models but the production of equipment which will give the best service at the lowest annual cost when all factors are considered, such as first cost, maintenance, operation, and obsolescence. The Laboratories make no profit and the equipment they design is owned and used by the telephone companies; and the emphasis is upon that use.

Organized Co-ordinated Research

In the second place the Laboratories design always with reference to the complete communication system in which the particular equipment is to play a part.

Reliable, economical telephone service, which is the product of its efforts, is not so much an assemblage of excellent apparatus as it is an excellent assembly of co-ordinated equipment—all designed to work together reliably and economically for a larger purpose.

It is not enough that Bell Laboratories shall design a new piece of electronic equipment which has merit or a new cable or telephone receiver. They must design with reference to all the other parts of the communication system so that the co-ordinated whole will give the best possible service.

4600 People in Bell Laboratories

Bell Laboratories contributions to the Armed Forces derived in large part from the technical background that the Laboratories had acquired through their steadily maintained program of research. The Laboratories had special knowledge, skill and techniques which could instantly be diverted to war problems.

At the time of Pearl Harbor, over a quarter of the 4600 people in the

Laboratories had twenty or more years of service. This breadth of background made possible many engineering developments outside the strict field of communication and these have been of value to the Armed Forces. So far the Armed Forces and the O.S.R.D. have engaged the Laboratories on over a thousand major projects. The majority of these assignments have been completed; and have contributed to our victories on many fronts.

Most of the Laboratories developments, of course, have been in the field of electrical communication. Communication, not simply between individuals as in ordinary telephony, but between mechanisms—as in the electrical gun director. The Laboratories techniques and electronic researches have produced many secret weapons for our country's Armed Forces.

Leader in Electronic Development

For those problems the Laboratories had a remarkable background of experiences in research and development. In World War I, they pioneered by developing radio telephone systems for talking between planes and between planes and ground stations. They also contributed methods and devices for locating enemy planes, submarines, and artillery.

In this war, Bell Laboratories have pioneered in the field of electronics. The Western Electric Company, which manufactures the designs of the Laboratories, is the largest producer of electronic and other war communication equipment in the United States and is now engaged almost exclusively in the manufacture of this equipment.

In war, Bell Telephone Laboratories devote their work to the needs of our Armed Forces. In peace, they are constantly exploring and inventing, devising and perfecting for continued improvements and economies in telephone service. Centralized research is one of the reasons this country has always had "the most telephone service and the best at the least cost to the public."

BELL TELEPHONE LABORATORIES



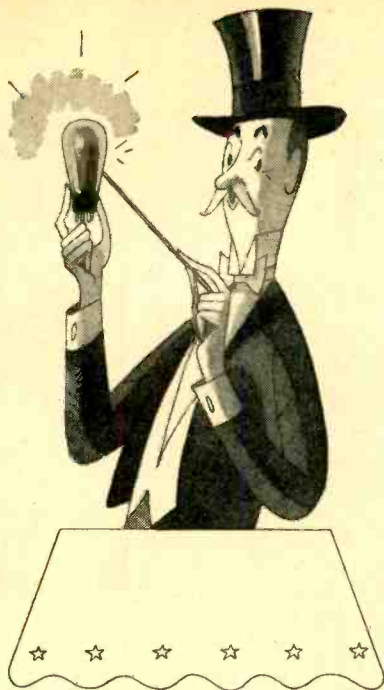

THEY SAID IT COULDN'T BE DONE !

Back in 1938, Hytron began designing new dies and converting production machinery for the first BANTAM GT tubes. The industry said in effect: "You're crazy; it won't work. You can't telescope standard glass tubes to BANTAM size and get the same results." Beam tetrodes, such as the 50L6GT, particularly were considered impossibilities. The intense heat developed during normal operation would warp the elements and crack the small glass bulb.

But Bruce A. Coffin, originator of the BANTAM GT, stuck to his guns. In a few short years, Hytron developed over fifty GT types. The GT became the most popular receiving tube.* Short leads, low capaci-

tances, advantages of shorter bombardment at lower temperatures, ruggedness of compact construction plus both top and bottom mica supports, smaller size, standardized envelopes and bases — all contributed to that popularity.

The BANTAM GT permitted new space economies in pre-war receivers. Only its universal acceptance as standard by all manufacturers makes possible fulfillment of the Services' demands for receiving tubes. In increasing numbers, as this war draws to its ultimate conclusion, Hytron will continue to supply you with the popular BANTAM GT tubes which everyone said just couldn't be made.

*1941 industry production figures: GT—52,000,000; metal—27,000,000; standard glass, G, and loctal—56,000,000.



OLDEST EXCLUSIVE MANUFACTURER OF RADIO RECEIVING TUBES

HYTRON
CORPORATION ELECTRONIC AND RADIO TUBES



SALEM AND NEWBURYPORT, MASS.

BUY ANOTHER WAR BOND

**SEALED AGAINST
THE ELEMENTS...**

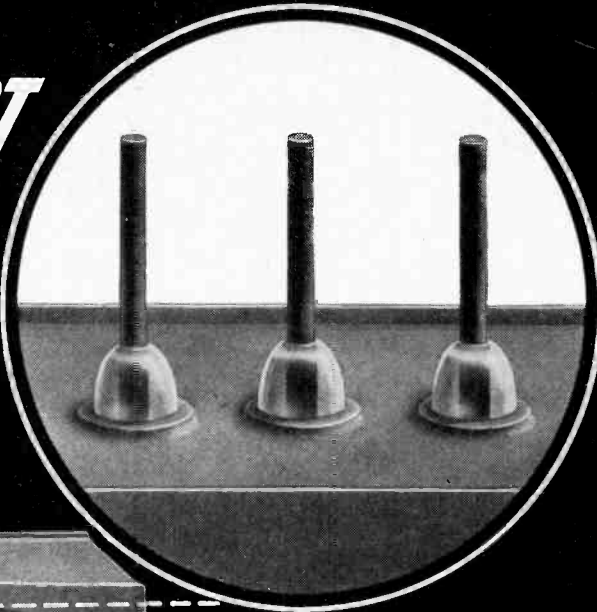

**...with STUPAKOFF
Metal-Glass Terminals**

The hermetically sealed transformer illustrated functions properly under the most adverse conditions. Stupakoff metal-glass terminals, soldered, welded or brazed to the container, protect against humidity, fungi and other elemental hazards. Ideal working conditions are sealed in—detrimental conditions are sealed out.

Stupakoff metal-to-glass sealed terminals are made possible by the metal, Kovar—a cobalt, nickel iron alloy which forms a chemical bond with glass through a heating process, in which the oxide of Kovar is dissolved into the glass. Kovar matches the expansion of thermal shock resistant

glass and forms a permanently vacuum and pressure tight seal.

Stupakoff manufactures Kovar-glass terminals with single or multiple, solid or hollow electrodes. For those equipped to do their own glass working, Kovar is supplied as sheet, rod, wire, or tubing; or fabricated into cups, eyelets or special shapes.

Write Stupakoff today for assistance in engineering Kovar-glass terminals to your product.

**KOVAR*Glass
Seals for**

**ELECTRONIC TUBES
TRANSFORMERS
RESISTORS
CAPACITORS
CONDENSERS
VIBRATORS
SWITCHES
RELAYS
INSTRUMENTS
GAUGES
METERS
RECEIVERS
TRANSMITTERS**

DO MORE THAN BEFORE—BUY EXTRA WAR BONDS

*TRADE MARK 337962 REGISTERED IN U. S. PATENT OFFICE



STUPAKOFF CERAMIC AND MANUFACTURING CO., LATROBE, PA.

Products for the World of Electronics

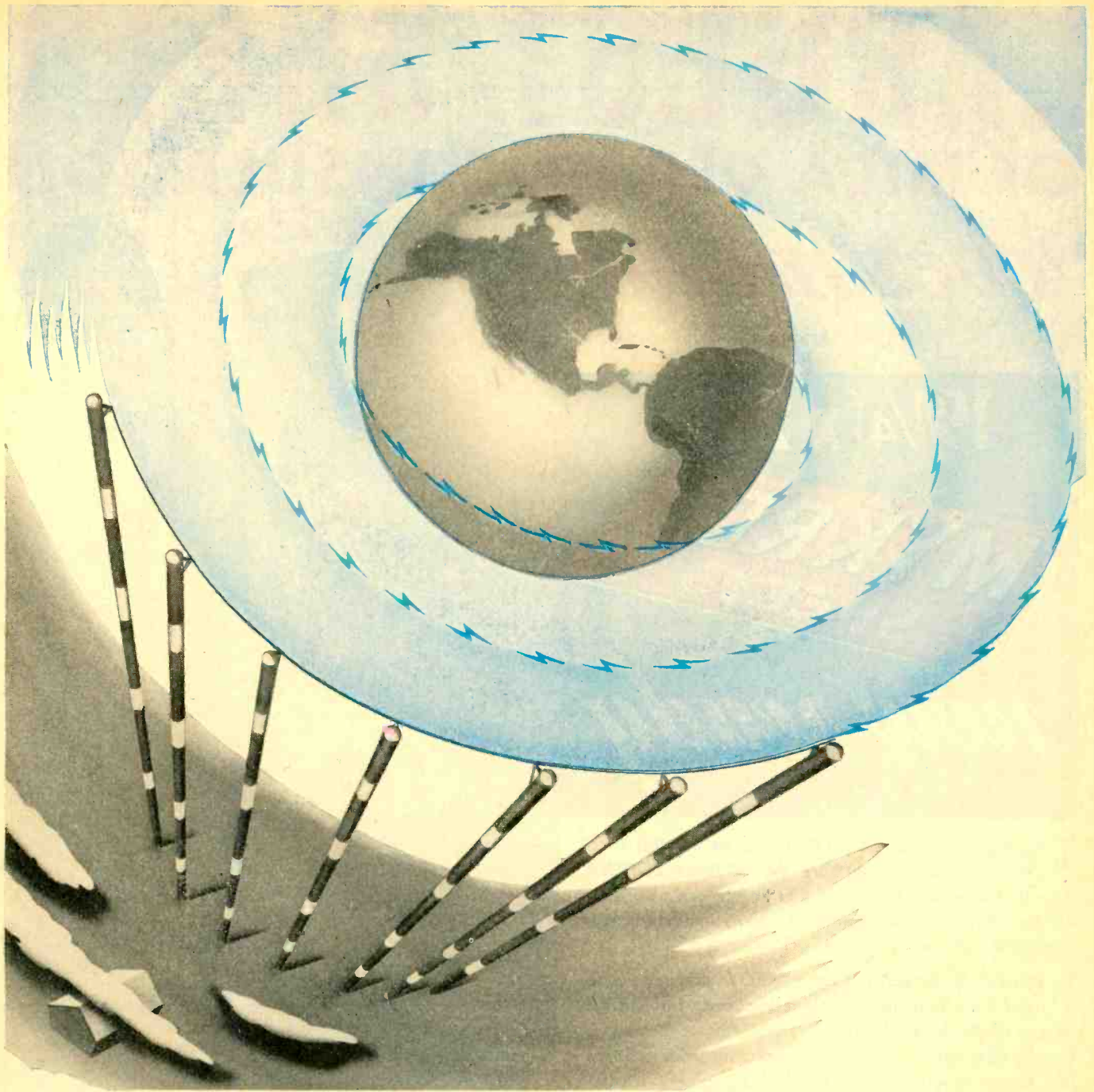

Round and Round They Go...



*Manufacturers
of Radio Equipment*

Constant Radio Communications

Day and night, throughout the world, Wilcox equipment is serving its important role in transmitting and receiving radio communications. For installations with the major airlines and for vital military uses Wilcox has proved its correct design for accurate functioning and rugged service. Look to Wilcox for leadership!

WILCOX ELECTRIC COMPANY

Fourteenth and Chestnut

Kansas City, Missouri

LARGEST SHEET OF MICA CERAMIC INSULATION

ever made

19 1/4" x 29 3/4"

**MYKROY
SHEETS**

now ready



THIS new size plate of MYKROY glass-bonded mica ceramic insulation is *more than 2 times LONGER* than the maximum size available heretofore affording Production and Design Engineers many important new application advantages:

- 1. Because of increased size** MYKROY can now be used for: Switchboard panels—Large inductance bars—Insulated table tops—Large meter panels—Transformer covers—Switch connecting rods—Bases for Radio Frequency or Electrical Equipment assemblies and structural members in R. F. equipment where low-loss insulation is indispensable.
- 2. Lower cost per square inch** of MYKROY in the 19 1/4" x 29 3/4" sheet makes possible savings as high as 33 1/3% depending upon workpiece size, considerably reducing the cost per fabricated unit.
- 3. Better cutting efficiency** in the new plate lowers unit cost still further and permits employing the superior insulating properties of MYKROY in a broader range of electronic applications.

All fabricators of glass-bonded mica materials should seriously consider the use of these larger plates to reduce costs and amount of time required in filling their orders. Ready for Immediate Delivery. Most thicknesses carried in stock.



WRITE FOR MYKROY SHEET BULLETIN #102

Just off the press, Bulletin #102 is a complete engineer's data book which combines practical data with a brief account of the dramatic story behind the development of the 19 1/4" x 29 3/4" sheet. It is replete with working data and comparison charts on the various sizes of MYKROY sheets. Write for your copy NOW!

MYKROY IS SUPPLIED IN SHEETS AND RODS . . . MACHINED OR MOLDED TO SPECIFICATIONS

MADE EXCLUSIVELY BY **ELECTRONIC MECHANICS** INC.

70 CLIFTON BOULEVARD • CLIFTON, NEW JERSEY
Chicago 47: 1917 NO. SPRINGFIELD AVENUE . . . TEL. Albany 4310
Export Office: 89 Broad Street, New York 4, N. Y.

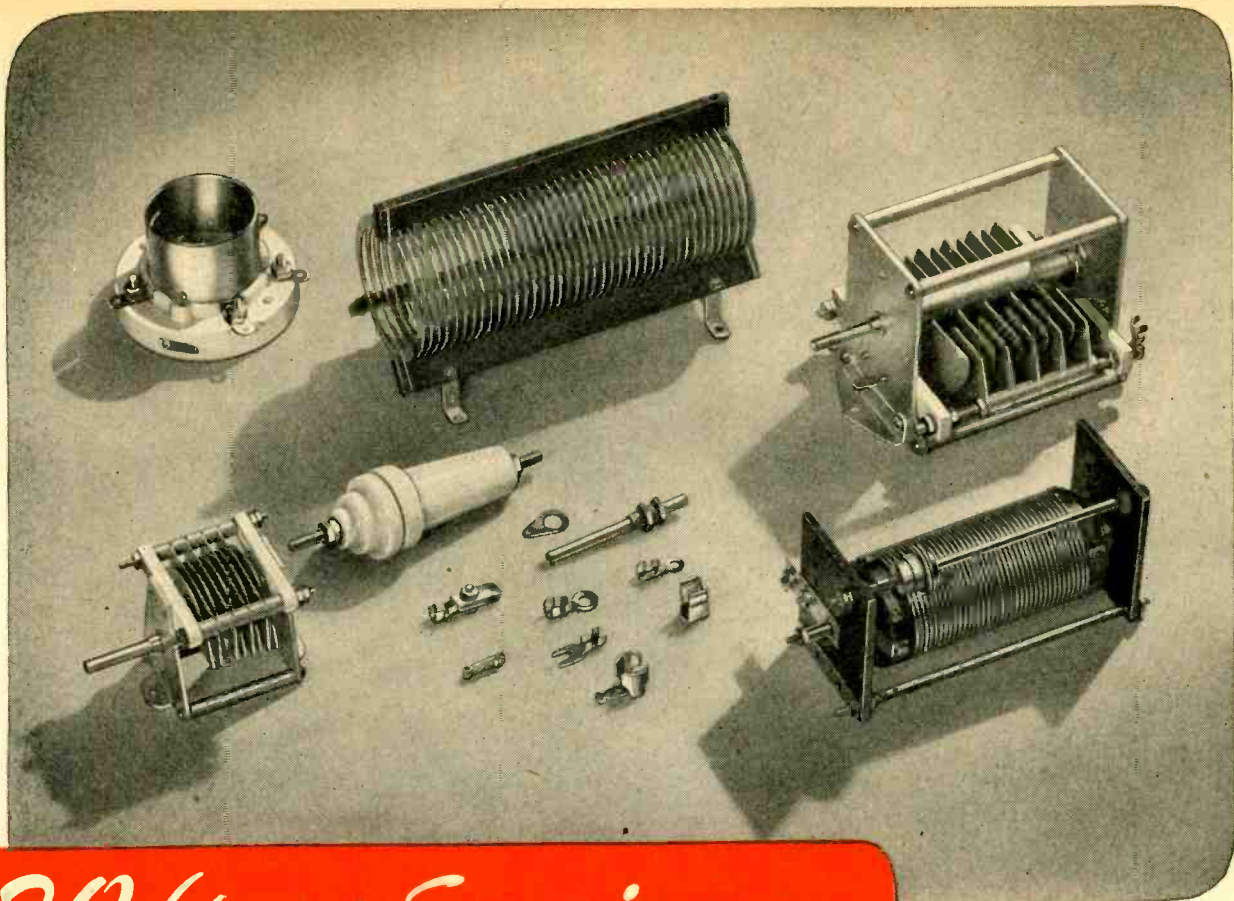

20 Years Experience In Parts Manufacture

- CONDENSERS—Variable, Fixed, Gas Filled Pressure, Neutralizing—a type for every transmitter need.
- INDUCTORS—Wire-wound, edgewise wound copper strip, copper tubing—fixed, tapped, or continuously variable—50 watt to 100 KW.
- INSULATORS—Stand-off, Thru-Panel, Cones, Bushings, Antenna Strain or Compression—a type for every requirement.
- TUBE SOCKETS—Steatite or Porcelain—Wafer, Bayonet, Miniature, Acorn or Special Types—a socket for almost any transmitting tube.
- HARDWARE—Tube Caps, Inductor Clips, Solder Terminals, Fuse Clips, Panel Bearings, Flexible Shafts—those hard-to-find constructional parts.

Ask for Catalog 968W

OTHER FAMOUS JOHNSON PRODUCTS

- Plugs and Jacks
- Couplings
- Concentric Line
- Chokes
- Antennas
- Antenna Phasing Equipment
- Antenna Coupling Units
- Heavy Duty R. F. Relays
- Make Before Break Switches
- Sampling Transformers

JOHNSON

a famous name in Radio



E. F. JOHNSON COMPANY • WASECA • MINNESOTA

SPRAGUE VITAMIN-Q*

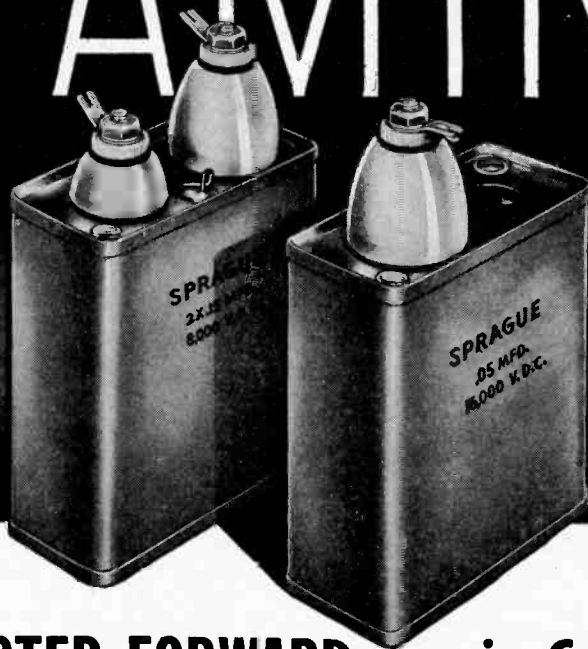

A BIG STEP FORWARD . . . in Capacitors for High Temperature, High Voltage Applications

Vitamin Q impregnant, pioneered and perfected by Sprague, has resulted in capacitor developments of far-reaching importance for high temperature, high voltage applications. Although extremely compact, Sprague Type 25P Capacitors, for instance, operate satisfactorily at thousands of volts at ambient temperatures as high as 105° C. Moreover, their leakage resistance at room temperature is 20,000 megohms X microfarads—or at least five times higher than that of previous types.

Sprague Vitamin Q impregnated Capac-

itors retain all of the virtues of conventional oil-impregnated capacitors throughout the extreme range of +105° C. to -40° C. Used where high temperature is not a factor, they result in materially higher ratings for a given size.

Standard types include hermetically sealed rectangular metal container units in styles for 95° C. and 105° C. continuous operation, and in d-c rated voltages from 1000 to 16000 V. Other types include Type 45P hermetically sealed in glass shells with metal end caps.

SPRAGUE ELECTRIC COMPANY, North Adams, Mass.

(Formerly Sprague Specialties Co.)

*TRADEMARK REG. U. S. PAT. OFF.

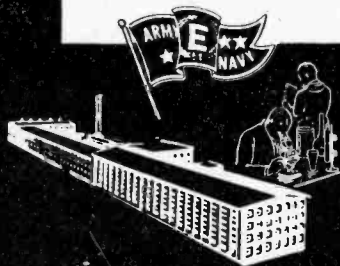

SPRAGUE CAPACITORS KOOLOHM RESISTORS

Variable Tuning Condensers, Push Button Tuning

Mechanisms and Actuators, Phonograph Record Changers



A NEW DIVISION
UNDER THE DIRECTION OF
LEE GOLDER
identified for more than 20 years with
the manufacture of radio speakers.

... and now
speakers
by G.I.

Millions of radio components on the far flung battle areas of the world bear the G.I. insignia. What they have accomplished is already in the archives.

Behind General Instrument's record of achievement in the quantity production of electronic equipment for military use, stands nearly a quarter century of highly specialized production and experience in the field of radio components for home receiving sets.

The addition of a complete line of speakers is, therefore, not a venture into a new field, but the logical outgrowth of our expanded facilities, developed by wartime activities and increased resources in the radio equipment industry.

The resourcefulness and ingenuity—the expanded and perfected facilities that made this mammoth production possible will be put, without stint, behind our new speakers. Set manufacturers will know what this will mean.

GENERAL ELECTRONIC APPARATUS CORP.

A SUBSIDIARY OF

GENERAL INSTRUMENT CORP.

829 NEWARK AVE., ELIZABETH 3, N. J.



Basic Design

makes the difference!

Smudge-voice

While these two columns read identically, word for word, the smudged column is a visual representation of an acoustical condition when background noise interferes with transmitted speech.

The words may be readable, but effort and concentration are required for accuracy. And so with reproduced sound: with general purpose microphones, articulation is lowered even though ambient noises do not completely override speech. The Electro-Voice Differential is specifically designed to erase interfering background noise. Speech is clean, clear, crisp . . . unadulterated by stray pickup or distracting background.

Electro-Voice

While these two columns read identically, word for word, the smudged column is a visual representation of an acoustical condition when background noise interferes with transmitted speech.

The words may be readable, but effort and concentration are required for accuracy. And so with reproduced sound: with general purpose microphones, articulation is lowered even though ambient noises do not completely override speech. The Electro-Voice Differential is specifically designed to erase interfering background noise. Speech is clean, clear, crisp . . . unadulterated by stray pickup or distracting background.

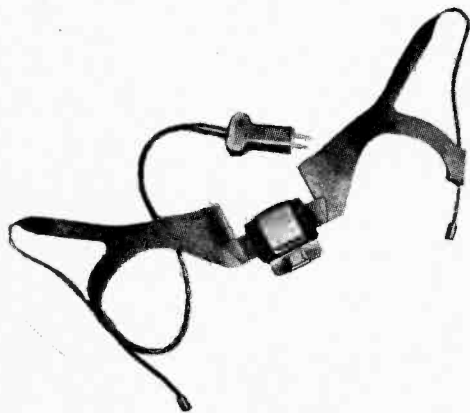

Electro-Voice DIFFERENTIAL MICROPHONES

Electro-Voice engineers have years of experience in the elimination of ambient noise. We designed and developed the now-famous "Lip-Mike," the first successful Differential microphone. Our new Model 205-S for aircraft, railroad, industrial and police applications is another Differential achievement. Soon there will be Electro-Voice Differential microphones for all communication services. Watch for them.

If any of your limited quantity needs can be met by standard model Electro-Voice microphones, with or without minor modifications, contact your local radio parts distributor.



BLOOD DONORS ARE URGENTLY NEEDED . . . SEE YOUR LOCAL RED CROSS

Electro-Voice MICROPHONES

ELECTRO-VOICE CORPORATION • 1239 SOUTH BEND AVENUE • SOUTH BEND 24, INDIANA

Export Division: 13 East 40th Street, New York 16, N. Y., U. S. A. Cables: Arlab



Made in Japan*

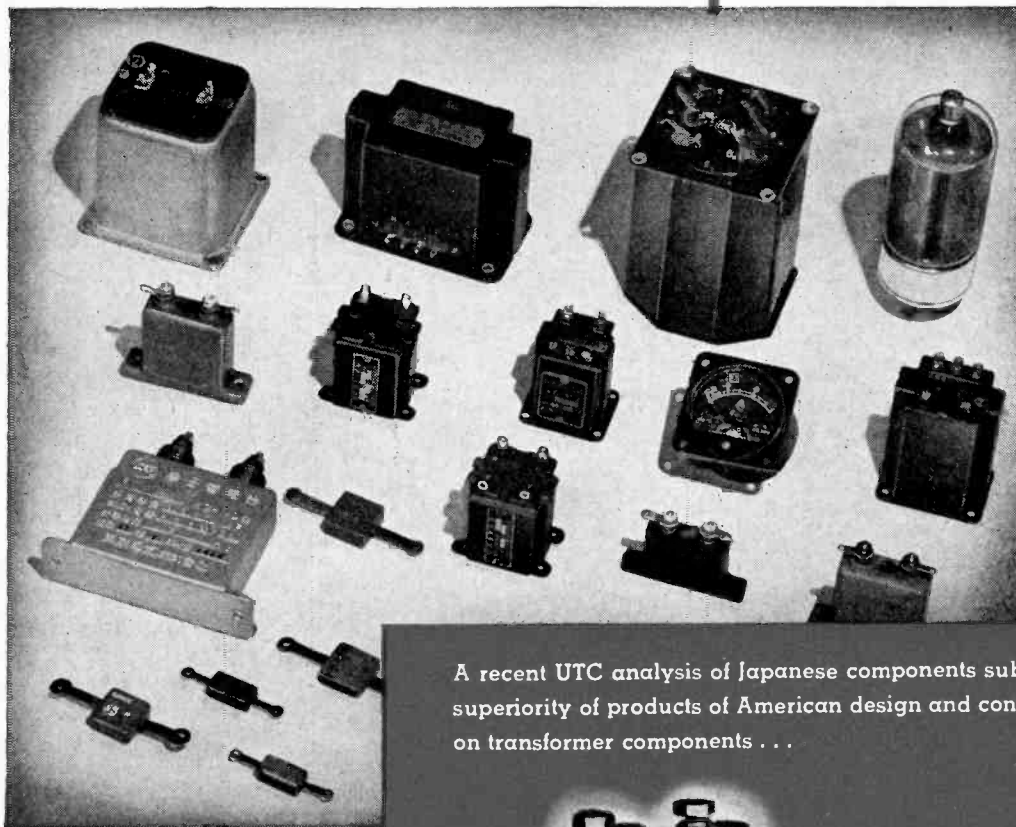

A recent UTC analysis of Japanese components substantiates the conclusive superiority of products of American design and construction . . . for example, on transformer components . . .

*
Japanese components illustrated obtained from the Pacific war theatre for the UTC Research Laboratory



JAPANESE unit weighs **8 oz.**
... failed on 15 minute submerison test
... very narrow frequency range.



UTC hermetic oincer weighs **1 oz.**
... takes full hermetic sealing tests
... has twice the frequency range.

MAY WE COOPERATE WITH YOU ON DESIGN SAVINGS FOR YOUR APPLICATION . . . WAR OR POSTWAR



United Transformer Co.
150 VARICK STREET NEW YORK 13, N. Y.
EXPORT DIVISION: 13 EAST 40th STREET, NEW YORK 16, N. Y. CABLES: "ARLAB"

Rauland Special-Purpose Phototubes



85 A

This new Visatron Phototube development is non-directional, having a 360° pickup. It features an increased sensitivity due to the elimination of any possible light loss. Applicable wherever multi-directional applications are required.



60 A

This new Visatron Phototube has high value on applications for double track sound systems or wherever dual cell operation is required and space is a factor.

Visatron Phototubes are available with caesium surface, either in gas filled or in vacuum for high stability.

To be sure . . . specify VISITRON!

RADIO • RADAR • SOUND •

Rauland

COMMUNICATIONS • TELEVISION

Electroneering is our business

THE RAULAND CORPORATION • CHICAGO 41, ILLINOIS

Buy War Bonds and Stamps! Rauland employees are still investing 10% of their salaries in War Bonds



Centralab

SELECTOR SWITCHES

Manufacturers

are invited to take advantage of Centralab's unchanging quality and splendid engineering co-operation on Selector Switches.

These switches are available in both steatite and bakelite insulation, the former being indicated where low loss and low moisture absorption for high frequency circuits are required. Built by Centralab to withstand the heavy service specifications required by the Army and Navy. May be had with fungicidal treatment for tropical climate.

All switches have double-wipe contact terminals for long life. Low contact resistance of less than $2\frac{1}{2}$ milliohms and are completely self cleaning.

Centralab

Division of GLOBE-UNION INC., Milwaukee
Producers of Variable Resistors—Selector Switches —
Ceramic Capacitors, Fixed and Variable—
Steatite Insulators.

3 WAYS

RCA METAL TUBES SIMPLIFY DESIGN

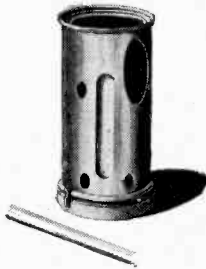

1. ELIMINATE SHIELD CANS

Metal tubes are self-shielding.

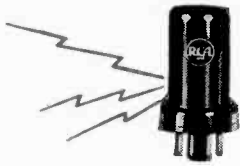
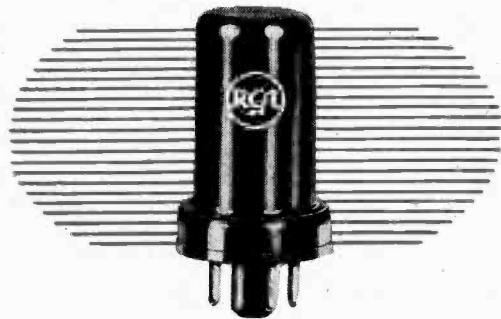

2. CAN BE LOCATED ANYWHERE

Metal tubes are little affected by stray fields.



3. ARE EASILY GROUNDED

Metal tubes provide simple grounding of the envelope through the No. 1 socket terminal.

• Your design and manufacturing problems are simplified both mechanically and electrically when you use RCA metal tubes. In addition, tubes with metal envelopes consistently give uniform performance... high stability... freedom from the effects of stray fields.

First to manufacture metal tubes, RCA has introduced over 90% of the metal types now available... and has built more than 120,000,000 metal tubes since 1935. Metal tubes were an important factor in RCA's prewar Preferred Type Program... and will be in RCA's postwar Preferred Type Program.

If you have a design problem involving electron tubes... metal, miniature, or glass types... call on RCA tube application engineers. Write to RCA, Commercial Engineering Section, Dept. 62-26P, Harrison, New Jersey.

Remember, The Magic Brain of all electronic equipment is a Tube... and the fountain-head of modern Tube development is RCA.

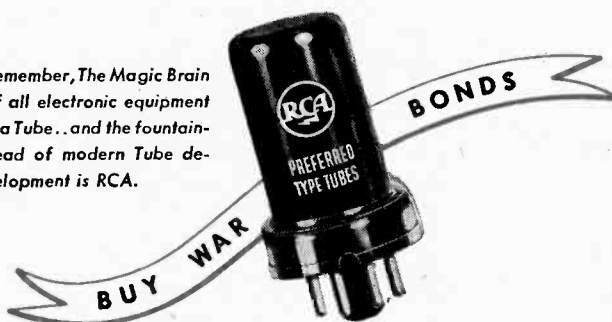

RADIO CORPORATION OF AMERICA

RCA VICTOR DIVISION • CAMDEN, N. J.

62-0190-20

Communication and electronic engineers, engaged in the difficult and complicated tasks of their profession in wartime, will find encouragement and cause for legitimate pride in certain of the thoughts expressed concerning their work by eminent industrial leaders in their field. Accordingly the PROCEEDINGS here presents, in its original form, the following views of the President of Sylvania Electric Products, Incorporated.

The Editor

The Challenge to Engineers

WALTER E. POOR

During the past four years, radio engineers have done far more than is generally known, or ever may be, to assure victory for the United Nations. They have worked out new designs in which the most advanced knowledge of the art has baffled, bested, and beaten the enemy. They have removed the time lapse between pure research and the commercial production. They have put radio quickly to work in battle. Indeed it may be said that the knowledge of the radio engineer is the secret weapon that has frustrated and destroyed much-publicized secret weapons of the enemy.

In this great work, as in all the titanic efforts the United Nations have made to win the war, skills have been joined together for the common good. Radio-tube engineers have, in some instances, proved to be the Minute Men of circuit design. Circuit engineers have, in other instances, presented almost impossible challenges to the radio-tube engineer. Together they have done a wonderful job. A far cry from yesterday's Engineering-As-Usual, today the radio-tube and the radio-circuit engineers must know the other's specific art, must be able fully to co-ordinate the knowledge that was once subdivided, specialized art.

In the peacetime to come this new united engineering effort will herald a new day of service to mankind. It will produce many new advances for the art of communication, the art of electronics in industrial production, and the art of electronics in the home.

From these postwar developments the tube and the circuit engineer, working closely together, will produce far-reaching and vital effects on the economy and social welfare of our people. They will create a host of jobs; they will create the means of better entertainment; more efficient public information; improved methods of making and controlling the quality of millions of products for millions of people. They will, I am certain, do the whole job exceedingly well, just as well as they have, through united skills and efforts, made possible the wonderful things which have made such a mighty contribution toward winning the war, so that the challenge of peace, a bigger, fuller life for everyone may be transformed into reality.



Adolph Bernard Chamberlain

Adolph Bernard Chamberlain was born on February 3, 1901, at Franklin, Massachusetts. He enlisted in the United States Navy in 1920, and, after naval training courses, served as a radioman second class in the Eighth Submarine Division.

On leaving the Navy, he joined the pioneer technical staff of the General Electric Company's broadcast station WGY at Schenectady, New York, and as engineer in charge of field operations, was responsible for the early technical work on regional network experiments.

In 1927 he left the General Electric Company to become chief engineer for Stromberg-Carlson's station WHAM, at Rochester, New York, becoming general manager of that station in 1928. In 1929 Commander Chamberlain became technical director of the Buffalo Broadcasting Corporation, which at that time operated stations WGR, WKBM, WMAK, and WKEN, outlets of both the National Broadcasting Company and the Columbia Broadcasting System. In 1930 he became vice-president of this organization.

From 1931 to 1942 Commander Chamberlain was associated with the Columbia Broadcasting System as

chief engineer and was directly responsible for the design, installation, operation, and maintenance of many phases of broadcast equipment, including standard broadcast antennas, transmitters, audio-frequency control facilities, measurement equipment and techniques, and broadcast studio acoustics. He was directly concerned with the planning and supervision of station modifications and new construction, the most outstanding of which include such installations as the 50-kilowatt transmitters at KNX, Hollywood, California; WTOP, Washington, D. C., WBBM, Chicago; and WABC, New York. His duties included considerable work with relay and international broadcasting.

Commander Chamberlain was called to active service in the Naval Reserve in 1942, and is now on active duty in the Radio Division, Bureau of Ships, as one of four officer assistants to the Head of the Design Branch.

He joined The Institute of Radio Engineers as an Associate in 1927, was transferred to Member grade in 1930, and became a Fellow in 1942. He has been active on general and technical committees, and is a past Chairman of the Rochester and Buffalo Sections.

Concurrent Graduate Study — Its Place in Postwar Engineering Education*

F. R. STANSEL†, SENIOR MEMBER, I.R.E.

Summary—This paper, which represents some personal views of the writer, advocates a more extensive development of facilities for graduate study taken concurrently with professional duties. The advantages of such a program are pointed out, and certain changes in educational routine that may be desirable are discussed.

ANY PLAN for a postwar educational program in any branch of engineering must take into consideration the large amount of new subject matter that must be covered as a result of developments of the past decade. While some place for the new subject matter undoubtedly can be made in the curriculum by regrouping and by more emphasis on basic theory, yet there naturally arises the question of whether the engineering course should not be lengthened. Even before the war some educators advocated an undergraduate course of five or six years to allow more time for the humanities. An alternative to lengthening the period of undergraduate study is to expect more students to supplement basic training with one or more years of graduate study.

Any extension of the period of full-time education, either undergraduate or graduate, brings new problems, social, personal, as well as financial into the picture, and hence it would be well not to increase the years required to enter the engineering profession without first asking whether there is not an alternative way. Stephen Leacock, the Canadian educator, once characterized the extension of formal education in the Liberal Arts field as "education eating up life".¹ He stated that in engineering, medicine and law "the adaptation of the means to the end is sufficiently direct to lessen the danger of wandering into the wilderness as liberal arts has done". Nevertheless, even in engineering, the danger of wandering does exist and should be avoided.

When considering alternatives to additional years of full-time study, one should remember that engineering is an experimental science to be learned as much in the laboratory as in the classroom. Once the neophyte has attained a certain degree of skill, where are there better laboratory facilities for advanced study than in industry itself? Would it not be well for the engineering profession, instead of advocating an increased period of preparation, to encourage the development of a vigorous course of graduate studies designed not to be taken on a full-time basis but concurrently with the laboratory work of the novice's early professional career?

Besides eliminating the problems arising from the ex-

ension of the period of full-time study, such concurrent graduate study offers advantages from a strictly educational viewpoint. There is the stimulus from contacts with professional and industrial activities, and courses may be taken in an advantageous sequence. The student may first pursue an advanced course in mathematics and follow this with a course in advanced theory. He is then better prepared to embark on a thesis project than he would be if, as in the case of full-time graduate study, it were necessary for him to take these two courses and undertake a thesis investigation at the same time.

The idea of graduate study concurrently with professional duties is not new. Such courses have been offered by many schools at various times, and some corporations have organized "out-of-hours" courses of truly graduate caliber. For example, one metropolitan engineering college has, for about twenty years, maintained an extensive graduate school offering courses in almost every branch and phase of engineering to part-time students.² The need is rather for engineering organizations to recognize the advantages and potential possibilities of such concurrent graduate study and to urge its development wherever the facilities for such courses exist. Full-time graduate study need not be discontinued, but with a vigorous program of concurrent study established many students will choose the concurrent program instead because of its advantages.

Concurrent graduate study can perform an important function in completing the training of engineering students who return from the armed forces. Many of these men, particularly those who were graduated from "speed-up" courses, will feel a need to bolster their training in specific subjects. A concurrent program flexible enough to meet the needs of these individual students can play an important part in education during the period following the end of hostilities.

The offering of concurrent graduate courses will call for some changes in the routine of many colleges. The question of time and place for classes must be decided to meet local conditions. At present, evening classes appear to be one way to serve a large number of students although when business returns to a more normal pace it may be possible to hold more classes on Saturdays.

As students often change business locations during the first few years of their professional career, a liberal policy towards the transfer of credits is desirable.

Colleges should recognize that many students will

* Decimal classification: R070. Original manuscript received by the Institute, October 11, 1944. Presented, New York Section, December 6, 1944.

† Bell Telephone Laboratories, Inc., New York, N. Y.

¹ Stephen Leacock, "Too Much College," Dodd, Mead and Co., New York, N. Y., 1939.

² R. Beach, "Evening courses at graduate levels—A challenge to colleges of engineering," *Trans. A.I.E.E. (Elec. Eng., February, 1942)*, vol. 61, pp. 88-94; February, 1942.

wish only to attain knowledge or skill in one specific subject, and concurrent courses should be organized to serve these students as efficiently as those seeking an advanced degree. For these students in particular instructors should be authorized to waive prerequisite courses when the student can demonstrate his fitness to derive benefit from the course.

A problem which should be studied in some detail by the engineering colleges is the place of the thesis in a concurrent graduate program. In the past it has been the almost universal custom for a candidate for a master's or a doctor's degree to present a thesis containing the results of some original investigation, both because of the educational value to be obtained from such research, and also to demonstrate the candidate's fitness for the advanced academic degree. This requirement is suitable for students engaged in full-time study, but for a student engaged in a concurrent program it may lead to difficulties and possibly to injustices to the student. The effect of a thesis requirement will vary from student to student, but as a starting point it would be well to consider its effect on three different groups of students.

The first group is composed of students whose professional duties are in the sales, administrative, or other fields in which there is little direct contact with the laboratory. For these students the experimental work involved in a thesis is undoubtedly beneficial, and for these students there is no need to change the present thesis program.

The second group is composed of students engaged in professional development and research work of much the same character as the investigation required for a thesis. For these students the educational value of a technical thesis is less. It may well be that they can gain more benefit from additional courses in parallel engineering or scientific subjects. Or they might profit from the preparation of a thesis dealing with some economic rather than technical aspect of their profession. Sometimes students in this group find it possible to present some phase of their professional work in thesis form. When such an arrangement is possible, it is quite advantageous from the student's viewpoint, but in modern industry development and research are often carried on by groups rather than by individuals, and it is frequently not feasible for the junior engineer to use his professional work to meet thesis requirements.

The third group consists of students who, by the time that they have completed a substantial program of studies and become candidates for the master's or doctor's degree, have independently of their studies published material which, had it been presented under the proper auspices, would have been acceptable as a master's or doctor's thesis. These men naturally feel that they have been denied an academic honor through a technicality. Before the war a number of such cases existed, and with the removal of wartime secrecy a substantial number will be added to this group. In fairness to these men, some consideration should be given to accepting their previous publications in lieu of a thesis. In order that no one college be criticized for undue leniency in this respect it might be well for all such cases to be passed on by a regional committee representing several engineering colleges.

In the matter of publication of thesis material the student may sometime find himself between two millstones, the college urging or even requiring publication, and the employer holding a restraining hand because of patent rights or editorial policies. This conflict often can be avoided by the choice of subjects of a theoretical nature not open to immediate commercial application, but the final solution of the problem can only be reached through closer co-operation between the college and the employer. In some cases it may be desirable for a representative of the employer to serve as a member of the student's guidance committee.

In conclusion, the writer feels that there is a definite need in the field of engineering for a broad program of graduate study taken concurrently with professional duties. Such a program will eliminate any need for prolonging the period of basic engineering training, and will make advanced study available to many engineers under favorable conditions. Some readjustments on the part of both the college and the employer are desirable if these courses are to produce the maximum benefits, but experience to date shows these readjustments can be made without great difficulty.

The professional engineering societies are urged, therefore, to encourage the colleges to supplement a sound, vigorous undergraduate course in the fundamentals of engineering, including due regard to the humanities, with such a program of concurrent graduate studies.

With the war victory of the Allied Nations steadily approaching, it is timely to turn attention both to the accomplishments of radio-and-electronic engineering during the war and the likely contributions it can make in the ensuing peacetime period. In this latter direction, an amazing vista is displayed—a prospect fraught with great possibilities of good for mankind. The following paper presents some of the wartime contributions and probable peacetime offerings of the radio-and-electronic field—a field in which The Institute of Radio Engineers and its PROCEEDINGS will continue to play a constructively contributory and widely useful part.

The Editor

Electronic Research Opens New Frontiers*

RALPH R. BEAL†, ASSOCIATE, I.R.E.

IT IS A great honor to address you on the occasion of the opening of this first National Electronics Conference. I feel that it is an especially high distinction to appear before you under the circumstances of this meeting. This is a gathering out of which should emerge a greater knowledge and understanding of the science of electronics, so vital in hastening the end of the war, and so important as a means of insuring a lasting peace—a happy and progressive peace.

I am deeply impressed with the prospects before us here. The very fact that such a conference has been called manifests the increasing urge of our scientists and engineers to move forward to the new frontiers, the challenging frontiers, which sweep across our horizons in the realm of electronics. It should give us confidence in the future to sense here a resurgence of the spirit of adventure traditional to our country, to find the same boldness and courage in pioneering on electronic frontiers that characterized the development and expansion of our geographical frontiers.

Standing out sharply against the backdrop of America's economy is the realization that our economy, our entire social and economic structure for that matter, depends upon change and progress. We must have new enterprises; we must have new services; we must have new products.

America's is an economy of plenty and not an economy of scarcity. To create employment and prosperity, we must have fresh sources of supply and raw materials—inspiring creations of science and engineering. We must cultivate change, because we thrive on change and our civilization advances on change. New things, new fundamentals, result from research. Research, and more research, is the order of the postwar world.

* Decimal classification: R010. Original manuscript received by the Institute, October 19, 1944. Presented, National Electronics Conference, Chicago, Illinois, October 5, 1944 (the Chicago Section of the Institute of Radio Engineers was one of the sponsors of the National Electronics Conference).

† Assistant to Vice-President-in-Charge, RCA Laboratories, New York 20, N. Y.

When war came on that terrifying Sunday morning at Pearl Harbor in 1941, only a small part of our vast manufacturing facilities had been converted for defense purposes; most of our great steel and textile mills, automobile factories, locomotive plants, radio manufacturing plants, and machine-tool works were engaged in peacetime enterprise.

The preparedness picture was dark indeed, but for one heartening fact: American research scientists and engineers were ready. The record is clear on this. Men equipped with knowledge and experience gathered so painstakingly by research and engineering between wars and before that period made an unbeatable combination when teamed with the great resources of this country and the American will to win.

We may picture Victory as a gigantic wheel, among the numerous cogs of which are all branches of science: physics, chemistry, aerodynamics, metallurgy, optics, radio, television, electronics. As this great wheel turns toward the final day of this war, we see all these cogs of science meshing perfectly with the gallant forces of our fighting services, the Army, Navy, and Air Force, and with our Allies.

During the past four years science has been mobilized into a co-operative effort unprecedented in all history. Throughout America, industrial research and engineering have been geared in perfect harmony. Internationally, the same co-operation has been in operation. Science, therefore, has been forged into an all-powerful wheel that turns to generate Victory.

When hostilities began in 1939, it looked as if science, perverted by our enemies, were on their side. But this was because in the days of peace that intervened between World War I and World War II, Germany had concentrated its research on warfare; it applied science to war, not to peace. In America, science was focused on peacetime pursuits. Our great industrial research laboratories were at work developing new commercial products and services. In the Axis countries, the laboratories

were secret gateways to war; they were creating new weapons of destruction.

When war came to America, we suddenly were awakened to the realization that science must be directed to warfare if we were to defeat an enemy fortified by ingenious scientific applications. Quickly America's men of science rallied to national defense; industrial research was organized to function as a unit with one aim, to win the war. America's great resources of research joined with the Army and Navy and our fighting men on the highways, on the sea lanes, and in the air.

In war, the scientist and the engineer answer the call in the laboratory and in the field. They go into all quarters of the globe and to all battle fronts. They are summoned into swift flight to gain first-hand knowledge and to make practical applications of their discoveries. They study the techniques and devices of the enemy; they build superior weapons to combat and to overcome the foe. They work and think quickly. They telescope years of development into months, so that Victory may be hastened.

We must be quick to recognize that if science can be so effective in war, it can be even more effective in peace. As soon as this war is won we must reconvert science from destruction to construction and by so doing rehabilitate the world and bring happiness and new comforts in living to every nation on earth.

In charting a course for the future, it is important that we keep in mind the ground already covered, the progress already made. Out of the preparedness of our research scientists and engineers in electronics have emerged new and vital weapons and new means of speeding industrial output. Radio, no longer confined to dots and dashes, as in the last war, became, thanks to electronic research, the eyes and ears of our fighting machine, the voice of our high command, the directing force behind our anti-aircraft guns, the unerring guides of warplanes and warships, and the swift means of communicating across every ocean and across every frontier.

Electron tubes flash facsimiles of maps, documents and photographs over great distances to aid Allied strategy. Radio broadcast stations are voices of liberty, informing and uniting our people. Yet, these are only a few of the achievements of radio and electronics. When the full story is permitted to be told, it will be an astounding chapter of scientific accomplishment.

The electronic triumphs during the Second World War become all the more remarkable when we realize that by far the majority of these wartime weapons and services were either unknown or nonexistent at the close of the first World War. In the latest developments we find clues to future progress and revolutionary trends of research and engineering. Close examination will reveal that virtually without exception the present wartime applications of electronics have their roots in the field of electrical communications, a field that has afforded fertile soil to research scientists for more than one hundred years.

The new frontiers that are opened by electronics, and

the horizons that extend before us, might never have become known were it not for the earlier research of Morse, Bell, Hertz, Thomson, Edison, de Forest, and Marconi, to name but a few. Hertz conducted his classic experiments in electromagnetic waves in 1887, and in his further investigations, he observed the photoelectric effect and reported it to the scientific world. In 1897, Thomson, in England, demonstrated the characteristics of the electron.

Edison had noted earlier that when a metallic plate was sealed into the glass bulb of his carbon filament lamp, a mysterious current flowed between the plate and the filament. This is known as the "Edison effect." This current was shown to be carried by a stream of electrons emitted from the filament.

In photoelectric effect and in thermionic emission, electrons are freed from matter to which they ordinarily are bound. They may be freed also by electronic and ionic bombardment and by the influence of electric fields of extremely high intensity.

The science of electronics deals with the flow of such freed electrons in vacuum or through a vapor.

One of the earliest applications of electronics was in a communication device, the Fleming Valve of 1904. And in 1906 de Forest announced the three-element tube which opened the way for far-reaching improvements in wireless. Successive steps in research, and inventions by Armstrong, Langmuir, Arnold, and others contributed to the extraordinary ability of controlled electrons to detect and greatly amplify feeble electrical impulses, to rectify currents, and to generate oscillations from a few cycles per second to billions of cycles per second.

Thirty years ago, de Forest's three-electrode tube was applied as a repeater on the telephone-wire circuits connecting New York and San Francisco, making transcontinental telephony practical. In wire telephony and telegraphy, as well as in radio, electronic applications provide a basic means from which successive developments are made to meet the communications needs of expanding industry and national activity.

Out of research have come the vacuum-tube detectors, amplifiers, and oscillators for radio receivers and power electron tubes for transmitters, developments which made the overseas radiotelephone a practical reality.

Our present system of sound broadcasting resulted from an upsurge, after the first World War, of interest in electronics as represented by the electron tube. Broadcasting was developed as a new industry, an industry of great significance in our national development.

Electronic research also produced the necessary vacuum tubes for the transmitters and receivers that opened the short-wave spectrum from 3 to 30 megacycles for use in long-distance communications services. This greatly expanded the number of radio channels and increased the efficiency of overseas circuits. It opened the way to progress from which we derive great benefit today.

Radiotelegraph circuits over distances in excess of 5000 miles now operate at transmitting speeds of 500 words per minute. Electronics also has made possible short-wave teletype circuits which reach practically any part of the world; radiophoto services in which pictures taken on the battlefields of Europe or in the Pacific are brought, within a few hours, to our daily newspapers; radiophone circuits which carry the voice to the remotest sections of the globe; and radiotelegraph and telephone services extending to ships and planes.

Research in electronics and vacuum-tube circuits is bringing into use the vast radio spectrum which lies in the frequency range from 30 megacycles to frequencies a thousand or more times greater. This radio spectrum opens new horizons of tremendous potentialities for exploration.

Generally speaking, the distance range of these staticless, nonfading microwaves may be referred to as "line-of-sight" transmission, for unlike long waves, they fail to follow the curvature of the earth. This characteristic is adaptable to domestic broadcasting, communications, and other services. The tiny waves may well be the means of establishing a new epoch in domestic communications and ultimately have a profound influence on communications in countries throughout the world.

One of the new services to emerge through the use of frequencies in the lower ranges of this radio spectrum is frequency-modulation broadcasting. It makes possible new realism and tonal quality and substantially reduces interfering noises or static.

A service that has yet to be developed in the very-high-frequency spectrum is facsimile broadcasting, by which we mean radio transmission and reception of the printed page, illustrations, and diagrams. In commercial communications of the future, electronic applications will make possible high-speed facsimile by which printed matter by the page may be sent from one side of the country to the other in a few seconds. An entire page of a newspaper may be transmitted over thousands of miles in a matter of minutes. Printed documents, handwritten letters, diagrams, and photographs may be flashed from point to point.

In other uses, facsimile also may be employed for copying and duplicating purposes and for the production of printing plates either locally or remotely over circuits to one or more points.

Radio-and-electronic developments are an indispensable aid to man in his conquest of the skyways, in attaining speed and safety in air travel. They have opened realms of vast scope to the airplane by affording freedom of movement over land and sea. Electronic applications in aviation cover a wide variety of services and aids. They provide radio-communication services and navigation systems. They make available to aircraft means of ascertaining their positions instantly. Long-distance radio direction finders supplement other means of navigation.

Clearance- and height-measuring instruments can inform the pilot of the character of the terrain over which

he is flying and enable him to remain at a safe altitude, regardless of the weather. Collision-prevention apparatus will indicate obstructions that may loom in the plane's course and afford ample warning for changing the direction or elevation of the plane to avoid collision. Electronic means for controlling the plane itself and for connecting the controls of the plane into guiding radio systems so that it may fly to its destination automatically are entirely feasible in the postwar period.

The outlook is bright for radio-communication services that can connect automobiles and other conveyances on land or water into telephone circuits and other communication services. It is within reason to predict that individual communication sets of the walkie-talkie type will come into wide use, and may also be connected into our national and world-wide telephone circuits.

Reward has come at last to man's inherent desire and striving to extend his sight beyond its normal limitations. Electronic television, now on the verge of becoming a great new industry and a service to the public, answers fully our expectations. It stands forth as a prime example of a major achievement of research and engineering. Into the development of this marvel of the age has gone more concentrated research than into any other modern development. Television involves fundamental discoveries dating back almost a century. It has tapped virtually all of the reservoirs of knowledge in radio, chemistry, physics, optics, and electronics.

Every element, every component of the system has required exploration and pioneering. New principles had to be discovered in picture-pickup devices, electron optics, electronic amplifiers, radio transmitters and transmitting tubes and antennas, and in methods for synchronizing the transmitted and received pictures. New parts of the radio spectrum had to be explored and harnessed.

Television today rests upon its own solid foundation of research. It encompasses many remarkable scientific advances, each of which in its own right rises as a monument to the progress of science. Key contributions to a television system are the iconoscope or electronic "eye," which picks up the scenes, and the kinescope or electronic receiver tube. Out of years of research has come an improved camera tube known as the orthicon, which has remarkable sensitivity. It makes possible the transmission of scenes which previously could not be picked up; and it opens the way for still more improvements which doubtless will enable the television "eye" to observe any scene that is visible to the human eye.

Television has the greatest promise of any development in the art and science of radio. With a television receiver in your home, you will become an eyewitness to interesting events and entertainment beyond your immediate horizon. From your living room, you will see the world pass in review.

Theater television is also being prepared as a great new service. For the first time in the centuries of theater history, a method has been devised for bringing to theater audiences the thrills and drama of actual events as

they occur at a distance. Electronic research has made it possible to produce pictures in motion of theater-screen size. Connected into television networks, theaters in cities and villages throughout this country may become playhouses for showing the newest dramatic productions, and in addition bring to audiences great sports events, news events, and educational features of national importance.

Through research, scientists have succeeded in transmitting electrical impulses, the human voice, and music, over great distances with and without wires. They now have added television to their achievements, and, out of their ability to transmit sight over wires as well as through space, has come still another service with fabulous possibilities. It is industrial television.

This application envisages the use of radio sight as the "eyes" of factories, the means of co-ordinating and controlling giant manufacturing enterprises, and the means also of looking into places that otherwise might be inaccessible or dangerous to man. Industrial television may be used by the plant manager to observe critical operations. It may be used to follow the flow of materials and observe progress of work. It may be used in chemical reaction chambers to make visible complicated chemical processes.

As a development in radio-electronics, which promises a remarkable expansion in domestic communications, radio relays are attracting wide attention. Radio relays utilize extremely high frequencies, highly directive transmitting and receiving antennas, and power output of only a few watts. Unattended stations may be placed across the country at intervals of about thirty miles.

These relays will provide the wide channels required for television, for high-speed facsimile and other modern domestic services. They may be utilized in aviation communications and for navigation and control services for aircraft. They may also serve as terminal stations to connect mobile craft of all kinds to telephone lines and other lines of communication. They may serve to report weather information or other information automatically from remote regions, either directly or through additional repeater stations.

Out of the accumulation of research in television and especially in electron optics, has come a new electronic instrument, the electron microscope, which uses electrons instead of light rays to penetrate the hidden mysteries of Nature and the submicroscopic world. This achievement of RCA Laboratories has been acclaimed as the most revolutionary laboratory tool of the twentieth century. It has played an important part in wartime research.

The range is wide indeed in which electron tubes play a vital role. They perform an astonishing array of tasks, none of which appears too heavy, too precise, or too vast for them. Radio tubes are the control elements in devices which open doors, bring elevators to a level landing, operate time devices, and ring alarms. They detect

smoke in fire-prevention apparatus; they count and sort merchandise, match colors, and gauge thickness of materials to a millionth of an inch. They provide safety devices in industry. They measure humidity and atmospheric pressure, and control temperatures to a point of perfection. We shall hear a great deal in the future about electronic industrial control.

Attention was focused recently upon a development in radiothermics, the fast-growing industrial use of the high-frequency power that generates heat. It is an electronic dehydrator perfected in RCA Laboratories. In thirty minutes it completes an operation requiring twenty-four hours by the conventional system in the production of the renowned drug penicillin. Electronic power heating now speeds output and reduces costs in many other manufacturing processes. Its achievements extend from sewing, riveting, and welding to dehydrating vegetables, tempering steel, and baking plywood planes.

The urgency of aircraft production, coupled with the shortage of aluminum, gave high-frequency heating one of its first opportunities. It was discovered that laminated-wood structural parts and sections combining light weight with maximum strength could be bonded more satisfactorily and rapidly with high-frequency heat than by any other means. Going still further, engineers produced high-frequency equipment that made possible the all-wood plane.

New applications of electronic devices and techniques have become partners of the woodman's ax and the saw-mill to make wood one of our most versatile and serviceable materials. Informed observers foresee a broad field for high-frequency heating in the furniture industry after the war, particularly in the manufacture of curved laminated sections for radio cabinets, pianos, and other pieces of furniture requiring formed-wood sections. Radiothermics has aided production immeasurably in the wartime metals field, in the production of vital plastics and other necessities brought on by the war but which should find a variety of important postwar uses.

Advances in the science of electronics have been so rapid in the twenty years before this war and during the war years that it requires more than a brief moment to appraise the full measure of progress. But one thing is evident: In their great movement forward, research scientists, in addition to opening new frontiers, have spread before themselves a vast new world of unexplored opportunities. This means that trained men in greater numbers than ever will be needed to conduct research and to apply the results to new products and new services. The education and training of these men for research and engineering is of paramount importance, because on their success, to a large extent, will hinge the progress and welfare of our nation.

In conclusion, I wish to make this plea—that industrial research never relinquish its harmonious co-operation with the Army and Navy. Science, which has helped to win the war, must continue to assist in preserving the

peace. If our armies, battleships, and bombers are equipped with the latest devices of science, no nation will be anxious to seek a fight. Our armor of science must be strong.

We know how destructive the weapons of science have been in this war. We know what the robot bomb has done; it makes us shudder to think what might happen were additional forces of science harnessed to its deadly wings. I can tell you, without revealing any military

secrets, that based upon what I have seen developed for warfare in the science of radio-electronics alone, another war would be much more destructive.

It is my urgent plea that our industrial research laboratories continue to work hand in hand with our Army and Navy in peace as they have done so magnificently in war. Let us through science put new power behind the wings of the Dove of Peace. That is the new challenge; it is our DUTY.

The Use of Radio Frequencies to Obtain High-Power Concentrations for Industrial-Heating Applications*

WESLEY M. ROBERDS†, NONMEMBER, I.R.E.

Summary—By the use of radio-frequency power it is possible to obtain controlled power concentrations which far exceed those obtainable by other means. For example, in the induction heating of steel or other metals, the application of 100 kilowatts to a square inch of area on the work is not difficult. At a frequency of 1 megacycle, 99 per cent of the resulting heat generation is confined to a layer approximately $\frac{1}{16}$ inch thick.

If very high power concentrations are used for short heating times, the resulting high temperatures may be localized in the regions of heat generation. This technique results in more uniform case-hardening, less distortion, and high heating efficiency, as well as high production rates.

The effect of frequency upon power concentration is discussed. It is shown that the optimum frequency varies with the size and shape of the work to be heated.

Induction-heating technique is contrasted, and compared, with radio-frequency dielectric heating. In the latter class of work, the heat generation is equally distributed throughout the body of the work.

With the use of radio-frequency dielectric heating, power concentrations in the order of 1 kilowatt per cubic inch can be obtained in thick wood sections, as for gluing operations. This is to be contrasted with the application of heat by heated press platens where power concentrations of only about 0.05 watt per cubic inch can be attained.

Again, the optimum frequency is determined by the size and shape of the work.

THERE ARE two general methods by which radio-frequency power is used in industrial-heating applications. These are usually designated as "induction heating" and "dielectric heating." Induction heating is used when the work is some good electric conductor such as a metal. The work to be heated is merely brought near the so-called inductor coil which is usually just a few turns of water-cooled, copper tubing electrically connected to a source of radio-frequency power. Alternating magnetic flux generated by the current in the coil links the work and induces in it the eddy currents which do the heating.

The dielectric type of heating is used on substances

which are relatively good electrical insulators. Here, the work to be heated is placed between electrodes which constitute the plates of a condenser. A high-voltage, high-frequency, electric field is established in the work by connecting the plates to a radio-frequency generator. Heating is caused by internal electrical losses in the work. These losses are supposed to be due to the atoms' taking up some of the vibratory motion of the bound electrons as these latter are shaken back and forth by the high-frequency electric field.

Therefore, while the two methods of radio-frequency heating use the same general type of equipment, yet they differ widely in several respects. In induction heating electrical energy is transferred from the generator to the work by magnetic flux; in dielectric heating the energy transfer is made by an electric field. In induction heating the load generally has a low impedance; in dielectric heating the load impedance is usually high. In induction heating the heat is generated in the work by conduction of induced currents; in dielectric heating there is no electrical conduction in the work, in the true sense of the term. The methods also differ in the way the heat energy is distributed. The induction method is essentially a surface-heating phenomenon, while in dielectric heating the heat is distributed quite uniformly throughout the volume of the load.

The techniques employed and the results obtained in both of these heating methods have been discussed and published on several previous occasions. Therefore, in this paper it is the author's hope only to emphasize two of the unique advantages of radio-frequency heating which so far seem not to have received their due attention.

These advantages are:

(1) By radio-frequency heating it is possible to attain controlled power concentrations which far exceed those obtainable by the more conventional methods; and

(2) In radio-frequency heating the heat is generated within the work itself. This obviates the necessity of transferring heat across boundary surfaces, which is always a very inefficient process.

* Decimal classification: R590. Original manuscript received by the Institute, October 11, 1944. Presented, National Electronics Conference, Chicago, Illinois, October, 1944 (the Chicago Section of the Institute of Radio Engineers was one of the sponsors of the National Electronics Conference).

† Communications and Industrial Equipment Engineering Department, Radio Corporation of America, Camden, N. J.

The ability to create very high power concentrations is especially advantageous in processes where it is desirable to confine the heating to a small, sharply defined volume. For example, in such operations as case-hardening, welding, brazing, or soldering it is desired to heat only a thin shell or narrow strip on the work while the other parts are to remain relatively cool. This effect may be accomplished by applying the necessary energy at high power levels for very short times. This minimizes the conduction of heat and the high temperatures are created only in those regions where heating is desired.

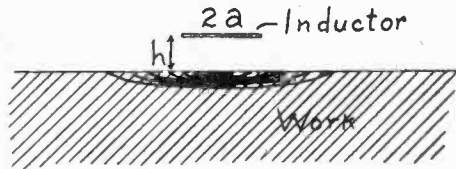

Fig. 1—Approximate distribution of induced current in infinite plane with ribbon-type applicator.

When high power concentrations are mentioned one immediately thinks of the oxyacetylene flame or the electric arc. In the case of the torch, the transfer efficiency from source to work is extremely low so that powers, into the work, of 5 kilowatts per square inch are about the maximum attainable at present. In radio-frequency induction heating it is not difficult to put 100 kilowatts into a square inch of surface area with an overall efficiency of 50 per cent.

In the arc, the power concentrations may be comparable to those in radio-frequency induction heating but the intensity of the arc has a much lower range of control. With a 100-kilowatt radio-frequency generator the surface of a 2-inch steel bar can be brought to the melting point in half a second, or the power may be reduced until it will require 5 seconds to solder a small milk can.

Radio-frequency induction heating is generally accomplished with frequencies above 100 kilocycles and for the majority of applications the most suitable frequencies lie between 200 and 500 kilocycles. Moreover, most of the applications involve the heating of steel. It may be well therefore to trace, in a rough fashion, just what happens when high powers are applied to a piece of steel work by means of high-frequency induction.

For the sake of simplicity let us assume that the work is a plane of infinite extent and depth, that the inductor is a thin ribbon of width $2a$, and that it is spaced a distance h above the work. (See Fig. 1.) The current in the work is distributed about as shown by the density of shading.

A very useful concept, which is used in dealing with high-frequency phenomena and which will aid in this description of the heating of steel is the so-called "depth of current penetration", or perhaps a better term is "the penetration unit". It is defined as the depth below the surface at which the current density is $1/e$ times its value at the surface. Here e is the base of the natural logarithms so that at a distance of one penetration unit

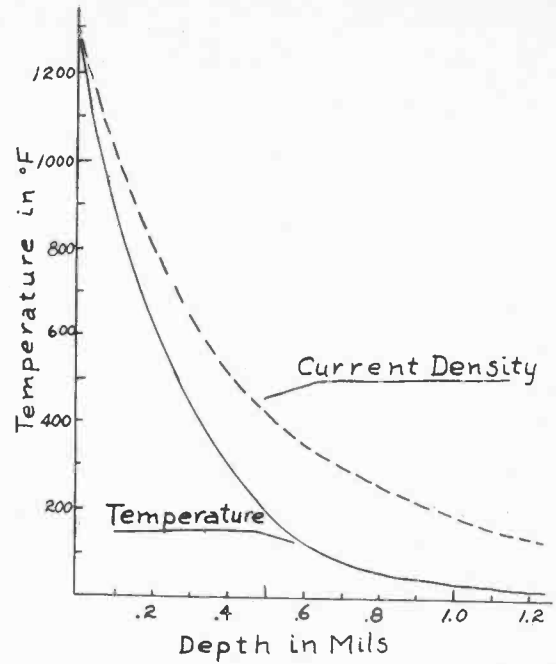

Fig. 2—Approximate distribution of current density and temperature after applying 100 kilowatts per square inch for 50 microseconds.

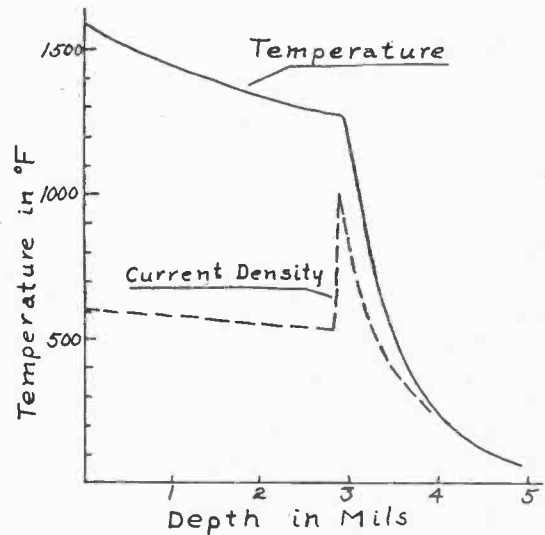

Fig. 3—Approximate distributions of current and temperature after 0.01 second.

below the surface the current is approximately 37 per cent of its value on the surface. The penetration unit, of course, varies with the frequency and with the electrical and magnetic properties of the substance in which the current is flowing. Table I lists the values of penetration

TABLE I
CURRENT PENETRATION UNITS IN MILS

Material	Kilo-cycles 10	Kilo-cycles 100	Kilo-cycles 500	Mega-cycles 1	Mega-cycles 10	Mega-cycles 100
Copper	25	8		2.5	0.8	0.25
Aluminum	35	12		3.5	1.2	0.35
Brass	55	18		5.5	1.8	0.55
Steel (Cold)	4	1.5	0.6	0.4	0.15	0.04
Steel (Hot)	240	75	35	24	7.5	2.4

units for a few common metals at a number of different frequencies.

Two values are given for iron. One is for iron at room

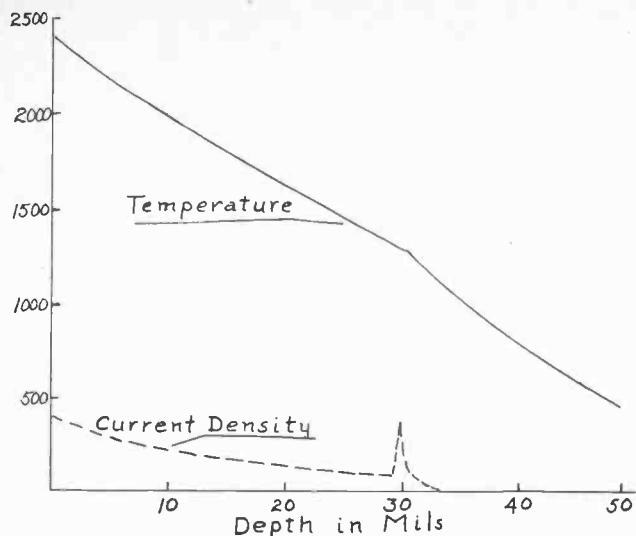

Fig. 4—Approximate distributions of temperature and current after 0.05 second.

NOTE: The curves of Figs. 2, 3, and 4 were drawn on the assumption that the permeability of steel below the Curie point is approximately 200. However, there are indications that, due to the high values of current which must exist under the present circumstances, the iron is far beyond its saturation value and therefore the effective permeability is much less than 200. Hence, at the higher power concentrations, the slope of the curves to the right of the Curie point are much less than those indicated.

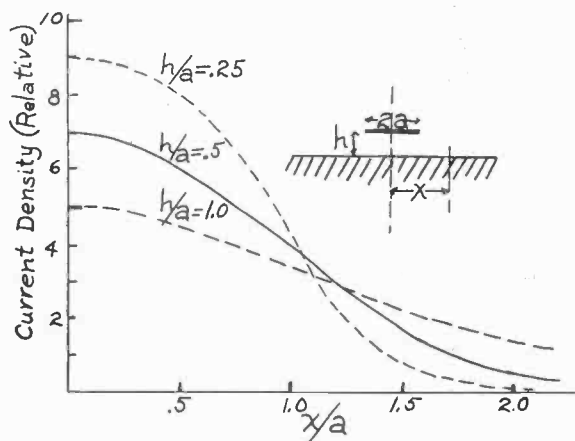

Fig. 5—Lateral distribution of induced current.

temperature, that is, magnetic iron; the other value, "hot iron," is for iron whose temperature is above its Curie temperature where it is no longer magnetic. The Curie point for most steels is about 1300 degrees Fahrenheit.

Now to return to the hypothetical heating problem: Let us assume that enough 500-kilocycle current is put through the inductor strip to feed 100 kilowatts of power into a square inch of the work surface. The penetration unit is approximately 0.6 mil. Let the power be applied for approximately 50 microseconds. The resulting temperature distribution in depth is something like that shown in Fig. 2. Note that the surface has been brought just to the Curie point.

If it is desired to harden the steel however, it will be necessary to heat it a little above the Curie point in order to carry it into the gamma phase and dissolve the free carbides. This means therefore that for part of the

heated volume the depth of current penetration will no longer be 0.6 mil but 35 mils. (The penetration unit for steel above the Curie temperature as shown in Table I.) The curves of Fig. 3 show the approximate distribution of current and temperature at the end of 0.01 second heating.

The curves of Fig. 4 show the approximate distributions after 0.5 second heating time.

Now these curves show orders of magnitude only, but they illustrate two important facts:

(1) The heating time must be very short, in the order of microseconds, if the high temperatures are to be closely confined to the volume occupied by the induced currents; and

(2) The greatest heating effect occurs right at the boundary between the magnetic steel and its nonmagnetic form. This high-intensity front, of course, moves inward as the steel is heated above the Curie temperature.

Another important relation is shown in the curves of Fig. 5. Here is plotted the current distribution in a lateral direction. It is seen that if the inductor has an equivalent width of $\frac{1}{4}$ inch and is spaced $\frac{1}{8}$ inch from the work, then more than 80 per cent of the heating effect is located in a strip $\frac{1}{4}$ inch wide.

From the data of the foregoing curves and Table I it can be determined that, since the current penetration is so small, the application of 100 kilowatts per square inch may result in a power concentration *in volume* of 20,000 kilowatts per cubic inch.

This concentration of energy beneath an inductor makes it possible to heat a very localized area on a piece of work. Again, since the depth of current penetration is so small, the heating can also be controlled in depth by varying the frequency, power, and heating time.

However, it should be pointed out again that in order to take advantage of the localization of the induced currents to heat restricted volumes it is necessary that the heating be accomplished in very short times. This, of course, requires high power concentrations. For practical considerations it is not possible, at the present time to apply power in much greater concentrations than about 100 kilowatts per square inch. Hence the heating times must be a few hundredths of a second or more. For example, it has been found that in order to put a uniform, hard case of 20 mils thickness on Society of Automotive Engineers 1050 carbon steel it is necessary to use power concentrations of at least 75 kilowatts per square inch and heating times in the order of 1/10 second.

Aside from the greater precision of heating control offered by the use of high power concentrations there are other marked advantages of this technique. For instance, the more rapid the heating the greater is the volume of production.

Then, in the surface hardening of steels, rapid heating makes possible the self-quenching of the work. For example in the case-hardening job previously described, the high temperatures are confined to a relatively thin

shell, perhaps 50 mils deep. The bulk of the material is thus relatively cool. At the end of the heating period, the heat is therefore rapidly conducted away from the high-temperature region. In many instances the resulting cooling is rapid enough to quench the steel surface. In general, the lower the carbon content of the steel the more rapid must be the heating and quenching cycle to produce full hardness. This in turn means higher power concentrations. When the work is a steel of low carbon content or when the ratio of the heated volume to the unheated volume is larger than about one to ten then a combination of self-quench and water quench may be used to produce fully hardened shells without the use of excessively high powers.

EFFECT OF FREQUENCY ON POWER CONCENTRATION

At first thought one might conclude that since the depth of current penetration decreases with increasing frequency, then the higher the frequency the greater are the power concentrations which are possible. Practical limitations, however, keep such a rule from being generally true. The optimum frequency is determined principally by the size and shape of the work to be heated. In general, the smaller the piece the higher is the frequency which should be used.

When supplying a given high power to a piece of work if the frequency is too low, the necessary currents in the inductor coil are exceedingly large; much power is lost in heat, and the electromagnetic forces may cause distortion of the inductor or may make it difficult to keep the work accurately positioned. Moreover, in extreme cases the efficiency of energy transfer to the work may become very small. For example, suppose the work to be heated is a thin steel strip perhaps 5 mils thick and half an inch wide. Let us say that the inductor coil is several turns of copper tubing wrapped around the strip with as close a spacing as is convenient. Let the frequency be 1 megacycle. It will be found that the strip heats quickly to a dull-red-color temperature and then fails to become any hotter. The temperature is slightly above the Curie point and the efficiency of energy transfer is only a few per cent of what it was when the steel was in the magnetic state.

The reason for this low transfer efficiency can be seen from a simple analysis of the situation. Since the inductor is wrapped around the strip the induced currents in the strip must flow across one face and back in the opposite direction across the other. When the strip is cold the current penetration unit is only about 0.4 mil and therefore approximately 99 per cent of the magnetic energy is absorbed within a depth corresponding to the half thickness of the strip. But on the other hand, when the steel is hot and nonmagnetic the current penetration unit is 24 mils, and in a half thickness of the strip only about 18 per cent of the magnetic flux energy is converted into heat. The other 82 per cent is canceled by the flux which penetrates from the opposite side.

In order to couple energy into the hot strip with high efficiency the current-penetration unit should be equal to or less than one fifth of the total thickness. This means that a frequency of several hundred megacycles is necessary to heat the 5-mil strip in the manner described.

In other cases the frequency may be too high for the size of the work. Again let us take a specific example. Suppose that 100 kilowatts are to be applied to a steel cylinder 4 inches in diameter and that the frequency is, again, 1 megacycle.

The inductive reactance of even a single-turn, 4-inch, inductor coil becomes quite large at this frequency. In fact it will be found that in order to feed 100 kilowatts into the work the voltage across the single loop must be near 1000 volts. For a close spacing between coil and work this voltage is likely to cause arcing, especially when the work is hot. A wider spacing greatly decreases the coupling to the work and results become worse rather than better. The solution to the problem is the use of a lower frequency.

There are many other difficulties encountered with high-frequency effects. In some cases where the work is very small it may be impossible to use as high a frequency as desired because of the difficulty of coupling megacycle energy into the work. At frequencies of several megacycles, electrical energy becomes quite elusive and an "inductor" coil may in reality turn out to be an electrical capacitance.

METHOD OF CONCENTRATING POWER

Aside from increasing the total power input it is possible to increase power concentration in the work by decreasing the area heated simultaneously. This, of course means fewer turns in the inductor coil and at the limit, a single turn.

The most satisfactory arrangement we have found, and a great many were tried, is the use of a current transformer between the oscillating tank circuit and a single-turn inductor loop. The simplest form of transformer consists of a primary of ten or more turns in the form of a solenoid, surrounded by a split copper can which forms a one-turn secondary. The primary winding constitutes the tank inductance and the tank capacitors are connected directly across its terminals.

The single-turn inductor loop is generally of $\frac{3}{16}$ -inch outside-diameter copper tubing. It is made to fit the work with a clearance of about 0.030 inch and is connected to the transformer secondary by leads which are as short and as close together as safe insulating conditions will allow.

With this arrangement there is no difficulty in feeding 100 kilowatts into a steel rod 2 inches in diameter. The width of the current path in the work is between $\frac{1}{8}$ inch and $\frac{3}{16}$ inch so that the total area heated is about one square inch. In order to heat the entire lateral area of the rod it is necessary only to pass the rod through the loop in a continuous manner. Speeds vary depending

upon the heating requirements, but may run from 0.5 inch per second to 3 inches per second, or more.

POWER CONCENTRATIONS IN DIELECTRIC HEATING

For dielectric heating the power concentrations are much lower than in induction heating. However, as a process for getting heat into a piece of work, it is usually possible to apply energy at far higher levels by radio-frequency heating than by any other means. In practically every other method of heating used in industry, the heat is generated in some convenient manner and then conducted or radiated into the work from the source, which of course must be at a higher temperature. Since dielectric materials are all relatively poor heat conductors, whenever an attempt is made to conduct or radiate heat into the work at a high rate the surface is usually overheated. On the other hand in high-frequency dielectric heating the heat is created *within the work itself*. And when the electric field has a uniform distribution and the work is homogenous the heat is created uniformly in all parts. The electrodes, being good electric conductors, are not heated by the electric currents, and therefore are generally cooler than the work. Thus the surfaces of the work are usually kept cooler than the interior. In fact, the conduction of heat from the work to the electrodes is one of the limiting factors in producing high-energy concentrations in the work.

Let us consider an hypothetical slab of material, d centimeters thick and A square centimeters in area. Let us also say that the dielectric constant is k , and that the power factor of the material is ϕ . In order to heat the whole slab as uniformly as possible, it is placed between electrodes which overhang the work as shown in Fig. 6.

The maximum voltage which can be applied in this case is, usually, the breakdown voltage in the air between the edges of the electrodes. Let us call this voltage E .

The power put into the work can then be written as $P = EI\phi = E^2C2\pi f\phi$ where the displacement current is $I = EC2\pi f$. Here C is the electrical capacitance of the work and f is the frequency. The capacitance of the work can be written $C = gkA/4\pi d$ where g is the conversion factor for the system of units used. Also let us express E in terms of the electric field strength F which will cause breakdown in the air. Very approximately therefore we may say $E = F \cdot d$.

Combining these transformations into a single formula the maximum power which can be put into the work is $P = F^2d^2gkA2\pi f\phi/4d\pi$ or $P = gF^2dAfk\phi/2$. The product $k\phi$ is known as the "loss factor" of the material and is listed in tables for most common materials. Above 10 megacycles this loss factor usually varies little with frequency but it generally increases rapidly with temperature. Of course dA is the volume V of work, and F is fairly constant. Combining $F^2/2$ and g into a single constant G , the power per unit volume becomes $P/V = Gf$ (loss factor). When P is in watts, V in cubic inches, f is in megacycles per second, and the loss

factor is in per cent, a reasonable, safe value of G is 200, when the thickness of the load is in the order of 1 inch. Note that the power concentration varies directly with frequency. It would seem therefore that the higher the frequency the greater will be the power concentration. But, again, practical conditions limit this rule. The first of these conditions is the total power necessary. Commercial generators have been built which supply 100 kilowatts at 25 megacycles but as the frequency increases above this value the power capabilities drop rap-

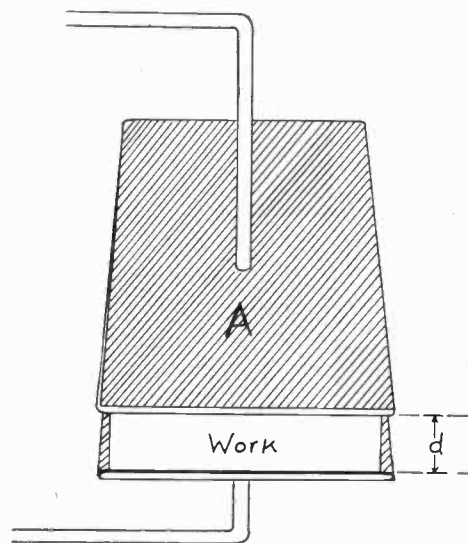

Fig. 6—General arrangement for dielectric heating.

idly. Thus if large power concentrations are to be attained at very high frequencies the volume heated must be quite small.

Another limiting factor in the use of very high frequencies is the electrical capacitance of the load. If the capacitance is large it is impracticable to tune the load.

Therefore it is seen that all is not so simple as the formula would indicate. Other complications are to be found in the derivation of the equation itself. It was derived with the help of some "very approximate" assumptions.

For instance, the breakdown field strength in air varies considerably with atmospheric conditions and the total breakdown voltage is not directly proportional to the distance between the electrodes. This factor changes considerably with wide variation in spacing between the plates and with their finish and shape.

Also as the work heats, the loss factor increases rapidly and this, of course, changes the power concentration and rate of temperature increase. Moreover, the work is never perfectly homogenous so that it is likely to heat more in some places than in others.

The equation can therefore be depended upon for orders of magnitude only and can be used with accuracy only under very restricted conditions.

Thus, although it is possible to attain power concentrations of 1 kilowatt per cubic inch, at 10 megacycles, in thin sections of wood, cardboard, plastics, etc., yet for

practical operations, such as gluing, the power concentrations seldom exceed 10 watts per cubic inch.

If the material is thin the heat may be rapidly carried away by conduction to the electrodes. A recent heating experiment in our laboratory may serve to illustrate the point. It was desired to heat a small sheet of thin plastic material for forming in a press. The electrodes were to be the press platens which were water-cooled. With no heat conduction to the electrodes the power required to heat the piece in the desired time of one second was calculated to be about 17 kilowatts. For convenience it would have been desirable to use a 10-megacycle generator to do the heating. However, it was discovered by substituting known values in the formula developed above, that the maximum power which could be put into the piece, at this frequency, without danger of arcing, was 13.5 kilowatts.

Moreover, since heat loss to the cold electrodes was not taken into account in the first estimate of power required, a more exact calculation was made. It was found that when heat losses were taken into consideration the power required to heat the piece in 1 second was not 17 kilowatts but 72 kilowatts. Moreover, this excessive power requirement could not be reduced by taking a longer heating time because, for times longer than two seconds, the power required remained practically constant at 70 kilowatts.

If it had been desirable to heat the pieces even though the power requirements were so high, then it would have been necessary to use a frequency of 50 megacycles in order to achieve the necessary power concentration in the work.

Therefore it is seen that, because of heat losses in thin materials, radio-frequency heating has little to offer in heating thin samples. There are instances, however, when great convenience or some special effect of radio-frequency makes this method economical. In certain sealing operations such as the "welding" of thin sheets of thermoplastic materials, radio-frequency heating has been found to possess some advantages. In one such sealing operation power concentrations as great as 20 kilowatts per cubic inch were attained. The frequency used was 200 megacycles.

But in general the advantage of radio-frequency dielectric heating lies in heating thick specimens. Suppose it is desired to heat a stack of oak boards for gluing. Let us further assume that the stack is 8 inches thick. A practicable frequency is 10 megacycles and a power concentration of 7 watts per cubic inch will bring the temperature of the entire block up to 300 degrees Fahrenheit in about 5 minutes.

Now compare this operation with the heating which could be accomplished by conduction from hot plates placed above and below the stack. Assume that the plates are at the charring temperature of the wood, about 400 degrees Fahrenheit, and that we apply the heat until the temperature at the center of the stack has risen to the required 300 degrees Fahrenheit. It will be found that the time required is approximately 20 hours instead of 5 minutes and the average power concentration is 0.04 watt per cubic inch instead of the 7 watts per cubic inch as in the radio-frequency heating. For thicker sections the disparity between the power concentrations in the two methods would be greater; for thinner sections, less.

THE POWER GENERATORS

Electronic generators of radio-frequency power are now being marketed by several companies. The frequencies range from about 100 kilocycles to 200 megacycles. But as stated before, as the frequency increases the power output becomes more limited. Typical examples of commercial radio-frequency generators for industrial heating range in power from 200 kilowatts at 100 to 500 kilocycles to 200 watts at 200 megacycles.

It should be pointed out that under the stimulation of war requirements and future industrial needs, rapid development of high-power, ultra-high-frequency generators is now under way. It is certain therefore that within a very short time commercial units of far greater power capabilities will become available.

CONCLUSION

Industry is rapidly making use of radio-frequency power for certain heating applications. But it should be recognized that, since the size and shape of the work restrict the use of radio-frequency in both induction heating and dielectric heating, the number of *ideal* applications are relatively few.

To put it another way, radio-frequency heating is not so much a substitute method as it is a *supplementary* process. That is, although it can be used to heat almost anything yet its particular value lies in a few applications where the unique properties of radio-frequency power can best be utilized. In such applications it is possible to perform heating operations that would be utterly impossible by any other method, or the radio-frequency method may speed up production rates by several hundred per cent, and in other instances may provide great savings in cost, time, and space.

The Standardization of Quartz-Crystal Units*

KARL S. VAN DYKE†, SENIOR MEMBER, I.R.E.

Summary—Quartz-crystal units have been thrust into enormous production before their engineering treatment as circuit elements has become formalized. As a result, crystals are specified in terms of the desired performance of the set which is to use them rather than in terms of their own properties. The intrinsic properties of crystal units form the ideal basis for their specification. When it becomes the practice to use the circuit properties of crystal units, when convenient instruments for measuring the impedance of crystal units at the frequency of oscillation are available, and when the formal treatment of oscillator-circuit design is extended to include crystal-controlled types, there will naturally follow the convenient cataloging of crystal units and their properties in conventional circuit terms, the reduction in the number of crystal types, and standardization of a few types. This will reduce the use of quartz-crystal units in radio circuits to an engineering basis where ordinary circuit-design methods will apply and will make unnecessary the "cut-and-try" procedures which are today's common practice.

INTRODUCTION

IT IS almost a quarter of a century since Cady first used the mechanical-resonance characteristics of pieces of crystalline quartz to establish with great precision the frequencies in the radio spectrum. During this period we have seen great increases in the precision with which frequencies are known and in the convenience of setting up good standards of frequency, and the development of crystal cuts giving low temperature coefficients of frequency. There has come extreme accuracy of frequency control of oscillators through quartz crystals, notably in the crystal clock and broadcast transmitters. The use of crystals has become common in radio communication systems. The number of crystal units which have been made for fixing the channels of the many models of commercial and military systems now run into many millions.

Experience with radio communication networks particularly leaves no room for doubt that the precision control of frequency and the instantaneous and dependable switching to prearranged channels, which crystal control makes possible, give both a flexibility and a reliability to radio communication which speeds up military action and maneuvering and makes possible a new order of co-ordination between co-operating field units.

There has been developed during the days of increasing use of the crystal unit a good understanding of the basic nature of the electrical behavior of the crystal. We have come to represent its electrical behavior in terms of an equivalent network and the elements of the network are commonly measured, at least in the laboratory.

* Decimal classification: R214. Original manuscript received by the Institute, May 22, 1944; revised manuscript received, September 29, 1944. Presented, New York Section, January 13, 1944.

† Office of the Chief Signal Officer, Army Service Forces, Washington, D. C.; professor of physics, on leave of absence, Wesleyan University, Middletown, Connecticut.

Much has been done to finish and mount the crystal unit for greater uniformity of performance and to permit the development of its highest Q 's. The art of orienting the crystals with precision, and of fabricating them in large quantities to close tolerances, has been pretty well mastered.

There are certain phases of the crystal art in which, in the opinion of the writer, progress has been less real. The formal treatment of the crystal unit as a circuit element having conventional electrical-circuit properties has not kept pace with its practical utilization. It appears as if most crystal oscillators were designed by the "cut-and-try" method. A crystal to be used is selected and a circuit laid out, "breadboard" fashion, to work with it. There seems usually to be little attention given to such matters of design as the consideration of the properties of the crystal unit, and of the association of such properties with the elements of the oscillator circuit. If the simple way in which the precise frequency of oscillation depends upon the characteristics of the circuit in which the crystal is placed were more widely appreciated, set designers would find greater freedom in considering alternative designs and circuit modifications. Also manufacturers of sets would pay more attention to the capacitance of the circuit into which the crystal is inserted, with the indirect result that the problem of providing, at long range, replacement crystals for sets would be a much simpler one. In this connection, it is a rather frequent experience to find that the set manufacturer has apparently no record of the capacitance across the crystal in sets which he has made in the past, and this is the one bit of information needed when one is to grind a new crystal to give the specified frequency.

There is room for some ambiguity in the term "the frequency of a crystal." Leaving out of consideration all other modes, and thinking only of the mode of the intended crystal vibration, the electrical response of that mode extends over a complete resonance curve. The crystal frequency might refer to any frequency in the resonance range, for it would probably be possible by a suitable choice of an oscillation circuit, and the use of a condenser or a coil in series with the crystal, to have the crystal control the oscillation or stabilize the frequency of an oscillator at any frequency in this range. In this paper oscillation alone will be considered and in only those common types of circuit in which the crystal operates in parallel with external capacitance between grid and filament, or grid and plate, of the oscillator tube. Crystal frequency will refer to its oscillation frequency in such a circuit.

Under these conditions, the precise frequency of oscillation depends to a considerable degree upon the

constants of the circuit into which the crystal is connected. It is higher than the frequency of series resonance (referring to the equivalent network) but a frequency where neither the quartz plate without electrodes, nor the completed crystal unit, shows any distinctive property whatsoever. The thing that is significant about the properties of the crystal unit is that at this oscillation frequency its reactance equals, though positive, the negative reactance of the external circuit across which it is placed for oscillation. This is, in other words, the condition for parallel resonance of the crystal and associated circuit elements.

By way of a brief review of some of the facts regarding the frequency of crystal oscillation, the two types of crystal-oscillator circuits which are in common use oscillate, as has just been indicated, at the frequency of parallel resonance of the crystal and its associated internal and external circuit capacitances. These common circuits are (1) that in which the crystal is connected between grid and filament of the oscillator tube, and (2) that in which the crystal is in the grid-plate position. These are often called the Miller and the Pierce circuits, respectively. The bridge-type oscillator devised by Meecham, in contrast, uses the crystal as a low-impedance device with the oscillation occurring at, or near, the series resonance of the crystal's motional properties. The difference in frequency between series and parallel resonance in a given crystal may be several hundred cycles per second per megacycle per second if the external capacitance is sufficiently small, or but 20 or 30 cycles per second per megacycle per second for large external capacitances. The parallel resonance frequency is, of course, always the higher and it is this frequency, not the series resonance, which varies with changing circuit constants. The oscillation frequency in the Miller and Pierce types of circuit, being the parallel-resonance frequency, is closer to the series-resonance frequency as the crystal is across larger external capacitances.

The extreme variation of the impedance of a crystal unit over the frequency range between series and parallel resonance probably complicates for the radio engineer the intuitive grasping of the mechanism of crystal operation in the same way that he habitually deals with the more common circuit components. In this range of twenty to a few hundred cycles per second per megacycle per second the impedance may vary many thousandfold. At one frequency the crystal unit is a circuit component which has an impedance of perhaps only 10 ohms; the same crystal unit at another frequency changes to an impedance approaching perhaps 100,000 ohms. In a way, this large change in the impedance of an element within a few cycles per second is almost as unusual a concept for electrical-circuit practice as was that of the large difference between the mutual conductances of vacuum tubes in two directions, direct and reverse, twenty years ago.

One might suppose that the basic experimental and

theoretical work on the electrical properties of crystals would have found earlier application in oscillator-circuit theory. Although the electrical behavior of crystal units has been known for many years, at least in its main form, the specification of the fundamental properties of crystals for oscillator use is not yet the practice. The usual specification of a crystal unit is rather that in association with a stated oscillator or radio set the desired performance of the latter shall be obtained. This is a very practical sort of specification. It is certainly the only one which could be used in the absence of adequate information about, and understanding of, the intrinsic properties of crystals, and also in the absence of formal knowledge of the demands of the oscillator circuit as to properties in its crystal units. Any attempt to procure crystals on the basis of an idealized, simplified, or incomplete conception of their circuit performance would be likely to meet disaster and need not be risked when a safe, practical method of specification is available.

However, in the author's view, the long range course of engineering development will be toward the use of the crystal's own properties in specifications and eventually it will not be necessary to test each crystal unit in the radio set for which it was made. When it has been determined what are the necessary properties of the crystal unit, convenient instruments to measure these will become available, the crystal properties which the radio set needs will be determined, and the crystal will be specified in conventional circuit terms, impedances, or the equivalent.

THREE METHODS OF SPECIFICATION OF CRYSTAL UNITS

The subject of standardizing crystal units may be approached by considering the methods by which their characteristics may be specified. It is proposed to discuss three methods: first, the one just referred to, that by reference to the using circuit; second, a method which is now being tried out, partly in the interest of standardization, where the crystal is referred to a standard test oscillator; and third, the specification of the crystal's properties as such without direct reference to the character of the crystal's performance in an oscillation circuit.

The first method of specification sets up an oscillator circuit in which the oscillation must be satisfactory as to frequency and amplitude when the crystal is inserted, if the crystal is to be considered as meeting the specification. There is little more to the specification than just this practical test. (We shall not here be concerned with such matters as the statement of tolerances of frequency, or the temperature range over which these must be met; nor with the mechanical details regarding form and finish of the plate of quartz, its mounting, and the characteristics of the holder, the pin data, etc. All of these, of course, make up in large part the cost of the finished crystal unit, and without a satisfactory specification of these the unit would not be useful.) Considering only its electrical and radio-frequency performance, the

crystal unit must have just one functional property; namely, in conjunction with the radio set with which it is to be used, an oscillation of the desired frequency in suitable amplitude must be set up and dependably maintained. The most direct specification of the crystal, considering it as a component of that radio set, is that in the radio set it provide the desired oscillation.

The second or alternative method is to require the crystal to operate some standard or reference oscillator. The scale of activity performance in this oscillator can be used to evaluate the crystal's performance in any one of a number of models of radio sets which are capable of being correlated with this standard oscillator. Whereas the first method is direct, and looks toward the manufacture of crystals for use in one single model of set, the second looks toward the manufacture of crystals to operate any set whose characteristics fall within certain ranges. It is a beginning of the standardization of crystal units when this first degree of universality is given to the use of a crystal instead of limiting it to association with a single set.

There are advantages and disadvantages in each of these first two methods of specifying the crystal. The first has a directness of approach and a readiness of application which have kept it in use for a long period. There are sometimes difficulties in furnishing models of the using radio set to the crystal manufacturer for testing his crystals, and production sets are not always suitable as standards in which to test such a product. Accordingly the practice of providing the crystal manufacturer with a "mock-up" or replica of the essential oscillator features of the radio set has grown up. This results in the use in crystal plants of many crystal "test sets," one for testing the crystals of each different model of radio set for which crystals are manufactured. The problem of maintaining these many models of test sets in calibration is an enormous one. The variability of the individual oscillators caused by the vacuum tube, by the changing Q 's of the coils with the weather, and by the shifting of circuit capacitances with slight displacements of the wiring is notorious. Both the frequency and the activity tests of the crystal are subject to considerable uncertainty due to the difficulties of maintenance of correlation between test sets and the using radio set, or even of maintaining a standard calibration of the test circuit alone.

An advantage of the second method of specification lies in its substitution of a single-standard scale of activity values for the many scales inherent in the replica-test-set method; or if not a single scale, at least a few scales. This reduction in the number of scales of activity simplifies the problem for the manufacturer, entirely aside from the avoidance of the physical problem of having a multiplicity of test sets. When confronted with an order for a new unit which he has not made before, familiarity with the relative difficulty of making other crystals whose activities are measured on the same scale provides him with an intuitive sense of the magnitude

of the task of manufacturing the new unit. He receives the new specifications in terms of a scale with which he is familiar instead of having to build a new test set, calibrate it, and become acquainted with its new scale before estimating the difficulties of producing the unit in question.

This second method of specification is by no means foolproof. There are some very definite pitfalls. There is, first, the correlation to be made in the laboratory between the activities developed in the test set and the crystal's operation of its radio set. This correlation must be established for each radio set and dividing points established on the scale of the test set to differentiate the acceptable from the unacceptable crystals for each using set. A higher order of engineering skill is required in the specification of the activity of the crystal unit in terms of the standard test set than in terms of the replica of the using radio set. Also there are the design difficulties of providing a standard test set which it is possible to correlate for both activity and frequency to a number of different radio sets.

Another pitfall is that when any change in the method of specifying an item is considered, it is apt to be found that there have been certain items implicitly involved in the earlier form of specification which may be overlooked. They may perhaps not be implicit also in the new form, nor appear as equivalent tests. In the case of crystals, the principal measured quantities, and the numerics with which the manufacturer is concerned, are frequency and activity. It must not be overlooked, however, that the crystal is also tested for its ability to stand up and not fracture in the replica test sets. This replica uses the same tubes as the radio set and the intensity of the oscillation is provided to be about the same. This means that the crystal experiences during its activity and frequency tests a vibration of about the same amplitude that it will later be called upon to withstand in the radio set. Implicitly then the replica test set provides, but does not specify in numbers, a test for the ability of the crystal to stand up under load, and the manufacturer makes crystals which by not breaking in the testing circuit will also stand up in the radio set. Similar statements hold for the effects of internal heating of the crystal in oscillation. If there were full numerical information regarding the performance of the radio set, then the necessary power-handling capacity or the amplitude of vibration of the crystal, or perhaps its radio-frequency current in operation, would be a matter of record. In the absence of these the test for load is only implicit and requires either the replica test set, or else special attention to load tests in the standard test set.

To sum up the characteristics of the second method of specification of crystal units: specification by test in the standard circuit provides first, that the crystal develop its nominal frequency under certain known and standardized adjustments of the test set; second, that the crystal have a minimum of activity in terms of a

scale which is known and which has meaning in relation to the activity of other crystals; and third, that all crystals of the series so tested shall withstand the driving conditions which are characteristic of that circuit at the frequency and activity which the specification calls for.

In general, crystals which have been thus specified to stand the drive of the standard circuit, and to develop their nominal frequencies of oscillation when connected across a given value of external capacitance in the test set, and which have shown a given minimum activity, are suitable for use in all radio sets for which these conditions are appropriate. Accordingly, selected values of the various parameters, activity, load, and parallel capacitances, might be selected as standard and several lines of crystal units produced to meet such standards.

The suggestion has been made several times that reference to crystal properties, and the design of oscillation circuits, would be much easier if crystal units were cataloged and described on data sheets much as vacuum tubes are so listed. Much progress can be made in this direction. The principal limitation in the usefulness of such data under present conditions lies in the uncertainties of the many test sets involved. The inclusion in the data sheets of the circuit diagrams of the replica test sets would not in itself provide satisfactory information for measuring either the frequency, the activity, or the power-handling capacity of the crystal. Reference to and correlation with the accepted physical test set itself is required.

If, however, a few standard reference test sets were to become accepted, and some organization were to accept the maintenance of the primary standards, it would then become a relatively simple matter for all crystal and radio-set manufacturers to provide themselves with secondary standards. If data sheets for crystal units were to be prepared stating crystal performance in terms of such standards, the data would be unambiguous. Such data sheets would place crystal unit and crystal oscillator design on an entirely new engineering level.

Even these data sheets, however, and the degree of standardization which has been discussed, would still leave the descriptions and specifications of crystal units far behind those which are so useful for vacuum tubes. For with this method of specification the crystal is described in an entirely arbitrary circuit, and in terms of an oscillation condition of that circuit where a vacuum tube is the central feature. All of the vagaries of tube performance, the nonlinearity of the tube's characteristics, the grid biases which build up, and the effect on the latter of the changing circuit constants are all involved in the specification. This specification is as much a description of the tube and the circuit as it is of the crystal. It does not offer the ideal characterization of the crystal units.

The crystal is an item in itself; it has properties entirely its own which are completely measurable. These are relatively simple, far simpler and easier to specify adequately than those of the oscillator circuit; this is true despite the enormous range of impedance variation in the vicinity of the oscillation frequency and other disturbing factors which arise from the mechanical complexity of the vibration of the quartz plate.

The third method of specification of crystal units which has been suggested, namely, to specify the crystal's own measurable properties, would remove the necessity for setting up and maintaining primary and secondary standards of oscillation circuits for reference of crystal performance. A catalog of crystal properties in terms of impedance or the equivalent would soon, it is believed, bring about also as a natural result a large degree of classification and standardization.

Just as the reference of crystal performance to a standard oscillation circuit instead of to a replica of the using radio set requires the use of greater engineering skill in designing and correlating the standard, so the use of the crystal's measured properties to predict the crystal's performance in an oscillator calls for a still higher level of engineering attainment. A more complete specification of the characteristics of the using oscillator circuit itself would be required, and there is the highly specialized problem of correlating the crystal properties with oscillation in the several forms of oscillator circuit. As is true generally of engineering, in the progress of the art there is more and more reliance on the tests and measurements made in the design and testing laboratories. An engineered crystal unit would be largely determined in the laboratory, including the details of dimensions and performance. This is in contrast to the present practice where in many cases the crystal plate is designed, or perhaps in this case the word is "fitted," or "hand-tailored," by the finishing operator who adjusts its dimensions so that it passes the direct test of replica-oscillator performance.

The emphasis upon the possession by the crystal unit of intrinsic properties which are suitable for use in its definition makes it desirable that some of the quantities which might be selected for its specification be indicated. It is not the intent of this discussion to consider the nature or the validity of particular indices. The point to be made is rather that there are properties which are simple enough to measure and to use, and that engineering progress will have been made when crystals are specified for such properties of their own.

One method of looking at the crystal unit is to consider it in terms of its equivalent circuit. Although there is some degree of simplification in the usual equivalent circuit of parallel motional and dielectric admittances, it is believed to be near enough to the facts to be the basis of tests and measurements. This common network, it will be recalled, consists of two parallel branches. The admittance of one is merely that of the dielectric

properties of the quartz and its holder, a simple quartz condenser with necessary power factor to include the losses in the holder. The other branch includes all of the motional properties of the plate, its electrical admittance depending upon the mechanical and piezoelectric properties of the quartz. This motional admittance is usually shown as a series arrangement of inductance, capacitance, and resistance. The values of these quantities are proportional respectively to the mechanical inertance, elastic compliance and dissipative resistance which characterize the vibration, the first and third being also inversely, the second directly, proportional to the square of the effective piezoelectric constant.

One possible method of procedure would be to measure each of the four or five parameters of the equivalent circuit and to specify that crystals be made to have those parameters within appropriate tolerances. While convenient for circuit representation, these parameters are not as convenient for direct measurement as the impedances which they represent at the oscillation frequency. It is believed that I. E. Fair of the Bell Telephone Laboratories will, in a forthcoming paper, discuss crystal performance indexes which involve such measured impedances. One possible index, and it is the one understood to be favored by Fair, is the maximum impedance which the crystal resonator and its associated parallel capacitances, including the circuit capacitance, develop at the parallel resonance frequency of this combination. Another indicator is the range through which the impedance swings from resonance to anti-resonance. Both of these indexes are measurable and they provide roughly the same sort of indicator of the effectiveness of a crystal when associated with the vacuum tube as does the so-called "activity" which is commonly used in crystal specifications.

These indicators, however, are measures of the properties of the crystal and the associated condensers with which it is to be used. A principal difficulty with the common index, "Activity," in addition to its arbitrary character and its changing value from circuit to circuit, is that the scale of activities on most test sets is likely not to be linear in terms of the intrinsic properties of the crystal. The scales of the indicators which specify only intrinsic properties of the crystal are at least as nearly linear as are the properties of the crystal unit.

A LONG-RANGE VIEW OF STANDARDIZATION

The conclusion of this academic discussion of the lines along which the development of one phase of the art of specifying crystal performance might well progress, will be still more academic in the suggestion of a rather ideal result of standardization. The practical problem of standardization is complicated, as is necessarily the case, by the existence of current designs and stocks of radio sets and crystals. These stocks might weigh heavily in any concrete standardization program, as would also uncertainties concerning the rela-

tive magnitude of crystal utilization in peace after war and of large stocks of wartime crystals and radio sets.

Predicated upon the basic simplicity of the properties which a crystal unit has to offer, it should be possible to plan in the ideal case for a few standard lines or series of crystal units in the 1- to 10-megacycle-per-second range for radio communication use. In each series the entire gamut of frequencies might be available for manufacture, but the characteristics of the series would be certain standardized values in the scale of activity or other index of oscillation control, of current-carrying capacity or load factor, of circuit capacitance for which the series is intended, of tolerances as to frequency adjustment and frequency deviation over the intended temperature range, and finally of the temperature range of intended use of the crystals of the series. It would seem that not more than six or eight such series of crystals (six or eight different specifications in all for the field where now very many more apply) could be defended in any standardization plan which did not have to accommodate the existing plant and stock, and that the resulting array of crystal units would give as much flexibility as radio-set design would find useful.

The number of standardized values of any one variable which it is justifiable to introduce into a planned set of designs depends upon the relative difficulty of producing crystals to the next higher value on the scale. Thus it might be justified to double the crystal activity from one series to the next, while differences of 10 per cent in activity would not justify a new series. It is particularly because of the absence of a universally applicable scale of crystal activity that insignificant differences in this parameter today commonly exist between different specifications. Similarly, frequency tolerances of ± 0.02 per cent over the temperature range are today common in many specifications. Perhaps other series with ± 0.015 per cent are justified; ± 0.01 per cent certainly, ± 0.019 per cent certainly not.

Crystal units are made in a wide range of models of holder, and with an amazing permutation of the diameters, length, and spacing of pins. It is possible that standardization of these items would quickly follow agreement concerning the requirements in electrical performance, and the establishment of standard values on accepted scales for these. The miscellany of external forms of crystal units may but reflect the belief that a particular crystal has to be made for a particular set; if nothing else will do electrically, the magic of peculiar electrical performance is easily extended to peculiarities of holder and pins as well.

In closing, it is desired to emphasize one aspect of a standardization program. And the emphasis given is predicated on the permanence of the crystal unit and the establishment of a degree of stability of crystal design which exceeds the permanence and stability of set design. The simplicity of the crystal's function and performance suggests that in the long run particular

models of radio sets may become obsolete more rapidly than the crystals which they use. If, as appears likely, the crystal unit may have a useful life long beyond that of the using set, the adaptability of the stock of any such crystal to another set after its own shall have been outmoded deserves consideration. With crystals specified in terms of the using set, or its replica, the peculiarities of that set are so involved in the specification that a special investigation is required to determine whether a new model or another radio set can use those crystals unless its oscillator circuit is identical with that of the outmoded model. This is a severe limitation upon the progress of set design.

In contrast, a group of crystals built to have certain intrinsic properties is available for use by anyone who has the information on their properties, for the adaptation of any oscillation circuit to use crystals of known properties is a straightforward engineering procedure.

The present discussion of the evolution of standard crystal units, and of the possible development of methods of specification, does not in any sense indicate the program of the Signal Corps, nor that such changes in the methods of specification are contemplated. The discussion must be taken rather as indicating something of the train of thought of an individual who is fundamentally interested in the performance of quartz crystals in radio. It may be confessed that it has come as something of a shock to learn how far the art is from the practical utilization of the known circuit properties of the crystal, to wake up to the fact that such circuit properties have not yet come out of the academic and into engineering utilization, and at the same time to appreciate the very real difficulty in their use which has forced the continued dependence upon the method of electrically fitting each crystal directly into the place where it is to be used.

Graphical Methods for Analysis of Velocity-Modulation Bunching*

ARTHUR E. HARRISON†, ASSOCIATE, I.R.E.

Summary—A review of the theory of velocity-modulation tubes is used as an introduction to a number of graphical representations of electron bunching. These methods are applied to single-resonator tubes as well as multiple-resonator designs. The curves are used to illustrate a method of obtaining the efficiency and the effective phase angle of the bunched electron beam from a simple graphical integration. These methods are not new, and correspond to the equations which have been used in the past to represent electron bunching, but the graphical representation offers a convenient method of using these equations.

VELOCITY-modulation tubes have aroused great popular interest because they are a comparatively new development which extends the useful frequency range of vacuum tubes tremendously. The existence of a simple physical explanation of the operating principle (electron bunching) has helped to maintain this interest. However, most of the published material on these tubes has been either purely descriptive or quite mathematical. It is possible to extend the simple physical explanation to include most of the more complicated characteristics of velocity-modulation tubes. This is easily accomplished by graphical methods which have the added advantage that they are not limited by assumptions which are not satisfied by the operating conditions in practical tubes. It is true that this graphical analysis does not produce results which cannot be obtained by other methods, but the results are easy to present and understand and in some cases easier to obtain.

* Decimal classification: R139. Original manuscript received by the Institute, August 2, 1944; revised manuscript received, October 27, 1944.

† Sperry Research Laboratories, Garden City, Long Island, N. Y.

A comparison of velocity-modulation tubes with the more familiar vacuum tubes will serve as an introduction to the newer types and a review of their basic principles. A triode functions by modulating the amplitude of the electron current between the cathode and anode or plate. Ordinarily the modulation frequency is so low that the electron transit time between cathode and plate is a small fraction of a cycle, although the average electron velocity may be quite small because the electrons begin this transit with negligible velocity. A number of difficulties appear as the frequency is increased. Tube dimensions must be decreased to maintain small transit times. Electrode and lead capacitances represent a larger part of the oscillating circuit and the losses in lumped-constant circuits become intolerable.

In contrast, the electron beam in a klystron or similar velocity-modulation tube is accelerated to a high uniform velocity before it is acted upon by the radio-frequency voltage. (See Fig. 1.) The transit time in the radio-frequency field can be a small fraction of a cycle even at super-high frequencies. The small changes in velocity introduced by the buncher resonator permit the electrons which left later in the cycle, with higher than average velocity, to overtake the electrons which were slowed down by the buncher field but passed the buncher grids earlier in the cycle. As a result, the beam is converted from a uniform current to a bunched or pulsating current. This action takes place in the "drift space" which is free of any radio-frequency field and may be completely field free. The bunched beam current

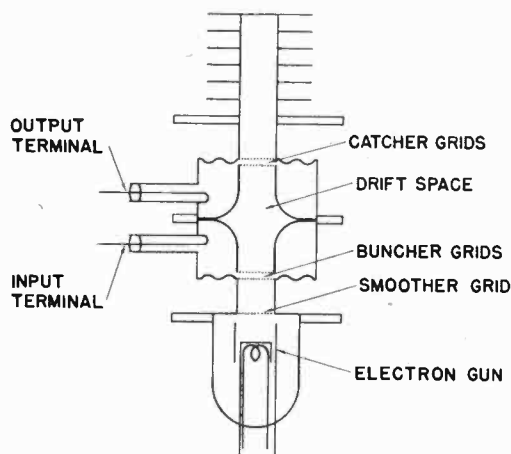

Fig. 1—Sectional view of a klystron amplifier.

is converted into radio-frequency energy at the catcher resonator. The transit time is again quite small in the region where the beam is acted upon by a radio-frequency field. The excess energy in the beam is dissipated in a suitable electron trap beyond the catcher resonator.

APPLEGATE DIAGRAMS ILLUSTRATE ELECTRON BUNCHING

These relations can be visualized readily with the aid of an Applegate diagram which is shown in Fig. 2. This type of representation was proposed by Applegate^{1,2} in order to describe electron-bunching phenomena. A similar space-time diagram has been used by Brüche and Recknagel,³ and Tombs⁴ has suggested a different graphical analysis. In an Applegate diagram, time is measured along the horizontal axis, and the position of electrons along the drift space is plotted as the vertical co-ordinate. The lines represent electrons passing the buncher at uniform time intervals. The slope of a line is the distance divided by time; i.e., the slope of a line represents the velocity of a particular electron. The electron velocities are identical and equal to the average electron velocity until the electrons reach the position of the buncher. The transit time between the buncher grids has been assumed negligible in all of the diagrams in order to simplify their construction. As a result, the electron velocities are again constant after passing the position of the buncher, but the velocities are no longer the same for the different electrons and the slopes of the lines have been modified in accordance with the expression

$$v = v_0 + v_1 \sin \omega_1 t \quad (1)$$

where v is the velocity of a particular electron passing the buncher at time t , v_0 is the average electron velocity

corresponding to the acceleration voltage of the electron gun, v_1 is the peak amplitude of the velocity modulation, and ω_1 is the angular frequency of the oscillation in the buncher resonator.

It should be pointed out that this analysis neglects space-charge effects in the electron beam, and assumes that the transit time between the resonator grids is negligible.

As a result of the velocity modulation and the transit time in the drift distance, the faster electrons overtake the slower electrons and produce electron bunching. An approximation for the current distribution at any point along the drift distance at any time may be obtained by inspection of the diagram, since the distance along the time axis between successive lines is inversely proportional to the instantaneous current in the beam. It is apparent that the electron density is uniform and the beam is direct current at the position of the buncher, but an alternating component of current is superimposed on the direct current as bunching progresses.

Maximum radio-frequency energy will be transferred to the catcher resonator if the catcher grids are placed at the position shown in Fig. 2. It is not necessary to vary the position of the catcher resonator along the drift distance; the correct bunching for maximum energy transfer may also be obtained by varying the amount of velocity modulation, i.e., the buncher voltage, or by changing the average electron velocity. Electrons in the bunches are decelerated by the catcher field and leave the catcher at very low velocities corresponding to almost horizontal slopes. Electrons passing the catcher grids during the other half of the cycle are accelerated and absorb energy from the radio-frequency field. However, very few electrons absorb energy due to the concentration of the electrons into bunches. Considerably greater power is transferred by the electrons in the bunch than is absorbed by the few electrons which become speeded up by the catcher field, and the net result is the conversion of direct-current beam power into radio-frequency power.

This simplified physical picture agrees with the popular conception of electron bunching as a symmetrical distribution of current as a function of time. The general acceptance of this form of current distribution is a natural interpretation of the analysis of Webster⁵ and others, which is based upon a small velocity modulation and sufficient drift time to permit bunching to occur. Under these conditions the current distribution is a symmetrical function of time. These conditions are satisfied if the drift time is an interval corresponding to 10 or more cycles. Drift times of this magnitude are obtained occasionally in tubes using low acceleration voltages; however, the usual conditions of operation correspond to drift times which are very much shorter.

Reference to Figs. 2 and 3 indicates that bunching

¹ L. M. Applegate prepared the specification in U. S. Patent No. 2,269,456. See footnote 2.

² W. W. Hansen and R. H. Varian, Electron Beam Oscillator, U. S. Patent No. 2,269,456 issued January 13, 1942; filed January 22, 1938.

³ E. Brüche and A. Recknagel, "Phase focusing of electrons in rapidly fluctuating electric fields," *Zeit. für Phys.*, vol. 108, pp. 459-482; March, 1938.

⁴ D. M. Tombs, "Velocity modulated beams—The electron density distribution," *Wireless Eng.*, vol. 17, pp. 54-60; February, 1940.

⁵ D. L. Webster, "Cathode ray bunching," *Jour. Appl. Phys.*, vol. 10, pp. 501-508; July, 1939.

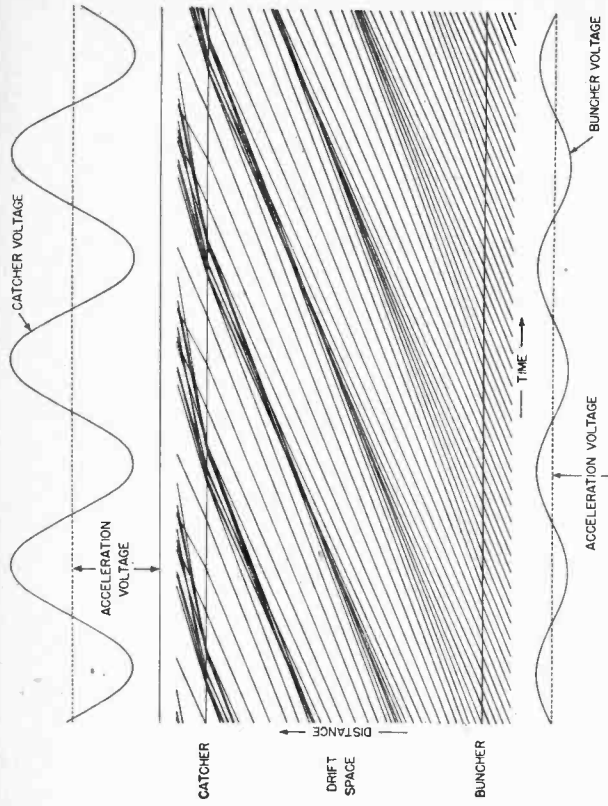

Fig. 3—Applegate diagram showing distortion of current distribution which occurs when drift time is 3.25 cycles and buncher voltage is sinusoidal.

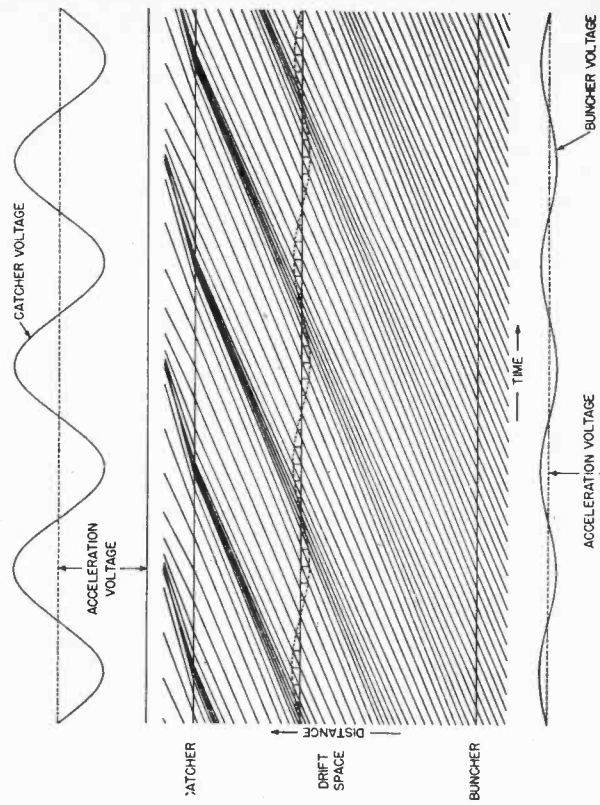

Fig. 6—Applegate diagram for an underbunched klystron amplifier. Bunching parameter is equal to 0.92.

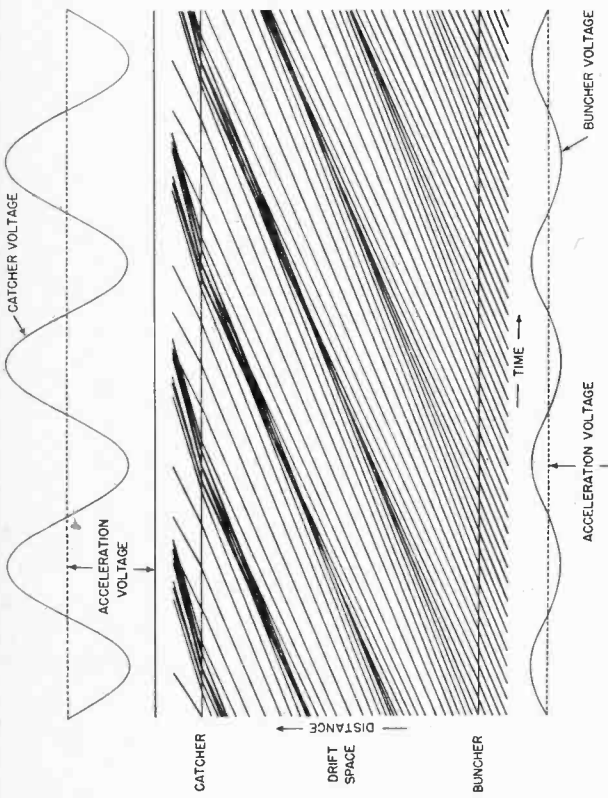

Fig. 2—Applegate diagram with nonsinusoidal buncher voltage giving symmetrical current distribution.

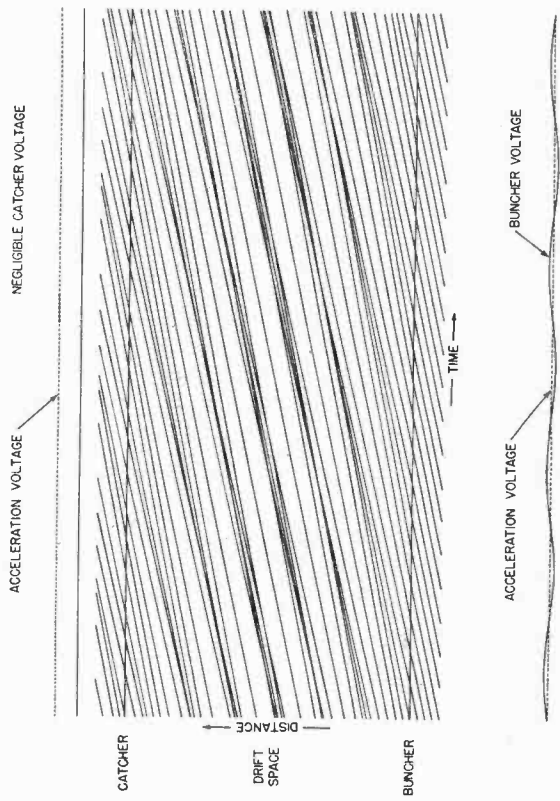

Fig. 5—Applegate diagram for an overbunched klystron amplifier. Bunching parameter is equal to 3.64.

in these diagrams occurs during an interval of $3\frac{1}{4}$ cycles. This number of cycles has been chosen arbitrarily to correspond to one of the modes of operation of a double-resonator oscillator with zero phase shift in the feedback line. The same drift time may also be used to explain the operation of an amplifier, although any drift time is permissible in an amplifier. Fig. 3 corresponds to the actual conditions of current distribution when the velocity modulation is produced by a sinusoidal buncher voltage, while the velocity modulation in Fig. 2 has been modified to produce a symmetrical current distribution with respect to time. The importance of representing actual conditions is indicated by a comparison of these two figures. The contrast would be even more pronounced if the amplitude of the velocity modulation had been greater. There has been some tendency to exaggerate the velocity modulation in most Applegate diagrams which have been published in the past. This produces a diagram which shows bunching occurring in an extremely short interval and it has been a rather general practice to deviate from the actual velocity-modulation conditions in order to conform to the popular conception of electron bunching with symmetrical current distribution.

As a result of the nonsymmetrical distribution of the bunched current at the catcher, the electron which left the buncher when the buncher field was zero and changing from deceleration to acceleration is not the center of the bunch. Inspection of Fig. 3 will verify this fact, and also shows a slight phase shift in the catcher voltage in comparison to Fig. 2. Only a slight modification in the buncher voltage is required to make the diagram appear symmetrical; this modification is hardly apparent in Fig. 2 and close inspection is required to observe that the curve for the buncher voltage is not sinusoidal but that the amplitude of the negative portion of the curve is less than the positive portion.

There are two reasons for the unsymmetrical current distribution when the drift time is short. A large ratio of buncher voltage to acceleration voltage is required to obtain bunching in a short time; as a result, the velocity distribution is not sinusoidal and the electrons which are decelerated are slowed down more than the electrons which are accelerated are speeded up. In addition, the slowest and fastest electrons cannot be considered as traveling with the average velocity when the velocity variations are large. This factor causes the slower electrons to be comparatively overbunched while the faster electrons are somewhat underbunched. The nonsinusoidal velocity distribution and the distortion due to large variations of velocity produce an additive effect on the current distribution in the bunch.

It will be convenient to refer to the number of cycles during bunching by the designation N , since the term recurs quite frequently in a discussion of velocity modulation. Certain other terms will also be used and a list of the terminology is given below. The notation

which is used is essentially the same as that appearing in the Klystron Technical Manual.⁶

N = number of cycles occurring during transit from buncher to catcher

f_1 = buncher frequency

$\omega_1 = 2\pi f_1$

t_1 = time an electron passes the buncher grids (departure time)

t_2 = time an electron passes the catcher grids (arrival time)

τ_0 = average value of transit angle in the drift space

I_0 = average value of beam current

E_0 = acceleration voltage (voltage between cathode and anode)

E_1 = buncher voltage (peak radio-frequency voltage at buncher grids)

I_2 = instantaneous beam current at the catcher grids

E_2 = catcher voltage (peak radio-frequency voltage at catcher grids)

ϕ = phase angle between catcher voltage and electron with average transit angle τ_0

i_2 = catcher current (radio-frequency component of the bunched beam current)

s = drift distance between buncher and catcher resonators

v = electron velocity

v_0 = average velocity of electrons corresponding to voltage E_0

v_1 = peak amplitude of the velocity modulation at the buncher

x = bunching parameter defined in equations which follow

e = charge of an electron

m = mass of an electron

The significance of N should be emphasized. The value of N represents the number of cycles which occur during transit of an electron with average velocity through the drift space. N may have any value in a klystron amplifier, but N is restricted to certain values which satisfy the proper phase relations if the klystron tube is used as an oscillator. The value of N should not be confused with the number of times the electrons may become bunched in the drift space. In an overbunched amplifier, the bunch may form, then separate and reform again farther along the drift tube. Oscillators do not become overbunched, and the electrons are formed into a bunch only once, although a number of bunches may be in the process of formation at the same time if transit of the drift space requires more than one cycle. Reference to an Applegate diagram will show that N also corresponds to the number of bunches in the process of formation at any instant in time.

The relations between the various factors in an analysis of velocity modulation will not be derived, but certain important results will be reviewed. One of the

⁶ A. E. Harrison, "Klystron Technical Manual," Sperry Gyro-scope Company, Inc., Brooklyn 1, New York, 1944.

most important relations expresses the output of a velocity-modulation tube as a function of the degree of bunching. If the magnitude of the catcher current, i.e., the radio-frequency component of the bunched beam current, is chosen to represent the output, the dependence is given by

$$i_2 = 2I_0J_1(x). \quad (2)$$

Fig. 4 shows the catcher current as a function of x .

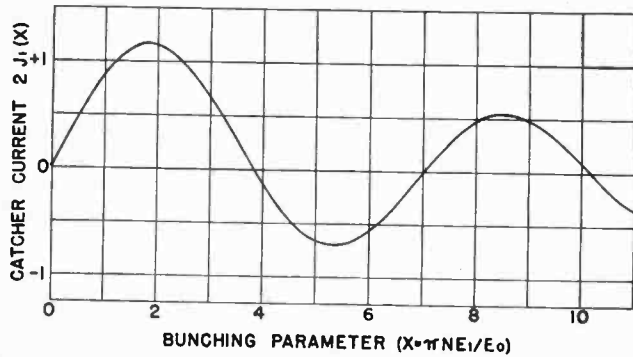

Fig. 4—Catcher current, or radio-frequency component of bunched beam current, for a klystron amplifier.

This relation is based on the assumption that E_1/E_0 is very small but that adequate time is available for any degree of bunching to occur.

The quantity x is known as the bunching parameter. It should be pointed out that the approximations which are used in the derivation of the bunching parameter are not valid if the ratio of buncher voltage to acceleration voltage is high. However, the values determined from the equations are quite useful in a discussion of bunching regardless of the validity of the approximations. Several expressions for the bunching parameters are given below.

$$x = (\omega_1 s / 2\sqrt{2e/m})(E_1/E_0)^{3/2}. \quad (3)$$

Substitution of the expression for the electron velocity in (3) gives

$$x = (\pi f_1 s / v_0)(E_1/E_0). \quad (4)$$

Since the number of cycles during transit of the drift distance s is given by

$$N = f_1 s / V_0, \quad (5)$$

Equation (4) may be rewritten in the form:

$$x = \pi N(E_1/E_0). \quad (6)$$

Changing one or more of the design factors in an Applegate diagram illustrates the effect of changing the variables in these equations. Fig. 5 has been prepared with the same ratio of buncher voltage to acceleration voltage as shown in Fig. 3; however, the average velocity of the electrons has been reduced. These changes correspond to reducing the buncher voltage and the acceleration voltage in the same ratio. The beam is now overbunched at the drift distance corresponding to the position of the catcher in Fig. 3, since the decreased velocity gives a larger value of N for this drift distance and the value of x given by (6) is increased. This over-

bunching gives negligible output at the catcher. Optimum bunching occurs at a shorter drift distance; inspection of Fig. 5 will show that the bunching corresponding to the total drift distance in Fig. 3 now occurs at a shorter drift distance although the number of cycles during transit of this shorter distance is unchanged. ($N=3\frac{1}{4}$ cycles.) This correlation between (6) and the Applegate diagram would be expected.

Fig. 6 shows a diagram in which the average velocity is the same as used in Fig. 3 but the buncher voltage has been reduced. This corresponds to operation with the same acceleration voltage but with the tube underdriven, i.e., the buncher voltage does not bunch the electron beam completely. Note that the electron distribution is almost symmetrical.

CONSTRUCTION OF AN APPLGATE DIAGRAM

A simple method for constructing an Applegate diagram to fit particular operating conditions is also illustrated by Fig. 6. The lines corresponding to the electrons with average velocity are drawn first; these lines start at the times when the buncher voltage is zero (twice in each cycle). They are drawn with any convenient slope if the electron velocity and the distance co-ordinate are arbitrary; however, the slope would be determined by the number of cycles during transit of the drift distance if the average electron velocity is chosen to represent some actual operating conditions. A line is drawn to correspond to the average velocity. The choice of scale is unimportant. The instantaneous velocity is then plotted from the relation.

$$v = v_0(1 + (E_1/E_0) \sin \omega_1 t)^{1/2}. \quad (7)$$

Since the scale is purely arbitrary, only the term in the radical needs to be considered. If E_1/E_0 is less than 0.06, corresponding approximately to $N=10$ cycles, the relation

$$(1 + (E_1/E_0) \sin \omega_1 t)^{1/2} \cong 1 + (E_1/2E_0) \sin \omega_1 t \quad (8)$$

may be used. The exact relation should be used if E_1/E_0 is greater than 0.06, although the use of the approximation may be satisfactory in most cases for much larger ratios of buncher voltage to acceleration voltage if the diagram is to be used merely as an illustration of electron bunching. This approximation has been used in Fig. 6.

The curve for the velocity modulation is not directly above the buncher-voltage curve but must be shifted along the time axis until the zero points coincide with the lines drawn with the average slope. The number of lines to be used per cycle will depend upon the detail to be shown. Twelve lines per cycle as used in the figures in this paper is probably the minimum number for a reasonable representation of bunching; more lines per cycle give a better picture of electron bunching but complicate the construction of the diagram. The same number of time intervals are marked off on the velocity modulation curve, and the lines are drawn from the equal spaces along the time axis at the position of the

buncher through the time intercepts on the velocity modulation curve. The slopes of the lines are therefore proportional to the electron velocities.

As pointed out in the discussion of Fig. 5, changing the average slope of the lines without changing the percentage of velocity modulation causes the bunching to occur after the same number of cycles, but at a different drift distance. This fact can be verified from geometrical considerations of the method of construction described above.

APPLEGATE DIAGRAMS FOR REFLEX KLYSTRONS

Space-time diagrams are not limited in usefulness to an explanation of bunching in a double-resonator type of velocity-modulation tube. Such a diagram has been used² to explain the operation of a Monotron and similar diagrams can be constructed to illustrate the principles of reflex klystron oscillators.

The electron beam in a reflex oscillator is velocity-modulated as it passes the grids of a cavity resonator; then the beam enters a decelerating electric field and is reflected back through the same pair of resonator grids. The velocity-modulated beam becomes bunched during the time it is in the reflecting space and then gives up part of its energy to maintain the electromagnetic field in the resonator. A single resonator serves as buncher and catcher. This type of oscillator is easy to operate because it is not necessary to tune two high- Q circuits to the same frequency, therefore these tubes are ideal as local oscillators in superheterodyne receivers or in other applications requiring a variable-frequency source.

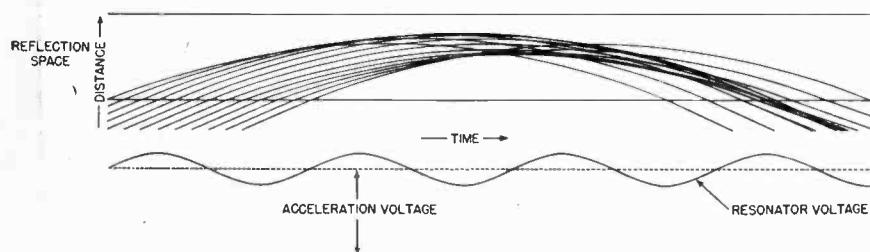

Fig. 7—Applegate diagram for a reflex klystron oscillator.

Reflex oscillators have an electrode, known as the reflector, which is normally at a potential more negative than the cathode and furnishes the reflecting field which returns the electron beam through the resonator. This field will be assumed to have no radial component in order to simplify the pattern of the electrons on the Applegate diagram. In addition, space-charge effects will be neglected. The electron paths can then be represented by different portions of a single parabola, since the velocity modulation will change only the initial slope of the parabola. This behavior is identical to that of an object acted upon by a gravitational field. The transit time in the reflecting space is directly proportional to the initial velocity; therefore, the bunched current distribution is symmetrical if the velocity vari-

ation is sinusoidal, regardless of the magnitude of the variation. However, a large ratio of resonator voltage to acceleration voltage will produce an unsymmetrical bunch since the velocity variation under those conditions is not sinusoidal.

An Applegate diagram for a reflex oscillator, based on these assumptions, is shown in Fig. 7. Several important differences between bunching in a reflecting field and bunching in a field-free drift space are immediately apparent. The faster electrons start later in the cycle and overtake the slower electrons in a field-free drift space, and the bunch centers about the electron which passed the buncher grids when the field was zero and changing from deceleration to acceleration. In a reflex tube, the faster electrons travel farther and return to the resonator grids at the same time as the slower electrons which left later. This means that the electron which becomes the center of the bunch passes the buncher grids when the field is zero and changing from acceleration to deceleration; i.e., there is a phase difference of 180 degrees between the two kinds of bunching.

A field which will accelerate the electrons on their first transit past the resonator grids will decelerate the returning bunch and absorb energy from the beam. Reference to Fig. 7 will show that the transit time in the reflection space for an electron with average velocity must correspond to $(n - \frac{1}{4})$ cycles, where n is an integer, if the bunched beam is to deliver a maximum amount

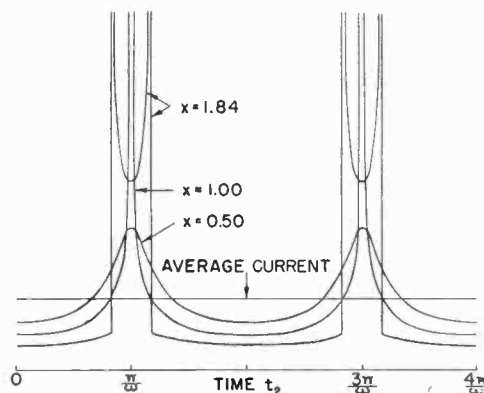

Fig. 8—Current distribution for the first peak in bunching. Two complete cycles are shown. The time corresponding to one cycle is $2\pi/\omega$. Three values of bunching parameter x are indicated.

of radio-frequency energy to the resonator. A double-resonator oscillator is not limited by the relation that the buncher field is in phase with the catcher field, and two families of modes may be observed corresponding to transit times of $(n \pm \frac{1}{4})$ cycles. The latter statement is based upon the fact that two tightly coupled resonant circuits may oscillate either in phase or 180 degrees out of phase.

Note also that the current distribution in the reflected bunch is similar to that in the field-free case, but that the manner in which the electrons reach this distribution is decidedly different. In the field-free case,

an infinite current peak exists before the bunched beam reaches the catcher grids. The electrons then pass each other; i.e., there is a "crossover" of electrons traveling along the beam. The infinite current peak separates and a large but finite current exists between two diverging infinite current peaks. This current distribution is illustrated in Fig. 8. A similar current distribution occurs in a reflex tube, but there is no single infinite current peak formed prior to the double infinite current peak.

It is possible to use a simple method for constructing a reflex Applegate diagram, and this method will be derived from the analogy to an object in a gravitational field. This analogy indicates that the expression for the position of an electron as a function of time will be of the form

$$s = v(t - t_1) - a(t - t_1)^2, \quad (9)$$

where a is a constant determined by the design of the tube, v is the velocity (after the electron has passed the resonator grids) of an electron passing the resonator grids at time t_1 . The velocity v has the value defined by (7). However, it will be convenient to consider a special case in which $t_1 = 12$ (the number of lines in the Applegate diagram), corresponds to 2π radians, and rewrite (7) in the form

$$v = v_0(1 + (E_1/E_0) \sin(2\pi/12)t_1)^{1/2}. \quad (7a)$$

The arrival time at the grids on the return trip will be given by substituting $s = 0$ in (9).

$$t_2 = t_1 + v/a. \quad (10)$$

If the bunching time corresponds to $2\frac{3}{4}$ cycles, a may be evaluated by substituting $t_2 - t_1 = 33$ in (10). A table of t_2 versus t_1 can then be computed from (7a) and (10). A parabolic template is plotted from values of s and t in (9) with $t_1 = 0$. The template should extend from $t = -2$ to $t = 35$ in order to include the paths of electrons which have been given a greater than average velocity by the buncher. This template is then used to connect corresponding t_1 and t_2 values which should be plotted along the horizontal axis of the Applegate diagram. The base of the template must always be parallel to the horizontal axis of the diagram when the electron path is transferred from the template, to insure that the path is plotted correctly with identical velocities when the electron leaves and returns to the resonator grids.

Field-free bunching and reflection bunching may oc-

cur in the same tube; since the two effects are out of phase, the resultant bunching is decreased if the velocity modulation remains the same. This effect is shown in Fig. 9, which shows the bunching in a tube with a field-free drift space between the resonator and the reflecting field. The velocity modulation has been maintained equal to that in Fig. 7 and the electron beam is underbunched due to the effect of the field-free drift distance.

The equation for the bunching parameter can be modified to include the combination of field-free and reflection bunching. Equation (6) is then written

$$x = \pi N_r(E_1/E_0) - \pi N_{ff}(E_1/E_0), \quad (11)$$

where N_{ff} is the number of cycles during both trips in the field-free drift space and N_r is the number of cycles during the round trip in the reflecting field. Since N_r is usually greater than N_{ff} we can write

$$N' = N_r - N_{ff} \quad (12)$$

and (11) becomes

$$x = \pi N'(E_1/E_0). \quad (13)$$

The phase of the returning electrons depends upon the total transit time N_t , and for maximum output

$$N_t = N_r - \frac{1}{2} N_{ff} = n - 1/4, \quad (14)$$

where n is an integer.

It is apparent from these relations that the beam must be considerably overbunched in the reflection space if proper bunching is to be obtained when the two types of bunching are combined in the same tube.

BEAM CURRENT DISTRIBUTION

Applegate diagrams are very useful as a picture of electron bunching but do not give a quantitative analysis of velocity modulation. Other methods are available which give the current distribution in the bunched beam. Webster⁵ has described one method of obtaining the current curves from a family of cycloids with a rolling circle of unit radius and a generating circle with a radius equal to x , the bunching parameter defined by (3), (4), and (6). The bunched beam current is proportional to the reciprocal of the value obtained from the cycloid curve when it is single-valued, and the sum of the reciprocals of the absolute magnitude of the values from the cycloid. The basis for neglecting the

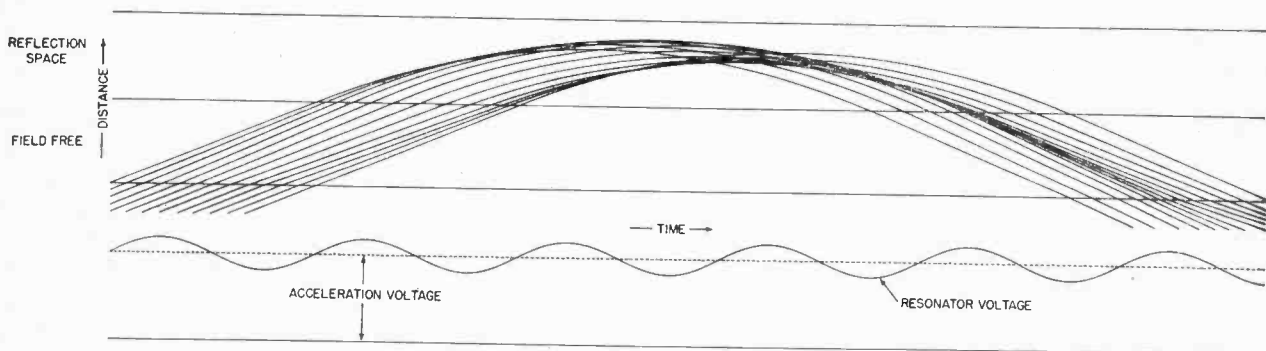

Fig. 9—Applegate diagram showing reflection bunching plus field-free bunching.

negative sign is explained in the discussion of the t_1 -versus- t_2 curves in Fig. 10. This point has also been explained by Webster⁷ in a letter to the Editor of the *Journal of Applied Physics*.

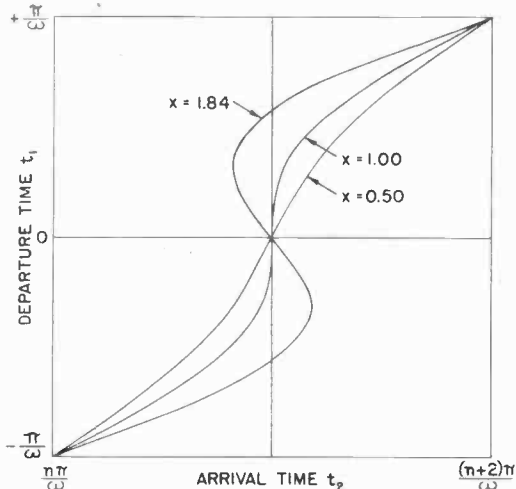

Fig. 10—Electron-arrival-time curves for underbunching and optimum bunching. One complete cycle corresponds to a time interval of $2\pi/\omega$. The average transit time is $(n+1)\pi/\omega$, where n is a large number, not necessarily an integer.

A series of cycloids representing six different values of the bunching parameter are shown in Fig. 11, and corresponding current distribution curves computed

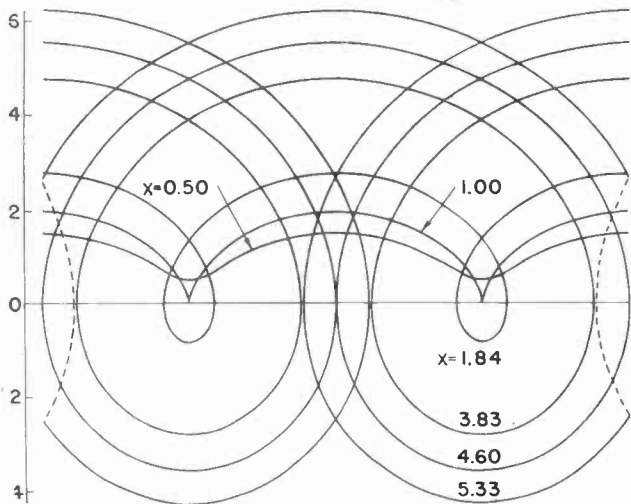

Fig. 11—Family of cycloids for obtaining current-distribution curves. The bunching parameter x corresponds to the ratio of the radius of the generating circle to the radius of the rolling circle.

from these cycloids are illustrated by Figs. 8, 12, and 13.

Fig. 8 includes the current-distribution curves for three values of the bunching parameter; $x=0.50$, $x=1.00$, and $x=1.84$. Reference to Fig. 4 will show that $x=0.50$ corresponds to an underbunched beam and $x=1.84$ is the value required for maximum output. A value of unity for the bunching parameter gives a single infinite current peak, but this value does not correspond to optimum bunching. More energy can be extracted from the bunched beam if the infinite current

peak is allowed to diverge slightly, since the energy in the bunch is increased and fewer electrons remain in the half of the cycle which subtracts energy from the radio-frequency field in the resonator.

There is no conversion of energy if the beam is overbunched until the bunching parameter has the value 3.83, which corresponds to the first zero of the J_1 Bessel function. The current distribution for this case is shown in Fig. 12. Note that the beam has not become direct current. This point was mentioned in the discussion of Fig. 5. Note also that the two infinite current peaks are not 180 degrees out of phase, but actually 86 degrees, as shown by Fig. 12. The basis for zero

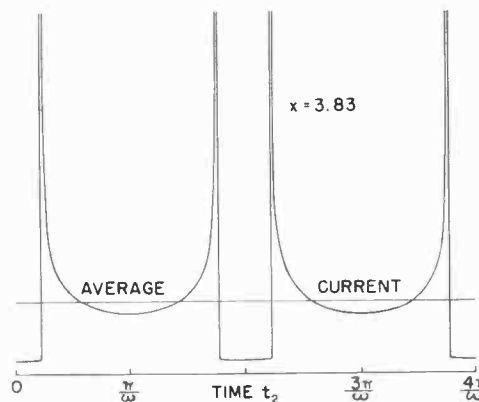

Fig. 12—Current distribution giving zero output corresponds to a value of 3.83 for the bunching parameter.

output is not obvious from inspection of Fig. 12, but depends upon the fact that the integrated effect over a complete cycle is zero.

If overbunching is increased, the two infinite current peaks will merge and form a single infinite current peak which is 180 degrees out of phase with the first infinite peak when the bunching parameter equals unity. This second single infinite peak corresponds to a value of 4.60 for the bunching parameter. Further increase of the bunching until $x=5.33$ produces a second maximum in the output. Reference to Fig. 4 will show that this degree of bunching corresponds to the first minimum of the J_1 Bessel function. These current distribution curves are shown in Fig. 13.

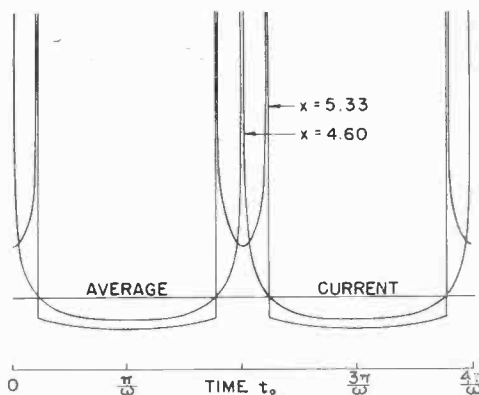

Fig. 13—Current distribution for the second peak in bunching when bunching parameter x is large.

⁷ D. L. Webster, "Velocity modulation currents," *Jour. Appl. Phys.*, vol. 13, pp. 786-787; December, 1942.

ELECTRON-ARRIVAL-TIME CURVES

The cycloid method of computing the current distribution depends upon the assumption that the velocity modulation is quite small and that sufficient time is allowed for bunching to occur. If a curve is plotted showing t_2 , the arrival time of a particular electron at the catcher, as a function of the departure time t_1 , i.e., the time that same electron left the buncher, then the cycloid gives the values of dt_2/dt_1 as a function of t_2 . The fact that the bunched current is proportional to the reciprocal of dt_2/dt_1 , i.e., dt_1/dt_2 , can be derived as follows: Consider the number of electrons passing the buncher grids at time t_1 . The number during an interval dt_1 will be $I_0 dt_1$, since the current at the buncher is the average beam current and I_0 is the number of electrons per unit time. These same electrons reach the catcher at time t_2 . The same electrons will pass the catcher grids during an interval dt_2 ; therefore,

$$I_0 dt_1 = I_2 dt_2. \tag{15}$$

Equation (15) may be rewritten

$$I_2 = I_0 (dt_1/dt_2). \tag{16}$$

This analysis is valid only if the transit time between the resonator grids is infinitesimal. When the transit time is an appreciable part of a cycle, the current peaks indicated in Figs. 8, 12, and 13 are reduced to a finite value.⁸

Electrons which left the buncher at a different time may arrive at the catcher at the same time t_2 . This means that the sum of the slopes must be used to obtain the total current at any time t_2 . A negative slope merely means that electrons which left the buncher later have arrived at the catcher first. For this reason, the absolute values of the slopes are used and the negative sign is ignored.⁷ This point was mentioned in the discussion of the cycloid curves in Fig. 11.

The curves in Figs. 10, 14, and 15 have been plotted with t_1 as the vertical co-ordinate. This construction correlates an infinite current at any time t_2 with an infinite slope of the curve. Figs. 10 and 14 show the

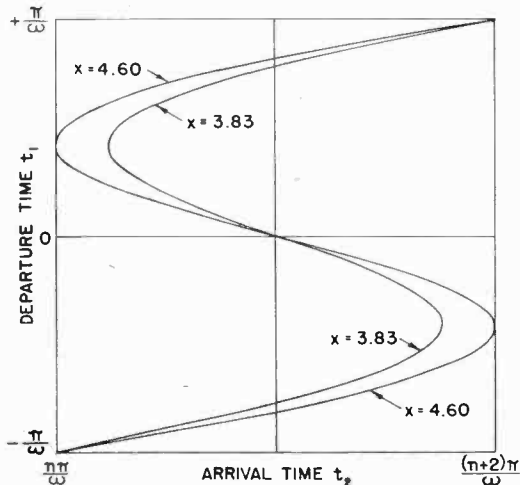

Fig. 14—Electron-arrival-time curves for overbunched case. Two values of bunching parameter x are shown.

⁸ L. J. Black and P. L. Morton, "Current and power in velocity-modulation tubes," PROC. I.R.E., vol. 32, pp. 477-482; August, 1944.

t_1 -versus- t_2 curves for $x = 0.50, x = 1.00, x = 1.84, x = 3.83,$ and $x = 4.60$. The curve for $x = 5.33$ has been plotted separately in Fig. 15 because some ambiguity is introduced by the simultaneous arrival of electrons from several bunching cycles. The curves for electrons which

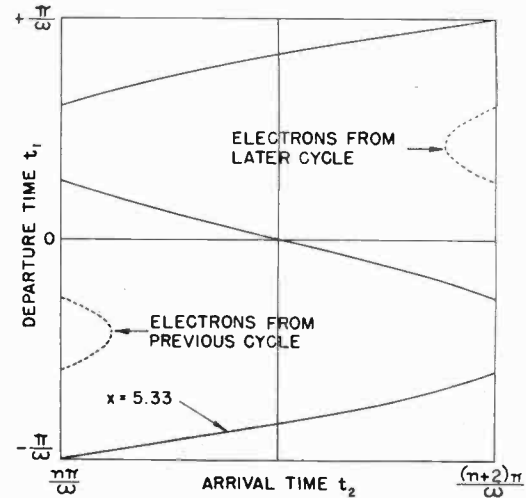

Fig. 15—Electron arrival time curves for second optimum in bunching, when bunching parameter is equal to 5.33.

left the buncher during an earlier or later cycle are shown dotted. The range of t_1 , has been chosen from $-\pi/\omega$ to $+\pi/\omega$ so that the electron bunch will occur at the center of the illustration. The buncher voltage is changing from negative to positive when t_1 is equal to zero.

PHASE SHIFT DUE TO DISTORTION OF THE BUNCH

All of the curves in Figs. 8, 10, and 11 to 15, inclusive illustrate bunching which is symmetrical, i.e., these curves represent the conditions when the assumption of a small buncher voltage is satisfied. As mentioned previously, a small number of cycles during the bunching interval requires a large buncher voltage; this condition causes a distortion of the bunched current distribution. Fig. 16 shows the distortion of the arrival-

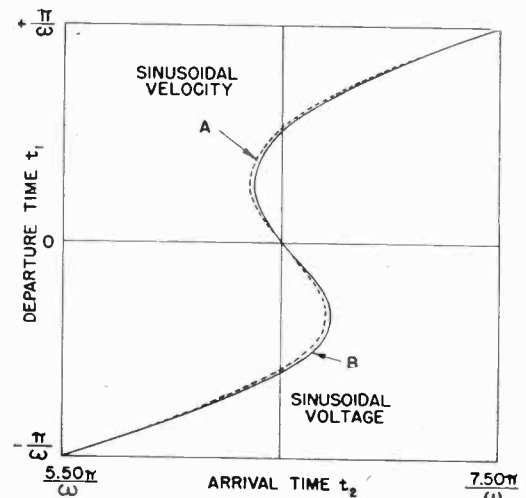

Fig. 16—Electron-arrival-time curves showing second-order effects when velocity modulation is large but sinusoidal (A) and when bunching voltage is sinusoidal (B).

time curve corresponding to $x = 1.84$ in Fig. 13, when the transit time is equivalent to $3\frac{1}{4}$ cycles. These conditions correspond to a ratio $E_1/E_0 = 0.18$. Line A of Fig. 16 shows the distortion due to the fact that the velocity variation is large compared to the average velocity,

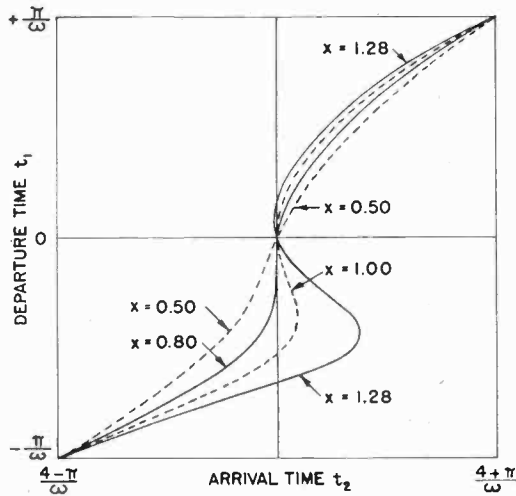

Fig. 17—Electron arrival time curves for an extremely short drift distance showing phase shift introduced as bunching is increased.

although the velocity variation has been assumed to be sinusoidal. The additional distortion caused by the nonsinusoidal velocity variation when the buncher voltage is large compared to the acceleration voltage is shown by the difference between A and B in Fig. 16.

There is a phase shift introduced by the distortion of the bunched current; this effect was mentioned in the discussion of Fig. 3. A drift time of $2/\pi$ cycles has been represented in Fig. 17 in order to emphasize this phase shift. Bunching parameter values of $x = 0.50$, $x = 0.80$, $x = 1.00$, and $x = 1.28$ have been used for computing the t_1 -versus- t_2 curves in Fig. 17. Corresponding current distribution curves are given in Fig. 18. Note that the curves for $x = 0.50$ do not differ greatly from the corresponding curves in Figs. 8 and 10. The distortion becomes greater as the buncher voltage is increased. As a result, the phase shift is a function of the buncher voltage.

The choice of a drift time of $2/\pi$ cycles means that

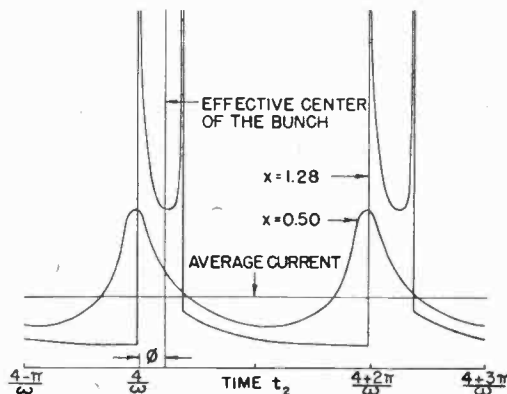

Fig. 18—Bunched current distribution corresponding to the short drift distance illustrated by Fig. 17. Two complete cycles are shown.

the four values of the bunching parameter correspond to E_1/E_0 ratios of 0.25, 0.40, 0.50, and 0.64. The larger values of buncher voltage cause a nonsinusoidal variation of velocity; as a result, the average velocity is somewhat less than the velocity corresponding to the acceleration voltage, and the expression for the bunching parameter in (6) is no longer valid. The slower electrons become bunched sooner, and an infinite current peak occurs when the value of x computed from (6) is only 0.80. A value of $x = 1.00$ gives a decided double peak in the current distribution, and optimum bunching corresponds to a value of 1.28 instead of 1.84. This deviation from the first-order theory indicates that the output characteristic of an amplifier may differ from the curve shown in Fig. 4.

The phase shift introduced by the distortion of the beam-current distribution when the bunching time is small and large variations of buncher voltage are required is evident from an inspection of either the t_1 -versus- t_2 curves or the Applegate diagrams. In fact, an Applegate diagram may be used to compute the t_1 -versus- t_2 curves, since the arrival time, i.e., t_2 , for an electron at any point along the drift space is given by the horizontal co-ordinate which represents time in an Applegate diagram. Similarly, the close approach of two adjacent lines corresponds to a large value of current, which is roughly proportional to the reciprocal of the spacing between the lines, although the limitation of a small number of lines means that $\Delta t_1/\Delta t_2$ is used to approximate the current instead of the exact relation dt_1/dt_2 . It should be pointed out that this relation between the current and the apparent density of the lines can be misleading after lines have crossed because it is difficult to determine at a glance whether two converging lines were adjacent at the position of the buncher. Also, there is an optical illusion of less density at the point representing an infinite current peak since the lines merge and individual lines cannot be detected.

It is apparent from this discussion that very accurate Applegate diagrams may be constructed from t_1 -versus- t_2 data. Points are chosen at uniform intervals along

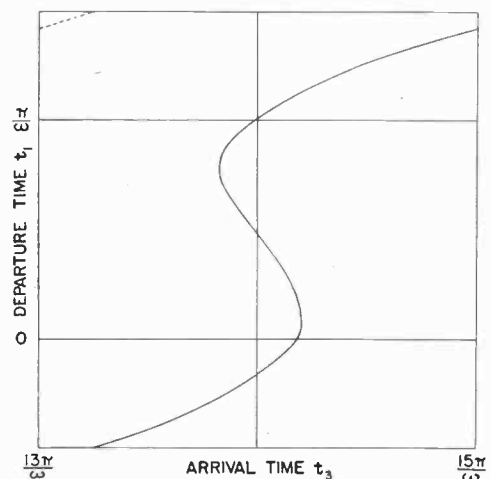

Fig. 19—Electron arrival time curve for a cascade-amplifier klystron.

the time scale at a position corresponding to the location of the buncher. Arrival time at the position of the catcher is computed from the relation

$$t_2 = t_1 + s/v. \tag{17}$$

Corresponding t_1 and t_2 points are connected by a straight line. This method is usually more accurate than the simpler method described in the discussion of Fig. 6, since small errors in the slope of a line may cause considerable error when the line is extended to the position of the catcher.

CASCADE-AMPLIFIER KLYSTRON

Curves of t_1 versus t_2 (not shown) and t_1 versus t_3 (Fig. 19) have been used to construct the Applegate diagram in Fig. 20 for a cascade-amplifier klystron. This type of tube has been described previously.⁶ Its theory of operation is easily explained with the aid of the sectional view of a three-resonator klystron amplifier in Fig. 21.

A review of Fig. 4 will emphasize the fact that the gain in a velocity-modulation amplifier is relatively independent of the buncher voltage when the voltage is small, and that this gain is greater than the gain of an amplifier with sufficient bunching to give optimum output. If a small radio-frequency voltage modifies the electron velocity at the buncher, the gain for the first

stage will introduce a much larger voltage at the second resonator, which will be designated the cascade buncher. A large velocity variation is superimposed upon the partially bunched electron beam at the second resonator. This velocity variation is much greater than that introduced by the buncher, due to the voltage gain in the first stage, and this additional velocity variation may give sufficient bunching for optimum output at the third resonator, or catcher.

This analysis of a cascade amplifier is well illustrated by the Applegate diagram in Fig. 20. The amplitudes of the voltages in the three resonators have been chosen to represent the conditions in a typical amplifier. The over-all voltage gain for the two stages is shown as 35; this corresponds to a power gain of 1225. These figures are purely arbitrary, but are not inconsistent with the actual conditions in a three-resonator amplifier.

There is a phase difference of 90 degrees between the bunching in the first and second resonators of a cascade amplifier if the second resonator is tuned exactly to the input frequency. This relation may be verified by referring all phases to the line in the Applegate diagram which represents the position of the electron which passed the buncher grids at zero time, instead of

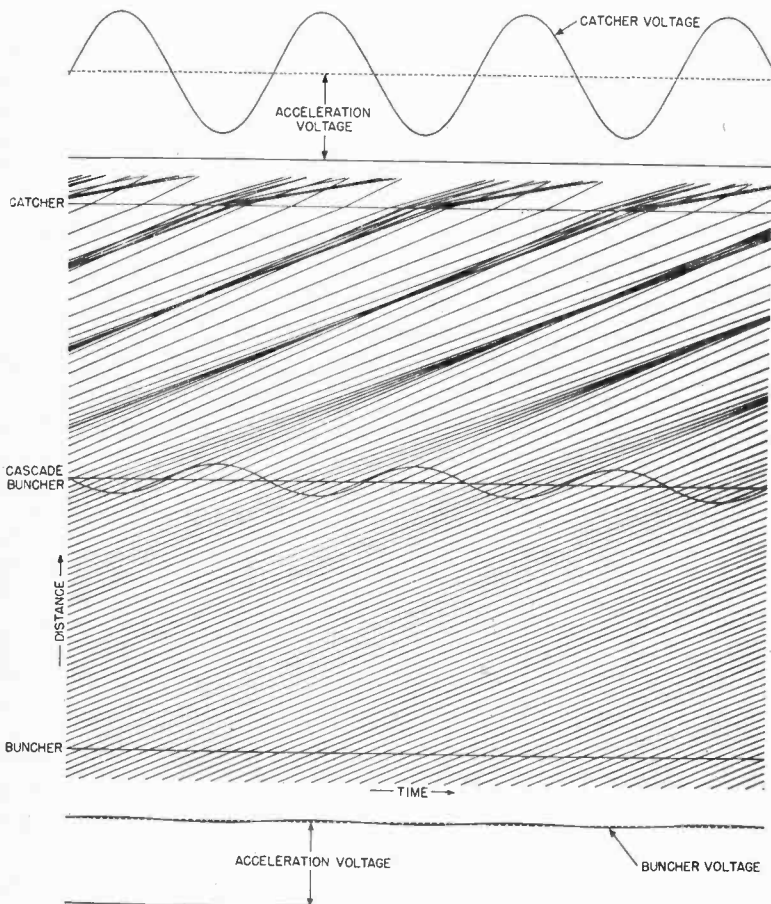

Fig. 20—Applegate diagram for a cascade-amplifier klystron illustrating two stages of amplification in a single tube.

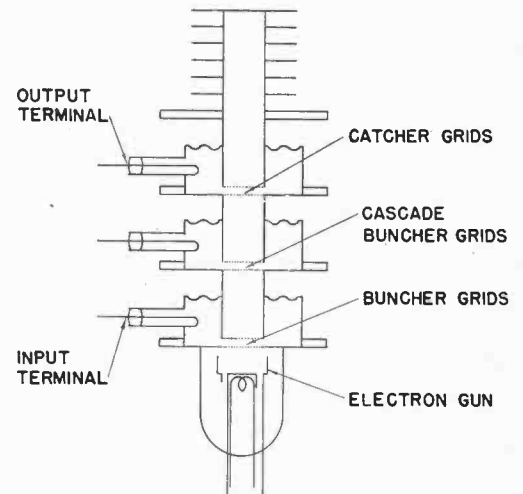

Fig. 21—Sectional view of a cascade-amplifier klystron.

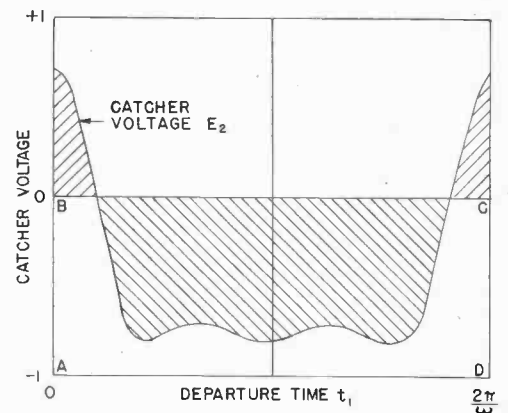

Fig. 22—Energy diagram for computing efficiency from a graphical integration. Efficiency corresponds to the ratio of the difference of the two shaded sections to the area of the rectangle ABCD.

using absolute time as a reference. This definition of phase is equivalent to subtracting the average transit time in the drift space from the absolute time. The electron which left the buncher at zero time becomes the center of the partially formed bunch at the second resonator. The radio-frequency voltage at the second resonator, or cascade buncher, will have a phase which will retard the greatest number of electrons if this resonator is tuned to the input frequency. For this reason, the radio-frequency voltage at the second resonator will lag the voltage at the first resonator by an angle of 90 degrees. Fig. 20 illustrates these phase relations.

The previous discussion of phase shift caused by the distortion of the bunch has been qualitative. Also, in the case of a cascade amplifier, there is no electron comparable to the electron with average velocity to be used as a phase reference; and there is no quantity comparable to the bunching parameter when the bunching is a composite effect caused by two different voltages with different phases, and with different drift distances. When the current distribution is not distorted badly, the simple assumption that the center of the bunch corresponds to the median time between the two infinite current peaks is quite satisfactory. Note that this assumption is not accurate for the current distribution in Fig. 18 when $x=1.28$, and the curve is quite unsymmetrical. It is usually satisfactory to assume that the bunching is optimum when the two infinite current peaks have separated by a time interval equal to that predicted for $x=1.84$ in the small-signal theory. The latter assumption was used in estimating the value of x required for optimum bunching in Fig. 17.

COMPUTATION OF KLYSTRON EFFICIENCY

An exact graphical analysis may be used if the assumptions above are unsatisfactory or if a quantitative answer is desired. The energy transferred from the beam to the catcher resonator will be given by

$$W = (\omega/2\pi) \int_0^{2\pi/\omega} I_2 E_2 \cos(\omega t_2 - \tau_0 - \phi) dt_2. \quad (18)$$

The angle τ_0 is the transit angle of the electron which passed the buncher grids at time $t=0$. This definition means that $(\omega t_2 - \tau_0)$ is zero for the electron corresponding to $t_1=0$, and is equivalent to shifting the t_2 coordinate in the diagrams of the arrival time, or t_1 -versus- t_2 diagrams. The phase angle ϕ is determined by the tuning of the catcher resonator and by the distortion of the bunched beam current. This value of ϕ will be zero if the catcher is tuned to resonance with the buncher frequency and there is no distortion of the bunch. If distortion of the bunch does occur, the phase will shift in order to transfer the maximum energy to the catcher resonator. Equation (15) may be substituted in (18) in order to avoid the difficulty of evaluating the energy contribution of the infinite current peaks. Since I_0 is a constant, equation (18) may be rewritten

$$W = (\omega/2\pi) E_2 I_0 \int_0^{2\pi/\omega} \cos(\omega t_2 - \tau_0 - \phi) dt_2. \quad (19)$$

Convenient limits are chosen for the integration since it is necessary to integrate only over one complete cycle. It is necessary to replot $E_2 \cos(\omega t_2 - \tau_0 - \phi)$ on the t_1 time scale before integration.⁷ This may be done conveniently by transferring the value of $E_2 \cos(\omega t_2 - \tau_0 - \phi)$ at a given time t_2 to the corresponding time t_1 given by the t_1 -versus- t_2 diagram. This process is illustrated by Fig. 22, which corresponds to a catcher voltage with a peak amplitude of $0.7 E_0$ replotted with the aid of line B of Fig. 16. A phase shift of 8 degrees has been assumed.

A value for the conversion efficiency of the tube can be obtained from the ratio of the effective energy transferred to the resonator, which is given by the difference between the shaded areas below and above the line representing the acceleration voltage, to the area of the rectangle $ABCD$ which represents the direct-current energy in the beam. The value of efficiency obtained from Fig. 22 is 40 per cent. This is a theoretical efficiency and includes the power absorbed by ohmic losses in the resonator. The output efficiency would depend upon the ratio of power delivered to the load to the power losses in the resonator.

PHASE SHIFT FROM A GRAPHICAL INTEGRATION

It is not necessary to estimate the phase shift, or obtain a value by cut-and-try from calculations of the efficiency using a number of arbitrarily chosen phase angles. A method suggested by E. Feenberg, derived in an appendix, allows the phase angle and the maximum efficiency to be computed exactly from two graphical integrations. If one integration is performed, using (19) with ϕ equal to zero, and a second integration is made from the following expression:

$$W_1 = (\omega/2\pi) E_2 I_0 \int_0^{2\pi/\omega} \sin(\omega t_2 - \tau_0) dt_2 \quad (20)$$

then the phase angle ϕ and the maximum value of the energy transferred W_{\max} may be computed from the relations

$$\tan \phi = W_1/W, \quad (21)$$

$$\text{and} \quad W_{\max} = \sqrt{W_1^2 + W^2}. \quad (22)$$

The phase shift for various ratios of E_1/E_0 , corresponding to the curves in Fig. 17, have been computed from (21) and are shown in Table I. These data verify the qualitative conclusion, stated in the previous

TABLE I

Bunching Parameter	E_1/E_0	Drift Time (cycles)	Phase Shift (degrees)
0.50	0.25	$2/\pi$	6.4
0.80	0.40	$2/\pi$	12.0
1.00	0.50	$2/\pi$	18.3
1.28	0.64	$2/\pi$	42.0

discussion of Figs. 17 and 18, that the phase shift increases as the buncher voltage is increased.

There is no convenient graphical method for determining the conditions for optimum output, although the efficiency may be computed for a number of choices of buncher voltage, and the buncher voltage required for optimum output may be estimated by inspection of the curve of efficiency-versus-buncher voltage.

CONCLUSIONS

These graphical methods of analysis emphasize several conclusions. First-order theories which assume small bunching voltages and correspondingly long drift times are not applicable to tubes with short drift distances. Graphical methods permit exact calculation of operating conditions, and are not limited by the approximations which are required in the first-order theory. In addition, a graphical analysis is often useful, even under the conditions when the first-order equations might apply, since such an analysis provides a physical picture which may give a better understanding of the electrical characteristics of a velocity-modulation tube.

APPENDIX A

DERIVATION OF INTEGRAL METHOD OF DETERMINING THE PHASE SHIFT AND MAXIMUM ENERGY OF A BUNCHED ELECTRON BEAM

The energy transferred per cycle from a bunched electron beam to the catcher resonator will be represented by the symbol W and is given by

$$W = \frac{\omega}{2\pi} E_2 I_0 \int_0^{2\pi/\omega} \cos(\omega t_2 - \tau_0 - \phi) dt_1. \quad (23)$$

Equation (23) is equivalent to (19) in the text. The cosine term may be expanded in the form

$$\cos(\omega t_2 - \tau_0 - \phi) = \cos(\omega t_2 - \tau_0) \cos \phi + \sin(\omega t_2 - \tau_0) \sin \phi. \quad (24)$$

The phase angle ϕ is a constant during integration; therefore,

$$W = \frac{\omega}{2\pi} E_2 I_0 \cos \phi \int_0^{2\pi/\omega} \cos(\omega t_2 - \tau_0) dt_1 + \frac{\omega}{2\pi} E_2 I_0 \sin \phi \int_0^{2\pi/\omega} \sin(\omega t_2 - \tau_0) dt_1. \quad (25)$$

Symbols may be assigned to the two parts of 25,

$$W_1 = \frac{\omega}{2\pi} E_2 I_0 \int_0^{2\pi/\omega} \sin(\omega t_2 - \tau_0) dt_1, \quad (26)$$

$$W_2 = \frac{\omega}{2\pi} E_2 I_0 \int_0^{2\pi/\omega} \cos(\omega t_2 - \tau_0) dt_1. \quad (27)$$

Then (25) may be rewritten

$$W = W_2 \cos \phi + W_1 \sin \phi. \quad (28)$$

Differentiating (28) with respect to ϕ and equating to zero gives an expression for ϕ_{\max} ; i.e., determines the value of ϕ required to make W a maximum.

$$-W_2 \sin \phi + W_1 \cos \phi = 0 \quad (29)$$

$$\tan \phi_{\max} = W_1/W_2. \quad (30)$$

Two more relations for ϕ_{\max} may be written

$$\sin \phi_{\max} = W_1/\sqrt{W_1^2 + W_2^2}. \quad (31)$$

$$\cos \phi_{\max} = W_2/\sqrt{W_1^2 + W_2^2}. \quad (32)$$

Equation (28) may, therefore, be written

$$W_{\max} = W_2 \frac{W_2}{\sqrt{W_1^2 + W_2^2}} + W_1 \frac{W_1}{\sqrt{W_1^2 + W_2^2}} \\ W_{\max} = \sqrt{W_1^2 + W_2^2}. \quad (33)$$

Consider next the case where $\phi \neq \phi_{\max}$ due to detuning of the catcher resonator. The cosine term in (23) may be written in the form

$$\cos(\omega t_2 - \tau_0 - \phi) = \cos(\omega t_2 - \tau_0 - \phi_{\max} + \phi_{\max} - \phi) \\ \cos(\omega t_2 - \tau_0 - \phi) = \cos(\omega t_2 - \tau_0 - \phi_{\max}) \cos(\phi_{\max} - \phi) \\ - \sin(\omega t_2 - \tau_0 - \phi_{\max}) \sin(\phi_{\max} - \phi). \quad (34)$$

If the sine term in (34) is expanded,

$$\sin(\omega t_2 - \tau_0 - \phi_{\max}) = \sin(\omega t_2 - \tau_0) \cos \phi_{\max} \\ - \cos(\omega t_2 - \tau_0) \sin \phi_{\max}. \quad (35)$$

Substituting (26), (27), (31), and (32) into (35) and integrating from zero to $2\pi/\omega$ gives

$$\int_0^{2\pi/\omega} \sin(\omega t_2 - \tau_0 - \phi_{\max}) dt_1 \\ = \frac{W_1}{(\omega/2\pi)E_2 I_0} \frac{W_2}{\sqrt{W_1^2 + W_2^2}} - \frac{W_2}{(\omega/2\pi)E_2 I_0} \frac{W_1}{\sqrt{W_1^2 + W_2^2}} \\ \int_0^{2\pi/\omega} \sin(\omega t_2 - \tau_0 - \phi_{\max}) dt_1 = 0. \quad (36)$$

Therefore, the second term of (34) does not make any contribution for any value of ϕ . Substituting (34) and (36) in (23) gives

$$W = \frac{\omega}{2\pi} E_2 I_0 \cos(\phi_{\max} - \phi) \\ \int_0^{2\pi/\omega} \cos(\omega t_2 - \tau_0 - \phi_{\max}) dt_1 \quad (37)$$

which may also be written

$$W = W_{\max} \cos(\phi_{\max} - \phi). \quad (38)$$

Equation (38) may be recognized as the form of the voltage across a resonant circuit in terms of the phase angle between the voltage and current in the circuit.

A Stabilized Narrow-Band Frequency-Modulation System for Duplex Working*

E. E. SUCKLING†, NONMEMBER, I.R.E.

Summary—A system is described whereby the two terminals of a duplex radiotelephone channel are stabilized against each other by the use of standard automatic-frequency-control circuits and the common use of an oscillator for both transmitting oscillator and superheterodyne high-frequency oscillator. The send and receive frequencies are separated from each other by an interval which is the frequency of the intermediate-frequency channel. The system can be designed to give adequate frequency stability** for most applications without the use of crystal control.

INTRODUCTION

A MAJOR difficulty in the design of ultra-high-frequency communication systems is the attainment of sufficient frequency stability of the transmitter and of the receiver.

The use of a wide band with either a superregenerative receiver or a wide-band superheterodyne circuit permits some variation in frequency but with the increasing use of the ultra-high-frequency spectrum these methods are no longer available and communication channels must be maintained within as narrow a band as can be used to convey intelligence. In the case of both amplitude- and frequency-modulated systems this requirement often means the use of crystal stabilized oscillators with numerous frequency multiplying stages and perhaps also a phase modulator.

In a remotely switched radio terminal it is usually necessary that whenever the unit is switched on, the assigned frequency be always available without any possibility of variation and in this case it is practically essential that a crystal-controlled oscillator be used. If the channel is frequency modulated, the Armstrong system¹ or some modification of it will be preferable, as the controlled reactance tube oscillator, although stabilized once it has been tuned to its stabilizing source, does not necessarily start oscillating at the frequency required and the commencing frequency of such an oscillator may be beyond the control limits of the automatic-frequency-control circuit. In many installations conditions are not as rigorous and preliminary tuning may be permissible. In such cases, as the use of crystal control involves con-

siderable complication of equipment, this factor, together with the difficulty of altering frequency when it may be required, opens the field for the development of a system which, while easily variable in frequency, has both stability and also simplicity of circuits.

The arrangement to be described incorporates these features and provides for a simultaneous two-way radiotelephone link with the characteristics which can be expected when using a frequency-modulated transmitter and a sensitive receiver.

PROPOSED SYSTEM

In the usual system of stabilized frequency modulation the transmitter frequency is stabilized against a crystal oscillator. The arrangement is very similar to the automatic-frequency-control circuits² used in some domestic receivers whereby the receiver oscillator is maintained at a required frequency by reference to an incoming carrier.

In both cases the oscillator to be controlled is arranged with an electronic reactance connected across its tuned circuit which enables the frequency of oscillation to be varied by an alteration of the bias on the reactance tube. Bias for the reactance tube is derived from a frequency discriminator connected in an intermediate-frequency channel. When, due to a drift in the variable oscillator, the frequency in the intermediate-frequency channel has deviated from the center frequency of the channel a steady voltage is obtained from the discriminator and this voltage applied as bias to the reactance tube alters the oscillator frequency in such a way as to correct the original drift. As a result, the drifting oscillator is constantly corrected and brought back towards the correct frequency since any deviation produces a direct voltage which will tune the oscillator back towards the original condition.

There cannot, of course, be perfect correction as a small frequency deviation is required to produce a correcting voltage. This deviation need only be a few hundred cycles to produce sufficient voltage to correct what would otherwise be an off-frequency condition of many kilocycles.

In the system here described the frequency used to control the oscillator is that of the incoming carrier. It is, in fact, a standard automatic-frequency-control system using a superheterodyne receiver, the oscillator of which is constantly corrected to maintain the intermediate

* Decimal classification: R414. Original manuscript received by the Institute April 29, 1943; revised manuscript received, August 14, 1944.

† Radio Section, Chief Engineer's Office, Post and Telegraph Department, Wellington C. 1, New Zealand.

** Editorial Note: The term "stability" is not used in this paper in its usual sense, that is, as the ability to maintain a given carrier frequency at a constant value. The method described in the paper relates instead to the maintenance of a fixed-frequency relation, or difference of frequencies, between the two carriers involved in one system; accordingly both carriers can drift equally in the same direction without bringing the corrective means into play.

¹ Edwin H. Armstrong, "A method of reducing disturbances in radio signaling by a system of frequency modulation," *PROC. I.R.E.*, vol. 24, pp. 689-740; May, 1936.

² D. E. Foster and S. W. Seeley, "Automatic tuning, simplified circuits, and design practice," *PROC. I.R.E.*, vol. 25, pp. 289-314; March 1937.

frequency at the correct value. The oscillator of a superheterodyne receiver can be used as the basis of a transmitter when it is satisfactory for the receive and send frequencies to be separated by an interval which is the frequency of the intermediate channel.³ This principle is used and as both send and receive channels are in simultaneous operation the automatic frequency control applied to the receive oscillator gives stability to the outgoing frequency. As the receiver oscillator (or its harmonic) is actually radiating, the transmitted frequency will have a stability similar to that of the incoming frequency (maintained by the automatic-frequency-control system), but spaced from it by the receiver intermediate frequency. The incoming carrier which supplies the stabilizing frequency for the transmitter-receiver arrangement can originate in a crystal-controlled transmitter in which case the frequency stability of the whole system will be approximately the same as that of the crystal oscillator. It is, however, possible to use at either end of the channel a transmitter-receiver arranged as described with, in each case, an automatic-frequency-controlled receiver oscillator working also as transmitting oscillator. In this case, absolute frequency stability will not be attained but the system will in itself be stable in that the two oscillators will be maintained at a frequency separation from one another which is the common frequency of both of the intermediate-frequency channels. A block diagram below shows the complete duplex-channel arrangement.

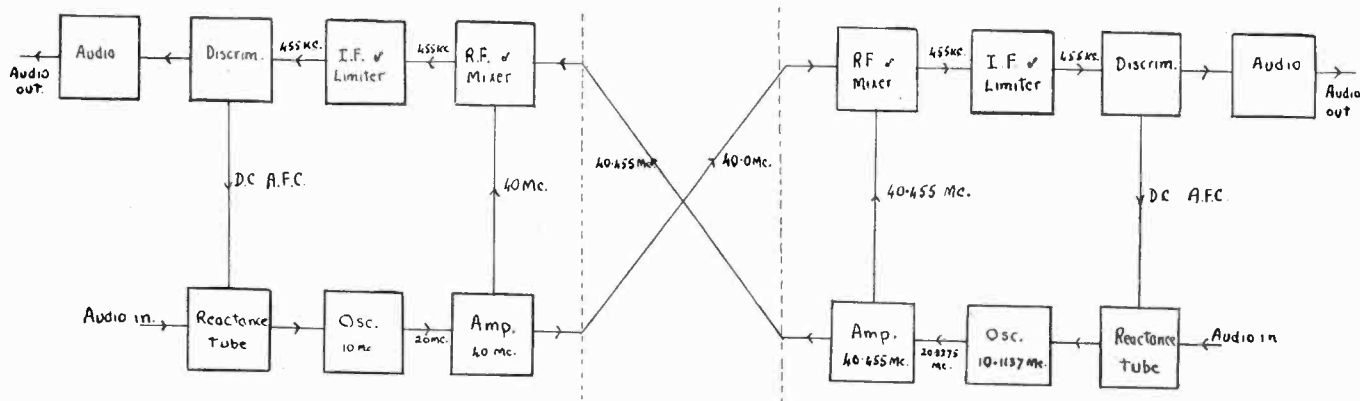

Fig. 1

Drift of the two oscillators simultaneously is possible and is not corrected. This, of course, may cause interference with adjacent channels, or it may involve working with receiver radio-frequency tuned circuits slightly out of alignment, but actually is unlikely to be of sufficient magnitude to give trouble due to either effect. As long as the two oscillators are maintained at the correct frequency separation the correct intermediate frequencies will be developed and the major requirement for re-

ceiver tuning will be satisfied.

It can be seen that either frequency or amplitude modulation can be used with the system but in view of the necessity for a discriminator and a reactance tube to effect automatic frequency control, the use of frequency modulation is the obvious choice as it involves merely the use of a microphone transformer with the reactance tube. Frequency modulation permits a closer spacing of transmitter and receiver frequencies with a lower intermediate-frequency channel and a more stable discriminator.

EQUIPMENT DESIGN

The efficient operation of the system depends upon the automatic frequency control and the design must therefore center about the automatic-frequency-control circuits. As a standard for commencement it was considered that a frequency variation due to external causes such as thermal, voltage variation, etc., of an uncompensated oscillator of reasonably careful design would be of the order of 0.1 per cent at 10 megacycles and that the consequent carrier drift to be encountered was up to 40 kilocycles at 40 megacycles. It was also considered that for a 10 kilocycle per second modulation deviation, an off-center tuning of ± 1 kilocycle was tolerable when the discriminator characteristic was linear to ± 12 kilocycles per second. The design of the automatic-frequency-control circuits must therefore be such that the discriminator reactance-tube combination produces sufficient re-

actance across the oscillator tuned circuit to cause a frequency deviation of 40 kilocycles when the intermediate frequency is 1 kilocycle off center.

In an experimental setup 2-watt carriers were used spaced 455 kilocycles apart, the working frequencies being 40 megacycles and 40.455 megacycles. Concise measurements of the performance of the system were not taken but the action of the automatic frequency control in "locking" the two carriers was very evident. The complete units each about the size of a domestic receiver enabled good quality duplex telephone conversation to be maintained over a distance of several miles.

³ W. W. Honner, B.E. and T. E. Trew, "A low power installation for ultra-high frequency radio telephone links," *A.W.A. Tech. Rev.*, vol. 5, pp. 287-293; 1941.

An interesting feature was the incorporation of single-dial control by which the radio-frequency and oscillator circuits were ganged. This enabled a wide choice of channel frequencies to be used but also gave the effect that on tuning around the dial and hearing the other station communication was then immediately possible as the local carrier was by the action of tuning the receiver set to and locked at the correct frequency for the remote station's receiver.

CONCLUSION

The principle used appears to have application in many cases for duplex ultra-high-frequency radiotelephony where high stability is required without the refinements (and also limitations) of crystal control. Tests indicate that as long as the signal received is sufficient to actuate the limiter, frequency stability is maintained despite variations in power-supply voltage and despite the usual thermal variations in the oscillator circuit.

On the Winding of the Universal Coil*

A. W. SIMON†, NONMEMBER, I.R.E.

Summary—A review is made of the derivation of the basic formula for calculating the gear ratio to be employed in winding a universal coil as a function of certain coil parameters, as given in a previous paper by the author.

From this basic formula a somewhat simpler, though less accurate, formula is derived merely by neglecting certain terms, and shown to be the equivalent of that evolved by Hershey. Also the nomenclature and notation originally introduced by the author are compared with those subsequently used by Hershey. The theory underlying the selection of the correct number of crossovers per turn (of the dowel) is reviewed, and rules for determining the number of crossovers per winding cycle (required in the use of the gear-ratio formulas) from the number of crossovers per turn are given. The steps in making a gear-ratio calculation are outlined and a table of useful formulas is appended.

In conclusion, the details of the mathematical solution involved in the derivation of the basic formula are given.

THE formula and method for calculating the gear ratio to be employed in winding universal coils were first deduced and discussed by the present author.¹ Subsequently, using a slightly different notation and nomenclature, Hershey² covered essentially the same ground, and evolved a somewhat simpler, though less accurate, formula. Hershey's theoretical treatment, however, is needlessly involved, and his formula can be deduced directly from that originally given by the present author simply by neglecting certain terms, and thus represents merely an approximate form of the same.

The radio engineer who desires to make his own gear-ratio calculations is now confronted by two sets of nomenclatures and formulas, and therefore it becomes desirable to present a critical review and comparison of the same, and that is the object of the present paper.

Parenthetically it might be noted, that since the mechanical stability, and therefore the electrical reproducibility and constancy, as well as the electrical char-

acteristics, of a coil depend very markedly on the gear ratio used, it is imperative that every radio engineer engaged in coil design be able to carry out his own gear-ratio calculations. The practical importance of using the proper gear ratios can be illustrated by the fact that at one plant coil rejections were reduced from as high as 30 to 3 per cent simply by the use of the correct gear ratios; in fact, after their introduction, all coil trouble practically disappeared.

I. THE GEOMETRY AND MECHANICS OF THE UNIVERSAL WINDING

The method of winding a universal coil is such that, as the dowel or tube on which the coil is wound rotates, the wire is guided back and forth by a shuttle, which displaces the wire in *linear proportion* to the angle of rotation of the dowel. The shuttle is actuated by a cam mounted on a shaft, which is geared in a definite ratio r to the shaft turning the dowel.

Accordingly (Fig. 1), if we denote by x the linear displacement of a point P of the wire parallel to the axis of the dowel, by y that perpendicular thereto (on the developed surface), by c the cam throw, by d the diameter of the dowel, by θ_C the angular rotation of the cam shaft, and by θ_D that of the dowel, we have

$$x/c = \theta_C/\pi \quad (1)$$

$$y/\pi d = \theta_D/2\pi \quad (2)$$

whence

$$y/x = \pi d/2c(\theta_D/\theta_C) = (\pi d/2c)r. \quad (3)$$

If, further (Fig. 1), we denote by ϕ the angle which the wire makes with a line parallel to the axis of the dowel, we have

$$y/x = \tan \phi = (\pi d/2c)r. \quad (4)$$

If next (Fig. 2) we denote³ by h the linear advance per crossover, by H the linear advance per winding cycle, by n the number of crossovers per turn of the dowel, by q the number of crossovers per winding cycle, and

* The significance of these definitions is discussed in greater detail in the previous paper by the author, footnote reference 1.

* Decimal classification: R230XR382. Original manuscript received by the Institute, May 29, 1944; revised manuscript received, October 13, 1944.

† John Luellen and Company, Hazel Crest, Illinois.

¹ A. W. Simon, "Winding the universal coil," *Electronics*, vol. 9, p. 22; October, 1936; Errata, p. 52; November, 1936.

² L. M. Hershey, "The design of universal winding," *PROC. I.R.E.*, vol. 29, pp. 442-446; August, 1941.

by s the spacing between centers of adjacent wires on the surface of the dowel, we have the relations

$$c \tan \phi = \pi d/n \pm h \quad (5)$$

$$s = H \cos \phi = qh \cos \phi \quad (6)$$

where the positive sign is taken for a progressive winding and the negative sign for a retrogressive one.

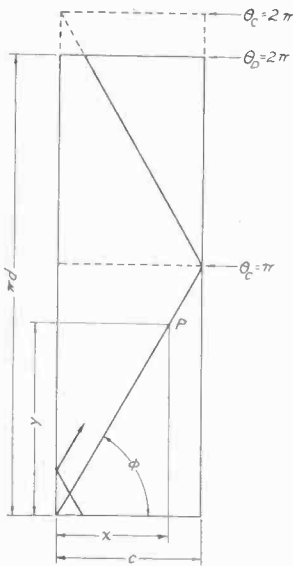

Fig. 1—Trace of wire on developed surface of dowel: progressive winding and two crossovers per turn.

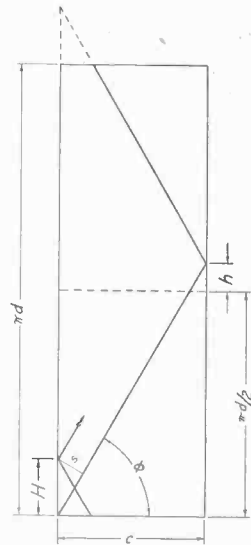

Fig. 2—Relation of wire spacing to linear advance per turn and per winding cycle: progressive winding and two crossovers per turn.

Elimination of ϕ between (4), (5), and (6) yields⁴

$$r = \frac{2}{n} \frac{(1 \pm \sqrt{a^2 + b^2} - a^2 b^2)}{(1 - a^2)} \quad (7)$$

where a and b are given by

$$a = s/qc \quad (8)$$

$$b = ns/q\pi d. \quad (9)$$

Since a and b are small quantities, (7) can be written with negligible error in the form

$$r = 2/n(1 \pm \sqrt{a^2 + b^2})(1 + a^2). \quad (10)$$

For the same reason and, moreover, because ordinarily b will be small compared to a , we can write *with an accuracy sufficient for most practical purposes also*

$$r = 2/n(1 \pm a). \quad (11)$$

This last equation can also be deduced directly from the basic equations (4), (5), and (6), provided only we note that, as will be explained below, ordinarily ϕ will be in the neighborhood of 78 degrees in which case, we can set in (6), approximately,

$$\cos \phi = \cot \phi$$

whence (11) follows directly.

Equation (10) is that originally given by the author; while, as will be shown below; (11) is the exact equivalent of the Hershey formula, which is thus seen to be merely an approximate form of the other.

⁴ The details of the mathematical solution are given at the end of this article.

If now we take note of the empirical fact that for best results the spacing factor, (that is the ratio of s to δ , where δ is the nominal diameter of the wire) should be 1.25, (11) takes the form

$$r = 2/n(1 \pm 1.25\delta/qc). \quad (12)$$

Equation (12) will suffice for most practical purposes; (10) can be used where a higher degree of accuracy is necessary.

II. COMPARISON OF NOTATION OF THE AUTHOR AND HERSHEY

Hershey denotes by g the actual gear ratio between the dowel shaft and the cam shaft; by g' the number of cam cycles per turn; by q' the number of cam cycles per winding cycle; by w the diameter of the wire; and by α the angle which the wire makes with a line *perpendicular* to the axis of the dowel. In view of these definitions there exist the following relations between the various quantities as defined by the author and by Hershey

$$r = 1/g, \quad (13)$$

$$n = 2g', \quad (14)$$

$$q = 2q', \quad (15)$$

$$\delta = w, \quad (16)$$

$$\phi = (90 \text{ degrees} - \alpha). \quad (17)$$

If we make these substitutions in the basic equation (4), there results

$$\tan \alpha = 2cg/\pi d \quad (4a)$$

which is (1) of Hershey's paper. Furthermore, if we make these same substitutions in (12), we obtain

$$1/g = 1/g'(1 \pm 0.63w/q'c) \quad (12a)$$

which is the gear-ratio formula as given by Hershey, namely his equation (12).

III. SELECTION OF THE NUMBER OF CROSSOVERS PER TURN

In (10) and (12) there still remain two quantities which need further discussion, namely, n , the number of crossovers per turn, and q the number of crossovers per winding cycle.

As pointed out in the previous paper by the author, the choice of n depends on the fact that for a mechanically stable coil the winding angle ϕ must lie between certain limits, and, as can be seen from (4), for a given gear ratio r , the angle will increase with the winding diameter; hence, to build a coil as high as possible, the angle ϕ should be at its lower limit *at the surface of the dowel*, i.e., *at the dowel diameter*.

Moreover, it is found that for a stable coil, the wire must not make too many excursions before completing the winding cycle; this means that in practice n must be an integer or a simple fraction.

Empirically it is found that ϕ is near its lower limit when n is chosen in accordance with the formula

$$n = 2d/3c. \quad (18)$$

This corresponds to a value of ϕ of approximately 78 degrees.

Hence the procedure in selecting n is to calculate its value as given by (18) and then select the nearest integer, or integer plus a simple fraction, *less than the calculated value*.

On substituting for n its value as given by (14), (18) takes the form

$$g' = d/3c \quad (18a)$$

which is the form of the same equation as given by Hershey, namely his (3). Also from (17), it is seen that $\phi = 78$ degrees corresponds to a value of α of 12 degrees, as given by Hershey.

We come now to a consideration of the value of q . The latter is determined once n has been fixed, and may be obtained either by drawing the corresponding winding pattern and counting the number of crossovers per winding cycle; or, better, by means of the following rule.⁵

Write $n/2$ in the form

$$n/2 = i_1/i_2 \quad (19)$$

where the right-hand side is expressed as a fraction in its lowest terms. The quantity q will then be given by

$$q = 2i_1. \quad (20)$$

For example, for the case $n = 1$, we have $n/2 = 1/2 = i_1/i_2$ which gives $i_1 = 1$ and $q = 2$; for $n = 2$, we have $n/2 = 2/2 = 1/1$ which gives also $i_1 = 1$ and $q = 2$; for $n = 1\frac{1}{2}$, we have $n/2 = 3/4$ which gives $i_1 = 3$ and $q = 6$, etc. Hence it is possible to set up the following supplementary rules:

- (1) For n an odd integer, $q = 2n$.
- (2) For n an even integer, $q = n$.

For fractional values of n , the fundamental rule is best applied directly.

IV. SUMMARY OF THE METHOD OF GEAR-RATIO CALCULATION

Whether or not the reader has followed the details of the foregoing theory, as a result, it can be stated that the gear ratio to be used in winding a given universal coil is determined by three factors:

- (1) The diameter d of the dowel or tube on which the coil is to be wound;
- (2) The cam throw c ;
- (3) The nominal diameter δ of the wire.

The first step in the calculation of the gear ratio is the selection of the quantity n . The latter is determined from the value calculated according to (18) by selecting *the nearest integer or integer plus a simple fraction, which is less than this calculated value*.

The second step is the determination of q , either by drawing the winding pattern and actually counting the number of crossovers per winding cycle, or by means of one of the special rules given above.

The third step is to calculate the numerical value of r

⁵ This rule is the equivalent of a relation first pointed out by Hershey, footnote reference 2.

either from (8), (9), and (10), if a high degree of accuracy is required, or the approximate formula (12).

The fourth and last step is to translate the resulting numerical value into the actual number of teeth of the corresponding gears.

This can be done by means of the slide rule as Hershey points out, or better by means of a table of *reciprocals*, which is usually part of sets of numerical tables.⁶

V. TABLE OF GEAR-RATIO FORMULAS

For convenience there is given, in Table I, gear-ratio formulas for frequently occurring values of n , that is, number of crossovers per turn. This table is based on the *approximate* formula for the gear ratio, namely, (12). In the table δ represents the nominal diameter of the wire in inches, and c the cam throw, also in inches. The gear-ratio formula gives the ratio of the number of teeth in the cam gear to the number of teeth in the driving gear. The values of q are included for reference. The value of n is, of course, determined from (18).

TABLE I
GEAR-RATIO FORMULAS

n	Gear Ratio	q
1	$2 (1 \pm 0.625 \delta/c)$	2
2	$1 (1 \pm 0.625 \delta/c)$	2
3	$\frac{2}{3} (1 \pm 0.208 \delta/c)$	6
4	$\frac{1}{2} (1 \pm 0.313 \delta/c)$	4
$1\frac{1}{2}$	$\frac{3}{2} (1 \pm 0.313 \delta/c)$	4
$1\frac{1}{3}$	$\frac{4}{3} (1 \pm 0.208 \delta/c)$	6
$2\frac{1}{3}$	$\frac{6}{7} (1 \pm 0.0893 \delta/c)$	14
$2\frac{1}{5}$	$\frac{4}{5} (1 \pm 0.125 \delta/c)$	10

VI. DETAILS OF THE MATHEMATICAL SOLUTION OF THE FUNDAMENTAL EQUATIONS

From trigonometry and (4), we have

$$1/\cos \phi = (1 + \tan^2 \phi)^{1/2} = [1 + (\pi d/2c)^2 r^2]^{1/2}. \quad (21)$$

Next if we substitute in (5) for h its value as found from (6), and furthermore transpose one term, we obtain

$$c \tan \phi - (\pi d/n) = \pm s/q \cos \phi. \quad (22)$$

After squaring both sides of (22), substituting therein for $\tan \phi$ and $\cos \phi$ their values as given by (4) and (21), respectively, and rearranging, there results

$$r^2(1 - a^2) - (4r/n) + 4/n^2(1 - b^2) = 0 \quad (23)$$

wherein a and b are as defined by (8) and (9). Equation (23) can be solved as a quadratic in r , to yield the result given by (7).

⁶ See, for example, "Mathematical Tables from Handbook of Chemistry and Physics," Chemical Rubber Publishing Company, Cleveland, Ohio, 1936; "Logarithmic and Trigonometric Tables," The Macmillan Company, New York, N. Y.

Analysis of Voltage-Regulator Operation*

W. R. HILL, JR.†, MEMBER, I.R.E.

Summary—The performance of any regulator circuit is analyzed in terms of two parameters defined as the internal resistance and the regulation factor. These two parameters together with a simple equivalent circuit permit calculation of the regulator performance in conjunction with any load circuit and direct-current supply. Typical regulator circuits are analyzed to evaluate the two parameters and to show the effect of circuit changes in improving regulator performance. A compensated circuit is presented which makes it possible to provide an output voltage that is substantially independent of any input-voltage or load-current change.

PRINCIPAL SYMBOLS

Instantaneous values of alternating components

e_c = glow-tube plate-to-cathode voltage
 e_g = grid-to-cathode voltage
 e_p = plate-to-cathode voltage
 e_r = regulator output voltage
 e_s = regulator input voltage
 i_p = plate current
 i_r = regulator output current
 i_s = regulator input current

Instantaneous total values

e_i = regulator input voltage
 e_o = regulator output voltage
 i_i = regulator input current
 i_o = regulator output current

Effective values of alternating components

E_g = open-circuit rectifier supply voltage
 E_r = regulator output voltage
 E_s = regulator input voltage
 I_r = regulator output current
 I_s = regulator input current

Average values

E_c = glow-tube plate-to-cathode voltage
 E_i = regulator input voltage
 E_o = regulator output voltage
 I_i = regulator input current
 I_o = regulator output current

Parameters

g_m = grid-plate transconductance, mhos
 r = internal resistance of regulator at output terminals, ohms
 \mathcal{R} = regulator regulation factor
 r_p = plate resistance, ohms
 Z_L = load impedance presented to regulator, ohms
 Z_g = internal impedance of supply rectifier, ohms
 μ = amplification factor
 ω = angular velocity, radians per second

* Decimal classification: R140×621.375.1. Original manuscript received by the Institute, July 10, 1944.

† University of Washington, Seattle 5, Wash.

THE increasing use of electronic regulator circuits has led to the need for an analysis of regulator-circuit performance to assist in the design of regulator circuits for best regulation and to permit calculation of the regulator performance when used in conjunction with a given rectifier and load.

The following analysis shows that the performance of any regulator circuit can be predicted by the use of two factors, one defined as the internal resistance and the other defined as the regulation factor of the regulating circuit. These factors are dependent upon the configuration of the regulating circuit, and by proper design can be made substantially equal to zero, in which case the output voltage of the circuit is not materially affected by either the input voltage or the load current. The analysis of regulator operation in terms of two parameters was suggested by Hunt and Hickman¹ in 1939. The present article extends this analysis to the use of equivalent circuits and alternating components familiar to the communications engineer.

GENERAL ANALYSIS

The output voltage of a regulator circuit is an approximately linear function of the input voltage and the output current. This may be expressed by the following relations:

$$e_o = a + be_i + ci_o \quad (1)$$

where a , b , and c are constants to be investigated. In practice an analysis based on the assumption of linear operation gives results that are accurate for any particular point on the operating curve of the circuit, but which for engineering purposes can be applied to the whole useful range of regulator operation.

Constant a of (1) is determined by the output-voltage setting of the regulator circuit. Since it contains no information concerning the performance of the circuit under changes of load or input voltage, it is of no interest in predicting the regulation of circuit. The nature of b can be determined by taking the partial derivative of e_o with respect to e_i . This gives

$$b = \partial e_o / \partial e_i = \mathcal{R} \quad (2)$$

which will be defined as the regulation factor of the circuit. Symbol \mathcal{R} will be used for this term. This factor is a measure of the effectiveness of the regulating circuit in reducing the effect of input-voltage variations on the output voltage.

Taking the partial of e_o with respect to i_o gives

$$c = \partial e_o / \partial i_o = -r \quad (3)$$

where r is defined as the internal resistance of the regulating circuit. The negative sign takes account of the

¹ F. V. Hunt and R. W. Hickman, "On electronic voltage stabilizers," *Rev. Sci. Instr.*, vol. 10, p. 6; January, 1939.

fact that an increase in output current normally produces a decrease in output voltage which is imagined to be produced by the voltage drop in a positive internal resistance.

Placing the newly defined factors into expression (1) the following is obtained:

$$e_0 = a + \mathcal{R}e_i - i_0r. \quad (4)$$

For e_0 to be independent of input-voltage and load-current variations it is apparent that both the regulation factor \mathcal{R} and the internal resistance r of the circuit should be as small as possible.

In analyzing the stability of a regulator circuit it is the variations of voltage and current that are of interest. Consequently, it is convenient to consider each of the variables of (4) as consisting of a steady-state or direct-current value plus a number of alternating components that go to make up the complex variation under study. Application of the superposition theorem then permits the analysis to be carried out for each component alone. Rewriting (4) in terms of a steady-state value and single component

$$E_0 + E_{r \max} \sin \omega t = a + \mathcal{R}E_i + \mathcal{R}E_{s \max} \sin (\omega t + \theta_s) - rI_0 - rI_{r \max} \sin (\omega t + \theta_r). \quad (5)$$

Under steady-state conditions the alternating components are zero so that

$$E_0 = a + \mathcal{R}E_i - rI_0.$$

Therefore,

$$E_{r \max} \sin \omega t = \mathcal{R}E_{s \max} \sin (\omega t + \theta_s) - rI_{r \max} \sin (\omega t + \theta_r).$$

Rewriting this in terms of effective vector values

$$E_r = \mathcal{R}E_s - rI_r. \quad (6)$$

A schematic circuit showing the supply rectifier, the regulator, and the load impedance is shown in Fig. 1.

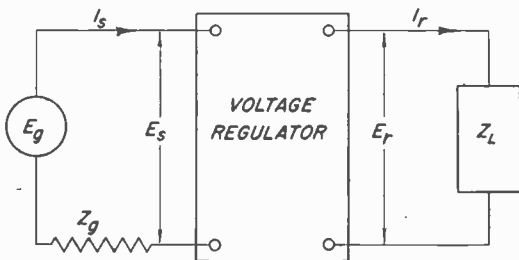

Fig. 1—Equivalent circuit of regulating system.

By Thevenin's theorem the rectifier is represented as a single voltage and internal impedance for each frequency component of the input voltage. For slow variations, such as those caused by line-voltage changes, Z_g is equal to the direct-current internal resistance of the rectifier; i.e., the slope of the voltage-current characteristic. For ripple- and higher-frequency components Z_g is practically equal to the reactance of the output condenser of the filter system.

It is now possible to eliminate E_s from (6) by substituting the relation

$$E_s = E_g - I_s Z_g.$$

This gives as a result

$$E_r = \mathcal{R}E_g - \mathcal{R}I_s Z_g - rI_r. \quad (7)$$

This relation can be simplified by taking advantage of the fact that in practical regulator circuits the input and output current changes are nearly equal. $I_s = I_r$. Although this is not strictly true it can be made almost exactly so by considering any impedances in the regulator that shunt the input or output terminals as part of impedances Z_g or Z_L . For most engineering purposes this refinement is not necessary. With this simplification, (7) becomes

$$E_r = \mathcal{R}E_g - I_r(\mathcal{R}Z_g + r). \quad (8)$$

This relation is important because it can be represented by the simple equivalent circuit shown in Fig. 2.

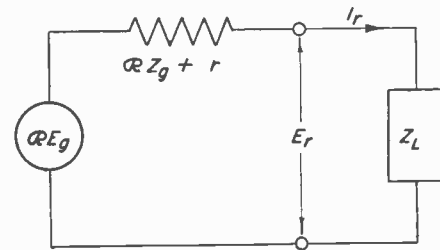

Fig. 2—Simplified equivalent circuit of regulating system.

Using the circuit of Fig. 2 it is easy to compute the over-all regulation of the circuit which will be defined as E_r/E_g . This can be written from an inspection of the circuit as

$$\text{over-all circuit regulation} = \mathcal{R}Z_L / (Z_L + \mathcal{R}Z_g + r). \quad (9)$$

In a well-designed regulator, factor \mathcal{R} is much smaller than unity and the internal resistance r is small compared to Z_L . Consequently, the over-all regulation is equal to the regulation factor \mathcal{R} within a few per cent. If the regulator output is shunted with a condenser, however, Z_L may become very small for high frequencies with a consequent improvement in the regulation for high-frequency components. Ordinarily the rectifier-filter system removes all but low-frequency components from the regulator input so that the regulation of the system for high-frequency input variations is of secondary concern.

Another characteristic of importance is the internal impedance of the regulator appearing between the output terminals. Inspection of Fig. 2 shows this impedance to be

$$\text{regulator output impedance} = Z_r = \mathcal{R}Z_g + r. \quad (10)$$

The factors $\mathcal{R}Z_g$ and r are usually comparable in magnitude for low-frequency variations where Z_g is equal to the internal direct-current resistance of the rectifier. For higher frequencies where Z_g is smaller (approximately equal to the filter output condenser reactance) the regulator output impedance is practically equal to r .

A knowledge of this output impedance is of importance in predicting the stability of the regulator output voltage under conditions of changing load, either slow changes or high-frequency changes due to alternating-current components drawn by a vacuum-tube amplifier load. With normal circuits, impedance Z_r is less than 10

ohms so that a regulator is more effective than large amounts of capacitance in reducing the low-frequency supply impedance presented to an amplifier.

No restriction has yet been placed on the nature of factors \mathcal{R} and r . Both factors are pure numbers up to frequencies where stray circuit capacitance and ionization delay in the gas tube cause phase shifts to take place. For normal circuits this covers a range extending from zero frequency through the audio-frequency band. Above this range the factors become complex quantities which can be measured for predicting the regulator performance through the use of Fig. 2 and (9) and (10).

The following analysis of factors \mathcal{R} and r is restricted to the frequency range in which they appear as real quantities although many of the conclusions drawn are essentially correct outside of this range.

ANALYSIS OF SPECIFIC CIRCUITS

An analysis of several typical regulator circuits will now be carried out to determine the regulation factor and the internal resistance of each. In this way it is possible to show clearly the effect of circuit arrangement and choice of circuit components on the magnitude of these factors. Reference to Fig. 2 indicates that the most desirable circuit is one possessing the smallest value of internal resistance and regulation factor, because changes in input voltage and output current will then have the least effect on the output voltage.

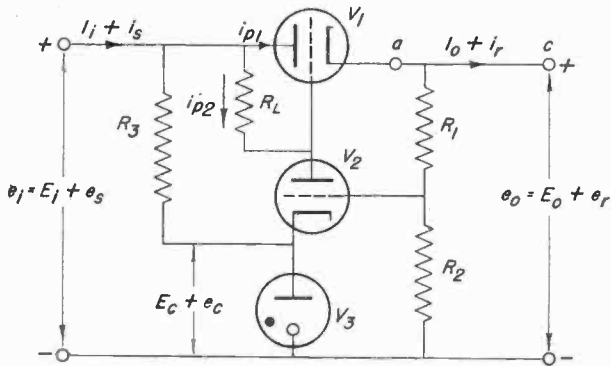

Fig. 3—Typical regulator circuit.

A typical regulator circuit commonly employed is that shown in Fig. 3. This circuit consists of a gas-filled, voltage-regulator tube V_3 to provide a constant reference voltage, a dividing network to obtain a fraction of the output voltage for comparison with the reference, an amplifier V_2 to observe and amplify the difference between the reference and the output, and a control tube V_1 which can be thought of as a variable resistance to take up the difference between the input and output voltages. Resistor R_3 in this circuit serves as a bleeder to bring the total current passing through the regulator tube to a suitable value near the middle of its operating characteristic.

Analysis of Fig. 3 for r

In obtaining an expression for the internal resistance

each of the voltages and currents in the circuit will be considered to consist of a steady-state and an alternating component, as indicated on the diagram. The analysis will then proceed using only the alternating components similar to amplifier analysis.

As defined in (3), $r = -\partial e_o / \partial i_o$. In terms of alternating components shown in Fig. 3, this can be stated

$$r = (-e_r / i_r) |_{e_s=0} \tag{11}$$

To find r , then, it is necessary to find the relation between e_r and i_r , required by the regulator circuit. This will now be done.

Voltage e_r produces a grid-to-cathode voltage change at V_2 of magnitude

$$e_{g2} = P e_r - i_{p2} R_c \tag{12}$$

where P represents $R_2 / (R_1 + R_2)$ to simplify the writing, i_{p2} is the alternating component of plate current of V_2 , and R_c is the internal resistance of the gas-filled tube, i.e., the slope of the voltage-current characteristic at the operating point. This is not a negligible resistance, being of the order of several hundred ohms. Voltage e_{g2} causes a plate-current change $i_{p2} = (\mu_2 e_{g2}) / (r_{p2} + R_L)$ where the effect on i_{p2} of the small change in plate-to-cathode voltage caused by the drop in R_c has been neglected. This produces an error of less than 0.5 per cent in typical circuits. Eliminating i_{p2} from (12)

$$e_{g2} = P e_r / (1 + (\mu_2 R_c) / (r_{p2} + R_L)).$$

Voltage e_{g2} produces an amplified voltage at the plate of V_2

$$e_{p2} = -A e_{g2} = - (A P e_r) / Q$$

where A is the expression for the amplification of a triode, $\mu_2 R_L / (r_{p2} + R_L)$ and $Q = 1 + (\mu_2 R_c) / (r_{p2} + R_L)$. The net grid-to-cathode voltage at V_1 is

$$e_{g1} = e_{p2} - e_r = -e_r [1 + P A / Q].$$

At tube V_1

$$i_{p1} = (\mu_1 e_{g1} + e_{p1}) / r_{p1} \tag{13}$$

But, since the input voltage is held constant as required by (11)

$$e_{p1} = -e_r.$$

Substituting in (13) for e_{g1} and e_{p1}

$$i_{p1} = (-\mu_1 e_r [1 + P A / Q] - e_r) / r_{p1} \tag{14}$$

By neglecting the small current change through R_1 and R_2 (a few microamperes in a practical circuit) the current i_r can be substituted for i_{p1} . For circuits where this approximation cannot be allowed, a rigorous approach is to consider terminals a and b as the regulator terminals. Then, having computed the internal resistance between a and b , the impedance appearing between b and c is equal to the a - b value in parallel with any shunt impedances connected between b and c .

Substituting i_r for i_{p1} in (14) provides an expression that can be solved for the ratio e_r / i_r . Performing this operation

$$-r = \frac{e_r}{i_r} = -1 / \left(\frac{\mu_1}{r_{p1}} \left[1 + \frac{P A}{Q} \right] + \frac{1}{r_{p1}} \right).$$

Replacing P , Q , and A by their equivalent expressions and substituting g_{m1} for μ_1/r_{p1} the final expression is obtained for the internal resistance r .

$$r = 1 / \left(g_{m1} \left[1 + \frac{R_2}{R_1 + R_2} \left(\frac{\mu_2 R_L}{r_{p2} + R_L} \right) \frac{1}{1 + \mu_2 R_c / (r_{p2} + R_L)} \right] + \frac{1}{r_{p1}} \right). \quad (15)$$

Investigation of the expression for r shows that to obtain a small internal resistance the transconductance of V_1 should be as large as possible. This substantiates the common use of 2A3s in regulator circuits. Factors μ_1 and r_{p1} are secondary considerations. The ratio $R_2/(R_1+R_2)$ should be as large as possible. Since this ratio is nearly equal to the ratio E_c/E_0 this indicates that the constant-voltage regulator tube should be rated for a voltage that is a large fraction of the output voltage. However, E_0 must be small enough to permit forcing the grid of V_1 sufficiently negative to afford proper control so that the ratio $R_2/(R_1+R_2)$ can seldom exceed 0.5. Factor $\mu_2 R_L/(R_{p2}+R_L)$ which represents the amplification of V_2 should be as high as possible so that the use of high- μ triodes or pentodes for V_2 is indicated. Supply of constant screen voltage for the pentode, however, increases the complexity of the circuit, and the extra gain is not always justified. The internal resistance R_c of the gas-filled tube should be as small as possible; this is mainly a matter of tube selection.

A sample computation for the circuit of Fig. 3 will serve to indicate the value of internal resistance that can be obtained with typical circuit constants. The circuit components selected are as follows:

- V_1 = triode-connected, type 6L6, $g_{m1} = 0.0047$ mho,
- $r_{p1} = 1700$ ohms, $\mu_1 = 8$
- V_2 = type 6SF5, $\mu_2 = 100$, $r_{p2} = 70,000$ ohms
- V_3 = type 150/30, $E_c = 150$ volts, $R_c = 370$ ohms
- $R_L = 250,000$ ohms
- $R_1 = R_2 = 100,000$ ohms
- $R_3 = 25,000$ ohms
- $E_1 = 500$ volts
- $E_0 = 300$ volts

Substitution of these values into (14) gives

$$r = 1 / \left(0.0047 \left[1 + \frac{1}{2} \left(\frac{100(250)}{320} \right) \frac{1}{1 + 100(0.37)/320} \right] + 0.00059 \right) = 5.9.$$

The measured value of the internal resistance for this circuit using commercial tubes and resistors was 5.3 ohms at 75 milliamperes output and 6.7 ohms at 40 milliamperes output. The change is due primarily to the change in transconductance of V_1 with plate current.

Analysis of Fig. 3 for \mathcal{R}

In terms of alternating components the expression for \mathcal{R} in (2) is

$$\mathcal{R} = e_r/e_s \Big|_{i_r=0}. \quad (16)$$

Fig. 3 will now be analyzed to determine the ratio e_r/e_s . Across the gas tube V_3 two components of voltage will appear, one caused by the change e_s and the other by the current i_{p2} .

$$e_c = S e_s + i_{p2} R_c$$

where S is the ratio $R_c/(R_c+R_3)$ to simplify the writing. The net grid-to-cathode voltage e_{g2} at V_2 caused by e_s and e_r is then

$$e_{g2} - P e_r = S e_s - i_{p2} R_c. \quad (17)$$

This grid voltage together with e_s produces a plate current i_{p2} .

$$i_{p2} = (\mu_2 e_{g2} + e_s) / (r_{p2} + R_L). \quad (18)$$

In (18) the small effect of e_c on i_{p2} has been neglected. Substituting (17) into (18) and solving for i_{p2}

$$i_{p2} = \frac{\left[\frac{\mu_2 P e_r}{r_{p2} + R_L} + \left(\frac{1 - S \mu_2}{r_{p2} + R_L} \right) e_s \right]}{1 + (\mu_2 R_c / (r_{p2} + R_L))}.$$

At V_1 the grid-to-cathode voltage e_{g1} is given by the relation $e_{g1} = e_s - i_{p2} R_L - e_r$. Substituting for i_{p2} and denoting $1 + (\mu_2 R_c / (r_{p2} + R_L))$ by Q

$$e_{g1} = \left[1 - \frac{(1 - S \mu_2) R_L}{Q(r_{p2} + R_L)} \right] e_s - \left[1 + \frac{P A}{Q} \right] e_r. \quad (19)$$

The varying component of plate voltage of V_1 is the difference between e_s and e_r .

$$e_{p1} = e_s - e_r.$$

Also e_{p1} and e_{g1} are related by the factor μ_1 if i_{p1} is zero. Since i_r must equal zero to satisfy (16), and i_{p1} differs from i_r only by the negligibly small current through R_1 and R_2 , this is closely true. Hence

$$e_{p1} = -\mu_1 e_{g1} = e_s - e_r. \quad (20)$$

Substituting the value of e_{g1} from (19) into (20) and solving for the ratio of e_r/e_s the regulation factor is obtained.

$$\frac{e_r}{e_s} = \frac{1 + \mu_1 [1 - (1 - S \mu_2) R_L / Q(r_{p2} + R_L)]}{1 + \mu_1 [1 + P A / Q]} = \mathcal{R}.$$

Replacing A , P , Q , and S by their equivalent expressions

$$\mathcal{R} = \frac{1 + \mu_1 \left[1 - \left\{ \frac{(1 - \mu_2 R_c / (R_c + R_3)) R_L}{r_{p2} + R_L} \right\} \cdot \left\{ \frac{1}{1 + \mu_2 R_c / (r_{p2} + R_L)} \right\} \right]}{1 + \mu_1 \left[1 + \frac{R_2}{R_1 + R_2} \left(\frac{\mu_2 R_L}{r_{p2} + R_L} \right) \frac{1}{1 + \mu_2 R_c / (r_{p2} + R_L)} \right]}. \quad (21)$$

A study of (21) shows that to obtain the smallest regulation factor the amplification factor μ_1 of V_1 should be several times larger than unity, but that large values of μ_1 are of little benefit. This fits nicely with the requirement that the transconductance of V_1 be as high as possible to insure a low value of r . Again the value of $R_2(R_1 + R_2)$ should be as large as possible consistent with other circuit requirements, and the amplification of

$$r = 1 / \left(g_{m1} \left[1 + \left(\frac{R_2}{R_1 + R_2} - \frac{R_c}{R_3 + R_c} \right) \frac{\mu_2 R_L}{r_{p2} + R_L} \frac{1}{1 + \mu_2 R_c / (r_{p2} + R_L)} \right] + \frac{1}{r_{p1}} \right). \quad (23)$$

V_2 should be made high. One serious defect of the circuit is that the input-voltage variation e_s produces an appreciable voltage change e_c across V_3 . This is reflected in (21) by the factor $\mu_2 R_c / (R_c + R_3)$ in the numerator. The value of \mathcal{R} for the circuit of Fig. 3 using the circuit constants previously listed is

$$\mathcal{R} = \frac{1 + 8[1 - (1 - 1.46)250/320(1.115)]}{1 + 8[1 + (0.5)(78.2)1/1.115]} = 0.04.$$

The experimentally determined regulation factor for this circuit was 0.042 which checks closely with the computed value.

Improved Regulator Circuit

A regulation factor of 0.04 does not represent particularly good regulation, and a great improvement can be made by obtaining the operating current for the regulator tube V_3 from the regulated output rather than

$$\mathcal{R} = 1 / \left(1 + \frac{\mu_1 R_L}{r_{p2} + R_L} \left[1 + \mu_2 \left(\frac{R_2}{R_1 + R_2} - \frac{R_c}{R_3 + R_c} \right) \frac{1}{1 + \mu_2 R_c / (r_{p2} + R_L)} \right] \right). \quad (24)$$

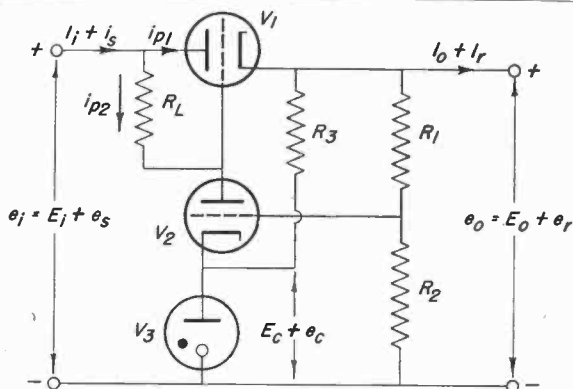

Fig. 4—Improved regulator circuit.

from the input. This circuit change is shown in Fig. 4.

The regulation factor derived in the appendix for this circuit is given by the expression

$$\mathcal{R} = \frac{1 + \mu_1 [1 - (R_L / (r_{p2} + R_L)) \cdot 1 / (1 + \mu_2 R_c / (r_{p2} + R_L))]}{1 + \mu_1 \left[1 + \frac{\mu_2 R_L}{r_{p2} + R_L} \left(\frac{R_2}{R_1 + R_2} - \frac{R_c}{R_3 + R_c} \right) \frac{1}{1 + \mu_2 R_c / (r_{p2} + R_L)} \right]}. \quad (22)$$

Inserting the previously used circuit values (R_3 changed to 12,000 ohms to provide proper operating current) gives a value for the regulation factor of 0.0124. The measured value for the circuit was 0.012. This represents

an improvement of three to one obtained by a simple circuit change. Although placing R_3 at the output reduces the available output current by using part of the allowable capacity of V_1 , the current drain can be made reasonably small by suitable selection of V_3 and R_3 .

The circuit change has only a slightly detrimental effect on the internal resistance, as shown by the following expression for the internal resistance.

The computed internal resistance for Fig. 4 is 6.25 ohms, as compared with 5.9 ohms for Fig. 3. This slight increase in internal resistance is a small price to pay for the greatly improved regulation factor obtained.

An additional improvement in regulation can be obtained by connecting resistance R_L to the output side of the circuit. The reason for this is that an input-voltage increase must produce a voltage decrease at the grid of V_1 in order to hold the output voltage approximately constant. This decrease is caused by the increase in plate current of V_2 through R_L . However, part of this IR drop must be spent in counteracting the input-voltage increase so that only the remaining fraction is effective at the grid of V_2 . The effect on the regulation is the same as though the amplification of V_2 were decreased. The expression for the regulation factor with this circuit change is as follows.

Unfortunately, however, this circuit change requires that V_2 operate in the region of cutoff, since at one end of the operating range the grid bias of V_1 and consequently the plate current of V_2 must approach zero. An estimate of the grid bias required at V_1 for an output current of 40 milliamperes shows that the plate current of V_2 is only 0.06 milliamperes, at which value the plate resistance of the 6SF5 rises to 500,000 ohms. Computation of \mathcal{R} under these conditions gives 0.0087 which checks closely with the measured value of 0.0093. Comparison with the value of regulation factor obtained for Fig. 4 (0.0124) shows the improvement to be unimportant. Coupled with this is the disadvantage that V_2 is operating on an excessively curved portion of its characteristic. This results in an undesirably large variation of internal resistance and regulation factor over the operating range of the circuit.

Compensated Regulator Circuit

Inspection of (22) and (23) for the regulation factor and internal resistance of Fig. 4 shows that, V_1 and V_3 having been chosen, the most important factor affecting

the value of \mathcal{R} and r is the amplification provided by V_2 . This suggests the use of a high- μ triode or pentode for V_2 or even the use of several tubes in cascade. However, this only results in decreasing the two factors in proportion to the effort expended in increasing the amplification; it still is not possible to make them zero. The reason for this is that the information regarding the correction comes from the output voltage only; the output voltage must change in order to provide the correcting voltage to counteract that change. Consequently, it is impossible to prevent fluctuation in the output voltage.

To eliminate output voltage changes due to input-voltage fluctuations it is necessary to obtain the information from the input circuit, since this is the source of the variation that must be eliminated. Likewise, to eliminate output-voltage fluctuations caused by load-current changes, it is necessary to obtain the correction voltage from the load current. If this is done it is then theoretically possible to select the circuit constants such that both factors \mathcal{R} and r are equal to zero or, if desired, actually negative.

The modification of Fig. 4 required to compensate for input-voltage and load-current fluctuations is shown by Fig. 5. Resistors R_4 and R_5 in this circuit serve as a

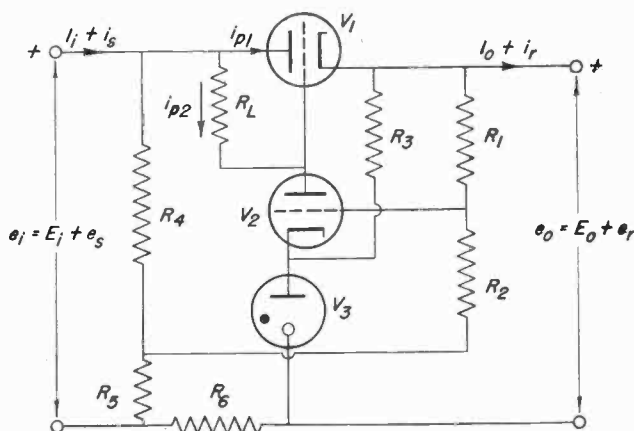

Fig. 5—Compensated regulator circuit.

voltage divider across the input that applies a fraction of the input-voltage change to the grid of V_2 for the purpose of correcting for input-voltage variations. Resistor R_6 provides a voltage drop proportional to the load current which is then applied to the grid of V_2 through the R_4 – R_5 and R_2 – R_1 networks. Proper adjustment of R_6 makes E_0 substantially independent of the load current and thus reduces factor r to zero.

An analysis of the circuit of Fig. 5 shows that for a zero regulation factor the following relation must exist between resistors² R_4 and R_5

$$\frac{R_5}{R_4 + R_5} = \frac{(1 + 1/\mu_1)(1 + \mu_2 R_c / (r_{p2} + R_L))}{(R_1 / (R_1 + R_2))(\mu_2 R_L / (r_{p2} + R_L)) - \frac{R_1 + R_2}{\mu_2 R_1}} \quad (25)$$

² See Appendix.

This is normally a small ratio so that R_5 is much smaller than R_4 . Using the same circuit components as those of Fig. 4 the computed value of the ratio required by (25) was 0.012. In the experimental circuit with R_4 equal to 100,000 ohms, R_5 was adjusted until zero regulation factor was obtained. Measurement of R_5 showed a value of 1160 ohms. Computing the ratio $R_5 / (R_4 + R_5)$

$$R_5 / (R_4 + R_5) = 1160 / 101160 = 0.0115.$$

This agrees with the computed value.

In practice it is convenient to make R_5 adjustable so that it can be set experimentally to the correct value. A convenient method of making this adjustment is to load the regulator with a resistance and connect an oscilloscope across the output terminals. Resistor R_5 is then adjusted until the output ripple is reduced to zero. If the regulator-input ripple is insufficient for this purpose, a few volts of ripple can be temporarily introduced at the input.

The internal resistance of the regulator circuit is controlled by R_6 . For zero internal resistance²

$$R_6 = \frac{1 + \mu_2 R_c}{r_{p2} + R_L} \left(g_{m1} \left(\frac{\mu_2 R_L}{r_{p2} + R_L} \right) \left(\frac{R_1}{R_1 + R_2} \right) \right) \quad (26)$$

The value of R_6 is usually less than 10 ohms, so that it is practicable to introduce it into the circuit as shown in Fig. 5. This requires that the negative return of the rectifier circuit be isolated from ground. The voltage drop across R_6 , however, is so small that this involves no insulation problems. Likewise R_6 is so much smaller than the shunting impedance presented by the rectifier-circuit capacitance to ground that no trouble is experienced from this source. The computed value of R_6 for a circuit having the constants previously listed is 6.05 ohms. The experimentally determined value for the circuit was 7.0 ohms at a load of 40 milliamperes. Part of the discrepancy between computed and measured values is due to the difficulty of accurately measuring the regulator internal impedance of less than an ohm in the presence of the direct-current output voltage.

The circuit analysis presented is based on the assumption that the behavior of the circuit is linear. This is not exactly true because of the curvature of the vacuum-tube characteristics. As a result the regulation factor and internal resistance actually vary over the operating range of the circuit. Consequently, the performance of the circuit of Fig. 5 is not so perfect as might be inferred from the existence of (25) and (26) for making both the regulation factor and internal resistance equal to zero. Both factors can be set at zero for any particular point on the operating curve, but at other points they will not be zero. The magnitude of this variation can best be shown by the curves of Figs. 6 and 7.

Fig. 6 shows the effect of input voltage on output voltage with R_5 set for best regulation near the middle of the useful operating range. A corresponding curve

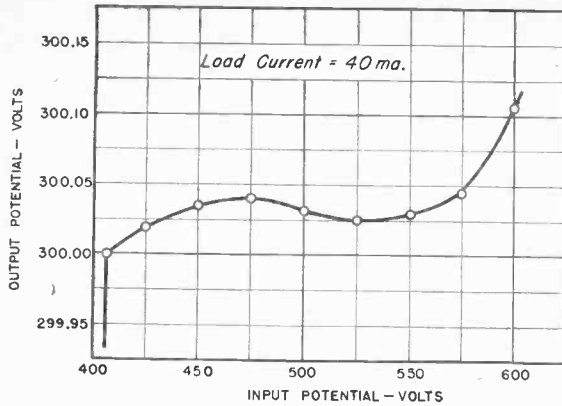

Fig. 6—Performance of compensated regulator.

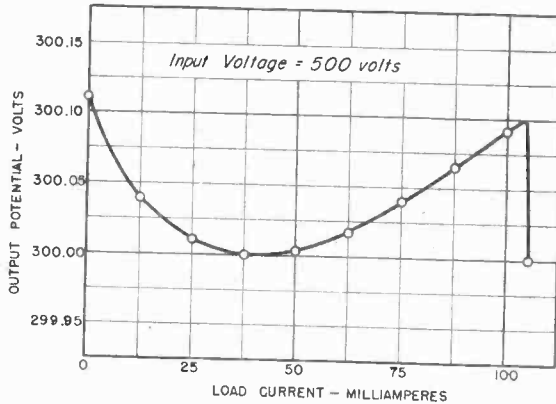

Fig. 7—Performance of compensated regulator.

showing the effect of output current on output voltage is given by Fig. 7. Both curves indicate that it is possible to maintain the output-voltage constant to within 0.1 volt over a large range of input-voltage and load-current variations. Both curves were taken with a cathode-ray oscilloscope by changing the variable under test at a 60-cycle rate. The long-time stability of the circuit is less, because of temperature changes of the resistor and tubes and aging of the gas tube. Selection of low-temperature-coefficient resistors will reduce trouble from this source but expansion of the vacuum-tube elements also affects the stability; in one circuit a suddenly applied load tending to heat V_1 produced a gradual change in voltage of about 0.1 volt over a period of 10 seconds. Temperature changes also affect the gas-tube voltage drop considerably but stable operation is usually reached after several minutes of operation. There is no assurance, however, that the gas tube will operate in exactly the same fashion after each firing. At times the operation of removing and reapplying the input voltage will result in a change of as much as a volt in the output potential. This is especially likely to happen when the gas tube is operated near a critical point in the operating curve where the glow discharge shifts from one area of the cathode to another. This shift usually results in a slight discontinuity of the voltage-current characteristic for the tube. Operation near this point should be avoided.

It should be observed that with R_6 set for best average performance of the circuit the internal resistance may

be negative over part of the range. If the resistive component of the load impedance is smaller than the negative internal resistance of the regulator at some frequency oscillations will occur. This is invariably the case when the output of the regulator is shunted with a condenser. If the use of a condenser in shunt with the output is desired, R_6 must be so set that the internal resistance is positive at all points on the operating curve.

APPENDIX

ANALYSIS OF COMPENSATED CIRCUIT

Analysis of Fig. 5 for \mathcal{R}

In terms of alternating components the expression for \mathcal{R} in (2) is

$$\mathcal{R} = e_r/e_s \Big|_{i_r=0} \quad (27)$$

Across the gas tube V_3 two alternating components of voltage will appear, one caused by e_r and the other by the plate current i_{p2} .

$$e_c = S e_r + i_{p2} R_c$$

where S is the ratio $R_c/(R_c + R_3)$ to simplify the writing. The net grid-to-cathode voltage e_{g2} caused by e_s and e_r is then the result of three components, a change proportional to e_r , a change proportional to e_s provided by the drop across R_5 , and the change in voltage, e_c . Thus

$$e_{g2} = P e_r + (U)(V) e_s - (S e_r + i_{p2} R_c)$$

where $P = (R_2 + R_5 + R_6)/(R_1 + R_2 + R_5 + R_6)$,

$U = R_1/(R_1 + R_2)$, and $V = R_5/(R_4 + R_5)$. In practical circuits R_5 and R_6 are so much smaller than R_1 and R_2 that they can be neglected in the computation of P . This makes $P = R_2/(R_1 + R_2)$ as previously defined. The expression for V is an approximation, in that R_5 should be replaced by the value of R_5 in parallel with $R_1 + R_2$. Since the sum $(R_1 + R_2)$ is usually several hundred times R_5 , the error is negligible.

Combining terms

$$e_{g2} = (P - S) e_r + UV e_s - i_{p2} R_c \quad (28)$$

This grid voltage together with the input voltage e_s produces a plate current

$$i_{p2} = (\mu_2 e_{g2} + e_s)/(r_{p2} + R_L) \quad (29)$$

The small effect of e_c on i_{p2} has been neglected as in the previous analysis. Substituting (28) into (29) and solving for i_{p2}

$$i_{p2} \left[1 + \frac{\mu_2 R_c}{r_{p2} + R_L} \right] = \left[\frac{\mu_2 (P - S)}{r_{p2} + R_L} \right] e_r + \left[\frac{1 + \mu_2 UV}{r_{p2} + R_L} \right] e_s$$

Indicating the quantity $1 + \mu_2 R_c/(r_{p2} + R_L)$ by the term Q

$$i_{p2} = \left[\frac{\mu_2 (P - S)}{Q(r_{p2} + R_L)} \right] e_r + \left[\frac{1 + \mu_2 UV}{Q(r_{p2} + R_L)} \right] e_s \quad (30)$$

This plate current produces a net grid-to-cathode voltage at tube V_1

$$e_{g1} = e_s - i_{p2} R_L - e_r$$

Substituting from (30) for i_{p2}

$$e_{o1} = \left[1 - \frac{R_L}{Q} \left(\frac{1 + \mu_2 UV}{r_{p2} + R_L} \right) \right] e_s - \left[1 + \frac{A(P - S)}{Q} \right] e_r \quad (31)$$

where A represents the quantity $\mu_2 R_L / (r_{p2} + R_L)$.

Equation (27) on which this analysis is based states that i_r is zero. By neglecting the current change through R_1 and R_3 as justified in derivation of (15) $i_{p1} = i_r = 0$. For constant plate current in V_1

$$e_{p1} = e_s - e_r = -\mu_1 e_{o1}$$

Substituting from (31) for e_{o1} and combining terms

$$\mathcal{R} = \frac{e_r}{e_s} = \frac{1 + \mu_1 \left[1 - (R_L(1 + \mu_2 UV)) / (Q(r_{p2} + R_L)) \right]}{1 + \mu_1 \left[1 + A(P - S) / Q \right]} \quad (32)$$

For the uncompensated circuit of Fig. 4, resistor R_6 is equal to zero and R_4 is infinite. This makes factor V equal to zero. Inserting this fact and replacing A , P , Q , and S by their equivalents results in the expression (22) given for the regulation factor of Fig. 4.

For the compensated circuit it is desired to obtain zero regulation factor. Since P is larger than S the denominator of (32) is finite so that the numerator must equal zero to reduce \mathcal{R} to zero. Setting the numerator of (32) to zero and solving for V

$$V = ((1 + 1/\mu_1)(Q)(r_{p2} + R_L) / (\mu_2 R_L U) - 1) / U \mu_2$$

Solution is made for V because the other factors are determined by the choice of tubes, circuit constants, and operating voltages, whereas the ratio between R_4 and R_6 which determines V can be set at any required value to obtain zero regulation. Substituting for Q , U , and V their equivalent expressions, the final expression for the establishment of zero regulation factor is obtained.

$$\frac{R_6}{R_4 + R_6} = \frac{(1 + 1/\mu_1)(1 + \mu_2 R_c / (r_{p2} + R_L))}{(R_1 / (R_1 + R_2))(\mu_2 R_L / (r_{p2} + R_L)) - \frac{R_1 + R_2}{\mu_2 R_1}} \quad (33)$$

Analysis of Fig. 5 for r

In terms of alternating components, the expression for r in (3) is

$$r = -e_r / i_r \Big|_{e_s=0} \quad (34)$$

Across V_2 two alternating components of voltage will appear, one caused by e_r acting through R_3 , and the other by the plate current i_{p2} .

$$e_c = S e_r + i_{p2} R_c$$

where S is the ratio $R_c / (R_c + R_3)$. The net grid-to-

cathode voltage e_{o2} caused by e_r and by i_r flowing through R_6 is given by the expression

$$e_{o2} = P e_r - i_r R_6 U - (S e_r + i_{p2} R_c)$$

where P and U are as defined for (28). The approximation has been made that the current through R_6 is i_r , whereas it actually consists of $i_r + i_{p2}$. The error in making this simplification is usually less than 5 per cent.

Combining terms

$$e_{o2} = (P - S) e_r - i_r R_6 U - i_{p2} R_c \quad (35)$$

This grid voltage produces a change in plate current

$$i_{p2} = \mu_2 e_{o2} / (r_{p2} + R_L) \quad (36)$$

where the small effect of e_c on i_{p2} has been neglected as before. Combining (35) and (36) and solving for i_{p2}

$$i_{p2} = (\mu_2(P - S) e_r / (Q(r_{p2} + R_L))) - (\mu_2 R_6 U i_r / (Q(r_{p2} + R_L))) \quad (37)$$

where Q is as defined in (30).

At V_1 this plate-current change produces a net grid-to-cathode change of

$$e_{o1} = -i_{p2} R_L - e_r$$

Substituting for i_{p2}

$$e_{o1} = - \left[1 + (A(P - S) / Q) \right] e_r + (A U R_6 / Q) i_r \quad (38)$$

Neglecting the extremely small current changes in R_3 and R_1 , the plate current i_{p1} of V_1 is equal to i_r . Hence

$$i_r = i_{p1} = (\mu_1 e_{o1} - e_r) / r_{p1}$$

Substituting from (38) for e_{o1}

$$i_r = \frac{\mu_1 A U R_6}{r_{p1} Q} i_r - \left[\frac{1}{r_{p1}} + \frac{\mu_1}{r_{p1}} \left(1 + \frac{A(P - S)}{Q} \right) \right] e_r \quad (39)$$

Rearranging (39) and solving for the ratio $-e_r / i_r$, the expression for r is obtained.

$$r = -\frac{e_r}{i_r} = \frac{1 - (g_{m1} A U R_6 / Q)}{g_{m1} \left[1 + (A(P - S) / Q) \right] + 1 / r_{p1}} \quad (40)$$

The transconductance g_{m1} has been substituted for the ratio μ_1 / r_{p1} .

For the uncompensated circuit of Fig. 4 resistor R_6 is equal to zero. Inserting this value of R_6 into (40) and replacing A , P , Q , and S by their equivalent expressions results in (23) given for the internal resistance of Fig. 4.

For the compensated circuit it is desired to make the value of r equal to zero. To do this the numerator of (40) must equal zero. Setting the numerator of (40) equal to zero and solving for R_6

$$R_6 = Q / g_{m1} A U$$

Substituting for A , Q , and U their respective expressions

$$R_6 = \frac{1 + \mu_2 R_c / (r_{p2} + R_L)}{g_{m1} (\mu_2 R_L / (r_{p2} + R_L)) (R_1 / (R_2 + R_1))} \quad (41)$$

A Method of Measuring Attenuation of Short Lengths of Coaxial Cable*

CHANDLER STEWART, JR.†, ASSOCIATE, I.R.E.

Summary—Measurement of attenuation of coaxial radio-frequency transmission cables has generally been made by methods requiring non-standard equipment and long samples. A method of measurement employing a standard "Q meter" and requiring short samples is described.

WITH the recent tremendous increase in the rate of production of flexible coaxial cable used on aircraft as radio- and video-frequency transmission lines, there has come quite naturally a requirement for testing samples of this cable in production. The measurement of attenuation of this cable has generally been made by at least three methods:

1. Use of diode voltmeters on a cable sample terminated in its characteristic impedance, as described by Race and Larrick.¹

2. Use of diode voltmeters at either end of a resonant length of open circuited cable, as described by Seeley and Barden.²

3. Use of tuned circuits to couple cable sample to an oscillator and a voltmeter. The ratio of the voltage obtained with the cable sample in the circuit to the voltage obtained directly without the cable is used as a basis for determining the attenuation.

These methods of attenuation measurement have been found in practice to have the following limitations:

1. Each requires special testing equipment; procurement of testing equipment may be difficult and results of tests in different laboratories or factories may not be directly comparable.

2. About a hundred feet of each sample is required. The handling of the sample requires considerable time and effort and the effects of small local defects in a sample may be "averaged out" and so pass unnoticed.

3. Results of tests on widely differing lengths of the same sample have not always agreed closely.

A fourth method of measurement of attenuation, employing radio-frequency bridges to measure the input impedance of resonant lengths of samples, has been suggested by Easton.³ Although this method uses standard instruments, it also requires long samples and is limited to the lower frequencies.

In order to overcome these limitations, a new and convenient method of measuring samples of cable less

* Decimal classification: R282.1. Original manuscript received by the Institute, May 1, 1944; revised manuscript received, July 28, 1944.
† 433 Brightwood Ave., Dayton 5, Ohio.

¹ H. H. Race and C. V. Larrick, "Coaxial cable attenuation measurements at 300 megacycles," *Gen. Elec. Rev.*, vol. 44, pp. 507-510; September, 1941.

² "Radio at Ultra-High Frequencies," RCA Institutes Technical Press, 75 Varich St., New York, N. Y., 1940; S. W. Seeley and W. S. Barden, "A New Method for Measurement of Ultra-High Frequency Impedance," pp. 272-294.

³ Ivan G. Easton, "Measurements of the characteristics of transmission lines," *Gen. Rad. Exp.*, vol. 15, pp. 5-8; November, 1943.

than 5 feet in length has been developed by the Signal Corps Aircraft Radio Laboratory at Wright Field, Dayton, Ohio. A description of this method follows:

1. Equipment Required for Making Measurements

Standard Q meter, capable of measuring at 100 megacycles, such as the Boonton Type 170A.

Two high-Q air-wound coils of number 10 American wire gauge tinned copper wire, formed on a $\frac{1}{2}$ -inch rod; L_1 , approximately 0.15 microhenry inductance, with Q of Q_{L1} .

L_2 , approximately 0.05 microhenry inductance, with Q of Q_{L2} . These are easily made and checked on the Q meter.

Lugs or other means of connecting the cable samples to the Q meter and coil.

For samples of cable an odd number of quarter wavelengths long, a 1-megohm $\frac{1}{2}$ -watt resistor, to provide a grid return circuit for the Q meter.

2. Measurement Procedure

Samples of cables of lengths to resonate at the desired frequencies are cut, and connected to the Q meter individually as shown in the diagrams. The frequency used with the series circuit (Fig. 1) is chosen so that short-circuiting the connected end of the cable will have no effect upon the setting of C_1 required for resonance.

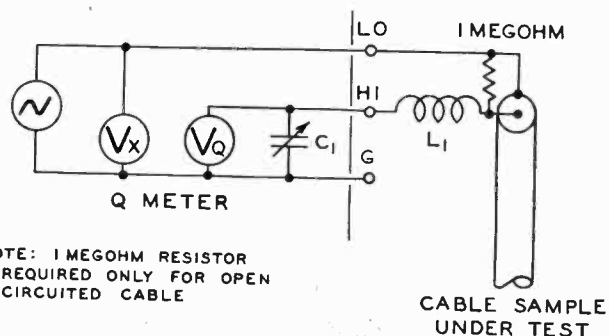

Fig. 1

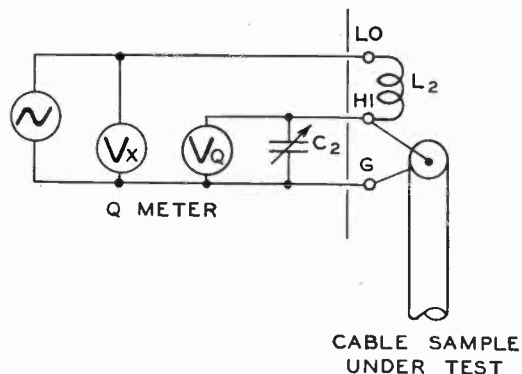

Fig. 2

Similarly, the frequency used with the circuit of Fig. 2 will be such that disconnecting the inner cable conductor at the Q meter will not change the C_2 setting required for resonance.

To insure minimum termination inductance in short-circuiting the end of the cable away from the Q meter, the inner strands are spread out umbrella-fashion, each contacting the outer shield.

The Q meter is operated in the usual fashion, obtaining Q and C readings for each condition.

To obtain the attenuation, the results are substituted in one of the following formulas:

For samples an odd number of quarter wavelengths long,

$$N = \frac{868.6}{l} \sqrt{\left(\frac{1}{Q_{01}} - \frac{1}{Q_{L1}}\right)\left(\frac{1}{Q_{S2}} - \frac{1}{Q_{L2}}\right) \frac{C_2}{C_1}} \text{ decibels per 100 feet} \quad (1)$$

where $Q_{01} = Q$ obtained with open-circuited cable as in Fig. 1

$Q_{S2} = Q$ obtained with short-circuited cable as in Fig. 2

$l =$ length of cable in feet.

For samples an even number of quarter wavelengths long,

$$N = \frac{868.6}{l} \sqrt{\left(\frac{1}{Q_{S1}} - \frac{1}{Q_{L1}}\right)\left(\frac{1}{Q_{02}} - \frac{1}{Q_{L2}}\right) \frac{C_2}{C_1}} \text{ decibels per 100 feet} \quad (2)$$

where $Q_{S1} = Q$ obtained with short-circuited cable as in Fig. 1

$Q_{02} = Q$ obtained with open-circuited cable as in Fig. 2.

3. Comparison of Results of Typical Measurements

Data obtained at approximately 100 megacycles on three samples of Type WC-549 cable, from Amphenol reel 3305B, are listed in Table I. Attempts were made

TABLE I
DATA TAKEN IN TESTS OF THREE SAMPLES OF CABLE WC-549 FROM AMPHENOL REEL 3305B

Length in inches	18½	56½	38
Frequency, megacycles	104.1	103.5	103.7
βl	$\pi/2$	$3\pi/2$	π
C_1 micromicrofarads	14	15.4	18.3
Q_{L1}	340	245	270
Q_{01}	198	90	100
C_2 micromicrofarads	14	64.6	18
Q_{L2}	340	175	346
Q_{S1}	85	88	65
N in decibels per 100 feet	2.38	2.37	2.41

to use this method at 200 megacycles, but excessively large errors were introduced by the inductance of the Q -meter terminals at that frequency. Although several different coils were used experimentally in this work, two would be sufficient for production testing under given conditions. The requirements that the circuit Q readings lie in a region of good meter accuracy prohibits the use of the same coil for L_1 and L_2 .

A comparison of results obtained by this method with those of other measurement methods was made on samples of Type WC-549 cable from the same reel. These are listed in Table II.

TABLE II

Method of measurement	Length of sample	Attenuation in decibels per 100 feet at 100 megacycles
Method using diode voltmeters on cable sample terminated in its characteristic impedance, as previously described ¹	Feet	
	133	2.27
Method using diode voltmeters on open-circuited cable sample at resonant frequencies. ²	133	2.47
	Even number of quarter waves	2.46
	Odd number of quarter waves	
Method using tuned circuits to couple cable sample to oscillator and voltmeter	100	2.6
Method of this report	Inches	
	18½	2.38
	56½	2.37
	38	2.41

Data of this type provide the only basis yet obtained for estimating the possible error in results by this method. In general, these results lie in the middle of the range of values obtained by other methods, and are just as easily duplicated.

4. Velocity of Propagation

The data obtained from these attenuation tests can be used for determining velocity of propagation, if the frequency is accurately checked with a frequency meter. This, however, is beyond the scope of this paper and consequently will not be treated here.

DEFINITION OF TERMS

$\alpha =$ attenuation of cable in nepers per foot

$\beta =$ wavelength constant of cable in radians per foot

$C =$ series capacitance in Q -meter circuit in farads

$C_1 =$ value of C required to resonate L_1 at the resonant frequency of the cable sample

$C_2 =$ value of C required to resonate L_2 at the resonant frequency of the cable sample

$l =$ length of cable in feet

$L_1 =$ inductance used in first test, in henries. (See Fig. 1)

$L_2 =$ inductance used in second test, in henries. (See Fig. 2)

$n =$ any whole integer

$N =$ attenuation of cable in decibels per 100 feet

$Q_{L1} = Q$ of coil L_1

$Q_{L2} = Q$ of coil L_2

$Q_{01} = Q$ of complete circuit (Fig. 1) for cable open-circuited and $\beta l = (n + \frac{1}{2})\pi$

$Q_{02} = Q$ of complete circuit (Fig. 2) for cable open-circuited and $\beta l = n\pi$

$Q_{S1} = Q$ of complete circuit (Fig. 1) for cable short-circuited and $\beta l = n\pi$

$Q_{S2} = Q$ of complete circuit (Fig. 2) for cable short-circuited and $\beta l = (n + \frac{1}{2})\pi$

$R_{L1} =$ radio-frequency resistance of coil L_1

$R_{L2} =$ radio-frequency resistance of coil L_2

$R_{01} =$ input impedance of open-circuited cable (Fig. 1), in ohms, when $\beta l = (n + \frac{1}{2})\pi$

$R_{02} =$ input impedance of open-circuited cable, in ohms (Fig. 2), when $\beta l = n\pi$

R_{S1} = input impedance of short-circuited cable, in ohms (Fig. 1), when $\beta l = n\pi$

R_{S2} = input impedance of short-circuited cable, in ohms (Fig. 2), when $\beta l = (n + \frac{1}{2})\pi$

ω = angular velocity of testing voltage in radians per second at resonant frequency of cable sample

Z_{0c} = input impedance of open-circuited cable, in ohms

Z_{sc} = input impedance of short-circuited cable, in ohms.

DERIVATION OF MEASUREMENT FORMULAS

From basic circuit theory

$$Q_{L1} = 1/\omega C_1 R_{L1} \quad (3)$$

$$Q_{01} = 1/\omega C_1 (R_{L1} + R_{01}) \quad (4)$$

$$Q_{L2} = \omega L_2 / R_{L2} \quad (5)$$

$$\omega L_2 = 1/\omega C_2 \quad (6)$$

$$Q_{S2} = \left| \frac{R_{S2}}{j\omega C_2 \left[R_{S2} - \frac{j}{\omega C_2} \right] \left[R_{L2} + j\omega L_2 + \frac{R_{S2}}{i\omega C_2 R_{S2} + 1} \right]} \right| \quad (7)$$

Combining (3) and (4) yields

$$R_{01} = \frac{1}{\omega C_1} [(1/Q_{01}) - (1/Q_{L1})]. \quad (8)$$

In a similar manner it can be shown that

$$R_{S1} = \frac{1}{\omega C_1} [(1/Q_{S1}) - (1/Q_{L1})]. \quad (9)$$

Combining (5), (6), and (7) to eliminate R_{L2} and L_2 yields

$$Q_{S2} = \left| \frac{\omega C_2 R_{S2} Q_{L2}}{1 + j(\omega C_2 R_{S2} + Q_{L2})} \right| \quad (10)$$

In actual practice, a high- Q coil is used for this measurement, so that

$$Q_{L2} > 100. \quad (11)$$

This justifies the following approximation of (10):

$$Q_{S2} = \frac{\omega C_2 R_{S2} Q_{L2}}{\omega C_2 R_{S2} + Q_{L2}} \quad (12)$$

from which

$$R_{S2} = \frac{1}{\omega C_2 [(1/Q_{S2}) - (1/Q_{L2})]} \quad (12a)$$

In a similar manner it can be shown that

$$R_{02} = \frac{1}{\omega C_2 ((1/Q_{02}) - (1/Q_{L2}))} \quad (13)$$

In accordance with equation (64), page 168, of Everitt's "Communication Engineering"

$$\tanh(\alpha + j\beta l) = \sqrt{Z_{sc}/Z_{oc}} \quad (14)$$

$$\frac{\sinh \alpha l \cos \beta l + j \cosh \alpha l \sin \beta l}{\cosh \alpha l \cos \beta l + j \sinh \alpha l \sin \beta l} = \sqrt{\frac{Z_{sc}}{Z_{oc}}} \quad (14a)$$

For the case of an open-circuited cable connected as in Fig. 1, and of a short-circuited cable connected as in Fig. 2,

$$\beta l = (n + 1/2) \quad (15)$$

in which case, since αl is positive and therefore Z_{sc}/Z_{oc} real,

$$\coth \alpha l = \sqrt{R_{S2}/R_{01}} \quad (16)$$

Substituting (6) and (12a) in (16),

$$\coth \alpha l = \frac{1}{\sqrt{\left(\frac{1}{Q_{01}} - \frac{1}{Q_{L1}}\right) \left(\frac{1}{Q_{S2}} - \frac{1}{Q_{L2}}\right) \frac{C_2}{C_1}}} \quad (17)$$

In actual practice, αl will always be less than 0.01, so that the following approximation of (17) is justified:

$$\alpha l = \sqrt{\left(\frac{1}{Q_{01}} - \frac{1}{Q_{L1}}\right) \left(\frac{1}{Q_{S2}} - \frac{1}{Q_{L2}}\right) \frac{C_2}{C_1}} \quad (18)$$

from which, since 1 neper represents 8.686 decibels,

$$N = \frac{868.6}{l} \sqrt{\left(\frac{1}{Q_{01}} - \frac{1}{Q_{L1}}\right) \left(\frac{1}{Q_{S2}} - \frac{1}{Q_{L2}}\right) \frac{C_2}{C_1}} \quad (19)$$

Similarly, it can be shown that, for the case of a short-circuited cable connected as in Fig. 1, and of an open-circuited cable connected as in Fig. 2, when $\beta l = n\pi$,

$$N = \frac{868.6}{l} \sqrt{\left(\frac{1}{Q_{S1}} - \frac{1}{Q_{L1}}\right) \left(\frac{1}{Q_{02}} - \frac{1}{Q_{L2}}\right) \frac{C_2}{C_1}} \quad (20)$$

CONCLUSIONS

This appears to be the most convenient method for measuring attenuation yet proposed.

Velocity of propagation can be obtained in the same operation in which attenuation is determined.

Measurements can be made on extremely short samples (less than 5 feet in length), making handling of samples more convenient.

Since short samples are used, nonuniformities along the length of the cable, which would be "averaged out" in tests by methods using long samples, are easily detected.

Only one instrument is required, a standard very high-frequency Q meter. A minimum amount of time is required in setting up equipment in preparation for a test, since the instrument is completely self-contained. Results made by different agencies should be directly comparable, since duplicate instruments are commercially available.

The results of tests by this method appear to be as reliable and accurate as those of more widely used methods; however, commercially available Q meters limit this method to frequencies in the neighborhood of 100 megacycles.

Institute News and Radio Notes

Winter Technical Meeting January 24, 25, 26, and 27, 1945 Hotel Commodore, New York, N.Y.

This is the second of the Winter Technical Meetings, which have supplanted, during the war period, the prewar Annual Conventions. There is much hope that 1945 will see a reduction of many of the restrictions which have interfered with such gatherings; this 1945 Winter Technical Meeting may be considered as the transition between the war meetings and those which may be anticipated in the postwar era. The Meeting, therefore, has been expanded over the one held last year, both in time and in program content. A record attendance is anticipated since there are indications that members of the Institute and nonmember radio engineers as well are becoming concerned over the long hiatus in free dissemination of technical information. Although accommodations for out-of-town members and guests will probably be more difficult to obtain than in any previous year, the choice of our largest city for the Meeting assures the maximum of hotel facilities.

The increase in Institute membership and the growth of its Sections have led to considerable emphasis on better co-ordination and co-operation between geographically separated groups. The entire first day of the Meeting, Wednesday, January 24, is to be devoted to Section affairs and there is good ground for hope that the discussions among Section representatives will lead to greater unification and a stronger Institute. A joint meeting with the American Institute of Electrical Engineers will be held on Wednesday evening. At this session the A.I.E.E. will award their Edison Medal and a very interesting and timely paper has been scheduled. The other A.I.E.E. meetings to be held January 22-26 will also include papers of interest to our own members. The titles of some of these are listed on page 57.

On Thursday morning, the Annual Meeting will be held, as required by the articles of incorporation, followed by the opening technical session, of which more later. Other high lights in the program are the Banquet, Thursday evening, at which the annual awards will be presented, and the guest speaker will be Francis De Wolf of the U. S. Department of State. The two special luncheons will be held on Friday in honor of the President of the Institute and, on Saturday, in honor of the many members and guests who are in the armed services. The commercial exhibits also add to the

attractions of this year's Meeting.

An interesting program has been arranged for the women guests attending this meeting. It is hoped that as many women as possible will be able to attend and participate in the women's activities.

The technical program reflects the changing conditions which have arisen as the war continues toward a successful termination. On Thursday morning, there will be a most interesting Symposium on the work of the Technical Committees. These Committees have continued their work throughout the war despite many difficulties, and it is expected that their activities will be intensified in the early postwar period. Every member of the Institute will be interested in the description of this work, and many, who have not actively participated in Technical Committee work, will be stimulated to contribute in the future. The large number of other papers were obtained chiefly by invitation and have been arranged in a number of special sessions to form an over-all well-balanced program. Some of the papers describe important war developments, which have only just been released; others show the growing diversity of radio as it expands into electronic and industrial applications; still others will have great significance in their import on postwar activities. It will be noted that the 40 or so papers come from 21 different organizations, a fact which indicates the diverse origin of much recent work.

In planning the technical program considerable emphasis was placed on originality, so that no member or guest at the Meeting need anticipate hearing material which is already available elsewhere. Because the presentation of a paper and its publication are considered to be separate and distinct matters, there can be no assurance that all or any of the papers presented will appear in print. Preprints or reprints of the papers are not available.

In the following program, papers are numbered in order, while the summaries which follow the program are listed alphabetically by the names of the authors and are given their order numbers as well. At the Meeting itself, special programs will be made available in which it is hoped to list also the approximate time at which each paper will be presented.

PROGRAM OF EVENTS

Wednesday, January 24, 1945

9:30 A.M.—12:30 P.M.

West Ballroom

Annual Meeting of Sections' Representatives

12:30 P.M.—2:00 P.M.

West Ballroom

Luncheon for Sections' Representatives

2:00 P.M.—5:00 P.M.

West Ballroom

Annual Meeting of Sections' Representatives

Joint Meeting of A.I.E.E. and I.R.E.

8:00 P.M.—10:00 P.M.

Engineering Societies Building

Award of Edison Medal to Dr. E. F. W. Alexanderson

"The Navy Electronics Program and Some of Its Past, Present, and Future Problems," by Captain J. B. Dow, U. S. Navy, Washington, D. C.

Thursday, January 25, 1945

8:30 A.M.—5:30 P.M.

Grand Ballroom Foyer

Registration and Sale of Tickets

8:30 A.M.—9:45 A.M.

West Ballroom

Exhibits of Manufacturers

9:45 A.M.—10:30 A.M.

Grand Ballroom

W. L. EVERITT, *Chairman*

Annual Meeting of The Institute of Radio Engineers

Technical Session

10:30 A.M.—12:30 P.M.

Grand Ballroom

F. B. LLEWELLYN, *Chairman***1. SYMPOSIUM ON THE I.R.E. TECHNICAL COMMITTEES**

Introduction

The Committee Structure

F. B. Llewellyn

Electronics Committee

(a) Scope and Activities

R. S. Burnap

(b) Cathode-Ray-Tube Problems

L. B. Headrick

(c) Admittance Coefficients for the Specification of Vacuum-Tube Performance

J. A. Morton

Piezoelectric Committee

How Crystal Cuts Are Specified

W. G. Cady

Circuits Committee

What Should a Circuits Committee Standardize, and Why

E. A. Guillemin

Facsimile Committee

A Common Language for all Kinds of Picture Transmission

C. J. Young

Radio Wave Propagation Committee

C. R. Burrows

Frequency-Modulation Committee

Translating Amplitude-Modulation Concepts to Frequency Modulation

C. C. Chambers

Transmitters Committee

Functions and Objectives

R. F. Guy

Symbols Committee

Co-ordination of Communication and Power Symbols

E. W. Shafer

Television Committee

Television Standards

I. J. Kaar

Electroacoustics Committee

Possible Future Activities

G. G. Muller

Receivers Committee

Rating of Receiver Noise

L. F. Curtis

Antennas Committee

Andrew Alford

Annual Review Committee

The Institute Adds a Chapter to Its Survey of Radio Progress

L. E. Whittemore

Standards Committee

Expansion of Standards Activities

H. A. Wheeler

Exhibits

10:30 A.M.—7:00 P.M.

West Ballroom

Technical Session

2:00 P.M.—5:00 P.M.

Grand Ballroom

H. M. TURNER, *Chairman*

2. "Measurement of Receiver Impulse-Noise Susceptibility," by Jerry P. Minter, Measurements Corporation, Boonton, N. J.

3. "Very-High-Frequency and Ultra-High-Frequency Signal Ranges as Limited by Noise and Co-channel Interference," by K. A. Norton, formerly, Federal Communications Commission; now, War Department, Washington, D. C., and E. W. Allen, Jr., Federal Communications Commission, Washington, D. C.
4. "Equivalent Networks for the Three Kinds of Triode Circuits," by Harold A. Wheeler, Hazeltine Corporation, Little Neck, L. I., N. Y.
5. "Exalted-Carrier Amplitude- and Phase-Modulation Reception," by Murray G. Crosby, Consulting Engineer; formerly, RCA Laboratories, Riverhead, L. I., N. Y.
6. "The Application of Double-Superheterodyne Receivers for Broadcast Reception," by John D. Reid, Crosley Corporation, Cincinnati, Ohio.
7. "Klystron Characteristics," by Coleman Dodd, Sperry Gyroscope Company, Inc., Garden City, L. I., N. Y.
12. "A New Very-High-Frequency Tetrode for Medium-Power Output," by Clayton E. Murdock, Eitel-McCullough, Inc., San Bruno, California.
13. "A Vacuum-Contained Push-Pull Triode Transmitter," by Major H. A. Zahl, J. E. Gorham, and G. F. Rouse, Signal Corps Ground Signal Agency, Asbury Park, N. J.

Technical Session "B"

9:30 A.M.—12:00 NOON

Parlors B and C

KARL S. VAN DYKE, *Chairman*

QUARTZ CRYSTALS

"Introduction," by Karl S. Van Dyke, Signal Corps Ground Signal Agency, Asbury Park, N. J.

14. "Quartz-Crystal Supply Program," by Major Edward W. Johnson, Signal Corps, Office of the Chief Signal Officer, Washington, D. C.
15. "Crystal Quality," by I. E. Fair, Bell Telephone Laboratories, Inc., Murray Hill, N. J.
16. "The Performance Index Meter," by C. W. Harrison, Bell Telephone Laboratories, Inc., New York, N. Y.
17. "Frequency Adjustment of Quartz-Oscillator Plates by X Rays," by Clifford Frondel, Reeves Sound Laboratories, Inc., New York, N. Y.
18. "Equipment for Frequency Adjustment of Quartz-Oscillator Plates by X Rays," by Charles Roddy, North American Philips Company, Inc., New York, N. Y.
19. "Aging of Quartz-Crystal Units," by Virgil E. Bottom, Signal Corps Ground Signal Agency, Asbury Park, N. J.

Annual I.R.E. Banquet—Awards—Address of Retiring President—Dress Informal

7:00 P.M.—10:30 P.M.

Grand Ballroom

Guest Speaker, Francis De Wolf, U. S. Department of State

Friday, January 26, 1945

9:00 A.M.—5:00 P.M.

Grand Ballroom Foyer

Registration

9:00 A.M.—9:00 A.M.

West Ballroom

Exhibits

Technical Session "A"

9:30 A.M.—12:00 NOON

Grand Ballroom

HARADEN PRATT, *Chairman*

VACUUM TUBES

8. "New Miniature Tubes," by R. L. Kelly and N. H. Green, RCA Victor Division, Radio Corporation of America, Harrison, N. J.
9. "Introducing the Disk-Seal Tube," by E. D. McArthur, General Electric Company, Schenectady, N. Y.
10. "Two-Resonator Klystron Oscillators," by D. R. Hamilton, Sperry Gyroscope Company, Inc., Garden City, L. I., N. Y.
11. "Reflex Oscillators," by J. R. Pierce, Bell Telephone Laboratories, Inc., New York, N. Y.

President's Luncheon

Honoring Dr. W. L. Everitt

12:30 P.M.

Grand Ballroom

Technical Session "A"

2:00 P.M.—5:30 P.M.

Grand Ballroom

W. L. EVERITT, *Chairman*

INDUSTRIAL ELECTRONICS

20. "Is Industrial Electronic Technique Different?," by W. D. Cockrell, Industrial Engineering Division, General Electric Company, Schenectady, N. Y.
21. "Practical Methods of Shielding Dielectric-Heating Installations," by G. W. Klingaman and G. H. Williams, Radio Corporation of America, Camden, N. J.

22. "Heating with High-Frequency Electric Fields," by Paul D. Zottu, Thermex Division, Girdler Corporation, Louisville, Ky.

9:00 A.M.—12:30 P.M.
West Ballroom

Exhibits

23. "Operating Experiences with Induction-Heating Oscillators," by Wallace C. Rudd, Induction Heating Corporation, New York, N. Y.

Technical Session "A"

9:30 A.M.—12:00 NOON
Grand Ballroom

24. "A High-Frequency Wattmeter and Its Uses in Industrial Applications," by Eugene Mittelman, Illinois Tool Works, Chicago, Ill.

RALPH BOWN, *Chairman*

25. "The Radio-Frequency Dehydration of Materials Labile with Heat," by George H. Brown, R. A. Bierwirth, and Cyril N. Hoyler, RCA Laboratories, Princeton, N. J.

RADIO LINKS AND RELAYS

"Introduction," by Ralph Bown, Bell Telephone Laboratories, Inc., New York, N. Y.

Technical Session "B"

2:00 P.M.—5:30 P.M.
Parlors B and C

R. A. HACKBUSCH, *Chairman*

26. "The Interdepartment Radio Advisory Committee," by Captain E. M. Webster, Vice-Chairman, Interdepartment Radio Advisory Committee, Washington, D. C.

27. "Activities of the Radio Technical Planning Board," by Alfred N. Goldsmith, Vice-Chairman, RTPB, New York, N. Y.

28. "Notes on Selectivity-Design Parameters of Superregenerative Receivers," by Allen Easton, Emerson Radio and Phonograph Corporation, New York, N. Y.

29. "A Portable Two-Channel Recording Oscilloscope for Battery Operation," by R. F. Wild and D. C. Culver, Brown Instrument Company, Philadelphia, Pa.

30. "High-Voltage Rectified Power Supply Using Fractional-Mu Triode Radio-Frequency Oscillator," by R. L. Freeman and R. C. Hergenrother, Hazeltine Corporation, Little Neck, L. I., N. Y.

31. "Radio-Frequency Spectrum Analyzers," by Dale Pollack, Templetone Radio Manufacturing Company, New London, Conn.

32. "An Electrometer Tube and Its Use in Minute Measurements," by W. A. Hayes, Westinghouse Electric and Manufacturing Company, Bloomfield, N. J.

Cocktail Party

6:00 P.M.—9:00 P.M.
East Ballroom

Saturday, January 27, 1945

9:00 A.M.—12:00 NOON
Grand Ballroom Foyer

Registration

33. "Cape Charles-Norfolk Ultra-Short-Wave Multiplex System," by N. F. Schlaack and A. C. Dickieson, Bell Telephone Laboratories, Inc., New York.

34. "Ultra-Short-Wave Multiplex," by Charles R. Burrows, Bell Telephone Laboratories, Inc., Deal, N. J., and Alfred Decino, formerly, Bell Telephone Laboratories, Inc., New York, N. Y.

35. "Ultra-Short-Wave Receiver for the Cape Charles-Norfolk Multiplex System," by D. M. Black, G. Rodwin, and W. T. Wintringham, Bell Telephone Laboratories, Inc., New York, N. Y.

36. "Ultra-Short-Wave Transmitter for the Cape Charles-Norfolk Multiplex Systems," by R. J. Kircher, Bell Telephone Laboratories, Inc., New York, N. Y., and R. W. Friis, Bell Telephone Laboratories, Deal, N. J.

37. "Radio-Relay Communication Systems in the United States Army," by Lieutenant-Colonel William S. Marks, Jr., Captain O. D. Perkins, and W. R. Clark, Signal Corps Ground Signal Agency, Asbury Park, N. J.

Technical Session "B"

9:30 A.M.—12:00 NOON
East Ballroom

G. B. HOADLEY, *Chairman*

38. "The Servo Problem as a Transmission Problem," by E. B. Ferrell, Bell Telephone Laboratories, Inc., New York, N. Y.

39. "Instrument Approach and Landing Systems," by Lieutenant-Colonel F. L. Moseley, Air Corps, Air Technical Service Command, Wright Field, Dayton, Ohio.

40. "The Design of Broad-Band Aircraft Antenna Systems," by Captain A. S. Meier, Air Corps, F. D. Bennett, and P. D. Coleman, Aircraft Radio Laboratory, Air Technical Service Command, Wright Field, Dayton, Ohio.

41. "Some New Antenna Types and Their Applications," by A. G. Kandoian, Federal Telephone and Radio Laboratories, New York, N. Y.
42. "Applications of High-Frequency Solid-Dielectric Flexible Lines to Radio Equipments," by H. Busignies, Federal Telephone and Radio Laboratories, New York, N. Y.

Luncheon in Honor of Men in the Armed Forces

12:30 P.M.—2:00 P.M.

Grand Ballroom

Final Adjournment

2:00 P.M.

SUMMARIES OF TECHNICAL PAPERS

35. ULTRA-SHORT-WAVE RECEIVER FOR THE CAPE CHARLES-NORFOLK MULTIPLEX SYSTEM

D. M. BLACK, G. RODWIN, AND W. T. WINTRINGHAM
(Bell Telephone Laboratories, Inc., New York, N. Y.)

The requirements for an ultra-short-wave receiver for use in a multiplex radiotelephone link circuit are outlined. The technical details of a receiver designed to meet such requirements in the circuit between Cape Charles and Norfolk, Virginia, are described.

19. AGING OF QUARTZ CRYSTAL UNITS

VIRGIL E. BOTTOM

(Signal Corps Ground Signal Agency, Asbury Park, N. J.)

Large numbers of quartz oscillator plates are made today in the frequency range of 6 megacycles per second and above. When the frequencies of such plates are adjusted by lapping, the units are unstable with respect to frequency and activity. The changes are aggravated by moisture. The effect is associated with the surface of the plate which is left in a disoriented condition as a result of the stresses produced in lapping. The remedy is removal of the disturbed material and adjustment of frequency by etching.

The stability of the unit is also affected by the material of the holder. Most plastics are quite permeable to water vapor resulting in unsatisfactory performance under conditions of high humidity. Much study is being given to the design of holders for tropical use.

The new order of permanence and frequency stability which is provided and the economy in the use of the etching method in quantity production opens the door to the widespread use of thinner crystals and thus to both higher-frequency crystal units and the extension of the range of application of AT-cut units with their better temperature coefficients to the frequency ranges now covered only with BT-cut plates.

25. THE RADIO-FREQUENCY DEHYDRATION OF MATERIALS LABILE WITH HEAT

GEORGE H. BROWN, R. A. BIERWIRTH, AND
CYRIL N. HOYLER

(RCA Laboratories, Princeton, N. J.)

Methods and equipment for dehydrating certain pharmaceutical materials which are sensitive to high temperatures have been worked out. The radio-frequency dehydration method particularly applicable to penicillin dehydration has been divided into two discrete steps. The first is a system for concentrating the material in bulk. This concentrate is then measured into the final containers, where it is then dried under sterile conditions by means of radio-frequency power. The two separate systems will be described, and the extension of this technique to other biologicals will be discussed.

34. ULTRA-SHORT-WAVE MULTIPLEX

CHARLES R. BURROWS

(Bell Telephone Laboratories, Deal, N. J.)

AND

ALFRED DECINO

(Formerly, Bell Telephone Laboratories, Inc., New York, N. Y.)

The technical requirements of a twelve-channel ultra-short-wave multiplex system are discussed and the means of meeting them are described. The intermodulation between channels in equipment based on this design has been reduced to the point where it is possible to use twelve-channel radio systems in the toll plant. By employing a sufficient amount of envelope feedback, the transmitter can be operated with a high-modulation factor without the use of spread sidebands.

42. APPLICATIONS OF HIGH-FREQUENCY SOLID-DIELECTRIC FLEXIBLE LINES TO RADIO EQUIPMENTS

H. BUSIGNIES

(Federal Telephone and Radio Laboratories,
New York, N. Y.)

The importance of the flexible lines in radio design, advantages and inconveniences of solid dielectric transmission lines versus air lines in radio design will be discussed. When the flexible transmission line is of paramount importance, the type of equipments and installations requiring flexible lines will be considered. Examples of applications are ship installations, aircraft installations, ground demountable equipments, and automotive installations. Particular problems involved in the direction-finder field, in the instrument landing field, and their solution with solid dielectric flexible transmission lines will be treated.



OLD MERCHANT'S HOUSE
To be visited by women guests to I.R.E. Convention.

20. IS INDUSTRIAL ELECTRONIC TECHNIQUE DIFFERENT?

W. D. COCKRELL

(Industrial Engineering Division, General Electric Company,
Schenectady, N. Y.)

With the reduction in production of military electronic equipment it is logical for radio engineers to consider entering the field of industrial electronics. This junior branch of the industry differs from communication work especially in the emphasis on costs and the type of personnel available for operation and routine servicing. The range of industrial electronics extends from standard communication equipment at one end to the large pumped ignitron and multianode tanks capable of rectifying thousands of kilowatts.

5. EXALTED-CARRIER AMPLITUDE- AND PHASE-MODULATION RECEPTION

MURRAY G. CROSBY

(Consulting Engineer; formerly, RCA Laboratories,
Riverhead, L. I., N. Y.)

An amplitude- or phase-modulation receiving system is described in which the harmonic distortion produced by fading of the carrier with respect to the sidebands is eliminated. The various parts of such a receiver including the carrier filter, automatic-frequency-control discriminator, and detecting systems are described. Analyses are given of the selectivity effect due to carrier exaltation and of exalted-carrier diode and multigrad detection. The optimum degree of carrier exaltation and the effect of carrier limiting are discussed. Results are given of observations of reception on an exalted-carrier diversity receiving system.

7. KLYSTRON CHARACTERISTICS

COLEMAN DODD

(Sperry Gyroscope Company, Inc., Garden City,
L. I., N. Y.)

Some of the most evident differences between a klystron-tube amplifier and a conventional triode amplifier

are pointed out. Typical klystron-tube amplifier characteristics are illustrated and some practical conclusions about the operation of the tube are mentioned. Typical two-resonator klystron-tube oscillator characteristics are shown and the effects of some of the variables are discussed. Block diagrams of the equipment which will be used to demonstrate these characteristics are included.

28. NOTES ON SELECTIVITY-DESIGN PARAMETERS OF SUPERREGENERATIVE RECEIVERS

ALLEN EASTON

(Emerson Radio and Phonograph Company, New York, N. Y.)

The general impression that superregenerative reception and poor selectivity are synonymous is shown to be erroneous. Actual tests on specific designs are reviewed and analyzed.

15. CRYSTAL QUALITY

I. E. FAIR

(Bell Telephone Laboratories, Inc., Murray Hill, N. J.)

Expressing the quality of crystals by their performance in certain oscillator circuits has been found to be unsatisfactory in many respects. It is more desirable to express quality in terms of the equivalent circuit constants in much the same manner as for coils and capacitors. The quality of coils and capacitors is defined as the ratio of reactance to resistance or Q of the element. Because of the fact that a crystal is equivalent to a combination of three elements, its quality is not so simply defined.

This paper discusses the factors which determine the performance of crystals in oscillators and suggests a measure of quality called figure of merit, M and a measure of performance called performance index PI . M is a ratio of the Q of the motional arm to the ratio of capacitance of the crystal while PI is a measure of the anti-resonant resistance of crystal and circuit capacitance in parallel *at the oscillating frequency*. The relations between M , PI , and oscillator grid current will be shown.

38. THE SERVO PROBLEM AS A TRANS- MISSION PROBLEM

E. B. FERRELL

(Bell Telephone Laboratories, Inc., New York, N. Y.)

The purpose of a servo is to reproduce a signal at a place or power level or form different from the original signal, but under its control. It is, therefore, a signal-transmitting system. It uses negative feedback to minimize noise and distortion, which the servo designer usually calls error. It generally uses mechanical and thermal circuit elements as well as electrical circuit elements, but the problems of circuit design are the same.

The methods of Nyquist and Bode, which have proved so useful in the design of electrical-feedback amplifiers, are equally useful in the design of servo sys-

tems. They encourage the determination of the significant constants of the system by experimental means involving steady-state amplitude measurements of the loop transmission characteristics. These measurements lead to quick estimates of errors and stability and of the transmission changes required to give various degrees of performance.

30. HIGH-VOLTAGE RECTIFIED POWER SUPPLY USING FRACTIONAL-MU TRIODE RADIO-FREQUENCY OSCILLATOR

R. L. FREEMAN AND R. C. HERGENROTHER
(The Hazeltine Corporation, Little Neck, L. I., N. Y.)

An oscillator circuit designed to operate with a triode having a small fractional mu has been used to develop across its grid-leak resistor a bias voltage whose value is over twenty times as great as the anode-supply voltage. The principle can be demonstrated by connecting a triode so that its grid and anode are interchanged. However, special tubes of unconventional design were constructed for generating several thousand volts. The rectified voltage is negative in polarity relative to cathode and thus is adapted for oscilloscopes and perhaps for television-picture tubes.

17. FREQUENCY ADJUSTMENT OF QUARTZ-OSCILLATOR PLATES BY X RAYS

CLIFFORD FRONDEL
(Director of Research, Reeves Sound Laboratories, Inc.,
New York, N. Y.)

A BT quartz oscillator plate irradiated with X rays gradually becomes smoky in color, and undergoes an accompanying change in the elastic constants which lowers the oscillator frequency. There is little or no accompanying change in crystal activity. The total frequency change is limited and varies with the initial frequency (thickness) of the plate. Changes of the order of 500 to 3000 cycles per second can be obtained in the frequency range from 5 to 9 megacycles. The rate of change of frequency is primarily determined by the intensity and wavelength of the X radiation. Both the rate of change and the total change of frequency increase with increasing initial frequency of the plate. Rates now achieved in production average about 40 cycles per second per minute of exposure to X rays. The frequency change brought about by irradiation can be reversed and the plate restored to its original frequency and color by baking at temperatures over about 175 degrees centigrade. Irradiated plates are stable at lower temperatures. The plates also can be sensitized to irradiation by prior baking.

Other kinds of radiation also have been found to cause color and frequency changes in quartz, including gamma rays, alpha particles, electrons, and deuterons. X rays, however, are the only practical choice for manufacturing operations although the radioactive radiations

have, under certain circumstances, a definite application.

The irradiation technique presents a number of practical advantages in the manufacture of oscillator plates: (1) Extremely precise frequency adjustments can be made by oscillating the plate in the X-ray beam, following visually the frequency change on a meter until the desired value is reached. The adjustment can be effected, under suitable circumstances, while the crystal is oscillating in its permanent holder. (2) The frequency of stabilized crystals can be adjusted without disturbing the surface condition of the quartz. (3) The fact that the frequency change is downward permits the salvage of crystals that have been overshoot in frequency during manufacture. Similarly, plates that have gone over frequency due to aging, recleaning, or underplating may be recovered.

27. ACTIVITIES OF THE RADIO TECHNICAL PLANNING BOARD

ALFRED N. GOLDSMITH
(Vice-Chairman, RTPB, New York, N. Y.)

The sponsorship, organization, panel activities, and reports of the RTPB and its Panels will be discussed. The nature of the contributions of the RTPB, as well as the co-operation of the I.R.E. in the work of the RTPB will also be considered.

10. TWO-RESONATOR KLYSTRON OSCILLATORS

D. R. HAMILTON
(Sperry Gyroscope Company, Inc., Garden City,
L. I., N. Y.)

The relation between the concepts of the two-resonator klystron oscillator and those of the conventional lower-frequency tubes and circuits is discussed with a view to making clear the points of similarity and differ-



ENLISTEE'S LOUNGE, WOMEN'S MILITARY SERVICE CLUB
One of the places to be visited by our women guests.

ence. It is shown that once the somewhat different origin of the beam transconductance in the two cases is understood, the remainder of the analysis follows conventional lines. The application of this analysis to calculations of dependence of power output and oscillation frequency in the two-resonator oscillator is then discussed.

32. AN ELECTROMETER TUBE AND ITS USE IN MINUTE MEASUREMENTS

W. A. HAYES

(Westinghouse Electric and Manufacturing Company
Bloomfield, N. J.)

In this paper an electrometer tube is described which permits the measurement of minute currents and/or potentials down to 10^{-16} ampere and 10^{-4} volt, respectively. The sensitivity of the tube is made possible by an extremely low grid current and a high grid-to-cathode resistance. Important construction and processing features of the tube are presented. Techniques involved in maintaining the standards required for sensitivity, stability, and long life are given. Characteristics are included with data relative to linearity of output current as a function of grid bias.

Zero control current is effected by proper selection of negative grid bias. This feature is described and data given. Stability of the tube with respect to random fluctuations internal and external to the tube is summarized relative to the accuracy of test results. Several special applications of the tube in the field of chemistry, metallurgy, and the medical professions are described.

16. THE PERFORMANCE INDEX METER

C. W. HARRISON

(Bell Telephone Laboratories, Inc., New York, N. Y.)

The principal features of this instrument which measures the antiresonant impedance of the quartz crystal and associated circuit will be pointed out and discussed. The difficulties associated with trying to measure high impedances at high frequencies are avoided by making certain measurements within the resulting resonant circuit embodying the crystal, and making certain calibrations. The operation occurs at a frequency determined by the crystal being tested. Measurements are facilitated by constructing the circuit so that constant amplitude occurs for the driving voltage at the point of application regardless of adjustments being made. The most important error likely to be introduced by the method employed will be pointed out and the magnitude of possible error mentioned.

14. QUARTZ-CRYSTAL SUPPLY PROGRAM

MAJOR EDWARD W. JOHNSON

(Signal Corps, Office of the Chief Signal Officer,
Washington, D. C.)

At the start of the war the Signal Corps found itself

committed to a policy of using quartz crystals as a means of frequency control, with military demands running into millions a year and with the then-existing industry capable of producing at most 100,000 units a year. Laboratory methods were used in those plants, no production machinery was available, no techniques standardized, and the situation on the supply of raw material from Brazil was such that the utmost economy had to be observed and appropriate processing methods adopted. The raw-quartz problem was further complicated by the then-prevalent belief in the industry that only the very best grades were suited to the manufacture of oscillator plates.

As a result of the concerted efforts of the Signal Corps and the wholehearted co-operation and ingenuity of industry the latter was expanded from some 15 prewar firms to approximately 115, and the capacity to the point where it is now producing at a rate of approximately 30,000,000 units a year. This expansion was made possible by the adoption of standardized equipment, improved techniques, and a continued search for improvements. The quality of the units has been vastly improved.

The Signal Corps has spent in excess of \$200,000,000 for crystals alone since the outbreak of the war. This sum represents about 50,000,000 crystal units. The efficiency of the industry in the utilization of critical raw material has improved substantially, costs of comparable crystals have been reduced by at least a 4-to-1 ratio, and processing techniques have progressed to the point where semiautomatic machinery is in widespread use.

In order to meet emergency demands for small quantities of crystals on special frequencies, field crystal-grinding equipments, manned by specially trained personnel, have been set up in all active theaters.

41. SOME NEW ANTENNA TYPES AND THEIR APPLICATIONS

A. G. KANDOIAN

(Federal Telephone and Radio Laboratories, New York, N. Y.)

Three newly developed types of antennas will be described. The radiation pattern of each is substantially omnidirectional in the horizontal plane. The first has horizontal polarization, the second vertical polarization, and the third is elliptically or circularly polarized.

Variations of the above types, bandwidth considerations, tuning range, advantages, and limitations of each type will be discussed as well as the use of these antennas singly or in directive arrays for high-power gain. Applications to very-high-frequency and ultra-high-frequency broadcast, television, and link communication will be considered.

Experimental models and measured characteristics, design and construction for various particular applications, the problem of transmission-line efficiency, elimination of balanced feeder, coaxial feeding system, and a typical installation will be presented.

8. NEW MINIATURE TUBES

R. L. KELLY AND N. H. GREEN

(RCA Victor Division, Radio Corporation of America,
Harrison, N. J.)

In the development of electronic equipment for use in World War II, a need was indicated for improved receiving tubes to satisfy the highly specialized requirements of the Army and Navy. Foremost among the features desired in these tubes were small size, excellent ultra-high-frequency performance, adequate mechanical strength, and minimum effects due to climatic variations.

The miniature type of tube design offers excellent possibilities of meeting these objectives and, therefore, a group of heater-cathode miniature tubes has been developed for war purposes.

Although dissipation problems were anticipated with the use of miniature envelopes, these proved to be less troublesome than expected because the short leads employed in this design are efficient heat conductors.

High-frequency performance is also exceptionally good because of the low-inductance leads and because of the stability provided by the all-glass base. The small size and light weight of miniature tubes have proven especially advantageous in the design of aircraft equipment.

36. ULTRA-SHORT-WAVE TRANSMITTER FOR THE CAPE CHARLES-NORFOLK MULTIPLEX SYSTEM

R. J. KIRCHER

(Bell Telephone Laboratories, Inc., New York, N. Y.)

AND

R. W. FRIIS

(Bell Telephone Laboratories, Inc., Deal, N. J.)

Design features of an unattended ultra-short-wave double-sideband multiplex transmitter are described. Forty decibels of envelope feedback is utilized over the 12- to 60-kilocycle band of the twelve type-K carrier-signal channels which modulate the last stage of the transmitter. Accessibility of apparatus and ease in maintenance contribute toward obtaining maximum reliability of the equipment in commercial service.

21. PRACTICAL METHODS OF SHIELDING DIELECTRIC-HEATING INSTALLATIONS

G. W. KLINGAMAN AND G. H. WILLIAMS

(Radio Corporation of America, Camden, N. J.)

This paper will discuss the field strengths to be expected around unshielded installations, based on measurement; shielding theoretically required to eliminate radiation; experiments to determine the minimum amount and kind of shielding required to reduce radiation to a satisfactory level, and methods and instruments used in locating points of maximum radiation in the installation.

37. RADIO-RELAY COMMUNICATION SYSTEMS IN THE UNITED STATES ARMY

LIEUTENANT-COLONEL WILLIAM S. MARKS, JR., CAPTAIN
O. D. PERKINS, AND W. R. CLARK

(Signal Corps Ground Signal Agency, Asbury Park, N. J.)

This paper describes the use of frequency-modulated, very-high-frequency radio sets in place of wire lines in Army tactical communication circuits. During the early phases of the war and pending development and production of equipment designed to meet requirements, standard police-type frequency-modulation sets were adapted for use. These were used with great success during the Tunisian, Sicilian, and Italian campaigns. They principally provided simplex teletype circuits from higher headquarters to lower units. By the use of radio repeater or relay stations these circuits were extended several hundred miles. Representative circuits are shown illustrative of employment, distances covered and antenna elevations. A broad-band frequency-modulated very-high-frequency set designated AN/TRC-1 was developed for use in conjunction with voice-frequency-carrier equipment CF-1 and CF-2 to provide multichannel voice and teletype circuits over a single radio frequency. This has met with great success and was a most important communication factor in the Normandy Invasion and Battle of France. It marks the first real marriage of wire and radio communications in the Army and provides an integrated communication system. The advantages of a radio system over conventional wire lines under certain conditions are pointed out, such as a saving in men and material, establishment and maintenance of communications in a fast-moving situation, use over water, enemy territory, rugged and mountainous terrain. Expanding and wider application of the principle is indicated.

9. INTRODUCING THE DISK-SEAL TUBE

E. D. McARTHUR

(Research Laboratory, General Electric Company,
Schenectady, N. Y.)

Several factors which limit the operation of grid-controlled tubes at ultra-high frequencies are discussed qualitatively. Starting with these problems, certain new basic principles in tube design are developed and it is shown that ultra-high-frequency tube design and development must include detailed knowledge and consideration of the entire electromagnetic system rather than just the evacuated bulb.

The evolution of typical generalized cavity circuits is traced and from these units the grid-separation circuit is developed. It is shown how the disk tubes used in conjunction with cavity resonators co-operate to alleviate many of the aforementioned problems so that very much higher operating frequencies can be attained.

The detailed structure of several typical disk tubes is

shown and an example of the grid-separation type resonant cavity oscillator.

Only a limited amount of operating data is given due to the need for military secrecy.

2. MEASUREMENT OF RECEIVER IMPULSE-NOISE SUSCEPTIBILITY

JERRY B. MINTER

(Measurements Corporation, Boonton, N. J.)

A method of measuring receiver susceptibility to impulse noise (such as ignition noise) will be described. Some data typical of prewar frequency-modulation receiver designs will be shown. Application of the method to television-receiver measurements together with typical data will also be presented.

The general application of this method should result in improved impulse noise rejection in postwar frequency-modulation and television receivers. These measurements can be made with equipment already available to most engineering laboratories.

24. A HIGH-FREQUENCY WATTMETER AND ITS USES IN INDUSTRIAL APPLICATIONS

EUGENE MITTELMANN

(Illinois Tool Works, Chicago, Ill.)

An instrument is described which allows separating the amount of power which is fed into the charge of a high-frequency heating generator from other losses associated with the circuit, such as radiation losses, circuit losses, etc. It can be shown that the indications of the instrument are independent of the geometrical configurations of the load and of the electrodes and are in wide limits independent of frequency.

Methods for using the instrument to match properly the load to the generator, and to maintain that matching, are discussed. Tests showing the accuracy of the instrument indications for various applications are shown.

12. A NEW VERY-HIGH-FREQUENCY TETRODE FOR MEDIUM POWER OUTPUT

CLAYTON E. MURDOCH

(Eitel-McCullough, Inc., San Bruno, Calif.)

A stable, efficient amplifier operating up to 200 megacycles, and capable of power outputs of up to 800 watts has been needed in several fields. The new 4-125-A adequately covers this range and also permits circuit and component simplicity because of its design. No neutralization is required except possibly at the higher frequencies, and the tube is easily plugged into its socket with only the plate connector to be made up. It will stand high voltage and has high overload capabilities.

The tube possesses extremely low feedback capacitance, low input and output capacitances, small physical

size and short leads, tantalum plate and processed grids, and very close interelectrode spacings for short electron transit time.

Typical operating conditions for a pair at class C are 3000 volts plate, 300 volts screen, 335 plate mils, less than 5 watts grid drive, and useful power output of 750 watts.

It is an excellent zero-bias class B tube when the grid and screen are tied together, having very low distortion up to 500 watts output.

3. VERY-HIGH-FREQUENCY AND ULTRA-HIGH-FREQUENCY SIGNAL RANGES AS LIMITED BY NOISE AND CO-CHANNEL INTERFERENCE

K. A. NORTON

(Formerly, Federal Communications Commission; now, War Department, Washington, D. C.)

AND

E. W. ALLEN, JR.

(Federal Communications Commission, Washington, D. C.)

It is proposed to prepare theoretical service-area maps for frequency-modulation broadcasting at several frequencies so as to show the variation in the size of the primary service area within the 50-microvolt-per-meter contour as well as the rural service area, say within the 10-microvolt-per-meter contour. The maps will also show the required spacing between co-channel stations, taking into account tropospheric effects to the extent to which they have been determined at this time. The sky-wave interference curves presented at the allocation hearing will be included and the effect of the sky-wave interference in reducing the station service area will be shown for each of the above frequencies.

In addition, it is planned to present signal-range-versus-frequency curves for frequencies from 30 to 3000 megacycles, for 1-kilowatt power, and for several antenna heights. One set of curves is planned for broadcast stations and a second set for communications services, such as police, where the range is limited by noise conditions.

11. REFLEX OSCILLATORS

J. R. PIERCE

(Bell Telephone Laboratories, Inc., New York, N. Y.)

This paper discusses qualitatively the behavior of reflex oscillators. Power production, electronic tuning, variation of frequency with resonator voltage, effect of modulation coefficient, and influence of load are considered.

6. THE APPLICATION OF DOUBLE-SUPERHETERODYNE RECEIVERS FOR BROADCAST RECEPTION

JOHN D. REID

(Crosley Corporation, Cincinnati, Ohio)

This paper will cover the technical details of design, construction, and performance of a standard broadcast

and short-wave band-spread receiver, using the double-superheterodyne principle. Novel developments in respect to shape factor, constructional materials, and tuning methods will be disclosed. An experimental model of the receiver will be demonstrated and will be available for inspection.

18. EQUIPMENT FOR FREQUENCY ADJUSTMENT OF QUARTZ OSCILLATOR PLATES BY X RAYS

CHARLES RODDY

(North American Philips Company, Inc., New York, N. Y.)

An account is given of preliminary experimental work on the frequency adjustment of quartz oscillator plates by means of X rays.

The necessity of relatively "soft" radiation of high intensity is demonstrated by radiating crystals directly on the windows of diagnostic X-ray tubes with non-shockproof apparatus.

Voltage and current were determined for economical time of radiation within present limits of tube design.

Absorption measurements were made to check the efficacy of copper and tungsten anode tubes under the same electrical loadings.

Equipment was designed for the above purpose in order to satisfy the following conditions:

- (1) Maximum intensity at shortest anode-crystal distance.
- (2) Radiation of two plates simultaneously.
- (3) Accommodation of various crystal sizes.
- (4) Oscillation of plate while being radiated.
- (5) Protection of operator from X radiation.
- (6) Protection of operator from electrical shock.

23. OPERATING EXPERIENCES WITH INDUCTION-HEATING OSCILLATORS

WALLACE C. RUDD

(Induction Heating Corporation, New York, N. Y.)

This paper will discuss the operating experiences gained in the observation of many hundreds of large-capacity induction-heating oscillators. Problems arising in long-continued operation of these units and their solution will be considered.

33. CAPE CHARLES-NORFOLK ULTRA-SHORT-WAVE MULTIPLEX SYSTEM

N. F. SCHLAACK AND A. C. DICKIESON

(Bell Telephone Laboratories, Inc., New York, N. Y.)

This paper describes the general features of a radio multiplex system which has been installed between Cape Charles and Norfolk, Virginia. The radio-frequency equipment operates in the vicinity of 160 megacycles. The system employs the 12 telephone channels of the type-K cable-carrier system which are in the frequency range 12 to 60 kilocycles.

26. THE INTERDEPARTMENT RADIO ADVISORY COMMITTEE

CAPTAIN E. M. WEBSTER

(Vice-Chairman, Interdepartment Radio Advisory Committee, Washington, D. C.)

The Interdepartment Radio Advisory Committee was founded in 1922 at the invitation of the Secretary of Commerce. Originally dealing only with government radio broadcasting, its activities developed with the Federal Government's growing interests in other facets of radio. Frequency assigning, at first a minor consideration, gradually increased in importance until now it constitutes almost the entire business of the Committee.

With an average of more than 150 requests for frequency assignments each month, a standardized procedure and record system has developed. Symbols and notes indicate the relative priority of users and any limitations deemed necessary to prevent interference.

The Interdepartment Radio Advisory Committee is related to the State Department, Federal Communications Commission, and Board of War Communications through the dovetailing of activities, but lines of responsibility are well established and no overlapping of functions results.

4. EQUIVALENT NETWORKS FOR THE THREE KINDS OF TRIODE CIRCUITS

HAROLD A. WHEELER

(Hazeltine Corporation, Little Neck, L. I., N. Y.)

There are three simple ways of connecting a triode in a four-terminal network, because the "common" or "grounded" electrode may be the cathode, anode, or grid. The grounded-cathode circuit is the original voltage-reversing one-way repeater, amplifying both voltage and current to give greatest amplification of power at low frequencies. The grounded-anode (cathode-follower) circuit is a nonreversing one-way repeater but amplifies only the current and, in a less degree, the power. The grounded-grid circuit has degenerative feedback by conductive coupling, in such a manner that it amplifies only the voltage and, in a still lesser degree, the power. It may be treated as a hypothetical "repeater-transformer" with an impedance ratio of μ plus one, which also multiplies the power in the same ratio. It has some advantages at high radio frequencies because the grid shields against capacitive-feedback coupling and because the input conductance decreases at higher frequencies while that of the other two circuits increases. The input conductance may be simulated by cathode-lead inductance, which gives a new picture of this phenomenon and its associated thermal noise. Series impedance in the common lead decreases the transconductance in the first two circuits. The double-triode circuit with cathode intercoupling is interesting as a nonreversing one-way voltage and current amplifier with less than

half the transconductance and much less capacitive-feedback coupling.

29. A PORTABLE TWO-CHANNEL RECORDING OSCILLOSCOPE FOR BATTERY OPERATION

R. F. WILD AND D. C. CULVER

(Brown Instrument Company, Philadelphia, Penn.)

This paper deals with the construction and design considerations of a portable cathode-ray oscilloscope for photographic recording. This instrument is self-contained, battery-operated, and designed for simultaneous recording of two signals and recording of marking signals of standard frequencies. The frequency band from 5 to 300 cycles is covered in three ranges. The total weight of the instrument is 27 pounds, the size is $6 \times 12\frac{1}{2} \times 16\frac{1}{2}$ inches.

The instrument has a high input impedance and is primarily designed for use in connection with strain gauges and vibration pickup devices.

13. A VACUUM-CONTAINED PUSH-PULL TRIODE TRANSMITTER

MAJOR H. A. ZAHL, J. E. GORHAM, AND G. F. ROUSE
(Signal Corps Ground Signal Agency, Asbury Park, N. J.)

A push-pull triode-transmitter type of construction is described in which the resonant circuits are contained inside the evacuated envelope to reduce lead effects and make possible the use of the resonant circuits to increase the anode dissipation. The internal resonant circuits consist of short-circuited sheet tantalum parallel transmission lines attached directly to the tantalum plates

and grids in such a way as to provide coupling between the plate and grid loops. Each side of the push-pull circuit has two sets of plate-, grid-, and thoriated-filament elements in parallel.

Although the tuning of the loop circuits inside the envelope cannot be changed, a limited control of the frequency is possible because of the tunable external-filament line. The radio-frequency output circuit consists of a parallel transmission line, which is connected directly to the two pairs of plates. The combined tube, transmitter, and appropriate shielding occupy a much smaller volume than is required for external resonant circuits at frequencies of 200 to 700 megacycles and weigh only a few pounds. Similar tubes having a radio-frequency grounded plate, grounded grid, and grounded-cathode type of construction are described.

22. HEATING WITH HIGH-FREQUENCY ELECTRIC FIELDS

PAUL D. ZOTTU

(Thermex Division, Girdler Corporation, Louisville, Ky.)

The history of high-frequency heating will be reviewed. The process of generating electrical heat in non-conductors, semiconductors, and conductors will be described. The variation of the electrical properties of the materials to be heated with temperature, moisture content, and other factors will be discussed.

The general requirements of radio-frequency power generators as to frequency, power output, controls, and circuits, together with a description of a number of dielectric heating units and some commercial installations will be given.

A.I.E.E. WINTER TECHNICAL MEETING, JANUARY 22-26, 1945

COMMUNICATION AND ELECTRONICS PAPERS

- "Transient Response of Controlled Rectifier Circuits," by P. T. Chin and G. E. Walter, General Electric Company
- "Arc Backs in Rectifier Circuits—Artificial Arc-Back Tests," by R. D. Evans and A. J. Maslin, Westinghouse Electric and Manufacturing Company
- "Rectifier-Fault Currents," by C. C. Herskind and H. L. Kellogg, General Electric Company
- "Voltage and Current Relations for Controlled Rectification with Inductive and Generative Loads," by K. P. Puchlowski, Westinghouse Electric and Manufacturing Company
- "Principles of Grid Control for Thyratrons," by P. T. Chin and E. E. Moyer, General Electric Company
- "Problems and Accomplishments of Industrial Electronic Control," by O. W. Livingston, General Electric Company
- "An Interval Timer for Arc Duration," by J. S. Quill, General Electric Company
- "A Comparison of the Amplitude-Modulation, Frequency-Modulation, and Single-Side-Band Systems for Power-Line Carrier Transmission," by R. C. Cheek, Westinghouse Electric and Manufacturing Company
- "The Resistance-Coupled Amplifier," by L. G. Cowles, The Texas Company
- "The Tapered Transmission Line," by J. W. Milnor, Consulting Engineer
- "Design of Sealed Ignitron Rectifiers for Three-Wire Service," by M. M. Morack, General Electric Company
- "Mercury-Arc Rectifiers for Railroads," by S. S. Watkins, Gibbs and Hill, Inc.
- "Power-Line Carrier Channels," by M. J. Brown, Westinghouse Electric and Manufacturing Company

I.R.E. Board Sets Goal of



B. E. SHACKELFORD (A'23-M'26-F'38)
Chairman, Building-Fund Committee

who has been appointed general head of the Building Fund program. As such, he has been chairman of its important Planning Committee, composed of:

I. S. Coggeshall, Vice-Chairman	
L. M. Clement	D. E. Foster
W. E. Donovan	R. A. Heising
W. C. Evans	Haraden Pratt
H. B. Richmond	

Dr. Shackelford was recently elected Director of I.R.E. for the 1945-1947 term. He is well known throughout the Institute and the industry, having been Chairman of the 1944 Winter Technical Meeting, is assistant to the vice-president in charge of RCA Laboratories, Radio Corporation of America, and active on Panels 1 and 2 of the Radio Technical Planning Board.

The November PROCEEDINGS carried an article setting forth the need which impelled the I.R.E. Board of Directors to embark upon a campaign to raise a fund sufficient to establish "a suitable headquarters building, whether alone or in association with other engineering societies, as the opportunity presents." The Board has now determined that a sum of not less than \$500,000 must be raised for a permanent home if the Institute is to undertake to give its members and communication and electronic science, engineering, and consequently industry, proper service in the future and thus to contribute suitably to their advancement.

So many years have passed since a building-fund campaign was instituted by engineers that many have forgotten that initiative in such matters must come from engineers themselves. In 1895, a member of the American Institute of Electrical Engineers submitted to Andrew Carnegie a plan for a union home for engineers. The plan "received warm commendation but led to no action." Nine years later, the American Institute of Mining Engineers, the American Society of Mechanical Engineers, and the American Institute of Electrical Engineers, with an aggregate membership of 8500 members, joined in the raising of funds in the amount of

\$541,000 for the purchase of land. Thereupon Carnegie added a gift of \$1,050,000 for the present Engineering Societies Building. When the American Society of Civil Engineers became the fourth Founder Society in 1916, its 7900 members raised \$262,500, which was applied to putting additional stories on the building. Altogether, the total cost of land and building has been \$2,000,000, of which practically \$1,000,000 was raised by engineers of the Founder Societies and their friends.

The Institute of Radio Engineers now has more than 12,000 members whose financial status must be of a level corresponding to that of the engineering profession generally. What others did years ago, we can undertake to repeat under the present favorable conditions.

The Board, while welcoming corporate gifts, attaches significant importance to gifts from the ranks of its own membership. Outsiders should hardly be asked to contribute to the Building Fund without definite evidence of interest made manifest by financial support on the part of our entire membership. As the campaign unfolds, the responsibility of the members, both in making contributions themselves and in securing them from friends of the Institute, will be made clear. The organization of the Sections will be availed of for the purpose.

Assuming universal and generous support by the Institute's membership, the Directors are counting upon a wide response from the radio-and-electronic industry to an appeal for capital funds—in fact, in terms of specific sums, the expectation of attaining our goal is based upon raising much of the fund through corporate and special individual nonmember gifts at the request of our members.

The philosophy underlying the decision to approach the industry for gifts is based upon the twofold dependence of modern industrial laboratories upon the universities and upon the scientific and technical societies for the constant replenishment, from without, of ideas and men with ideas. We, who are in the profession and the industry, see the importance of the detached and unselfish attitude of the engineer and scientist perhaps less clearly than those who survey the whole gamut of human endeavor. Thus, Wells, in "The Outline of History" (xxxiv, 6), points out that "the essential use and virtue" of scientific societies "is *publication. . . . Frank report . . . and open discussion . . . is the life of the modern scientific process*. For the true scientific method is this: to trust no statements without verification, to test all things as rigorously as possible, to *keep no secrets, to attempt no monopolies, to give out one's best modestly and plainly, serving no other end but knowledge*."

Again, Lippmann, in "A Preface to Morals" (xii, 2) says that, at the heart of research, "the habit of disinterested realism in dealing with the data is the indispensable habit of mind This is an original and tremendous fact in human experience: that a whole civilization should be dependent upon technology, that this

Building Fund at \$500,000

technology should be dependent upon pure science, and that this pure science should be dependent upon a race of men who consciously refuse . . . to regard their 'own desires, tastes, and interests as affording a key to the understanding of the world.' An elaborate method of detecting and discounting their prejudices has been developed," he says, consisting of "instruments of precision, an accurate vocabulary, controlled experiment, and the submission not only of their results but their processes to the judgment of their peers. This method provides a body in which the spirit of disinterestedness can live. . . . The scientific discipline has become . . . an essential part of our social heritage. For the machine technology requires a population which in some measure partakes of the spirit which creates it."

So broad and firm a base obviously would justify (from the viewpoint of an actual, if not acknowledged, indebtedness) an appeal for public support of the Institute. Perhaps such a claim for sympathetic consideration will be entertained, during the course of the campaign, by one or more public-spirited individuals or foundations having no direct connection with the radio-and-electronic industry.

How much greater the force of the suggestion within the industry itself! Hardly a company now successful in its field but has drawn mightily upon the organized engineering effort of I.R.E. The Institute was on the job during World War I, before organizations now directly supported by the returns of the industry were created. Its technological publications in the radio-boom decade of the '20's were fundamental to that expansion. For its detached attitude in recording scientific progress in investigation of electron tubes, the relationships of circuit elements, in measurements, standards, and the mathematics of the art, when it might have spent its energy merely exploiting detailed applications of technology to the radio business, the Institute is to be credited with the initial dissemination of information upon which radio manufacturing, industrial electronics, and much of modern electrical communication is now built. The greatest minds in the field have contributed to its pages. In turn, it has reached out to serve the industry in all its phases, making for the broadest conceivable example of exchange of information. Among industrial laboratories the Institute has not been a dead-leveler but a dynamic catalyzer, putting at the disposal of all, the fundamental contributions of each laboratory.

The PROCEEDINGS has similarly leveled upwards the teaching staffs and curricula of the universities, whence comes the industry's technological raw material. By publication, meetings, and conventions the engineers have been continuously stimulated and re-educated, it being axiomatic in a branch of technology as rapidly expanding as ours that static dependence upon knowledge acquired in college will be found de-



WALTER C. EVANS (M'36)
Chairman, Building Fund Advisory Committee

Vice-President, Westinghouse Electric and Manufacturing Company, and head of its Radio, X-Ray, and Broadcasting Divisions, who has accepted designation as Chairman of the Advisory Committee. Its other members are:

R. C. Cosgrove
J. V. L. Hogan
F. R. Lack
George Lewis

Frank E. Mullen
E. A. Nicholas
E. R. Shute
F. D. Williams

Mr. Evans was a 1921 pioneer in radio broadcasting at Station KYW, Chicago. He has just completed a three-year term as Director of the Radio Manufacturers Association. Mr. Evans and his associates have already functioned in an industrial advisory capacity to the I.R.E. Board on matters of fund-campaign policy.

efficient in competition with the learning of those who, because more recently trained, bring to the industry new skills and fresher outlooks.

The Institute is not making a monetary claim for these services, nor is it rendering the industry a statement of indebtedness. It recognizes the reciprocal benefits it has received in the form of time given to it, gratis, by its authors, speakers, committeemen, and officers, many of them working "on company time." Even more fundamentally, it recognizes its indebtedness to businessmen and industrialists for their permission for their technologists to disclose the results of millions of dollars' worth of laboratory effort. In one sense, such a co-operative effort between the industry and its technical society is purely mutual and completely satisfied without exchange of funds. But because the Institute must have more office space to meet the expanding needs of its engineering activities and services to the industry which naturally arise therefrom, and because the engineers alone cannot finance so great an objective without help, it is felt that most businesses founded on radio and electronics will wish to make a substantial contribution towards permanently housing an institution whose permanence to date has been the best assurance that the art will continue to progress.

W. E. Fromm, F. N. Frost, U. R. Furst, W. M. Hall, E. N. Hauber, Sanford Helt, Clarence Herbert, E. A. Hertzler, C. E. Himoe, M. W. Horrell, M. C. Jensen, Edmund Kahl, F. W. King, Jr., A. F. Knoblauch, K. A. Moore, E. R. Meissner, D. B. Nason, D. A. Newberry, W. A. Oker, P. N. Partridge, R. S. Peterman, L. B. Phillips, C. G. Pierce, J. P. Quitter, R. O. Schlegelmilch, H. C. Storck, F. L. Wedig, F. A. Wissel, and R. R. Wright; for admission to Member grade, J. J. Ayres, R. A. Becker, A. J. Bissonette, L. F. Boeckerman, R. P. Cherpeski, F. C. Clark, P. W. Crapuchettes, D. J. Dietrich, G. E. Evans, S. J. Featherstone, Samuel Freedman, H. N. Frihart, E. S. Goebel, L. C. Holmes, Leonard Katz, J. P. Lenkerd, A. S. LeVelle, G. B. Litchford, G. B. Loper, I. G. Marchant, G. H. Mar-mont, K. G. Miles, R. G. Pelton, F. G. Popp, R. L. Ringer, Jr., Merl Saxon, M. R. Shaw, Jr., J. C. Simmons, W. B. Shirk, G. O. Smith, O. J. M. Smith, T. J. Talley, III, E. W. Van Winkle, and W. D. Voelker, and at the October 4, 1944, meeting: for transfer to Senior Member grade, I. D. Ball, E. P. Buckthal, O. E. Dunlap, Jr., J. H. Eichel, Burwell Graham, J. H. O. Harries, F. G. Levy, H. J. Lyman, C. W. Lytle, J. O. Mesa, D. A. Meyer, J. A. Ouimet, E. B. Passaw, C. A. Petry, Grote Reber, H. C. Roberts, W. J. Schnell, D. L. Waidelich, J. D. Wallace, and A. R. Willson; for admission to Senior Member grade, R. D. Bennett, W. P. Short, and C. K. Stedman; elected to Senior Member grade, L. McC. Young and C. M. Wheeler; for transfer to Member grade, W. S. Alberts, F. W. Albertson, C. E. Day, W. O. Freitag, H. R. Hesse, Ross Hilker, J. L. Hollis, E. J. Hughes, R. M. Krueger, F. N. Lantzer, Howard Lepple, J. M. McDonald, J. S. McNeely, W. W. Miehler, J. M. Morgan, R. L. Schenck, C. B. Sloan, O. H. Schuck, W. T. Sumerlin, Ben Warriner, IV, and P. A. Young; for admission to Member grade, W. C. Ackard, H. W. Baker, Jr., W. H. Boghosian, F. E. Collins, D. C. Curley, W. S. Lovett, R. W. Marshall, R. G. Mayfield, Henry Meltvedt, Nathan Most, G. D. Ostrander, E. F. Peterson, A. K. Schenck, J. O. Schock, R. L. Shearer, A. D. Smith, Jr., B. C. Stone, and D. E. Sunstein; Associate grade, 138; and Student grade, 71.

Committees and Appointments

Building-Fund: The Building-Fund Committee plans and activities were considered in detail.

Conferences: Mr. W. C. White was unanimously appointed chairman of the Committee on Conferences. He will be responsible for the organization of conferences, such as those listed below:

Electronics	Communications
Broadcasting	Radars and Navigation
Broadcast Receivers	Tubes
Similar Conferences	

Electronics: J. H. Hutchings was unanimously recommended to the Board for appointment to the Electronics Committee.

Technical Committees: After favorable discussion of the need for employing a full-time technical secretary, it was moved to authorize the Executive Committee to interview applicants for the proposed salaried position.

Postwar Publication of Wartime Papers

The Board of Directors of the Institute of Radio Engineers has earmarked a fund of \$20,000 to be used, according to present plans, for the postwar publication of wartime papers. This fund, translated into pages in the PROCEEDINGS, means that about 1000 extra pages can be printed. The average manuscript runs approximately ten PROCEEDINGS pages, so the Institute is greatly interested in obtaining information on the likely future availability of an additional 100 worth-while papers, dealing with matters which, for security reasons, cannot now be released.

With Victory, these papers may be released, and now is the time for prospective authors to start gathering material and to think about papers which would be suitable for publication in the PROCEEDINGS. At this time, authors might well be preparing outlines for future papers and assembling illustrations for them. Undoubtedly, when censorship restrictions are relaxed, a large number of papers will be released. Obviously only the best and most carefully prepared of these can be accepted for publication in the PROCEEDINGS, and, on any particular subject, those papers which are first received by the Institute and are of acceptable character, will be published. This may preclude the acceptance of later papers covering similar ground.

Headquarters will be glad to furnish authors with copies of "Suggestions to Authors" and "Abbreviations of Publications." These will be found very helpful in the preparation of manuscripts. It would be appreciated if requests were to be accompanied by a stamped, self-addressed envelope.

PROCEEDINGS: A new design for the front cover of the PROCEEDINGS was described and favorably received. Unanimous approval was given to the motion authorizing Editor Goldsmith to redesign the front cover in the manner described, and to begin using the new cover design starting with the January, 1945, issue of the PROCEEDINGS or earlier if possible.

Sections

Ottawa: Mr. Wheeler pointed out that the Ottawa Section agreed to the indicated areas as its territory, considered to be satisfactory to the adjoining Montreal and Toronto Sections, as previously reported:

COUNTIES IN ONTARIO

Lennox and Addington		
Lanark	Prescott	Leeds
Carleton	Renfrew	Dundas
Grenville	Frontenac	Glengary
Stormont		Russell

ELECTORAL DISTRICTS IN PROVINCE OF QUEBEC

Pontiac Hull
Laval (Labelle)

It was understood that these counties and districts would constitute the official territory of the Ottawa Section.

Summer Convention: Unanimous approval was given to the motion stating that the Executive Committee favors calling a summer convention to be held approximately June, 1945, at a location other than New York City. It was understood that the Executive Committee would decide the location of the 1945 Summer Convention. The appointment of the committee for this convention was given consideration, and it was stated that the personnel of this group would be named at the next meeting.

Rochester Fall Meeting

In spite of wartime pressure, some 700 radio engineers found time to attend the annual Fall Meeting at Rochester on November 13 and 14. A record attendance registered, and some 300 were at the banquet at which Major General Colton, Army Air Force, was the guest speaker.

In the two-day session, technical papers were delivered on subjects ranging from a reactance theorem for a resonator as presented by W. R. MacLean of Polytechnic Institute of Brooklyn, to the organization of research in radio after the war, discussed by Rupert MacLaurin, economist at Massachusetts Institute of Technology.

The evening of November 13 was devoted to some backward glances and much forward looking at the industry by the professional optimist, Kenneth W. Jarvis. Tribute was paid by him to industry figures who had been faithful attendants at these annual meetings but who had been lost during the war.

At this evening meeting, a vigorous discussion developed over a talk by Sarkes Tarzian on the subject of frequency-modulation broadcasting. Mr. Tarzian's thesis was that frequency modulation was an unwarranted expenditure of space in the ether, that frequency-modulation receivers will inevitably cost more to produce than amplitude-modulation sets; that listeners have shown no interest in high-fidelity broadcasting; that narrow-band broadcasting on the high frequencies would make it possible for the Federal Communication Commission to grant many more licenses than will be possible with frequency modulation; and that ignition noise is the limiting factor on the high frequencies and not natural static. Proponents of frequency modulation took up the cudgels for their stand, and as is usual at the Fall Meetings, much interest and some warm arguments were generated in the ensuing discussion.

At the banquet were present Professor Turner, retiring president of the Institute of Radio Engineers; the president-elect, Professor Everitt, head of the Operational Research Branch of the Signal Corps of the United States Army, and S. F. Barton, past vice-president of the Institute, who presided.

At the banquet a plaque was presented to Keith Henney, Fellow of the Institute,

for "his many years of unselfish service to the radio and electronic industry through the technical press." Previous recipients of Fall Meeting plaques are W. R. G. Baker for his "accomplishments in the organization and direction of the National Television Systems Committee"; L. C. F. Horle, past-president of the Institute for his "accomplishments in the Radio Manufacturers' Association Material Bureau"; R. A. Hackbusch, vice-president of the Institute for his "work in forwarding the technological war effort by direct action in the elimination of unnecessary detail."

IRE People

W. L. EVERITT

Appointment of Dr. W. L. Everitt (A'25-M'29-F'38), one of America's foremost authorities on electronics, as professor and head of the department of electrical engineering at the University of Illinois was recently announced by the University's president, Arthur Cutts Willard.

Dr. Everitt has been granted an automatic leave of absence from his new post because of the importance of his present work with the Army, for which he has been, since 1942, Chief of the Operational Research Branch in the Office of the Chief Signal Officer, at Washington, D. C. He will take up his duties at the University immediately on release from war service.

Since 1934, Dr. Everitt had been professor of electrical engineering at Ohio State University, and previously an instructor at Cornell University and at the University of Michigan. He is the author of several books and a number of technical papers on radio and telephone communications; has served as research and consulting engineer to the American Telephone and Telegraph Company and to various manufacturing concerns, and is the inventor of a number of electronic devices.

In 1942, Dr. Everitt was elected to the Board of Directors of The Institute of Radio Engineers, and has served on numerous committees. He is President Elect of the Institute for the year 1945. He is a Fellow of the American Institute of Electrical Engineers.



DONALD B. SINCLAIR

Donald B. Sinclair, of the General Radio engineering staff, has recently been appointed assistant chief engineer and will be in charge of circuit development.

Dr. Sinclair received the S.B. degree from Massachusetts Institute of Technology in 1931, the S.M. degree in 1932, and the Sc.D. degree in 1935. He was a research assistant at M.I.T. from 1932 to 1935 and a research associate during 1935-1936 when he joined the engineering staff of the General Radio Company. Dr. Sinclair is a member of Sigma Xi. He joined The Institute of Radio Engineers as a Junior in 1930, transferred to



Discussing activities at the National Electronics Conference in Chicago, October 5-7, are (left to right) Earl Abbott, General Electric Company, Chicago; Dr. J. E. Hobson and Dr. P. G. Andres (A'27), Chairmen respectively of the Executive and Arrangements Committees of the Conference; and W. C. White (A'15-M'15-F'40) in charge of the electronics section of the General Electric Company's research laboratory.



DONALD B. SINCLAIR

Associate in 1933, to Member in 1938, Senior Member in October of 1943, and was made a Fellow in December of the same year.



ROBERT BURDETTE WOOLVERTON

Robert Burdette Woolverton (A'13-M'13-F'15) was born on September 22, 1884, at Greensboro, Pennsylvania. He received the B.S. degree from Harvard University in 1912.

From 1904 to 1908, Mr. Woolverton served in the United States Navy as chief radio electrician on the U.S.S. *Kentucky*, and maintained for that vessel the world's long-distance record for radio communication. In 1905, when reception through headphones was just being initiated into use, Mr. Woolverton conceived the idea of a very high spark frequency for improved reception

through interference and static. In partial recognition of this pioneer work he was made a Fellow of the Institute of Radio Engineers, in 1915.

Upon graduation from Harvard, Mr. Woolverton joined the National Electric Signaling Company, in Brooklyn, N. Y., as research engineer, devoting his efforts exclusively to the development of the Fessenden system of heterodyne reception. From 1913 to 1916 he was Pacific coast radio inspector for the Department of Commerce, and left government service in 1916 to become associated with the Federal Telegraph Company of San Francisco, as a radio and electrical engineer. During this association he assisted in the design of the high-power arc transmitters for the United States Navy, and later installed the 250-kilowatt station at San Diego, California, and the 500-kilowatt stations at Pearl Harbor, Hawaii, and Cavite, Philippine Islands.

In 1918, Mr. Woolverton was commissioned a captain in the Signal Corps Reserve, and served in France until the Armistice. Upon his return to the United States in 1919, he served as Pacific Coast radio supervisor for the United States Shipping Board until 1920, when he returned to the Signal Corps as a radio engineer in the office of the Chief Signal Officer. In this capacity he founded the War Department Radio Net, connecting the headquarters of the ninth corps areas of the War Department. Commissioned as a Captain in the Army Signal Corps in 1920, he became officer in charge of all Army radio stations, ashore and afloat, continuing in charge of the radio plant and traffic section of the office of the Chief Signal Officer as the War Department Net grew to include 58 stations and increased its service.

From 1927 to 1929 he served as officer in charge of the Second Section, Alaska Communication System, with headquarters in

Seward, Alaska. Returning from this post, Captain Woolverton was assigned as radio officer to the Ninth Corps Area, with headquarters at San Francisco, and in 1935 became Executive Officer of the Signal Office, Seventh Corps Area, at Omaha, Nebraska. In 1938 he returned to the Alaska Communication System, with headquarters in Seattle, Washington, and in the following year was promoted to the rank of Major. In 1941, as Lieutenant Colonel, he became officer in charge of the Alaska Communication System, and later in the same year was transferred to Hawaii, where he served as radio officer for the Hawaiian Department, at Fort Shafter.

Ordered to Recife, Brazil, in 1943, Colonel Woolverton was assigned as Theater Signal Officer for the South Atlantic Theater, and was promoted to the rank of Colonel. He was retired from the Army for physical disability in September, 1944, after more than forty years of continuous experience in radio work, and long and useful service as an officer of the Army.

Correspondence

Correspondence on both technical and nontechnical subjects from readers of the PROCEEDINGS OF THE I.R.E. is invited, subject to the following conditions: All rights are reserved by the Institute. Statements in letters are expressly understood to be the individual opinion of the writer, and endorsement or recognition by the I.R.E. is not implied by publication. All letters are to be submitted as typewritten, double-spaced, original copies. Any illustrations are to be submitted as inked drawings. Captions are to be supplied for all illustrations.

Frequency and Phase Modulation

The subject of frequency and phase modulation has been taken up in two different contributions to this correspondence page this year.^{1,2} Although no direct reference is made, it is evident that the last one presents arguments against some points in the first one, and as authors of the original letter we find a brief reply in order.

In our suggested terminology we tried not only to clarify the fundamental concepts but also to find a compromise which everyone could accept. We believed this possible since there is very little controversy about facts but merely about presentation of facts in words. First we interpreted "modulation" as a characteristic property of a wave and defined the fundamental types of "modu-

lated waves" in very general terms in order to satisfy the analytical minds who rightly maintain that a frequency-modulated wave and a phase-modulated wave are fundamentally equivalent. Dr. Hund himself concedes this point in his book³ by stating that frequency modulation has its "equivalent phase modulation" and vice versa. The second interpretation of "modulation" as the process of producing modulated waves gave us a new set of definitions, which should satisfy the practical minds who rightly maintain that a phase modulator works quite differently and gives a transmission channel with different properties compared to a frequency modulator. Dr. Hund evidently did not read our note to the end, or he would have found that he had very little reason to argue with us.

As it now reads, Dr. Hund's letter illustrates in a striking manner our observation that use of a vague terminology is the main cause of confusion regarding this subject. Although another interpretation may be possible, it is our impression that when Dr. Hund speaks about "a mathematical point of view" he has in mind what we call "a modulated wave" while "the engineering point of view" refers to methods of modulation and the properties of the corresponding transmission channels. If so, his facts are in general correct though his presentation renders them obscure. His failure to make this distinction clear is the only reason why he gets "into deep water" when applying the mathematical analysis to engineering problems.

Dr. Hund's letter is not free from factual errors, however. His equation $\phi_t = 2\pi F_t t + \theta$ in the bottom paragraph of the first column is not correct, since the instantaneous electric angle can never be given in terms of one single instantaneous value of a variable frequency.

Dr. Hund's attempt to illustrate the "great" difference between phase and frequency modulation using a stiff card and a rubber strip, respectively, is not very successful. The twenty waves on the card are evidently consecutive in time, and therefore a gradual phase variation with time⁴ must make the consecutive cycles differ from each other. Thus we actually need a rubber strip to illustrate phase modulation as well as frequency modulation. For the same reason uniform stretching of the rubber strip will not truly represent frequency modulation. A longitudinal wave motion of compression and expansion along the rubber strip on the other hand would give a picture of both a phase-modulated and a frequency-modulated wave. Dr. Hund's "illustration" is apt to give an uncritical reader the impression that it is possible to vary the phase without obtaining corresponding frequency variations and vice versa. Dr. Hund's treatment of "equivalent frequency modulation" in his book testifies that this is certainly not his intention, but what he really has in mind is not clear.

Most of Dr. Hund's arguments, however,

constitute an attack on windmills. Nobody with any knowledge of the art will deny the difference between the methods of phase and frequency modulation and the different relations between the spectrum of the impressed signal and the radio-frequency spectra obtained with the respective methods. In our suggested terminology we gave these facts due credit in the definition of the different types of transmissions.

Dr. Hund succeeds in bringing out one fact very clearly: the importance of a common basis of clear, unambiguous concepts to prevent misunderstandings.

HARRY STOCKMAN
Cruft Laboratory

GUNNAR HOK
Radio Research
Laboratory

Harvard University
Cambridge, Massachusetts

A Circuit Study

When I first read the article on "Phase-Shift Oscillators" by Messrs. Gintzon and Hollingsworth which appeared in the PROCEEDINGS INSTITUTE OF RADIO ENGINEERS in February, 1941, I set myself to the task of finding another resistance-capacitance circuit with 6 elements which would produce a 180-degree phase shift. In this I did not succeed. However I found that the circuit which appears in Fig. 1 possesses the same properties as the well-known Wien circuit, so widely used in the Wien bridge and in the resistance-capacitance oscillators.

By a simple application of Kirchhoff's laws or by considering the circuit as two voltage-dividing networks connected in tandem the ratio between the output and input voltages can be easily shown to be

$$\frac{e}{E} = \frac{-j \times R}{R^2 - x^2 - 3jRx} \quad (1)$$

For the frequency for which $x=R$ this equation becomes

$$e/E = 1/3. \quad (2)$$

It would now be convenient to find whether or not the maximum value that the ratio e/E can have is 1/3. This may be done by rationalizing (1), finding its absolute value,

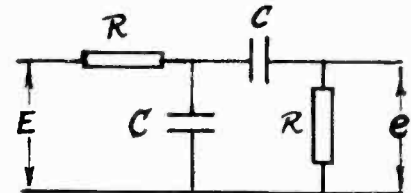

Fig. 1

and setting the first derivative of the output voltage which respect to the capacitive reactance equal to zero, since we can rightfully consider e as a function of x .

The absolute value of (1) when rationalized gives

$$\frac{e}{E} = \frac{\sqrt{9x^4R^4 + x^2R^2(R^2 - x^2)^2}}{(R^2 - x^2)^2 + 9R^2x^2} \quad (3)$$

To obtain the maximum value of e only the numerator of the derivative of (3) need be

¹ Harry Stockman and Gunnar Hok, "A note on frequency-modulation terminology," Proc. I.R.E., vol. 32, pp. 181-182; March, 1944.

² August Hund, "Frequency and phase modulation," Proc. I.R.E., vol. 32, pp. 572-573; September, 1944.

³ August Hund, "Frequency Modulation," McGraw-Hill Company, New York 18, N. Y., 1942.

⁴ For instance, a sinusoidal variation; in the limit the same will apply to triangular, rectangular, etc., variations, if at least one complete cycle is considered.

considered. When this is done and some simplifications are made the following expression is obtained:

$$\frac{1}{E} \frac{de}{dx} = [(R^2 - x^2)^2 + 9R^2x^2] \\ [18R^2x^2 - 2x^2(R^2 - x^2) + (R^2 - x^2)^2] \\ - [9x^2R^2 + x(R^2 - x^2)^2] \\ [18xR^2 - 4x(R^2 - x^2)] = 0. \quad (4)$$

Equation (4) is satisfied only when $R=x$ and therefore the maximum value of e/E is $1/3$. Thus this circuit has exactly the same properties and uses the same number of circuit elements as the Wien Circuit.

The circuit obtained by interchanging the positions of the condensers and the resistances on the accompanying figure has also the same properties.

BRAULIO DUEÑO
University of Puerto Rico,
Mayaguez, P. R.

Proposed Changes to Bylaws

October 10, 1944

Mr. Haraden Pratt, Secretary
Institute of Radio Engineers, Inc.
330 West 42nd Street
New York 18, New York

Dear Mr. Pratt:

It appears to me that a system of membership with fixed dues, rather than on the sliding scale, is the only sensible way of conducting an organization such as ours, and the proposals brought forward by the Canadian members regarding classes might work out to an advantage.

A number of years ago I became a member of an engineering society as a junior member, and upon completing 25 years of full membership, I was handed a life membership ticket, the same as had been set up for other 25-year members, relieving me of the payment of further dues, but which does not relieve me of my obligations to the society as a fellow engineer. I merely mention this in order to show that sometimes there is a reward for continuous co-operation and membership in an organization, and perhaps our Institute might consider some type of a life membership at some time in the future, if the time is not right now to add this type of membership.

In conclusion I wish to say that, in my humble opinion, our executives and board have carried through a very fine program, and it is my hope that they may continue to grow and prosper, and hold their place among the engineering profession in the years to come. It would be commendable indeed to be associated with some organization with club rooms, a meeting hall, etc., in the Metropolitan area in New York, and that could only be accomplished by a large membership, and by proper and adequate financing.

Yours very truly,
Stupakoff Ceramic and
Manufacturing Company
Latrobe, Pennsylvania
R. E. Stark
Vice-President



FRANCIS A. HUBBARD

Francis A. Hubbard, a development engineer of Bell Telephone Laboratories, Inc., died on June 6, 1944, in his office, of a heart attack. He was fifty-four years old.

Mr. Hubbard was born in Cambridge, Massachusetts, and was graduated from Harvard College with an A.B. degree, in 1911. He received the degree of Master of Electrical Engineering in 1914. After a year's teaching at Cornell he entered the engineering department of the Western Electric Company in 1915. When the foreign business of Western Electric was sold to the International Telephone and Telegraph Company, Mr. Hubbard joined its subsidiary International Standard Electric Company. As its transmission engineer and later assistant chief engineer he laid out the Stockholm-Gothenburg long-distance telephone cable and a similar cable connecting Milan, Turin, and Genoa. He also established the first trans-Andean telephone circuit in 1928. Later he became vice-president and general manager for the Mexican Telephone and Telegraph Company. In 1930 he returned to the United States as a transmission engineer for the American Telephone and Telegraph Company. He transferred to Bell Laboratories in 1934 where he was switching research engineer. During the war he had charge of instructing Army personnel in the use and care of the electrical director for anti-aircraft guns.

Mr. Hubbard joined the Institute of Radio Engineers as an Associate in 1924, was transferred to Member grade in 1940, and to Senior Member grade in 1943.

Books

International Telecommunications, by Osborne Mance and J. E. Wheeler

Published (1944) by Oxford University Press, 114 Fifth Avenue, New York 11, N. Y. 86 pages+4-page index+xii pages. $8\frac{1}{2} \times 5\frac{1}{2}$ inches. Price, \$1.00.

This book, recently written in England, was issued under the auspices of the Royal Institute of International Affairs. This Institute is an unofficial and nonpolitical body, founded in 1920 to encourage and facilitate the scientific study of international affairs. It is stated on the flyleaf that since the Institute, as such, is precluded by its Royal Charter from expressing any opinion on any aspect of international affairs, the opinions in the book are purely individual. The authors explain that they were entrusted with the preparation of a study of International Transport and Communications, and that for this communication work they enjoyed the assistance of a large number of important official and unofficial experts and had access to facilities and information of the Foreign Office, the General Post Office, and the Air Ministry.

The subject matter is nontechnical and is presented largely from the standpoint of postwar planning. It would be most useful to persons not fully versed in the ramified aspects of international communications, who expect to have some future part in activities either directly or indirectly associated with this subject, particularly legislators, administrators, and other officials.

The major portion of the book deals with the history and present status of international agreements, presented in an easy and understandable manner, commencing first with the machinery of international regulation and then continuing with a brief review of the general provisions of the Telecommunication Convention, followed by specific information on telegraphy, telephony, radio communications, propaganda broadcasting, and special services. All the various committees and international organizations concerned with telecommunications are briefly explained.

A chapter tells the reader considerable about cable and wireless concessions from an historical point of view, giving a helpful background for understanding the present situations in China, South America and elsewhere. The British Imperial System of Communications is discussed briefly from a world standpoint.

The closing chapter attempts to state factors and problems that will influence the makeup of a future world organization of telecommunication, considering both commercial and political aspects. Here the authors indulge in some speculation as to a type of organization that they believe would overcome some of the handicaps of the present and past.

This reviewer considers the work accurate and useful, and in addition it has some value as a reference. Sources of information are set forth.

HARADEN PRATT
Mackay Radio and Telegraph Co.
New York, N. Y.

Sampling Inspection Tables— Single and Double Sampling, by Harold F. Dodge and Harry G. Romig

Published (1944) by John Wiley and Sons, Inc., 601 W. 26 St., New York 1, N. Y. 101 pages+4-page index+vi pages. 18 illustrations. $8\frac{1}{2} \times 5\frac{3}{4}$ inches. Price, \$1.50.

Broadly speaking, the object of industry is to set up economic means of satisfying human wants, and in doing so to reduce manufacturing techniques to routines requiring a minimum amount of human effort. Through the use of modern statistical concepts, it has been found possible to set up limits within which the results of routine efforts must lie if they are to be economical. The application of statistical methods to inspection technique is the natural outgrowth of efforts that have been made by a number of scientists to develop a scientific basis for obtaining economic control of quality of manufactured products. It has long been recognized, where sampling instead of complete inspection is used, that certain errors or risks are unavoidable. Modern statistical theory, however, offers means of computing probability of acceptance curves for given boundary conditions. It is with such curves and data that this book is concerned.

This book consists of a re-edited version of two papers by the authors and a paper by D. B. Keeling and L. E. Cisne, all of which have previously been published in the *Bell System Technical Journal*. These papers and the book deal with sampling inspection tables that have come into general use by industry. The text includes the three papers mentioned, and in addition, contains a brief introduction. The papers have been reproduced without modification except for rearrangement of the material. Chapter I outlines the pertinent factors to be considered in setting up inspection plans and develops the theory of single sampling inspection. Chapter II covers single and double sampling, the average outgoing quality limit (OAQL) concept and the mathematical background of the tables. Chapter III outlines the shop procedures required for the application of the tables given in the text.

The tables contained in the text are developed around the concept of lot tolerance; that is, an allowable percentage of defective articles in a given lot. Two levels of quality are considered, referred to by the authors as consumer's risk and producer's risk. Two general types of tables are given; one based on the concept of lot tolerance, and the other on the average outgoing quality limit. The broad conditions under which the different types have been found best adapted are discussed in detail in Chapter II. For each of the types, tables are provided both

for single sampling and for double sampling. Each of the individual tables constitutes a selection of solutions to the problem of minimizing over-all inspection. The tables indicate acceptance number, sample size, and the average number of pieces per lot for specified risks. Appendixes to Chapters I and II give the mathematical bases for the tables and for the curves used in the text.

This book is intended for inspection personnel concerned with mass production of quantities of essentially identical items to which statistical theory may be applied. It is well written, easy to read, and appears adequately to cover the ground intended by the authors. The information is presented in a clear and logical fashion, and the material has already stood the test of time since it has been previously published in the *Bell System Technical Journal*. It is believed that this book will be found a useful and worthwhile compilation for engineers and executives dealing with inspection methods and inspection techniques for mass production.

F. X. RETTENMEYER
RCA Victor Division
Camden, N. J.

Die Beziehungen Zwischen Nutzspannung und Störspannung bei den Frequenzumsetzungen der Drahtlosen Mehrkanaltelefonie (The Relationships Between Useful and Interfering Voltages in the Frequency Translations of Multiplex Radio Telephone Systems), by Erwin Huber

Published (1943) by Verlag A.-G. Gebr. Leemann and Company, Zurich, Switzerland. 95 pages. 20 illustrations. $8\frac{7}{8} \times 6\frac{1}{2}$ inches. Price. SFr 7.20/6.80.

This is a pamphlet of special interest to communication engineers concerned with multichannel radio or wire systems.

When several speech channels are simultaneously passed through the same amplifying and translating elements for radiation or transmission over wires, there are intermodulation phenomena which result in the generation of unwanted frequencies and the consequent production of cross talk and noise. The frequency, magnitude, and timing of the unwanted components depend on many factors, such as the nonlinearity of the amplifiers and modulators in the circuit, the exact frequency allocation, the make-up of the speech channels in frequency and amplitude distribution, etc. It is a complex subject which invites theoretical analysis as well as experiment. One of the greatest difficulties is to determine what assumptions should be used in a study of the kind, and since the nature of speech generally prohibits a thoroughly rigid treatment, the element of probability enters and may be an important, if not determining, factor in the result.

This treatise is a definite and serious con-

tribution in this field in which there has been a scarcity of published literature. It appears, however, to omit certain factors which are commonly considered to play an important part in a practical solution, such as the fact that, in a working system, all of the channels are not carrying speech at the same volume and at the same time. In this and other apparent omissions, it fails to recognize the existence of one or two papers published in the United States of America on the subject as early as 1939 and 1940, although the author states that most of his work was done in the period between 1940 to 1942.

On the whole, however, it is believed that engineers interested in the subject will derive benefit from a consideration of this document, and it is in a field in which it may be expected that there will be considerable activity during the ensuing years.

H. A. AFFEL
Bell Telephone Laboratories
New York, New York

Instrument Flying and Radio Navigation, by Holland L. Redfield

Published (1944) by the Ronald Press Co., 15 E. 26 St., New York 16, N. Y. 189 pages + 5-page index. 107 illustrations. $8\frac{1}{4} \times 5\frac{1}{4}$ inches. Price, \$3.00.

Four chapters of this book are devoted to the fundamentals of flight, five chapters to radio-range flying, two chapters to direction-finder navigation, and one chapter to the link trainer. The first four chapters carefully review the fundamentals of flight for the benefit of the pilot and radio personnel, and the latter chapters are devoted to problems concerning radio-range technique, direction-finding technique, and link-trainer problems.

The author has covered the subject quite thoroughly, evidently based on an intimate knowledge and experience in connection with the various systems in use. However, due to military restrictions, the book obviously does not cover all of the latter phases of radio navigation. The book is very well planned and the various subjects are treated in considerable detail and clarity which would no doubt find definite application in the training of pilot personnel as well as radio personnel.

The chapters on radio ranges and the various problems regarding orientation and navigation are exceptionally well done and these chapters should be of prime interest to pilot personnel. The author has attempted to avoid repetition insofar as possible and, in most cases, has accomplished that aim and has only used repetition for emphasis and correlation of one particular problem to another insofar as radio-range operation is concerned.

The chapters devoted to radio direction finding particularly stress the aural-null-type direction finder and the left-right indicators. These two chapters are not perhaps as complete as they might be in that greater detail should have been included regarding

automatic direction finders of both the single and dual types. It is a generally recognized fact that under difficult radio conditions it is necessary, for safety's sake, to revert to aural-null direction-finder operation. However the automatic-type direction finder can also be used to considerable advantage, and if the dual units are utilized it is much easier for the pilot to hold a straight course than when only one direction finder is utilized. In connection with the boxing procedure utilizing the direction finder for letdown, it seems that considerable additional explanation is in order concerning the boxing procedure with drift due to wind conditions. This point would be of interest as boxing procedure is usually begun above a cloud layer, in which case the wind components can be of considerable magnitude, while at lower altitudes and in blind operation wind components rapidly decrease.

There has been a definite need for a book of this kind for several years and it is felt that it should be of considerable interest to personnel in the aviation industry.

H. C. Leuteritz
Pan American Airways, Inc.
New York, N. Y.

Electronics Today and Tomorrow, by John Mills

Published (1944) by D. Van Nostrand Company, Inc., 250 Fifth Avenue, New York 3, New York. 170 pages+5-page index+ii pages. 5½×8 inches. Price, \$2.25.

This book is intended for the intelligent layman and definitely not for the expert. It presents an interesting introduction to many things electronic, especially suitable for those people who have been using electronic devices without ever stopping to wonder how they work.

In the Introduction there is given a necessarily cursory but interesting discussion of the physics underlying the new science of electronics and a brief recapitulation of applications such as telephony, broadcasting, and television. In elucidating the concept of electromotive force the author calls it "electron moving force."

Part I starts with hot cathodes and continues with diodes, triodes, multigrid tubes, photocells, and gas-filled tubes giving uses and applications of each.

Part II treats more complicated topics—electron guns and their application to cathode-ray tubes for oscillographic and television use; electron optics and its application to electron microscopy; ultra-high frequencies and their generation; and finally a discussion of the cyclotron.

The book contains no line drawings, diagrams, or photographs. The exposition is clear, simple and interesting.

V. K. ZWORYKIN
RCA Laboratories
Princeton, New Jersey

Contributors



RALPH R. BEAL

Ralph R. Beal (A '15) was born at Maude, Kansas, on November 22, 1887. He received a degree in electrical engineering in 1912 from Leland Stanford University. From 1912 to 1926, he conducted technical studies of continuous waves and engaged in the development, design, and application of long-wave radio equipment of the Poulsen-arc converter type.

During the First World War, Mr. Beal was a resident engineer in Washington, D. C., and actively supervised the installation of high-power arc converter equipment in stations constructed by the United States Navy for transoceanic communications.

In 1926 he became associated with the Radio Corporation of America. As Pacific Division Engineer of R.C.A. Communications, Inc., he directed the installation and operation of modern short-wave radio apparatus in overseas circuits to the Orient. In 1934 he became research supervisor attached to the New York office, and in 1937 was appointed research director of the Radio Corporation of America. Since 1943 Mr. Beal has held his present position as assistant to the vice-president in charge of R.C.A. Laboratories.

Arthur E. Harrison (A '41) was born on January 20, 1908, at San Luis Obispo, California. He received the B.S. degree in electrical engineering from the University of California in 1936. From 1936 to 1939 he was a teaching Fellow at the California Institute of Technology, and received the M.S. degree in 1937 and the Ph.D. degree in 1940. He did research work for the department of mechanical engineering at the University of California in 1940. Mr. Harrison joined the klystron laboratory of the Sperry Gyroscope Company at San Carlos, California in May, 1940 and is now located at the Sperry Research Laboratories in Garden City, Long Island, New York. He is an associate of the American Institute of Electrical Engineers and is a member of Sigma Xi, Tau Beta Pi and Eta Kappa Nu.

W. R. Hill, Jr. (A'43), was born at Seattle Washington, on February 1, 1911. He received the B.S. degree in electrical engineering from the University of Washington in 1934. From 1934 until 1936 he was associated with the Northern Radio Company, Seattle, as a radio engineer. He then became a teaching assistant at the University of California, and in 1939 was awarded the M.S. degree in electrical engineering.

From 1938 to 1941 Mr. Hill was employed as an engineer by the Standard Oil



ARTHUR E. HARRISON

Company of California, during which time he was engaged in the development of cathodic corrosion-protection systems. From 1942 to date he has been assistant professor of electrical engineering at the University of Washington.

Wesley M. Roberds was born at Burlington, Kansas, in 1903. He received the A. B. degree from the University of Kansas in 1925, and the A.M. and Ph.D. degrees from the same institution in 1926 and 1935, respectively.



W. R. HILL, JR.



WESLEY M. ROBERDS

From 1925 to 1927 Mr. Roberds was assistant professor of physics at the University of Kansas, and was on the staff of the University of Arkansas from 1927 to 1942. In 1942 he became associated with the Radio Corporation of America as development engineer in the field of applications of radio-frequency power.

He is a member of Sigma Xi and the American Physical Society.



Alfred W. Simon was born in Chicago, Illinois, on September 16, 1897. He studied physics and mathematics at the University of Chicago, receiving the degrees of B.S. in 1921 and Ph.D. in 1925. Subsequently, as a National Research Fellow in Physics at the California Institute of Technology, he carried on researches on electrostatic generators. Entering the industrial field in 1927, he was appointed director of the Cottrell Research Laboratory of the Tennessee Coal, Iron and Railroad Company, a subsidiary of the United States Steel Corporation, and held this position until 1932. From 1935 to 1937 he was employed as research physicist in the radio laboratory of the Stewart Warner Corporation, where he specialized in



F. R. STANSEL

the design of coils for radio receivers; from 1937 to 1939 he was employed as a geophysicist by the Geophysical Research Corporation and the Stanolind Oil and Gas Company of Tulsa, Oklahoma; and from 1939 to 1941 he was chief engineer of the American Harmonica Company in Chicago. At the outbreak of the war, Dr. Simon transferred to the Naval Ordnance Laboratory of the United States Navy Yard in Washington, D. C., where he stayed until 1943 when he was appointed instructor in mathematics and communication engineering in the Army Specialized Training Program at Washington University in St. Louis. At present, he holds the position of chief engineer with John Luellen and Company at Hazel Crest, Illinois.

Dr. Simon has been a frequent contributor to scientific and engineering journals since 1921.



F. R. Stansel (A '26-M '33-SM '43) was born in Raleigh, North Carolina, on August 7, 1904. He received the B.S. in E.E. degree from Union College in 1926, the M.E.E. degree from the Polytechnic Institute of Brooklyn in 1934, and the D.E.E. degree from the same institution in 1941. In 1926 he joined the Bell Telephone Laboratories and until 1936 was engaged at their Whippany laboratory in the development and design of high-power radio transmitters. Since 1936 Dr. Stansel has been engaged in the development and design of special testing equipment for the armed forces.

He is a member of the American Institute of Electrical Engineers and Sigma Xi.



Chandler Stewart, Jr. (S '39-A '41) was born in San Francisco, California, on February 1, 1916. He received the B.S. degree in electrical engineering from the University of California in 1939.

From 1939 to 1940 he was employed as a radio engineer by R.C.A. Communications, and from 1940 to 1941 he was with the United States Navy Bureau of Ships. Since 1941 Mr. Stewart has been with the United States Army Signal Corps, for whom he spent a year instructing inspectors and



CHANDLER STEWART, JR.

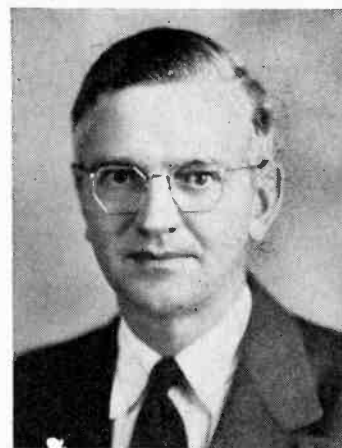

ALFRED W. SIMON



trainees, and later became engaged in developing methods for and making specialized electrical measurements at the Aircraft Radio Laboratory, Wright Field, Ohio. He is a member of Tau Beta Pi.



Karl S. Van Dyke (M'26-SM'43) was born at Brooklyn, New York, on December 8, 1892. He received the B.S. degree in 1916 and the M.S. degree in 1917 from Wesleyan University, and the Ph.D. degree in 1921 from the University of Chicago. From 1916 to 1917 Dr. Van Dyke was an assistant in physics at Wesleyan University; 1917 to 1919 in the general engineering department of the American Telephone and Telegraph Company; 1919 to 1921, assistant in physics at the University of Chicago; 1921 to 1925, an assistant professor of physics at Wesleyan University; 1925 to 1928, associate professor; 1928 to date, professor; and 1941 to date, on leave of absence; 1941 to 1942, assistant director of Division of Defense Research, University of California; 1942, associate director; 1942 to 1943, expert consultant, Office of the Chief Signal Officer, Army Service Forces; 1943 to date, chief physicist. He is a Fellow of the American Association for the Advancement of Science, and a Member of the American Physical Society, the Acoustical Society of America, and Sigma Xi.



KARL S. VAN DYKE



HARVEY UHX-25

A 25-Watt General Purpose Radio-Telephone Transmitter—Available for operation between 1.5 M.C. and 30 M.C.



HARVEY "AMPLI-STRIP"

For I-F and AUDIO Amplification.

HARVEY

OF CAMBRIDGE

RADIO AND ELECTRONIC EQUIPMENT

The units illustrated are representative of HARVEY OF CAMBRIDGE design and construction "know-how" as well as precision of manufacture and testing. Each is a precision product designed and developed by HARVEY OF CAMBRIDGE to fill specific needs in the radio-electronic fields.

Some, like the 206 PA Power Supply and the "Ampli-Strip" are new developments resulting from HARVEY's one-hundred per cent war work.

Others, like the UHX-25 Transmitter and

Marine 25 Radio Telephone are typical of HARVEY OF CAMBRIDGE products which have long been recognized as standards of quality and dependability.

Years of exclusive specialization in the manufacture and development of this type of equipment are your guarantee of complete satisfaction from all HARVEY OF CAMBRIDGE products and of competent, intelligent assistance in bringing to a successful solution any of your present or projected radio-electronic problems.

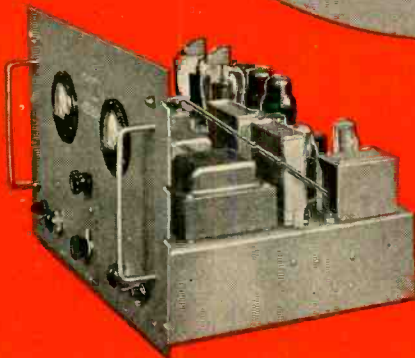

HARVEY Regulated Power Supply 206 PA

For laboratory D. C. Source—Range 500 to 1000 volts.

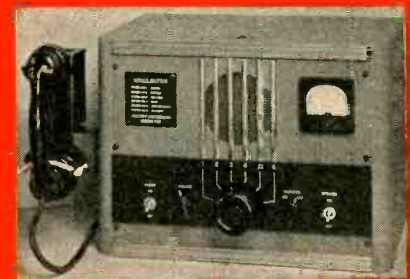

HARVEY MARINE 25

A 6-Channel Marine-Radio Telephone.

HARVEY

OF CAMBRIDGE

HARVEY RADIO LABORATORIES, INC.

447 CONCORD AVENUE • CAMBRIDGE 38, MASSACHUSETTS

1,001 USES

Condensed Power for Years of Service

VERSATILITY and dependability were paramount when *Alliance* designed these efficient motors — *Multum in Parvo!* . . . They are ideal for operating fans, movie projectors, light home appliances, toys, switches, motion displays, control systems and many other applications . . . providing economical condensed power for years of service.

Alliance Precision

Our long established standards of precision manufacturing from highest grade materials are strictly adhered to in these models to insure long life without breakdowns.

EFFICIENT

Both the new Model "K" Motor and the Model "MS" are the shaded pole induction type — the last word in efficient small motor design. They can be produced in all standard voltages and frequencies with actual measured power outputs ranging upwards to 1/100 H. P. . . Alliance motors also can be furnished, in quantity, with variations to adapt them to specific applications.

DEPENDABLE

Both these models uphold the *Alliance* reputation for all 'round dependability. In the busy post-war period, there will be many "spots" where these Miniature Power Plants will fit requirements . . . Write now for further information.

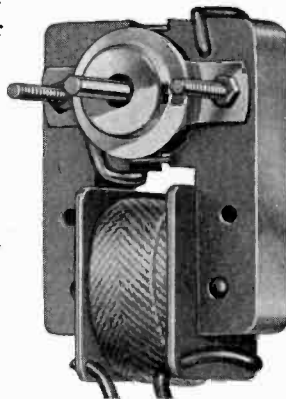

Model "MS" — Full Size
Motor Measures
1 3/4" x 2 x 3 1/8"

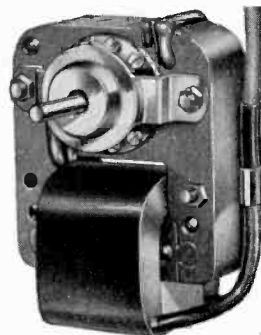

New Model "K" — Full Size
Motor Measures
2 1/8" x 2 3/8" x 3 1/16"

Remember Alliance!
—YOUR ALLY IN WAR AS IN PEACE

ALLIANCE

MANUFACTURING CO.

ALLIANCE . OHIO



BUENOS AIRES

"Cinematographic Exhibition: Scientific Films," September 1, 1944.

"Cathode-Ray Oscilloscopes," by J. P. Calvelo, Tel-Rad, S.A.; September 15, 1944.

"Electromedical Technique," by C. A. Lamarque, Consultant Engineer; October 6, 1944.

CONNECTICUT VALLEY

"Forum—Engineering Education Postwar," led by H. M. Turner, president, The Institute of Radio Engineers; October 26, 1944.

DALLAS-FORT WORTH

"The Application of Electronics to Electric-Power System Operation," by M. J. Thrasher, Texas Power and Light Company; November 22, 1944.

DETROIT

"Wave Concepts of Electricity," by Simon Ramo, General Electric Company; October 24, 1944.

MONTREAL

"Canadian I.R.E. Council and Canadian R.T.P.B.," by R. A. Hackbusch, vice-president, The Institute of Radio Engineers; October 25, 1944.

"Engineering Education," by W. L. Everitt, United States Signal Corps; November 8, 1944.

NEW YORK

"A Frequency-Dividing Locked-in Oscillator Frequency-Modulation Receiver," by G. L. Beers, Radio Corporation of America; November 1, 1944.

"Velocity-Modulated Tubes," by A. E. Harrison, Sperry Gyroscope Company; November 8, 1944.

"Looking Through the Keyhole at Electronics," by J. F. Rider, United States Signal Corps, November 8, 1944.

"Synchro Data Systems and Associated Electronic Circuits," by R. C. Goertz, Sperry Gyroscope Company; November 22, 1944.

OTTAWA

"Radio Technical Planning Board," by R. A. Hackbusch, vice-president, The Institute of Radio Engineers; October 24, 1944.

PHILADELPHIA

"Klystron Operation—A Presentation of the Fundamental Principles of Klystron Tubes," by A. E. Harrison, Sperry Research Laboratories; November 2, 1944.

PITTSBURGH

"Use of Radio to Restore Disrupted Telephone Service," by W. M. Kluttz and G. R. Griffith, Bell Telephone Company of Pennsylvania; September 18, 1944.

"Television and Frequency-Modulation Broadcasting—Postwar," by P. L. Chamberlain, General Electric Company; October 10, 1944.

SEATTLE

"Mathematics as an Engineering Tool," by Cornelius Lenczos, Boeing Aircraft Company; October 10, 1944.

"The Flux-Gate Compass, An Electronic Instrument for Aeroplanes," by J. D. Peterson, Pioneer Instrument Company; November 16, 1944.

WILLIAMSPORT

"Use of Graphite in Radio Tubes," by L. L. Winters, National Carbon Company; November 17, 1944.

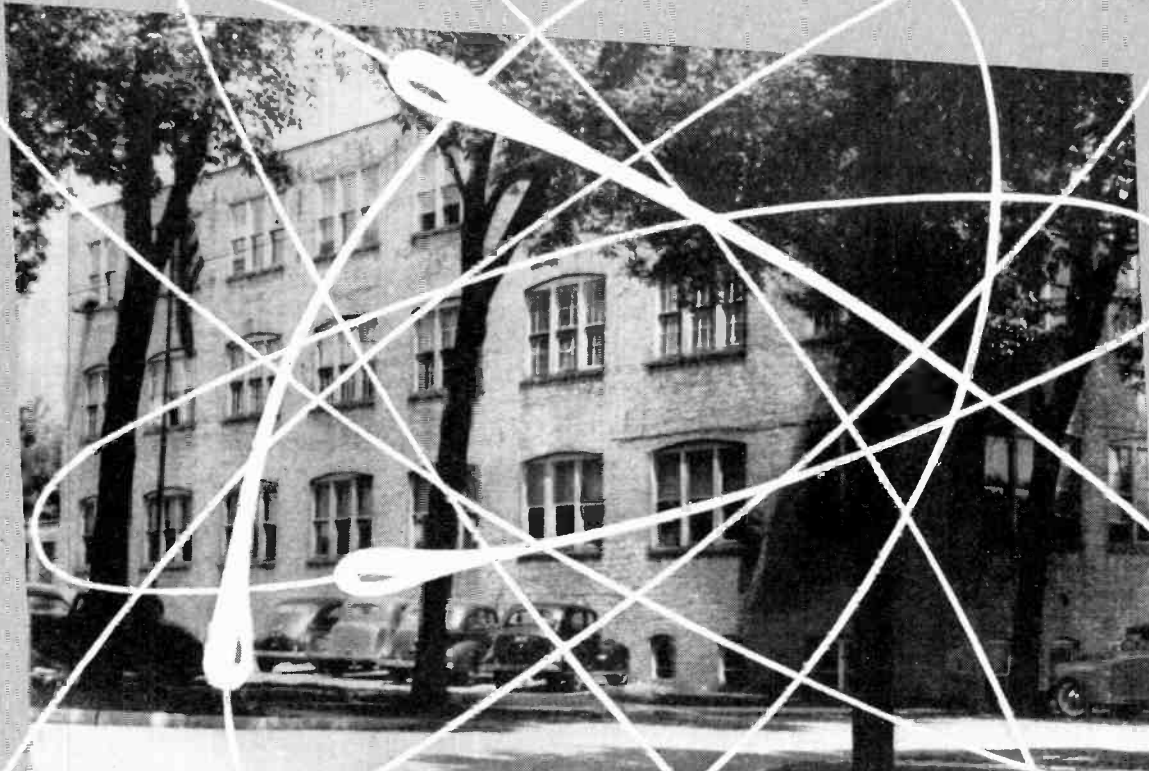

THE HOME OF **CETRON**
is a Hub of Activity

Long before war started, Cetron tubes were firmly established as being well-nigh indispensable to many industrial operations. Countless industrial engineers, who themselves "know their stuff" consistently look to, and consult with Cetron engineers when any important tube problem must be solved.

For the duration we, like other manufacturers, have devoted a large share of our efforts to supplying important needs of the Armed Forces. But during this period we still have been able to take care of most urgent civilian industrial needs. We have increased our capacity as well as the scope of our technical knowledge . . . turning out more serviceable tubes even than formerly, for a more broader usage. In the field of phototubes, especially, Cetron now occupies the premier position in producing these tubes for all sorts of purposes. Our Rectifiers and Electronic Tubes of many types are improving efficiency and increasing productivity in a host of industries.

In your own operations there may be places where Cetron tubes could radically and favorably affect operating costs. We invite you to outline your problem, whatever it may be, for consideration by our engineers without obligation.

CONTINENTAL
ELECTRIC COMPANY GENEVA, ILL.



★ CHICAGO OFFICE, 903 Merchandise Mart
NEW YORK OFFICE, 265 West 14th Street

LINGO RADIATORS are back!

LINGO VERTICAL TUBULAR STEEL RADIATORS

*Now Available for
Prompt Delivery*
subject to existing regulations.

Deliveries can now be made in a few weeks to those with proper priority to cover purchases of new equipment. If you are planning improvements, you must have an antenna that will produce top efficiency, an antenna that operates with more economy, greater performance. We are prepared to serve you *now*. Radiators are available in standard heights—100 to 500 feet. Lingo also produces tubular steel poles for the support of FM, Television and other UHF antennas.

Our staff will be pleased to provide you with the complete story as it applies in your own case. In writing, please give location, power, frequency of station, and indicate radiator height desired.

JOHN E. LINGO & SON, INC.
EST. 1897 CAMDEN, NEW JERSEY

LINGO VERTICAL TUBULAR STEEL RADIATORS



The following admissions and transfers (November) were approved on October 31, 1944:

Transfer to Senior Member

Wheeler, C. M., 39 Essex Ave., Montclair, N. J.

Admission to Senior Member

Young, L. Mc., 152 Patterson Rd., Dayton 9, Ohio

Transfer to Member

Albertson, F. W., Dow, Lohnes and Albertson, Munsey Bldg., Washington 4, D. C.

The following admissions and transfers (December) were approved on November 27, 1944:

Transfer to Senior Member

Bridgland, C. J., 266 S. Kingsway, Toronto, Ont., Canada

Clark, J. H., 1132 E. Elmwood Ave., Burbank, Calif.

Cobine, J. D., 80 Douglas Rd., Belmont 78, Mass.

Deardorff, R. W., 7627 S.E. 30 Ave., Portland 2, Ore.

Eager, M., 75 Abbott Rd., Wellesley Hills 82, Mass.

Everett, L., 40 S. Munn Ave., East Orange, N. J.

Goldberg, H., 215 Brett Rd., Rochester 9, N. Y.

Marks, W. S., Jr., 668 Broadway, Long Branch, N. J.

Mittlemann, E., 427 W. Wrightwood Ave., Chicago 14, Ill.

Pekin, H. T., 543 Centre St., Newton 58, Mass.

Shapiro, L. C., 250 W. 99 St., New York, N. Y.

Simson, A. G., 1701-16 St., N.W., Washington, D. C.

Walz, R. F., 265 Forest Ave., Glen Ridge, N. J.

Admission to Senior Member

Larson, R. W., 1295 Wheatland Ave., Lancaster, Pa.

Transfer to Member

Adams, J. J., 447 Cottage Hill Ave., Elmhurst, Ill.
Baptist, W. G., 1907 Willow Spring Rd., Dundalk 22, Md.

Bonney, R. B., 343 Knollwood Ave., Douglaston, L. I., N. Y.

Brewer, A. F., 100 Huntington Rd., Garden City, L. I., N. Y.

Burks, A. W., Moore School of Electrical Engineering, Philadelphia, Pa.

Cutting, W. A., United States Civil Aeronautics Administration, Box 1807, Portland, Ore.

DeShong, J. A., Jr., 1414 N. Austin Blvd., Oak Park, Ill.

Emurian A. D., 337 Wells Ave., Elberon, N. J.

Goldin, H., Dominion Sound Equipments, Ltd., 114 Bond St., Toronto, Ont., Canada

Gray, R. O., 56 N. Laramie Ave., Chicago 44, Ill.

Konkle, P. J., 1704 Melvin Cir., Cincinnati 31, Ohio

Mitchell, F. T., Jr., 4500 Dexter St., N.W., Washington 7, D. C.

Montgomery, B. E., United Air Lines Communications Laboratories, 5959 S. Cicero Ave., Chicago, Ill.

Novy, E. W., 3310 Glenhurst Pl., Cincinnati 9, Ohio

Okrent, J. J., 58-25 Little Neck Pkwy., Little Neck, L. I., N. Y.

Ostaf, W., 2817 Connecticut Ave., N.W., Washington 8, D. C.

Palmer, V. L., 316 Engineering Hall, University of Washington, Seattle 5, Wash.

Probeck, C., 914 S. Menard Ave., Chicago 44, Ill.

Reed, O. W. B., Jr., 970 National Press Bldg., Washington, D. C.

Reese, K. E., 908 N. Austin Blvd., Oak Park, Ill.

Admission to Member

Albright, A. R. G., 45 Cedar Ave., West End, Long Branch, N. J.

Bauer, W. M., 3809 McGregor Dr., Columbia 39, S. C.

(Continued on page 38A)

Have you looked into METALLIZED GLASS?

YOUR electronic problems may find an answer in Corning's process for permanently bonding metal to glass.

Which of the following qualities will help you?

1. Hermetic bond between glass and metal — assures positive and permanent seal against oil, water, and gas.

2. Precision metallizing — allows accurate control of capacitance, inductance, or resistance.

3. Permanent mechanical and electrical qualities—maintain accurate tolerances indefinitely.

4. Superior electrical properties of glass — low power factor, high dielectric strength, extremely high resistance, wide range of dielectric constants.

5. Thermal endurance of a high order. Metallized glass easily meets Army and Navy specifications for thermal shock.

• • •

Write us about your problems. We'd be interested in seeing if glass can help you. Address Electronic Sales Dept. P-1, Corning Glass Works, Corning, N. Y.

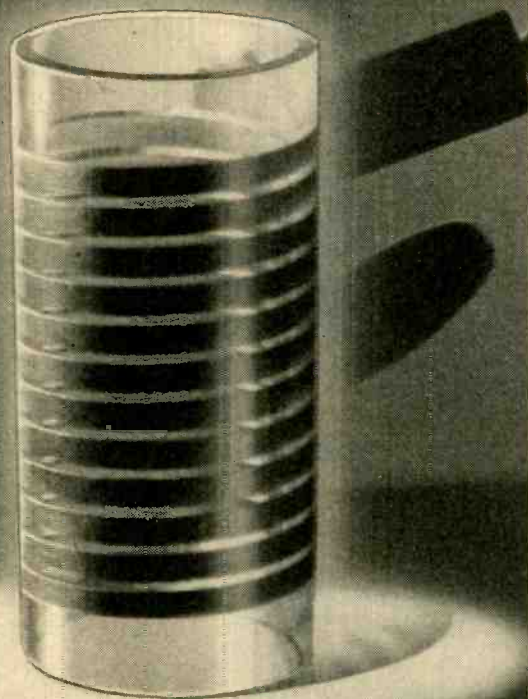

CORNING
— means —
Research in Glass

Electronic Glassware



"PYREX" and "CORNING" are registered trade-marks of Corning Glass Works

Unsurpassed QUALITY

• The Industrial Condenser Corporation manufactures a complete line of Oil-filled, Electrolytic, Wax and Special Mica Capacitors for all industrial, communications and signalling applications up to 250,000 volts working. Complete laboratory and engineering facilities available for solution and design of capacitor problems for special applications.

An Industrial Condenser for every industrial application.

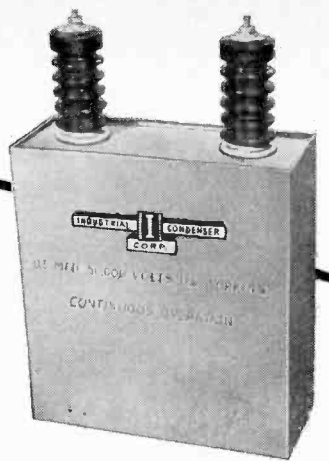

**.5 MFD. 50,000 VOLTS
DC WORKING**

(Illustrated above)...28 inches high, weight 175 pounds, built by Industrial Condenser Corporation to meet Navy specifications. Oil-filled, oil impregnated. Built for 24 hour continuous operation and total submersion in salt water.

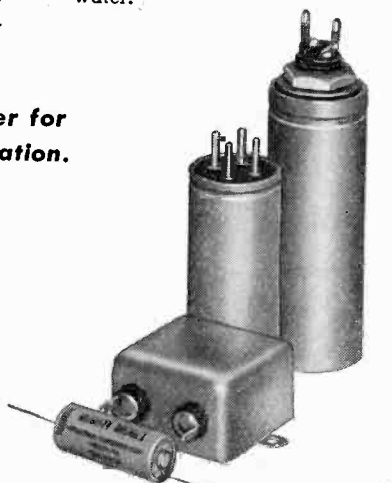
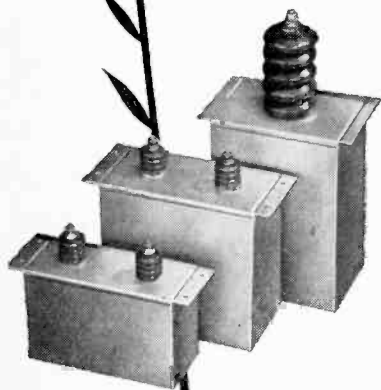

PAPER, OIL AND ELECTROLYTIC CAPACITORS

**INDUSTRIAL
CONDENSER
CORPORATION**

3243-65 NORTH CALIFORNIA AVE., CHICAGO 18, U.S.A.

DISTRICT OFFICES IN PRINCIPAL CITIES

Membership

(Continued from page 36A)

- Bennett, P. L., 1011 E. Orange Grove Ave., Burbank, Calif.
 Meyerson, A. H., 200 Dyckman St., New York 34, N. Y.
 Griffing, B. L., 838 Wilfred Ave., Dayton 10, Ohio
 McNaughton, R. A., R.D. 2, Emporium, Pa.
 Mehrbach, E., 223 N. Munn Ave., East Orange, N. J.
 Millett, L. F., 33 Regent St., Ottawa, Ont., Canada
 Park, F. R., Apt. 12, 612 Bank St., Ottawa, Ont., Canada
 Patchett, G. N., 1 Leafield Grove, Eccleshill, Bradford, Yorkshire, England
 Rundlett, L. M., Radio Materiel Office (M-50) Roof Bldg. 3, Navy Yard, N. Y.
 Stemm, R. E., 21 E. Van Buren St., Chicago 5, Ill.
 Stoner, C. R., 297 Cherryhinton Rd., Cambridge England
 Thomson, F. P., 11 Old Dr., Welwyn Garden City, Herts, England

Admission to Associate

- Acosta, F. B., 132 W. 90 St., New York 24, N. Y.
 Allan, W. K., 804-15 Ave., W., Calgary, Alta., Canada
 Arthurs, L. J., 730 Wellington St., Cedar Rapids, Iowa
 Andzer, A., 182 Hollenbeck St., Rochester 5, N. Y.
 Anns, J. J., c/o Grindlays Bank, Bombay, India
 Baer, L. A. C., No. 5 (M.E.) A.R.C., R.A.F., M.E.F.
 Banerji, S., All India Radio 1, Garstin Pl., Calcutta, India
 Barasch, M. V., 2487 Grand Ave., Bronx 63, N. Y.
 Barber, G. C., 2457 Cleveland Ave., Columbus 3, Ohio
 Baylac, J. R., Solis 1470, Buenos Aires, Argentina
 Beach, O. R., c/o Fleet Post Office, San Francisco, Calif.
 Beck, K. H., Jr., 6625 McCallum St., Philadelphia 19, Pa.
 Behlke, J. E., 121 Gillick St., Park Ridge, Ill.
 Benson, H. C., 737 Register Ave., Baltimore 12, Md.
 Bernbaum, B., 5746 N. Park Ave., Philadelphia 41, Pa.
 Berninger, J. W., Box 453, Monmouth Beach, N. J.
 Bird, R. E., British Admiralty Delegation, 1025 Vermont Ave., Washington, D. C.
 Boll, R. W., 207 Western Ave., Allegan, Mich.
 Bones, T. M., Jr., 13 State St., Schenectady 5, N. Y.
 Boss, N. D., 379 Talbot St., London, Ont., Canada
 Boyd, W. E., 660 Hampton St., Brighton S.5, Victoria, Australia
 Brazda, J. C., Jr., Naval Research Laboratory Radio Materiel School Staff, Washington 20, D. C.
 Breed, W. M., 3909 B Ave., N.E., Cedar Rapids, Iowa
 Breslow, A. J., 701 W. Butler St., Philadelphia 40, Pa.
 Brock, R. L., N.A.T.T.C. Class "M," Gainesville, Ga.
 Bubb, F. W., Jr., 901 Greeley Ave., Webster Groves 19, Mo.
 Butman, R. C., 17 Sharon St., Lacey Park, Hatboro, Pa.
 Campbell, J. K., 431 W. Seventh St., Sioux Falls, S. D.
 Carlson, R., 3566 N.E. Stanton St., Portland 13, Ore.
 Chadwick, P. S., Radio Navy 41, c/o Fleet Post Office, San Francisco, Calif.
 Clark, J. H., 1312 Sherman St., Williamsport, Pa.
 Claxton, M. E., No. 1 Radio School, Cranwell, Lincs., England
 Conway, B. B., 4717 Norma St., Ft. Worth, Texas
 Cook, R. H., 1421 Pinecrest Dr., Ferndale, Mich.
 Cortner, H. M., Naval Supply Depot, Oakland, Calif.
 Cram, L. A., No. 3 Pembroke Mansions, Oakfield Rd., Bristol 8, England
 Curry, J. R., 16 Brown St., Cambridge 38, Mass.
 Curtis, D. L., Section B 3508 Base Unit, Truax Field, Madison 7, Wis.
 Cutler, C. N., Maipu 555, Buenos Aires, Argentina

(Continued on page 40A)

Proceedings of the I.R.E. January, 1945

...Hardly had man learned to fly than he began to feel the urgency of the need to communicate between ground and plane.



Radio headsets are one of C. T. & E. Division's contributions to aviation communications in World War II.



One of the first successful attempts in such two-way contact was accomplished with equipment designed and manufactured by Connecticut Telephone & Electric.

Since the early days of the telephone, our people have been identified with progress in communications. Today the principles of communications have applications of the greatest importance to industry, in connection with product development and production control.

Our developmental engineers also have much to offer to industrial executives seeking to produce a better product at lower cost. If our engineering and production facilities might tie in with your plans, we shall be happy indeed to talk with you.

CONNECTICUT TELEPHONE & ELECTRIC DIVISION

GREAT AMERICAN INDUSTRIES, INC.
MERIDEN, CONNECTICUT



TELEPHONIC SYSTEMS • SIGNALLING EQUIPMENT • ELECTRONIC DEVICES • ELECTRICAL EQUIPMENT • HOSPITAL AND SCHOOL COMMUNICATIONS AND SIGNALLING SYSTEMS • IGNITION SYSTEMS

MOTOR DATA
No. 129

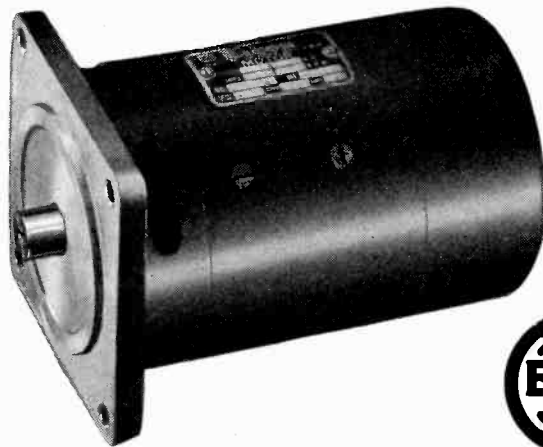

4000 FRAME MOTOR
1/2 HP at 3900 RPM

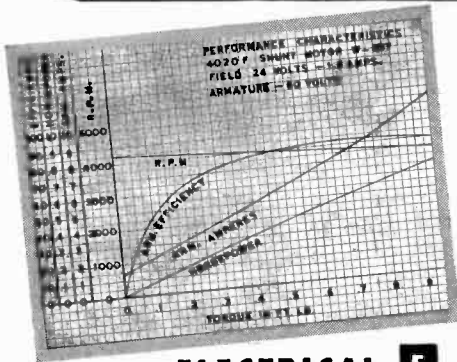

The output—the weight—the size—of these 4000 Frame Motors are features well worth remembering. Every adaptation of the standard design is engineered for the precise requirements of an aircraft, portable, or industrial application.

ELECTRICAL
Series, shunt, or compound-wound
Unidirectional or reversible
Optional torque
Optional speed
Optimum efficiency
For control circuits
Electric braking optional

MECHANICAL
Ventilated or enclosed types
Base or flange mounting
Operation in any position
Low space factor
Ball bearing equipped
Optional shaft details
Rugged construction

4000 FRAME MOTORS		4020 Shunt	4020 Series
Watts, Output, Con.	(Max.)	375	746
Torque at 3900 RPM	(ft. lbs.)	.65	1.4
Torque at 6000 RPM	(ft. lbs.)		.88
Speed Regulation		8%	
Lock Torque	(ft. lbs.)	2.5	4
Volts Input	(min.)	12	24
Volts Input	(max.)	110	110
Diameter		4"	4"
Length Less Shaft		7 1/8"	7 1/8"
Shaft Dia.	(max.)	.625"	.625"
Weight	(lbs.)	9.2	9.2

EICOR INC. 1501 W. Congress St., Chicago, U. S. A.
DYNAMOTORS • D. C. MOTORS • POWER PLANTS • CONVERTERS
Export Ad Aurema, 89 Broad St., New York, U. S. A. Cable Aurema New York

Membership

(Continued from page 38A)

- Davis, G. A., 2 Elm St., Ottawa, Ont., Canada
 Davis, H., 180 Avenel Blvd., Long Branch, N. J.
 Deeter, E. L., 1443 Channing St., N.E., Washington 18, D. C.
 Drake, H. L., 819—13 St., Woodward, Okla.
 Di Giacinto, L., "B" Det. Fifth Radio Squadron, A.P.O. 487, Postmaster, New York, N. Y.
 Dixon, G. F., Windyridge, Withernsea, E. Yorks, England
 Dropkin, H., 111 Parkville Ave., Brooklyn 30, N. Y.
 Dunn, J. R., R.F.D. 9, Kansas city 3, Mo.
 Eggerding, H. B., 144 E. Sixth St., Plainfield, N. J.
 Epstein, B., 5547 S. Ingleside St., Chicago 37, Ill.
 Eslinger, R. L., c/o Pan American Airways, Juneau, Alaska
 Evans, C. L., 516 Maycox Ave., Norfolk, Va.
 Fogel, C. M., 214 N. Sixth St., Newark 7, N. J.
 Forristal, J. A., 1905 Hedges, Independence, Mo.
 Forst, P. P., Jr., 2016 S. 11 Ave., Maywood, Ill.
 Franz, W. J., 3202 Wisteria Ave., Baltimore 14, Md.
 Freudenberg, H. O., Det. Signal Corps., Fort Snelling, Minn.
 Gary, A., Jr., Avda de Mayo 1370, 1er piso, Buenos Aires, Argentina
 Gates, B., 209 Cowper St., Palo Alto, Calif.
 Gehrke, F., 208 S. Broad St., Emporium, Pa.
 Genz, W. F., Kenilworth Apt., 1115 Alden Park, Philadelphia, Pa.
 Gibbs, N. E., R.F.D. Rogers Lake, Old Lyme, Conn.
 Gilvarry, J. J. J., Naval Ordnance Laboratory, Navy Yard, Washington, D. C.
 Gissing, H. R., 5136 Decarie Blvd., Apt. 12, Montreal, Que., Canada
 Good, L. H., 4201 Otterbein Ave., Indianapolis 3, Ind.
 Gofencheffer, M., 48 W. 87 St., New York, N. Y.
 Graham, D. J., 1514 Third Ave., S.E., Cedar Rapids, Iowa
 Guthrie, H. G., 812 North Ivy, Arlington, Va.
 Gribetz, D., Mass. Hall B-31, Harvard University, Cambridge 38, Mass.
 Haines, R. A., Army Motion Picture Service, 200 Orpheum Bldg., Seattle 1, Wash.
 Hale, N. H., 1295 Elmhurst Dr., N.E., Cedar Rapids, Iowa
 Hankar, R. E., 118 E. 16 St., New York 33, N. Y.
 Hartman, R. E., 247 S. Washington St., Tiffin, Ohio
 Harvey, L. A., 951 Connecticut St., San Francisco, Calif.
 Havel, J. M., 112 Monmouth St., Red Bank, N. J.
 Hawthorne, C. T., 65 McGowan Ave., Abbeville, S. C.
 Hendricks, H. J., 308-21 St., N.E., Cedar Rapids, Iowa
 Henthorn, J. E., 2422 Harlem Ave., Baltimore 16, Md.
 Hohberger, H. P., Box 91, St. Charles, Ill.
 Holets, I. L., 618-32 St., N.E., Cedar Rapids, Iowa
 Holland, S. J., 5605 Fair Oaks Ave., Baltimore 14, Md.
 Hritsko, S., 201 Wilson Ave., Columbus 5, Ohio
 James, A., 1218 Pierce St., Sandusky, Ohio
 Jobe, D. J., 2134 S. Humboldt St., Denver 10, Colo.
 Jorgensen, R. E., c/o Fleet Post Office, San Francisco, Calif.
 Kakkeri, V. S., Vithal Maruthi Galli, Sulthan Bazar, Hyderabad-Dn., Nizam State, India
 Kantor, M., Research Department, Stromberg-Carlson Co., Rochester, N. Y.
 Kimble, E. B., 455 Dorinda St., London, Ont., Canada
 Kmosko, J. A., 2401 Park Ave., South Plainfield, N. J.
 Kreezer, G. L., Radiation Laboratory, M.I.T., Cambridge 39, Mass.
 Kurthy, J. P., 4584 Ellenwood Dr., Los Angeles 41, Calif.
 Keith, J. M., 3918 Nyandotte, Kansas City, Mo.
 Last, E., 2520 Ave., W., Brooklyn, N. Y.
 Leger, R. M., 3400 First Ave., N.E., Cedar Rapids, Iowa
 Lewis, W. R., 506 E. Hereford St., Independence, Mo.
 Lieske, E. W., 112-31 St., N.E., Cedar Rapids, Iowa

(Continued on page 42A)

Seven years ago we started out as a west coast distributor of aircraft parts. We named our company Aircraft Accessories Corporation. • Then we started developing aircraft hydraulics. The next thing we knew we were full-fledged manufacturers—and out of the parts business. • Later, someone came along with an embryo electronic plant in Kansas City. Being young and ambitious—we bought it. To everyone's amazement—and somewhat to our own—we made it grow. And pay.

NEW NAME NEW HORIZONS

We're still young, ambitious. Our explorations in hydraulics, electronics and other fields promise post-war growing pains. And so we've outgrown our name. • Aircraft Accessories Corporation no longer adequately describes our operations. We couldn't think of a name that did. So we coined one: Aireon. It's a name that's partly aircraft, partly electronics; but it will be largely what we make it. We hope—and intend—to make Aireon worthy of a place among America's most honored corporate and trade names.

Aireon

MANUFACTURING CORPORATION
Formerly AIRCRAFT ACCESSORIES CORPORATION

Radio and Electronics • Engineered Power Controls

NEW YORK • CHICAGO • KANSAS CITY • BURBANK

Extremes Meet

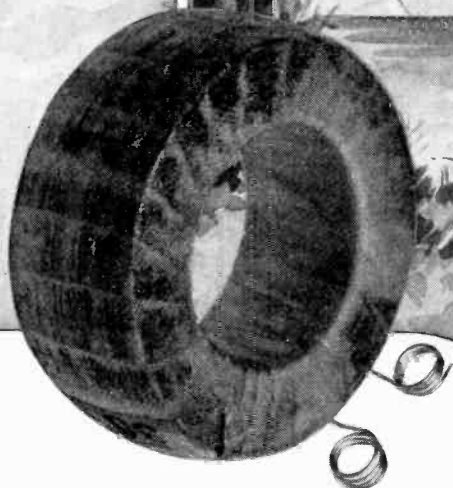

THOUSANDS of these coils have gone to war . . . in the far corners of the earth . . . under the sea and in the sky . . . under the worst conditions.

Imagine . . . six miles of hair-size wire in a coil suddenly lifted from a jungle temperature of 120° F to a rarified atmosphere of -40° F and "taking it" day after day.

Only experience can wind coils like these . . . to do the job required of them.

Their use cannot be told but statistics may be interesting. In producing this one type of coil for the Army and Navy we have consumed one-half million miles of wire . . . 136,000 pounds of copper. The machines used in winding them have turned 3 TRILION, 360 BILLION revolutions.

We hope soon to be able to put some of this production capacity and experience to work on YOUR postwar problem.

COIL SPECIALISTS SINCE 1917

COTO-COIL CO., INC.

65 PAVILION AVE.

PROVIDENCE 5, R. I.

Membership

(Continued from page 40A)

- Lopez, R. L., Calle Bulnes 1827, Buenos Aires, Argentina
- Ludwick, C. A., 36 Portship Rd., Dundalk, Md.
- Macdonald, W. D., LST Group 42, c/o Fleet Post Office, San Francisco, Calif.
- Mackey, R. J., Jr., 6301 Sherwood Rd., Philadelphia 31, Pa.
- MacLeod, D. A., M.T.D., R.M.S. 2344-1, Naval Research Laboratory, Washington 20, D. C.
- Madill, L. J., 37 Elmwood Ave., London, Ont., Canada
- Main, W. F., Jr., 119 Anacostia Rd., S.E., Washington 19, D. C.
- Maize, J. A., 2471-47 Ave., San Francisco 16, Calif.
- Manning, R. G., 4112 First, N.W., Seattle, Wash.
- Marsh, R. A., R.C.A.F., Clinton, Ont., Canada
- Marsano, R. W. S., 44 Lippincott Ave., Long Branch, N. J.
- Masters, E. W., 2743 Farwell Ave., Chicago 45, Ill.
- Mattson, E., 250 S. Berkeley Ave., Pasadena 8, Calif.
- McKinley, G., 6149 N. Ozark Ave., Chicago 31, Ill.
- Meador, R. E., 1504 Wyoming Ave., Dayton, Ohio
- Mefford, M. E., 1024 Evans St., San Bernardino, Calif.
- Meikle, J. F., 605 W. 95 St., Los Angeles 44, Calif.
- Meyer, C. F., 3909 Erie St., S.E., Washington 20, D. C.
- Mentz, C. H., c/o Associated Broadcasters, Inc., Mark Hopkins Hotel, San Francisco, Calif.
- Middleton, E. J., 178 St. Frusquin St., Johannesburg, South Africa
- Mihelich, J. B., 3313 Egerton Rd., Baltimore 15, Md.
- Miller, R. M., 3125 Penwood Rd., Harrisburg, Pa.
- Milne, D. D., National Union Radio Corp., 251 Plane St., Newark, N. J.
- Milwitt, W., 280 Watson Ave., Perth Amboy, N. J.
- Modley-Jones, H. S., 22 Marlowe Cresc., Ottawa, Ont., Canada
- Monk, K. R., 3411-16 Ave., S., Seattle 44, Wash.
- Moore, W. E., 34 Mary Ave., Dayton 5, Ohio
- Moskowitz, L., 7 Mockingbird La., Audubon, N. J.
- Muir, J., 1903 Broderick St., San Francisco 15, Calif.
- Neidig, D. F., Summerdale, Pa.
- Nelson, A. E., 121 Galveston Pl., Washington 20, D. C.
- Nexon, V. J., Hq. Air Technical Service Command, Box 1208 Area "A," Wright Field, Dayton, Ohio
- Olson, D. O., R.F.D. 3, Woyzata, Minn.
- Pearson, P., 15 Lime Cresc., Old Trafford, Manchester 16, England
- Phillips, W. E., 475 1/2 York St., London, Ont., Canada
- Piecewicz, C. T., 74 Pavonia Ave., Kearney, N. J.
- Phillips, C. W., 72 Grand Ave., Ely, Cardiff, South Wales, England
- Powers, J. S., 4035 N. Mozart St., Chicago 18, Ill.
- Purnell, G. W., 1210 Buchanan St., Sandusky, Ohio
- Quijano, R. A., Box 324, Angola, Ind.
- Ramler, W. J., 1156 Murray Hill Ave., Pittsburgh 17, Pa.
- Renoff, G. F., 2814 The Alameda, Baltimore 18, Md.
- Reintjes, I. C., 7 Huntington Pl., Dayton 10, Ohio
- Rosen, C. A., 162 St. Lawrence St., Longueuil, Que., Canada
- Ross, A. L., Jarvis Apts., Princess Ave., London, Ont., Canada
- Roughton, E. R., 8108 Gonzaga Ave., Venice, Calif.
- Runkle, E. G., Jr., R.F.D. 10, North Kansas City 16, Mo.
- Sanford, C. V., Box 1133, New London, Conn.
- Scalbon, J. D., 109 Smithwood Ave., Catonsville 28, Md.
- Scherba, M. B., 270 S. Melborn, Dearborn, Mich.
- Schmitt, E. C., 2218 N. Sixth St., Harrisburg, Pa.
- Schlegel, R. A., 4237 Union St., Flushing, L. I., N. Y.
- Spencer, J. C., 346 Beacon St., Boston 16, Mass.
- Scott, G. H., 502 N. College Ave., Fayetteville, Ark.
- Sharp, A. G., 321 N. Lawn, Kansas City, Mo.
- Sharrard, L. L., 12 Bosworth St., Springfield 8, Mass.

(Continued on page 44A)

Proceedings of the I.R.E. January, 1945



FINEST PICTURE QUALITY IN BLACK AND WHITE AND IN FULL COLOR!

Sharper, more brilliant pictures than ever before possible are now a reality with Federal's new broad-band television technique . . .

In a revolutionary contribution to the television art, Federal's system permits combining *sight and sound* on one carrier frequency . . .

For the broadcaster—a single transmitter, and consequently, lower first cost, lower power consumption, less space requirement, and fewer high power tubes . . .

For the television audience — a

simpler, less expensive receiver, more compact and efficient, and requiring fewer tubes.

This great forward stride is the logical outcome of Federal's long list of achievements in the field and the contribution of Federal's engineers to the development of the "Micro-ray" more than a decade ago . . . the forerunner of modern television technique.

And as a result . . . Federal has been selected by the Columbia Broadcasting System for the construction

of its new television transmitter atop the Chrysler Tower in New York.

Federal's modern television technique will also be reflected in an equally advanced Federal television receiver for the home . . . producing the finest picture quality.

Federal has the experience, the facilities, the technique, needed to build television equipment for any broadcasting requirement. For the best in television — see Federal first.



Federal Telephone and Radio Corporation



Newark 1, N. J.

ONE CENTRAL SOURCE FOR
All Types of Industrial
ELECTRONIC TUBES

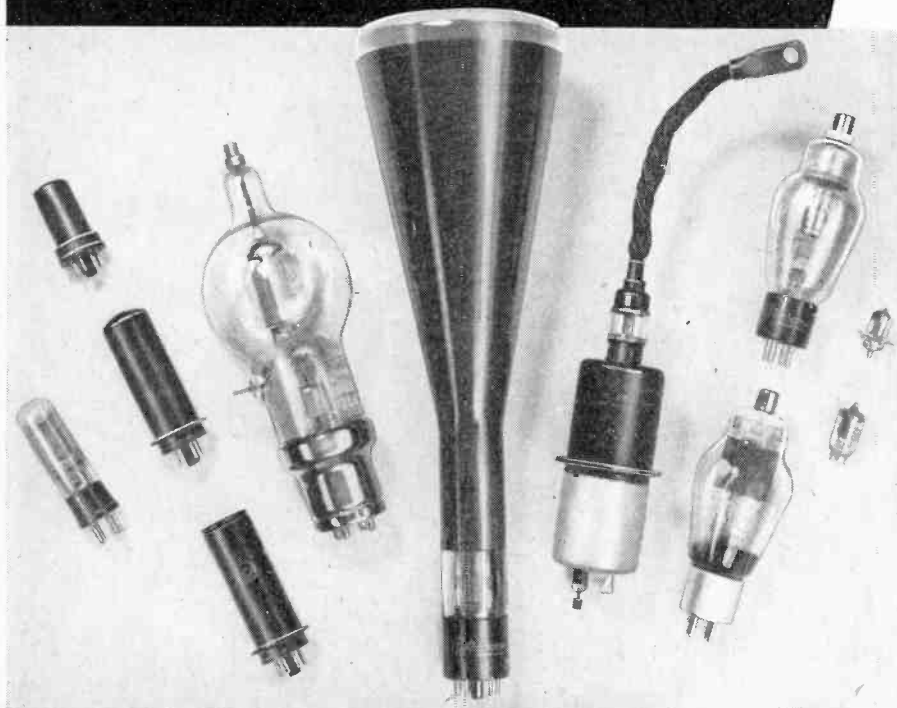

STOCKS ON HAND FOR
Immediate Delivery

RECTIFIER
 POWER
 CONTROL
 PHOTO-ELECTRIC
 TRANSMITTING
 RECEIVING

Here you have the advantage of a complete, centralized service on all types of industrial electronic tubes. Many are "on-hand" for *rush delivery!* This enables you to obtain the exact type you require, in the shortest possible time. Rectifier, power, control, photo-electric, cathode ray, transmitting, or receiving . . . in RCA, G.E., Raytheon, Amperex, Eimac, Taylor, and other well known makes.

*Save time and work—Call Allied First!
 Write, Wire or Phone Haymarket 6800*

Engineering Service Available

**EVERYTHING IN
 ELECTRONICS & RADIO**

It's faster, simpler to get all your electronic and radio supplies from this one central source. We carry the largest and most complete stocks of parts and equipment under one roof . . . ready for immediate shipment. Besides, our procurement experts are in constant contact with all leading manufacturers. This complete service simplifies and speeds supply of diversified needs.

Helpful
**BUYING
 GUIDE**
 Available
 on Request
 Write for it!

ALLIED RADIO

C O R P O R A T I O N

833 W. Jackson Blvd. Dept. 3-A-5 Chicago 7, Illinois

SUPPLIERS OF ELECTRONIC PARTS AND EQUIPMENT TO INDUSTRIAL AMERICA

Electronic Tubes, Rectifiers, Power Supplies, Intercommunicating Systems, Sound Systems, Photo-Cell Equipment, Batteries, Chargers, Converters, Generators, Supplies for Resistance Welders, Fuses, Test Instruments, Meters, Broadcast Station Equipment, Relays, Condensers, Capacitors, Resistors, Rheostats, Transformers, Switches, Coaxial Cable, Wire, Soldering Irons, Microphones, Speakers, Technical Books, etc.

Membership

(Continued from page 42A)

- Silvester, D. D., 8 Carlos St., Godalming, Surrey, England
- Simpson, A. D., Johns Hopkins University, Baltimore 18, Md.
- Smith, J. W., 719 Chatham, Montreal 3, Que., Canada
- Stecher, A. C., 1829 Lunt Ave., Chicago 26, Ill.
- Sterling, H. T., 66 Chiswick Rd., Brookline, Mass.
- Streator, A. L., c/o Fleet Post Office, San Francisco, Calif.
- Sublett, R. H., 3103 E. Ave., N.E., Cedar Rapids, Iowa
- Swanson, R. E., 1268 W. 72 St., Kansas City, Mo.
- Swingle, L. M., 4723—48 St., N.W., Washington 16, D. C.
- Tarantur, S., 3510 W. Cortland St., Chicago 47, Ill.
- Tharp, B. W., 5055 N. Illinois St., Indianapolis 8, Ind.
- Thompson, N., 1 Myrtle Pl., Uphams Corner 25, Mass.
- Torn, W. R., 218 S. Fourth Ave., St. Charles, Ill.
- Vore, M. P., 2519 Wilkens Ave., Baltimore 3, Md.
- Wainwright, L. F., Collins Radio Co., 855—35 St., N.E., Cedar Rapids, Iowa
- Watterlohn, R. H., 5448 W. Huron St., Chicago 44, Ill.
- Weast, E. F., 4639 Montgall, Kansas City, Mo.
- Weigel, E. L., 1711 E. 35 St., Baltimore 18, Md.
- Weiler, I., Hazeltine Electronics Corporation, 58-25 Little Neck Pkwy., Little Neck, L. I., N. Y.
- Wells, W. F., 5602 Edmondson Ave., Baltimore 29, Md.
- Westbrooks, H. D., 235 N. Hill St., Griffin, Ga.
- Wilcox, S. R., 800 N. Lafayette, Macomb, Ill.
- Weaver, C., 3 Thompson Ave., Whitefield, Manchester, England
- Williams, G. J., 11 Washington Ave., Collingswood, N. J.
- Williams, J. A., 614—18 St., S., Arlington, Va.
- Wilson, J. E., 1040 Allard St., Montreal 19, Que., Canada
- Winston, R. H., 215 Fulton Ave., St. Charles, Ill.
- Withers, W. A., Jr., 6601 Romaine St., Hollywood 38, Calif.
- Witt, R., 2005 Maple Ave., Norwood 12, Ohio
- Wolfson, H., 2461 Davidson Ave., Bronx 63, N. Y.
- Woster, G. W., 2718 W. 51 Ter., Kansas City, Kan.
- Wright, P. C., Jr., 1397 Hamlet St., Columbus 1, Ohio
- Young, H. A., 582 N. Madison Ave., Pasadena, Calif.
- Zumstag, H. O., 105 Chadbourne Ave., Millbrae, Calif.
- Student**
- Adler, F. P., 2516 Ridge Rd., Berkeley 5, Calif.
- Adler, R. B., Box 131, R.F.D. 2, Norwalk, Conn.
- Allen, J. E., 425 Albert St., East Lansing, Mich.
- Arnett, D. H., 2115 Hamphill St., Ft. Worth, Texas
- Arsem, A. D., M.I.T., Dormitories, Cambridge, Mass.
- Balmer, P. D., 189 Quebec Ave., Toronto, Ont., Canada
- Barber, G. D., Navy V-12 Unit, University of Louisville, Louisville, Ky.
- Beiser, A. P., Co. A 1552 ASTU, Ohio State University, Columbus 10, Ohio
- Bell, E. A., 2727 S. Third, Louisville 8, Ky.
- Bernstein, G. D., c/o S. Bernstein, 168 Bellingham St., Chelsea 50, Mass.
- Blumenthal, I. S., 1658 Yale Station, New Haven, Conn.
- Bockmier, G. E., V-12 Unit, 1716 E. 45 St., Seattle, Wash.
- Bott, R., Douglas Hall, McGill, Montreal, Que., Canada
- Bozer, F., Box 561 W. Lafayette, Ind.
- Bregman, A., 5381 Esplanade Ave., Montreal, Que., Canada
- Bronerwine, C. B., Box 816, Phi Epsilon Pi, Storrs, Conn.
- Brown, F. C., Lowell House H-41, Cambridge 38, Mass.

(Continued on page 46A)



The United States Navy has awarded the men and women of Hallicrafters a special "Certificate of Achievement" . . . first award of its kind . . . for outstanding service with the radar-radio industries of Chicago in speeding vital war material to the Navy. Added to the four Army-Navy "E" awards, this makes five times Hallicrafters workers have been cited for distinguished service. They promise that this kind of service will be continued until total victory is ours.

★ BUY A WAR BOND TODAY

hallicrafters RADIO



THE HALLICRAFTERS CO., MANUFACTURERS OF RADIO AND ELECTRONIC EQUIPMENT, CHICAGO 16, U. S. A.

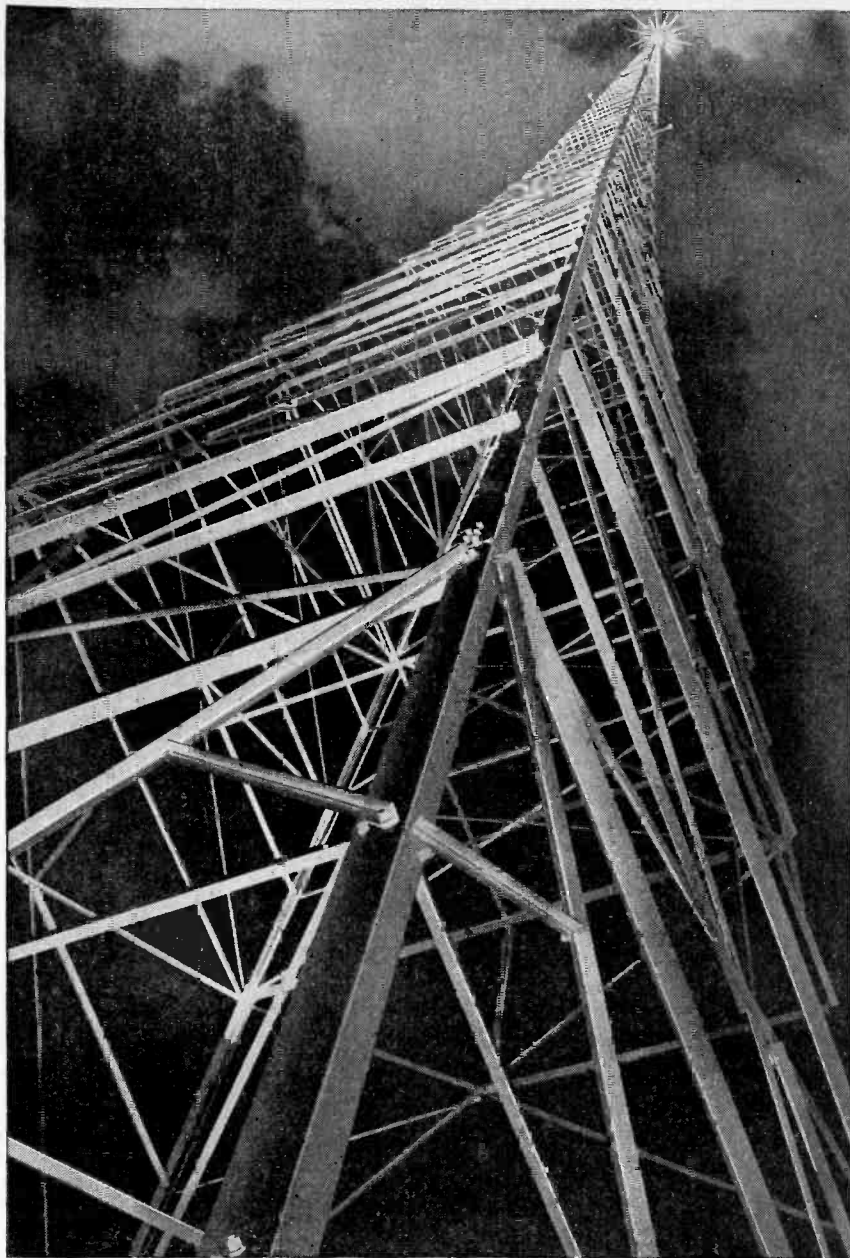

TONIGHT

**BLAW-KNOX speaks
to you over the air**

Tonight when you tune in, it's highly probable that your favorite programs will emanate from stations equipped with *Blaw-Knox Radio Towers*.

These Vertical Radiators have been specified by major broadcasting systems because they are both electronically and structurally sound — providing clear signals and maximum range . . . It is of note, too, that Blaw-Knox Directional Radio Beacons are used to guide all air transport service in the United States.

BLAW-KNOX vertical RADIATORS

Membership

(Continued from page 44A)

- Calderone, A. C., 10 Castle Knock Rd., Toronto, Ont., Canada
- Carlin, J., 669 Stone Ave., Brooklyn 12, N. Y.
- Carter, H. B., 3851 University St., Montreal, Que., Canada
- Chang, T., M.I.T., Dormitories, Cambridge, Mass.
- Connelly, D. B., Co. A 1552 S.U., Ohio State University, Columbus 10, Ohio
- Craig, D. R., Jr., Dormitory 10, NCTP Cornell University, Ithaca, N. Y.
- Crandon, L. H., 656 W. 162 St., New York 32, N. Y.
- Culbertson, A. F., Co. A Sec. 5, N.W. Cary Hall, West Lafayette, Ind.
- D'Arey, D. F., 9 Linden St., Toronto, Ont., Canada
- Dickinson, W. E., 14 Durant Rd., Wellesley, Mass.
- Didinger, G. H., Jr., 1531 Tolma Ave., Dormont, Pgh, Pa.
- Drake, W. W., Jr., 8 Broad St., Freehold, N. J.
- Elmore, H. C., E. 2707—18 Ave., Spokane, Wash.
- Elton, R. W., 5 Shattuck St., Natick, Mass.
- Ertoin, C., 622 Ferry St., Lafayette, Ind.
- Etheridge, E., Jr., 541 Boylston St., Boston 16, Mass.
- Feinberg, N., 1765—76 St., Brooklyn, N. Y.
- Fishman, G. N., 1365 Morris Ave., Bronx 56, N. Y.
- Fitch, J. L., 1017 E. Harrison, Seattle 2, Wash.
- Ford, H. H., Jr., Caltech V-12, 1301 E. California St., Pasadena 4, Calif.
- Frisch, F. W., 1409 Brook Ave., New York 56, N. Y.
- Gaines, R. I., c/o Green, 29 Wadsowrth Ave., New York 33, N. Y.
- Galane, M. R., 1904 Vyse Ave., New York 60, N. Y.
- Gans, N., 4389 St. Lawrence Blvd., Montreal, Que., Canada
- Gausman, K. W., c/o A. E. Gausman, Ravenna, Neb.
- Gendler, S. E., 37-21—65 St., Woodside, L. I., N. Y.
- Goodman, L. J., Jr., 2175 E. Broad St., Columbus 9, Ohio
- Grass, J. W., Co. A 1552 S.U., Columbus 10, Ohio
- Hadden, F. A., 214 Ricardo Ave., Piedmont, Calif.
- Hagelbarger, D., 390 S. San Gabriel Blvd., Pasadena 8, Calif.
- Hale, F. L., Rm. 433, Callaghan Hall, Berkeley 4, Calif.
- Haller, M. N., Co. 3 Bks. B-114 V-12 Unit, University of Louisville, Louisville, Ky.
- Harman, W. W., Pines-on-Seven, Arnold, Mo.
- Henry, J. L., Cleave Ranch, Amber, Wash.
- Hetland, G., Jr., 475 Commonwealth Ave., Boston, Mass.
- Hickman, R. E., 411 Riddell Rd., St. Heliers, Auckland, New Zealand
- Hicks, R. L., 45 Balmoral Ave., Toronto, Ont., Canada
- Hildebrandt, T. W., 418 Beacon St., Boston 15, Mass.
- Hill, D. M., 77 Hancock St., Cambridge 39, Mass.
- Hogg, W. R., Co. A 1552 S.U., Columbus, Ohio
- Hughes, W. G., c/o Prof. S. T. Fife, University of Louisville, Louisville 8, Ky.
- Hull, M. H., 27 N. Ashland Ave., La Grange, Ill.
- Hunten, D. M., 253 Huron St., London, Ont., Canada
- Hurley, R. B., Callaghan Hall, Rm. 700, University of California, Berkeley 4, Calif.
- Jakeway, C. E., R. F. D. 3, Belding, Mich.
- Kantor, W., 1340 N. University, Ann Arbor, Mich.
- Kerrigan, W. M., 23 Delevan Ave., Toronto, Ont., Canada
- Knox, R. V., 1301 E. California St., Pasadena 4, Calif.
- Kullman, F. W., 1716 E. 45 St., Seattle 5, Wash.
- Kupchik, P., Co. A 1552 S.U., Ohio State University, Columbus 10, Ohio
- Leo, R. E., 1301 E. California St., Pasadena 4, Calif.
- Lester, N., 69 Manhattan Ave., Brooklyn, N. Y.
- Lippe, R. E., Co. A 1552 S.U., Ohio State University, Columbus 10, Ohio
- Lyon, J. B., F-13, V-12 N.T.U., Pasadena 4, Calif.
- Maxim, W. A., 337 E. Beverly Ave., Pontiac 16, Mich.
- Lewis, T. E., Jr., University of Louisville, Louisville, Ky.

(Continued on page 48A)

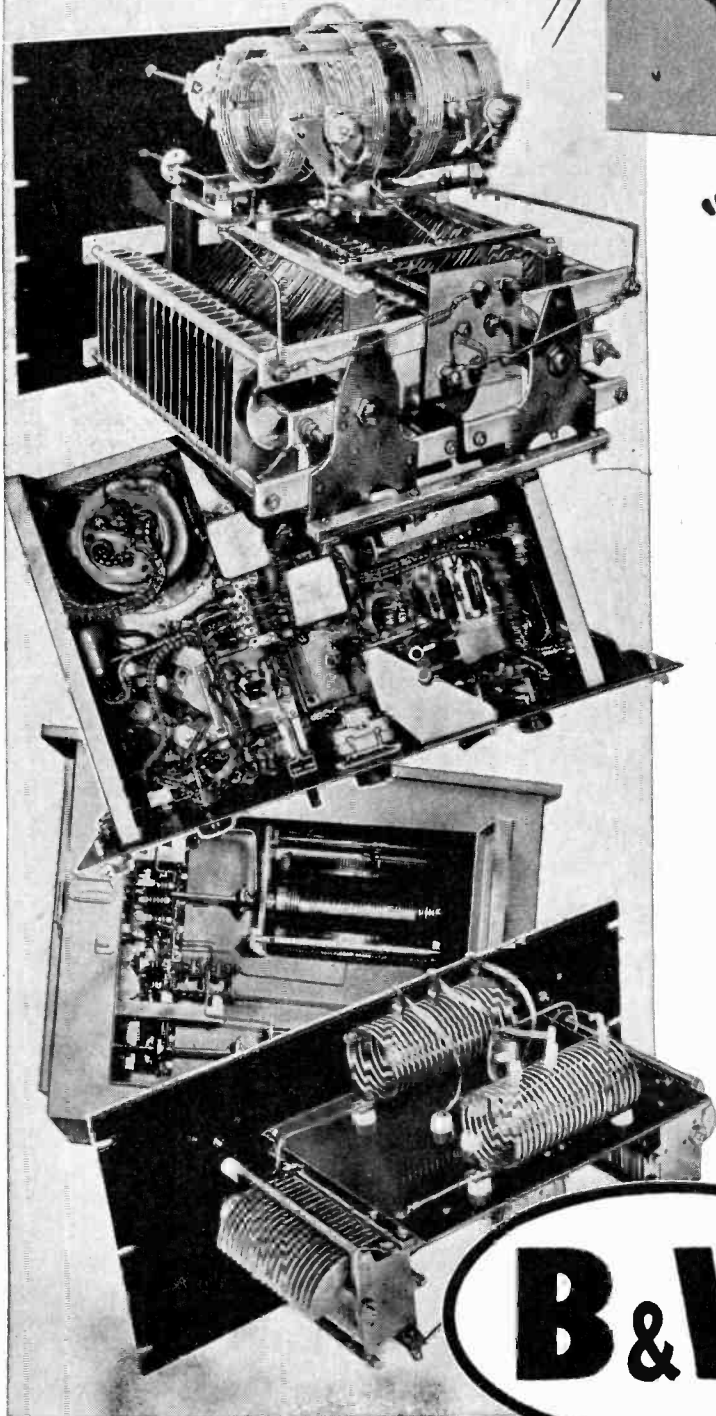
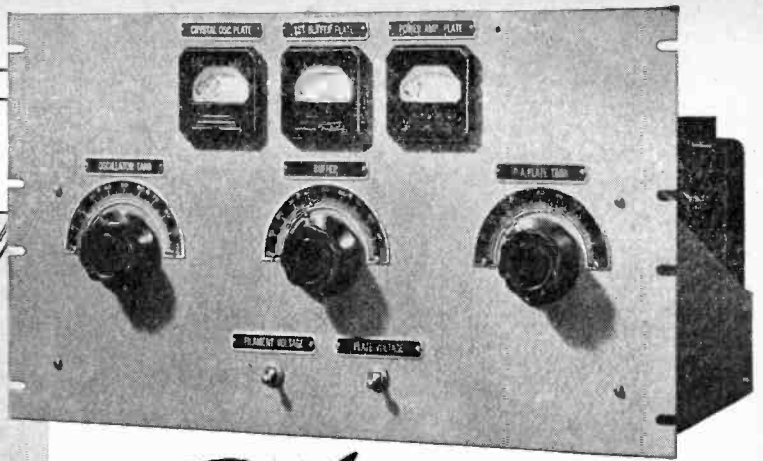

"Tailor-made"
**ELECTRONIC
 EQUIPMENT
 ASSEMBLIES**

Designed and produced from stem to stern by recognized experts to match your needs *exactly*.

**DIELECTRIC AND INDUCTION
 HEATING EQUIPMENT • TUNING
 UNITS • TEST EQUIPMENT • RADIO
 TRANSMITTERS • HIGH AND ULTRA-
 HIGH FREQUENCY EQUIPMENT**

B & W is neither too large for the smallest job nor too small for the largest. Write for details, outlining your requirements.

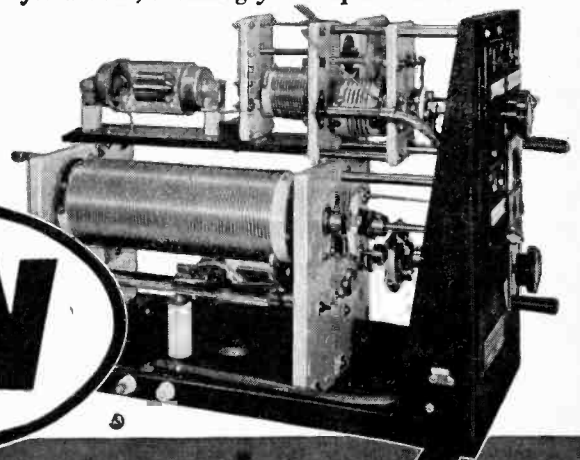

BARKER & WILLIAMSON

AIR INDUCTORS • VARIABLE CONDENSERS • ELECTRONIC EQUIPMENT ASSEMBLIES

DEPT. EL-114, 235 FAIRFIELD ROAD, UPPER DARBY, PA.

Export: LINDETEVES, INC., 10 Rockefeller Plaza, New York, N. Y., U. S. A.

Membership

(Continued from page 46A)

- MacDougall, D. D., College Naval Training Unit, V-12, 1301 E. California St., Pasadena 4, Calif.
- Meining, R., 3003 Fenkell Ave., Detroit 21, Mich.
- Miller, H. J., Jr., 803-40 St., Kenosha, Wis.
- Milot, R., 3588 Jeanne-Mance St., Montreal, Que., Canada
- Moore, J. E., 929-15 St., Boulder, Colo.
- Moreno-Frers, J., Ayacucho 1823, Buenos Aires, Argentina
- Niemuth, F. W., 103 E. Sellar St., Bessemer, Mich.
- Odze, W. K., 592 Lansdowne Ave., Westmount, Canada
- Oney, C. E., Navy V-12, Co. A Plt. 1, Louisville, Ky.
- Owen, T. J., Ward Island, Corpus Christi, Texas
- Perry, M. A., 565 Crown St., Brooklyn, N. Y.
- Pfefer, B. L., 3314 Highland Ave., Kansas City, Mo.
- Plaisance, S. F., Bks 12, Ward Island, Corpus Christi, Texas
- Polking, U. H., 1605 N. Adams, Carroll, Iowa
- Pool, V. R., 631 Jackson St., Decatur, Ala.
- Postman, M. H., 48-20-44 St., Woodside, L. I., N. Y.
- Purvis, W. J., 793 Woodbine Ave., Toronto, Ont., Canada
- Rademaker, L. C., Jr., 231 S. 41 St., Louisville, Ky.
- Regan, E. D., 759 Middlefield Rd., Palo Alto, Calif.
- Rhodes, E. F., Jr., 4021 Blvd. Place, Indianapolis, Ind.
- Riddell, R. B., 37-06-89 St., Jackson Heights, L. I., N. Y.
- Riese, R. L., Navy V-12 Unit, University of Washington, Seattle 5, Wash.
- Rinaldo, P. M., 829 N. Wheaton Ave., Wheaton, Ill.
- Roberts, B. H., Van Wie's point, Glenmont, N. Y.
- Roberts, W. A., 1301 E. California St., Pasadena, Calif.
- Rothman, J. I., 307 First Ave., New York, N. Y.
- Rowland, E. G., Bks. 13 Naval Aviation Tech., Training Center, Corpus Christi, Texas
- San Pietro, A. G., 107-62-113 St., Richmond Hill, L. I., N. Y.
- Scarborough, A. D., Caltech V-12 N.T.U., 1301 E. California St., Pasadena, Calif.
- Schupp, G. A., Worcester Polytechnic Institute, Worcester, Mass.
- Seborer, O., Co. A 1552 S.U., Baker Hall, Columbus, Ohio
- Seeley, G. F., 2906 Douglas St., Sioux City, Iowa
- Shanty, F., 708 S. Deckee Ave., Baltimore, Md.
- Sielski, A. T., 344 Communipaw Ave., Jersey City 4, N. J.
- Sinclair, D. W., College V-12 N.T.U., 1301 E. California St., Pasadena 4, Calif.
- Siocos, C. A., 572 Lasuen St., Stanford University, Palo Alto, Calif.
- Sleven, M. O., 120-06-97 Ave., Richmond Hill 19, L. I., N. Y.
- Smith, E. L., Jr., Box 117, M.I.T., Dormitories, 3 Ames St., Cambridge, Mass.
- Smith, F. S., Jr., 399 Park Ave., Leonia, N. J.
- Spiegel, G., 14 Dalton Pkwy., Salem, Mass.
- Springer, R. E., 1301 E. California St., Pasadena, Calif.
- Stevens, K. N., 58 Brookdale Ave., Toronto, Ont., Canada
- Tamres, I., 25 Bay 35 St., Brooklyn, N. Y.
- Tanyolac, N. N., Box 562, W. Lafayette, Ind.
- Terwilliger, K. M., Co. A 1552 S.U., Ohio State University, Columbus 10, Ohio
- Tilden, S. F., 40 Oakland Ave., Westmount, Que., Canada
- Tirpak, G. A., 144 Broadway, Passaic, N. J.
- Varsavsky, O. A., Araoz 2975, Buenos Aires, Argentina
- Venable, R. H., Box 1574 Georgia Tech, Atlanta, Ga.
- Vilas, E. T., Co. A Bks. 5 3303 S.U., State College, Pa.
- Wiggins, T., 202 E. 22, Austin, Texas
- Wolk, A. B., Co. A 1552 S.U., Ohio State University, Columbus, Ohio
- Yokelson, B. J., 1552 S.U., Ohio State University, Columbus, Ohio

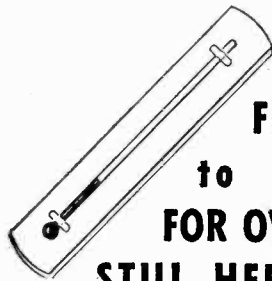
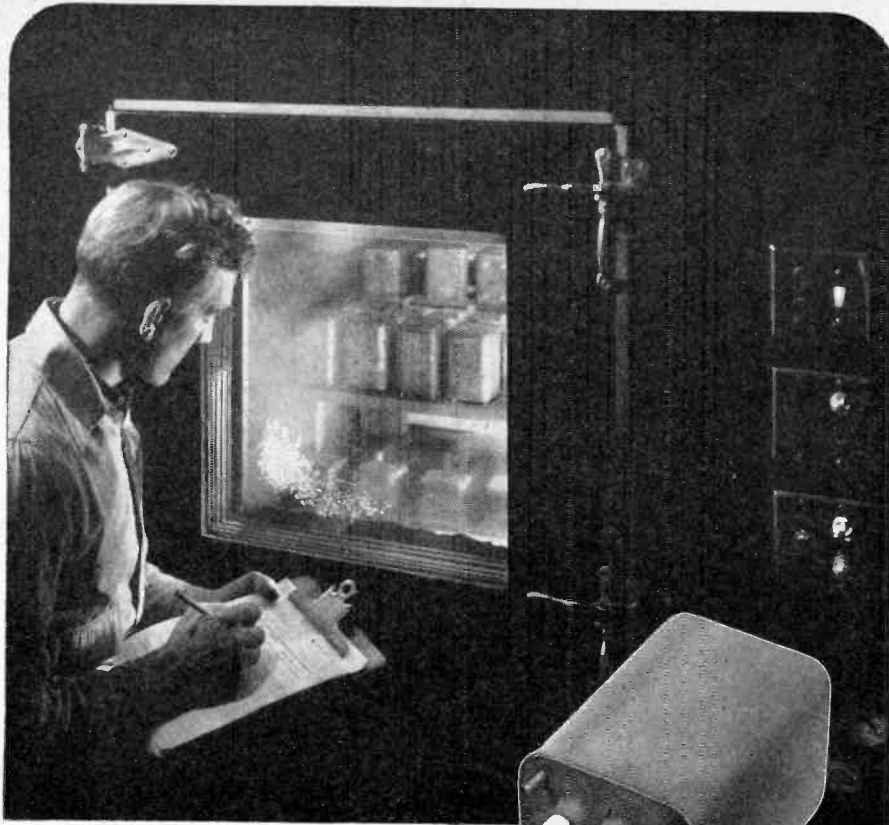

**FROM -55°C (-67°F)
to $+85^{\circ}\text{C}$ ($+185^{\circ}\text{F}$)
FOR OVER 2400 HOURS and
STILL HERMETICALLY SEALED!**

Two hundred and forty seven cycles of alternating heat and cold for over two thousand four hundred hours failed to break the seal or cause failure of oil filled Chicago Transformers.

Chicago Transformer's bushing construction and deep-sealed drawn steel cases will withstand the severest conditions.

Write for full particulars on this improved hermetic line.

CHICAGO TRANSFORMER

DIVISION OF ESSEX WIRE CORPORATION

3501 WEST ADDISON STREET

CHICAGO, 18



3 Views OF THE FUTURE

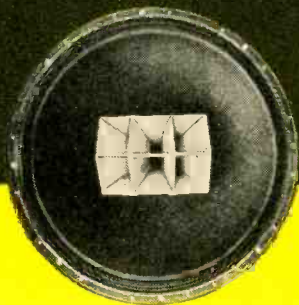

DUPLEX SPEAKER

The Speaker that
Revolutionizes the
Methods of Sound
Reproduction!

SEND FOR BULLETINS

ALTEC

LANSING CORPORATION

1210 TAFT BLDG., HOLLYWOOD 28, CALIF.

DO YOU MAKE:

RADIO, SOUND AND COMMUNICATIONS EQUIPMENT?

Loud Speakers	Sound-powered	Vibration Pick-ups
Headsets	Telephones	Polarized Relays
Microphones	Telephone Ringers	Generators
Hearing Aids	Voltage Regulators	Meters
Electrical Musical Instruments	Phonograph Cutting Heads	Magnetron Fields
	Phonograph Pick-ups	

AUTOMOTIVE AND AVIATION EQUIPMENT?

Magnetos	Voltage Regulators	Generators
Tachometers	Motors	Magnetic Oil Filters
Compasses	Speedometers	

INSTRUMENTS?

Ammeters	Oscillographs	Light Meters
Voltmeters	Flux Meters	Cardiograph
Galvanometers	Watt-hour Meters	Recorders
Seismographs	Flow Meters	Vibration Pick-ups

MISCELLANEOUS PRODUCTS?

Magnetic Separators	Arc Blow-out Magnets	Clocks
Magnetic Chucks	Temperature and Pressure	Toys and Novelties
Magnetic Conveyors	Control Equipment	Coin Separators
Magnetic Clutches	Circuit Breakers	for Vending
Magnetic Damping Devices	Limit Switches	Equipment
	Holding Magnets	

IF YOU make any of the above products, it will pay you to find out how *better permanent magnets* can improve efficiency and reduce costs. Put your design, development or production problems up to The Arnold Engineering Company. Arnold engineers have been of great assistance to many manufacturers and are at your service to advise exactly what Alnico permanent magnet will solve your particular problem.



NEW! Get your copy of this valuable, up-to-the-minute manual on the design, production and application of modern Alnico permanent magnets. Write us, on your company letterhead, today.

THE ARNOLD ENGINEERING COMPANY

147 EAST ONTARIO STREET, CHICAGO 11, ILLINOIS

Specialists in the manufacture of ALNICO PERMANENT MAGNETS

FIELD SERVICE ENGINEERS

FOR DOMESTIC AND FOREIGN SERVICE MUST POSSESS GOOD KNOWLEDGE OF RADIO

Essential workers need release

HAZELTINE CORPORATION

58-25 Little Neck Parkway
Little Neck, Long Island

SENIOR ELECTRONIC ENGINEERS

Preferably graduates of communication engineering courses are required for designing, receiving-type electronic equipment covering all frequency ranges, and other specialized electronic apparatus. Design experience necessary and knowledge of production is desirable. Excellent post-war opportunities. Salary open. Requirements urgent. Proof of citizenship and certificate of availability are necessary.

Write giving detailed qualifications and if satisfactory, interview will be arranged at our expense.

SUBMARINE SIGNAL CO.

Dept. 420
175 State St. Boston, Mass.



The following positions of interest to I.R.E. members have been reported as open. Apply in writing, addressing reply to company mentioned or to Box No.

The Institute reserves the right to refuse any announcement without giving a reason for the refusal.

PROCEEDINGS of the I.R.E.

330 West 42nd Street, New York 18, N.Y.

TELEVISION TECHNICIANS

The Television Laboratories of the Columbia Broadcasting System, in New York, need television technicians. Men having had definite experience in the television field, transmitters, or receivers, preferred. Excellent opportunity for well qualified applicants. Our staff knows of this advertisement and replies will be kept confidential. Write, giving all details, to CBS Television Engineering Department, 485 Madison Avenue, New York 22, New York.

ENGINEERS

A Midwestern manufacturer of radio transmitters and associated equipment has openings for several junior project engineers qualified to supervise or assist development of transmitters, speech input systems, control apparatus, and similar items. Salary average \$2500 per year. Give full details first letter. Address Box 365.

ELECTRICAL ENGINEER FOR ELECTRONIC RESEARCH

An unusual opportunity for a man who has a knowledge of hot and cold cathode tubes and tube applications in amplifiers, multivibrators, triggers, and switching circuits. Permanent position in laboratory of established manufacturer, doing research and development work, both present and post war. Salary open and commensurate with experience, initiative, and ability. Include complete details of education, experience, and WMC availability with reply to Box 366.

ELECTRICAL OR RADIO ENGINEER

Should have general experience in Electrical or Radio Measurements. Graduate engineer (radio or electrical) from recognized engineering school, desirable. Long-established radio-electrical components manufacturer in New England, doing war work at present. Postwar future for right man. Give detailed outline of experience, etc., salary requirements. Address Box 367.

ELECTRONIC ENGINEER

Electronic engineer or physicist for developmental work.

Also, electronic technician for construction work on radio test equipment.

Post-war future in both positions. Write to Premier Crystal Laboratories, 63 Park Row, New York 7, N.Y.

ASSISTANT PROFESSORS

Assistant professors or instructors in electrical engineering to specialize in electronics, communications, and illumination. Strong eastern engineering college. Submit professional record and photograph with application. Positions permanent. Address Box 362.

ELECTRONIC ENGINEERS AND DRAFTSMEN

The services are required of several electronic equipment design engineers capable of supervising the system layout of electronic and electro-mechanical devices.

Also, several draftsmen are needed with experience in electronic schematics, circuit layouts, and wiring diagrams, or with considerable experience in other related electrical fields.

Write giving full qualifications to the Personnel Department, Curtiss-Wright Corp., Development Division, 88 Llewellyn Ave., Bloomfield, N.J.

CONSULTING ENGINEERS

For laboratory with adequate facilities to take on the design of R.F. precision measuring instruments on a contract basis. Send reply to Box 359.

ELECTRONICS ENGINEERS

Development engineers on television and ultra-high-frequency tubes. Technician on tubes. Radio engineers on special applications.

Write full details to Box 363.

(Continued on page 52A)

FOR AN ABLE CHIEF ENGINEER

... an Opportunity

To take charge of all engineering activities in design, processing and tooling of communications and electro-mechanical products.

This growing company has a well-established peacetime product sold internationally, and several other big postwar projects including one in the business machine field with large postwar market. Now working on war contracts of highest urgency.

Our Chief Engineer must have a broad manufacturing background and experience in design, engineering, processing and tooling for electrical manufacture and assembly.

If you have such qualifications, please apply ... if you haven't, please don't. However we need several more electrical and mechanical engineers (preferably under 40) who need not have such broad experience. We shall be very glad to hear from these.

WRITE TO W. E. DITMARS, President, telling your experience, background and qualifications in detail, and salary expected. Your letter will be treated with complete confidence by Mr. Ditmars and no further investigation will be made without your express permission.

THE GRAY MANUFACTURING COMPANY

16 Arbor Street, Hartford, Conn.

After Victory... WHAT?

When Victory is ours, and Peace returns to the land . . . will YOU be snug in your own paid-for home—with security against illness, provision for retirement, education for your children—all ASSURED BY BONDS?

Or will you be one of those "too busy" people who "meant to buy Bonds tomorrow"? Who find themselves entering the postwar period empty-handed . . . facing the future with uncertainty? The choice is yours.

For, wherever you are, in the service, the factory, the farm, the office, YOU and that family you love so much *can* be provided for—or can be neglected . . . it's up to *you*.

Yes, actually! It all depends on what *you* do. On what you do *before* the war's over; on what you do, in fact, TODAY!

You must know by now that the best, the safest investment in the world—the one with the most liberal terms—is United States' WAR BONDS. What you may not know is that they are the best insurance policy there is. If you regularly invest a percentage of your weekly income in bonds—and also buy them with your savings or extra earnings, NOW—you can accumulate that very Nest Egg which spells security for your family . . . easily, painlessly, right away. And, in just ten short years, you'll have 4 DOLLARS FOR EVERY 3 you invest!

We guess that makes War Bonds just about the best darn buy there is. You're helping the boys to come home sooner—and you're insuring a bright, safe future for those you love. *When you invest in Bonds, the full faith and credit of the United States Government is behind that future of yours!*

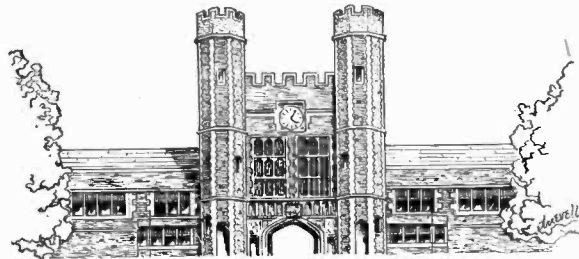

THE MARK OF

EXCELLENCE

If You Believe in America . . . BUY BONDS!

Here at Kenyon, we're proud to play our small role on the stage of a BIG war. That's why EVERY Kenyon transformer used by our fighting forces throughout the world reflects only the highest precision craftsmanship. Kenyon workers are doing their share—bringing Victory closer by turning out top quality transformers uninterruptedly—and as fast as possible!

KENYON TRANSFORMER CO., Inc. 840 BARRY STREET
NEW YORK, U. S. A.

INSTRUMENT ENGINEER

WANTED

Engineer needed to develop and apply electronic instruments for measuring vibrations, strains, pressures and temperatures. Experience with electro-mechanical devices desirable. Position of permanent nature and at present concerned with measurement of aircraft and engine characteristics on projects of war urgency. Apply in writing stating education, experience and salary expected.

Persons now utilized at highest skill in essential industry need not apply as all hiring is done in accordance with Hartford area stabilization plan.

**PRATT & WHITNEY AIRCRAFT
INSTALLATION
ENGINEERING DEPARTMENT
EAST HARTFORD 8, CONNECTICUT**

-ENGINEERS-

For Mechanical Design of Radio Instruments

A good connection today can mean security for you in the postwar era. Aggressive, successful newcomers in home radio, we have openings for several men with prewar experience in producing low-cost designs for fast manufacture. Write today. Postwar program in the offing!

Wanted: Radio Engineer

Experienced in

MICROWAVE TECHNIQUE

To work with experienced designers in developing new products and applications of the microwave spectrum. Must have had prewar radio and wartime microwave experience. Ph.D. or D.Sc. preferred. Large postwar program planned. Write today.

MAGUIRE INDUSTRIES, INC.

Electronics Division
342 W. Putnam Ave. Greenwich, Conn.



(Continued from page 50A)

ELECTRONIC EXPERT

Needed in management of large New York plant. Capable of supervising manufacture of transmitting and receiving radio assemblies, transformers and other electronic equipment. Excellent opportunity. Write personal and professional qualifications, salary expected, to Box 210, Suite 1024, 122 E. 42 St., New York 17, N.Y.

ELECTRONIC ENGINEER

Radio or electronic engineer for design and development of Army and Navy electronic equipment. Position offers excellent opportunity with well established and expanding company in Connecticut, employing over one hundred personnel. The company's big post-war program in the industrial electronics, radio, and aircraft communications fields assures engineering personnel a continued opportunity for advancement. Address reply to Box 364.

RADIO ENGINEERS, SUPERVISORS AND TECHNICIANS

Chief Radio Engineers, Transmitter and Studio Supervisors and Technicians between thirty and forty-five years of age are needed at once in important war work in the Pacific to construct and operate radio stations. These positions are with the United States Government, with good salaries and subsistence, and for the duration plus six months. Interested persons with actual broadcast experience should write, giving details of radio work, to Box 356.

RADIO, ELECTRICAL AND MECHANICAL ENGINEERS

In the development and production of all types of radio-receiving and low-power transmitting tubes. Excellent post-war opportunities with an established company in a field of opportunities. Apply in person, or write to Personnel Manager of Raytheon Manufacturing Company, 55 Chapel Street, Newton, Mass.

RADIO ENGINEERS

Need radio engineers with experience in Frequency-Modulation transmitting and receiving equipment. Familiarity with F.C.C. rules and field operation of equipment desirable. Send complete experience and education in letter of application, and state salary desired. Company located in the Midwest where living conditions are good, and expenses below average. Address to Box 351.

RADIO ENGINEER

Unusual opportunity for experienced radio engineer. Well established medium-size Midwest radio manufacturer. Large post-war program. Nationally advertised radio line. Write qualifications and experience to the Agency Service Corporation, 66 East South Water Street, Chicago 1, Ill.

VACUUM-TUBE DESIGNERS

Engineers and physicists for research and development work on small vacuum tubes.

An opportunity for post-war employment with a growing organization doing both war and essential civilian production. Recent graduates with adequate training and experienced personnel will be considered for these positions.

Certificate of availability required. Write to Director of Research, Sonotone Corporation, Elmsford, N.Y.

ELECTRICAL ENGINEERS

Needed in connection with the manufacture of a wide variety of new and advanced types of communications equipment and special electronic products. Openings available in St. Paul, Minn., Eau Claire, Wis., and Chicago. Apply or write, giving full qualifications and furnish snapshot, to D. L. R., Employment Department, Western Electric Company, Hawthorne Station, Chicago 23, Illinois.

FIELD SERVICE ENGINEERS

For domestic and foreign service. Must possess good knowledge of radio. Essential workers need release. Write to Hazeltine Electronics Corporation, 58-25 Little Neck Pkwy., Little Neck, L.I., N.Y.

(Continued on page 54A)

Micro-Wave Design Engineers

An opportunity for radio engineers who have had extensive experience in the design of micro-wave apparatus. Their services are needed for long range development program for the government.

Broadcast Receiver Designers

Still other radio engineers with experience are needed.

Mechanical Engineers for telephone and radio work—

whose experience fits them to design electro mechanical devices for production are also needed.

• While the above openings are for senior men, we do have opportunities for several junior engineers in these fields. Interested persons are invited to write giving full qualifications to the Engineering Personnel Manager.

War Manpower Commission rules
will be observed.

**STROMBERG-CARLSON CO.
ROCHESTER 3, N. Y.**

Wanted ENGINEERS

Radio

- * Electrical
- * Electronic
- * Mechanical
- * Metallurgical
- * Factory Planning
- * Materials Handling
- * Manufacturing Planning

Work in connection with the manufacture of a wide variety of new and advanced types of communications equipment and special electronic products.

Apply (or write), giving
full qualifications, to:

R.L.D.
EMPLOYMENT DEPT.

Western Electric Co.

100 CENTRAL AVE., KEARNY, N.J.

*Also: C.A.L.
Locust St., Haverhill, Mass.

Applicants must comply with WMC regulations

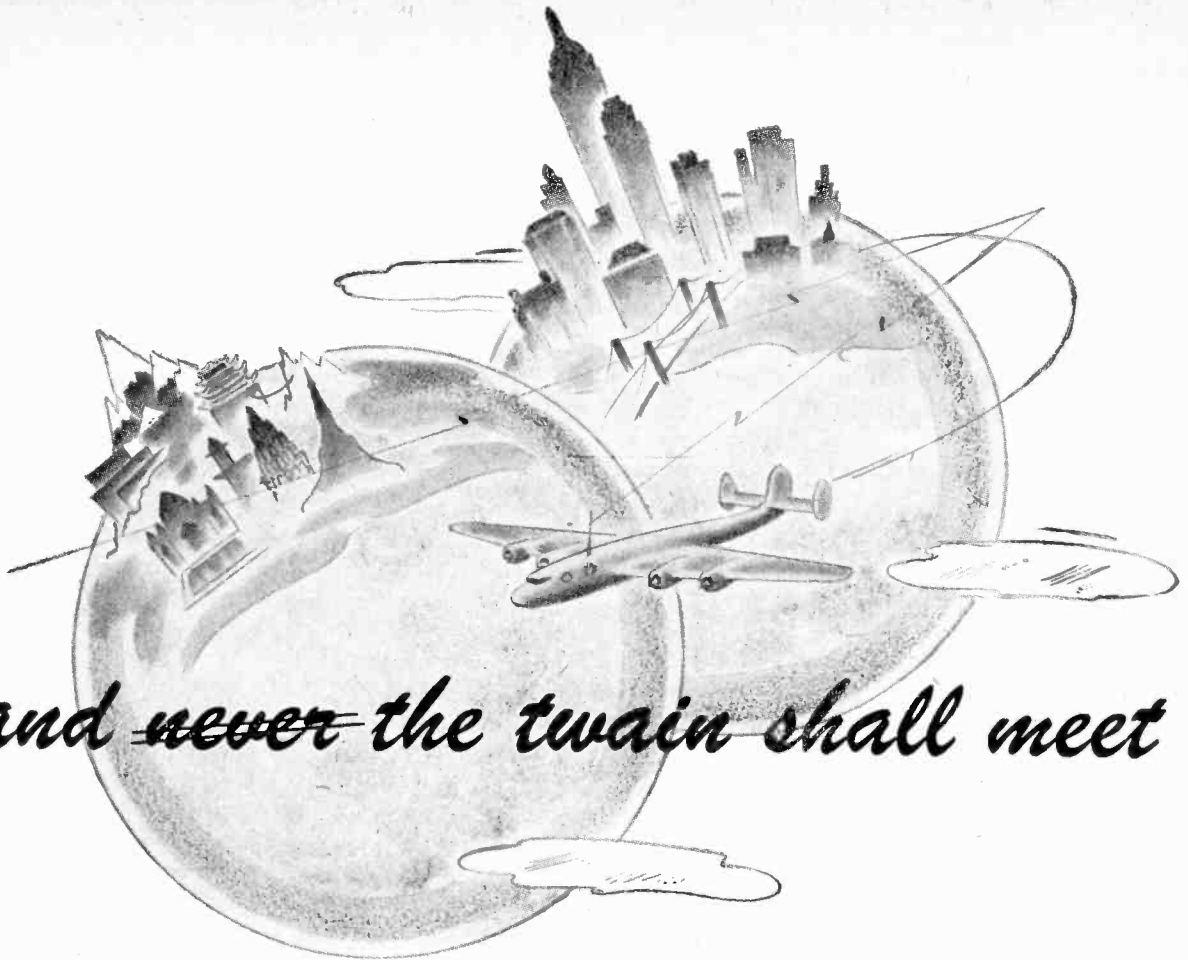

... and ~~never~~ the twain shall meet

"East is east and west is west," wrote the poet, "and never the twain shall meet."

But he was wrong.

The twain *shall* meet. The peoples of the earth shall begin to know each other — and work together — for peace and plenty for all.

And the miracle will be due in great part to the coming Age of Flight. . . .

Communications will help make Air Transport safer — more economical — faster. Harvey-Wells Electronics produces communications equipment designed for complete dependability, engineered for maximum efficiency . . . selected for War, perfected for Peace.

In the Age of Flight, look to Harvey-Wells for ideas, skill, imagination — setting the pace for progress in communications!

Know the company that wants your business! Our CASE BOOK tells the story of Harvey-Wells and its place in Electronics. Send for it today. Your name on your letter-head is sufficient.

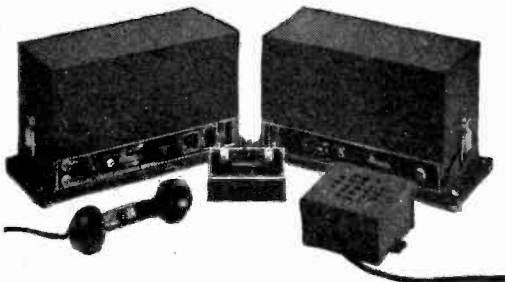

Harvey-WELLS
ELECTRONICS

SETTING THE PACE FOR PROGRESS IN COMMUNICATIONS

HARVEY-WELLS ELECTRONICS, INC. SOUTHBRIDGE, MASSACHUSETTS

CHIEF BROADCAST RECEIVER ENGINEER

Large eastern radio manufacturer has an opening for a Chief Engineer in its Broadcast Receiver Section. Excellent opportunity for the right person. Must have adequate experience and background. Salary \$8,000 to \$12,000 per year depending upon ability and experience of applicant.

War Manpower Commission Regulations Apply.

Address all replies to:

BOX NO. 360

THE INSTITUTE OF RADIO ENGINEERS

330 West 42nd St.
New York 18, N.Y.

CHIEF LOUD SPEAKER ENGINEER

The Rola Company, Inc. requires the services of an Engineer who has had several years experience and capable of heading this division.

Present work is on 100% urgent war products.

Excellent post-war opportunity with an outstanding, financially sound, long-established manufacturer of radio loudspeakers and transformers.

This Company now has definite plans for an extensive expansion in its Engineering and Manufacturing Divisions.

Salary open.

Write to
**The Rola Company,
Inc.**
2530 Superior Avenue
Cleveland 14, Ohio



(Continued from page 52A)

DESIGNER

A central New England manufacturer employing over 1000 people needs draftsman-designer on telephone and signaling (mechanical) apparatus.

Knowledge of die-casting and plastic applications desirable. WMC regulations prevail. Write to Box 339.

DEVELOPMENT ENGINEERS

Mechanical and electrical. Graduate or equivalent training. Required for development work in the following branches:

1. Electro-mechanical devices, communication systems. Must be interested in development and familiar with magnetic circuits.
2. Measuring and control instruments. Background should be in electrical engineering, including electronics.

Statement of availability required. Address Box 340.

RADIO-ELECTRONIC ENGINEERS

A young progressive radio-electronic firm needs top-flight men for these key positions:

- Electronic engineers and technicians
- Electro-mechanical engineers, familiar with mechanical design of electrical and electronic equipment
- Chief inspector
- Supplier's contact engineer
- Master mechanic
- Transformer engineers
- Project engineers

Engaged 100% in war work, with excellent post-war future and possibilities. Our staff knows of these openings. Write in confidence to Box 352.

ELECTRICAL ENGINEERS

Electrical engineers for research and development in the field of radio communications and electrical test equipment. Good post war opportunity. Address reply to Allen D. Cardwell Mfg. Corp., 83 Prospect Street, Brooklyn, N.Y.

OPPORTUNITIES in INDIA...

India offers a rich outlet for manufacturers of industrial chemicals, plastics, textiles, sugar, paper, leather, rubber, etc.

Your key to this vast market is an outstanding Indian company, backed by twenty-five years of experience.

Full information on request from our American representative:

MAX VAN PELS
441 LEXINGTON AVE.
NEW YORK 17, N.Y.

A NEW JUNGLE FIGHTER

Moves Up...

TROPICALIZED Q-MAX A-27 H. F. Lacquer Protects Com- munication Equipment Against FUNGI



Tropical fungus and mold does not respect the finest workmanship and performance which can be built into communication and electrical equipment. Ruthless as any Jap, it attacks unprotected surfaces and swiftly deteriorates vital communications such as walkie-talkie, handy-talkie, radar, power plants, signal detector apparatus and scores of other electrical devices that "move up" with our armed forces and contribute to victory. But they can "move up", jungle-proofed against this insidious enemy, if you use Tropicalized Q-Max A-27 H.F. Lacquer.

The tropicalizing of this effective dielectric coating material was a wartime achievement of our chemists who sought and found an ideal fungicide that would combine well with Q-Max Lacquer, and yet retain its good electrical characteristics and its high corrosion resistance.

To fungus-proof components of your communication equipment destined for the tropics and shut out harmful moisture, play safe by using this tropicalized lacquer.

Communication
PRODUCTS COMPANY, INC.

346 BERGEN AVE., JERSEY CITY, N. J.

Q-MAX CHEMICAL DIVISION

Coaxial Transmission Line & Fittings • Sterling Switches • Auto Dryaire • Antenna & Radiating Systems • Tropicalized Q-Max A-27 H.F. Lacquer
Proceedings of the I.R.E. January, 1945

GAMMATRON TUBES

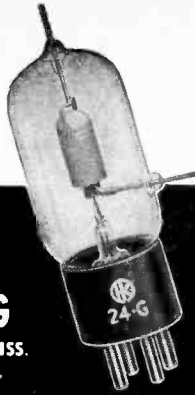

24G
PLATE DISS.
25 W.

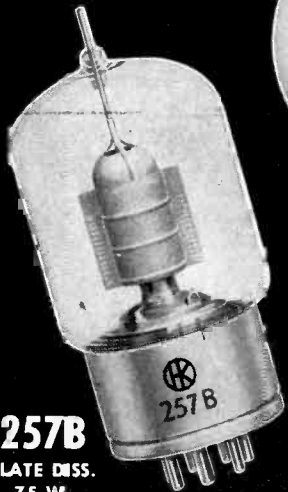

257B
PLATE DISS.
75 W.

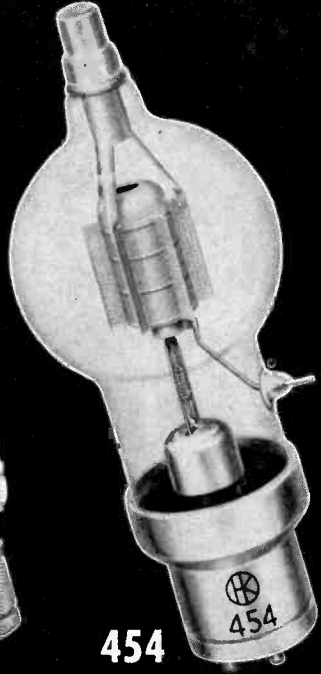

454
PLATE DISS.
250 W.



This complete line, covering a power range of 50 to 5,000 watts, embodies 18 years of pioneering and experience in the design and manufacture of tantalum tubes. Special plate, grid, and filament design, and new metal-to-glass seals, give Gammatrons remarkable VHF performance. Other features: ability to withstand high plate voltages, complete protection against tube failure due to overloading, and long, efficient operating life. The Gammatron engineers responsible for these developments will be glad to help you with your special problems.



TYPE NO.	24	24G	54	254	257B	304L	304H	354C	354E	454L	454H	654	854L	854H	1054L	1554	2054A	3054
MAX. POWER OUTPUT: Class 'C' R.F.	90	90	250	500	230	1220	1220	615	615	900	900	1400	1800	1820	3000	3600	2000	5300
PLATE DISSIPATION: Watts	25	25	50	100	75	300	300	150	150	250	250	300	450	450	750	1000	1200	1500
AVERAGE AMPLIFICATION FACTOR	25	25	27	25		10	19	14	35	14	30	22	14	30	13.5	14.5	10	20
MAX. RATINGS: Plate Volts	2000	2000	3000	4000	4000	3000	3000	4000	4000	5000	5000	4000	6000	6000	6000	5000	3000	5000
Plate M.A.	75	75	150	225	150	1000	1000	300	300	375	375	600	600	600	1000	1000	800	2000
Grid M.A.	25	25	30	40	25	150	150	60	70	60	85	100	80	110	125	250	200	500
MAX. FREQUENCY, Mc.: Power Amplifier	200	300	200	175	150	175	175	50	50	150	150	50	125	125	100	30	20	30
INTERELECTRODE CAP: C _{g-p} u.u.f.	1.7	1.6	1.8	3.6	0.08	9	10.5	3.8	3.8	3.4	3.4	5.5	5	4	5	11	18	15
C _{g-f} u.u.f.	2.5	1.8	2.1	3.3	10.5 In	12	14	4.5	4.5	4.6	4.6	6.2	6	8	8	15.5	15	25
C _{p-f} u.u.f.	0.4	0.2	0.5	1.0	4.6 Ou	0.8	1.0	1.1	1.1	1.4	1.4	1.5	0.5	0.5	0.8	1.2	7	2.5
FILAMENT: Volts	6.3	6.3	5.0	5.0	5.0	5.10	5.10	5	5	5	5	7.5	7.5	7.5	7.5	11	10	14
Amperes	3	3	5	7.5	7.5	26-13	26-13	10	10	11	11	15	12	12	21	17.5	22	45
PHYSICAL: Length, Inches	4 1/4	4 1/4	5 7/16	7	5 15/16	7 3/4	7 3/4	9	9	10	10	10 3/8	12 1/2	12 1/2	16 1/2	18	21 3/4	30 3/4
Diameter, Inches	1 3/8	1 3/8	2	2 5/8	2 5/8	3 1/2	3 1/2	3 3/8	3 3/8	3 3/4	3 3/4	3 3/4	5	5	7	6	6	9
Weight, Oz.	1 3/2	1 1/2	2 1/2	6 1/2	6	9	9	6 1/2	6 1/2	7	7	14	14	14	42	56	66	200
Base	Small UX	Small UX	Std. UX	Std. 50 Watt	Giant 7 Pin	Johnson #213	Johnson #213	Std. 50 Watt	Std. 50 Watt	Std. 50 Watt	Std. 50 Watt	Std. 50 Watt	Std. 50 Watt	Std. 50 Watt	Johnson #214	HK 255	W.E. Co.	HK 255

WRITE FOR FULL DATA ON ALL **GAMMATRONS**

Now, Even Greater Facilities

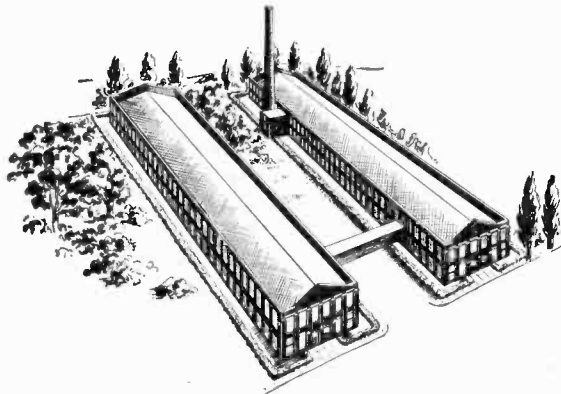

The new and larger Templetone plant at New London, Conn.

Our entire Electronics Division is now located in new quarters—affording not only greater facilities to meet ever-expanding wartime production, but also greater scope to anticipate the great electronics developments of peacetime. From this vast, new plant—containing 100,000 square feet of space—will come rich contribution to the vast commercial requirements at war's end.

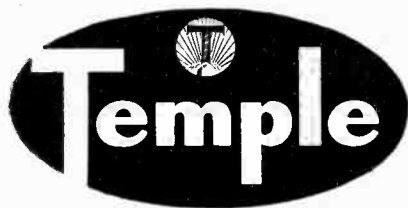

Electronics Division

TEMPLETONE RADIO MFG. CORP.

New London, Conn.

*Easy to
Erect*

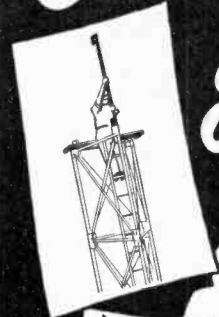

**MASTS
AND
TOWERS**

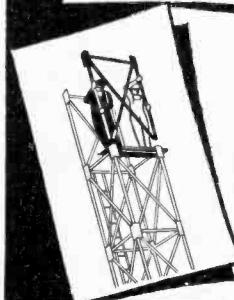
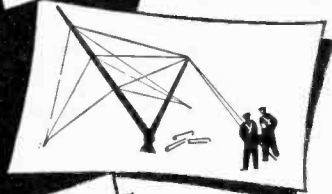

Catalog will be sent to engineers and executives writing on their business letter-head.

Address Dept. AG

HARCO

STEEL
CONSTRUCTION CO.
Elizabeth 4, N. J.

The Answer

TO YOUR
PROCUREMENT PROBLEMS

MAY LIE
BETWEEN
THESE
COVERS!



OVER
10,000 ITEMS
IN STOCK!

FAST DELIVERY
Assured on Priority

**RADIO PARTS
RADIO TUBES**

and

**INDUSTRIAL
ELECTRONIC
EQUIPMENT**

Send for this
FREE
800 Page

Buying Guide

Available solely to authorized purchasing agents and engineers who write to us on company letter-head. Address Box VR.

★
Telephone
BRclay
7-1840

**SUN RADIO
& ELECTRONICS CO.**
212 Fulton Street, New York 7, N. Y.

**CONTINENTAL
DIAMOND
ENGINEERED**

Plastic Materials

The part illustrated is an airborne radio insulating part . . . made from grade "L" DILECTO . . . a laminated phenolic plastic. It was sawed, milled, drilled, countersunk and tapped. Tolerance requirements were close. DILECTO parts such as this one will be widely used in all branches of air transportation.

Here is a strong, tough plastic . . . with high electrical insulating properties that remain stable under extremes of temperature and humidity. DILECTO is readily fabricated on ordinary metal working tools. It is NON-corrosive and highly resistant to many chemicals.

This versatile plastic may be the answer to your "What Material?" problem. C-D technicians will be glad to help you find out. Their wealth of "Know-How," the result of a half century of service to industry, makes available to you thousands of case histories of solved design and operational problems.

KG-45

C-D PRODUCTS

The Plastics

DILECTO—A Laminated Phenolic.
CELORON—A Molded Phenolic.

DILECTENE—A Pure Resin Plastic
Especially Suited to U-H-F
Insulation.

HAVEG—Plastic Chemical Equip-
ment, Pipe, Valves and Fittings.

The NON-Metallics

DIAMOND Vulcanized FIBRE
VULCOID—Resin Impregnated
Vulcanized Fibre.

MICABOND—Built-Up Mica
Electrical Insulation.

Standard and Special Forms

Available in Standard Sheets,
Rods and Tubes; and Parts
Fabricated, Formed or
Molded to Specifications.

Descriptive Literature

Bulletin GF gives Compre-
hensive Data on all C-D
Products. Individual Cata-
logs are also Available.

DISTRICT OFFICES

NEW YORK 17 • CLEVELAND 14 • CHICAGO 11
SPARTANBURG, S. C. • SALES OFFICES IN PRINCIPAL CITIES

WEST COAST REPRESENTATIVES
MARWOOD LTD., SAN FRANCISCO 3

IN CANADA:
DIAMOND STATE FIBRE CO. OF CANADA, LTD., TORONTO 8

Continental - Diamond FIBRE COMPANY

Established 1895 . . . Manufacturers of Laminated Plastics since 1911 — NEWARK • DELAWARE

*Communications...
the Permoflux Way!*

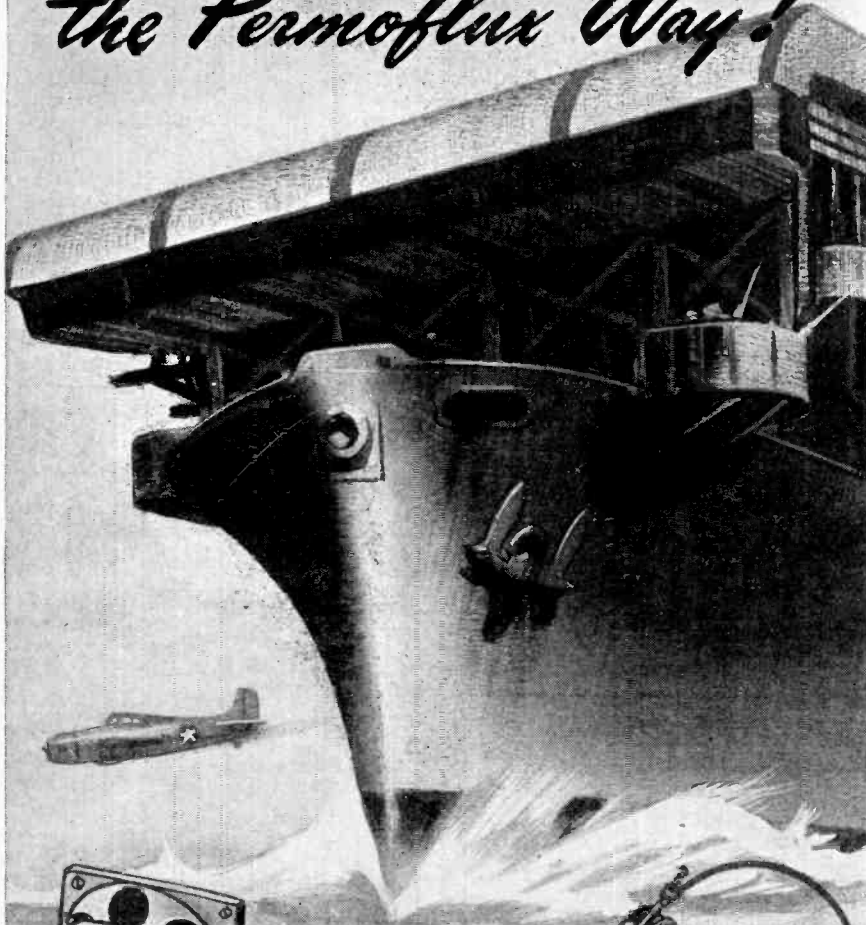

*... a New Influence
in Tomorrow's Designs*

Throughout the entire war, Permoflux Acoustical Devices have consistently surpassed the efficiency specifications of Army and Navy requirements. In addition, they have established new standards of durability under the most grueling service conditions. Permoflux products for postwar will reflect these achievements as they render improved performance in hundreds of applications. Let us consult with you on your specific design problems.

BUY WAR BONDS FOR VICTORY!

TRADE MARK
PERMOFLUX

PERMOFLUX CORPORATION
4916-22 W. Grand Ave., Chicago 39, Ill.

PIONEER MANUFACTURERS OF PERMANENT MAGNET DYNAMIC TRANSDUCERS

Binders

for the Proceedings
Protect your file
of copies against
damage and loss

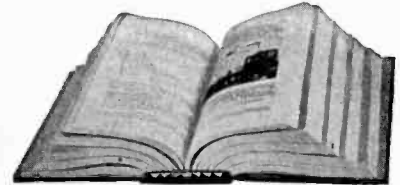

Binders are available for those who desire to protect their copies of the PROCEEDINGS with stiff covers. Each binder will accommodate the twelve monthly issues published during the year. These binders are of blue Spanish grain fabricoid with gold lettering and will serve either as temporary transfers or as permanent binders. They are so constructed that each individual copy of the PROCEEDINGS will lie flat when the pages are turned. Copies can be removed from the binder in a few seconds and are not damaged by their insertion.

Available for both the old, small size, PROCEEDINGS or the new, large size (1939 to date).



Price: \$1.50

**either size (specify which)
Postpaid to all countries**

You may have a volume number or your name stamped in gold for 50 cents additional.

*Remittance should accompany
your order*

**THE INSTITUTE OF
RADIO ENGINEERS, INC.**
330 West 42nd Street,
New York 18, N.Y.



INSPECTION ON THE LINE

MAKING HISTORY IN COMMUNICATIONS



Inspection before assembly, quality control . . . more than that . . . team work from material dispatcher, assembler, inspector, to the girl on the packing line . . . have made possible the fine achievement represented by the Army and Navy "E" Award presented to the men and women of the Universal Microphone Company.

In production of military microphones before Pearl Harbor, Universal had the necessary "know how" for immediate war production. The engineering experience and production efficiency of war production will be reflected in the electronic voice communication components offered by Universal to consumers in the future. Until then — BUY WAR BONDS.

UNIVERSAL MICROPHONE COMPANY
INGLEWOOD, CALIFORNIA



*Clip
the
Coupon*

PEERLESS Electrical Products Co.
6920 McKinley Ave., Los Angeles 1, Calif.

Please mail new 20-page catalog No. 431 to:

Name _____
 Firm _____
 Position _____
 Street _____
 City _____ State _____

**FOR YOUR COPY OF THE NEW
PEERLESS TRANSFORMER CATALOG**

Contains latest information and prices on the complete line of Peerless transformers, windings and reactors.



PEERLESS
ELECTRICAL PRODUCTS CO.

6920 McKinley Avenue, Los Angeles 1, California

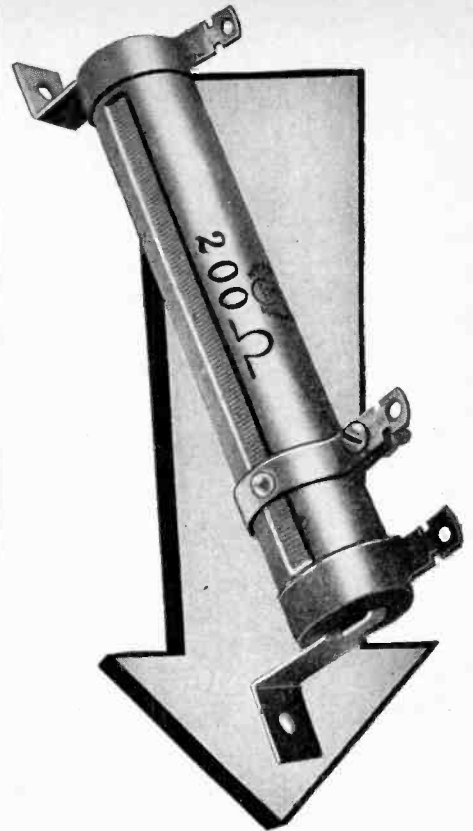

**For the TOUGHEST
RESISTORS. ask for
GREENOHMS**

★ Greenohms—those green-colored cement-coated Clarostat power resistors—definitely “stay put.” You find them today in the finest electrical, electronic and radio assemblies. They are TOUGH. Resistance is right to start with—and stays right, after years of use and abuse. Yet they cost no more.

Standard 10 and 20 watt fixed. 1-50,000 and 1-100,000 ohms. Standard adjustable 25 to 200 watts, 1-100,000 ohms. Brackets. Additional sliders available. Also available in special windings, taps, terminals, mountings, etc.



★ **Write for Literature**

Descriptive bulletin sent on request. Also sample for your test. Let us quote on your resistor needs.



CLAROSTAT MFG. CO., Inc. - 285-7 N. 6th St., Brooklyn, N. Y.

*Gates Brings You New Turntable Improvements
that assure Noiseless, Positive Operation!*

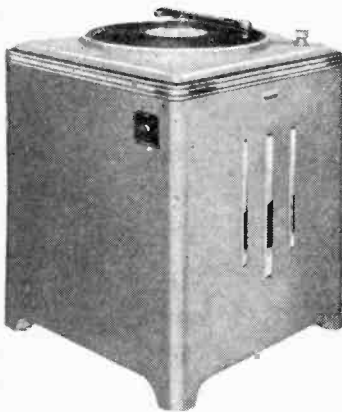

**THE GATES CB-7
Transcription
Turntable**

ENGINEERED FOR EXCEPTIONAL PERFORMANCE DESIGNED FOR THOSE WHO DEMAND THE BEST

Developed after months of experimentation with various synthetic rubbers that are impervious to oil and temperature, to provide an inside rim drive that is positive and “wow” free. The result is an efficient, yet handsomely designed, Turntable that is proving its sturdiness throughout the world under the most rigid wartime conditions—and here at home to the complete satisfaction of those who demand a trouble-free turntable for all recording and play-back purposes.

AVAILABLE NOW ON PROPER PRIORITY

(Wartime restrictions do not allow the sale of new broadcasting equipment without priority; therefore, this equipment is presented merely to acquaint you with Gates' developments. Our post-war priority delivery system may be of interest. Write at once for details.)

**GATES
RADIO CO.
QUINCY, ILL.**

Manufacturers of radio broadcast transmitters, speech equipment, recording apparatus and allied equipment in the electronics field.

A HIGH HONOR FOR

THE **DeJUR** INSPECTION PERSONNEL

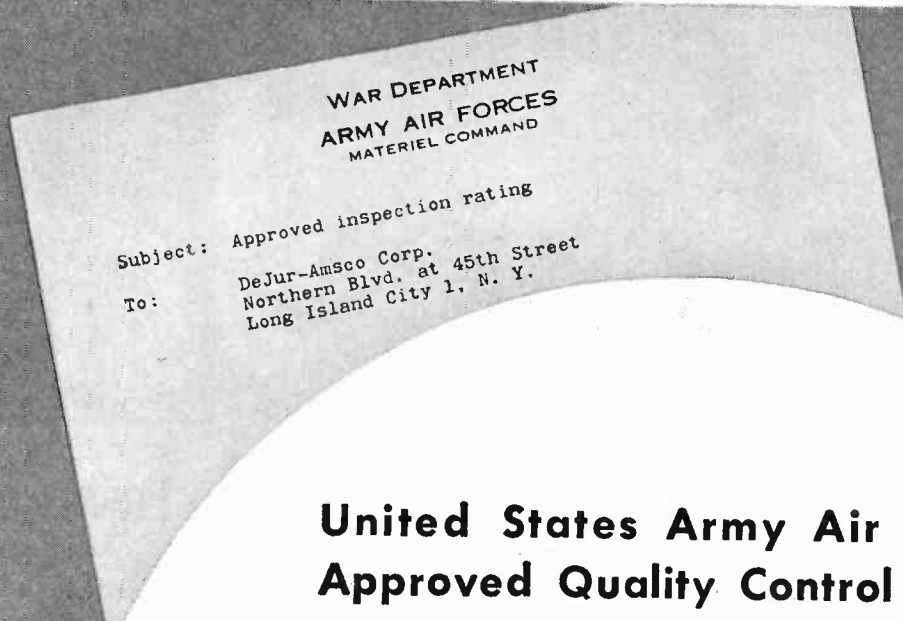

United States Army Air Forces' Approved Quality Control Rating

"As a result of the efficiency of your inspection personnel and procedures in production of equipment for the Army Air Forces, your company has been given an 'approved' quality control rating"—this is a direct quotation from the letter received by the DeJur-Amsco Corporation from the District Supervisor, Eastern Procurement District, AAF Technical Service Command.

This rating is the Army Air Forces' official recognition of the ability of the DeJur inspection personnel to meet all AAF inspection requirements. And it means that in future fabrication of DeJur products, Air Corps inspectors will not function in the same capacity as heretofore but will stand by merely for supervisory purposes. The men and women inspectors of the DeJur-Amsco Corporation are extremely pleased with this new honor, and pledge unrelenting care in the performance of their duties.

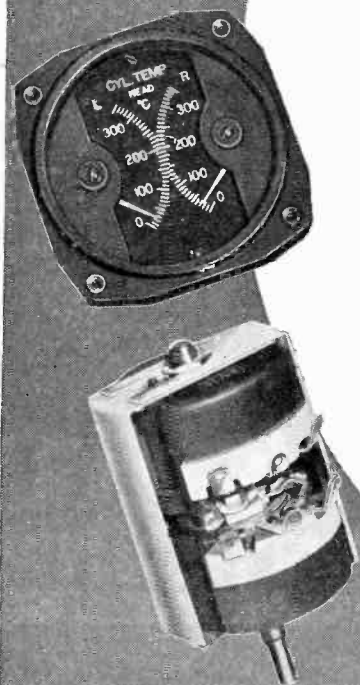

BUY MORE WAR BONDS... HOLD ON TO THEM

DeJur-Amsco Corporation

NORTHERN BOULEVARD AT 45th STREET
Long Island City 1 New York



Greetings

To the many friends of Stancor, our sincere thanks for your generous cooperation throughout the past year . . . It is a genuine pleasure to assure you that the future not only will bring greater fulfillment of your needs, but electronic refinements of which you and we both shall be proud . . . Won't you kindly accept our wishes for your good health and prosperity.

STANDARD TRANSFORMER CORPORATION, 1500 NORTH HALSTED ST., CHICAGO 22, ILLINOIS



PREMAX

**Serving
In War...and
In Peacetime
... On Land and
On Sea . . .**



Premax Antennas

Premax Tubular Metal Antennas, in standard and special designs, are now performing a vital service in maintaining communications all over the world.

In the Armed Services of the Allied Nations . . . in the airport services . . . in municipal communications tasks, the exceptionally reliable service of Premax is winning new friends everywhere.

Write for special detailed information on Antennas to suit your particular needs.

RADIO ANTENNA

Premax Products

Division Chisholm-Ryder Co., Inc.
4503 Highland Ave. Niagara Falls, N.Y.
Proceedings of the I.R.E. January, 1945



The Final Test...

These unretouched Oscillogram photos of the DuMONT Type 248 Oscilloscope, tell the story best



► This is the DuMont Type 248 Oscilloscope. As is true of all other precision instruments, it must stand or fall by its performance. Because written specifications often give little indication of how well an oscilloscope meets today's critical requirements, we believe the accompanying *unretouched* photos cover points of particular interest to those who work with modern electronic circuits. To wit:

① Sinusoidal frequency response curve of the vertical amplifier. Free from irregularities. No rise caused by over-compensation at high end. Fall-off is gradual.

② The excellent transient response of this instrument is shown by absence of overshoot or other distortion in this pulse having

a rise time of about 1/10th microsecond. Here the driven (or "slave") sweep is triggered by the pulse itself, which is then delayed by a self-contained distortionless network so that the leading edge is not obliterated. The one microsecond markers (or others at intervals of 10 or 100 microseconds) are blanked into the trace by an internal marker oscillator. A beam-control circuit eliminates the bright spot of the beam rest position.

③ Continuous sweep circuit has a range when free-running of from 15 c.p.s. to 150 kc. When moderately synchronized with a signal of higher frequency, however, it will operate at much faster rates. This oscilloscope shows a one megacycle sine wave at a sweep frequency of approximately 300 kc. Return trace is normally completely blanked but may be seen if necessary by fully advancing the intensity control. Notice the

good linearity of this time-base as well as that of the driven sweep in (2).

④ Correct compensation at the low end of the frequency range is illustrated by almost distortionless transmission of a 30 cycle square wave through the vertical amplifier. Compensating circuits for both low and high frequencies are carefully adjusted for optimum phase characteristics:

All of which, together with other equally convincing characteristics, boils down to this: The DuMont Type 248 Oscilloscope, used on the bench or mounted on its matching streamlined truck, is an instrument without equal for laboratory, shop or production line.

► Write for Literature . . .

© ALLEN B. DUMONT LABORATORIES, INC.

DUMONT

Precision Electronics & Television

ALLEN B. DUMONT LABORATORIES, INC., PASSAIC, NEW JERSEY • CABLE ADDRESS: WESPXLIN, NEW YORK

CRYSTALS

HOLLISTER  CRYSTAL CO.
Boulder Colorado

QUARTZ OSCILLATORS SINCE 1927

Concentric Transmission Line

by Doolittle

*A Standard Product
Since 1934*

• Ten years of experience in building concentric transmission line and associated impedance matching equipment assures you highest quality and workmanship.

Doolittle lines are made in seven standard sizes. Each line uses seamless copper tubing for the outer and inner conductor, except Types C-1 and C-6 which use solid inner conductors. The insulating heads are made of low loss ceramic—impervious to moisture—spaced and fastened securely for maintaining proper electrical and mechanical characteristics.

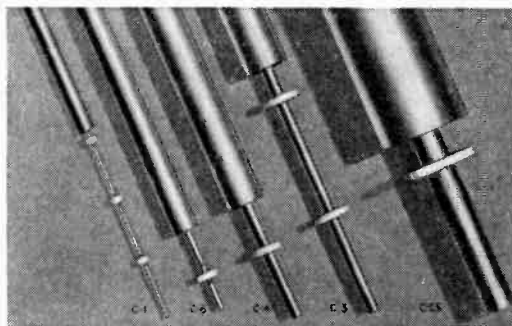

Carefully designed fittings and accessories for any requirements are also available.

Special sizes are made to order. For engineering information concerning installation and use, feel free to consult our engineering staff.

**WRITE
FOR
CATALOG
AND
PRICES**

QUICK DELIVERY

On All Standard
Sizes Upon
Suitable Priority

Doolittle **RADIO, INC.**

Builders of Precision Communications Equipment
7421 SOUTH LOOMIS BLVD., CHICAGO 36, ILLINOIS

electronics...

problem
child or
benefactor?

THE N-Y-T SAMPLE DEPARTMENT
CAN TAKE THE GUESSWORK OUT OF
TRANSFORMER SPECIFYING FOR YOUR
POST-WAR NEEDS

Placing the cart before the horse is to publicise in glowing terms, electronics of the future. Constructively, it's a job for engineers and designers with 'both feet on the ground'.

The N-Y-T Sample Department is helping to set the pace with research, engineering and development in the electronic field. Specially-built transformers, filters and solenoids—for every industrial and electronic requirement—are being produced to the highest degree of perfection ever attained.

Immediately that military needs taper, collaboration in the solution of transformer problems will be available to aid in the advancement of electronics . . . through product prestige and integrity.

NEW YORK TRANSFORMER COMPANY

24-26 WAVERLY PLACE,
NEW YORK 3, N. Y.



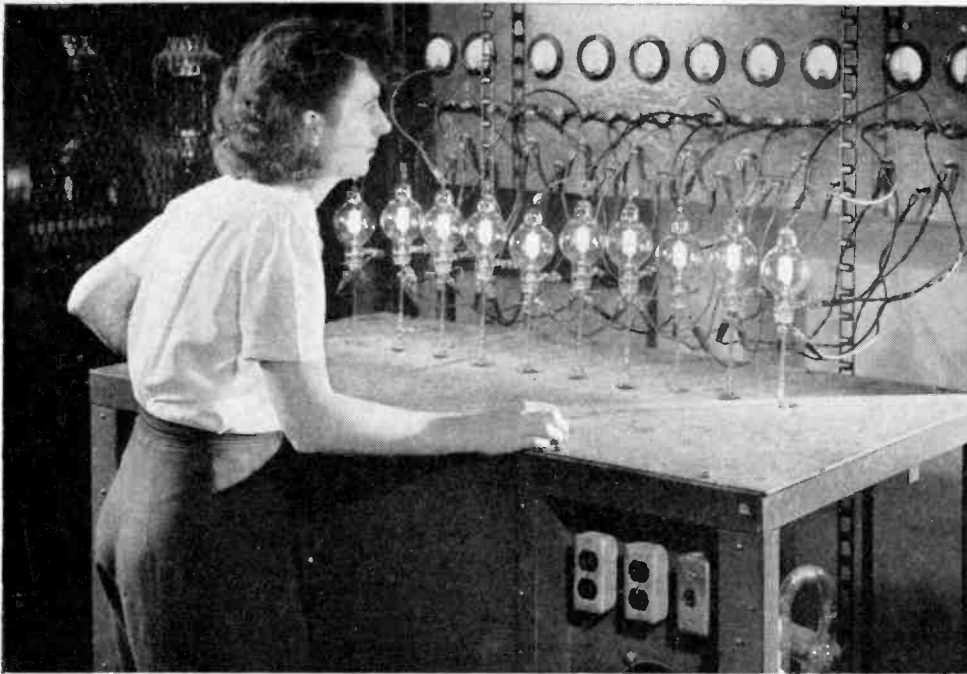

VACUUM PUMPING WITH MODERN EQUIPMENT IN THE I. C. E. PLANT



Specified by Engineers for Precision

On drafting tables postwar electronic equipment takes shape designed to use I. C. E. vacuum tubes, condensers and relays. This confidence is not alone due to records of dependable performance by I. C. E. products under extreme conditions all over the world. There is a strong bond of partnership that goes much deeper. Forward looking engineers know that I. C. E. research in the field of vacuum tubes is matching their own work in the industry. They know I. C. E.'s unexcelled manufacturing facilities and methods builds products meeting their exacting specifications for precision.

HELP WITH YOUR PROBLEMS

Consult I. C. E. engineering and research departments on designing and production of tubes required in your plans for electronic equipment or applications. This service is available by writing or wiring.

NEW CATALOG NOW READY...

For complete information on I. C. E. precision products write today for your copy of our latest catalog.



PRECISION ELECTRONIC TUBES
Research • Designing • Production

INDUSTRIAL & COMMERCIAL ELECTRONICS

BELMONT, CALIFORNIA

AVAILABLE NOW



I. C. E.
Beam Pentode

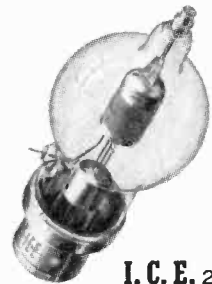

I. C. E. 250th

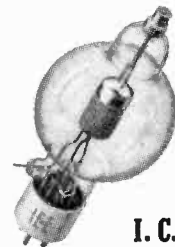

I. C. E. 100th

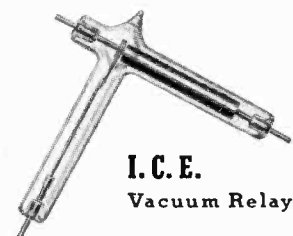

I. C. E.
Vacuum Relay



I. C. E.
Condensators

Sizes VC-12...25...50 and 100

*Laboratory
Standards*



MODEL 62

VACUUM TUBE VOLTMETER

SPECIFICATIONS:

RANGE: Push button selection of five ranges—1, 3, 10, 30 and 100 volts a. c. or d. c.
ACCURACY: 2% of full scale. Useable from 50 cycles to 150 megacycles.
INDICATION: Linear for d. c. and calibrated to indicate r.m.s. values of a sine-wave or 71% of the peak value of a complex wave on a. c.
POWER SUPPLY: 115 volts, 40-60 cycles—no batteries.
DIMENSIONS: 4¾" wide, 6" high, and 8½" deep.
WEIGHT: Approximately six pounds. **PRICE:** \$135.00 f.o.b. Boonton, N. J.

**MEASUREMENTS CORPORATION
BOONTON, NEW JERSEY**

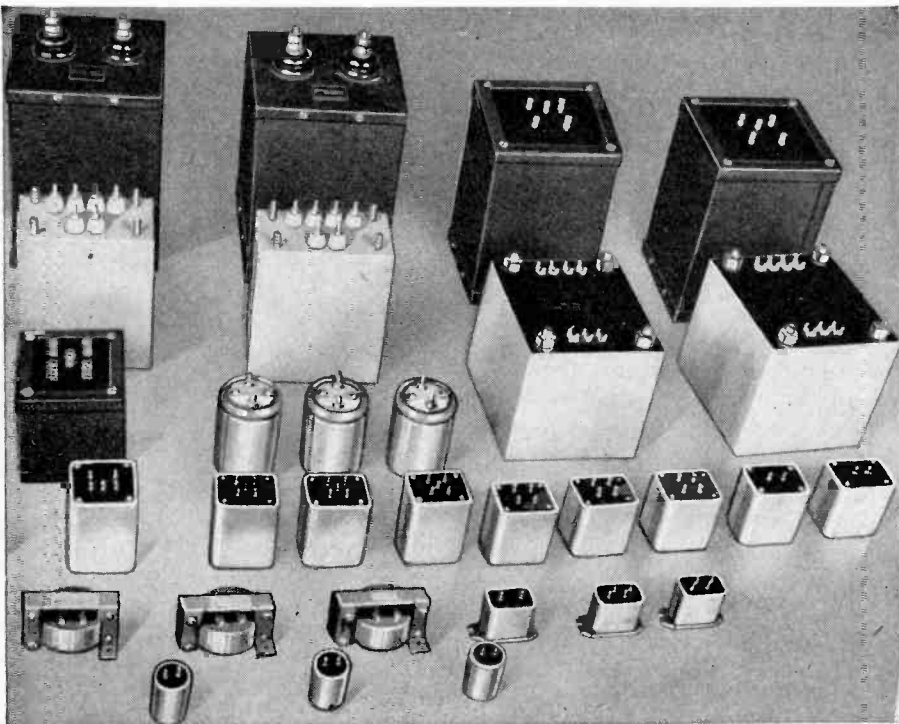

Performance Engineered Electronic Transformers
THE ACME ELECTRIC & MANUFACTURING CO. • CUBA, N. Y. • CLYDE, N. Y.

Acme  **Electric**

*Attention
Associate
Members!*

Many Associate Members can qualify for higher membership grades and should certainly do so. Members are urged to keep membership grade up in pace with their present development.

An Associate over 24 years of age who is occupied as a radio engineer or scientist, and is in this active practice three years may qualify for Member Grade.

An Associate who has taught college radio or allied subjects for three years may qualify.

Some may possibly qualify for Senior Grade. But transfers can be made only upon your application. For fuller details request transfer application-form in writing or by using the coupon below.



Coupon

Institute of Radio Engineers
 330 W. 42nd St.
 New York 18, N.Y. 1-45

Please send me the Transfer Application Membership-Form.

Name

Address

Place

State

Present Grade

"THINKING" MACHINES

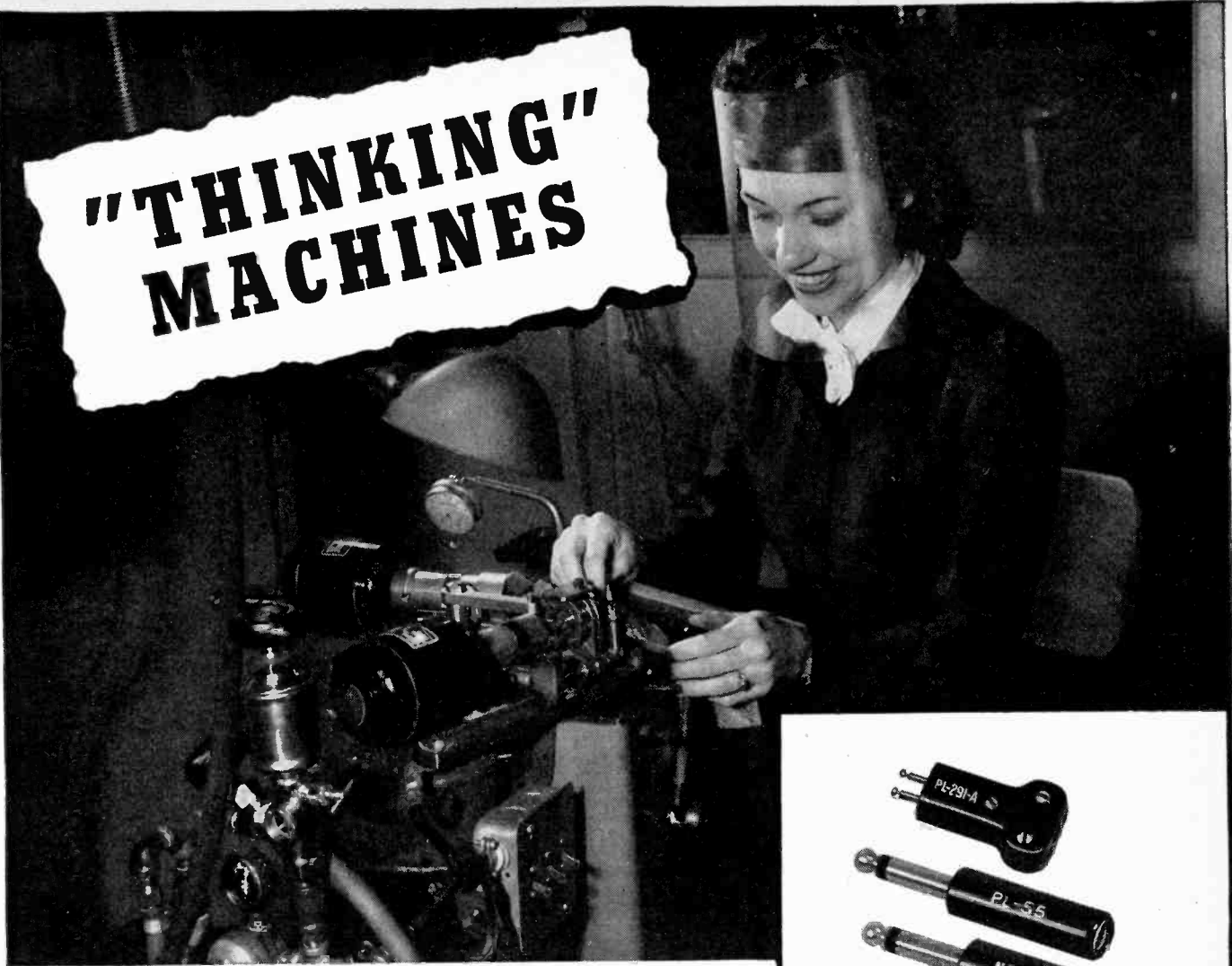

Machine designed by Remler to perform multiple operations: automatic slotting; indexing; drilling; milling and reaming.

REMLER ENGINEERS design and build robots with "brains" to improve production techniques. Ingenious jigs and dies, and in many instances entire machines are constructed to combine intricate operations. These innovations contribute to the precision accuracy of Remler products; release manpower for other tasks; reduce costs and speed up deliveries.

For complete sound transmitting systems; radio; plugs and connectors and other electronic components in metal and plastic, consult . . .

REMLER COMPANY, LTD. • 2101 Bryant St. • San Francisco, 10, Calif.

REMLER

SINCE 1918

Announcing & Communication Equipment



PLUGS & CONNECTORS

Signal Corps • Navy Specifications

Types :		PL			NAF		
50-A	61	74	114	150			
54	62	76	119	159			
55	63	77	120	160		1136-1	
56	64	104	124	291-A			
58	65	108	125	354		No.	
59	67	109	127			212938-1	
60	68	112	149				
		PLP		PLQ		PLS	
56	65	56	65	56	64		
59	67	59	67	59	65		
60	74	60	74	60	74		
61	76	61	76	61	76		
62	77	62	77	62	77		
63	104	63	104	63	104		
64		64					

OTHER DESIGNS TO ORDER

WILEY Books

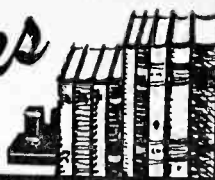

in COMMUNICATIONS-ELECTRONICS

Postwar plans in your field are being made now. Now is the time, then to step up your knowledge. Be ready for new ideas. Look over the important titles listed below. Then, make your selection and order from the coupon today.

FIELDS AND WAVES IN MODERN RADIO

By Simon Ramo and John R. Whinnery

503 Pages \$5.00

Authoritative data on high-frequency circuits, skin effect, shielding problems, problems of wave transmission and reflection, transmission lines and wave guides, cavity resonators, and antennas and other radiating systems—with a rigorous account of the technique of applying field and wave theory to the solution of modern radio problems.

HOW TO PASS RADIO LICENSE EXAMINATIONS—Second Edition

By Charles E. Drew

320 Pages \$3.00

This revised edition of a well-known book offers the most up-to-the-minute material for amateur radio operators, radiotelephone and telegraph operators, whether in the broadcasting, marine, aeronautical, or any other field of transmission or reception.

RADIO RECEIVER DESIGN—Part I

By K. R. Sturley

435 Pages \$4.50

Communications engineers will want to own this book, which covers radio frequency amplification and detection. A detailed study, stage by stage, beginning with the aerial and going as far as the detector.

TIME BASES—(Scanning Generators)

By O. S. Puckle

204 Pages \$2.75

Covers the subject from both the design and the development points of view; assembles more time bases circuits than have heretofore been available in one volume.

THE TECHNIQUE OF RADIO DESIGN

By E. E. Zepler

312 Pages \$3.50

Thoroughly practical, this treatment of radio design deals with the day-to-day problems of the radio engineer, both in the development and in the testing of radio receiving apparatus of all types.

APPLIED ELECTRONICS

By the Electrical Engineering Staff, Massachusetts Institute of Technology

772 Pages \$6.50

Provides a thorough understanding of the characteristics, ratings, and applicability of electronic devices. Gives a working knowledge of the physical phenomena involved in electronic conduction, plus its applications common to various branches of engineering.

HYPER AND ULTRA-HIGH FREQUENCY ENGINEERING

By Robert I. Sarbacher and William A. Edson

644 Pages \$5.50

A practical treatment of an important new branch of communications engineering, requiring no special advanced knowledge. Of value to the beginner, as well as those having some familiarity with the subject.

GUIDE TO CATHODE RAY PATTERNS

By Merwyn Bly

30 Pages \$1.50

Important for technicians and laboratory workers. This book summarizes briefly by means of sketches and captions the cathode-ray pattern types encountered in the usual course of laboratory and test bench work.

FUNDAMENTALS OF ELECTRIC WAVES

By Hugh H. Skilling

186 Pages \$2.75

Discusses the principles of wave action as applied to engineering practice, with particular emphasis on the basic ideas of Maxwell's equations and repeated use in simple examples; also on physical concepts and mathematical rigor.

PRINCIPLES OF ELECTRONICS

By Royce G. Kloeffler

175 Pages \$2.50

Tells clearly and simply the story of electron theory and the operation of the electron tube. Beginning with the discovery of the electron and the forces of attraction and repulsion of charged particles, the entire action taking place in electronic devices is carefully explained.

HIGH FREQUENCY THERMIONIC TUBES

By A. F. Harvey

244 Pages \$3.00

Gives the details of these important new tubes and describes the experimental work that has been done with them. Presents a thoroughly comprehensive account of the properties of thermionic tubes at very high frequencies and their relation to those of the associated electric circuits.



AVAILABLE I.R.E. STANDARDS

- Price
- 1) Standards on Electroacoustics, 1938 \$0.50
Definitions of Terms, Letter and Graphical Symbols, Methods of Testing Loudspeakers. (vi + 37 pages, 6 × 9 inches.)
 - 2a) Standards on Electronics, 1938 \$0.20
Definitions of Terms
 - 2b) Standards on Electronics: Methods of Testing Vacuum Tubes, 1938 \$0.50
 - 3a) Standards on Transmitters and Antennas: Definitions of Terms, 1938 \$0.20
A Reprint (1942) of the like-named section of "Standards on Transmitters and Antennas, 1938." (vi + 8 pages, 8½ × 11 inches.)
 - 3b) Standards on Transmitters and Antennas: Methods of Testing, 1938 \$0.50
A Reprint (1942) of the like-named section of "Standards on Transmitters and Antennas, 1938." (vi + 10 pages, 8½ × 11 inches.)
 - 4a) Standards on Radio Receivers: Definitions of Terms, 1938 \$0.20
A reprint (1942) of the like-named section of "Standards on Radio Receivers, 1938." (vi + 6 pages, 8½ × 11 inches.)
 - 4b) Standards on Radio Receivers: Methods of Testing Broadcast Radio Receivers, 1938 \$0.50
A reprint (1942) of the like-named section of "Standards on Radio Receivers, 1938." (vi + 20 pages, 8½ × 11 inches.)
 - 5) Standards on Radio Wave Propagation: Definitions of Terms, 1942. \$0.20
(vi + 8 pages, 8½ × 11 inches.)
 - 6) Standards on Radio Wave Propagation: Measuring Methods, 1942. \$0.50
Methods of Measuring Radio Field Intensity, Methods of Measuring Power Radiated from an Antenna, Methods of Measuring Noise Field Intensity. (vi + 16 pages, 8½ × 11 inches.)
 - 7) Standards on Facsimile: Definitions of Terms, 1942 \$0.20
(vi + 16 pages, 8½ × 11 inches.)
- ASA STANDARDS**
(Sponsored by the I.R.E.)
- 9) American Standard: Standard Vacuum-Tube Base and Socket Dimensions \$0.20
(ASA C16.2—1939). (8 pages, 7¼ × 10½ inches.)
 - 10) American Standard: Manufacturing Standards Applying to Broadcast Receivers \$0.20
(ASA C16.3—1939). (16 pages, 7¼ × 10½ inches.)
 - 11) American Standard: Loudspeaker Testing 0.25
(ASA C16.4—1942). (12 pages, 7¼ × 10½ inches.)
 - 12) American Standard: Volume Measurements of Electrical Speech and Program Waves \$0.20
(ASA C16.5—1942). (8 pages, 7¼ × 10½ inches.)

Prices are net and include postage to any country. Include remittance with order, and address:

THE INSTITUTE OF RADIO ENGINEERS, Inc.

330 West 42nd Street, New York 18, N.Y.

ON APPROVAL COUPON

JOHN WILEY & SONS, Inc.

440 Fourth Ave., New York 16, N.Y.

Please send me on ten days' approval the books I have checked in this advertisement (or I am attaching to this coupon a separate list of the books desired). At the end of that time, if I decide to keep the books, I will remit indicated price plus postage; otherwise I will return the books postpaid.

Name

Address

City and State

Employed by

I.R.E.-1-45

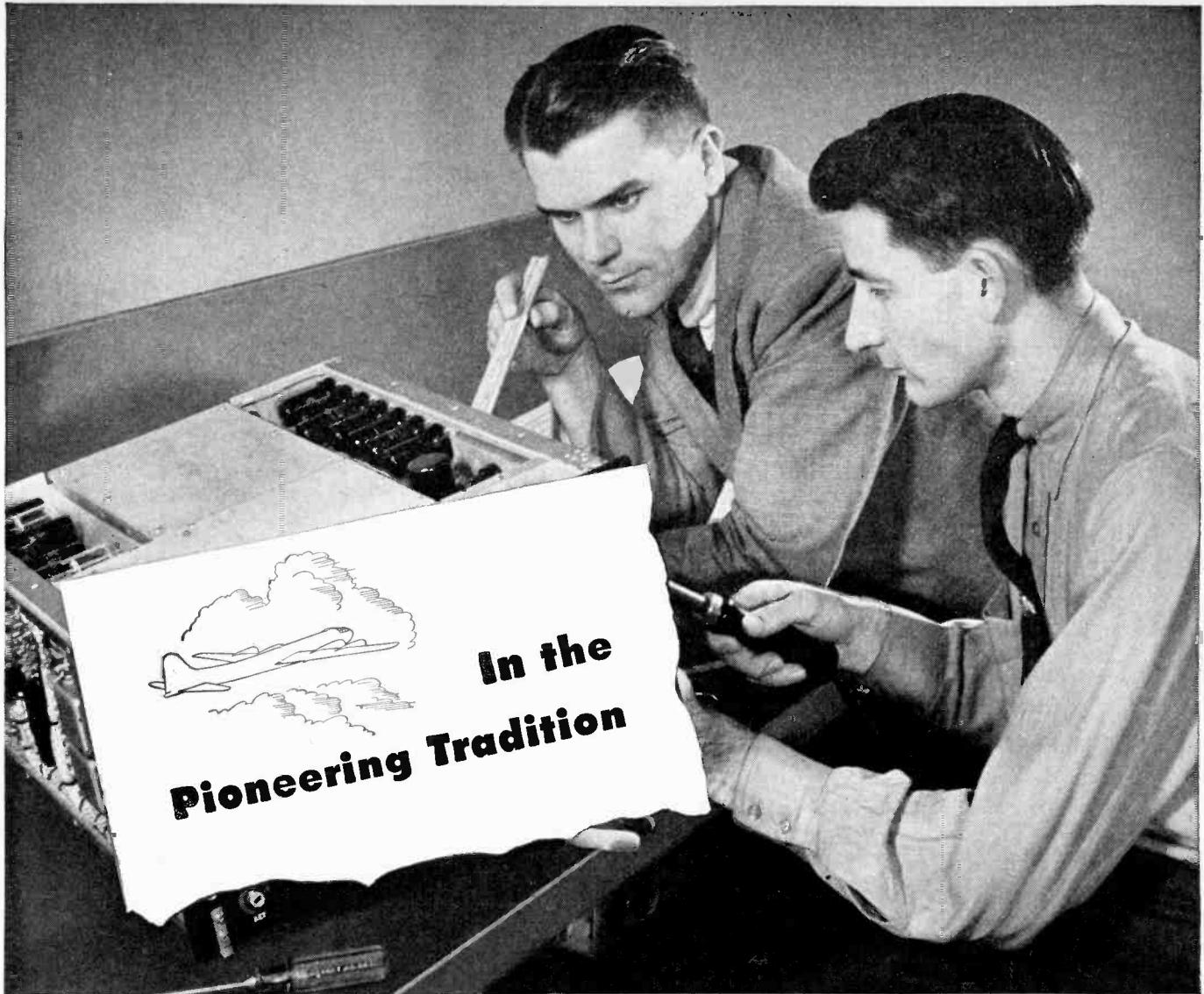

THE COLLINS RADIO organization has always been driven by the urge to pioneer . . .

To introduce professional standards of design and performance in transmitters and receivers for radio hams in the early thirties.

To engineer a radio outfit that stood up to the rough-and-tumble of Admiral Richard E. Byrd's second expedition to Little America.

To take high quality broadcast equipment out of the laboratory and make it economically practicable for any broadcasting station.

To meet the individual requirements of some of our great airlines with specially engineered communication equipment, including the Collins Autotune.*

To be prepared on December 7, 1941, to go into

production of airborne and ground based radio gear of highly advanced design for the Armed Forces—the result of research and development looking years ahead.

Very soon, we hope, this restless Collins urge to pioneer beyond present horizons will be exerting itself again for the airlines and other commercial and private users of radio communication equipment. *Collins Radio Company, Cedar Rapids, Iowa.*

*The Collins Autotune is a repositioning mechanism which quick-shifts all transmitter or receiver controls simultaneously and with extreme precision to any one of a number of pre-determined frequencies. U. S. Patents issued and pending.



IT'S DRY!

— and so is your equipment when it's been pressurized with an **ANDREW DRY AIR PUMP**



Type 876-A

● Dry Air Pumps provide simple, inexpensive source of dehydrated air for your pressurized electronic products. You can avoid component failure due to humidity by enclosing the entire apparatus in an air tight chamber and maintaining dry air pressure.

FOR DETAILED INFORMATION
WRITE FOR BULLETIN No. 30

For air-borne equipment, too! Condenser plates will not spark over at high altitudes if the apparatus is pressurized with dry air, because then moisture condensation is no longer a problem.

ANDREW CO.

363 East 75th Street
Chicago 19, Illinois



ARPIN

RECTIFIERS

MERCURY VAPOR
HALF WAVE
575-A
FOR HIGH VOLTAGE

for

- HIGH POWER TRANSMITTERS
- INDUCTION HEATING EQUIPMENT
- SPECIAL INDUSTRIAL APPLICATIONS

WE SPECIALIZE IN INDUCTION HEATING APPLICATIONS

575-A is a heavy-duty half-wave rectifier tube of exceptional performance. Filament of edge-wise wound ribbon of a new alloy, giving greater thermionic emission reserve. No arc-back at full rating. Used by Signal Corps and many large manufacturers. Two tubes for full-wave rectification in single phase circuits deliver 5000 volts DC at 3 amps, with good regulation. Filament 5 volts, 10 amps. Peak Plate Current 6 amps. Peak inverse Voltage 15,000 volts.

WRITE FOR NEW CATALOG illustrating and describing the above rectifier and other ARPIN Tubes.

ARPIN MANUFACTURING CO.
422 Alden St. Orango, N.J.

HIGH "Q" for MIDGETS

Available in DX Isoso-Loops



During peacetime, as the World's largest loop aerial manufacturers, our job was to build the highest "Q" loop for every size and kind of radio receiver. If you make midgets you get the same DX Isoso-loop quality that goes into the large consoles. All of our present day efforts are devoted to making DX Xtals but we would like to discuss your post war receiver plans with you.

DX CRYSTAL CO.

GENERAL OFFICES: 1200 N. CLAREMONT AVE., CHICAGO 22, ILL., U.S.A.



PLATINUM and PLATINUM ALLOYS . . .

SHEET
WIRE
TUBING

For all Electronic Applications

Platinum metals scrap and residues refined and re-worked on toll charges; or purchased outright by us . . .

Write for list of Products. Discussion of technical problems invited

SIGMUND COHN & CO.

44 GOLD ST. NEW YORK
SINCE 1901

Skilled hands seal-in the original precise characteristics of Hammarlund variable capacitors so that moisture and vibration can not change them — even after long periods of operation in all sorts of climates and under varied working conditions.

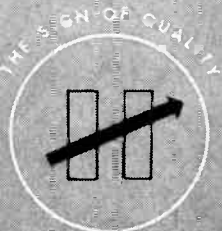

ESTABLISHED 1910

HAMMARLUND

THE HAMMARLUND MFG. CO., INC., 460 W. 34TH ST., N. Y. C.
MANUFACTURERS OF PRECISION COMMUNICATIONS EQUIPMENT



INDEX

Section Meetings	34A
Membership	36A
Positions Open	50A

DISPLAY ADVERTISERS

Acme Electric & Manufacturing Co.	66A
Aerovox Corp.	19A
Aireon Manufacturing Corp.	41A
Alliance Manufacturing Co.	34A
Allied Radio Corp.	44A
Altec Lansing Corp.	49A
American Lava Corp.	12A
American Telephone & Telegraph Co.	20A
American Transformer Co.	9A
Amperex Electronic Corp.	Cover II
Andrew Co.	70A
Arnold Engineering Co.	49A
Arpin Manufacturing Co.	70A
Barker & Williamson	47A
Blaw-Knox	46A
Centralab	31A
Chicago Transformer Corp.	48A
Claroat Mfg. Co., Inc.	60A
Sigmund Cohn & Co.	70A
Collins Radio Co.	69A
Communication Products Co., Inc.	54A
Communications Co., Inc.	72A
Connecticut Telephone & Elec. Div.	39A
Continental-Diamond Fibre Co.	57A
Continental Electric Co.	35A
Cornell-Dubilier Electric Corp.	Cover III
Corning Glass Works	37A
Coto-Coil Co., Inc.	42A
DeJur-Amsco Corp.	61A
Toke Deutschmann Corp.	73A
Doollittle Radio, Inc.	64A
Allen B. DuMont Labs., Inc.	63A
DX Crystal Co.	70A

Eicor Inc.	40A
Eitel-McCullough, Inc.	74A
Electronic Laboratories, Inc.	3A
Electronic Mechanics, Inc.	24A
Electro-Voice Corp.	28A
Federal Telephone & Radio Corp.	43A
Gates Radio Co.	60A
General Aniline Works	4A, 5A
General Instrument Corp.	27A
General Radio Co.	Cover IV
Gray Manufacturing Co.	50A
Guardian Electric Mfg. Co.	17A
Hallcrafters Co.	45A
Hammarlund Mfg. Co., Inc.	71A
Harco Steel Construction Co.	56A
Harvey Radio Laboratories, Inc.	33A
Harvey-Wells Electronics Inc.	53A
Hazeltine Corp.	50A
Heintz & Kaufman, Ltd.	55A
Hewlett-Packard Co.	15A
Hollister Crystal Co.	64A
Hytron Corp.	21A
Industrial & Commercial Electronics	65A
Industrial Condenser Corp.	38A
International Resistance Co.	11A
International Telephone & Telegraph Corp.	43A
E. F. Johnson Co.	25A
Kenyon Transformer Co., Inc.	51A
John E. Lingo & Son, Inc.	36A
Maguire Industries, Inc.	52A
Measurements Corp.	66A
Merit Coil & Transformer Corp.	72A
National Co.	10A
New York Transformer Co.	64A
North American Philips Co., Inc.	13A
M. F. M. Osborne Associates	72A

Peerless Electrical Products Co.	60A
Permoflux Corp.	58A
Pratt & Whitney Aircraft	52A
Premax Products	62A
Radio Corp. of America, RCA Victor Div.	6A, 7A, 32A
Rauland Corp.	30A
Remler Co., Ltd.	67A
Rola Co., Inc.	54A
Sola Electric Co.	14A
Sprague Electric Co.	26A
Stackpole Carbon Co.	18A
Standard Transformer Corp.	62A
Stromberg-Carlson Co.	52A
Stupakoff Ceramic & Mfg. Co.	22A
Submarine Signal Co.	50A
Sun Radio & Electronics Co.	56A
Templetone Radio Mfg. Corp.	56A
United Electronics Co.	16A
United Transformer Co.	29A
Universal Microphone Co.	59A
Utah Radio Products Co.	8A
Max van Pels	54A
Western Electric Co.	52A
Wilcox Electric Co.	23A
John Wiley & Sons, Inc.	68A

M. F. M. Osborne Associates
Consulting Physicists
 Mathematical Analysis of Physical Problems, Higher Mathematics, Approximations, Electronic Design, Fluid Dynamics, Mechanics, Electromagnetic and Acoustic Wave Propagation, Literature Surveys, Reports.
 703 Albee Bldg., Washington 5, D.C.
 Telephone District 2415

PRODUCTS OF MERIT SHARE IN THIS RECOGNITION



Merit Coil and Transformer Corporation is proud of this U.S. Navy Certificate of Achievement, awarded to us as part of Radar-Radio Industries of Chicago, Inc.

With highly skilled workers and the most modern equipment for manufacturing in accordance with the latest trends in radar-radio production and assembly, Merit has specialized in specific transformer applications for widely varying fields, climates and altitudes.

These same facilities and broad experience are available now for development of your post-war products.

Your inquiries will have prompt attention.



MERIT COIL & TRANSFORMER CORP.

4427 North Clark St. CHICAGO 40, ILL.



DESIGNERS AND MANUFACTURERS OF HIGH FREQUENCY TRANSMITTERS and RECEIVERS



*For Airlines
Police and
Fire
Departments*

Comco Model 170 VHF Transmitter Range 100-150 Mc.

A 50-watt, self-contained unit, designed especially for airport traffic control and aeronautical service; also practical for police, fire department and fleet dispatching service.

Matching receivers, rack-type for ground use, or compact equipment for installation on mobile units, as well as transmitters of other types, are part of Comco models. Write for complete details. Special units engineered and built to order—send us your specifications.

COMMUNICATIONS COMPANY, INC.

CORAL GABLES 34, FLORIDA

LONG LIFE

is built into every

Tobe Capacitor



In War, Long Life Saves Lives
 In Peace, Long Life Saves Customers



SPECIFICATIONS OF JUST ONE TYPE OF THE MANY TOBE OIL-IMPREGNATED AND OIL-FILLED PAPER CAPACITORS...

OM-CAPACITORS

TYPE	OM-*
RATINGS	.05 to 2.0 mfd. 600 V.D.C. .05 mfd. to 1.0 mfd. 1,000 V.D.C.
STANDARD CAPACITY TOLERANCE	20%**
TEST VOLTAGE	Twice D. C. rating
GROUND TEST	2,500 Volts D. C.
OPERATING TEMPERATURE	-55° F to 185° F
SHUNT RESISTANCE	.05 to 0.1 mfd. 20,000 megohms .25 to 0.5 mfd. 12,000 megohms 1.0 to 2.0 mfd. 12,000 megohms
POWER FACTOR	At 1,000 cycles—.002 to .005
CONTAINER SIZE	Width 3/8", length 1-5/16", height 2 3/4"
MOUNTING HOLE CENTERS	1 1/2"

MIDGET OM-CAPACITORS

TYPE	OMM.*
RATINGS	.05, .1 and 2 x .05 600 V.D.C. .05 x .1 1,000 V.D.C.
STANDARD CAPACITY TOLERANCE	20%**
GROUND TEST	2,500 V.D.C.
OPERATING TEMPERATURES	-55° F to 185° F
SHUNT RESISTANCE	20,000 megohms
POWER FACTOR	At 1,000 cycles—.0075
CONTAINER SIZE	Width 3/8", length 1-5/16", height 1-11/64"
MOUNTING HOLE CENTERS	1 1/2"

*Data sheets showing complete code number for units having a specific capacitance value and voltage rating available on request. **Other tolerances available.

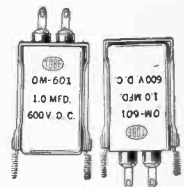

This new separate mounting is stronger and helps prevent leaks caused by breaks in can. This outstanding Tobe design takes the minimum amount of space.

A SMALL PART IN VICTORY TODAY... A BIG PART IN INDUSTRY TOMORROW

Eimac "X" Grid

Solves grid emission problem!

Grid emission, with the resulting instability of operation, parasitic oscillations and prematurely burned out filaments, has become a thing of the past. The new Eimac "X" grid will not emit electrons even when operated at incandescent heat.

The solution to the problem of grid emission lifts a great barrier which has long stood in the path of electron vacuum tube development and the progress of electronics. Eimac Engineers in developing the "X" grid have made a real contribution . . . and a very important one . . . toward the development of new and more efficient vacuum tubes. It is such heads-up Engineering that has made Eimac first choice of leading electronic engineers throughout the world . . . and maintained them in that position year after year.



Follow the leaders to

Eimac REG. U. S. PAT. OFF.
TUBES

ELECTRONIC
TELESIS

The layman's handbook of Electronics will be sent you upon request without cost or obligation.

EITEL-McCULLOUGH, INC., 874 San Mateo Avenue, SAN BRUNO, CALIF.
Plants located at: San Bruno, California and Salt Lake City, Utah

Export Agents: FRAZAR & HANSEN, 301 Clay St., San Francisco 11, Calif., U.S.A.

The Science Behind the Science of Electronics

the focusing of all branches of science upon the development and improvement of electron vacuum tubes.



PHYSICS... Especially designed electron microscope enables operator actually to view electron emission.



OPTICS... Photomicrographic studies help achieve perfection in processing.



POWDER METALLURGY... Compounding special alloys.



CHEMISTRY... Experimentation with metallic components and preparation of chemical compounds.

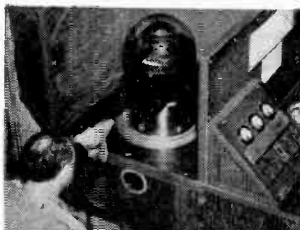

THERMO-DYNAMICS... Vacuum furnaces heat materials to exceedingly high temperatures.



ELECTRONICS... Determining facts about and recording data on vacuum tube capabilities.



The train of events leading to Victory is speeding right into Tokyo and Berlin . . . and many of the deciding factors may be traced back to the service of skilled hands on the home front.

Here at Cornell-Dubilier skills handed down from mother to daughter as well as from father to son have helped to bring Victory nearer. Some of our workers have been with C-D almost as long as modern capacitors have been in existence. Others are proud—as we are—of their five, ten and twenty years with C-D.

C-D's expanded production facilities and expert workmanship are at your service. Write us for further information. Cornell-Dubilier Electric Corp., South Plainfield, N. J.



TYPE 6 Medium Power Mica Transmitter Capacitor. Designed for a wide variety of r. f. applications where size and weight must be kept to a minimum. Patented series mica construction; vacuum impregnated—resulting in low loss, high insulation—no air voids; special low-loss filler reduces stray losses.

CORNELL-DUBILIER
CAPACITORS 1910  1944

MICA • DYKANOL • PAPER • WET AND DRY ELECTROLYTICS

ALSO AT NEW BEDFORD, BROOKLINE, WORCESTER, MASS.; PROVIDENCE, R. I.

IN A BUTTERFLY CIRCUIT

$$L = 2.12r \left(\ln \frac{36r}{t + w} - 2 \right) \text{ centimeters}$$

If you haven't seen these plates before, you may think them the futuristic effort of a designer on the day after the night before. Actually they represent some of the steps in the development of an entirely new circuit for ultra-high-frequency use.

The problem of designing a compact ultra-high-frequency circuit with a large and continuously-adjustable range, and with no sliding contacts, is a difficult one.

Transmission lines, with none of these desirable features, have been used widely in the past. They offer numerous mechanical difficulties, very precise machine work being required to obtain acceptable accuracy. In addition, very often they are too large to be incorporated in many instruments.

The new circuits, developed by General Radio, are for obvious reasons called Butterfly Circuits. They have no sliding contacts, afford a tuning ratio of about 4 to 1, are very compact, can be designed for a satisfactory value of Q, and are mechanically comparatively simple.

The design of Butterfly Circuits is described in detail in the October 1944 issue of the *G-R Experimenter*. If you haven't seen a copy, we'd like to send you one.



WRITE FOR BULLETIN 914



GENERAL RADIO COMPANY Cambridge 39, Massachusetts
NEW YORK CHICAGO LOS ANGELES