

Proceedings



of the

I·R·E

Joseph Stue

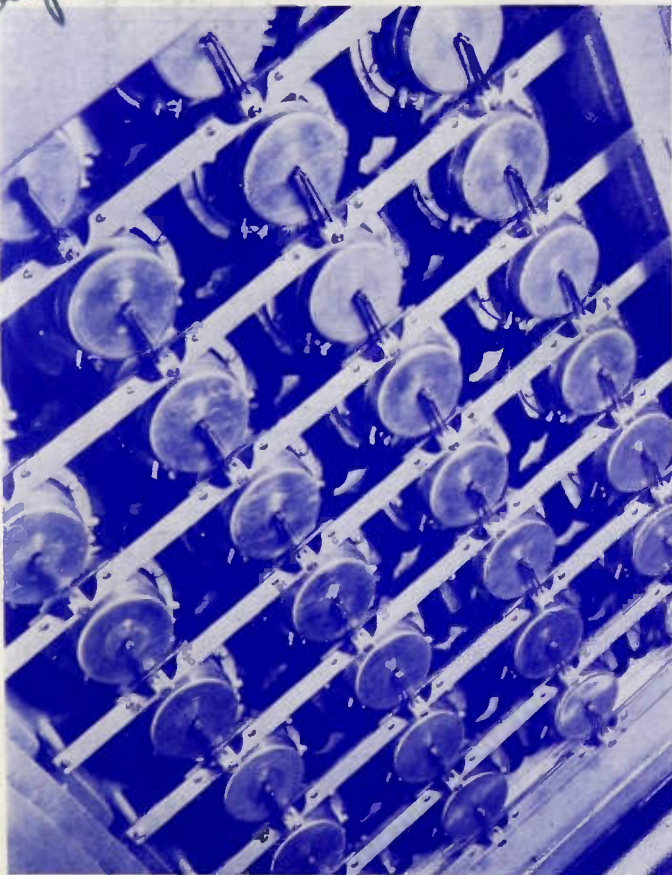

"MUSA"

Bell Telephone Laboratories, Inc.

Phase shifters for multiple-unit steerable rhombic antennas used for controllably directional short-wave transatlantic radiotelephony.

APRIL, 1944

VOLUME 32 NUMBER 4

Scope of the Institute

Generating Circular Traces

Quartz-Crystal Cuts

Studies of Magnetrons

Loop-Antenna Errors

Wave-Reflection Analogies

Institute of Radio Engineers

Can YOU use this



VARIABLE INDUCTOR

Culminating a number of years of research, the UTC Variable inductor is an ideal tunable device for peaked amplifiers, filters, etc. This sealed unit measures 1 1/4" x 1 7/16" x 1 7/16". Available in inductance value from 10 Mhy. to 10 Hys.

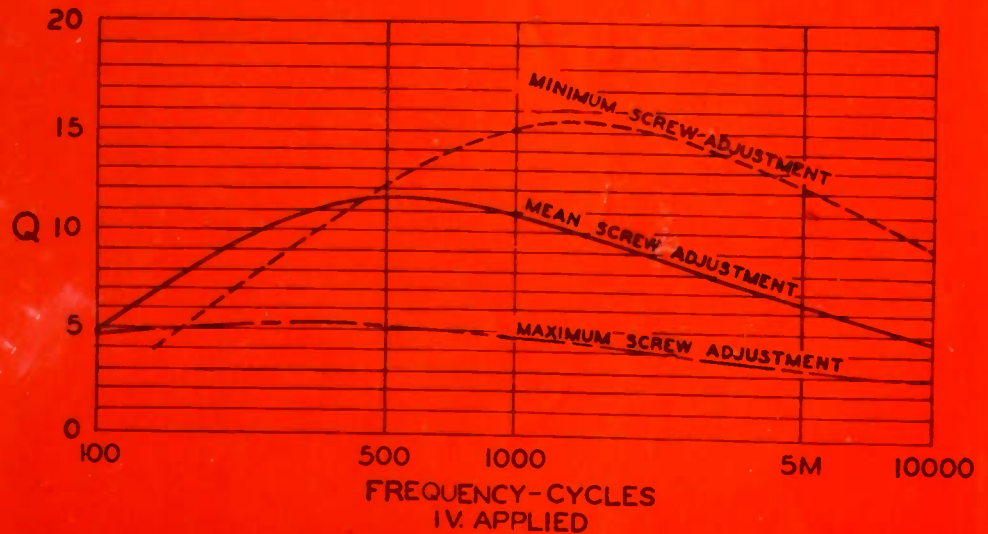
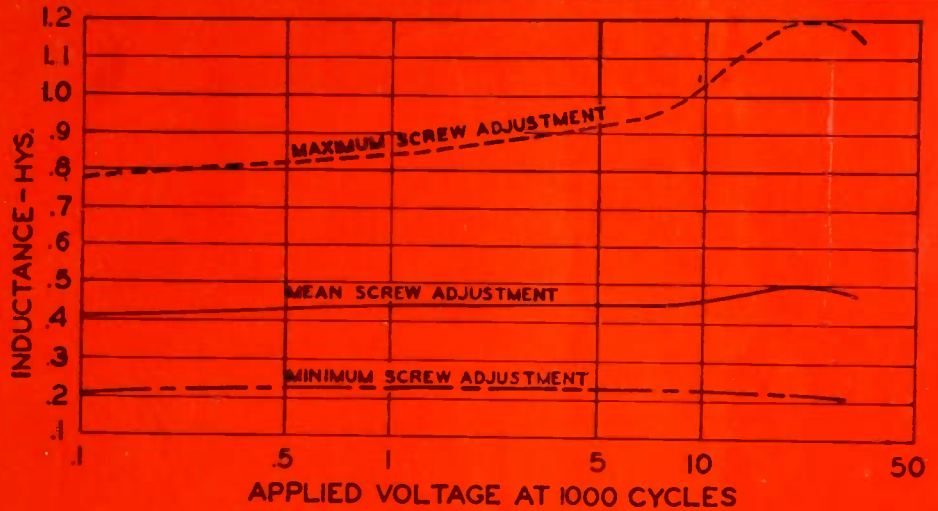
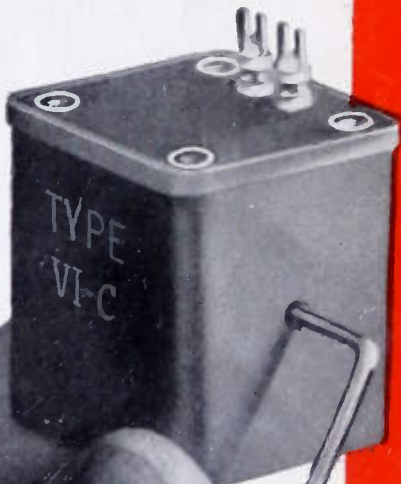

United Transformer Co.

150 VARICK STREET

NEW YORK 13, N. Y.

EXPORT DIVISION: 13 EAST 40th STREET, NEW YORK 16, N. Y., CABLES: "ARLAB"

BOARD OF DIRECTORS
1944

- Hubert M. Turner
President
- Ralph A. Hackbusch
Vice President
- Raymond A. Heising
Treasurer
- Haraden Pratt
Secretary
- Alfred N. Goldsmith
Editor
- Stuart L. Bailey
Wilmer L. Barrow
E. Finley Carter
dolph B. Chamberlain
Ivan S. Coggeshall
William L. Everitt
Raymond F. Guy
Lawrence C. F. Horle
Charles B. Jolliffe
Frederick B. Llewellyn
Herbert J. Reich
Crowder J. Thompson
Arthur F. Van Dyck
Harold A. Wheeler
Lynde P. Wheeler
William C. White

Harold R. Zeamans
General Counsel

BOARD OF EDITORS

- Alfred N. Goldsmith
Editor
- Ralph R. Batcher
Robert S. Burnap
Philip S. Carter
Lewis M. Clement
Maurice Deloraine
Olmer W. Engstrom
William L. Everitt
George W. Gilman
Peter C. Goldmark
Frederick W. Grover
Lewis B. Headrick
C. M. Jansky, Jr.
John D. Kraus
Donald G. Little
Frederick B. Llewellyn
Emuel S. Mackeown
Edward L. Nelson
Harry F. Olson
Cenleaf W. Pickard
Ralph A. Powers
Haraden Pratt
Conan A. Priest
Herbert J. Reich
V. W. Sherman
Lynne C. Smeby
E. C. Wente
Harold A. Wheeler
Loren E. Whittemore
Gerald W. Willard
William Wilson
Charles J. Young
Vladimir K. Zworykin

Proceedings

of the I·R·E

Published Monthly by
The Institute of Radio Engineers, Inc.

VOLUME 32 *April, 1944* NUMBER 4

Creative Radio Research Workers—Their Opportunities and Obligations	E. A. Nicholas	187
Haraden Pratt		188
The Scope of the Institute	L. P. Wheeler	189
Television Broadcast Coverage	Allen B. DuMont and Thomas T. Goldsmith, Jr.	192
Circuit for Generating Circular Traces of Different Frequencies on an Oscillograph	W. D. Hershberger	205
Low-Frequency Quartz-Crystal Cuts Having Low Temperature Coefficients	W. P. Mason and R. A. Sykes	208
Practical Results from Theoretical Studies of Magnetrans	Leon Brillouin	216
Note on the Bearing Error and Sensitivity of a Loop Antenna in an Abnormally Polarized Field	F. S. Howes and F. M. Wood	231
Transmission-Line Analogies of Plane Electromagnetic-Wave Reflections	Arthur Bronwell	233
Institute News and Radio Notes		241
Board of Directors		241
Executive Committee		242
Montreal Petition		243
Book Preview:		
"Radio Direction Finders," by Donald S. Bond	H. A. Wheeler	243
Books:		
"Time Bases," by O. S. Puckle	A. V. Bedford	243
"Electron-Optics," by Paul Hatschek (Translated by Arthur Palme)	James Hillier	244
"Communication Circuits," by L. A. Ware and N. R. Reed	Frederick W. Grover	244
"Fundamentals of Telephony," by Arthur L. Albert	H. A. Affel	244
Institute Committees—1944		245
Institute Representatives on Other Bodies—1944		246
Institute Representatives in Colleges—1944		247
Contributors		247
Section Meetings		250, 34A
Membership		36A
I.R.E. People		44A
No "Victory" Models from the Radio Industry by Paul V. Galvin		46A
Positions Open		50A
Advertising Index		62A

Responsibility for the contents of papers published in the PROCEEDINGS rests upon the authors. Statements made in papers are not binding on the Institute or its members.



Entered as second-class matter October 26, 1927, at the post office at Menasha, Wisconsin, under the Act of February 28, 1925, embodied in Paragraph 4, Section 538 of the Postal Laws and Regulations. Publication office, 450 Ahnaip Street, Menasha, Wisconsin. Editorial and advertising offices, 330 West 42nd St., New York 18, N. Y. Subscription \$10.00 per year; foreign, \$11.00.

Copyright, 1944, by The Institute of Radio Engineers, Inc.

PAPERS COMMITTEE

- Frederick B. Llewellyn
Chairman
- Herman A. Affel
Wilmer L. Barrow
Howard A. Chinn
James K. Clapp
Ivan S. Coggeshall
Frederick W. Cunningham
Robert B. Dome
William G. Dow
Enoch B. Ferrell
Donald G. Fink
H. S. Frazier
Frederick W. Grover
O. B. Hanson
John V. L. Hogan
Frederick V. Hunt
Harley Iams
Loren F. Jones
John G. Kreer, Jr.
Emil Labin
Frederick R. Lack
Hugo C. Leuteritz
De Loss K. Martin
Knox McIlwain
Harry R. Mimno
Ilia E. Mouromtseff
G. G. Muller
Albert F. Murray
Harold O. Peterson
A. F. Pomeroy
Jack R. Popple
Simon Ramo
Francis X. Rettenmeyer
Peter C. Sandretto
Sergei A. Schelkunoff
Donald B. Sinclair
Karl Spangenberg
Hubert M. Turner
Dayton Ulrey
Karl S. Van Dyke
William C. White
Irving Wolff
J. Warren Wright
Harold R. Zeamans

PAPERS PROCUREMENT COMMITTEE

- Dorman D. Israel
General Chairman
- William L. Everitt
Vice Chairman

GROUP CHAIRMEN

- Jesse E. Brown
Edward J. Content
Harry Diamond
Edward T. Dickey
Carl J. Madsen
Dan H. Moore
Harold A. Wheeler
William C. White

- Helen M. Stote
Associate Editor
- William C. Copp
Advertising Manager
- William B. Cowilich
Assistant Secretary

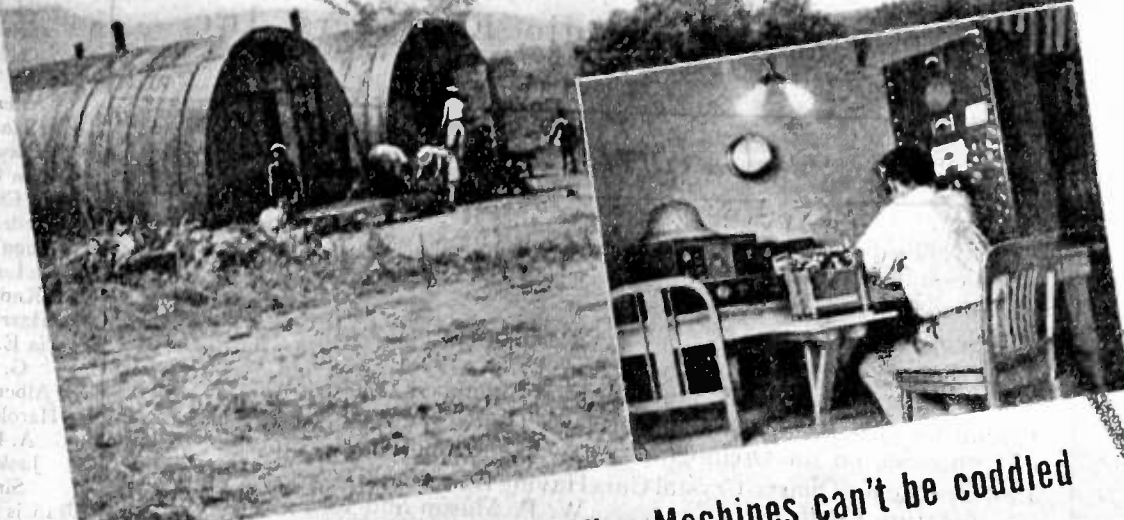

Where Office Machines can't be coddled
Underwood's the choice...



—From Remote African Base Pan
 American World Airways reports Hardihood of
 Underwood Equipment.

No Casualties Permitted—Unlike the
 cities where service facilities
 are, even in wartime
 such remote

vacations, they have required remarkably
 little special attention.

**THIS GOES FOR
 RADIO RECEIVERS,
 TOO**

It's an old tradition for National equipment to do the
 tough jobs at inaccessible outposts. Long before the war,
 National receivers had already become the first choice of
 expeditions to the far corners of the earth.

Pan American has long used National equipment, and
 many years of experience with the ruggedness and depend-
 ability of National receivers were back of Pan American's
 choice in the picture shown above.

NATIONAL COMPANY, INC., MALDEN, MASS.





Accurately MAINTAINED CAPACITANCE

over temperature range between
-40° C. to +70° C.

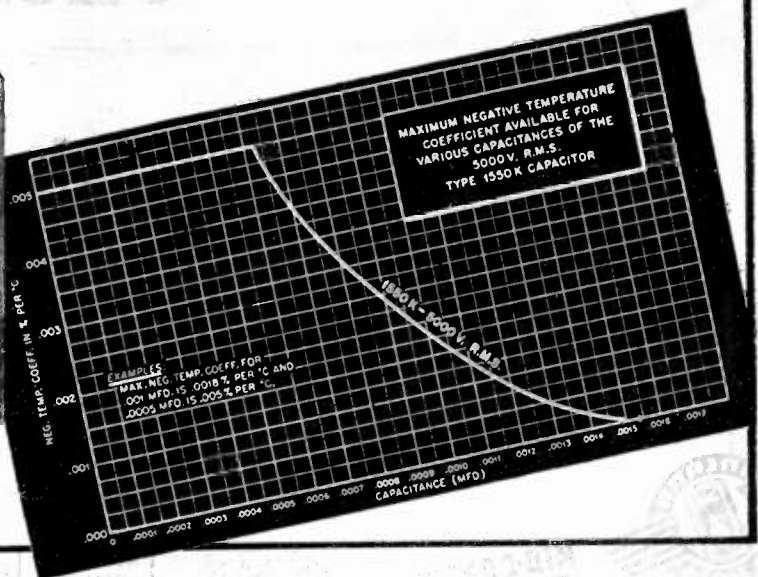
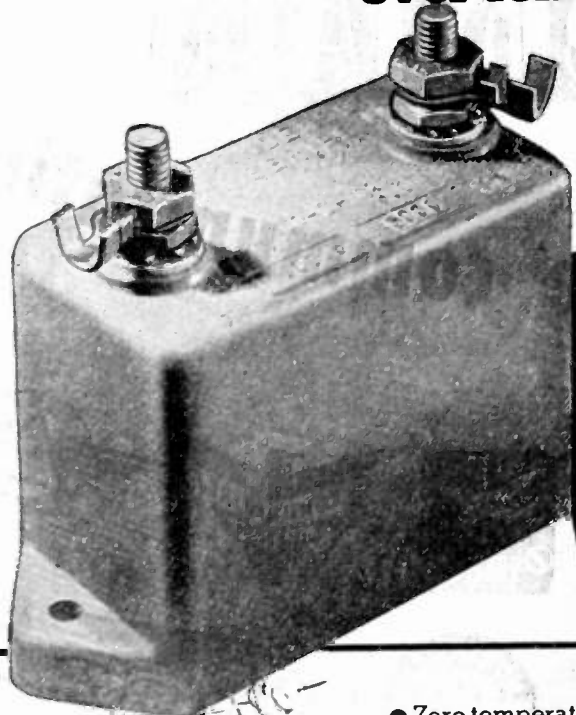

Type K compensating capacitors are supplied only in low-loss (yellow) XM bakelite cases. Sealed for immersion.

Available in limited range of capacitances and voltage ratings as listed in latest catalog.

Obtainable in any temperature co-efficient from $-.005\%$ to $+.005\%$ per degree C. over temperature range from -40°C. to $+70^{\circ}\text{C.}$

Standard tolerance is plus/minus 5%. Closer tolerances obtainable at extra cost. Minimum tolerance available is plus/minus 2% or 2 mmf., whichever is greater.

Can be used to correct normally positive temperature co-efficient of inductances for maintenance of constant LC products (resonant frequency) of tuned circuits independent of temperature.

● Zero temperature co-efficient capacitors can be used wherever a capacitance independent of temperature is required. Furthermore, since Aerovox Type K compensating capacitors are also available in any temperature co-efficient from $-.005\%$ to $+.005\%$ per degree C., various circuits can be developed or refined to utilize the negative, zero or positive temperature co-efficients of such compensating capacitance. Examples:

One suggested application is as a shunt for the measurement of r.f. currents with a vacuum-tube voltmeter as the indicating instrument.

Compensating capacitors may be

used in radio range beacons where it is essential to maintain uniform currents both in magnitude and phase relationship simultaneously in several circuits, regardless of wide temperature changes,

By the use of compensating capacitors it is feasible to obtain oscillator frequency stability comparable with that obtained from quartz crystals, and with marked economies in weight, space, cost.

Therefore, when you face the problem of maintaining constant operational characteristics despite temperature variations, just specify Aerovox Type K compensating capacitors.

● **WRITE FOR LITERATURE...**

Aerovox Type K compensating capacitor curves, technical details and listings, are included in the new Aerovox Capacitor Manual. Write on your business stationery, for your copy.



Capacitors

INDIVIDUALLY TESTED

AEROVOX CORPORATION, NEW BEDFORD, MASS., U. S. A. SALES OFFICES IN ALL PRINCIPAL CITIES
 Export: 13 E. 40 ST. NEW YORK 16, N. Y. • Cable: 'ARLAB' • In Canada: AEROVOX CANADA LTD., HAMILTON, ONT.

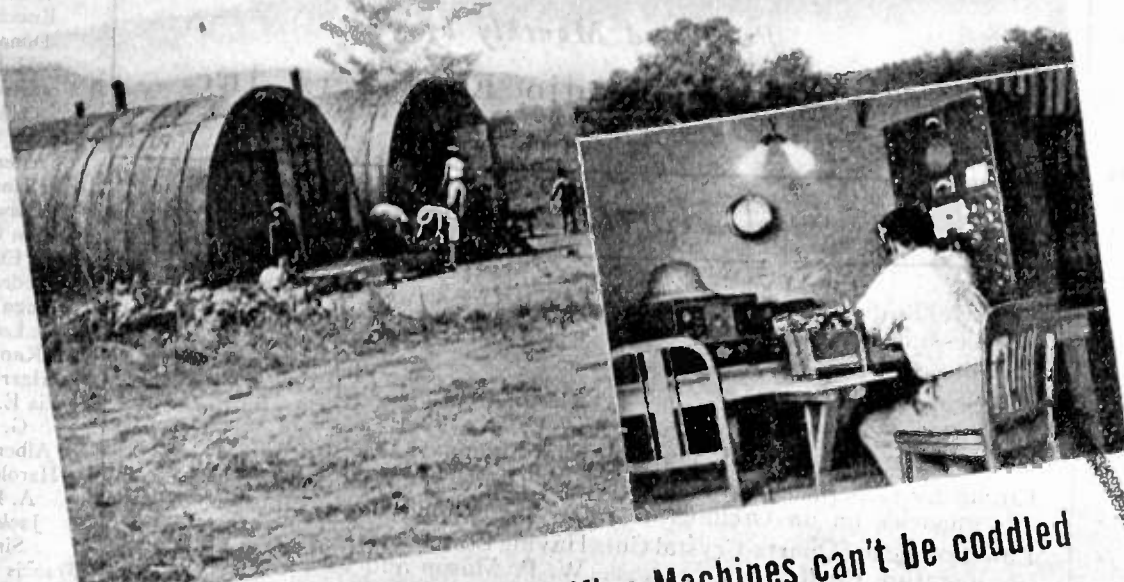

Where Office Machines can't be coddled
Underwood's the choice . . .



—From Remote African Base Pan American World Airways reports Hardihood of Underwood Equipment.

No Casualties Permitted—Unlike the outposts of other airlines, such remote cities where service facilities are, even in wartime

vacations, they have required remarkably little special attention.

**THIS GOES FOR
 RADIO RECEIVERS,
 TOO**

It's an old tradition for National equipment to do the tough jobs at inaccessible outposts. Long before the war, National receivers had already become the first choice of expeditions to the far corners of the earth.

Pan American has long used National equipment, and many years of experience with the ruggedness and dependability of National receivers were back of Pan American's choice in the picture shown above.

NATIONAL COMPANY, INC., MALDEN, MASS.





Accurately MAINTAINED CAPACITANCE

over temperature range between

-40° C. to +70° C.

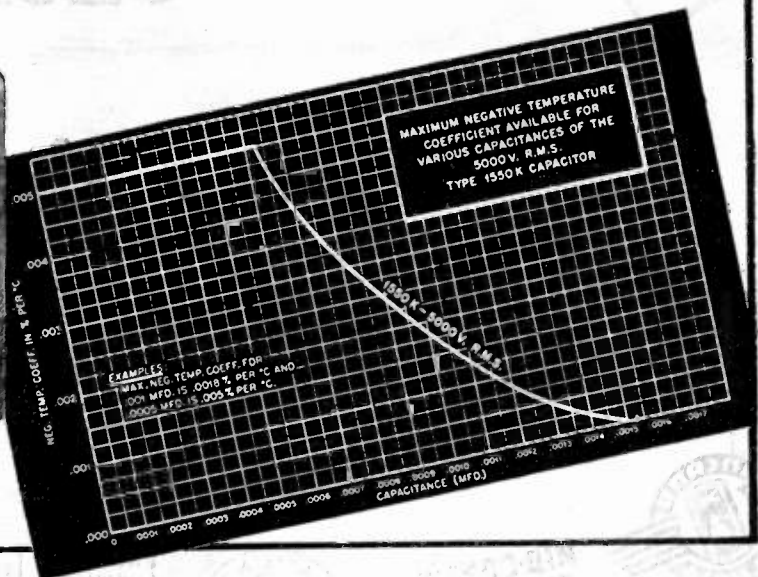
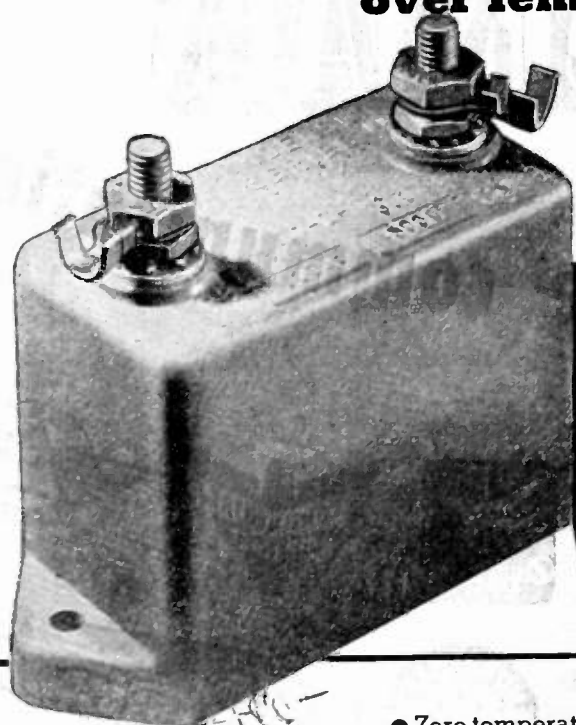

Type K compensating capacitors are supplied only in low-loss (yellow) XM bakelite cases. Sealed for immersion.

Available in limited range of capacitances and voltage ratings as listed in latest catalog.

Obtainable in any temperature co-efficient from $-.005\%$ to $+.005\%$ per degree C. over temperature range from -40°C. to $+70^{\circ}\text{C.}$

Standard tolerance is plus/minus 5%. Closer tolerances obtainable at extra cost. Minimum tolerance available is plus/minus 2% or 2 mmil., whichever is greater.

Can be used to correct normally positive temperature co-efficient of inductances for maintenance of constant LC products (resonant frequency) of tuned circuits independent of temperature.

● Zero temperature co-efficient capacitors can be used wherever a capacitance independent of temperature is required. Furthermore, since Aerovox Type K compensating capacitors are also available in any temperature co-efficient from $-.005\%$ to $+.005\%$ per degree C., various circuits can be developed or refined to utilize the negative, zero or positive temperature co-efficients of such compensating capacitance. Examples:

One suggested application is as a shunt for the measurement of r.f. currents with a vacuum-tube voltmeter as the indicating instrument.

Compensating capacitors may be

used in radio range beacons where it is essential to maintain uniform currents both in magnitude and phase relationship simultaneously in several circuits, regardless of wide temperature changes.

By the use of compensating capacitors it is feasible to obtain oscillator frequency stability comparable with that obtained from quartz crystals, and with marked economies in weight, space, cost.

Therefore, when you face the problem of maintaining constant operational characteristics despite temperature variations, just specify Aerovox Type K compensating capacitors.

● WRITE FOR LITERATURE...

Aerovox Type K compensating capacitor curves, technical details and listings, are included in the new Aerovox Capacitor Manual. Write on your business stationery, for your copy.



Capacitors

INDIVIDUALLY TESTED

AEROVOX CORPORATION, NEW BEDFORD, MASS., U. S. A. SALES OFFICES IN ALL PRINCIPAL CITIES
 Export: 13 E. 40 ST., NEW YORK 16, N. Y. • Cable: 'ARLAB' • In Canada: AEROVOX CANADA LTD., HAMILTON, ONT.

AAC

Quartz

CRYSTALS

help keep the communications



Today..and Tomorrow
Illustrated at right is a typical crystal manufactured by Aircraft Accessories Corporation and used in both ground and plane radio installations by America's commercial airlines. Many other types of AAC crystal units are being supplied various branches of the armed service and other government agencies.

Today, practically all AAC facilities are devoted to war production. Tomorrow, advanced AAC electronic developments will be available for the post-war world.



Products



AIRCRAFT

Manufacturers of PRECISION
Burbank, Calif.

systems of the World's Greatest Airlines Working Efficiently!

REALIZING the extreme importance placed by the airlines upon the proper maintenance of their communications facilities, Aircraft Accessories Corporation has set aside a special division of its crystal laboratories to provide rapid delivery to airlines and associated communications services of a variety of standard crystals. Deliveries in limited quantities can be made within a few days after receipt of purchase order with adequate priority.

In the manufacture of quartz crystals, AAC development and production engineers employ the experience gained as one of America's largest producers of transmitters and other precision radio equipment. AAC crystal units will meet the most exacting requirements under severe operating conditions. Address all crystal orders and inquiries to Electronics Division, Kansas City, Kansas.

The services of our Engineering Department in designing special equipment are available to you without obligation.

Products of

ELECTRONICS DIVISION

TRANSMITTERS • AIRCRAFT AND TANK ANTENNAS
QUARTZ CRYSTALS • RADIO
TEST EQUIPMENT



PROMPT DELIVERY

◀ Type AA9 Crystal, 2.5 parts/million temperature coefficient, accuracy of carrier frequency .01%. Made in three models—A, G and E, covering total fundamental frequency range of 200 to 10,000 kc. Internal adjustment screw permits small amount of frequency control in the single crystal units, AA9A and AA9G.

ACCESSORIES CORPORATION

AIRCRAFT EQUIPMENT • HYDRAULICS • ELECTRONICS

City, Kans.

New York, N. Y.

Cable Address: AACPRO

NEW



LOW FREQUENCY STANDARD

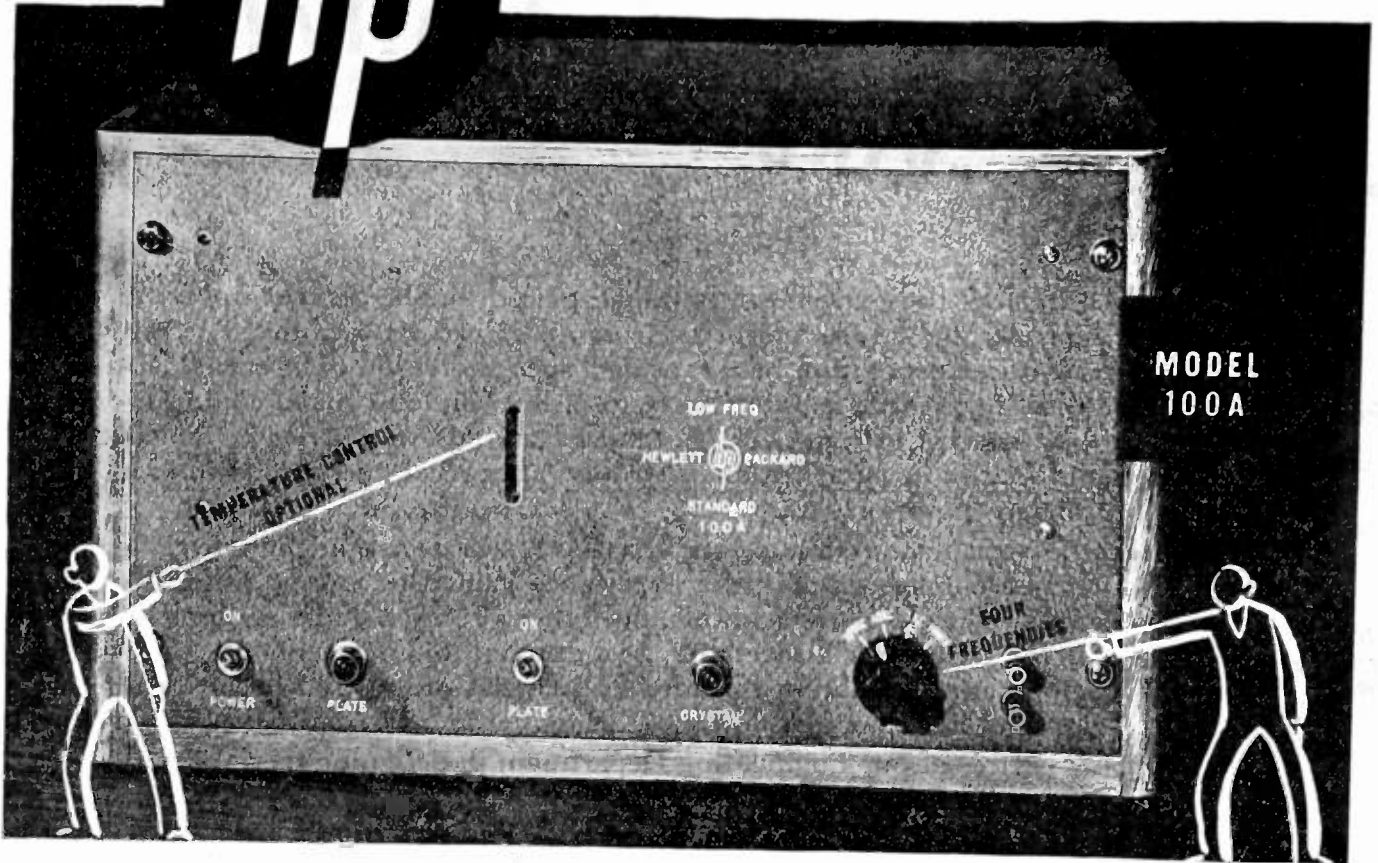

Four Standard Frequencies Available Simultaneously



Standard frequencies of 100 cps, 1 KC, 10 KC and 100 KC are supplied through a crystal controlled oscillator and a series of frequency dividers of the regenerative modulator type. The output of each of these frequency dividers is made available separately through a low impedance output system. Thus the *-hp-* Model 100A becomes extremely valuable for production test work because the single instrument will provide standard frequencies at a number of test positions. The output impedance is low enough that long lengths of shielded cable can be used for distribution in the laboratory or test department. Separate terminals are provided as shown in the block diagram.

Make accurate interpolation measurements and standardize such measurements to a high degree, calibrate audio equipment accurately and make many other useful tests and measurements with this Model 100A Frequency Standard. Get the complete details on this new *-hp-* instrument today. Also ask for the fully illustrated *-hp-* Catalog which gives you much valuable information about electronic instruments and how to use them. Write today for yours... there is no obligation whatsoever.

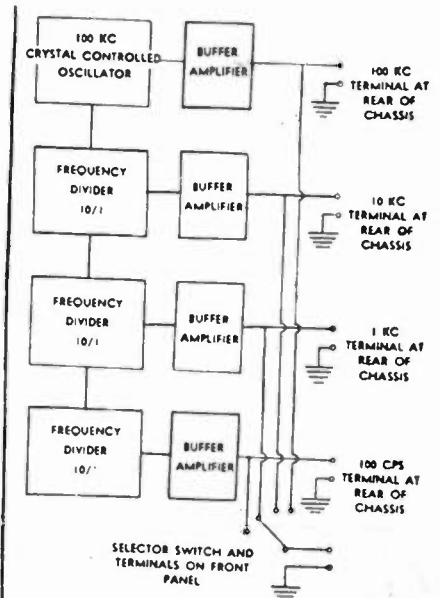

HEWLETT - PACKARD COMPANY

P. O. Box 662D, Station A, Palo Alto, California

STANDARD OF EXCELLENCE



TODAY, the entire output of Bliley Crystal Units is directed to vital communications equipment for war purposes. When the United Nations win the last battle, as they most certainly will, the fruits of increased engineering knowledge, expanded facilities and improved production technique, will be available to a peace time world . . . a new world of greater human comfort through applied engineering and science.

In this new world, Bliley Crystals will take their rightful place with their pre-war record of dependability, accuracy and user acceptance. Not counting applications covered by war time secrecy necessities, there will be Bliley Precision-made Crystals for diathermy, ultrasonic generators, pressure gauges, carrier-current communications systems, radio frequency filters, and precision interval timers. And, of course, in greater quantities than ever before, frequency controlling crystal units for all radio communication necessities, F. M. or A. M., fixed, portable, mobile or air borne. As always, Bliley Engineers are ready to extend their assistance to you . . . call on them freely.

Let's All Back The Attack—BUY MORE WAR BONDS

BILLEY ELECTRIC COMPANY . . . ERIE, PA.



Bliley Crystals



TWO IMPORTANT NEW IRON CORE DEVELOPMENTS

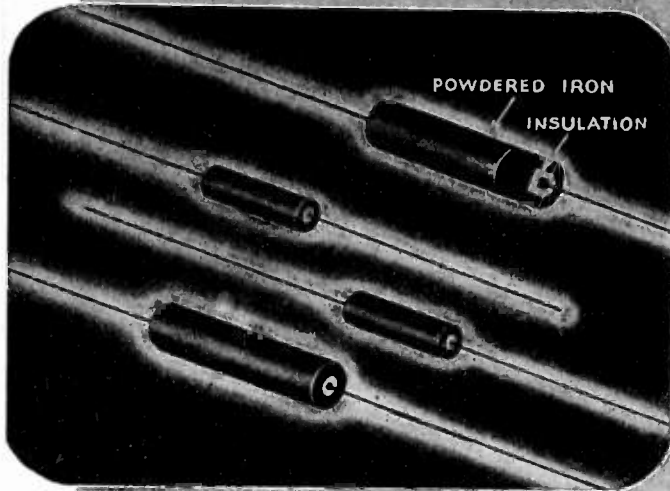

**IRON CORES FOR
CHOKE COILS**

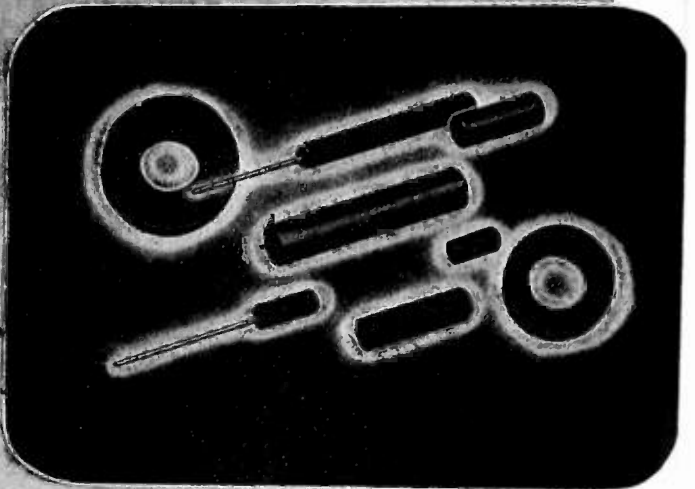

**HIGH-RESISTIVITY
CORES**

These little units have been designed for use with audio chokes, "hash" chokes, R-F chokes and various others. They consist of an iron core having insulated leads and resembling the axial lead-type resistors. These cores reduce the physical dimensions of the choke coil, and the iron serves to increase the "Q". The insulated leads serve as connections to the coil and permit point-to-point wiring. Available in a complete line for present day requirements.

★ ★ ★
OTHER STACKPOLE IRON CORES include a complete line for modern high frequency equipment from 40 meg. to 175 meg. and higher; insulated cores, high-resistivity cores; molded iron transformer cores, and various others. Samples to your specifications gladly submitted

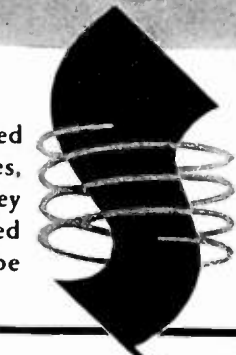

STACKPOLE MAKES:

- Brushes for all rotating equipment
- Carbon, Graphite, Molded Metal and Composition Contacts
- Powder Metallurgy Components
 - Bearings • Anodes
 - Electrodes
 - Power Tube Anodes
 - Brazing Blocks
 - Welding Rods, Electrodes and Plates
 - Rheostat Plates and Discs
 - and various other molded items.

Where cores having high unit resistivity are needed, Stackpole offers a special material showing resistance of practically infinity. Cores of this material are recommended for applications where a resistance of 150 megohms or greater is required, and where voltages do not exceed the breakdown value. The insulation reduces leakage currents and their resultant noise troubles when coil is located on or touching this high resistance core; possibilities of voltage breakdown between coils and cores are greatly reduced; and, in applications using cup cores, this material avoids the necessity for heavily insulated lead wires.

STACKPOLE CARBON CO.
St. Marys, Pennsylvania

STACKPOLE

MOLDED METAL POWDER AND CARBON PRODUCTS

HOW TO MAKE SCARCE TIN GO THREE TIMES AS FAR!

WE'RE a "have not" nation when it comes to tin. That's why a new plating method—developed by Westinghouse—makes big news! High frequency induction heating is the answer, and it not only fuses a uniform, corrosion-resisting tin coat on sheet steel five times faster than previous methods—it also uses only one-third as much tin!

Unexpectedly, glass made by Corning plays an important part in this job. The picture at the left shows the key units creating the high-frequency, tin-smoothing waves. They are glass vacuum tubes about like you'd find in a radio station. Note, too, the glass bowl insulators handling the "juice." As an example of the type of service these glasses must give, one plant is installing tin-plating oscillator units with 72 times the power of the largest radio broadcasting station now on the air in the United States!

High electrical insulating qualities are just one of the interesting characteristics you can get in glass made under the Army-Navy "E" flag at Corning. There are glasses with an expansion coefficient practically equal to that of fused quartz; glasses that are extremely resistant to mechanical shock; glasses that can be made into intricate shapes formerly considered impossible. If you even suspect that glass may help solve one of your problems, we want you to know that Corning's "know-how" is at your service. A study called "There Will Be More Glass Parts In Post-War Electrical Parts" will help bring you up-to-the-minute. Won't you write for a copy? Address the Electronic Sales Department P-4, Bulb and Tubing Division, Corning Glass Works, Corning, N. Y.

Photo Courtesy of Westinghouse

CORNING
means
Research in Glass

Electronic Glassware



"PYREX" and "CORNING" are registered trade-marks of Corning Glass Works

SILVER MICA

Capacitors

Special purpose oil impregnated silver mica capacitors particularly useful in high frequency applications.

These capacitors made in a diameter of less than 1/2 inch, in capacities up to 500 MMF are of mica discs of the highest grade individually silvered for maximum stability and stacked to eliminate any "book" effect. The assembly is vacuum impregnated with transil oil. The outside metal ring or cup connects to one plate of the capacitor . . . the center terminal connects to the other plate by means of a coin silver rivet. All units are color coded. For additional information send for Form 586.

Type 831
"lead thru" construction.

Type 830
Cup style assembled to a threaded brass mounting stud.

Type 890
with extra long terminal.

Centralab

Division of GLOBE-UNION INC., Milwaukee

PRODUCERS OF VARIABLE RESISTORS · SELECTOR SWITCHES · CERAMIC CAPACITORS, FIXED AND VARIABLE · STEATITE INSULATORS

he should be twins



The electronic engineer is one of the hardest-working men contributing to the war effort today. His highly specialized training and knowledge is not easily or quickly acquired. His skill calls for many years of constant application. Because the demand for experienced engineers and designers jumped so greatly after Pearl Harbor, each one vir-

tually has been doing the work of two men.

Raytheon is proud of its engineers and their great contribution to the war effort . . . and Raytheon is proud of its part in furnishing electronic tubes and equipment that meet all requirements of stamina, "Plus-Extra" quality, and complete dependability under the most severe wartime demands.



RAYTHEON

DEVOTED TO RESEARCH AND THE MANUFACTURE OF TUBES AND EQUIPMENT FOR THE NEW ERA OF ELECTRONICS

RAYTHEON MANUFACTURING COMPANY
Waltham and Newton, Massachusetts

9 MORE LOGICAL REASONS FOR THE EXCELLENCE OF DeJUR POTENTIOMETERS

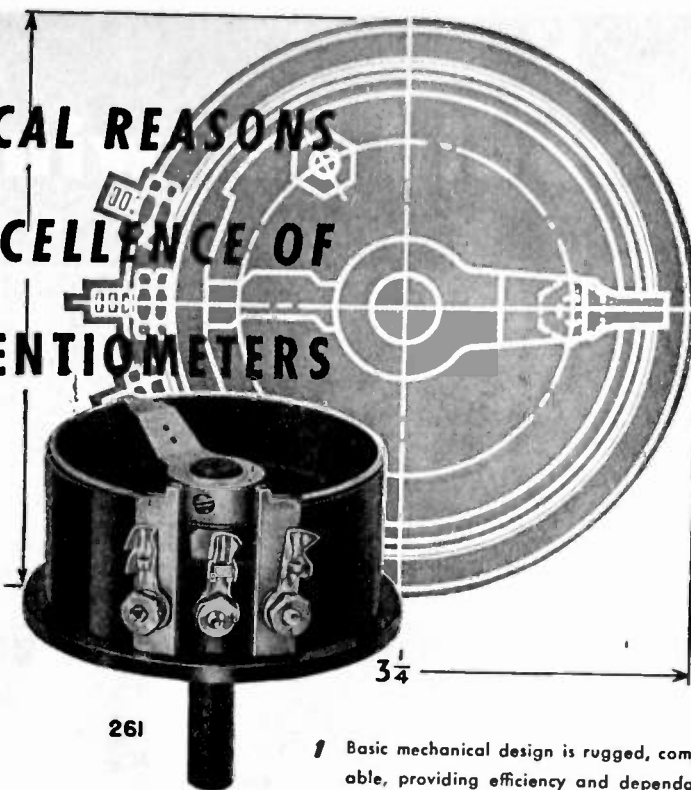

261

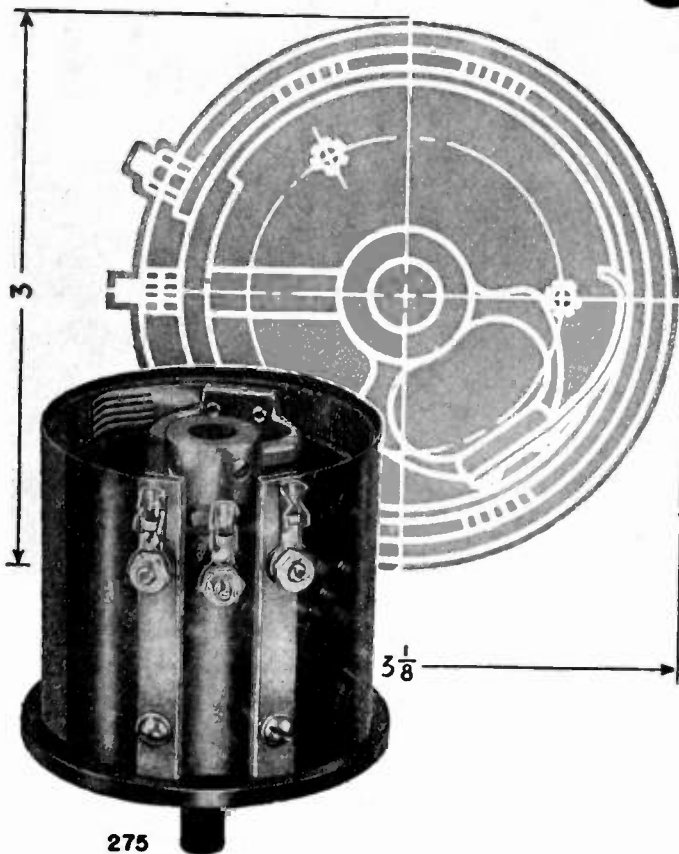

275

- 1 Basic mechanical design is rugged, compact and easily adaptable, providing efficiency and dependability.
- 2 Difficult applications in power and high frequency circuits are met with ease. Resistance winding elements are permanently close, smooth, and free from shorted out or irregular turns.
- 3 Excellent control as variable resistors in filament and plate supply control units, and in tube voltage and circuit elements.
- 4 Resistance element for heavy duty and heavy watt designs are specially wound to set up better radiation conditions in the component elements.
- 5 A close tolerance held on full resistance value for regular production units.
- 6 Controlled resistance wire quality from ingot to final drawing of wire sizes; resistance element is externally protected against damage.
- 7 Internal multiple fingers contact arm design, and reduces extraneous noises; assures a smooth operating rotation.
- 8 Terminal and mounting holes easily re-located for special applications; terminals are heavily tinned for adaptability in subsequent circuit hook-up.
- 9 Electrical power ratings and the mechanical characteristics are in accordance with National Electrical Manufacturers' Association standards.

ATTACK AGAIN AND AGAIN . . . BUY MORE WAR BONDS . . . NOW



DeJur-Amsco Corporation
MANUFACTURERS OF DeJUR METERS, RHEOSTATS, POTENTIOMETERS AND OTHER PRECISION ELECTRONIC COMPONENTS
SHELTON, CONNECTICUT



NEW YORK PLANT: 99 Hudson Street, New York 13, N. Y. • CANADIAN SALES OFFICE: 560 King Street West, Toronto

When Voltage
Must Walk The
"STRAIGHT
AND
NARROW"

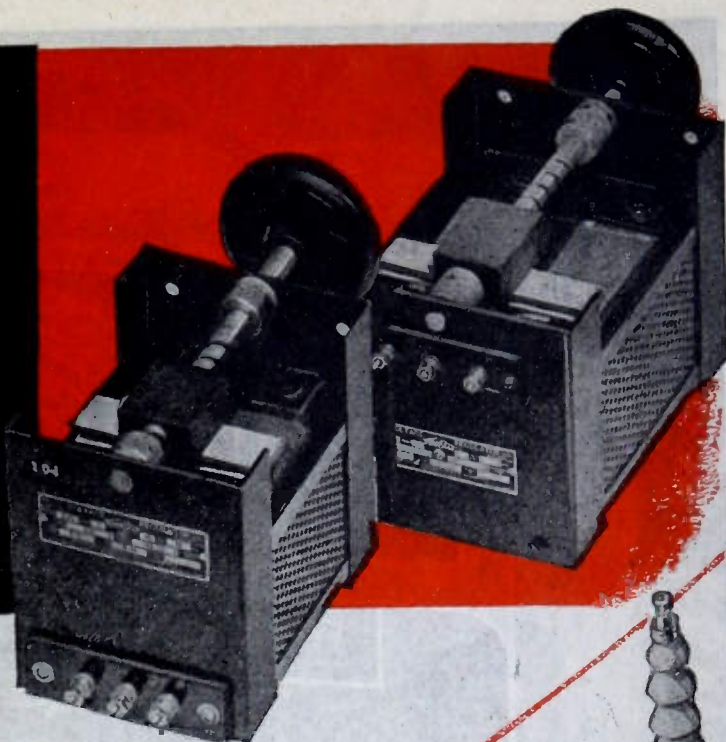

USE THE
"RH" TRANSTAT

FOR ANY COMMERCIAL OR AIRCRAFT
FREQUENCY, VOLTAGES UP TO 480

The type "RH" Transtat was developed for electronic applications where voltage must be continuously adjustable in minute fractional-volt increments, or line fluctuations must have instant and accurate compensation. In achieving such results, these regulators sacrifice neither high electrical efficiency nor extreme compactness.

Like other Transtats, this is a highly efficient transformer type regulator that does not distort wave form or interfere with radio reception. The velvety smooth Transtat system that con-

trols without circuit interruption is further refined by Vernier type actuation and innovations in the core, coil and commutator construction.

If you wish improved efficiency and wider latitude in designing your electrical apparatus, consider the advantages of the compact, lightweight "RH" Transtat as a component. Write for Bulletin 51-2E.

THE AMERICAN TRANSFORMER COMPANY
178 EMMET STREET NEWARK 5, N. J.

Pioneer Manufacturers
of Transformers, Reactors
and Rectifiers for Electronics
and Power Transmission



AMERITRAN

MANUFACTURING PLANT 178 EMMET STREET NEWARK, N. J.

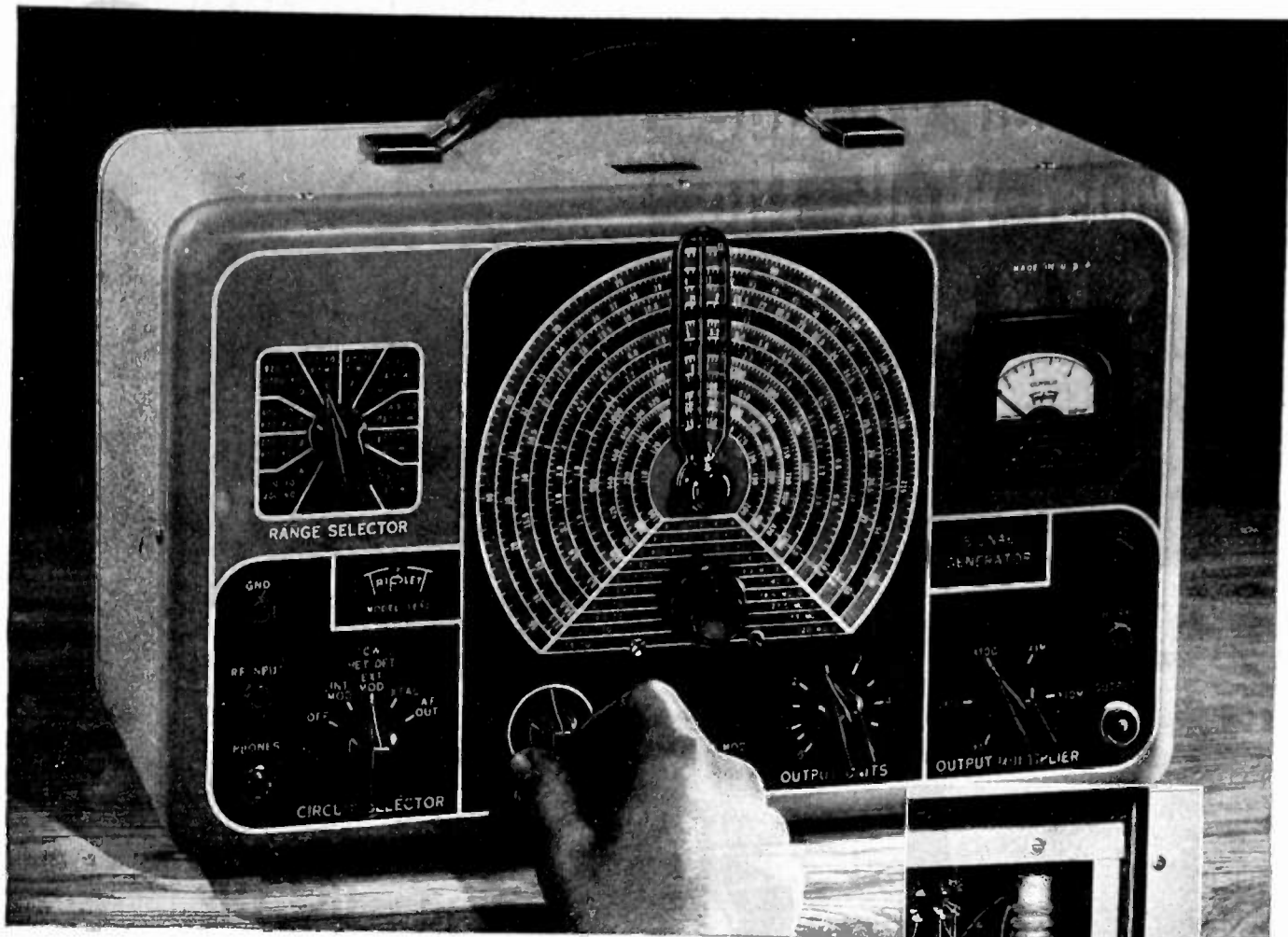

MODEL NO. 1632

Signal Generator

CONTINUOUS COVERAGE—100 KC. TO 120 MC. • ALL FREQUENCIES FUNDAMENTALS

A complete wide-range Signal Generator in keeping with the broader requirements of today's testing. Model 1632 offers accuracy and stability, beyond anything heretofore demanded in the test field, plus the new high frequencies for frequency modulated and television receivers, required for post-war servicing. Top-quality engineering and construction throughout in keeping with the pledge of satisfaction represented by the familiar Triplet trademark.

Of course today's production of this and other models go for war needs, but you will find the complete Triplet line the answer to your problems when you add to your post-war equipment.

Triplet

ELECTRICAL
BLUFFTON



INSTRUMENT CO.
OHIO ★ ★ ★

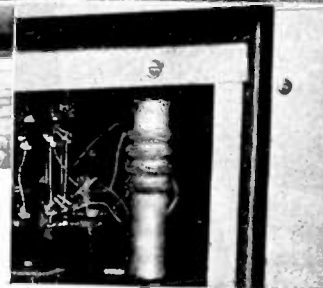

- Triple shielding throughout. Steel outer case, steel inner case, plus copper plating.

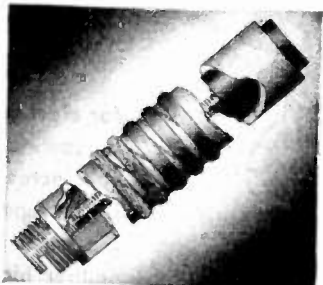

- All coils permeability tuned. Litz wire wound impregnated against humidity with "high-Q" cement.

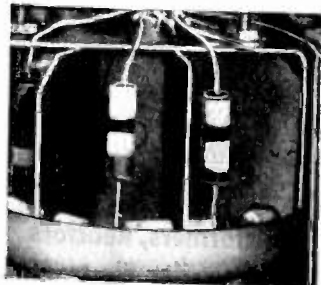

- Note sections individually shielded with pure copper. Entire unit encased in aluminum shield.



NOW A DOT OF SILVER...

Increases tube capabilities at 125-mc by more than 20 times!

The new coating of silver around the grid leads of Gammatron tubes answers one of the most baffling problems in high-frequency communication.

Until W. G. Wagener, chief engineer of Heintz and Kaufman Ltd. hit upon this simple solution, the life of all transmitting tubes at high frequencies was relatively short. Even tubes such as the HK-254 lasted only a brief 50 to 100 hours at 125 megacycles when very heavily loaded. The trouble was always the same... the glass around the grid lead would crack, and the tube would be ruined.

Heintz and Kaufman engineers found that the grid bead crack was caused by a change in composition of the glass adjacent to the tungsten. This change was due to a minute current flow resulting in electrolysis.

The silver coating now intercepts this current far

enough away from the grid lead so that the glass immediately surrounding the lead retains its normal characteristics. Thus Heintz and Kaufman's patented coating enables such tubes as the HK-54, HK-254, and HK-454 to operate at high frequencies at higher powers for as long as 2000 hours—one Gammatron now outlasts 20 to 40 ordinary tubes without the silver dot!

HEINTZ AND KAUFMAN LTD.

SOUTH SAN FRANCISCO • CALIFORNIA, U. S. A.



Gammatron Tubes

15A

SINCE 1897

STUPAKOFF

Products for the World of Electronics

STUPAKOFF CERAMIC AND MANUFACTURING CO., LATROBE, PA.

COIL FORMS

TRANSMISSION
LINE PARTS

TUBE PARTS

CONDENSER
PARTS

RESISTOR CASES
TUBES, SPOOLS AND
CONDENSER SHAFTS

STUPAKOFF

Ceramic

INSULATORS

STUPAKOFF produces a complete line of precision made, "radio grade" insulators, made of Steatite and other ceramic materials.

Stupakoff insulators are subjected to the most severe laboratory and field tests, to assure their unfailing performance in actual service.

The dependability of Stupakoff Ceramic Insulators is the result of a



combination of important factors. They include the absolute control over raw materials, modern manufacturing facilities equipped with precision tools, correct engineering, and most important of all, the invaluable experience and knowledge gained through years of producing ceramic insulators. This experience is available to you upon request.

Let's All Back The Attack—Buy More War Bonds

STUPAKOFF CERAMIC AND MANUFACTURING CO., LATROBE, PA.



Want to move 35 Tons?

WE wouldn't tell you how fast America's fighting planes go. That's a military secret.

But we've all read it's well over 300 miles an hour.

We've read too how they hit 700 or 800 miles an hour in dives. And how paint was peeled by the air pressure.

Did you ever stop to think that the plane's flaps and controls have to work surely, smoothly and dependably against pressures like that?

It's done by such mechanisms as you see in the picture.

They are called Lear Actuators.

They are powerful. Some can push up to 75,000 pounds.

They are light. That's a "must" in aircraft.

They are small. They have to fit in available space.

A good many preconceived notions had to go by the board to meet all these requirements. For example, the little electric motor that runs them is full of revolutionary engineering refinements.

Every man and every minute we have now can't make all the motors and actuators that we would like to deliver for Uncle Sam's aircraft.

But the day is coming when they will have different jobs to do. New jobs on peacetime products—perhaps like steering ocean liners, or parking cars, or things we've never thought of.

That is one reason for this advertisement. We want to know who can use an actuator or a motor like these.

Another reason is, we want you to know that there is available the kind of thinking and engineering which have produced these and some 250 other Lear products.

Even this small actuator weighing but 3.3 pounds can move 1200 pounds.

**LEAR
AVIA
INC.**

PIQUA • OHIO

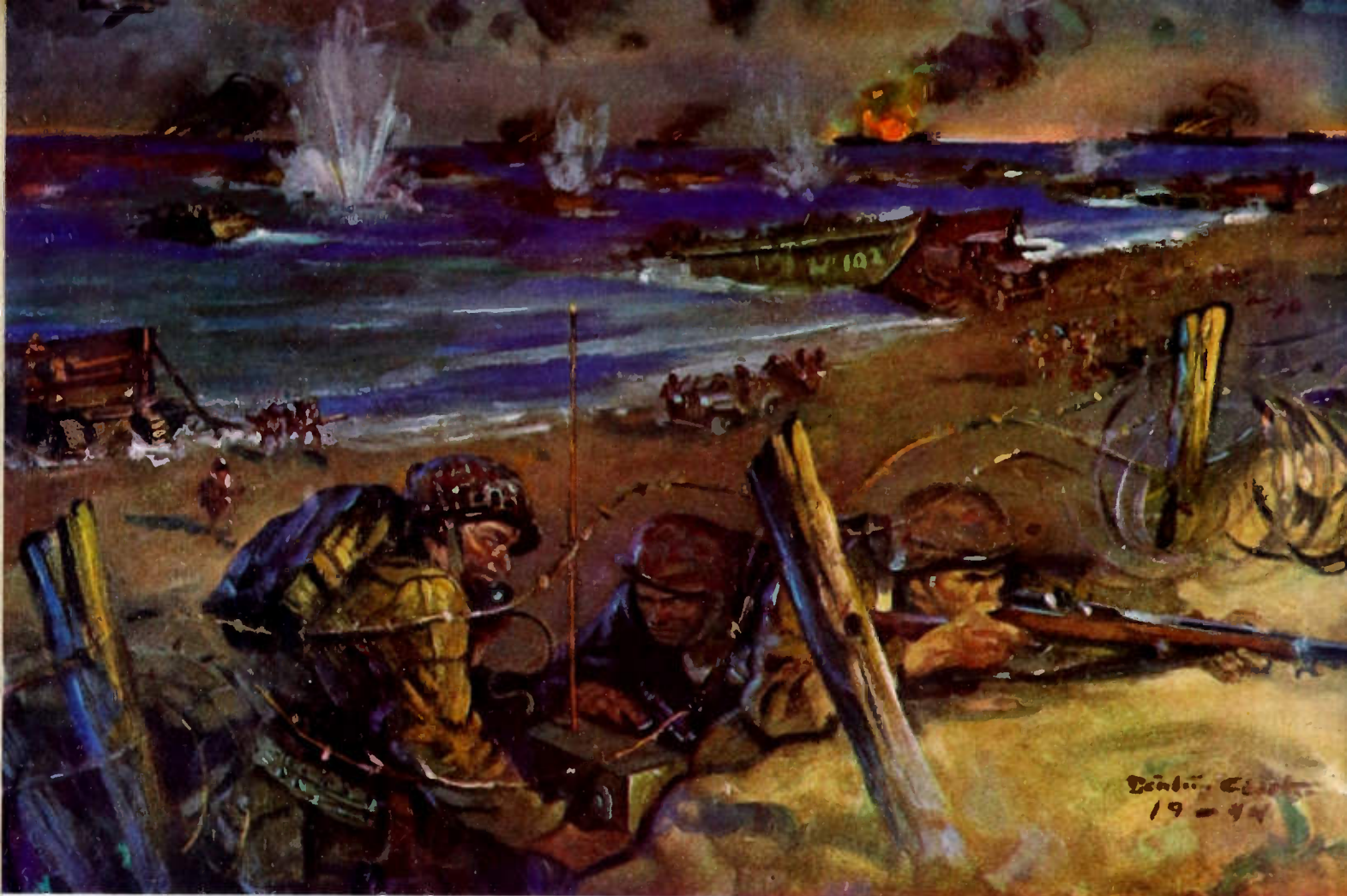

PAINTED FOR ELECTRONIC LABORATORIES, INC., BY BENTON CLARK

"Beach 3 Calling Fire Control 3 ... pinned down by pillbox on right flank!"

★ Landing parties must depend on supporting fire from ships off shore until their own artillery can get into action. By radio communication the Navy's fire is brought instantly to bear on enemy strong points holding up the advance.

When the Marines carry out the tough landing operations for which they are noted, Walkie-Talkies are among the first ashore. *They must get the messages through!* For unfailing power, many depend on *E·L* Vibrator Power Supplies.

Wherever reliability is a "must," *E·L* Vibrator Power Supplies are also proving their other advantages of light weight, small size and high efficiency. They are products of the most extensive research in vibrator power supplies and circuits ever known.

That research has extended the scope and usefulness of vibrator type power supplies beyond all previous conception. Certainly, in the electronic era of peace to come *E·L* Power Supplies will contribute new advances and economies wherever electric current must be changed in voltage, frequency or type.



Electronic

LABORATORIES, INC.

INDIANAPOLIS

E·L ELECTRICAL PRODUCTS — Vibrator Power Supplies for Communications . . . Lighting . . . Electric Motor Operation . . . Electric, Electronic and other Equipment . . . on Land, Sea or in the Air.



Power Supply using rechargeable, non-spill storage battery for operation of Walkie-Talkie radio equipment. Input Voltage: 4 Volts D.C.; Output: Numerous Voltages, supplying plate and filament requirements of the equipment. Width, 3½"; Length, 6½"; Height, 4¾".





"I understand, Colonel, that you're interested in performance!"



There is a time and place for everything. Oscar's single-minded enthusiasm might have been better timed. On the other hand, his point is well taken.

In manufacturing electronic tubes, performance is the ultimate goal. To assure uniform reliability, Hytron tubes are painstakingly produced to standard factory test specifications tighter than customer tolerances. Then for the final ver-

dict on actual performance, we turn to you who design, build, and operate the intricate electronic tools of war.

Those using Hytron tubes such as the 1616, OC3/VR-105, and OD3/VR-150, will not be surprised to discover that these tubes have earned the reputation of being the best in the industry.

You owe it to yourself to become familiar with these and other popular Hytron tubes, many of which appear on the Army-Navy Preferred List.



OLDEST EXCLUSIVE MANUFACTURER OF RADIO RECEIVING TUBES

HYTRON
CORPORATION
ELECTRONIC AND RADIO TUBES
SALEM AND NEWBURYPORT, MASS.



BUY
ANOTHER
WAR BOND

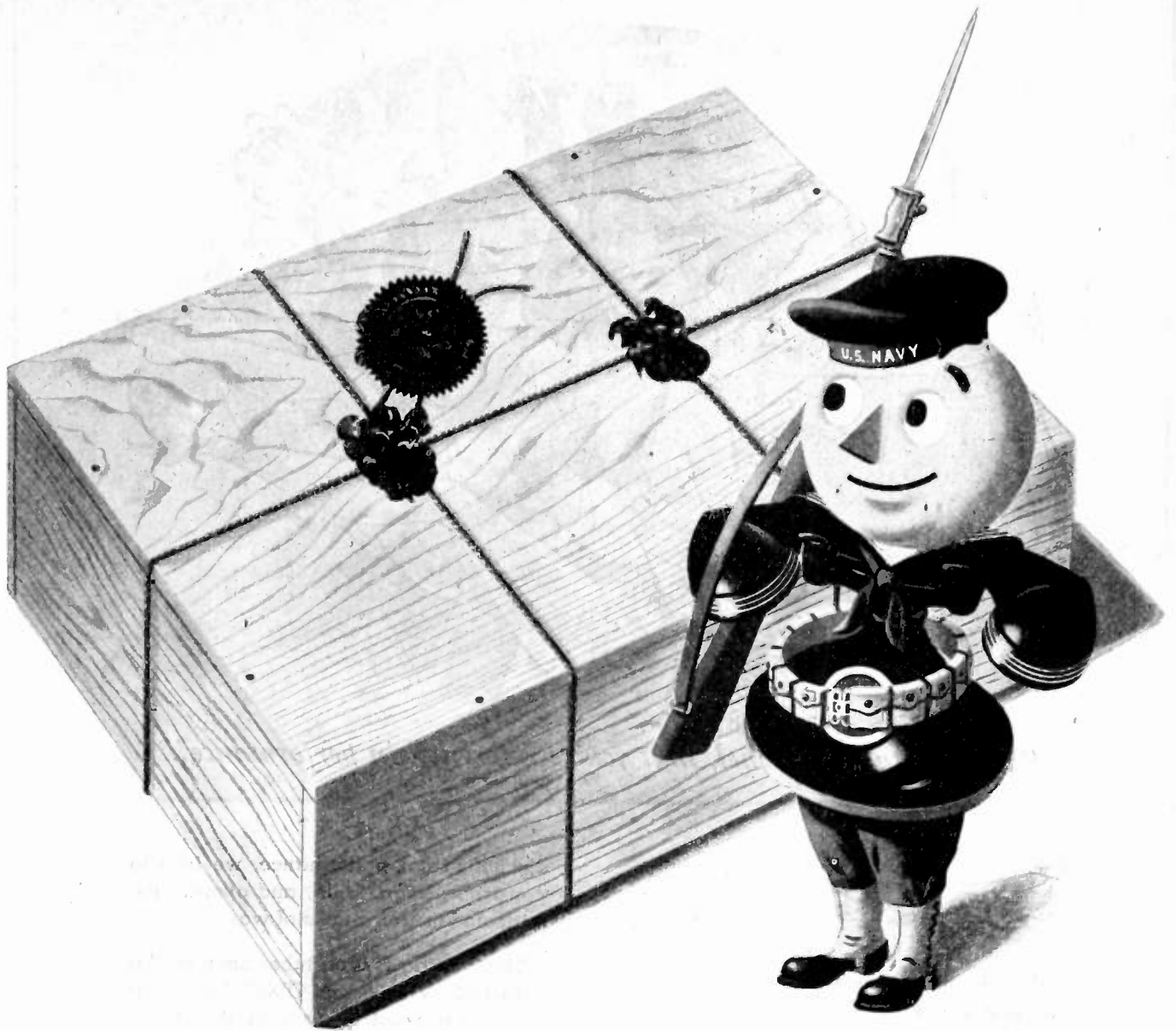

IT HELPED WIN A GREAT BATTLE

Sealed in this box and deposited in the vaults of the Bell Telephone Laboratories is a special device that helped win a great battle. It is being preserved for its historical significance.

SUCH things do not just happen. New instruments of war may appear suddenly on the battle-fronts. But behind them are long years of patient preparation.

Our scientists were organized to have this device ready for battle—just as our fighting forces were organized to be ready for that battle.

Developing secret military devices is a big job but big forces are busy on it, day and night.

Concentrating on this job are more than 7000 people in the Bell Telephone Laboratories. Its scientists and engineers and their skilled associates form a highly organized team, experienced in working things out.

Today's work for war had its beginning many years ago when these laboratories were founded as part of the Bell System's service to the public.

BELL TELEPHONE SYSTEM



The **ONLY**
Resistors
wound with
*** CERAMIC
INSULATED
WIRE!**



*IT'S FLEXIBLE

*IT'S
MOISTURE-
PROOF



*IT'S HEAT-PROOF
TO 1000°C

*IT PERMITS USE OF
LARGER WIRE SIZES
IN LESS SPACE

A MAJOR RESISTOR IMPROVEMENT

The outstanding superiority of Sprague Koolohm Resistors in practically every important characteristic could—and did—result only from an entirely different engineering approach to basic problems—from the wire up. Research proved that the resistor was no better than the insulation on the wire. Koolohm ceramic insulation applied to resistance wire permitted such valuable engineering features that, in less than four years, these resistors have set higher standards of performance on hundreds of the most exacting applications. Standard units include 5- to 150-watt power types, bobbin types and meter multipliers. Write for Catalog—today!

SPRAGUE SPECIALTIES CO.

RESISTOR DIVISION
NORTH ADAMS, MASS.



SPRAGUE KOOLOHM RESISTORS

SOLVING PROBLEMS

of

**UNWIELDY SIZE
REDUCED WATTAGES
CHANGED VALUES
HIGH AMBIENTS
MOUNTINGS
SHORTS**

...and many more!

A Tribute



A TRIBUTE to the members of the Signal Corps, United States Army, for their great achievements in the field of military communications. On every front, from the development laboratory to the most remote outpost, they are doing their job superbly well.

Hallicrafters employees are proud of the part they are privileged to take in the design and production of radio equipment for the Signal Corps.

hallicrafters RADIO



BUY MORE BONDS!

THE HALLICRAFTERS CO., MANUFACTURERS OF RADIO AND ELECTRONIC EQUIPMENT, CHICAGO 16, U. S. A.

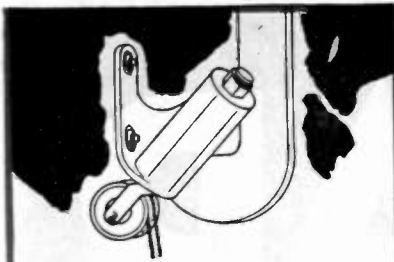

THROTTLE EQUALIZER MECHANISM fastened with Elastic Stop Nuts keeps throttle settings the same, even when the hull is distorted by heavy seas.

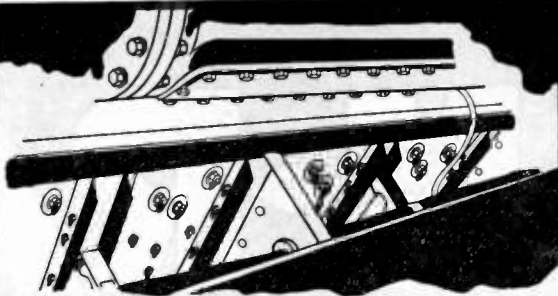

ENGINE BEDS. PT boats are a blasting mass of power. Besides, stresses and strains make the hulls weave. So, to hold the engines tight and secure against vibration and other forces, they are fastened down with Elastic Stop Nuts.

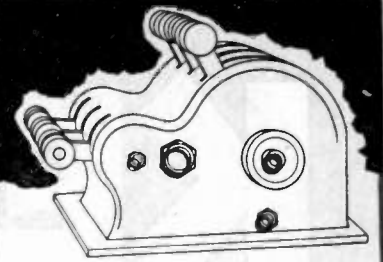

ENGINE ROOM SIGNALS and engine controls center in this unit held firm and secure with Elastic Stop Nuts.

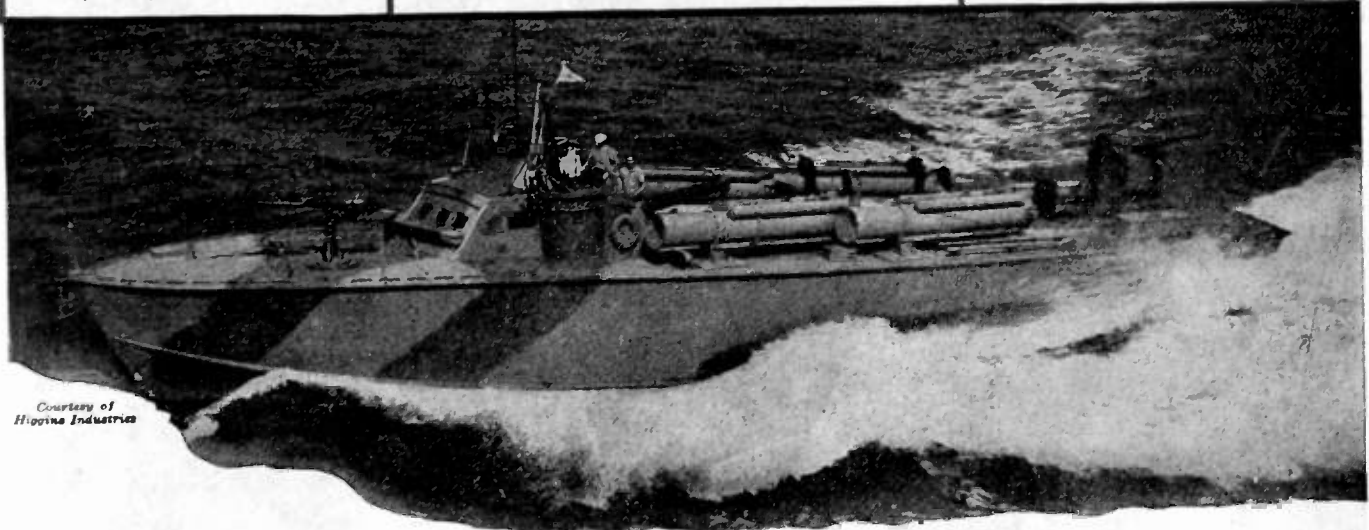

Courtesy of Higgins Industries

GRIPPING TIGHT ON THE BATTLING COCKLESHELLS

They're swift. They're light. They're crammed with 4,000 throbbing horsepower that drives them, fighting like demons, through giant seas at breakneck pace.

Naturally they take an awful beating.

Under such shock and vibration only the surest fastenings will hold. That's why throughout Higgins Boats you'll see the famous red collar that marks Elastic Stop Nuts.

These nuts hold fast in the face of the worst vibration. This is accomplished by the elastic collar built in the head of the nut. This collar

grips the bolt — presses itself between the bolt threads and holds tight. The nut can't wiggle. It can't turn. It can't shake loose.

These nuts will work wonders in peacetime uses. They'll make products safer, stronger and longer-lasting. They'll keep production equipment working with fewer inspections, take-ups and replacements.

Get the facts from our engineers. They'll gladly tell you about Elastic Stop Nuts and sit down with you to help work out any fastening problem you have.

ELASTIC STOP NUT CORPORATION

Gentlemen:

Torpedo boats must be built to stand terrific punishment — not only from heavy seas, but from vibration of engines, machine guns and depth charges. Precious time in maintenance and a greater sense of security are gained by the use of Elastic Stop Nuts at all vital points. Weight is also at a premium in PT's as in aircraft and prohibits the use of more cumbersome and less positive locking methods.

Yours very truly,

PROJECT ENGINEER, HIGGINS INDUSTRIES, INC.

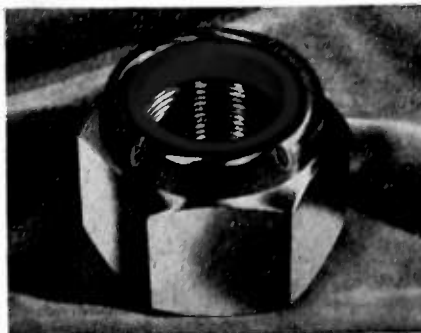
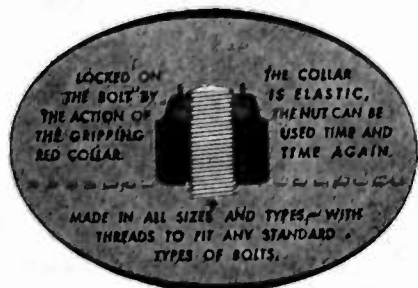

ESNA

TRADE MARK OF

ELASTIC STOP NUT CORPORATION OF AMERICA

ELASTIC STOP NUTS

Lock fast to make things last
UNION, NEW JERSEY AND LINCOLN, NEBRASKA

KEN-RAD

ELECTRON TUBES



KEN-RAD

EXECUTIVE OFFICES

OWENSBORO · KENTUCKY

EXPORTS 18 MOORE STREET NEW YORK

TRANSMITTING TUBES RECEIVING TUBES
CATHODE RAY TUBES INCANDESCENT LAMPS
SPECIAL PURPOSE TUBES FLUORESCENT LAMPS

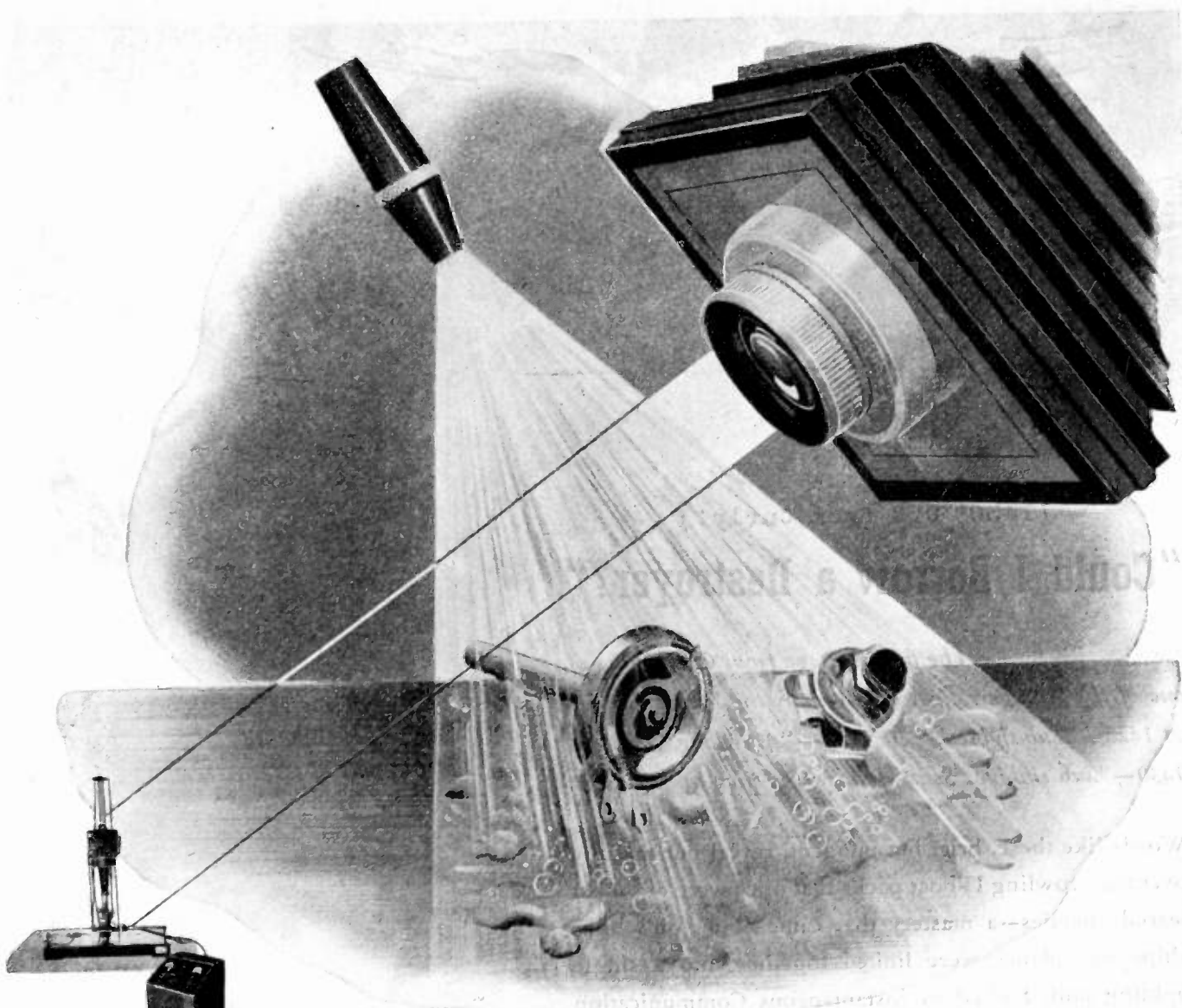

how to photograph salt eating its dinner

Salt, from the sea and air, has a tremendous appetite for many metals—eating them away unless they're protected. The exact effect of its gluttony and the success of the means used in preventing this costly damage are measured accurately by Utah's salt-spray test. One of the stages in Utah's complete circuit of radio and electronic tests.

Immediately after the parts have been subjected to the salt spray, microphoto-

graphs are taken and developed in the especially equipped Utah dark room. Thus, it is possible to make a microscopic inspection of the actual condition of the metal *before* other atmospheric changes take effect. Since metal surfaces exposed to salt-spray tests change rapidly *after tests are completed*, it is necessary and possible, by this photographic method, to determine and *accurately* record corrosion in metals.

As a result of this and other Utah tests, efficient performance of Utah parts is assured under any and all conditions normally encountered—the failures due to inadequate, inaccurate testing are avoided. ★ ★ ★

Every Product Made for the Trade, by Utah, Is Thoroughly Tested and Approved

utah

Radio Products Company,

842 Orleans Street, Chicago 10, Illinois



Keyed to "tomorrow's" demands:
Utah wirewound controls, switches, plugs,
jacks, vitreous enamel resistors, transform-
ers, vibrators, speakers.



(1430* CVE from Curly:)

"Could I Borrow a Destroyer?"

The first message from Curly, pilot of one of the Avengers, was received by the Escort Carrier at 1426—"Sub sighted." At 1427—"Attacking," and at 1430—"Sub sinking. Send destroyer to pick up survivors."

* * *

Words like these, brief but pungent, reveal our mastery over the prowling U-boat packs that once were our most feared enemies—a mastery that came about only after ships and planes were linked together into a single fighting unit. Linked by instantaneous Communication from ship to ship, ship to plane, and from pilot to crew.

Into the sea-air-land communication systems of our fighting forces go many Rola products, Transformers, Coils, Headphones and other electronic parts. And into these Products go the knowledge and skill that Rola has acquired through a quarter of a century's leadership in the art of Sound Reproduction. THE ROLA COMPANY, INC., 2530 Superior Avenue, Cleveland 14, Ohio.

*2:30 PM

ROLA

Let's do more



in forty-four!

MAKERS OF THE FINEST IN SOUND REPRODUCING AND ELECTRONIC EQUIPMENT

IMPROVED radiotelegraph communications from

SHIP to SHIP
SHIP to SHORE
POINT to POINT



NEW McELROY ELECTRONIC CODE TAPE PERFORATOR PFR-443-A

Every ship and every marine station should and probably will, eventually, be equipped with perforator and transmitter.

Marine radiotelegraph communications were given a substantial boost in efficiency when Ted McElroy perfected the McElroy Code Tape Perforator PFR-443. This new model . . . the PFR-443-A . . . represents an even greater advancement in reducing the human margin of error. Entirely mechanical, the PFR-443-A comprises two units: The Keying Unit which is made up of an assembly of two keys, the space bar and punching mechanism; plus the Electronic Unit which relieves the keying contacts of high current and voltage, and provides for utmost ease in operation.

Operation of the PFR-443-A is similar to a semi-automatic ("bug") key excepting that the transmission of dots and dashes is automatic. A light touch actuates the punching mechanism for as long as either the key or space bar is depressed. Experienced operators can maintain, with ease, an accurate speed of more than 40 words per minute . . . in all Morse combinations assigned to the Russian, Turkish, Greek, Arabic and Japanese alphabets and languages, which are not found on the keyboards of standard perforators manufactured in the United States and Great Britain. *Write for additional information.*

McElroy engineers never imitate . . . never copy
We CREATE . . . DESIGN . . . BUILD



MANUFACTURING
CORPORATION

62 BROOKLINE AVENUE
BOSTON, MASS.

KEEP IT UP . . . BUY MORE
AND MORE WAR BONDS

TUNG-SOL TUBES STAND UP FOR HIM

...so your use is a cinch

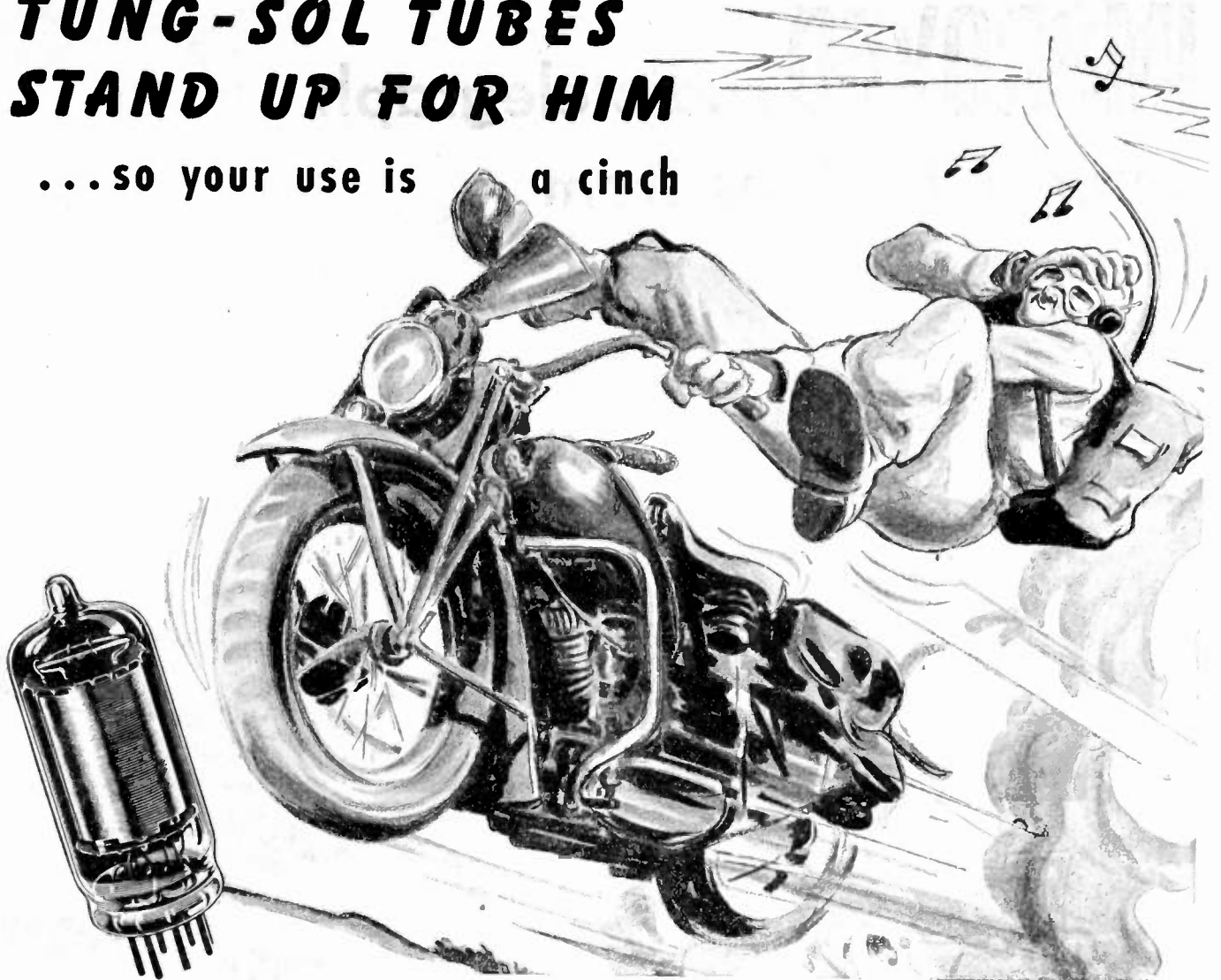

The enviable record of TUNG-SOL Electronic Tubes in military equipment shows the ability of these tubes to withstand abuse far beyond ordinary civilian requirements. This sturdiness is the result of many construction features developed by TUNG-SOL engineers in their never ending cycle of designing and testing.

A typical TUNG-SOL feature is the method of anchoring the filament tension spring. It practically eliminates the possibility of spring

failure, one of the causes of damage to the filament. It is the sum of these features that enables TUNG-SOL Electronic Tubes to remain efficient longer under adverse conditions.

After the war, manufacturers of electronic products will find at TUNG-SOL a wealth of engineering and production skill to help them make new or better electronic devices. Those engaged in war work are invited to bring their problems to TUNG-SOL now.

ANCHORING THE FILAMENT TENSION SPRING (GREATLY ENLARGED)



The common practice was to spot-weld the end of the spring to the top of an anchor post. The weld always causes crystallization of the spring at the point where flexibility was needed. The TUNG-SOL design locates the weld back from the fulcrum point so that the crystallization is at a point where it cannot impair the spring.

TUNG-SOL

vibration-tested

ELECTRONIC TUBES



TUNG-SOL LAMP WORKS INC., NEWARK 4, NEW JERSEY

ALSO MANUFACTURERS OF MINIATURE INCANDESCENT LAMPS, ALL-GLASS SEALED BEAM HEADLIGHT LAMPS AND CURRENT INTERMITTORS



Birthplace of Electroneering*

In this ever-widening field of Electronics, *specialization* is the modern keynote. Early recognition of that fact is the reason behind the RAULAND growth and reputation for advanced electronic ideas and high quality products. For RAULAND is an organization of experienced, electronic engineering specialists . . . men, devoted to custom-engineered tasks, who have produced such notable examples as *High Powered Cathode Ray Tubes, Frequency Standards, Transmitting Type Tuning Condensers, Two-Way Radio and Intercommunicating and Sound Control Units* for Industry. All of these precision, electronic instruments are busily at work now in our war and industrial effort, as they will one day serve industry and the home.

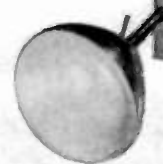
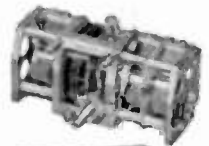
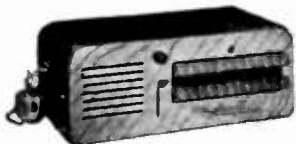

* *Electroneering*—the RAULAND term for engineering vision, design and precision manufacture.

RADIO . . . SOUND . . .

Rauland

. . . COMMUNICATIONS

Electroneering is our business

THE RAULAND CORPORATION . . . CHICAGO, ILLINOIS

Buy War Bonds and Stamps! Rauland employees are still investing 10% of their salaries in War Bonds

"End of the Line" is only the Beginning



• This is the end of the Sylvania Radio Tube production line.

Here trained operators begin a series of tests designed to safeguard high-quality manufacture from any bit of human error.

Standardized precision testing instruments enable them quickly to determine basic radio tube fitness. The slightest defect dooms a tube to instant destruction.

Then come more exhaustive and specialized tests for any deviation at all from specification in the quality inspection and customer inspection departments.

Every Sylvania Radio Tube must pass these rigorous tests — and pass them with a perfect score — before shipment from the factory. This painstaking precision test system is your insurance for Sylvania quality that you can sell with complete confidence.

Quality That Serves the War Shall Serve the Peace

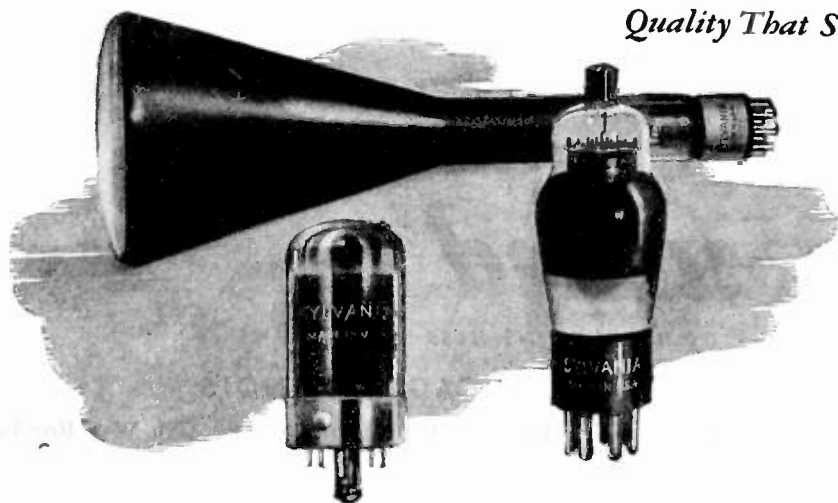

RADIO DIVISION  EMPORIUM, PENNSYLVANIA

SYLVANIA

ELECTRIC PRODUCTS INC.

RADIO TUBES, CATHODE RAY TUBES, ELECTRONIC DEVICES, INCANDESCENT LAMPS, FLUORESCENT LAMPS, FIXTURES AND ACCESSORIES

Proceedings of the I.R.E. April, 1944

Geared to exacting laboratory standards

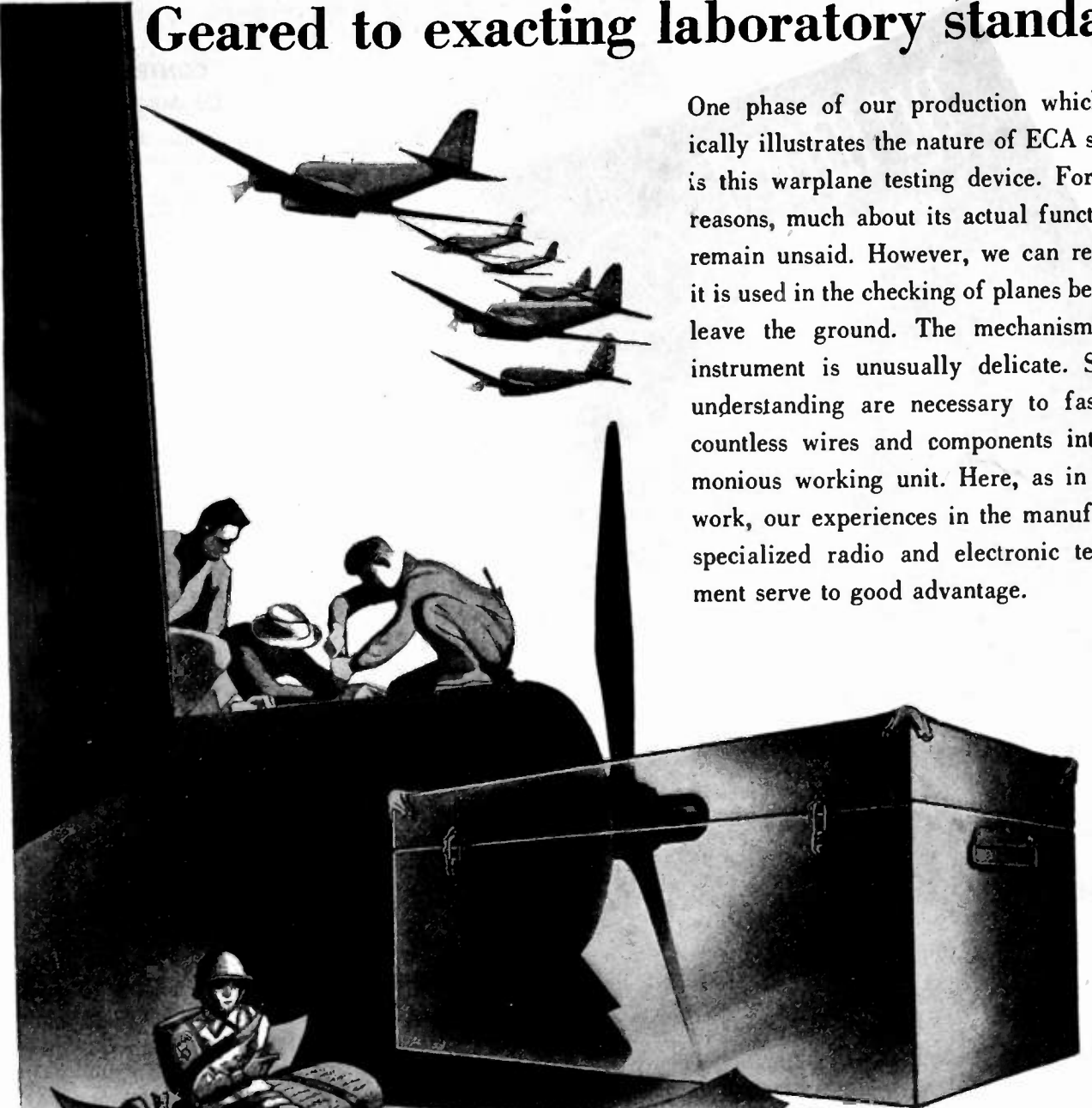

One phase of our production which graphically illustrates the nature of ECA standards is this warplane testing device. For obvious reasons, much about its actual function must remain unsaid. However, we can reveal that it is used in the checking of planes before they leave the ground. The mechanism of this instrument is unusually delicate. Skill and understanding are necessary to fashion the countless wires and components into a harmonious working unit. Here, as in all ECA work, our experiences in the manufacture of specialized radio and electronic test equipment serve to good advantage.



Why the Federal Ballot for Soldiers?

At ECA, we earnestly cooperate with every phase of the war program. We are also conscious of another responsibility to our soldiers, that is, the preservation of their rights. As this is being written, legislation permitting soldiers to vote is under consideration. The Federal Ballot is unconstitutional, it violates states' rights—so some men say. To us, the argument for the Federal Ballot is quite clear. If the government has the power to go into any state and select a man for service, then it should have the equal power to make certain that he can take advantage of his *constitutional* right to vote—in the easiest possible manner. Back the President, the War Department and all others who support the Federal Ballot. There is no red tape wrapped around a bullet. It should not be wrapped around a ballot.



ELECTRONIC CORP. OF AMERICA

45 WEST 18th STREET • NEW YORK 11, N. Y. WATKINS 9-1870



CONTENTS OF MANUAL

The Cathode-Ray Oscillograph: Introduction, general description, high-voltage power supply, amplifiers, linear time-base generator, intensity modulation, low-voltage power supply, mechanical considerations, conclusion.

Oscillograph Design Considerations: power supplies, amplifier design, time-bases or sweep generators.

DuMont Cathode-Ray Equipment: description, specifications, accessories, oscillograph type comparison list, specialty products.

DuMont Cathode-Ray Tube: general information, installation notes, type specification sheets, tube type comparison list.

Sales and Service Information: how to order, patent notice, price list, etc.

Instrument and Tube Application Notes: frequency and phase determination, photographic measurements, observation of relay rebound, etc.

Cathode-Ray Tubes

... and how they are applied

► For a dozen years past the Allen B. DuMont Laboratories have specialized in the development, production and application of cathode-ray tubes.

DuMont was the first to introduce the commercialized cathode-ray tube as a practical tool for research worker, production engineer and technician. Not only have DuMont tubes and oscillographs resulted in savings in time required to inves-

tigate the many problems to which they are applicable, but they have also revealed truths in man's laws of the working forces of nature.

And now, as a further service, DuMont engineers have compiled a manual of pertinent data, together with detailed descriptions of DuMont tubes and associated equipment. This data is in loose-leaf form. The binder permits constant revision to keep pace with the

fast-moving cathode-ray technique. Each manual bears a serial number so that the name and address of its recipient may be duly registered. Additional pages are mailed from time to time.

Write on your business stationery for your copy. Our Engineering Department is interested in aiding you with your cathode-ray application problems.

DUMONT

Precision Electronics & Television

ALLEN B. DUMONT LABORATORIES, INC., PASSAIC, NEW JERSEY • CABLE ADDRESS: WESPEXLIN, NEW YORK

Sound Ideas . . .

Sound ideas! On the drafting board . . . in practical engineering . . . in production "know-how". These form a strong union out of which come many Electro-Voice developments. And the latest of these is the Model T-45 "Lip Mike" . . . a noise-cancelling Differential Microphone.

The soundness of Electro-Voice design refinements will be even more effectively demonstrated in peacetime. We have grown up with the field. We know its needs and its possibilities. You may be sure that products born of Electro-Voice ideas will perform a sound function.

Electro-Voice distributors are giving greater understanding to your requirements than ever before. If your limited quantity needs can be filled by any of our Standard Model Microphones, with or without minor modifications, we suggest that you contact your nearest radio parts distributor.

DON'T WASTE WASTEPAPER . . . TURN IT IN TO FIGHT FOR OUR SIDE



Electro-Voice MICROPHONES

ELECTRO-VOICE MANUFACTURING CO., INC.
1239 South Bend Ave. • South Bend 24, Indiana
EXPORT DIVISION: 13 EAST 40th ST., NEW YORK 16, N.Y.—U.S.A. CABLES: ARLAB

THESE 4 RCA MINIATURES

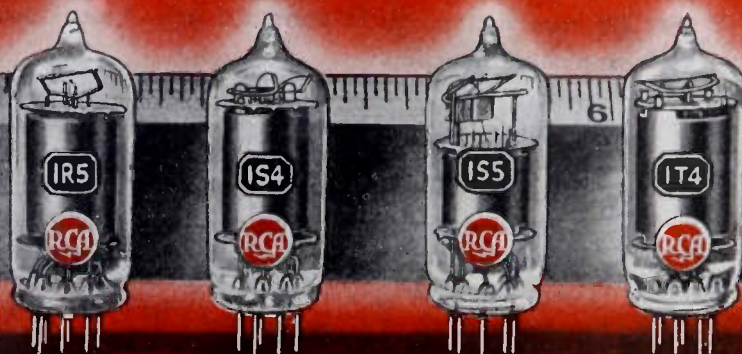

MADE HISTORY—

AND THEY HAVEN'T STOPPED YET!

BUY MORE WAR BONDS

Remember them—the RCA 1R5, 1S4, 1S5, and 1T4—the “granddaddies” of them all, the miniatures that made the popular Personal Radio possible back in 1940?

Only $2\frac{1}{8}$ " tall, with a $\frac{3}{4}$ " diameter—but they were born wearing 7-league boots! Right now miniatures are doing battle service—and plenty of it—in many types of compact, light-weight, vital war equipment.

Tomorrow? No need for us to tell you radio designers to watch the post-war trend to miniatures! But here's how we can help you, right now:

You know about RCA's Preferred-type Tube program that, two years before Pearl Harbor, made possible larger manufacturing runs on fewer types of tubes, resulting in better tubes of greater uniformity at lower cost. And you know about today's "Army/Navy Preferred List of Tube Types" that insures ready replacement of standard types on the fighting fronts.

Miniatures, due to their post-war importance, will almost certainly earn their peace-time RCA "Preferred" rating, just as so many of them today are on the Army/Navy list. Our engineers will gladly advise you right now which RCA tube types—and which miniatures—are likely to be included in our post-war Preferred Tube program. Write today to RCA, Commercial Engineering Section 702 South 5th Street, Harrison, New Jersey.



RADIO CORPORATION OF AMERICA

• The Magic Brain of all electronic equipment is a Tube... and the fountain-head of modern Tube development is RCA

Knowledge of the viewpoint of pioneering commercial leaders in the radio industry is of interest and help to radio-and-electronic engineers. In pursuance of this thought, such men have been invited to prepare "guest editorials" for the PROCEEDINGS OF THE I.R.E., to be published in their received form.

The PROCEEDINGS here presents an analytic expression from the President of the Farnsworth Television and Radio Corporation, whose long and successful career in the radio industry lends added weight to his viewpoint.

The Editor

Creative Radio Research Workers— Their Opportunities and Obligations

E. A. NICHOLAS

At the outbreak of war, the radio industry had reached a position of tremendous importance in the American economy. With over fifty million radio receivers in use in the United States and nearly half a billion dollars worth of sets sold in a single year, the radio industry was classed as one of America's leading industrial fields. The radio industry proceeded to accomplish a task that brought high commendation from our armed forces, by converting all of its facilities and energy to the war effort. It provided devices for furnishing intercommunication between our fighting units, that in many instances made the difference between defeat and victory—it created secret weapons, some of which were credited with saving England and giving the Allies control of the seas.

Credit for these achievements has been justly given to the men and women in our factories—the foreman, the expeditors, and others who have worked diligently to produce speedily, undreamed-of quantities of war material. Similarly management has been complimented on its achievements, that of controlling, operating, and producing a radio industry that has increased many times over its peacetime requirements.

However, above all, it was the engineer and scientist who made all this possible. This war may well be termed a "technical war," because it was the engineer and scientist who had the ingenuity and integrity to develop new radio equipment for military applications. It was they who developed new secret devices and converted substitute materials into production when many items became difficult to obtain. As a result, industrialists of today have a fuller appreciation of the importance of, and continuing need for, a well-balanced research and engineering organization.

The failure to evaluate properly this in the past has been a serious and costly mistake. While it is true, that before the war the radio industry reached a position equal to many of our large industrial fields, it is important to recognize certain shortcomings of the industry. Why did it continue a monotonous race to make unprofitable sales of hundreds of thousands of \$10.00 receivers? How many years went by without anything basically new or better being added? Why were television and frequency modulation so long delayed?

Because research and development engineering, the very foundation of the radio industry, were left to a comparatively few organizations which had the vision to recognize the future possibilities of the art and enough faith to make an investment for the future. Because the importance of research and engineering to the industry, with a few exceptions, was not properly evaluated. Because companies were willing to spend hundreds of thousands of dollars in promoting \$10.00 radio sets, but were not willing to contribute a fraction of this expenditure to the creation of something fundamentally new and better. Many of these companies, which did not realize the importance of research and engineering, may well recall their difficulties in converting to military production, where research and design were important factors. It took the war itself to make the industry generally understand that an investment in research to create fundamentally new and better services and devices was more vital to a progressive radio organization than engineering devoted principally to changing the appearance of the old.

The responsibility for this failure rests not only with the industrialists and commercial leaders of the industry. It lies also with the scientists and engineers themselves. Here is a great body of professional men, recognized for their ability and their achievements and carrying with them the genius of creation—without which any industry must eventually become stagnant. These men themselves must not be content with the passive attitude toward their work which existed in the past. It is their duty to see that their influence and the value of their work is recognized.

The possibilities of the radio industry in the coming peace era are obvious. The promise is great and the responsibility is tremendous. The leaders of the industry must recognize the importance of creative research to the future progress of the industry and the engineer must see that what he has to contribute is understood and encouraged. Only then can the lifeblood of the industry, the creative function of research and development engineering, flow freely. Only then can the radio industry expect to follow a dynamic and progressive program.

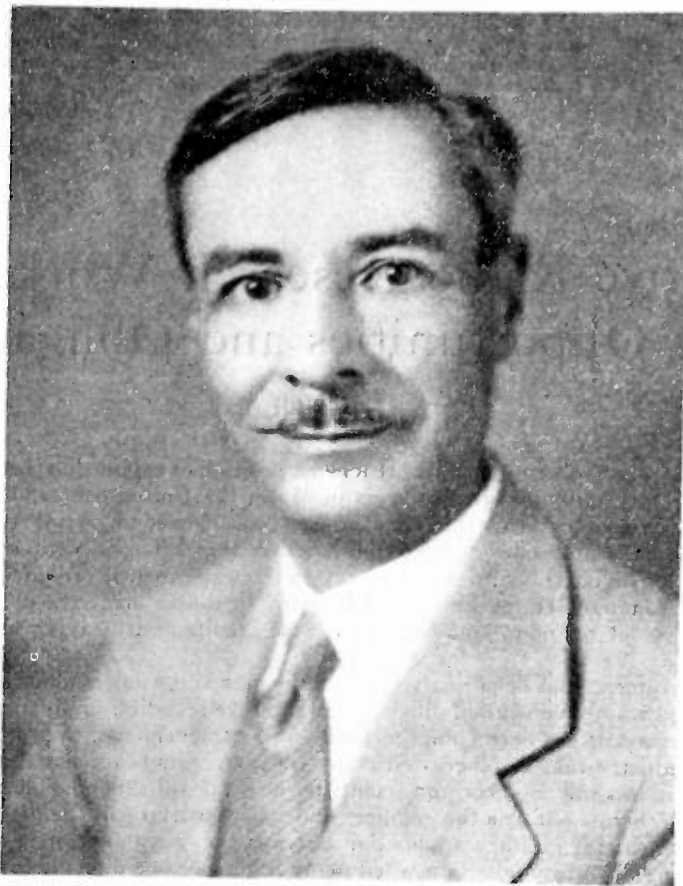

Haraden Pratt

Recipient, Medal of Honor, 1944

Haraden Pratt, Fellow, director, secretary, and past president, of the Institute of Radio Engineers, was presented with the I.R.E. Medal of Honor at the Institute's dinner held in New York City on January 28, 1944. The award, made annually, is for distinguished service in the field of radio communication.

The specific achievements for which Mr. Pratt was selected for the 1944 Medal of Honor were stated in the following citation which accompanied the formal presentation: "In recognition of his engineering contributions to the development of radio, of his work in the extension of communication facilities to distant lands, and of his constructive leadership in Institute affairs."

Mr. Pratt's radio career started in 1906 in the amateur wireless-telegraph field in San Francisco. From 1910 to 1914 he was secretary and president of the Bay Counties Wireless Telegraph Association, one of the few radio clubs in existence in those days. At the same time he was a commercial wireless-telegraph ship-and-shore station operator and installer for the United Wireless Telegraph Company and the Marconi Wireless Telegraph Company of America in San Francisco.

After receiving his degree at the University of California, he was engaged as engineer in the construction and operation of the Marconi 300-kilowatt trans-Pacific radio stations at Bolinas and Marshall, California. From 1915 to 1920 he was expert radio aide, Bureau of Steam Engineering, United States Navy Department. He was placed in charge of the radio laboratory and engineering work at the Mare Island Navy Yard, California; later, he was sent to Washington, D. C., to take charge of the construction and maintenance of all

high-power Navy radio stations, including those of private companies operated by the Navy Department during the last war.

From 1920 to 1923 he was engineer of the Federal Telegraph Company at Palo Alto, California, in charge of factory operations and construction of Federal's Pacific Coast radiotelegraph system, now part of Mackay Radio and Telegraph Company's radio network.

From 1925 to 1927 he constructed and supervised operation of a short-wave, point-to-point radiotelegraph system for Western Air Express. From 1927 to 1928 he was in charge of development of radio aids for Air Navigation, Bureau of Standards, Department of Commerce, Washington, D. C.

He became chief engineer of Mackay Radio in 1928 and, soon thereafter, was made vice president. He served as company representative at meetings of the International Radio Consultative Committee in Bucharest in 1937 and at the International Radio and Telegraph Conferences in Cairo in 1938. He also served as United States Government technical advisor at the International Radio Conference at Washington, D. C., in 1927 and on the Consultative Committee on Radio at Copenhagen in 1931. He is now vice president, chief engineer, and director of the Mackay Radio and Telegraph Company, and vice president and director of the Federal Telephone and Radio Corporation.

From 1939 to 1942 he was a director of the American Standards Association. Mr. Pratt is the delegate of the Institute of Radio Engineers to the Radio Technical Planning Board, and is chairman of the Panel on Radio Communications of the Radio Technical Planning Board.

The Scope of the Institute*

LYNDE P. WHEELER†, FELLOW, I.R.E.

DURING the present year the Institute of Radio Engineers will enter upon the thirty-third year of its life. In the last three years of this period the membership has been almost exactly doubled. This extraordinary recent growth calls for more than casual notice. It is too large to be attributed solely to the increased radio personnel developed for the armed forces, although that probably accounts for a considerable part of the growth. It is believed that history will record this remarkable increase in the size of the Institute as one of the symptoms of the coming of age of the radio-and-electronic arts, a symptom which would have been of significant magnitude even if the war had not intervened to emphasize it. The first thirty years of the Institute's life mark a distinct and now completed epoch in the history of communications. In 1912 the radio art was no more than a lusty infant. By 1942 it had passed through its period of adolescence to the realization of mature powers useful and used in large domains outside of that of communications.

The Institute, as the corporate representative of those responsible for this great technical development and expansion of the field of application of its techniques, is thus faced with greatly enlarged responsibilities. If it is to maintain its leadership of the profession in the future, it must make sure that its organization and methods inherited from prevacuum-tube days and as modified during the adolescent period of the arts, are adequate to serve the profession now that the art has come of age. If changes are necessary it is vital that they should be made promptly or the opportunity for leadership will be lost.

Parenthetically it should be remarked that if the Institute has faltered in its leadership in the past or if it should do so in the future it has not been and will not be through lack of sufficient powers under our charter. These are certainly broad enough to permit of keeping the pace with any conceivable development or expansion in the art. Failure to achieve effective leadership can only come about from faulty or inadequate use of the means placed at our disposal in that document.

I have been asked by the Board of Directors to discuss on this occasion the question of the scope of Institute activities which would seem to be required to ensure a continuing leadership of the profession. As these activities are or should be specified in our Constitution the prescriptions of that document must necessarily form the background of what I have to say. I must warn you that the conclusions at which I have ar-

rived and any suggestions I may make are the result of my own thought on the matter and must not be taken as an official expression of Board opinion.

First consider our objectives. From the very beginning these have been broadly two in number, (1) the advancement of the science and art of radio and allied branches of engineering, and (2) the maintenance of a high professional standard in the membership. These objects would seem to be as valid and adequate today as they were in 1912. They would seem to embody the "whole of the law and the prophets" for a professional society and their wording as given in Article I, Section 2, of the Constitution does not require any legalistic interpretation to make them applicable to present-day conditions. That is no small compliment to the framers of a thirty-two-year-old document.

Next consider the prescribed means of attaining these objectives. Specific methods for ensuring a high professional standard in the membership are provided in Article II. This article has recently been revised with the intention of concentrating the voting control of Institute affairs in the hands of those who make a profession of radio or electronic engineering, while leaving our doors open as they have been from the beginning to welcome those for whom our science or art is an avocation rather than a vocation. In addition this revision established two classes of full membership, one embracing those who have attained a position of responsible activity in their profession and the other, those nearer the beginning of their careers. I am aware that not all of us have been entirely happy over the name designations chosen for these two groups—possibly because of a fear that seniority might carry a taint of senility! The question of names aside however, I think that the principles underlying this revision mark a forward step in fulfilling our obligation to promote high professional standards, and one tending to a membership structure more in accord with the pace of the times.

But no matter what rules may be set up in Article II, we must recognize that the real guardian of our honor with respect to the maintenance of the professional standards of the membership is the Admissions Committee. To the conscientious labors of that committee we must in the future as in the past, look for the effective implementing of this important objective.

With respect to the means of attaining the other objective—that of promotion of the sciences and arts involved, only two are specifically named in the Constitution (Article I, Section 2), although the wording is such as to permit any means whatsoever provided it is "appropriate." Now other means than those specifically mentioned have been employed in the past and still others will probably be found advisable in the

* Decimal classification: R060. Original manuscript received by the Institute, January 25, 1944. Presented, Banquet, Winter Technical Meeting, New York, N. Y., January 28, 1944.

† Federal Communications Commission, Washington, D. C.

future. Hence I would suggest that a revision of the last sentence in this Section is in order both to bring it more closely into line with our charter provisions and to avoid any possibility of controversy as to the "appropriateness" of the "other" means which have been or may be put into effect.

The first of the means of advancing the radio and allied arts specifically mentioned in the Constitution is that of holding meetings for the reading and discussion of professional papers. In the providing of this means of advancement I think that it can be fairly said that the Institute has at least moderately well kept pace with a rapidly developing art. The holding of upwards of two hundred meetings per year (a figure representative of our immediately prewar activity) would offhand seem to furnish ample means of disseminating technical information suitable for presentation and discussion by word of mouth. Nevertheless the time has come to consider whether certain changes in the organization of our meeting activities should not be instituted.

As the radio art has expanded and its techniques have found ever-increasing applications in allied branches of science and engineering it has inevitably followed that the individual radio engineer has tended to become a specialist with his particular interest restricted to a relatively narrow part of the field. The present situation is very different in this respect from that which existed in the early days of the Institute when practically every member had a keen interest in every paper presented at a meeting. In contrast with that situation I have heard recently at one of our meetings two specialists in different lines each separately complaining of being bored by a paper on the other's specialty. If this attitude becomes at all general, it will carry with it a threat of disintegration—of the withdrawal of specialized groups to form organizations of their own.

Now the formation of associations of specialists has much to recommend it, provided the specialty is not too narrow and that it forms a natural subdivision of the whole field. I am not arguing against such affiliations. I am only concerned that segregations of this nature, which I am convinced are inevitable, should take place *within* the structure of the Institute and thus permit us to retain the great advantages and prestige of a large body to represent the profession before the public and in large co-operative enterprises. These problems of specialization are not peculiar to the Institute but are confronting nearly all of the national scientific and engineering societies.

There would seem to be two ways at least in which a reorganization of our meeting activities to avoid this possible splitting up of the Institute into smaller more specialized bodies may be accomplished. The first is by the formation of semiautonomous divisions—such as an Electronics Division, a Wave Propagation Division, a Transmitter Division, a Receiver Division, a Direction Finding and Ranging Division, a Measurements Divi-

sion, an Electroacoustics Division, etc., with one or more of which members would express their desire to affiliate. Each Division would have its own officers and arrange for its own meetings, conferences, etc., all under the general supervision of the Board of Directors. This type of organization would correspond in a broad general way with that of the American Society of Mechanical Engineers. If adopted by us it would probably require a considerable revision of our Constitution and might lead to some difficult problems in connection with our Sections, especially the smaller ones.

The second way of accomplishing the desired end is simpler and requires probably only minor changes in the Bylaws. It consists merely in enlarging the duties and responsibilities of certain of the existing technical committees to include those of arranging for and holding meetings and conferences in their own specialities, such as the successful prewar "Electronics" conferences. With certain additions to the present list of technical committees, this plan has been under discussion in the Executive Committee of the Board during the past year and I believe that with the coming of more propitious times—which we all trust will not now be long deferred—this or a similar move to attune our meeting activities more closely to the trend of the times will be put into effect. It may be that this second plan will in time grow into something quite like the first one mentioned. But we need not worry about that now.

One more of our obligations is to advance the art by holding meetings and conferences. Our membership is now so large and so widespread geographically that it would seem that possibly the time has come to inaugurate a planned program of regional conventions. For the holding of such conventions we have the precedent of our own prewar Pacific Coast Conventions as well as those of other National Engineering Societies. Action to this end may very well originate from certain groups of our sections which are geographically contiguous. I have no definite recommendations on the matter, but believe that in order to fulfill our duties in respect of meetings in a manner commensurate with our growth in membership we shall have to meet this problem adequately in the not distant future.

Turn now to the second of the means of fulfilling our objectives specifically mentioned in the Constitution—that of publication. In this respect no one questions that the Institute deserves a very high rating. The PROCEEDINGS has from the beginning maintained a high standard of excellence. For this pre-eminent position we are largely indebted to the devoted (and unpaid) services of those who have worked on the Boards of Editors and Readers and in particular, to Dr. Goldsmith who has functioned as Editor-in-Chief for all but one of the years from the very first. I am aware of course that *some* credit must be apportioned to the contributors, and also that there has been some criticism of the editorial policy, ranging all the way from

complaints of too high a content of "high-brow" articles to those alleging that too much "low-brow" material was being published. Such criticisms are however merely tributes to the fact that the PROCEEDINGS is a *live* journal and really stem from the critic's pride in and jealousy for its prestige.

With regard to our other main publishing activity, that of the Institute Standards, it is also incontestable that here also we have made a creditable effort to keep the pace with an advancing art. Our success in this activity has been due to the unpaid and unpurchasable services of the experts constituting our technical committees, and we must acknowledge that no small part of the prestige of the Institute in the radio world is to be credited to them.

But although we may have discharged our obligations with respect to publication reasonably well in the past, the question arises whether the rapid growth in the art does not demand more of us along these lines in the future. I think unquestionably that it will. The very breadth of the present-day field of radio and electronics is making it increasingly difficult to cover it all adequately in one journal. There is a demand both for an outlet for releasing new research and for authoritative surveys of recent developments covering particular fields. This points toward the publication of more than one journal, for which we have the precedent of the American Physical Society. It has further been suggested that the Institute should publish a "Handbook" which would carry a weight comparable to that of its "Standards." These are the principal suggestions as to increased publication activities which have been discussed informally in the Executive Committee during the past year. Although I am not prepared to recommend any increase in these activities at the moment, yet I believe that this question will be one of the most urgent ones facing us in the immediate post war period.

Let us next consider those "other" means of advancing the radio and allied arts, which though not mentioned in the Constitution have nevertheless been recognized as "appropriate" and have been employed in the past. The principal one of these has been that of co-operation with other bodies in matters of concern to radio engineers. Thus for many years there have been Institute representatives on various committees of the American Standards Association. We have also had representatives on numerous other scientific and engineering bodies, the most recent one of which to seek our co-operation is the National Research Council. We have co-operated with the Wireless Section of the British Institution of Electrical Engineers in the exchange of courtesies and privileges to visiting members and are looking forward to still closer co-operation after the war. Another and an outstanding example is that venture in co-operative enterprise which has culminated in the Radio Technical Planning Board of which we heard this afternoon. All of these and other similar

activities are certainly appropriate means of fulfilling our objectives and their use will be continued in the future, sanctioned by the provisions of our charter, if not explicitly by our Constitution.

Another means of advancing the art not prescribed in the Constitution and which has been employed, although very infrequently in the past, has been in the interpretation of the views of the profession to government departments and agencies. It is a somewhat delicate matter to exercise this function wisely. To the best of my knowledge it has never been exercised and it probably never will be except upon request by such an agency. From my limited experience of these matters it seems to me that it may be wise to set up some formal procedures to define our responsibilities as advisor or interpreter more clearly. In any case this is a means of advancing the art which we cannot side-step.

There is another "appropriate" means of fulfilling our objectives also not specifically provided for in the Constitution and one in respect of which we have done very little in the past, although steps have recently been taken by the Board for its more adequate implementing. This is the provision of suitable machinery designed to improve the professional standing and the degree of economic welfare of radio engineers. In the past our activities along such lines have been confined to the operation of a very limited placement service. What the committee which is working on this matter may recommend or what the Board may decide to do, I cannot, of course, say. I mention it merely as one of the items in broadened scope of Institute activities which is under consideration and one which I believe is very necessary to the continuance of our leadership in the profession.

I next turn to another means of achieving our objectives which is not only unmentioned in the Constitution but has also been regrettably neglected in our past history. Although we have official Institute representatives at various colleges and engineering schools, we have never set up any machinery for exerting a proper influence on the education of radio engineers. This is certainly an "appropriate" activity and it is a pleasure to report that steps are now being taken to remedy this omission. In my opinion this expansion of our activities will be an important factor in maintaining our leadership in the profession.

Time will not permit me more than merely to mention two further items of increase in the scope of our activities which have been suggested and are at present under consideration. These are the increase of our library facilities and the establishment of a book department through which our numbers can conveniently build up their personal libraries. These are both certainly "appropriate" means of serving the profession and should be prosecuted as promptly as may be possible.

From what I have said this evening, you may possibly infer that I believe in some considerable increase in the scope of Institute activities. You are right, I do. I

believe that a static Institute would be a moribund Institute and that the management should be continually on the alert to find new ways in which it can advance the art and serve the membership. But if we do expand our activities along some such lines as I have noted and hold ourselves alert for similar proper expansion in the future, the Board of Directors finds itself faced with a serious problem of management. For to handle efficiently our present activities with our greatly increased membership requires at least a fifty per cent increase of our headquarters office space, while to take care of even a modest expansion of the scope of our activities demands that the present space be doubled. A committee of the Board which has been working on the problem has come to the tentative conclusion that the costs of renting or of owning adequate quarters differ

so little that it would seem to be the part of wisdom to acquire a building of our own for the national headquarters. The consummation of this project will probably touch all of our individual pocketbooks—but not, I can assure you, to a burdensome extent.

In conclusion I want to say that as a result of my four years' service on the Board of Directors I am an optimist as to the future of the Institute. Every question that has arisen during this time has been approached and discussed, not from selfish or personal viewpoints, but in a sincere attempt to find the best solution for the good of the Institute as a whole. So long as such an attitude prevails you can be assured of an Institute which will successfully expand the scope of its activities to meet the needs of an expanding radio world.

Television Broadcast Coverage*

ALLEN B. DU MONT†, FELLOW, I.R.E AND THOMAS T. GOLDSMITH, JR.†, ASSOCIATE, I.R.E.

Summary—An extensive field survey has been made of the three television transmitters in the New York City territory. The survey consisted of observations of many receivers permanently installed in the metropolitan area and of observations made with special receiving equipment mounted aboard the cruiser *Hurricane II*. Continuous recordings of field strength and still photographs have been made.

This paper deals extensively with the multipath problem in television broadcasting which causes multiple patterns in the received picture. Extensive use is made of photographs and diagrams illustrating the appearance of these patterns and explaining the causes of these various types of "ghosts."

The findings of this survey definitely lead to the conclusions that the lower-frequency channels provide the least multipath interference in metropolitan territory such as New York City. Reasonably good reception is found from all three New York stations at distances beyond five miles up to the distances where signal level becomes too low for satisfactory receiver operation.

Photographs are used to exhibit the quality of reception and types of programs now current in good locations around New York City.

INTRODUCTION

IN THE deliberations of the National Television System Committee before the adoption of standards in June, 1941, very little attention was given to the effect of secondary images, also called reflected images or ghosts, upon the received signal. It was generally assumed that if a picture of 525 lines definition were faithfully transmitted and a receiver capable of reproducing that picture were employed the resulting image would show no appreciable loss of detail. It is quite understandable how this happened. The only transmitter in operation was transmitting on a fre-

quency between 44 and 50 megacycles, relatively few receivers were in operation, and the picture was not viewed in the critical way it is today. With the elimination of this channel to make room for frequency-modulation transmissions and television broadcast stations going into operation on frequencies between 50 and 84 megacycles it has become apparent since that time that secondary images are the number-one technical problem of the telecaster. Although this paper will cover television broadcast coverage generally, because of the importance of this subject particular stress will be laid on multipath conditions.

In understanding the problem of television transmission it must be kept in mind that, unlike audio broadcasting where multiple signals arriving several hundred microseconds apart cannot be detected by the ear, in television a difference of about 10 microseconds would cause one picture superimposed on the other but displaced one inch from it.

The results and conclusions are based on television transmissions in the area covered by the New York stations which extends in a radius of approximately 75 miles from Manhattan. Although this area may not be typical of conditions throughout the United States, nevertheless similar problems in secondary images will be experienced in any locality with tall buildings, bridges, or hilly terrain, and the other problems covered will be met with universally.

GENERAL RECEIVING CONDITIONS

There are three television stations transmitting in this area:

Station WNBT of the National Broadcasting Company operates on channel 1 (50 to 56 megacycles). Its antenna is 1300 feet high and its video transmitter

* Decimal classification: R270XR583. Original manuscript received by the Institute, December 13, 1943. Presented, Joint Meeting, Institute of Radio Engineers (New York Section) and Radio Club of America, December 1, 1943.

† Allen B. Du Mont Laboratories, Inc., 2 Main Ave., Passaic, N.J.

output is 6.0 kilowatts peak power while the sound transmitter operates at 3.5 kilowatts peak power.

Station WCBW of the Columbia Broadcasting System operates on channel 2 (60 to 66 megacycles). Its antenna is 1000 feet high and its video transmitter output is 2.5 kilowatts peak power while the sound transmitter operates at 1.0 kilowatt peak power.

Station W2XWV of the Allen B. Du Mont Laboratories, Inc., operates on channel 4 (78 to 84 megacycles). Its antenna is 650 feet high and its video transmitter output is 6.0 kilowatts peak power while the sound transmitter operates at 1.0 kilowatt peak power.

Transmissions are staggered, WNBT operating Monday afternoon and evening with films, WCBW operating on Thursday and Friday evenings with films, and W2XWV on Sunday, Tuesday, and Wednesday evenings with live talent and films. All three stations transmit test patterns Wednesday afternoon between 3:00 and 4:30 P.M. for service purposes. All transmitters are located near the center of Manhattan Island within a radius of 1 mile.

Some 6000 television receivers are in operation and are being used to receive the previously mentioned transmitters. As a considerable number of these were of the Du Mont manufacture and were installed by the factory, the field problems encountered have undergone careful study leading to valuable solutions. To start with, only one station was in operation (W2XBS of the National Broadcasting Company operating on 44 to 50 megacycles). As it was not known what other stations might be on later or on what frequencies, simple dipole antennas were installed with a twisted-pair lead-in (Fig. 1). This particular antenna was generally used ex-

cept in outlying areas where weak signals prevailed, in which cases a reflector would be added and a coaxial cable used to connect the antenna to the set to provide the maximum signal to the receiver (Fig. 2). When W2XBS shifted frequency to the new number one channel (50 to 56 megacycles) and became WNBT it was found advisable to cut the antennas so they would resonate at the new frequency to provide maximum signal strength and also to prevent deterioration of the

picture quality due to the narrow-band characteristics of the antenna. Considerably increased secondary images were noted on this higher-frequency channel and in a number of cases it was found advisable to install reflectors in high-signal areas to sharpen the directional characteristics and reduce secondary images. With WCBW of the Columbia Broadcasting System on a frequency of 60 to 66 megacycles and W2XWV of the Allen B. Du Mont Laboratories, Inc., on a frequency of 78 to 84 megacycles going on the air it was soon found

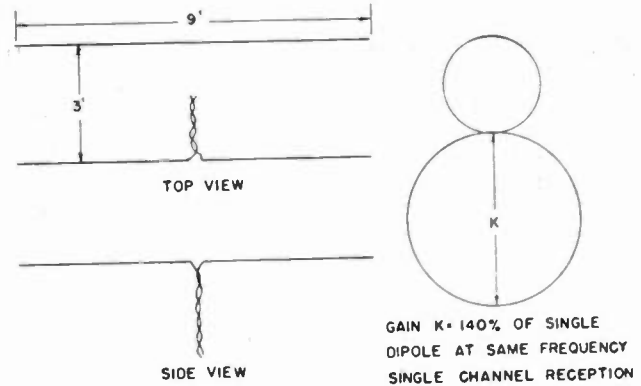

Fig. 2—Horizontal dipole and reflector.

cept in outlying areas where weak signals prevailed, in which cases a reflector would be added and a coaxial cable used to connect the antenna to the set to provide the maximum signal to the receiver (Fig. 2). When W2XBS shifted frequency to the new number one channel (50 to 56 megacycles) and became WNBT it was found advisable to cut the antennas so they would resonate at the new frequency to provide maximum signal strength and also to prevent deterioration of the picture quality due to the narrow-band characteristics of the antenna. Considerably increased secondary images were noted on this higher-frequency channel and in a number of cases it was found advisable to install reflectors in high-signal areas to sharpen the directional characteristics and reduce secondary images. With WCBW of the Columbia Broadcasting System on a frequency of 60 to 66 megacycles and W2XWV of the Allen B. Du Mont Laboratories, Inc., on a frequency of 78 to 84 megacycles going on the air it was soon found

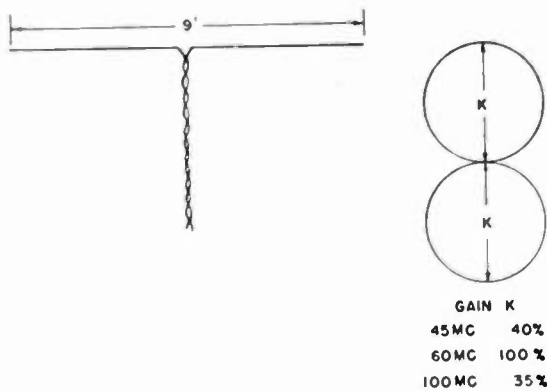

Fig. 1—Horizontal dipole.

Generally speaking the greatest difficulty has been experienced with secondary images within a radius of about 8 miles from the transmitters. This should be more or less expected as within that area the tall buildings, bridges, etc., of New York City are located. Difficulty is also experienced outside of this area where the receiving antenna is blocked by hills or buildings or is located between the transmitter and a prominent hill. Signal strengths of above 500 microvolts at the

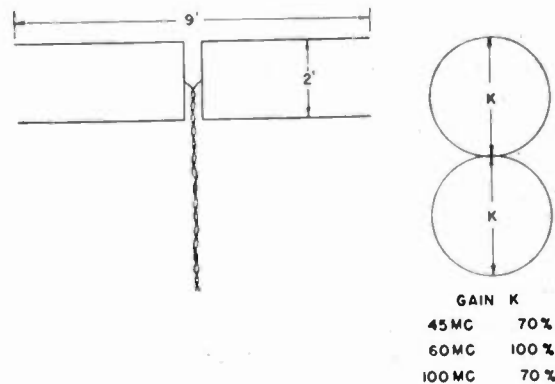

Fig. 3—Horizontal double dipole.

Signal strengths of above 500 microvolts at the

receiver have generally been obtained at distance up to 35 miles from WNBT and W2XWV, and up to 20 miles from WCBW. It has been found that signal strengths of 100 microvolts at the receiver are adequate in quiet locations.

Following is a summary of listener reports received by W2XWV in connection with its transmissions during the past nine months, which gives an idea of the distribution of receivers (Table I).

TABLE I
LISTENER REPORTS

Number of Reports	Location	Approximate Distance From Transmitter	Estimated Distribution Percentage
		miles	
53	Manhattan	0-5	9.8
44	Bronx	4-12	8.1
53	Brooklyn	3-13	9.8
70	Queens	3-15	12.9
56	Nassau County, N. Y.	13-30	10.3
6	Richmond County, N. Y.	10-20	1.1
32	Westchester County, N. Y.	12-30	5.9
1	Suffolk County, N. Y.	40	0.2
1	Orange County, N. Y.	55	0.2
21	Hudson County, N. J.	1-9	3.9
36	Bergen County, N. J.	4-20	6.6
36	Passaic County, N. J.	10-30	6.6
70	Essex County, N. J.	8-20	12.9
26	Union County, N. J.	11-25	4.7
6	Morris County, N. J.	20-35	1.1
9	Middlesex County, N. J.	20-40	1.6
5	Monmouth County, N. J.	25-40	0.9
1	Mercer County, N. J.	45	0.2
1	Sussex County, N. J.	45	0.2
2	Philadelphia, Pa.	85-95	0.4
14	Connecticut	25-50	2.6
543			100.0

It is interesting to note in this connection that a number of listeners at distances up to 100 miles are receiving programs. These listeners usually have erected 40- to 50-foot poles for their antennas and in some cases, have added additional radio-frequency amplification to their sets. At these locations the signal is influenced by atmospheric conditions.

While diathermy interference has not been particularly objectionable except in isolated cases, it may become a serious problem after the war if the use of diathermy machines is greatly increased. Hence it is important that action be taken to see that they are either assigned operating channels or, preferably, are adequately shielded.

Interference from automobile ignition has not been serious within a 40-mile radius from the transmitter. In a few cases it has been necessary to relocate the antenna to minimize its effect.

Practically no difficulty has been experienced from natural atmospheric (static and thunderstorms) within 40 miles from the transmitter. Over the past several years a receiver located about 20 miles from the transmitter has been operated during thunderstorms with lightning flashes close by, with no effect on the picture or sound.

The synchronism of pictures has been very satisfactory from all three stations on the majority of receivers and up to distances of 75 miles, provided multipath conditions are not too severe. It has been found necessary to use a ratio of not more than 2 to 1 between peak video transmitter power and peak sound transmitter power if

reasonably good sound quality is to be maintained.

FIELD TESTS

In order to obtain a comprehensive over-all picture, field tests of the signals radiated from the three television stations in New York City have been made using calibrated television receiving equipment installed aboard the cruiser *Hurricane II* (Fig. 4). The tests aboard ship have been found to be particularly useful as compared to a previous survey made with the equipment installed in a field-survey truck as all readings are

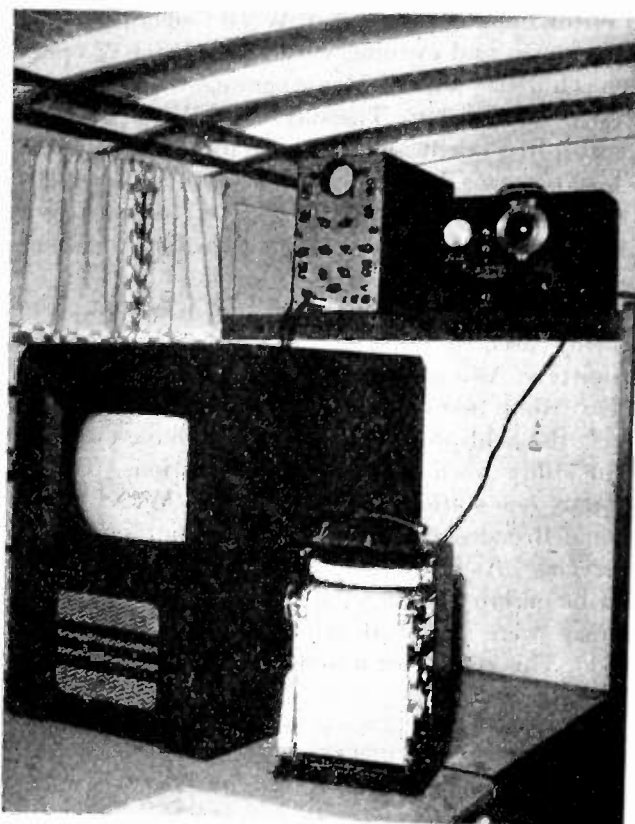

Fig. 4—Field-test recording setup.

taken at a fixed elevation, the readings are not influenced by always-present near-by structures as in the case of a field truck, and the cause of distant secondary images at considerable distances can be determined more readily. Waterways are available so a complete circle can be made of the transmitters and radials can be run in a north, east, and south direction. The field intensity was recorded on a continuous-paper Esterline-Angus 1-milliamperer recorder, running at a recording speed of 0.71 inch per minute. The sensitivity of the receiver was changed as necessary to prevent overloading of the recorder and the microvolts input to the antenna terminals of the set was measured for calibration using a Ferris type 18B microvolter. During the calibration the dial settings of the contrast control were recorded and the microvolts output from this microvolter were recorded. The calibration signals were applied to the antenna terminals through a 100-ohm resistor.

Although the recorder used gives valuable data and is generally sufficient for field measurements on audio transmitters, a film record of the received pictures at various intervals is necessary to interpret video results. In the case of dynamic rather than static secondary images a motion-picture record is vital. Films have been taken illustrating the results at various locations.

During the field runs, the antenna was connected to the receiver through a simplex cable and could be rotated to keep lined up with the transmitter (Fig. 5). The antenna was a double dipole, one section above the other, the signal being taken off from the centers of the two connecting bars joining the centers of the dipoles. The antenna center was approximately 15 feet above the water line of the boat.



Fig. 5—Receiving antenna.

Power for the receiver, the monitoring oscillograph, and calibrating microvolter, was taken from a 60-cycle, 115-volt generator, driven by one of the Chrysler marine engines.

Numerous test runs were made between the following points during the past three years (Fig. 6):

1. From Englewood, New Jersey, to Red Bank, New Jersey. (South)
2. From Englewood, New Jersey, through the Harlem River and out the Long Island Sound to Huntington, Long Island. (East)
3. From Englewood, New Jersey, up the Hudson River to Croton-on-Hudson, New York. (North)
4. From Englewood, New Jersey, to Hackensack,

New Jersey, through the Hudson River, Lower Bay, Newark Bay, and Hackensack River.

5. Circuit of Manhattan Island.

The recorder records show interesting phenomena of interference patterns and rapid variations of signal intensity where buildings and terrain offer interfering and reflecting surfaces.

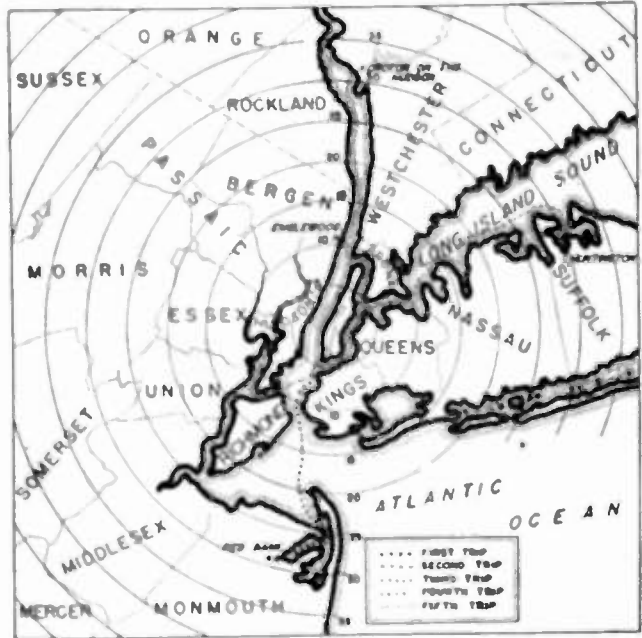

Fig. 6—Map showing percentage of receivers by county and location of recordings shown in Figs. 23, 26, 27, and 28.

GHOST PATTERNS

Several types of ghost patterns have been observed, some of which may be briefly classified as follows:

- | | |
|-----------------------|------------------------|
| Type A—Fixed ghost | Type D—Pulsating ghost |
| B—Smear ghost | E—Negative ghost |
| C—Racing ghost | F—Bouncing pattern |
| G—Synchronizing ghost | |

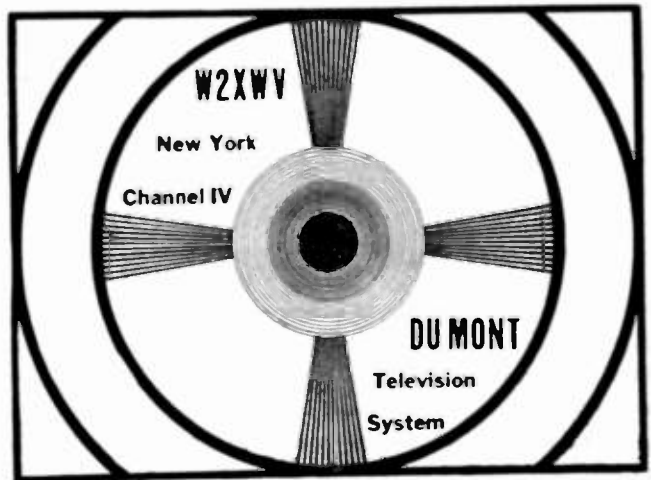

Fig. 7—Test pattern.

These ghost patterns are most readily observed when the receiver is in motion, but these characteristic

interference patterns can be interpreted for many fixed-location receiving sets.

The type A (fixed ghost) and type B (smear ghost) are the most common.

As a number of examples of distorted test patterns are shown later, Fig. 7 illustrates the test pattern used at the receiver and Fig. 8, this test pattern as observed on the station monitor.

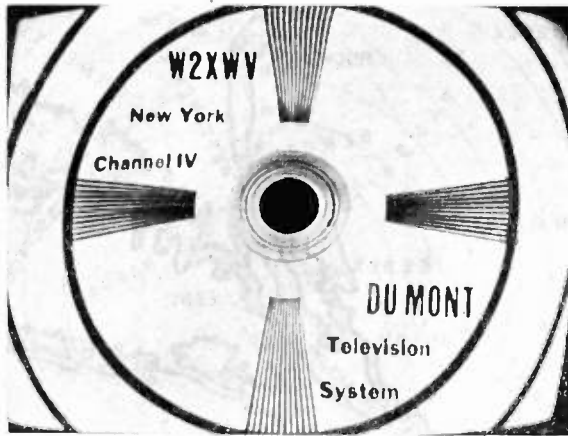

Fig. 8—Pattern on station monitor.

Type A—Fixed Ghost

A fixed ghost appears as another and generally weaker pattern displaced usually to the right of the main pattern. It may be caused either by a reflecting object near the receiver (Fig. 9), or near the transmitter (Fig. 10),

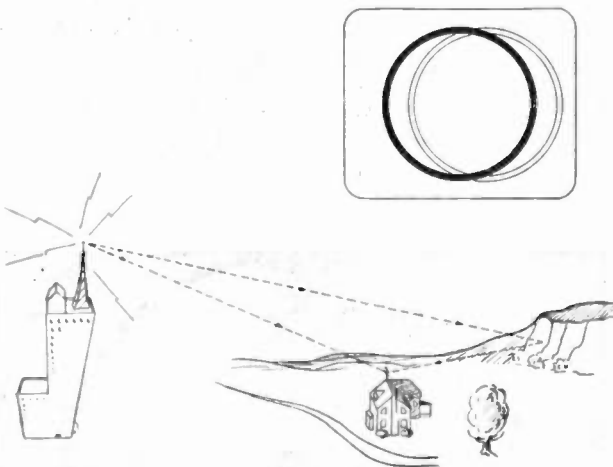

Fig. 9—Type A—fixed ghost. Reflection near receiver.

or at some intermediate point. In certain cases this reflection only occurs within a narrow arc (Fig. 11). The three figures illustrate only a few of the many position conditions which can produce a rather crisp displaced pattern in addition to the main picture. For such a fixed ghost, a reflecting object near the transmitter can give appreciable energy to the receiver over a path of greater distance than the straight line from the transmitter to the receiver. If the receiver is at rest or else is moving in a direction such that the difference in these two paths is

not changing rapidly, then the ghost pattern may remain essentially fixed and be of an unchanged relative intensity with respect to the main pattern.

An ellipse diagram is useful in determining the relative position of transmitter, secondary target, and receiver for these fixed ghosts. The displacement of the ghost pattern from the main pattern can be measured on the face of the cathode-ray tube. From this displacement measured in inches, converted to microseconds, one can then compute the difference in path length of

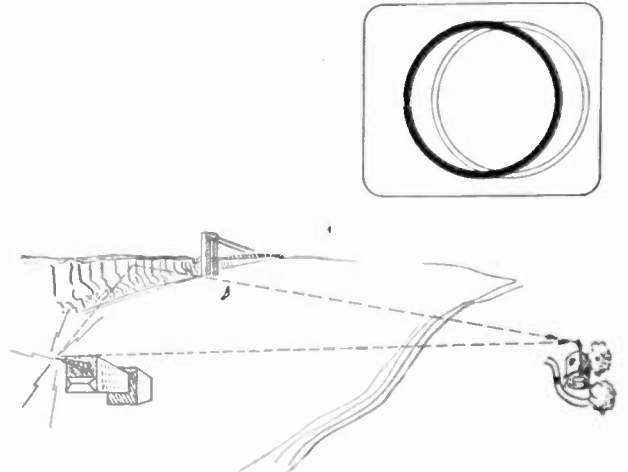

Fig. 10—Type A—fixed ghost. Reflection near transmitter.

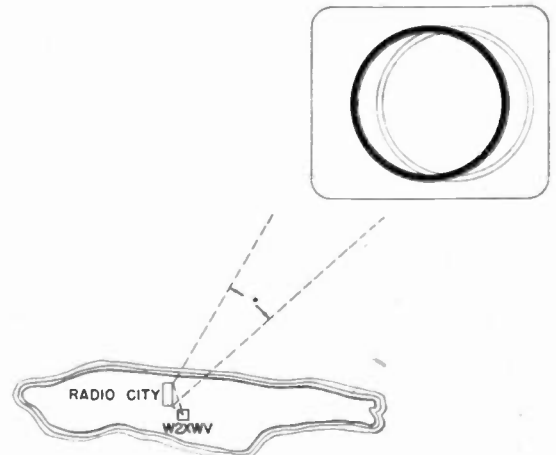

Fig. 11—Type A—fixed ghost. Narrow-angle reflection near transmitter.

the ghost path over the direct path from the transmitter. The ellipse pattern can then be drawn. Place a dot representing the transmitter on paper and another dot representing the receiver at a distance proportional to the distance from transmitter to receiver. These dots will be the foci of an ellipse. To determine the amplitude of the ellipse, next plot a point on the line extended from the transmitter through the receiver and at a distance beyond the receiver proportional to half the path difference computed from the cathode-ray-tube screen. This would locate one possible target which could cause the spurious-ghost pattern. Now using this point, describe through it an ellipse about the two foci. A reflecting object located anywhere on the ellipse could

produce a type A fixed-ghost pattern of the measured displacement observed on the cathode-ray-tube screen. Many times the use of such an ellipse plotted directly on a map will help in identifying the sources of ghost images. Ghost patterns displaced a lesser or a greater amount will require respectively thinner or fatter ellipses about the same foci for a given transmitting and receiving location.

Some examples of type A ghosts might be mentioned. In Fig. 9 is a condition quite prevalent in Montclair, New Jersey, where the antenna is located between the Watchung Mountains and the New York transmitters. It can be considerably reduced by directive antennas using reflectors. Fig. 12 is a typical pattern

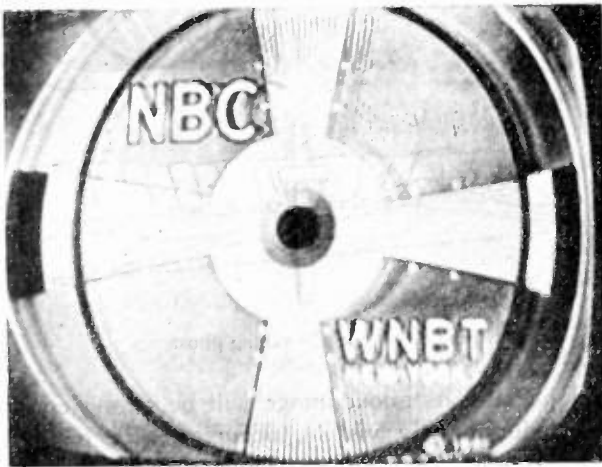

Fig. 12—Reflection $\frac{1}{2}$ mile from receiver.



Fig. 13—Reflection $\frac{1}{2}$ mile from receiver.

where the receiving antenna is approximately one eighth of a mile from the mountain and Fig. 13 where it is located about one-half mile away. It also occurs in Maywood, New Jersey, and other points in a small sector as shown in Fig. 11. This condition is very difficult to correct as the angle between the direct and secondary image is extremely small so a directive antenna does not help. Some improvement has been accomplished by

using two antennas and feeding the output into a phasing arrangement to cancel out the secondary image.

Type B—Smear Ghost

In the smear ghost, the receiver path has no separate and distinct test patterns displaced, the order of $\frac{1}{4}$ of an inch to an inch from the main pattern, but particularly the wedged lines which run vertically appear blurred and have no crisp definition. Such loss of high-frequency resolution may be expected when the receiver is located at a point such that practically no direct energy is received, but nearly all of the energy at the receiving antenna comes over paths reflected from near-by objects, Fig. 14. If these reflected energy

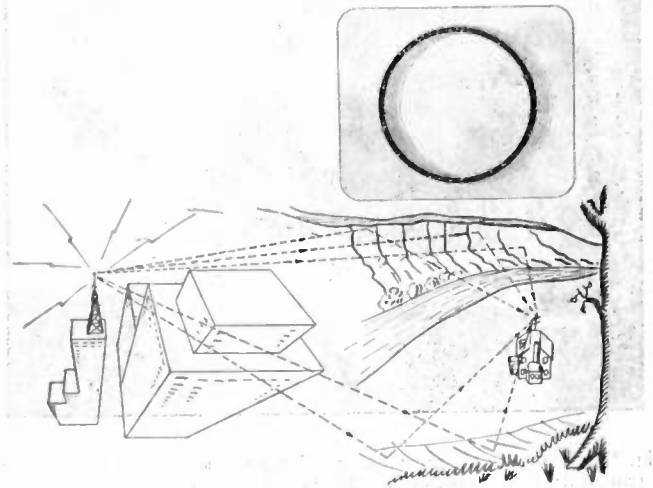

Fig. 14—Type B—smear ghost.



Fig. 15—Example of smear ghost. Test pattern as received 45 miles from transmitter with 1600-foot hill between receiver and transmitter.

paths are numerous and have only small differences in path, then the several patterns received will not be appreciably displaced, but will tend to smear one another, causing poor resolution. In some cases, the wedge running vertically in the test pattern can exhibit periodical regions of good and poor resolution running down the wedge. This smear ghost is quite common at

fixed-receiver locations in New York City where the receiver is located in a canyon between several tall reflecting buildings. If a receiver is in motion, such that a number of local reflecting surfaces give the main energy to the receiver, then these smear ghosts can come and go with the relative motion of the receiver antenna. Figs. 15 and 16 show typical patterns. They were taken in Warwick, New York, a town situated 45 miles from the transmitter and located in a valley with no direct signal path from the transmitter. A 1600-foot hill screens the receiving location from the transmitter.



Fig. 16—Example of smear ghost. Picture as received 45 miles from transmitter with 1600-foot hill between receiver and transmitter.

Another typical location is in the Hudson River Valley between the George Washington Bridge and almost to Tarrytown, New York. At some spots in this section it occurs even though the transmitting tower can be seen from the receiving location.

Likewise a receiving antenna located on the top of the 42-story building at 515 Madison Avenue, which houses the Du Mont transmitter, about 1 mile from the National Broadcasting Company's transmitter on the Empire State Building and in direct line of sight, cannot resolve more than a 200-line definition picture from NBC. This is because of the many secondary images from numerous buildings.

Type C—Racing Ghost

The appearance on the screen for the racing ghost is a main image of good intensity with ghost patterns of relatively weak intensity which appear to travel rapidly across the main image when the receiver is in motion. However, the direction of travel of this racing ghost may be either left to right or right to left depending upon the relative motion of the receiver with respect to surrounding objects. A probable explanation of such racing ghosts is reception of signals from an extended headland scattering reflections from any portion of the headland (Fig. 17). The receiver will accept a direct signal from the transmitter not reflected by such a head-

land. Other signals are received over several different paths but reflected from the extended headland. At a given position of the receiver, some one of these reflected-path signals will arrive in phase with the direct carrier and consequently will register a ghost pattern, say, 3 inches to the right of the main pattern. However, upon a small motion of the receiver, say parallel to the headland, this 3-inch displaced-ghost signal will no longer arrive in phase, but may arrive out of phase and thus be practically neutralized, whereas energy over one of the other reflected paths now may be in phase with the

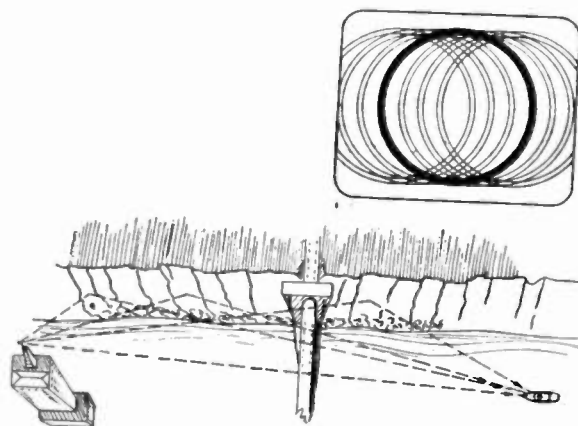

Fig. 17—Type C—racing ghost.

main signal and its ghost image will be strong enough to be predominantly visible, occurring, for example, at a displacement of $2\frac{1}{2}$ inches. In the same way, as the receiver moves along for a wavelength or so further, other reflected-path signals may cause the predominating ghost to appear at 2 inches, $1\frac{1}{2}$ inches, and 1 inch, for example, causing an appearance of a traveling ghost, racing from right to left across the main pattern. If the receiver moves in the opposite direction, then one should expect the racing ghost to appear to move from left to right.

Among the places this condition has been noted are along the Palisades below the George Washington Bridge and at the confluence of the Harlem and East Rivers.

Type D—Pulsating Ghost

A pulsating ghost has been observed wherein the ghost image is displaced to the right of the main image and in which the ghost image will vary up and down in intensity while the main image stays nearly fixed in intensity, (Fig. 18). Such a pulsating-ghost image was observed when approaching the Whitestone Bridge, as the boat sailed east from the transmitter. The displacement of the ghost image from the main image could be correlated with the distance to the Whitestone Bridge and as the Whitestone Bridge was approached the ghost pattern came closer and closer to the main image. As the signal of the reflected pattern beat successively in phase and out of phase with the signal over the direct path, the ghost image was intensified and annulled. As

soon as the boat passed the bridge a steady signal with no secondary images was obtained.

It was observed that the reflected signal in the case of WNBT's transmission on 50 to 56 megacycles was weaker than the direct signal while the reverse was true in the case of W2XWV operating on 78 to 84 megacycles when the boat was near the bridge. In this case the reflected signal was more than three times the signal

the normal test pattern and indicates a negative ghost appearing as a white vertical bar.

Fig. 20 illustrates this negative ghost wherein the lettering appears displaced well to the right of the picture and seems to be white instead of the original black.

One of the locations where this has been observed is in the Hudson River above the George Washington Bridge for a distance of about five miles.

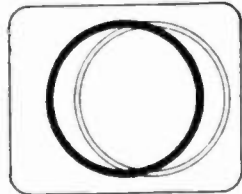

GHOST VARIES IN INTENSITY.

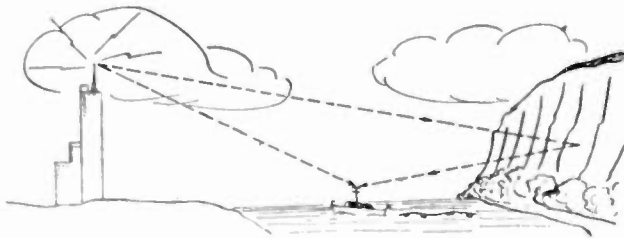

Fig. 18—Type D—pulsating ghost.

strength of the direct signal, and at some points this delayed signal actually took over synchronizing of the receiver, causing the direct-path signal to appear with weaker intensity to the left of its normal position on the face of the cathode-ray tube.

This same condition prevails around the many bridges around New York City. Its effect extends for about one-half mile from the larger bridges (i.e., Whitestone and George Washington).

Type E—Negative Ghost

Under some conditions, a main image, say of a black signal, can be observed while a ghost image appears

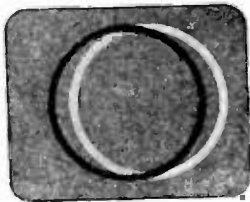

Fig. 19—Type E—negative ghost.

displaced some distance to the right, the ghost image being white instead of black, thus being reversed in polarity. Out-of-phase ghost signals combined with a gray field produce reversed intensity which is frequently observed (Fig. 19). Another simple way of observing such a ghost pattern is the appearance of the horizontal blanking signal displaced slightly from the left side of the picture. Since this signal is no longer blacker than black, this blanking signal appears upon



Fig. 20—Negative ghost.

Type F—Bouncing Pattern

1. Sometimes a test pattern will be present which has good resolution and which has practically no displaced-ghost pattern at all, but nevertheless this rather clean pattern will rise and fall in intensity. Such a pattern could be produced where the receiver gets no direct signal from the transmitter but gets two approximately

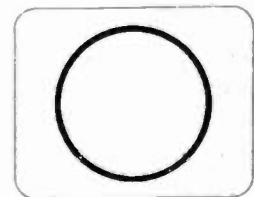

PICTURE VARIES IN INTENSITY

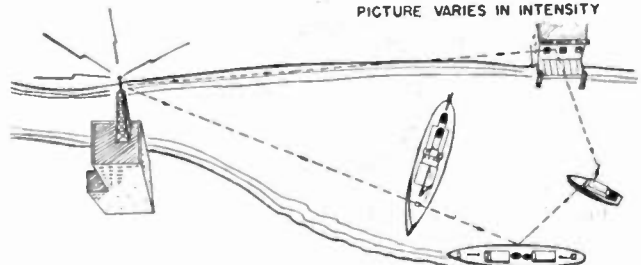

Fig. 21—Type F—bouncing pattern.

equal intensity signals over approximately equal paths from rather widely separated reflecting objects (Fig. 21). If the receiver is moving with respect to these two objects, then the energy over these two nearly equal length paths will combine so as to give resultant energy varying over a possible value from nearly zero to

approximately twice the energy of each path separately.

2. If the path difference is only slight, but insufficient to produce a predominantly visible displaced ghost, then a receiver at rest could exhibit this bouncing pattern where the pattern varies up and down in intensity if the transmitter frequency should vary slightly and periodically.

3. A bouncing pattern can be produced where energy is received directly from the transmitter over the main path and energy is also received over a path reflected by a bridge between the receiver and the transmitter and at some distance from the receiver so that the angle between these two received signals is very small. In this case the energy reflected down from the bridge may be of approximately the same magnitude as the energy over the direct path due to the fact that the bridge received its energy with less attenuation than the energy over the direct path beneath the bridge since a direct path would be, let us say, much closer to the salt water. The receiving antenna would accept the signals over the two paths with very little time delay between the two. Still, as the receiver antenna moves there would be a beat in and out of phase of the two carrier signals.

4. A bouncing pattern can be observed both on the direct-path pattern and on ghost patterns when a receiver is at rest and a surface of reflection of secondary energy is in motion. A typical example of this type of interference has been observed where an airplane flying overhead makes a direct-energy pattern go up and down in intensity. With careful observation of the interference, it sometimes can be seen that the airplane causes a displaced ghost to appear and disappear periodically, but this ghost is frequently of very low intensity compared with the main pattern.

Type G—Synchronizing Ghost

Under some conditions, it has been noticed that a pattern may have certain ghosts present, but is reasonably constant in intensity while the synchronizing signals come and go (Fig. 22). This type of interference is



Fig. 22—Type G—synchronizing ghost. Picture loses synchronization.

best observed by noting the "tear-out" of the pattern horizontally which recurs cyclically and also by noting the video signals on the oscillograph. On the oscillograph the synchronizing signals seem to go up and down in intensity while the major video components remain relatively unchanged. These distortions of the synchronizing wave forms upset the normal function of the "front porch" of the synchronizing wave forms so that

the "tear-out" of the pattern is influenced by the relative blackness or whiteness of the associated lines of the picture. For example, the relatively dark portion of the wedges in the center of a test pattern may cause "tear-out" at the point in the presence of synchronizing ghosts while the relatively brighter portions of the remainder of the test pattern remain reasonably stable. The low-frequency-response characteristics of the television-receiver synchronizing circuit will cause certain receivers to be more susceptible than others to synchronizing-ghost interference. The best way to diagnose the presence of synchronizing ghosts is the observation of the video wave form on an oscillograph, wherein the blacker-than-black level cyclically is depleted of all signal while the picture region of the video wave forms remains relatively unchanged. A possible cause for such synchronizing ghosts might be the beats in and out of phase of a secondary-path signal which arrives displaced in time, approximately the duration of the horizontal synchronizing signals period. The bobbing up and down of the synchronizing components may also be related to those causes of negative-ghost patterns.

While the preceding analysis might lead one to believe that only one of these various types of ghosts are present at one location actually one or more may be present.

RECORDINGS

While it is impracticable to reproduce the Esterline-Angus recordings in full as some of them are in excess of 30 feet in length, sections have been picked out for comment. The recordings and observations made on various trips show a number of interesting effects which had been suspected from the results of the installation of receivers. These may be summarized as follows:

1. From the George Washington Bridge to the Narrows (in the Hudson River), large variations in signal strength may be expected. These variations in many cases occur within relatively short distances (not over 50 feet). In this section, secondary images of various types are prevalent for most of the distance. The same condition holds true for the entire length of the Harlem River and for the East River from the Battery to the Hell Gate Bridge.

2. From the George Washington Bridge to Dobbs Ferry (in the Hudson River) the picture is smeared considerably.

3. From Dobbs Ferry northward, a ghost-free pattern is obtained and from Hell Gate Bridge eastward out the Long Island Sound the same is true except while passing under the Whitestone Bridge and a ghost-free pattern is also obtained from the Narrows southward.

4. In runs made to determine the maximum range of the transmitters it was found that with a ratio of 2 to 1 between the video and audio transmitter the best balance between them was obtained.

5. No difficulty was experienced with synchronization at extreme distances even when the video signal could be just observed.

6. Secondary images became progressively worse on the stations operating on the higher frequencies.

In Fig. 23 is shown a typical recording made in the Harlem River on channels 1 and 4. It will be observed that variations in signal strength of up to 500 per cent may be experienced in distances not over 100 feet apart.

test patterns are observed, secondary images are considerably worse on channel 4 than channel 1. This is shown best by studies with motion-picture-film records.

In Fig. 26 a recording is shown of the signal strength variation on channel 1 and channel 4 when passing under the Whitestone Bridge. It will be noticed that

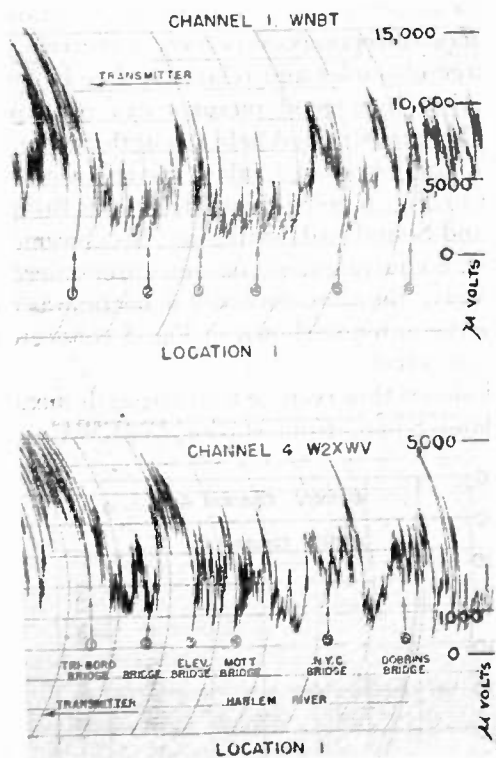

Fig. 23—Field-strength variations in Harlem River.

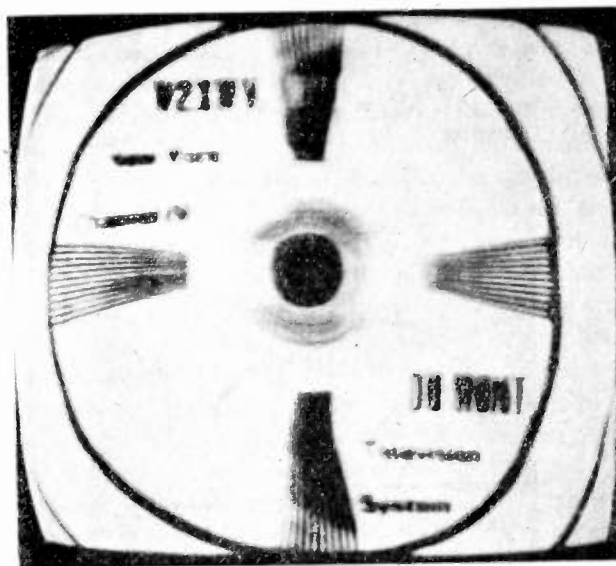

Fig. 25—Example of pattern in Harlem River.



Fig. 24—Example of pattern in Harlem River.

Figs. 24 and 25 illustrate the wide variation in quality of received signal in the Harlem River within a relatively short distance. It is apparent from Fig. 23 that, although the variations in signal strength are somewhat worse on the higher frequency channel 4, the effect is quite similar on channels 1 and 4. However, when the

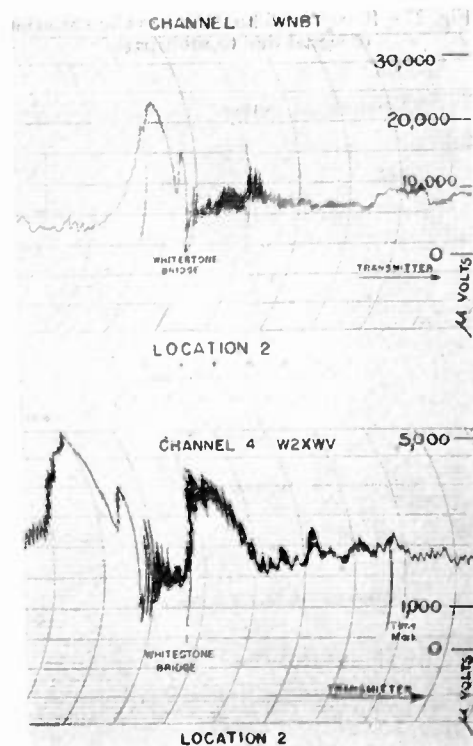

Fig. 26—Field-strength near Whitestone Bridge.

the increase in signal strength of the reflected signal is considerably greater for channel 4 than for channel 1. This is also confirmed by noting the test patterns in which the density of the direct and reflected patterns can be observed.

Fig. 27 shows a typical recording obtained where the transmitter is shielded from the receiver, thus providing no direct signal.

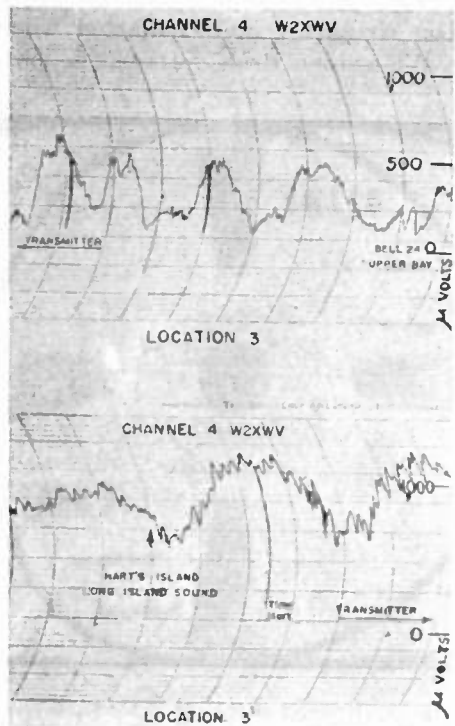

Fig. 27—Recording illustrating cyclic variation of signal due to multipath.

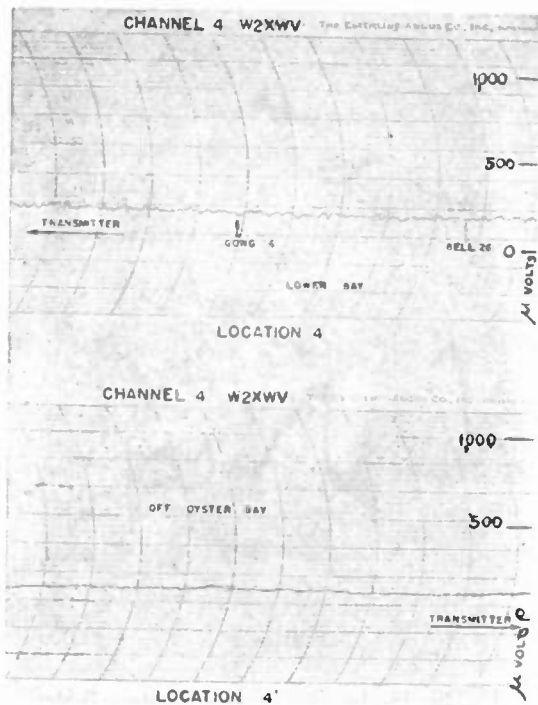

Fig. 28—Stable signal at a distance when receiver is in the clear from the transmitter.

In Fig. 28 are recordings taken in Long Island Sound off Oyster Bay and in the lower New York Bay. Its variations are typical of the signal at distances greater

than approximately eight miles from the transmitters in Manhattan.

The field patterns produced by the transmitters on channels 1 and 4 have been averaged from the recorded signal strengths. The actual recordings show extreme variations in regions where buildings cause multipath reception, an average signal drawn through these curves indicates a satisfactory field strength to distances of 35 miles in most directions. Wherever a receiving location free of large obstacles and relatively free of local interference exists then good pictures can be expected. A study of the unobstructed field strength can be obtained best from the recordings taken on the second trip illustrated in Fig. 6 going from Hell Gate Bridge out in Long Island Sound to Huntington. Measurements were made of the equivalent signal generator microvolts required to give the same recorder deflection as that produced by the antenna shown in Fig. 5 connected to the television receiver.

Fig. 29 shows this average field strength measured out Long Island Sound from station W2XWV, channel 4

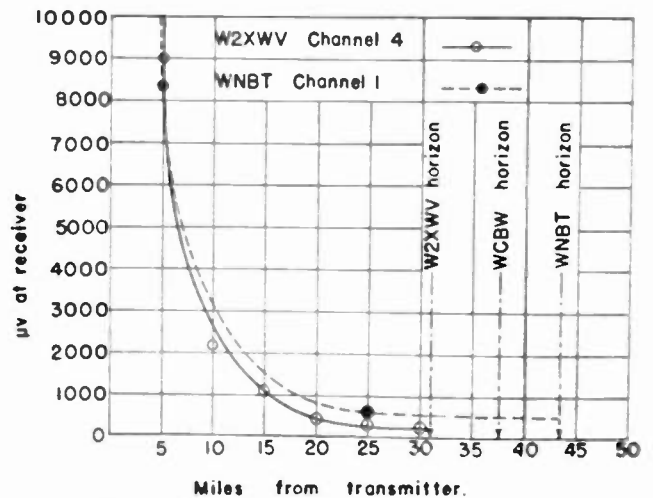

Fig. 29—Measured microvolts at the receiver.

and station WNBT, channel 1. It is difficult to arrive at a figure of absolute microvolts per meter since the characteristics of the antenna and transmission line are not completely accounted for in this method of field-strength measurement. However, the curves indicate very accurately those signal strengths available for operation of the average television receiver.

MULTIPATH EFFECTS ON FREQUENCY-MODULATION SOUND CHANNEL

The quality of the frequency-modulation sound accompanying the picture transmissions has been studied along with the picture-signal-strength recordings and photographic picture records. It was found that the sound quality varies tremendously in territories where picture multipath conditions exist. As would be expected the sound intensity varies over a rather wide range in a relatively short distance of motion of the receiving antenna.

However a much more serious condition was observed wherein the frequency-modulation sound quality was found to be permanently degraded for certain fixed locations of a receiving antenna. This degradation of the sound quality is to be expected with frequency-modulation transmission when multipath conditions exist. The sound becomes quite distorted as though an overload condition existed at even a low sound level. Let us consider, for example, the condition where a main signal arrives at the antenna over path P_1 which has a total path length d_1 . When a second path P_2 having a path distance d_2 provides considerable energy to the receiving antenna the frequency-modulation receiver will respond to the summation voltage from these two signals. If $d_2 - d_1 = \Delta d$ and is of the order of 1000 meters then this will be 200 wavelengths of the rest frequency of a frequency-modulation transmitter whose wavelength is 5 meters or 60 megacycles. In this case both signals will arrive in phase with one another and will reinforce each other to provide a strong receiver signal. However, a slight displacement of the receiving antenna to a new location will cause a change in Δd say of half a wavelength and the two signals then arrive out of phase and if each is of approximately the same magnitude they can practically cancel each other. Unfortunately where frequency-modulation transmission is present the swing in frequency of the transmitter can cause this same effect of successive reinforcement or cancellation as is experienced with a small displacement of the receiving antenna. This condition becomes most critical when Δd is a number of wavelengths plus a fraction of a wavelength such that the resulting receiver signal is just above the limiter level. Now when the audio modulation is applied at the transmitter the frequency swing will cause the receiver signal to be reinforced on one phase of its swing and cause the signal to be annulled on the other phase of the swing to such an extent that the limiter momentarily goes out of operation. When this happens a very serious distortion occurs.

In effect the multipath conditions literally transform the constant-amplitude variable-frequency radiated signal into a signal which is variable in amplitude and variable in frequency, thus making it impossible for the receiver to take this signal and utilize it for high-quality reproduction through its limiters and sloping discriminator. The presence of several multipath signals unfortunately does not offer a smooth discriminator slope in its generation of amplitude modulation upon the carrier.

Multipath conditions are common in which two signals of approximately equal strength arrive at a receiving antenna and therefore this type of distortion with frequency-modulation sound transmission can be expected to occur frequently.

In a region where multipath conditions exist, it is difficult to find any one location for the receiving antenna where good sound quality is available from several different frequency-modulation stations.

Since this distortion of frequency-modulation sound

is related to the phase shift between two signals arriving over different paths, then the distortion will prove more serious on shorter wavelength stations such as the higher television channels than on the television channel 1 or the present frequency-modulation broadcast channels.

The time delay of 5 to 50 microseconds between signal over one path and signal over another path gives very little noticeable distortion to the audio signals as such since this time interval is quite short in comparison with the period of the highest audio frequencies in use.

In the past several years transmissions were first made on amplitude modulation and then with modification of standards frequency modulation has been employed on the sound channel. Field tests generally have shown satisfactory sound reception in most cases, but in a number of cases reports from the field indicate that the sound quality is worse with frequency-modulation transmission than it was previously with the amplitude-modulation transmission. It is, therefore, worth while to consider seriously the fundamental advantage of amplitude-modulation transmission of the sound to regions where multipath conditions abound.

Fortunately amplitude-modulation sound transmission is free of some of these distortions. If the receiving antenna receives appreciable energy then the antenna is not subject to this pseudo displacement by a fraction of the wavelength in position which is experienced with the frequency-modulation reception.

MULTIPATH EFFECTS ON COLOR

Just before the war started considerable field experimentation was carried on with color television. Only a few complete color receivers were operated in the field though many receivers were provided which could receive these transmissions in black and white. Although a complete study of color reception in multipath receiving locations has not been made, the multiple images in color become even more serious than multiple images in black and white due to the improper blending of colors at the receiver. For example, a green portion of a main pattern may have superposed upon it a red portion of a displaced ghost pattern causing both patterns to be rendered in false colors. Since multipath problems become more serious at the higher frequencies it is expected that the best color transmissions will be possible on the lower-frequency channels.

FREQUENCY-MODULATION VIDEO TRANSMISSIONS

A few test transmissions have been made using frequency modulation on the video transmitter. Reasonably good reception was experienced where only a crisp direct-path signal was received. However in the presence of multipath received signals the frequency-modulation transmission of pictures proved very unsatisfactory. This is to be expected since the much wider frequency shift with pictures augments the difficulties already outlined for sound transmission. Under certain multipath conditions a change in level from black to white would

cause the receiver detected signal to go through several null voltages while the transmitter is making a uniform frequency swing over its 4-megacycle range. Obviously these distorted wave forms cannot reproduce a crisp undistorted picture. The appearance of the ghost patterns produced when frequency modulation of the video is employed shows displaced images of about the same displacement as with amplitude modulation but much more prominent in contrast. For multipath pictures received by amplitude modulation which could be con-

1. The prime requisite is a method to eliminate secondary images (ghosts) which become worse with higher frequencies.

2. Diathermy interference is worse on channel 1 than channel 4. Although this generally is not serious, a plan should be worked out gradually to eliminate it.

3. Automobile ignition is not particularly serious and usually can be corrected by antenna design or location.

4. Natural atmospheric are noticeable only at extreme ranges.

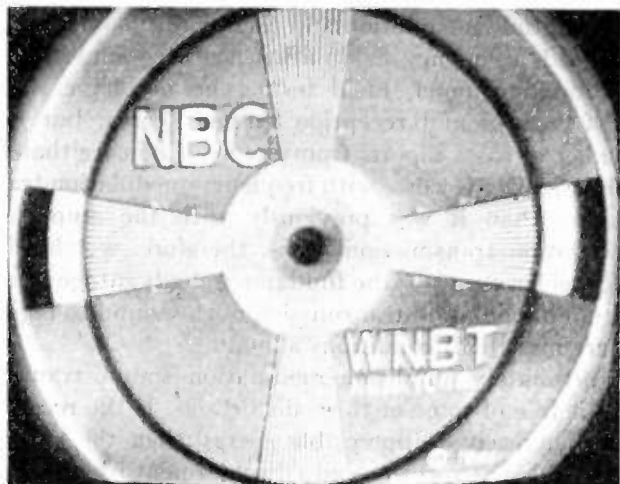

Fig. 30—Channel 1. Test pattern as received on prewar receiver in average location.

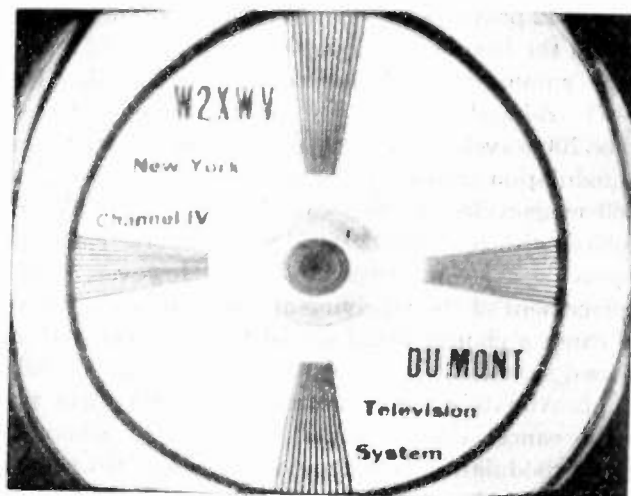

Fig. 32—Channel 4. Test pattern as received on prewar receiver in average location.



Fig. 31—Channel 2. Test pattern as received on prewar receiver in average location.



Fig. 33—Picture quality in recent transmissions.

sidered reasonably satisfactory, the corresponding frequency-modulation pictures were hopelessly degraded.

Frequency modulation, with its higher transmitter efficiency does prove promising for relay transmission purposes where both the transmitting and receiving locations can be suitably chosen to have very little multipath difficulty.

TELEVISION CONCLUSIONS

By way of summary the following points are presented:

5. Particular attention must be paid to antenna design to cover a wide frequency band and reduce secondary images.

6. Particular attention must be paid to the type of lead used so as not to discriminate against the higher-frequency stations.

7. In practice a power ratio of 2 to 1 of the video transmitted power to the audio works out satisfactorily.

8. Synchronism difficulties with either type of pulse are minor even at extreme ranges.

9. No interference between stations has been detected.

10. Increased transmitter power will reduce present troubles very materially.

The major portion of this paper may have given certain readers the impression that television is not very practical due to the multipath conditions. However this is far from true since a great many locations in and around New York are excellently suited for the reception of good programs from the three existing New York transmitters. The enthusiastic listener response to the rather extensive programs which were possible before the war and the somewhat curtailed programs of the present time indicate that television is very satisfactory as a medium of entertainment and education. Figs. 30, 31, and 32 illustrate the test-pattern reception available from the three New York transmitters as photographed recently from a prewar receiver in an average location. While still further improvements in quality of reception can be obtained the pictures are quite satisfactory. Figs. 33 and 34 illustrate the picture quality available via television in recent transmissions.

Television in New York is ready technically to render an excellent service within the present standards and is awaiting an opportunity to resume its expansion with improved transmitting and receiving equipments and extended programs when the war allows it.



Fig. 34—Picture quality in recent transmissions.

Circuit for Generating Circular Traces of Different Frequencies on an Oscillograph*

W. D. HERSHBERGER†, ASSOCIATE, I.R.E.

Summary—A circuit is described which enables two circular timing traces to be placed on a cathode-ray oscillograph. Switching from one trace to the other is effected at a superflicker rate so they are viewed "simultaneously." The circle frequencies normally are in the ratio of five or ten to one; thus, when the same transient is viewed on both scales, the slow sweep gives a general picture of the phenomenon being studied and the fast sweep allows a more detailed examination of a chosen portion of the transient. The analysis of the circuit yields the information needed for element design.

IN equipment using cathode-ray oscillographs it is often desirable to make measurements simultaneously on both compressed and extended scales. These measurements may involve the determination of such quantities as phase differences or the time interval which elapses between the occurrence of two events, or one may wish to examine transient phenomena simultaneously on two such scales. The compressed scale will give a general picture of the transients being studied, while the extended scale makes possible a more detailed and precise examination of the same transients. This paper describes a method which is used to produce two timing circles on a single oscillograph. Switching from one circle to the other is accomplished at a rate so high that owing to the persistence of vision both circles are viewed at once. The ratios of circle frequencies used most often are five to one and ten to one. Conventional

methods for producing radial deflections of the beam in the cathode-ray oscillograph may be used.

Ordinarily, one produces a circular sweep on an oscillograph by impressing a sinusoidal voltage on one set of deflecting plates, and at the same time impressing on the second set of plates a voltage differing in phase from the first by ± 90 degrees but having the same amplitude. The present equipment uses the same general method, only a single network accomplishing the desired result at two frequencies bearing a required ratio to one another.

At a single frequency, the deflecting voltages may be derived from $L-R$, $C-R$, or tuned networks. This last method is particularly useful if the impressed wave form

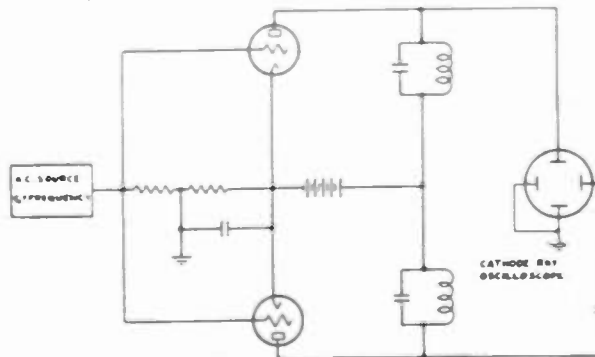

Fig. 1—Circuit for circle generation at a single frequency.

* Decimal classification: R140XR388. Original manuscript received by the Institute, July 23, 1943; revised manuscript received, October 1, 1943.

† RCA Laboratories, Princeton, New Jersey.

is not strictly sinusoidal. Fig. 1 shows the method employed. The grids of the two amplifier tubes are excited

in parallel from a single source of alternating voltage. One output circuit is tuned above resonance and the second below resonance to the frequencies $f_0(1 \pm 1/2Q)$ for which the two output voltages are equal in amplitude but differ in phase by 90 degrees. Two adjustments are required in setting up the one circular trace.

The same general method is used when two frequencies¹ are used instead of one. If we use separate amplifiers for the two deflecting voltages as in Fig. 1, output circuits having two resonance peaks with a valley between are required. If no mutual inductance is used, the

If the Q 's of the two coils having inductance L and pL , respectively, and resistance R and sR , are equal, $p=s$ and

$$\alpha_k = R/2L \quad (3)$$

or the damping factor at the two resonant frequencies is equal. This means in particular that the time of build-up and decay of voltage is the same at either of the circle frequencies. Throughout this analysis, equal Q 's for the two coils will be assumed, as this is a reasonably good approximation and simplifies the analysis very materially. Then (1) becomes

$$Z(j\omega) = \frac{j\omega}{C} \frac{\omega^2 - (1/pqLC)(1 + j(1/Q))}{\omega^4 - \frac{\omega^2}{LCpq} \frac{n^2 + 1}{n} + \frac{1}{L^2C^2pq} - j \frac{1}{LC\sqrt{pq}} \frac{n^2 + 1}{nQ} \left[\omega^2 - \frac{2}{LC\sqrt{pq}} \frac{n}{n^2 + 1} \right]} \quad (4)$$

minimum number of circuit elements needed is four. Two adjustments will be needed in each output circuit. Four different circuit configurations may be used, but the one shown in Fig. 2 is convenient and is here analyzed. L is an inductor with resistance R , and it is shunted both by the capacitor C , and by a series-resonant branch having inductance pL , capacitance qC , and resistance sR . p , q , and s are numerical ratios. The analysis of this circuit gives pertinent information on the performance one may expect as well as the conditions to be met in setting up the circuit for generating two circles at once. A similar analysis of course can be made of any one of the variety of circuits which may be used.

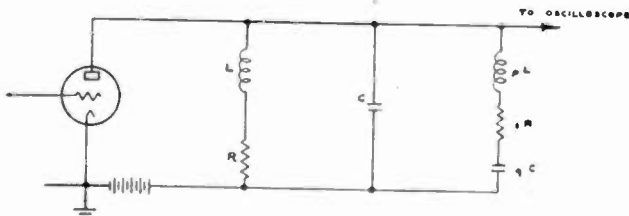

Fig. 2—Circuit for circle generation for two frequencies.

The impedance of the circuit is

$$Z(\lambda) = \frac{\lambda^2 L/C(1 + R/\lambda L)[p\lambda L + sR + 1/\lambda qC]}{H(\lambda) + G(\lambda)} \quad (1)$$

where $H(\lambda) = \lambda^2 L^2 p + \lambda^2 (L/C)(1 + p + 1/q) + 1/C^2 q$
 $G(\lambda) = \lambda[\lambda^2 LR(p + s) + (R/C)(1 + s + 1/q)]$
 and $\lambda = j\omega$.

$H(\lambda)$ is an even function of λ and is used in determining resonances.

$G(\lambda)$ is an odd function of λ and determines the impedance at resonance.

The damping factor α_k at the two resonant frequencies $\omega_1/2\pi$ and $\omega_2/2\pi$ is

$$\alpha_k = \frac{G(\lambda)}{H'(\lambda)_{\lambda=j\omega_k}} = \frac{R}{2L} \times \frac{\lambda^2(p+s) + (1/LC)(1+s+(1/q))}{2\lambda^2 p + (1/LC)(1+p+(1/q))} \quad (2)$$

$k = 1$ or 2 .

¹ See U. S. Patent No. 2,312,761 issued March 2, 1943.

where n is defined by the equation

$$n + 1/n = (1 + pq + q)/\sqrt{pq} \quad (5)$$

If Q is reasonably large, resistance has a second-order effect on frequency. The zeros and poles of $Z(j\omega)$ are determined if we set $R=0$. Then

$$Z(j\omega) = \frac{j\omega}{C} \frac{(\omega^2 - \omega_s^2)}{(\omega^2 - \omega_1^2)(\omega^2 - \omega_2^2)} \quad (6)$$

where

$$\omega_s^2 = 1/(LCpq) \quad (7)$$

$$\omega_1^2 = 1/(nLC\sqrt{pq}) \quad (8)$$

$$\omega_2^2 = n/(LC\sqrt{pq}) \quad (9)$$

$Z(j\omega) = 0$, when $\omega = \omega_s$. This is the frequency for series resonance in the pL - qC branch of the circuit.

$Z(j\omega) = \infty$, when $\omega = \omega_1$ or ω_2 . These are the poles of the function, and for these frequencies we have maximum amplifier gain.

It will be noted that

$$\omega_2 = n\omega_1 \quad (10)$$

or n is the ratio between the two resonant frequencies of the circuit. It is noted in (5) that n is a function of p and q only. Thus for any n we may choose, we are limited in our choice of p and q to such values as are consistent with (5). We may confine ourselves without loss of generality to values of n greater than unity. It is first to be noted that

$$\omega_s^2 = \omega_1\omega_2/\sqrt{pq} \quad (11)$$

Also, in all cases, by Foster's reactance theorem

$$\omega_1 < \omega_s < \omega_2 \quad (12)$$

Let $\omega_p^2 = 1/LC$ be the resonance frequency of the parallel L - C circuit if isolated from the series pL - qC circuit. We at once note that

$$\omega_s\omega_p = \omega_1\omega_2 \quad (13)$$

and

$$\omega_1 < \omega_p < \omega_2 \quad (14)$$

Thus both ω_p and ω_s lie between ω_1 and ω_2 . Also

$$\omega_p^2 = \omega_1\omega_2\sqrt{pq} \quad (15)$$

If we begin by specifying ω_1 and ω_2 , we may adjust both ω_s and ω_p to any desired values between these limits by choice of the product pq . The position of the zero between the two peaks determines the relative height of the two impedance peaks at the two resonant frequencies. We now proceed to calculate these impedances from (4).

The low-frequency resonant impedance is found to be

$$Z(j\omega_1) = \frac{L}{CR} \times \frac{n/\sqrt{pq} - 1}{n^2 - 1} \tag{16}$$

while the high-frequency resonant impedance is

$$Z(j\omega_2) = \frac{L}{CR} \times \frac{n(n - 1/\sqrt{pq})}{n^2 - 1} \tag{17}$$

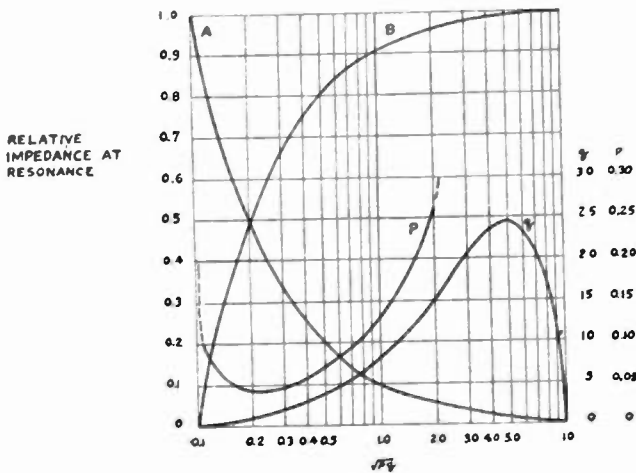

Fig. 3—Relative impedance at the two circle frequencies.

One result of interest is this

$$Z(j\omega_1) + Z(j\omega_2) = L/CR \tag{18}$$

which tells us that irrespective of height of the two

peaks, their sum is a constant; namely, L/CR which is the same as that developed by a single parallel resonant $L-C$ circuit. The two peaks share the available gain between them in a manner determined by the location of the zero between them.

If we adjust pq so that the gain at the two frequencies is of the same order of magnitude, the impedance zero is well removed from both impedance maxima. Then the numerator of (4) approximates a pure imaginary and does not change materially in value over the narrow range involved in sweeping across a resonance peak. To find the width of the resonance curve at the points where $Z(j\omega)$ has a phase angle of 45 degrees, we equate the real and j parts of the denominator of (4) and solve the biquadratic equations which result. The four frequencies satisfying this condition are found to be

$$\omega_{\Delta 1} = \omega_1(1 \pm 1/2Q) \tag{19}$$

and

$$\omega_{\Delta 2} = \omega_2(1 \pm 1/2Q) \tag{20}$$

Thus the width of the peaks at the 45-degree points is determined by circuit Q and is the same as that characterizing a circuit with but one peak.

Also it is noted that

$$Z(j\omega_{\Delta k}) = 1/\sqrt{2} Z(j\omega_k) \angle 45 \text{ degrees.} \tag{21}$$

Equations (19) and (20) give us the frequencies to which the doubly peaked circuits must be adjusted for two-circle generation. In practice two frequencies are applied in alternation to the parallel grids of the two tubes used. The output circuit of one tube is tuned to the two frequencies of (19) and (20) in which the plus sign is used, while for the second, we tune to the frequencies characterized by the minus sign. Of course, other adjustments may be used but these will give us circles not rotating in

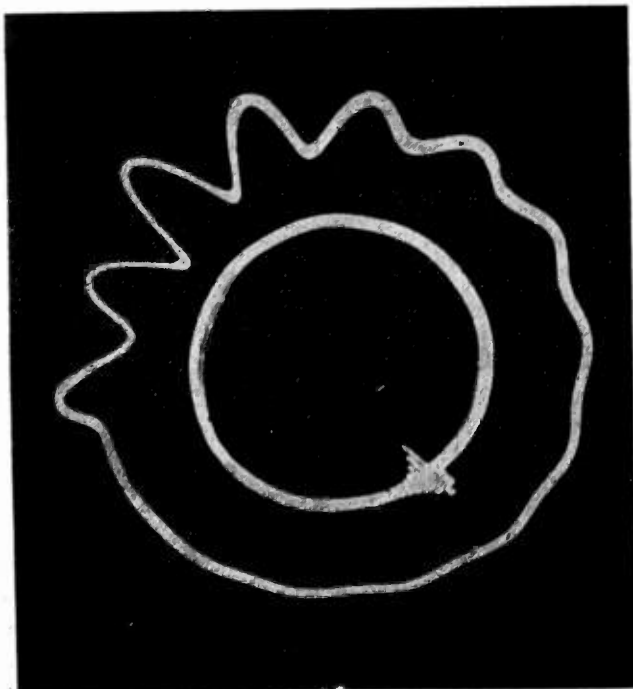

Fig. 4—Highly damped $3\frac{1}{2}$ -megacycle transient viewed on the sweep.

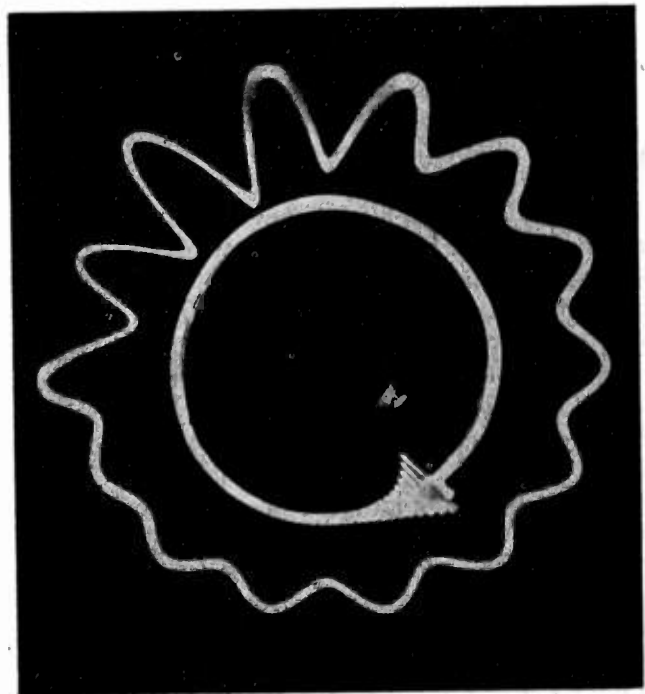

Fig. 5—Same transient as shown in Fig. 4, but with less damping.

the same sense. These circles are interesting but not particularly useful.

TABLE I

\sqrt{pq}	p	q	$\frac{Z(j\omega_1)}{L/CR}$	$\frac{Z(j\omega_2)}{L/CR}$	$\frac{Z(j\omega_1)}{Z(j\omega_2)}$
$\frac{1}{n}$	∞	0	1	0	0
$\frac{2n}{n^2+1}$	$\left(\frac{2n}{n^2-1}\right)^2 = \text{min.}$	$\left(\frac{n^2-1}{n^2+1}\right)^2$	$\frac{1}{2}$	$\frac{1}{2}$	1
1	$\frac{n}{(n-1)^2}$	$\frac{(n-1)^2}{n}$	$\frac{1}{n+1}$	$\frac{n}{n+1}$	n
$\frac{n^2+1}{2n}$	$\left(\frac{n^2+1}{n^2-1}\right)^2$	$\left(\frac{n^2-1}{2n}\right)^2 = \text{max.}$	$\frac{1}{n^2+1}$	$\frac{n^2}{n^2+1}$	n^2
n	∞	0	0	1	∞

We next determine the optimum value for the product pq . Table I summarizes results obtained by a study of (5), (16), and (17). Values of \sqrt{pq} are given in the first column. Various critical values of p and q are given in the next two columns, while the three remaining col-

umns give the relative magnitudes of the resonance peaks. It is first noted that q is positive only if $1/n < \sqrt{pq} < n$. p attains a minimum value for equality of the two resonance peaks. When q attains a maximum value, the high-frequency peak is n^2 times as high as the low-frequency peak. When pq is unity, the high-frequency peak is n times as high as the low-frequency peak. Only one resonance peak is found when $\sqrt{pq} = n$, since ω_1 and the impedance zeros are coincident. Similarly, when $\sqrt{pq} = 1/n$, ω_2 and ω_s are coincident, and but one peak is found. In each case, $q = 0$, and the series-resonant circuit is open. The quantities p , q , and relative gain at the two frequencies are plotted against \sqrt{pq} for $n = 10$ in Fig. 3. From this figure we obtain all the information needed in setting up circuits to generate two circles for a frequency ratio of one to ten. Relative gain may be adjusted to any desired ratio. In Fig. 4 a $3\frac{1}{2}$ -megacycle damped sinusoid is shown on both compressed and extended scales. Fig. 5 shows the same transient with considerably less damping.

Low-Frequency Quartz-Crystal Cuts Having Low Temperature Coefficients*

W. P. MASON †, FELLOW I.R.E., AND R. A. SYKES †, SENIOR MEMBER, I.R.E.

Summary—This paper discusses low-frequency, low-temperature-coefficient crystals which are suitable for use in filters and oscillators in the frequency range from 4 to 100 kilocycles. Two new cuts, the MT and NT, are described. These are related to the +5-degree X -cut crystal, which is the quartz crystal having the lowest temperature coefficient for any orientation of a bar cut from the natural crystal. When the width of the +5-degree X -cut crystal approaches in value the length, the motion has a shear component, and this introduces a negative temperature coefficient which causes the temperature coefficient of the crystal to become increasingly negative as the ratio of width to length increases.

The MT crystal has its length along nearly the same axis as the +5-degree X -cut crystal, but its major surface is rotated by 35 to

50 degrees around the length axis. This results in giving the shear component a zero or positive temperature coefficient and results in a crystal with a uniformly low temperature coefficient independent of the width-length ratio. A slightly higher rotation about the length axis results in a crystal which has a low temperature coefficient when vibrating in flexure and this crystal has been called the NT crystal. The NT crystal can be used in a frequency range from 4 to 50 kilocycles, while the MT is useful from 50 kilocycles to 500 kilocycles.

A special oscillator circuit is described which can drive a high-impedance NT flexure crystal. This circuit together with the NT crystal has been used to control the mean frequency of the Western Electric frequency-modulated radio transmitter.

I. INTRODUCTION

MOST of the effort spent in developing quartz-crystal orientations has been directed towards obtaining high-frequency crystals with advantageous frequency spectra and low temperature coefficients. Another important frequency region for which little work has been done is in the frequency region from 4 to 100 kilocycles. This range is particularly important for carrier cable and open-wire communication work, since all of the oscillators and filters required are in this frequency region. In addition, a number of constant-frequency sources for use in controlling rotating machinery and time standards are desired. Another use to which the low-frequency crystal described here has been put is in controlling the mean frequency of the Western Electric frequency-modulated radio transmitter.¹

* Decimal classification: 537.65XR214. Original manuscript received by the Institute, July 20, 1943; revised manuscript received, October 27, 1943.

† Bell Telephone Laboratories, Inc., New York, N. Y.

It is the purpose of this paper to describe two new crystal cuts, the MT and NT, which cover this frequency range. The MT crystal is a longitudinally vibrating crystal, having a low temperature coefficient which can be used in the frequency range from 50 to 100 kilocycles. The NT crystal is a flexurally vibrating crystal having a low temperature coefficient, which can be used in the frequency range from 4 to 50 kilocycles. Hence, by the use of these two crystals, this low-frequency range of from 4 to 100 kilocycles can be covered adequately.

II. PROPERTIES OF +5-DEGREE X -CUT CRYSTAL VIBRATING IN LONGITUDINAL AND FLEXURAL MOTION

Both the MT and NT crystals are related to the +5-degree X -cut crystal used, respectively, in longitudinal and flexural motion. This crystal itself has been used as

¹ J. F. Morrison, "A new broadcast-transmitter circuit design for frequency modulation," Proc. I.R.E., vol. 28, pp. 444-449; October, 1940.

a longitudinal and flexural crystal to cover this frequency range. It therefore appears worth while to describe its properties and mode of operation.

The +5-degree X-cut crystal is cut with its major surfaces normal to the X or electrical axis of the crystal and with its length at an angle of +5 degrees from the Y or mechanical axis. In terms of the recently defined I.R.E. system of specifying orientation angles, $\phi = 0$, $\theta = 90$ degrees, $\Psi = 85$ degrees. As shown by Fig. 1, the I.R.E. method of orienting a crystal consists in taking the X' axis along the length of the crystal, the Y' axis along the width of the crystal, and the Z' axis along the thickness dimension of the crystal. θ is then the angle between the Z and Z' axis, ϕ the angle between the +X axis and the

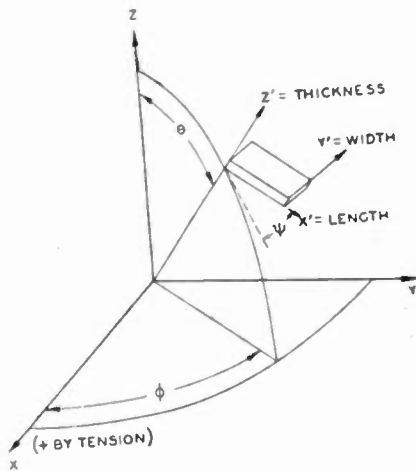

Fig. 1—I.R.E. system of designating orientations.

intersection of the plane containing the Z and Z' axes with the XY plane, while Ψ the skew angle is the angle between the length X' and the tangent of the great circle containing the Z and Z' axes. All angles are called positive when measured in a counterclockwise direction. Fig. 1 is applicable to a right-hand crystal (crystallographer's definition) and the positive X axis is the axis for which a positive charge develops on an extensional stress.

A long thin +5-degree X-cut crystal is the member of the X-cut family which has the lowest temperature coefficient of frequency. This is shown by Fig. 2 which plots the measured temperature coefficient of a number of rotated X-cut crystals. The +5-degree crystal has nearly a zero coefficient while all other angles have negative coefficients. The modes of motion of a +5-degree X-cut crystal are very similar to those of a 0-degree X-cut crystal which have been discussed at some length previously.² When the crystal is long and thin, the longitudinal expansion is the predominant motion. As the crystal becomes wider, a coupling to a face shear mode of motion becomes more prominent. This is shown by the fact that the resonant frequency is lowered and the nodal line is no longer normal to the length of the crys-

tal. The face shear mode is closely coupled to the second flexure mode of motion, and since this coincides with the longitudinal mode when the width-length ratio is about 0.25, a coupled-frequency curve for a +5-degree crystal results as shown in Fig. 3. This curve shows the natural

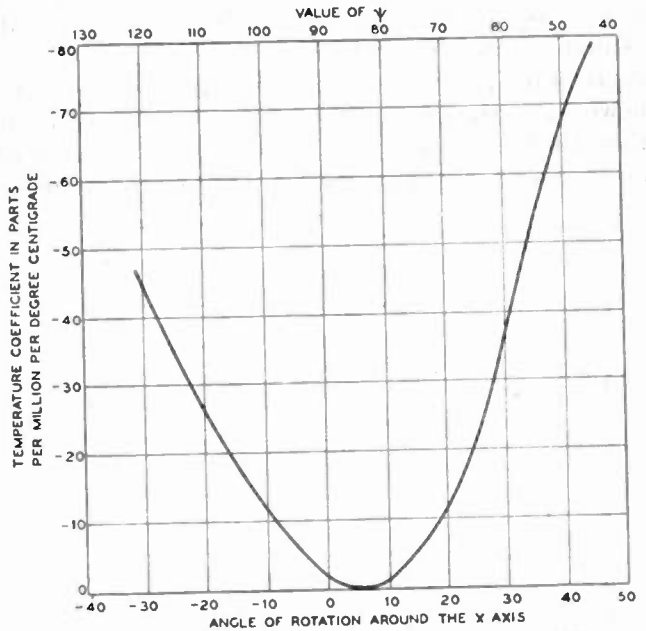

Fig. 2—Temperature coefficients of rotated X-cut bars.

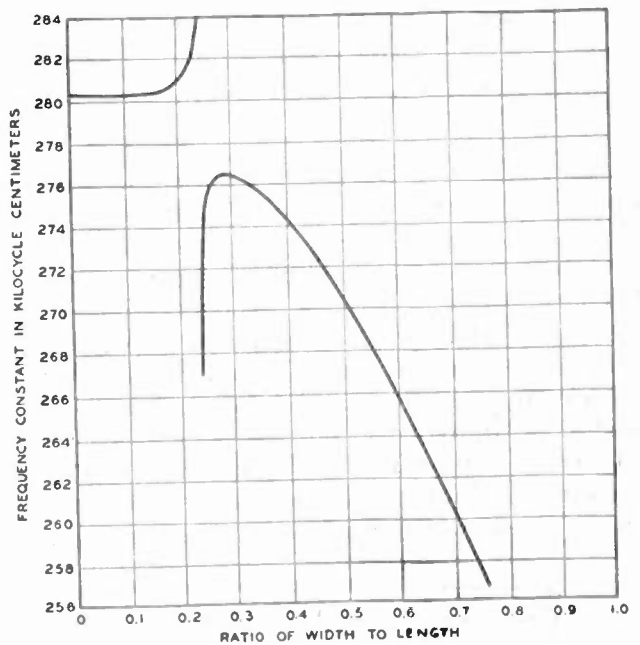

Fig. 3—Frequency constant of a +5-degree X-cut crystal as a function of the ratio of width to length.

frequency for a crystal 1 centimeter long, 0.05 centimeter thick, and having a width-to-length ratio shown by the ordinates. The effect of the shear coupling and flexure coupling are also evident in the temperature coefficient. When the width-length ratio is 0.1 or less, the coefficient is nearly zero. As the ratio increases, the coefficient becomes sharply negative in the region of the

² W. P. Mason, "Electrical wave filters employing quartz crystals as elements," *Bell Sys. Tech. Jour.*, vol. 13, pp. 405-452; July, 1934 (see Appendix).

flexure coupling, as shown in Fig. 4. Above this region the coefficient becomes progressively more negative as the shear-mode frequency approaches the longitudinal frequency. This change in temperature coefficient is caused by the high negative temperature coefficient of the face shear mode. The result is that for crystals half as wide as they are long, which is the usual ratio of interest, temperature coefficients of -4 parts per million per degree centigrade are as low as can be obtained. Due, however, to the small ratio of capacitances (around 125) that can be obtained with this crystal, it has been used quite extensively in filter work. It is feasible to use this

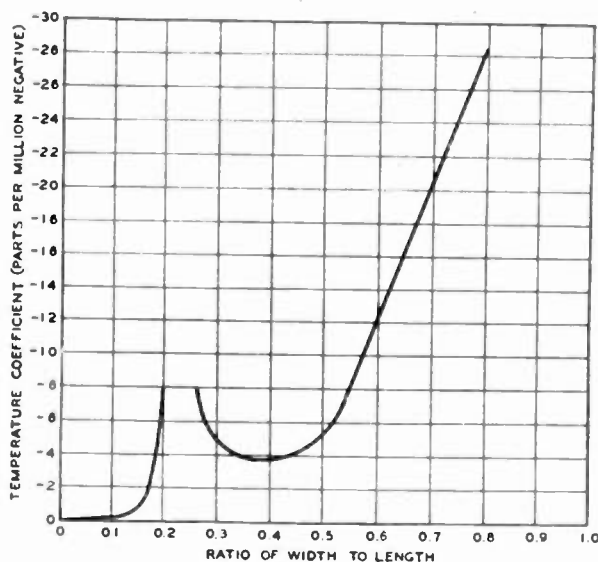

Fig. 4—Temperature coefficient of a +5-degree X-cut crystal as a function of the ratio of width to length.

crystal from 50 to 500 kilocycles since the length will vary from 5.6 centimeters to 0.56 centimeter for this range.

When it is desirable to obtain frequencies lower than 50 kilocycles it is usually not feasible to obtain them by crystals in longitudinal or shear vibrations on account of the large sizes of the crystals required. For lower frequencies it is the flexure mode of motion that can be used, since the frequency obtainable for a flexure crystal is lower for a given size crystal than for any other mode of motion. A flexure crystal with free ends, as shown in Fig. 5, is one which expands along one side and con-



Fig. 5—Lowest "free-free" flexure mode of motion.

tracts along the other. Such a motion can be set up in a longitudinally vibrating crystal, by the use of two sets of platings, the top set charged in different polarity from the bottom set. This causes one side to expand and the other side to contract, thus setting up a flexural motion. When the length of the crystal is large compared to its width, points at 0.224 of the length from each end will

be nodal points of the motion and hence will not move appreciably. These points can then be used as supporting points for the crystal. Fig. 5 shows the platings cut with small ears at these nodal points. The crystal can be clamped at these points if desired, but the usual method is to solder small wires to the crystals on both sides at the two nodal points and to use the four wires as mechanical supports and electrical connections. Care has to be taken to attach the wires so that they are not anti-resonant near the flexure frequency of the crystal for otherwise the characteristics of the wire support would appear in the measured resonance of the crystal.

The first crystal used as a flexure crystal was the +5-degree X-cut crystal since again it produces the lowest temperature coefficient of any X-cut crystal. This follows from the frequency equation of a long thin crystal

$$f = m^2 l_w / 2\pi \sqrt{12} \sqrt{s'_{22} \rho} l^2 \quad (1)$$

where s' is the compliance modulus (inverse of Young's modulus) along the length of the crystal, ρ is the density, l_w is the width of the crystal, l is the length of the crystal, and m is a constant depending on the order of the flexure mode. For a crystal free on the ends in its lowest mode of motion, $m = 4.73$. If we differentiate (1) with respect to the temperature T and divide through by the frequency, we have

$$T_f = \frac{(df/dT)}{f} = T_{l_w} - \left[\frac{1}{2} [T_{s'_{22}} + T_\rho] + 2T_l \right] \quad (2)$$

where the temperature coefficient of any quantity α is defined as $(d\alpha/dT)/\alpha$. Hence, the temperature coefficient of frequency of a long thin crystal vibrating in flexure is equal to the temperature coefficient of expansion of the width minus twice this coefficient for the length, minus 1/2 the sum of the coefficients of s'_{22} and the density ρ . The temperature coefficient of expansion along the optic axis is 7.8 parts per million per degree centigrade, whereas in the plane perpendicular to this axis, the coefficient is 14.3 parts per million. For any direction making an angle θ with the optic axis, the coefficient will be

$$T_l = 7.8 + 6.5 \sin^2 \theta. \quad (3)$$

Hence, if A_2 is taken as the angle of the length from the Y axis of the crystal,

$$T_l = 7.8 + 6.5 \cos^2 A_2 \quad (4)$$

while the coefficient of the width is

$$T_{l_w} = 7.8 + 6.5 \sin^2 A_2. \quad (5)$$

Since the total mass of the crystal remains constant independent of temperature, the temperature coefficient of the density will be the negative of the sum of the temperature coefficients of expansion of the three axes or

$$T_\rho = -36.4. \quad (6)$$

The variation of the temperature coefficient of s'_{22} as a function of A_2 can be obtained from the temperature coefficient of frequency for a long thin crystal in

longitudinal vibration given by Fig. 2. This follows since the frequency of a long thin bar is given by

$$f = 1/2l\sqrt{\rho s_{22}'} \quad \text{and} \quad T_f = -[T_l + \frac{1}{2}(T_p + T_{s'_{22}})] \quad (7)$$

Inserting the values of T_l and T_p , we have for a longitudinal crystal

$$\text{(longitudinal)} \quad T_f = 10.4 - 6.5 \cos^2 A_2 - (1/2)T_{s'_{22}} \quad (8)$$

Since the temperature coefficient of frequency for $A_2 = +5$ degrees is nearly zero, the value of $T_{s'_{22}}$ for this angle is $+7.9$. At the same angle, the temperature coefficient for a long thin flexure crystal should be

$$\begin{aligned} \text{(flexure)} \quad T_f &= 10.4 + 6.5(\sin^2 A_2 - 2 \cos^2 A_2) \\ &\quad - (1/2)T_{s'_{22}} = -6.4 \end{aligned} \quad (9)$$

Since the variation of $\cos^2 A_2$ in this region is small,

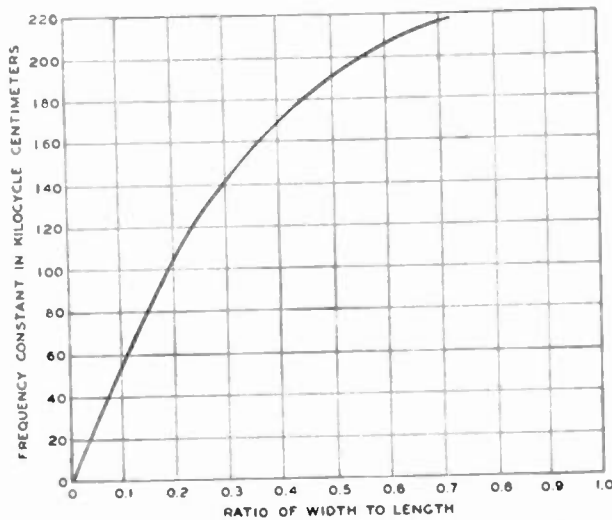

Fig. 6—Frequency constant of a +5-degree X-cut flexure crystal.

whereas the variation of $T_{s'_{22}}$ is large, the lowest coefficient for a flexure crystal occurs at the same angle as for a longitudinal crystal.

The frequency equation (1) and the temperature-coefficient equation (2) for a long thin crystal vibrating in flexure hold only when the crystal is long compared to its width. As the width increases, two other factors affect the frequency equation and temperature coefficient. These are the rotary inertia of a section about its center as an axis, and the shear forces set up by the motion. Both of these factors cause the frequency to increase less than in proportion to the width. These effects are shown by the frequency curve of Fig. 6 which plots the frequency of a +5-degree X-cut crystal 1 centimeter long, 0.05 centimeter thick and with various width-length ratios. Initially, the frequency increases proportionally to the width but for larger width-length ratios, the increase is less, and the frequency approaches an asymptotic value. The effect of the shear stresses is shown by the temperature-coefficient curve of Fig. 7, which plots the coefficient as a function of the length-width ratio. For a long thin crystal, the coefficient is about 6 parts in a million negative in agreement with (9). For larger ratios the effect of the high negative

shear temperature coefficient is shown by the increasing value of the negative temperature coefficient.

Another question of interest for flexure crystals used in filters and oscillators is the amount of drive put on the crystal by the piezoelectric effect. This is usually measured by evaluating the ratio of capacitances C_0 to

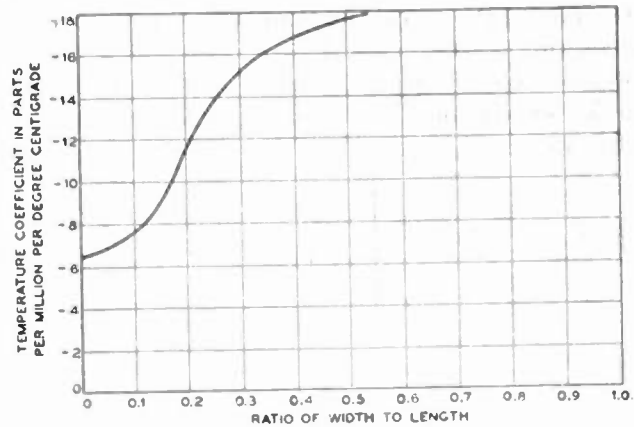

Fig. 7—Temperature coefficient of a +5-degree X-cut flexure crystal.

C_1 in the equivalent circuit of the crystal shown in Fig. 8. The ratio of capacitances for a +5-degree X-cut flexure crystal for width-to-length ratios up to 0.4 is around 180, whereas the ratio for a longitudinal crystal is 125. This agrees well with a theory worked out for a flexure crystal³ which shows that the ratio of capaci-

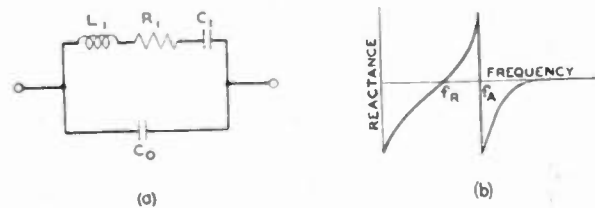

Fig. 8—Equivalent circuit of a crystal vibrating in flexure.

tances of a crystal driven in flexure should be $128/9\pi^2$ times that for the same crystal driven in a longitudinal mode. The Q obtainable with a wire-supported flexure crystal in an evacuated container is quite high, i.e., greater than 30,000. The effect of the air loading on a flexure crystal is larger than for a longitudinal crystal both as to frequency reduction and Q reduction.

III. MT LOW-COEFFICIENT LONGITUDINALLY VIBRATING CRYSTAL

The MT low-coefficient longitudinally vibrating crystal grew out of the data of Fig. 4, which shows that an increase of width causes a closer coupling to the shear mode and hence a high negative temperature coefficient as the width-length ratio is increased. If a crystal can be obtained with the same longitudinal constants but with a face shear having a lower or zero temperature coefficient, the large increase in temperature coefficient should not take place as the width-

³ W. P. Mason, "Electromechanical transducers and wave filters," D. Van Nostrand Company, New York, N. Y., 1942, chapter VI, page 215.

length ratio is increased. Such a crystal can be obtained by maintaining the same length direction in the crystal (which gives the same compliance modulus s'_{22} along the length) and rotating the normal to the major surfaces away from the X axis. This has the effect of changing the temperature coefficient of the face shear mode from highly negative through zero to highly positive.

To show this, use can be made of an analysis of the temperature coefficient of the face shear mode given in a previous paper.⁴ If we translate (21) of that paper into an expression involving the I.R.E. orientation angles, we have

$$T_f = 10.4 - 3.25 \sin^2 \theta + \left[\frac{-5877.5 \sin^4 \theta \sin^2 2\psi + 15,790 \cos^2 \theta + 2655 [\sin 2\theta \sin 3\phi (2 \cos^2 2\psi - \sin^2 2\psi (1 + \cos^2 \theta))] + \sin 4\psi \cos 3\phi \sin \theta (1 + 3 \cos^2 \theta) - 19,525 \left(\sin^2 \theta \cos^2 2\psi + \frac{\sin^2 2\psi \sin^2 2\theta}{4} \right)}{195 \sin^4 \theta \sin^2 2\psi + 292.8 \cos^2 \theta - 43.1 [\sin 2\theta \sin 3\phi (2 \cos^2 2\psi - \sin^2 2\psi (1 + \cos^2 \theta))] + \sin 4\psi \cos 3\phi \sin \theta (1 + 3 \cos^2 \theta)} \right] + 200.5 \left(\sin^2 \theta \cos^2 2\psi + \frac{\sin^2 2\psi \sin^2 2\theta}{4} \right) \quad (10)$$

for the temperature coefficient of the face shear mode becomes

$$T_f = 10.4 - 3.25 \sin^2 \theta + \left[\frac{15,790 \cos^2 \theta - 19,525 \sin^2 \theta}{292.8 \cos^2 \theta + 200.5 \sin^2 \theta} \right] \quad (11)$$

As the normal is rotated from the X axis the coefficient of the shear mode becomes less negative and passes through zero when the angle from X is 40 degrees ($\theta = 50$ degrees or $\theta = 130$ degrees). The expectations are then that with a crystal cut at one of these orientations the large increase in the negative temperature coefficient

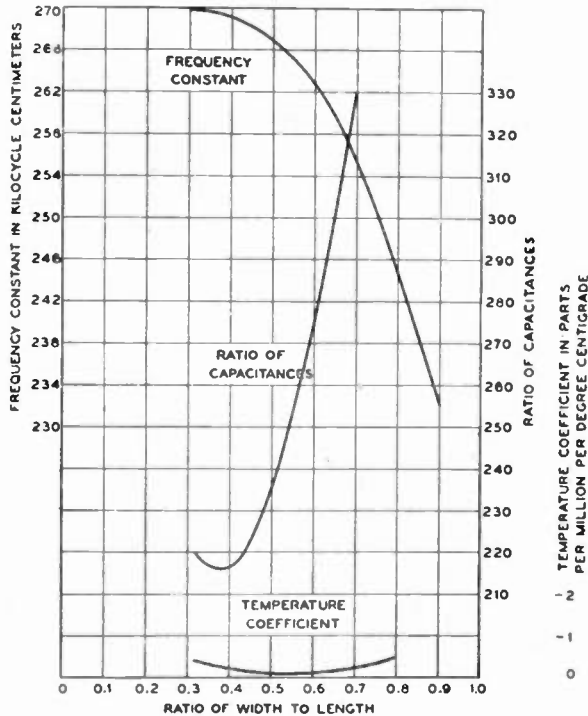

Fig. 9—Frequency constant, ratio of capacitances, and temperature coefficient of a crystal with its length along the Y axis and the normal to the principle surface at an angle of 45 degrees from the X axis.

For purposes of illustration, let us consider an X -cut crystal with its length along the Y axis ($\phi = 0$, $\theta = 90$ degrees, $\Psi = 90$ degrees). For this condition (10), shows that the face shear mode has a negative temperature coefficient of -90.2 .

If now the length is kept along the Y axis but the normal to the principal surface is rotated from the X axis ($\phi = 0$; $\theta = \text{variable}$; $\Psi = 90$ degrees), the equation

⁴ W. P. Mason, "Low temperature coefficient quartz crystals," *Bell Sys. Tech. Jour.*, vol. 19, pp. 74-93; January, 1940.

should not occur with an increase in the width-length ratio.

Such a crystal was obtained and its properties measured as a function of the width-length ratio. The temperature coefficient starts out at -2 parts per million per degree centigrade, when the width-length ratio is 0.1 or less in agreement with the result found for the X -cut crystal. As the width increases, the large increase in coefficient does not occur as with the X -cut. Instead the coefficient is uniformly low over the whole region. The frequency constant and the ratio of capacitances are also shown in Fig. 9. As might be expected, the ratio of capacitances for this crystal is higher than for an X -cut crystal, since the piezoelectric constant decreases as the normal varies from the X axis. For a general orientation it can be shown that the d'_{31} piezoelectric constant is given by the equation

$$d'_{31} = d_{11} \sin \theta [\cos 3\phi (\cos^2 \theta \cos^2 \phi - \sin^2 \psi) - \sin 2\psi \sin 3\phi \cos \theta] - (d_{14}/2) \sin^2 \theta \sin 2\psi.$$

For this orientation ($\phi = 0$, $\theta = 50$ or 130 degrees, $\Psi = 90$ degrees) it has a value of 76.6 per cent of the constant for an X -cut crystal resulting in a larger ratio of capacitances for the crystal.

The initial value of -2 parts per million per degree centigrade found for this crystal can be lowered, if the length is taken in the same direction as the $+5$ -degree X -cut crystal. By rotating the normal to the principal plane about this axis, the face shear mode can be made to have a zero coefficient at a rotation of ± 40 degrees which is slightly less than for the first cut described. The characteristics of this crystal are shown by Fig. 10 and are somewhat more favorable than the $\phi = 0$; $\theta = 50$ or 130 degrees; $\Psi = 90$ degrees crystal. Fig. 11 shows a further measurement when the length is at an angle of $A_2 = +8.5$ degrees from the Y axis and the normal to

the surface rotated by ± 34 degrees. A typical temperature-frequency curve of this crystal, with ratio of width to length = 0.42, used to control an oscillator is shown by Fig. 12. The curvature as with most quartz crystals is negative and about the same order as the CT crystal. This series of crystals has been designated the MT cuts. They comprise those crystals that have angles A_z from 0 to $+8.5$ degrees, and angles of rotation about Y' of from 34 to 50 degrees, with the associated ratios of dimensions that give low temperature coefficients.

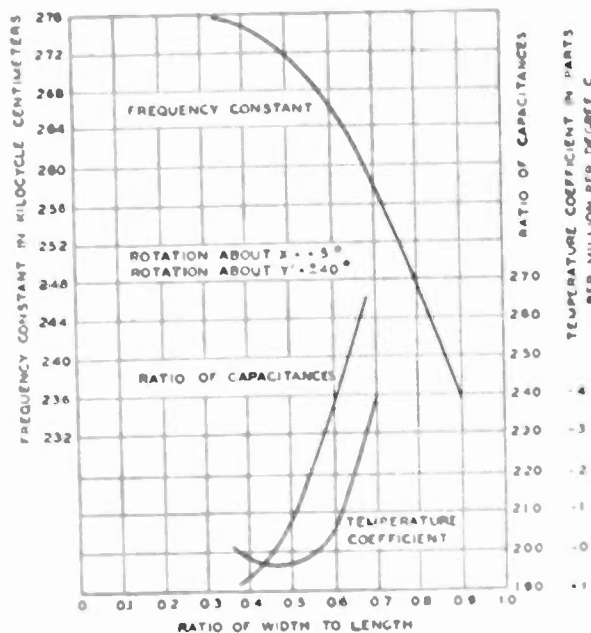

Fig. 10—Properties of a crystal with double rotation of $+5$ degrees about X , 40 degrees about Y' .

The MT crystal has been used in pilot-channel filters of the carrier system, that are subjected to wide temperature ranges, and to control oscillators in the 50- to 100-kilocycle range. On account of its lower ratio of capacitances the $+5.0$ -degree X -cut is usually used where a moderate degree of temperature stability is required and wider filter bands desirable. When a temperature coefficient of 25 parts in a million can be tolerated and a freedom from secondary modes of motion desirable, as in the band-selection filters of the carrier systems, the -18.5 -degree X -cut crystal is still preferable.

IV. THE NT FLEXURE LOW-COEFFICIENT CRYSTAL

The method of obtaining a low-coefficient flexure crystal from a $+5$ -degree X -cut crystal is the same as that for a longitudinal crystal, namely, rotating the normal to the principal surface away from the X axis. Furthermore, this procedure will not only neutralize the negative coefficient put in by the shear stresses but will also lower the coefficient for a long thin crystal where the effect of the shear stresses is negligible. This follows from the fact that the width direction changes from being nearly along Z (where its expansion coefficient is small) to being nearly along X (where its expansion coefficient is larger). For a 90-degree rotation the flexure

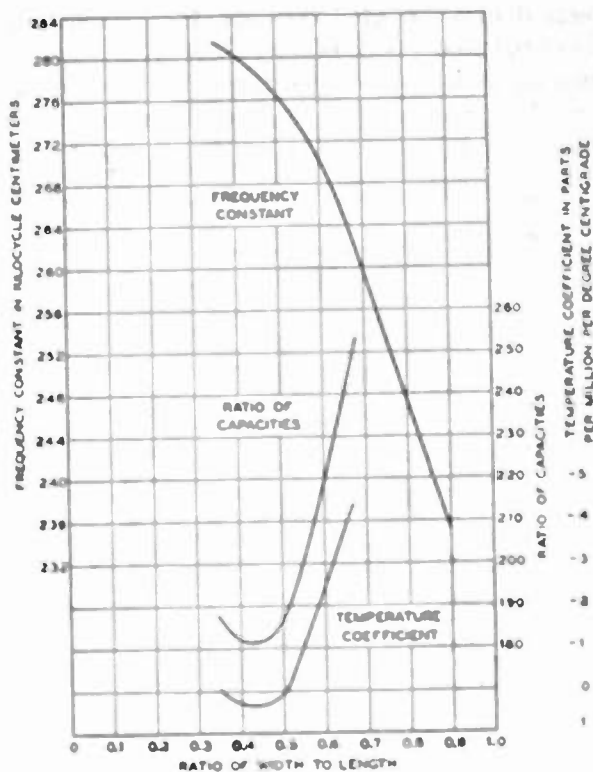

Fig. 11—Properties of a crystal with double rotation of $+8.5$ degrees about X , 34 degrees about Y' .

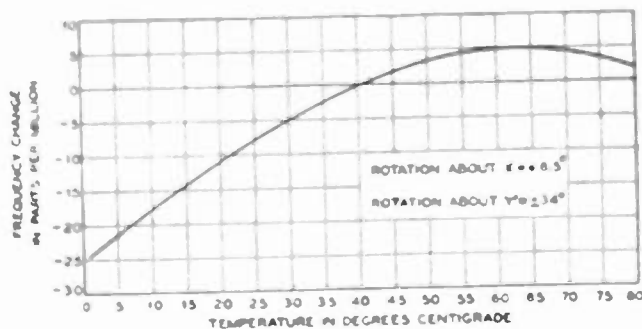

Fig. 12—Change in frequency of an MT crystal over a wide temperature range.

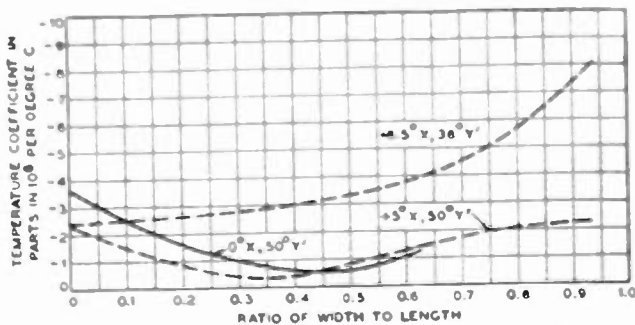

Fig. 13—Temperature coefficients of low-frequency NT flexure crystals.

vibration has the same coefficient as the longitudinal vibration, that is, nearly zero. Since, however, the piezoelectric modulus disappears at this angle, it cannot be used. A useful compromise is effected by using a rotation angle of 50 to 70 degrees.

Fig. 13 shows the temperature coefficient at 30 degrees centigrade as a function of width to length for

several doubly oriented crystals. If a width-to-length ratio of 0.2 to 0.5 is to be used, low coefficients are obtained by using angles of rotation about X of from 0 to +8.5 degrees, and a 50-degree rotation about the resulting Y' axis. Fig. 14 shows the corresponding fre-

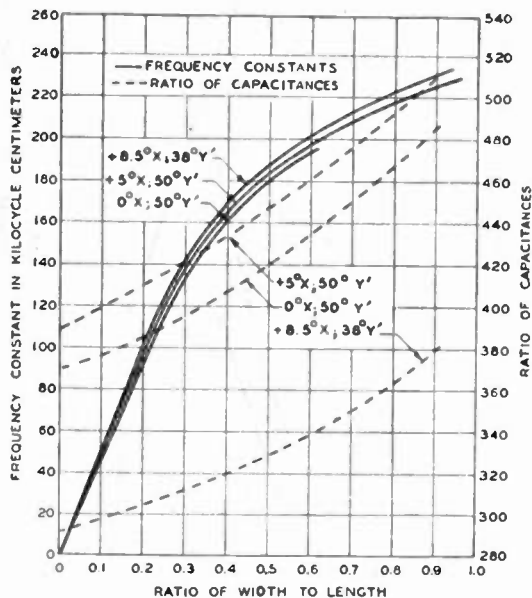

Fig. 14—Frequency constants and ratios of capacitances of low-frequency NT flexure crystals.

quency constants and ratios of capacitances for these crystals as a function of frequency.

For lower ratios of axes and consequently for lower frequencies, a higher rotation about the Y' axis should be employed. Fig. 15 shows the relation between a rota-

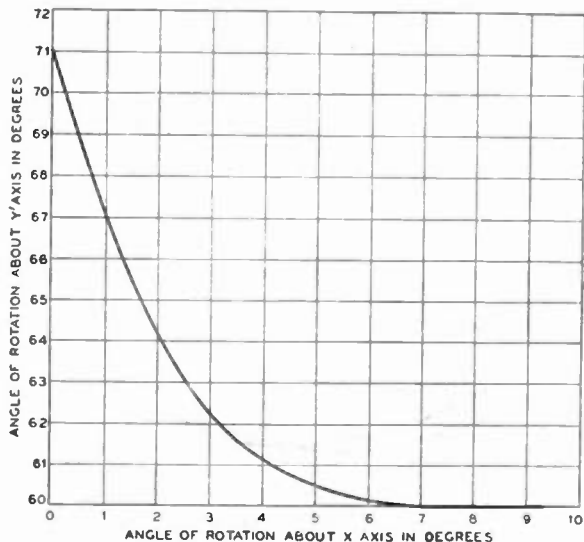

Fig. 15—Locus of angular orientations about X and Y' to produce a zero temperature coefficient for long thin NT flexure crystals.

tion about the X axis and rotation about the Y' axis to give a zero coefficient at 25 degrees centigrade for a crystal, whose width is 5 per cent of its length. Crystals of this type have been used with the Western Electric frequency-modulation broadcast transmitter.¹ Operating

in the region of 5 kilocycles they maintain the frequency of the transmitter constant to ± 0.0025 per cent without temperature control.

The wider crystals with ratios from 0.2 to 0.5 have been used in the pilot-channel filters of the cable-carrier system to pick off pilot frequencies from 10 to 50 kilocycles.

V. OSCILLATOR CIRCUIT FOR DRIVING LOW-FREQUENCY NT CRYSTALS

Because of the small capacitance and high impedance of these low-frequency crystals, they do not work well in conventional oscillator circuits. Consequently, some work has been done in developing an oscillator circuit for which they will function satisfactorily. The circuit employed is shown in Fig. 16. The feedback from plate to grid occurs through the four-electrode crystal. The plate circuit of the tube is connected to the terminals 1, 2, in Fig. 17 while the grid is connected to terminal 4. Terminals 2 and 3 are connected together and connected to ground through a variable condenser, which allows the frequency to be varied by 50 to 60 parts in a million. In order that sufficient output may be obtained an

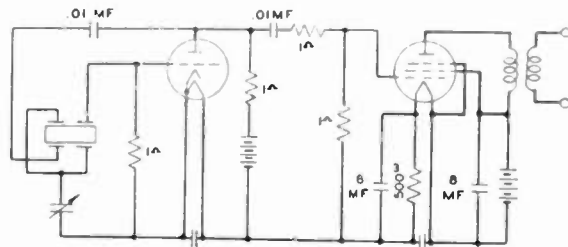

Fig. 16—Oscillator circuit for driving a low-frequency flexure crystal.

amplifier has been added. To reduce the effects of change in input impedance of the amplifier a loss network is added between tubes. Thus, a change in the load impedance or supply voltage will have little effect upon the oscillator.

The connection of terminal 1 to the plate, terminals 2 and 3 to ground, and terminal 4 to the grid reverses the input current by 180 degrees at the resonant frequency of the crystal. Since the tube itself introduces a 180-degree phase shift, this allows the oscillator to work at the resonant frequency of the crystal. As pointed out in a previous paper,⁵ this is the condition for maximum stability at maximum oscillator output. The effect of the capacitance C_E between ground and the terminals 2, 3 can be analyzed as was done for the case of a longitudinal crystal with two sets of plates recently.⁶ Employing the same analysis, it can be shown that the three-terminal crystal with capacitance C_E to ground is equivalent to the lattice network of Fig. 17,

⁵ W. P. Mason and I. E. Fair, "A new direct crystal-controlled oscillator for ultra-short-wave frequencies," PROC. I.R.E., vol. 30, pp. 464-472; October, 1942.

⁶ See chapter VIII, Fig. 8.8, of footnote 3. For a flexure crystal, since the two sets of plates, if of the same polarity, produce opposite effects in driving the flexure mode, the numbering of the output terminals has to be interchanged to get the same equivalent circuit.

where $C_0/2$ is the static capacitance of one set of the crystal platings, L_1 , C_1 , and R_1 the equivalent motional inductance, capacitance, and resistance of a completely plated crystal, C_{14} is the stray capacitance from terminal 1 to terminal 4, and $C_{13} = C_{24}$ is the stray capacitance from terminal 1 to terminal 3, which from symmetry is equal to that from terminal 2 to terminal 4. When C_E is large the impedance of the lattice branch at the crystal resonant frequency will be the resonance resistance of the crystal which is small in impedance compared to the reactance of the shunt capacitance of the series arm. Therefore, the circuit will reverse the phase of the input and the oscillator will work at the crystal resonant frequency. As C_E becomes smaller, the resonance of the lattice arm will increase in frequency and also in effective resistance. By this means the oscillator frequency

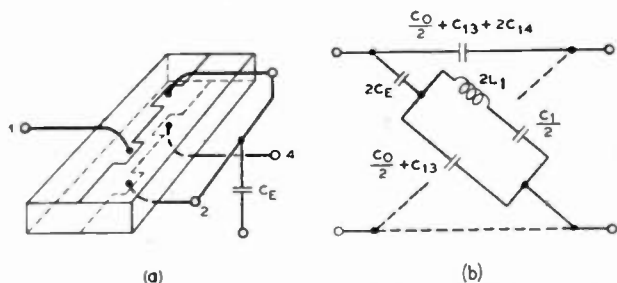

Fig. 17—Crystal connections and equivalent circuit for a flexure crystal used to obtain a phase reversal.

can be varied by 50 to 60 parts in a million, thus allowing a wider tolerance for the resonant frequency of the crystal.

Fig. 18 shows a photograph of a crystal mounted in a special vacuum-tube case. Electrical connection as well as mechanical shockproof mounting is obtained by soldering 0.005-inch phosphor-bronze wires to the plated areas on the crystal. To allow for severe shocks due to accidental drops and shipping, mica supports have been provided. This type of cage support has been used for the coaxial filter crystals and was originally developed by A. W. Zeigler.

Some performance data for this oscillator are shown in Fig. 19. Curve A shows the variation of frequency with supply voltage to the oscillator. Large variations in the order of 50 per cent in load or supply voltage to the amplifier produce a frequency change of less than 1 part in a million. The frequency-temperature characteristic is shown in curve B and is similar to the MT type. It is necessary to maintain a high Q and be free of other modes of motion in the crystal as well as the support wires to produce the characteristic shown in curve B. A typical aging characteristic is shown by curve C.

A crystal of this type was first used in the Mutual Broadcasting Company's experimental frequency-modulation transmitter W2XOR operating at 43.5 mega-

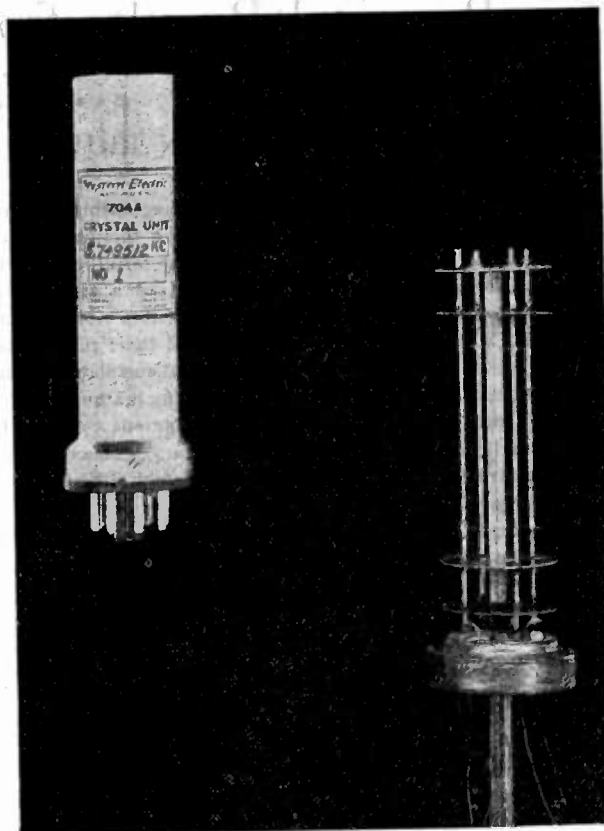

Fig. 18—Photograph of NT flexure crystal and holder.

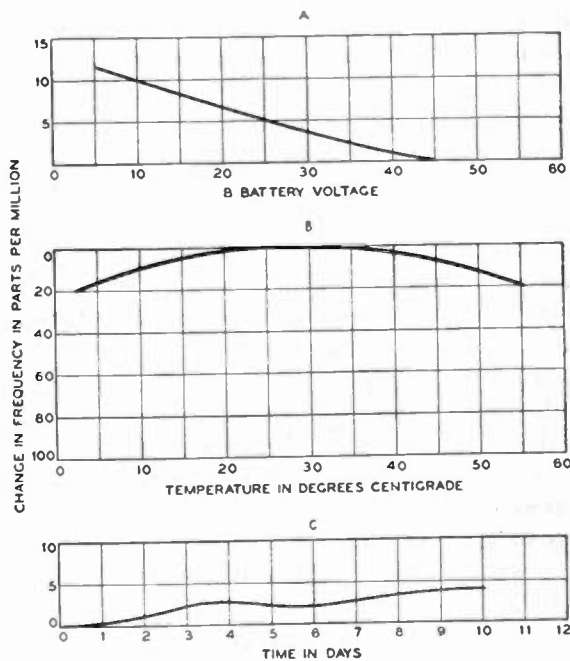

Fig. 19—Performance data for NT crystal-controlled oscillator.

cycles. A bimonthly check of the transmitter over a period of four months showed a maximum frequency change of less than ± 0.0006 per cent.

Practical Results from Theoretical Studies of Magnetrons*

LEON BRILLOUIN†, SENIOR MEMBER, I.R.E.

Summary—The effect of space charge in magnetrons is found to have a profound effect upon performance even though the critical motions of the electrons may be correctly determined by disregarding it. The inclusion of space charge gives a simple picture based on a rotating cloud of space charge. Possible vibration modes for this space-charge cloud are discussed and their relation to the impedance seen from an external circuit is correlated with the possibility of oscillation production. For obtaining mathematical solutions, the approximation of assuming the filament cylinder to be infinitely small in diameter has been necessary. Places where this assumption causes trouble are pointed out. Finally, the opposite case of a very large filament diameter is discussed briefly in terms of a planar structure. The description of the results is visualized by comparison with well-known problems of electrotechnics, such as alternators or cyclotrons.

I. INTRODUCTION

THE importance of magnetron tubes for the generation of high-frequency oscillations is well known, and some valuable information relating to the behavior of these tubes can be obtained from theoretical investigations. The purpose of this paper is to summarize the main results of the theory without going into all the details of the calculations, which are sometimes rather elaborate. Hence, the presentation will be mostly descriptive with the idea of visualizing, as far as possible, the most important facts in a way that can be useful to technicians and promote understanding of the typical phenomena involved.

A great many theoretical attempts have been made, many of them inadequate. The first thing to discuss is the reason why some of these theoretical investigations failed; this will, at the same time, emphasize the fundamental problems relating to magnetrons. A typical magnetron structure consists of a rectilinear filament (of radius a) with a cylindrical anode of radius b around it. A magnetic field H parallel to the filament is applied, and this magnetic field, in most cases, is uniform throughout the structure. In some instances the magnetic field makes a small angle with the filament, but this special case will not be discussed here.

It is well known that an electron (charge e , mass m) moving with a velocity v in a magnetic field H is acted upon by a force

$$F = \mu_0 e v H \quad (\text{Lorentz force}) \quad (1)$$

perpendicular to the magnetic field H and to the velocity v . All equations in this paper are written with two coefficients: ϵ_0 = dielectric permittivity of vacuum and μ_0 = magnetic permeability of vacuum. These two coefficients are connected by the relation

$$\epsilon_0 \mu_0 c^2 = 1 \quad c = \text{light velocity.}$$

* Decimal classification: R133XR130. Original manuscript received by the Institute, August 6, 1943.

† Columbia University, and Consulting Engineer, Federal Telephone and Radio Laboratories, New York, N. Y.

Electrostatic units correspond to $\epsilon_0 = 1$, $\mu_0 = c^{-2}$, while electromagnetic units yield $\epsilon_0 = c^{-2}$ and $\mu_0 = 1$. The formulas are not rationalized, leaving the 4π factors in their usual positions, as known in the electrostatic-unit or electromagnetic-unit systems. Giorgi rationalized units, as used in the books of Slater or Stratton, are obtained by taking

$$\epsilon_{0u} = \epsilon_0 / 4\pi = 10^{-11} / 36\pi \text{ farad per centimeter and} \\ \mu_{0u} = 4\pi \mu_0 = 4\pi 10^{-8} \text{ henry per centimeter.}$$

Fig. 1 gives a schematic representation of a magnetron structure. Electrons will be moving in xy planes, per-

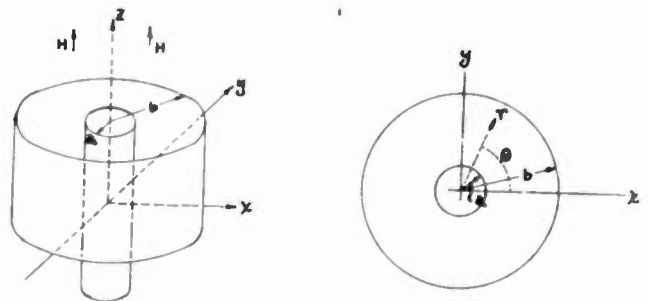

Fig. 1—Schematic representation of a magnetron.

pendicular to the filament and to the magnetic field. Their equations of motion, in the xy plane are

$$m(d^2x/dt^2) = eE_x + \mu_0 e v_y H \\ m(d^2y/dt^2) = eE_y - \mu_0 e v_x H, \quad (2)$$

including the action of an electric field $E_x E_y$ and of the Lorentz force (1).

If there were no magnetic field, the structure would be just an ordinary diode where electrons flow on straight lines from the filament to the anode. The problem of the diode has been completely discussed by Irving Langmuir. He assumes that electrons are emitted by the filament with no initial velocity. If the anode voltage is low, there is no field at the surface of the filament ($E_r = 0$ for $r = a$) and the diode works far from saturation. The space-charge distribution, in this case, plays a very important role and yields a relation

$$V_L = 1/2(-m/e)^{1/2} (9\beta^2(I/\epsilon_0)b)^{2/3} \quad (3)$$

between the current I reaching the anode (per unit of length) and the potential V_L of the anode. In the formula, β is a certain numerical coefficient tabulated by Langmuir and practically equals 1 when b/a is greater than 10.

As is well known, the filament is unable to yield a current larger than the saturation current I_s . When the voltage is increased above the limit corresponding to I_s (in (3)) the conditions change gradually: the space charge decreases, an electric field E obtains on the

filament ($r=a$) and the velocity of the electrons increases. For a very high voltage V on the anode, the space charge practically disappears inasmuch as the velocity of electrons becomes very large and their transit time between cathode and anode is extremely short.

If a magnetic field is applied on such a structure, the electron trajectories are no longer straight lines running from filament to anode. Bending of the trajectories by the magnetic field (as shown by (1) or (2)) results in an increase in the transit time and hence in the space-charge density. For a large magnetic field the electrons can be deflected sufficiently to prevent their reaching the anode, and the current I drops approximately to zero. These general results are easy to understand, even without any detailed computation of the trajectories and space charge. It is also known that magnetrons operated in the neighborhood of these critical conditions (with current I very small) are very effective for the generation of high-frequency oscillation.

Hence, the important problem for actual applications is the case of a small current I , large transit time, very large space charge, as obtained for a magnetic field slightly below the critical magnetic field.

Many authors have considered the motion of electrons in a magnetron, but have ignored the space-charge effect. This of course greatly simplifies the problem. As noted for the diode, the only case where space charge can be neglected is the case of saturation when a very high voltage is applied on the anode. In the magnetron, saturation is obtained only for a very small magnetic field when the bending of the trajectories is small. All this is very far from representing actual working conditions in magnetrons, and is of very little practical value. At any rate, when such results are extrapolated for a large magnetic field, they are certainly wrong inasmuch as a large magnetic field always means large space-charge density.

This has not always been clearly understood because of a curious coincidence which should be discussed as it explains some of the misunderstandings that have arisen. Assuming the electron trajectories to be calculated without considering space-charge effects, one may try to determine the magnetic field for which the trajectory ceases to reach the anode for a certain given voltage of the anode. This yields the correct relation between the critical magnetic field and the anode voltage. Hence an unreliable calculation happens to give a correct result. But this is explained by a more general theory, which shows that the critical magnetic field depends only on the voltage difference between anode and cathode, and can be obtained without taking into account the detailed field distribution between filament and anode. The space charge, however, greatly perturbs the field distribution between filament and anode, and the shape of electron trajectories, but it does not affect the potential difference. Hence a wrong assumption regarding space charge (as for instance the hypothesis of zero space charge) gives erroneous results in regard to field

distribution and the shape of the trajectories, but it is immaterial in the calculation of the critical magnetic field. The fact that calculations neglecting space charge yield a correct value for the critical magnetic field is no proof in favor of this theoretical attempt. It is merely an accidental coincidence. The relation between anode voltage V_0 and magnetic field H , corresponding to critical conditions ($I=0$), is

$$V_0 = - (m/2e)\omega_H^2(b - a^2/b)^2 \quad (4)$$

where $\omega_H = -(1/2)\mu_0(e/m)H$, Larmor's angular velocity $\omega_H = 0.887 \cdot 10^7 H$, when H is measured in oersted units.

In other theoretical researches, attempts were made to start with Langmuir's space-charge distribution in a diode without magnetic field. Trajectories were calculated with this space charge and a small magnetic field. Then, using the modified trajectories, a correction for the space-charge distribution could be obtained. This method is correct for small magnetic fields and can be applied in systematic successive approximations. While it is satisfactory for small magnetic fields when the current reaching the anode is slightly lower than the current in the diode without a magnetic field, it fails for large magnetic fields because the successive approximations cease to be convergent. The fact that a correct value of the critical field can be obtained in this way is again no proof for the validity of the method. The reason is the same as in the preceding example.

The idea of starting from Langmuir's solution for the diode is, nevertheless, a very useful one. As explained later in this paper, it can be applied in the immediate neighborhood of the filament up to a certain critical distance.

Another method of attack, used by some authors, is based on the use of the famous Larmor theorem. This is fundamentally valid, but Larmor's original calculations were performed on the assumption that the electron, in its unperturbed motion (no magnetic field), describes an orbit with a very high angular velocity $\dot{\theta} \gg \omega_H$. This resulted from the fact that Larmor was especially interested in electronic orbits inside an atom or a molecule where such conditions actually occur. In the problem of the magnetron, the unperturbed motion is along a straight line, from cathode to anode, and the unperturbed angular velocity is zero. Hence Larmor's equations should be completed by a corrective term, which has very often been omitted. This will be more clearly understood by writing the equations of motion (equation (2)) in polar co-ordinates. They result in

$$\begin{aligned} \dot{\theta} &= \omega_H + C/r^2 \\ \ddot{r}/r &= - (e/mr)E_r + (\dot{\theta} - \omega_H)^2 - \omega_H^2 \end{aligned} \quad (5)$$

where E_r is the electric field, assumed always to be directed along the radius r . C is an arbitrary constant, to be determined from the conditions on the filament. When the electrons are emitted without velocity, $\dot{\theta}$ must be zero for $r=a$ (on the filament); hence

$$C = -\omega_H a^2, \quad \dot{\theta} = \omega_H(1 - a^2/r^2). \quad (6)$$

Larmor assumed $\dot{\theta} \gg \omega_H$ and neglected the ω_H^2 term in the second equation. While justified in the case of atomic orbits, this term is essential in the magnetron problem since $\dot{\theta}$ and ω_H are of the same order of magnitude, as shown by (6).

To complete this general discussion, one should cite another difficulty of a more special mathematical nature. The equations of motion, for an electron moving inside a vacuum tube, always admit a solution of the following type

$$d/dt(rE_r) = 2(I/\epsilon_0) \quad (7)$$

where I is the current flowing to the anode, per unit of length, while E_r is the electric field and r the distance of the electron from the axis of symmetry. The derivative d/dt refers to a derivative taken along the line of motion of the electron.

$$d/dt(rE) = \partial/\partial t(rE) + \dot{r}(\partial/\partial r)(rE) \quad (8)$$

where $(\partial/\partial t)(\partial/\partial r)$ are the usual partial derivatives. In the static case, for a magnetron operated without oscillations, the first derivative $\partial/\partial t$ is zero, and the current I is constant. Equation (7) can be integrated readily and yields

$$\epsilon_0 r E_r = 2I\tau; \quad (9)$$

r is the distance from the axis of the filament, E_r the electric field at this distance, and τ the transit time of an electron traveling from the filament $r=a$ to the distance r . This formula is well known for usual electron tubes without magnetic fields, and it is easily proved to apply also to magnetrons. The difficulty starts when it is used for a magnetron operated under critical conditions. The current I is zero, τ is not zero, but what about E_r and τ ? The answer is not easy, and happens to be the following: in a magnetron operated under critical conditions, the electrons never reach the anode, and their trajectories curl indefinitely around the filament, making the transit time τ infinite. The product $I\tau$ takes the indeterminate form $0 \cdot \infty$, and thus the possibility of a finite electric field E_r exists.

Hence, (9) is valid, but leads to an uncertainty for critical conditions. More detailed consideration is therefore necessary; in fact, (9) cannot be used without previous knowledge of the type of actual solution.

II. ELECTRONIC TRAJECTORIES AND SPACE CHARGE IN MAGNETRONS

The electron trajectories between filament (radius a)^{1,2} and anode (radius b) are very sensitive to the detailed field distribution between these electrodes. Any erroneous assumptions of space-charge distribution results in a wrong field and yields electron trajectories which may be completely different from the actual ones, thus accounting for the incorrect results obtained from the theoretical calculations, which yield trajectories with

one or many loops between cathode and anode (Fig. 2). Similar trajectories were experimentally observed in some tubes when traces of ionized gas were introduced in order to make the trajectories visible, but this does not

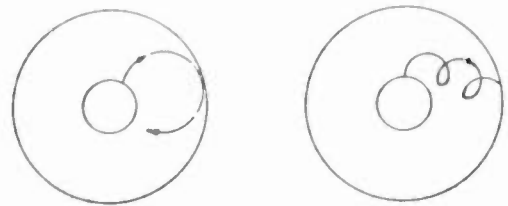

Fig. 2—Wrong electronic trajectories computed with incorrect space-charge distribution.

prove anything regarding the real electron trajectories in vacuum. It is well known that the slightest trace of gas in a tube results in ion production and completely perturbs the space-charge distribution.

The actual electron trajectories, as computed from a presumably correct theory, are shown in Fig. 3 where cases A, B, C, D correspond to increasing magnetic

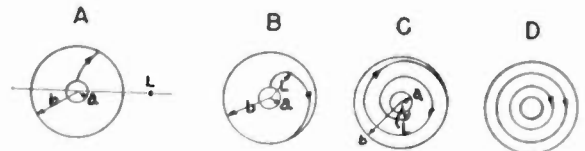

Fig. 3—Electronic trajectories for different magnetic fields

- A—small magnetic field $L \gg b$
- B—moderate magnetic field $L \approx b$
- C—strong magnetic field $L \ll b$
- D—critical magnetic field $L = 0$

fields. The calculations were performed on the assumption of *no saturation*, the electrons being emitted by the filament with *no initial velocity*, and the electric field at the surface of the filament being zero (*no saturation*). For a small magnetic field (case A) the trajectory is just slightly bent near the anode. This bending increases for a higher magnetic field (case B) and the electron moves through quite a large angle near the anode before reaching it, signifying a large increase of space charge near the anode. For a strong magnetic field (case C) electrons start radially from the cathode (radius a) but they are soon bent and curl *about the filament* in the form of a long spiral which may describe a large number of loops before reaching the anode. This means a very long transit time and a very large space charge in the whole region where the spiraling takes place. Under critical conditions (D), no current flows to the anode and no electron is able to move from cathode to anode, but a large space charge still exists between the cathode and anode. The spiraling degenerates into a set of concentric circles, and the entire space-charge distribution rotates about the filament like the rotor of an electric motor. In order to fix the order of magnitudes corresponding to the different cases A, B, C, D of Fig. 3, it is necessary to define a certain characteristic length L_H by the following formula:

$$L_H = \sqrt{-eI/\epsilon_0 m \omega_H^2} \quad (10)$$

¹ A. W. Hull, "The paths of electrons in the magnetron," *Phys. Rev.*, vol. 23, pp. 112-A; January, 1924.

² L. Brillouin, "Theory of the magnetron," *Elec. Comm.*, vol. 20, no. 2, pp. 112-122; 1941.

where e and m = charge and mass of the electron, respectively,

I = current reaching the anode per unit of length (in centimeters)

ω_H = Larmor's angular velocity from (4).

Approximately,

$$L_H = 48\sqrt{J/H^3} \quad (10a)$$

where J is the current in milliamperes per centimeter; H is in oersteds.

For each value of current I and magnetic field H , one can compute the length L_H , which may vary from ∞ ($H=0$) down to zero (critical conditions, $I=0$). The cases of Fig. 3 correspond to

A	B	C	D
$L_H \gg b$	$L_H \approx b$	$L_H \ll b$	$L_H = 0$

(11)

i.e., magnetic field: weak, moderate, strong, critical, respectively.

It will be noted that (6) shows that the first result obtained from the theory is the value of the angular velocity θ as a function of r . This angular velocity is zero on the filament ($r=a$) and increases progressively to the limit $\theta = \omega_H$. For all distances r noticeably greater than the radius a , the angular velocity will practically be equal to Larmor's angular velocity ω_H (Fig. 4). It applies for all cases A, B, C, D for any value of the magnetic field.

$$\theta = \omega_H(1 - a^2/r^2). \quad (6a)$$

Critical conditions are now very easy to obtain without any special knowledge of the detailed shape of the trajectory. Writing the kinetic energy E_{kin} of the electrons at the distance r and using (6), we have

$$E_{kin} = 1/2m(\dot{r}^2 + r^2\dot{\theta}^2) = 1/2m(\dot{r}^2 + \omega_H^2(r - a^2/r)^2). \quad (12)$$

Here the principle of conservation of energy is utilized and the electric potential $V(r)$ is introduced:

$$E_{kin} + eV(r) = E = \text{total energy}. \quad (13)$$

One may measure all potentials from the filament, i.e., $V(a)=0$, is assumed. Next, since electrons are emitted by the filament without velocity, their total initial energy is zero; hence,

$$E_{kin} + eV(r) = 0. \quad (14)$$

This permits very direct calculation of critical conditions; on the assumption that the current reaching the anode is zero, the radial velocity \dot{r} of the electrons must be zero on the anode ($r=b$); hence, critical conditions result in

$$E_{kin} + eV(b) = \frac{1}{2}m\omega_H^2(b - a^2/b)^2 + eV(b) = 0 \text{ anode } r=b \quad (15)$$

which yields directly the relation (4) between the potential of the anode (V_0 or $V(b)$) and the magnetic field (or ω_H) for critical conditions. It should be emphasized that this result is obtained without any detailed calculation of space-charge distribution. This is proof of the contention developed in Section I of this paper to the effect that correct critical conditions can be obtained without any knowledge of space-charge distribution, a point which should always be kept in mind.

The space-charge distribution in the magnetron operated under *critical conditions* is given by

$$\rho_0(r) = \epsilon_0(m\omega_H^2/2\pi e)(1 + a^4/r^4). \quad (16)$$

A constant value $\epsilon_0(m\omega_H^2/2\pi e)$ is maintained at great distance; it rises to 100 per cent near the filament (Fig. 5). Examination of (6a) and (16), or of the curves of Figs. 4 and 5, reveals that, at some distance from the filament, the space charge and the angular velocity are

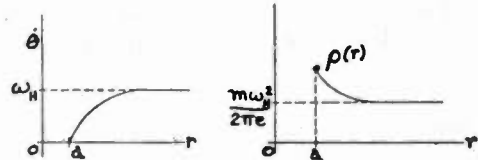

Fig. 4—Angular velocity θ of the electrons, as a function of the distance r , with a filament of radius a .

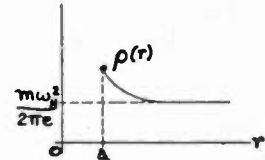

Fig. 5—Space-charge distribution, as a function of r , under critical conditions.

both constant. The potential inside the cloud of rotating electrons is represented by

$$V_0(r) = -m\omega_H^2/2e(r - a^2/r)^2. \quad (17)$$

Hence, a very simple conclusion is obtained:

In a magnetron operated under critical conditions, there is (aside from the immediate neighborhood of the filament) a cloud of electrons rotating about the filament. This cloud has a uniform density and a constant angular velocity and rotates about the filament like a solid rotor. It extends up to the anode but does not actually reach it.

This simple concept is very important and is especially useful in understanding the magnetron's properties. Obviously, it refers to a nonoscillating magnetron.

Returning now to a magnetron working with a weaker magnetic field (case B or C), we can distinguish two regions.

(1) Near the filament, $r \ll L_H$ —the electrons move almost radially, their trajectories being slightly bent by the magnetic field. The space charge is not very much greater than Langmuir's space charge for the diode. In this region, the process of successive approximations (see description following (4) above) can be usefully applied.

In the neighborhood of the circle of radius L_H , the trajectories travel at an angle of $\pi/4$ with the radius and enter the second region.

(2) Far away from the filament, $r \gg L_H$, the electrons spiral around the filament, their radial component of velocity being much smaller than the angular component. The space charge is much higher than in the first region. A process of successive approximations can be worked out starting from the limiting case of critical conditions, as represented by (16) and (17). A correction must be applied to take account of the radial velocity which is small but finite in case C while it is zero in case D. The potential distribution for $r \gg L_H$ is given approximately by

$$V(r) = V_0(r) - I^2/\epsilon_0^2 \cdot e/2m\omega_H^4 r^2 \quad (18)$$

where V_0 results from (17) and I is the current per unit of length of the structure.

Further consideration of the behavior of a magnetron under critical conditions is interesting. A very small filament radius is assumed inasmuch as all formulae can be greatly simplified when a is made zero. The space charge retains a constant density ρ_0 (equation (16)) and rotates about the filament with a uniform angular velocity ω_H . The total (negative) charge Q of the electron cloud (per unit length of the structure) is

$$Q = \rho_0 \pi b^2 = \epsilon_0 (m/2e) \omega_H^2 b^2, \quad \rho_0 = \epsilon_0 (m\omega_H^2/2\pi e). \quad (19)$$

As the whole system must be electrically neutral, there is an equal positive charge $-Q$ on the anode and no current flows from cathode to anode. With the potential of the filament taken as zero, the anode potential is

$$V_0(b) = - (m/2e) \omega_H^2 b^2 = - Q/\epsilon_0 \quad (20)$$

from (4), where a is made zero. This shows that the magnetron exhibits a direct-current capacitance ϵ_0 per centimeter of filament, regardless of the length of the radius b of the anode, provided operation occurs just under critical conditions.

$$\text{The mass of the electron cloud totals } M = (m/e)Q \quad (21)$$

the moment of inertia J is

$$J = M(b^2/2) = (m\omega_H/2e)^2 b^4 \quad (22)$$

and the kinetic energy is

$$E_{kin} = 1/2 J \omega_H^2 = 1/8 (m^2/e^2) \omega_H^4 b^4 \quad (23)$$

all per unit length of the structure.

The latter result can be expressed as

$$\begin{aligned} E_{kin} &= -1/2 Q V_0(b) = (\epsilon_0/2) V_0^2(b) \\ &= (1/1.8) 10^{-5} U_0^2 \text{ centimeter-gram-second (ergs)} \\ \text{as } \epsilon_0 &= 1, V_0 = (1/300) U_0 \text{ in electrostatic units} \\ &U_0 \text{ in volts.} \end{aligned} \quad (24)$$

In addition to kinetic energy, one must compute the potential energy of both negative and positive charges. The negative charges (electron space charge) may be segregated in cylindrical layers, r , $r+dr$, the volume of which is $2\pi r dr$ per unit length, yielding a charge $dQ = \rho_0 2\pi r dr$, the potential of which is $V_0(r) = -(m/2e) \omega_H^2 r^2$. This means a contribution to potential energy of $V_0(r) dQ = -2(m/2e)^2 \epsilon_0 \omega_H^4 r^3 dr$.

Hence the contribution of negative charges to the potential energy is

$$\int_{r=0}^{r=b} V_0(r) dQ = -\frac{\epsilon_0}{8} \frac{m^2}{e^2} \omega_H^4 b^4 = -\frac{\epsilon_0}{2} V_0^2(b). \quad (25)$$

The positive charge $-Q$ is all located on the anode, at the potential $V_0(b)$, and yields a contribution $-Q V_0(b) = \epsilon_0 V_0^2(b)$. Hence the total potential energy of negative and positive charges is

$$E_{pot} = 1/2 \epsilon_0 V_0^2(b) = E_{kin} \quad (26)$$

and the total energy (kinetic plus potential) amounts to

$$\begin{aligned} E_{total} &= \epsilon_0 V_0^2(b) \text{ per unit length} \\ &= 1.111 \cdot 10^{-5} U_0^2 \text{ where } U_0 \text{ is the anode voltage} \\ &\text{in volts; } E \text{ is in ergs.} \end{aligned} \quad (27)$$

This represents a comparatively large amount of energy, much more important than in any other type of electron tube. It should be noted that the result is independent of the radius of the anode, provided critical conditions are satisfied. If the anode voltage U_0 is 10,000 volts, the total energy stored up in 1 centimeter of the magnetron structure is 1111.1 ergs or $1111 \cdot 10^{-4}$ joule, sufficient to maintain a current of 10 milliamperes for 1 second in a resistance of 1111 ohms. If this energy could be changed into high-frequency oscillations, enough power would be delivered to run a 1-kilowatt station for 10^{-7} seconds.

Where does this energy come from, and how is it dissipated afterwards? The magnetic field does not do any work as the Lorentz force is always perpendicular to the electron trajectories. Let us assume that we shall operate a magnetron, first switching on the magnetic field H and the anode voltage V_0 , and finally heating the filament. A negative charge Q leaves the filament and spreads out between cathode and anode to build up the space charge, while a positive charge $-Q$ appears on the anode. This positive charge $-Q$ passes through the anode battery V_0 , which yields energy $-Q V_0$, just the amount (27) of the total energy accumulated in the magnetron (per unit length). Now, let us stop heating the filament. The space charge, built up between cathode and anode, goes on rotating about the filament, until the magnetic field is switched off. Then all electrons fall on the anode, and the whole energy E_{tot} of (27) is dissipated.

These explanations show the difference between a magnetron (under critical conditions) and a condenser. The charge Q per unit length is the same as for a capacitor of capacitance ϵ_0 or 1 centimeter (in electrostatic units) but the energy accumulated (27) is twice that of the capacitor, and the processes of charge or discharge differ materially.

III. PROPER OSCILLATIONS OF THE SPACE CHARGE — SINGLE-ANODE MAGNETRONS

Once the behavior of the magnetron under steady conditions has been carefully studied, the next step is to proceed with an analysis of the possible modes of vibration of the electron cloud constituting the space charge. This will be done *assuming critical conditions* (no current to the anode) when electrons travel in concentric circles (Fig. 3, D) with angular velocities θ (equation (6a) and Fig. 4) and space charge $\rho_0(r)$ (equation (16) and Fig. 5). The fundamental mode of vibration is one which is cylindrically symmetrical. All electrons on a certain circle move in unison radially, the circle expanding and shrinking alternately, while the average rotation θ goes on unperturbed. This will be called the $n=0$ mode of vibration, as compared with other modes $n=1, 2, \dots$ which will be discussed later on. Such symmetrical vibration may result in large oscillations if it happens to proceed with a frequency

corresponding to one of the proper frequencies of oscillation of the space charge.

An analysis of the possible motion shows that a cylindrical layer, comprised between r and $r+dr$, should exhibit a proper frequency of oscillations $\omega(r)$;

$$\omega^2(r) = 2\omega_H^2(1 + a^4/r^4) \text{ mode } n = 0. \quad (28)$$

Hence, for this type of oscillation, the inner proper frequencies range from

$$\omega = \sqrt{2}\omega_H, \quad r \gg a \quad (28a)$$

at a great distance from the filament, up to

$$\omega(a) = 2\omega_H, \quad r = a \quad (28b)$$

near the filament.

Of course the vibration of the space charge as a whole is a rather complicated phenomena, involving a sort of coupling between the successive layers because of the necessary conditions of continuity. Nevertheless, the following conclusion can be reached immediately. In a magnetron under critical conditions, large oscillations may occur when the frequency ω is near the band of internal proper frequencies, extending from $2\omega_H$ near the filament down to $\omega_H\sqrt{2+2(a^4/b^4)}$ near the anode ($r=b$).

This assumption is supported by a more detailed analysis. Blewett and Ramo,^{3,4} for instance, discussed the case of a magnetron built as shown in Fig. 6. It consists essentially of a sort of coaxial cable with a short filament of length l in the middle. Electrons emitted by

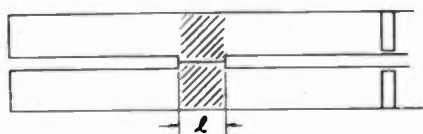

Fig. 6—A magnetron with coaxial resonators.

this filament travel towards the outer cylinder, and build up a space charge in the shaded area. Hence the magnetron is constituted by this shaded area of length l , while the rest of the coaxial cable represents the tuning circuit. These authors discussed the case of oscillations with cylindrical symmetry and found that the space charge should behave (for high frequencies) like a medium of dielectric permittivity

$$\epsilon = \epsilon_0(1 - 2(\omega_H^2/\omega^2)), \quad \omega \gg \sqrt{2}\omega_H. \quad (29)$$

They assumed a very fine filament and ignored the eventual role played by the propinquity of the filament. This explains why their formula contains only the proper frequency (28a) corresponding to the electronic layers far removed from the filament. Experimental observations check rather well with the theoretical formula.

Starting from this result, one may try to predict the alternating-current behavior of the magnetron when oscillations of high frequency are applied on the anode.

³ J. P. Blewett and S. Ramo, "High frequency behavior of a space charge," *Phys. Rev.*, vol. 57, pp. 635-641; April, 1940.

⁴ J. P. Blewett and S. Ramo, "Propagation of electromagnetic waves in a space charge rotating in a magnetic field," *Jour. Appl. Phys.*, vol. 12, pp. 856-859; December, 1941.

The magnetron constitutes a sort of cylindrical condenser with electrodes of radii a and b . This condenser is filled with a medium of dielectric constant ϵ (equation (29)). Hence it should exhibit (per unit length of the structure) a capacitance

$$C = \epsilon/2 \log \frac{b}{a}, \quad (30)$$

which means an internal impedance per unit length of

$$Z = -\frac{i}{C\omega} = -\frac{i}{\epsilon\omega} 2 \log \frac{b}{a} = \frac{i}{\epsilon_0} \frac{2\omega}{2\omega_H^2 - \omega^2} \log \frac{b}{a} \quad (31)$$

Z should be positive for $\omega < \sqrt{2}\omega_H$, infinity for $\omega = \sqrt{2}\omega_H$ (resonance), and negative (like a capacitance) for $\omega > \sqrt{2}\omega_H$.

Such a formula, however, merely represents a crude first approximation. Its inconsistency results from the use of a finite a (radius of the filament) in (30), while (29) was obtained for $a \rightarrow 0$.

More detailed consideration leads to rather lengthy calculations. It can be shown that (31) is correct for very high frequencies

$$Z = \frac{i}{\epsilon_0} \frac{2\omega}{2\omega_H^2 - \omega^2} \log \frac{b}{a}, \quad \omega \gg 2\omega_H. \quad (32)$$

In this case, the magnetron behaves like a condenser.

For the frequency band corresponding to internal vibrations of the space charge, the magnetron should exhibit a rather large positive resistance R , plus an imaginary term X

$$Z = R + iX. \quad \omega_H\sqrt{2 + 2(a^4/b^4)} \leq \omega \leq 2\omega_H. \quad (33)$$

For lower frequencies, the resistance term drops out, and the internal impedance is positive imaginary (like for a self-inductance coil).

$$Z = \frac{i}{\epsilon_0} \frac{\omega}{2\omega_H^2 - \omega^2} \log \frac{b^4/a^4 + \beta'}{1 + \beta'} \quad (34)$$

$$\beta' = \frac{2\omega_H^2}{2\omega_H^2 - \omega^2}, \quad \omega < \sqrt{2}\omega_H$$

where β' initially is ∞ ($\omega = \sqrt{2}\omega_H$) and decreases down to 1 when ω becomes zero.

The foregoing corresponds to a magnetron under critical conditions when the anodic current is zero, and no direct-current power is supplied to the magnetron. This explains why the magnetron behaves like a pure reactance, and cannot exhibit any negative resistance. Such a magnetron is unable to sustain oscillations in an external circuit.

The situation is different when the magnetron is operated just above critical conditions with a small anodic current I and a direct-current power supply $I \cdot V_0$ from the anodic battery. In such a case, the internal impedance of the magnetron may exhibit a negative resistance term when the frequency lies just below the lower limit of the band of internal frequencies

$$\omega \leq \omega_H\sqrt{2 + 2(a^4/b^4)}, \quad (35)$$

as verified by experimental results.

For a magnetron with a fine filament and, when a'/b' is very small, a negative resistance term occurs for

$$y = \frac{\omega}{\omega_H} \approx \sqrt{2}. \quad (36)$$

Since $y = \frac{\omega}{\omega_H} = \frac{2\pi c}{\lambda \omega_H} = \frac{21310}{\lambda H}$ λ in centimeters
 H in oersteds

equation (36) becomes

$$\lambda H = \frac{21310}{\sqrt{2}} \approx 15000 \quad (37)$$

which is the exact empirical formula found for single anode magnetrons.

IV. HIGHER MODES OF VIBRATION

The type of oscillation discussed in the preceding section is characterized by its cylindrical symmetry. Other modes of vibration can be excited in the space charge, and these new types will depend on the angular directions and as $\cos \theta$ (or $\sin \theta$), $\cos 2\theta$ ($\sin 2\theta$) The general type of vibration corresponds to $\cos n\theta$ (or $\sin n\theta$), and shows n maxima or crests and n minima or troughs along the whole circle. It is now evident why the symmetrical vibration discussed in Section III was called "mode $n=0$." In fact, $n=0$ results in no dependence of the angle θ .

Fig. 7 shows a schematic of these different types of oscillations. $n=0$ illustrates cylindrical symmetry where the different cylindrical configurations expand or shrink symmetrically. For $n=1$ the oscillations occur in opposite directions at $\theta=0$ and $\theta=\pi$, and the resulting motion is a transverse oscillation of the cloud. For $n=2$,

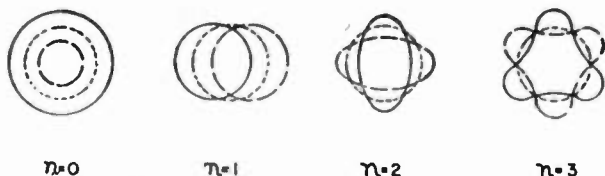

Fig. 7—Different types of possible oscillations in the space-charge distribution.

two maxima and two minima occur along the circle, thus quickly distorting the original circle into an ellipse. In all these schematic sketches the dotted circular curve represents the position of the cylindrical configuration when in equilibrium. The solid curve shows the distortion in one of its maximum oscillations; the broken curve corresponds to the opposite maximum distortion (half a period later).

When equations of oscillation of the electron cloud are formulated completely, two groups of terms result. The first can be said to correspond to the proper oscillation of one cylindrical configuration, considered as a separate unit, and the other terms exhibit a strong coupling between these successive configurations. Consideration of the case of a filament of finite radius would involve great complexity; hence, in this Section, a *very fine filament* of radius $a \rightarrow 0$ is assumed and a will be neglected in formulating the equations.

Let us commence with consideration of the first group of terms, yielding the proper vibrations of the electron cloud. These motions are best described as rotations of the distorted cloud as a whole. If Larmor's angular velocity ω_H be taken as positive, one of the proper rotations is in the same direction as Larmor's and will be counted as positive ($+\Omega_1$ angular velocity) while the other proper rotation occurs in the opposite direction and will be regarded as negative with negative Ω_2 angular velocity.

Here one must pay attention to the difference between the frequencies of oscillation (designated ω_1, ω_2) and the angular velocity of the space charge. A space charge distorted along a mode n resembles the rotor of an *alternator with $2n$ poles* (n positive poles corresponding to the crests and n negative poles to the troughs in the charge distribution). When rotated with an angular velocity Ω_1 or Ω_2 it exhibits frequencies

$$\omega_1 = n\Omega_1, \quad \omega_2 = n\Omega_2 \quad (38)$$

since $T_1 = 2\pi/\Omega_1$ is the time required for complete rotation through an angle 2π while $\tau_1 = 2\pi/\omega_1$ is the period after which the whole system returns to its initial shape, attained after rotation through an angle $2\pi/n$.

To summarize the preceding theoretical discussion: For each mode of vibration ($n=1, 2, 3$, etc.) there are two proper frequencies ω_1 and ω_2 . The positive frequency ω_1 corresponds to rotation of the whole electron cloud in the ω_H (Larmor's rotation) direction with an angular velocity Ω_1 . The negative proper frequency ω_2 indicates rotation of the cloud as a whole in a direction opposite to Larmor's with an angular velocity Ω_2 .

These two proper frequencies are the two roots of the equation

$$\omega(\omega - n\omega_H) - 2\omega_H^2 = 0 \quad (39)$$

$$y(y - n) - 2 = 0, \quad y = \omega/\omega_H = 21310/\lambda H$$

where y is defined as in (36). The roots of the latter equation are

$$y = n/2 \pm \sqrt{n^2/4 + 2}. \quad (40)$$

Fig. 8 depicts the curve with y (frequency ω in ω_H units) as a function of n (number of crests in Fig. 7, or half the number of poles of an equivalent $2n$ pole alternator). The curve is an hyperbola with a horizontal asymptote and another at 45 degrees. For each n value, one obtains a positive root y_1 (upper curve) and a negative root y_2 (lower curve), corresponding to the two opposite rotations. It is interesting to note that for $n=0$ the roots are $y = \pm\sqrt{2}$, which checks with the results of Section III (equation (36)).

The angular velocities Ω_1, Ω_2 corresponding to these two rotations are obviously

$$\Omega_1 = \frac{\omega_H}{n} y_1 = \frac{1}{2} + \sqrt{\frac{1}{4} + \frac{2}{n^2}}$$

$$\Omega_2 = \frac{\omega_H}{n} y_2 = \frac{1}{2} - \sqrt{\frac{1}{4} + \frac{2}{n^2}} \quad (41)$$

When the "number of crests" n increases, the two roots y_1, y_2 tend to the limits $y_1 = n, y_2 = 0$ and the angular velocities become $\Omega_1 \rightarrow \omega_H, \Omega_2 \rightarrow 0$.

Hence, for the higher modes of vibrations, a simple picture is obtained. The first proper vibration is one in which the whole system of crests and troughs rotates with Larmor's angular velocity ω_H . But it is known that the space charge itself also rotates like a solid body with velocity ω_H . This was proved for an unperturbed space-charge distribution, and the result now is extended to a perturbation of type n ($n \gg 1$). The perturbed space charge may rotate as a whole, behaving like a rigid body and playing exactly the same role as the rigid rotor of a $2n$ pole alternator.

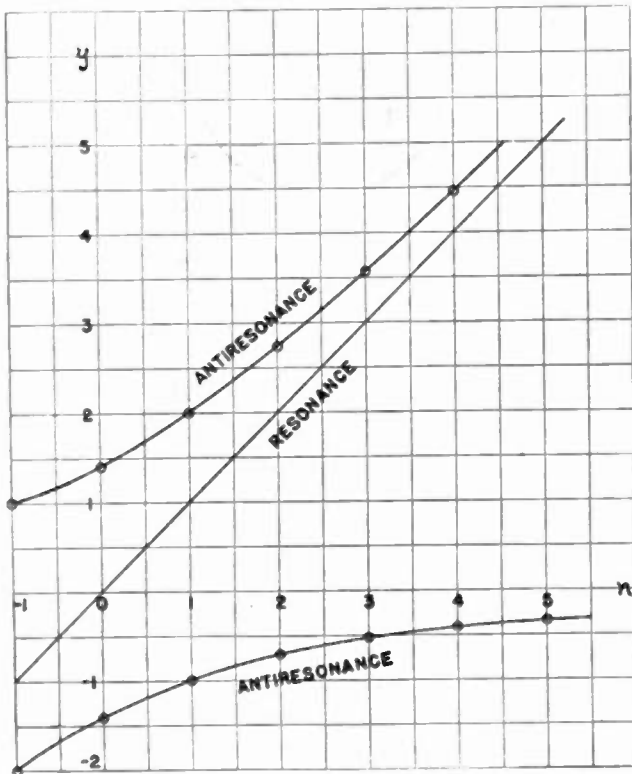

Fig. 8—Proper frequencies of oscillation corresponding to the different types indicated on Fig. 7, $y = \omega/\omega_H$ is the ratio of frequency to Larmor's frequency, while n specifies the type of vibration.

The second proper vibration is quite different; the electron cloud always rotates with Larmor's angular velocity ω_H but despite this general rotation the whole system of crests and troughs remains at rest (with just a slight tendency to rotate backwards).

For each of these modes of vibration it will be found that the voltage V and the components J_r, J_θ of the current density depend on the time t and the angle θ of an imaginary exponential in $e^{i(\omega t - n\theta)}$, i.e., an angular velocity $\Omega = \omega/n$ with the same sign as ω . In further discussions it may be useful to retain the usual definition of the frequency as a positive member. This can be done by employing a positive n value when ω is positive and a negative n when ω is negative,

$$n\Omega_1 = \omega_1 \quad \omega_1 > 0 \quad n > 0 \quad \text{rotation in the } \omega_H \text{ direction}$$

$$\Omega_2 = \frac{\omega_2}{n} = \frac{|\omega_2|}{-n} \begin{cases} \omega_2 < 0 \quad n > 0 \quad \text{rotation in the opposite} \\ \text{or } |\omega_2| > 0 \quad -n < 0 \quad \text{direction.} \end{cases} \quad (42)$$

The two methods are equivalent. As may be seen from Fig. 8 or 11, greater continuity of the curves sometimes is obtained by the use of negative ω values (or negative y values). But for applications to the theory of circuits, and especially for consideration of the internal impedance of a magnetron, the usual definition will hereinafter be adhered to, i.e., ω always positive, and negative n values characterizing negative rotation.

Following this general discussion of the proper motion of the space charge, the coupling between the concentric shells which constitute this space charge must be considered. The coupling corresponds to Maxwell's equations, together with the necessary conditions of continuity for the field and velocity components. These equations show that V and the J components must vary as functions of r such as powers r^x, r^{x-1} of this radius, where the exponent x is defined as a certain function of ω and n .

The subscript a will be used to characterize the alternative components of the voltage V_a and of the current densities $J_{ar}, J_{a\theta}$ in the r and θ directions. The calculations can be performed only for the case of very small oscillations, and yield the following results:

$$V_a = Kr^x$$

$$J_{ar} = -iV_a \frac{\epsilon_0 x}{4\pi r} \left[\frac{2\omega_H^2}{\omega - n\omega_H} - \omega \right]$$

$$J_{a\theta} = -V_a \frac{\epsilon_0 x^2}{4\pi nr} \left[\frac{2\omega_H^2}{\omega - n\omega_H} - \omega \right]. \quad (43)$$

They represent the amplitudes of the voltage and current densities corresponding to an $e^{i(\omega t - n\theta)}$ factor.

As in (42), ω is always treated as a positive quantity. Negative rotations are represented by negative n values. In the magnetron, the voltage of the anode is assumed to be positive, and the voltage of the filament is taken as zero. Hence, according to the usual circuit theory definitions, the current J_r is regarded as positive when it flows from the anode towards the filament.⁵⁻⁸

The exponent x in the V_a formula depends upon ω and n in a rather complicated way. It always is defined as the root of a second-order equation, signifying that for each couple of ω, n values, one may obtain two different real roots x_1, x_2 (positive or negative) or two complex roots $x_1 = x_r + ix_i; x_2 = x_r - ix_i$.

⁵ A different sign convention was first used by the author in the paper referred to as "Magnetron I" and in the beginning of "Magnetron II." The usual sign definition was used in "Magnetron II," equation 77 and in "Magnetron III." This explains why the present equation (43) exhibits a different sign from equation 60 in "Magnetron II."

⁶ L. Brillouin, "Theory of the magnetron I," *Phys. Rev.*, vol. 60, pp. 385-396; September, 1941.

⁷ L. Brillouin, "Theory of the magnetron II," *Phys. Rev.*, vol. 62, pp. 166-167; August, 1943.

⁸ L. Brillouin, "Theory of the magnetron III," *Phys. Rev.*, vol. 63, pp. 127-136; February, 1943.

A real value of x means that the electron cloud rotates as a whole with no phase shift along a certain direction defined by an angle θ . A complex value of x means a phase shift between the successive cylindrical shells as, for instance,

$$r^{x_1} = r^{x_1 - iz_1} = r^{x_1} e^{-iz_1 \log r}; \quad (44)$$

the imaginary exponential can be combined with $e^{i(\omega t - n\theta)}$ in the form

$$e^{i(\omega t - n\theta - z_1 \log r)}.$$

Propagation of the disturbance from the filament to the anode (for the x_2 root), or vice versa (for the x_1 root), is thus indicated.

The choice of x_1 or x_2 , or in certain cases the use of a superposition of the two solutions in the V and J formulas, depends essentially on the specific problem presented and on the implied boundary condition. For instance, in an ordinary 1-anode magnetron, V_a must be constant on the filament and zero also on the cylindrical anode ($r=b$), a result obtainable by a superposition of the two r^{x_1} and r^{x_2} solutions.

Reverting to (43) it is seen that both J_{or} and $J_{a\theta}$ exhibit a coefficient showing the resonance properties previously described. The term inside the bracket is

$$\left[\frac{2\omega_H^2}{\omega - n\omega_H} - \omega \right] = \frac{\omega(\omega - n\omega_H) - 2\omega_H^2}{-\omega + n\omega_H}; \quad (45)$$

the numerator is similar to the (39) term, already discussed. It becomes zero for the two proper frequencies ω_1 (corresponding to $+n$) and $\omega_2 > 0$ (corresponding to $-n$), the usual definition of the frequency as a positive number being retained in accordance with (42).

These two internal *proper frequencies* appear with *antiresonance* properties inasmuch as both current components must be zero, which corresponds to an infinite internal impedance for the magnetron. A *resonance* frequency, on the contrary, is found for $\omega = n\omega_H$ which makes the current components infinite.

V. MULTIANODE MAGNETRONS

Multianode magnetrons are structures wherein the anode is composed of an even number $2n$ of shells, equally spaced on a cylinder around the filament. The most popular type, known as "split-anode magnetron" is built with two half-cylindrical anodes on both sides of the filament, but other models with 4, 8, 10, 12, or more anodes have also been successfully used. The oscillating circuit is connected in parallel, one of its terminals being connected to the even anodes and the other terminal to the odd anodes. A type with four anodes ($n=2$) is shown in Fig. 9 with connections to the oscillating circuit and the anodic battery V_a .

Previously, the motion of the space charge inside the magnetron was compared to that of the rotor in an *alternator*. The anodes of these new structures play the role of the $2n$ poles of the stator. Another comparison is also interesting, and refers to the case of the usual

split-anode magnetron, which can be considered as the *reverse of a cyclotron*.

The cyclotron functions with ions instead of electrons, high-frequency oscillations together with a magnetic field being employed to obtain ions at very high velocities. Thus it transforms high-frequency power into direct-current power. The ions describe a spiral, from the ion source up to the ion collector. In the split-anode magnetron, direct-current power is converted into high-frequency oscillations, while the electrons describe spiral trajectories, very similar to those of the ions in the cyclotron.

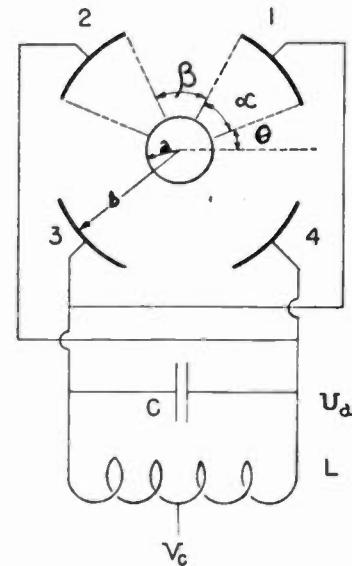

Fig. 9—Schematic representation of a split-anode magnetron connected to one single circuit ($n=2$, 4 anodes).

While one process is just the reverse of the other, both are based on the same general property, namely, the spiral shape of the trajectories occasioned by the magnetic field. There is, however, an important difference between the two phenomena since space-charge effects are negligible in cyclotrons, but play a major role in magnetrons.

Let us assume a device of the type shown on Fig. 9 with oscillations in the LC circuit. These oscillations result in additional potentials applied on the odd and even anodes tending to excite vibrations of type $\pm n$ (Fig. 7) in the space charge. The analysis of the preceding Section will aid in the discussion of these multianode magnetrons.

To be more precise, one must first note that the potential distribution on the anode circle ($r=b$) is not sinusoidal but is represented by a broken curve (Fig. 10). This curve can be analyzed in a Fourier series and, according to its properties of symmetry, it will exhibit only odd harmonics. This means that a magnetron, with $2n$ anodes on its "stator," may excite harmonic motions in the space charge corresponding to the *modes*

$$n' = \pm n, \pm 3n, \pm 5n, \dots \quad (46)$$

But there is no experimental evidence, for the moment, that modes corresponding to higher harmonics ($n' = \pm 3n$

for instance) have been observed. Such a possibility is not excluded but it will be assumed that the first term is by far the most important. Thus the voltage distribution along the anodic circle will be a sinusoidal one in $\sin n\theta$ or $\cos n\theta$. The assumption involving Figs. 9 and 10 corresponds to a sine curve

$$V(b) = V_c(b) + CU_a \sin n\theta e^{i\omega t}, \quad (47)$$

where V_c is the direct average voltage and $\pm U_a e^{i\omega t}$ the oscillating additional voltage on odd and even anodes. The C coefficient results from the process of Fourier expansion of the curve of Fig. 10. As a matter of fact, this coefficient is very nearly unity.⁷ The extreme cases are

very fine anodes $\alpha = 0 \quad \beta = \pi/n \quad C = 8/\pi^2 \approx 0.8$
 larger anodes $\alpha = \pi/n \quad \beta = 0 \quad C = 4/\pi \approx 1.28$
 more generally $C = (8/\pi n\beta) \sin(n\beta/2)$.

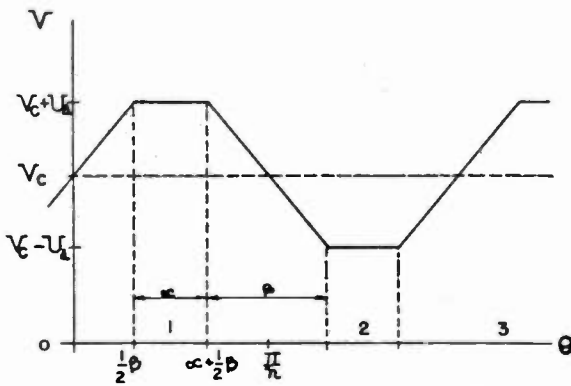

Fig. 10—Potential distribution on the anodic circle, for a split-anode magnetron.

The following formulas summarize previous assumptions regarding the location and the alternative potentials of the anodes:

odd anodes $0 < \theta < \frac{\pi}{n}$
 $\frac{2\pi}{n} < \theta < \frac{3\pi}{n}$

 even anodes $\frac{\pi}{n} < \theta < \frac{2\pi}{n}$
 $\frac{3\pi}{n} < \theta < \frac{4\pi}{n}$

$$+ U_a e^{i\omega t} \text{ or } C \overline{\sin n\theta} = 1 \quad (48)$$

$$- U_a e^{i\omega t} \text{ or } C \overline{\sin n\theta} = -1.$$

The $\sin n\theta$ term in (47) can be broken up into two imaginary exponentials, a procedure which amounts to the usual resolution of an oscillation into two opposite rotations. This leaves a distribution of alternative potentials on the anodic circle.

$$CU_a \sin n\theta e^{i\omega t} = \frac{CU_a}{2i} [e^{i(\omega t + n\theta)} - e^{i(\omega t - n\theta)}] \quad (49)$$

that is, this exhibits two fields rotating in opposite di-

rections, both characterized by imaginary exponentials similar to those of (43).

The exact boundary conditions in a multianode magnetron can now be stated. According to the idealized problem just discussed, it is necessary to find an alternating potential $V_a(r)$ which should be zero on the filament ($r=a=0$) since the filament is the origin for the scale of electric potentials. The potential V_a on the anodic circle ($r=b$) must be in agreement with the assumptions of (48) and (49).

$$V_a(b, \theta, t) = \frac{1}{2i} CU_a [-e^{i(\omega t - n\theta)} + e^{i(\omega t + n\theta)}]. \quad (50)$$

The first term with exponent $i(\omega t - n\theta)$ corresponds to the so-called $(+n)$ case (equations (42) and (43)) while the second exponential, with $i(\omega t + n\theta)$, refers to the $(-n)$ case. The problem therefore splits into two parts: the first $(+n)$ for a field rotating in the positive direction and the second $(-n)$ for rotation in the negative direction. Both cases exhibit the same voltage amplitude on the anodes $V_a(b)$; each yields different current densities which may be called $J_a(+n)$ and $J_a(-n)$. The two currents are superimposed in the outer circuits. Hence the magnetron actually works as a system of two parallel impedances $Z(+n)$ and $Z(-n)$, the resulting impedance Z being

$$\frac{1}{Z} = \frac{1}{Z(+n)} + \frac{1}{Z(-n)} \quad U_a = Z(+n)I(+n) \quad (51)$$

$$U_a = Z(-n)I(-n)$$

when $I(+n)$ and $I(-n)$ are the currents reaching the odd anodes. These currents are computed from the current densities J_{ar} . There are n odd anodes working in parallel, each collecting the current on a π/n sector; hence

$$I_a(\pm n)e^{i\omega t} = n \int_0^{\pi/n} J_{ar}(\pm n)e^{i(\omega t \mp n\theta)} r d\theta$$

$$= \mp 2ir J_{ar}(\pm n)e^{i\omega t}. \quad (52)$$

The formula summarizes both $\pm n$ cases; r must be taken equal to b when the anodic current is sought. The current reaching the even anodes is $-I_a(\pm n)$.

The $+n$ or the $-n$ case can now be dealt with, using solution (43). The first thing is to choose the exponent x in these formulae (43) in order to satisfy the boundary conditions (50). As V_a is required to be zero for $r=0$, the exponent x must have a *positive real component*. If large oscillations are to be avoided an additional condition should be added, namely, that the electric field on the filament should be zero. This is necessary to prevent saturation. Hence

$$\text{necessary condition} \dots \text{Re}(x) > 0 \quad (53)$$

in order to avoid saturation $\dots \text{Re}(x) \geq 1$.

The second condition is obvious: the electric potential in r^x yields an electric field in $-xr^{x-1}$ which is zero on the filament ($r=0$) only under the second condition.

Consideration of the equation yielding x shows that the following cases may occur:

I—Two real roots, both comprised between 0 and 1.

⁷ Loc. cit., equations (2), (66), and (73).

In this case, it is impossible to avoid saturation current, a situation to be discussed later.

II—Two real roots, one positive, greater than unity and the other one negative. This leaves one root satisfying (53).

III—Two real roots greater than unity. This occurs only for exceptional conditions, and leaves the problem without any definite answer. Both roots x_1 and x_2 can be used, and the potential equation may be formulated as a linear combination of the two solutions

$$V_a = K_1 r^{x_1} + K_2 r^{x_2} \quad (54)$$

where there is only one condition to satisfy on the anodic circle. Hence one of the two coefficients K_1, K_2 remains arbitrary.

IV—Two complex roots, $x = x_r \pm ix_i$, with $x_r < 1$.

This situation is similar to case I as it is impossible to prevent saturation.

V—Two complex roots $x = x_r \pm ix_i$, with $x_r > 1$.

This occurs only for a small frequency band, and leaves the problem without any definite answer, as in case III.

The sketch of Fig. 11 shows the conditions under which these different cases occur. Here n represents half the number of anodes and $y = \omega/\omega_H = 21310/\lambda H$ as before. Different types of shading have been used for the regions, in the y, n plane, corresponding to cases I to V. A complete map would include negative values of y and n but the whole figure is symmetrical about the origin,

so that only one half is really needed. As previously noted, cases $y < 0, n > 0$ and $y > 0, n < 0$ are equivalent and signify negative rotation. In the same way, cases $y > 0, n > 0$ and $y < 0, n < 0$ both mean positive rotation, which explains the symmetry of the whole figure.

Continuous curves have been drawn, treating n as a continuous variable. Of course, only integer values of n are of practical significance.

The question arises, how are these mathematical results to be used for the practical treatment of the problem?

To start with the simplest case, namely, case II, assume that y and n are such as to yield only one useful root. This may occur for positive or negative n , but let us take n positive and write down the solution.

According to (43), without the exponential factor $e^{i(\omega t - n\theta)}$, the solution for the potential is

$$V_a(r) = Kr^x \text{ with } x(+n) \quad n > 0 \quad (56)$$

$V_a(r)$ must be $-(1/2i)CU_a$ on the anodic circle $r=b$ (equation (50)), hence

$$K = -\frac{1}{2i}CU_a b^{-x}, \quad V_a(r) = -\frac{1}{2i}CU_a \left(\frac{r}{b}\right)^x \quad (57)$$

which solves the problem. This relates to a field rotating in the positive direction (+ n case) and should make possible calculation of the $Z(+n)$ part of the internal impedance (51). It is merely necessary then to apply (43) and substitute (57). According to (52) the alternating current reaching the set of odd anodes is

$$\begin{aligned} I_a(+n) &= -2ibJ_{ar}(+n) \\ &= -\frac{\epsilon_0}{2\pi} x(+n)V_a \left(\frac{2\omega_H^2}{\omega - n\omega_H} - \omega \right) \end{aligned} \quad (58)$$

and the internal impedance $Z(+n)$ is

$$\frac{1}{Z(+n)} = \frac{I_a(+n)}{U_a} = -i \frac{\epsilon_0}{4\pi} Cx(+n) \left[\frac{2\omega_H^2}{\omega - n\omega_H} - \omega \right] \quad (59)$$

since U_a is the potential of the odd anodes (48). A similar formula could be obtained in the ($-n$) case. Thus, in case II, the whole theory applies without any special difficulty. Small oscillating potentials $\pm U_a$ on the anodes excite small oscillations in the space charge and result in small currents. These currents are out of phase (i component), i.e., the internal impedance of the magnetron contains no real resistance term, either positive or negative.

The internal impedance $Z(+n)$ is zero for $\omega = n\omega_H$ and infinite for the two "antiresonance frequencies" ω_1, ω_2 , discussed in Section IV ((39) to (45) and Fig. 8). These characteristics seem to yield no important results with respect to the behavior of the magnetron as a generator of high-frequency oscillations.

For a computation of the actual internal impedance of the magnetron, one should use two impedances $Z(+n)$ and $Z(-n)$ in parallel, as shown in (51).

In cases I, III, IV, V (Fig. 11), the theory fails to apply. The two cases III and V are probably of no great

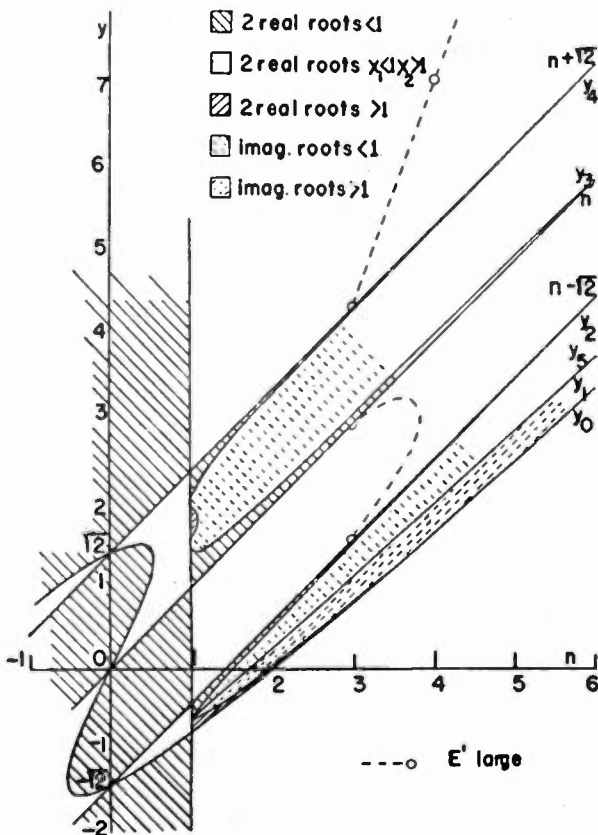

Fig. 11—A diagram summarizing the properties of a split-anode magnetron, with $2n$ anodes, at different frequencies $y = \omega/\omega_H$. Sustained oscillations should be obtained for the frequencies corresponding to shaded areas I or IV.

significance. An uncertainty exists relative to a solution for case III, but any solution (54) should yield similar results to case II just discussed. Both terms in (54) have a structure similar to the term used in case II (56) and would also yield pure imaginary internal impedance terms. The difficulty here probably comes from the assumption of a very fine filament (radius $a = 0$). In case V the situation is similar and should also be solvable by a more detailed study of the role played by the filament when its radius is not zero.

More interesting are cases I and IV. They yield a finite electric field on the filament, a result contradictory to the assumption of a small perturbation of the space charge. This means that one set of anodes would collect the saturation current (the other set of anodes receiving no current) during one-half period, after which the situation would suddenly be reversed. It is hard to foresee what could be the relative phase angle of current with respect to voltage. The present theoretical attempt was based entirely on the assumption of small oscillations, and here one must deal with very large oscillations so that (43) can no longer be applied. Case IV with imaginary exponents $x, \pm ix$, certainly provides for internal phase shifts (see (44)). Less certain is case I, where the phase shift would result only from higher approximations taking into account the large amplitude of space-charge oscillations.

The conclusions thus reached are the following:

Case II (white areas in Fig. 11)—No large oscillations, finite internal impedance.

Case III, V—The present theory gives no definite answer, the difficulty being most probably connected with the simplifying assumption of a filament of zero radius.

Cases I, IV—Large oscillations, with current impulses from zero to saturation. When an additional phase factor is realized, these conditions should result in the possibility of sustained oscillations in an outer circuit. The conditions for the most important cases I, IV are

$$\begin{aligned} \text{first band} & \quad y_3 < y < n - \sqrt{2} \\ \text{second band} & \quad n < y < n + \sqrt{2} \end{aligned}$$

with

$$y = \frac{\omega}{\omega_H} = \frac{21310}{\lambda H} \quad (60)$$

where λ is in centimeters and H in oersteds.

It should be noted that the resonance frequency $\omega = n\omega_H$ or $y = n$ is just on the boundary of the second band. The lower antiresonance frequency ω_1 lies outside these bands while the upper one ω_2 is inside the second band. The two bands (60) are easily recognizable in Fig. 11.

Calculations were made on the assumption that the oscillating components of the magnetic field could usually be neglected as of secondary importance. The resulting approximation is generally correct, but fails along the dotted line of Fig. 11. This dotted line touches the two important bands (60) for the 6-anode magnetron

($n = 3$). Hence, some anomalous behavior for this special type of magnetron may be predicted.

VI. COMPARISON WITH EXPERIMENTAL RESULTS AND APPLICATIONS

The best known type of magnetron is the one comprising two anodes, facing each other, on opposite sides of the filament.

For this usual split-anode magnetron ($n = 1$; 2 anodes) it is hard to foresee the conditions of oscillations inasmuch as the whole diagram of Fig. 11 changes just on the line $n = 1$. These very typical circumstances should make this magnetron highly sensitive, relative to increase in the diameter of the filament, effect of large oscillations, etc. Experimental values on the usual split-anode magnetron are found in a paper by G. R. Kilgore,^{9,10} with an attempt at theoretical explanation which, unfortunately, does not take account of space charge effects and, therefore, deviates considerably from actual conditions in magnetrons. Fig. 12 is a re-

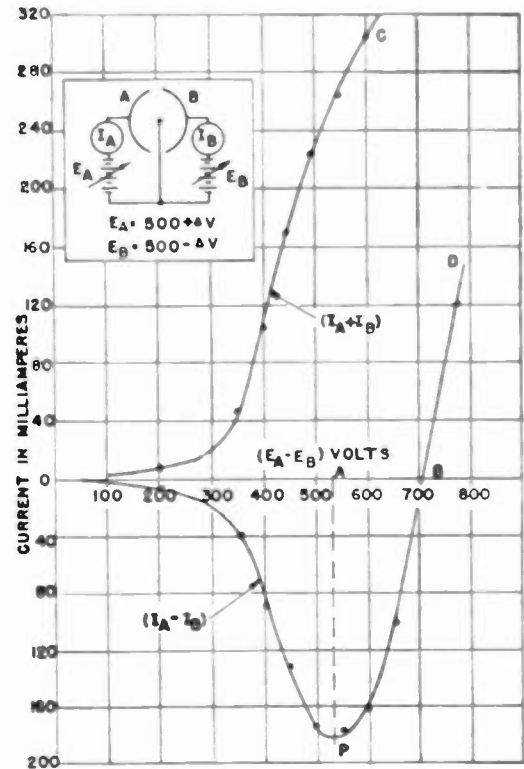

Fig. 12—Experimental results obtained by Kilgore for a split-anode magnetron ($n = 1$, 2 anodes). The interesting curve is the lower one, giving the static characteristic of $I_A - I_B$ as a function of $E_A - E_B$. Notice the negative resistance corresponding to a slope downward.

production of Kilgore's Fig. 3, showing the static characteristic for a split-anode magnetron in which $\omega = 0$, $y = 0$. The magnetic field applied was 1.5 times the critical field. The average anode potential was 500 volts, and variations as great as ± 400 volts (giving $E_a - E_b$

⁹ G. R. Kilgore, "Magnetron oscillators for the generation of frequencies between 300 and 600 megacycles," Proc. I.R.E., vol. 24, pp. 1140-1158; August, 1936.

¹⁰ G. R. Kilgore, "Radio at Ultra-High Frequencies, RCA, Institutes Technical Press, 75 Varick St., New York, New York; 1940, pp. 360-378.

= 800 volts) were applied. This means very large perturbations for which our theory would certainly be only a rough first approximation. It appears from the curves that the negative resistance is zero for small V and reaches a maximum of about -1500 ohms for $V = 400$ volts. Efficiencies of magnetrons operated under different conditions are given by Kilgore¹⁰ and can be summarized as follows ($H = 1.5H_c$, H_c critical field):

efficiency	10%	20%	30%	40%	50%
$\lambda H \times 10^{-4}$	5.45	6.7	8.1	9.8	12

(61)

$$y = \omega/\omega_H \quad 0.39 \quad 0.32 \quad 0.265 \quad 0.218 \quad 0.178$$

If these y values be taken with a negative sign, they lie just between the horizontal n axis and the line $y = n - \sqrt{2}$. Another type of oscillation has been found on split-anode magnetrons with λH values around 12,000 which gives $y \approx 1.8$. This value of y seems to correspond to the upper band of our diagram since it lies between 1 and $1 + \sqrt{2}$.

A further indication involved in the theory is the possibility of a magnetron of type n functioning as magnetrons of types $3n$, $5n$ (see (46)) but probably with a very low efficiency.

Experiments on magnetrons with a large number of anodes (4 to 12, i.e., $n = 2$ to 6) have been very successfully performed by Gutton and Berline.¹¹ They found that in most cases these magnetrons could generate oscillations $\omega \approx n\omega_H$, a condition which corresponds to the first band (60) predicted by the theory. Similar cases also seem to have been observed by Okabe and Gross.^{12, 13} A typical instance of such oscillations is described by Alekseev and Malairov,¹⁴ but they use a different type of connection between the magnetron and the oscillating circuits; and the corresponding problem requires careful study since it presents some very peculiar features.

It should be noted that these authors emphasize the need for restricting the size of the filament radius. They stress the fact that the ratio b/a of anode radius to filament radius must be no smaller than 1.3 in certain cases or 1.5 in others. They found experimentally the importance of this ratio in connection with the efficiency of the tubes. Such results also were noticed by Gutton and Berline and seemed rather mysterious. It can be easily understood if, in addition to conditions (60), one keeps in mind another necessary requirement: the current reaching the anodes must have a phase just opposite to the phase of the voltage in order to yield a negative resistance. In other words, the perturbation

must be allowed a certain time to travel from the filament to the anode; hence the two electrodes must not be too close to each other (see end of Section V).

Gutton and Berline used a single oscillating circuit, as illustrated in Fig. 9, and so did the Russian physicists in some experiments but they also worked, in other cases, with a number of circuits connected to the anodes as in Fig. 13. This type of structure was especially convenient for centimeter waves when the circuits were built as tank resonators.

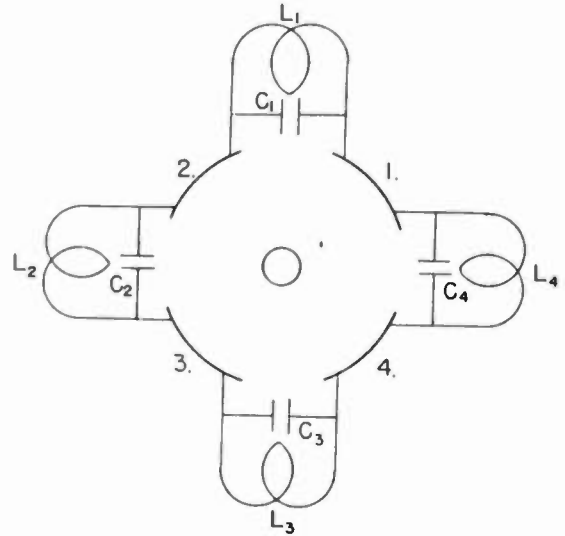

Fig. 13—Connections of a 4-anode magnetron with 4 separate circuits, instead of the conventional scheme of Fig. 9.

The connections shown on Fig. 13 require special discussion. In our original problem (Fig. 9), no question of phase shift between two neighbor anodes was involved. It had to be π , as these anodes were connected on both sides of one single LC circuit. With Fig. 13, where all four L_1C_1 , L_2C_2 , L_3C_3 , L_4C_4 circuits are identical, one must consider the phases of the different anodes. There are, as a matter of fact, two possibilities:

anode	1	2	3	4	1	
case A phase	0	π	2π	3π	4π	(equivalent to 0)
case B phase	0	$\frac{\pi}{2}$	π	$\frac{3\pi}{2}$	2π	(or 0)

(62)

The only condition is that, after a complete revolution, anode 1 must again be reached at phase 0 or $2n\pi$. More generally, with $2n$ anodes, the total phase shift for a whole revolution may amount to: $2\pi, 4\pi, \dots, 2n\pi$, which results in a number of independent solutions for the phase angle between two successive anodes, namely, $\phi = \pi/n, 2\pi/n, \dots, (n-1/n)\pi, \pi$. Thus, in such an arrangement, the magnetron may work on *under-harmonics* corresponding to

$$n' = 1, 2, \dots, n-1 \text{ or } n \quad (63)$$

where n' defines the type of symmetry of the vibrations of the space charge (see Fig. 7) while $2n$ is the actual number of anodes.

Another point should be emphasized: on the normal

¹⁰ *Loc. cit.*, p. 372.

¹¹ H. Gutton and S. Berline, "Production de fortes puissances sur ondes décimétriques," *Proc. verbaux Comm. Soc. fr. Phys.*, vol. 9, January, 1938. *Bull. de la Soc. Franc. Radio El.*, vol. 12, p. 30; 1938.

¹² K. Okabe, *Rep. Rad. Res.* (Japan), vol. 8, p. 27; 1938.

¹³ O. H. Gross, *Hochfrequenz techn.*, vol. 51, p. 37, 1938.

¹⁴ N. F. Alekseev and D. R. Malairov, "Generation of high-power oscillations with a magnetron in the centimeter band," *Jour. Tech. Phys.* (U.S.S.R.), vol. 10, pp. 1297-1230, 1940, and *Proc. I.R.E.*, vol. 32, pp. 136-139; March, 1944.

vibration ($n' = n$, case of Fig. 9), the voltage oscillations applied on the cathodes result in two rotating fields moving in opposite directions (50). This is also the case here for the mode $n' = n$, but modes (63) obtain where $n' < n$, i.e., the phase shift is less than π between two neighboring anodes. These fields are *purely rotating fields*. There is only one rotating component instead of two opposite ones as in the other case.

Fig. 14 illustrates the foregoing, including phase angles for the case of the structure shown in Fig. 13. The former is similar to Fig. 10 and shows the voltage distribution along the anodic circle. The broken curve

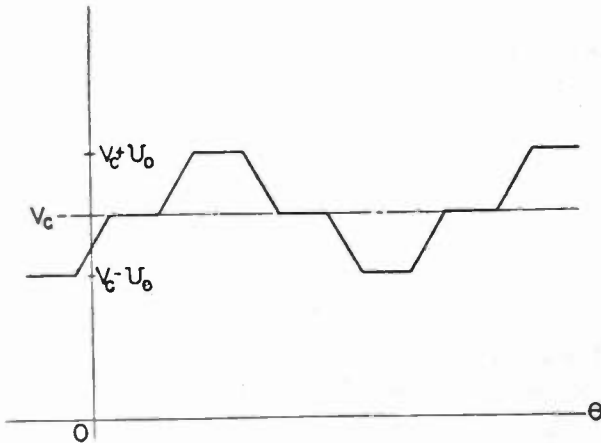

Fig. 14—A possible type of oscillation, in the device of Fig. 13 where oscillations $n = 1$ are sustained in a structure of type $n = 2$ (4 anodes).

may again be analyzed in a Fourier series but, instead of commencing with a term in $\sin 2\theta$, it starts with a $\sin \theta$.

Alekseev and Malairov experimented on such a four-anode structure. They found first a type of oscillation (which they call $n = 1$, also corresponding to $n = 1$ in our classification) very similar to that obtained in the usual split-anode magnetron. The λII products, for split, anode magnetrons, range from 12,000 to 20,000 yielding $1 < y < 1.8$ (Kilgore's indication is $\lambda II = 12,000$, $y = 1.8$), which checks with the first type of oscillation in the structure of Fig. 13.

In addition to these oscillations the Russian authors found another type, which they call $n = \frac{1}{2}$, but their n has a meaning different from ours. This second type should, in our opinion, correspond to the real case $n = 2$ (which the device of Fig. 9 should yield). For this second case, the experimental values of λII extend from 6500 to 9000, which means $2.3 < y < 3.2$ ($n = 2$).

$$y = 21310/\lambda II, \quad 2.3 < y < 3.2. \quad (64)$$

These y values fall very conveniently within the upper band of oscillations predicted by the theory (condition 60)

$$2 < y < 3.414. \quad (64a)$$

The experimental results check very well with the theory despite the numerous approximations included in the theoretical discussion (the more dangerous one being the assumption of a very fine filament).

Comparison of the scheme of Fig. 13 with a similar problem involving multipole alternators is very interesting. It has already been used, viz., the electron cloud, rotating with Larmor's angular frequency ω_H is somewhat similar to the rotor of an alternator, the $2n$ poles of which should play the role of our $2n$ electrodes. In the case of Fig. 13, a $2n$ pole structure may be employed for two purposes:

single-phase alternating current—case $n = 2$

double-phase alternating current—case $n = 1$ (Fig. 14),

A result that could be generalized for an odd number of anodes. In the scheme of Fig. 9 there is, for instance, no possibility of using a magnetron structure with 3 anodes. On the other hand, it is perfectly suitable with the connections of Fig. 13 and results in the three-phase magnetron of Fig. 15. Oscillation should occur under the same

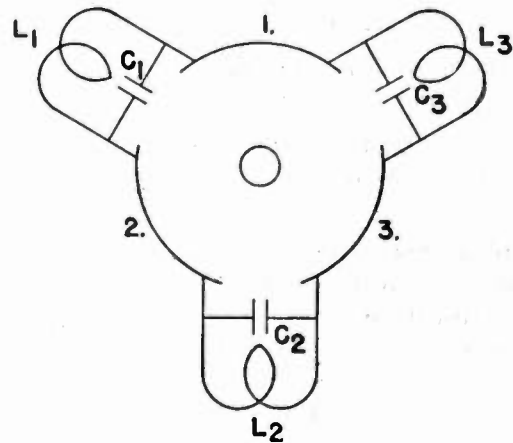

Fig. 15—A 3-phase magnetron.

conditions as in the usual split-anode magnetron, both structures working with $n = 1$ as far as the angular velocity of the rotating field is concerned.

Blewett and Ramo noticed that the preceding considerations apply not only to magnetrons, but also to all sorts of vacuum tubes using electron beams when a magnetic field is applied for focusing purposes. The usual method is to impose a magnetic field parallel to the beam, thus inducing a rotation of the electrons around the magnetic field or the average direction of the beam. The space-charge density and the angular velocity inside the beams are given by the same formulas as in a magnetron with filament of radius 0, namely,

$$\rho = \epsilon_0(m\omega_H^2/2\pi e), \quad \omega = \omega_H \quad (65)$$

but, in addition to rotation in a plane perpendicular to the magnetic field, the whole cloud of electrons moves forward along the magnetic field.

Such electron beams are the essential feature of Klystrons or Rumbatrons, the purpose of additional electrodes being to induce different types of vibrations on the beam. These vibrations are very similar to those of magnetrons but for the fact that boundary conditions differ in each case.

Oscillations of types 0, 1, 2, . . . , as defined on Fig. 7,

can be excited along these beams and used for amplifying purposes or for the generation of oscillations.

VII. PLANE MAGNETRON

As an example of application of the general theory, the case of the plane magnetron will be briefly discussed. This case is obtained as the limit of a cylindrical magnetron when the radius a of the filament is increased to infinity, while the distance $d = b - a$ between filament and anode is kept constant. Hence,

$$a \rightarrow \infty, \quad b = a + d = a(1 + p) \quad (66)$$

a point at a distance r from the center will be defined by a parameter p

$$r = a(1 + p), \quad p = (r - a)/a \text{ small.} \quad (67)$$

The angular velocity of the electrons is given by (6) which becomes

$$\begin{aligned} \dot{\theta} &= \omega_H(1 - a^2/r^2) = \omega_H(1 - 1/(1 + p)^2) \\ &= \omega_H(2p - 3p^2 \dots). \end{aligned} \quad (68)$$

The tangential velocity then is

$$\dot{x} = r\dot{\theta} = 2a\omega_H p(1 + p)(1 - 3/2p) = 2a\omega_H p(1 - p/2).$$

Designating y as the distance $r - a$ from the surface of the cathode, we obtain

$$\dot{x} = 2\omega_H y(1 - y/2a). \quad (69)$$

For the plane magnetron ($a \rightarrow \infty$) the \dot{x} velocity increases proportionately to the distance y from the cathode.

Under critical conditions (no current on the anode), the space-charge density is given by (16)

$$\rho = \epsilon_0 \frac{m\omega_H^2}{2\pi e} \left[1 + \frac{a^4}{r^4} \right] = \epsilon_0 \frac{m\omega_H^2}{\pi e} [1 - 2p \dots] \quad (70)$$

which, at the limit of a plane magnetron ($p \rightarrow 0$), is a constant. In a plane magnetron (of infinite length) operated under critical conditions, a uniform space-charge density (70) obtains between the plane cathode and the plane anode. This charge has no perpendicular component of velocity ($\dot{y} = 0$) and moves parallel to the electrodes with a velocity \dot{x} given by (69). The voltage V is obtained from (4)

$$\begin{aligned} V_0(r) &= -\frac{m\omega_H^2}{2e} \left(r - \frac{a^2}{r} \right)^2 \\ &= -\frac{m\omega_H^2 a^2}{2e} \left[1 + p - \frac{1}{1 + p} \right]^2 \\ &= \frac{2m\omega_H^2}{e} a^2 p^2 (1 - p \dots) \end{aligned} \quad (71)$$

$$\text{or} \quad V_0(y) = \frac{2m\omega_H^2}{e} y^2 \left(1 - \frac{y}{a} \right).$$

This yields the anode voltage $V(b)$ when $y = d$ is inserted in the formula. When the total electric charge Q between the electrodes is computed, it is found to be

$$Q = -\epsilon_0 V_0(L/2\pi d), \quad (72)$$

L being the length measured along the x axis per unit length of filament. The plane magnetron thus yields a capacitance twice as large as a plane condenser of the same dimensions.

Such a plane magnetron can be used for sustained oscillations. Discussion in the preceding Section shows that it should oscillate in the neighborhood of the frequency

$$\omega = 2\omega_H \text{ as } b/a \rightarrow 1 \quad (73)$$

which corresponds to the proper frequency of vibration for the electronic layers near the filament, as emphasized in Section III.



Fig. 16—Electronic trajectories in a plane magnetron.

These theoretical results refer to the case of a plane magnetron of infinite length. In a finite magnetron, electrons would start from one edge of the cathode and move across the electrodes and the magnetic field to the opposite edge of the anode. In the median part of the structure, these electrons move parallel to both electrodes, their horizontal velocity being zero on the cathode and increasing proportionately to the distance y from the cathode (69 with $a = \infty$).

The space-charge density is constant between the electrodes (70). There is a curious coincidence between the proper frequency of this electron cloud (73) and the frequency of rotation for a free electron in a vacuum with no space charge. This coincidence is purely accidental.

Higher-modes of vibrations should be found in the plane magnetron, with sinusoidal waves propagating through the space charge from one side to the other, or also with standing waves across the electrodes. The theoretical discussions of these higher modes (Section V) was, however, possible only for magnetrons with very thin filaments. For extending the problem to the plane magnetron, a comprehensive study of the case of large filaments would seem necessary. Alternatively, in many respects, basing further investigation on the plane case might prove simpler.

Note on the Bearing Error and Sensitivity of a Loop Antenna in an Abnormally Polarized Field*

F. S. HOWES†, SENIOR MEMBER, I.R.E., AND F. M. WOOD‡, NONMEMBER, I.R.E.

Summary—An expression is derived for the response of a loop antenna to a radio wave arriving at any angle with any linear polarization and its application to direction finding is discussed. Curves of loop-bearing error and loop sensitivity as functions of the angles of vertical incidence and polarization are given.

INTRODUCTION

A PROBLEM of considerable importance in radio direction finding is the response of a loop antenna to radio waves arriving with various angles of vertical incidence and polarization. A great deal of experimental work which has been reported indicates that large errors in bearing are frequently encountered and these have been shown to be due to abnormal polarization of the received wave. However, a survey of the literature on direction finding fails to yield an entirely satisfactory solution for the relationship between the field parameters and the loop output. This relationship has therefore been derived and is given below.

GENERAL EXPRESSION FOR LOOP OUTPUT

It can be shown readily that the output voltage from a plane, rectangular loop antenna located in a field due to a plane, linear, normally polarized wave, arriving at an angle of vertical incidence of 90 degrees, is given by

$$V = 2lNE \sin \{(\pi b/\lambda) \sin \Delta\}, \quad (1)$$

where E is the strength of the radio wave in volts per meter; l is the length and b is the width of the loop; N is the number of turns on the loop and λ is the wavelength. Δ is the angle between the direction of wave travel and the normal to the plane of the loop or, what is the same thing, the angle between the direction of the magnetic vector and the plane of the loop.

If the width of the loop is small compared with the wavelength, $\sin(\pi b/\lambda \sin \Delta)$ is very nearly equal to $\pi b/\lambda \sin \Delta$ and hence, $V = (2\pi AN/\lambda)E \sin \Delta$ where $A = lb$, the area of the loop.

Thus, $V = KE \sin \Delta$, (2)

where $K = 2AN\pi/\lambda$. Clearly, therefore, the voltage V is proportional to the sine of the angle which the magnetic lines make with the plane of the loop.

Suppose now we consider a wave, abnormally polarized and arriving at some angle of vertical incidence less than 90 degrees. In this case, we shall find that the loop voltage is

$$V = KE \sin \Sigma \quad (3)$$

* Decimal classification: R125.3. Original manuscript received by the Institute, March 31, 1943; revised manuscript received, November 18, 1943.

† Assistant Professor of Electrical Engineering, McGill University, Montreal, Que., Canada.

‡ Associate Professor of Civil Engineering, McGill University, Montreal, Que., Canada.

where Σ is not equal to Δ , but is a function of the angles of vertical incidence and polarization. We require an expression for $\sin \Sigma$ in terms of these angles of vertical incidence and polarization.

The diagram of Fig. 1 has been drawn to show the derivation of this expression.

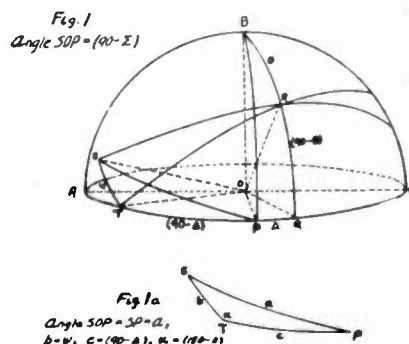

The plane of the loop is in the plane of the paper $OABC$ the normal to the loop being OP . The construction necessary to derive the required expression is as follows:

a) Assume a wave approaching the loop along the line PO with magnetic flux perpendicular to PO and hence parallel to the loop plane. Regard this wave as a plane, linear, normally polarized wave.

b) Rotate the line of projection PO , originally normal to the loop, through some angle POQ to the position QO so that QO now makes an angle Δ with the normal to the plane of the loop. The magnetic flux is thus moved from the horizontal tangent at P to the horizontal tangent at Q , i.e., from the direction AOC to the direction TO , TO being perpendicular to QO .

c) Now raise the line of projection in elevation within the plane QOB to the position RO , having rotated it through the vertical angle $QOR = (90 - \theta)$, where θ is the angle of incidence measured from the vertical. The magnetic flux now lies along the horizontal tangent at R and is therefore still parallel to TO .

d) Finally, let us rotate the magnetic flux in the tangent plane at R , i.e., in the plane normal to RO , through an angle ψ so that it becomes tangent to the great circle SR , making an angle $SRT = \psi$ with its previous position. The magnetic flux is now parallel to SO , so that it has been moved in all from the direction AO to the direction SO . Originally the magnetic flux was parallel to the plane of the loop and perpendicular to PO . Now its angle with the plane of the loop is

$$\Sigma = (90 \text{ degrees} - \text{angle } SOP).$$

We must determine this angle SOP .

Solving the spherical triangle *STP*, for *SP* = (90 degrees - Σ), we obtain (by the use of the cosine formula,

$$\cos a = \cos b \cos c + \sin b \sin c \cos \alpha$$

where *a*, *b*, *c*, and α have the significance shown in Fig. 1a), the following relationship:

$$\cos SP = \cos \psi \cos (90 - \Delta) + \sin \psi \sin (90 - \Delta)(-\cos \theta)$$

or, $\sin \Sigma = \sin \Delta \cos \psi - \cos \Delta \cos \theta \sin \psi.$ (4)

Thus we have for the voltage at the terminals of the loop, for the case of an abnormally polarized wave arriving with an angle of vertical incidence θ and polarization ψ ,

$$V = KE \sin \Sigma = KE(\sin \Delta \cos \psi - \cos \Delta \cos \theta \sin \psi). \quad (5)$$

If $\theta = 90$ degrees and $\psi = 0$ (normally polarized wave of horizontal incidence), the above expression reduces to $V = KE \sin \Delta$ as required.

BEARING ERROR

If the loop is rotated so that its output is zero, i.e., $\sin \Sigma = 0$, then

$$\sin \Delta \cos \psi - \cos \Delta \cos \theta \sin \psi = 0$$

or, $\tan \Delta = \cos \theta \tan \psi.$ (6)

Now when the loop has been rotated so that the output is zero, Δ should be zero for zero error in the bearing. In other words, the direction of travel of the wave and the normal to the plane of the loop would be in the same vertical plane. If Δ is not equal to zero for zero output from the loop, the residual Δ is the angular error in the bearing. Hence,

$$\Delta = \tan^{-1} (\cos \theta \tan \psi) \quad (7)$$

represents the angular error in the bearing obtained from the loop at minimum signal.

Δ may be calculated from this expression for any combination of values of θ and ψ . Fig. 2 shows the bearing error as a function of θ and ψ .

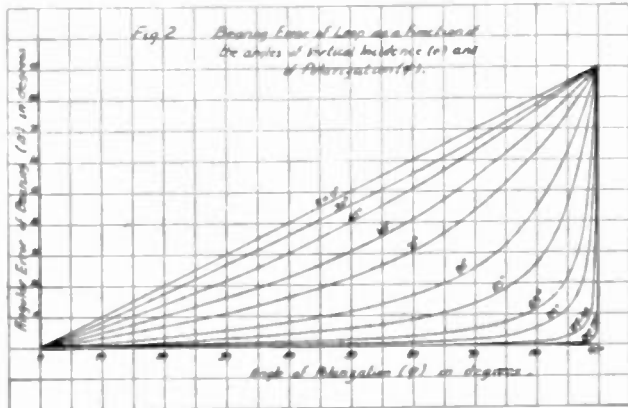

If we consider a "standard wave" as defined by Barfield¹ for which $\theta = \psi = 45$ degrees, and substitute in the above expression for Δ , we obtain for the "standard

¹ R. R. Barfield, "Some principles underlying the design of spaced-aerial direction-finders," *Jour. I.E.E. (London)*, vol. 76, pp. 425-443; April, 1935.

wave error," $\Delta = 35$ degrees, 16 minutes which agrees with Barfield's result.

From the curves of Fig. 2, (values of Δ for a series of values of θ and ψ , the loop having been rotated on a vertical axis to give minimum signal), it is seen that the nearer θ is to 90 degrees, for any value of ψ , the smaller the angular error in the bearing. When θ is exactly 90 degrees, and ψ is also 90 degrees, the value of Δ is indeterminate analytically although from physical considerations it is clear that Δ must pass through zero as it changes sign with the change of sign of $\cos \theta$ as θ passes through 90 degrees.

SENSITIVITY OF THE LOOP

It is of interest to know how the strength of the signal induced in the loop varies as we pass through the minimum when varying the bearing angle Δ . To find this, we differentiate $\sin \Sigma$ with respect to Δ .

The sensitivity is then given by

$$d \sin \Sigma / d\Delta = \cos \Delta \cos \psi + \sin \Delta \cos \theta \sin \psi. \quad (8)$$

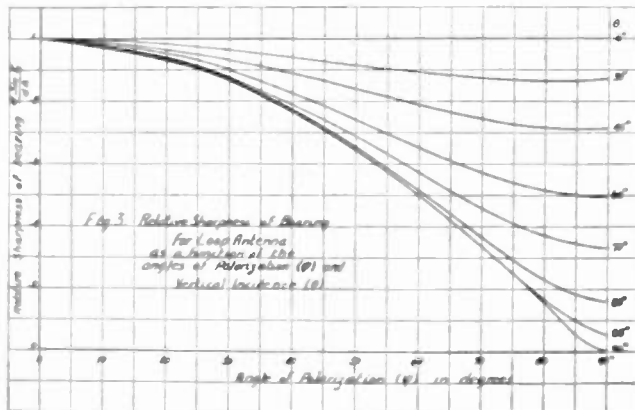

If now we define Δ_{min} as the value of Δ at which $\sin \Sigma$ is a minimum, then, since $\tan \Delta_{min} = \cos \theta \tan \psi$, we may write,

$$\sin \Delta_{min} = \cos \theta \sin \psi / R, \text{ and } \cos \Delta_{min} = \cos \psi / R, \text{ where}$$

$$R = \sqrt{\cos^2 \theta \sin^2 \psi + \cos^2 \psi}.$$

The expression for the sensitivity of the loop at the minimum is then

$$\begin{aligned} d \sin \Sigma / d\Delta &= \cos \Delta_{min} \cos \psi + \sin \Delta_{min} \sin \psi \cos \theta \\ &= (\cos^2 \psi / R) + (\sin^2 \psi \cos^2 \theta / R) \\ &= 1/R(\cos^2 \psi + \sin^2 \psi \cos^2 \theta) \\ &= R. \end{aligned} \quad (9)$$

Thus the rate of change of $\sin \Sigma$ with respect to Δ as the loop is rotated about a vertical axis through the position of minimum signal is

$$\begin{aligned} d \sin \Sigma / d\Delta &= R = \sqrt{\cos^2 \psi + \sin^2 \psi \cos^2 \theta} \\ &= \sqrt{1 - \sin^2 \psi \sin^2 \theta}. \end{aligned} \quad (10)$$

It is seen, therefore, that the greatest rate of change occurs when $\sin^2 \psi \sin^2 \theta$ is small. If $\theta = 0$, i.e., a wave of vertical incidence, $d \sin \Sigma / d\Delta = 1$ and is thus independent of ψ .

If θ is equal to 90 degrees, the larger ψ is, the less sensitive is the loop near the minimum. Thus whatever the value of θ may be, down to zero, i.e., vertical incidence, the sensitivity of the loop decreases as ψ increases;

in fact, the sensitivity decreases for any increase in θ or ψ or both.

Fig. 3 shows values of loop sensitivity plotted against the angle of polarization ψ for a complete range of values of θ , the angle of vertical incidence.

Transmission-Line Analogies of Plane Electromagnetic-Wave Reflections*

ARTHUR BRONWELL†, SENIOR MEMBER, I.R.E.

Summary—The similarity between the equations for unguided plane electromagnetic-wave propagation and those of propagation along conventional transmission lines is illustrated here. It is shown that the conventional transmission-line equations expressed in terms of receiving-end voltage and current may be used to express the field-intensity components of uniform plane waves in any medium. Normal-incidence reflection of plane waves at surfaces of discontinuity are shown to be analogous to transmission-line reflections at impedance discontinuities. The transmission-line equations are then modified to apply to oblique incidence reflection. The relationships developed here assist in visualizing as well as solving plane-wave propagation and reflection problems using the conventional transmission-line equations. It also makes possible the use of transmission-line charts for the solution of wave-reflection problems.

RECENT advances in the techniques of ultra-high frequencies have compelled the engineer to turn his attention more and more to problems involving electromagnetic radiation and reflection. To the engineer who is more familiar with circuit concepts than with field concepts, this has required a complete reorientation of viewpoint. There is, however, a close parallelism between the physical concepts and equations of plane electromagnetic-wave propagation and reflection and those involving transmission-line phenomena. This has been clarified by Schelkunoff,¹ Slater,² Stratton³ and others. In this analogy, the voltage and current of the transmission line are analogous, respectively, to the electric- and magnetic-field intensities. Reflections on transmission lines due to discontinuities in impedance are analogous to plane electromagnetic-wave reflections at surfaces of discontinuity.

The field intensities may be expressed in terms of (1) the incident and reflected-wave intensities or, (2) the field-intensity components at the surface of discontinuity. Previous treatments have expressed these equations in terms of the incident and reflected-wave intensities. It will be shown here that the wave equations expressed in terms of electric- and magnetic-field intensity at the

reflection surface are identical to voltage and current equations for a transmission line expressed in terms of the receiving-end voltage and current. It is, therefore, possible to use the familiar transmission-line equations for the solution of plane-wave-reflection problems. Since the equations in this form are expressed in terms of the field intensities at the reflection surface, or boundary, the problem of satisfying boundary conditions is greatly simplified.

In the following treatment, the general transmission-line equations and certain special cases will be discussed for sinusoidally impressed voltages.⁴ It will then be shown how these equations apply to plane electromagnetic-wave reflections at normal incidence and at oblique incidence. In each case the transmission-line analogies will be indicated. The rationalized MKS system of units is used.

TRANSMISSION-LINE EQUATIONS

Consider a transmission line as shown in Fig. 1 hav-

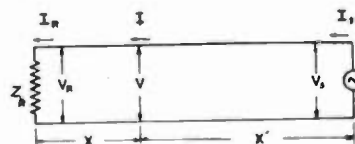

Fig. 1

ing complex characteristic impedance Z_0 , and propagation constant γ , given by

$$Z_0 = \sqrt{z/y} \quad (1)$$

$$\gamma = \sqrt{zy} = \alpha + j\beta \quad (2)$$

where z and y are, respectively, the complex series impedance and shunt admittance of the line. Sinusoidal impressed voltages are assumed.

If the line is terminated in an impedance Z_R , the equations for the voltage between wires and current in either wire at a distance x from the receiving end are given by (3) and (4) in exponential form and (5) and (6) in hyperbolic form. Equation (7) gives the impedance at any point which is defined as $Z = V/I$

* See, for example, W. L. Everitt, "Communication Engineering," second edition, McGraw-Hill Book Co., New York, N. Y., 1932, chapters 4 and 5.

* Decimal classification: R116XR113. Original manuscript received by the Institute, April 26, 1943; revised manuscript received, July 9, 1943.

† Electrical Engineering Department, Northwestern University, Evanston, Illinois.

¹ S. A. Schelkunoff, "The impedance concept," *Bell Sys. Tech. Jour.*, vol. 17, January, 1938.

² J. C. Slater, "Microwave Transmission," McGraw-Hill Book Co., New York, N. Y., 1942.

³ J. A. Stratton, "Electromagnetic Theory," McGraw-Hill Book Co., New York, N. Y., 1941, p. 282.

$$V = V_R/2[(1 + Z_0/Z_R)\epsilon^{\gamma x} + (1 - Z_0/Z_R)\epsilon^{-\gamma x}] \quad (3)$$

$$I = V_R/2Z_0[(1 + Z_0/Z_R)\epsilon^{\gamma x} - (1 - Z_0/Z_R)\epsilon^{-\gamma x}] \quad (4)$$

$$V = V_R[\cosh \gamma x + (Z_0/Z_R) \sinh \gamma x] \quad (5)$$

$$I = I_R[\cosh \gamma x + (Z_R/Z_0) \sinh \gamma x] \quad (6)$$

$$Z = Z_0 \left[\frac{Z_R + Z_0 \tanh \gamma x}{Z_0 + Z_R \tanh \gamma x} \right] \quad (7)$$

The voltages and currents are complex quantities and either the receiving-end voltage or current may be chosen for the reference, if desired. The instantaneous voltage or current may be obtained by multiplying these equations by $\epsilon^{i\omega t}$. The first terms on the right-hand side of (3) and (4) contain the exponential $\epsilon^{\gamma x}$ which is a wave traveling in the $-x$ direction, while the second terms contain $\epsilon^{-\gamma x}$ representing a wave traveling in the $+x$ direction. The first term is therefore the incident wave and the second term the reflected wave. The ratio of voltage to current for either the incident-wave components or the reflected components is the characteristic impedance of the line. The incident and reflected waves are not obvious as separate components in the hyperbolic form of these equations, since each of the hyperbolic terms contains parts of both the incident and reflected waves. However, the hyperbolic forms are frequently justified on the grounds of mathematical facility.

The "voltage-reflection coefficient," which is defined as the ratio of reflected voltage to incident voltage at the load, may be found by dividing the coefficient of the second term of (3) by the first term, giving

$$r_r = (Z_R - Z_0/Z_R + Z_0). \quad (8)$$

SHORT-CIRCUIT LINE

Several special cases will now be considered which will later be shown to be analogous to plane polarized elec-

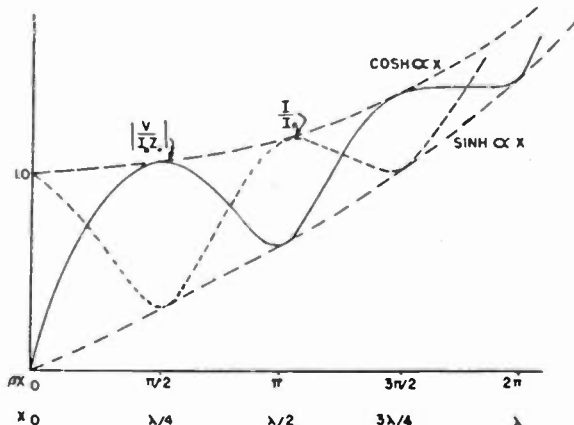

Fig. 2—Voltage and current ratios of short-circuited lines. High attenuation.

tromagnetic-wave reflections. Consider first the case of a transmission-line short-circuited at the receiving end. Thus, when $x=0$, $Z_R=0$, and $V_R=0$, (5), (6), and (7) reduce to

$$V = I_R Z_0 \sinh \gamma x \quad (9)$$

$$I = I_R \cosh \gamma x \quad (10)$$

$$Z = Z_0 \tanh \gamma x. \quad (11)$$

Substituting $\gamma = \alpha + j\beta$ and expanding gives

$$V = I_R Z_0 [\sinh \alpha x \cos \beta x + j \cosh \alpha x \sin \beta x] \quad (12)$$

$$I = I_R [\cosh \alpha x \cos \beta x + j \sinh \alpha x \sin \beta x] \quad (13)$$

$$Z = Z_0 \left[\frac{\tanh \alpha x + j \tan \beta x}{1 + j \tanh \alpha x \tan \beta x} \right]. \quad (14)$$

At successive quarter-wave distances from the receiving end, we have $\beta x = n\pi/2$, where n is any integer. Equation (12) shows that the voltage becomes either $V = I_R Z_0 \sinh \alpha x$ or $V = I_R Z_0 \cosh \alpha x$ at the quarter-wave points, these being the approximate minimum and maximum values of the voltage if the attenuation is low. Similarly, the current values vary between $I = I_R \cosh \alpha x$ and $I = I_R \sinh \alpha x$. Consequently, a plot of the scalar values of the ratios $|V/I_R Z_0|$ or $|I/I_R|$ would have $\cosh \alpha x$ and $\sinh \alpha x$ as the approximate envelopes. This plot is shown in Figs. 2 and 3 for large and small values

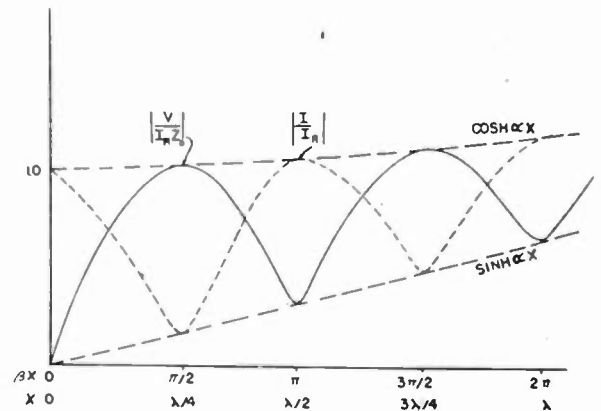

Fig. 3—Voltage and current ratios of short-circuited lines. Low attenuation.

of attenuation. The envelopes are easy to calculate and provide a rapid means of sketching the scalar values of voltage and current.

A similar investigation of the impedance in (14) shows that the values alternate between $Z = Z_0 \tanh \alpha x$

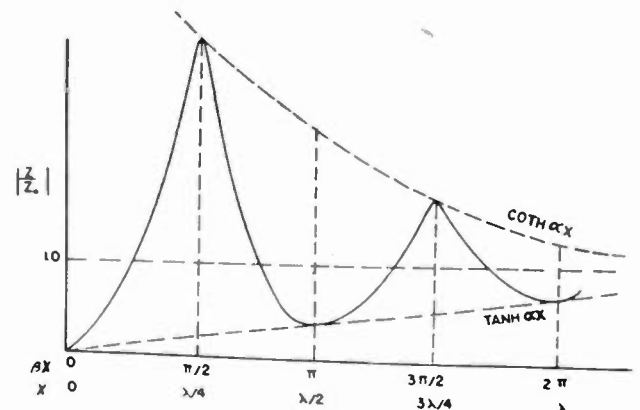

Fig. 4—Impedance ratios of short-circuited line. Normal line.

and $Z = Z_0 \coth \alpha x$ at successive quarter-wavelength distances, and the plot of the scalar ratio $|Z/Z_0|$ is shown in Fig. 4. For a very long line, the ratio approaches unity and the impedance approaches the characteristic impedance of the line.

DISSIPATIONLESS LINE

A case of special importance is that of the lossless line in which the resistance and conductance are negligible in comparison with the series reactance and shunt susceptance. This condition is approached in many ultra-high-frequency applications. For this case, we may assume that the attenuation constant $\alpha=0$ and the propagation constant is imaginary $\gamma=j\beta=j\omega\sqrt{LC}$. The hyperbolic functions of (5), (6), and (7) then reduce to trigonometric functions and become

$$V = V_R[\cos \beta x + j(Z_0/Z_R) \sin \beta x] \tag{15}$$

$$I = I_R[\cos \beta x + j(Z_R/Z_0) \sin \beta x] \tag{16}$$

$$Z = Z_0 \left[\frac{Z_R + jZ_0 \tan \beta x}{Z_0 + jZ_R \tan \beta x} \right] \tag{17}$$

The incident and reflected waves undergo phase shift but are not attenuated with distance along the line. The characteristic impedance is of the nature of a pure resistance, its value being $Z_0 = \sqrt{L/C}$.

For the short-circuited lossless line, the curves of voltage and current shown in Fig. 3 degenerate into rectified sine waves having only positive values since all scalar values are plotted as positive values.

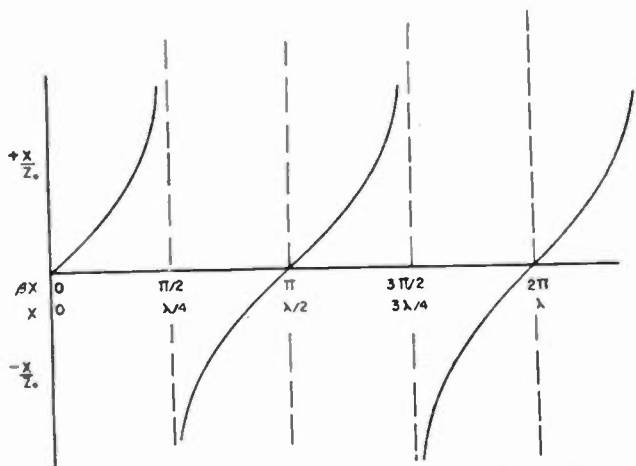

Fig. 5—Impedance ratios of short-circuited lossless line.

The impedance is a pure reactance except at the quarter-wavelength points, where resonance or anti-resonance occurs, where it is either zero or infinite. The impedance has a tangent variation as shown in Fig. 5. Fig. 4 is a plot of the scalar values of the complex impedance which degenerates into the rectified tangent curve for the lossless line.

INFINITELY LONG LINE

The transmission-line equations with distance measured from the sending end provide the simplest interpretation for the infinitely long line. Using the lower-case subscript "s" to designate the sending-end conditions, and the distance measured from the sending end as x' , the equations become

$$V = V_s e^{-\gamma x'} \tag{18}$$

$$I = I_s e^{-\gamma x'} \tag{19}$$

$$Z = V/I = Z_0 \tag{20}$$

Since the receiving end is assumed to be an infinitely long distance away, there is no reflected wave. The input impedance to the line is equal to the characteristic impedance.

All of the preceding equations satisfy Maxwell's dynamic field equations.

TRANSVERSE ELECTROMAGNETIC WAVES—
CONTINUOUS MEDIUM

Consider now the simplest case, that of a linearly polarized uniform plane wave in a continuous, homogeneous, isotropic medium. This constitutes a transverse electromagnetic wave since the electric- and magnetic-field intensities lie in equiphase planes perpendicular to the direction of propagation. Sinusoidal time variation is assumed.

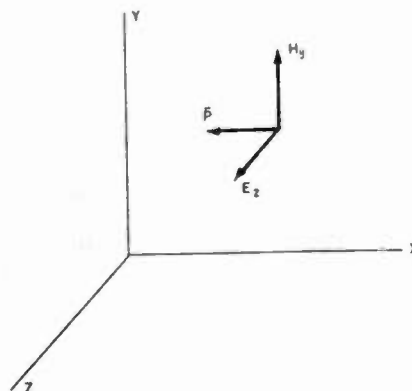

Fig. 6

The electric- and magnetic-field intensities shown in Fig. 6 may be expressed by equations similar to (18) and (19) for the infinite line. Choosing the plane $x=0$ as the arbitrary reference plane and designating the complex field intensities at this surface as E_R and H_R , the equations for a wave progressing in the $-x$ direction are

$$E_z = E_R e^{\gamma_0 x} \tag{21}$$

$$H_y = H_R e^{\gamma_0 x} \tag{22}$$

$$Z_0 = E_z/H_y = E_R/H_R \tag{23}$$

The $-x$ direction of propagation was chosen rather than the $+x$ direction in order to be consistent with the subsequent discussion. In these equations $\gamma_0 = \alpha_0 + j\beta_0$ is the "intrinsic propagation constant" for the medium, analogous to the propagation constant of the transmission line, and contains an attenuation constant α_0 and a phase constant β_0 . Equation (23) defines an "intrinsic impedance" analogous to the characteristic impedance of the transmission line.

Maxwell's equations may now be used to establish the values of γ_0 and Z_0 and also confirm (21) and (22) assumed for E and H . The equations of principle importance here are the two curl equations and the wave equation. For sinusoidal time functions, these are

$$\text{curl } \vec{H} = [g + j\omega\epsilon] \vec{E} \tag{24}$$

$$\text{curl } \vec{E} = -j\omega\mu \vec{H} \tag{25}$$

$$\nabla^2 \vec{E} = \mu\omega [jg - \epsilon\omega] \vec{E} \tag{26}$$

where g , ϵ , and μ are, respectively, the conductivity, permittivity, and permeability of the medium. Substituting (21) in (26), the value of γ_0 is found to be

$$\gamma_0 = \alpha_0 + j\beta_0 = \sqrt{\mu\omega(jg - \epsilon\omega)}. \quad (27)$$

The value of Z_0 may be found by substituting (21) and (22) in either (24) or (25). Substituting in (24) yields

$$Z_0 = E_z/H_y = \gamma_0/(g + j\omega\epsilon). \quad (28)$$

Using (25) gives

$$Z_0 = j\omega\mu/\gamma_0. \quad (29)$$

In a medium with dissipation the intrinsic propagation constant and intrinsic impedance are both complex which is analogous to the transmission line containing losses. The wavelength and phase velocity are similar to the transmission-line equations.

$$\lambda = 2\pi/\beta_0 \quad (30)$$

$$v = \lambda f. \quad (31)$$

The above equations are general and apply to plane-wave transmission through any medium. We shall now consider the special cases of the perfectly insulating medium and the conducting medium.

PERFECT DIELECTRIC MEDIUM

In a perfectly insulating medium, the conductivity is zero. The equations for Z_0 , γ_0 , λ , and v then become

$$\gamma_0 = j\omega\sqrt{\mu\epsilon} \quad (32) \quad \lambda = 2\pi/\omega\sqrt{\mu\epsilon} \quad (34)$$

$$Z_0 = \sqrt{\mu/\epsilon} \quad (33) \quad v = 1/\sqrt{\mu\epsilon}. \quad (35)$$

The propagation constant is imaginary, showing that the field-intensity components experience a phase shift with distance but there is no attenuation. The real intrinsic impedance shows that the electric- and magnetic-field intensities are in time phase, though in space quadrature. The conclusions are identical with those of the infinite lossless transmission line. The intrinsic impedance of free space is $Z_0 = 377$ ohms, and the phase velocity is equal to the velocity of light.

CONDUCTING MEDIUM

In a conducting medium it may be shown that the conductivity g is very much greater than the value of $\epsilon\omega$ even in the ultra-high-frequency spectrum. This results in a simplification of (27), (28), and (29). Assume, for example, that the conductor is silver having a conductivity of 6.14×10^7 mhos per meter. While the permittivity of metals is not known, the evidence indicates that it is not much different from that of free space. We may, therefore, assume a value of $\epsilon = 1/36\pi \times 10^9$ farads per meter. Even at the relatively high frequency of 10^{11} cycles per second, the value of $\epsilon\omega$ is of the order of 5. It is obvious, therefore, that g is much greater than $\epsilon\omega$ for most conductors. The equations for γ_0 and Z_0 then simplify to

$$\gamma_0 = \alpha_0 + j\beta_0 = \sqrt{g\mu\omega/2} + j\sqrt{g\mu\omega/2} \quad (36)$$

$$Z_0 = \sqrt{\mu\omega/2g} + j\sqrt{\mu\omega/2g} = \sqrt{\mu\omega/g} \angle 45 \text{ degrees}. \quad (37)$$

The attenuation and phase constant have equal val-

ues in a conducting medium. The intrinsic impedance has a phase angle of 45 degrees indicating that the electric-field intensity leads the magnetic-field intensity by a time angle of 45 degrees.

Some idea of the rapidity of attenuation of electromagnetic waves in metal may be obtained by evaluating the attenuation constant. In silver at a frequency of 100 megacycles, the value of α_0 is 15.7×10^4 nepers per meter. The electric-field intensity will decrease in amplitude to $1/\epsilon$ of the surface value when $\alpha x = 1$ or at a depth of 0.637×10^{-5} meter. In good conductors at ultra-high frequencies, the wave is attenuated to a negligibly small value in a few thousandths of an inch. The wavelength and phase velocity in the conductor are greatly reduced as seen from (30) and (31) which give $\lambda = 0.4 \times 10^{-4}$ meter, and $v = 4 \times 10^3$ meters per second. For comparison $\lambda = 3$ meters and $v = 3 \times 10^8$ meters per second in free space.

TRANSVERSE ELECTROMAGNETIC-WAVE REFLECTION —NORMAL INCIDENCE

An electromagnetic wave propagating in a medium which is discontinuous will experience a reflection at the surface of discontinuity similar to the reflection occurring on a transmission line which is not terminated in its characteristic impedance. Now let us consider the case of a plane wave passing from one medium to another at normal incidence. Both media are assumed to be infinite in extent in all directions except at the plane surface of intersection. The media may be conducting, semiconducting, or insulating as the case may be. Subscripts (1) and (2) will be used to differentiate between the properties of the two media.

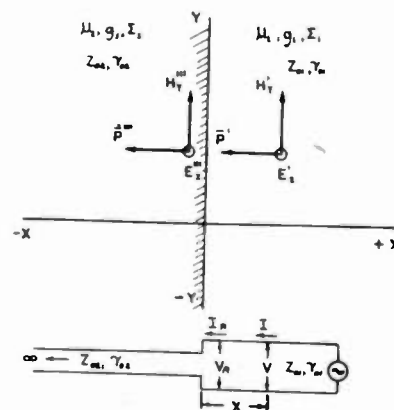

Fig. 7—Field-intensity vectors of incident and refracted waves at normal incidence and transmission-line analogue. (Vectors of reflected wave are omitted.)

Fig. 7 shows the vector field components of the incident wave of medium 1 and the wave in medium 2. There will also be a reflected wave in medium 1, the vectors of which are omitted to avoid confusion.

The equivalent transmission-line analogue for this case is a line having one value of characteristic impedance and propagation constant terminated in an infinite

line having different characteristics as shown in Fig. 7. The transmission-line equations (3), (4), (5), (6), and (7) may be used to express the electric and magnetic intensities and "impedance" in medium 1. The intrinsic impedance and propagation constant will have the values given by (27), (28), and (29). The impedance-terminating medium 1 will be shown later to be the intrinsic impedance of medium 2, that is, Z_{02} . Expressing the field equations in terms of the resultant field intensities at the reflection surface E_R and H_R , analogous to the voltage and current equations (5) and (6), these become

$$E_x = E_R [\cosh \gamma_{01} x + (Z_{01}/Z_{02}) \sinh \gamma_{01} x] \quad (38)$$

$$H_y = H_R [\cosh \gamma_{01} x + (Z_{02}/Z_{01}) \sinh \gamma_{01} x] \quad (39)$$

$$Z = \frac{E_x}{H_y} = Z_{01} \left[\frac{Z_{02} + Z_{01} \tanh \gamma_{01} x}{Z_{01} + Z_{02} \tanh \gamma_{01} x} \right] \quad (40)$$

The field-intensity equations contain both the incident- and reflected-wave components. The impedance Z is defined in a manner similar to that of the transmission line and is the ratio of the resultant electric-to-magnetic-field intensity.

Since the wave in medium 2 is traveling in the $-x$ direction, (21), (22), and (23) apply. The intensities and impedance in medium 2, designated by triple primes, then become

$$E_x''' = E_R e^{\gamma_{02} x} \quad (41)$$

$$H_y''' = H_R e^{\gamma_{02} x} \quad (42)$$

$$Z_{02} = E_x'''/H_y''' = E_R/H_R \quad (43)$$

It is necessary to satisfy certain boundary conditions, and here we observe one of the simplicities of this method of representation. The boundary conditions require that the resultant tangential electric intensities on both sides of the boundary be equal. The tangential magnetic intensities must also be equal on either side of the boundary except for the ideal case in which medium 2 is a perfect conductor. In this case an infinite current density at the surface of medium 2 terminates the magnetic intensity in medium 1. Thus, the surface values E_R and H_R in medium 1 are the same as those in medium 2 except for the perfect conductor case in which there is no field in medium 2. Since the ratio $E_R/H_R = Z_{02}$ applies to either medium, it is clear that this is the impedance terminating medium 1. Thus, Z_{02} was substituted for the terminating impedance in (38), (39), and (40). All of the above equations may be shown to satisfy Maxwell's equations.

If desired, the incident and reflected-wave components in medium 1 at the reflecting surface, designated, respectively, by single and double primes, may be found by setting $x=0$ in (3) and (4).

$$E_R' = E_R/2(1 + Z_{01}/Z_{02}) \quad (44)$$

$$E_R'' = E_R/2(1 - Z_{01}/Z_{02})$$

$$H_R' = E_R/2Z_{01}(1 + Z_{01}/Z_{02}) \quad (45)$$

$$H_R'' = -E_R/2Z_{01}(1 - Z_{01}/Z_{02})$$

It is advisable now to consider several special cases.

NORMAL-INCIDENCE REFLECTION FROM A CONDUCTING MEDIUM

The previous discussion of the transmission of waves in a conducting medium is enlightening here. First, consider the reflection coefficient. Substituting the values of Z_{01} and Z_{02} for Z_0 and Z_R in (8) gives

$$r_r = (Z_{02} - Z_{01}/Z_{02} + Z_{01}) \quad (46)$$

Since the intrinsic impedance of a metal (assumed to be medium 2) is very small, the reflection coefficient will approach the value (-1) and most of the energy will be reflected. The energy which does penetrate into the conductor is rapidly attenuated. The wavelength and phase velocity are very small in comparison with those for the same frequency in free space. Further, the electric- and magnetic-field intensity components have a 45-degree time displacement in the metal as shown by (37).

If the reflector is a perfect conductor, that is, $g = \infty$, the value of γ_{02} is infinite and the intrinsic impedance $Z_{02} = 0$. The wavelength in medium 2 is zero. The wave cannot therefore penetrate beyond the surface of medium 1 but is totally reflected. This is substantiated by the value of (-1) for the reflection coefficient.

It is obvious that the perfect-conductor case is analogous to the short-circuit transmission line. The equations for the field components in medium 1 are then similar to (9), (10), and (11), and may be found by setting $Z_{02} = 0$ in (38), (39), and (40).

$$E_x = H_R Z_{01} \sinh \gamma_{01} x \quad (47)$$

$$H_y = H_R \cosh \gamma_{01} x \quad (48)$$

$$Z = E_x/H_y = Z_{01} \tanh \gamma_{01} x \quad (49)$$

The curves shown in Figs. 2 and 3 may be used to represent the electric- and magnetic-field intensity components in medium 1, and Fig. 4 represents the impedance, defined by (49).

If medium 1 is lossless, the equations are still further simplified.

$$E_x = jH_R Z_{01} \sin \beta_{01} x \quad (50)$$

$$H_y = H_R \cos \beta_{01} x \quad (51)$$

$$Z = jZ_{01} \tan \beta_{01} x \quad (52)$$

The electric- and magnetic-field-intensity standing waves have a sinusoidal space distribution analogous to the short-circuit lossless line, and the impedance becomes a tangent curve as shown in Fig. 5. The electric- and magnetic-field intensities are in time quadrature as indicated by the j term in (50), as are also the voltage and current in the short-circuit transmission line.

NORMAL-INCIDENCE REFLECTION FROM A PERFECT INSULATOR

If both media are perfectly insulating but have unequal intrinsic impedances and propagation constant, there will still be a reflection at the surface of discontinuity, with part of the energy being reflected and part being transmitted.

If the conductivities of both media are zero, the propagation constants are imaginary and the intrinsic impedances are real. The impedance-terminating medium

1 is again the intrinsic impedance of medium 2, i.e., Z_{02} . The field equations in medium 1 are similar to (15), (16), and (17).

$$\gamma_{01} = j\beta_{01} = i\omega\sqrt{\mu_1\epsilon_1} \quad Z_{01} = \sqrt{\mu_1/\epsilon_1} \quad (53)$$

$$E_x = E_R[\cos \beta_{01}x + j(Z_{01}/Z_{02}) \sin \beta_{01}x] \quad (54)$$

$$H_y = H_R[\cos \beta_{01}x + j(Z_{02}/Z_{01}) \sin \beta_{01}x] \quad (55)$$

$$Z = Z_{01} \left[\frac{Z_{02} + jZ_{01} \tan \beta_{01}x}{Z_{01} + jZ_{02} \tan \beta_{01}x} \right] \quad (56)$$

In medium 2 $E_z''' = E_R e^{i\beta_{01}x}$ (57)

$$H_y''' = H_R e^{i\beta_{01}x} \quad (58)$$

$$Z_{02} = E_z'''/H_y''' \quad (59)$$

Partial reflection will occur, the reflection coefficient being given by (46).

OBLIQUE-INCIDENCE REFLECTION—TE WAVE

We shall now consider the case of a uniform, linearly polarized plane wave impinging upon a plane surface of discontinuity at oblique incidence. Two special cases will be considered, the transverse electric or TE wave, and the transverse magnetic or TM wave. The TE wave has its electric-field intensity polarized parallel to the reflecting surface, while the magnetic-field intensity has components both parallel and normal to the reflecting plane. In the TM wave the magnetic-field intensity is polarized parallel to the reflecting plane. We shall first consider the TE wave.

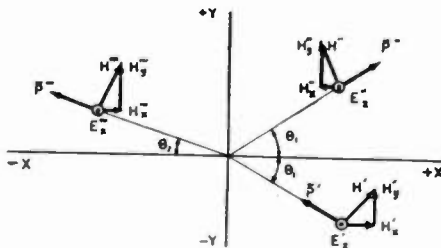

Fig. 8—Vector components of an oblique-incidence transverse-electric wave

A plane wave at oblique incidence may be interpreted in either of two ways. The customary procedure is to view the wave front as consisting of parallel equiphase planes having uniform field intensities moving in the direction of propagation of the wave. This wave impinges upon the reflection surface at oblique incidence causing a plane reflected wave in medium 1 and a plane refracted wave in medium 2. However, another equally valid interpretation is to assume a nonuniform wave to be traveling in a direction normal to the reflection surface. In this case, the electric- and magnetic-field intensities vary in phase and amplitude from point to point in the assumed plane of the wave front which is parallel to the reflecting surface. Thus, with some modifications, the equations developed for normal-incidence reflection may be adapted to the case of oblique incidence.

Consider the TE wave shown in Fig. 8. The electric-field intensity is assumed to be polarized in the z direction which is perpendicular to the page. The surface of discontinuity coincides with the plane $x=0$. A plane

drawn normal to Poynting's vector for the incident wave will, at each instant of time, be an equiphase and constant-amplitude surface. The equation for such a plane, if θ is taken as a positive angle, is

$$S' = x \cos \theta - y \sin \theta \quad (60)$$

where S' is the normal distance from the origin to the plane. Since the incident wave is traveling in the direction of decreasing S' in medium 1, it may be expressed by

$$E_z' = E_R' e^{\gamma_{01} S'} = E_R' e^{\gamma_{01}(x \cos \theta - y \sin \theta)} \quad (61)$$

The equiphase plane of the reflected wave and expression for the reflected field intensity are

$$S'' = x \cos \theta + y \sin \theta \quad (62)$$

$$E_z'' = E_R'' e^{-\gamma_{01} S''} = E_R'' e^{-\gamma_{01}(x \cos \theta + y \sin \theta)} \quad (63)$$

Again the single prime designates the incident and double prime the reflected components of the wave. The resultant electric intensity in medium 1 is the sum of (61) and (63) and, for convenience, may be written

$$E_z = [E_R' e^{\gamma_{01} x \cos \theta} + E_R'' e^{-\gamma_{01} x \cos \theta}] e^{-\gamma_{01} y \sin \theta} \quad (64)$$

The ratio of the electric-field intensity to magnetic-field intensity for either the incident or reflected components is Z_{01} . The magnetic-field intensity is, then,

$$H = 1/Z_{01} [E_R' e^{\gamma_{01} x \cos \theta} - E_R'' e^{-\gamma_{01} x \cos \theta}] e^{-\gamma_{01} y \sin \theta} \quad (65)$$

The negative sign in the reflection term is analogous to that in (4) and is due to the reversal of the magnetic-field intensity with respect to the electric intensity at the reflection surface. This reversal is necessary in order that the direction of Poynting's vector for the reflected wave be directed away from the plane of reflection.

Written in this form, the field equations may be viewed as representing incident and reflected waves propagating at normal incidence to the reflecting plane. The final exponential shows that the intensity components have an amplitude and phase variation in the y direction as well as in the x direction.

As in the TEM wave, we shall be interested in evaluating the ratio of the field-intensity components E_z/H_y . The value of H_y is

$$H_y = \cos \theta / Z_{01} [E_R' e^{\gamma_{01} x \cos \theta} - E_R'' e^{-\gamma_{01} x \cos \theta}] e^{-\gamma_{01} y \sin \theta} \quad (66)$$

A few simplifications will now make these equations resemble more closely the preceding equations for the transmission line. We may define the following quantities:

$$Z_{11} = Z_{01} \sec \theta \quad (67)$$

$$\gamma_{11} = \gamma_{01} \cos \theta \quad (68)$$

$$Z_R = E_R/H_{yR} \quad (69)$$

Equations (67) and (68) give the effective intrinsic impedance and propagation constant of the normally incident wave. Equation (69) is the impedance terminating the normally incident wave where E_R and H_{yR} are the resultant surface field-intensity components at the origin. The values of E_R' and E_R'' may be expressed in terms of the resultant field intensities at the origin by setting $x=y=0$ in (64) and (66). We then have

$$E_R' = E_R/2(1+Z_{11}/Z_R) \quad E_R'' = E_R/2(1-Z_{11}/Z_R) \quad (70)$$

The field-intensity equations then become

$$E_x = E_R/2[(1 + Z_{11}/Z_R)\epsilon^{\gamma_{11}x} + (1 - Z_{11}/Z_R)\epsilon^{-\gamma_{11}x}]e^{-\gamma_{01}y \sin \theta} \quad (71)$$

$$H_y = E_R/2Z_{11}[(1 + Z_{11}/Z_R)\epsilon^{\gamma_{11}x} - (1 - Z_{11}/Z_R)\epsilon^{-\gamma_{11}x}]e^{-\gamma_{01}y \sin \theta}. \quad (72)$$

Expressed in hyperbolic form, these become

$$E_x = E_R[\cosh \gamma_{11}x + (Z_{11}/Z_R) \sinh \gamma_{11}x]e^{-\gamma_{01}y \sin \theta} \quad (73)$$

$$H_y = E_R/Z_R[\cosh \gamma_{11}x + (Z_R/Z_{11}) \sinh \gamma_{11}x]e^{-\gamma_{01}y \sin \theta}. \quad (74)$$

With the exception of the final exponential, these equations are identical to those of the transmission line or the plane wave at normal incidence. We must, however, bear in mind that the intrinsic impedance and propagation constant are now functions of the angle of incidence as given by (67) and (68) and that the final exponential indicates that the field-intensity components have variation in both phase and magnitude in the y direction.

In the second medium the equiphase plane is

$$S''' = -x \cos \theta_2 + y \sin \theta_2. \quad (75)$$

Again the boundary conditions are easily evaluated since the tangential-field intensities at the origin must be equal on both sides of the boundary. Thus, the tangential-field intensities at the origin in either medium are E_R and H_{yR} . Since the wave in medium 2 is traveling in the direction of increasing S''' we have

$$E_x''' = E_R e^{-\gamma_{01}(-x \cos \theta_2 + y \sin \theta_2)} \quad (76)$$

$$H_y''' = (E_R/Z_{02}) \cos \theta_2 e^{-\gamma_{01}(-x \cos \theta_2 + y \sin \theta_2)}. \quad (77)$$

Making the simplifications

$$Z_{22} = Z_{02} \sec \theta_2 \quad (78)$$

$$\gamma_{22} = \gamma_{02} \cos \theta_2. \quad (79)$$

the equations become

$$E_x''' = E_R e^{\gamma_{11}x} e^{-\gamma_{01}y \sin \theta_2} \quad (80)$$

$$H_y''' = (E_R/Z_{22}) e^{\gamma_{11}x} e^{-\gamma_{01}y \sin \theta_2}. \quad (81)$$

With the exception of the final exponential terms, these are analogous to the infinite-line equations. It still remains to evaluate the impedance terminating medium 1. Substituting $x=y=0$ in (80) and (81), we have

$$Z_R = E_R/H_{yR} = Z_{22}. \quad (82)$$

The reflection coefficient for the normally incident wave becomes

$$r_r = (Z_{22} - Z_{11})/(Z_{22} + Z_{11}). \quad (83)$$

The wavelength and phase velocity are of particular interest in the oblique incidence case since they introduce a new concept. The propagation constants for the normal wave in medium 1 and medium 2 are

$$\gamma_{11} = \gamma_{01} \cos \theta = (\alpha_{01} + j\beta_{01}) \cos \theta \quad (84)$$

$$\gamma_{22} = \gamma_{02} \cos \theta_2 = (\alpha_{02} + j\beta_{02}) \cos \theta_2. \quad (85)$$

Now define the "true wavelengths" λ_{01} and λ_{02} as being the wavelengths in media 1 and 2 taken in the direction of propagation of the incident or refracted wave, thus,

$$\lambda_{01} = 2\pi/\beta_{01} \quad \lambda_{02} = 2\pi/\beta_{02}. \quad (86)$$

If, now, we measure the wavelength in a direction normal to the surface of discontinuity, the phase con-

stants in this direction are $\beta_{01} \cos \theta$ and $\beta_{02} \cos \theta_2$ and

$$\lambda_{n1} = 2\pi/\beta_{01} \cos \theta = \lambda_{01}/\cos \theta \quad (87)$$

$$\lambda_{n2} = 2\pi/\beta_{02} \cos \theta_2 = \lambda_{02}/\cos \theta_2.$$

Thus, we have a new virtual wavelength along the normal to the plane of reflection which has been stretched by the factor $1/\cos \theta$ in medium 1 and $1/\cos \theta_2$ in medium 2. This increase in wavelength arises out of the fact that the wavelength which we are considering here is not the wavelength in the direction of propagation.

Another consideration of special interest is the virtual wavelength parallel to the plane of incidence. The effective propagation constants and wavelengths λ_{P1} and λ_{P2} in this direction as given by the final exponential in (72) and (80) are

$$\gamma_{01} \sin \theta = (\alpha_{01} + j\beta_{01}) \sin \theta \quad (88)$$

$$\lambda_{P1} = \lambda_{01}/\sin \theta \quad \lambda_{P2} = \lambda_{02}/\sin \theta_2. \quad (89)$$

Here again the virtual wavelengths are greater than λ_{01} and λ_{02} due to the fact that they are not measured in the direction of propagation. As the angle of incidence decreases, approaching normal incidence, the wavelength measured normal to the plane decreases approaching the true wavelength, whereas the wavelength parallel to the plane of incidence increases approaching a limiting value of infinity.

The incident and reflected waves combine to produce a standing wave normal to the plane of reflection in medium 1, although no such standing wave exists parallel to the plane.

The virtual wavelength parallel to the reflecting plane is the effective wavelength of the $TE_{0,1}$ wave in wave guides. It gives rise to a fictitious velocity known as the phase velocity v_P given by

$$v_P = \lambda_P f. \quad (90)$$

Since, in oblique incidence, the wavelength λ_P is always greater than the true wavelength, the phase velocity is greater than the velocity of light in a lossless medium. However, this does not mean that the impulse travels with a velocity exceeding that of light since the phase velocity was computed on the basis of the virtual wavelength and not the true wavelength.

OBLIQUE INCIDENCE—PERFECT CONDUCTOR REFLECTOR

As a special case of oblique incidence, assume that medium 2 has infinite conductivity. The values of Z_{22} and Z_R are then both zero, and the tangential electric-field intensity at the origin E_R is zero. Equations (73) and (74) expressed in terms of the y component of magnetic-field intensity at the origin H_{yR} become similar to the short-circuit transmission line shown in (9), (10), and (11).

$$E_x = [H_{yR}Z_{11} \sinh \gamma_{11}x]e^{-\gamma_{01}y \sin \theta} \quad (91)$$

$$H_y = [H_{yR} \cosh \gamma_{11}x]e^{-\gamma_{01}y \sin \theta} \quad (92)$$

$$Z = E_x/H_y = Z_{11} \tanh \gamma_{11}x. \quad (93)$$

OBLIQUE INCIDENCE—INSULATING MEDIA

The final case to be considered for the *TE* wave is that of oblique incidence in which both media are perfectly insulating. The propagation constants are imaginary and the equations in media (1) and (2) then become

$$\gamma_{11} = j\omega\sqrt{\mu_1\epsilon_1} \cos \theta \tag{94}$$

$$\gamma_{22} = j\omega\sqrt{\mu_2\epsilon_2} \cos \theta_2 \tag{95}$$

$$Z_{11} = \sqrt{\mu_1/\epsilon_1} \sec \theta \tag{96}$$

$$Z_{22} = \sqrt{\mu_2/\epsilon_2} \sec \theta_2. \tag{97}$$

Medium 1

$$E_x = E_R [\cos \beta_{11}x + j(Z_{11}/Z_{22}) \sin \beta_{11}x] \epsilon^{-j\beta_{01}y \sin \theta} \tag{98}$$

$$H_y = E_R/Z_{22} [\cos \beta_{11}x + j(Z_{22}/Z_{11}) \sin \beta_{11}x] \epsilon^{-j\beta_{01}y \sin \theta}. \tag{99}$$

Medium 2

$$E_x''' = E_R \epsilon^{j\beta_{22}x} \epsilon^{-j\beta_{02}y \sin \theta_2} \tag{100}$$

$$H_y''' = (E_R/Z_{22}) \epsilon^{j\beta_{22}x} \epsilon^{-j\beta_{02}y \sin \theta_2}. \tag{101}$$

A relationship between the angle of incidence and angle of reflection may be found by setting $x=0$ in (98) and (100) and equating the values of E_x giving Snell's law of refraction if $\mu_1 = \mu_2$. This becomes

$$\sin \theta_2 / \sin \theta = \sqrt{\mu_1\epsilon_1/\mu_2\epsilon_2} = \sqrt{\epsilon_1/\epsilon_2} = n_1/n_2 \tag{102}$$

where n_1 and n_2 are, respectively, the indexes of refraction of media 1 and 2.

The reflection coefficient becomes

$$r_r = -\frac{\tan \theta - \tan \theta_2}{\tan \theta + \tan \theta_2} = -\frac{\sin(\theta - \theta_2)}{\sin(\theta + \theta_2)} \tag{103}$$

which is Fresnel's equation for wave refraction. Equation (103) expresses the electric-field-intensity reflection coefficient analogous to the voltage reflection coefficient in the transmission-line treatment. In physics texts it is customary to express the equation for the magnetic-field-intensity reflection coefficient which is analogous to the current reflection coefficient of the transmission line. These have equal magnitudes but opposite signs.

OBLIQUE-INCIDENCE *TM* WAVE

The treatment of the *TM* wave at oblique incidence is similar to that of the *TE* wave.

The equiphase surfaces again are

$$\begin{aligned} \text{incident wave } S' &= x \cos \theta - y \sin \theta \\ \text{reflected wave } S'' &= x \cos \theta + y \sin \theta \\ \text{refracted wave } S''' &= -x \cos \theta_2 + y \sin \theta_2. \end{aligned} \tag{104}$$

Expressing the field intensities in terms of the incident and reflected components of magnetic-field intensities at the origin H_R' and H_R'' , we have

$$H_x = [H_R' \epsilon^{\gamma_{01}x} \cos \theta - H_R'' \epsilon^{-\gamma_{01}x} \cos \theta] \epsilon^{-\gamma_{01}y \sin \theta} \tag{105}$$

$$E_y = Z_{01} \cos \theta [H_R' \epsilon^{\gamma_{01}x} \cos \theta + H_R'' \epsilon^{-\gamma_{01}x} \cos \theta] \epsilon^{-\gamma_{01}y \sin \theta}. \tag{106}$$

Letting H_R and E_{yR} be the resultant field intensities at the origin, and defining the new intrinsic impedance and propagation constant as

$$Z_{11} = Z_{01} \cos \theta \tag{107}$$

$$\gamma_{11} = \gamma_{01} \cos \theta \tag{108}$$

$$Z_R = E_{yR}/H_R \tag{109}$$

the field equations then become

$$H_x = (E_{yR}/Z_R) [\cosh \gamma_{11}x + (Z_R/Z_{11}) \sinh \gamma_{11}x] \epsilon^{-\gamma_{01}y \sin \theta} \tag{110}$$

$$E_y = E_{yR} [\cosh \gamma_{11}x + (Z_{11}/Z_R) \sinh \gamma_{11}x] \epsilon^{-\gamma_{01}y \sin \theta}. \tag{111}$$

In medium 2, the equations are

$$H_x''' = (E_{yR}/Z_{22}) \epsilon^{\gamma_{22}x} \epsilon^{-\gamma_{02}y \sin \theta_2} \tag{112}$$

$$E_x''' = E_{yR} \epsilon^{\gamma_{22}x} \epsilon^{-\gamma_{02}y \sin \theta_2} \tag{113}$$

$$\text{where } \gamma_{22} = \gamma_{02} \cos \theta_2 \quad Z_{22} = Z_{02} \cos \theta_2. \tag{114}$$

The value of Z_R may be found by setting $x=y=0$ in (112) and (113).

$$Z_R = E_{yR}/H_R = Z_{22}. \tag{115}$$

The conclusions regarding phase velocity, virtual wavelength normal to and parallel to the reflecting plane, and Snell's law apply equally well here. The reflection coefficient is again given by (83). This gives the Fresnel equation

$$r_r = \frac{\sin \theta_2 \cos \theta_2 - \sin \theta \cos \theta}{\sin \theta_2 \cos \theta_2 + \sin \theta \cos \theta} = -\frac{\tan(\theta - \theta_2)}{\tan(\theta + \theta_2)} \tag{116}$$

A particular case of interest here is that in which $\theta + \theta_2 = 90$ degrees and $\tan(\theta + \theta_2) = \infty$. This may occur for a particular angle of incidence known as the "polarizing" angle. There will be no reflection if the angle of incidence equals the polarizing angle. For a lossless medium having the permeability of free space, this occurs when

$$\tan \theta = \sqrt{\epsilon_2/\epsilon_1} = n_2/n_1.$$

MULTIPLE REFLECTION

Problems dealing with multiple reflections at normal or oblique incidence may be readily analyzed by the methods developed here. Consider the plane-wave reflections occurring at normal incidence upon two different media as shown in Fig. 9. Any one or all of the

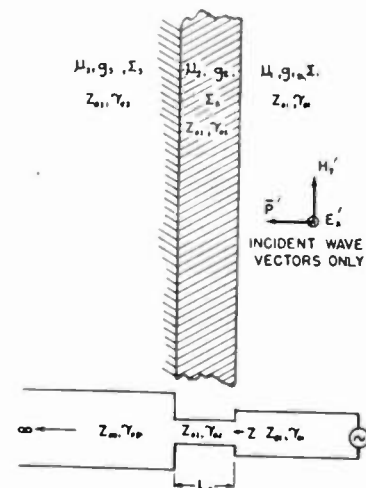

Fig. 9—Multiple-reflection and transmission-line analogue.

media may be conducting, semiconducting, or insulating. If the reflection at the first surface is of primary interest, we may easily write the equation for the impedance at this surface. In the equivalent transmission line this impedance consists of line 2 terminated in the

infinite line 3. Therefore, using (14), we have at the first reflecting surface

$$Z = Z_{02} \frac{[Z_{03} + Z_{02} \tanh \gamma_{02} l_2]}{[Z_{02} + Z_{03} \tanh \gamma_{02} l_2]} \quad (117)$$

The reflection coefficient at this surface is

$$r_r = (Z - Z_{01}) / (Z + Z_{01}) \quad (118)$$

An interesting application of multiple reflection is that of "matching" the impedance between two different media. Assume, for example, that medium 1 and medium 3 are lossless but have different intrinsic impedances. If medium 2 is omitted and a plane wave impinges upon the boundary between medium 1 and medium 3, a reflection will occur at the boundary. If, however, a quarter-wavelength thickness of medium 2 having the proper intrinsic impedance is inserted between media 1 and 3, it is possible to obtain a perfect impedance match and no reflection will occur at any of the surfaces. This is analogous to the quarter-wave matching transformer used in transmission lines.

The characteristics required of medium 2 to satisfy this condition may be easily determined by applying

(117). If all three media are lossless, this equation reduces to

$$Z = Z_{02} \frac{[Z_{03} + jZ_{02} \tan \beta_{02} l_2]}{[Z_{02} + jZ_{03} \tan \beta_{02} l_2]} \quad (119)$$

If the thickness of medium 2 is exactly a quarter wavelength, the familiar equation for the quarter-wave-matching section is obtained.

$$Z = Z_{02}^2 / Z_{03} \quad (120)$$

To avoid reflection, this impedance must equal the intrinsic impedance of medium 1, thus

$$\sqrt{\mu_1 / \epsilon_1} = \mu_2 / \epsilon_2 \sqrt{\epsilon_1 / \mu_3} \quad (121)$$

If all the permeabilities are equal

$$\epsilon_1 = \epsilon_2^2 / \epsilon_3 \quad (122)$$

This method of analysis makes it possible to use either the rectangular or the circular transmission-line-impedance chart to solve plane-wave reflection problems. The procedure is first to draw the equivalent transmission-line circuit, and evaluate the equivalent characteristic impedances and propagation constants. The analysis then proceeds exactly as in the solution of the equivalent-transmission-line problem.

Institute News and Radio Notes

Board of Directors

February 2 Meeting: At the regular meeting of the Board of Directors, which took place on February 2, 1944, the following were present: H. M. Turner, president; S. L. Bailey, W. L. Barrow, I. S. Coggeshall, W. L. Everitt, Alfred N. Goldsmith, editor; R. F. Guy; R. A. Heising, treasurer, L. C. F. Horle, C. B. Jolliffe, Haraden Pratt, secretary; H. J. Reich, B. J. Thompson, H. A. Wheeler, W. C. White, and W. B. Cowilich, assistant secretary.

Membership: The following applications for membership were approved: for transfer to Senior Member grade, L. J. Andres, G. S. Kraemer, G. F. Leydorf, and A. E. Newlon; for admission to Senior Member grade, G. J. Lehmann; for transfer to Member grade, J. H. Eichel, J. N. Fricker, J. D. Reid, C. B. Reynolds, E. A. Speakman, LeRoy Thompson, Jr., R. A. Varone, H. M. Watson, and W. P. West; for admission to Member grade, A. G. Chambers, J. R. Gelzer, and W. R. Watson; Associate grade, 175; and Student grade, 74.

The Board assigned to the Executive Committee authority to approve all applications for membership below the grade of Fellow.

Sections: Treasurer Heising, as chairman of the Sections Committee, reported that the annual meeting of this committee, which was held on January 27, 1944, was attended by representatives of most of the Sections and was considered a success. The following motion was passed at this meeting: "The Sections Committee is dissatisfied with the present names for new and old member

Important Notice CONSTITUTION

In the recently published Constitution, which was sent to all members of the Institute of Radio Engineers, there is a typographical error in Bylaw 16 on page 3. The third sentence of this Bylaw reads as follows:

"Not later than April first, each member whose dues remain unpaid shall be so notified by the Secretary and informed that, in accordance with Article III, Section 7, of the Constitution, should his dues remain unpaid after March 30, his membership will terminate and he will lose the right to vote and to receive the publications of the Institute."

March 30 should read April 30

grades and recommends that the Board cease transferring members to the new grades until the subject has been settled."

Dr. Heising also reported on the Canadian Region which was proposed by the Montreal Section. He was authorized to communicate to the Montreal and Toronto Sections that the Board of Directors is sympathetic to their suggestions and is prepared to take reasonable and corresponding steps within the limits of the present Constitution.

The Constitution and Laws Committee Chairman, Treasurer Heising, was requested to draw up a plan to provide for the proposed Canadian Region in the light of applying it to other countries. Treasurer

Heising also read the January 31, 1944, letter from the Montreal Section, proposing amendments to the Constitution.

Conventions: Assistant Secretary Cowilich reported that 1704 members and guests were registered at the Winter Technical Meeting; 390 attended the President's luncheon; 808 were at the banquet; and 266 were present at the Students' luncheon. It was moved that a letter be written to the chairman and members of the general Convention Committee expressing the appreciation of the Board of Directors for their outstanding work.

There will be no Summer Convention this year but plans are being formulated for holding a Winter Convention early in 1945.

Finances: The auditor's report for the fiscal year ending December 31, 1943, was unanimously accepted.

In view of the fiscal problems of the Institute, it was proposed that membership dues should be increased, beginning in 1945. The following members were appointed to serve on a committee to study this matter and to recommend methods of increasing dues: I. S. Coggeshall, chairman; W. L. Everitt, R. A. Heising, and Haraden Pratt.

Readmissions: The following resolution, concerning the readmission of former members, was unanimously approved: "RESOLVED, that the Board of Directors readmit to the grade of membership previously held (or in the Associate grade if formerly a Junior) those former members (a) whose memberships terminated before or during 1943 and who pay either current dues or all dues in arrears, or (b) whose memberships terminate on April 30, 1944. The payment of a new entrance fee, if such would normally

be required, is waived. Associates, who formerly had the privilege of voting, will be readmitted as nonvoting Associates."

Constitution and Bylaws: The proposed amendments to the Bylaws were adopted as follows:

Section 44A. This Section, in revised form, was transferred to Section 44.

Section 44. The revised wording of Section 44A, quoted below, was added to Section 44:

"The Board of Directors is authorized to waive, in whole or in part, the application in any particular case of the contents of this Bylaw during a war and six months thereafter."

Section 45. The following amendment to this Section was unanimously adopted:

Section 45. Add "Education" to the list of standing committees.

The indicated amendments to the Sections Constitution, adopted at the annual Sections Committee meeting on January 27, 1944, were unanimously approved.

ARTICLE II

Section 2—Insert "Senior Member" between the words "Fellow" and "Member," and add at the end "except that after January 1, 1945, Associates may not hold the office of Chairman."

Section 3—Delete "Junior and."

Appointments: The following committee appointments were made:

Board of Editors: V. W. Sherman and E. C. Wentz.

Papers Committee: H. A. Chinn.

Admissions: A. R. Hodges.

Education: W. L. Everitt, chairman; C. C. Chambers, C. M. Jansky, Jr., F. H. Kirkpatrick, and Ernst Weber.

Professor Maxwell Henry was unanimously appointed Institute Representative at the College of the City of New York.

Professor C. C. Chambers was unanimously appointed to represent the Institute at the annual meeting of the American Academy of Political and Social Sciences to be held on April 14 and 15, 1944, at Philadelphia.

Office Quarters: Reports relative to purchasing a permanent home for the Institute were discussed at length. Building and operational costs were considered, as well as available buildings and the expenditures involved in renting office space. It was agreed to continue this meeting on February 19 for the purpose of inspecting suitable buildings and for further consideration of the matter.

Clark Collection: In a letter to the Board, Secretary Pratt recommended that assistance be given to the Engineering Societies Library Committee in cataloguing and reindexing the George H. Clark collection which has been presented to the library. The Board of Directors went on record as sympathetic to the proposal and appointed Professor Alan Hazeltine to assist the committee.

February 19 Meeting: The adjourned meeting of the Board of Directors, reconvened in the Institute office on Saturday, February 19, 1944. Those present were H. M. Turner, president; S. L. Bailey, W. L. Barrow, E. F. Carter; I. S. Coggeshall, P. S. Dixon, Alfred N. Goldsmith, editor;

R. F. Guy, R. A. Heising, treasurer; F. B. Llewellyn, Haraden Pratt, secretary; B. J. Thompson, H. A. Wheeler, W. C. White, H. R. Zeamans, general counsel; and W. B. Cowilich, assistant secretary.

Office Quarters: Treasurer Heising, acting as temporary chairman and in his capacity as chairman of the Office-Quarters Committee, explained that the primary purpose of this meeting was to inspect several buildings considered suitable for purchase as a permanent home for the Institute, which buildings had been selected by the committee with the assistance of Mr. P. S. Dixon, vice president of the Equity Conservation Corporation.

At the meeting there were distributed copies of a list of the buildings to be inspected, including descriptive data in each case. The buildings under consideration were discussed generally and later inspected.

President Turner read letters from Messrs. L. C. F. Horle and A. F. Van Dyck expressing their views against the advisability of purchasing a building for the Institute at this time but in favor of renting larger quarters.

Treasurer Heising, as chairman of the Office-Quarters Committee, emphasized the importance of giving sufficient consideration to the following basic factors before making a decision.

1) General aspects of owning a building versus renting office quarters.

2) Effect of type of building versus location of building.

3) Cost of operation: ownership basis versus rental basis.

A vote was taken on the buildings inspected during the intermission and an order of preference was produced. An informal vote was taken as a measure to indicate the further steps to be taken in matter of purchasing a building. The votes "for" and "against," in some cases cast with qualifications, were evenly divided.

A discussion was held on the manner in which funds would be raised in the event the decision is made to purchase a home for the Institute. The consensus of opinion favored restricting the solicitations to the members of the Institute.

The Office-Quarters Committee was requested to submit, at the next meeting, a summary of a plan for providing funds for the purchase of a building.

Executive Committee

February 1 Meeting: The Executive Committee meeting, held on February 1, 1944, was attended by H. M. Turner, president; Alfred N. Goldsmith, editor; R. A. Heising, treasurer; Haraden Pratt, secretary; H. A. Wheeler, and W. B. Cowilich, assistant secretary.

Membership: The following applications for membership were approved for confirming action by the Board of Directors: transfer to Senior Member grade, L. J. Andres, G. S. Kraemer, G. F. Leydorf, and A. E. Newlon; admission to Senior Member grade, G. J. Lehmann, transfer to Member grade, J. H. Eichel, J. N. Fricker, J. D. Reid, C. B. Reynolds, E. A. Speakman, LeRoy Thompson, Jr., R. A. Varone, H. M. Watson, and

W. P. West; admission to Member grade, A. C. Chambers, J. R. Gelzer, and W. R. Watson; Associate Member grade, 175; and Student grade, 74.

Appointments: F. B. Llewellyn was placed in charge of the Standardization Committee and other Technical Committees; H. A. Wheeler in charge of Advertising, Conventions and Conferences, and Sections; and E. F. Carter in charge of Admissions, Membership, and Public Relations Committees.

The following personnel were recommended to the Board of Directors for appointment to the Committee on Education with the provision that the chairman may suggest additional members for the committee: W. L. Everitt, chairman; C. C. Chambers, C. M. Jansky, Jr., F. H. Kirkpatrick, and Ernst Weber.

At the suggestion of Editor Goldsmith, the recommendation was made that the Board of Directors appoint the additional personnel, listed below, to the named standing committees:

Board of Editors: V. W. Sherman and E. C. Wentz

Papers Committee: H. C. Chinn

The appointment of Mr. A. R. Hodges to the Admissions Committee, suggested by Chairman Royden of that committee, was recommended to the Board of Directors.

It was recommended to the Board of Directors that Professor Maxwell Henry be appointed Institute Representative at the College of the City of New York.

ASA Conference: President Turner represented the Institute at the ASA Conference on Co-ordination of Electrical Graphical Symbols held on January 22, 1944, in New York City and stated that definite progress had been made toward standardization of the particular symbols. It was noted that another meeting of the group has been scheduled.

Conventions: Reports on the Winter Technical Meeting, held on January 28 and 29, 1944, were given by Mr. Wheeler and the assistant secretary.

A total of 1704 members and guests were registered; 390 attended the President's luncheon, 808 the banquet, and 266 the Students' luncheon.

It was decided to omit a Summer Convention this year.

The Executive Committee unanimously recommended that the Board of Directors appoint the general committee for the annual Winter Convention, to be held in New York City, and that this committee begin making its plans at once.

Publications: Editor Goldsmith pointed out that the mailing of the "Temporary Facsimile Test Standards" will be separate from the PROCEEDINGS but in the same wrapper with the revised Constitution and the publication, "Radio Markets after the War."

Papers Procurement Committee: Approval was granted to the reorganization of the Papers Procurement Committee under the General Chairmanship of Dorman Israel, and a series of Group Chairmen. Editor Goldsmith stated that the following groups would be set up in this committee: Electron Therapeutics, Electron Tubes; Instrumentation; Propagation and Meteorology; Radio Broadcasting;

Radio Communication; Radio Navigation and Location; Specialty Devices; Television and Facsimile; Thermolectronics; and Timers and Mechanical Controls.

Sections: The subject of a Canadian Region, proposed by the Montreal Section in their letter of January 31, 1944, was discussed at length.

In the discussion it was brought out that another name, such as Council, Authority, or Division might be more adequate for the purpose; that the proposed form of suborganization might serve as a pattern for similar regional groups in other nations; that it might be necessary to amend the Bylaws to provide for such suborganizations; and, that there may be some question relative to the suggested appointment of representatives of such suborganizations to the Board of Directors.

The recommendation was made that the Board of Directors give sympathetic consideration and further study to the proposal.

A discussion was held on the petition from the Montreal Section, accompanied by their letter of January 31, 1944, containing the required number of signatures and proposing amendments to the Constitution. This petition was referred to the Board of Directors for consideration.

Office Quarters: Four reports, dated January 31 and February 1, 1944, and prepared separately by Treasurer Heising, Secretary Pratt, and Editor Goldsmith of the Office-Quarters Committee, were distributed at the meeting.

Following a discussion of the data given therein it was decided to refer the reports to the Board of Directors for further consideration and with the suggestion that a special meeting, to be devoted to the study of the office-quarters situation, be called for February 19, 1944.

Student Branch: Treasurer Heising, as chairman of the Sections Committee, read a recent letter from a group of Student members at the College of the City of New York, requesting permission to form a Student Branch and to use the Institute's name and stationery.

Montreal Petition

The Board of Directors is in receipt of a petition from the Montreal Section proposing amendments to the Institute Constitution. In the main, the proposed amendments are aimed at changing the names of Senior Member, Member, and Associate grades to Member, Associate, and Affiliate grades, respectively. The petition was signed by the required number of voting members, and appears to be in order. It was turned over to the Constitution and Laws Committee at the February meeting of the Board for study.

Under the Constitution, the Board is required to submit the amendments to the membership for a vote. The Montreal petitioners however, not wishing to precipitate the Institute into any difficult situation, were considerate enough in their petition to suggest to the Board "to make such modifying suggestions to us, the petitioners, as they may see fit, in the interest of clarity,

conformity, and workability—." The Constitution and Laws Committee at the March 1 meeting of the Board reported the amendments in order, but that on one point it would be desirable to secure greater clarity. The Committee was therefore instructed by the Board to take up this matter with the petitioners. The Committee expects that the amendments will be in shape to submit to the membership in a short time.

The Montreal Section was opposed to the present membership-grade names as approved in the constitutional ballot of last summer. They felt that insufficient time and opportunity had been given at that time for discussion and consideration of the subject. They informed the Board at that time of their intention to propose these amendments, and this petition is the result.

The Constitution and Laws Committee reports that a number of other matters have come up in the last year due to changing conditions that will at some time or other have to be handled by amendments to the Constitution. They intend to prepare the necessary amendments and bring them to the Board shortly so that they can be handled on the same ballot as the Montreal amendments. It is suggested to the membership that they watch the PROCEEDINGS carefully during the next few months in order that they may be fully informed on the suggested changes and be able to express themselves fully by their ballot.

Book Preview

Radio Direction Finders by Donald S. Bond

Published (1944) by McGraw-Hill Book Company, 330 W. 42 St., New York 18, N. Y. 274 pages. 162 figures. $5\frac{1}{2} \times 8\frac{1}{2}$ inches. Price \$3.00.

This volume offers a generous collection of information, both theory and practice, underlying the art of radio direction finding and especially some of the more conventional types of equipment. While replete with mathematical background taken from the literature, the description of systems and equipment and methods of testing is readable without a thorough appreciation of the mathematics. Therefore the book is recommended to the nontheoretical worker as an introduction to the subject, and to the theoretical man as an indication of the various mathematical problems encountered in securing dependable operation.

The introduction deals largely with the various properties of the direction finder as a specialized radio receiver. There are reviewed the methods of testing formulated by the Institute of Radio Engineers and by the Radio Technical Committee for Aeronautics. This chapter includes a 6-page chart of various tests and notes relating to such equipment.

The section on wave propagation is a summary of the theoretical work of recent years. It is mainly useful for range computations on the assumption of idealized surface conditions, although some parts are related to the special problems of direction finding.

There is a brief treatment of antennas,

with emphasis on the simpler types of directive antennas, such as the loop, spaced loops, and Adcock. Errors caused by oblique polarization receive special attention in comparing these types of antennas.

In the chapter on aural-null direction finders, there is a special treatment of the phase relations in radio-frequency selective circuits. The phase is usually neglected but becomes an essential factor in combining signals from directive and nondirective antennas for compensation of errors or for sense indication. The thermal noise generated in the receiver is described as one of the factors limiting not only the range but also the precision of direction finding.

Three commercial aircraft radio compasses with visual indicators are described in some detail—the Mark I of the Radio Corporation of America and Sperry, the MN-31 of Bendix, and the AVR-8F of RCA.

The book concludes with methods of testing directive receivers and of calibrating direction finders by field tests. Incidentally, various types of map projections are described.

The radio engineer looking for an inspired treatment of this fascinating subject will be disappointed to find how much space the author has filled with the less interesting mathematical derivations and theoretical background available elsewhere for reference, as compared with the small variety of systems he has selected to describe from the many that have been published.

H. A. WHEELER

Hazeltine Electronics Corporation
Little Neck, L. I., New York

Books

Time Bases, by O. S. Puckle

Published (1943) by John Wiley and Sons, Inc., 601 W. 26 St., New York 1, N. Y. 198 pages + 6-page index + xii pages. 124 figures. $5\frac{1}{2} \times 8\frac{1}{2}$ inches. Price, \$2.75.

The last two decades have witnessed great application of cathode-ray oscillography for the observation of the shapes of electrical waves in many research and engineering fields. By means of suitable transducers, useful observations have been made in many nonelectrical fields, such as mechanics, combustion, biology, geology, ballistics, and navigation, as well as in communications and electric-power apparatus. The oscilloscope generally includes a "time base" or "sweep circuit" for deflecting the beam periodically at a known speed in one direction while the signal, whose wave shape is to be observed, causes deflection at right angles to the time base. Since the accuracy and stability of the time base directly affect the accuracy of the oscillographic observation, this portion of the apparatus deserves great consideration.

The present book is a fairly complete survey of the many time bases which have been devised. These include circuits for simple linear sweep (saw-tooth), circular sweep, spiral sweep, radial sweep, and the two-way sweep used to produce the raster in television. Both electrostatic and magnetic deflection are discussed, but treatment

of the latter is inadequate. In particular, the problem of damping the magnetic-deflecting coils for line scanning in television is not treated adequately. No material on design of magnetic-deflecting yokes is given. Synchronization is discussed only for cases where the synchronizing signal is free of spurious signal. Frequency dividers are discussed inadequately, the so-called "pulse-counter" circuit being ignored.

The emphasis and the terminology of the book are predominantly British, there being extremely few references to American publications or inventions. For example, the operation of the blocking oscillator (used extensively in America) is discussed in only a few paragraphs (which, incidentally, do not agree with the explanations in American publications). The author describes the Schmitt trigger circuit, but fails to mention the Potter oscillator which is almost identical, and which was conceived earlier, according to their publications. On page 65 the circuit which is presented as the RCA time base, differs from the circuits published by that company in important respects which would result in inferior operation.

Though the book has serious shortcomings, it offers a collection of circuits not to be found in any other volume known to the reviewer, and, hence, should be of value to engineers engaged in development of, or extensive use of, cathode-ray oscillography. The same readers will find the appendixes of definite value, since they treat the fundamentals of the subject, such as the cathode-ray tube itself, discharge, and other basic circuits. This part is not likely to become obsolete as readily as the part treating individual trick circuits.

The book is an extension of an article by the author, published in the *Journal of the British Institution of Electrical Engineers* in June, 1942.

A. V. BEDFORD
RCA Laboratories
Princeton, N. J.

Electron-Optics, by Paul Hatschek (Translated by Arthur Palme)

Published (1944) by American Photographic Publishing Company, 353 Newbury St., Boston, Mass. 157 pages +3-page index +v pages. 125 figures, $6\frac{1}{2} \times 9\frac{1}{4}$ inches. Price, \$3.00.

This book was written in the years 1935-1936 and, therefore, describes an intermediate stage in the development of nearly all the electron optical equipment found in practical use today. It covers a wide range of the applications of electron optics and is written in plain language which should interest a large group of readers whether they are acquainted with the subject or not. After a somewhat sketchy beginning, the book settles down to describing electron optics and its close analogy to light optics. A number of applications of electron optics are included incidental to this discussion. The last four chapters of the original book, on the other hand, confine themselves to the description of the applications of electron optics to television, sound recording, electronic compass, amplifying tubes and elec-

tron multipliers of various types. A chapter has been added by the translator which brings a discussion of these applications up to date.

While the book provides much interesting reading, it leaves the impression of having been hurriedly and not too carefully written. The number of erroneous statements is disturbing. It is inexcusable that a technical book—even if written for popular reading—should contain such statements as: "In the electron case—magnification equals image distance divided by twice the object distance" (p. 60, line 19), "the speed of the stream is at a maximum when leaving the nozzle and gradually decreases because of air resistance, while at the same time the gravitational force increases as the stream is nearing ground" (p. 68, line 20), and "our screen will appear red when two (white) light rays impinge upon it which have a wavelength difference equal to a multiple of the wavelength red; it will appear yellow if that difference equals or is a multiple of the wavelength of yellow light, etc." (p. 89, line 4).

In attempting to describe some of the phenomena of electron optics in plain language, the author uses some interesting and new comparisons. However, in a number of cases his choice of comparison is very inappropriate. His most serious error in this regard is probably his use of the structure of an onion to describe the equipotential surfaces of an electrostatic lens. In this analogy he considers the electron paths as corresponding with the piercing of an onion by a knitting needle. In so doing, he puts the needle through the onion perpendicular to the axis of symmetry, while in the actual case, of course, the electron beam must coincide with the axis of symmetry. It is interesting that on a two-dimensional cross-sectional diagram the analogy appears quite good but when considered in the three dimensions of the actual case it creates an entirely erroneous impression. In fact, there is no possible orientation of a knitting needle and an onion that corresponds accurately to the practical arrangement of an electron beam and the equipotential surfaces of an electrostatic lens.

At the time the book was written, the electron microscope was at a much earlier stage of its development than the other applications of electron optics which are described. The enormous strides which have been made in the development of the electron microscope in the last five or six years have made the description given very inadequate. Realizing this, the translator devotes considerable space in the added chapter to the present status of the electron microscope.

It is exceedingly difficult to present in popular language the true significance of resolving power and magnification. In the part of the book devoted to this subject the author has not been very successful. He seems to have the basic ideas clear in his own mind but the presentation is confusing even to an individual who has spent considerable time studying this particular subject. The value of this chapter is further reduced by a number of careless choices of wording.

Viewed as a whole, the book does not appear to be of much value to the individual

who is interested in obtaining accurate information on the subject of electron optics. It does provide, however, interesting reading for someone desiring a quick survey of the work being done in this field.

JAMES HILLIER
RCA Laboratories
Princeton, New Jersey

Communication Circuits, by L. A. Ware and N. R. Reed

Published (1944) by John Wiley and Sons, Inc., 601 W. 26 Street, New York 1, N. Y. 325 pages +4-page index, +v pages. 146 figures. $5\frac{1}{2} \times 8\frac{1}{2}$ inches. Price \$3.50.

This is a textbook of college grade intended to serve as a first course in the theory of circuits used in communications.

The earlier chapters deal, naturally, with such subjects as network theorems, transmission on infinite lines, reflection of energy on open-circuited and short-circuited lines, impedance matching, and conventional filter theory. An interesting chapter makes clear the relations existing between power transmission circuits and the lines used for communications.

Although circuit principles apply generally over the whole range from audio frequencies to ultra-high frequencies, special attention is paid, at every opportunity, to applications to ultra-high-frequency work. The chapters on rectangular and cylindrical wave guides are unusually complete for a work of this scope, and, in order to make clear that the use of Maxwell's equations is not confined to these high-frequency applications, the special case of the coaxial line is treated both on this basis and by the methods of ordinary line theory.

In spite of the inherently mathematical character of such a work, the book is both clearly and interestingly written. A knowledge of calculus and elementary alternating theory is assumed and, as an aid to the reader, appendixes on the elements of hyperbolic functions and Bessel functions are provided to help in the understanding of the sections where these functions are naturally employed. Illustrative problems are solved in the text and further problems for the student accompany each chapter.

This present second edition includes new material on impedance matching and the use of the circle diagram for practical problems involving matching stubs, and a new chapter deals with practical problems having to do with the use of wave guides.

The book is suitable, not only for a general course on communications circuits, but as a foundation course for work in ultra high frequencies in general.

FREDERICK W. GROVER
Union College
Schenectady, N. Y.

Fundamentals of Telephony, by Arthur L. Albert

Published (1943) by McGraw-Hill Book Co., 330 W. 42 St., New York 18, N. Y. 336 pages +9-page index +vi pages. 200 figures. $5\frac{1}{2} \times 8\frac{1}{2}$ inches. Price, \$3.25.

This volume is physically small, about three quarters of an inch in thickness, but,

by the use of thin paper and a studied brevity, carries considerable information. It carries out well the author's avowed purpose of covering the fundamentals of telephony, i.e., wire telephony, for beginning students and for telephone workers. An adequate course in high-school mathematics and physics would seem to be essential for a good understanding of the material covered although considerable elementary electrical theory is contained in the opening chapters.

The author has in general, balanced his material, and the division of topics and the information are up to date. It has chapters on

- Direct-Current Theory
- Alternating-Current Theory
- Electric Networks
- Sound, Speech, and Hearing
- Telephone Transmitters

- Telephone Receivers
- Telephone Sets
- Manual Telephone Systems
- Dial Telephone Systems
- Transmission Over Circuits With Distributed Constants
- Transmission Over Circuits With Lumped Constants
- Measurements in Telephony
- Inductive Interference
- Telephone Repeaters and Carrier Systems

Each chapter is supplemented by review questions and problems to carry out its use as a textbook.

The chapter on dial-telephone systems seems somewhat unbalanced in content. The explanation of the step-by-step or Strowger system far outweighs in size the material

devoted to the panel and crossbar systems, which are of equal importance in the telephone plant, considered from the standpoint of numbers of subscribers affected. The more advanced phases of telephone transmission involving repeaters, carrier systems, etc., are sketchily covered, as is perhaps justifiable in a book devoted to fundamentals.

On the whole, this volume may be recommended as a good general summary for a beginner. It might be expected that the telephone industry would find considerable use for it in training its own personnel, for the author has drawn largely on Bell System and independent telephone sources for his references to current telephone practice.

H. A. AFFEL
Bell Telephone Laboratories, Inc.
New York 14, N. Y.

Institute Committees—1944

ADMISSIONS

- G. T. Royden, *Chairman*
- | | |
|----------------|-------------------|
| S. L. Bailey | Lloyd Espenschied |
| H. H. Beverage | A. R. Hodges |
| E. F. Carter | Knox McIlwain |
| E. D. Cook | F. A. Polkinghorn |
- H. J. Reich

AWARDS

- W. L. Everitt, *Chairman*
- | | |
|--------------|-------------------|
| W. L. Barrow | Haraden Pratt |
| D. D. Israel | B. E. Shackelford |
| R. K. Potter | H. A. Wheeler |
- W. C. White

BOARD OF EDITORS

- A. N. Goldsmith, *Chairman*
- | | |
|-------------------|------------------|
| R. R. Batcher | E. L. Nelson |
| R. S. Burnap | H. F. Olson |
| P. S. Carter | G. W. Pickard |
| L. M. Clement | R. A. Powers |
| E. M. Deloraine | Haraden Pratt |
| E. W. Engstrom | C. A. Priest |
| W. L. Everitt | H. J. Reich |
| G. W. Gilman | V. W. Sherman |
| P. C. Goldmark | L. C. Smeby |
| F. W. Grover | E. C. Wente |
| L. B. Headrick | H. A. Wheeler |
| C. M. Jansky, Jr. | L. E. Whittemore |
| J. D. Kraus | G. W. Willard |
| D. G. Little | William Wilson |
| F. B. Llewellyn | C. J. Young |
| S. S. Mackeown | V. K. Zworykin |

CONSTITUTION AND LAWS

- R. A. Heising, *Chairman*
- | | |
|---------------|---------------|
| Austin Bailey | F. E. Terman |
| W. L. Barrow | H. R. Zeamans |

EDUCATION

- W. L. Everitt, *Chairman*
- | | |
|-------------------|-------------------|
| A. B. Bronwell | F. H. Kirkpatrick |
| C. C. Chambers | B. R. Teare, Jr. |
| C. M. Jansky, Jr. | Ernst Weber |

EXECUTIVE

- H. M. Turner, *Chairman*
R. A. Heising, *Vice Chairman*
Haraden Pratt, *Secretary*
- | | |
|---------------------|-----------------|
| E. F. Carter | F. B. Llewellyn |
| Alfred N. Goldsmith | H. A. Wheeler |

INVESTMENT

- R. A. Heising, *Chairman*
- | | |
|---------------|---------------|
| Haraden Pratt | H. M. Turner |
| | H. R. Zeamans |

MEMBERSHIP

- E. D. Cook, *Chairman*
- | | |
|----------------|------------------|
| V. J. Andrew | L. G. Hector |
| C. R. Barhydt | J. F. Johnson |
| C. M. Burrill | R. L. Kelly |
| W. F. Choat | J. G. Kreer, Jr. |
| J. M. Clayton | J. A. Morton |
| R. I. Cole | Albert Preisman |
| W. C. Copp | J. L. Reinartz |
| W. H. Doherty | Bernard Salzberg |
| A. V. Eastman | R. B. Shanck |
| W. G. Eaton | R. L. Snyder |
| A. J. Ebel | J. C. Stroebel |
| W. N. Eldred | Sarkes Tarzian |
| D. G. Fink | Bertram Trevor |
| A. W. Graf | K. S. Van Dyke |
| Samuel Gubin | H. M. Wagner |
| L. B. Headrick | Ernst Weber |
- (Section Secretaries *ex officio*)

NOMINATIONS

- Ralph Bown, *Chairman*
- | | |
|------------------|-----------------|
| I. S. Coggeshall | F. B. Llewellyn |
| J. V. L. Hogan | L. P. Wheeler |
| O. B. Hanson | W. C. White |

PAPERS PROCUREMENT COMMITTEE

- Dorman D. Israel, *General Chairman*
William L. Everitt, *Vice Chairman*

GROUP CHAIRMEN

- | | |
|---------------|---------------|
| J. E. Brown | C. J. Madsen |
| E. J. Content | D. H. Moore |
| Harry Diamond | H. A. Wheeler |
| E. T. Dickey | W. C. White |

PAPERS

F. B. Llewellyn, *Chairman*

- | | |
|------------------|-------------------|
| H. A. Affel | D. K. Martin |
| W. L. Barrow | Knox McIlwain |
| H. A. Chinn | H. R. Mimno |
| J. K. Clapp | I. E. Mouromtseff |
| I. S. Coggeshall | G. G. Muller |
| F. W. Cunningham | A. F. Murray |
| R. B. Dome | H. O. Peterson |
| W. G. Dow | A. F. Pomeroy |
| E. B. Ferrell | J. R. Poppele |
| D. G. Fink | Simon Ramo |
| H. S. Frazier | F. X. Rettenmeyer |
| F. W. Grover | P. C. Sandretto |
| O. B. Hanson | S. A. Schelkunoff |
| J. V. L. Hogan | D. B. Sinclair |
| F. V. Hunt | Karl Spangenberg |
| Harley Iams | H. M. Turner |
| L. F. Jones | Dayton Ulrey |
| J. G. Kreer, Jr. | K. S. Van Dyke |
| F. R. Lack | W. C. White |
| H. C. Leuteritz | Irving Wolff |
| Emil Labin | J. W. Wright |
- H. R. Zeamans

PUBLIC RELATIONS

- I. S. Coggeshall, *Chairman*
- | | |
|-----------------|--------------------|
| O. H. Caldwell | O. B. Hanson |
| E. K. Cohan | Keith Henney |
| P. B. Findley | D. D. Israel |
| Augustin Frigon | T. R. Kennedy, Jr. |
| George Grammer | J. R. Poppele |
- R. C. Poulter

SECTIONS

- R. A. Heising, *Chairman*
- | | |
|----------------|-------------------|
| C. N. Anderson | J. H. Miller |
| E. D. Cook | F. A. Polkinghorn |
| V. M. Graham | G. T. Royden |
| J. K. Johnson | B. E. Shackelford |
- (Section Chairmen, *ex officio*)

TELLERS

- H. F. Dart, *Chairman*
- | | |
|-----------------|---------------|
| T. T. Goldsmith | G. B. Hoadley |
| | C. E. Scholz |

Technical Committees

May 1, 1943, to May 1, 1944

ANNUAL REVIEW

L. E. Whittemore, *Chairman*

R. S. Burnap	R. F. Guy
C. R. Burrows	Keith Henney
W. G. Cady	I. J. Kaar
J. L. Callahan	G. G. Muller
C. C. Chambers	H. M. Turner
C. J. Franks	A. F. Van Dyck

H. A. Wheeler

ELECTROACOUSTICS

G. G. Muller, *Chairman*

S. J. Begun	G. M. Nixon
F. V. Hunt	Benjamin Olney
V. N. James	H. F. Olson
Knox McIlwain	H. H. Scott

L. J. Sivian

ELECTRONICS

R. S. Burnap, *Chairman*

E. L. Chaffee	J. A. Morton
H. P. Corwith	I. E. Mouromtseff
K. C. Dewalt	L. S. Nergaard
W. G. Dow	G. D. O'Neill
R. L. Freeman	H. W. Parker
A. N. Glover	H. J. Reich
T. T. Goldsmith, Jr.	A. C. Rockwood
L. B. Headrick	J. B. Russell, Jr.
D. R. Hull	Bernard Salzberg
S. B. Ingram	A. L. Samuel
Ben Kievit	C. M. Wheeler
D. E. Marshall	J. R. Wilson
J. M. Miller, Jr.	Irving Wolff

Jack Yolles

FACSIMILE

J. L. Callahan, *Chairman*

Maurice Artzt	H. J. Lavery
E. P. Bancroft	B. V. Magee
J. C. Barnes	Pierre Mertz
F. R. Brick, Jr.	L. D. Prehn
W. A. R. Brown	G. D. Robinson
J. J. Callahan	W. L. Roe
D. V. Dillenback, Jr.	L. A. Smith
J. V. L. Hogan	F. T. Turner
L. C. Horn	R. J. Wise

C. J. Young

FREQUENCY MODULATION

C. C. Chambers, *Chairman*

J. E. Brown	V. D. Landon
W. F. Cotter	H. B. Marvin
M. G. Crosby	D. E. Noble
W. L. Everitt	B. E. Shackelford
R. F. Guy	D. B. Smith
C. M. Jansky, Jr.	L. P. Wheeler

W. D. White

RADIO RECEIVERS

C. J. Franks, *Chairman*

G. L. Beers	D. E. Foster
W. M. Breazeale	J. K. Johnson
W. F. Cotter	Garrard Mountjoy
Harry Diamond	H. O. Peterson
W. L. Dunn	E. K. Stodola
H. B. Fischer	A. E. Thiessen
H. C. Forbes	H. P. Westman

R. M. Wilmotte

RADIO WAVE PROPAGATION

C. R. Burrows, *Chairman*

S. L. Bailey	H. R. Mimno
J. L. Barnes	K. A. Norton
J. H. Dellinger	H. O. Peterson
W. A. Fitch	H. P. Thomas
G. D. Gillett	W. D. White

STANDARDS

H. A. Wheeler, *Chairman*

R. S. Burnap	C. J. Franks
C. R. Burrows	R. F. Guy
W. G. Cady	I. J. Kaar
J. L. Callahan	G. G. Muller
C. C. Chambers	H. M. Turner

SYMBOLS

H. M. Turner, *Chairman*

R. R. Batcher	E. T. Dickey
M. R. Briggs	H. S. Knowles
R. S. Burnap	O. T. Laube
C. R. Burrows	A. F. Pomeroy
J. H. Dellinger	E. W. Schafer

TELEVISION

I. J. Kaar, *Chairman*

Hollis Baird	L. M. Leeds
J. E. Brown	H. M. Lewis
A. B. DuMont	A. V. Loughren
D. E. Foster	H. T. Lyman, Jr.
P. C. Goldmark	A. F. Murray
T. T. Goldsmith, Jr.	R. E. Shelby
A. G. Jensen	D. B. Sinclair

D. B. Smith

TRANSMITTERS AND ANTENNAS

R. F. Guy, *Chairman*

Andrew Alford	W. E. Jackson
Raymond Asserson	R. W. P. King
M. R. Briggs	J. F. Morrison
W. W. Brown	J. C. Schelleng
Harry Diamond	Robert Serrell
W. S. Duttera	D. B. Sinclair
Sidney Frankel	W. D. White
F. A. Gunther	J. E. Young

Institute Representatives on Other Bodies—1944

American Documentation Institute: J. H. Dellinger
 Council of the American Association for the Advancement of Science:
 J. C. Jensen
 Joint Co-ordination Committee on Radio Reception of the E.E.I.,
 N.E.M.A., and R.M.A.: C. E. Brigham
 National Research Council, Division of Engineering and Research:
 F. E. Terman
 U. R. S. I. (International Scientific Radio Union) Executive Com-
 mittee: C. M. Jansky, Jr.
 U. S. National Committee, Advisers on Electrical Measuring Instru-
 ments: Melville Eastham and Harold Olesen
 U. S. National Committee, Advisers on Symbols: L. E. Whittemore
 and J. W. Horton
 U. S. National Committee of the International Electrotechnical
 Commission: H. M. Turner
 ASA Standards Council: Alfred N. Goldsmith (H. P. Westman, alter-
 nate)
 ASA Board of Examination: H. P. Westman
 ASA Electrical Standards Committee: H. M. Turner (H. P. West-
 man, alternate)
 ASA Sectional Committee on Acoustical Measurements and Termi-
 nology: E. D. Cook and H. F. Olson
 ASA Sectional Committee on Definitions of Electrical Terms:
 Haraden Pratt
 ASA Subcommittee on Vacuum Tubes: B. E. Shackelford
 ASA Sectional Committee on Electric and Magnetic Magnitudes and
 Units: J. H. Dellinger

ASA Sectional Committee on Electrical Installations on Shipboard:
 I. F. Byrnes
 ASA Sectional Committee on Electrical Measuring Instruments:
 Wilson Aull
 ASA Sectional Committee on Graphical Symbols and Abbreviations
 for Use on Drawings: Austin Bailey (H. P. Westman, alternate)
 ASA Subcommittee on Communication Symbols: H. M. Turner
 ASA Sectional Committee on Letter Symbols and Abbreviations for
 Science and Engineering: H. M. Turner
 ASA Subcommittee on Letter Symbols for Radio Use: H. M.
 Turner
 ASA Sectional Committee on National Electrical Safety Code, Sub-
 committee on Article 810, Radio Broadcast Reception Equip-
 ment: E. T. Dickey (Virgil M. Graham, alternate)
 ASA Sectional Committee on Preferred Numbers: A. F. Van Dyck
 ASA Sectional Committee on Radio: Alfred N. Goldsmith, chairman;
 Haraden Pratt, and L. E. Whittemore
 ASA Sectional Committee on Radio-Electrical Co-ordination:
 J. V. L. Hogan, C. M. Jansky, Jr., and L. E. Whittemore
 ASA Sectional Committee on Specifications for Dry Cells and Bat-
 teries: H. M. Turner
 ASA Sectional Committee on Standards for Drawings and Drafting
 Room Practices: Austin Bailey (Harold P. Westman, alternate)
 ASA Committee on Vacuum Tubes for Industrial Purposes: B. E.
 Shackelford
 ASA War Committee on Radio: Alfred N. Goldsmith*

* Also Chairman of Its Subcommittee on Insulating Material
 Specifications for the Military Services.

Institute Representatives in Colleges — 1944

Alabama Polytechnic Institute: Woodrow Darling
 Alberta, University of: J. W. Porteous
 Arkansas, University of: P. K. Hudson

British Columbia, University of: H. J. MacLeod
 Brooklyn, Polytechnic Institute of: F. E. Canavaciol

California Institute of Technology: S. S. Mackeown
 California, University of: L. J. Black
 Carleton College: C. A. Culver
 Carnegie Institute of Technology: R. T. Gabler
 Case School of Applied Science: P. L. Hoover
 Cincinnati, University of: W. C. Osterbrock
 Colorado, University of: J. M. Cage
 Columbia University: J. B. Russell
 Connecticut, University of: P. H. Nelson
 Cooper Union: J. B. Sherman
 Cornell University: True McLean

Drexel Institute of Technology: R. T. Zern
 Duke University: W. J. Seeley

Florida, University of: P. H. Craig

Georgia School of Technology: M. A. Honnell

Harvard University: E. L. Chaffee

Idaho, University of: Hubert Hattrup
 Illinois Institute of Technology: P. G. Andres
 Illinois, University of: A. J. Ebel
 Iowa, University of: R. C. Kent

Johns Hopkins University: Ferdinand Hamburger, Jr.

Kansas State College: Karl Martin
 Kansas, University of: G. A. Richardson

Lawrence Institute of Technology: H. L. Byerlay
 Lehigh University: C. B. Brenecke
 Louisiana State University: Taintor Parkinson

Maine, University of: W. J. Creamer, Jr.
 Manhattan College: J. F. Reintjes
 Maryland, University of: G. L. Davies
 Massachusetts Institute of Technology: W. H. Radford and
 F. Guillemin
 McGill University: F. S. Howes
 Michigan, University of: L. N. Holland
 Minnesota, University of: O. A. Becklund

Nebraska, University of: F. W. Norris
 Newark College of Engineering: Solomon Fishman
 New York, College of the City of: Maxwell Henry
 New York University: Philip Greenstein
 North Dakota, University of: E. I. O'Brien
 Northeastern University: G. E. Pihl
 Northwestern University: A. B. Bronwell
 Notre Dame, University of: H. E. Ellithorn

Ohio State University: E. C. Jordan
 Oklahoma Agriculture and Mechanical College: H. T. Fristoe
 Oregon State College: A. L. Albert

Pennsylvania State College: G. H. Crossley
 Pennsylvania, University of: C. C. Chambers
 Pittsburgh, University of: R. C. Gorham
 Princeton University: J. G. Barry
 Purdue University: R. P. Siskind

Queen's University: H. H. Steward

Rensselaer Polytechnic Institute: H. D. Harris
 Rice Institute: C. R. Wischmeyer
 Rose Polytechnic Institute: G. R. Schull
 Rutgers University: J. L. Potter

Southern Methodist University: R. E. Beam
 Stanford University: Karl Spangenberg
 Stevens Institute of Technology: F. C. Stockwell

Texas, University of: E. W. Hamlin
 Toronto, University of: R. G. Anthes
 Tufts College: A. H. Howell

Union College: F. W. Grover
 United States Naval Academy: G. R. Giet
 Utah, University of: O. C. Haycock

Virginia, University of: L. R. Quarles
 Virginia Polytechnic Institute: R. E. Bailey

Washington, University of: A. V. Eastman
 Washington University: Stanley Van Wambeck
 Wayne University: G. W. Carter
 Western Ontario, University of: G. A. Wootton
 West Virginia University: R. C. Colwell
 Wisconsin, University of: Glenn Koehler
 Worcester Polytechnic Institute: H. H. Newell

Yale University: H. M. Turner

Contributors

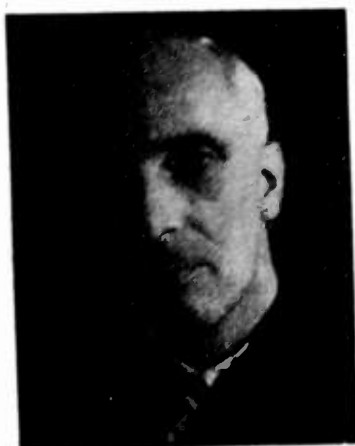

LEON BRILLOUIN

Leon Nicolas Brillouin (SM'44) was born at Sevres, France, on August 7, 1889. He received the degree of Agregation Physique in 1912 for the Ecole Normale Supérieur and his Doctorate in 1920 from the University of Paris. During 1914-1919 he was a radio engineer in the French Signal Corps. From 1920 to 1928 he was a professor at the École Supérieur d'Electricité; 1928 to 1932, professor at the University of Paris; 1932 to 1939, professor at the College de France; 1936 to 1939, consultant with Le Materiel Telephonique; 1939 to 1941, general director of the French National Broadcasting System; 1941 to 1942, professor at the University of Wisconsin; 1941 to 1943, consultant with the Federal Telephone and Radio Laboratory; 1942-1943 Brown University; 1943 to date, Columbia University. Dr. Brillouin is the author of many books



ARTHUR B. BRONWELL



THOMAS T. GOLDSMITH, JR.

❖

and papers on theoretical physics and radio engineering. He is a Fellow of the American Physical Society.

❖

Arthur B. Bronwell (A'39-SM'43) was born in Chicago in 1909. He received his B.S. degree in electrical engineering in 1933 and M.S. degree in 1936 from Armour Institute. This was followed by additional graduate work at the University of Michigan. He was employed by the Commonwealth Edison Company as substation operator and valuation engineer while attending school. In 1937, he was appointed to the electrical engineering staff of Northwestern University and at present holds the rank of Associate Professor and is head of the communications work in the electrical engineering department. Professor Bronwell

❖



W. D. HERSHBERGER

was employed by the Bell Telephone Laboratories in the summer of 1941. At present, he is a consulting engineer for the Galvin Manufacturing Company. He is chairman of the Chicago Section of the Institute of Radio Engineers, member of A.I.E.E., Sigma Xi, Eta Kappa Nu, and S.P.E.E.

❖

Allen B. DuMont (M'30-F'31) was born January 29, 1901, in Brooklyn, New York. From 1915 to 1920 he held a first-class commercial operator's license and worked during the summers on coastwise and transatlantic vessels. He also owned and operated an amateur transmitting station, W2AYR. In 1924 Mr. DuMont received the degree of electrical engineer from Rensselaer Polytechnic Institute. From 1924 to 1928 he was employed by the Westinghouse Lamp Company and from 1928 to 1931 he was with the de Forest Radio Company. In 1931 he organized the Allen B. DuMont Laboratories, Inc., for the manufacture of cathode-ray tubes. Mr. DuMont has many patents to his credit, chiefly in the cathode-ray tube and television fields and he is the author of many technical papers on these subjects. Mr. DuMont is a Fellow of the American Institute of Electrical Engineers and the Television Society; a Member of Sigma Xi; and President of Television Broadcasters Association, Inc.

❖

Thomas T. Goldsmith, Jr., (A'38) was born on January 9, 1910. He received the B.S. degree in physics from Furman University in 1931 and the Ph.D. degree from Cornell University in 1936. While a graduate student at Cornell he was in charge of the electronics laboratory, directing both undergraduate and graduate work. During 1936 Dr. Goldsmith was a physicist at the Biophysics Laboratory. Since 1936 he has been associated with the Allen B. DuMont Laboratories as director of research. He was chairman of the Synchronization Panel of the National Television System Committee and is now chairman of the RMA Committee on Cathode-Ray Tubes and is active in the work of the Radio Technical planning Board. Dr. Goldsmith is a member of Sigma Pi Sigma, Sigma Xi, American Physical Society, Radio Club of America, Society of Motion Picture Engineers, and the Montclair Society of Engineers.

❖

W. D. Hershberger (A'37) received the A.B. degree in mathematics from Goshen College in 1927, an A.M. degree in physics from George Washington University in 1930, and the Ph.D. degree in electrical engineer-



ALLEN B. DUMONT

❖

ing from the University of Pennsylvania in 1937. He was a Harrison Fellow in electrical engineering at Pennsylvania during 1936-1937. From 1927 to 1931 he was employed as a junior physicist at the Naval Research Laboratory and worked on supersonics and problems relating to submarine detection. From 1931 to 1936 he served as an associate physicist at the Signal Corps Laboratories at Fort Monmouth, New Jersey, working for one year on underwater sound and for four years on microwaves and their applications to communication and detection problems. In 1937 Dr. Hershberger joined the microwave research group of the RCA Manufacturing Company, Inc., in Camden, New Jersey, to work on aircraft collision prevention and radio altimeters and since October, 1942, has been located at Princeton, New Jersey, as a member of RCA Laboratories. He is a member of the American Physical Society, the American Association for the advancement of Science, and Sigma Xi.

❖



FREDERICK S. HOWES



WARREN P. MASON



Frederick S. Howes (A '37-M '43-SM '43) was born on July 25, 1896, at Paris, Ontario, Canada. He served in the Canadian Army infantry signals from 1916 to 1919. He received the B.Sc. degree in electrical engineering from McGill University in 1924 and the M.Sc. degree in 1926. After two years of graduate work at the Imperial College, University of London, he was granted the Ph.D. degree in electrical engineering in 1929. All of his graduate work has been in the field of communication engineering.

From 1929 to date, Dr. Howes has been a member of the staff of the department of electrical engineering at McGill where he has been in charge of all instruction in thermionics and radio engineering. He is also supervisor of the evening graduate courses in communication engineering.

Since the war began, Dr. Howes has assisted with the organization of the courses for the training of Radio Mechanics for the Royal Canadian Air Force. More recently he



ROGER A. SYKES



Lynde P. Wheeler (F'28) was born in Bridgeport, Connecticut, on July 27, 1874. He received the Ph.B. degree from Yale Sheffield Scientific School in 1894 and the Ph.D. degree in 1902. He remained there until 1926 as a professor. During the Spanish-American war he served in the United States Navy, and in World War I he organized the course for Signal Corps Officer Candidates School in 1918 and he has written numerous papers on electrical and radio subjects. In 1926 Dr. Wheeler joined the scientific staff of the Naval Research Laboratory where he was Superintendent of the Consultant Division in addition to his duties in its Radio Division. During 1929 and 1930 he was with the Fleet, conducting radio experiments on aircraft carriers and in sub-

has been retained by the Northern Electric Company in Montreal as consultant on studies in connection with antenna development.

Dr. Howes was chairman of the educational committee of the Montreal Section of the Institute of Radio Engineers during 1942-1943 and he is vice-chairman of the section and chairman of the Meetings and Papers Committee for the 1943-1944 season.



Warren P. Mason (A'36-F'42) was born in Colorado Springs, Colorado, on September 28, 1900. He received the B.S. degree in electrical engineering from the University of Kansas in 1921, the M.A. degree from Columbia University in 1924, and the Ph.D. degree in 1928 from Columbia. He has been a member of the research department of the Bell Telephone Laboratories since 1921. His work has been mainly with wave propagation networks, both electrical and mechanical, and with piezoelectric crystals. Dr. Mason is head of the group specializing on piezoelectric research. He is a member of the Physical Society and a Fellow of the Acoustical Society.



Roger A. Sykes (A'29-M'42-SM'43) was born in Windsor, Vermont, in 1908. He attended the Massachusetts Institute of Technology taking the co-operative course in electrical engineering and received the B.S. degree in 1929 and the M.S. degree in 1930. He joined the radio research laboratory of Bell Telephone Laboratories in 1930 and was engaged in the early research and development of selective networks employing quartz crystals as elements. Later work resulted in the design of electrical, electro-mechanical, and electroacoustical networks involving piezoelectric crystals and coaxial elements. For the past two years Mr. Sykes has been connected with the design and development of oscillator crystals for specific war applications.



LYNDE P. WHEELER



marines. In 1935 he became a member of the Science Advisory Board and in 1936 he accepted his present position with the Federal Communications Commission as chief of the engineering department's information division. He has served on numerous Institute Committees, its Board of Directors, and during 1943, was its President.

F. M. Wood was graduated from Queen's University, Kingston, Ontario, Canada, with the degree of Master of Arts in mathematics in 1911 and with the B.Sc. degree in civil engineering in 1914.

Professor Wood has been with the civil engineering and mathematics departments of McGill University since 1925.

Professor Wood's professional interests lie in the fields of mechanics and hydraulics with practical experience in topographic and hydrographic surveying, location and construction of irrigation works, and the design of hydroelectric machinery.



F. M. Wood

THE INSTITUTE OF RADIO ENGINEERS

INCORPORATED



SECTION MEETINGS

ATLANTA April 21	CHICAGO April 21	CLEVELAND April 27	DETROIT April 21	LOS ANGELES April 18
NEW YORK May 3	PHILADELPHIA May 4	PITTSBURGH May 8	PORTLAND May 8	WASHINGTON May 8

SECTIONS

- ATLANTA**—Chairman, Walter Van Nostrand; Secretary, Ivan Miles, 554—14 St., N. W., Atlanta, Ga.
- BALTIMORE**—Chairman, G. J. Gross; Secretary, A. D. Williams, Bendix Radio Corp., E. Joppa Rd., Towson, Md.
- BOSTON**—Chairman, R. F. Field; Secretary, Corwin Crosby, 16 Chauncy St., Cambridge, Mass.
- BUENOS AIRES**—Chairman, G. J. Andrews; Secretary, W. Klappenbach, *La Nacion*, Florida 347, Buenos Aires, Argentina.
- BUFFALO-NIAGARA**—Chairman, Leroy Fiedler; Secretary, H. G. Korts, 432 Potomac Ave., Buffalo, N. Y.
- CHICAGO**—Chairman, A. B. Bronwell; Secretary, W. O. Swinyard, Hazeltine Electronics Corp., 325 W. Huron St., Chicago, Ill.
- CINCINNATI**—Chairman, J. L. Hollis; Secretary, R. S. Butts, 3017 Verdin Ave., Cincinnati 11, Ohio.
- CLEVELAND**—Chairman, A. S. Nace; Secretary, Lester L. Stoffel, 1095 Kenneth Dr., Lakewood, Ohio
- CONNECTICUT VALLEY**—Chairman, W. M. Smith; Secretary, R. F. Shea, General Electric Co., Bridgeport, Conn.
- DALLAS-FORT WORTH**—Chairman, D. J. Tucker; Secretary, P. C. Barnes, WFAA-WBAP, Grapevine, Texas.
- DAYTON**—Acting Secretary, Joseph General, 1319 Superior Ave., Dayton, 7, Ohio.
- DETROIT**—Chairman, R. A. Powers; Secretary, R. R. Barnes, 1411 Harvard Ave., Berkley, Mich.
- EMPORIUM**—Chairman, H. D. Johnson; Secretary, A. Dolnick, Sylvania Electric Products, Inc., Emporium, Pa.
- INDIANAPOLIS**—Chairman, A. N. Curtiss; Secretary, E. E. Alden, WIRE, Indianapolis, Ind.
- KANSAS CITY**—Chairman, A. P. Stuhrman; Secretary, R. N. White, 4800 Jefferson St., Kansas City, Mo.
- LOS ANGELES**—Chairman, L. W. Howard; Secretary, Frederick Ireland, 1000 N. Seward St., Hollywood, 38, Calif.
- MONTREAL**—Chairman, L. T. Bird; Secretary, J. C. R. Punchard, Northern Electric Co., 1261 Shearer St. Montreal, Que., Canada.
- NEW YORK**—Chairman, Lloyd Espenschied; Secretary, J. E. Shepherd, 111 Courtenay Rd., Hempstead, L. I., N. Y.
- PHILADELPHIA**—Chairman, W. P. West; Secretary, S. Gubin, RCA Victor Division, Radio Corporation of America Bldg. 8-10, Camden, N. J.
- PITTSBURGH**—Chairman, B. R. Teare; Secretary, R. K. Crooks, Box, 2038, Pittsburgh, 30, Pa.
- PORTLAND**—Chairman, W. A. Cutting; Secretary, W. E. Richardson, 5960 S.W. Brugger, Portland, Ore.
- ROCHESTER**—Chairman, O. L. Angevine, Jr.; Secretary, G. R. Town, Stromberg-Carlson Co., Rochester, N. Y.
- ST. LOUIS**—Chairman, N. J. Zehr; Acting Secretary, C. H. Meyer, KFUE, 801 DeMun Ave., St. Louis, Mo.
- SAN FRANCISCO**—Chairman, W. G. Wagener; Secretary, R. V. Howard, 225 Mallorca Way, San Francisco, Calif.
- SEATTLE**—Chairman, F. B. Mossman; Secretary, E. H. Smith, Apt. K, 1620—14 Ave., Seattle, 22, Wash.
- TORONTO**—Chairman, R. G. Anthes; Secretary, J. T. Pfeiffer, Erie Resistor of Canada, Ltd., 128 Peter St., Toronto, Ont., Canada.
- TWIN CITIES**—Chairman, E. S. Heiser; Secretary, B. R. Hilker, KSTP, St. Paul Hotel, St. Paul, Minn.
- WASHINGTON**—Chairman, J. D. Wallace; Secretary, F. W. Albertson, c/o Dow and Lohnes, E Street between 13th and 14th Sts., Washington, D. C.

STABILITY

AS PERMANENT as the North star, ALSIMAG Steatite Insulators are hard, strong, rigid... impervious to moisture... resistant to heat and cold.

The stability of ALSIMAG steatite ceramics lends rigidity and permanence to electronic circuits—affording constancy under climatic or other operating conditions.

Our Engineering and Research Staff is

ready at all times to cooperate in developing the most practical design for insulators and to aid in selecting the most suitable of the numerous ALSIMAG bodies.

Today for our fighting forces, Tomorrow for the miraculous electronic devices of Peace... American Lava is pledged to this Principle: Production to the highest standards... Research to find a better product.

AMERICAN LAVA CORPORATION

CHATTANOOGA 5, TENNESSEE

MADE IN U. S. A.



Army Navy "E"
First Awarded July 27, 1942
Second Award: "Star" February
13, 1943
Third Award: "Star" September
25, 1943

ALSIMAG

TRADE MARK REGISTERED U. S. PATENT OFFICE

OUT OF TODAY'S RESEARCH
TOMORROW IS ENGINEERED

STEATITE CERAMIC INSULATORS

CHARACTERISTICS TAILORED TO YOUR REQUIREMENTS

HERMETICALLY SEALED against the TROPICS

Thordarson's new development, Transformer terminals in glass, finally and completely overcomes the dangers of break-downs caused by extreme humidity and mysterious fungus growths which often attack electrical equipment.

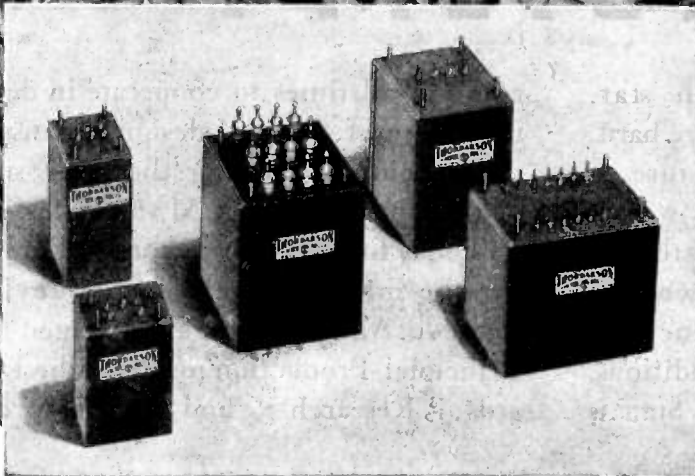

The Thordarson principle of sealing terminals in glass is applicable, not only to small transformers, but for large power and filament transformers, and reactors as well.



THORDARSON

TRANSFORMER DIVISION
THORDARSON ELECTRIC MFG. CO.
300 WEST HURON STREET, CHICAGO, ILL.

Transformer Specialists Since 1895
ORIGINATORS OF TRU-FIDELITY AMPLIFIERS

SECTION MEETINGS

BOSTON

"Captured Enemy Communications Equipments," by R. A. Gordon and Commander J. L. Reinartz, Naval Research Laboratories; December 17, 1943.

"High-Precision Tunable Receiver Design 50 to 500 Megacycles," by S. Y. White, General Communications Company; January 21, 1944.

"Recent Developments in the Design, Testing, and Application of Solid Dielectric Transmission Lines," by Harner Selvidge, Fournier Institute of the Arthur J. Schmitt Foundation; February 18, 1944.

CHICAGO

"The Radisonde," by V. E. Suomi, University of Chicago; February 18, 1944.

"Industrial Application of Radio Frequency," by Eugene Mittelmann, Illinois Tool Works; W. D. Wenger, Radio Corporation of America; H. R. Weinmueller, Commonwealth Edison Company; Victor Stefanides, Illinois Tool Works; February 18, 1944.

CINCINNATI

"War Developments of Bell Telephone Laboratories," by R. K. Honaman, Bell Telephone Laboratories, Inc.; February 17, 1944.

Motion Pictures, "The PT Trainer," and "Cradle of Victory," by Consolidated-Vultee Aircraft Corporation; February 17, 1944.

CLEVELAND

"Electronics in Industry," by Stanley Schneider, Westinghouse Electric and Manufacturing Company; January 27, 1944.

CONNECTICUT VALLEY

"Remote-Control Devices," by L. R. Fink, General Electric Company; February 15, 1944.

DALLAS-FORT WORTH

"Directional Antennas as Applied to Radio Transmitters," by Milton Woodward, Commercial Radio Equipment Company; February 24, 1944.

DETROIT

"Electronic Generator of Timing Pulses Variable over a Period of 10 Seconds in Intervals of 10 Microseconds," by G. H. Marmont, Bendix Aviation Corporation; January 21, 1944.

INDIANAPOLIS

"A Mechanical Theory of Electron-Image Formation," by Kurt Schlesinger, Purdue University; January 21, 1944.

MONTREAL

"Quartz-Crystal Production," by L. W. Elliott, Canadian Marconi Company; January 26, 1944.

PHILADELPHIA

"What the Electronic Future Has in Store for You," by O. H. Caldwell, *Electronic Industries*; February 2, 1944.

ROCHESTER

"Million-Volt Radiography," by Herbert Mermagen, University of Rochester; February 17, 1944.

ST. LOUIS

Reports of Conference of the FM Broadcasters, Inc., and the Winter Technical Meeting of the Institute of Radio Engineers," by C. H. Meyer, Station KFUP; February 2, 1944.

"Communications Systems of China," by E. C. Zimmermann, Concordia Seminary; February 2, 1944.

SEATTLE

"X-Ray Technique and Inspection," by Donald Erdman, Triplett and Barton Company; December 10, 1943.

(Continued on page 36A)

Proceedings of the I.R.E. April, 1944

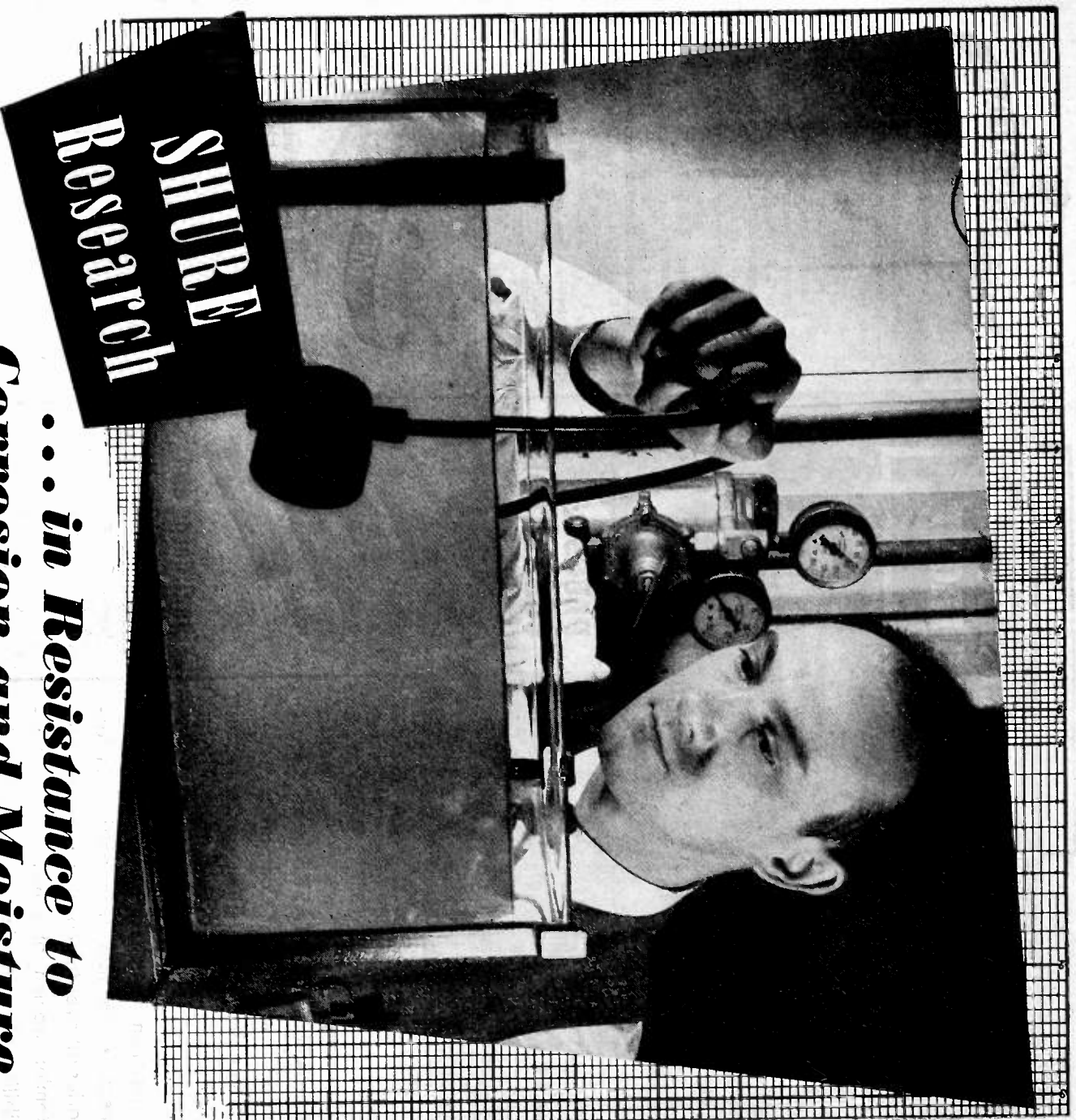

*... in Resistance to
Corrosion and Moisture*

This is a standard test at Shure Brothers. The microphone is connected to the air pressure line and submerged. No bubbles—its “insides” are protected against rain and ocean spray. More than that, Shure engineers have successfully defeated corrosion of iron, steel, brass and aluminum microphone parts—and they were the first to moisture-proof, successfully, Rochelle Salt Crystal Microphones. You may well look to Shure engineers to provide you with better microphones and headphones.

SHURE BROTHERS, 225 West Huron Street, Chicago

Designers and Manufacturers of Microphones and Acoustic Devices

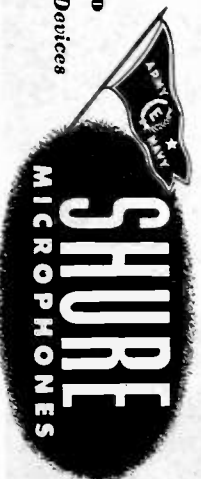

MOTHER'S ON THE PLASTIC FRONT



Remler worker removing threaded ear pieces for telephone hand set from plastic molding press.

A VARIETY OF TASKS in all departments of the Remler Company are performed by women. Their dexterity and painstaking attention to detail contribute to the precision accuracy of Remler components and communication equipment. • Like their sister workers in factories all over the country, many of these Remler women also have the responsibility of managing a household. To this double task they bring a devotion worthy of their menfolks in the fighting fronts. Hats off to the women of America!

Wire or telephone if we can be of assistance

REMLER COMPANY, LTD.
2101 Bryant St. • San Francisco, 10, California

REMLER

SINCE 1918

Announcing & Communication Equipment

PLUGS & CONNECTORS



Signal Corps and Navy Specifications

Types:		P L		
50-A	61	74	114	150
54	62	76	119	159
55	63	77	120	160
56	64	104	124	291-A
58	65	108	125	354
59	67	109	127	
60	68	112	149	

PLP		PLQ		PLS	
56	65	56	65	56	64
59	67	59	67	59	65
60	74	60	74	60	74
61	76	61	76	61	76
62	77	62	77	62	77
63	104	63	104	63	104
64		64			

N A F
1136-1 No. 212938-1

Other Designs to Order



(Continued from page 34A)

"Frequency-Modulation Radio Broadcasting," by F. P. Barnes, General Electric Company; February 18, 1944.

TORONTO

"The Manufacture of Small Meters," by J. R. Bach, Spanton of Canada, Ltd.; December 6, 1943.

"Laboratory Standards and Measuring Equipment," by G. B. Tebo, Hydro-Electric Power Commission Laboratories; December 6, 1943.

"Applications of Small Meters," by E. Wilson, Stark Electrical Instruments Company; December 6, 1943.

"Electronics in Industry," A. G. Turnbull, Canadian General Electric Company, Ltd.; January 7, 1944.

"Transcription Recording," by E. O. Swan, Station CKCL; February 7, 1944.

WASHINGTON

"Television Broadcast Coverage," by A. B. DuMont and T. T. Goldsmith, Jr., Allen B. DuMont Laboratories, Inc.; February 14, 1944.



The following indicated admissions and transfers of membership have been approved by the Admissions Committee. Objections to any of these should reach the Institute office by not later than April 30, 1944.

Admission to Member

Allen, E. W., Jr., 3225 S. Sixth St., Arlington, Va.
Anton, N. G., 225 Sterling Pl., Brooklyn, N. Y.
Carroll, T. J., 3067 Ordway St., N.W., Washington, D. C.

Cronburg, C. I., Jr., Bell Telephone Laboratories, 463 West St., New York, N. Y.

Daubaras, E. J., 160 Himrod St., Brooklyn, N. Y.
Evans, C. R., 228 Manhasset Ave., Manhasset, L. I., N. Y.

Kocher, C. F., 3634 Avalon Rd., Shaker Heights, Cleveland, Ohio.

Liska, R. W., Plant Engineering Agency, Rm. 1303 Architects Bldg., 17 and Sansom Sts., Philadelphia, Pa.

McDermott, S. J., 35 Longview Rd., Port Washington, L. I., N. Y.

Transfer to Member

Bailey, R. C., Box 112, Richmond, 1, Va.
Brunner, G. V., 220 W. Fourth St., Emporium, Pa.
Burroughs, F. L., 301 E. Alleghany Ave., Emporium, Pa.

Campbell, C. H., National Broadcasting Co., 30 Rockefeller Plaza, New York, N. Y.

Dickinson, W., Special Tube Plant, Sylvania Electric Products, Inc., Emporium, Pa.

Doane, J. E., 317 N. Thomas St., Arlington, Va.
Eckel, C. B., 1118 Mulberry, Williamsport, Pa.

Ellefson, B. S., Sylvania Electric Products, Inc., Emporium, Pa.

Goldberger, E. M., c/o Pilot Radio Corp., 37-06—36 St., Long Island City, L. I., N. Y.

Halinton, H., 612 N. Michigan Ave., Chicago, Ill.
Kinsburg, B. J., Rm. 1304, 180 Varick St., New York, N. Y.

Laeser, P. B., 9410 Harding Blvd., Wauwatosa, Wis.

(Continued on page 38A)

Proceedings of the I.R.E. April, 1944

IRC WILL BE READY

With **PRECISION WIRE WOUND RESISTORS**

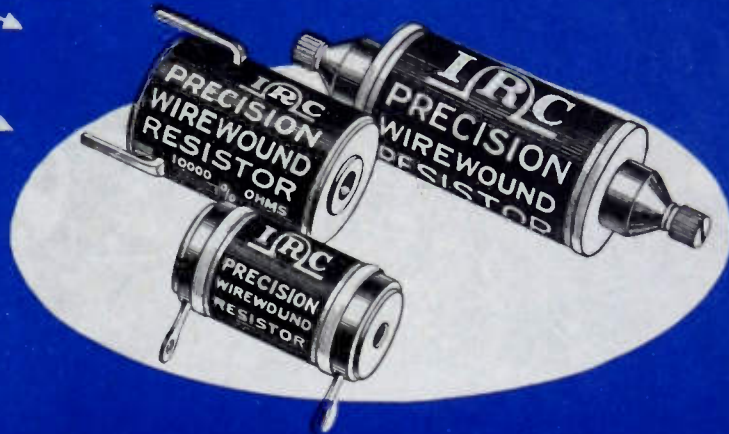

WHEN IT'S OVER "OVER THERE"

IRC will be in a specially favorable position to supply *all types* of Resistance units—of high Quality—in large Quantity—at low costs made possible by mass production.

FIRST IN WAR . . . FIRST IN PEACE

Produced by the most modern and efficient manufacturing methods, tested and perfected to meet the exacting demands of war, IRC Resistors will maintain their leadership as first choice of electronic engineers, manufacturers and service industries of tomorrow. . . . You are invited to consult our engineering-research staff now, in confidence, on any resistance problems connected with your peacetime products.

CHECK THESE FEATURES OF IRC PRECISION WIRE WOUND RESISTORS

1. Most rigid specifications on enameled wire.
2. Largest size wire used for each resistance value and size.
3. Steatite ceramic (with baked impregnation to prevent moisture absorption and to protect enameled wire from surface abrasions).
4. Specially designed winding machines eliminate stress and strain, avert damage to insulation and minimize fatigue of wire.
5. Baked impregnation of winding insures that wires remain rigidly in place and that resistors are independent of temperature variations.



INTERNATIONAL RESISTANCE CO.

401 N. Broad St. Philadelphia 8, Pa.

IRC makes more types of resistance units, in more shapes, for more applications than any other manufacturer in the world.



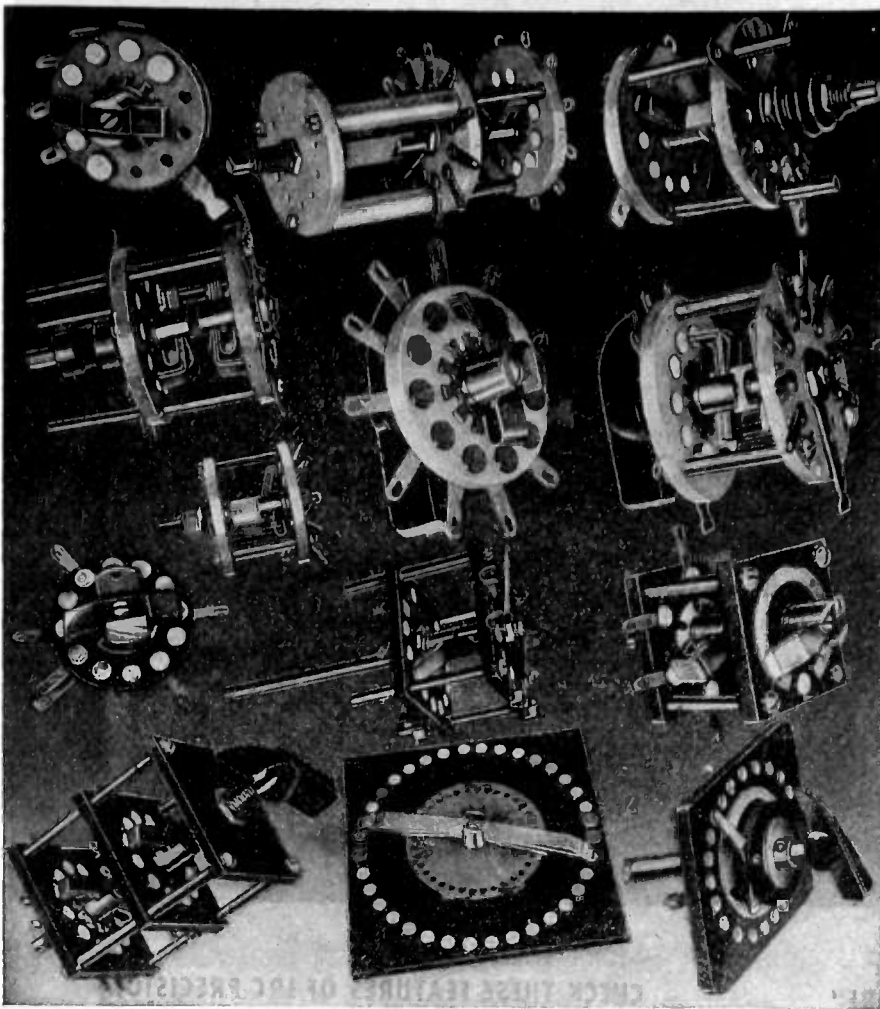

Shallcross SELECTOR SWITCHES

**OTHER
SHALLCROSS
PRECISION
PRODUCTS**

Ayrton Universal Shunts
Ratio Boxes
Wheatstone Bridges
Kelvin-Wheatstone
Bridges
Low-Resistance
Test Sets
Milli-ohm-meters
Decade Resistance
Boxes
Megohmmeters
and many more

For quality selector switches—try Shallcross!
Dozens of standard designs are available
—and each of these is subject to many variations
to suit individual requirements.

Shallcross Selector Switches are the logical
outgrowth of our own need for dependable,
high-quality units for exacting Shallcross
electrical measuring devices and other
equipment. You'll find them unexcelled for
use wherever the call is for switches of
assured better performance.

WRITE FOR CATALOG

Although Shallcross Selector Switches are produced
in an almost infinite number of types,
you'll find our data sheets a worthwhile
guide. Ask for Switch Bulletin C-1, and C-2.

SHALLCROSS MFG. CO.
ENGINEERING • DESIGNING • MANUFACTURING
Dept. IR-44, Collingdale, Pa.



(Continued from page 36A)

Marchand, N., 403 W. 115 St., New York, N. Y.
Overmier, E. E., 20 W. Sixth St., Emporium, Pa.
Plummer, C. B., Box 3, Alfred, Maine.
Schoen, A. L., 110 Parkdale Ter., Rochester, N. Y.
Vaughan, E. W., 2284 Neil Ave., Columbus, Ohio.
Velas, W. A., 333 W. Sixth St., Emporium, Pa.
Wolfe, H., 10415 McCormick St., North Hollywood, Calif.

Admission to Senior Member

Brillouin, L. N., 88 Central Park West, New York, N. Y.
Cooke, W. T., 107 Locust St., Garden City, L. I., N. Y.
Fruth, H. F., 5032 W. Morse, Skokie, Ill.
Huber, G. H., 221 Ryder Rd., Munsey Park, Manhasset, L. I., N. Y.
Richter, W., 5426 N. Kent Ave., Milwaukee, 11, Wis.
Taylor, M. K., Warwick Lodge, Hale, Cheshire, England.
Willenbecher, J. F., 15 Prospect St., Great Neck, L. I., N. Y.

Transfer to Senior Member

Adair, G. P., 101 Allegheny Ave., Takoma Park, Md.
Dunning, O. M., Hazeltine Electronics Corporation, Little Neck, L. I., N. Y.
Honaman, R. K., Bell Telephone Laboratories, 463 West St., New York, N. Y.
Moore, C., 327 Potomac Ave., Lombard, Ill.
Peterson, A. C., Jr., 15 Inwood Rd., Chatham, N. J.
Seielstad, H. D., 1017 South Bend Rd., Webster Groves, Mo.
Smith, D., 9 Rose Lan., Chestnut Hill, Philadelphia, Pa.

The following admissions and transfers were approved by the Board of Directors on March 1, 1944.

Admission to Member

Clarke, F. H., Naval Research Laboratory, Anacostia Station, D. C.
Maurtiz, F. E., 6001 Dickens Ave., Chicago, Ill.
Preist, D. H., Naval Research Laboratory, Anacostia Station, D. C.
Sorensen, E. G., 154 Roxbury Rd., Garden City, L. I., N. Y.

Transfer to Member

Chapman, R. W., 2819 Myrtle Ave., N.E., Washington, D. C.
Goldberg, H., 215 Brett Rd., Rochester, N. Y.
O'Shea, J. G., 290 W. State St., Presque Isle, Maine.
Spence, P. W., Bell Telephone Laboratories, 463 West St., New York, N. Y.

Transfer to Senior Member

Angevine, O. L., Jr., 284 Brooklawn Dr., Rochester, N. Y.
Dushman, S., General Electric Company, 1 River Rd., Schenectady, N. Y.
Lohnes, G. M., 4938 Wakefield Rd., Friendship P. O., Washington, D. C.
Shepherd, J. E., 111 Courtenay Rd., Hempstead, L. I., N. Y.
Tholstrup, H. L., 135 Willowbend Rd., Rochester, N. Y.

The following admissions to Associate were approved by the Board of Directors on March 1, 1944.

Allcock, E., 111 Stuyvesant Ave., Lyndhurst, N. J.
Anderson, W. H., c/o T.C.A., Moncton Airport, Moncton, N. B., Canada.
Augustine, J. W., 17652 Albion, Detroit, Mich.

(Continued on page 40A)

How to machine PLAX POLYSTYRENE

... from sheets, rods, tubes ... into special and standard parts

Plax Polystyrene is specially heat treated so that it may be machined without subsequent cracking or crazing. Because its softening point is about 180F, and because it will become gummy at about 220F, one should prevent overheating of the material. When overheated, even if gumming does not occur, subsequent cracking is possible. By avoiding excessive friction, aiding chip clearance, and in some cases using a coolant, *no difficulty is encountered and excellent results are obtained.*

Gasoline, kerosene, and other oils will dissolve Polystyrene. Hands and rags must be free of oil. Use soap and water as a coolant, or, to avoid rusting, a water solution of Solvac 100M special.

SAWING: A 9-inch circular hollow ground saw is satisfactory. It should be $3/32$ " thick, to avoid vibration. When cutting material less than $1/4$ " thick, a saw with 12-15 teeth/inch is used. When cutting heavier sections, a saw with 10 teeth/inch should be used. No heating occurs if the saw is run at 1850 rpm. with a coolant running through

the kerf with teeth.

DRILLING: High speed drills with polished or chromium plated flutes are desirable. Drills should have large clearance with a low rake. When drilling through holes, a neutral rake or slow helix is used to prevent breaking through. When drilling blind holes, a fast helix is preferred. In most instances coolants are used in drilling. Drills are available with a central hole through which the coolant is pumped into the tip, from which it flows back along the flutes. When drilling small holes, the drill must be backed out frequently to clear chips.

TURNING: Polystyrene can be readily turned. Best results are accomplished by using a sharp tool with only a slight rake and large clearance. A coolant is usually used for interval boring.

MILLING: Special cutters with low side friction are desirable. In some cases a coolant is necessary. If a coolant is not used, an air nozzle should be used to blow away chips.



Write Plax for other data and for stock sizes available NOW.

1,001 USES

Condensed Power for Years of Service

VERSATILITY and dependability were paramount when *Alliance* designed these efficient motors — *Multum in Parvo!* . . . They are ideal for operating fans, movie projectors, light home appliances, toys, switches, motion displays, control systems and many other applications . . . providing economical condensed power for years of service.

Alliance Precision

Our long established standards of precision manufacturing from highest grade materials are strictly adhered to in these models to insure long life without breakdowns.

EFFICIENT

Both the new Model "K" Motor and the Model "MS" are the shaded pole induction type — the last word in efficient small motor design. They can be produced in all standard voltages and frequencies with actual measured power outputs ranging upwards to 1/100 H. P. . . Alliance motors also can be furnished, in quantity, with variations to adapt them to specific applications.

DEPENDABLE

Both these models uphold the *Alliance* reputation for all 'round dependability. In the busy post-war period, there will be many "spots" where these Miniature Power Plants will fit requirements . . . Write now for further information.

A

Remember Alliance!
—YOUR ALLY IN WAR AS IN PEACE

ALLIANCE MANUFACTURING CO. ALLIANCE . OHIO

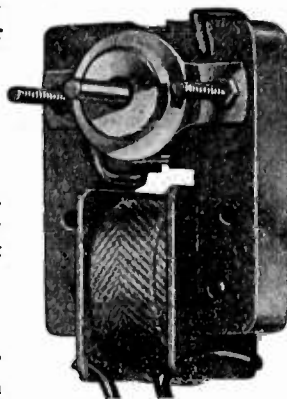

Model "MS"—Full Size
Motor Measures
1 1/4" x 2 x 3 1/8"

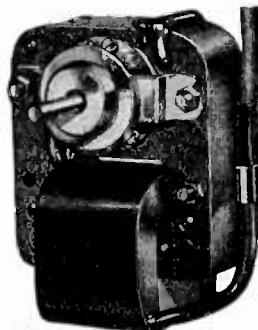

New Model "K"—Full Size
Motor Measures
2 1/8" x 2 1/2" x 3 1/4"



(Continued from page 38A)

- Balamuth, L., 10-20-45 Rd., Long Island City, L. I., N. Y.
 Ballasch, L. J., A.P.O. 868, c/o Postmaster, Miami, Fla.
 Batchelder, R. T., 5023 Copley Rd., Philadelphia, Pa.
 Berthold R. V., 186-40-139 Ave., Springfield, L. I., N. Y.
 Blaker, E. H., 3500 Jackson, Amarillo, Texas
 Bolam, G. D., c/o The Crescent, Tanfield Lea, Newcastle-on-Tyne, England.
 Brannen, P. M., 5626 Broad St., Pittsburgh, 6, Pa.
 Brewster, T. P., Rm. 818, 80 E. Jackson Blvd., Chicago, 4, Ill.
 Burzycki, M., Box 64, Alfred, N. Y.
 Campbell, A. L., Box 256, Innisfail, Alta., Canada.
 Carle, P. V., 14 E. 31 St., Brooklyn, N. Y.
 Carrozza, W. M., 800 Mifflin Rd., Hays, Pittsburgh, 7, Pa.
 Cohen, H., 1180 E. Broad St., Elizabeth, 4, N. J.
 Cooper, J. H., 360 Lafayette, Apt. 2, San Leandro, Calif.
 Cramer, L. F., c/o Allen B. DuMont Laboratories, Inc., Passaic, N. J.
 Curran, B. F., 2040-23 Ave., N., Seattle, 5, Wash.
 Dempsey, R. H., Box 807, Red Bank, N. J.
 Delafeld, J. D., 339 Grosvenor Ave., Westmount, Que., Canada.
 DeMunbrun, E., Jr., 358 Hillcrest Ave., Louisville, Ky.
 Deutsch, S., 7602-21 Ave., Brooklyn, 14, N. Y.
 DeVore, C., 449 Broadway, Long Branch, N. J.
 Dillon, P., Box 192, Marion, N. C.
 Dudley, T. C., 211 Bellevue St., Newton, 58, Mass.
 Dunn, J. L., 3 Frank St., Schenectady, N. Y.
 Eckmann, L. G., 303 N. Byers Ave., Joplin, Mo.
 Ellis, I. M., 363 Housatonic Dr., Devon, Conn.
 Ellison, G. C., Jr., Rt. 15, Box 1065, Portland, Ore.
 Elmer, W. D., Sig. Sec., AFHQ A.P.O. 512, c/o Postmaster, New York, N. Y.
 Flath, E. H., Jr., Graduate Applied Science Research Laboratory, University of Cincinnati, Ohio.
 Forrester, A. W., 17 Seymour Rd., Malvern, Natal, South Africa.
 Freeland, R. R., Box 172, Little Silver, N. J.
 Ganic, I. R., 942 Larkspur Rd., Oakland, Calif.
 Goldsmith, B. M., 7 Lenox Ter., South Orange, N. J.
 Gollhofer, P., 95 Leonard St., Brooklyn, N. Y.
 Grantham, M. D., 3818 Interlake Ave., Seattle, 3, Wash.
 Green, C. A., 7262 Greenway Ave., University City, 5, Mo.
 Hankison, W. C., Rm. 312, 900 Polk St., Amarillo, Texas.
 Hartke, D., Apt. 8, 2030 Ashby Ave., Berkeley, 3, Calif.
 Hayden, E. C., 316 W. 102 St., New York, N. Y.
 Headley, R. W., 302 E. California Ave., Pleasantville, N. J.
 Heckman, E. M., 5 Ridge Ave., Greenville, Pa.
 Hendry, E. L., 379 Edgewood Ave., New Haven, Conn.
 Horbach, S., 6 Hayward St., Presque Isle, Maine.
 Hotchkiss, C. S., 412 LaPorte Ave., Melrose Park, 3, Ill.
 Jackson, W. C., c/o R.C.A. Communications, Inc., Marion, Mass.
 Jacobson, L., Airadio, Inc., Barry Pl., Stamford, Conn.
 Kamm, G. N., 460 Beacon St., Boston, 15, Mass.
 Kaufmann, H. W., 1702 Orchard St., Alexandria, Va.
 Klinkhamer, A. J., 10029 Balfour, Detroit, 24, Mich.
 Koch, S. J., 65 Sussex Rd., Allwood, N. J.
 Larkins, D. H., 29 Goldlay Ave., Chelmsford, Essex, England.
 Lee, J. L., 813 Union Depot Bldg., Galveston, Texas.

(Continued on page 42A)

Proceedings of the I.R.E. April, 1944

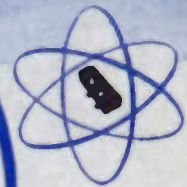
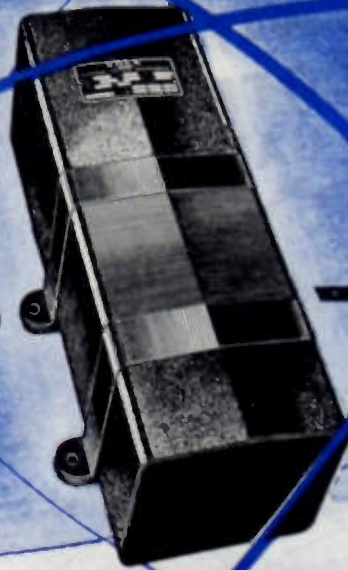

ELECTRONIC PERFORMANCE is always exactly predictable with built-in **CONSTANT VOLTAGE**

Constant, stable voltage comes first in design consideration if the electronic miracles promised for the post-war world are to be realized.

Perfect performance cannot be guaranteed if delicate electronic devices, too sensitive to tolerate ordinary voltage fluctuations, are left vulnerable to the sags and surges of commercial power lines.

FM and television transmitters and receivers, food sorting and testing devices, scientific instruments, X-ray, sound and projection equipment, precision machinery—these are but a few of the products, once requiring frequent adjustments and constant attention by watchful oper-

ators, whose performance is now automatic and exactly predictable with *built-in* Constant Voltage.

Many new products that have not yet progressed beyond the laboratory stage because of critical voltage problems will be available to the post-war world, with built-in Sola Constant Voltage Transformers reducing their operation to a simple "just plug in" basis.

Engineers and sales executives who are responsible for product design should bear this fact in mind—that the precisely controlled voltages of the research laboratory *are not* the voltages that will be encountered once the product reaches the

user. An otherwise perfect piece of engineering may be headed for trouble at the hands of less experienced operators.

Dependably close voltage control to within $\pm 1\%$ can be made available to all electronic devices, or electrically operated equipment, with built-in automatic Sola Constant Voltage Transformers.

Without manual adjustments or supervision, they instantly reduce voltage fluctuation as great as 30% to the rated voltage required for successful operation. They protect themselves against short circuit damage. Capacities and sizes are available to meet any design requirements.

CONSTANT VOLTAGE TRANSFORMERS

SOLA

To Manufacturers:

Built-in voltage control guarantees the voltage called for on your label. Consult our engineers on details of design specifications.

Ask for Bulletin KCV-74

Transformers for: Constant Voltage • Cold Cathode Lighting • Mercury Lamps • Series Lighting • Fluorescent Lighting • X-Ray Equipment • Luminous Tube Signs
Oil Burner Ignition • Radio • Power • Controls • Signal Systems • Door Bells and Chimes • etc. SOLA ELECTRIC CO., 2525 Ciybourn Ave., Chicago 14, Ill.

**WHEN 50 MILLION
PEOPLE WATCH A
FOOTBALL
GAME...**



...the "Rose Bowl" will be as large
as the television hook-up that will telecast the game
... on a beam of electrons.

Invisible to these millions, but essential to television, will be transformers: regulators of electronic energy... The intimate experience gained from war communication musts, will be applied by Stancor engineers to electronic controls of the future—an incalculable plus value... Refinement in transformers spells Stancor.

STANCOR Transformers

STANDARD TRANSFORMER CORPORATION
1500 NORTH HALSTED STREET - CHICAGO

Manufacturers of quality transformers, reactors, rectifiers, power packs and allied products for the electronic industries.



SEND FOR
NEW
COMPLETE
CATALOG

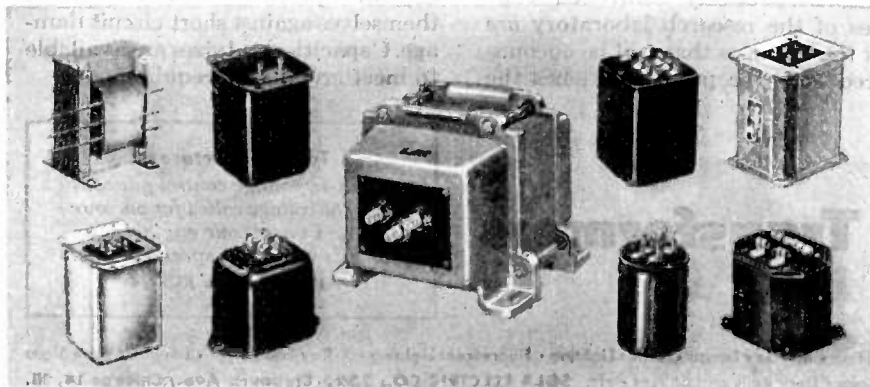

(Continued from page 40A)

- Leggett, W. S., University Club, 3813 Euclid Ave., Cleveland, Ohio.
- Lett, R. P., 340 Harvard St., Brookline, 46, Mass.
- Lorenzen, R., 333 E. 70 St., New York, N. Y.
- Lovick, E., Jr., 3612 Victory Blvd., Burbank, Calif.
- Madey, R., 91 Paulison Ave., Passaic, N. J.
- Maron, M., Rm. 422, Y.M.C.A., Passaic, N. J.
- McCleery, J., 6362 Hollywood Blvd., Hollywood, Calif.
- McCallum, D. M., Schoolhouse, Armadale, West Lothian, Scotland.
- McCormick, L. P., 5505 Fifth Ave., Brooklyn, 20, N. Y.
- McNulty, J. W., 95 Morris Ave., New Gosport, Portsmouth, Va.
- Mentcher, I., 35 Handsome Ave., Sayville, L. I., N. Y.
- Messitt, J. B., General Electric Company, 4966 Woodland Ave., Cleveland, 4, Ohio.
- Moore, F. B., 1717 Linden St., Scranton, 10, Pa.
- Nelson, C. O., 829 N. LaSalle St., Indianapolis, 1, Ind.
- Neri, H. E., 3704 N. Lockwood Ave., Chicago, Ill.
- Parker, R. H., CKPR, Ft. William, Ont., Canada.
- Pastor, C. C., 6248 Primrose Ave., Los Angeles, 28, Calif.
- Perry, W. E., 42 Station Approach, Wembley, Middlesex, England.
- Phillips, W. F., 15700 Myrtle Ave., Harvey, Ill.
- Pitts, M. L., 2416 Gold St., El Paso, Texas.
- Pittsley, E. L., WNBK, Binghamton, N. Y.
- Poole, C. C. S., 91 Laycock Rd., Penshurst, N.S.W., Australia.
- Potoski, A. P., 1110 Eighth St., N., Lethbridge, Alta., Canada.
- Priest, W. F., 216 Ney St., Playa del Rey, Venice, Calif.
- Raabe, R. W., 4523 W. Seminary Ave., Richmond, 22, Va.
- Ratynski, M. V., 81 Highland Blvd., Keansburg, N. J.
- Reich, P. J., 394 Ridgefield Ave., Bridgeport, Conn.
- Reichardt, J. P., 224 E. 47 St., New York, 17, N. Y.
- Reiss, L., 1230 Park Ave., New York, 28, N. Y.
- Roberts, H. W., 400 E. 57 St., New York, 22, N. Y.
- Ross, T. G., 246 Tenth St., E., Owen Sound, Ont., Canada.
- Ruth, G., 354 Princess Ave., London, Ont., Canada.
- Sanborn, C. B., Jr., 2112—32 St., S.E., Washington, D. C.
- Schuster, N. A., 2101 Campbell Ave., Schenectady, 6, N. Y.
- Schubert, H. C., 999 DeGrott Ave., Ridgefield, N. J.
- Schneider, P., 457 Lake Forest Dr., Bay Village, Ohio.
- Schwank, R. H., 1036 S. Larch St., Inglewood, Calif.
- Seaton, E. H., 3602 Watson Rd., Indianapolis, Ind.
- Simms, O. E., 14 Nichols Rd., Reading, Mass.
- Singer, G., National Bureau of Standards, Washington, D. C.
- Slocum, O. B., Box 235, Roscommon, Mich.
- Smith, E. J., 217 Smith St., Brooklyn, 2, N. Y.
- Soward, R., 510 W. Washington, East Point, Ga.
- Steadman, A., 14 Burnside St., Upper Montclair, N. J.
- Stewart, T. E., Jr., Engineer Board, Ft. Belvoir, Va.
- Stone, D. L., 466 Victory Ave., South San Francisco, Calif.
- Summer, E. M., 5116 Inadale Ave., Los Angeles, Calif.
- Thienpont, M. S., 552 W. 171 St., New York, 32, N. Y.
- Traino, C., Stromberg-Carlson Company, Rochester, N. Y.
- Tung, Yu-Hsiu, c/o Mr. Kipping, Tara Lodge, 5 Richmond Rd., New Barnet, Herts, England.

(Continued on page 44A)

Proceedings of the I.R.E. April, 1944

HAMMARLUND **RADIO**

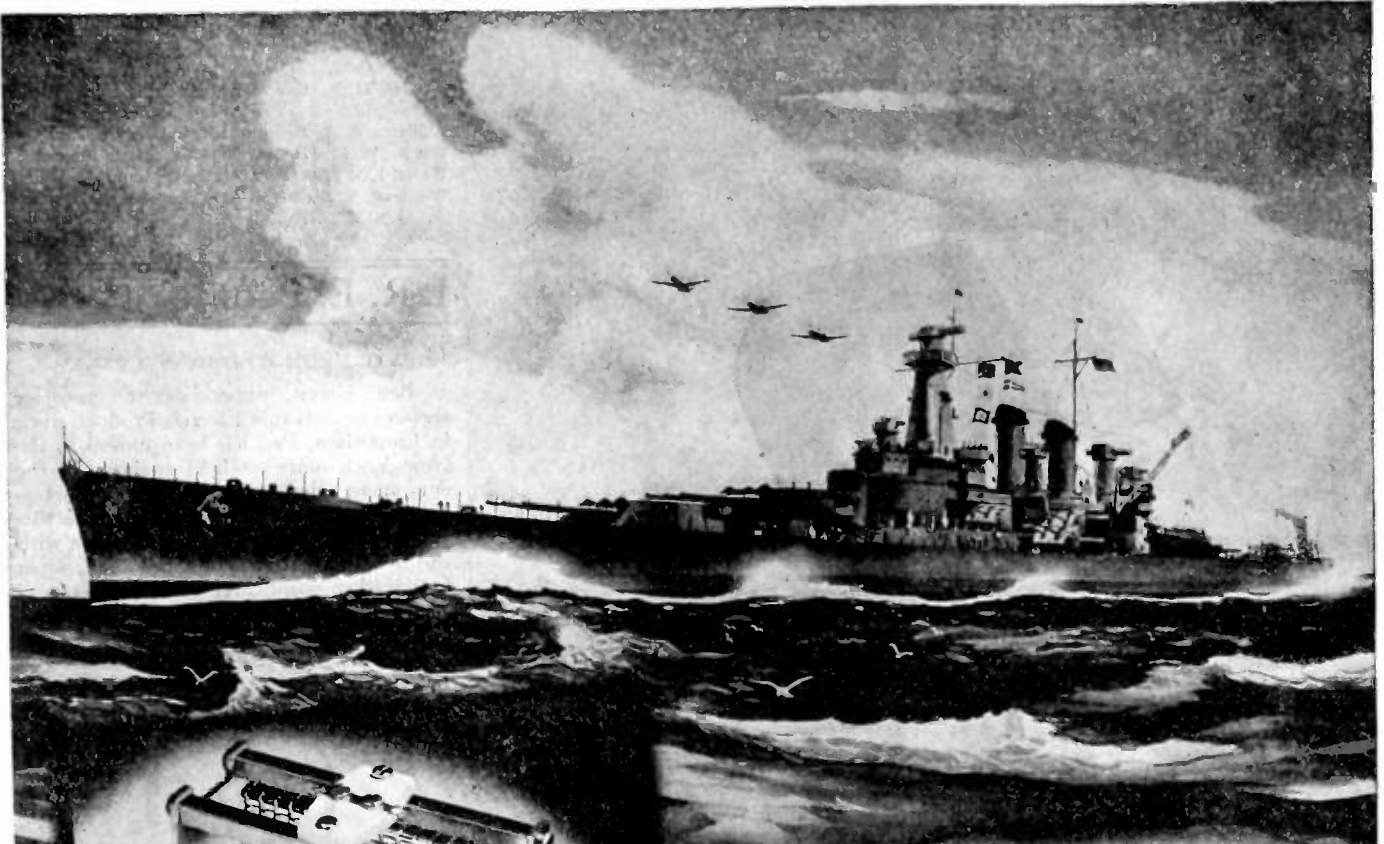

Official U. S. Navy Photo

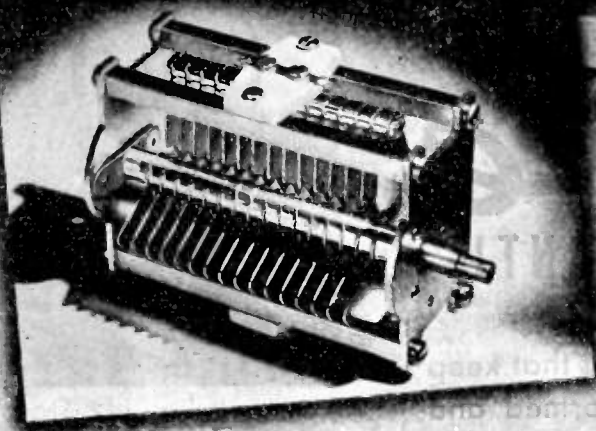

EYES AND EARS OF THE NAVY

As our Navy prowls the seas, searching out and destroying the enemy, Hammarlund Radio products help guide our great ships to certain victory. In commercial type marine equipment too, you'll find Hammarlund products are outstanding for their record of service.



THE HAMMARLUND MANUFACTURING CO., INC.

460 WEST 34th ST., NEW YORK, N. Y.

Established 1910



A

Choke

IS IMPORTANT!

Found in all important units that keep fighting men warned, informed and directed, are chokes.

Chicago Transformer has contributed many features of importance to their design, manufacture and improvement.



CHICAGO TRANSFORMER

DIVISION OF ESSEX WIRE CORPORATION

3501 WEST ADDISON STREET • CHICAGO, 18



(Continued from page 42A)

- Van Scoyoc, J. N., 334 S. Lombard Ave., Oak Park, Ill.
- Watson, B. S., 15812 Arcade Ave., Cleveland, 10 Ohio.
- Westlake, P. R., Army Detachment, Box H, Lompoe, Calif.
- Whiting, G. W., 1118 Dwight Way, Berkeley, 2, Calif.
- Wilkins, H. F., Box 235, Madison St., Lafayette, Ill.
- Williams, E. A., Box 1005, Ft. Lauderdale, Fla.
- Winget, W. F., 471 Greenfield Ave., Glen Ellyn, Ill.
- White, J. M., 2484 S. W. 24 Ter., Miami, 35, Fla.
- Woodruff, E. T., 87-38-114 St., Richmond Hill, L. I., N. Y.
- Zeltz, A., 58 Washington Village, Asbury Park, N. J.

I. R. E. People

KIEVIT PROMOTED BY SYLVANIA

Ben Kievit, supervisor of customer services of Sylvania Electric Products Inc., in Emporium, Pa., has been moved to the New York office as field engineer in the equipment sales department for the metropolitan and New England area, effective January 1, 1944. Mr. Kievit has been with the Sylvania corporation since 1930, when he joined the company as a research physicist. He became supervisor of the tube application department in 1931, and in 1934



BEN KIEVIT

was advanced to assistant director of the department. In 1941 he was appointed assistant director of commercial engineering, and the next year became supervisor of customer services in Emporium.

Mr. Kievit's experience and ability will be well used in this new post of field engineer, for he is widely known in engineering circles. He is a Senior Member of the Institute of Radio Engineers, and a member of the Electronics Committee of that group. His other affiliations include fellowship in the American Association for the Advancement of Science and membership in Sigma Xi and the American Physical Society. He has also served as technical editor of the *Sylvania Engineering News Letters* and the *Sylvania Technical Manual*, as well as assistant technical editor of *Sylvania News*.

Toledo, Ohio, is Mr. Kievit's birthplace.

(Continued on page 60A)

Proceedings of the I.R.E. April, 1944

WORLD FAMOUS OSCILLOSCOPES by DUMONT

Use Capacitors by
INDUSTRIAL CONDENSER CORP.

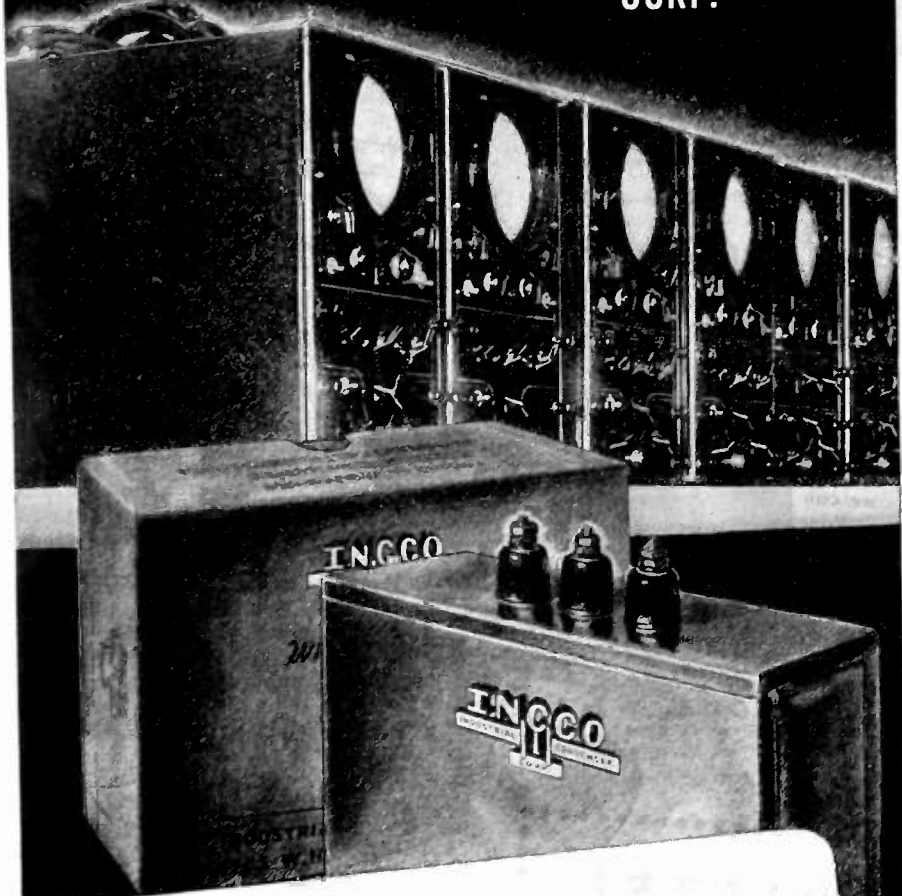

Capacitors used in Dumont's famous oscilloscopes are especially designed, engineered and manufactured for unusual performance under difficult operating conditions.

PAPER, OIL AND ELECTROLYTIC CAPACITORS

INDUSTRIAL CONDENSER CORPORATION

1725 W. NORTH AVE., CHICAGO 22, U. S. A.

DISTRICT OFFICES IN PRINCIPAL CITIES
QUICK DELIVERY FROM DISTRIBUTOR'S STOCKS



REGULATED POWER SUPPLY

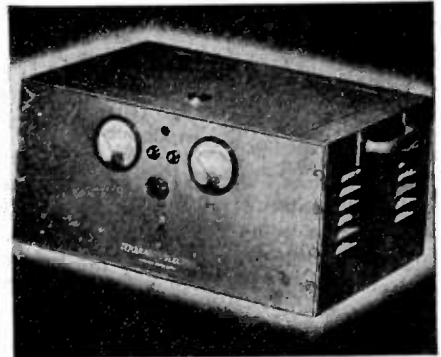

THIS power-supply unit is used in electronic research and development laboratories for amplifiers, television pulse generators, constant-frequency oscillators, high-speed electronic counting devices—wherever moderate amounts of d-c power are required within the voltage range of from 250 to 450 volts.

Designed in the famous G-E laboratories, this is only one of the new General Electric line of **ELECTRONIC MEASURING INSTRUMENTS**. A wide choice of compact apparatus for service maintenance and research include: G-E unimeters, capacitometers, audio oscillators, wide band oscilloscopes, square wave generators, signal generators, and other units for measuring electronic circuits and checking component parts.

• We invite your inquiry for G-E electronic measuring equipment made to meet your specific requirements.

FREE CATALOG



**ELECTRONICS DEPARTMENT
GENERAL ELECTRIC CO.
Schenectady, N. Y.**

Please send, without obligation to me, the General Electric Measuring Instrument Catalog, P-4 (1000-leaf), for my information and files.

Name _____
Company _____
Address _____

GENERAL ELECTRIC
177-CAA
Electronic Measuring Instruments

CETRON RECTIFIER CE 872-A*

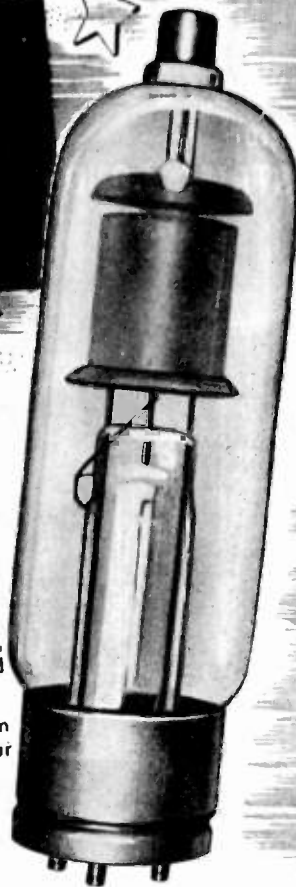

- Continental, one of the pioneers in the electronic tube industry, produces a wide range of Power Rectifiers, grid control tubes (Thyratrons), Phototubes and other special electronic tubes.
- Long before the war, their high quality and thorough dependability had earned for them national recognition and acceptance by many of the country's leading companies. From raw materials to the finished tube, we tolerate only the best of materials, rigidly controlled processes, close inspections and exacting final tests.
- Have you a tube problem? If so, perhaps we can help you as we have helped many others. Your inquiry is invited—No obligation incurred.

* An outstanding tube in the famous CETRON line

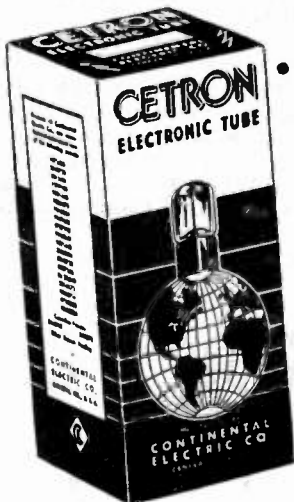

COMPLETE!

We produce a wide line of
RECTIFIERS, PHOTOTUBES
AND ELECTRONIC TUBES

Write for catalog
giving complete details.

● Continental's CE 872A is designed to meet rigid Army and Navy specifications. It incorporates numerous improvements in design and processes which insure EFFICIENCY... RUGGEDNESS... LONG LIFE.

● Detailed specifications are given in Bulletin 117-A which will be sent on request. We are able to make prompt delivery on satisfactorily rated orders.

CONTINENTAL ELECTRIC COMPANY

CHICAGO OFFICE
903 MERCHANDISE MART

GENEVA, ILL.

NEW YORK OFFICE
265 W. 14th ST

No "Victory" Models from the Radio Industry

By

PAUL V. GALVIN, President
of Galvin Mfg. Corp.
President of Radio Manu-
facturers' Association
(An address before the
National Retail Furniture
Association, Chicago.)

Radio is a very broad subject to cover briefly. In fact, radio has become so broad in these war days, that the word "radio" itself no longer encompasses the field; and thus we hear and read a lot about "electronics."

The radio industry is giving attention to post-war problems. Many studies are in progress in Committees and Panels for the purpose of exploring the technical and merchandising considerations so as to give the public the radio merchandise they will desire. Though I am the president of the Radio Manufacturers' Association, the national association of the radio industry, I would like to qualify to you that anything that I might say here as to views or predictions are my own personal slants, and they in no way represent any position or any resolution of the Association.

Radio was an important element in our social and economic set-up before the war. Radio in the post-war period, with the added innovation of television, will be even more important. Any home without a radio is really out of touch with the world. The influence of radio in the post-war period will increase. Today, during war time, radio is a much more important factor, both on the home front and the war front than it has ever been. We have war news at our finger tips by the turn of a dial or the press of a button—happenings in Europe or the Pacific are known to us almost instantly after they happen. Consequently, we are kept currently up to date almost play-by-play. For diversion we also have the radio for relaxing entertainment during these fast moving days.

For you to get a clearer picture of radio in the post-war period, it is important that you know what radio is doing during the war period. On the war front, radio is many-sided. Many of the developments of the past few years and those that are coming to light from day to day with breathtaking pace are—of war-time necessity—classified as "military secrets". Some day, at the right time we shall be permitted to speak more freely of these achievements. At this time you will proudly learn that some of the most important "secret weapons" of the war were radio devices. You will have to wait for the post-war period to learn more about these accomplishments, but when you do you will be very proud of the radio industry and its contribution to victory.

On the war front, radio is today the most important means of communication, from the central staff headquarters down to the smallest unit in the Army, Navy and Air Corps. Every airplane, every tank, every artillery and infantry group, every

(Continued on page 58A)

Proceedings of the I.R.E. April, 1944



THIS GUARD'S BACK IS *Never* TURNED

The Browning Signal System for plant protection effectively covers every inch of a given "beat" by means of a balanced-capacitance, electronic circuit. Proved in service before Pearl Harbor, it obviates human failure, releases guards for needed man-power.

Browning Frequency Meters pre-check radio transmitters, help assure communications clarity and dependability. Long have been standard equipment for police, fire, public utility and similar emergency radio systems. Meet FCC requirements.

Illustrated Literature Upon Request



BROWNING
LABORATORIES, INCORPORATED
WINCHESTER, MASSACHUSETTS

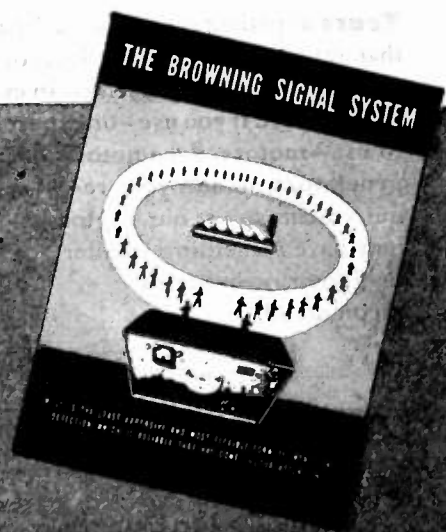



SPADEWORK

Far in advance of today's production schedules and in anticipation of tomorrow's needs, EICOR engineers are preparing to meet the inevitable demand for rotary electrical equipment designed for new applications. During recent years their store of knowledge has been used to direct our activities and those of others in the manufacture of more and better motors and dynamotors for war service. The breadth of experience gained in this effort fits them, and our entire organization, for an important future in this field

An exceptional range of designs and frame sizes facilitates the development of equipment to meet your exact specifications—from tiny direct current motors to dynamotors and generators for every conceivable output or purpose. Our facilities are equally adaptable to the engineering of a single experimental unit or to production runs.

Years of patient research, the "spadework" that improves existing products or creates new designs, are represented in every EICOR part. If you use—or expect to use—motors, dynamotors, or generators, submit your requirements to us; our engineers may have something smaller or lighter or better to recommend.

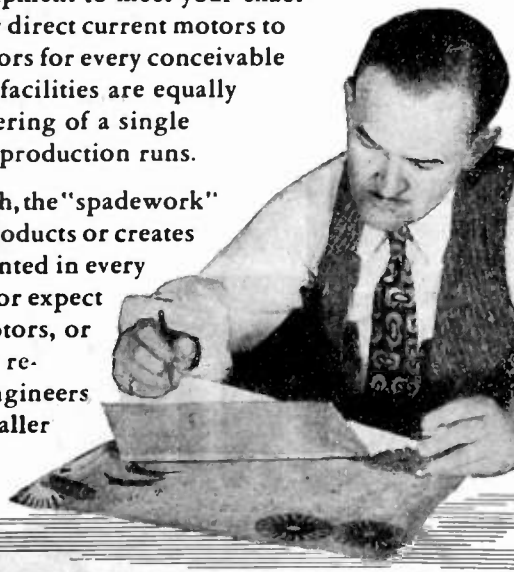

EICOR INC. 1501 W. Congress St., Chicago, U. S. A.
 DYNAMOTORS • D. C. MOTORS • POWER PLANTS • CONVERTERS
 Export: Ad Auriema, 89 Broad St., New York, U. S. A. Cable: Auriema, New York

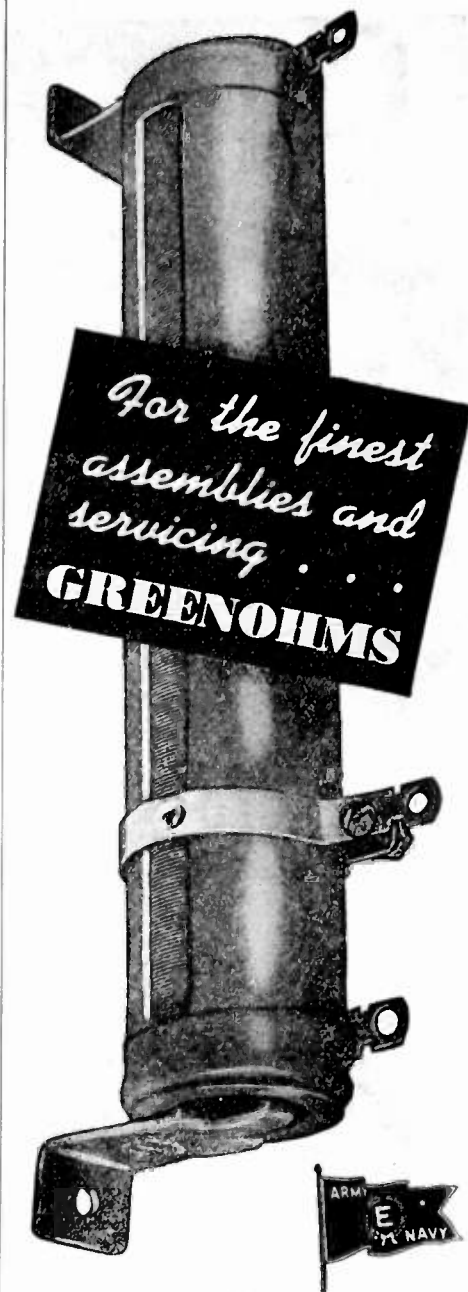

★ They can take an awful beating, those Clarostat Greenohms (green-colored cement-coated power resistors) now found in communications transmitters, aircraft and police radio, high-grade instruments, electronic assemblies, and in many industrial applications. Even when seriously overloaded—red hot—they won't burn out, flake, peel, crack. Just remember, Clarostat Greenohms can take it—and then some—when you specify power resistors.

★ **Consult Us . . .**



CLAROSTAT MFG. CO., Inc. • 285-7 N. 6th St., Brooklyn, N. Y.

Proceedings of the I.R.E. April, 1944

**"Here's the only
CONTINUOUSLY ADJUSTABLE
COMPOSITION TYPE RESISTOR**

**having a rating
of 2 watts with
a good safety
factor"**

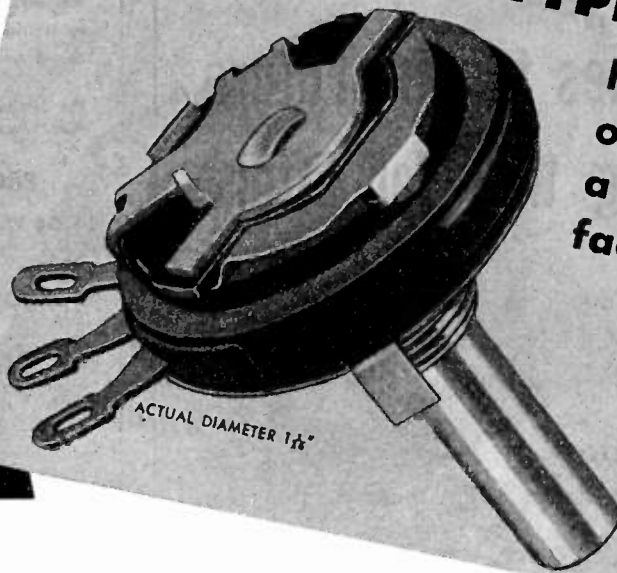

A low resistance carbon brush makes a smooth contact with the resistor and assures long life and quiet operation.



Cross section of Bradleyometer showing how terminals are imbedded in solid, molded resistor. (Actual size.)



Type JS Bradleyometer with positive contact shielded line switch.



Bradleyometers may be used separately, or assembled in dual . . .



. . . or triple construction to fit any control need. Available for rheostat or potentiometer applications.

This is the Allen-Bradley Type J Bradleyometer in which the resistor element has substantial thickness . . . approximately 1/32-inch. In this respect it differs radically from the thin film, paint, or spray type variable resistors. The resistor material, insulation, terminals, face plate, and threaded bushing are molded into a single unit. In the process of manufacture, the resistor material can be varied to produce practically any form of resistance-rotation curve. Once the Bradleyometer has been molded, the toughest war service cannot alter its performance. It is the only composition type variable resistor that will consistently stand up under the Army-Navy AN-QQ-S91 salt spray test. Enclosure is sealed, dust-proof, and splash-proof.

Bradleyometers have high rating and high current carrying capacity. They have no rivets, no soldered or welded connections, and no conducting paints in the electrical circuits. Their simple construction and few parts make them positively reliable and trouble-free.

Allen-Bradley Co., 114 W. Greenfield Ave., Milwaukee 4, Wis.



Actual size 1-watt and 1/2-watt insulated Bradleyunit fixed resistors.



ALLEN-BRADLEY
FIXED & VARIABLE RADIO RESISTORS

QUALITY

Engineers and Technical Men

Real Opportunities for the Future While Promoting the War Effort

Here are positions, not for the duration only, but offering excellent opportunity for permanent advancement with a successful and growing organization for those particularly skilled in the latest electronic techniques.

Gilfillan Bros. Inc. of Los Angeles offers these positions for qualified men:

Electronic and radio engineers (both transmitters and receivers) to design electronic and navigational equipment.

Mechanical Engineering graduates with five to ten years' experience in design and layout of light mechanical devices plus shop experience or equivalent.

Men of engineering grade for extensive electronic production and field test operations.

Technical men with ability to write technical material for instruction books and to handle complicated parts lists.

These positions are in essential war work and availability certificates are required.

Write stating qualifications, experience and personal data.

Important—Interviews for successful applicants will be conveniently arranged.

In Reply—Refer to: R110-CFW

GILFILLAN BROS., INC.
1815 VENICE BLVD. LOS ANGELES 6, CALIFORNIA



The following positions of interest to I.R.E. members have been reported as open. Apply in writing, addressing reply to company mentioned or to Box No.

The Institute reserves the right to refuse any announcement without giving a reason for the refusal.

PROCEEDINGS of the I.R.E.

330 West 42nd Street, New York 18, N.Y.

COMMUNICATION-EQUIPMENT ENGINEER

To design electronic devices, transformers, filters, etc.—mostly audio frequency. Working knowledge of trigonometry and LC circuits necessary. Also, some experience on communications equipment or mechanical manufacturing. Salary open. Draft exempt or deferable by reason of education or experience. Excellent post-war prospects. USES referral card required. Write to Audio Development Company, 2833 13th Ave. S., Minneapolis, Minn.

RADIO ENGINEER—CANADIAN

Must be able to assume full responsibility for design and development of military and post-war radio-communication equipment in a large organization situated in Ontario.

Applicant, if now resident of Canada, must be available under Order in Council PC 246 Technical Personnel Regulations. Address reply to Box 319.

ELECTRICAL ENGINEERS

Graduate electrical engineers or men with equivalent industrial experience, needed for the development and design of pocket-size radio and audio-frequency equipment. Especially interested in qualified engineers looking to post-war period who, at present, are not being used in their highest skill or capacity. Company is well established in electronic field and located in suburb of a large New England city. Reply to Box 320.

INSTRUCTORS FOR ADVANCED ARMY-NAVY PROJECT

Prominent New England technical institute requires instructors for officer-training project, in modern electronics and applications of ultra high-frequency radio. Exceptional opportunity to acquire advanced knowledge and serve in important war effort. Men having various degrees in electrical engineering, physics, or communications—or long experience in radio engineering—and interested or qualified as teachers, are needed. Salary adjusted to qualifications and experience. Applicants must be U. S. citizens of unimpeachable reputation. Inquiries will be treated as confidential. Please send personal history and small photograph to Box 321.

ELECTRICAL ENGINEERS

Electrical engineers needed with experience in the transformer or rotary-equipment field, either in design, technical, or production work. Company manufactures the smaller types of transformers.

Starting salary range will be between \$4,000 and \$6,000 per year. Write to Box 322.

ELECTRONIC-DESIGN ENGINEERS AND ELECTRICAL DESIGNERS

For complex equipment similar to radio transmission apparatus. High priority war work.

(Continued on page 52A)

Proceedings of the I.R.E. April, 1944

Voice communications on every front...

Whether by radio or land wire telephone, a voice command gets the job done with clarity and speed.



Available from stock, 1700U series microphone. Single button carbon type, push-to-talk switch, etc. For trainers, inter-communication and general transmitter service.

UNIVERSAL microphones are playing a vital part in voice communications of all the Armed Forces . . . being the first instrument through which a command is given. Care must be taken that the electronic patterns of the voice are held true for the many electrical circuits through which they must later pass. UNIVERSAL microphones with their precise workmanship are carrying the message through in all forms of voice communication whether from a tank, ship or aeroplane. UNIVERSAL products meet all U. S. Army Signal Corps Laboratory tests. Standardization of parts, inspection, and workmanship of high order combined with the best of material, make UNIVERSAL'S microphones and accessories outstanding in every application.

U. S. Army Signal Corps and U. S. Navy plugs and jacks are offered as voice communication components to manufacturers of transmitters and sound equipment for the Armed Forces. Catalog No. 830 contains complete details.



UNIVERSAL MICROPHONE CO. LTD.

INGLEWOOD, CALIFORNIA

FOREIGN DIVISION, 301 CLAY ST., SAN FRANCISCO 11, CALIF. • CANADIAN DIVISION, 560 KING ST. W., TORONTO 2, ONTARIO

ENGINEERING OPENING

Project Supervisor

Permanent position with an established concern manufacturing communications equipment.

Prefer top-notch man with UHF experience who can take charge of development or design project.

Salary commensurate with ability.

Additional compensation for assignment of patents to company.

Pleasant working conditions.

W.M.C. rules observed.

Address

DALE POLLACK
Engineering Director
**TEMPLETONE RADIO
COMPANY**
Makers of Temple Radios
MYSTIC, CONN.



(Continued from page 50-A)

Must have had all technical training required for bachelors degree in engineering or physics. Two openings demand three or more years responsible research or commercial experience.

Salary open, 48-hour week. Apply, Personnel Office, Radiation Laboratory, University of California, Berkeley, California.

RADIO ENGINEERS, INSPECTORS, AND DRAFTSMEN

Engineering department of manufacturer, while continuing its war program, is expanding to meet requirements for postwar product development. Well established as a radio-coil and trimmer-condenser manufacturer. Interested in stable men who have an eye to the future. Address reply to Automatic Winding Company, Inc., 900 Passaic Ave., East Newark, N.J.

RADIO ENGINEERS

Radio engineers wanted with at least two years design and development experience with radio communications-equipment manufacturer on items subsequently satisfactorily produced in quantity. Knowledge and experience in two-way mobile equipment, low-power transmitters, receivers, and controlled equipment essential. Permanent position, West Coast manufacturer. Will pay expenses to coast for interview if qualifications satisfactory. Write giving complete past experience, employment record, salary received, and technical references to Box 323.

RADIO ENGINEER

An opportunity with an established firm now engaged in the war effort, for a radio engineer having experience in the design and development of audio amplifiers, carrier-current systems, radio receivers, etc. Ideal working conditions

in a well equipped laboratory. Write to Box 324.

SALES REPRESENTATIVE

A high-grade man, who knows the electronic field, particularly design and component parts, is wanted for sales work. Position offers good opportunity. Applicants must be energetic and ambitious with ability and vision and submit evidence that past record is above reproach. Will pay salary or commission or combination of both. Give full details of education, experience, previous earnings, personal history, etc. Send reply to Box 325.

RADIO AND ELECTRONICS ENGINEERS

Engineers with the ability and experience required to design and develop radio and electronic equipment.

The men who qualify will become permanent members of engineering staff, and will participate in the post-war program of a progressive and well-established company. This firm has excellent laboratory facilities, and is one of the leaders in its field.

All inquiries will be kept confidential. Send all details of experience, etc. with reply to Box 326.

ELECTRO-MECHANICAL ENGINEER

Electro-mechanical engineer with standing, ability, and experience wanted for permanent position. Company, in business for over sixty years, is now engaged in the preparation of a substantial post-war program. All inquiries will be kept confidential. Company offices located in Manhattan, New York, and factory located in Brooklyn, N.Y. Reply to Box 327 and state experience, age, and compensation required.

TEST EQUIPMENT ENGINEER

To design, build and maintain electronic test boards and equipment; for electrical manufacturer. Right man can advance to process or product engineer with post-war possibilities. Long established Chicago manufacturer. Give details. Statement of availability required. Address Box No. 314.

PRODUCT ENGINEER

With general background of education and experience to assist in development and improvement of new and old products such as automatic record changers, recorders, pick-ups, switches, timers and relays. Combination of mechanical and electrical designing ability necessary. Good future for qualified man, Chicago manufacturer. Give details. Statement of availability required. Address Box No. 315.

ENGINEERS, PHYSICISTS, DRAFTSMEN

Opportunities with growing organization doing both war and essential civilian production. Recent graduates with adequate training will be considered for these positions:

Electrical Engineers and Physicists for research and development work on vacuum tubes, circuits, electroacoustic devices and related measuring equipment.

Design Engineers and Draftsmen for design and production work on communication equipment.

Certificate of availability required. Write to Director of Research, Sonotone Corporation, Elmsford, New York.

RADIO ENGINEERS

Radio Engineer for installation, maintenance and servicing essential electronic equipment in United States and abroad. Electrical background and practical radio experience required. Age 28-40. Salary \$3,600 up, plus living expenses. Wire or write for application forms to Westinghouse Electric & Manufacturing Company, Radio Division, 2519 Wilkens Avenue, Baltimore 23, Maryland.

RADIO ENGINEERS

Graduate engineers with laboratory experience needed for research and development work. Permanent employment with progressive corporation located in small city in central Pennsylvania.

(Continued on page 54A)

ENGINEERS

PHYSICISTS

RADIO ENGINEERS

ELECTRONICS ENGINEERS

PHYSICISTS

A non-profit research laboratory engaged in urgent war research must increase its scientific staff. MEN OR WOMEN (COLLEGE GRADUATES), with experience in vacuum tube circuit design, construction of aircraft radio equipment and design of small electro-mechanical devices are needed.

Salaries range from \$3,000 to \$8,000, depending upon experience, ability, education and past earnings. Release statement and USES consent needed.

Apply by mail

AIRBORNE INSTRUMENTS LABORATORY

COLUMBIA UNIVERSITY

DIVISION OF WAR RESEARCH

BOX 231, MINEOLA, N.Y.



ART AND SCIENCE...BOTH



Little wonder that tube making is often referred to as an *art*. For much of the work is by hand. To fashion these complex assemblies of filaments, grids, plates and wires; to position the parts within such close space limitations—parts, mind you, that often are so fragile, flimsy and elusive, *tweezers* are required to handle them—calls for a high degree of skill, a steady hand and an eye for accuracy. Art is right!

Yet, today, guiding every move of every N. U. production worker's hands is the "know how" of many scientists and engineers. Here are

chemists, physicists, metallurgists, and men high in the sciences of electronics and mechanics—all teamed up in a scientific tube development and production program recognized as a model throughout this industry.

It takes a lot of *both* science and art to make the advanced-design, high performance N. U. tubes now being produced for combat service. It is such superior tubes that will do your electronic jobs better, after the war. *Count on National Union.*

NATIONAL UNION RADIO CORPORATION, NEWARK, N. J.
Factories: Newark and Maplewood, N. J., Lansdale and Robersonia, Pa.



NATIONAL UNION RADIO AND ELECTRONIC TUBES

Transmitting, Cathode Ray, Receiving, Special Purpose Tubes • Condensers • Volume Controls • Photo Electric Cells • Panel Lamps • Flashlight Bulbs

CML SERVES THE ELECTRONIC INDUSTRY

Designed to meet the most rigorous specifications for precision, every CML unit is equipment of accredited performance.

1

ROTOBRIDGE . . . This automatic inspector checks for proper wiring, correct resistance, capacity and inductance values in all types of electronic equipment.

2

MODEL 1100, MODEL 1110 . . . Voltage regulated power supply units; with extremely low noise level and excellent regulation.

3

MODEL 1420 GENERATOR . . . Furnishes test power over a wide frequency range; may also be employed in 3-phase circuits.

4

MODEL 1200 STROBOSCOPE . . . Stops motion within range of 600 to 600,000 R.P.M.

WRITE FOR DESCRIPTIVE BULLETINS

COMMUNICATION MEASUREMENTS LABORATORY

1720 GREENWICH ST., NEW YORK 6, N. Y.

WIDE RANGE VACUUM TUBE VOLTMETERS



- High input impedance for both AC and DC measurements.
- Convenient, low capacity "Probe" especially adapted to high frequency radio use—100 megacycles and over.
- Self-regulating operation from power line; no batteries.
- Multiple voltage ranges — accurate and stable.

BULLETIN ON REQUEST

ALFRED W. BARBER LABORATORIES

34-04 Francis Lewis Blvd. Flushing, N.Y.



(Continued from page 52A)

Persons now employed at essential activities at their highest skill cannot be considered without a statement of availability. Write for application form to Airplane & Marine Instruments, Inc., Clearfield, Pennsylvania.

RADIO AND ELECTRONICS ENGINEERS

We are seeking the services of one or two trained engineers who have had ample experience in transmitting-tube engineering. The men selected will not only be concerned with current war production, but should eventually fill good positions in postwar operation.

Also, we are looking for a few young engineers with good schooling and background to be trained for transmitting-tube development and production.

This is an excellent opportunity for men who qualify to connect with a progressive, highly regarded manufacturer of transmitting tubes. Many special benefits will be enjoyed in your association with this company.

Please reply in writing, giving complete details, past experience, etc. Interviews will be promptly arranged. Persons in war work or essential activity not considered without statement of availability. Address, Chief Engineer, United Electronics Company, 42 Spring Street, Newark 2, New Jersey.

ELECTRONIC OR AMPLIFIER ENGINEERS

A well-known company is in need of engineers experienced in the design and use of electronic equipment, particularly audio and control amplifiers.

Also, laboratory assistants and junior engineers, who are experienced in testing and laboratory work on electronic apparatus.

Send complete details to Post Office Box 30, Bloomfield, New Jersey.

ENGINEERS AND DRAFTSMEN

EXECUTIVE ENGINEER: Graduate electrical engineer with 15 years' experience in radio research and development, associated with the manufacturing of radio equipment.

DESIGN DRAFTSMEN: Experience in radio communications equipment drafting, as assistant, associate or draftsman.

ENGINEERING ASSISTANTS: May be radio engineers with about five years' experience, preferably in the manufacturing of radio equipment.

Positions offer post-war opportunities. Salaries open. Location, Connecticut. Send full details to Box 312.

ELECTRONIC ENGINEER

or electrical engineer with high frequency experience, preferably with some background in mechanical engineering. Position with well established company of known reputation in the Middle-West with post-war possibilities in the manufacture of industrial electronic equipment. State education, experience, salary expected, marital and draft status. Write Box 313.

LOUD SPEAKER ENGINEER

A medium-size manufacturing organization, with a concrete financial foundation, requires an engineer experienced in loud-speaker design and acoustics, plus knowledge audio-amplifier design and construction.

This company has been successful in manufacturing identical prewar equipment now being produced for the war effort, and shall continue without interruption upon the resumption of post-war activities. Laboratory and plant located in Brooklyn, N.Y.

If interested in a permanent position with an excellent future, write to Box 318 and include full details.

The foregoing positions of interest to I.R.E. members have been reported as open. Apply in writing, addressing reply to company mentioned or to Box No.

Attention radio instructors

The 2 new workbooks

Shop Job Sheets in Radio

By Robert N. Auble

Supervisor of Signal Corps
Radio School, Indianapolis

provide the practical step-by-step training required for Signal Corps and Communications work.

These two manuals on the electrical fundamentals and on the basic components of radio give the student thorough training in the application of radio principles under operating conditions. Each is abundantly illustrated.

The price of each is \$1.60

Write to our College Department
for examination copies.

The Macmillan Co., 60 5th Ave., New York 11

RADIO ENGINEERS WANTED!

For laboratory design and development work we are interested in radio engineers with a college degree in communication engineering or physics or with the equivalent in radio design experience. We wish to add to our staff competent engineers for work on war products now and later to participate in our post-war development program.

Write, giving full details as to education, age, experience, family and draft status and salary desired.

If you are now engaged in essential industry at your highest skill please do not apply. We will welcome correspondence from honorably discharged service men who can qualify as radio engineers. Applicants living outside the Chicago area must obtain a "Statement of Availability" from their nearest U. S. Employment Service office.

MAJESTIC RADIO & TELEVISION CORPORATION

2600 WEST 50TH STREET
CHICAGO 32, ILLINOIS

REPUTATION for RESULTS

Yes, men who devote their own money and spare-time toward improving their technical ability through CREI training, are an asset to any technical organization.

In our entire 17 years the CREI home study courses have been written and planned exclusively for the professional radioman to enable him to improve his technical ability and to be in a position to assume added technical duties.

The remarkable achievements made by CREI men throughout the military, government, commercial and manufacturing radio fields are convincing testimony that our efforts, properly confined to this one important course in Practical Radio Engineering, have been of real value to the industry in training better engineers.

Chief engineers fully recognize the need for men with modern technical training, and many welcome regular reports concerning students' progress. (Reports of student's enrollment and progress are made to employers *only* upon the direct request of the student.)

Alert engineers are quick to recognize the value of CREI technical training and the important part it plays in increasing the efficiency of their own personnel. CREI-trained men are the ones to whom added responsibilities and added technical duties can be relegated.

We will be glad to send our free descriptive booklet and complete details to you, or to any interested radioman.



CAPITOL RADIO ENGINEERING INSTITUTE

Home Study Courses in Practical Radio-Electronics
Engineering for Professional Self-Improvement

Dept. PR 3224—16th Street, N.W.
WASHINGTON 10, D.C.

Contractors to the U. S. Navy, U. S. Coast Guard
and Canadian Broadcasting Corp.

Producers of Well-trained Technical Radiomen
for Industry

If We Were To Design a Transformer For You . . .



. . . our first objective would be to create a unit that would serve you in a completely satisfactory way. It would therefore be important that you provide us with as much detailed information as possible.

For an Audio Transformer this data would include — impedance ratio, primary and secondary load impedances, value of direct current involved in any windings, operating voltages and frequency range with degree of uniformity over entire range. In some instances it might be necessary to specify phase angle, accurate impedance in one direction or the other, perhaps insertion loss, size and type of mounting. To aid in supplying the information, especially for units approaching the limits of practicability, it would be helpful to send us a statement or sketch outlining the actual operating conditions. In designing Power Transformers or Inductors, it would be important to have similarly complete data.

In endeavoring to secure optimum transformer performance, ADC takes all of these involved factors into consideration before a single unit is approved for production.

New ADC Catalog Available!

Our new Catalog covering the specialized line of ADC Transformers, Filters, Equalizers, Key Switches, Jacks, Plugs and other electronic components is now ready. Write for ADC Catalog No. 11.



Audio Development Co.
2833 13th Ave. S., Minneapolis, Minn.

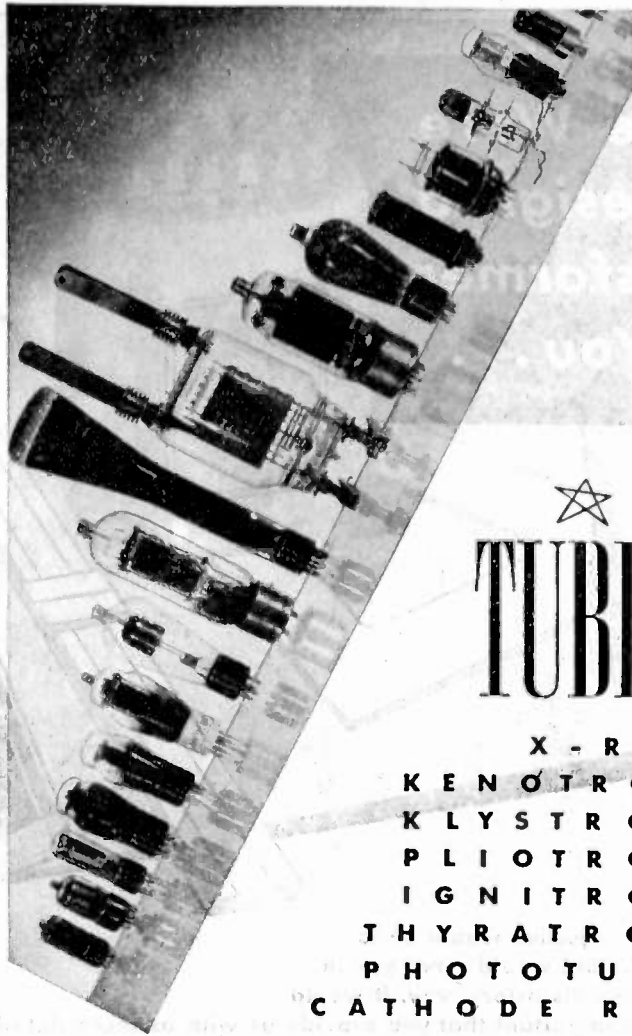

★
TUBES

X - R A Y
K E N O T R O N
K L Y S T R O N
P L I O T R O N
I G N I T R O N
T H Y R A T R O N
P H O T O T U B E
C A T H O D E R A Y

Every Type Ready for FAST Deliveries

THE surface has scarcely been scratched in developing industrial applications for electronic tubes! Yet, today's war plants are using vast quantities of new and replacement tubes . . . most of which perform vital functions in connection with heating, measurement, test, power, control, inspection and special research. Radio Group . . . comprising the three distributors below . . . have perfected a unique NATIONAL INDUSTRIAL EMERGENCY SERVICE by which Electronic TUBES and Supplies of every description are made available with speed heretofore considered impossible. Special stocks and technical staffs are constantly ready to render this speedy service, everywhere. Send along your orders or write on company stationery for free reference book and buyer's guide.

WRITE OR PHONE YOUR NEAREST DISTRIBUTOR

TERMINAL RADIO CORP.

85 Cortlandt St., Phone WOrth 2-4416 NEW YORK 7

WALKER-JIMIESON, INC.

311 S. Western Ave., Phone Canal 2525 CHICAGO 12

RADIO SPECIALTIES CO.

20th & Figueroa, Phone Prospect 7271 LOS ANGELES 7

NATIONAL INDUSTRIAL EMERGENCY SERVICE

NEW IMPROVED

"T"-PAD

ATTENUATORS
BY TECH LAB

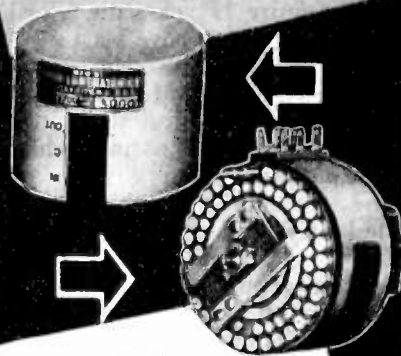

- Stainless Silver Alloy contacts and wiper arms.
- Rotor hub pinned to shaft prevents unauthorized tampering and keeps wiper arms in perfect adjustment.
- Can be furnished in any practical impedance and db. loss per step upon request.
- Write for our Bulletin No. 431.

TECH LAB MICROHMMETER



Direct and instantaneous resistance readings down to 5 microhms and up to 1,000,000 megohms. Write for Bulletin No. 432.



9 LINCOLN STREET
JERSEY CITY 7, N. J.

New *Littelfuse* Protection



Advances include electric welding of side terminals

Cutaway of Littelfuse Extractor Post No. 1075 exemplifies new construction with side terminals electrically welded.



Littelfuse EXTRACTOR POSTS

Better conductivity and strength for maximum resistance to heat and severe vibration insured by electric welding, making terminals integral with inside of shell. Strong body molded black bakelite for insulation, and prevention of corrosion and shorts, positive Fuse Grip permitting full visual shock-proof inspection, knob that pulls and holds fuse, Special Grip preventing fuse from dropping out are other Littelfuse factors.

EXTRACTOR POSTS FOR WIDEST RANGE OF MOUNTINGS

Illustrated at top No. 1075 for 3 A G fuses for radio and other currents. Screw-driver operated (Underwriters' spec.); also finger-operated. No. 1087 similar type for 8 AG fuses. Aircraft Littelfuse types at right.

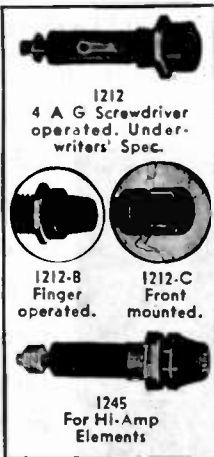

Send for B/P and Engineering Data
Ask for samples for your applications.
Write

LITTELFUSE Inc.

263 Ong St., El Monte, California
4793 Ravenswood Ave., Chicago 40, Ill.



It's an act of bravery to possess a radio receiver in any country occupied by the Nazi or the Jap today. It's an act of heroism to operate a transmitter.

What could prove more convincingly the total value of radio than the frantic haste with which it is silenced or controlled by the Totalitarian? Or its use by the Free Peoples in directing their offensives . . . and in keeping their will for victory living and single-purposed?

Some day, the experiences Jackson has been having in developing and supplying electrical testing equipment to our armed forces will be reflected in finer products for you.

In the meantime thousands of pre-war Jackson Instruments are still performing to keep 'em listening on the home front. The dependability this represents is but another benefit of the "hidden" plus of *all* Jackson Instruments . . . INTEGRITY OF DESIGN.

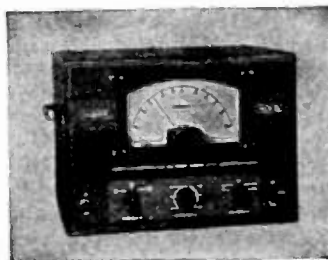

Model 652 Audio Oscillator

If your Jackson Instruments should need calibration, checking, or parts replacement, write to the factory. Maintaining products bearing the Jackson trade mark is a responsibility that we will fulfill as promptly as possible under wartime conditions.

Buy War Bonds and Stamps Today!

JACKSON

Fine Electrical Testing Instruments

JACKSON ELECTRICAL INSTRUMENT COMPANY, DAYTON, OHIO



FLEXIBILITY OF CIRCUITS
one of seven special features described
IN THIS NEW BOOKLET

Communication Products Company describes in this new booklet the many features of these exceptional switches—developed after careful research and a thorough testing of their performance in the laboratory.

The use of pure silver in the construction of STERLING SWITCHES makes unnecessary the high spring pressures ordinarily required to cut the insulating oxides formed on the base metal contacts commonly used on this type of switch. The reduction in friction thus effected provides great ease of operation in multiple-section assemblies. Careful planning of contact arrangement assures maximum voltage flash-over between all parts of the switch and frame.

Described and illustrated in detail is the careful design which gives to STERLING SWITCHES a maximum of strength and rigidity with a minimum of weight. Illustrated also is the unusual flexibility in circuit design which is possible with STERLING SWITCHES.

Send for your copy of this informative booklet today.

Other C. P. products available to the communications industry are: a radiation-free line of copper or aluminum Coaxial Transmission Line, Auto-Dry-aire for dehydrating transmission lines, Antennas and Radiating Systems, Q-Max A-27 Radio Frequency Lacquer.

Communication
PRODUCTS COMPANY, INC.
 744 BROAD ST., NEWARK, N. J.
 Factory: 346 Bergen Ave.,
 Jersey City, N. J.

Communication Products Company, Inc.
 744 Broad Street,
 Newark, New Jersey

Send: STERLING SWITCH Booklet

Data on _____

Name _____

Company _____

Address _____

No "Victory" Models

(Continued from page 16A)

naval and merchant marine vessel, no matter how large or how small, is equipped with two-way radio communication apparatus. If you were able to comprehend all the countless little segments of military units and organizations equipped with radio apparatus, you would further have a realization of the gigantic job that is being done by the American radio industry in providing this apparatus, not only in sufficient quantity, but the finest military electronic apparatus in use in the world.

With all that we read and hear about electronics and the fantastic predictions that pop up here and there, I can well see where a merchant interested in radio as part of his post-war merchandising program could become quite confused. There are some things I think you should like to know and have cleared up. I shall attempt to sort out those things of greatest interest to you. What is going to come out of this so-called "electronic war activity"? We hear about the revolutionary "this and that"—so let's analyze the electronic picture very broadly. It quickly breaks down into two groupings; one, communications—the other "special service apparatus." The unusual developments, in the main, have been in the "special service apparatus" classification. The new and startling elements that will be utilized and applied after the war will be primarily for industrial and commercial usage—with the exception of some findings which will apply to advanced and refined development in television.

The developments in the communication classification will have a more direct application to radio as you are interested in it—that is, radio for the home. The improvements in war time radio communication will result in a greatly improved home radio for the future. This applies primarily to circuit and tube developments. Exterior design developments will be the result of the imagination of the designers, who are even now busily engaged in cooking up a wide variety of new radio cabinet designs. From our war-time scientific and design activities we shall draw a wealth of material from which we will build finer radios for many years to come.

Thus, as you look at the electronic effort of the war, you can eliminate from your plans everything except radio broadcast receivers, both FM and AM, phonograph combination and television. Forget all of the rest of the art of electronics that pertains to industry application, aviation and navigation. Postwar merchandise is not going to be fantastic, and it is not going to be 1942 models. There will be new radio models, improved over anything available before the war.

From the first release, upon resumption of civilian radio manufacture, we will get broadcast receivers, both the AM and FM type. There will be no Victory models. Each manufacturer will have his own designs. We may possibly get phonograph combinations on the first release. Phonograph combinations will depend upon how soon we will resume production and upon the material situation at that time.

(Continued on page 60A)

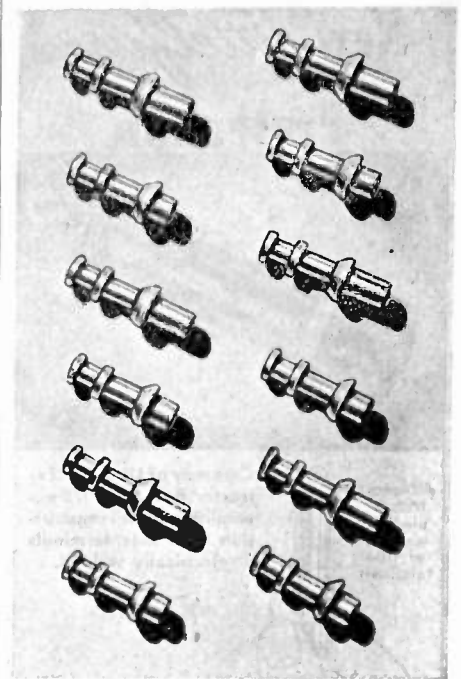

TURRET LUGS

To Meet YOUR
Board Thicknesses

Just tell us the thickness of the terminal boards on which you wish to use them, and in short order these fine, precision made Turret Lugs will be on their way to you.

You'll like these Lugs, Just slip 'em into the hole, swage 'em and you have good firm Turret Ter-

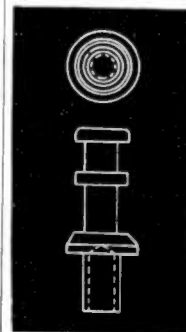

minals that are convenient for soldering and that make lasting, dependable contacts. Order them by mail, phone or wire from

CAMBRIDGE THERMIONIC CORPORATION
 447 CONCORD AVENUE
 CAMBRIDGE 38, MASSACHUSETTS



Proceedings of the I.R.E. April, 1944

Products of
"MERIT"
 means
Fine Radio Parts

... PARTS manufactured exactly to the most precise specifications.

Long manufacturers of component radio parts, MERIT entered the war program as a complete, co-ordinated manufacturing unit of skilled radio engineers, experienced precision workmen and skilled operators with the most modern equipment.

MERIT quickly established its ability to understand difficult requirements, quote intelligently and produce in quantity to the most exacting specifications.

Transformers—Coils—Reactors—Electrical Windings of All Types for the Radio and Radar Trade and other Electronic Applications.

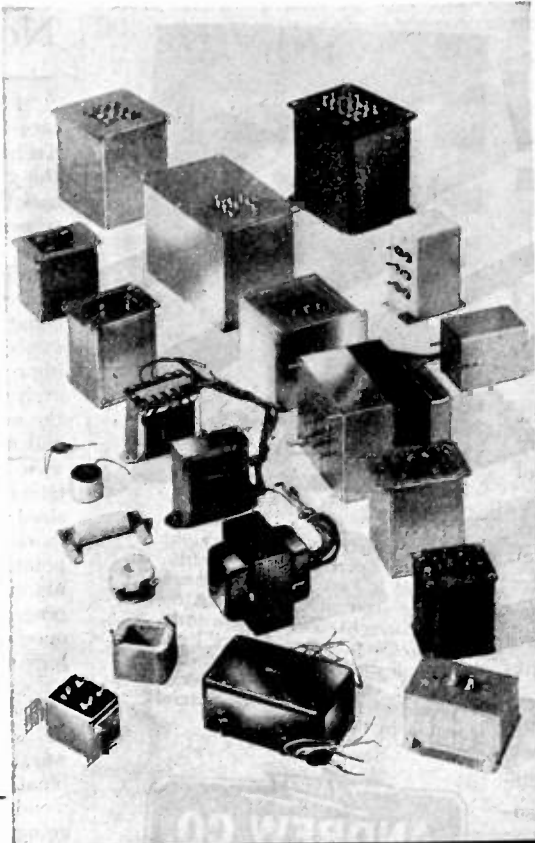

MERIT COIL & TRANSFORMER CORP.
 311 North Desplaines St. CHICAGO 6, ILL.



KEY TO
Laboratory Standards

- Standard Signal Generators
-
- Square Wave Generators
-
- Vacuum Tube Voltmeters
-
- U. H. F. Noisemeters
-
- Pulse Generators
-
- Moisture Meters
-

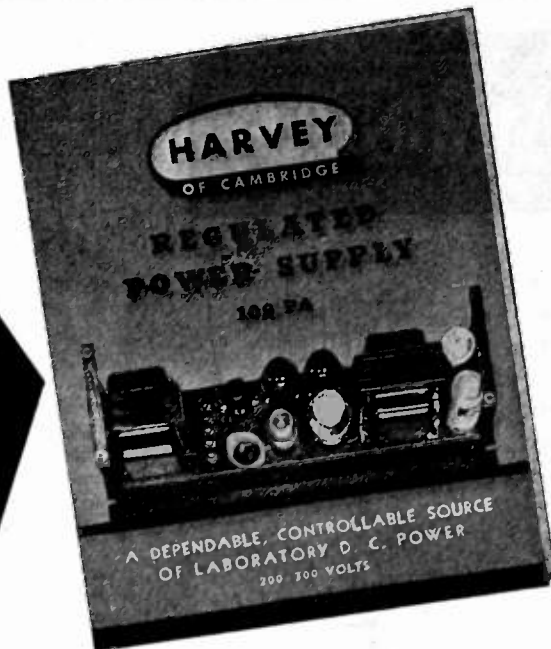

Reading time only two minutes, yet this boiled-down bulletin on the HARVEY Regulated Power Supply gives you all the answers on a dependable source of D.C. power. You'll want it for reference whether or not you have immediate

use for a controlled power supply.

It's yours for the asking. Just jot down your name, position and company address and say, "Send me the bulletin on the HARVEY Regulated Power Supply." Write to



HARVEY RADIO LABORATORIES, INC.

447 CONCORD AVENUE

CAMBRIDGE 38, MASSACHUSETTS

MEASUREMENTS CORPORATION
 BOONTON, NEW JERSEY

X-RAYED!

TO INSURE PERFECT JOINT

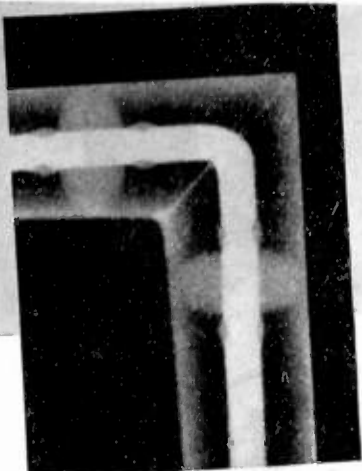

"Photo by G. A. Russ, Claud S. Gordon Co."

Note elimination of junction boxes in right angle bends, designed and engineered by Andrew to meet exacting requirements of this special application.

Inner conductor is bent, not spliced. Outer conductor is mitered and silver soldered. X-ray insures no silver solder penetration into cable, eliminating danger of short circuit. Sealing and pressurizing transmission lines before plating prevents possible corrosion.

For your problems in radio antenna equipment, consult Andrew. The Andrew Co. is a pioneer in the manufacture and engineering of coaxial cables and accessories. Free catalog on request. Write today.

X-ray illustrates Andrew right angle coaxial cable assembly, part of a Fan Marker Beacon Transmitter made for CAA by Farnsworth Television and Radio Corporation. Pilots' lives depend on the 100% reliability of this equipment. Andrew is proud of the use of its coaxial cable in this installation.



363 EAST 75TH ST.
CHICAGO 19, ILLINOIS

COAXIAL CABLES

PERMANENT MAGNETS

THE Arnold Engineering Company is thoroughly experienced in the production of all ALNICO types of permanent magnets including ALNICO V. All magnets are completely manufactured in our own plant under close metallurgical, mechanical and magnetic control.

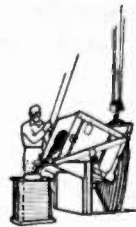
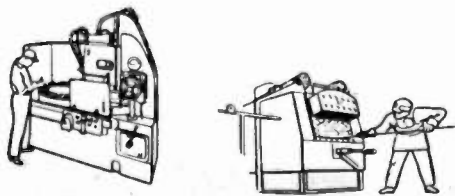

THE ARNOLD ENGINEERING COMPANY

147 EAST ONTARIO STREET, CHICAGO 11, ILLINOIS

No "Victory" Models

(Continued from page 58A)

I believe that there will be no television sets built until after Japan is defeated. Technically, television is here today, but the system standards and frequency allocation problems, as well as the station transmitting problems, relay station problems, and programing problems for commercial television will hold it back. However, when commercial television does come it will move very fast. Technical advances during the war have brought forth improvements that make possible moderately priced television sets which will reach the mass market. Television after the war will not be confined to a little peep-hole view somewhere in front or on top of the television cabinet. Projection of a good-sized picture on the wall will make it much more acceptable from a viewing standpoint. The post-war opportunities in manufacturing, merchandising, advertising, programing, and broadcasting of television open such a tremendously interesting field for American ingenuity and enterprise that we will have a new industry—television—superimposed onto a now already large industry—the radio industry. After the war, the automatic radio-phonograph combination is going to be the source of tremendous activity. The disc record is not going to pass out—the record manufacturers are not sound asleep. The automatic radio-phonograph combination will be within reach of the mass American buying public, and it will be an instrument of very high quality.

This is a thumb-nail picture of post-war radio as I see it. The term "post-war" is somewhat ambiguous because we are not actually going to wait until our entire war effort is completed before we resume the production of civilian sets. We are going to resume production some time after the European phase has been concluded. This period will cover the filling of the pipe lines with very greatly improved models. From there on out, the industry will continue to incorporate its war-time improvements into models which will meet the current radio wants of consumers.

It is well to keep a wide berth open for radio in any post-war merchandising program. With the sustained and ever-growing interest of radio in the home, with millions of radios wearing out every month and no replacements available, with new improvements in future models, with FM as an added feature in broadcasting, with a greatly expanded market in automatic radio-phonograph combinations, with the tremendous popular appeal of television at a price for the mass market, one cannot afford to overlook these splendid opportunities in radio merchandising after the war.

I. R. E. People

(Continued from page 44A)

He received his training at the University of Toledo, followed with B.S. and M.S. degrees from the University of Kentucky and a Ph.D. degree from the University of Michigan. He served as instructor of physics at both the University of Kentucky and the University of Michigan. Mr. Kievit's new headquarters will be at the office of Sylvania Electric Products Inc., 500 Fifth Avenue, New York.

Each day
we build



Since our inception we've been constantly building. Each day we learn something new to add to the worth of our product. Each day we accumulate experience that qualifies us for our present assignments . . . building condensers for equipment to help fight a war.

Upon this foundation, we build plans for the future. We can visualize faintly the postwar world . . . and our constructive part in it. We anticipate the time when Cardwell Condensers will go forward with the progress in electronics, and continue to be, as always, the Standard of Comparison.

CARDWELL CONDENSERS

THE ALLEN D. CARDWELL
MANUFACTURING CORPORATION
81 Prospect Street, Brooklyn 1, N. Y.

SAVE IT . . . CONSERVE IT . . . COLLECT IT—
SCRAP METAL FIGHTS FOR OUR SIDE

Proceedings of the I.R.E. April, 1944

QUICKLY APPLIED LABELS ENABLE YOU TO

Code

WIRES ON ELECTRICAL INSTALLATIONS
EFFICIENTLY, EFFECTIVELY, INEXPENSIVELY

There is an E-Z Code Label for every electrical and electronic assembly; for maintenance and repairs. They speed production, save man hours, reduce costs. Of flexible, durable material, with transparent coating. Ready to apply — no moistening necessary. In standard code numbers or "tailor made" with special symbols or colors for specific requirements. Used by the biggest names in the electrical world.

Send for samples and price list. Give priority, whether under MRO or numbered war contract and whether for assembly or maintenance.

WESTERN LITHOGRAPH COMPANY

600 E. Second St., Los Angeles 54, Calif.
Bayside, L. I., N. Y., Chicago
Kansas City, Mo., Marion, Ohio

E-Z Code LABELS
QUICK — EASY TO APPLY AND READ

SIMPLE AS
A B C

READY TO USE

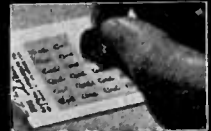

PEEL OFF STRIP



WRAP AROUND WIRE



EACH WIRE CODED

TURQUOISE

*Proved World's Smoothest
Drawing Pencil*

BY GIANT PENDULUM TEST

For a point that fairly glides across the paper . . . for a gritless, even flow of perfect line . . . try an Eagle TURQUOISE. Laboratory tests and drafting room results have long since proved TURQUOISE unrivalled for accuracy of grade, opacity of line, strength of point and durability of lead. Now the Giant Pendulum Test, described below, proves that TURQUOISE is also the world's smoothest drawing pencil.

This gigantic pendulum, with its 540-pound bob swinging freely, makes 49,920 oscillations from a single impulse before coming to rest. When the point of a pencil (A) presses against a sheet of paper (B) on a platen attached to the pendulum shaft, its friction reduces the oscillations to a number that measures the relative smoothness of that point. The smoother the pencil, the longer the pendulum swings; and the extra smoothness of TURQUOISE is accurately registered by the extra oscillations.

YOU CAN TEST TURQUOISE, TOO. We can't ship the pendulum, but we can send a pencil; and TURQUOISE smoothness is so outstanding you can feel it by hand. Write for a test sample, naming this magazine, your dealer and the grade you desire.

**EAGLE Chemi-Sealed
TURQUOISE
DRAWING PENCILS and LEADS**

EAGLE PENCIL COMPANY, 703 EAST 13th STREET, NEW YORK
EAGLE PENCIL COMPANY OF CANADA, LTD., TORONTO

PLATINUM

and PLATINUM ALLOYS

in
SHEET . . .

WIRE . . .

TUBING . . .

For all Electronic
Applications

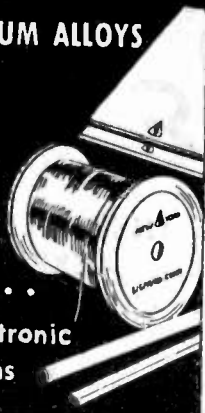

Platinum metals scrap and residues refined and re-worked on toll charges; or purchased outright by us . . .

Write for list of Products.
Discussion of technical
problems invited

SIGMUND COHN & CO.

44 GOLD ST. NEW YORK
SINCE 1901

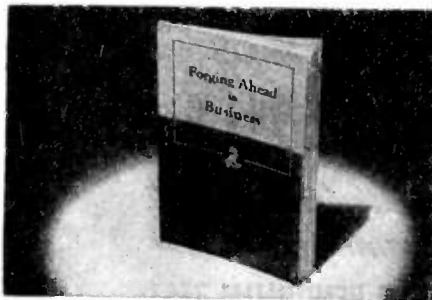

Every Ambitious Man in Industry
Should Read this Free Booklet!

"FORGING AHEAD IN BUSINESS" contains FACTS for all thoughtful, forward-looking men; it has a message of particular interest to technical men.

This 64-page booklet, of which more than 3,000,000 copies have been circulated, outlines a definite plan of training for your future progress in industry.

Said one man who had sent for it:

"In thirty minutes this booklet gave me a clearer picture of my business future than I have ever had before."

Fill in the coupon below and this helpful manual will be sent to you by mail and without cost.

ALEXANDER HAMILTON INSTITUTE
Dept. 127, 73 West 23rd Street, New York 10, N. Y.
In Canada, 54 Wellington St., West, Toronto, Ont.
Please mail me a copy of the 64-page book—"FORGING AHEAD IN BUSINESS."

Name.....
Address.....

INDEX

Section Meetings	34A
Membership	36A
I.R.E. People	44A
No "Victory" Models	46A
Positions Open	50A

DISPLAY ADVERTISERS

Aerovox Corporation	3A
Airborne Instruments Laboratory	52A
Aircraft Accessories Corporation	4A, 5A
Allen-Bradley Company	49A
Alliance Manufacturing Company	40A
American Lava Corporation	33A
American Telephone & Telegraph Co.	18A
American Transformer Company	13A
Andrew Company	60A
Arnold Engineering Company	60A
Audio Development Company	55A
Alfred W. Barber Laboratories	51A
Bliley Electric Company	7A
Browning Laboratories, Inc.	47A
Cambridge Thermionic Corp.	58A
Capitol Radio Engineering Institute	55A
Allen D. Cardwell Mfg. Corp.	61A
Centralab	10A
Chicago Transformer Corporation	44A
Clarostat Mfg. Company, Inc.	48A
Sigmund Cohn & Company	62A
Communication Measurements Laboratory	54A
Communication Products Company, Inc.	58A
Continental Electric Company	46A
Cornell-Dubilier Electric Corp.	Cover III
Corning Glass Works	9A
DeJur-Amsco Corporation	12A
Tobe Deutschman Corp.	63A
Allen B. DuMont Laboratories, Inc.	30A
Eagle Pencil Company	61A
Eicor Inc.	48A
Eitel-McCullough, Inc.	64A
Elastic Stop Nut Corp. of America	21A
Electronic Corp. of America	29A
Electronic Laboratories, Inc.	Facing 17A
Electro-Voice Mfg. Company, Inc.	31A
General Electric Company	45A
General Radio Company	Cover IV
Gilfillan Brothers Inc.	50A
Hallicrafters Company	20A
Alexander Hamilton Institute	62A
Hammarlund Mfg. Company, Inc.	43A
Harvey Radio Laboratories, Inc.	59A
Heintz & Kaufman, Ltd.	15A
Hewlett-Packard Company	6A
Hytron Corporation	17A
Industrial Condenser Corp.	45A
International Resistance Company	37A
Jackson Electrical Instrument Co.	57A
Ken-Rad Tube & Lamp Corp.	22A
Lear Avia Inc.	Facing 16A
Littelfuse Inc.	57A
Macmillan Company	54A
Majestic Radio & Television Corp.	54A
McElroy Manufacturing Corp.	25A
Measurements Corporation	59A
Merit Coil & Transformer Corp.	59A
National Company, Inc.	2A
National Union Radio Corp.	53A
National Vulcanized Fibre Co.	62A
Plax Corporation	39A
Radio Corp. of America, Victor Div.	37A
Radio Specialties Company	56A
Rauland Corporation	27A
Raytheon Mfg. Company	11A
Remler Company, Ltd.	36A
Rola Company, Inc.	24A
Shallcross Mfg. Company	38A
Shure Brothers	35A
Sola Electric Company	41A
Sprague Specialties Company	19A
Stackpole Carbon Company	8A
Standard Transformer Corp.	42A
Stupakoff Ceramic & Mfg. Co.	16A
Sun Radio & Electronics Co.	62A
Sylvania Electric Products Inc.	28A
Tech Laboratories	55A
Templestone Radio Company	52A
Terminal Radio Corp.	56A
Thordarson Elec. Mfg. Co.	34A
Triplet Electrical Instrument Co.	14A
Tung-Sol Lamp Works Inc.	26A
United Transformer Company	Cover II
Universal Microphone Co. Ltd.	51A
Utah Radio Products Co.	23A
Walker-Jimieson, Inc.	56A
Western Lithograph Company	61A

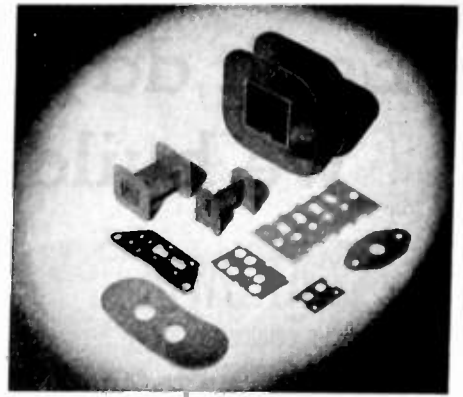

In Everything of Uncle
Sam's that "flies, floats
or shoots"

**NATIONAL
VULCANIZED
FIBRE**

PHENOLITE
Laminated BAKELITE

—because of their lightness in weight, high dielectric strength, ready machineability, exceptional wearing and other qualities—are playing a vital part.

"BACK THE ATTACK" with WAR BONDS

**NATIONAL VULCANIZED
FIBRE CO.**

Offices in Principal Cities
WILMINGTON, DELAWARE

Purchasing Agents!
Engineers!

JUST
OUT!



NEW
1944
EDITION
FREE!

800 Page
Buying Guide

RADIO PARTS

RADIO TUBES
and INDUSTRIAL
ELECTRONIC EQUIPMENT
—IN A HURRY

FROM OUR LARGE STOCK!

★ ★ ★

SEND FOR FREE CATALOG!

New 1944 Edition—Just Out!

Write today on your company letterhead for this massive 800 page, bound volume containing everything in radio and electronic equipment.

Address Box T.A.
Telephone BRarclay 7-1840

**SUN RADIO
& ELECTRONICS CO.**
212 Fulton Street, New York 7, N. Y.

Stalwart *against* Time

THE REPUTATION of Tobe Capacitors for *long life* rests on a record of practically no "returns". Ratings are always conservative. Constant research... manufacturing skill born of long, specialized experience... frequent, rigid inspections—these are the "secrets" of Tobe's ability to master difficult specifications, like those of the new American War Standards. The "DP" Molded Paper Condenser shown below is an example. It is made of high grade Kraft tissue paper and aluminum foil—mineral oil impregnated and molded in low-loss Bakelite. Leads are tin copper wire. Whatever your condenser problems, Tobe engineers will gladly work with you. Inquiries and requests for samples will receive prompt attention.

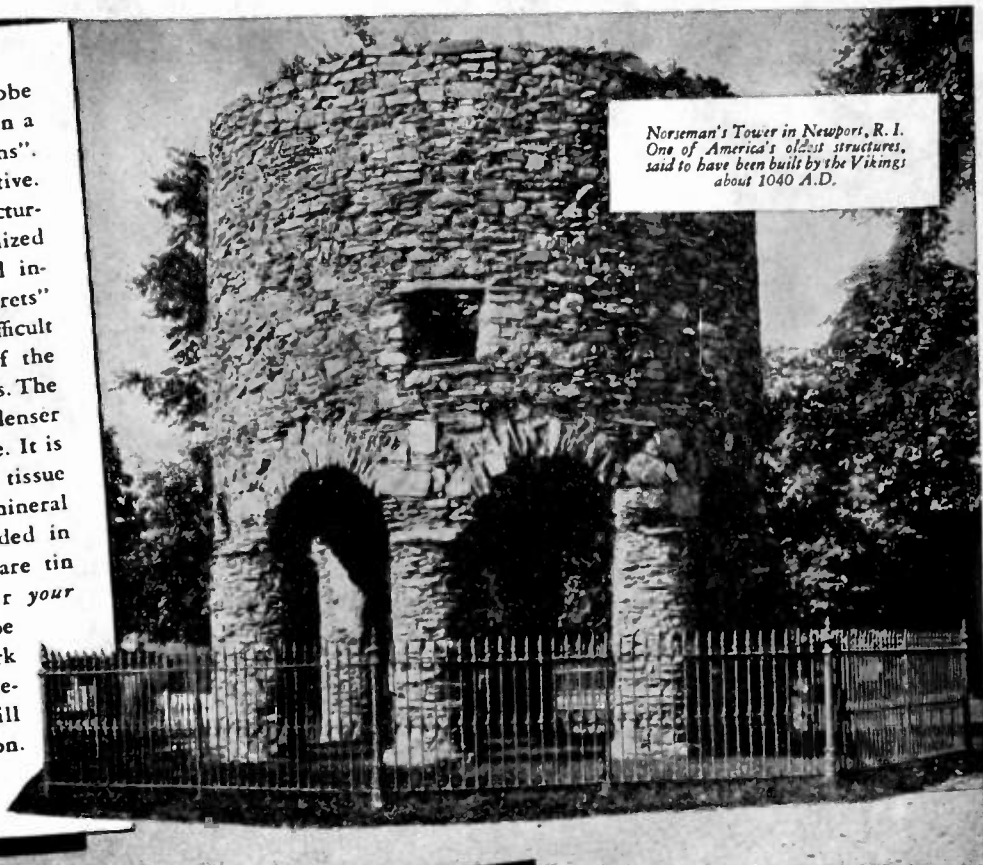

Norseman's Tower in Newport, R. I. One of America's oldest structures, said to have been built by the Vikings about 1040 A.D.

LONG LIFE ASSURED



SPECIFICATIONS "DP" MOLDED PAPER CONDENSERS

CAPACITANCE.....001 to .04 MFD
 WORKING VOLTAGE.....See chart at right
 Flash test 3 times rated DC working voltage
 SHUNT RESISTANCE At 185° F— 1000 megohms or greater
 At 72° F—50000 megohms or greater
 WORKING TEMPERATURE RANGE Minus 50° F to plus 185° F
 OPERATING FREQUENCY RANGE . .Upper limit 40 megacycles
 Q at one megacycle—average 20
 POWER FACTOR.....At 1000 cycles .004 to .006
 DIMENSIONS.....13/16" x 13/16" x 19/64"

Capacity in MMFD.	DC Working Voltage Rating	TOBE & AMERICAN WAR STANDARDS DESIGNATIONS	
		"A" Characteristic	"B"
1000	600—1500	CN35A102	CN35B102
1500	600—1500	CN35A152	CN35B152
2000	600—1500	CN35A202	CN35B202
2500	600—1250	CN35A252	CN35B252
3000	600—1000	CN35A302	CN35B302
4000	600—1000	CN35A402	CN35B402
5000	600— 800	CN35A502	CN35B502
6000	600— 800	CN35A602	CN35B602
7000	500— 700	CN35A702	CN35B702
8000	500— 700	CN35A802	CN35B802
10000	400— 600	CN35A103	CN35B103
20000	200— 300	CN35A203	CN35B203
30000	50— 150	CN35A303	CN35B303
40000	50— 100	CN35A403	CN35B403



A SMALL PART IN VICTORY TODAY

A BIG PART IN INDUSTRY TOMORROW



Their hobby is radio too . . .

These are the leaders of science and communications. They are professionals in what has become a most vital element of modern civilization . . . radio communications and the science of electronics. Some of them wear the uniforms of top ranking military officers because we are engaged in war. Others remain civilians as doctors of science . . . the leaders of radio, electronic and electrical industries which are amazing the world through their achievements. Achievements which not only aid in war but which are creating the new era of industry to follow. They are the great men of today . . . they will be still greater tomorrow . . . and they are radio amateurs.

Eimac tubes are leaders too. First choice of these leading engineers . . . first in the new developments in radio. They are first with radio amateurs too, which is no coincidence.

Follow the leaders to

Eimac
REG. U. S. PAT. OFF.
TUBES

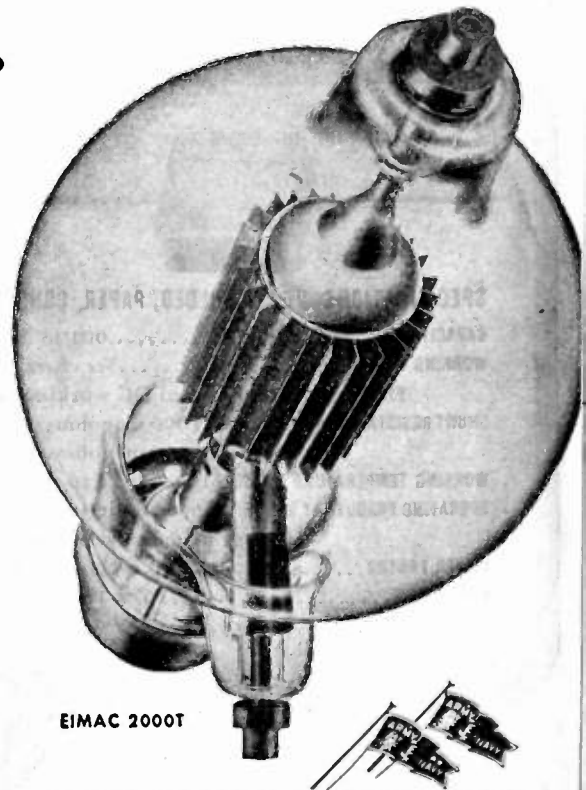

EIMAC 2000T

EITEL-McCULLOUGH, INC., 794 San Mateo Ave., SAN BRUNO, CALIF. • Plants located at San Bruno, California and Salt Lake City, U

Export Agents: FRAZAR & HANSEN • 301 Clay Street • San Francisco, California, U. S. A.

when you say

Cornell Dubilier

you say **DEPENDABLE**
CAPACITOR
PERFORMANCE.....



Once the name of a product is firmly established, its mention awakens definite associations in the mind. It is no longer just a name . . . it is an actual symbol of the product. Thus it is that the name Cornell-Dubilier has come to mean incomparable capacitor performance. It is the name of the oldest, largest exclusive capacitor manufacturer in the world. It is the safest name to think of when you need capacitors for any purpose. It means trouble free long life, so important in any capacitor installation. Cornell-Dubilier Electric Corporation, South Plainfield, New Jersey.

IT'S C-D FOUR TO ONE: In an independent inquiry just completed, 2,000 electrical engineers were asked to list the first, second and third manufacturers coming to mind when thinking of capacitors. When all the returns were in, Cornell-Dubilier was far in the lead—receiving almost four times as many "firsts" as the next named capacitor.

TYPE **TK** DYKANOL FILTER CAPACITORS

No other capacitor of such fine quality for large capacity and high voltage filter service has ever been offered in such compact dimensions. Thus the design engineer, faced with arbitrary space limitations, solves a knotty problem. TK features are:

HIGH PURITY ALUMINUM FOIL—Lower R.F. resistance—High tensile strength, means longer life.

HIGH GRADE MULTI-LAMINATED KRAFT TISSUE—Higher voltage breakdown—maximum safety—high insulation resistance.

DRIED, IMPREGNATED AND FILLED — Under Continuous Vacuum—Lower equivalent series resistance, particularly at higher temperature—8,000 megohms per microfarad insulation resistance.

HEAVY-DUTY WET-PROCESS GLAZED PORCELAIN INSULATOR—High dielectric and mechanical strength.

CORK-GASKETED PRESSURE-SEALED Terminals—Leakproof joints—high dielectric strength.

STURDY, ARC-WELDED STEEL CASE—Leakproof—durable strong.

CONSERVATIVE D.C. RATING—Will safely operate continuously at 10% above rated voltage.

FILLED WITH FIRE-PROOF DYKANOL—Eliminates all fire hazard.

Cornell Dubilier

more in use today than any other make

capacitors



MICA • DYKANOL • PAPER
WET AND DRY
ELECTROLYTIC CAPACITORS

RESISTORS

GENERAL RADIO CO.

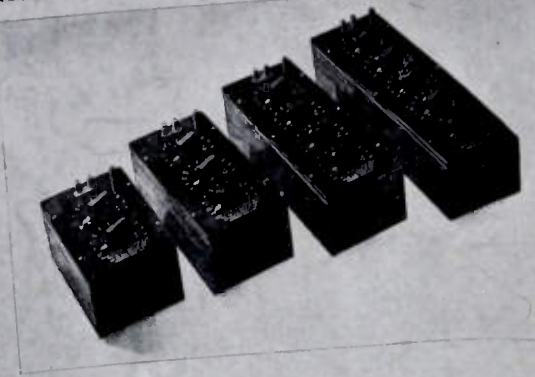

TYPE 602 DECADE-RESISTANCE BOX

USES: Accurate resistance boxes are extremely valuable wherever electrical measurements are made. Such boxes are constantly used in circuits where a wide range of resistance values is required or where variable dummy generator and load resistances are needed. The accuracy of Type 602 Decade-Resistance Boxes also permits them to be used as laboratory standards and as ratio arms for direct- and alternating-current bridges.

Although designed primarily for direct-current and audio-frequency work, they are useful well into the radio-frequency range for many applications.

DESCRIPTION: The Type 602 Decade-Resistance Box is an assembly of two or more Type 510 Decade-Resistance Units in a single cabinet. Mechanical and electrical protection of the units is provided by the shielded walnut enclosure and aluminum panel, which completely enclose both the resistance units and switch contacts. The resistance elements have no electrical connection to the shield, which is brought out to a separate terminal connected to the panel.

Two-, three-, four-, and five-dial decade assemblies are available. Each decade has eleven contact studs and ten resistance units, so that the dials overlap. A positive detent

mechanism assists in setting squarely on the contacts and so permits adjustments to be made without looking at the dials.

FEATURES: By careful mechanical design the zero resistance of the Type 602 Decade-Resistance Boxes has been kept below 0.003 ohm per decade. In applications where a minimum zero resistance is desired, this feature is very valuable. On the other hand, there are many types of measurement, such as substitution measurements, in which the difference between two settings of a resistance box is the significant value. This difference is given correctly only when the individual resistors have been adjusted independently of switch and wiring resistance. Accordingly, the resistance units in the Type 602 Decade-Resistance Boxes are adjusted to have their specified values at their own terminals, rather than at the terminals of the box.

All resistors except the 10,000-ohm card are wound with manganin wire; consequently no difficulty due to thermal emf is encountered in direct-current measurements, except when in direct-current measurements decades of the using the high-resistance decades of the Types 602-N and 602-L. With these decades, some attention should be given to temperature differences, if maximum accuracy is desired.

At radio frequencies, the residual inductances

and capacitances cause the effective series resistance at the terminals to depart from the low-frequency value.* In addition, the reactance component, which is negligible at audio frequencies, may become significant. The 100-, 10-, and 1-ohm-per-step decades of the Type 602 Decade-Resistance Boxes are the most

satisfactory for use at high frequencies in no case, however, is the frequency error serious below 50 kc. The magnitudes of the residual impedances are given in the specifications below.

The maximum allowable current for each decade, based on a 40° Centigrade temperature rise, is engraved just above each decade switch knob.

SPECIFICATIONS

Frequency Characteristics: A Type 602 Decade-Resistance Box may be represented quite closely by the equivalent circuit below, which represents one decade of a box, with the remaining decades not in view. R_0 and L_0 are the zero resistance and inductance of the box, due to the wiring and contacts. These values are proportional to the number of decades in the box. C_0 is the inter-dial capacitance and depends on the dial setting. The effective capacitance and inductance in general upon the dial setting, the variation being approximately linear with setting (the higher value being approximately linear). The values of the constants are tabulated below:

R_0 (ohm)	0.10	1.0	10	100	1000	10,000
L_0 (ohm)	0.14	0.5	0.11	0.29	3.8	9.5
C_0 (pfd)	—	27	26-23	23-13	—	—

Zero Resistance: The direct-current zero resistance of various boxes depends on the number of dials, as follows:

No. of Dials	Zero Resistance
2	0.004-0.006 ohm
3	0.003-0.005 ohm
4	0.002-0.012 ohm
5	0.010-0.015 ohm

Temperature Coefficient: Less than ±0.002% per degree Centigrade at room temperature, except for the 510 decade where the low wiring will affect the overall temperature coefficient.

Dielectric Properties: Characteristic of Dielectric Materials —
 See "Dielectric Properties Characteristic of Dielectric Materials" General Radio Reference Manual, Vol. 2, V, No. 6.

The values of the capacitance constants of a single decade in a box are the same as the values of the decades in the box, as well as the wiring and may be taken as representative of the entire box.

If several decades of a box are in circuit at the same time, the electrical inductance of the several decades may be added to give the total inductance. The capacitance may be taken as the highest decade in use.

Type of Winding: See specifications for Type 510 Decade-Resistance Units, page 24.

Accuracy of Adjustment: All cards are adjusted within 0.1% of the stated value between card terminals, except the 1-ohm cards which are adjusted within 0.25% and the 0.1-ohm cards which are adjusted within 1%.

Maximum Current: See specifications for Type 510 Decade-Resistance Units, page 24. Values for 50° Centigrade rise are marked on panels directly above each decade knob.

Switches: Quadrant type, phosphor bronze, resilient liner on contact studs 3/16 inch in diameter. Switch brushes are bent so as not to be tangent to the arc of contact. There are eleven contact points (0 to 10 positions).

Terminals: Lock-type binding posts on General Radio standard 3/4 inch spacing for resistance connections. There is one extra post at the center of the panel for capacitance to the shield.

Mounting: A suggested walnut cabinet, with aluminum panel, completely encloses resistors and resistance units. The panel finish is black crackle lacquer.

Dimensions: Panel length depends on the number of dial units; panel width, 1 3/4 inch for 2-dial, 1 7/8 inch for 3-dial, 2 1/8 inch for 4-dial, and 2 3/4 inch for 5-dial. Panel depth, 5 inches. Overall height, 5 inches.

Net Weights: 3 1/2 lbs for 2-dial, 0 1/2 lbs for 3-dial, 5 lbs for 4-dial, and 6 1/2 lbs for 5-dial boxes.

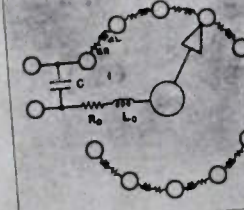

Type	Resistance	No. of Filaments	Type 510 Decade-Resistance Unit	Code Word	Price
602-D	11 ohms, total, in steps of 0.1 ohm	2	A, B	004-006	\$35.00
602-E	110 ohms, total, in steps of 1 ohm	2	B, C	004-006	\$5.00
602-F	110 ohms, total, in steps of 0.1 ohm	3	A, B, C, D	004-006	\$5.00
602-G	110 ohms, total, in steps of 1 ohm	4	A, B, C, D, E	004-006	\$5.00
602-H	110 ohms, total, in steps of 0.1 ohm	5	A, B, C, D, E, F	004-006	\$5.00
602-I	11,110 ohms, total, in steps of 1 ohm	—	H, C, D, E, F	004-006	\$70.00
602-J	11,110 ohms, total, in steps of 0.1 ohm	—	C, D, E, F, G	004-006	\$8.00
602-L	111,100 ohms, total, in steps of 1 ohm	—	—	—	—

COMPLETE Specifications Give You Your Answers

This Decade Resistance Box is well designed and well constructed. Its reactance is low so that it can be used at moderately high frequencies without appreciable error. But you must have *all* the facts when you need a resistance box for use in a precise measuring circuit at radio frequencies. You may ask, for example, "What are the series reactance and effective resistance of this box at one megacycle for a setting of 95 ohms?"

You'll find the answer to this, and many other questions about decade box characteristics in the General Radio Catalog, and the data is backed by accurate measurements in the General Radio laboratories.

Catalog specifications for General Radio instruments are definite, accurate and complete. They are written for engineers by engineers. They tell you all you need to know about an instrument before you buy it, including the price.

Because all of our facilities are devoted to war projects,  this equipment is at present available only for war work.



GENERAL RADIO COMPANY Cambridge 39, Massachusetts
 NEW YORK CHICAGO LOS ANGELES