

# Proceedings

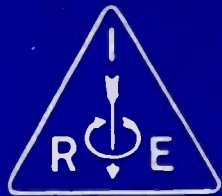

*of the*

# I · R · E

SEPTEMBER 1943

VOLUME 31

NUMBER 9

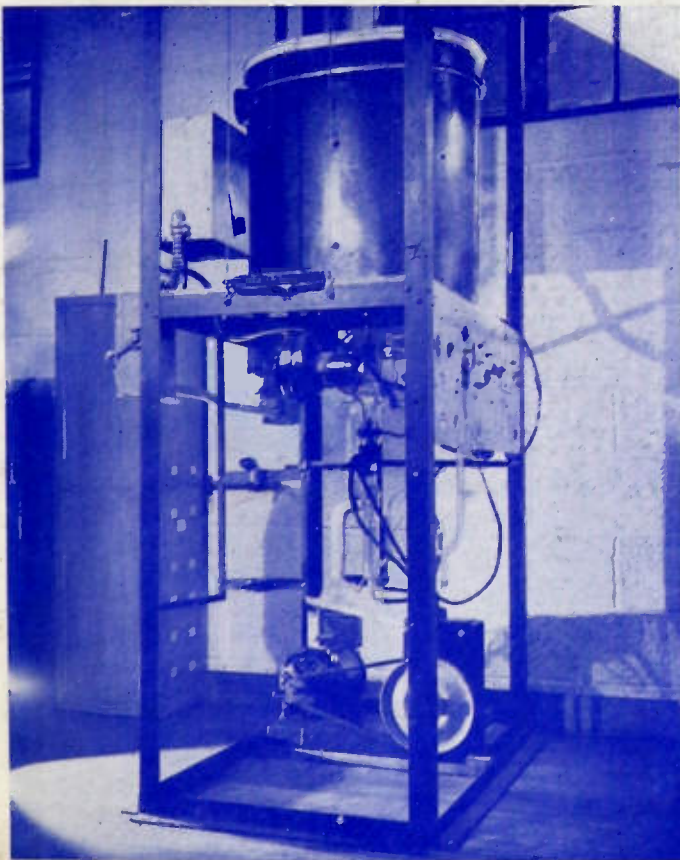

*Hazeltine Electronics Corporation*

BIRTHPLACE OF LARGE ELECTRON TUBES

Color Television—Part II

Radio Sonde

V-T Space Currents

Radio Reception at U.H.F. Parts II  
and III

Engineer in Psychological Warfare

Engineer in Manpower Program

Radio Engineer in the Navy

# Institute of Radio Engineers



**More tube hours  
are going into battle**



Through a series of design and construction developments tending to prolong normal operating life, we have increased the length of actual service that is being derived from each AMPEREX tube. Basically, our facilities are of laboratory type. And any measure of our war production, computed solely on the number of tubes manufactured, would not be a true indication of our total effort.

We, at AMPEREX, have kept pace with numerical production increases being registered throughout the nation. But we are infinitely more proud of our attainments in building longer life into our transmitting and rectifying tube designs. Each AMPEREX radio tube is bringing extra hours of performance to equipment at the front.

**AMPEREX ELECTRONIC PRODUCTS**  
79 WASHINGTON STREET  
BROOKLYN, NEW YORK

BOARD OF DIRECTORS  
1943

Lynde P. Wheeler, *President*  
F. Sherbrooke Barton,  
*Vice President*  
Raymond A. Heising, *Treasurer*  
Haraden Pratt, *Secretary*  
Alfred N. Goldsmith, *Editor*  
Stuart L. Bailey  
Wilmer L. Barrow  
E. Finley Carter  
Adolph B. Chamberlain  
Ivan S. Coggeshall  
William L. Everitt  
Harold T. Friis  
Gilbert E. Gustafson  
O. B. Hanson  
Frederick B. Llewellyn  
Frederick E. Terman  
Browder J. Thompson  
Hubert M. Turner  
Arthur F. Van Dyck  
Harold A. Wheeler  
William C. White

•  
Harold R. Zeamans,  
*General Counsel*

BOARD OF EDITORS

Alfred N. Goldsmith, *Editor*  
Ralph R. Batchler  
Philip S. Carter  
Lewis M. Clement  
Elmer W. Engstrom  
William L. Everitt  
Peter C. Goldmark  
Frederick W. Grover  
C. M. Jansky, Jr.  
John D. Kraus  
Frederick B. Llewellyn  
Samuel S. Mackeown  
Edward L. Nelson  
Harry F. Olson  
Greenleaf W. Pickard  
Haraden Pratt  
Conan A. Priest  
Lynne C. Smeby  
Browder J. Thompson  
Harold A. Wheeler  
Laurens E. Whittemore  
Gerald W. Willard  
William Wilson  
Charles J. Young

•  
Helen M. Stote,  
*Associate Editor*

William C. Copp,  
*Advertising Manager*  
William B. Cowlich,  
*Assistant Secretary*

# Proceedings

of the I·R·E

*Published Monthly by*

The Institute of Radio Engineers, Inc.

VOLUME 31

*September, 1943*

NUMBER 9

|  |   |
|--|---|
| John Stone Stone.....  | 463   |
| Your Institute.....  | Board of Directors 464  |
| Color Television—Part II.....  | P. C. Goldmark, E. R. Piore,<br>J. M. Hollywood, T. H. Chambers, and J. J. Reeves 465 |
| The Radio Sonde.....   | W. H. Pickering 479   |
| Space-Current Flow in Vacuum-Tube Structure.....                         | B. J. Thompson 485  |
| Some Aspects of Radio Reception at Ultra-High Fre-<br>quency.....        | E. W. Herold and L. Malter  |
| Part II. Admittances and Fluctuation Noise of<br>Tubes and Circuits..... | L. Malter 491   |
| Some Aspects of Radio Reception at Ultra-High Fre-<br>quency.....        | E. W. Herold and L. Malter  |
| Part III. The Signal-to-Noise Ratio of Radio Re-<br>ceivers.....         | E. W. Herold 501  |
| The Radio Engineer in Psychological Warfare.....                         | Roy C. Corderman 510  |
| The Engineer's Position in the Manpower Program.....                     | T. K. Miles 514   |
| The Radio Engineer in the Navy.....                                      | Carl F. Holden 517  |
| Section Meetings.....  | 520   |
| Institute News and Radio Notes.....                                      | 521   |
| Postwar Television.....  | Lee de Forest 521   |
| John Stone Stone.....  | George H. Clark 522   |
| Books:   |   |
| “Dynamical Analogies,” by Harry F. Olson.....                            | F. V. Hunt 524  |
| Contributors.....  | 525   |

Responsibility for the contents of papers published in the PROCEEDINGS rests upon the authors. Statements made in papers are not binding on the Institute or its members.



Entered as second-class matter October 26, 1927, at the post office at Menasha, Wisconsin, under the Act of February 28, 1925, embodied in Paragraph 4, Section 538 of the Postal Laws and Regulations. Publication office, 450 Ahnaip Street, Menasha, Wisconsin. Editorial and advertising offices, 330 West 42nd St., New York, N. Y. Subscription \$10.00 per year; foreign, \$11.00.

Copyright, 1943, by The Institute of Radio Engineers, Inc.

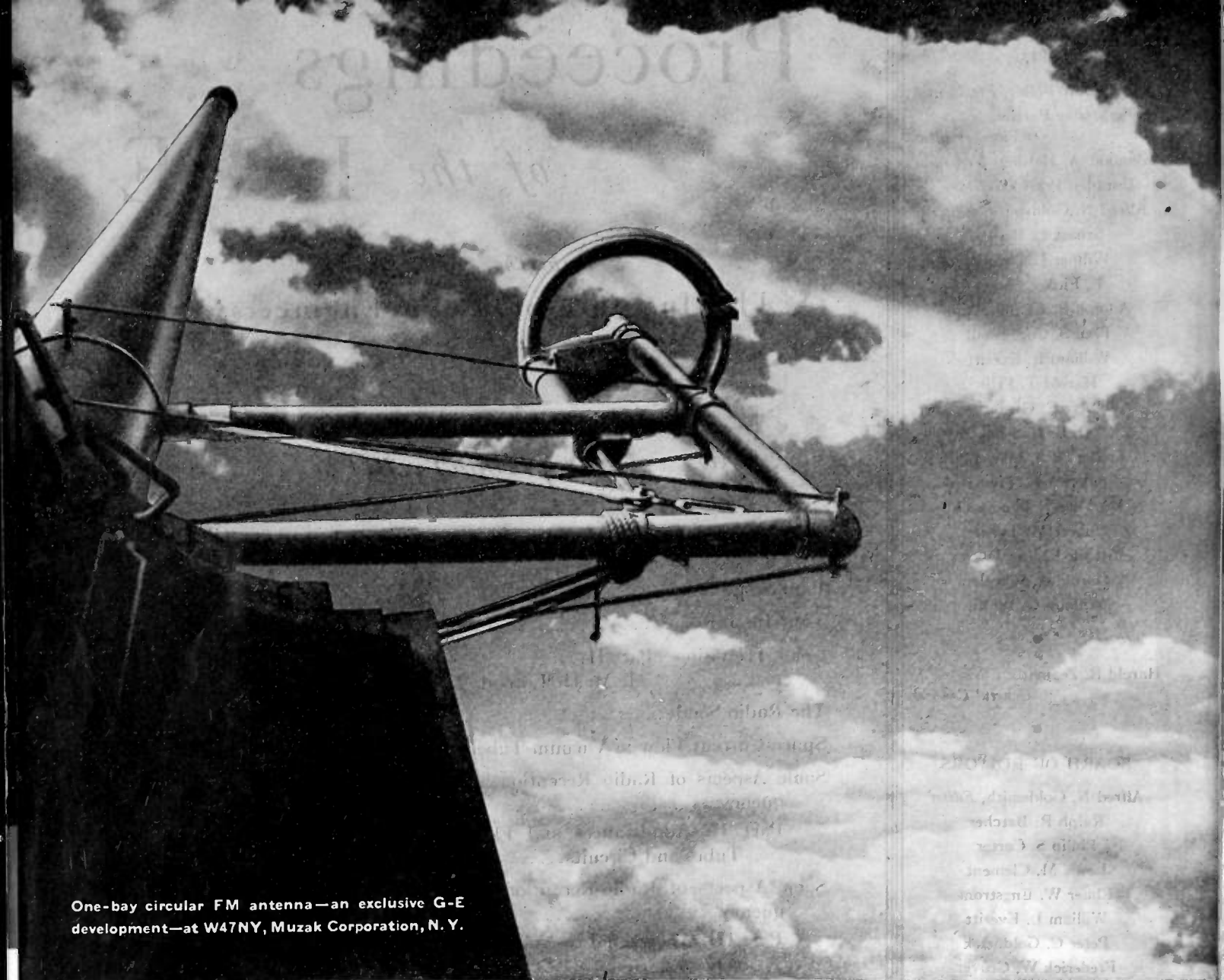

One-bay circular FM antenna—an exclusive G-E development—at W47NY, Muzak Corporation, N. Y.

## To 144\* broadcasters planning FM stations right after the war

No other manufacturer offers so much FM equipment and experience.

From helping you select the best transmitter site to providing a full line of FM equipment, G. E. offers you complete service.

For instance, G. E. can supply its exclusive S-T relay equipment to bridge the gap between studio and transmitter *without wires*. You locate the station for maximum coverage, the studio for maximum convenience.

General Electric has built more FM broadcast transmitters than any other manufacturer . . . more than a third of existing stations.

General Electric is the only manufacturer that has built both FM transmitters and FM home receivers.

General Electric's line of FM equipment includes: Broadcast apparatus, studio equipment, police radio, military radio, complete S-T FM relay equipment, monitoring equipment, high-gain antennas, home receivers.

General Electric is the only manufacturer who offers a complete promotional plan and local promotional effort on the day your General Electric FM station opens its doors. In newspapers, over local radio, with publicity releases and through every General Electric

dealer in your vicinity, the sale of FM home receivers is pushed in a determined drive to help you establish your station and FM in your area.

It's not too soon now to start detailed plans for the years following Victory. We invite your inquiries. Write to *Electronics Department, General Electric, Schenectady, New York.*

Tune in "THE WORLD TODAY" and hear the news direct from the men who see it happen, every evening except Sunday at 6:45 E.W.T. over CBS. On Sunday evenings listen to the G-E "Hour of Charm" over NBC network.

\*According to a recent G-E survey of broadcasters.

**GENERAL**  **ELECTRIC** **FM • TELEVISION • AM**

160-07-6912



*Stepping up to*  
**TEN MILLION  
 VOLTS**

**X-Ray and Impulse  
 Generator Capacitors**

**AEROVOX TYPE '26**

**Applications :**

- X-ray filter capacitors
- Impulse test generators
- Carrier-current coupling capacitors
- High-voltage laboratory equipment
- Many other high-voltage applications

**Ratings :**

- 50,000 v. D.C. — .005 to .1 mfd.
- 75,000 v. D.C. — .001 to .05 mfd.
- 100,000 v. D.C. — .001 to .05 mfd.
- 150,000 v. D.C. — .001 to .03 mfd.

● Charged in parallel, discharged in series, these capacitors provide for voltages up to ten million and over for certain deep-penetration X-ray and impulse generator applications. For usual X-ray work, single units operate up to 150,000 volts.

Aerovox Type '26 capacitors are designed for just such service. Multi-layer paper sections, oil-impregnated, oil-filled, housed in sturdy tubular bakelite cases. Choice of metal cap terminals facilitates stack mounting and connections. Sections of matched

capacitance insuring uniform voltage gradient throughout length of capacitor.

Behind these capacitors stand those giant Aerovox winding machines handling dozens of "papers" at a time for highest-voltage paper sections. Likewise batteries of Aerovox vacuum tanks insuring thorough impregnation even to the last paper fibre. Such facilities spell Aerovox—the last word in oil capacitors—safeguarded by thorough inspection and testing from raw materials to finished units.

● New catalog, listing an outstanding line of heavy-duty capacitors for radio, electronic and industrial functions, sent on request to individuals engaged actively in professional engineering or production. Submit your capacitance problems and requirements.



*Capacitors*

**INDIVIDUALLY TESTED**

AEROVOX CORPORATION, NEW BEDFORD, MASS., U. S. A. • SALES OFFICES IN ALL PRINCIPAL CITIES  
 Export: 100 VARICK ST., N. Y. C. • Cable: 'ARLAB' • In Canada: AEROVOX CANADA LTD., HAMILTON, ONT.

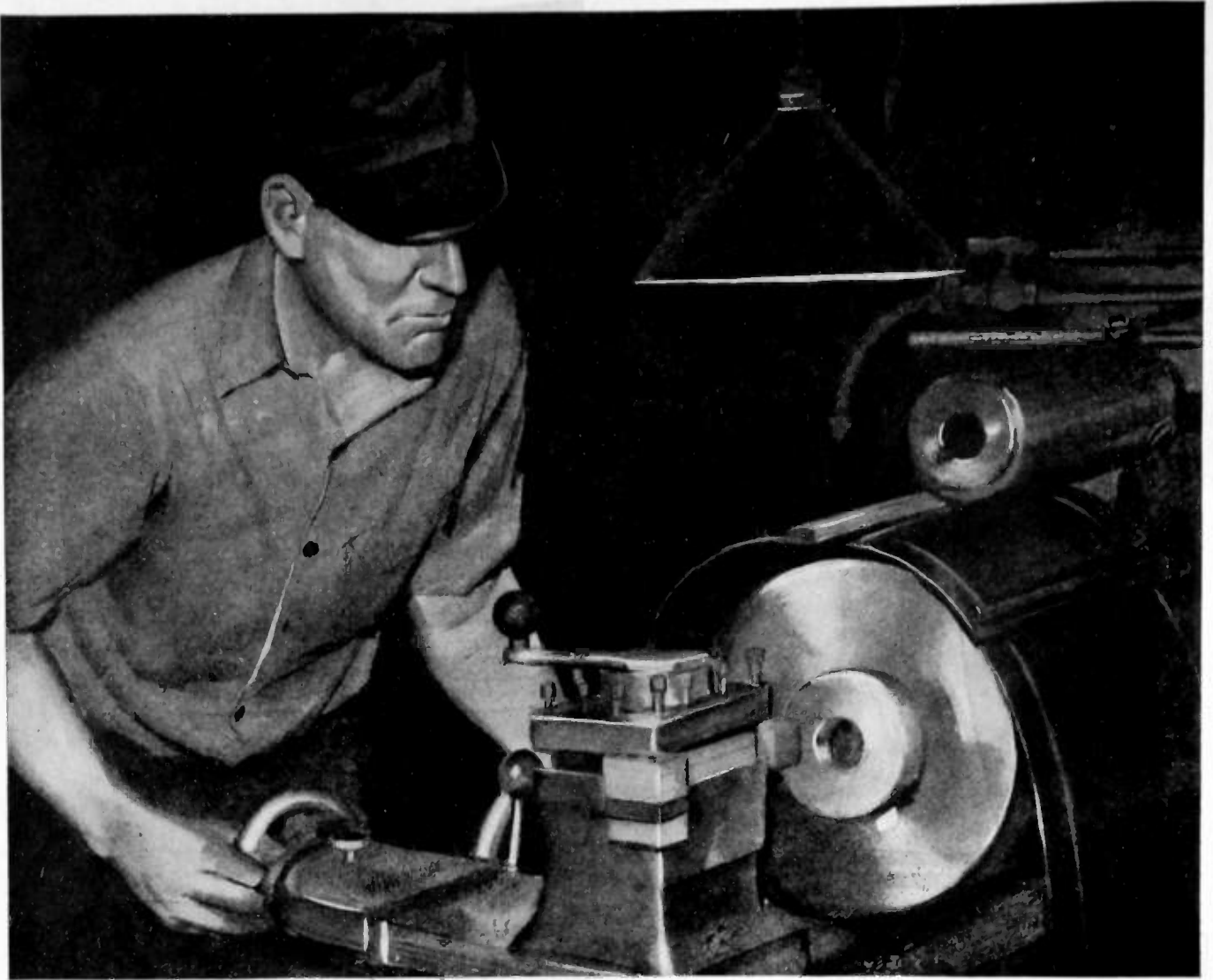

## GUNNER BY REMOTE CONTROL

**H**IS battleground is located far from the fighting fronts. His skill and long experience have been lent to the making of vital parts—parts that are vital to a boy in a bomber over Germany or his neighbor's son in a fighter in the Pacific. Their equipment is dependent on split-hair accuracy of Utah Parts—and he's giving it to them. He's a gunner by remote control.

There are hundreds like him at Utah—soldiers in coveralls. By the skill of their hands and the sweat of their brow, they're making sure that Utah Parts don't fail at the critical moment—as a switch releases a stream of machine gun bullets . . . as a headset receives a command to take a strategic height. These and many other vital electrical and electronic devices are being turned out in quantity and *on time* . . . by this precision task

force at Utah. Important to the success of this task force is the work of the Utah laboratories. Here, new solutions to electrical and electronic problems are being worked out. Here, a great store of knowledge and experience is being accumulated.

*Tomorrow* that knowledge and experience will be at the service of peacetime America. There will be better Utah products built—more convenience, enjoyment and efficiency for many Americans—because of today's great advancements, necessitated by war.

UTAH RADIO PRODUCTS COMPANY, 842 Orleans Street, Chicago, Illinois. Canadian Office: 560 King Street, West, Toronto. In Argentine: UCOA Radio Products Co., SRL, Buenos Aires. Cable Address: UTARADIO, Chicago.

**PARTS FOR RADIO, ELECTRICAL AND ELECTRONIC DEVICES, INCLUDING SPEAKERS, TRANSFORMERS, VIBRATORS, VITREOUS ENAMELED RESISTORS, WIREWOUND CONTROLS, PLUGS, JACKS, SWITCHES, ELECTRIC MOTORS**



**BOY-IT'S GOT TO BE GOOD**



The Hytron 807—peacetime all-purpose favorite—is now a veteran. Before it joins its battle-scarred brothers, however, like all Hytron tubes it must pass Hytron factory specifications which weed out the 4-F's as efficiently as Army doctors at an induction center. Unless a Hytron 807 is in top fighting condition, it never leaves the factory. Let's look at a few of the many test hurdles it must surmount.

**BUMP TEST**



Ever stop to think of what a leaping, bouncing jeep or peep can do to a tube's "innards"? One answer to the question of a tube's ability to withstand such punishment, is the Bump Test. Several resounding smacks by a heavy, swinging hammet loosens up the weak sisters pronto!



**IMMERSION TEST**



A "PT" boat leaning back on its stern, and plowing a foaming furrow through steaming tropical waters would spell disaster to poorly-cemented bases and top caps. That is why Hytron 807's are thoroughly soaked in a hot bath, before they are O.K.'d.



**LIFE TEST**

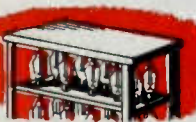

Day and night, Hytron 807's on life-testracks are proving that they can give long, dependable service. Soaring skyward in our big bombers, these tubes have a big investment in men and materiel to protect. Long after the big fellows have been patched for the last time, these tubes are still doing their jobs.



**VIBRATION TEST**



Link-trainer for 807's aspiring to tank service is a motor-driven eccentric arm which shakes the tube like an angry terrier while a v. t. voltmeter in the plate circuit records the ability of the elements to take it like the iron men who ride those clanking, thundering monsters.



**HYTRON TOLERANCES**

**tighter than**

**CUSTOMER TOLERANCES**



No manufacturer makes all tubes of a given type exactly alike. Hytron does manufacture its tubes to tight specifications which insure against slight inaccuracies due to meters and the human element. Engineered to these narrower limits, Hytron tubes fit exactly the circuit constants with which they must operate.



OLDEST EXCLUSIVE MANUFACTURER OF RADIO RECEIVING TUBES



**HYTRON CORPORATION**  
ELECTRONIC AND RADIO TUBES

SALEM AND NEWBURYPORT, MASS.

# Savings in DESIGN

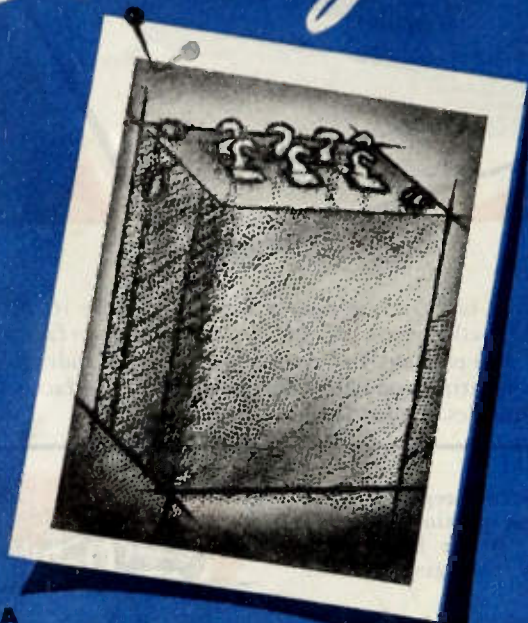

A



B

PREVIOUS UTC ads have illustrated the importance of engineering design in the saving of critical materials, machine time and man hours. The engineer's responsibility in our war effort is tremendous. We can win or lose the war because the winner will be that group of nations which gets there first with the most. We illustrate the functioning of this viewpoint at UTC by a highlight design for the month, as below.

A... Contemporary transformer as brought to UTC for duplication.

B... UTC final design, illustrating design savings.

**VOLUME REDUCTION 80%** ... This represents a vital reduction in critical material.

**WEIGHT REDUCTION 78%** ... Used in portable apparatus, weight reduction is important.

**PRICE REDUCTION 84%** ... This means more war units for the same cost ... Quicker.

**DEPENDABILITY --%** ... Considerably more efficient electrically and submersion proof.

May we design a war unit to your application?

## UNITED TRANSFORMER CO.

150 VARICK STREET



NEW YORK 13, N. Y.

EXPORT DIVISION: 13 EAST 40th STREET, NEW YORK 16, N. Y. CABLES: "ARLAB"



Here's design help on  
**HIGH ALTITUDE PROBLEMS**



Proper functioning of sensitive radio parts in the rarified atmosphere and sub-zero temperatures encountered at high altitudes has been a troublesome problem. Westinghouse engineers have co-operated with many designers to work out a variety of solutions, of which the accompanying illustrations are typical examples.

Perhaps these are directly applicable to your problem; or it may be that yours is completely different. In either case, trained and experienced Westinghouse representatives are ready to help you; call them today. Westinghouse Electric & Manufacturing Company, Dept. 7-N, East Pittsburgh, Pennsylvania. J-94566

Tuffernell polymerizing potting compound. A new material that does not melt. Has negligible coefficient of expansion, maintains flexibility at -40°C and offers good moisture resisting and electrical characteristics.

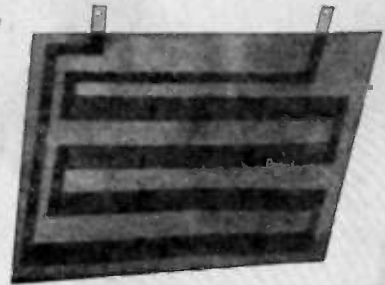

Battery heater for installation between cells to maintain 65°-70° temperature, for maximum battery efficiency.



High altitude carbon brushes, eliminating excessive wear and providing dependable d-c power under severe high altitude conditions.



Solder seal bushings for transformers, condensers, vibrators, antennas.



**Westinghouse**

PLANTS IN 25 CITIES...OFFICES EVERYWHERE



# STEATITE

*by Centralab*

No Shortage • Ample Capacity  
Custom - Made to Your  
Requirements

# Centralab

Division of GLOBE-UNION INC., Milwaukee

FROM HUNDREDS OF MILES AT SEA CAME

# THE ALARM THAT SAVED MIDWAY!



*Midway was ready when the Jap attempt to capture this strategic U. S. outpost came June 4 to 7, last year. Long before the Jap fleet of battleships, carriers, cruisers, destroyers and transports could bring their big guns into range—vigilant patrol planes with modern radio communications equipment had sounded the alarm. Many miles from Midway's shores American planes blasted their fleet...drove their survivors into a frantic homeward retreat.*

**R**EPEATEDLY it has been said—"this war is different". Yes, different because, on land, at sea and in the air, battles are being planned and fought with weapons never before available to our fighting men. Among these is the electronic tube. It is reassuring to know that no nation is making wider or better use of this great weapon of modern warfare than the U. S. A. To help serve the vast requirements of our Army and Navy National Union, for example,

is producing electronic tubes on a scale far exceeding its pre-war peak. Yet, dramatic as are the achievements of electronics in war, there will be even more miraculous peace-time tasks for tubes to perform. National Union will be prepared to aid engineers and production men in applying the power of electronics to their special needs. To producers of war goods, this industrial electronics service of National Union engineers is now available.

NATIONAL UNION RADIO CORPORATION • NEWARK, NEW JERSEY • LANSDALE, PENNSYLVANIA

# NATIONAL UNION RADIO AND ELECTRONIC TUBES

Transmitting Tubes • Cathode Ray Tubes • Receiving Tubes • Special Purpose Tubes • Condensers •  
Volume Controls • Photo Electric Cells • Exciter Lamps • Panel Lamps • Flashlight Bulbs

# ***THE ROAD***



**OUT OF TODAY'S RESEARCH • • • TOMORROW IS ENGINEERED**

# AHEAD

*MAN reached for the stars and grasped . . . Electronics.*

*Devoted now to war, this amazing science promises wondrous adventures for mankind on THE ROAD AHEAD.*

*As constant research has developed the potentialities of Electronics, so the search for a BETTER WAY, here at American Lava, has perfected steatite insulation best suited to the new requirements.*

*Pioneers of steatite electrical insulation . . . now in our 41st year of Ceramic Leadership, we are able to say with full confidence that ALSIMAG Steatite Insulators represent the highest quality, precision, dielectric properties and mechanical strength to be found among the Steatites.*

*There will be no compromise with quality in the production of ALSIMAG Steatite Insulators.*

## AMERICAN LAVA CORPORATION

CHATTANOOGA, TENNESSEE



AWARDED JULY 27, 1942

# ALSIMAG

TRADE MARK REGISTERED U. S. PATENT OFFICE

## STEATITE CERAMIC INSULATORS

*CHARACTERISTICS TAILORED TO YOUR REQUIREMENTS*

Where stability is an important requirement, ALSIMAG Steatite ceramics are unsurpassed for lending rigidity and permanence of alignment to electronic circuits.



Long before the war, American Export Airlines giant "Flying Aces" were equipped complete with radio transmitting, receiving and direction-finding equipment... designed and built by Bendix Radio.

## Electronic Systems for

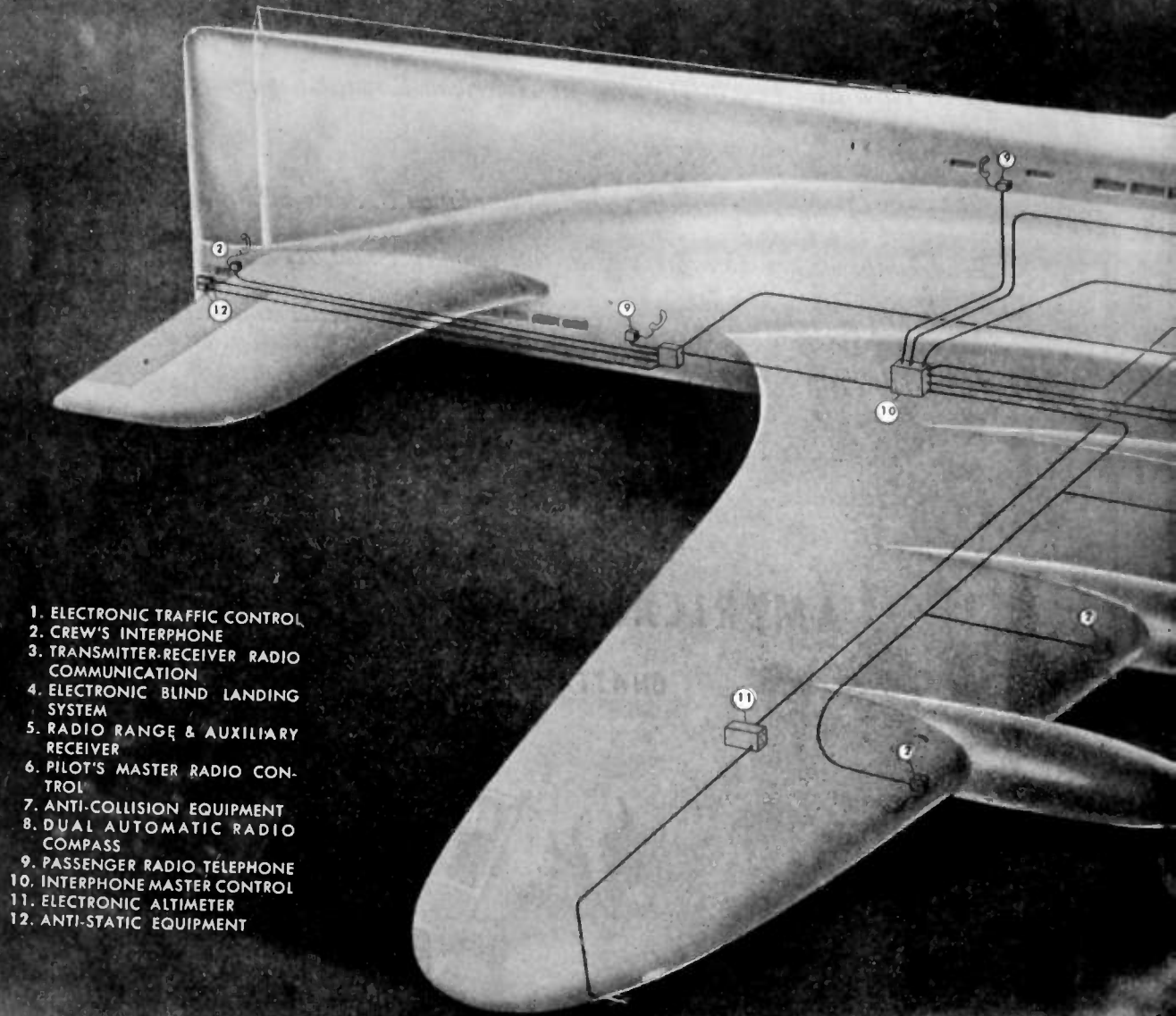

1. ELECTRONIC TRAFFIC CONTROL
2. CREW'S INTERPHONE
3. TRANSMITTER-RECEIVER RADIO COMMUNICATION
4. ELECTRONIC BLIND LANDING SYSTEM
5. RADIO RANGE & AUXILIARY RECEIVER
6. PILOT'S MASTER RADIO CONTROL
7. ANTI-COLLISION EQUIPMENT
8. DUAL AUTOMATIC RADIO COMPASS
9. PASSENGER RADIO TELEPHONE
10. INTERPHONE MASTER CONTROL
11. ELECTRONIC ALTIMETER
12. ANTI-STATIC EQUIPMENT

# the Skyliners of the FUTURE

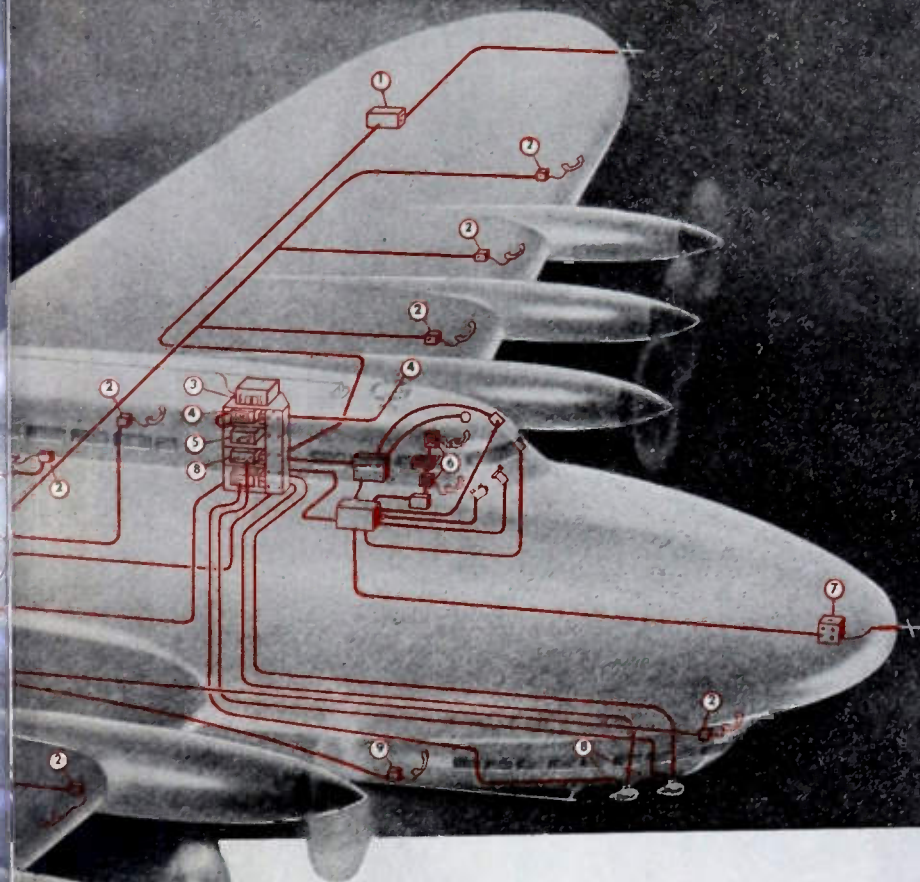

## Engineering the complete RADIO ELECTRONIC SYSTEM is the business of BENDIX RADIO!

Vastly more than transmitters and receivers make up the radio-electronic system of a long-range bomber or transport. Even for pre-war airliners, Bendix Radio and airline engineers cooperated to design complete radio systems . . . custom-built.

Radio transmitters and receivers, interphone systems, remote indicating radio navigating installations . . . these and other complex electronic equipment comprise the signal corps of

"The Invisible Crew." Designing and producing this whole network, with all necessary wiring, conduits and connections, is the business of Bendix Radio . . . now going forward on a vastly increased scale.

Back of these vital members of "The Invisible Crew" stand the specialized experience and pre-war "know-how" of Bendix Radio engineers . . . helping to make our fighting machines *The Vehicles of Victory*, and *The Transports of Tomorrow*.

Products of this division are vital members of "The Invisible Crew"—precision equipment which 25 Bendix plants from coast to coast are speeding to our fighting crews on world battle fronts.



**BENDIX RADIO**

**B E N D I X**

**R A D I O**

**D I V I S I O N**

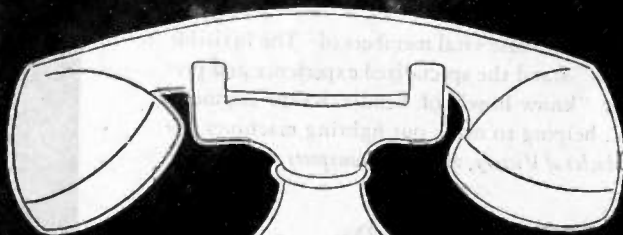

**Joe needs  
the Long Distance  
lines tonight**

He has a promotion to report. Or a week-end leave coming up. Or it's his mother's birthday.

Evening is about the only time he's free to call and it's important to him.

Will you do your best to avoid Long Distance calls after 7 at night, for the sake of millions of Joes — and Josephines? They'll appreciate it.

BELL TELEPHONE SYSTEM





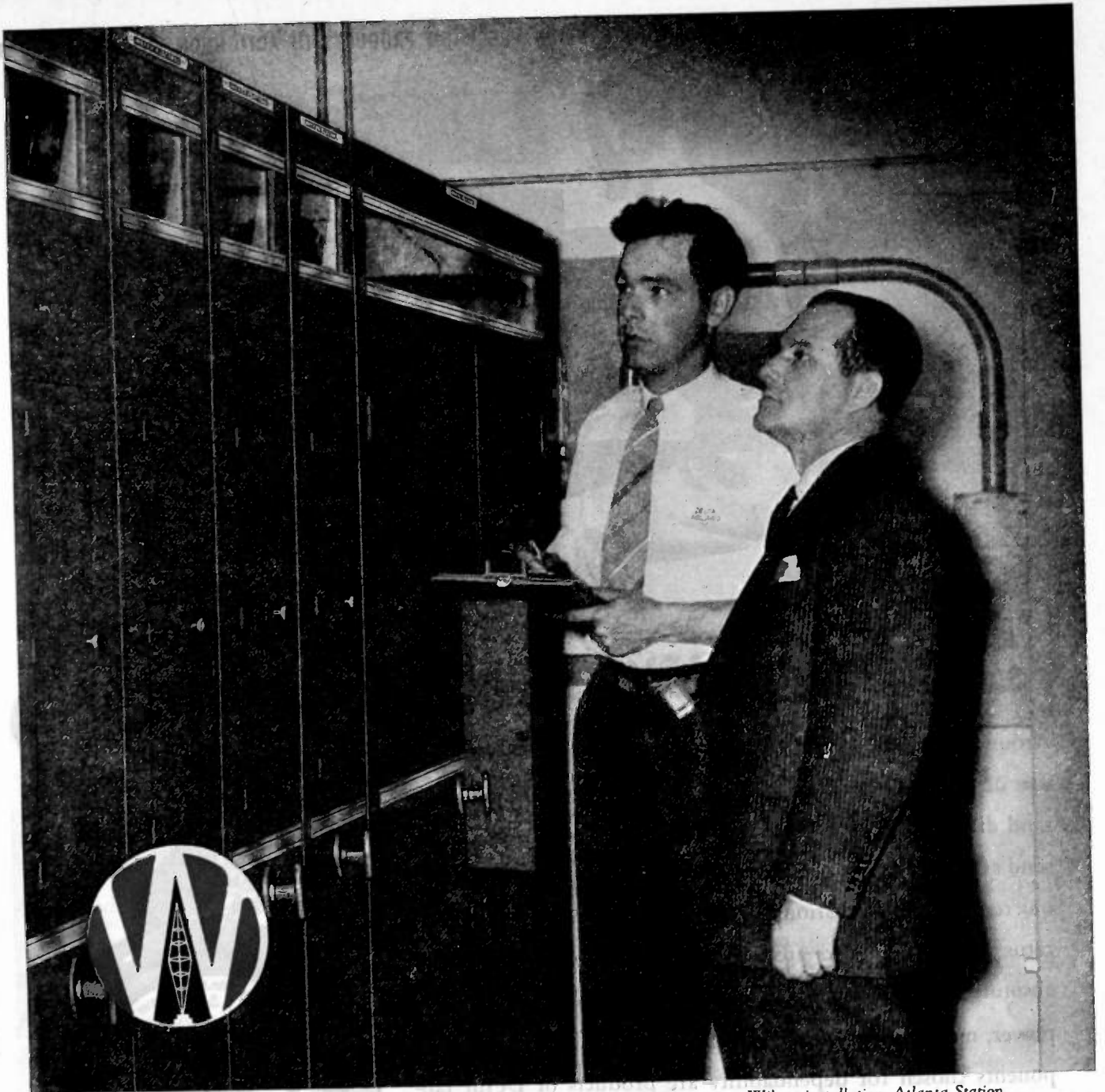

(Right) L. T. Campbell, Supt. Communications, Delta Air Lines, with J. B. Kramer, at Wilcox installation, Atlanta Station.

# SERVING THE NATION'S AIRLINES

Wilcox equipment has been used by the major airlines for many years...and while, today, Wilcox facilities are producing largely for military needs, the requirements of the essential airlines also are being handled. Look to Wilcox for leadership in dependable communications!

- Communication Receivers
- Aircraft Radio
- Transmitting Equipment
- Airline Radio Equipment

## WILCOX ELECTRIC COMPANY

Quality Manufacturing of Radio Equipment

14TH & CHESTNUT

KANSAS CITY, MO.



# THEY LISTEN...

Around the clock, from Monday to Monday, America's "monitors of the air" sit at their posts—and listen. Serving in a thousand different ways, they check foreign news and propoganda, send and receive weather reports, keep air channels clear, ferret out renegade radio stations. Of prime importance in the apparatus used by monitors are meters and rheostats which assure absolute control and give accurate indications of volume, power, modulation and recording. In many instances the components chosen for dependability are products of DeJur laboratories. Built of the finest materials to exacting precision standards, DeJur instruments are backed by a tradition of twenty-five years of outstanding electrical accomplishment.

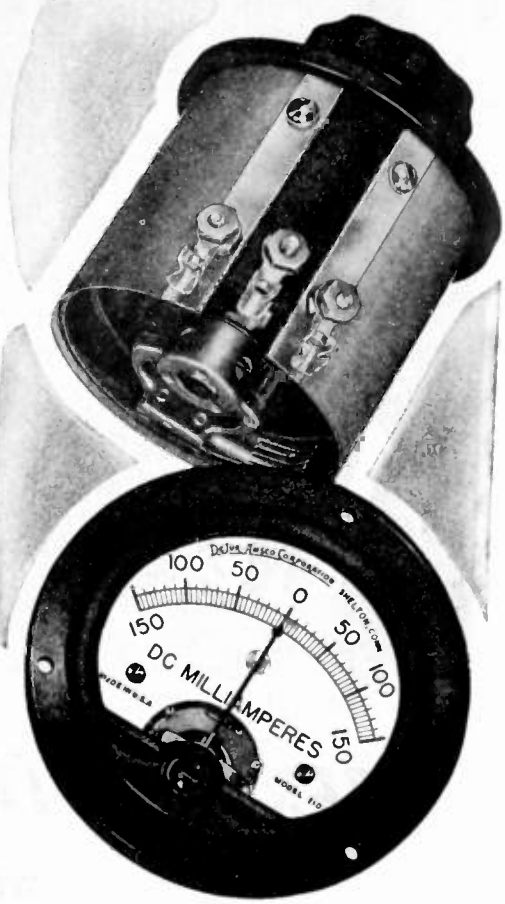

**BACK THE ATTACK . . . SUPPORT THE THIRD WAR LOAN DRIVE**



*Awarded for Excellence in Production and Quality of Material*

## DeJUR-AMSCO CORPORATION

**SHELTON, CONNECTICUT**

**NEW YORK PLANT:** 99 Hudson Street, New York City • **CANADIAN SALES OFFICE:** 560 King Street West, Toronto



## Not Good Enough for Transformers "at War"

"Satisfaction or your money back," "defective parts replaced free," etc., are ample protection for users of civilian goods but with lives and battles depending on Communication Equipment, these peacetime guarantees fail to satisfy. There's no time in a dog-fight to replace a defective transformer, and in battle the only dependable warranty is the assurance that the equipment will *not* fail . . . even under the most abnormal conditions and usage.

Building transformers for aerial communication

is one of Rola's war jobs. *Into* this task goes the knowledge and skill accumulated through years of manufacturing leadership. And *out* of it, certainly, will come new knowledge and new skill for the tasks of Tomorrow.

THE ROLA COMPANY, INC., 2530 Superior Avenue, Cleveland, Ohio.

*In addition to transformers of varying types, Rola manufactures headsets and coils of all kinds for aerial communications. If your problem involves Electronics . . . and is important to the war effort . . . why not discuss it with a Rola engineer.*

# ★ ROLA ★

MAKERS OF THE FINEST IN SOUND REPRODUCING AND ELECTRONIC EQUIPMENT



REPUBLIC P-47

OFFICIAL PHOTOGRAPH,  
U. S. ARMY AIR FORCE.

In receivers as in airplanes,  
it is the margin of superiority  
that wins victory. Almost good  
enough is no good at all.

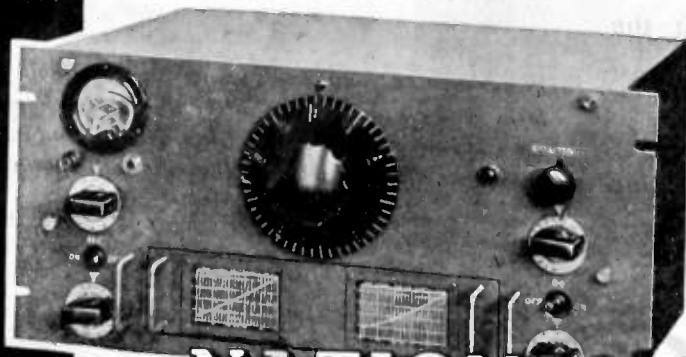

**NATIONAL COMPANY**

MALDEN, MASS. U. S. A.



**JAMES**

*Crystals*

**KNIGHTS**



### **CRYSTAL HEADQUARTERS**

Behind the volume production of James Knights Crystals stands a background of specialized experience nearly as old as radio itself. The service of James Knights Crystals in thousands of vital battlefront positions is a tribute to the modern and carefully engineered facilities which produce them. If you have an essential Crystal problem, these dependable facilities are at your command.

.... Phone 65

**The JAMES KNIGHTS Co.**  
SANDWICH, ILLINOIS

Any Type,  
Cut or  
Frequency

PRECISION CUTTERS OF QUARTZ  
FOR RADIO AND OPTICAL USES

# WE REMEMBER!

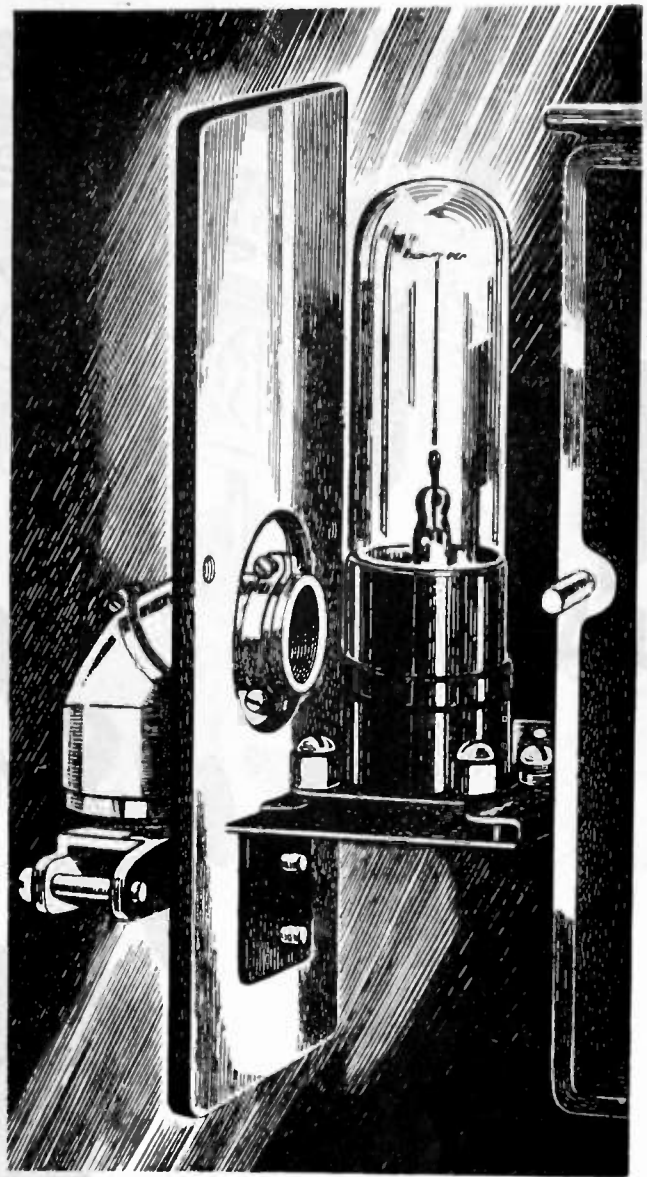

... it seemed an impossible job, but it was our country asking for help! Raytheon laboratories went on an "all out" basis . . . time went on and there were no "clock watchers." Power tubes for intricate new electronic applications had to be developed immediately and there was no pattern, no precedent to follow. The results depended solely upon the skill of Raytheon's corps of specially trained engineers.

Just how well Raytheon's power tube division has succeeded in delivering these intricately designed tubes in quantities heretofore unknown, is evidenced by the production increases that have enabled Raytheon to be an important factor in the successful operations of our military forces. *Look to Raytheon for your postwar power-tube requirements.*

DEVOTED TO RESEARCH AND THE MANUFACTURE  
OF TUBES AND EQUIPMENT FOR  
THE NEW ERA OF ELECTRONICS



# RAYTHEON

**Raytheon Manufacturing Company**  
WALTHAM AND NEWTON, MASSACHUSETTS



## ***Worthington For President!***

*Favorite Son Worthington's name has just been introduced. Around and around the convention floor go the delegates, a'whooping and a'hollering, hell-bent for putting Worthington across.*

**T**O BRING the dramatics and color of America's biggest show—a presidential convention—to the folks back home will be another peacetime assignment for Electro-Voice Microphones. Announcers' broadcasts will be heard clearly and distinctly above an adjustable volume of background noise that may be retained, if desired.

Fitting easily into the hand or attached snugly to the face, weighing barely more than a whisper, these new Electro-Voice Microphones are incomparable from the standpoint of stability, articulation and reduction of background noise. We'd like to tell you more about this radically different microphone design . . . show it to you. Manufacturers of war equipment may receive full particulars.

Make your present equipment last. Submit your Electro-Voice Microphone to your local distributor for TEST and REPAIR at the factory.



**BACK THE ATTACK — SUPPORT THE THIRD WAR LOAN DRIVE**

# *Electro-Voice* MICROPHONES

**ELECTRO-VOICE MANUFACTURING CO., INC. • 1239 SOUTH BEND AVENUE • SOUTH BEND, INDIANA**  
 Export Division: 13 East 40th Street, New York 16, N. Y. — U. S. A. Cables: ARLAB



## BETTER BANK ON THE **HUMAN** ELEMENT, TOO

In the excitement of electronic discoveries and predictions, one great and important factor—the *human element*—stands forlorn. Machines and uses are, after all, only the offspring of man's experience and ingenuity. The more capable the man, the more dependable his product.

This is the *human element* upon which the Electronic Corporation of America places a high evaluation. And this, we suggest, is the element you should seek when planning your future program. Find out more about your man and his background. Is he an old-timer or a "war baby"? Does he have the ability and facilities to produce? How high are his standards? These are questions we'll gladly answer. We're 100% in war work now . . . but, occasionally production schedules enable us to accept additional contracts . . . *communicate with us.*

**A CALL FOR GREATER EFFORT...** The WPB reports that war production has fallen off considerably. This is a challenge to industry and labor, and it's up to us to find the reason, whether it be optimism, internal strife, working conditions, discrimination, etc. The roar of battle is thousands of miles away, but, if you listen closely, you can hear the screams of a dying soldier. Can it be because we failed him?

**ELECTRONIC CORP. OF AMERICA**

45 WEST 18th STREET • NEW YORK 11, N. Y. • WATKINS 9-1870

*CCA*



**THE PEACETIME  
MEASURES OF  
REFLECTION AND  
DEFLECTION . . . .  
WILL BE READ FROM**



# **TRIPLETT**

**ELECTRICAL MEASURING INSTRUMENTS**

**WITH CONFIDENCE  
AND ECONOMY**

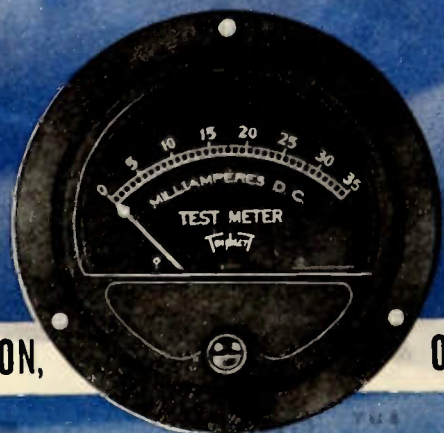

**THE TRIPLETT ELECTRICAL INSTRUMENT CO., BLUFFTON,**

**OHIO**

***BACK UP YOUR BELIEF IN AMERICA...BUY WAR BONDS***

# SCR-299

## VANGUARD OF INVASION!



THE SCR-299 Mobile Radio Communications unit played a great part in the invasion of Africa and Sicily . . . these units were used as mobile radio stations, transmitting voice commands to fast moving armored units while in action, or as permanent radio stations . . . even under the most difficult operating conditions.

A leading military authority said, "My observations in the theatres of war make it possible to say that the SCR-299 hit the jack pot in the mobile radio field as has the jeep in transportation."

BUY  
MORE  
BONDS!



**the hallicrafters co.**

CHICAGO, U. S. A.

THE WORLD'S LARGEST EXCLUSIVE MANUFACTURER OF SHORT WAVE RADIO COMMUNICATIONS EQUIPMENT

# RCA 935—A NEW PHOTOTUBE



FOR PRECISE MEASUREMENT OF  
**ULTRAVIOLET RADIATION**

ULTRA  
VIOLET

VIOLET

BLUE

GREEN

YELLOW  
ORANGE

RED

INFRA-RED

6300 Å

**I**F YOU deal with ultraviolet radiation and have a measurement or detection problem, RCA 935 may be of help to you. This new tube was designed by RCA engineers to give high sensitivity in the ultraviolet range—down to 2,000 Angstroms—yet to eliminate the effects of infra-red radiation. Applications already include use in the detection of certain hazardous gases, in the continuous analysis of certain solutions, and for the measurement of ultraviolet radiation *per se*. There's an RCA phototube for nearly every application.

The RCA 935 has an overall length of 4¼ inches (max.); max. diameter, 1-5/16 inches; skirted miniature cap; T-9 bulb; intermediate shell octal 5-pin base. Maximum ratings are as follows: anode supply voltage, 250 (d-c or peak a-c); anode current, 20 microamperes; ambient temperature, 50°C; luminous sensitivity at color temperature of 2870°K, 30 microamperes per lumen. Mounts in any position. Range: 2000Å° to 6300Å°. RCA Victor Division, Radio Corporation of America, Camden, New Jersey.

Here are the 935's most important features:

- High ultraviolet sensitivity — 0.02 microamperes per microwatt (at 2537 Å°)
- No response to infra-red
- High vacuum—for high stability
- High leakage resistance — 500,000 megohms
- Special envelope glass — providing excellent U-V passage



The Magic Brain of All Electronic Equipment is a Tube — and the Fountain-Head of Modern Tube Development is RCA.



TUNE IN "WHAT'S NEW?"

RCA's great new show Saturday nights, 7 to 8, E. W. T., Blue Network.

## RCA ELECTRON TUBES



### FREE!

RCA, 465 S. 5th Street, Harrison, N. J.  
Please send me the RCA publications checked below:  
..... RCA Phototubes—containing 16 pages of helpful information on phototube operation for relays, measurement, and sound reproduction.  
..... RCA 935—a technical data sheet on this new RCA ultraviolet-sensitive phototube.

NAME.....  
(COMPANY).....  
STREET.....  
CITY.....STATE.....

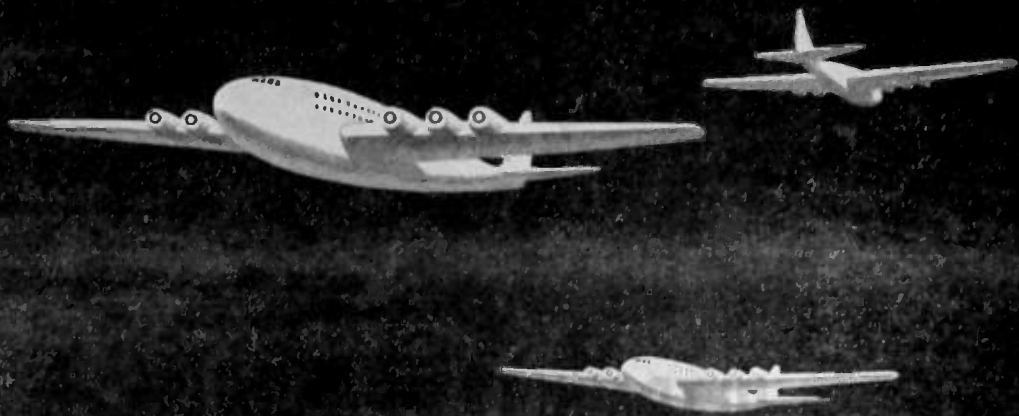

## Crossroads of the world



When Lieut. Commander Richard E. Byrd made his memorable round-trip flight with Pilot Floyd Bennett from Spitsbergen to the North Pole in 1926, his trimotored Fokker plane carried a short-wave transmitter designed by Ralph M. Heintz, co-founder of Heintz and Kaufman, Ltd.

Two years later Sir George Hubert Wilkins flew a similar transmitter over the Pole while determining the feasibility of establishing weather stations in the Far North, and while proving the efficiency of planes at polar latitudes. Taking off from Pt. Barrow, Sir Hubert crossed the top of the world in a successful 2100-mile flight to Dead Man's Island.

The forecasts of these scientific pioneers are becoming a reality as Great Circle routes to distant countries lead our bombers and transports over Arctic regions. Today an air-minded generation

speaks of the North Pole as "the crossroads of the world."

The polar flights of Byrd and Wilkins are part of the heritage of Heintz and Kaufman, Ltd., and are reflected in the many types of Gammatron tubes our engineers have designed especially for aviation transmitters.

In the Heintz and Kaufman plant and in our laboratories, Gammatrons are being ceaselessly perfected to safeguard planes and their crews as they soar over the top of the world.

**HEINTZ AND KAUFMAN, LTD.**  
SOUTH SAN FRANCISCO · CALIFORNIA, U. S. A.

### *Gammatron Tubes*



HK-257—Highly popular Gammatron beam pentode of advanced design, made with tantalum elements. It has high voltage and power capabilities, needs no neutralization even at high frequencies, and requires very low driving power and screen current. Plate dissipation, 75 watts; power output, 225 watts.

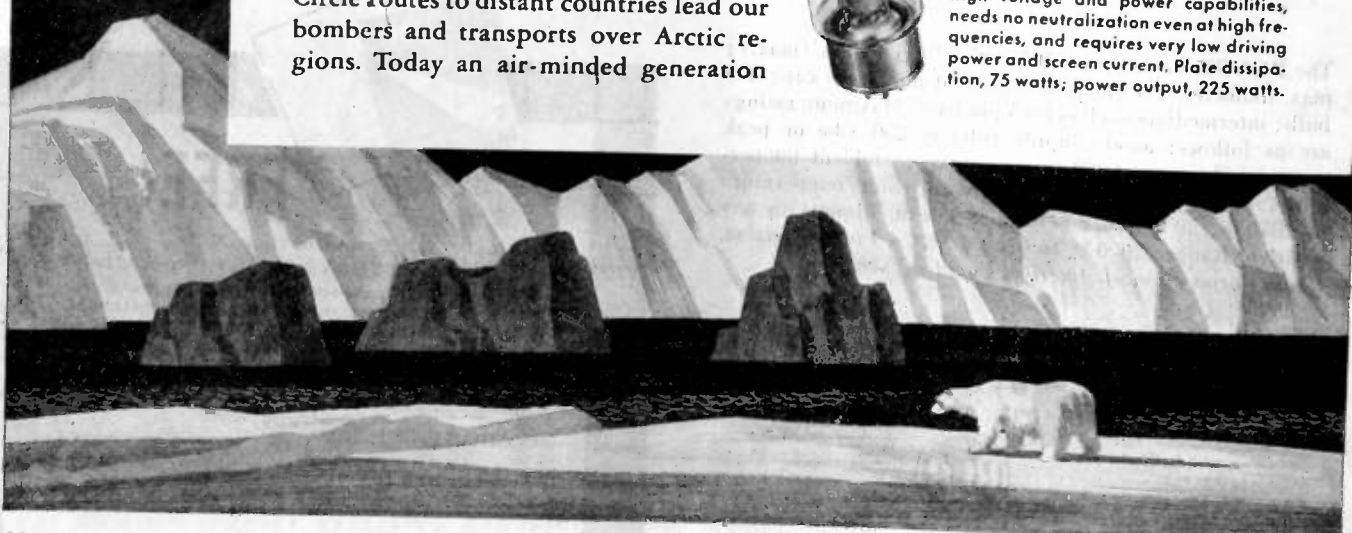

BLUEPRINTS OF SAFETY



# TANKS...A MILLION

No slang intended, men, but we're told that's the way it looked . . . when the Shermans started rolling Rommel in reverse. Today . . . headlines emphasize the increasingly effective job that our mechanized units are doing over the entire invasion front . . . And since, in the roar and din of mechanized battle, quartz crystals are the one method for keeping harried Commanders tuned to pre-arranged frequencies, so vital for clear transmission . . . for accurate co-ordination . . . A. A. C. methods of manufacturing are of vital importance. Our "Blueprints of Safety" demand that A. A. C. crystals be matched to guard the invisible tolerance. . . . .



ELECTRONICS DIVISION

*Aircraft Accessories Corporation*

MANUFACTURERS OF  
PRECISION AIRCRAFT EQUIPMENT  
HYDRAULICS . . . . . ELECTRONICS

BURBANK, CALIF. - KANSAS CITY, KANS. - NEW YORK, N. Y. - CABLE ADDRESS: AACPCO

*Joseph C. Walker 1945*

# INSULATED IRON CORES

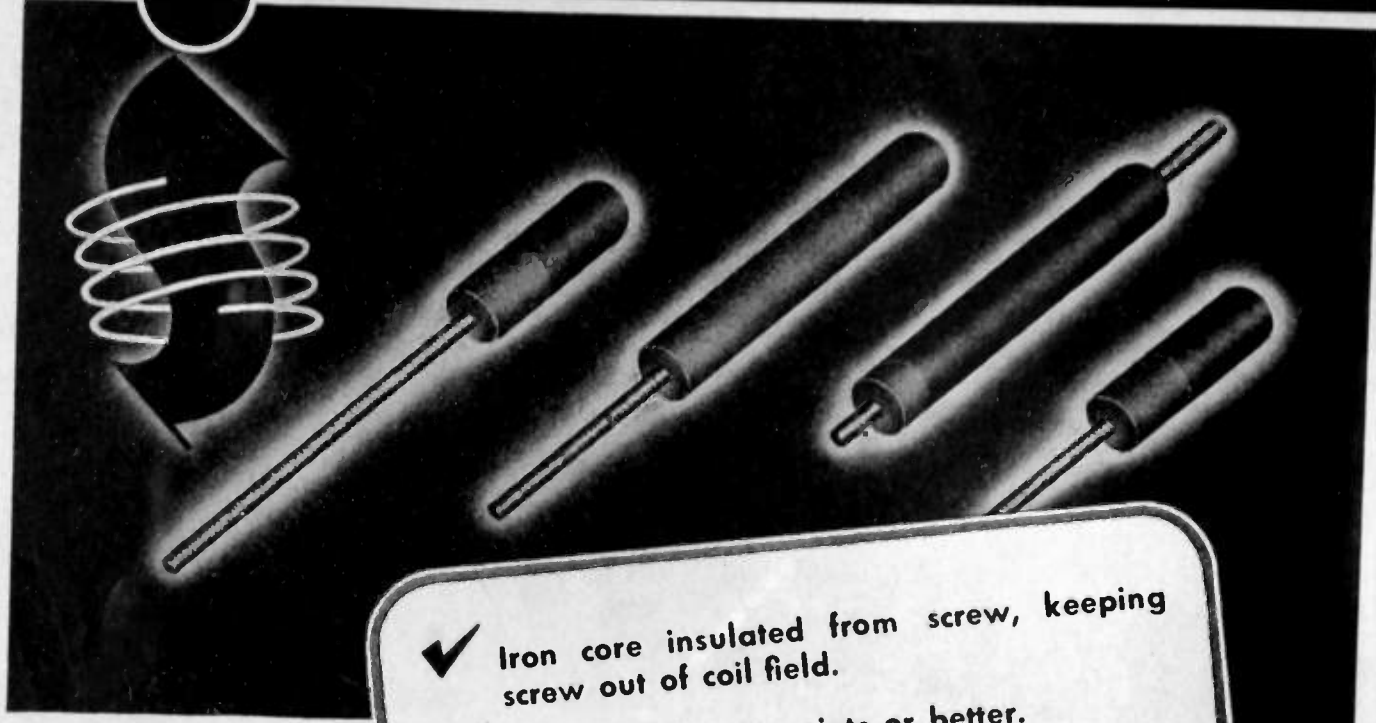

- ✓ Iron core insulated from screw, keeping screw out of coil field.
- ✓ Increases "Q" 30 points or better.
- ✓ Reduces distributed capacity of coil.
- ✓ Reduces hand capacity effect where screw is not grounded.

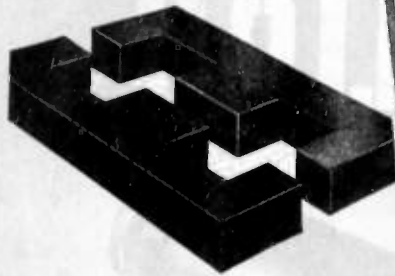

## MOLDED IRON TRANSFORMER CORES

... another Stackpole development in powder metallurgy. Designed for transformers and chokes where constant inductance is required over a given frequency range—also where constant inductance, limited only by the saturation point of the core, is needed for various currents. This saturation point can be predetermined to meet specific conditions

Stackpole Insulated Iron Cores mean new standards of efficiency for applications such as antenna or oscillator coils; I-F transformers of either top and bottom-tuned or top-tuned types; permeability tuning (either audio modulation or frequency modulation): transmitting tuning and others. The insulation is bonded to the core to form an integral unit, and may be any length from  $\frac{1}{4}$ " up to 1". Core diameters of .198", .250", and .365" are produced as "standard", although other diameters are available.

STACKPOLE CARBON COMPANY, ST. MARYS, PENNA.

# STACKPOLE

**EVERYTHING IN CARBON BUT DIAMONDS** — BRUSHES (all types for all rotating machines) — CONTACTS (all carbon, graphite and composition types — also molded rare metal contacts) — ANODES — ELECTRODES — BRAZING BLOCKS — BEARINGS — WELDING RODS, ELECTRODES AND PLATES — PIPE — PACKING, PISTON AND SEAL RINGS — RHEOSTAT PLATES AND DISCS — BRAKE LINING, etc.

# TRANSTAT VOLTAGE REGULATORS for smooth control of A. C. Voltage

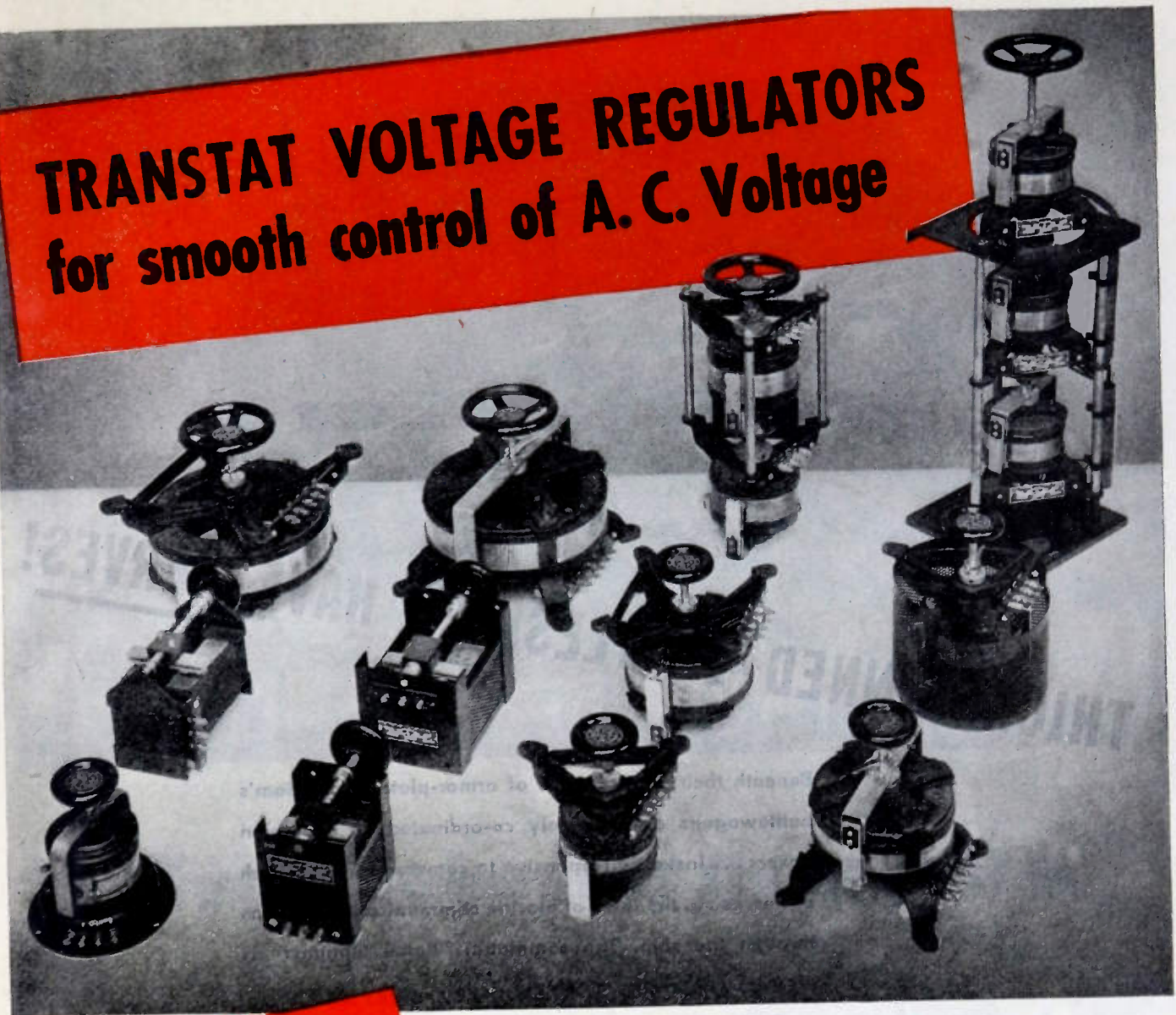

PIONEER MANUFACTURERS  
OF  
TRANSFORMERS,  
REACTORS,  
AND RECTIFIERS FOR  
ELECTRONICS AND  
POWER TRANSMISSION

**T**RANSTAT Voltage Regulators have unusual features for radio, industrial or laboratory apparatus requiring a special voltage—a continuously adjustable voltage—or a constant voltage from a fluctuating power source. With high electrical efficiency (93-97%), they provide a velvety smooth, practically stepless control through their range of rating in increments of no more than 0.75 volts. In addition, they maintain power factor, cannot distort wave form or

interfere with radio reception. Standard Type TH Transtat Voltage Regulators operate on 115, 230 and 460 volt single phase or polyphase circuits and handle 20 KVA and smaller loads. They maintain voltages within a narrow range in changing from no load to full load. The American Transformer Company also manufactures motorized and fully automatic voltage regulators. Full information upon request.

AMERICAN TRANSFORMER COMPANY, 178 Emmet St., Newark, N. J.



# AMERTAN

MANUFACTURING SINCE 1901 AT NEWARK, N. J.

# THICKSKINNED BATTLESHIPS HAVE NERVES!

Beneath their many inches of armor-plate, Uncle Sam's battlewagons are as finely co-ordinated as champion boxers . . . instantly responsive to commands. A network of nerves . . . the lines of electric communication . . . runs through the ship. The command, "Battle Stations!" is electric . . . *literally.*

To keep these nerves alive with energy is one of the war jobs now being done by Stancor Transformers. When peace is won, American industry will enter a new age of electronics . . . the transformation of electric power to build and serve a happier world. Stancor engineers are preparing, by foresighted research, to serve the needs of peace after victory.

## S T A N C O R



STANDARD TRANSFORMER CORPORATION - 1500 NORTH HALSTED STREET - CHICAGO



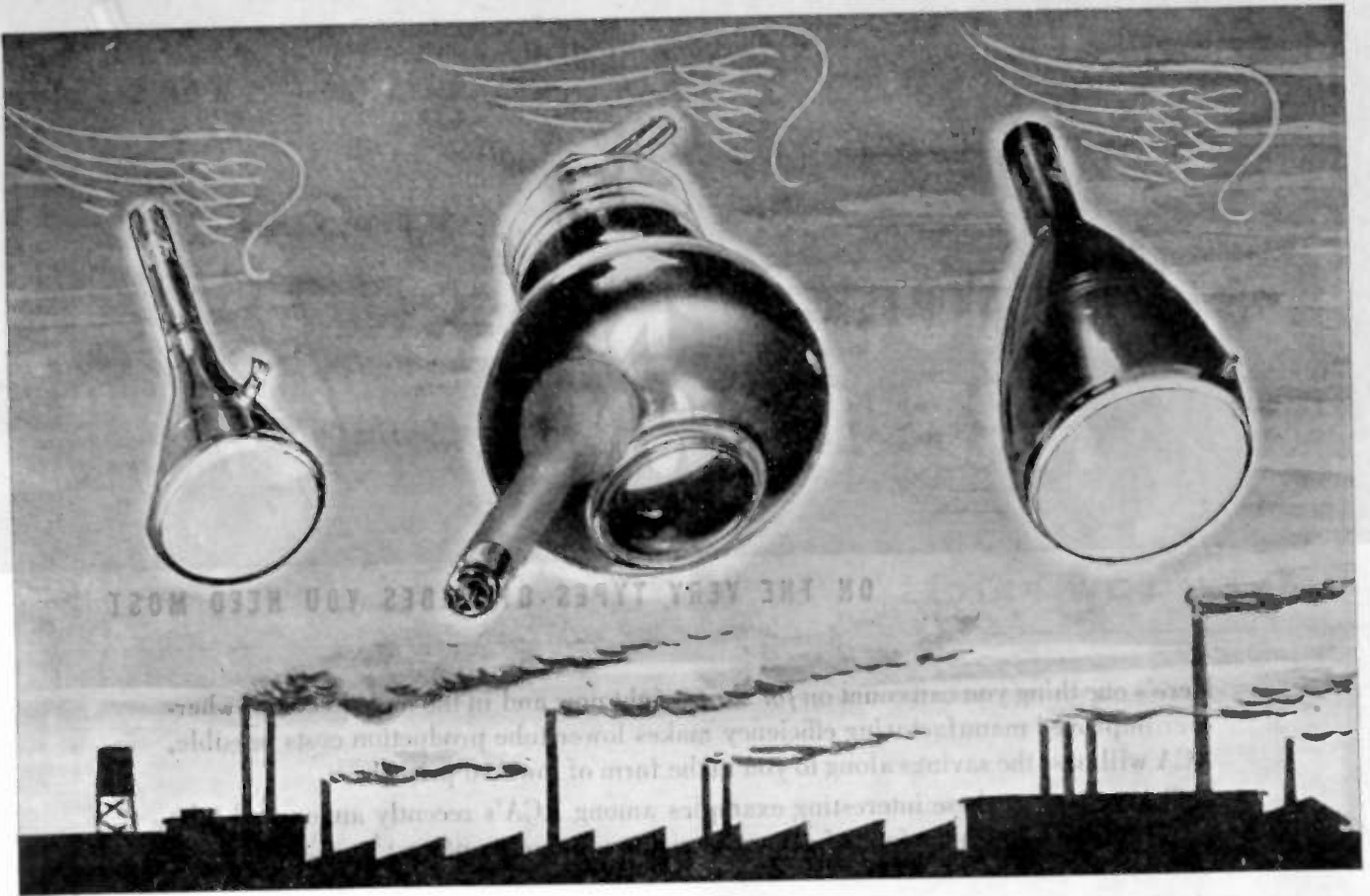

## Every tube has its mission

No single tube can serve the many and diversified applications of electronics in war and industry. Because their purposes vary widely, so must size, shape and power. Every tube has its mission . . . every purpose its specially designed and engineered tube. RAULAND engineers have dedicated their time and combined skill to the development of electronic tubes for the unending uses of this new science . . . with an impressive record of achievements ranging from the large cathode ray television tube which made possible televised projection on 15 foot x 20 foot screens . . . to the tiny tube with power out of all ratio to its size. Forward looking research is ceaselessly going on in RAULAND laboratories today to help clear the way for industrial progress tomorrow.

RADIO...SOUND...

# Rauland

...COMMUNICATIONS

*Electroneering is our business*

THE RAULAND CORPORATION . . . CHICAGO, ILLINOIS

Buy War Bonds and Stamps! Rauland employees are still investing 10% of their salaries in War Bonds



Meat, Vegetables and Groceries

are going **UP**... but

# RCA TUBE PRICES ARE DOWN!



**NEW LOW PRICES ON THE VERY TYPES OF TUBES YOU NEED MOST**

Here's one thing you can count on *for sure*—right now and in the days to come: wherever improved manufacturing efficiency makes lower tube production costs possible, RCA will pass the savings along to you in the form of lowered prices!

Take a look at these interesting examples among RCA's recently announced tube price reductions—in the face of generally rising commodity prices:

| Type      | DESCRIPTION   | Old Price* | Present Price | Here's What You Save |
|-----------|---|------------|---------------|----------------------|
| 803       | R-f power amplifier pentode; plate dissipation, 125 watts; RCA's biggest pentode.                                 | \$28.50    | \$25.00       | \$3.50               |
| 807       | Beam power amplifier; full power output with very low driving power.  | 3.50 †     | 2.25          | 1.25                 |
| 833-A     | Amplifier and oscillator; one of RCA's most powerful glass-type triodes.  | 85.00      | 76.50         | 8.50                 |
| 837       | Heater-cathode type pentode r-f power amplifier, frequency-multiplier, oscillator; designed for exacting service. | 7.50       | 2.80          | 4.70                 |
| 872-A/872 | Half-wave mercury-vapor rectifier; max. rating, 10,000 peak inverse volts.  | 11.00      | 7.50          | 3.50                 |

\*October, 1941. Between Oct. 14, '41, and Mar. 15, '43, food prices have increased 24% (U. S. Dept. of Commerce Bulletin). RCA Transmitter Tube prices, on the other hand, have been materially reduced — an example of RCA's policy of passing the benefit of production economies on to its customers.  
 † This price was reduced to \$2.50 June 1, 1942.



For complete information write for copy of latest RCA Tube Price List.



## RCA ELECTRON TUBES

TUBE & EQUIPMENT DEPT., RCA VICTOR DIVISION, RADIO CORPORATION OF AMERICA, CAMDEN, N. J.

---

# John Stone Stone

1869-1943

Radio, and the field of electric communications more generally, lost an outstanding personality and a pioneer inventor-scientist with the passing of John Stone Stone at San Diego, California, on May 20, 1943.

Born in Dover, Virginia, September 26, 1869, son of a soldier-engineer, Stone spent his early boyhood in Egypt and Europe, and then studied at Columbia and at Johns Hopkins at the time of the great Professor Rowland. He proved to be an apt student of the sciences, and was impressed with the early rapid development of the telephone and with the scientific beauty of electric-wave propagation especially as shown in the scientific experiments of Hertz. These early impressions appeared to have left upon Stone a lifelong imprint, for his many original contributions, as exemplified in some 144 patents granted to him, were concerned primarily with electric-wave propagation both along wires and in free space.

Stone's career developed in four phases. First, was his early service in the Laboratories of the American Bell Telephone Company of Boston from about 1890 to 1899. That he early gave evidence of analytical ability and originality is indicated in his first patent, No. 487,102 applied for in 1891 and issued the following year. In it we find him drawing a distinction between the direct-current supply of a microphone telephone transmitter, and the alternating-current products of modulation, separating the two components much as we today separate the carrier and the sidebands in high-frequency telephony. In his early telephone work Stone contributed inventions on the common battery telephone, on the overcoming of reflection losses in telephone lines by means of loading, and on the application of the phenomenon of electrical resonance to the selecting of the individual channels of early carrier-current multiplex systems.

In the second step of his career we find Stone developing his lively interest in the telephone, with its simultaneous transmission of the many frequency components of the human voice, to the technique of multifrequency transmission by means of space waves and this on his own account, and through his own company, the Stone Telegraph and Telephone Company. It appears to have been the high-frequency experiments of Lodge and the adaptation of space electric waves to the purposes of practical communication as initiated by Marconi that led Stone into the radio field. This was at the turn of the century, before the day of the vacuum tube, and unfortunately there was not then available to radio an adequate group of the physical tools to enable it to be carried on as a successful business, and the Stone Company failed. But this was not until Stone himself had made important technical contributions, as witnessed by many patents, toward the goals of the day—those of continuous-wave operation, of the more selective working of space radio, and the attaining of radiotelephony.

It was in this period, around the turn of the century, that Stone did his pioneering work on increasing the persistence of oscillation of radio waves by the use of highly resonant closed circuits loosely coupled to the antennas and pointed the way to the more highly selective phase of radio. Interestingly enough, and unfortunately only after his death, the Supreme Court of the United States handed down a decision giving to Stone and his Patent No. 714,756, applied for on February 8, 1900, the credit for the subject matter of the famous Marconi 4-circuit tuning patent. (Supreme Court Opinion announced June 21, 1943, in Marconi Wireless Telegraph Co. versus United States, No. 369; and United States versus Marconi Wireless Telegraph Co., No. 373.)

In the third chapter of Stone's career he carried on as an independent consultant. In this role he aided his friend deForest in recognizing the probable importance of the audion as a prospective



telephone amplifier and in bringing it to the attention of the Telephone Company. This was in 1912. At the same time he published what is perhaps the most remarkable of his technical papers, that entitled "The Practical Aspects of the Propagation of High Frequency Electric Waves Along Wires" which appeared in the October, 1912, number of the *Journal of the Franklin Institute*. It was in this paper that he hailed high-frequency wire telephony as a new art and sketched so beautifully the main technical considerations of it. Also it was in this paper that there appeared as a footnote what is perhaps the first recognition in print of the use of deForest's audion as an amplifier, in these words: "A new telephone relay amplifier has recently been discovered which is entirely electrical in its action, having no moving parts whatever. It is productive of great amplification, and it appears to do this without appreciably distorting the telephone current."

In the final chapter of his career, Stone again joined forces with the Telephone Company as a consultant and inventor, in the period from 1920 to the time of his retirement in 1934. This period is characterized by original contributions in the field of high-frequency long-distance directive (beam) transmission. The nature of these contributions is illustrated by what is perhaps the greatest of this series of inventions, that of an antenna array in which vertical directivity is imparted to the beam for the first time by means of dipoles stacked vertically, one above the other. This is the subject of his U. S. Patent No. 1,683,739 (Filed November 2, 1921) which is quite early in the short-wave long-distance art. In fact Stone may be said to be the father of the three-dimensional antenna array such as is used for long-distance beam transmission.

Very much of an individualist, possessed of an interesting personality, of an artistic temperament, a gracious sense of humor, and a high sense of honor, Stone lived a good life. Well trained technically and given to the classical scientific method of analysis as it were, Stone was one of the last of the pioneers who witnessed the very inception of radio and gave his whole life to it and lived to see it flower into a great industry. A past president of one of the two predecessor societies of The Institute of Radio Engineers, the Society of Wireless Telegraph Engineers of Boston, a Past President of the Institute itself, and recipient of its Medal of Honor, a major pioneer passes from our midst.

---

# Your Institute

## A Message to the IRE Membership From the Board of Directors:

The responsibility for administering the affairs of The Institute of Radio Engineers in the best interests of its membership has become increasingly heavy through the years. From a handful the Institute has grown to a membership exceeding 10,000. Its activities have increased widely and its problems have multiplied correspondingly. The Board of Directors and the Executive Committee devote several tens of meetings each year to consideration of the affairs of the Institute. However conscientiously and thoughtfully such work may be done, it is inevitable that its results may occasionally be inadequate or susceptible of improvement. Primarily this message to the membership is one of friendliness, of a plea for expressions of opinion concerning the activities and plans of the Institute, and for comments on any of its procedures. Through such messages from the membership to the Board there may flow great good to the Institute and better understanding between the membership and its representatives.

The principles which have guided the Board are simple. It is believed that The Institute of Radio Engineers has primarily the following objects. It should afford to the membership, locally, regionally, and nationally, the opportunity to foregather in frank and friendly discussion of technical and welfare questions. It should supply to the members an engineering journal of high technical standards and major practical worth. It should set up appropriate technical committees whose aims should be to improve terminology, graphical and literal symbols, tests, and standards in the radio-and-electronic field. It should engage in any activities which fall reasonably within the purview of an engineering society including the maintenance of the welfare of radio-and-electronic engineers and the promotion of their best technical and related personal interests. It should maintain close contact between the membership and their official representatives on the Board to the end that a truly democratic administration of the Institute is continually and judiciously being planned and administered. These, then, are the main articles in the Institute's unwritten charter of opportunity.

Fair consideration of the work and standing of the Institute will lead candid men to admit that, in the main, its objects are being measurably fulfilled. It is too much to expect that they shall be fully carried out at any time. But whenever the membership shall convey its viewpoints and proposals to the directors, independently or collectively, the Institute will be helped to flourish and its members will derive increased benefit from its existence. In this spirit of shoulder-to-shoulder co-operation and friendliness, the Board seeks the thoughts of the membership concerning the present work of the Institute, its accomplishments, the paths it should choose in the future, and the aims it should pursue. The response of the membership most certainly will add to the unity of action and spirit of the Institute.

For the Board of Directors  
*Lynde P. Wheeler, President*



# Color Television—Part II\*

P. C. GOLDMARK†, FELLOW, I.R.E., E. R. PIORE‡, MEMBER, I.R.E.,  
J. M. HOLLYWOOD\*\*, MEMBER, I.R.E., T. H. CHAMBERS\*\*\*,  
ASSOCIATE, I.R.E., AND J. J. REEVES\*\*, ASSOCIATE, I.R.E.

*Summary*—Part I of this paper included the fundamentals of the Columbia Broadcasting System color-television system and the general application of colorimetry to color television. The equipment used in this color method was described.

Part II deals with improved receiver-tube phosphors and the attendant changes in transmitter color characteristics. The color-reproduction theory is extended to include changes in gamma and the action of the color mixer. An automatic color-phasing system is described. Sixty-cycle interference in viewing tubes and its prevention are reported as investigated. Work on the problem of increasing definition of color television by use of a wider frequency band is described, and some considerations of certain possibilities of large-screen color-television pictures are given.

## INTRODUCTION

WHILE PART I of this paper<sup>1</sup> dealt largely with the general theory and the equipment employed in the Columbia Broadcasting System color-television system, Part II is mostly concerned with certain improvements which were carried out simultaneously with a daily experimental color-television broadcast schedule. Reference is made to work initiated on the utilization of this system for a wider frequency band, with corresponding increase in definition.

In April, 1942, the laboratories and the entire staff were called upon to become active in certain phases of radio warfare. Naturally, all work on color television was shelved immediately and thus some sections of Part II of this paper are necessarily incomplete.

## I. COLOR

The general application of colorimetry to color television was presented in Part I. The emphasis was on the spectral characteristics of the filters at the transmitter and the variation introduced by the "hangover" phenomenon, which is caused by incomplete discharge of the orthicon pickup tube. In Part II, these data, as modified by the use of a more desirable phosphor combination in the receiver tube, will be presented. Some indication of the variation of the transmitter color characteristics as a new set of primary colors at the receiver is chosen will be given. Also the action of the color mixer and the limitations of the color reproduction of the over-all system will be discussed in greater detail.

\* Decimal classification: R583. Original manuscript received by the Institute, February 10, 1943.

† Columbia Broadcasting System, Inc., New York, N. Y., and Radio Research Laboratory of Harvard University, Cambridge, Mass.

‡ Formerly, Columbia Broadcasting System, Inc., now, Navy Department, Bureau of Ships, Washington, D. C.

\*\* Columbia Broadcasting System, Inc., New York, N. Y.

\*\*\* Formerly, Columbia Broadcasting System, Inc., now, Naval Research Laboratories, Anacostia Station, D. C.

<sup>1</sup> P. C. Goldmark, J. N. Dyer, E. R. Piore, and J. M. Hollywood, "Color television—Part I," *Proc. I.R.E.*, vol. 30, pp. 162-182; April, 1942.

At this stage of the development of the art the aim was not to obtain the closest possible matching between certain colors of the objects in the original scenes and the corresponding colors visible through the filters at the receiver, but rather to reproduce the colors with only reasonable accuracy but over as wide a range in the spectrum as possible without impairing the information and entertainment value of the picture. A certain amount of mismatching of colors is permissible and even may be desirable. The limits of the mismatching can only be determined by extensive experimentation and field tests. The available data<sup>2</sup> on matching are restricted to color comparisons under prescribed conditions, usually one color with a white, gray, or black background. The application of these data to the present problem is limited since in color television the criterion is not the matching of every individual color in the scene, but the over-all effect. The general relation between various colors must be maintained, although colors at the receiver are mismatched with the corresponding colors in the original scene.

### Phosphor Mixture

It was desirable for a number of reasons (as stated in Part I), to have at the receiver a combination of phosphors and filters which, in order to furnish white of a certain color temperature, would require three equal signals on the grid of the cathode-ray tube. A phosphor composed of a mixture of 42.5 per cent Patterson No. 70, a blue phosphor; 45 per cent Patterson No. 62, a yellow-green phosphor; and 12.5 per cent Patterson No. 19, a red phosphor, gives a fair approximation to the desired result. These powders were zinc and zinc cadmium sulphides. They were mixed mechanically and dusted on the tube face. A spectral distribution curve obtained from an average tube is shown in Fig. 1. The comparison of this curve with Fig. 3 of Part I shows that the peak in the blue has been reduced, while the minimum in the blue-green is now less pronounced and at the same time has been shifted towards the blue.

The criterion for whiteness is best visualized by means of the unified trichromatic coefficient diagram, (color triangle). Using equation (3) of Part I and taking for  $P(\lambda)$  in that equation the values given in Fig. 1, we obtain for  $r=g=b$  (three equal signals) the tristimulus values for "white," which can be converted to trichromatic coefficients. The latter are represented by point A in Fig. 2. The Wratten filters used in the calculation were blue No. 47, green No. 58, and red

<sup>2</sup> D. L. MacAdam, "Visual sensitivities to color differences in daylight," *Jour. Opt. Soc. Amer.*, vol. 32, pp. 247-274; May, 1942.

No. 26. Comparing point *A* with point *W* in Fig. 2 (white defined by  $X = Y = Z$ ) shows that the former is bluish. The closest color temperature to point *A* is approximately 6500 degrees Kelvin. The improvement of point *A* over the original phosphor mixture repre-

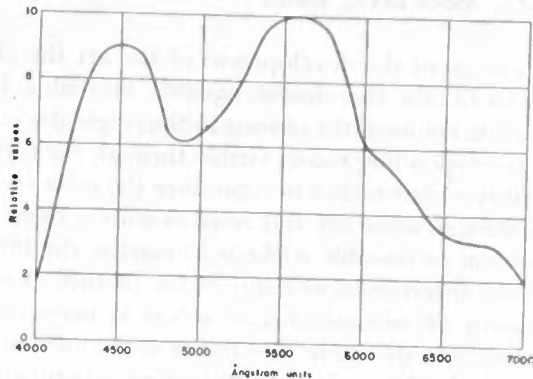

Fig. 1—Spectral characteristic of an experimental phosphor.

sented by point *B* is quite marked. The spectral characteristic of the phosphor designated by *B* was given in Fig. 3 of Part I.

The flicker analysis for the new phosphor is still valid. The ratio of the *Y*'s that are to be used in equations (10) to (17) of Part I is  $Y_b : Y_g : Y_r = 1 : 12.6 : 3.95$ . Therefore, the maximum permissible screen brilliance, to avoid flicker, is found to be 2.5 apparent foot-candles.

#### Characteristics at the Transmitter

The use of the new phosphor mixture has, in effect, introduced a new set of three primary colors. These primary colors give a slightly different gamut of colors than that determined by phosphor *B* in Part I. With both phosphors the same Wratten filters were used: No. 47 blue, No. 58 green, and No. 26 red. The two conditions shown in Fig. 2 differ in the boundary regions. The three primaries determined by phosphor *A* (latest mixture) lose slightly in purity in the yellow and purple region, yet gain in the blue-green region as compared with phosphor *B*. There is a definite theoretical advantage of *A* over *B* when one considers that the eye is more sensitive to color changes in the blue-green region than in the yellow and purple region.<sup>2</sup> In practice the actual superiority of one gamut over another can best be determined by extensive tests on a variety of program material. Phosphors *A* and *B* were thus compared to a limited extent and as a result it was found that apart from a more superior "white" when using the *A* mixture, the difference in available and reproducible colors was not strikingly noticeable.

The choice of a set of new primary colors involves a change in the corresponding spectral characteristics at the transmitter. To make the analysis slightly more extensive, the spectral characteristics at the transmitter were calculated for two additional sets of primaries, *C* and *D*. The set *C* is composed of Wratten filters Nos. 47, 58, and 26, and presupposes that the phosphor has uniform spectral response in the visual region.

The set *D* is composed of Wratten filters Nos. 47, 61, and 29 and again a phosphor with uniform spectral response in the visual region. *C* and *D* differ essentially in the width of the spectral band covered by the primaries. In Fig. 2 the gamut of colors determined by the *C* and *D* primaries is shown as triangles *C* and *D*. The points *C* and *D* in the same figure represent the "whites" obtained with three equal signals. The color triangle formed by the *D* set is the largest since *D* contains the purest primaries.

The transmitter spectral characteristics for *A*, *C*, and *D* appear in Figs. 3, 4, and 5 respectively. The corresponding curves for *B*, as well as the method of constructing the curves, can be found in Fig. 4 of Part I.

In all these calculations the separation between points was taken every 100 angstrom units. The curves have the same general appearance. The wavelengths at which the maxima for the respective red, blue and green curves occur are the same within 30 angstrom units for all four sets, *A*, *B*, *C*, and *D*. This also applies to the zero points on the wavelength axis as well as the minima points. This result gives some indication of the permissible latitude in changing color primaries (standards) at the receiver without necessitating a corresponding change in the color standards at the transmitter. The remaining difference in relative amplitudes of the respective set of curves can be readily compensated with the aid of the color mixer.

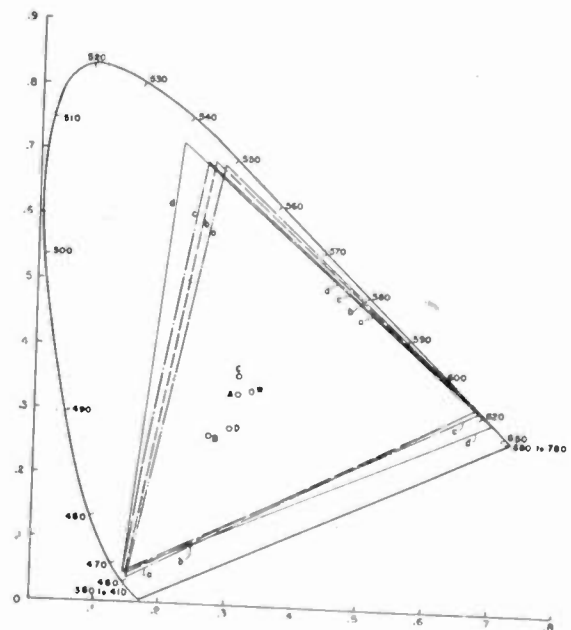

Fig. 2—Unified trichromatic coefficient diagram: the gamut of colors enclosed by primary sets *A*, *B*, *C*, and *D*.

The slight changes involved in the shape of color curves at the transmitter are related to the fact that the various sets of primaries are chosen in limited spectral regions; they are localized in restricted areas in the unified trichromatic diagram. In the present system the Wratten filters are the confining factors. Curves similar to Figs. 3, 4, and 5 have been computed

by others<sup>3,4</sup> for additive reproduction processes using three primary colors. Such curves match the shapes of the corresponding curves given here very closely and the primaries chosen, which are in a more logical region in the color triangle for that particular type of reproduction, differ only slightly in their position in the triangle from the location of sets, *A*, *B*, *C*, and *D*.

It is gratifying to know that the transmitter spectral characteristics are only slightly changed as the spectral response at the receiver is shifted, for it gives some indication of the permissible tolerance in manufacturing cathode-ray tubes. It has been found that the color characteristics of cathode-ray tubes can be

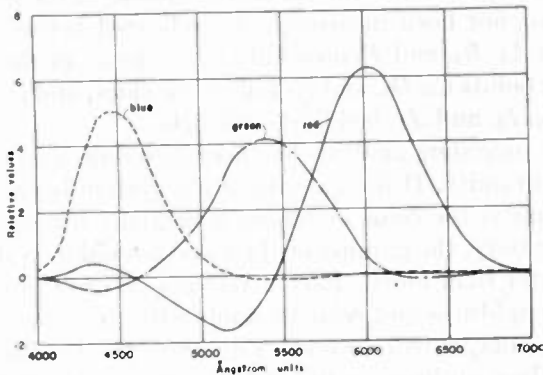

Fig. 3—Spectral characteristics at transmitter; primaries *A*.

specified satisfactorily with readings obtained on a Weston No. 2 cell through filters Nos. 47, 58, and 26. For phosphor *A* the average relative readings were 2.6 through filter No. 47, 3.16 through filter No. 58, and 2.43 through filter No. 26.

**Color Reproduction**

The computed transmitter curves, Figs. 3, 4, and 5, all exhibit negative ordinates. There is no provision in the television system to reproduce these values. Thus, even within the gamut of colors enclosed by the tri-

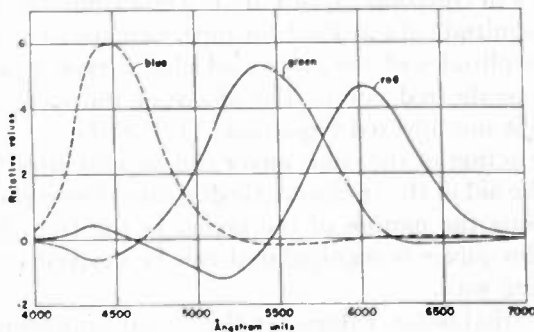

Fig. 4—Spectral characteristics at the transmitter; primaries *C*.

angle which is formed by the three primaries, there is falsification of colors. Within the triangle the positive contribution is larger than the negative. However,

<sup>3</sup> D. L. MacAdam, "Photographic aspects of the theory of three-color reproduction," *Jour. Opt. Soc. Amer.*, vol. 28, pp. 399-418; November, 1938.

<sup>4</sup> A. C. Hardy and F. C. Wurzburg, Jr., "The theory of three-color reproduction," *Jour. Opt. Soc. Amer.*, vol. 27, pp. 227-240; July, 1937.

colors that in nature appear outside the triangle, are reproduced with the television system inside the triangle. For the latter type of mismatching there exists no compensating mechanism. For the former, however, the color mixer and a gamma other than unity will

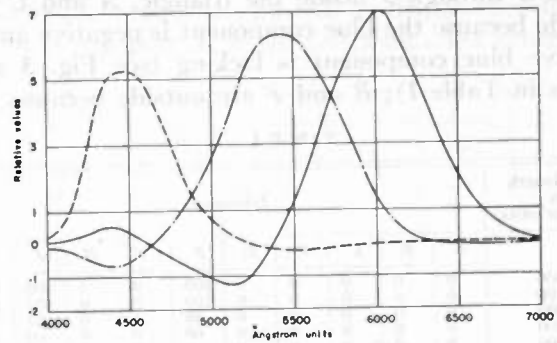

Fig. 5—Spectral characteristics at the transmitter; primaries *D*.

furnish improvement. In Fig. 6 an attempt is made to illustrate the operation of the present system.

At this time it would be well to point out that there is good reason to suppose that if negative values cannot be utilized, the best transmitter spectral characteristics are represented by the positive portions of the computed curves.

Points *A* to *J* in Fig. 6 were chosen arbitrarily to illustrate the color-reproduction mechanism. Their spectral emission data are given in Table I. At the

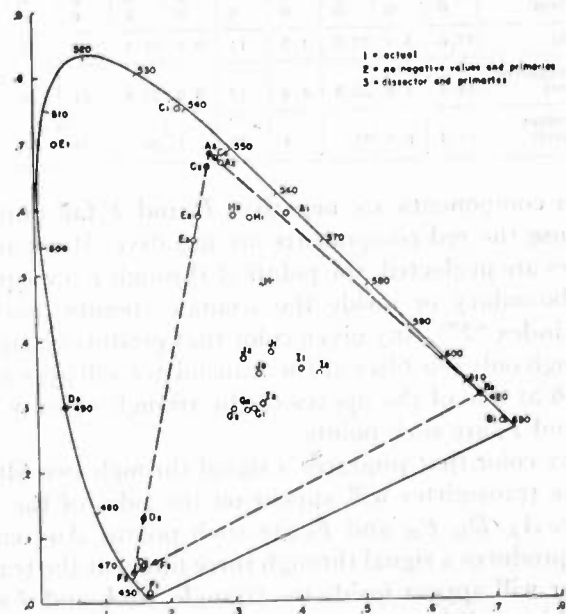

Fig. 6—Comparison of color reproduction.

bottom of the table the luminosity data of the various points are also listed. The points in Fig. 6 marked with index "1" are the colors as they appear to the eye. They were obtained by performing the operation indicated by equation (2), Part I.

Points *A*<sub>3</sub>, *B*<sub>3</sub>, and *F*<sub>3</sub> form a color triangle which corresponds to the use of phosphor *A* combined with Wratten filters Nos. 47, 58, and 26 as primaries.

The points marked with index "2" were constructed by utilizing only positive portions of the curves drawn in Fig. 3 while phosphor A with Wratten filters Nos. 47, 58, and 26 were used as the primaries.

The eye places points A through F outside and points G through J inside the triangle. A and C are outside because the blue component is negative and a positive blue component is lacking (see Fig. 3 and values in Table I); B and F are outside because the

to 5200 angstrom units will appear as the green apex of the triangle, A<sub>3</sub>; and colors confined to 4800 to 4000 angstrom units will appear at the blue apex of the triangle, F<sub>3</sub>. For the orthicon, the corresponding regions are 6700 to 6300, 5700 to 5300, and 4600 to 4000 angstrom units. Thus, under actual operating conditions a greater number of colors will appear at the apexes and along the sides of the triangle than with the closest approximation to conditions shown in Fig. 3, (i.e., neglecting the negative values).

The points marked with index 3 indicate the colors in Table I as viewed with a dissector (see Fig. 6, Part I). Thus far calculations have been made for the dissector only, because the spectral response of the orthicon has not been measured. As indicated before, the points A<sub>3</sub>, B<sub>3</sub>, and F<sub>3</sub> now fall at the apexes of the triangle; points C<sub>3</sub>, D<sub>3</sub>, and E<sub>3</sub> fall on the sides, and points G<sub>3</sub>, H<sub>3</sub>, I<sub>3</sub>, and J<sub>3</sub>, inside the triangle.

The preceding analysis has been based on a gamma equal to unity. If the gamma of the system is greater than unity, the color matching is partially improved.<sup>2</sup> Fortunately, the gamma of the color-television system is greater than unity. This introduces an error in contrast brightness and relative luminosity; however, the colors appear more vivid. Equation (5) in Part I shows how an increase in gamma improves the purity of the colors. The coefficients r, g, and b are now raised to some power greater than 1 and thus the contribution from the largest coefficient is increased. The corresponding shift in the trichromatic diagram will be towards the apex of the triangle. If r is the largest coefficient, the shift will be towards the red apex, etc. Since the points are moved toward the triangle boundaries, the colors in the reproduced scene are more saturated than in the original scene.

Another mechanism available in television to improve color matching is the color mixer. The color mixer changes the relative values of the coefficients r, g, and b in equation (5) of Part I. The manipulation of the magnitude of r at the transmitter changes the relative amplitudes of the green and blue curves, as compared to the red curve. The shape of the individual curves is not affected (equation (9), Part I).

The action of the color mixer can be visualized best with the aid of the trichromatic diagram. The equation governing the motion of the points in the triangle as the color mixer is manipulated can be derived in the following way.

The tristimulus values for the signal appearing at the receiver are

$$\begin{aligned} X &= a_{11}r + a_{12}g + a_{13}b \\ Y &= a_{21}r + a_{22}g + a_{23}b \\ Z &= a_{31}r + a_{32}g + a_{33}b \end{aligned} \tag{1}$$

r, g, b and the a<sub>i</sub>'s are defined in Part I.

The trichromatic coefficients are given by

$$\begin{aligned} x &= (a_{11}r + a_{12}g + a_{13}b)/S = X/S \\ y &= Y/S \\ x + y + z &= 1 \end{aligned} \tag{2}$$

TABLE I

| Wavelength in Angstrom units | Intensity |     |      |     |     |     |      |     |     |     |
|------------------------------|-----------|-----|------|-----|-----|-----|------|-----|-----|-----|
|                              | A         | B   | C    | D   | E   | F   | G    | H   | I   | J   |
| 4000                         | 0         | 0   | 0    | 0   | 0   | 100 | 0    | 0   | 100 | 100 |
| 100                          | 0         | 0   | 0    | 0   | 0   | 100 | 0    | 0   | 100 | 100 |
| 200                          | 0         | 0   | 0    | 0   | 0   | 80  | 0    | 0   | 80  | 80  |
| 300                          | 0         | 0   | 0    | 0   | 0   | 60  | 0    | 0   | 60  | 60  |
| 400                          | 0         | 0   | 0    | 0   | 0   | 0   | 0    | 0   | 0   | 0   |
| 500                          | 0         | 0   | 0    | 0   | 0   | 0   | 50   | 0   | 0   | 50  |
| 600                          | 0         | 0   | 0    | 0   | 0   | 0   | 100  | 0   | 0   | 100 |
| 700                          | 0         | 0   | 0    | 0   | 0   | 0   | 50   | 0   | 0   | 50  |
| 800                          | 0         | 0   | 0    | 0   | 0   | 0   | 0    | 0   | 0   | 0   |
| 900                          | 0         | 0   | 0    | 70  | 0   | 0   | 0    | 70  | 0   | 70  |
| 5000                         | 0         | 0   | 0    | 0   | 100 | 0   | 0    | 0   | 100 | 100 |
| 100                          | 0         | 0   | 0    | 0   | 90  | 0   | 0    | 0   | 90  | 90  |
| 200                          | 0         | 0   | 40   | 0   | 50  | 0   | 0    | 40  | 50  | 90  |
| 300                          | 0         | 0   | 60   | 0   | 0   | 0   | 0    | 60  | 0   | 60  |
| 400                          | 0         | 0   | 100  | 0   | 0   | 0   | 0    | 100 | 0   | 100 |
| 500                          | 40        | 0   | 50   | 0   | 0   | 0   | 40   | 50  | 0   | 90  |
| 600                          | 60        | 0   | 0    | 0   | 0   | 0   | 60   | 0   | 0   | 60  |
| 700                          | 80        | 0   | 0    | 0   | 0   | 0   | 80   | 0   | 0   | 80  |
| 800                          | 0         | 0   | 0    | 0   | 0   | 0   | 0    | 0   | 0   | 0   |
| 900                          | 0         | 0   | 0    | 0   | 0   | 0   | 0    | 0   | 60  | 60  |
| 6000                         | 0         | 0   | 0    | 0   | 0   | 0   | 100  | 0   | 70  | 70  |
| 100                          | 0         | 0   | 0    | 0   | 0   | 0   | 0    | 0   | 80  | 80  |
| 200                          | 0         | 0   | 0    | 0   | 0   | 0   | 0    | 0   | 100 | 100 |
| 300                          | 0         | 0   | 0    | 0   | 0   | 0   | 0    | 0   | 0   | 0   |
| 400                          | 0         | 100 | 0    | 0   | 0   | 0   | 0    | 100 | 0   | 100 |
| 500                          | -0        | 100 | 0    | 0   | 0   | 0   | 0    | 100 | 0   | 100 |
| 600                          | 0         | 50  | 0    | 0   | 0   | 0   | 0    | 50  | 0   | 50  |
| 700                          | 0         | 50  | 0    | 0   | 0   | 0   | 0    | 50  | 0   | 50  |
| 800                          | 0         | 0   | 0    | 0   | 0   | 0   | 0    | 0   | 0   | 0   |
| 900                          | 0         | 0   | 0    | 0   | 0   | 0   | 0    | 0   | 0   | 0   |
| 7000                         | 0         | 0   | 0    | 0   | 0   | 0   | 0    | 0   | 0   | 0   |
| Y (true)                     | 17.6      | 3.3 | 22.5 | 1.5 | 11  | 0.1 | 25.1 | 27  | 31  | 83  |
| Y (no negative values)       | 14.2      | 3.9 | 22.5 | 4.4 | 13  | 0.9 | 24.8 | 31  | 30  | 86  |
| Y (disssector channel)       | 12.3      | 1.5 | 31.  | 1   | 24  | 1   | 20   | 34  | 36  | 90  |

green components are negative; D and F fall outside because the red components are negative. If negative values are neglected, the points A through F appear on the boundary or inside the triangle (points marked with index "2"). Any given color that produces a signal through only one filter at the transmitter will appear in Fig. 6 at one of the apexes of the triangle. Points A<sub>3</sub>, B<sub>3</sub>, and F<sub>3</sub> are such points.

Any color that produces a signal through two filters at the transmitter will appear on the sides of the triangle. A<sub>2</sub>, D<sub>2</sub>, E<sub>2</sub>, and F<sub>2</sub> are such points. Any color that produces a signal through three filters at the transmitter will appear inside the triangle, G, I, and J satisfy this condition.

In actual practice the filters at the transmitter, besides lacking the negative values, do not have the secondary maxima as indicated in Fig. 3, for the red filter in the blue region, and the blue filter in the red region. In addition, the filters actually used do not overlap to the same extent. The Wratten filters used with the dissector are Nos. 47, 58, and 25, and with the orthicon, Nos. 47, 57, and 25. With the daylight dissector, colors confined to 7000 to 6200 angstrom units will appear in Fig. 6 as the red primary, B<sub>3</sub>; colors confined to 5700



where 
$$S = \sum_{j=1}^3 (ra_{j1} + ga_{j2} + ba_{j3}). \quad (3)$$

If  $r$  is changed to  $cr$ , then the new trichromatic coefficients are

$$\begin{aligned} x' &= \frac{X - a_{11}r(1 - c)}{S - R(1 - c)} \\ y' &= \frac{Y - a_{21}r(1 - c)}{S - R(1 - c)} \\ x' + y' + z' &= 1 \\ R &= r(a_{11} + a_{21} + a_{31}). \end{aligned} \quad (4)$$

where

Combining (2) and (4),

$$\begin{aligned} x - x' &= \frac{(1 - c)(a_{11}r - xR)}{S - R(1 - c)} \\ y - y' &= \frac{(1 - c)(a_{21}r - yR)}{S - R(1 - c)}. \end{aligned} \quad (5)$$

Combining the two sets of equations above,

$$y' = \frac{y - y_r}{x - x_r} x' + \frac{y_r x - x_r y}{x - x_r} \quad (6)$$

where  $x_r$  and  $y_r$  are the co-ordinates of the red primary defined by

$$x_r = \frac{a_{11}}{a_{11} + a_{21} + a_{31}} \quad \text{and} \quad y_r = \frac{a_{21}}{a_{11} + a_{21} + a_{31}}$$

Equation (6) is the equation of a straight line passing through the points  $xy$  and  $x_r y_r$ . As the red signal is changed by a factor  $c$ , the color is shifted in the trichromatic diagram from the point  $xy$  to a new point  $x' y'$ , both of which are located on a straight line as defined by (6). Changing the amplitudes of two primaries at the color mixer can be visualized as taking place in two steps. These operations are shown in Fig. 7. Point  $A$  is the original color.  $A_g$  corresponds to an increase of the green amplitude for color  $A$ .  $A_r$  corresponds to the increase of the red amplitude. If both are applied, or the blue amplitude correspondingly decreased, the new location for  $A$  will be  $B$ . The latter must lie on a straight line going through  $A$  and the blue apex of the color triangle.

If the original signal has a component through each of the filters at the transmitter, the color mixer can shift that color to any place within the triangle. If the original signal has components through not more than two filters, the mixer can move it only along the line joining the two corresponding primaries. If the original signal has only one component, the color mixer has no effect on it.

The above analysis can be made valid for gamma other than unity if the factors  $r$  and  $cr$  are replaced by  $r^n$  and  $(cr)^n$ .

### Color Sequence

There are two available sequences of color: red, blue, and green, or red, green, and blue. The desirability of one sequence over the other arises from the presence of hangover. The color appearing at the receiver at a

given field is a combination of the signal of that field and a partial signal from the preceding field. The hangover is caused by incomplete discharge of the orthicon and, in certain cases, from excessive afterglow of the fluorescent powder. From observations and measurements it was found that the latter effect is negligible for sulphide phosphor and can be disregarded for all practical purposes. It is the contamination caused by

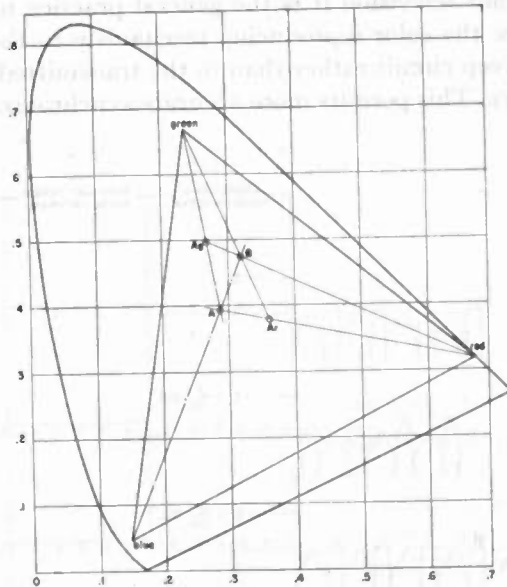

Fig. 7—The action of the color mixer.

the orthicon hangover which forces a choice between the two color sequences.

The experiment that led to the choice of the red, blue, and green sequences is simple. It involved a number of observers, a receiver with a color disk and the color mixer. The red background control of the color mixer was adjusted to give at the receiver a bright, flickerless signal while the green and blue background controls were set at zero. The observer would be asked to manipulate the green control, keeping the blue control at zero until the red at the receiver could no longer be considered a satisfactory red color. The ratio of red to green was measured on an oscilloscope. This procedure was repeated, keeping the green control at zero and manipulating the blue control. Then the blue was kept constant with, first, red as the variable, then green as the variable; and finally green was kept constant with, first, red as the variable, and then blue as the variable. This whole procedure was repeated with each observer. The results are tabulated below. Color matching is not involved in these observations. The question these observations attempt to answer is: Is orange (a mixture of red and a small amount of green) considered to be nearer red than magenta (a mixture of red and a slight amount of blue)?

The table shows that for red and green there is preference for the red-blue-green sequence, while for blue the preference is for a red-green-blue sequence. In view of this the red-blue-green sequence was finally adopted.

TABLE 11

| Color Mixture       | Preference              |
|---------------------|-------------------------|
| Per Cent            | Percentage of Observers |
| 100 red + 15 green  | 60                      |
| 100 red + 15 blue   | 40                      |
| 100 green + 20 blue | 100                     |
| 100 green + 20 red  | 0                       |
| 100 blue + 20 red   | 20                      |
| 100 blue + 20 green | 80                      |

## II. AUTOMATIC COLOR PHASING

In color television it is the general practice to synchronize the color-reproducing mechanism to the vertical sweep circuit rather than to the transmitted color sequence. This permits more accurate synchronization,

temporarily lost, the correct color phasing is assured as soon as the rest of the system is synchronized.

To accomplish automatic phasing the following conditions are necessary:

1. Some fixed point in the color sequence must be identified.
2. The color sequence of both the transmitter and the receiver must be synchronized to this identification.

The identification can be done by means of a synchronizing signal of one third of the field frequency (thus, the color-frame frequency) generated in the

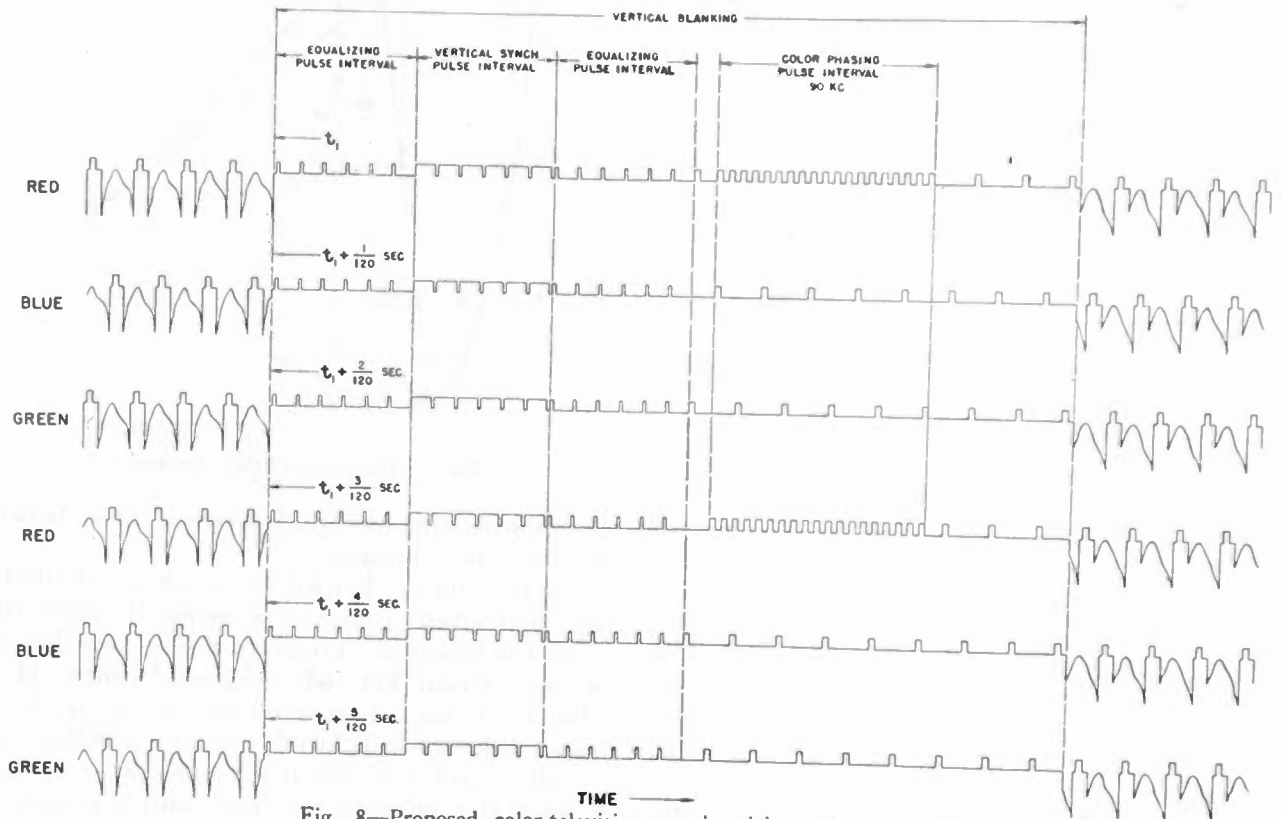

Fig. 8—Proposed color-television synchronizing. 375 lines, 60 frames per second, 120 fields per second, interlaced, 2:1.

but at the same time makes it possible for the color sequence to assume any one of three phases (in a three-color system). That is, while the transmitter is transmitting the signal corresponding to the red color field, the receiver may be showing the picture in either red or blue or green. To overcome this deficiency a push button has been provided which, when operated, removes the synchronization from the color disk until the color sequence drifts into proper phase. Synchronization is then restored and allowed to lock the color disk in the proper phase.

There is a distinct need for performing this operation automatically. This need arises from several factors, foremost among which is the understandable difficulty which the public experiences in performing the operation of hand-phasing. Also, it is highly desirable not to have to rephase by hand when switching from one station to another. Furthermore, if reproduction is

synchronizing signal generator. There are many forms which this signal may take but whatever its form may be, it is necessary that it should not interfere with horizontal or vertical synchronization or with interlacing, and at the same time it must be easily separable from the remainder of the signal at the receiver.

The type of signal developed and proposed as a possible standard is shown in Fig. 8. This will be recognized as the standard National Television System Committee synchronizing signal with the addition of a period of pulses preceding each red field. These pulses are square in shape and occur at four times line frequency. Horizontal synchronization is carried out on the leading edge of every fourth pulse. The pulses occur after the vertical synchronizing signal (when vertical synchronization is completed) and thus do not interfere with vertical synchronization or interlacing. The separation of the pulses at the receiver is carried out

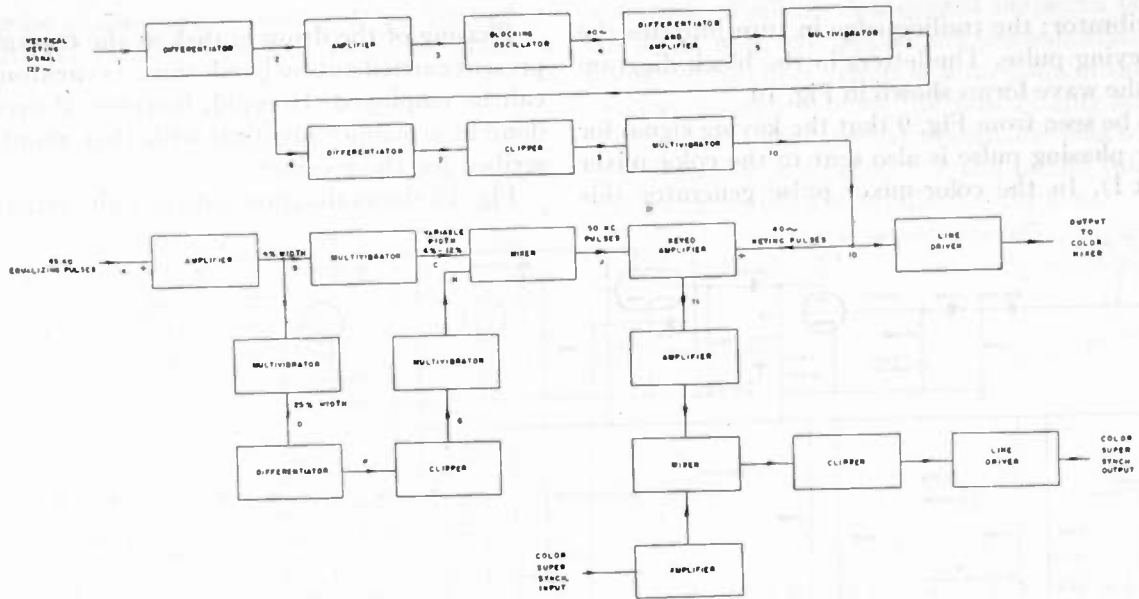

Fig. 9—Color-phasing pulse-generator block diagram.

by selecting, by means of a tuned filter, the 4H (quadruple horizontal frequency) component of the total synchronizing signal. Since the 4H is the fundamental frequency constituting the color-phasing pulses, the energy content at this frequency will be many times that of the horizontal, the equalizing, or the serrated vertical synchronizing pulses. Since a single pulse is

indicated in the diagrams, for operation, the unit requires only the vertical synchronizing-signal keying pulse, continuous unkeyed equalizing pulses, and the composite standard synchronizing signal. Since all of these are generally available, the unit will operate from any ordinary synchronizing signal generator.

The operation of the system can be understood from

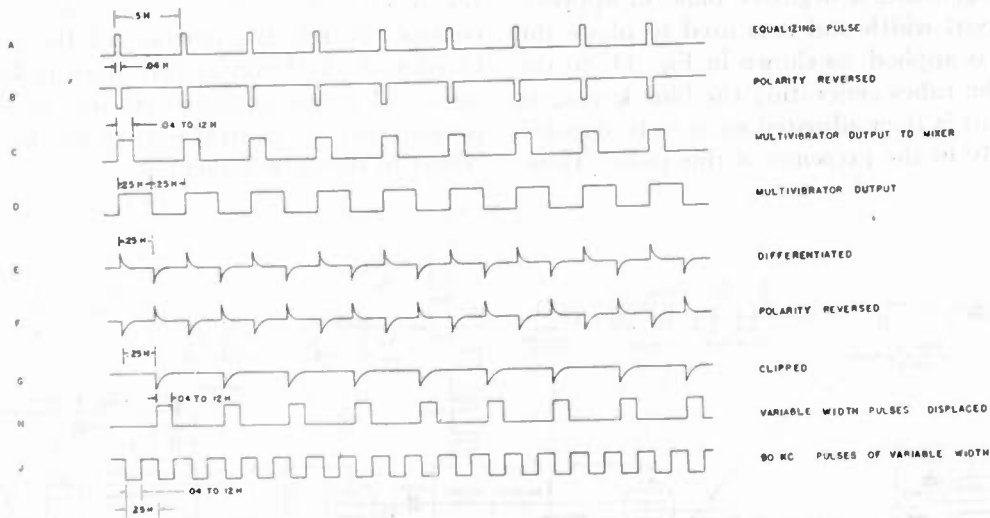

Fig. 10—Color-phasing pulse-generator wave forms.

desirable for actual phasing of the receiver, the output of the filter is rectified.

The circuit for generating the color-phasing signal at the transmitter is shown in block form in Fig. 9. Fig. 10 shows the wave forms appearing at progressive points in this circuit.

The phasing pulse generator was constructed and designed to operate with an RCA synchronizing signal generator revised for color standards.<sup>5</sup> However, as in-

a study of Figs. 9 and 10. The 4H pulses (in the present case, 90 kilocycles) are generated by adding the pulses from two multivibrators. One of these is synchronized to the equalizing pulses (45 kilocycles) directly; the other is synchronized to the trailing edge of a 50 per cent pulse synchronized to the equalizing pulses. Thus the pulses of the second set fall equidistantly between the pulses of the first set, giving a 90-kilocycle repetition rate. To key in these pulses the trailing edge of the vertical keying pulse is used to synchronize a dividing oscillator which gives a pulse every third color field. The leading edge of this pulse synchronizes

<sup>5</sup> A. V. Bedford and J. P. Smith, "A precision television synchronizing signal generator," *RCA Rev.*, vol. 5, pp. 51-69; July, 1940.



40-cycle pulse of about 30 per cent width is applied to the screen grid. This is obtained from a two-sided contactor on the shaft of the 1200-revolution-per-minute color disk.

The wave-shape diagrams in Fig. 12 show how these two pulses add during the in-phase as well as out-of-phase conditions. The combined voltages are fed through a triode clipper and integrator to the grid of a double triode which operates the brake on the color disk. If they are in phase, the brake circuit operates normally, as described in Part I; but if they are out of phase the brake circuit is inoperative and the color disk "drifts" until the in-phase condition is established. The contactor is laid out so that the voltages are in phase over two sectors of about 54 degrees, and out of phase over two sectors of about 126 degrees. Thus operation of the brake is confined to the disk angular position corresponding roughly to the proper phase relation. Exact phase relation is established by the arrangement described in Part I, using the low-frequency synchronizing pulse, a double triode, a 120-cycle shaft generator, and the brake.

The magnetic brake is, in its present form, capable of keeping the color disk in synchronization for alternating-current line variations of from 96 to 124 volts, without indicating to the observer that such a line-voltage change has taken place. Actually, the magnetic brake will hold the disk in synchronization over a total range of from 88 to 132 volts, but if the former limits are exceeded, the edges of the color filters will appear in the picture. The stability of disk synchronization is illustrated in Fig. 13.

### III. SIXTY-CYCLE INTERFERENCE AT THE RECEIVER

As mentioned in Part I, precautions must be taken in color receivers to minimize the effects of 60-cycle magnetic fields and of 60-cycle ripple voltages in power supplies, if pairing of the interlaced lines is to be avoided.

The effectiveness of some materials in shielding against 60-cycle magnetic fields is given in Table III.

TABLE III

| Material  | Shielding Effectiveness |
|---|-------------------------|
|   | Per Cent                |
| Cold rolled steel, 0.035 inch                                     | 83.5                    |
| Silicon sheet steel, 0.015 inch                                   | 93.0                    |
| Silicon sheet steel after hammering                               | 85.0                    |
| The above rolled steel and silicon steel separated by heavy paper | 95.6                    |
| Two sheets silicon sheet steel separated by heavy paper           | 96.5                    |
| Mumetal 0.020 inch heat-treated by torch                          | 94.8                    |
| Mumetal more carefully heat-treated                               | 97.2                    |

In actual practice the shielding seldom forms a closed surface; a shield in the form of a box with the bottom open may be about 60 per cent effective.

The shielding effectiveness of three viewing tube shields is indicated in Fig. 14. Two of these were made of Mumetal built to conform to the shape of the tube with allowance for the scanning and focusing coils, are carefully heat-treated after construction; the third

was made of silicon in a conical shape. In both types the joints were overlapped and riveted. Fig. 14 shows the shielding effectiveness as a function of the position of an exploring coil along the axis. Placing a flat circular sheet of silicon steel at the smaller end with a hole sufficiently large to clear the end of the tube gives a further improvement of about 5 per cent.

Fig. 15 shows the sensitivity of a typical 7-inch viewing tube to extraneous 60-cycle magnetic field, as

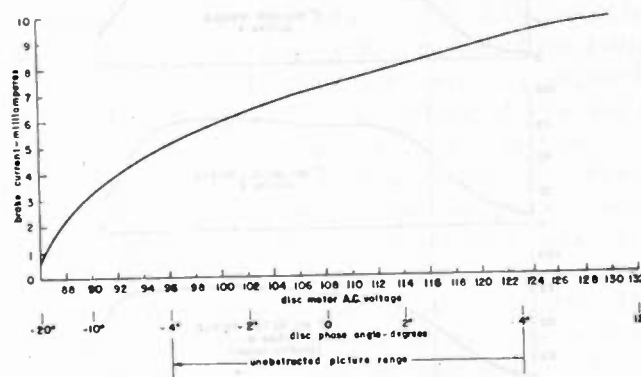

Fig. 13—Brake current versus motor voltage.

a function of the location of the interfering source parallel to and near the tube axis, without shielding and with two types of shields.

Measurements were made of the magnetic fields surrounding the receiver transformers and disk motor. The axis of the pickup coil was kept in a fixed position relative to the transformer or motor. Fig. 16 shows a field contour in one plane containing a typical high-voltage transformer. A large half-shell type of low-voltage power transformer gave a 10-milligauss contour. Fig. 17 shows a 10-milligauss field-strength contour around a typical  $\frac{1}{10}$ -horsepower disk driving motor in a particular plane.

In an effort to correlate field-strength readings with visual observations of interlace pairing, it was established that a table-model color-television receiver with a 7-inch viewing tube gave barely visible pairing at 0.003 gauss root-mean-square and complete pairing at 0.04 gauss root-mean-square. The magnetic field strength was measured at the deflecting yoke of the cathode-ray tube.

Field-strength measurements of 60-cycle magnetic fields in a number of homes and apartments, particularly around electric clocks, refrigerators, lighting systems, and metal beams, showed that these sources interfered only negligibly with interlacing, particularly if the viewing tube were shielded. One exception was the case of an electric clock placed on top of the receiver, and within 8 inches of the viewing tube.

The results of these and other tests lead to some recommendations as to receiver construction. The viewing tube should be shielded either with high-permeability metal, heat-treated after fabrication, or with cold-rolled steel and a separated silicon

sheet-steel lining. The latter is most easily made in a straight conical shape and will give comparable results.

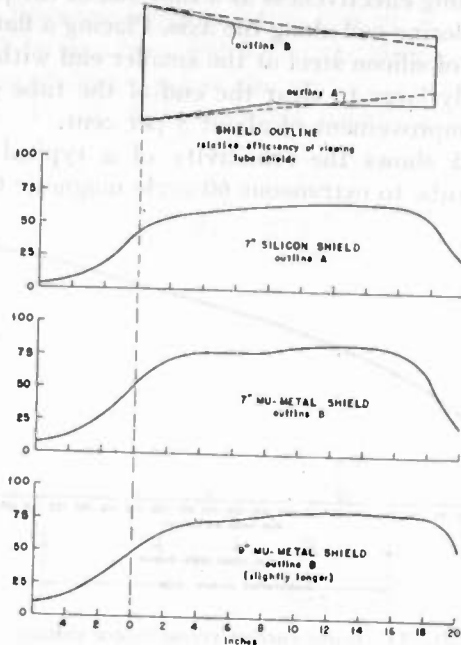

Fig. 14—Distribution of magnetic fields inside various viewing tube shields.

The proper distancing and positioning of the receiver power transformers are preferable to the use of any

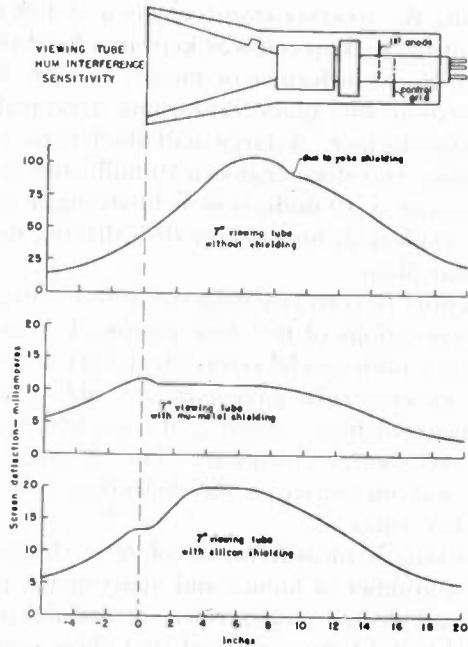

Fig. 15—Distribution of magnetic fields inside various viewing tube shields.

shielding external to the transformers. Most half-shell power transformers cause no interference if mounted 20 inches or more from the viewing tube, preferably toward the socket of the viewing tube. If the transformer is rotated so that the tube is between the main lobes of interference, it can be mounted much closer. The use of a fully shielded type of transformer

is recommended, especially for the high-voltage transformer; the improvement is worth the slight added expense. If a certain transformer cannot be moved or shielded, the field from another transformer can be made to cancel it, if the fields are fairly uniform and the loads do not vary.

An average  $\frac{1}{2}$ -horsepower motor mounted near the back end of a shielded viewing tube may be as close as 8 inches without visible interlace interference, but

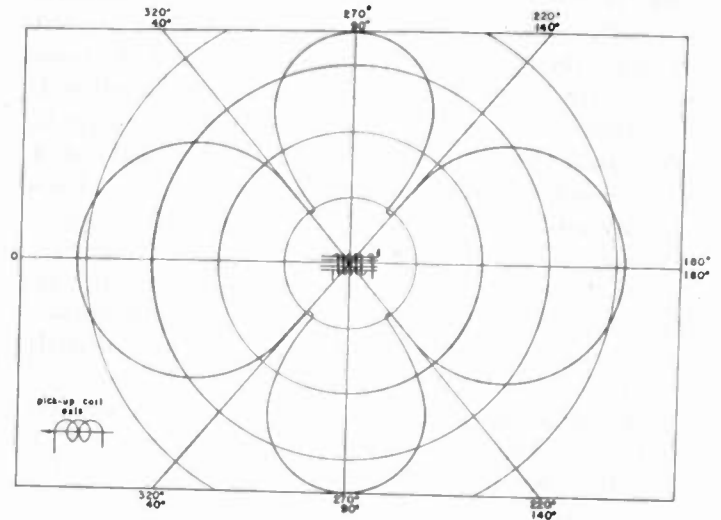

Fig. 16—Typical high-voltage transformer magnetic field.

shielding around the motor may be required. The color disk should be disconnected from the motor when such a test is made.

In regard to interlace interference caused by 60-cycle power-supply ripple, it was found that a standard high-voltage supply utilizing a 2V3G half-wave rectifier and two 0.2-microfarad filter condensers gave 0.5

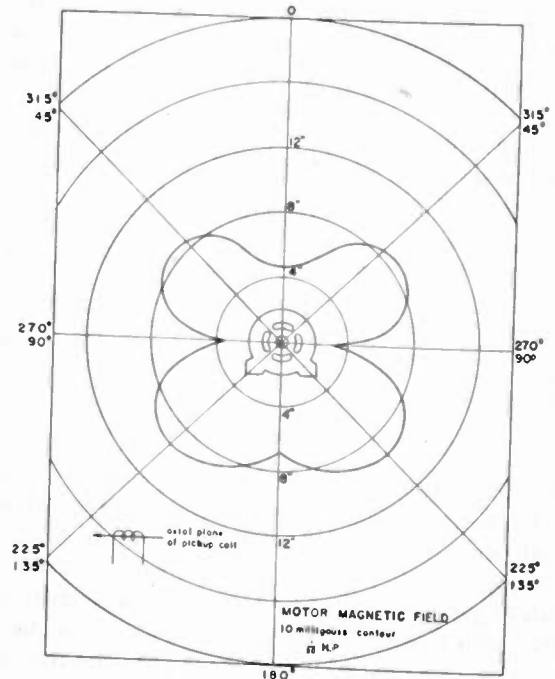

Fig. 17—Motor magnetic field.

volt of 60-cycle ripple, which represents the largest tolerable ripple voltage; if full-wave rectification is used, less filtering is necessary. A standard low-voltage supply using a full-wave rectifier caused no pairing, due to the fact that the ripple was 120 cycles per second.

All filaments, including that of the viewing tube, can be operated from a 60-cycle source. However, if a common ground lead from receiver chassis to power-supply chassis is made to carry both the filament and B-supply returns, interlace interference may be expected. Thus, all leads from the filament transformers should be extended to the receiver chassis, where any ground connections may be made.

#### IV. COLOR TELEVISION UTILIZING A WIDER BAND

The color-television system described in Part I has thus far been applied to a 6-megacycle channel. While laymen with untrained eyes were rarely able to notice the decreased geometric definition inherent in the color pictures, the engineers who were informed of the standards employed were naturally aware of this 50 per cent loss.

Widening the video bandwidth would have made it necessary to utilize the ultra-high frequencies (about 300 megacycles). This would have delayed the commencement of a regular service of color television for many years, and the reduced geometric definition involved, namely, 50 per cent of black and white, might not have justified this delay in the eyes of the public. Almost all laymen who witnessed color-television demonstrations of a variety of subjects felt that more definition seemed to exist than in the black-and-white system which actually had twice the definition. Of course, these laymen did not differentiate between pure geometric definition and additional information provided by the existence of color.

It is likely that increased knowledge in the use of ultra-high frequencies will be at the disposal of the television art as a result of advances made during the war, thereby permitting not only the coexistence of many more television channels than have been available in the lower bands, but also increasing the width of each channel.

A certain amount of investigation and research was carried out in connection with applying the color-television system described in this paper to a wider channel, before this work had to be interrupted for more urgent war needs.

In these investigations of a wide-band channel the number of lines per frame remained the same as in the present black-and-white picture, that is, 525. However, the corresponding video band was more than doubled since it was believed that vertical definition in the present 6-megacycle channel is somewhat emphasized at the expense of definition in the horizontal direction. Thus, a video bandwidth of 9.5 megacycles was selected.

No attempt is made to estimate the exact width of

an ultra-high-frequency channel which might be employed. (The video band occupies 9.5 megacycles.) It is to be expected that the cutoff slope due to single-sideband transmission, as well as the guard bands, will occupy several times more space than is now required in the 6-megacycle channel. Thus, it seems that this new channel in the region of 400 megacycles would require about 17 megacycles.

#### 10-Megacycle Video Amplifier

Problems concerning the extension of the usual television-receiver wide-band video amplifier from 4 megacycles upwards to 10 megacycles were investigated.

The required grid-driving voltage of the average 9-inch and 12-inch cathode ray viewing tube is approximately 30 volts for average picture contrast, and about 50 volts for extreme contrast (these voltages being peak-to-peak values). An amplifier between the second detector and the cathode-ray viewing tube would need to have a gain of approximately 15, a maximum undistorted output of 50 volts, and naturally should pass the required frequency band.

A single-stage amplifier, capable of fulfilling these requirements and passing frequencies up to 10 megacycles with linear phase and amplitude response, has been designed, employing a type 6AG7 tube with series-M-derived high-frequency compensation using a 1600-ohm resistive load. The gain of the stage is 16, and gives a maximum peak-to-peak output of 85 volts. Careful wiring and placing of leads, connecting plugs, and other circuit parts are required to keep the circuit capacitance at a minimum. The values shown in the schematic diagram, Fig. 18, were obtained under practical conditions.

If necessary, an intermediate amplifier may be used ahead of the output tube in the form of a series-shunt-compensated stage, employing a 6AC7 type tube with a load resistance of 1000 ohms, a gain of 8, and furnishing more than 15 volts peak-to-peak output, which is more than sufficient voltage to drive a type 6AG7 output tube. A two-stage amplifier thus built has a total gain of 130.

A rigorous investigation was made of the distributed capacitances of different types of coils of the size most commonly used for this application (range 3 to 60 microhenries). The single-layer solenoid, of course, proved to have the least distributed capacitance of any type of coil, with capacitances varying between 0.5 to 1.1 micromicrofarads. To keep physical size and consequent stray capacitance to ground at a minimum for the larger size inductances, size No. 40 enamel wire can be used safely for plate currents up to 250 milliamperes. A 60-microhenry coil wound on a  $\frac{3}{8}$ -inch form as a solenoid will operate with a 250-milliamperere current at a temperature of 42 degrees centigrade (108 degrees Fahrenheit).

Different types and makes of resistances between the sizes 300 to 2000 ohms were also measured for their

distributed capacitances. The stem-type carbon resistors varied about 0.6 to 2.0 micromicrofarads, and the full-body-type carbon resistors slightly less. Because of the very small size of available carbon resistors and the fact that the  $\frac{1}{2}$ - or  $\frac{1}{4}$ -watt sizes are fully adequate for intermediate-amplifier work, even this capacitance could be cut in half by using two small resistors in series. The noninductive wire-wound resistors had very small distributed capacitance; however, those under 1000 ohms gave trouble from residual inductance, in many cases giving more than sufficient high-frequency compensation, usually peaking the amplifier between

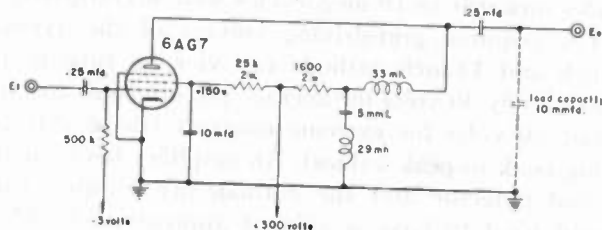

Fig. 18—10-megacycle amplifier.

6 and 8 megacycles. When such resistances are used, it will be found that only a small amount of external high-frequency coil compensation is required.

In existing line amplifiers as used in studio equipment where 5 megacycles used to be the required band limit, the circuit in most common use was a type 6AC7 with shunt compensation, using a 1000-ohm load. This assumed a total circuit capacitance of 32 micromicrofarads and gave a gain of approximately 8. The extension in frequency from a 5- to 10-megacycle bandwidth can be accomplished without too much loss in gain if meticulous care is taken to keep circuit capacitances to a minimum. If particular attention is paid to the placing of parts, and selection of peaking coil and resistors, the total capacitance in such a circuit can be kept below 23 micromicrofarads, thus permitting a load resistance of 700 ohms with a consequent gain of 5.6 per stage. A stage thus compensated will give 50 per cent of full response at 15 megacycles.

Cathode-follower-type circuits can also be used quite successfully to keep circuit capacitances low because of their degenerative action. This allows the use of large load resistances and provides coupling to capacitive circuits larger than usual. These circuits have the disadvantage of distorting at high signal levels, unless very high plate-current tubes are used. With beam power tubes, particularly the 6Y6G tube which is ideal for the purpose, maximum voltage output at 10 megacycles is limited to approximately 65 volts peak at the cathode. Another advantage of this type of coupling is that very low resistance attenuators can be used as the cathode load, thus providing nonreactive attenuators up to 10 megacycles.

#### HIGH-FREQUENCY-SCANNING CIRCUITS

An investigation was made of the limitations that would be imposed upon horizontal magnetic- and elec-

trostatic-deflection systems using 525 horizontal line scanning in color television, with a vertical repetition rate of 120 fields (60 complete frames) per second.

The ideal requirements of such a scanning system are:

(a) The generation of linear saw-tooth wave forms of a frequency  $60 \times 525$ , i.e., 31,500 cycles per second, the wave forms to be such that the portion of the saw-tooth used for scanning be within 0.85  $H$  and the flyback to occur within 0.15  $H$ .

(b) The preservation of the scanning wave form in the amplifier subsequent to the scanning generator. This is in particular reference to the output stages of electrostatic-deflecting systems.

(c) In magnetic-deflection systems, the use of an output transformer which must meet the amplitude and phase-frequency characteristics of the amplifier itself.

(d) In magnetic-deflection systems, the use of a scanning yoke that has the proper  $L/R$  ratio to secure linear deflection for a given amplifier and output transformer.

With reference to (a), no trouble was experienced in obtaining voltage saw-tooth wave forms at this frequency with either the multivibrator- or blocking-type oscillators. By keeping capacitance low and plate resistance high in the discharge-tube circuit, flyback time was less than 0.1  $H$ , which is within the requirements. More than sufficient voltage amplitude was developed, so that it could be fed directly to the grid of the output tube.

With reference to (b), the frequency requirements are such that the amplifier must pass the fundamental frequency of the saw-tooth and in addition, components up to the 20th harmonic, with linear phase and amplitude response. This requires a frequency range of 31.5 to 630 kilocycles. With electrostatic-deflecting systems it was, therefore, very important to keep circuit capacitances to a minimum in order to obtain the resulting high scanning voltages necessary. With magnetic scanning, the frequency response of the amplifier depends upon the characteristics of the output transformer, yoke, and damping circuit used.

With reference to (c) and (d), wartime priorities precluded the possibility of obtaining specially designed transformers and yokes, so a thorough test was made of transformers and yokes commercially available. Several combinations of different types of existing components came close to fulfilling the requirements and, with alterations, were sufficient, though not ideal, for the purpose. With the transformers and yokes used, any type of  $RC$  or tube damping (to attenuate high-voltage transients developed during flyback) added sufficient capacitance to the circuits to lengthen the flyback return to more than 0.15  $H$ . The addition of a small amount of negative feedback brought the frequency response up sufficiently so that the amplifier was just passable. Finally, the complete elimination of the damping tube and the use of negative feedback both to quench the high transient voltage and to improve the frequency response proved to be quite



successful. Such a circuit using standard, commercially available parts is shown in Fig. 19.

V. PROJECTION OF COLOR-TELEVISION PICTURES

In black-and-white television this problem has been quite successfully solved by projecting onto a viewing screen by means of projection lenses, or mirrors, or a combination of both, the image of a small but extremely intense picture produced at the end of a projection-type cathode-ray tube. While it is conceivable that practical home receivers for black-and-white television utilizing this principle could be produced, for color television this method seems to present great difficulties. The use of color filters would necessitate that the original brilliance be stepped up about sevenfold.

It became apparent that a new approach to this technique of projection would have to be sought. As pointed out in Part I of this paper, when cathode-ray-tube pictures are viewed directly, through color filters, there results a certain loss in light. This loss is offset to a large degree by an increase in contrast range due to the second-power absorption of the incident light versus the first-power absorption of the radiated light. At least this is true when the color images are viewed in an undarkened room. This advantage cannot be utilized in a projection system where the color filter rotates in front of a projection tube and where the final image is projected onto a viewing screen.

Not long before the conversion of the laboratories to war work, this problem was approached along the lines of the so-called "diavisor" (a British expression),<sup>6</sup> which is based on the principle of rendering certain surfaces opaque or transparent by scanning with an electron beam, modulated with picture signals. The original picture then would appear as a surface of varying transparency, or in some cases, of varying reflectivity. Once the electron beam touched a certain point on the sensitive area of the surface, it is desirable to have that particular spot retain the accompanying optical change until the electron beam returns. Then a new cycle of modulation for that spot would begin.

By employing an extraneous light source and optical means for projection, the scanned-image plane could be reproduced on a viewing screen, furnishing images of almost any size, provided an adequate light source and optical means for projection were available.

Arrangements such as these for the projection of television pictures have been suggested previously.<sup>6-10</sup> In this country the first demonstration of this principle was given by T. S. Donal and D. B. Langmuir. They

<sup>6</sup> J. C. Wilson, "Television Engineering," Sir Isaac Pitman and Sons, Ltd., London, England, 1937, p. 443.  
<sup>7</sup> M. von Ardenne, *Teleg. Ferns. und Funk-Techn.*, vol. 27, p. 518; November, 1938.  
<sup>8</sup> M. von Ardenne, *Teleg. Ferns. und Funk-Techn.*, vol. 28, p. 180; May, 1939.  
<sup>9</sup> M. von Ardenne, *Teleg. Ferns. und Funk-Techn.*, vol. 28, p. 403; November, 1939.  
<sup>10</sup> A. H. Rosenthal, "A system of large-screen television reception based on certain electron phenomena in crystals," *PROC. I.R.E.*, vol. 28, pp. 203-213; May, 1940.

employed a light valve consisting of a large number of opaque disymmetric particles suspended in an insulating fluid. The orientation of these particles by external electrical fields which are produced by a cathode-ray beam, determined the light transmission properties of this cell.

Also, among the promising "diavisor" systems are those based on the photoconductive effect. Rosenthal<sup>10</sup> deals with this subject quiet thoroughly and, in addition, gives a number of references pertaining to the fundamental effect.

Application of these methods to the additive type

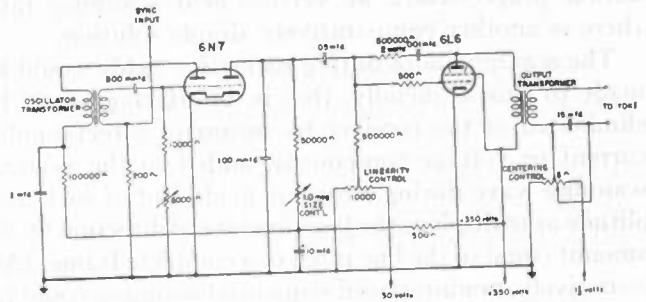

Fig. 19—High-frequency scanning circuit.

of color television would not be difficult. A color disk or drum (as described in Part I), rotates near the plane of the "diavisor." If the transparent (or reflecting) portions of the scanned image surface are uncolored, then light from the extraneous light source, controlled by the "diavisor" and transmitted to the color filters, should have a spectral characteristic similar to that shown in Fig. 1. In case the transparent or reflecting portions of the image screen display absorption effects for certain colors, suitable color compensation has to be introduced before the light reaches the viewing screen.

The modulated-image screen of the "diavisor" would presumably be small enough so that color disks or drums of moderate dimensions and driving motors of low power can be employed. The synchronizing and phasing methods described before could apply equally in these projection systems. Certain simplifications would be feasible due to the smaller dimensions of the parts involved.

As pointed out previously, the color filters would introduce a loss of light in the ratio of approximately 7:1. To offset this the extraneous light source and the optical projection system would have to produce seven times the amount of light that would be needed in a corresponding black-and-white system; or, if additional light cannot be secured, the size of the projected image would have to be reduced in a ratio of roughly 2.6:1 of its linear dimensions in order to provide the same image brilliance. Thus it becomes almost axiomatic that advantages with regard to illumination can be derived from the "diavisor" type of projection only if the change in reflectivity or opacity is maintained over a substantial portion of a frame, or, field period.

In view of this storage effect, considerations similar to those discussed in Part I on storage-type pickup tubes have to be taken into account. When the image field is scanned with interlaced sets of lines and if storage in any area of the received picture persists until the beam returns to the same place, two successive interlaced fields appear under one and the same color filter and false color values would result. Thus, when interlacing is employed, changes in opacity or reflectivity must not last longer than one color-field period. Aside from employing some form of decay within that period, or some extinguishing medium to cancel the storage action progressively at vertical-field scanning rate, there is another comparatively simple solution.

The scanning lines during successive fields would be made to pair artificially, that is, interlacing would be eliminated at the receiver by means of a rectangular current or voltage component, added to the vertical scanning wave during alternate fields and of such amplitude as to displace the lines in vertical direction by an amount equal to the line pitch of a complete frame. (Alternatively, noninterlaced sequential scanning could be transmitted, with optical interlacing at the pickup tube, eliminating the need for electrical pairing. This would require universal adoption of such standards.) Thus the scanning and color-change rates would be the same for all areas of the picture field. What would remain to be done would be to restore the interlacing optically.

This could be accomplished by combining the color disk in front of the image plane with a disk composed of parallel-plane glass alternating in thickness and of substantially the same height as the image. The vertical axis of the "wobbler" disk plane is slightly inclined, while the horizontal axis is parallel with respect to the image plane. The difference in thickness between the two sets of parallel-plane glass plates (plastic plates with color filters are equally usable), and the angle of the disk plane and the refractive index of the material used will determine the difference in vertical shift between alternate fields. It was pointed out already that this amount should be equal to the line pitch of a frame.

The necessary accuracy required for this vertical displacement would not be too difficult to obtain, since a scanning linearity in vertical direction of one part in ten is usually obtainable, the resultant spacing between alternate sets of lines in this area of the picture would also be within the same tolerance. When judging the quality of interlacing, this is considered satisfactory. Naturally, it is necessary for the vertical image size to stay within 10 per cent of a predetermined dimen-

sion, as the amount of optical displacement has to be based on a certain image height.

A combined color and wobbler disk can be shaped like the disk shown in Fig. 21 of Part I. The filter segments of that disk would be placed between two sheets of plastic, one of them being fabricated so that along a ring at the periphery (where the color filters are located) alternate segments are thicker by a predetermined amount. A disk of this shape gives color contamination over not more than 10 per cent of the vertical image dimension. The same would apply to the interlacing action of such a disk, that is, if the separation between alternate thicknesses of plastic coincides with the boundary line of adjacent color filters, then the area of contamination caused by interlacing would coincide with the 10 per cent limits mentioned.

The diameter of such a disk necessarily would be larger than that of an ordinary color disk (see construction in Fig. 29, Part I). However, due to the greater number of filters (circumferential speed has to remain constant), the rate of revolution would be correspondingly lower.

A simplified formula for the displacement of light through a parallel-plane transparent object is

$$d = T \sin \alpha \left( 1 - \frac{\cos \alpha}{\mu} \right) \quad (7)$$

where  $d$  = displacement in inches

$\mu$  = index of refraction

$T$  = thickness of the medium in inches

$\alpha$  = angle of incidence (should not exceed 15 degrees when using this formula).

The required difference in plate thickness is

$$T_2 - T_1 = \frac{d_2 - d_1}{\sin \alpha (1 - \cos \alpha / \mu)} \quad (8)$$

For an image height of 2 inches and 375 lines per frame, a vertical displacement of 0.006 inch is required. For an angle of 15 degrees between the plane of the disk and that of the image and for a refractive index of  $\mu = 1.5$ , the difference in thickness between alternate segments would have to be 0.028 inch. The corresponding figure for a 525-line picture of the same height would be 0.02 inch. Fine adjustment of the interlacing would be provided automatically by the vertical image size control.

#### ACKNOWLEDGMENT

The authors wish to express sincere thanks to all their tireless associates who contributed valuable help in the work carried out and in the preparation of this paper.

# The Radio Sonde\*

W. H. PICKERING†, ASSOCIATE, I.R.E.

*Summary*—The radio sonde has been developed in recent years as a practical instrument for transmitting information from the stratosphere. This paper discusses some of the problems connected with the application of the radio-sonde principle to the radio meteorograph and also to the cosmic-ray radio sonde.

## INTRODUCTION

WITHIN recent years techniques have been successfully developed for the automatic transmission of meteorological and other information from instruments sent into the stratosphere by free balloons. This article is intended to review some of the problems encountered with such instruments, and, in particular, to describe the successful application of the radio sonde for cosmic-ray observations.

About six years ago latex-rubber balloons were first made commercially available in large sizes. This meant that relatively large weights could be lifted to great altitudes at a reasonable expense, and so greatly extended the possible field of usefulness for radio exploration of the stratosphere. These latex balloons are produced in sizes up to a weight of rubber in the balloon of 700 grams. Such a 700-gram balloon may be inflated with hydrogen to lift about 1500 grams at a rate of almost 1000 feet per minute to an altitude of 70,000 feet or more. If the balloon is inflated to a larger initial lift, then the bursting altitude will be correspondingly reduced. If the balloon is inflated to give a very slow ascent there will not be much gain in the maximum altitude reached. This is probably because one of the limiting factors in the bursting of the balloon is the fact that the thin, stretched rubber deteriorates rapidly under the action of sunlight and ozone.

When a flight is being made to the maximum altitude, the ascent will require about 90 minutes. During this time the balloon may drift a considerable distance. In temperate latitudes the drift will usually be to the east and may amount to 75 miles. At lower latitudes conditions may be found where light and variable winds are encountered and the drift may be only 10 or 20 miles. However, the probability that no wind will be encountered at any altitude is very small, although in the author's experience, flights made in Southern Mexico in December, 1941, consistently showed no wind between a slight surface wind only a few hundred feet thick and a westerly wind at about 30,000 feet.

The descent after the maximum of the flight has been reached may be accomplished either by using a parachute or a second balloon. When two balloons with approximately equal lift are used for a flight, the probability that both balloons will burst simultaneously is

very small, and thus the remaining balloon will lower the instrument safely to the ground. In this case there is an advantage as far as recovery of the instrument is concerned, in that the grounded instrument with the balloon attached is a fairly conspicuous object.

Since the descent may take almost as long as the ascent, the equipment should be designed to operate for 3 to 4 hours, and to transmit a readable signal at the end of this time to a range of 150 miles.

## DESIGN OF THE TRANSMITTER

The factors affecting the design of the transmitter may be listed as follows:

(a) Weight. Obviously the weight must be as small as possible, particularly as the transmitter is merely a means for passing on the information obtained by the instrument.

(b) Power supply. The power required, both filament and plate power, must be kept to a minimum.

(c) Operation at low temperature. The frequency shift at temperatures as low as  $-60$  degrees centigrade should be small.

(d) Operation at low pressure. No voltages should be high enough to produce corona difficulties at air pressures of a few millimeters.

The choice of wavelength is not restricted by the transmitting antenna for this may readily be made of almost any length. The weight of the antenna wire is certainly small, and it can act as a part of the connection to the balloon. The wavelengths used in sounding-balloon flights are chosen with regard to such other factors as, for example, the wavelengths assigned for such use, the physical size and weight of the resonant circuits in the transmitter, and the wavelength at which the transmitting tubes will operate most efficiently. If the receiving station is to be reasonably portable, considerations of receiving antenna design may also govern the choice of wavelength.

The transmitting antenna is nearly always a vertical half-wave antenna. Such an antenna is simple from a mechanical standpoint and it radiates equally well in all horizontal directions. There is no radiation vertically downward, but, as mentioned above, the chance of the balloon remaining vertically over the receiving station is very small. The radiation is a maximum in the horizontal direction, which is desirable because, when the balloon is at a great distance, the angle will of necessity be small.

A simple calculation shows that if vertical dipole antennas are used at both transmitter and receiver, and if the effect of the ground is neglected, the received signal strength is given by  $E = (k/h) \cos^2 \theta \sin \theta$  where  $\theta$  is the elevation angle to the balloon and  $h$  is the height of the balloon over a plane earth.

\* Decimal classification: R539. Original manuscript received by the Institute, February 1, 1943.

† California Institute of Technology, Pasadena, California.

For a constant  $h$  the maximum received signal will occur when  $\theta = 35$  degrees. See Fig. 1.

If steady signals are to be received at the ground station there must be no fluctuation in radiated signal as the balloon and instrument rotate about a vertical axis or swing back and forth about a horizontal axis. The effect of rotation will be eliminated by insuring that the vertical antenna is the only radiator. This is difficult to attain at ultra-high frequencies without complete shielding of the transmitter. Swinging may give rise to two effects. First, the mechanical motion

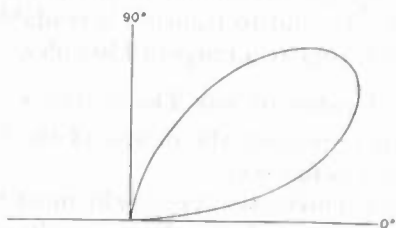

Fig. 1—Polar diagram showing the received signal at a ground station from a transmitter on a balloon at a constant height over a plane earth, as a function of the elevation angle of the balloon. Vertical dipole antennas at both transmitter and receiver and ground reflections neglected.

may cause a shift in transmitter frequency, and second there will be a change in the polarization and signal radiated in the direction of the receiver, with a corresponding change in receiver output. This can only be eliminated by eliminating the swinging as much as possible. A long supporting string between balloon and instrument will help a great deal, and the use of the antenna as a part of the supporting system will make a further improvement.

The fractional change in received signal due to a swing through an angle  $\delta$  on each side of the vertical may be shown to be approximately  $2\delta \tan \theta$ , where  $\theta$  is the elevation angle. Hence the effect of swinging is more pronounced at large elevation angles.

A typical radio-sonde transmitter is illustrated in Fig. 2. This transmitter operates on 180 megacycles (1.67 meters) and therefore acorn-type tubes are used. The 958 is chosen because it is more conservative of filament power, and will give about the same output as the 955 with a given plate voltage. Since the transmitter is expected to operate for only a few hours, and since it may deliver power for only a fraction of this time, the oscillator tube may be operated safely at a considerable overload. The circuit of Fig. 2 is a standard Colpitts' oscillator circuit. Trimmer condensers are used for tuning adjustments. The half-wave antenna is attached through a short flexible lead directly to the tank coil. In a cosmic-ray radio sonde, where the transmitter is keyed with short pulses, this oscillator has been used with 1.7 volts on the filament and 135 volts on the plate.<sup>1</sup>

Radio-sonde transmitters operating in the ultra-high-frequency region may be expected to have much

the same design as shown in Fig. 2. At wavelengths of a few meters, tubes such as the 30, or the 1C5, or the newer small tubes such as the 1S4 are satisfactory.

The power supply for the transmitter frequently will contribute the major part of the weight of the complete radio sonde. Batteries offer the only practical means of supplying this power. Both primary and secondary batteries are used. Much can be said for and against each of these.

The primary battery is always ready for use, there is no danger from spilled acid, it can be mounted wherever convenient in the instrument, and can even be left connected with a switch to be closed for the actual flight or for testing. It has the disadvantage of short shelf-life, particularly in the small sizes of B battery. Small dry batteries have been constructed commercially for radio-sonde use. The smallest sizes of batteries used in camera-type radio receivers are also useful for radio-sonde applications.

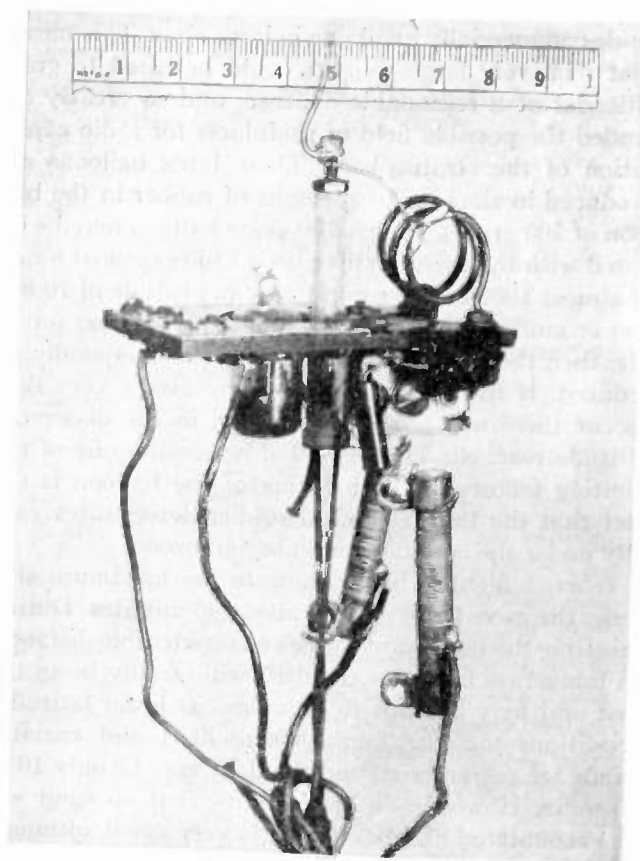

Fig. 2—A radio-sonde transmitter for a frequency of 180 megacycles. Signals from this transmitter have been received at distances up to 200 miles.

Storage batteries have advantages of indefinite shelf life when stored dry, constancy of voltage during discharge, operation at very low temperatures, and light weight. By using small sections of the very thin plates used in airplane-type storage batteries, a battery can be assembled which has less than half the weight of the equivalent dry-cell battery. The disadvantages of storage batteries are primarily the mechanical problems of

<sup>1</sup> H. V. Neher and W. H. Pickering, "A cosmic-ray radio sonde," *Rev. Sci. Instr.*, vol. 13, pp. 143-147, April, 1942.

construction of the B battery. The cells must be designed so as to avoid internal short circuits or open circuits, and also they should be almost completely enclosed to prevent acid from spilling or short-circuiting the battery.

In some early work with radio-equipped balloons, power was supplied from an A battery alone, with the plate power provided by a vibrator and transformer.<sup>2</sup> The modern developments in lightweight B batteries, however, have resulted in their use in all recent work. Although it might be possible to make a vibrator and transformer unit of comparable weight with the B battery, the additional complication in the circuit would be hard to justify. On the other hand some cosmic-ray equipment requires a voltage of 1000 to 1500 volts with a negligible current drain, for a Geiger counter voltage supply. Here the vibrator and transformer offer a very satisfactory solution. A high-voltage supply of this sort has been previously described.<sup>3</sup> It uses a transformer, rectifier tube, and filter circuit sealed in an airtight can to avoid corona difficulties and it is operated by a 4-volt storage battery and a buzzer. The current drain is about 50 milliamperes at 4 volts, plus the rectifier filament which requires about 40 milliamperes at 1 volt. The total weight, including battery power for three hours operation, is 650 grams. During the operating period the high-voltage output will change about 50 volts out of 1200.

#### THE METEOROGRAPH

The application of the radio-sounding balloon to meteorological problems requires that pressure, temperature, and humidity measurements be made as frequently as possible during the balloon flight. An ideal meteorograph would complete the cycle of readings every 30 seconds and would have an accuracy of 3 millibars in the pressure, 0.5 degree centigrade in temperature, and 5 to 10 per cent in the relative humidity. Two basic principles have been used for converting the readings of the meteorological elements into modulation of the transmitter. These are:

- (1) The use of the Olland telemeteorograph principle.
- (2) Modulation directly by the variations, either mechanical or electrical, of the meteorological elements, together with some switching mechanism for connecting the elements in sequence to the transmitter.

The Olland principle is illustrated schematically in Fig. 3. Expansion of the aneroid barometer causes the arm *A* to move in the region between points *B* and *C*. A contact arm *D* is turned uniformly by a clockwork or motor mechanism and makes contact in turn with *B*, *A*, and *C*. At each contact a circuit is closed which then operates a relay or, in this case, completes the

plate circuit of the transmitter. Thus a signal is radiated for the duration of the contact. At the ground station these signals are recorded on a uniformly moving paper tape. The distance on the tape between the signals corresponding to contacts *B* and *A* will then be a measure of the barometric pressure. Contact *C* will serve as a check on the uniformity of clock speed, or an additional point for measurement in the event contact *B* is not received properly. The temperature and humidity measurements are made similarly by inserting additional contact arms into the cycle and using the mechanical motion of a bimetallic strip thermometer and a hair hygrometer to drive them. With reasonable care in the design such a unit can be constructed to give a sequence of signals which is readily identified, and which will have good accuracy. The final limitation on accuracy, if the unit is driven by a clock, is the fact that the clock arm moves forward in jumps with the

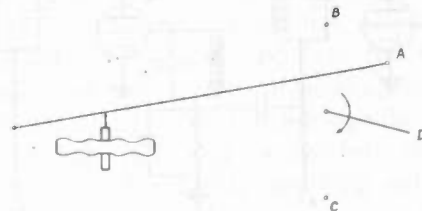

Fig. 3—The Olland telemeteorograph principle.

beats of the balance wheel. For a clock beating 5 times a second, and a clock arm rotating once in 30 seconds, the arm actually moves forward 1/150 of a revolution at each jump. Hence, if conditions were as sketched in Fig. 3, where the total movement of *A* is less than half a revolution of the arm *D*, the accuracy in the reading of *A* would correspond to about 1/75 of an atmosphere change in pressure or about 15 millibars. This is not good enough. To improve the accuracy, the clock can be made to beat faster,<sup>4</sup> or the design may be modified to allow the travel of the contact arms to correspond to several revolutions of the clock.<sup>5,6</sup>

Several different types of radio meteorograph have used the second method of modulating the transmitter. For example, in the Diamond-Hinmann meteorograph, used by the United States Weather Bureau, the temperature and humidity elements are designed to produce changes of electrical resistance with changes of temperature and humidity.<sup>7</sup> The transmitter is modulated at an audio frequency which is made a function of the circuit resistance, and thus switching the temperature unit in to the circuit will produce an audio-frequency modulation whose frequency will be a

<sup>4</sup> O. C. Maier and L. E. Wood, "The Galcit radio meteorograph," *Jour. Aero. Sci.*, vol. 4, pp. 417-422; August, 1937.

<sup>5</sup> K. O. Lange, "The 1935 radio-meteorographs of Blue Hill Observatory," *Bull. Amer. Met. Soc.*, vol. 17, pp. 139-140; May, 1936.

<sup>6</sup> K. O. Lange, "The 1936 radio-meteorographs of Blue Hill Observatory," *Bull. Amer. Met. Soc.*, vol. 18, pp. 107-126; March, 1937.

<sup>7</sup> C. B. Pear, "Radio sounding in the United States," *Electronics*, vol. 16, pp. 82-85; January, 1943.

<sup>2</sup> W. R. Blair and H. M. Lewis, "Radio tracking of meteorological balloons," *Proc. I.R.E.*, vol. 19, pp. 1531-1561; September, 1931.

<sup>3</sup> H. V. Neher and W. H. Pickering, "A lightweight high voltage supply for Geiger counters," *Rev. Sci. Instr.*, vol. 12, pp. 140-142; March, 1941.

measure of the temperature, and similarly, when the humidity unit is in the circuit the audio frequency received is a function of the relative humidity. The switching is done by the barometer element. As the pressure changes, the arm connected to the aneroid barometer moves over a contact strip and switches the other elements alternately into the modulation circuit. The pressures at which the switching takes place are determined in a calibration. At definite pressure intervals a fixed resistor is switched into the circuit to check on the audio frequency transmitted and to assist in the identification of the switching pressures. The basic circuit of the oscillator and modulator is shown<sup>8,9</sup> in Fig. 4.

Tube  $T_1$  oscillates at a relatively low radio frequency. Because of the long time constant  $RC$  in its grid circuit, the oscillations are periodically blocked

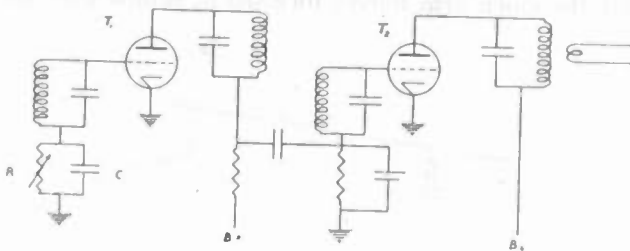

Fig. 4—The basic circuit of the Diamond-Hinmann radio-meteorograph transmitter.

at an audio frequency determined by  $RC$ . This blocking produces periodic impulses at the grid of  $T_2$  and hence modulates the radio-frequency output of  $T_2$ .

One of the earliest successful radio meteorographs was due to Moltchanoff.<sup>10</sup> He used an arrangement in which the mechanical movement of the meteorological elements was converted into a coded sequence of transmitted dots and dashes. The switching and keying were provided by a wind-driven fan.

Meteorographs have been developed in which the change in the meteorological elements is converted into a change in the transmitted radio frequency. In the Väisälä instrument used in Finland<sup>11</sup> the meteorological elements are mechanically connected to variable condensers whose capacitances are thus a function of the quantity to be measured. A fan-driven switch connects each condenser in turn to the transmitter tank circuit and thus the radio frequency transmitted is made to measure the desired quantities. An additional fixed condenser is also switched into the circuit periodically in order to serve as a reference frequency.

<sup>8</sup> H. Diamond, W. S. Hinmann, F. W. Dunmore, and E. G. Lapham, "An improved radio sonde and its performance," *Nat. Bur. Stand. Jour. Res.*, vol. 25, pp. 327-367; September, 1940.

<sup>9</sup> H. Diamond, W. S. Hinmann, F. W. Dunmore, "A method for the investigation of upper-air phenomena, and its application to radio meteorography," *Proc. I.R.E.*, vol. 26, pp. 1235-1265; October, 1938.

<sup>10</sup> P. Moltchanoff, "Drei Jahre Aufstiege von Radiosonden im Institute der Aerologie, Sloutzk, U.S.S.R.," *Meteor. Zeit.*, vol. 50, p. 428; November, 1933.

<sup>11</sup> V. Väisälä, "Eine neue Radiosonde," *Mill. d. Met. Inst. d. Univ. Helsingfors*, vol. 29, pp. 1012-1029; 1935.

The meteorograph of Duckert, Germany, uses a variable condenser driven by a bimetallic strip and permanently connected to the transmitter.<sup>12,13</sup> By careful design, this is made to be the chief factor affecting transmitter frequency, and thus a continuous record of temperature is obtained. The pressure element moves an arm over a contact strip and interrupts the transmitted signal at certain definite pressures. Humidity is not recorded.

#### RECEIVING EQUIPMENT

Receivers used for radio-sonde work normally will be designed along conventional lines except for the recording mechanism necessary. At the higher frequencies superregenerative receivers usually have been used because of their sensitivity, broad tuning, freedom from pulse interference, and inherent automatic-volume-control action.

The recording technique for a radio meteorograph should be such that measurements of the meteorological elements can be made during the flight, and the complete flight record completed within an hour of the end of the flight. Relatively unskilled personnel, from a radio point of view, should be able to handle all ordinary adjustments on the recorder. The accuracy of the recorder should be at least as good as that of the transmitter.

When the Olland principle is used the recording technique is very simple. The output from the receiver is amplified sufficiently to operate a relay which then makes a mark on a moving strip of paper. The accuracy of measurement depends on the precision with which the speeds of the clock at the transmitter, and the motor driving the recorder, can be held constant. Because of the power necessary to make the various contacts and because of the wide variation in temperature to which it is necessarily exposed, it is difficult to keep the transmitter clock running uniformly. Experiments have been made with small electric motors, gravity drives, and wind drives, as substitutes for a mechanical clock, but these have not proved very successful. In spite of this problem, the simplicity and directness of the Olland principle at both the transmitting and the recording ends, makes a very satisfactory system for radio-sonde measurements.

The Diamond-Hinmann system requires a recording audio-frequency meter at the receiving station. The discontinuities in the frequency record are then correlated with pressures. The precision of the temperature and humidity measurements is determined by the accuracy with which the variation of resistance introduced by the temperature and humidity elements is known and reproducible, and the accuracy with which

<sup>12</sup> P. Duckert, "Das Radiosondenmodell Telefunken und seine Anwendung," *Beitr. z. Phys. d. fr. Atmosph.*, vol. 20, pp. 303-311; 1933.

<sup>13</sup> K. O. Lange, "Other radio meteorographs," *Bull. Amer. Met. Soc.*, vol. 16, pp. 233-236; 267-271; 297-300; October, November, December 1935.

the audio modulating frequency is determined by this resistance. The precision of the measurement of this audio frequency is also a limiting factor. An accuracy of 0.5 degree centigrade in a total range of about 100 degrees centigrade is 0.5 per cent, and this is almost certainly approaching the limit of any recording electrical meter. The pressure determination depends, in the last analysis, on the accuracy and reproducibility of the calibration. The movement of the barometer arm across the contact strip must be free of any irregularities.

The meteorographs depending on a variation of the transmitted radio frequency require a wide frequency channel for successful operation. Assuming that a frequency deviation is to be measured rapidly and accurately to 0.5 per cent, it is obviously desirable that 0.5 per cent of the maximum deviation be large compared with the deviations of the carrier frequency produced by tube variations, change of battery voltage, change of temperature, etc. These deviations may well amount to 0.1 per cent of the carrier frequency in themselves, and thus it appears that the frequency deviation produced by the variation of the meteorological elements should approach the magnitude of the carrier frequency. In the Väisälä meteorograph, a comparison with a reference condenser is made periodically. This makes the deviation requirement much less stringent, but still requires a wide channel for accurate measurement. The recording technique used with these instruments consists essentially in keeping a receiver tuned to the signal and periodically noting the tuning.

It is not the intent of this paper to discuss the merits of the various instruments from a meteorological point of view, or to discuss the mechanical design of a successful radio meteorograph. These are problems for the meteorologist and the instrument maker. However, one feature of the problem does concern the radio engineer. A practical instrument must be used under all sorts of field conditions. It must be released under bad weather conditions, it may fly through snow and rain, ice may form on the instrument. To release a balloon in a high wind is well nigh impossible unless a very short connection between instrument and balloon is used. From the radio point of view this is unfortunate because the instrument will swing violently during a considerable portion of the flight. Thus, in designing a radio-sonde transmitter, although weight must be counted in grams, at the same time, the unit must have sufficient mechanical stability to withstand considerable abuse.

#### A COSMIC-RAY RADIO SONDE

The radio-sonde technique has been used for cosmic-ray observations at great altitudes. Briefly the electrical problems may be stated thus. The cosmic-ray impulses from one or more Geiger counters, are to be amplified until they can modulate the transmitter. The number of cosmic-ray impulses may be of the order of 1000 per minute with a statistically random-time distri-

bution, and thus their number must be scaled down electrically at either the transmitter or the ground station before they can be recorded. If, as seems logical, this scaling is done on the ground, the length of the transmitted pulse must be of the order of 100 microseconds. A barometer signal must also be sent periodically.

An instrument to satisfy these requirements will be much heavier and more complicated than a radio meteorograph. The instrument used by the author, Fig. 5, weighs about 3500 grams complete with protective coverings and lines as compared with weights of less than 1000 grams for a radio meteorograph. The component parts of this instrument are as follows: The Geiger counters to detect the cosmic rays require a power supply delivering about 1200 volts direct current. Each pair of counters is connected to a three-stage resistance-coupled amplifier. The outputs from the third stages are then paralleled in such a manner that only coincident impulses in the two amplifiers are passed. These impulses are further amplified with a power-amplifier tube and modulate the transmitter. The final modulation and pulse-shaping circuit is shown in Fig. 6. The barometer signals are derived from an Olland cycle, and are fed into the circuit as indicated in Fig. 6. The transmitting unit requires a total tube complement of 9 tubes.

The received signal consists of an irregular succession of very short pulses, interrupted by audio signals at about 5000 cycles lasting for about 1 second. The superregenerative receiver unfortunately cannot be used because it fails to respond to very short pulses. This is shown by its ability to suppress automobile ignition noise, whereas the desired signal actually has very much the same appearance as ignition noise. With such a short signal, a superheterodyne receiver must be used. Furthermore, a receiving location that is free from ignition interference is absolutely necessary. The desired information is the number of cosmic-ray impulses per minute as a function of barometric pressure, hence the impulses must be counted and recorded. To do this an electrical scaling circuit is needed so that every  $n$ th pulse may be fed into a recording relay and written on a paper tape. The basic scaling circuit is the vacuum tube "scale-of-two" circuit.<sup>14</sup> Six stages in cascade give a total scaling factor of 64 which may be adjusted in powers of two by a selector switch. Figs. 7, 8, and 9 illustrate, respectively, the circuits of the input pulse equalizing circuit, the scale of two, and the output pulsing circuit which operates the recording pen. This pen writes on a paper tape moving at about 15 centimeters per minute. Near the beginning of a flight the scaling circuit is switched to the "multiply-by-1" position, and each incoming pulse is recorded as a transverse line on the tape. These pulses are statistically random in time and thus appear quite irregular. When the audio frequency from one of the Olland

<sup>14</sup> H. Lifschutz and J. L. Lawson, "A triode vacuum tube scale-of-two circuit," *Rev. Sci. Instr.*, vol. 9, pp. 83-89; March, 1938.





the stratosphere. Already the meteorological observations of pressure, temperature, and humidity at altitudes far beyond the reach of any airplane, are an everyday occurrence. In the not-too-distant future it is reasonable to expect that accurate direction finding will give the meteorologists data on wind velocities at these altitudes. The cosmic-ray observations have proved to be of the greatest value in the physicist's search for knowledge concerning these most energetic of all known radiations. Measurements of almost any type can be adapted to the radio-sonde technique. For example, photoelectric measurements could be made in several different ways. The radio-sonde transmitter is essentially a telemetering system and it may be used

accordingly. Indeed, lightweight, battery-operated transmitters of the radio-sonde type may prove useful for such purposes on the ground as well as in the air.

Future developments in radio-sonde techniques, besides involving the applications of the technique to specific new problems, will call for the development of more satisfactory lightweight power sources, improvement of operating efficiency for the higher frequencies, development of balloons capable of reaching higher altitudes. Improvements are always possible in any instrument and, to take the important example of the radio meteorograph, much remains to be done to make this a completely stable and reliable field instrument.

## Space-Current Flow in Vacuum-Tube Structures\*

B. J. THOMPSON†, FELLOW, I.R.E.

*Summary*—From well-known formulas for space-current in diodes and for amplification factor in triodes, interelectrode capacitance, plate current, and potential distribution in triodes and multigrad tubes are determined through use of the concept of planes of equivalent potential. By the same means, amplification factor in multigrad tubes is derived.

### INTRODUCTION

VACUUM-TUBE design is a subject which has intrigued many workers, largely, one may suspect, because it has presented many possibilities for ingenious methods of analysis. The resulting knowledge of the design factors which determine the various performance characteristics of tubes is quite complete and is expressed in terms which can readily be applied to practical tube-design problems. In spite of this state of the art, the general tendency is to make use of the more "scientific" phases of tube design to aid qualitative understanding rather than to supply specific design information. In this paper, the writer presents some of the concepts of vacuum-tube analysis which he has found informative and useful.

First, space-current flow in diodes will be discussed. Then, methods will be presented for reducing triodes and multigrad tubes to equivalent diodes. Amplification factor, interelectrode capacitance (cold), and electron transit time will be covered. The writer claims little originality and no novelty in this material. Some effort has been made to give credit to the proper sources.

### A. DIODE THEORY

#### *Ideal Case*

The simplest vacuum tube is the diode. The behavior of multielectrode tubes may be described most

readily in terms of the behavior of a diode. For these reasons our treatment will start with the diode.

In the ideal diode, electrons are emitted from the cathode in unlimited numbers at zero velocity and a part of these are drawn over to the anode under the influence of the positive field established by its potential.

In Fig. 1,  $K$  represents the infinite plane cathode at zero potential and  $A$  the plane anode at a positive potential  $E_b$  spaced a distance  $d_{kp}$  from the cathode. Let us suppose first that no electrons are emitted from the cathode. The potential distribution will then be as represented by the line  $a$ , the gradient at all points being  $E_b/d_{kp}$ . If now the cathode begins to emit a limited supply of electrons, all of these electrons will be drawn to the anode. The electrons move at a finite velocity and, therefore, there is a certain number of them in the space at all times. The field set up by the negative "space charge" of these electrons acts to depress the potential in the space below that of the first condition, increasing the field near the anode and decreasing it near the cathode. This condition is shown by line  $b$ .

If the rate of emission of electrons is continually increased, all of the emitted electrons will be drawn to the anode and the gradient at the cathode continually reduced until the gradient reaches zero. Since the electrons are assumed to be emitted with zero velocity, they can not move against a retarding field; therefore, there will be no increase in anode current with further increase in emission beyond this point. The condition of zero gradient at the cathode is represented by the line  $c$  in Fig. 1.

The mathematical analysis of the ideal parallel-plane case is quite simple. It will be presented here as an example of this type of analysis.

Poisson's equation in rectangular co-ordinates is

$$\partial^2 E/\partial x^2 + \partial^2 E/\partial y^2 + \partial^2 E/\partial z^2 = -4\pi\rho. \quad (1)$$

Since there is no gradient in directions parallel to the cathode and anode, the equation becomes simply

\* Decimal classification: R131. Original manuscript received by the Institute, March 16, 1943. With the exception of the introduction, this material was prepared for use within the RCA Manufacturing Company, Inc., during the fall of 1937. Similar material was presented by the author in July, 1937, at the Electronics Institute, University of Michigan, Ann Arbor, Michigan.

† RCA Laboratories, Princeton, New Jersey.

$$\partial^2 E / \partial x^2 = -4\pi\rho. \quad (2)$$

We may also write that

$$I = \rho v \quad (3)$$

and

$$v = (2eE/m)^{1/2} \quad (4)$$

where  $\rho$  is the space-charge density,  $E$  the potential at any point a distance  $x$  from the cathode,  $v$  the velocity of the electrons at  $x$ ,  $I$  the current per unit area, and  $e$  and  $m$  the charge and mass of the electron.

On combining the last three equations, we obtain

$$\frac{d^2 E}{dx^2} = -4\pi \frac{I}{(2eE/m)^{1/2}}. \quad (5)$$

If we multiply both sides by  $dE/dx$  and integrate once, we obtain

$$\frac{1}{2} \left( \frac{dE}{dx} \right)^2 = \frac{8\pi I}{(2e/m)^{1/2}} E^{1/2} + F_0^2 \quad (6)$$

where  $F_0$  is the field at the cathode. If we let  $F_0$  equal zero, a second integration gives us

$$E^{3/4} \Big|_0^{E_b} = 3(\pi I)^{1/2} \left( \frac{m}{2e} \right)^{1/4} x \Big|_0^{d_{kp}} \quad (7)$$

or

$$I = \frac{1}{9\pi} \left( \frac{2e}{m} \right)^{1/2} \frac{E_b^{3/2}}{d_{kp}^2} \\ = 2.33 \times 10^{-6} (E_b^{3/2} / d_{kp}^2). \quad (8)$$

This is the well-known Langmuir-Child<sup>1</sup> equation for space-charge-limited current flow per unit area between parallel-plane electrodes. It means that for each square centimeter of cathode or anode area 2.33 mi-

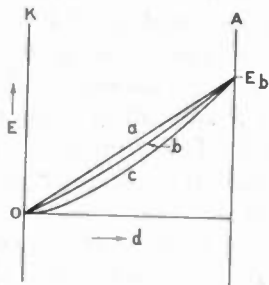

Fig. 1—Potential distribution in a diode with varying amounts of space charge.

croamperes of current will flow with 1 volt difference in potential and a distance of 1 centimeter between cathode and anode, and that a current of 233 microamperes per square centimeter will flow if the potential be raised to a little over 30 volts or the distance reduced to 1 millimeter.

The foregoing analysis is for parallel-plane electrodes. The case of concentric cylinders, of much practical interest, is very much less simple to analyze and, therefore, only the result will be presented here. Excellent analyses are available in the literature.<sup>2</sup>

The current in amperes per centimeter length of the concentric cylinders is given by the well-known Langmuir equation

<sup>1</sup> I. Langmuir and K. T. Compton, "Electrical discharges in gases—Part II," *Rev. Mod. Phys.*, vol. 3, pp. 238-239; April, 1931.

<sup>2</sup> See pp. 245-249 of footnote reference 1.

$$I = 14.66 \times 10^{-6} (E_b^{3/2} / r_b \beta_b^2) \quad (9)$$

where  $r_b$  is the radius of the anode and  $\beta_b^2$  is a function depending on the ratio of anode radius to cathode radius. Tables and curves of  $\beta$  have been published.<sup>3</sup> It will be noted that the current again depends on the 3/2 power of the anode voltage; otherwise, the expressions at first glance do not appear very similar. Part of this difference is due to the fact that one expression is for current per unit area, while the other expression is for current per unit length.

It will be interesting to put the two expressions in similar form. Let us divide equation (9) by  $2\pi r_b$ . Equation (9) then becomes identical with equation (8) except for the presence of the term  $\beta_b^2$  in the denominator and the fact that the distance  $r_b$  is measured from the axis of the cylindrical system. When the ratio of anode diameter to cathode diameter becomes very large,  $\beta_b^2$  approaches unity and, of course, the distance between cathode and anode approaches  $r_b$  as a limit. At this limit, then equations (8) and (9) become identical, and we observe the interesting fact that the anode current flow per unit area is the same in a cylindrical system with fine-wire filament as it would be in a parallel-plane system with the same distance between cathode and anode. This statement, of course, neglects the effect of initial velocity of emission.

At the other limit where the cathode and anode diameters approach each other the system is obviously essentially a parallel-plane one. The value of  $\beta_b^2$  then changes rapidly and maintains such a value that  $r_b^2 \beta_b^2$  is equal to  $d_{kp}^2$ .

The fact that the two expressions give identical results at the two limits of ratio of anode-to-cathode diameter should not lead one to suppose that the expressions are approximately identical for intermediate ratios. Where the anode diameter is from 4 to 20 times the cathode diameter, the current calculated from (8) is in excess of that indicated by (9) by very nearly 20 per cent. This is the maximum error that would result from the use of expression (8) for cylindrical structures.

The potential distribution between cathode and anode may be calculated most usefully from the expressions for current. From (8) we may write

$$E_b^{3/2} / d_{kp}^2 = E^{3/2} / x^2$$

or

$$E = E_b (x / d_{kp})^{4/3}.$$

In other words, the potential between parallel planes varies as the four-thirds power of the distance from the cathode in the case of space-charge-limited currents.

The potential distribution between concentric cylinders is less simple. We may write from (9)

$$E_b^{3/2} / r_b \beta_b^2 = E^{3/2} / r \beta^2$$

or

$$E = E_b (r \beta^2 / r_b \beta_b^2)^{2/3}$$

where  $\beta^2$  is taken for the ratio  $r/r_b$ . This expression is

<sup>3</sup> See pp. 247-248 of footnote reference 1.

not analytical, the values of  $\beta$  and  $\beta_b$  being obtained from curves or tables.

### Effects of Velocities of Emission

Electrons are emitted from a heated surface with a random distribution of velocities in all directions. The velocities which concern us in the present analysis are those normal to the surface of the cathode. This velocity distribution may be expressed most simply as follows:  $n/n_0 = e^{-Ee/kT}$  where  $n$  is the number of electrons out of the total number  $n_0$  which have a sufficient velocity to reach a plane electrode parallel to the cathode at a negative potential of  $E$ ,  $T$  is the temperature of the cathode, and  $k$  is Boltzmann's constant. Expressed in terms of current this becomes  $I = I_s e^{-Ee/kT}$  where  $I$  is the current reaching the negative electrode and  $I_s$  is the total emission current from the cathode. To carry this out experimentally, it is necessary that the collector electrode be placed so close to the cathode that space-charge effects do not cause a potential minimum in space.

We initially assumed that all electrons were emitted with zero velocity and that, therefore, the field at the cathode would not be negative. In the practical case where all electrons have finite velocities normal to the cathode, all of the emitted electrons must reach a positive anode parallel to the cathode unless at some point between cathode and anode a negative potential exists.

Fig. 2 shows the potential distribution between parallel-plane cathode and anode for successively higher values of emission. Line *a* represents the case where there is no emission, and, therefore, no space charge, with resulting constant potential gradient between cathode and anode. Line *b* shows the case where there is sufficient emission to reduce the gradient at the cathode just to zero. This is similar to the condition represented by *c* in Fig. 1 with the important difference that now all electrons pass over to the anode because of their finite velocities of emission.

Any further increase in cathode emission, however, will cause the potential near the cathode to become slightly negative as shown in line *c*. In this case all electrons having velocities less than  $E_m$  are turned back to the cathode, while those electrons having greater velocities of emission pass on to the anode. Further increases in cathode emission cause the potential minimum to become more negative with the result that a larger fraction of the emitted electrons return to the cathode. For continued increase in cathode emission, however, there will always be some slight increase in anode current.

The results obtained from the simple analysis based on zero velocity of emission are obviously not applicable to this practical case if precision is desired. Since a greater maximum potential difference ( $E_b + E_m$ ) is acting over a shorter effective distance ( $d_{kp} - d_{km}$ ) and since the average velocity of electrons is higher because of their initial velocities and hence the space-charge ef-

fect of the electrons is less, it is obvious that the space-charge-limited current flow for a given anode potential is greater in the actual case than in the ideal.

Langmuir<sup>4</sup> has presented a complete analysis of the space-charge-limited current flow with initial velocities of emission. He has shown that a good approximation may be made by the use of (8) with a correction for the

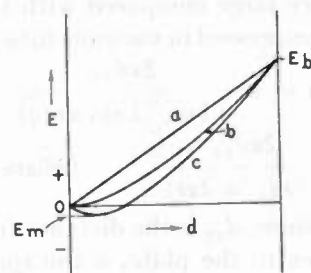

Fig. 2—Potential distribution in a diode, showing the effect of initial velocity of electron emission.

reduced effective distance and the increased effective potential. His equation is as follows:

$$I_b = 2.33 \times 10^{-6} \frac{(E_b - E_m)^{3/2}}{(d_{kp} - d_{km})^2} \times \left[ 1 + \frac{0.0247T^{1/2}}{(E_b - E_m)^{1/2}} \right] \quad (10)$$

where  $T$  is the cathode temperature in degrees Kelvin.  $I_b$  is in amperes per unit area.  $E_m$  is negative in sense. The value of  $d_{km}$  in centimeters may be calculated from the approximate expression

$$d_{km} \approx 0.0156 (1/1000I_b)^{1/2} (T/1000)^{3/4}.$$

The value of  $E_m$  is given by

$$E_m = - (T/5040) \log_{10} (I_s/I_b).$$

More complete results of Langmuir's analysis are too cumbersome to be presented here. The use of (10) should lead to errors not greatly in excess of 2 per cent even under extreme conditions.

It is interesting to observe from Langmuir's calculation in a practical case where the cathode temperature is 1000 degrees Kelvin, the emission density greatly in excess of the anode current, and the anode current density 1 milliamperere per square centimeter, that the distance from cathode to virtual cathode is approximately 0.016 centimeter (0.006 inch). Thus, in modern close-spaced vacuum tubes the position of the virtual cathode cannot be neglected.

The error involved in using (9) as compared with the exact solution for cylindrical structures is less than in the corresponding case of parallel planes. For a discussion of the effect of initial velocities in this case, the reader is referred to Langmuir and Compton.<sup>5</sup>

The potential distribution between parallel planes, taking into account initial velocities, may best be determined by the use of a plot presented by Langmuir and Compton.<sup>6</sup>

<sup>4</sup> See pp. 239-244 of footnote reference 1.

<sup>5</sup> See pp. 252-255 of footnote reference 1.

<sup>6</sup> See Fig. 42, p. 243 of footnote reference 1.

B. TRIODE THEORY

Triode Mu Formulas

The earliest analysis of the electric field existing between parallel planes with a parallel-wire screen interposed is that of Maxwell.<sup>7</sup> In this it is assumed that the spacings between the planes and the screen are large compared with the spacings between wires and that these in turn are large compared with the wire diameter. The result expressed in vacuum-tube terminology is

$$\mu = - \frac{2\pi d_{gp}}{a \log_e (2 \sin \pi r/a)}$$

or 
$$\mu = \frac{2\pi d_{gp}}{a \log_e (a/2\pi r)} \quad (\text{where } \pi r/a \text{ is small}).$$

In these expressions,  $d_{gp}$  is the distance from the center of the grid wires to the plate,  $a$  the spacing between grid wires ( $a=1/n$ , where  $n$  is the number of wires per unit length), and  $r$  is the radius of the grid wires. It will be noted that the distance between grid and cathode does not appear.

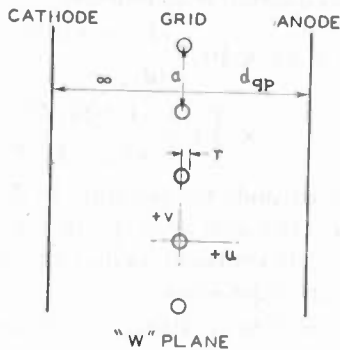

Fig. 3—Cross section of a triode in normal co-ordinates.

This formula is in serious error when the spacing between grid wires is not large compared with the wire diameter, as is frequently the case. Because of this, van der Bijl developed empirically the formula  $\mu = Cd_{gp} r n^2 + 1$ , where  $C$  is equal to 160 for parallel planes. An obvious defect of this expression is that  $\mu$  can never be less than unity.

The most generally useful and accurate formula for amplification constant which has been published is that developed by Vogdes and Elder.<sup>8</sup> This analysis assumes that the spacing between grid wires is small compared with the distances between the grid and the other electrodes. The development is as follows.

Fig. 3 represents the geometry of the vacuum tube. By means of a conformal transformation, this same geometry may be represented in different co-ordinates. In such a transformation, equipotential surfaces and flux lines still cross at right angles and all laws of electricity still apply.

Suppose the geometry represented in the  $w$  plane in Fig. 3 be transformed to the  $z$  plane by the transformation  $z = e^{2\pi n w}$ .

<sup>7</sup> J. C. Maxwell, "Electricity and Magnetism," third edition, 1904, vol. 1, section 203.

<sup>8</sup> B. F. Vogdes and F. R. Elder, "Formulas for the amplification constant for three-element tubes," *Phys. Rev.*, vol. 24, p. 683; December, 1924.

Since  $z = x + jy$   
and  $w = u + jv$   
then  $x + jy = e^{2\pi n u} \times e^{j2\pi n v} = \rho e^{j\theta}$ .

This transformation is represented in Fig. 4. The cathode is a point at the origin. The grid wires become a single figure intersecting the  $x$  axis at  $e^{-2\pi n r}$  and  $e^{2\pi n r}$ . The center of the grid wires is at  $x=1$ . The anode is a circle about the origin of radius equal to  $e^{2\pi n d_{gp}}$ .

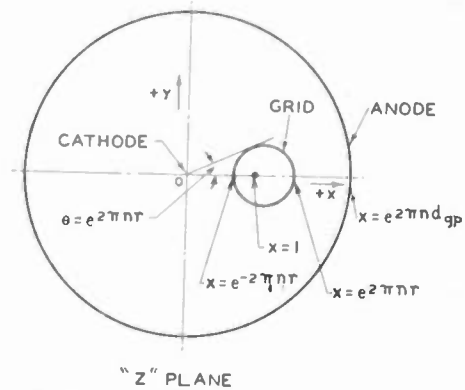

Fig. 4—Cross section of the triode of Fig. 3 transformed from the  $w$  plane to the  $z$  plane.

The figure representing the grid wires is not a circle. If  $r$  is less than  $a/2\pi$ , however, it can be shown readily that the figure is essentially circular and it will be assumed, therefore, that such is the case. If the figure is a circle, its radius is

$$\frac{e^{2\pi n r} - e^{-2\pi n r}}{2} = \sinh 2\pi n r$$

and its center is located at

$$x = \frac{e^{2\pi n r} + e^{-2\pi n r}}{2} = \cosh 2\pi n r.$$

In Fig. 3, if the anode were removed to infinity and a potential applied to the grid, the successive equipotential surfaces at greater distances from the grid would become more and more nearly planes until, at distances several times  $a$ , the surface could be regarded as essentially a plane. Therefore, under the limitations of our assumptions concerning relative spacings, the anode plane may be considered to be the equipotential surface due to the field of the grid alone. This is equivalent to saying that a circle of radius  $e^{2\pi n d_{gp}} - \cosh 2\pi n r$  drawn about the "center" of the grid wire in Fig. 4 does not differ materially from a circle of radius  $e^{2\pi n d_{gp}}$  drawn about the origin. The justification for this assumption may be checked by considering the rather extreme case where  $n d_{gp} = 0.50$  and  $n r = 0.03$ . Then  $e^{2\pi n d_{gp}}$  equals 23.1 and  $\cosh 2\pi n r$  equals 1.02.

The convenient result of these assumptions is that a line charge placed at the "center" of the circular grid wire, Fig. 4, produces equipotential surfaces at the surface of the grid wires and at the anode, since the charge on the cathode located at minus infinity must be zero.

Let us place a charge  $-Q$  at the "center" of the grid wire. The potentials  $E_k$ ,  $E_g$ , and  $E_a$  of the cathode, grid, and anode become

$$E_k = C + 2Q \log \cosh 2\pi nr$$

$$E_o = C + 2Q \log \sinh 2\pi nr$$

$$E_a = C + 2Q \log 2\pi n d_{op}$$

If the cathode potential be taken as zero,

$$E_o = 2Q \log \sinh 2\pi nr - 2Q \log \cosh 2\pi nr$$

$$= 2Q \log \tanh 2\pi nr$$

and  $E_a = 2Q \log 2\pi n d_{op} - 2Q \log \cosh 2\pi nr$ .

Under these circumstances, the amplification constant may be defined as  $\mu = -E_a/E_o$

whence 
$$\mu = \frac{\log \cosh 2\pi nr - 2\pi n d_{op}}{\log \tanh 2\pi nr}$$

The assumptions made in this derivation invalidate the expression for use with relatively very close spacings between electrodes. The same type of analysis as that presented by Vogdes and Elder may be made to give more rigorous results. Salzberg<sup>9</sup> has carried out such an analysis. It differs from that just presented chiefly in that an additional line charge is placed on the  $x$  axis, Fig. 4, outside the anode at such a position as to make the true anode cylinder an equipotential surface. Therefore, the anode may be allowed to approach much more closely to the grid. This leads to an expression accurate for cases where the spacing between anode and grid is small compared with the wire spacing, though not when the wire spacing is small compared with the wire diameter. Salzberg's expression is

$$\mu = \frac{\log \cosh 2\pi nr - 2\pi n d_{op}}{\log \tanh 2\pi nr - \log (1 - e^{-4\pi n d_{op}} \times \cosh^2 2\pi nr)}$$

There is no obviously useful definition of amplification factor in the purely electrostatic case (no space charge) when the charge density induced on the cathode is not uniform. It is possible by extension of the analysis described above, however, to arrive at an expression for the charge distribution on the cathode when the spacing between cathode and grid is finite. Salzberg has carried out such an analysis.<sup>10</sup> It departs from that of the cathode at infinity by considering the potentials in space produced by a line charge at the cathode in addition to the others.

The amplification-factor formulas here given may be applied to cylindrical tubes if  $r_o \log(r_a/r_o)$  is substituted for  $d_{op}$ , where  $r_o$  and  $r_a$  are the radii of the grid and anode, provided  $r/r_o$  is small.

**Equivalent Potentials in Triodes**

For most practical purposes in calculating the electric fields at cathode, anode, and the space between, except very near the grid, a potential may be assigned to the plane of the grid. In other words, it is assumed that an equipotential plane may be substituted for the grid without altering the electric fields. This would be true only when the grid wires are small and closely spaced in comparison with the spacings between grid and cathode and anode.

The equivalent potential of the plane of the grid  $E_G$  may be derived in several ways. The most simple with which the writer is familiar is the following. The capacitance between anode and the equivalent plane  $G$  at the grid, Fig. 5, is  $C_{pG} = 1/4\pi d_{op}$  and the capacitance from cathode to  $G$ ,  $C_{kG} = 1/4\pi d_{ok}$  while, by definition,  $C_{oG} = \mu C_{pG}$ .

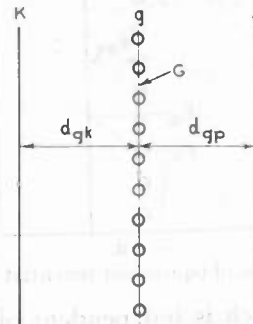

Fig. 5—Triode with equivalent plane  $G$  at grid.

In the star network of capacitances, Fig. 6,

$$E_G = \frac{E_c C_{oG} + E_b C_{pG} + E_k C_{kG}}{C_{oG} + C_{kG} + C_{pG}}$$

Let us make  $E_k$  equal to zero. Then,

$$E_G = \frac{\mu E_c + E_b}{\mu + 1 + d_{op}/d_{ok}}$$

or

$$E_G = \frac{E_c + E_b/\mu}{1 + 1/\mu + d_{op}/d_{ok}\mu}$$

The physical basis for this analysis is that the anode can influence the field at the cathode only by acting through the grid plane. By definition, the grid has  $\mu$  times the influence of the anode. It is obvious that this

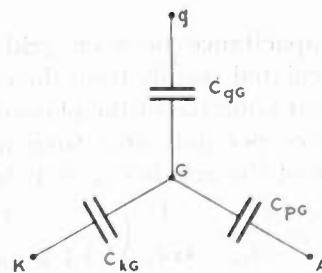

Fig. 6—Star network of the capacitances of the triode of Fig. 5.

reasoning implicitly assumes that amplification factor is proportional to grid-anode spacing, for we might just as well have called the cathode the anode. The quantity  $d_{op}/d_{ok}\mu$  is simply the reciprocal of the amplification factor of the grid with respect to the cathode.

We shall find it convenient to determine another equivalent-potential plane. The equivalent potential of the grid plane depends on grid and anode potentials and on grid-cathode and grid-anode spacings. Is there an equivalent plane the potential of which depends only on grid and anode potentials and grid-anode spacing?

In Fig. 7,  $E_G$  is the equivalent potential of the grid. If the constant potential gradient between grid and cathode extended past the grid, the potential  $E$  at any point a distance  $x$  from the grid would be

<sup>9</sup> Bernard Salzberg, "Formulas for the amplification factor of triodes," PROC. I. R. E., vol. 30, pp. 134-138; March, 1942.

<sup>10</sup> Not published.

$$E = E_0(1 + x/d_{gk}) = \frac{(E_c + E_b/\mu)}{1 + 1/\mu + d_{gp}/d_{gk}\mu} (1 + x/d_{gk}).$$

We wish to find a potential  $E = E_q$  at a distance  $x = d_{gq}$

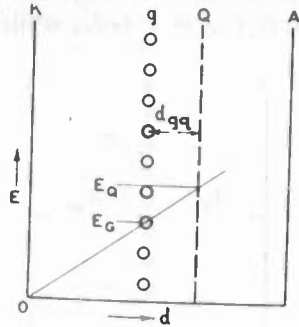

Fig. 7—Determination of equivalent potential  $E_q$  of the  $Q$  plane.

from the grid which is independent of  $d_{gk}$ . At such a point the ratio

$$\frac{1 + x/d_{gk}}{1 + 1/\mu + d_{gp}/d_{gk}\mu}$$

must be independent of  $d_{gk}$ . Obviously this means that

$$\frac{x}{d_{gk}} = \frac{d_{gp}/d_{gk}\mu}{1 + 1/\mu}$$

or  $x = d_{gp}/(\mu + 1) = d_{gq}$ .

The potential  $E_q$  is given by

$$E_q = \frac{E_c + E_b/\mu}{1 + 1/\mu}$$

Applications of this equivalent-potential plane will be given.

*Interelectrode Capacitances in Triodes without Space Charge*

The direct capacitance between grid and anode,  $C_{gp}$ , may be calculated readily from the expression for  $E_g$ , the equivalent potential of the plane of the grid.

The capacitance per unit area from anode to the equivalent plane of the grid is  $C_{pG} = 1/4\pi d_{gp}$ .

Then  $C_{gp} = C_{pG} \frac{dE_g}{dE_c} = \frac{1}{4\pi d_{gp}} \left( \frac{1}{1 + 1/\mu + d_{gp}/d_{gk}\mu} \right)$ .

Similarly  $C_{gk} = \frac{1}{4\pi d_{gk}} \left( \frac{1}{1 + 1/\mu + d_{gp}/d_{gk}\mu} \right)$ .

By definition  $C_{pk} = \frac{C_{gk}}{\mu} = \frac{1}{4\pi d_{gk}} \left( \frac{1}{\mu + 1 + d_{gp}/d_{gk}} \right)$ .

These derivations are for the parallel-plane case. The case of cylindrical electrodes may be treated in a similar fashion.

*Amplification Factor in Multigrad Tubes*

The analysis of multigrad tubes may be readily carried out by use of the second expression for equivalent potential  $E_q$ .

In Fig. 8, the  $Q$  plane is to be substituted for  $g_2$  and  $A$ . Its potential is

$$E_q = \frac{E_{c2} + E_b/\mu_{g2p}}{1 + 1/\mu_{g2p}}$$

and its distance from  $g_1$  is  $d_{g1p} = d_{g1g2} + d_{g2p}/(1 + \mu_{g2p})$ . We now have a triode and can calculate its  $\mu$ . The simplest expression is  $\mu_{g1q} = (\mu'_{g1g2}/d_{g1g2})d_{g1q}$  where  $\mu'_{g1g2}$  is the amplification factor of  $g_1$  with respect to a plane at  $g_2$ .

Now  $\mu_{g1g2} = \mu_{g1q}(dE_{c2}/dE_q) = \mu_{g1q}(1 + 1/\mu_{g2p}) = \mu'_{g1g2}(d_{g1q}/d_{g1g2})(1 + 1/\mu_{g2p})$ .

On substituting the expression for  $d_{g1q}$  in this equation, one may reduce it to the following form by simple manipulation:  $\mu_{g1g2} = \mu'_{g1g2} + \mu'_{g1p}/\mu_{g2p}$  where  $\mu'_{g1p}$  is the value  $\mu_{g1p}$  would have if  $g_2$  were removed.

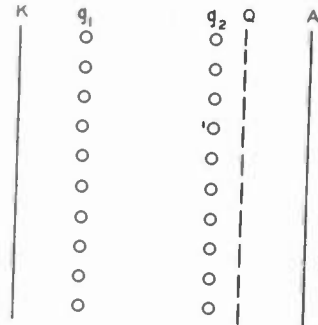

Fig. 8—Determination of amplification factor and inter-electrode capacitance in multigrad structures by use of the  $Q$  plane.

Of course  $\mu_{g1p} = \mu_{g1g2}\mu_{g2p}$  whence  $\mu_{g1p} = \mu'_{g1g2}\mu_{g2p} + \mu'_{g1p}$ . The direct capacitance between  $g_1$  and  $g_2$  may also be determined readily, since  $C_{g1g2} = C_{g1q}(dE_q/dE_{c2})$ . Also, the capacitances between grids and anode or cathode may be determined in the same manner.

By an obvious extension of the method, amplification factors and capacitances may be determined in structures containing any number of grids.

*Effects of Space Charge on Potential Distribution in Triodes*

In the case where space charge between grid and anode may be neglected (as is usually the case in re-

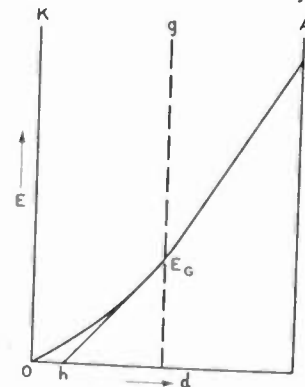

Fig. 9—Apparent location  $h$  of the cathode as seen from the grid.

ceiving tubes with negative control grids), a quite precise equivalent diode may be constructed by the use of the first expression for equivalent potential with a space-charge correction. Fig. 9 shows the potential

<sup>11</sup> For an alternative derivation see S. Koizumi, "On the amplification constants of multi-electrode vacuum tubes," *Jour. I.E.E. (Japan)*, pp. 505, 857; 1930.

distribution in a triode with space-charge-limited current. It is obvious that the field at the grid is the same as would exist without space charge if the cathode were at point  $h$ , determined by drawing a tangent to the potential curve at the grid. If it be assumed that the potential between cathode and grid varies as the four-thirds power of distance,  $d_{gh}$  is three fourths of  $d_{gk}$ . Hence, we must modify the expression for  $E_G$  as follows:<sup>12</sup>

$$E_G = \frac{E_c + E_b/\mu}{1 + 1/\mu + (4/3)(d_{gp}/d_{gk}\mu)}$$

The analysis of the current-voltage relationship of a triode may be made directly from the diode case by the use of this equivalent-diode expression. If in the equivalent diode the space current  $I_b = f(E_G)$  the cathode current (equal to the plate current with negative grid) is given directly. The transconductance  $g_m$  is found by taking the derivative of  $f(E_G)$  with respect to  $E_c$ . The plate conductance  $1/r_p$  is found by taking the derivative<sup>13</sup> of  $f(E_G)$  with respect to  $E_b$ .

<sup>12</sup> B. D. H. Tellegen, "The calculation of the emitted current in a triode," *Physica*, vol. 5e, pp. 301-315; 1925.

<sup>13</sup> Note added April 6, 1943: Fremlin<sup>14</sup> discusses several old expressions for equivalent diode potential, none of which is similar to that given above, and then derives an expression for anode current of a triode starting from the known condition of grid and anode at such potentials as to maintain the space-potential distribution of a diode undisturbed to the anode (grid at "space potential"). Unfortunately, no simple analysis of this sort is valid when there is appreciable space charge in the grid-anode space as is implicit under Fremlin's assumptions. In the case of negligible grid-anode space charge, Tellegen's expression seems satisfactory.

<sup>14</sup> J. H. Fremlin, "Calculations of triode constants," *Elec. Communications*, July, 1939.

### Electron Transit Time in Negative-Grid Triodes

The electron transit time in any electrode structure may be calculated readily if the potential distribution is known. In general

$$t = \int \frac{dx}{v} = \left(\frac{m}{2e}\right)^{1/2} \int \frac{dx}{E^{1/2}}$$

The calculation of transit time in the absence of space charge is obvious. In a parallel-plane diode with space-charge-limited current, the transit time from cathode to anode may be calculated if it be assumed that

$$\begin{aligned} E &= E_b(x/d_{kp})^{4/3} \\ \text{whence } t &= \left(\frac{m}{2e}\right)^{1/2} \frac{d_{kp}^{2/3}}{E_b^{1/2}} \int_0^{d_{kp}} x^{-2/3} dx \\ &= \left(\frac{m}{2e}\right)^{1/2} \frac{3d_{kp}}{E_b^{1/2}} \\ &= 5.05 \times 10^{-8} (d_{kp}/E_b^{1/2}) \end{aligned}$$

where  $t$  is in seconds,  $d_{kp}$  in centimeters, and  $E_b$  in volts. In other words, the electron takes three times as long to pass from cathode to anode as if it had traveled at the final velocity the entire distance, and half again as long as if it had been uniformly accelerated.

The cylindrical analysis is not so simple but may be carried out as presented by W. R. Ferris.<sup>15</sup>

In the case of electron transits between grid and anode, the integration is carried out with the initial velocity of the electron corresponding to the equivalent potential of the grid.

<sup>15</sup> W. R. Ferris, "Input resistance of vacuum tubes as ultra-high-frequency amplifiers," *Proc. I.R.E.*, vol. 24, pp. 82-108; January, 1936.

It has been planned to present in the PROCEEDINGS OF THE I.R.E. instructional material of timely interest. This procedure was instituted some time ago, and here continues by the publication, in successive issues of the PROCEEDINGS, of a series of co-ordinated parts, together entitled "Some Aspects of Radio Reception at Ultra-High Frequency" by Messrs E. W. Herold and L. Malter. Part I was published in the August, 1943, issue of the PROCEEDINGS. Parts II and III of the five parts are here presented. Forthcoming issues of the PROCEEDINGS will contain succeeding Parts of this series. Each Part will be preceded by its own related summary.

The Editor

## Some Aspects of Radio Reception at Ultra-High Frequency\*

E. W. HEROLD†, MEMBER, I.R.E., AND L. MALTER‡, ASSOCIATE, I.R.E.  
PART II. ADMITTANCES AND FLUCTUATION NOISE OF TUBES AND CIRCUITS  
L. MALTER‡

**Summary**—The signal-to-noise ratio of radio receivers depends in part upon tube and circuit admittances and upon noise sources present in tube and circuit elements. Tubes operating in a linear fashion can

be represented by a 4-terminal network consisting of admittances, of which the most important are the input, output, and feedback admittance, and by two constant-current generators of which the more important is the one which determines the transadmittance.

\* Decimal classification: R261. Original manuscript received by the Institute, July 7, 1943.

† RCA Laboratories, Princeton, N. J.

‡ Formerly, RCA Laboratories, Princeton, N. J.; now, RCA Victor Division, Radio Corporation of America, Lancaster, Pa.

The input admittance of conventional type tubes is determined largely by: 1. ohmic losses; 2. interelectrode capacitances; 3. electrode self and mutual inductances; 4. lead self and mutual inductances; 5. the space-charge conditions within the tube; and 6. the

magnitude of the cathode—control-grid transit angle. The cathode lead inductance, which may be the most important, results in an input admittance term which varies as the first power of the transconductance, and as the square of the frequency. The cathode—control-grid transit angle introduces a similarly varying admittance term which is also proportional to the transit angle, (provided the latter is not too large). These added admittance terms are positive for the case of space-charge-limited emission and negative for temperature-limited emission. Similarly, the input capacitance is increased over the "cold-cathode" value in the space-charge-limited emission case and decreased in the temperature-limited emission case.

The transmittance does not vary greatly in magnitude as a function of frequency, although its phase angle may vary considerably. The feedback admittance (primarily a capacitance) may reverse in sign at a particular frequency. The output admittance is generally altered less than the input admittance by an increase in frequency.

Various noise sources, which are factors in determining the signal-to-noise ratio of receivers, are treated. These include thermal fluctuations, shot noise, current division, induced noise, and secondary emission. The concept of equivalent noise resistance of a tube is introduced, it being a fictitious resistance of such value that if placed across the input terminals of a tube, it will result in an increase in the plate-circuit noise equal to the shot noise of the plate current. Its utility will be brought out in Part III of this series.

I. INTRODUCTION

AS WAS pointed out in Part I of this series, the function of the receiving antenna is to "capture" a portion of the transmitted power. In general, a portion of the captured power is consumed in the first tube of the receiver through the mechanism of the input circuit. In some cases, however, when the tube has an infinite or *negative* input resistance, the tube will not be power-consuming.<sup>1</sup> The ultimate goal in many receiver designs is maximum possible signal-to-noise ratio, that being aimed after, regardless of the nature of the input resistance of the first tube, subject to the condition that the bandwidths of the various circuits be adequate for the utilization of all the information contained in the received signal. If the receiver input is strictly power-operated, the condition for maximum signal-to-noise ratio coincides with that for maximum signal on the control electrode of the same tube, it merely being necessary to maintain an impedance match at the tube input terminals. Whether the receiver input is strictly power-operated or not, the signal-to-noise ratio of the receiver will be determined in part by the tube and circuit admittances. As a consequence, a study of tube admittances is of prime importance as a prelude to the investigation of receiver response. The signal-to-noise ratio of a receiver is determined not only by the tube and circuit admittances, but by the unavoidable noise voltages due to thermal agitation, electron emission, the division of current, and other "noise sources" which will be discussed in detail below. This part of the series on ultra-high-frequency reception will concern itself with a discussion and evaluation of tube admittances and with the noise present in the components of radio receivers. In Part III it will be shown how the influence of these factors may be combined to give a measure of the so-called noise factor of a radio receiver.

<sup>1</sup> See Part I, Section II, 3 of this series for added discussion of this point.

II. THE TUBE AS A 4-TERMINAL NETWORK

A tube, as e.g., a triode or pentode, operating over a linear portion of its characteristics can be represented by the 4-terminal network shown in Fig. 1 where

$I_g$  is the effective alternating component of grid current.

$I_p$  is the effective alternating component of plate current.

$E_p$  is the effective alternating component of plate voltage.

$y_m E_g$  is the effective alternating component of plate current due to the effect of grid voltage  $E_g$  upon electron current to the plate.

$y_n E_p$  is the effective alternating component of grid current due to the effect of plate voltage  $E_p$  upon electron current to the grid.

$y_m E_g$  and  $y_n E_p$  are thus currents over and above those which would flow in the plate and grid circuits in the absence of electron emission, the circuit in that case being purely passive in nature with currents determined by impressed voltages and impedances of circuit elements only.

It should be clearly realized that the representation of a tube by the 4-terminal network is, strictly speaking, permissible only if the tube is linear in operation. This effectively limits the representation to amplifiers only, excluding such devices as mixer or detectors. However, even in the case of nonlinear devices, a 4-terminal representation can be made for successive small portions of the characteristic as are effectively linear, and the results for these successive portions then combined for the whole region of operation so as to give useful information.

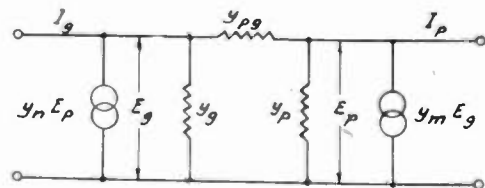

Fig. 1—Representation of a vacuum tube by a 4-terminal network which contains as elements, admittances and constant-current generators.

From Fig. 1 it can be seen that the following relations hold:

$$I_p = y_m E_g + y_p E_p + (E_p - E_g) y_{p0}$$

$$I_g = y_n E_p + y_g E_g + (E_g - E_p) y_{p0}$$

If the output terminals are short-circuited  $E_p = 0$ ; then,

$$I_p = y_m E_g - y_{p0} E_g$$

$$I_g = y_g E_g + y_{p0} E_g$$

If there were no emission,  $y_m E_g = y_n E_p = 0$ . It is then seen that  $y_{p0}$  is the feedback admittance between plate and grid.  $y_m$  is defined as the grid-plate transadmittance, and  $y_g$  as the input admittance. If the input terminals are short-circuited,  $E_g = 0$ ; then,

$$I_p = y_p E_p + y_{p0} E_p$$

$y_p$  is defined as the output admittance;  $y_n$ , which is defined as the plate-grid transadmittance, in general



plays a minor role and may usually be neglected. The above treatment is applicable to practically all types of receiving tubes if by the term "grid" in the preceding discussion, it is understood that one refers to the "control electrode." The various tube admittances will now be considered in turn, as a preliminary to the consideration of their influence upon the signal-to-noise ratio of a receiver.

III. INPUT ADMITTANCE

Case 1. Cold Cathode

To enable the influence of electron emission upon the input admittance to be determined, it will be of value first to consider the case of a tube with a cold cathode, where, since no emission is present, the 4-terminal network becomes passive in nature, and the problem is purely a circuit one.

The input circuit of a multielectrode tube with the cathode cold may be represented as shown in Fig. 2. The combination of inductances and capacitances, when examined at the input terminals, exhibit series and parallel resonances at various frequencies. As a rule the lowest frequency resonance is of the series type, wherein the input lead inductances resonate with the remainder of the circuit, which behaves like a capacitance at that frequency. As one attempts to tune to this frequency, the external circuit diminishes in size until it finally consists of a short circuit across the input terminals. To operate at higher frequencies it then becomes necessary to use a transmission-line circuit operating at a three-quarter or higher mode. However, with tube types employing wire leads through the envelope, the ohmic losses are usually increasing rapidly with frequency in

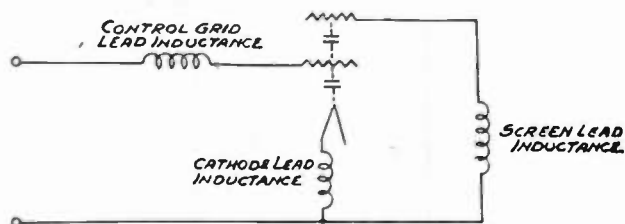

Fig. 2—Tube-input circuit indicating presence of inductance in electrode leads.

this region, so that satisfactory performance cannot always be obtained.

Case 2. Hot Cathode

When emission is present, the picture is altered in that the input conductance becomes increasingly large at ultra-high frequencies. This conductance serves to load down the input circuit, thus limiting the gain obtainable from the antenna to the signal grid. The input conductance, frequently referred to as loading, arises primarily from two distinct sources, 1) the inductance and resistance of the tube leads, and 2) the finite transit time of the electrons in traversing the tube. These will be considered in turn.

(a) Lead Effects

A complete study of the input admittance involves the consideration of the effects of lead self and mutual

inductances as well as of capacitances between leads and of distributed capacitances. This problem has been handled in a thorough fashion by Strutt.<sup>2</sup> It will suffice for the purpose of illustration to consider the simple case wherein self-inductance is present in the cathode lead, only, as shown in Fig. 3. This is due to the fact that in certain cases it is the cathode lead inductance which plays the preponderant role in determining the input conductance at ultra-high frequency.

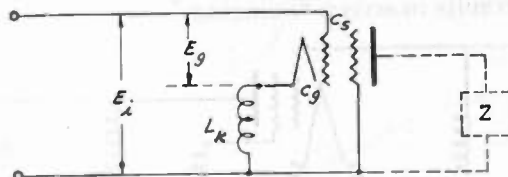

Fig. 3—Tube circuit indicating presence of cathode-lead inductance.

For the circuit of Fig. 3, there can be substituted its equivalent as shown in Fig. 4.

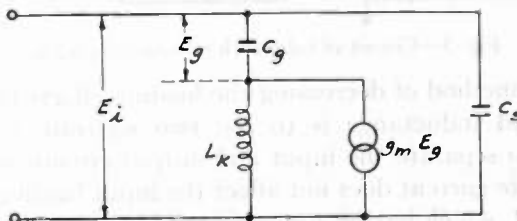

Fig. 4—Equivalent input circuit of tube represented in Fig. 3.

$C_g$  is the cathode—control-grid capacitance.

$C_s$  is the control-grid—screen-grid capacitance.

$L_k$  is the cathode lead inductance.

$E_g$  is the effective alternating voltage between grid and cathode.

$E_i$  is the effective alternating voltage across the input terminals.

$g_m$  is the sum of the transconductances as measured between the control grid and all other electrodes to which electron current flows.

The  $g_m E_g$  generator across  $L_k$  is a current generator which supplies the plate current, screen current, etc., which flow through  $L_k$ , the cathode lead inductance.

$$\text{Then, } E_i = E_g + j\omega L_k g_m E_g$$

$$= E_g(1 + j\omega L_k g_m)$$

$$I_o = E_g j\omega C_g + E_i j\omega C_s$$

$$= (E_i j\omega C_g) / (1 + j\omega L_k g_m) + E_i j\omega C_s$$

$$= E_i (j\omega C_g + \omega^2 L_k C_g g_m) / (1 + \omega^2 L_k^2 g_m^2)$$

If the discussion is limited to the case for which  $\omega^2 L_k^2 g_m^2 \ll 1$ , then

$$I_o = E_i [j\omega(C_g + C_s) + \omega^2 L_k C_g g_m]$$

and finally  $Y_o = I_o/E_i = j\omega(C_g + C_s) + \omega^2 L_k C_g g_m$ .

If the screen lead inductance is appreciable and of value  $L_s$ , the expression for input admittance becomes

$$A = j\omega(C_g + C_s) + \omega^2(g_m L_k C_g - g_s L_s C_s)$$

where  $g_s$  is the grid-screen transconductance.

<sup>2</sup> M. J. O. Strutt, "The causes for the increase of the admittances of modern high-frequency amplifier tubes on short waves," *Proc. I.R.E.*, vol. 26, pp. 1011-1033; August, 1938.

Thus the cathode and screen lead inductances result in the introduction into the input admittance of real components, which vary as the first power of transconductance and as the square of the impressed frequency. The effect of the screen lead inductance is to tend to "neutralize" the effect of the cathode lead inductance. However, due to the fact that  $g_s$  is usually a fraction of  $g_m$  the neutralization could be complete only by making  $L_s$  several times  $L_k$ , a method which is unsatisfactory in that it results in screen "swinging."

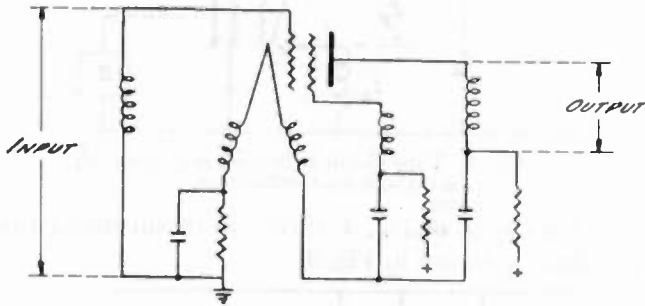

Fig. 5—Circuit of tube with two cathode leads.

One method of decreasing the loading effects of cathode lead inductance is to use two separate cathode leads to separate the input and output circuits so that the plate current does not affect the input loading. This method, which has been made use of in tubes produced for ultra-high-frequency operation is illustrated in Fig. 5.

(b) Capacitance Changes and Transit-Time Loading

The influence of the flow of electrons within the tube upon the input capacitance and conductance will now be examined. It is customary to think of current flow occurring to an electrode only when electrons strike it, a concept which is strictly valid only for static conditions. A more appropriate concept is best arrived at by examining the behavior of a diode, in which it can be seen that plate current begins to flow as soon as electrons leave the cathode. Every electron in the space between cathode and plate induces an "image" charge on the plate; the magnitude of the charge depending upon the proximity of the electron to the plate. Because the proximity changes with electron motion, there is a current flow through the external circuit due to the motion of electrons in the space between cathode and plate.

This concept of current flow can be used to envisage the way in which the grid current flows in a triode as illustrated in Fig. 6.  $e_g$  is the instantaneous value of the alternating component of grid voltage. In this triode, the plate is positive with respect to the cathode and the grid is negatively biased. Due to the motion of electrons between cathode and grid there is a current  $i_a$  flowing into the grid and in addition there is a current  $i_b$  flowing out of the grid due to the motion of electrons away from the grid towards the plate. When no alternating voltages are present  $i_a = i_b$  and the net grid current  $i_g = 0$ . While under static conditions no current flows in the grid circuit, the presence of electrons in the space causes a positive image charge to appear on the

grid. Now if the grid potential is varied in the positive direction, the positive charge on the grid will be increased, the increase being due in part to the effect of the capacitance between the grid and other electrodes and in part to the increase of electron space charge in the region surrounding the grid. The increase in space charge results from the increased electron current caused by the grid going more positive. From the fact that the positive charge on the grid is increased over and above the charge due to the capacitance with the cathode cold, it may be seen that the space charge effectively results in an increase in the effective capacitance between the grid and the other electrodes. This added capacitance depends upon the electron space charge and increases with decreasing grid bias.

If a small alternating voltage  $e_g$  is applied to the grid, the electron current will vary correspondingly and consequently the grid charge too. If the time taken for the electrons to traverse the region between the cathode and grid is small compared with the period  $T$  of the alternating voltage  $e_g$ , the charge on the grid due to the electron space charge will vary in phase with  $e_g$  and thus the added input admittance resulting from current flow will be purely susceptive. The time taken for the electrons to traverse the region between cathode and grid is referred to as the cathode-grid transit time and is denoted by  $\mathcal{T}_g$ . The transit time between grid and plate  $\mathcal{T}_p$  is generally small compared with  $\mathcal{T}_g$  due to the high average electron speed in this region. As a consequence consideration of the effects of transit times upon input admittance may be restricted to the cathode—control-grid transit time  $\mathcal{T}_g$ .

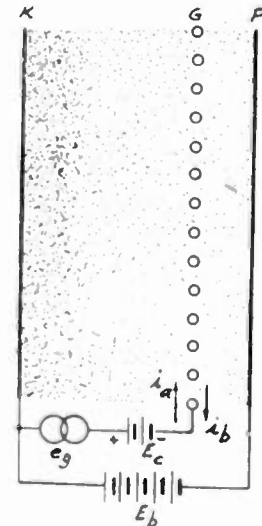

Fig. 6—Triode showing presence of electron space charge.

It is frequently convenient to make use of the quantity "transit angle" which is defined as  $\omega\mathcal{T} = 2\pi f\mathcal{T} = 2\pi(T/\mathcal{T})$ . For the above case where  $\mathcal{T}_g \ll T$ ,  $\omega\mathcal{T}_g \ll 2\pi$ . Now if the cathode-grid transit angle is appreciable, which is just another way of saying that the time taken for an electron to traverse the cathode-grid region is not negligible compared with the period of the impressed signal, the grid charge will go through its maximum

value somewhat later than the instant when the grid voltage passes through its maximum. This "lag" in the grid charge denoted by  $\theta$  in Fig. 7, results in a corresponding lag in the grid current. The courses of the grid voltage, charge, and current for this case are depicted in Fig. 7. Since the grid voltage and current are not in quadrature, the input admittance is complex and contains a real or conductance term. From Fig. 7 it may be seen that the conductance term is positive indicating that the effect of finite transit angle is to result in the introduction of a real conductance across the grid-cathode terminals. This problem has been investigated by Ferris<sup>3</sup> and North<sup>4</sup> who found that if the transit angle is not too great the input conductance is given by  $A = kg_m \omega^2 \tau_o^2$  where  $k$  is a constant and  $\tau_o$  is the cathode-grid transit time. If the transit angle is greater than about  $\pi/2$ , the behavior may be quite different, in

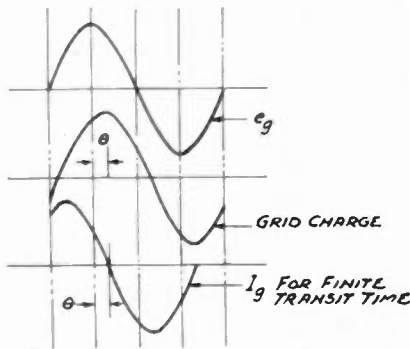

Fig. 7—Variations of grid potential, grid charge, and grid current in tube with appreciable cathode—control-grid transit angle.

that the input conductance and susceptance may oscillate through positive and negative values as the transit angle increases.<sup>4</sup> It will be noted that this expression is similar to that for the input conductance due to lead inductances in that it varies as the first power of the  $g_m$  and the square of the applied frequency. The similarity of the two expressions makes their experimental unraveling difficult.<sup>5</sup>

For the purposes of illustration, the input loading and capacitance change of a 6AC7 are shown in Fig. 8 as a function of plate current. While the measurements were made at 40 megacycles, they can be extended to other frequencies by making use of the facts that the input conductance varies as the square of the frequency and that, to a first approximation, the change in input capacitance is independent of the frequency.

The preceding discussion applies to the case of space-charge-limited emission. For temperature-limited emission the behavior is the converse, the capacitance change being negative and the input conductance due to finite transit time also being negative. That this is so can be seen by considering the behavior of a space-charge grid

<sup>3</sup> W. R. Ferris, "Input resistance of vacuum tubes as ultra-high-frequency amplifiers," *Proc. I.R.E.*, vol. 24, pp. 82-105; January, 1936.

<sup>4</sup> D. O. North, "Analysis of the effect of space charge on grid impedance," *Proc. I.R.E.*, vol. 24, pp. 108-136; January, 1936.

<sup>5</sup> M. J. O. Strutt, "Moderne Kurzwellen-Empfangstechnik," pp. 113-118, Julius Springer, Berlin, Germany, 1940.

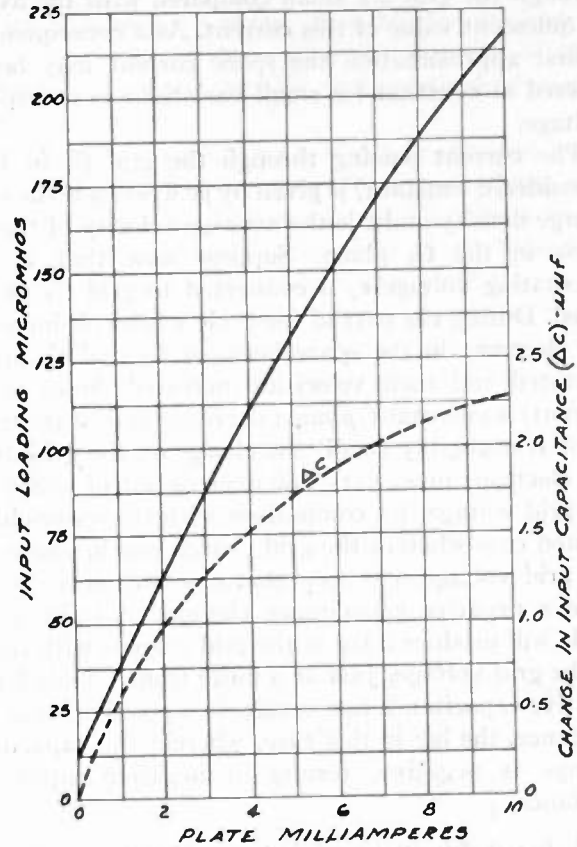

Fig. 8—Variation of input conductance and of input capacitance as function of plate current in 6AC7 pentode measured at 40 megacycles.

$E_f = 6.3$  volts  
 Plate volts = 250  
 Suppressor volts = 0  
 Screen volts = 150  
 Grid volts = varied  
 Frequency = 40 megacycles

tube (see Fig. 9) wherein a grid  $G_1$  interposed between cathode and control grid  $G_2$  is operated at a positive potential. The current passing through the control grid  $G_2$  and then through the screen grid  $G_3$  to the plate is practically unaffected by variations in control-grid volt-

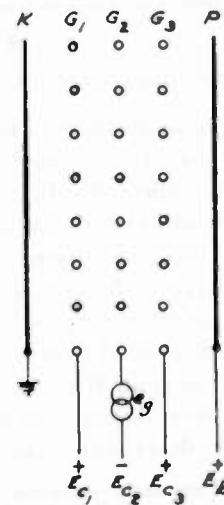

Fig. 9—Space-charge-grid tube in which effect of space charge is to lower effective input conductance and capacitance.

age. There is, of course, some variation in plate current as the grid voltage is varied. However, for small changes in the grid voltage, the variations in current transmitted

through the grid are small compared with the average or quiescent value of this current. As a consequence, to a first approximation the space current may be considered as constant for small variations in control grid voltage.

The current passing through the grid  $G_2$  in Fig. 9 (considered constant) is given by  $\rho v$  where  $\rho$  is the space-charge density and  $v$  is the average velocity of the electrons in the  $G_2$  plane. Suppose now that a small alternating voltage  $e_0$  is connected to grid  $G_2$  as indicated. During the part of the cycle when  $e_0$  is increasing the electrons in the space between  $G_2$  and  $G_3$  are accelerated and their velocities increased. Since  $\rho v$  (the current) is a constant,  $\rho$  must decrease, and (if the transit angle is negligibly small) the charge on the grid due to the electrons must vary 180 degrees out of phase with the grid voltage. By comparison with the space-charge-limited case wherein the grid charge was in phase with the grid voltage it is seen that electrons serve to produce a negative capacitance change.<sup>6</sup> A finite transit angle will produce a lag in the grid current with respect to the grid voltage. Just as a finite transit angle for the positive capacitance case results in a positive input conductance, the lag in this case, wherein the capacitance change is negative, results in negative input conductance.

### (c) Input Admittance of Velocity-Modulation Devices

In recent years, a new method for the control of electron beams or current has been described,<sup>7-9</sup> wherein the velocity rather than the magnitude of a current is affected by voltages applied to control electrodes. In Fig. 10 let  $A$  and  $B$  represent grids which are connected

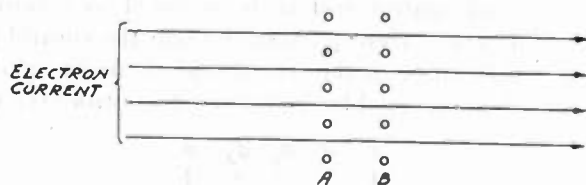

Fig. 10—Velocity-modulating grids traversed by electron current.

to the opposite terminals of a radio-frequency circuit and which are traversed by an electron current or beam. If the transit angle in the space between  $A$  and  $B$  is not too great, the beam will experience a "velocity modulation." Thus, when the radio-frequency electric field is such that  $B$  is positive with respect to  $A$ , the electrons will be accelerated as they traverse the region between  $A$  and  $B$  and will be slowed down during the opposite phase. If the region beyond  $B$  is free of radio-frequency fields, the velocity modulation will be retained in that region. By methods described,<sup>7</sup> e.g., deflection conver-

sion, drift tube conversion (bunching), or retarding-field conversion, the velocity modulation can be transformed into a current modulation which can be used to develop signal voltage in an output circuit.

If the transit time between  $A$  and  $B$  is infinitesimal, no net interchange of energy between the electrons and circuit takes place since the energy transfer from the circuit to the beam during the portion of the cycle when the beam is accelerated is balanced exactly by the transfer of energy in the reverse direction during the opposite phase of the oscillation. For finite transit angles less than  $\pi$  radians, however, there is a net transfer of energy from the circuit to the electron stream, this being evidenced externally by an apparent loading of the circuit between grids  $A$  and  $B$  of Fig. 10. The shunt conductance is given by<sup>10</sup>  $g = (i_0/v) (\omega^2 \tau^2/6)$  where  $i_0$  is the beam current and  $V_0$  is the average volt velocity of the beam. This expression, which holds very closely up to transit angles of about  $\pi/2$ , is similar to those for the other forms of input loading in that the conductance increases as the square of the transit angle.

### (d) Transadmittance

In the case of grid control tubes, transadmittance is more uniform in magnitude as a function of frequency than the other admittance terms of the 4-terminal equivalent network described above.<sup>11</sup> Whereas, the input conductance is already radically altered at frequencies for which the transit angle is  $\pi$  radians, the transadmittance is practically unaltered in magnitude for the same frequencies. Its phase, as measured by the relative phase of plate current with respect to signal-grid voltage, may, however, be radically altered. Lead effects, too, may considerably affect its phase. These phase changes are of no importance in amplifier operation, except through the effect of plate-grid feedback, but for the case of self-excited oscillators, the phase of the feedback must obviously be altered to compensate for phase changes in the transadmittance.

### (e) Output Admittance

The output circuit of a multielectrode tube may be represented as shown in Fig. 11. The behavior of this

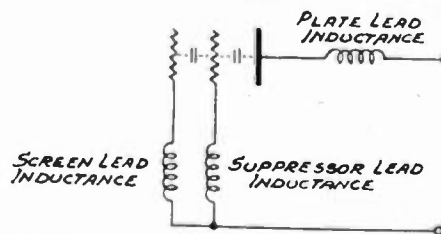

Fig. 11—Output circuit of multielectrode tube.

circuit is similar to that at the input end of a tube as discussed in Section III, 2, above, and the same general conclusions are valid. The influence of the electron

<sup>6</sup> L. C. Peterson, "Impedance properties of electron streams," *Bell Sys. Tech. Jour.*, vol. 18, pp. 465-482; July, 1939.

<sup>7</sup> W. C. Hahn and G. F. Metcalf, "Velocity-modulated tubes," *Proc. I.R.E.*, vol. 27, pp. 106-117; February, 1939.

<sup>8</sup> A. A. Heil and O. Heil, "A new method for the production of short electromagnetic waves," *Zeit. für Phys.*, vol. 95, pp. 752-762; July 12, 1935.

<sup>9</sup> R. H. Varian and S. F. Varian, "A high frequency oscillator and amplifier," *Jour. Appl. Phys.*, vol. 10, pp. 321-327; May, 1939.

<sup>10</sup> D. L. Webster, "Cathode ray bunching," *Jour. Appl. Phys.*, vol. 10, pp. 501-508; July, 1939.

<sup>11</sup> M. J. O. Strutt, "Messungen der Komplexen Steilheit Moderner Mehrgitterrohren im Kurzwellen Gebiet," *Elek. Nach. Tech.*, vol. 15, pp. 103-111; April, 1938.

space charge upon the output capacitance is negligible due to the high speed of the electrons in the output region. Its influence upon the output conductance, while not negligible, is many times less than upon the input conductance. Consequently, in an amplifier employing a number of tubes (except in the case wherein a matching transformer is employed between stages), the output conductance due to electron flow may play a minor role in loading down the circuits, when account is taken of the influence of the input conductance of the following tube. However, unless particular attention is paid to the matter of minimizing ohmic losses in the leads, these losses may exercise a preponderant role in both input and output at extremely high frequencies.

(f) Feedback Admittance

There still remains for consideration the remaining term in the 4-terminal network equations, i.e., the feedback admittance. At low frequencies, this is obviously capacitive in character, the capacitance being the static capacitance of plate to grid. Consider the equivalent circuit of a typical pentode as shown in Fig. 12. At low frequencies, the lead inductances to screen and suppressor exert a negligible influence and so the effective feedback capacitance is given by  $C_{(p0)}$  (the static ca-

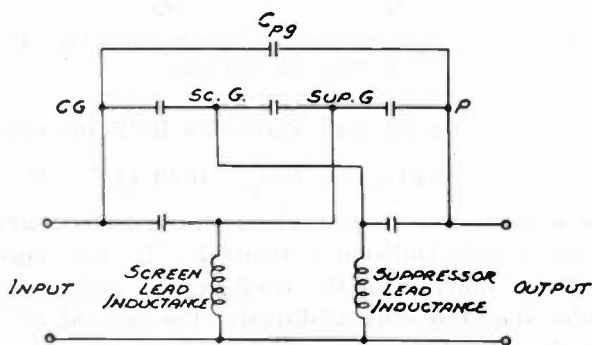

Fig. 12—Equivalent circuit of pentode.

pacitance). At high frequencies, the lead inductances become of importance, and the effective capacitance is given by a very complex expression derived in the paper by Strutt.<sup>2</sup> This complex expression can be represented at moderately high frequencies by  $C_{p0} = C_{(p0)0} - A\omega^2$ .

$A$  is of the order of  $10^{-19}$  when  $C_{p0}$  is expressed in micromicrofarads and  $\omega = 2\pi f$  where  $f$  is measured in cycles per second. Thus with increasing frequency, the effective feedback capacitance decreases and finally passes through zero at the so-called self-neutralization point, and becomes negative at still higher frequencies. This expression shows that for wide tuning-range receivers, neutralization at ultra-high frequencies may be a serious problem in view of the rapid frequency variation of the effective feedback capacitance.

IV. NOISE DUE TO STATISTICAL FLUCTUATIONS

In the preceding sections, the high-frequency behavior of tube admittances, which directly affect the over-all gain of any amplifier system, were studied. However, it is not gain alone that sets a limit to the sen-

sitivity of a receiver, since, after all, any desired gain can be achieved by increasing the number of stages (provided, of course, the gain of the individual stages is greater than unity).

The actual sensitivity limit is also determined in part by the statistical fluctuations of the electric charge within a conductor, or fluctuations of electron emission. These give rise to "noise," which sets a lower limit to the signal which can be detected. In this section some general theoretical results concerning noise will be presented and in Part III of this series these results will be used to compute the limiting sensitivity of radio receivers.

1. Thermal Agitation Noise

Consider a resistor  $R$  as shown in Fig. 13(a). Due to the internal random motion of the electrons within  $R$ , a

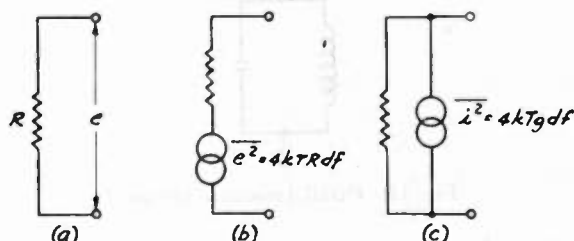

Fig. 13—(a), (b), and (c) are equivalent if the resistor  $R$  in (a) is a normal noisy resistor, while those in (b) and (c) are noise-free but connected to the voltage or current noise generators as shown.

mean-square open-circuit voltage will be present across its terminals given by<sup>12</sup>  $\bar{e}^2 = 4kTRdf$  where  $k$  is Boltzmann's constant  $= 1.37 \times 10^{-23}$  joule per degree centigrade and  $T$  is the temperature in degrees Kelvin.

$df$  is the element of bandwidth in cycles per second. In the general case one limits oneself to an element  $df$  for the reason that the value of  $R$  may be a function of frequency in which case it becomes necessary to perform an integration, if the noise voltage squared over a finite bandwidth is desired. If  $R$  is independent of frequency, the noise voltage produced over any bandwidth is the same regardless of its position in the frequency spectrum.

The "noisy" resistor can be represented by means of an ideal noise-free resistor in series with a constant-voltage generator of mean-square voltage  $\bar{e}^2 = 4kTRdf$  as shown in Fig. 13(b) or by means of a noise-free resistor in parallel with a constant-current generator of mean-square current  $\bar{i}^2 = 4kTgdf$  where  $g = 1/R$ . That the constant-voltage series generator and the constant-current shunt generator modes of representation are completely equivalent as far as external effects are concerned may be seen readily by connecting an impedance  $Z$  across the output terminals of Figs. 13(b) and 13(c). Then for the constant-voltage-generator representation the mean-square current through  $Z$  is given by

$$\bar{i}_Z^2 = e^2 / (R + Z)^2 = 4kTRdf / (R + Z)^2.$$

<sup>12</sup> J. B. Johnson, "Thermal agitation of electricity in conductors," Phys. Rev., vol. 32, pp. 97-110; July, 1928.

For the constant-current generator representation the mean-square current through  $Z$  is given by

$$\overline{i_Z^2} = \overline{i^2} \frac{R^2}{(R+Z)^2} = \frac{4kTdf}{R} \frac{R^2}{(R+Z)^2} = \frac{4kTRdf}{(R+Z)^2}$$

which is identical with that derived above, thus demonstrating the interchangeability of the constant-current and constant-voltage representations.

The choice of which concept to use depends in general upon the nature of the application. For parallel combinations the constant-current concept is more useful since the separate mean-square noise currents are simply added to produce the resultant mean-square noise current. Similarly for series connections the voltage generator concept is the more useful one since, for this case, the separate mean-square noise voltages add to produce the resultant.

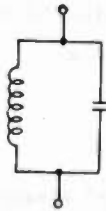

Fig. 14—Parallel resonant circuit.

In the preceding discussion reference was made only to resistors. The results given are actually applicable to any passive two-terminal networks subject to the condition that for  $R$  one uses the real part of the complex impedance. Thus, consider the parallel resonant circuit of Fig. 14, with real part  $R$  of its impedance as function of frequency as shown in Fig. 15. For this case the mean-square noise voltage between frequency limits  $f_1$  and  $f_2$  is given by

$$\overline{e^2} = 4kT \int_{f_1}^{f_2} Rdf.$$

2. Tube Noise

Schottky<sup>13</sup> predicted that the emission in a temperature-limited diode would contain a fluctuation component given by  $\overline{i^2} = 2eIdf$  where  $e$  is the electronic charge and  $I$  is the average total emission. It is assumed in this that the transit time through the diode is small compared with the frequencies whose noise components are under study.

If the diode anode is operated at a uniform negative potential with respect to the cathode so that the arrival or nonarrival of an electron at the anode is determined by its emission velocity solely, then the mean-square noise current is given by  $\overline{i^2} = 2eI_bdf$  where  $I_b$  is the actual plate current.

For the intermediate conditions wherein the emission is space-charge-limited, the so-called shot noise is less than that due to the same current under temperature-

limited conditions and is given by<sup>14</sup>  $\overline{i^2} = 2eI_b\Gamma^2df$  where  $\Gamma$  is a factor depending upon the ratio of available emission to actual plate current and upon the value of the anode potential.

If the available emission is large compared with the plate current, and the anode potential is not too close to that of the cathode,  $\Gamma$  is less than 0.2 for conventional structures, indicating how considerable a reduction in the noise current is produced by the presence of the space charge. North<sup>14</sup> has shown that if the available emission is large compared with the actual current drawn from the cathode, then  $\Gamma^2 = 1.29(kT_K/e)g/I_b$  where  $e$  is the electronic charge,  $k$  is Boltzmann's constant and  $T_K$  is the absolute temperature of the cathode and  $g$  is the conductance of the diode, given by  $g = I_b/E_b$  where  $I_b$  is the plate current and  $E_b$  the plate voltage.

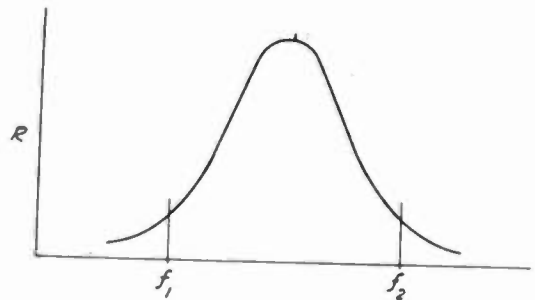

Fig. 15—Real part  $R$  of impedance of circuit of Fig. 14, as a function of frequency.

If this is substituted in the expression for  $\overline{i^2}$ , one obtains

$$\overline{i^2} = 2.58eI_b(kT_K/e)(g/I_b)df = 0.64(4kT_K)gdf.$$

This indicates for a space-charge-limited diode wherein large excess emission is available, the noise current is a linear function of the conductance and does not involve the plate current directly. For an oxide-coated cathode ( $T_K = 1000$  degrees Kelvin)  $\Gamma^2 = 0.11(g/I_b)$  and  $\overline{i^2} = 3.54 \times 10^{-12}gdf$ .

It is interesting to look into the physical picture of the process in order to see exactly how noise reduction is brought about by the presence of space charge. Under space-charge-limited conditions, a potential minimum exists in the region between the cathode and anode and is very close to the cathode. In the region between the cathode and the potential minimum electrons are traveling in both directions. The electrons returning towards the cathode are those emitted with a volt velocity less than that of the potential minimum so that they are unable to get over the "crest." Now if in the normal course, as determined by probability considerations, there is a sudden excess emission of charge, a depression of the potential minimum will occur which will in turn cause some electrons to be turned back that might otherwise have reached the plate. The variations in the potential minimum in correspondence with the fluctuations in emission current thus tend to smooth out the fluctuations in current passing through the potential minimum to the plate.

<sup>13</sup> W. Schottky, "Spontaneous current fluctuation in various conductors," *Ann. der Phys.*, vol. 57, pp. 541-567; December 20, 1918.

<sup>14</sup> D. O. North, "Fluctuations in space charge limited currents at moderately high frequencies," *RCA Rev.*, vol. 4, pp. 441-473; April, 1940.

The above expressions, which are based on the theoretical work of North,<sup>14</sup> are not in agreement with the measured values for space-charge-limited diodes. Actually, for this case the noise is considerably greater than predicted by theory. North<sup>14</sup> indicates that the explanation for this is most likely that elastic reflections of electrons at the anode (which is operating at a comparatively low potential) contribute to an increase in the noise in the plate circuit. For the temperature-limited case, wherein the anode can operate at much higher potential, the agreement between theory and experiment is excellent.

From the noise standpoint, a negative-grid triode can be looked upon as a diode whose anode potential is equal to the effective potential in the grid plane. Since all electrons which pass the grid plane are collected by the plate, the theoretical results for the space-charge-limited diode should (and do) describe the actually observed values for the negative-grid-triode, if for  $g$ , the conductance, one substitutes  $g_m$ , the grid-plate transductance.

### 3. Equivalent Noise Resistance

For many purposes it is convenient to suppose that the current flow in a tube is noise-free but that the noise in the plate current arises from the presence of a noise-voltage generator in series with the grid. We can set for

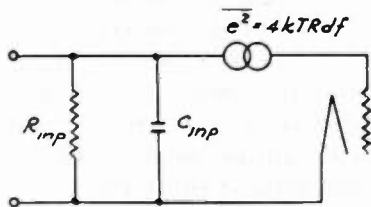

Fig. 16—Tube circuit wherein plate noise is represented as being due to noise-voltage generator in series with grid lead.

the mean-square voltage of this fictitious generator  $\overline{e^2} = 4kTRR_{eq}df$ , where  $R_{eq}$  is a fictitious resistance at room temperature ( $T_R = 300$  degrees Kelvin) and of such value that, if shunted across the input of a noise-free tube, the noise current in the plate circuit is the same as that for the noisy tube with shorted input. An expression for  $R_{eq}$  may be derived as follows:

$$\begin{aligned} \overline{i^2} &= 2eI_b\Gamma^2df \\ &= g_m^2 \overline{e^2} \\ \overline{e^2} &= 4kTRR_{eq}df \end{aligned}$$

where  $R_{eq} = \overline{e^2}/4kTRdf = \overline{i^2}/g_m^2 4kTRdf$   
 $= 2eI_b\Gamma^2df/g_m^2 4kTRdf = 20I_b\Gamma^2/g_m^2.$

If for  $\Gamma^2$  one inserts the approximate value for negative-grid triodes with oxide-coated cathode  $\Gamma^2 = 0.11g_m/I_b$  there results

$$R_{eq} = 20I_b/g_m^2 \times 0.11(g_m/I_b) = 2.2(I_b/g_m).$$

A complete list of values of  $R_{eq}$  for various types of tubes has been prepared by Harris.<sup>15</sup>

$R_{eq}$  is a totally fictitious resistance and must, under no circumstances, be considered as actually being present in the circuit. The noise-voltage generator is represented as being directly in series with the grid, the tube internal capacitance or loading being effectively external to the generator so that the full generator voltage is effective across the input circuit. This is illustrated for a simple case in Fig. 16, where  $R_{inp}$  is due to input loading and  $C_{inp}$  is the input capacitance of the tube.

$R_{eq}$  is an excellent measure of the "noisiness" of a tube and varies from values as low as 220 ohms for a 6AC7 operating as a triode amplifier to values of hundreds of thousands of ohms for multigrad converters such as the 6SA7. In the case of converters, the value of the conversion transconductance rather than the amplifier transconductance enters into the expression for the equivalent noise resistance. Since optimum conversion transconductance is always less than maximum amplifier transconductance for a given tube, the equivalent noise resistance of a tube when operating as a converter is usually greater than when operating as an amplifier. This conclusion should be borne in mind as reference will be made to it in Part IV of this series when consideration is given to the question of whether to use an amplifier or mixer for specific applications.

### 4. Noise Due to Current Division

In multielectrode tubes the electron current usually divides between several electrodes at a positive potential which gives rise to additional fluctuations. For example, in the case of a pentode, the fluctuations arise from the fact that the chance of any electron hitting a screen wire or of landing on the anode is purely random. If there is no secondary emission from any of the electrodes, drawing current, as is the case of pentodes, theory indicates<sup>16,17</sup> that the noise in the plate circuit will in general exceed that for a similar triode with the same plate current but will never exceed that due to the same value of temperature-limited plate current.

### 5. Effects of Secondary Emission

Secondary electron emission enters into the noise picture in one of two ways: 1) by the noise introduced by secondaries emitted at any electrode which then go to a more positive electrode, or 2) in the use of a secondary-emission multiplier to multiply an electron current. The first of these is of no importance in triodes or pentodes but is a factor in tetrodes and some multigrad tubes.<sup>18</sup>

At times an electron multiplier is used to multiply a modulated electron current. If there were no fluctuations in the secondary electron emission, i.e., if each primary produced the same number of secondary electrons, no more, no less, then the signal and the noise

<sup>16</sup> D. O. North, "Multi-collectors," *RCA Rev.*, vol. 5, pp. 245-260; October, 1940.

<sup>17</sup> C. J. Bakker, "Current distribution fluctuations," *Physica*, vol. 5, pp. 581-592; July, 1938.

<sup>18</sup> C. J. Bakker and B. van der Pol, "Spontaneous fluctuations," *Compt. Rend. de l'Union Radio-Scientifique Internationale*, Venice 5, pp. 217-227; 1938.

<sup>15</sup> W. A. Harris, "Fluctuations in vacuum tube amplifiers and input systems," *RCA Rev.*, vol. 5, pp. 505-525; April; and vol. 6, pp. 115-124; July, 1941.

would be multiplied alike so that the signal-to-noise ratio would be unchanged. This method of amplification would be superior to the normal use of a following tube with coupling impedance, since the noise introduced by the coupling impedance and following tube would be eliminated. However, secondary electron emission is also a "statistical" phenomenon in that the secondary-emission ratio  $n$  is actually the average of a distribution of

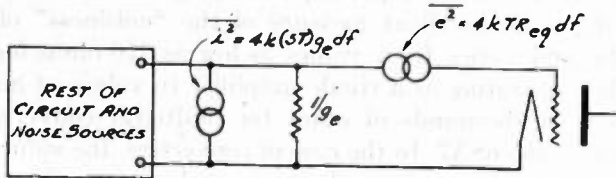

Fig. 17—Circuit indicating how induced noise in a triode may be represented as being due to a constant-current generator in shunt with a conductance.

ratios for all the primary electrons. As a consequence the ratio of signal-to-noise in the output of an electron multiplier is always less than in the input. If the secondary-emission ratio of the initial stage is not too small, say 5 or greater, the decrease in signal-to-noise ratio by an electron multiplier is almost negligible. It is thus extremely desirable to use electron multipliers in cases where the tube geometry permits.<sup>19</sup>

As a final item it must be emphasized that in the preceding discussion it was tacitly (and incorrectly) assumed that the multiplication of a varying signal is the same as that of a direct current. The amplification of a multiplier decreases with frequency due to the spread in transit angle resulting from nonuniform initial velocities and differing paths. At ordinary intermediate frequencies this is of no importance, so that the use of multipliers for amplifying the intermediate-frequency signal of a converter or mixer is feasible. However, since the gain of ordinary multipliers begins to drop off at frequencies of only a few hundred megacycles, care must be used in applying electron multiplication to the amplification of ultra-high-frequency signals.<sup>20</sup>

## 6. Induced Noise

### (a) Induced Noise in Grid-Controlled Tubes

This is the one source of noise which may be considered as an ultra-high-frequency noise in that it is present only when transit angles are appreciable and increases with frequency. It arises from the fact that for finite transit angles through the tube the noise-current

<sup>19</sup> V. K. Zworykin, G. A. Morton, and L. Malter, "The secondary emission multiplier—a new electronic device," *Proc. I.R.E.*, vol. 24, pp. 351–376; March, 1936.

<sup>20</sup> L. Malter, "Behavior of electrostatic multipliers as a function of frequency," *Proc. I.R.E.*, vol. 29, pp. 587–598; November, 1941.

fluctuations in the emission current induce noise current on the grid which in turn react upon the electron current traversing the tube. North and Ferris<sup>21</sup> have shown that induced noise current in grid-controlled tubes is equivalent to the thermal-noise produced by a resistor whose reciprocal is equal in value to the input conductance due to finite transit angle and whose temperature is about 5 times room temperature. They have also shown that, to a first approximation, induced grid noise may be added to the plate noise (referred to the grid) of the

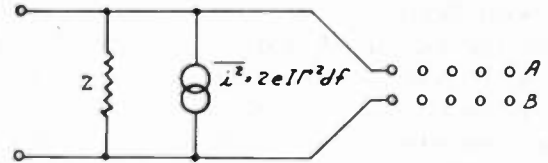

Fig. 18—Representation of induced noise in velocity-modulation device as being due to a constant-current generator in shunt with conductance as measured between velocity-modulating grids.

same tube as if they were independent sources of noise. The representation is shown in Fig. 17, where  $g_e$  is the input conductance due to finite transit angle.

### (b) Induced Noise in Velocity-Modulation Devices

If the electron stream traversing the region between the velocity-modulation grids *A* and *B* of Fig. 9 is current-modulated as, e.g., by noise-current components, a serious type of induced noise comes into existence. A current-modulated beam passing between *A* and *B* induces a current in the circuit of which *A* and *B* are part, this current approaching in value the modulated component of the stream for small transit angles between *A* and *B*. If this induced current be denoted by  $i$ , then a potential difference will be established between *A* and *B* given by  $e = iZ$  where  $Z$  is the circuit impedance. This varying voltage  $e$  will make itself felt upon the beam in the form of a velocity modulation. If  $i$  is due to noise, the resultant noise source can be represented by the circuit of Fig. 18.  $I$  is the beam current and  $\Gamma^2$  the space-charge reduction factor. Since in tubes of this type beams are generally employed, noise due to current division generally is introduced at focusing electrodes preceding the velocity-modulation grids. As a consequence there exists a "wiping out" of space-charge reduction effects, resulting in a final  $\Gamma^2$  approaching unity. As a consequence, the contribution of the induced noise to the total noise may be considerable or even preponderant.

<sup>21</sup> D. O. North and W. R. Ferris, "Fluctuations induced in vacuum-tube grids at high frequencies," *Proc. I.R.E.*, vol. 29, pp. 49–50; February, 1941.



# Some Aspects of Radio Reception at Ultra-High Frequency\*

E. W. HEROLD†, MEMBER, I.R.E., AND L. MALTER‡, ASSOCIATE, I.R.E.

## PART III. THE SIGNAL-TO-NOISE RATIO OF RADIO RECEIVERS

E. W. HEROLD†

**Summary**—The signal-to-noise ratio of a radio receiver can best be analyzed by finding all the various noise sources and then referring them to a single point. When the equivalent-noise-resistance concept is used at the input to express the output noise of the first tube of a series, noise sources beyond this point are also conveniently referred back to this same input. Thus, a single equivalent noise resistance  $R_{eq}$  can be used to express all the noise sources at or beyond the first tube. In the simplest case, where noise sources at the input of the first tube can be neglected, the maximum signal at the input also gives best signal-to-noise ratio. The signal-to-noise ratio then depends on the ratio of tube input resistance (which determines the maximum signal) to equivalent noise resistance.

When there is induced noise in the input of the first tube, the optimum signal-to-noise ratio is obtained by coupling the antenna somewhat more tightly to the tube input than for maximum power transfer. Although this reduces the signal at the grid from its maximum value, the reduction of impedance is more marked and causes an even greater reduction in induced noise. The optimum signal-to-noise ratio depends on the product of induced noise and equivalent noise resistance. Even when the input resistance is infinite or negative, the optimum signal-to-noise ratio is limited either by this induced noise or by the bandwidth of the input circuit. Exact analysis, including all noise sources, is more complex but the behavior is qualitatively the same as for the simpler cases.

The effect of feedback, either degenerative or regenerative, on signal-to-noise ratio is often minor, since in many instances both signal and noise are fed back alike. Thus, when this is so, the signal-to-noise ratio may be estimated as if the feedback did not exist and the tube input resistance to be used for such an estimate should not include the part due to feedback.

The signal-to-noise ratio is always inherently limited by the receiving antenna and associated transmission line which have noise of their own. In the laboratory the antenna noise is simply thermal agitation in the dummy-antenna resistance. The ratio of total receiver noise to that produced by the dummy antenna may be used to evaluate the performance of receivers. This ratio, which was introduced by North and is called noise factor, is readily measured, and for a completely noise-free receiver, is unity. All signal-to-noise ratio estimates are conveniently put in this form, since the noise factor is often independent of bandwidth and of antenna-radiation resistance.

### I. INTRODUCTION

#### 1. Prefatory Remarks

THIS third paper of the series is concerned almost entirely with one phase of receiver performance, the signal-to-noise ratio. It has already been shown that this is of extreme importance at ultra-high frequencies and, very fortunately, it is a subject which is no longer difficult to understand. Some years ago, the subject of fluctuation noise was considerable of a mystery even to the best scientists and engineers. In 1928,

Johnson<sup>1</sup> and Nyquist<sup>2</sup> cleared up the subject of thermal agitation noise in circuits. Since about 1935 or so, fluctuation noise in the plate circuit of amplifier tubes has been fairly completely worked out<sup>3</sup> and, with some additional work on mixer and converter noise,<sup>4,5</sup> it is now possible to use accurate quantitative data on tube noise for receiver calculations. Finally, at high frequencies, induced input noise must also be considered and this has also been evaluated.<sup>6,7</sup> In Part II of this series some of the fundamental noise relations were discussed.

The signal-to-noise ratio of a radio receiver at ultra-high-frequencies is primarily dependent on the above-mentioned noise relations for tubes and circuits but, in addition, consideration must be given to the input signal and its transfer to and through the receiver. However, the earlier published work<sup>8-10</sup> on signal-to-noise ratio did not include induced input noise and hence was not strictly applicable at ultra-high frequencies. Furthermore, until North's exposition<sup>11</sup> of the quantity known as noise factor, there appeared to be no widely accepted basis on which experimental or analytical results could be quantitatively compared. The extension of the analysis to include induced noise has now been made<sup>12</sup> and the interpretation of results in terms of noise factor is now common. As a result, it is possible to discuss signal-to-noise ratio at ultra-high-frequencies with considerably greater clarity.

<sup>1</sup> J. B. Johnson, "Thermal agitation of electricity in conductors," *Phys. Rev.*, vol. 32, pp. 97-109; July, 1928.

<sup>2</sup> H. Nyquist, "Thermal agitation of electric charge in conductors," *Phys. Rev.*, vol. 32, pp. 110-113; July, 1928.

<sup>3</sup> B. J. Thompson, D. O. North, and W. A. Harris, "Fluctuations in space-charge-limited currents at moderately high frequencies," *RCA Rev.*, pp. 269-285; January; pp. 441-472; April; pp. 115-124; July; pp. 244-260; October, 1940; pp. 371-388; January; April; pp. 505-524; July, 1941.

<sup>4</sup> E. W. Herold, "Superheterodyne converter system considerations in television receivers," *RCA Rev.*, vol. 4, pp. 324-337; January, 1940.

<sup>5</sup> E. W. Herold, "The operation of frequency converters and mixers," *Proc. I.R.E.*, vol. 30, pp. 84-103; February, 1942.

<sup>6</sup> D. O. North and W. R. Ferris, "Fluctuations induced in vacuum-tube grids at high frequencies," *Proc. I.R.E.*, vol. 29, pp. 49-50; February, 1941.

<sup>7</sup> C. J. Bakker, "Fluctuations and electron inertia," *Physica*, vol. 8, pp. 23-43; January, 1941.

<sup>8</sup> F. B. Llewellyn, "A rapid method of estimating the signal-to-noise ratio of a high gain receiver," *Proc. I.R.E.*, vol. 19, pp. 416-420; March, 1931.

<sup>9</sup> F. C. Williams, "Thermal fluctuations in complex networks," *Jour. I.E.E. (London)*, vol. 81, pp. 751-760; December, 1937.

<sup>10</sup> K. Fränz, "The limiting sensitivity in the reception of electric waves and its attainability," *Elek. Nach. Tech.*, vol. 16, pp. 92-96; April, 1939.

<sup>11</sup> D. O. North, "The absolute sensitivity of radio receivers," *RCA Rev.*, vol. 6, pp. 332-343; January, 1942.

<sup>12</sup> E. W. Herold, "An analysis of the signal-to-noise ratio of U-H-F receivers," *RCA Rev.*, pp. 302-331; January, 1942.

\* Decimal classification: R261. Original manuscript received by the Institute, July 1, 1943.

† RCA Laboratories, Princeton, N. J.

‡ Formerly, RCA Laboratories, Princeton, N. J.; now, RCA Victor Division, Radio Corporation of America, Lancaster, Pa.

## 2. The Simple Amplifier and Its Equivalent Noise Resistance

It is instructive to examine the simplest possible amplifier case and see what is meant by a calculation of signal-to-noise ratio. In Fig. 1(a) there is shown a signal source connected to a tube, delivering a voltage  $e_s$ . In the plate of the tube is connected an amplifier and finally some sort of indicating device which may be a loudspeaker, a cathode-ray tube, or any other utilization

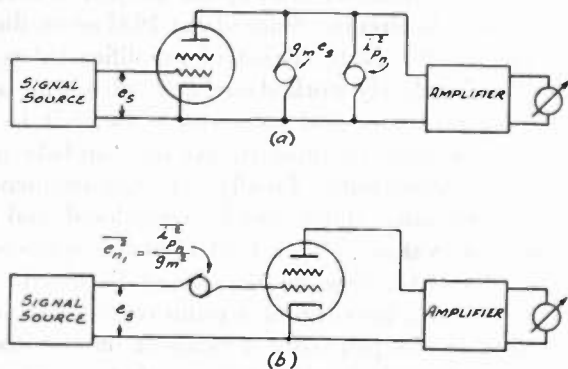

Fig. 1—Simple amplifier case to illustrate the concept of signal-to-noise ratio; (a) noise generator introduced at point of origin, (b) fictitious but equivalent noise generator introduced in grid by use of the transconductance  $g_m$ .

means. It is known that the tube plate current, although it has an average value  $I_b$  will actually have very minute fluctuations around this average value. These fluctuations are called shot noise and to evaluate them some sort of average value must be found. Since they go as much above as below the average direct current of the tube, an ordinary averaging process will give no information. If the instantaneous fluctuating component of current is squared, however, all the fluctuations, both positive and negative, will give a positive contribution which may then be averaged. Such an average is called the "mean-squared value" of the fluctuation. At the same time, it should be appreciated that such an averaging will give a quantity proportional to noise power. Furthermore, since noise is random, if there are two independent noise sources at one point, their total effect is obtained by simple addition of their noise power, or by just adding their mean-squared values. If the noise fluctuations are in plate current, they may be called  $\overline{i_{pn}^2}$ , where the bar indicates the averaging of the squares of the fluctuations. Now, in general, random noise is distributed over all frequencies. The total noise effect is, therefore, dependent on what frequencies are able to pass through the amplifier and affect the measuring circuit. Thus, the tube noise which reaches the output of an amplifier will depend on the power-gain-versus-frequency characteristic. If the noise is compared with a signal, or if the noise response is compared with the response at some reference frequency, it becomes possible to use the quantity  $\Delta f$ , an effective noise bandwidth which was discussed in Part I. In the discussion to follow, such a comparison is implicitly intended.

We may say, therefore, that the tube noise is

$\overline{i_{pn}^2} = k_n \Delta f$  remembering always that the value of  $\Delta f$  depends on the response at some reference frequency.<sup>13</sup> It is of interest to note that, for most tubes which do not include secondary emitters,  $k_n$  has a *maximum* value of  $2eI_b$  where  $e$  is the electron charge and  $I_b$  is the average plate current. It is usually less than this value, however, as pointed out in Part II.

To go back to the original simplified problem, the tube noise may be shown on Fig. 1(a) by the constant-current noise generator of value  $\overline{i_{pn}^2}$ . Since the signal output current is  $g_m e_s$ , it is seen that the signal-to-noise ratio at the input to the final amplifier is

$$\frac{\text{signal}}{\text{noise}} = \frac{S}{N} = \sqrt{\frac{g_m^2 e_s^2}{\overline{i_{pn}^2}}} = e_s \sqrt{\frac{g_m^2}{\overline{i_{pn}^2}}}$$

If no other sources of noise are present, this will be the over-all signal-to-noise ratio. To eliminate the square root, it is advantageous to consider the square of the signal-to-noise ratio and, this will be done from now on. The use of  $(S/N)^2$  instead of  $(S/N)$  merely means that the results are expressed as a power ratio instead of as a voltage or current ratio. This is always a convenience when several noise sources must be considered, since it is their powers which add.

In this simple problem the signal-to-noise ratio was very easily calculated as follows. First, the origin of the noise was located and then a generator was put in which represented the noise magnitude. Finally, the signal was calculated at that point. This is not the only way in which the same answer could have been obtained and, obviously, if the noise sources are distributed at a number of different points, some other procedure must be adopted. If the *real* noise generator is removed from the plate circuit, and an *entirely fictitious* one put in the grid circuit, it is possible to find a magnitude for the latter generator which would give the same answer for the signal-to-noise ratio. If a fictitious grid noise generator,  $e_{n1}^2$ , is substituted for the actual plate noise as in Fig. 1(b), then the plate noise current due to the fictitious generator is  $\overline{i_{pn}^2} = e_{n1}^2 g_m^2$ . Thus it is found that for the same plate noise as in Fig. 1(a), the fictitious noise generator must have a value  $e_{n1}^2 = \overline{i_{pn}^2} / g_m^2$ . The signal at the grid is still  $e_s$  so that

$$(S/N)^2 = e_s^2 / e_{n1}^2 = e_s^2 (g_m^2 / \overline{i_{pn}^2})$$

the same as before. It is thus seen that it is not always necessary to evaluate noises at their point of origin; they may, instead, be referred to some other point. Although in the simple case analyzed, one method has no advantage over another; if there were many noise sources, it would be advantageous to refer them all to the one point.

It is common practice to refer tube noise back to the input as we have done, but it usually is done in terms of an equivalent grid noise resistance. The advantages of this are apparent to those who have been greatly concerned with noise although it may seem like an

<sup>13</sup> See the discussion of bandwidth at the beginning of Part I of this series.

additional complication at this point. An actual resistor of value  $R$  will have a mean-squared noise voltage due to thermal agitation of<sup>14</sup>  $\overline{e_{n1}^2} = 4kT_R R \Delta f$  where  $k = 1.37 \times 10^{-23}$  joule per degree Kelvin and  $T_R$  is the temperature in degrees Kelvin (i.e., ambient temperature). Thus,  $R = \overline{e_{n1}^2} / 4kT_R \Delta f$ . In the case of the tube,  $\overline{e_{n1}^2}$  is not really due to thermal agitation noise. In fact it is not a true noise source at all but simply an equivalent to the true noise. Thus, as long as this is fictionalized anyway, we may go further and call  $R_{eq}$  the value of a resistance whose open-circuit noise voltage is the same as  $\overline{e_{n1}^2}$ .

$$R_{eq} = \overline{e_{n1}^2} / 4kT_R \Delta f = \overline{i_{pn}^2} / 4kT_R \Delta f g_m^2$$

$$\text{If this is used, } (S/N)^2 = e_s^2 / (1/4kT_R R_{eq} \Delta f)$$

In this simple example, the signal-to-noise ratio depends simply on the reciprocal of the equivalent noise resistance. The same considerations apply to frequency-changing tubes, except that the conversion transconductance  $g_c$  is used instead of the transconductance  $g_m$ .

In any actual receiver there are many sources of noise. In particular, those sources of noise which follow the first tubes are of small importance in most cases, because the previous sources of noise are much more amplified and exceed these later fluctuations. Thus, as a rule, one may forget the later noise sources and concentrate on those sources in, and ahead of, the first tube, since these receive greatest amplification. For the sake of complete generality, however, let us show that the later sources of noise may be easily accounted for by a slight change in the concept of  $R_{eq}$ . Suppose there is a second noise source, at a point  $k$  in the amplifier as in Fig. 2(a). If this real noise source is removed and an equivalent substituted at the input grid, the same total output noise must still be present. A noise generator  $\overline{e_n^2}$  at the input will produce at point  $k$  a noise  $\overline{e_{nk}^2} = \overline{e_n^2} A_k^2$  where  $A_k$  is the gain of the system from the input to point  $k$ . Thus it is found that  $\overline{e_n^2} = \overline{e_{nk}^2} / A_k^2$ . If there are many noise sources the total mean-squared noise at the input is

$$\overline{e_n^2} \text{ total} = \sum \frac{\overline{e_{nk}^2}}{A_k^2}$$

Using an equivalent noise resistance concept,

$$R_{eq} = \overline{e_n^2} \text{ total} / 4kT \Delta f = R_{eq1} + R_{eq2} + \dots$$

where the values of  $R_{eq2}$ , etc., are computed using squares of gains. In the remainder of this paper, the concept of  $R_{eq}$  may, therefore, be considered to include all noise at or beyond the anode of the first tube.

A numerical example may be of interest. A type 955 triode mixer for an ultra-high-frequency receiver has a plate noise, for a 7-megacycle noise bandwidth of<sup>15</sup>  $\overline{i_{pn}^2} = 2.8 \times 10^{-16}$  (ampere)<sup>2</sup>. Since the conversion transconductance  $g_c$  is  $700 \times 10^{-6}$  mho, the equivalent grid noise voltage is  $\overline{e_n^2} = \overline{i_{pn}^2} / g_c^2$  and  $R_{eq1} = 5200$  ohms. This tube is followed by a single-tuned intermediate-frequency

circuit of impedance 520 ohms (so as to give a 7-megacycle bandwidth) and a type 6AC7 tube whose equivalent noise resistance is 700 ohms. At the grid of the second tube there are two noise sources; one is the thermal agitation noise in the intermediate-frequency circuit and the second is the 6AC7 tube noise referred to its own

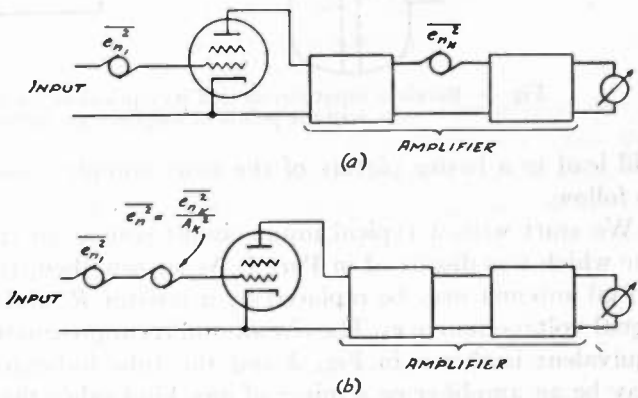

Fig. 2—Noise sources at any point in an amplifier system may be considered in terms of fictitious but equivalent sources at the input; (a) noise introduced at point of origin, (b) equivalent noise generator in input by use of the voltage gain  $A_k$  between input and point of origin.

grid. In terms of equivalent resistance, at the first grid (i.e., the grid of the 955 mixer)

$$R_{eq1} = \frac{520}{(\text{gain})^2} = \text{contribution of the thermal noise of the intermediate-frequency circuit}$$

$$R_{eq2} = \frac{700}{(\text{gain})^2} = \text{contribution of the first intermediate-frequency tube noise.}$$

If other noise sources are negligible, the total equivalent noise resistance is then  $R_{eq} = R_{eq1} + R_{eq2} + R_{eq3}$ . Since the gain from mixer grid to intermediate-frequency grid is just  $g_c \times 520 = 0.36$  it is seen that  $R_{eq} = 5200 + 520 / (0.36)^2 + 700 / (0.36)^2 = 5200 + 9400 = 14,600$  ohms. With a properly designed double-tuned intermediate-frequency transformer, it should be noted, this could have been reduced to 6270 ohms.<sup>12</sup> Since the design of interstage coupling networks for best signal-to-noise ratio is beyond the scope of this paper, the reader is referred to Section VII of footnote reference 12 for details.

## II. THE ANALYSIS OF THE SIGNAL-TO-NOISE RATIO OF AN ULTRA-HIGH-FREQUENCY RECEIVER—NOISE FACTOR

### 1. Simple Relations Using Only One Noise Source—Matched Impedance

In many well-designed ultra-high-frequency receivers using conventional triodes or pentodes above about 300 megacycles, it will be found that the chief sources of noise are at the plate of the first tube and at points which follow it. For this reason, the simplified case of a receiver with only these noise sources will be taken up. A very simple relation for the signal-to-noise ratio can then be derived. Furthermore, it will be fairly accurate for triodes and pentodes whose control grid is adjacent to the cathode since, with these tubes, induced input noise is often negligible. Finally, the result is simple and

<sup>14</sup> See Part II of this series.

<sup>15</sup> This value was obtained by utilizing the triode mixer formulas in footnote reference 4.

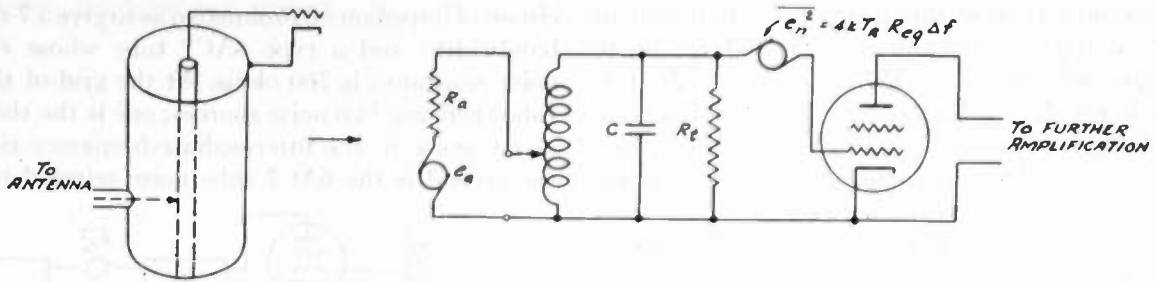

Fig. 3—Receiver input circuit and its equivalent for noise analysis. Noise sources at plate of first tube and at subsequent points of amplifier are included in an equivalent generator at the input.

will lead to a better picture of the more complex cases to follow.

We start with a typical input circuit similar to the one which was discussed in Part I. As we saw then, the actual antenna may be replaced by a resistor  $R_a$  and a signal voltage source  $e_a$ . The circuit and its approximate equivalent is shown in Fig. 3 and the tube indicated may be an amplifier or a mixer of any kind other than the diode. Let us first assume that the input-transformer tap is adjusted for maximum gain and that the input-circuit bandwidth with such an adjustment is adequate. Maximum gain will result when the impedances are matched, and this means that, looking at the input terminals of the receiver, their impedance will look like the value  $R_a$ . Thus,  $e_o$  is equally divided between  $R_a$  and the transformer. The primary voltage is  $e_a/2$ . The secondary voltage applied to the grid is

$$e_o = m(e_a/2) = (e_a/2)\sqrt{R_t/R_a}$$

since the effective turns ratio  $m$  is fixed by the impedance match. The signal-to-noise ratio is then

$$(S/N)^2 = e_o^2/e_n^2 \approx (e_a^2/4)(R_t/R_a)(1/4kT_R R_{eq}\Delta f) \\ \approx (e_a^2/4kT_R R_a \Delta f)(1/4)(R_t/R_{eq})$$

Remembering from Part I that  $e_o^2/R_a$  depends only on the antenna directivity, it is seen that the only other method to increase the signal-to-noise ratio lies in an improvement of  $R_t/R_{eq}$ , that is, by an increased ratio of input resistance to equivalent noise resistance. Because only noise sources at or beyond the anode of the first tube were included, the signal-to-noise ratio computed by this formula will always be better than can actually be obtained in practice and for this reason the relation has been written as an approximation rather than an equality. It is shown in this simple example that the input resistance of the tube is just as important as the equivalent noise resistance in determining signal-to-noise performance since it is only their ratio which matters.

Before leaving this simplified illustration, it should be noted that the antenna itself may have noise associated with its radiation resistance (see Part I of this series). If this may be considered at room temperature  $T_R$ , as with a dummy antenna, the limiting maximum signal-to-noise ratio will be that of the antenna itself, namely the ratio of its signal voltage to its thermal agitation noise voltage,

$$\text{antenna}(S/N)^2 = e_a^2/4kT_R R_a \Delta f.$$

The ratio of this antenna signal-to-noise ratio to the actual signal-to-noise ratio computed above is then

$$F = \frac{\text{antenna } (S/N)^2}{\text{over-all receiver } (S/N)^2} \approx 4 \frac{R_{eq}}{R_t} \quad (\text{when } R_{eq}/R_t \gg 1).$$

Actually, of course,  $F$  cannot be less than unity since this would imply that the over-all  $(S/N)^2$  was greater than that of the antenna itself. Hence, it is seen that the approximation which was implicit by neglecting input-circuit noise sources breaks down for values of  $R_{eq}/R_t$  which approach unity or less. The quantity  $F$  is the same as North's noise factor<sup>11</sup> and it will be discussed at greater length in a later part of this paper. Suffice it to say at this point that the lower the quantity  $F$ , the more nearly noise-free is the receiver and the better the signal-to-noise ratio.

## 2. Effect of Transformer Step-up Adjustment

It has been seen how easily the signal-to-noise ratio is obtained from the matched-impedance condition. Let us next examine what happens when the antenna tap on the transformer is varied. The transformer, only, may be considered first. The effect of the primary may be determined by using its reflected value as seen in the secondary. Thus, approximately equivalent circuits, as shown in Fig. 4(a), (b), and (c), may be derived, where in Fig. 4(c) the signal is expressed as a constant-current generator and  $R_{oif} = 1/(1/R_t + 1/m^2 R_a)$ . The signal voltage  $e_o$  is then just the current  $e_a/mR_a$  multiplied by the total shunt resistance  $R_{oif}$ ,

$$e_o = e_a [m^{-1} + m(R_a/R_t)]^{-1}.$$

An expression of this kind is one which is frequently encountered in signal-to-noise computations; the denominator is of the form  $f(x) = (ax^{-1} + bx)$ . It has a minimum value which may be found to occur at  $x^2 = a/b$  and the minimum is

$$f(x)_{\min} = f(\sqrt{a/b}) = 2\sqrt{ab}.$$

So that, in the above case where  $x$  corresponds to  $m$ ,

$$e_o]_{\max} = e_a(1/2)\sqrt{R_t/R_a} \quad (\text{for } m^2 = R_t/R_a)$$

which, of course, is the matched-impedance condition which was already used in Section II, 1. If the signal voltage is plotted against  $m$  a curve is obtained similar to that shown in *A* of Fig. 5.

Let us now find the bandwidth of the input circuit. Calling the equivalent-lumped-circuit capacitance  $C$

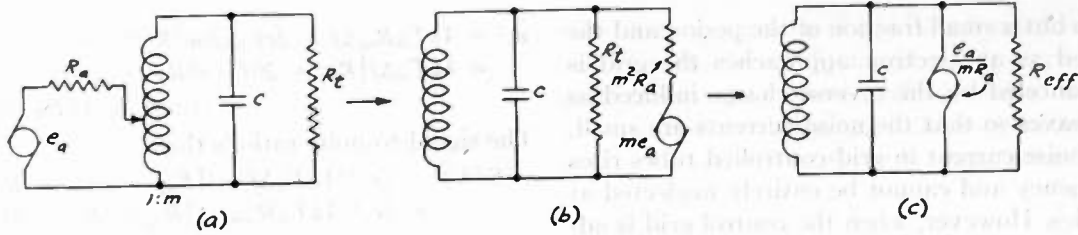

Fig. 4—Equivalent circuits of input transformer of receiver for any value of effective step-up ratio  $m$  between antenna and tube.

(see Appendix to Part I), the circuit bandwidth<sup>16</sup>  $\Delta f'$  between points 3 decibels down from resonance, is

$$\Delta f' = \frac{f}{Q} = \frac{f}{\omega C R_{eff}} = \frac{1}{2\pi C} \left( \frac{1}{R_t} + \frac{1}{m^2 R_a} \right)$$

The bandwidth varies with  $m$  because of the antenna loading, and a typical curve is shown in *B* of Fig. 5; this curve can be understood physically. If  $m$  is very large the antenna is practically not coupled at all and the tap on the transformer of Fig. 4(a) is near the bottom. The bandwidth is then the same as that of the circuit alone. As the tap is moved up on the transformer of Fig. 4(a),  $m$  is decreased and the bandwidth gets wider. At  $m = \sqrt{R_t/R_a}$  the bandwidth is just double that of the circuit alone.

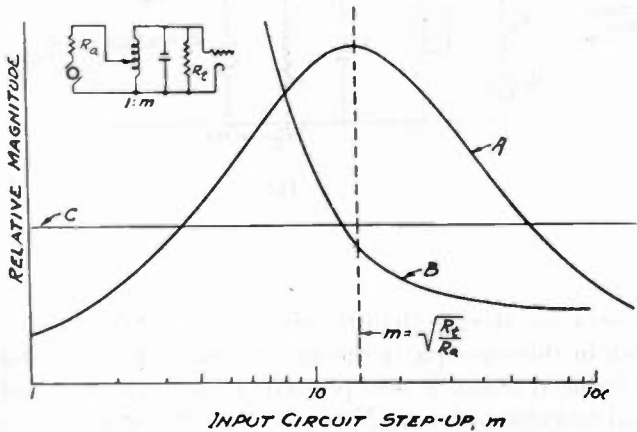

Fig. 5—Curves showing effect of variations of input circuit step-up ratio  $m$ . Curve *A* shows the signal voltage at the grid of the first tube. Curve *B* shows the bandwidth of the input circuit. Curve *C* shows the contribution of noise sources at or beyond the plate of the first tube.

In Part I it was shown that the bandwidth can always be reduced by tapping the tube down on the circuit, which has the same effect as increasing the capacitance  $C$ . Furthermore, if circuit losses are negligible, this entails no loss in signal voltage. It is now seen that the bandwidth may be increased by overcoupling the antenna, but it is also seen from Fig. 5 that some sacrifice in signal voltage will then result. However, this method of increasing bandwidth is less harmful in this respect than that of lowering  $R_t$ .

Finally, we may consider the noise. In this simple example, the only sources of noise were at or beyond the plate of the first tube. These noise sources, of course, do not vary with changes in  $m$ . The noise can, therefore, be

<sup>16</sup> As distinguished from the noise bandwidth  $\Delta f$ .

drawn as a horizontal line *C* in Fig. 5. Obviously, therefore, the signal-to-noise ratio is a maximum when the impedances are matched since this is when the signal is a maximum. As will be shown later, this is not usually the optimum condition when noise sources in the input are appreciable.

### 3. Wide-Band Adjustment

If the input-circuit bandwidth is too narrow for the receiver requirements, it can be seen from the curve *B* of Fig. 5 that a lower value of  $m$  is then in order, although this means a reduction in signal-to-noise ratio. As a special case, let us consider what happens when  $R_t$  becomes very large. It might be expected that the signal-to-noise ratio would also rise to its maximum value. However, this is not the actual case because the design must always be based on some particular bandwidth. If  $R_t$  is very large, then the bandwidth equation of the preceding discussion may be solved to give

$$m^2 R_a \approx 1/2\pi\Delta f' C \approx 1/\Delta\omega C \quad (\text{assuming } \Delta\omega C R_t \gg 1)$$

where  $\Delta\omega$  is introduced for  $2\pi\Delta f'$ . The grid signal is then

$$e_g = \frac{e_a}{(1/m) + m(R_a/R_t)} \approx m e_a \approx \frac{e_a}{\sqrt{\Delta\omega C R_a}}$$

In this case, since the noise is again  $4kTR_{eq}\Delta f$ ,

$$\left(\frac{S}{N}\right)^2 \approx \frac{e_a^2}{4kT R R_a \Delta f} \frac{1}{\Delta\omega C R_{eq}} \quad (\text{assuming } \Delta\omega C R_t \gg 1).$$

Far from having its maximum value, the  $S/N$  ratio is definitely limited by the product of  $CR_{eq}$ . The noise factor in this example is then  $F \approx \Delta\omega C R_{eq}$ .

All that has been given so far is qualitatively applicable to every exact analysis which might be made and is very useful in understanding the behavior of the more complicated expressions which occur in exact analyses. It is now opportune to consider another interesting example in which an important additional and independent noise source is present in the input.

### 4. The Signal-to-Noise Ratio with Induced Input Electrode Noise

In all tubes used for high frequencies, the input electrode also has noise current flowing in it<sup>6,7</sup> whereas, up to this point, only the plate noise of a tube has been considered. For example, in an ordinary grid-controlled tube, the electron current has fluctuations, and induces a fluctuating charge on the control grid. The rate of change of charge represents a grid current, which therefore fluctuates also. However, at low frequencies, the

transit time is but a small fraction of the period and the charge induced as an electron approaches the grid is very nearly canceled by the reverse charge induced as the electron leaves so that the noise currents are small. The induced-noise current in grid-controlled tubes rises with the frequency and cannot be entirely neglected at high frequencies. However, when the control grid is adjacent to the cathode, the induced noise is subject to space-charge damping and does not play an important role, as has been seen.<sup>6,12</sup> With other control methods, the noise may be large at low frequencies as well.

To illustrate the behavior of a tube when induced input noise is present, we shall use as an example a velocity-modulation mixer<sup>17</sup> because, as was shown in Part II of this series, this type of tube has a very large induced noise in the input which is roughly independent of frequency. The mixer, rather than the amplifier, is used because then the input noise and the output noise occupy different frequency bands and may be considered independently. The tube is indicated in Fig. 6(a) and has an equivalent circuit as shown in Fig. 6(b) where the

$$\begin{aligned} \overline{e_n^2} &= 4kT_R R_{eq} \Delta f + 2eI_d \Delta f (m^2 R_a)^2 \\ &= 4kT_R \Delta f [R_{eq} + 20I_d (m^2 R_a)^2] \end{aligned}$$

(since  $2e/4kT_R = 20 \text{ volts}^{-1}$ ).

The signal-to-noise ratio is then

$$\begin{aligned} (S/N)^2 &\approx (e_a^2/4kT_R \Delta f) m^2 [R_{eq} + 20I_d (m^2 R_a)^2]^{-1} \\ &\approx (e_a^2/4kT_R R_a \Delta f) 1 [R_{eq}/m^2 R_a + 20I_d m^2 R_a]^{-1} \end{aligned}$$

(assuming  $R_t \rightarrow \infty$ ).

The denominator is again of the form  $(ax^{-1} + bx)$  which was studied in Section II, 2, above and has a maximum value at  $m^4 R_a^2 = R_{eq}/20I_d$ . This gives

$$(S/N)^2]_{\max} \approx (e_a^2/4kT_R R_a \Delta f) 1 / (2\sqrt{20I_d R_{eq}})$$

(assuming  $R_t \rightarrow \infty$ ).

This may be understood better by a consideration of curves of the various factors plotted against the coupling  $m$ . Referring to Fig. 7, the signal voltage at the gap increases directly with  $m$  and its square  $S^2$ , which is plotted, is therefore parabolic. The plate noise, as given by  $R_{eq}$ , is constant and does not vary with coupling. The input-circuit impedance varies as  $m^2$ , so that the mean square of the induced input noise varies as  $m^4$  and

Fig. 6—A velocity-modulation type of mixer tube and its equivalent circuit. Two noise generators  $\overline{e_n^2}$  equivalent to noise at the anode and at points beyond, and the other as a current generator  $\overline{i_n^2}$  corresponding to induced noise across the input electrodes.

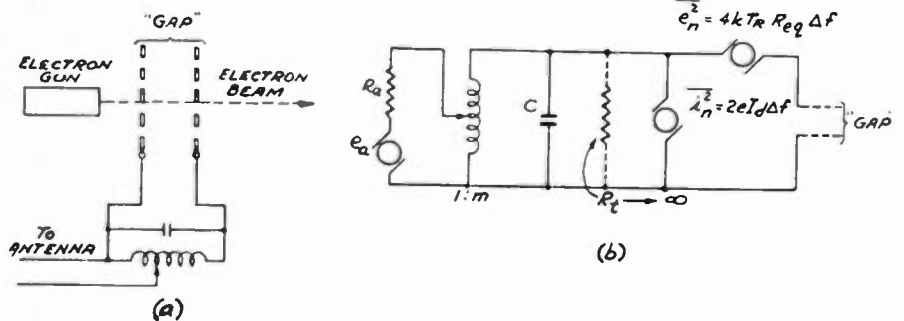

voltage input to the tube corresponds to the "gap" voltage of the velocity-modulated control. Any of the described methods<sup>17</sup> of operating the tube as a mixer may be used and the one selected is immaterial to the discussion. For small transit angles, the full beam current through the "gap" of the tube induces noise in the input circuit, so that across the "gap" there exists a noise generator containing the full mean-squared noise current of the beam. If it be assumed that this is full shot noise it will be  $\overline{i_n^2} = 2eI_d \Delta f$  where  $I_d$  is the beam current. Such a tube will also have output noise and there may be referred back to the "gap" as an  $R_{eq}$  in the same way as before. Thus the equivalent circuit of Fig. 6(b) is justified. The total impedance across the gap is usually very high; in fact the electron loading may be made negligible if the transit time is made very small<sup>18</sup> and the circuit may be very low loss. So, for illustrative purposes, we may assume an infinite circuit impedance, i.e.,  $R_t \rightarrow \infty$ . Let us examine the signal-to-noise ratio as the antenna coupling  $m$  is varied. The signal voltage at the gap, assuming an infinite impedance, is  $e_g \approx m e_a$ . The noise voltage is

so rises more steeply than the signal. The total noise  $N^2$ , which in this example is the sum of the plate noise and the induced noise, is also plotted. Finally the squared signal-to-noise ratio,  $(S/N)^2$  is shown and has a definite optimum. This optimum is the result of the rapid increase in total noise when the input impedance (as seen by the tube) is increased by lowering the damping effect of the antenna (i.e., increasing the effective step-up  $m$ ).

As the analysis shows, it is desirable in such a tube to have the lowest possible product of  $R_{eq}$  and beam current. Once again, the results may be interpreted in terms of a noise factor  $F \approx 2\sqrt{20I_d R_{eq}}$ .

The bandwidth of the input circuit must sometimes be considered and is shown as a curve on Fig. 7. If this is too narrow when the coupling is adjusted for best signal-to-noise ratio, it may be widened by decreasing  $m$ . In this event,  $m$  may be chosen from  $\Delta\omega$  (3 decibels down)  $\approx 1/m^2 R_a C$  so that  $m^2 R_a \approx 1/\Delta\omega C$  and

$$(S/N)^2 \approx (e_a^2/4kT_R R_a \Delta f) 1 / [\Delta\omega C R_{eq} + 20I_d/\Delta\omega C].$$

The signal-to-noise ratio of this type of tube is handicapped by the high noise in the input. If such a tube is used, it is clear that the antenna coupling should not be adjusted for maximum gain if it is desired to obtain best signal-to-noise ratio.

<sup>17</sup> W. C. Hahn and G. F. Metcalf, "Velocity-modulated tubes," Proc. I.R.E., vol. 27, pp. 106-116; February, 1939.

<sup>18</sup> See Part II of this series for transit-time loading in such a tube.

5. The Exact Signal-to-Noise Ratio

Up to this point the noise of the antenna has been neglected and also the thermal agitation noise of the part of the input resistance which is due to ohmic losses. Even in the treatment just preceding, the induced input

considered as composed of the electronic conductance  $g_e$  and the ohmic conductance  $g_\Omega$ . In terms of current generators, the mean-squared noise currents are: antenna noise =  $4kT_{eff}g_a\Delta f$ ; thermal noise =  $4kT_Rg_\Omega\Delta f$ ; induced noise =  $2eI_d\Delta f$ ; and plate noise and beyond

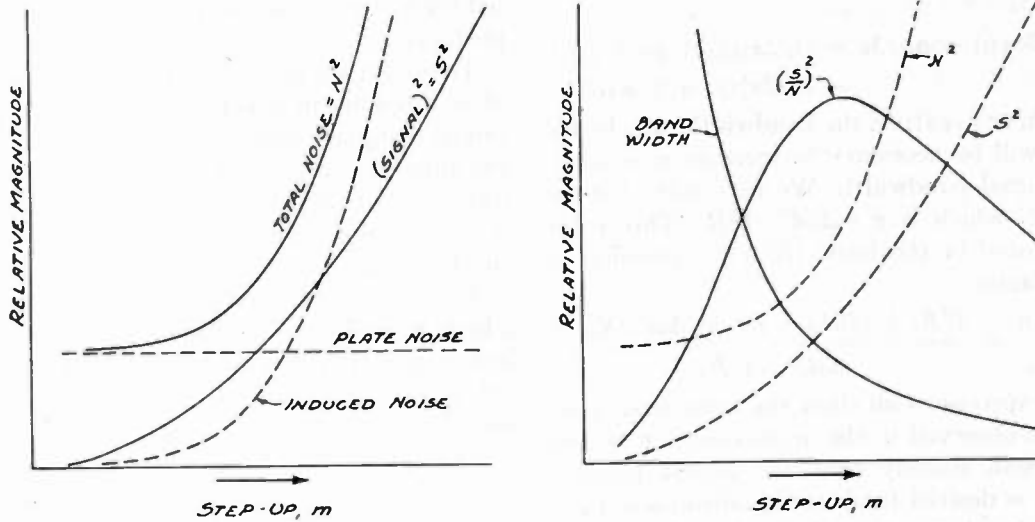

Fig. 7—Relative magnitudes of signal, noise, bandwidth, and signal-to-noise ratio for a case where input resistance is infinite. The curves are divided into two groups only to avoid confusion; the  $S^2$  and  $N^2$  curves are common to both groups.

noise was treated only for the simplified case wherein the input resistance  $R_i$  was very high, approaching infinity. If the exact case is to be treated, it is necessary to split  $R_i$  into its two possible components, the ohmic and the electronic. The former is accompanied by ther-

mal agitation noise, whereas the latter component may be said to be noise-free, since its noise is already included in what has been called induced input noise. With grid-controlled tubes, whose control grid is adjacent to the cathode, the induced noise bears a direct relationship to the electronic loading.<sup>6</sup> In other types of tubes there may be no simple relationship at all. In the following, the induced noise will be considered in terms of an equivalent saturated-diode noise  $2eI_d\Delta f$ . For the control-grid-adjacent-to-cathode tubes with oxide-coated cathodes it was found<sup>6</sup> that  $I_d \approx (1/4)g_e$ , where  $g_e$  is the electronic input conductance of the tube in mhos and  $I_d$  is in amperes. In the treatment, induced input noise will be regarded as a noise source independent of (i.e., not coherent with) the anode noise, since this is approximately correct in most ordinary tubes at small transit angles or under mixer conditions.

$$\begin{aligned} \left(\frac{S}{N}\right)^2 &= \frac{e_a^2}{4kT_R R_a \Delta f} \frac{1}{T_{eff}/T_R + g_\Omega/g_a + (2e/4kT_R)(I_d/g_a) + R_{eq}(g_a + g_\Omega + g_e)^2/g_a} \\ &= \frac{e_a^2}{4kT_R R_a \Delta f} \frac{1}{T_{eff}/T_R + 2(R_{eq}/R_i) + 1/g_a(g_\Omega + 20I_d + R_{eq}/R_i) + g_a R_{eq}} \\ &= (e_a^2/4kT_R R_a \Delta f)(1/F). \end{aligned}$$

As in the previous cases, this general result is best interpreted in terms of the noise factor  $F$ . The one variable in  $F$  is the quantity  $g_a$  which depends on the antenna coupling  $m$ . We may see immediately that  $F$

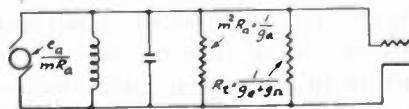

Fig. 8—Equivalent circuit of receiver input with the antenna signal  $e_a$  and antenna resistance  $R_a$  introduced in terms of their reflected value in the secondary. The effective step-up of the transformer is  $m$ . The tube input resistance  $R_i$  is split into electronic and ohmic components whose conductances are  $g_e$  and  $g_\Omega$ , respectively.

has a minimum since the denominator again contains a function of the type  $ax^{-1}+bx$  which was analyzed in Section II, 2. Using the relation for the minimum therein found

$$\begin{aligned} F_{\text{minimum}} &= T_{eff}/T_R + 2(R_{eq}/R_i) \\ &\quad + 2\sqrt{(R_{eq}/R_i)^2 + g_\Omega R_{eq} + 20I_d R_{eq}} \\ &= T_{eff}/T_R + 2(R_{eq}/R_i) \\ &\quad + 2\sqrt{(R_{eq}/R_i)^2 + R_{eq}/R_i + (20I_d - g_e)R_{eq}}. \end{aligned}$$

The equivalent circuit for a transformer with effective step-up  $m$  is shown in Fig. 8 where the noise generators have been omitted. In the figure, the reflected antenna conductance is shown as  $g_a$ , and the resistance  $R_i$  is con-

The matched-impedance noise factor is obtained by letting  $g_a = 1/R_t$  in the original expression, since this equates the antenna reflected resistance to the input resistance. This is

$$F_{\text{matched}} = 1 + T_{\text{eff}}/T_R + 4(R_{\text{eq}}/R_t) + (20I_d - g_a)R_t.$$

The bandwidth of the input circuit is given by the expression

$$\Delta f'(3 \text{ decibels down}) = \Delta\omega/2\pi = (1/2\pi)(g_a + g_u + g_e)/C \\ = (1/2\pi)(g_a + 1/R_t)/C.$$

When  $R_t$  is high, or negative, the bandwidth may be too narrow and it will be necessary to increase  $g_a$  so as to realize the required bandwidth. We may solve for the necessary value, which is  $g_a = \Delta\omega C - 1/R_t$ . This value may be substituted in the basic  $(S/N)^2$  expression to find the noise factor

$$F_{\text{wide band}} = \frac{T_{\text{eff}}}{T_R} + \frac{1/R_t + (20I_d - g_e) + (\Delta\omega C)^2 R_{\text{eq}}}{\Delta\omega C - 1/R_t}.$$

These exact expressions all show the same basic phenomena that we observed in the approximate relations previously derived, namely that the lowest possible value of  $R_{\text{eq}}/R_t$  is desired for best signal-to-noise ratio and, in the wide-band case, that  $R_t$  should be high while  $\Delta\omega CR_{\text{eq}}$  should be small. Furthermore, it may be seen that induced noise can seriously affect the noise factor, especially when  $R_{\text{eq}}/R_t$  is high. In each of the above cases, the substitution  $I_d \approx (1/4)g_e$  makes the results applicable to oxide-coated-cathode tubes whose control grid is adjacent to the cathode provided the transit angles are not too great.<sup>6</sup> It should be noted that, for laboratory measurements with a dummy antenna,  $T_{\text{eff}} = T_R$ . Further discussion of the magnitude of  $T_{\text{eff}}$  will be found below in Section II, 7. More details of the exact signal-to-noise ratio analyses are to be found in footnote reference 12.

#### 6. Effect of Feedback on Signal-to-Noise Ratio

The analyses made thus far have neglected feedback. If the first tube or tubes of a receiver are radio-frequency amplifiers, however, feedback in one form or another (i.e., degenerative, regenerative, or both) must often be considered in the operation of the amplifier. However, the effect of feedback on signal-to-noise ratio is often relatively minor.<sup>19</sup> We may see this by thinking of a vacuum tube in terms of an equivalent circuit containing a noise generator of mean-squared value  $\overline{i_{pn}^2}$  and a signal-current generator  $g_m e_v$  in the plate circuit. If any of the plate output is fed back to the input, the apparent input impedance and gain of the tube may be radically raised or lowered but the ratio of the noise generated to the signal generated as given by  $\overline{i_{pn}^2}/g_m^2 e_v^2$  remains approximately unchanged. Thus, noise will always be fed back along with the signal and in about the same ratio. If the feedback is regenerative, the input impedance is raised, the gain is increased, the grid sig-

nal is augmented by the energy fed back, but the noise is also increased and in approximately the same proportion as the increase in signal. For the degenerative case, the signal and noise are *decreased* by just about the same ratio. Thus, the effect of feedback on signal-to-noise ratio is chiefly due to the noise sources which are not fed back, and these are, in some instances, of minor importance.

To obtain a rough estimate of the signal-to-noise ratio of an amplifier in which a known and definite feedback exists, one may, therefore, make the computation as in the previous cases, making sure that the feedback effects are not included in the values of equivalent-noise resistance and tube-input resistance which are used in the formulas.

There is one common form of feedback which is worth a little more discussion, namely, that due to cathode-lead inductance. It was shown in Part II of this series that this is a degenerative form of feedback which leads to a lowering of the input resistance. In the case of a triode, we should follow the above rule: neglect the lowered resistance due to lead effects and compute the signal-to-noise ratio as if the tube had the higher input impedance of one with an ideal cathode connection. In the case of a pentode, the noise current flowing in the cathode lead is only a fraction of the noise in the plate lead. The screen-grid-distribution-noise current<sup>20</sup> flows between screen and plate and is not in the cathode lead; it is not fed back through the cathode-lead inductance at all. Thus the noise is not reduced by the feedback as much as the signal, and the signal-to-noise ratio is worse than the one computed by neglecting the cathode-lead feedback. However, it is possible to feed back some of the screen-lead noise (e.g., through an impedance in the lead and capacitance to the control grid) so as to obtain an improved signal-to-noise ratio, even approaching that of the triode.<sup>21</sup>

A practical effect of the feedback which exists in most ultra-high-frequency receivers is to invalidate some of the cruder methods of checking the signal-to-noise ratio which are based on detuning the input.<sup>8,9</sup> For example, it has been proposed that if the noise output is observed both with the input circuit normally connected and with it short-circuited, the relative contributions of tube and thermal input noise can be found. This is only true if there is no induced-input noise and if the feedback remains constant; neither condition is generally so at ultra-high frequencies.

#### 7. Attenuation and Thermal Noise of Transmission Line

A transmission line which connects the antenna to the receiver will obviously decrease the possible signal-to-noise ratio if it attenuates the received signal. At the same time, its losses may contribute to thermal noise

<sup>19</sup> W. A. Harris, "Fluctuations in space-charge-limited currents at moderately high frequencies—Part V," *RCA Rev.*, vol. 6, pp. 122-124; July, 1941.

<sup>20</sup> D. O. North, "Fluctuations in space-charge-limited currents at moderately high frequencies—Part III," *RCA Rev.*, vol. 5, pp. 244-260; October, 1940.

<sup>21</sup> M. J. O. Strutt and A. van der Ziel, "Methods for the compensation of the effects of shot noise in tubes and associated circuits," *Physica*, vol. 8, pp. 1-22; January, 1941.



in the input. In the exact analysis that was discussed above, the antenna and its associated transmission line (if any) were considered as having a signal voltage  $e_a$  and a noise voltage whose mean-squared value was  $4kT_{\text{eff}}R_a\Delta f$ . It is a simple matter to determine how these two quantities depend on an associated transmission line or other passive network between the actual antenna and the connection to the receiver.

Let the actual antenna have an open-circuit signal voltage  $e_a'$ , and a radiation resistance  $R_a'$ . The available signal power is then  $(e_a')^2/R_a'$  of which one quarter can be delivered to a matched transmission line or other transducer. At the other end of the line or transducer, there will be an open-circuit voltage  $e_a$  and a resistance  $R_a$  (which may or may not equal  $R_a'$ ). Thus the ratio of output power available to available input power is

$$M = \frac{\text{output power/input power}}{= (e_a^2/R_a) / [(e_a')^2/R_a']}$$

which, of course, is a maximum when the antenna is matched to the line or transducer. This power ratio is often expressed in decibels, and is called the attenuation.

If the antenna is at an effective noise temperature of  $T_a$  it will have a noise voltage  $e^2 = 4kT_aR_a'\Delta f$ . The available noise power at the antenna is then

$$\text{noise power at antenna} = \frac{e^2}{R_a'} = 4kT_a\Delta f.$$

At the other end of the line or transducer, i.e., at the receiver, this is  $M$  times as great,

$$\begin{aligned} \text{noise power from antenna getting to receiver} \\ = M4kT_a\Delta f. \end{aligned}$$

The transducer or transmission line will have thermal agitation associated with its losses at a temperature which we shall call  $T_L$ . Thus, if in a hypothetical case, the antenna and transducer were both at this temperature  $T_L$ , the available noise power at the receiver would be  $4kT_L\Delta f$ . This is too high by the quantity  $M4kT_L\Delta f$  which would be the antenna contribution in this hypothetical case. Thus, in the actual case,

$$\begin{aligned} \text{noise power from transducer getting to receiver} \\ = (1-M)4kT_L\Delta f. \end{aligned}$$

The total available noise power at the receiver is, therefore,

total noise power at receiver  $= 4k\Delta f [T_L(1-M) + MT_a]$  and the effective noise temperature of the antenna and associated transducer is  $T_{\text{eff}} = T_L(1-M) + MT_a$ . Ordinarily, the transmission line or transducer is at room temperature so that  $T_L = T_R$ .

It is seen by reference to the expression in Section II, 5, above, that the signal-to-noise ratio of an over-all system containing a transmission line whose power-loss ratio is  $M$  is reduced from that of one with a loss-free line, first by the factor  $M$  (which is the loss in  $e_a^2/R_a$ ), and second by the change of apparent antenna noise temperature from  $T_a$  to  $T_{\text{eff}}$ . This may be written

$$\left(\frac{S}{N}\right)_{\text{loss}}^2 \Bigg|_{\text{with line}} = \left(\frac{S}{N}\right)_{\text{loss}}^2 \Bigg|_{\text{with no line}} M \frac{T_a/T_R + F - 1}{T_{\text{eff}}/T_R + F - 1}$$

where  $F$  is the noise factor of the receiver alone as it

would be with a dummy antenna (whose temperature is  $T_R$ ).

### III. THE RATING OF RECEIVERS

#### 1. The Noise Factor

It was found by the analyses above that all the signal-to-noise ratios could be written in the form

$$(S/N)^2 = (e_a^2/4kT_RR_a\Delta f)(1/F)$$

and the quantity  $F$  was identified with what North has called the noise factor.<sup>11</sup> In the laboratory, with a dummy antenna at room temperature, it can be seen that  $F$  represents simply the number of times that the total receiver noise exceeds that of the dummy antenna and, as North showed, this may be made a general concept for any receiver whatever. The concept implies that, in a completely noise-free receiver, the total noise will be dummy antenna noise only and  $F_{\text{min}} = 1$ . Thus the higher the number  $F$  which is measured in the laboratory, the poorer is the receiver compared with the ideal. It may be noted that it is not usually possible to obtain a noise factor approaching unity with a matched-impedance input connection except when the input impedance is a result of feedback. In other cases, the thermal noise of the receiver input impedance (or the matching impedance which may have been added), leads to a value of 2 for  $F$  even though no other noise sources are present.

In the field, with an actual antenna, we have seen that  $F$  contains a term which depends on the effective noise temperature of the antenna and its transmission line  $T_{\text{eff}}$ . Thus, with an antenna whose noise temperature is less than room temperature, and a low-loss line, an operating noise factor is obtained which is less than that measured in the laboratory and, with an ideal noise-free receiver, is less than unity. On the other hand, a noisy actual antenna and transmission-line system results in an increase in the operating noise factor over that measured in the laboratory. When the receiver noise greatly exceeds that of the antenna it becomes difficult to measure the actual operating noise factor directly so that this quantity is often not known at ultra-high frequencies.

Ordinarily, receivers are most easily compared in the laboratory and, as we shall see, a noise-factor measurement is a simple and straight-forward process. Thus the laboratory noise factor<sup>22</sup> was originally proposed<sup>11</sup> to define a method of rating receivers for signal-to-noise ratio, since noise factor is often independent of bandwidth and of the magnitude of the antenna radiation resistance from which the receiver was intended to operate. An important accompaniment of North's proposal was the analysis of the receiving antenna (also discussed in Part I of this series) which showed that the available received power from a given transmitter and at a given wavelength depends only on the receiving antenna directivity, and is independent of the radiation resistance.

<sup>22</sup> I.e., the noise factor when  $T_{\text{eff}} = T_R$ .

Since the noise factor is a power ratio, it is conveniently expressed in decibels, so that an ideal, noise-free receiver, with  $F=1$ , may also be said to have a noise factor of zero decibels. Similarly, a matched-impedance receiver which has a resistive input impedance which is at room temperature for noise purposes but wherein the receiver is otherwise noise-free, has a noise factor  $F=2$  which corresponds to three decibels.

## 2. The Measurement of Receiver Noise Factor

In order to measure the receiver noise factor  $F$  we must measure the actual signal-to-noise ratio of a receiver and compare it with that of the dummy antenna  $e_a^2/4kT_R R_a \Delta f$ . To do this in the laboratory, a known voltage source  $e_a$  (e.g., a signal generator), and a dummy antenna of value  $R_a$  may be used. One possible procedure may be outlined.

We first apply a small signal of frequency  $f_0$  anywhere in the band to which the receiver is responsive and of a magnitude  $e_a$  somewhat in excess of the noise. In the output of the receiver, prior to any audio or video amplification, we connect a power-measuring device<sup>23</sup> (such as a thermocouple meter) suitable for reading the total output power over the entire frequency spectrum to be utilized. With the signal turned on, the output power will then be the sum of signal and noise powers. Let us call its value  $P_1$ . If the signal is now turned off, the out-

<sup>23</sup> Any other device responsive to signal and noise, such as a linear detector, may be used if a power calibration for the combination of signal and noise has been calculated or has been experimentally determined.

put power will be that due to noise only, which may be called  $P_2$ . Then the signal-to-noise ratio is

$$(S/N)^2 = (P_1 - P_2)/P_2.$$

By the definition of noise factor  $F$ , however,

$$(S/N)^2 = (e_a^2/4kT_R R_a \Delta f)(1/F)$$

so that  $F = (e_a^2/4kT_R R_a \Delta f)P_2/(P_1 - P_2)$

$$= 0.62 \times 10^{20}(e_a^2/R_a)(1/\Delta f)P_2/(P_1 - P_2).$$

To compute  $F$  we need, in addition to the power measurement, therefore, only the quantity  $e_a^2/R_a$  and the noise bandwidth  $\Delta f$ . The former may be obtained if  $e_a$  and  $R_a$  are known and the latter (see Part I of this series) is defined as the ratio of the area under the power-selectivity curve to the height of this curve at the signal frequency  $f_0$ . Mathematically

$$\Delta f = [\int_0^\infty P(f)df]/P(f_0)$$

where  $P(f)$  is the output power as a function of receiver signal input frequency,  $f$ .

Since the calculation of noise factor requires a knowledge of  $e_a^2/R_a$ , it is clear that  $F$  may be found without knowing  $e_a$  and  $R_a$  separately. In fact, all that is required is a shielded oscillator and attenuator with an ultra-high-frequency power-measuring device. If the oscillator is matched to the power-measuring device, it will measure the quantity  $e_a^2/4R_a$  and this will enable  $F$  to be computed. In practice, one usually must design the equipment for a specified value of  $R_a$  so that actually  $e_a$  and  $R_a$  will both be known.

# The Radio Engineer in Psychological Warfare\*

ROY C. CORDERMAN†, NONMEMBER, I.R.E.

**Summary**—This paper presents a brief review of the short-wave broadcast situation in the United States at the outbreak of the war as compared to that of England and Germany, followed by a description of the expansion of short-wave facilities accomplished and planned by the Office of War Information and the Coordinator of Inter-American Affairs, including the considerations given recognition in the selection of locations for additional transmitters. It also includes reference to the various miscellaneous communication services utilized in releasing news from the United States to the other United Nations and neutral countries throughout the world. It further includes evidence of the effectiveness of the psychological-warfare program in Axis-occupied areas.

THIS IS the first war in which the American radio engineer has played a part in its psychological aspect. His tools are old tools well known to the radio art for many years. He has had no secret developments. However, the application of these tools is of interest to the layman and may be of interest to radio engineers.

\* Decimal classification: R560×R550. Original manuscript received by the Institute, March 31, 1943. Presented, Winter Conference, Washington, D. C., January 28, 1943.

† Assistant Chief, Bureau of Communication Facilities, Office of War Information, Washington, D. C.

Prior to this war, the United States, unlike other nations, had no international voice and offered no propaganda. Our short-wave broadcast stations, privately owned, sought listeners for much the same reason as our radio amateurs sought listeners, that is, to prove they were being heard. They had no propaganda or product to sell. In addition to musical entertainment some stations carried news programs, others carried both news and commentaries. In most cases the stations were being operated for only a few hours each day. As of December 7, 1941, those stations in operation were WBOS at Boston, owned by the Westinghouse Electric and Manufacturing Company; WRUL, WRUS, and WRUW, at Scituate, Massachusetts, owned by the World Wide Broadcasting Corporation; WGEA and WGEO at Schenectady, New York, owned by the General Electric Company; WRCA and WNBI at Bound Brook, New Jersey, owned by the National Broadcasting Company and operated from its studios at New York; WCBX, WCRC, and WCDA at Brentwood, Long Island, owned by the Columbia Broadcasting System and also operated from studios at New

York; WLWO at Cincinnati, Ohio, owned by the Crosley Corporation; and KGEI at San Francisco, California, owned by the General Electric Company.

Contrasted with this let us consider the short-wave development of the other large nations of the world. England had six high-power short-wave stations in operation; Germany had thirteen; Italy had nine; France had five; Holland had five; Belgium had two; Poland had four; and Japan had four. A few other countries, notably in South and Central America, had quite a number of small short-wave broadcast stations used entirely for local coverage owing to the bad reception conditions prevalent in those areas on the standard broadcast band because of static.

Both England and Germany, through their many years of experience in broadcasting on short waves, were using highly developed transmitting equipment, antenna systems having the special characteristics required for long-distance transmission, and a programming technique which, by actual test, had been found to be effective in attracting listeners on the short-wave bands.

This, then, was the situation before the European war. As the war progressed and various countries fell to Germany, their radio stations were taken over and programmed by the Axis. Based upon monitoring reports from the Foreign Broadcast Intelligence Service, a part of the Federal Communications Commission, and confirmed by reports from the British Broadcasting Corporation, we believe at the close of 1942 there were well over 100 short-wave broadcast stations available to the Axis and in use either for programming or for jamming the programs of the United Nations.

Despite this extremely large number of outlets, reports indicate that Germany has been constructing during 1942 twelve or more 200-kilowatt transmitters for international short-wave broadcasting. These transmitters are based upon a design captured from the French which uses a 100-kilowatt tube, much larger than any presently available for short-wave use here.

On December 7, 1941, when the United States was suddenly forced into war, she was not entirely unprepared for during 1941 we had been training an increasing number of soldiers, preparing equipment for their use, and in many other ways had started the transition from a normal peacetime status to one of war or readiness for war. On the psychological warfare front, the office of the Coordinator of Information had been established in August and through its Foreign Information Service branch had set up studios in New York connected by means of the Bronze Network to the short-wave broadcast stations on the east coast. Although the programs originating in these studios at that time consisted largely of news and commentaries in various languages, a sound basis for expansion and increased programming had been established. On December 7, America's voice on the psychological-warfare front was being heard through twelve stations.

Starting in August, 1940, through the office of the

Coordinator of Inter-American Affairs, a second approach to our international voice had been developing. This Coordinator was charged with the responsibility of extending the good-neighbor policy to the other American Republics. Short-wave radio broadcasting, offering an excellent means for the presentation of information and cultural programs, was quickly adopted for this purpose. In this case, however, the programs were originated in the production departments of the several radio stations from material provided by the Coordinator.

After December 7 the tempo of these operations increased. The studios of the Coordinator of Information were enlarged and many programs were added by both government agencies, making necessary an increase in the hours of operation of the stations. On the west coast, where only one station, KGEI, was available, it was recognized that there was urgent need for additional facilities in order that our troops defending the Philippines could be heartened by news from home. The only other transmitters on that coast capable of short-wave program transmission were those of R.C.A. Communications, Inc., at Bolinas and that of the American Telephone and Telegraph Company at Dixon, California. It was found that the telephone company transmitter was busy with military traffic but the R.C.A. Communications, Inc., transmitters were available and quickly placed in service. When the Japanese jammed KGEI, and in those days they often did, MacArthur and his troops tuned in to these R.C.A. Communications transmitters. As many as four were used at one time during the days of Bataan and Corregidor and two have been continued since then.

Early in April, 1942, a 100-kilowatt transmitter, the most powerful short-wave broadcast transmitter ever built in the United States, was placed in operation at San Francisco by The Associated Broadcasters, Inc. This transmitter was just being completed in December, 1941, by the General Electric Company, and, although it had been scheduled for installation in Schenectady, it was agreed by all that it should be installed on the west coast where the need was more urgent. It is equipped with the most modern type of curtain arrays engineered through the assistance of the Federal Communications Commission and is putting the strongest signal into all parts of the Pacific Area.

As some of the various functions of the office of the Coordinator of Information required the sending of field representatives to many parts of the world not occupied by the Axis, these representatives were asked in addition to supply reports on the reception of our short-wave programs in those countries. Their reports showed that in many areas important to us our programs were not being received with regularity or with sufficient strength to attract listeners. A survey of available transmitters on the east coast which could supplement our short-wave broadcast facilities showed that the communication companies had several

transmitters which would be useful for this purpose. Two of the Press Wireless transmitters at Hicksville, Long Island, rated at 10 kilowatts carrier power, and one American Telephone and Telegraph Company transmitter at Ocean Gate, New Jersey, rated at 20 kilowatts carrier power, were leased during May and were beamed on some of these areas.

After June 13, when the new Office of War Information absorbed the operations previously conducted by the Foreign Information Service branch of the Coordinator of Information, a committee was formed composed of Elmer Davis, Director of the Office of War Information, Nelson Rockefeller, the Coordinator of Inter-American Affairs, and T. A. M. Craven, a Commissioner of the Federal Communications Commission. This committee, called the Interdepartmental Committee for International Radiobroadcasting Facilities, had as its first assignment a study of the short-wave broadcast facilities required for the conduct of psychological warfare. In order to give adequate coverage during the best listening hours in those areas which can be effectively programmed from the United States, a plan proposing a total of 36 transmitters of from 50 to 100 kilowatts power was adopted as the minimum requirement. This plan was based on two-frequency coverage, as there was ample evidence to justify such coverage offering a six-to-one improvement in reception over single-frequency coverage. Since there are in operation only 14 short-wave broadcast transmitters, twelve of which meet the 50 to 100 kilowatts specification, it will be necessary to increase the power of the remaining two existing transmitters and add 22 new transmitters.

To provide co-ordination with the production of military equipment it was referred to the Board of War Communications and the Joint Chiefs of Staff, which agencies have sanctioned the over-all plan as well as the specific schedule for their production. The first of these transmitters is expected to be in operation in late February or early March, and the last is expected to be ready for use before the close of 1943. Twelve of the new transmitters will be located in stations on the east coast and ten will be located in stations on the west coast. In selecting locations for these transmitters consideration has been given to the following factors:

1. The availability of experienced operating personnel.
2. The availability of building and power supplies.
3. The availability of existing antenna arrays or land on which new arrays can be erected.

While it is recognized that the curtain-type antenna, properly designed and constructed, is most effective for long-range short-wave transmission, it is felt however that owing to the scarcity of materials needed for its construction, it is desirable to utilize instead, for those antennas built during the war, the rhombic type of antenna. This type of antenna requires no more wire and contains only a fraction of the number of insulators

needed for the curtain type. Ordinary telephone poles can be used for their support whereas high towers are required for the support of curtain antennas. In addition, they have an advantage in that they are useful over a wider range of frequencies without special adjustments. Under wartime conditions this feature becomes important as it may be necessary from time to time to change frequencies in order to overcome interference.

To provide programs for the additional transmitters, an expansion of the studio facilities at New York is under way. When completed there will be a total of fifteen studios of modern construction and a master-control room, supplemented by recording facilities and the other usual equipment found in a large studio operation. At San Francisco a similar installation of only nine studios is being provided.

From our New York studios the Office of War Information daily transmits programs to London from which point they are rebroadcast to the European continent over the medium-wave transmitters of the British Broadcasting Corporation. From our San Francisco studios, in a similar manner, the Office of War Information daily transmits programs to Sydney, Australia, where they are released over the Australian domestic networks and broadcast over the local medium-wave transmitters.

Besides the foregoing, the Office of War Information is providing program material in the form of recordings of the American domestic commercial broadcasts with the commercial advertising deleted, which material is used at the medium-wave broadcast stations in Hawaii, Alaska, and Puerto Rico where it is effective in providing American troops and local citizens with morale-building entertainment.

In addition to short- and medium-wave broadcasting, the Office of War Information utilizes other means of disseminating news throughout the world. Through the usual channels provided by the commercial communication companies it transmits daily more than 30,000 words of press. These are received at foreign points by communication companies, by representatives of United Nations governments, and by the Office of War Information field representatives and disseminated to the local press. These transmissions have been found necessary in order to provide accurate and timely news in many areas where the regular news services have broken down or have been discontinued because of the war.

Supplementing this service and operating in conjunction with it, radiophoto transmission has been established to a number of points where such transmission was unavailable prior to the war. This has been accomplished through the installation of special radiophoto equipment developed at the direction of the Office of War Information and installed in many cases with the assistance of its engineers at the foreign points. As an interesting side light on the future of

such service it will no doubt be of interest to you to learn that the installation of radiophoto equipment has opened the door to a brighter day for communications in China. As many of you know the transmission of a telegram in China requires its translation from the Chinese into some other language for which there is a telegraph code before it can be transmitted over the telegraph wires in this code. After reception it has to be retranslated into Chinese, making the operation not only slow but also subject to many errors. Radiophoto, or its less expensive substitute, generally designated facsimile, offers the advantage of immediate transmission of the Chinese characters in their original form. We have been told that when Generalissimo Chiang Kai-shek first saw a radiophoto transmission of the Chinese characters he immediately requested the purchase of a sufficient number of units to enable him to establish such telegraph transmission to his principal field officers.

Undoubtedly radiophoto or facsimile would be similarly useful in the transmission of other languages where telegraph codes have not been developed or, where developed, are more complicated than those used in the transmission of English or other similar languages using the international Morse code for transmission.

In the transmission of scripts and other material used in the Office of War Information broadcast studios and in the preparation of news releases for overseas transmission, the Office of War Information uses private-line teletypewriter circuits between its principal offices in Washington, New York, and San Francisco. There are five teletypewriter circuits between Washington and New York carrying an average daily load of over one-quarter million words, and there is one such circuit between Washington and San Francisco carrying an average daily load of over 100,000 words. In presenting these load figures it was thought that they might serve as an indication of the extremely large communication problem which faces the Office of War Information in the production of its broadcasts and in the dissemination of its news releases throughout the world.

With the opening of the North African front, the Office of War Information and the American press were faced with a new problem, that of obtaining adequate and timely news from that front. During the early days of this campaign, when the only facilities available were the commercial channels operated by Cable and Wireless, Ltd., terminating at Tangier, due to the extremely heavy file of traffic delays, up to as much as three days, were not at all uncommon. In early January, however, the Office of War Information, through arrangements with the Army, established a channel from Washington to Algiers, which channel is available to the American press at no cost. This channel is now carrying over 30,000 words per day. It is planned to continue its operation for the American press until such time as commercial facilities have been

established which are capable of handling the press file without delay.

As the war progresses it is hoped that we may in the same manner continue to meet our responsibility for keeping the American public promptly informed of developments on each of the fronts which may be opened.

We are often asked about the effectiveness of American propaganda. Recently the monitoring stations of the Foreign Broadcast Intelligence Service and the British Broadcasting Corporation have reported that all programs from any country which cover developments on the Russian front are being jammed in Germany. If there was no likelihood of these programs being received no effort would be made to jam them.

Another report provided by the monitoring station of the Foreign Broadcast Intelligence Service on the west coast, covering a broadcast to the domestic audience in Japan, will undoubtedly be of interest as it indicates the degree to which the Japanese are informed of the activities of the Office of War Information and the steps they are taking to overcome its effectiveness. I read directly from this report as follows:

"Accompanying the new developments of the world-war situation the enemy nations America, Britain and others have recently been recovering repeatedly from the great blows suffered in various battles and—looking forward to a recovery of the situation in the Solomon Islands, the Aleutians area, or in North Africa—have been planning military counterattacks. Hand in hand with this, even in the war of thought, they have begun an extremely active offense and these propaganda schemes bear attention.

"Okumura, vice-president of the Board of Information, explained as follows in today's regular vice-minister's meeting about the organization of the American Office of War Information and its propaganda policy; and revealing the true nature of America's propaganda schemes which have recently become very active, he issued a warning to the people of the nation. That is to say, he stated as regards to the organization of the Office of War Information:

"The American Office of War Information was established last year in June. It became a single organ of supervision of propaganda facilities such as newspapers, periodicals, and the radio. The Chief of the Office is Elmer Davis, who is a man from newspaper circles; 2500 staff members are employed. With a yearly expenditure of 100 million yen, the office is totally mobilizing newspapers and the radio throughout entire America and is active in the elevation of the people's will to fight, as well as propaganda directed against the enemy.

"In particular, recently there have been special correspondents dispatched from the Office of War Information to Soviet Russia, Turkey, Iran and other areas throughout the world. At London and at Dublin in Ireland, branch offices have been established and efforts are being made to collect information.

Altogether there are 44 branch offices in principal cities in America, and these offices are devoted to collection of domestic information and in spreading propaganda.

"The Office (OWI) is emphasizing that speedy victory in this world war lies with America and Britain and the main strength of propaganda is devoted to creating this impression in many ways. Consequently, in spite of defeats in various battles, the point that America's national strength is very enormous is being propagandized in a big way at home, in Allied Nations, and in neutral nations. As an example of this, the Boeing-17 type plane, which is their pride, has been named the Flying Fortress and its abilities are propagandized by means of pictures . . . ; or again, propaganda concerning America's strong productive power is carried in such things as periodicals, war victory wrapping papers, and even on match boxes. In this manner the plans for propaganda of America and Britain are centered on impressing everyone at home and abroad with the magnificence of their nations.

"As against the Axis nations of Japan, Germany, Italy and others, they are strengthening the war of nerves which follows along with a war of long duration and are planning internal confusion by spreading false propaganda in an even more lively manner. Consequently, if false propaganda not based on truth arises in our ranks regarding uneasiness over the war situation or criticism of our war leaders, to believe in it will in itself be falling prey to the propaganda schemes of enemy countries. Therefore, the people of the nation must not be seduced by such false propaganda, must co-operate as one, and fight to the end to win in this

war of thought'."

Summarizing, the Office of War Information, jointly with the Coordinator of Inter-American Affairs, is utilizing all of the existing short-wave broadcast stations for the conduct of psychological warfare. It is supplementing these stations with such of the commercial communication telephone transmitters as are available. It is expanding these facilities through the addition of twenty-two 50- to 100-kilowatt transmitters being produced on schedules arranged to offer the minimum interference with military production. It is now operating studios in New York and San Francisco, which studios will ultimately be expanded to a total of fifteen in New York and nine in San Francisco.

It is disseminating news throughout the world through commercial communication channels, is sending radiophotos to nine countries for publication in the newspapers of these or adjacent countries, and through newly established facilities between the United States and Algiers is providing a means for the transmission of timely and accurate news of the activities on that front to the American public through its regular press associations and radio networks. In all of this activity of the Office of War Information many radio engineers will be found, some at the short-wave broadcast transmitters and others in the studios, in the commercial communication stations and control terminals, in the radiophoto rooms, and still others at the circuit terminals operated by the army and used by the Office of War Information. In all, there are well over 200 radio engineers serving their country on the psychological-warfare front.

## The Engineer's Position in the Manpower Program\*

T. K. MILES†, NONMEMBER, I.R.E.

I HAVE been asked to sum up and correlate the various regulations and practices in the manpower program affecting engineers. Many of you undoubtedly are aware of some of these arrangements, but to present a related picture it is necessary at least to touch on all of them.

The President has recently, by Executive Order, placed the Selective Service System under the War Manpower Commission. The Commission was then reorganized so that its functions in Washington are now carried on by five bureaus; namely, Program Planning and Review, Selective Service, Placement, Training, and Labor Utilization. Three of these bureaus are of particular interest to engineers: Selective Service, Training, and Placement. You all know what Selective Service includes. The Bureau of Training includes

training within industry and utilization of the colleges. The Bureau of Placement now includes the Washington staff of the United States Employment Service and the National Roster of Scientific and Specialized Personnel.

The national headquarters of the Selective Service System which has, for organizational purposes, been designated as the Bureau of Selective Service, has issued a number of regulations providing for the deferment of "necessary men." To be classed as a "necessary man" and thus be eligible for deferment an individual must meet three criteria:

- (1) He must be engaged in war production or in activities supporting the war effort.
- (2) He must be in a critical occupation or, in other words, there must be a shortage of personnel of his qualifications and training such that if he were removed he could not be replaced.
- (3) His removal would cause a loss of effectiveness in the activity in which he is engaged.

\* Decimal classification: R560. Original manuscript received by the Institute, April 12, 1943. Presented, Winter Conference, New York, N. Y., January 28, 1943.

† National Roster of Scientific and Specialized Personnel, War Manpower Commission, Washington, D. C.

Occupational bulletins have been issued from time to time listing essential activities and critical occupations therein. All professional and technical engineers have been classed as being in critical occupations when working in war production or in activities supporting the war effort. The Selective Service Act provides that there shall be no blanket deferment of individuals by occupational groups, but that the case of each individual must be considered separately on its own merits.

A revision of Occupational Bulletin No. 10 dated December 14, 1942, provides that fully qualified engineering students in good standing who have previously completed one year of their schooling in a recognized college or university may be considered for occupational deferment while they continue as full-time students in good standing in such courses of study. This bulletin is recognized as being of a purely temporary nature and will be replaced before July 1, 1943, by another dealing with the whole problem of the training of professional personnel.

Occupational Bulletin No. 23 provides that deferment may be granted for teachers of engineering in all colleges and universities. This includes graduate assistants engaged in part-time classroom or laboratory instruction for not less than twelve hours per week or engaged in scientific research certified as related to the war effort.

The National Roster of Scientific and Specialized Personnel, through its Military Advisory Section, has for some time been giving advice to the Selective Service Boards concerning the professional qualifications of its male registrants. On the basis of the individual's registration form and other information which the Roster receives, the qualifications of each registrant are evaluated in line with the essential industry and critical occupation listings to determine whether or not he should be classified as a necessary man. In any case in which the Military Advisory Section believes that an individual should be classed as a necessary man it certifies this fact to the National Headquarters of the Bureau of Selective Service who in turn notify the local draft boards. The local boards may use this information in determining whether or not to defer the individual in question. It must be understood that this notification in no way binds the local boards to classify anyone as a necessary man; it only serves to give them information which they might not otherwise be in a position to obtain.

A somewhat more formalized system is now in existence for the field of physics, and it may be extended to other scientific and specialized fields in the future. Selective Service Local Board Release No. 159 states that, "When the War Manpower Commission has determined that there is . . . a critical shortage in a scientific or specialized field, the Director of Selective Service may authorize the appointment of a National Committee in that field, to assist the Selective Service System by reviewing affidavits for occupational classi-

fication." So far, such a committee has been set up only in the field of physics. This committee includes two physicists and four representatives of the Federal Government who are not physicists but who are in a position to be familiar with nation-wide needs for personnel with respect to physics. When a firm or an academic institution wishes to request the deferment of an employee who is a physicist or of a student in training therefor it sends the original of the form requesting deferment to the National Committee on Physicists and a copy to the local Selective Service Board. The physicist's committee then investigates the individual. When in the opinion of the committee the individual possesses the requisite training, qualifications, or skill, and is a necessary man in an essential activity or a necessary man in training or preparation therefor, the National Committee is authorized to place a stamped indorsement on the original form and to file the form with the individual's local draft board which uses this information in making its classification. The Committee on Physicists does have one further prerogative. It, as well as the employer, or college, or university, has the power to appeal the local board's decision concerning the occupational classification of any physicist.

Another section of the National Roster, the Qualifications Unit, uses the Roster registration files in an attempt to fill any job requests for scientific and specialized personnel that it may receive. Since the inception of the Roster, an estimated 20,000 to 25,000 jobs have been filled in this manner. So far the facilities of the Roster have been used much more by the various governmental agencies than by industry, probably because of proximity and a greater awareness of the Roster's files. However, an arrangement with the United States Employment Service exists whereby any local office that is unable locally to recruit professional personnel requested by an employer may forward the request to the National Roster which will then use its files in an attempt to fill the job. Any employer may file a job request with the local Employment Service office and request them to avail themselves of the facilities of the Roster. Some new plants have been staffed almost entirely in this manner. However, I don't wish to create the impression that there exists a reserve pool of unemployed trained engineers of all kinds. In some fields, and radio engineering is one of them, it is extremely difficult to locate available personnel. However, the Roster has the advantage of being a central agency containing at present the registrations of over 100,000 engineers and thus is in a position to have information on a scale that is not available in a local area.

The Professional Surveys Section of the Roster has for some time been working to obtain information on the over-all demand for and supply of personnel in the various professional fields. This division was organized as part of the Roster's function to secure the maximum utilization of professional personnel in conjunction with the war effort. As one source of statistical data it

has available the Roster registrations. At present, however, these registrations can be considered only as representing a sample of most fields. For example, whereas there are now in excess of 100,000 engineers registered with the Roster, this represents less than 50 per cent of the estimated number in the country. Efforts are constantly being made to increase the number of Roster registrants in the critical professional fields. On the Selective Service Occupational Questionnaire, which is sent to every male in the country between the ages of 18 and 65, there was one section devoted to the reporting of professional qualifications. In every case in which an individual indicated that he was qualified in a professional field this particular section of the questionnaire was torn off and forwarded to the Roster. The Roster is presently engaged in sending registration blanks to such individuals. It is hoped that when this undertaking is completed we will have in our central files substantially complete registrations covering all male professional personnel in the critical fields. Most of the registration data are placed upon punch cards so that when our registrations are complete it will be possible by use of the various card-sorting machines to obtain statistical data of the very type we desire in assessing the supply in any professional field. I might add that the Roster, from time to time, is recircularizing all registrants to bring its information up to date. A registrant is asked to return the recircularization blank noting any changes that have occurred in his status since the previous registration blank was filled out. We are entirely dependent upon the registrant informing us in this manner of any change in his status. The usefulness of our files is definitely related to the currency of the information on hand.

For the present we have had to obtain data from every possible source and much of it is necessarily approximate. Nevertheless, the reports we are able to write may be of value as painting the general picture which would probably not be very different even with more precise data. The Professional Surveys Section has issued a report on the personnel situation in physics and has nearly completed similar reports in the fields of chemistry and engineering. These reports are primarily for the use of the War Manpower Commission in guiding their policies, although it is possible that they will be circulated outside the Government to a limited extent.

Some of the findings in the report on the personnel situation in engineering may be of interest to you. We estimate that there are in the United States about 280,000 professional engineers of all kinds, of whom about 60,000 or roughly 20 per cent are electrical engineers. This must be taken as an estimate only because engineers, unlike physicians or surgeons for example, are extremely difficult to define. The best estimate of the number of trained radio engineers alone seems to be about 7000 to 8000.

According to a survey of engineering colleges made

by the Roster in November, 1942, there were 14,800 graduates of engineering schools during the academic year 1941-1942 of whom 2900 graduated in electrical engineering. It is interesting to note that the proportion of electrical engineers to total engineers in the entire population is nearly the same as the percentage of electrical engineering graduates to total engineering graduates for last year. This has been approximately true in most of the fields of engineering. There has, however, been a decided shift in enrollment away from civil engineering coexistent with a trend towards chemical engineering. This same survey reports that there were in November over 17,000 seniors majoring in engineering, of whom about 37 per cent were members of enlisted reserve corps or otherwise committed to the armed forces.

Personnel needs vary widely in different special fields of engineering. The demand is extremely acute in relation to supply in the broad fields of electrical and mechanical engineering. On the other hand, present indications are that as construction projects draw to a close a number of civil engineers may be released from that industry. However, these civil engineers are rapidly being absorbed in other fields such as the aircraft and shipbuilding industries.

A valid estimate of the actual number of engineers required during any future period is extremely hard to arrive at. In the first place, there is always the recurrent problem of just who is an engineer. For example, one branch of the armed forces last spring said that they expected to recruit during 1942 something over 12,000 radio engineers. This is a larger number than the most liberal estimate of the number of trained radio engineers known to be in the country. In the second place many of the estimates are optimum or padded figures given with the hope that when they are pared down the number finally allowed will be about the number actually needed. Then there is the third factor that many of the estimates on personnel requirements include a generous allowance for replacements or turnover. And finally, many employers are still estimating their requirements on the basis of normal use during a period when engineers were plentiful. The best estimate of the additional number of electrical engineers needed during the next year seems to be about three to four times the number that the colleges will graduate. Obviously, this creates a situation that will require considerable change in the prevailing idea of job requirements, for there is no good way in which trained electrical engineers can be produced in a short time.

There are some people who state that the armed forces do not place enough value on engineering training and cite cases in which engineers have been inducted into the Army and no use made of their engineering training whatsoever. However, figures I have seen on the previous civilian occupations of men inducted into the Army during the first part of 1942 show that the actual number of professional engineers who



have been inducted is extremely small, and that as a general rule the draft boards have used excellent judgment in deferring engineers. Some people believe, on the other hand, that the armed forces may have placed too high a value on engineering training by requiring this background for many jobs that could be performed without it.

It has been thought that accurate long-range forecasting is necessary to plan properly an educational program to train the number of engineers who will be required by industry and the armed forces. To be able to do this, however, we must needs foretell the course of the war and the emphasis which will be placed two or three years hence on various types of weapons. We must also be able to foresee any new scientific developments which might require large numbers of men trained in one specialized field. For example, had such an estimate been made in 1939 or 1940 we would, undoubtedly, have completely underestimated the number of radio engineers required because of lack of knowledge of the existence or requirements of the radar program. We believe that the forecast of professional labor needs cannot go much farther than six to twelve months in the future. However, it seems safe to

say, even without precise long-range data, that every mechanical or electrical engineer who can be graduated from colleges or universities can be used to good advantage and that there is absolutely no danger of training too many at the present time.

The main reason for the extremely large current demand for engineers is that they are in demand from two sides. On one side there is the steady demand by industry for production and research and on the other there is the large demand for operational purposes by the Army and the Navy. Either one of these demands without the other could be met without much trouble, but the two together have created an extremely tight situation. It will be necessary to evaluate the demands both of industry and the armed forces and to reach a working compromise as to the number of engineers required by each. It is notable that there is only one other professional field in which this double demand exists to the same extent. That is the field of medicine. Just as the doctors have had to double up and work longer hours so have the engineers. For today the professional engineer is needed as much in combat as in production. He has, indeed, a singular opportunity to serve his country.

## The Radio Engineer in the Navy\*

CARL F. HOLDEN,† NONMEMBER, I.R.E.

**Summary**—Radio is essential to the command control of Naval forces. The adaption of radio to Naval needs is a complex function of the practical seagoing military officer and the civilian technical masters of the art. Time is a vital factor in speed of communications as well as in design, production, and installation of equipment. The remarkable advances in standardization and simplification of components should be carried even further. More new methods in production are needed. The results will help shorten the war and reflect themselves favorably in postwar commercial activity.

### COMMUNICATIONS FOR THE NAVY

THE NAVY has become a tremendous organization which today includes thousands of ships, more than a million men, and forty or fifty thousand officers, together with hundreds of ports, bases, Navy Yards, Naval observers, and other establishments. These many elements are scattered not only all over the face of the globe, but many fly in the air, cruise on the surface of the ocean, and operate beneath the sea in submarines.

A Navy is large in numbers because it thereby can conquer its opponent through its superior strength. But to gather and place superior numbers and hence superior strength at the proper point at the proper moment of time, against a weaker force of the enemy, requires the use of communications. Without com-

munications to give him such control of his forces, a commander cannot take advantage of his strength which rests in numbers.

To provide communications satisfactory for the control of Military Power which must be so scattered and disposed as it is over wide areas, would be a staggering challenge to any communication organization, but it is additionally complicated by the fact that communications must be adapted and co-ordinated to serve joint operations in which the Army and the Navy function together as a single force.

Nor is this all—communications must be made further to serve the needs of combined operations of the armies, navies, and air forces of all of the United Nations. This constitutes a communication job of the very first magnitude.

### RADIO ESSENTIAL

Obviously, it would be quite impossible to provide the requisite communications without the use of radio. This powerful war tool is indispensable to the military man. He must thoughtfully devise ways to use the remarkable qualities and possibilities of radio and to avoid its equally remarkable inherent disadvantages. He must discover and obey the definite "safety precautions" attendant upon radio, if radio is to be employed profitably and with a minimum amount of injury to his own cause.

\* Decimal classification: R565. Original manuscript received by the Institute, March 31, 1943. Presented, Winter Conference, Washington, D. C., January 28, 1943.

† Captain, United States Navy, Navy Yard, Philadelphia, Pennsylvania.

### FITTING RADIO TO NAVAL USE

The *provision* of radio equipment for Naval ships, aircraft, and bases, and the adaption of the electronic art to Naval uses is almost completely a job for radio design, development, and production engineers.

The *adaption*, or *fitting*, of radio equipment to military use and the development of methods and procedures for its use, is a function which involves military officers.

Thus it is evident that full understanding between the military mind and the mind of the radio engineer is certainly required if the best possible control of military units and forces is to be had.

The co-operation (coworking) of the scientist and the engineer with the fighting man is an interesting problem because the normal fields of action of these individuals are so completely different. Their individual outlooks are quite different, and the factors which govern their professional work are different. The engineer is apt to strive for a perfection which will not warrant achievement in war because of the added time it requires. In peace, the engineer may be influenced by dollar cost which is a compelling regulation in his ordinary work. The military man may be influenced by conservatism. The latter in war recognizes the value of time and the need for haste in development and production. The military man has been educated to be of practical rather than of theoretical mind. He almost invariably needs a convincing demonstration of the practical worth of the equipment. The wedding of the interests and energies of the scientist or engineer and of the military man is of extreme importance.

### THE RADIO ENGINEER AND (INSTEAD OF IN) THE NAVY

In justice to the subject of Navy radio, I must ask your leave to enlarge the scope of my assigned subject a little so that it will include the radio engineer *and* the Navy. It thus includes both those *in* the Navy and those associated with the Navy.

A. During peace, the Naval Communication Reserve consisted of about 850 officers, a considerable number of whom were engineers. The greater part were practical radio amateurs. A considerable portion of them came to active duty before Pearl Harbor and now almost all of them are on active duty.

B. During the past 20 months the Bureau of Personnel has commissioned in the Reserve many radio engineers directly from civil life. These officers are on active duty at sea, in Naval districts, and in Washington.

C. Within the Navy itself there is a group of regular seagoing line officers who have received postgraduate instruction in radio engineering. Members of this group of more than a hundred, perform tours of regular line duty as well as tours in communications.

Engineering from these three groups in the Service in collaboration with radio engineers in civil callings face the challenging problem of adapting and fitting

radio to serve naval war purposes. Such co-operation is not a new matter, because there has been close and valuable association of civil agencies with Naval material agencies during peace.

In war a number of changed factors bear upon the problem of utilizing radio for military purposes. These are of intriguing interest and carry a peculiar challenge to the professional ability and cleverness of the engineer as well as to his realization of practical immediate difficulties at war.

The only limit to the field of application of radio to war is the engineer's own mind. Actually there are practical limits, defined by useful effectiveness and by the time and material which the device costs. The civilian engineer must place much dependence upon the man in the service with seagoing experience to know what the field requirements and practicable usefulness may be. A major problem now is to perfect liaison bonds between laboratories and the men who fight the war.

The engineer in war is governed by changed conditions:

He now finds himself more guided by necessity and available materials than by dollar cost.

No longer can equipment be developed to the last fine perfection of the scientist. It must be taken from the laboratory to be placed in production so that delivery and use in the field may occur at the most advantageous moment from a military point of view.

Equipment must be developed sooner and used before the enemy can counter it. Equipment must be quickly produced in quantity so that advantages of its possession can be realized on a wholesale scale before the enemy can vitiate the advantage or produce similar equipment himself and thereby enjoy the same benefits and thus restore the natural state of stalemate in war.

He must recognize the rapidity and magnitude of development of his field. Radio has grown to adolescence concurrently with aviation. It may be easier to realize the rapid rate of change of the art if a comparison is drawn to aviation progress. Mr. Churchill recently wrote in a letter to Mr. Cripps:

"Surveying the war at this moment, it seems to me that the production of aircraft and the development of radio technique lie at the very heart of our affairs."

The dollar value of orders already placed compared with the annual factory capacity of this country additionally attests the rapid growth and importance of radio.

The field of standardization could receive increased attention. But any action taken must be cleverly moderated and tempered to prevent slowing production. The valuable start already made on tubes and sockets should be continued, and include every possible part and even subassemblies. Hole spacing and physical shapes and sizes are important. During this war, there well may be the opportunity for standardization which might never be matched in peace.

Simpler equipment and simpler components will permit quicker manufacture and easier maintenance particularly with the inevitable and universal shortage of technicians in the field which we face.

After the billions of dollars of electronic equipment now on order is delivered and is placed in use, the need for ingenious "plug-in," or built-in test equipment will be apparent. Some simple scheme of fitting a test board onto a control panel with meters marked to show whether or not the apparatus is in good repair would be of great value because a relatively untrained man could immediately know when he needs the services of a specialist to make adjustments or repairs.

Lighter, smaller equipment is forever in demand.

Different materials may well be developed or adapted for use, especially those which are not difficult to procure.

Different, simpler, quicker ways of making parts and of their assembly will help out labor and time consumption.

More and more, necessity compels the production engineer to be at the elbow of the design and development man from the very genesis of new equipment to help keep the details easy to build, or to anticipate any new or difficult detail so production techniques can be worked out concurrently with the main design. It is felt that this field of co-operation will bear great promise to save time in getting equipment to the man who fights for us on land, or sea, or in the air. In this regard I must digress long enough to point out that in war there are three *bests* instead of one:

*First*, there is the scientific *best*, judged by an absolute scale. This achievement is the natural desire of the scientist and to a lesser degree perhaps of the practical engineer. It is a goal completely in the future, and never quite realized.

It is forever as unattainable as the Holy Grail.

War cannot wait and hope for this unattainable *best*.

*Second*, there is a practical perfection obtainable at the expense of considerable delay. Because time is such a vital factor in war engineering, and is even more critical and vital in the actual fighting of war this *best* can rarely be accepted.

War cannot wait for this attainable second *best*, because time simply will not wait for us.

*Third*, there is a *best* which can be had now, a *best* which is ready to go. Though this *best* may fall considerably short of the other *bests*, it is the practical choice forced upon the military commander. He knows it is better to have some imperfect device than to have none at all while awaiting a better one which may either come too late or never arrive at all.

War tends to be a stalemate because neither belligerent has over-all advantage of courage, physical strength, or intellectual ability. Each side learns from the tactics and material development of the other. It therefore becomes the job of the engineer in and out of the military service to perfect apparatus valuable to war ends *and to produce more of it quicker* than the enemy. Remember illiterate Bedford Forrests' universal rule for war—to get there "fustest with the mostest." The quicker and the more we can get, the sooner that advantage helps bring the end of the war. *This is the relation of the radio engineer in and out of the Navy to the Navy.*

Despite all the reasons why it can't be done, it may be that in radio fields the methods of Henry Kaiser to do the job in a novel, quicker way are needed to save time. Willow Run quantities of standardized components and perhaps radically changed assembly and construction methods may be possible now to save time. The benefit to the fighting man and the shortening of the war are justifying reasons for the effort and change. I think the commercial benefits will be even greater to the electronic industry eventually than those realized by the motor industry from the partial standardization achieved in the automotive field by the Society of Automotive Engineers.

The magnitude and seriousness of this war is probably not appreciated entirely by any of us, but all of us in radio *do know* the importance of radio and electronics in the war, and all of us can keep on bending our best ingenuity and effort to make radio serve the men who fight for us on land and sea and in the air.

### FITTING RADIO TO NAVAL USE

The *provision* of radio equipment for Naval ships, aircraft, and bases, and the adaption of the electronic art to Naval uses is almost completely a job for radio design, development, and production engineers.

The *adaption*, or *fitting*, of radio equipment to military use and the development of methods and procedures for its use, is a function which involves military officers.

Thus it is evident that full understanding between the military mind and the mind of the radio engineer is certainly required if the best possible control of military units and forces is to be had.

The co-operation (coworking) of the scientist and the engineer with the fighting man is an interesting problem because the normal fields of action of these individuals are so completely different. Their individual outlooks are quite different, and the factors which govern their professional work are different. The engineer is apt to strive for a perfection which will not warrant achievement in war because of the added time it requires. In peace, the engineer may be influenced by dollar cost which is a compelling regulation in his ordinary work. The military man may be influenced by conservatism. The latter in war recognizes the value of time and the need for haste in development and production. The military man has been educated to be of practical rather than of theoretical mind. He almost invariably needs a convincing demonstration of the practical worth of the equipment. The wedding of the interests and energies of the scientist or engineer and of the military man is of extreme importance.

### THE RADIO ENGINEER AND (INSTEAD OF IN) THE NAVY

In justice to the subject of Navy radio, I must ask your leave to enlarge the scope of my assigned subject a little so that it will include the radio engineer *and* the Navy. It thus includes both those *in* the Navy and those associated with the Navy.

A. During peace, the Naval Communication Reserve consisted of about 850 officers, a considerable number of whom were engineers. The greater part were practical radio amateurs. A considerable portion of them came to active duty before Pearl Harbor and now almost all of them are on active duty.

B. During the past 20 months the Bureau of Personnel has commissioned in the Reserve many radio engineers directly from civil life. These officers are on active duty at sea, in Naval districts, and in Washington.

C. Within the Navy itself there is a group of regular seagoing line officers who have received postgraduate instruction in radio engineering. Members of this group of more than a hundred, perform tours of regular line duty as well as tours in communications.

Engineering from these three groups in the Service in collaboration with radio engineers in civil callings face the challenging problem of adapting and fitting

radio to serve naval war purposes. Such co-operation is not a new matter, because there has been close and valuable association of civil agencies with Naval material agencies during peace.

In war a number of changed factors bear upon the problem of utilizing radio for military purposes. These are of intriguing interest and carry a peculiar challenge to the professional ability and cleverness of the engineer as well as to his realization of practical immediate difficulties at war.

The only limit to the field of application of radio to war is the engineer's own mind. Actually there are practical limits, defined by useful effectiveness and by the time and material which the device costs. The civilian engineer must place much dependence upon the man in the service with seagoing experience to know what the field requirements and practicable usefulness may be. A major problem now is to perfect liaison bonds between laboratories and the men who fight the war.

The engineer in war is governed by changed conditions:

He now finds himself more guided by necessity and available materials than by dollar cost.

No longer can equipment be developed to the last fine perfection of the scientist. It must be taken from the laboratory to be placed in production so that delivery and use in the field may occur at the most advantageous moment from a military point of view.

Equipment must be developed sooner and used before the enemy can counter it. Equipment must be quickly produced in quantity so that advantages of its possession can be realized on a wholesale scale before the enemy can vitiate the advantage or produce similar equipment himself and thereby enjoy the same benefits and thus restore the natural state of stalemate in war.

He must recognize the rapidity and magnitude of development of his field. Radio has grown to adolescence concurrently with aviation. It may be easier to realize the rapid rate of change of the art if a comparison is drawn to aviation progress. Mr. Churchill recently wrote in a letter to Mr. Cripps:

"Surveying the war at this moment, it seems to me that the production of aircraft and the development of radio technique lie at the very heart of our affairs."

The dollar value of orders already placed compared with the annual factory capacity of this country additionally attests the rapid growth and importance of radio.

The field of standardization could receive increased attention. But any action taken must be cleverly moderated and tempered to prevent slowing production. The valuable start already made on tubes and sockets should be continued, and include every possible part and even subassemblies. Hole spacing and physical shapes and sizes are important. During this war, there well may be the opportunity for standardization which might never be matched in peace.

Simpler equipment and simpler components will permit quicker manufacture and easier maintenance particularly with the inevitable and universal shortage of technicians in the field which we face.

After the billions of dollars of electronic equipment now on order is delivered and is placed in use, the need for ingenious "plug-in," or built-in test equipment will be apparent. Some simple scheme of fitting a test board onto a control panel with meters marked to show whether or not the apparatus is in good repair would be of great value because a relatively untrained man could immediately know when he needs the services of a specialist to make adjustments or repairs.

Lighter, smaller equipment is forever in demand.

Different materials may well be developed or adapted for use, especially those which are not difficult to procure.

Different, simpler, quicker ways of making parts and of their assembly will help out labor and time consumption.

More and more, necessity compels the production engineer to be at the elbow of the design and development man from the very genesis of new equipment to help keep the details easy to build, or to anticipate any new or difficult detail so production techniques can be worked out concurrently with the main design. It is felt that this field of co-operation will bear great promise to save time in getting equipment to the man who fights for us on land, or sea, or in the air. In this regard I must digress long enough to point out that in war there are three *bests* instead of one:

*First*, there is the scientific *best*, judged by an absolute scale. This achievement is the natural desire of the scientist and to a lesser degree perhaps of the practical engineer. It is a goal completely in the future, and never quite realized.

It is forever as unattainable as the Holy Grail.

War cannot wait and hope for this unattainable *best*.

*Second*, there is a practical perfection obtainable at the expense of considerable delay. Because time is such a vital factor in war engineering, and is even more critical and vital in the actual fighting of war this *best* can rarely be accepted.

War cannot wait for this attainable second *best*, because time simply will not wait for us.

*Third*, there is a *best* which can be had now, a *best* which is ready to go. Though this *best* may fall considerably short of the other *bests*, it is the practical choice forced upon the military commander. He knows it is better to have some imperfect device than to have none at all while awaiting a better one which may either come too late or never arrive at all.

War tends to be a stalemate because neither belligerent has over-all advantage of courage, physical strength, or intellectual ability. Each side learns from the tactics and material development of the other. It therefore becomes the job of the engineer in and out of the military service to perfect apparatus valuable to war ends *and to produce more of it quicker* than the enemy. Remember illiterate Bedford Forrests' universal rule for war—to get there "fustest with the mostest." The quicker and the more we can get, the sooner that advantage helps bring the end of the war. *This is the relation of the radio engineer in and out of the Navy to the Navy.*

Despite all the reasons why it can't be done, it may be that in radio fields the methods of Henry Kaiser to do the job in a novel, quicker way are needed to save time. Willow Run quantities of standardized components and perhaps radically changed assembly and construction methods may be possible now to save time. The benefit to the fighting man and the shortening of the war are justifying reasons for the effort and change. I think the commercial benefits will be even greater to the electronic industry eventually than those realized by the motor industry from the partial standardization achieved in the automotive field by the Society of Automotive Engineers.

The magnitude and seriousness of this war is probably not appreciated entirely by any of us, but all of us in radio *do know* the importance of radio and electronics in the war, and all of us can keep on bending our best ingenuity and effort to make radio serve the men who fight for us on land and sea and in the air.

# THE INSTITUTE OF RADIO ENGINEERS

INCORPORATED



## SECTION MEETINGS

|                                    |                                |                                  |                                 |
|------------------------------------|--------------------------------|----------------------------------|---------------------------------|
| <b>ATLANTA</b><br>September 17     | <b>CHICAGO</b><br>September 17 | <b>CLEVELAND</b><br>September 23 | <b>DETROIT</b><br>September 17  |
| <b>LOS ANGELES</b><br>September 21 | <b>NEW YORK</b><br>October 6   | <b>PHILADELPHIA</b><br>October 7 | <b>PITTSBURGH</b><br>October 11 |
|                                    |                                |                                  | <b>WASHINGTON</b><br>October 11 |

## SECTIONS

- ATLANTA**—Chairman, C. F. Daugherty; Secretary, Ivan Miles, 554—14 St., N. W., Atlanta, Ga.
- BALTIMORE**—Chairman, G. J. Gross; Secretary, A. D. Williams, Bendix Radio Corp., E. Joppa Rd., Towson, Md.
- BOSTON**—Chairman, R. F. Field; Secretary, Corwin Crosby, 16 Chauncy St., Cambridge, Mass.
- BUENOS AIRES**—Chairman, J. P. Arnaud; Secretary, Alexander Nadosy, Florida St. 1065, Dept. C-16, Buenos Aires, Argentina.
- BUFFALO-NIAGARA**—Chairman, Leroy Fiedler; Secretary, H. G. Korts, 432 Potomac Ave., Buffalo, N. Y.
- CHICAGO**—Chairman, A. B. Bronwell; Secretary, W. O. Swinyard, Hazeltine Electronics Corp., 325 W. Huron St., Chicago, Ill.
- CINCINNATI**—Chairman, Howard Lepple; Secretary, J. L. Hollis, 6511 Betts Ave., North College Hill, Cincinnati, Ohio.
- CLEVELAND**—Chairman, F. C. Everett; Secretary, Hugh B. Okeson, 4362 W. 58 St., Cleveland, 9, Ohio.
- CONNECTICUT VALLEY**—Chairman, W. M. Smith; Secretary, R. E. Moe, Radio Dept., General Electric Co., Bridgeport, Conn.
- DALLAS-FORT WORTH**—Chairman, H. E. Applegate; Secretary, P. C. Barnes, WFAA-WBAP, Grapevine, Texas.
- DETROIT**—Chairman, F. M. Hartz; Secretary, E. J. Hughes, 14209 Prevost, Detroit, Mich.
- EMPORIUM**—Chairman, R. K. Gessford; Secretary, H. D. Johnson, Sylvania Electric Products, Inc., Emporium, Pa.
- INDIANAPOLIS**—Chairman, S. E. Benson; Secretary, B. H. Rinehart, 1920 Park Ave., Indianapolis, Ind.
- KANSAS CITY**—Chairman, B. R. Gaines; Secretary, R. N. White, 4800 Jefferson St., Kansas City, Mo.
- LOS ANGELES**—Chairman, Lester Bowman; Secretary, R. C. Moody, 4319 Bellingham Ave., North Hollywood, Calif.
- MONTREAL**—Chairman, L. T. Bird; Secretary, J. C. R. Punched, Northern Electric Co., 1261 Shearer St., Montreal, Que., Canada.
- NEW YORK**—Chairman, H. M. Lewis; Secretary, H. F. Dart, 33 Burnett St., Glen Ridge, N. J.
- PHILADELPHIA**—Chairman, W. P. West; Secretary, H. J. Schrader, Bldg. 8, Fl. 10, RCA Manufacturing Co., Camden, N. J.
- PITTSBURGH**—Chairman, D. A. Myer; Secretary, A. P. Sunnergren, West Penn Power Co., Rm 1304, West Penn. Bldg., Pittsburgh, Pa.
- PORTLAND**—Chairman, K. G. Clark; Secretary, E. D. Scott, Rt. 14, Box 414, Portland, Ore.
- ROCHESTER**—Chairman, O. L. Angevine, Jr.; Secretary, G. R. Town, Stromberg-Carlson Tel. Mfg. Co., Rochester, N. Y.
- ST. LOUIS**—Chairman, N. J. Zehr; Secretary, H. D. Seielstad, 1017 S. Berry Rd., Oakland, St. Louis, Mo.
- SAN FRANCISCO**—Chairman, Karl Spangenberg; Secretary, David Packard, Hewlett-Packard Co., Palto Alto, Calif.
- SEATTLE**—Chairman, L. B. Cochran; Secretary, H. E. Renfro, 4311 Thackeray Pl., Seattle, Wash.
- TORONTO**—Chairman, T. S. Farley; Secretary, J. T. Pfeiffer, Erie Resistor of Canada, Ltd., Terminal Warehouse Bldg., Toronto, Ont., Canada.
- TWIN CITIES**—Chairman, E. S. Heiser; Secretary, B. R. Hilker, KSTP, St. Paul Hotel, St. Paul, Minn.
- WASHINGTON**—Chairman, C. M. Hunt; Secretary, H. A. Burroughs, Rm. 7207, Federal Communications Commission, Washington, D. C.

# Institute News and Radio Notes

## Postwar Television

Television with its electronic eyes made sensitive to ordinary light will emerge from the war strongly qualified to become a vast postwar industry giving employment to many people in various fields associated with the new art, Ralph R. Beal, research director of RCA Laboratories and Associate member of The Institute of Radio Engineers since 1915, said in discussing "Radio-Electronic Research" before the Institute of Finance at the New York Stock Exchange. He said that the spectrum of tiny wavelengths, measured in centimeters, is being opened by the development of new radio tubes bringing possibilities to radio greater in scope than all of its past.

Predicting unparalleled progress in other fields as well as in radio, he added that the potentialities stimulate the imagination of research scientists to visions of new and unexpected horizons in the fields of physics, chemistry, metallurgy, biology and in many industries.

Commenting on the post-war prospects of television, Mr. Beal continued:

"We now have electronic television. As an added service in broadcasting it has potentialities which surpass those of other mass communications services of information, education, and entertainment. With postwar television broadcast stations connected into networks, events of the nation will pass in review on the picture screens of home television receivers. Larger and brighter pictures of greatly improved quality will be realized and research and development plus genius in design and production will bring the television receiver set within the range of the average pocketbook.

"Postwar television will use electronic camera tubes which will be greatly improved in sensitivity. This will make it possible to pick up scenes with ordinary amounts of illumination. Night events, theater performances, opera and many other programs which utilize artificial lighting will come well within the range of camera-tube sensitivity. The problems of heat and glare in television studios have been solved.

"And then we have theater television with possibilities as a postwar service. For the first time in the centuries of theater history a means is available for bringing to theater audiences the thrills and drama of events as they occur in real life. Electronic methods have made it possible to produce pictures of theater-screen size. RCA Laboratories demonstrated a picture about twenty feet wide shortly before the outbreak of the war."

Envisaging automatic radio-relay stations as the key to network television, he told how the television pictures would be flashed from city to city to home audiences. At the same time he depicted interconnecting circuits carrying television pictures of events directly from the scene of action to theaters in different cities.

"Research and electronics in the field of television make ready a new industry and service to meet a pressing need for postwar employment," he continued. "Television will provide permanent new employment for an unusually wide range of arts, trades, and professions. It has no aspects of imminent technological unemployment. On the contrary, the quantities of equipment and services and of new facilities needed, will be such as to require a number of years to complete the initial expansion."

Continuing his preview of radio-electronics, Mr. Beal reported on the latest developments of the electron microscope, as well as the field of radiothermics, the application of radio-frequency heating to industrial processes.

The obituary notice of John Stone Stone on page 463 of this issue of the PROCEEDINGS was prepared by Lloyd Espenschied, Fellow of the I.R.E. The scientific and personal eminence of John Stone Stone, the high office he held in the Institute, and the historical significance of his pioneer work in the radio and electrical communication fields alike serve as warrant, were that needed, for the inclusion in the PROCEEDINGS of a tribute from Dr. Lee de Forest entitled: "May 20, 1943" and an historical presentation: "The Career of John Stone Stone" by George H. Clark. These contributions follow.

*The Editor*

MAY 20, 1943

In the lamentable death to-day of John Stone Stone, the radio engineering profession has lost one of the few who remained of the original pioneers of wireless. And none of those early researchers into the great new realm revealed by the immortal experiments of Hertz can begin to compare with Stone in clear-sighted mathematical analyses of the basic principles on which the science of radio is founded. He was the first of us all to reduce to concise analytical terms the fundamentals of synchronism, mapping precisely the laws of resonant, tuned circuits, then but dimly understood. Even today no exposition of these laws of circuit resonance have been so clearly set forth as in the early patents of John Stone Stone. His theoretical analyses therein contained are classics for their insight and clarity of exposition. John Stone invariably prepared his own patent papers and I know of none in any art whose language is so precise, yet so elegant in expression. To read them is a delight, for they may well be classed as literature, difficult to the layman, but of the highest order.

Stone was graduated with high honors from Johns Hopkins, a classmate and lifelong friend of Dr. Louis Duncan and John J. Carty. Long prior to his labors in wireless he had distinguished himself as an outstanding telephone engineer, possessing imagination and courage, one of the few who never permitted mathematical skill to atrophy his native ingenuity. In those preradio years he had developed the theory of "wired wireless"—or carrier currents, anticipating in this the work of Pupin and long antedating that of General George Owen Squire. When Marconi's early experiments were first heralded, Stone turned his keen and highly ingenious mind to the fascinating problems of wireless communication, embarking upon a career of theoretical yet practical research, marked today by no less than 100 patents in the new art.

Those analyzing the laws of "four tuned circuits" (transmitter and receiver) anticipated, in my opinion, the inventions of Professor Braun in Germany and Marconi in England. On these laws the entire structure of selective wireless communication, whether with spark, arc, or tube, depend.

Throughout his career Stone's keen interest in wireless and radio never flagged until his death. While mathematics constituted his tools and stock in trade (he was never a "laboratory man"), his direct, straightforward methods of analysis so clearly illumined the subjects he discussed, that his results were as convincing as they were unassailable. He made theory clear and fascinating to the layman. He was a past master in applications of the Fourier theorem and made it amazingly useful throughout his work.

One of Stone's earliest patents covers broadly the basic principles of direction finding and wave projection. In this special field his brain was transcendently brilliant. In later years, following the advent of short-wave transmission, the new science and technique of directive antenna arrays owes its origin and completeness largely to the genius of John Stone Stone. His many patents in this branch are truly basic and show amazing ingenuity and widest knowledge.

The Stone Wireless Telegraph and Telephone Company founded at the beginning of the century was a pioneer in the development of American wireless telegraphy. Some distinguished radio engineers are indeed proud to have been disciples of John Stone Stone.

The Society of Wireless Telegraph Engineers, first of its kind, was founded in 1904 by Stone, who, eight years later, became a cofounder of its thriving successor—The Institute of Radio Engineers.

Although modest to a fault and all too little known to the public, his influence upon the expanding science of radio has been ever profound. After his hundred wireless patents had been acquired by my company in 1915, Stone returned to the telephone fold, and thereafter until his retirement, at the age of 65, assigned all

further communication patents to the Telephone Company.

I shall never forget that Stone was the first radio engineer to recognize the epochal qualities of the grid audion tube. As early as 1907 he was extending to me needed encouragement in its development, at a time when few indeed foresaw the possibilities lying latent in that Promethean device.

It was Stone to whom, in 1912, I described the newly demonstrated audion amplifier of telephone currents, and who, sensing the limitless value of this relay in long-distance telephony, forthwith aroused the interest of chief engineer John J. Carty in this device, and arranged for its demonstration in October of that year, before the engineers of the Bell Laboratories.

There began the development of the radio amplifier tube to the demands of worldwide telephonic communication. It was Stone's unerring, unassailable testimony, factual and expert, which helped me win many a bitterly fought patent-interference suit.

As he grew older, his ingenuity never wearied, never grew stale. Whenever I visited him in San Diego, where his ailing heart had forced him to live quietly, almost as a recluse, for the past twenty years, he would eagerly describe novel ideas and new inventions, on which he was then preparing patent papers.

His mind was ever sparkling and effervescent, a quiet humor ever pervading; ready and keen for a joke, he laughed easily and loved a good story; a somewhat Rabelian spirit—a friend of rarest worth, such as are too seldom known on earth, such as I shall never find again.

#### ADDENDUM:

By the irony of fate Stone's death occurred less than one month before the Supreme Court of the United States, in a historic decision handed down June 21, 1943, announced the invalidity of the once famed "four-tuned circuits" patent of Marconi.

In coming to its decision, the Court lays especial emphasis on the early work of Stone and Tesla, particularly the Stone patent No. 714,756, applied for nine months prior to Marconi's and allowed February 2, 1902, a year and a half before the grant of Marconi's patent. This, the Court said, "showed a four-circuit wireless telegraph apparatus substantially like that later specified and patented by Marconi. It described adjustable tuning . . . of the closed circuits of both transmitter and receiver, with antenna circuits so constructed as to be resonant to the same frequencies as the closed circuits."

"Stone's application shows an intimate understanding of the mathematical and physical principles underlying radio communication"—"Stone discusses in some detail the difference between 'natural' and 'forced' oscillations."

The Court here goes into great detail in analysis of the Stone patent, finding that Stone, at this early date, had a perfectly clear comprehension of the basic principle of tuned, resonance circuits, and how to apply these to prevent interference between several wireless "circuits." It points out

also Stone's emphasis on "loose coupling," the first in the art so to do. Quoting freely from the Stone patent, the Court adds: "These statements sufficiently indicate Stone's broad purpose of providing a high degree of tuning at sending and receiving stations," and "Stone's full appreciation of the value of making all of his circuits resonant to the same frequency . . ." "Stone showed tuning of the antenna circuits before Marconi, and if this involved invention, Stone was the first inventor."

In view of the Court's sweeping decisions, concurred in by all but two Judges, it is indeed to be regretted that John Stone could not have lived to witness this long-belated official recognition of his well-merited claim to have preceded Marconi in this all-important invention, so vital to radio communications.

Incidentally, in the same Opinion, but in another suit, the Supreme Court finds the Fleming Valve patent to have been invalid long before the first infringement suit was filed under same, in 1915. The disclaimer of obviously too broad claims then filed did not in any wise restore that patent's validity.

LEE DE FOREST

### THE CAREER OF JOHN STONE STONE

John Stone Stone, fourth president of The Institute of Radio Engineers, was born at Dover, Virginia, on September 24, 1869. He was the son of General Charles Pomeroy Stone and Jeannie Stone. His father, on leaving West Point, served under General Scott in Mexico, and was twice brevetted "for gallant and meritorious conduct"; thus he gained his captaincy before arriving at the age of twenty-three. He also served through the Civil War, during which, on a campaign in the Mississippi Valley, he met Miss Stone, a Southern girl. It was from this duplication of names that John Stone Stone was so baptized.

In March, 1870, General Stone became Chief of the General Staff of the Khedive of Egypt, having been designated for this position by General Sherman, who was then General in Chief of the United States Army and whom the Khedive of Egypt had consulted as to the appointment. John Stone Stone took advantage of the opportunity to travel extensively not only through Egypt but also through many of the countries bordering on the Mediterranean Sea. Thus he became as fluent in French and Arabic as he was in English.

His education in America was obtained at the Columbia Grammar School, New York City, two years at the Columbia School of Mines, and two years at Johns Hopkins University, from which he was graduated in 1890.

From 1890 to 1899 he was with the research and development laboratory of the American Bell Telephone Company at Boston, Massachusetts, where his exceptional ability in mathematical analysis came into full play. Among the devices brought out by him in this work was the Stone common-battery system for telephony, the use of uniformly spaced inductance coils for loading telephone wires,

and the carrier-current system of transmission over wires. Because of his special study of electrical oscillations and radiation at Johns Hopkins, and his further study of the work of Professor Elihu Thompson, Nikola Tesla, and others along the line of electromagnetic-wave theory and practice, he was asked by H. V. Hayes, chief engineer of the company, to investigate the possibility of transmitting speech telephonically by Hertzian waves without the use of wire conductors, and made a masterly report on this work. He also filed patents covering his work on carrier current, or "wired wireless," as it was termed later. This led to an interference in the Patent Office between Stone, Pupin, and Hutin and Le Blanc, the latter being well-known electrical engineers of Paris, France. The Pupin interference lasted eight years.

During this work, Stone passed from ordinary telephone investigations into a more and more comprehensive investigation of electrical resonance, and later into the field of radio-frequency phenomena. In January or February, 1899, he left the Telephone Company and set up offices of his own in Boston, being retained as advisory expert by the American Bell Company in connection with patent litigation.

Stone did not have "wireless" particularly in mind when he set himself up as consultant, but events forced his hand, for his first client was Herman W. Ladd. His client had a method of direction finding based on a cylindrical metal screen around a vertical receiving antenna, the screen having an up-and-down slit through which electric waves were supposed to strike the antenna as the screen was rotated. Stone had two stations set up to test this device, and while working on it became so interested in the general subject of wireless telegraphy that before long he had taken it up as his major effort.

He was also led in this direction by his former work on carrier-current engineering, wherein he became more and more certain that the wireless-telegraphic art in general needed certain drastic improvements, chief of which was the requirement of sharper tuning. This, and his practical work with Ladd's apparatus, finally brought him to the wireless-telegraph fold, and in the late spring or early summer of 1899 he conceived a system of selective wireless communication, in the development of which he led the world for a time.

In those days, all existent spark transmitters were closely coupled, and hence were broadly tuned, even to the extent of emitting two "humps" or energy peaks. At the transmitter, Stone eliminated this crude practice by the use of loose coupling at the sending end, bringing about the emission of a single, sharply defined transmitted wave. The use of loading coils as "swamping inductances" was also a feature of his system. At the receiving end, his receivers likewise embodied very loose coupling, and also featured an intermediate circuit known as the "weeding-out circuit," which greatly enhanced the selectivity of the device. Great pains were taken to reduce the losses in the receiver, as by the use of coils wound with square cross



section and by the introduction of a home-made form of litzendraht made by twisting together strands of enamel-coated wire.

The company formed by Stone to translate these ideas into apparatus was first known as the Stone Wireless Telegraph Syndicate, formed early in 1901, which was followed soon after by the Stone Telegraph and Telephone Company. Headquarters of the company was in Boston, with an experimental transmitting station near Riverbank Court, Cambridge, where Harvard University now has an experimental station, and a receiving station in Lynn, Massachusetts.

Speaking further of the reduction of losses in the various parts of the Stone apparatus, the transmitting condensers were first of air dielectric, but when space requirements for larger sets made this undesirable, condensers with glass dielectric and with beeswax and rosin binding were later substituted. One of the essential features of these sets was an efficient form of protective device, to prevent radio-frequency energy from backing up into the power apparatus; this was in the form of air-spaced coils, wound so as to have a minimum of distributed capacitance by the use of wood or hard-rubber holding parts. This was a "series" type of protector as opposed to the "shunt" type provided by the later mica-condenser forms, but it worked equally as well as any of its successors.

Stone's methods revolutionized spark telegraphy in the United States, particularly in Government stations. Soon his ideas as to the emission of a single wave, and his requirements as to selectivity, were made a part of specifications for Government-purchased wireless equipment, and almost all of the older sets in service, particularly in the United States Navy, were changed over to loose-coupled types. Sets were purchased from the Stone Company for a number of shore stations, as at the Navy Yards of Boston, Massachusetts; Portsmouth, New Hampshire; Philadelphia, Pennsylvania; as well as for a number of warships. Until the advent of the quenched gap, which proved to be the nemesis of the Stone system, this latter was the leading system in the United States from the standpoint of betterment of the art.

In addition to the design and manufacture of apparatus, Stone directed many researches which were landmarks in the development of wireless. Before a single piece of work was done commercially, he and his chief research engineer, Ernest R. Cram, calculated the inductance, turn by turn, of air-spaced coils with a minimum of distributed capacitance caused by the necessary structural holding parts, and likewise the capacitance of sliding-plate condensers. These, used later as wave-meters for Stone's experimental work, were compared after many years with Bureau of Standards official apparatus and were found to be correct within two per cent.

One of the most advanced research problems of the company was carried on in 1905 by Stone and his engineers, to determine the effective reactance of vertical antennas of different heights over a wide range of wavelengths. (Stone, it may be

mentioned, did not subscribe to the use of "meters" as a measure of radiated waves, but used instead the term " $p$ ," which was  $2\pi n$ .) This work was far ahead of its time, and is only today coming into recognition. The results were published in the *Electrical Review* for October 15, 1904, in the *Transactions of the St. Louis International Electrical Congress, 1904*, page 555, and in the report of the Canadian Society of Civil Engineers, Montreal, for 1905.

Another early investigation of the Stone Company was in the field of marine direction finding. The system used was in the form of two vertical antennas, suspended respectively from the foremast and mainmast of a ship, their horizontal leads connecting to separately tuned primary circuits which in turn coupled to a common secondary. If the two primaries were wound so as to oppose each other, null signals would be obtained when the vessel was turned so that the plane of the verticals was at right angles to the line between the ship and the sending station, and maximum signals when they were in this line. Tests by the United States Navy gave results correct within less than a point. However, the system was not adopted, chiefly because the limitation of reception in those days made the device workable over only about fifty miles, thus causing it not to be of especial use in naval maneuvering. Also, the requirement of turning the ship was a great handicap in the minds of naval officials. It remained for F. A. Kolster, who assisted in these tests, to bring a workable system of direction finding to the United States Navy about nine years later.

Mr. Stone was a special lecturer on electrical oscillations for the Massachusetts Institute of Technology from 1896 to 1906. The writer was the first student to attend these lectures and later enter into wireless work—incidentally with the Stone company.

After the collapse of the company in 1910, as a result of the impossibility of successfully financing such a concern in those days through the sale of apparatus only, Mr. Stone again took up his work as consulting engineer, in New York, but in 1920 he was compelled for reasons of health to take up residence in San Diego, California, and from that time until his death on May 20, 1943, he resided there as associate engineer at large, department of research, American Telephone and Telegraph Company.

Mr. Stone was directly a major cause of the formation of The Institute of Radio Engineers. During the days of the Stone Company, he saw the need of a technical society for the field of wireless communication, similar to those of other engineering branches, and so in 1905 he formed the Society of Wireless Telegraph Engineers. Membership at first consisted of Stone employees, but later engineers of the National Electric Signalling Company, and others such as Dr. Lee deForest and Mr. Fritz Lowenstein, joined. In 1912 the total membership was forty three.

A similar society had been formed in New York, principally among operators of the United Wireless Telegraph Company. Robert H. Marriott, one of the pioneers of

wireless, was sponsor and head of this movement. This was known as the Wireless Institute. Collapse of both the Stone Company and the United Wireless Telegraph Company caused both company-sponsored organizations to become "orphans"; and therefore Mr. Stone in 1912 initiated steps to have both groups join to form the present world-wide association known as The Institute of Radio Engineers, the merger date being May 13, 1912.

Mr. Stone was a director of the I.R.E. in 1912 and from 1914 to 1919, vice president in 1914, and president in 1915. He had been president of the Society of Wireless Telegraph Engineers from 1906 to 1909. He was organizer and vice chairman of the Radio Engineers Committee on National Defense in World War I, delegate to the International Electrical Congress in 1904 and to the second Pan American Scientific Congress in 1917, member of the Franklin Institute, the American Electro-Chemical Society, the American Institute of Electrical Engineers, the American Defense Society, and the Academy of Political Science, and a Fellow of the American Academy of Arts and Sciences and of The Institute of Radio Engineers.

He was awarded the Edward Longstreth Medal of the Franklin Institute in 1913 for a paper on "The Practical Aspects of the Propagation of High-Frequency Waves along Wires," in 1913, and the Medal of Honor of The Institute of Radio Engineers, "for distinguished service in radio communication," awarded in 1923.

Technical papers written by Mr. Stone were presented by him before the Society of Wireless Telegraph Engineers, in 1908, 1909, and 1910; the Wireless Institute, in 1909; and The Institute of Radio Engineers, in 1914 and 1915. References to his paper on antenna reactance have been already given. He was also a contributor of numerous papers on electrical subjects to the scientific and engineering press.

During his life he had obtained about one hundred and twenty patents on telephonic and radio subjects, in the United States, as well as a similar number in foreign countries.

GEORGE H. CLARK

Stone Telegraph and Telephone Company,  
1902-1909

June 3, 1943

#### LOYD A. BRIGGS

Lloyd A. Briggs, general superintendent, of R.C.A. Communications, Inc., has been elected vice president and general superintendent at a meeting of the company's Board of Directors, David Sarnoff, president of RCAC, announced.

Mr. Briggs, former European communications manager of RCAC in London, is a veteran of the international radio communications field. Starting in 1916 as a telegrapher for the Chicago and North-Western Railway, he served during World War I as a radioman in the transatlantic communications service of the United States Navy. He joined the Marconi Wireless Telegraph Company of America a few

weeks before it was acquired by the Radio Corporation of America in 1919.

With RCA ever since, Mr. Briggs has served as supervisor, technician, traffic engineer, manager of the RCA Frequency Bureau, and as European communications manager, holding the latter post from 1934 to 1938. He has been attached to RCAC'S central office at 66 Broad Street, New York, since 1938, first as assistant to the vice president and general manager and more recently as general superintendent.

As the representative of RCA and RCAC, Mr. Briggs attended all of the major international conferences and technical committee meetings on radio and telegraphy from 1929 to 1938. He has been a Member of the Institute of Radio Engineers since 1929.

## Some Problems in Which the Army Is Interested

The National Inventors Council has secured the consent of the Army to the release of a list of some of the problems in which the Army is interested. A practical and effective solution of any of them will be a real contribution to the war effort. Actual war experience has shown the need of various devices or methods not practically available, and has also shown the need or the desirability of substitutes or alternatives for devices and methods which are already in our possession.

While information of the needs of the Army has only been given to agencies officially authorized to receive and use it, such a list has not heretofore been released since it might give information of what we possess or do not possess. The present list is not of this character and is being released to appropriate professional societies and research organizations in order that it may be passed along to their membership. It is here published by permission. Additional lists may be released in the future.

Suggestions on any of these problems should be submitted to the National Inventors Council, Room 1313, Commerce Building, Washington, D. C., and should comprise a clear description of the proposal with such sketches or drawings as may be necessary. The following list includes only matters which appear to be within the radio-and-electronic field, broadly interpreted.

1. Suitable substitute for rubber for insulating wire; should be flexible and durable.
2. Detectors of enemy personnel who may be approaching (unseen) on jungle trails or fences or similar barriers.
3. Sonic or supersonic means or methods of signaling in the field.
4. Improved means or methods of signaling the identification of ground troops to friendly airplanes and vice versa.
5. Better air cleaners for use on tank engines and the like; more effective than present cleaners and requiring less maintenance.
6. Storage battery not adversely af-

ected by very low temperatures.

7. The detector and method of locating nonmetallic land mines.
8. Equipment or methods for removing land mines rapidly from mine fields without injury to equipment or personnel.
9. Methods of rustproofing ferrous metals, which are more durable than present methods, such as bonderizing, etc.
10. Absorbents for carbon monoxide or catalysts or other means for oxidation of this gas to render it noninjurious to personnel.
11. Means of defeating darkness to permit vision at night without aid of visible reflected light. *Note:* probably involves an apparatus to translate infrared rays to visible light.
12. Means of long-distance communication outside the present scope of radio and not restricted by line-of-sight projection.
13. Searchlights which may afford ready means for spreading the beam from narrow high intensity to 15 degrees of greatest intensity practicable.
14. A simple non-toxic process for darkening aluminum and other metals; to make them nonreflectant to light.
15. Methods of sabotage by friendly inhabitants within occupied areas.

## Books

### Dynamical Analogies, by Harry F. Olson

Published (1943) by D. Van Nostrand Co., Inc., 250 Fourth Ave., New York, N. Y. 190 pages + 6-page index + XI pages. 59 illustrations. 5 $\frac{1}{2}$  × 8 $\frac{1}{2}$  inches. Price, \$2.75.

The announced objective of this book is "the establishment of analogies between electrical, mechanical, and acoustical systems, so that anyone familiar with electrical circuits will be able to analyze the action of vibrating systems." The case method is relied upon and the reader's transference of knowledge from one field to another is assisted through copious examples, both real and artificial, drawn from the domains of mechanical and electrical systems. After an introductory section, involving definitions and examples of the mechanical and electrical-circuit components, the exposition is subdivided according to the classifications of electrical-network theory. Following examples drawn to illustrate systems of 1, 2, and 3 degrees of freedom, there are chapters on corrective networks, wave filters, network theorems, generating and receiving systems, transients, and miscellaneous applications. This horizontal method of subdivision of the broad basic subject provides a convenient gradation of complexity, so that the reader is led almost painlessly from simple systems in which the analogy is obvious to more complex situations in which mechanical ingenuity is taxed in order to find equivalents for such common electrical circuits as the band-pass filter.

The author has continued the excellent

practice begun in his "Elements of Acoustical Engineering" of making the illustrations self-contained, so that electrical, mechanical, and acoustical circuit configurations, together with their performance curves, are shown together. The formulas, which are usually presented without derivation, and the notation are designed to facilitate quantitative calculation in any of the systems with equal confidence. There is perhaps too little acknowledgment of the engineer's usual difficulty with the conversion of units—a defect which might have been remedied by the inclusion of more numerical examples.

In a volume such as this, devoted entirely to the subject of dynamical analogies one might expect to find a critical survey of the various different analogies which have been proposed in the past. All of these analogies rest upon the similarity of the differential equations which appear in the analysis of the electrical or the mechanical problems. Since these equations may be written in many forms, a variety of analogies can be drawn. Some of these, such as the mobility method proposed by Firestone for the solution of vibrational problems, have particular virtues in dealing with particular classes of mechanisms. This phase of the subject is summarily disposed of in a footnote on page 3, and the remainder of the volume is devoted exclusively to the analogy which identifies electromotive force with mechanical force or acoustic pressure, and which links electric current with linear velocity or volume velocity. The fact that these correspondences have been standardized in the definitions of acoustical and mechanical impedance does not entirely absolve the author from justifying their unique acceptability as dynamical analogies.

Since there is almost nothing in the literature on the subject, special attention may be called to the chapter on transient response, in which Heaviside's operational calculus is applied through the electrical analogy to mechanical systems. Since it has been said that a hammer is the best tool for producing the unit function experimentally, it is perhaps especially appropriate to apply Heaviside's method to mechanical problems. Although this chapter will provide heavy going for those who meet the operational calculus for the first time here, it may equally well stimulate methods of approach for those who may have to deal with impact problems in mechanical systems.

In most college curricula the subject of dynamic analogy arises in connection with courses in acoustical engineering or vibration engineering. This book is more likely to find its place as collateral reading than as a textbook for such courses. By and large, the electrical and communication engineer who has some regard for his reference library should have it. Sooner or later he will meet a mechanical and acoustical problem, and he will find in this volume a wide variety of examples to assist him in transforming the new and unfamiliar problem into the kind of electrical circuits he knows how to handle.

F. V. HUNT  
Underwater Sound Laboratory  
Harvard University  
Cambridge, Massachusetts

# Contributors



TORRENCE H. CHAMBERS

Torrence H. Chambers (S'40-A'42) was born at Ardmore, Pennsylvania, on June 11, 1919. He received the B.S. degree from Haverford College in 1941, graduating with honors and having majored in both physics and electrical engineering. From June to December, 1941, he was with the Columbia Broadcasting System doing research work on color television. In December, 1941, he entered the Naval Research Laboratory as a radar research engineer. Mr. Chambers is a member of the American Radio Relay League, the Army Ordnance Association, and a Student member of the Franklin Institute.



Roy C. Corderman was born near Hagerstown, Maryland, on July 17, 1898. For three years he studied electrical engineering at the Carnegie Institute of Technology.

From May 22, 1918, to February 6, 1919, Mr. Corderman was a member of the United States Naval Reserve and completed his courses at the United States Naval Radio School, Harvard University.

He was the first radio broadcast operator to be employed by KDKA in 1921.



ROY C. CORDERMAN

From 1925 to 1941, he was with the American Telephone and Telegraph Company. From December, 1941, to June, 1942, he was with the Coordinator of Inter-American Affairs. Since June, 1942, Mr. Corderman has been in the Office of War Information where he is assistant chief, Bureau of Communication Facilities, Overseas Operations Branch.

He was an inventor in both telephone and radio fields prior to the war and has contributed several inventions since the start of the war.

Radio has been his hobby since 1911 and his most recent station, W3ZD, was active until December 7, 1941.

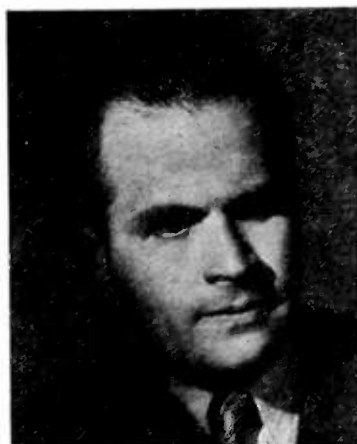

PETER C. GOLDMARK

Peter C. Goldmark (A'36-M'38-F'42) was born on December 2, 1906, at Budapest, Hungary. He received the B.Sc. degree in 1930 from the University of Vienna and the Ph.D. degree in physics in 1931. Dr. Goldmark was in charge of the Television Department of Pye Radio, Ltd., Cambridge, England, from 1931 to 1933; consulting engineer in New York City, 1933 to 1935. Since 1935 he has been chief television engineer at the Columbia Broadcasting System.

Early in 1942 Dr. Goldmark became associated with Harvard University when he was appointed to the senior staff of Radio Research Laboratory of the Office of Scientific Research and Development at Cambridge, Massachusetts.



Carl F. Holden, a native of Bangor, Maine, was appointed to the Naval Academy from that state in 1913 and was graduated during World War I on March 28, 1917. He saw war service on destroyers operating out of Queenstown, Ireland. Shortly after 1922 he took a postgraduate course in communication engineering at the Naval Academy and at Harvard University, from which University he received a masters degree in electric communication engineering in 1924.

From 1924 to 1934, except for two years in command of a destroyer during 1932-



CARL F. HOLDEN

1934, his activities were devoted largely to communication work afloat, and as a communication and radio member of the United States Naval Mission to Brazil.

He was stationed in Hawaii, T.H., during the next two years serving as the District Communication Officer of the 14th Naval District. This was followed by sea duty from 1936 to 1938, and after this tour he served for two years in the Office of Naval Operations in Naval Communications in Washington.

Captain Holden was Executive Officer of the Flagship *Pennsylvania* in Pearl Harbor during the attack of December 7, 1941. He came to Washington again in January, 1942, as Fleet Communication Officer on the Staff of the Commander-in-Chief of the United States Fleet, which assignment continued until his appointment as Director of Naval Communications on September 15, 1942. On April 4, 1943, he assumed his present duties as Commanding Officer of the U.S.S. *New Jersey*.



John M. Hollywood (J'30-A'32) was born at Red Bank, New Jersey, on February 4, 1910. He received the B.S. degree in



JOHN M. HOLLYWOOD



THOMAS KIRK MILES

communications in 1931 and the M.S. degree in electrical engineering in 1932 from Massachusetts Institute of Technology. From 1933 to 1935 Mr. Hollywood was with the Electron Research Laboratories; from 1935 to 1936 with the Ken-Rad Tube Corporation engaged in cathode-ray-tube development; and from 1936 to the present time, with the Columbia Broadcasting System working on television development.



Thomas Kirk Miles was born in Iowa City, Iowa, on February 17, 1910. He received his bachelor's degree in engineering from Stanford University in 1932 and his master's degree from Massachusetts Institute of Technology in 1933.

He worked for the Hawaiian Dredging Company for one year as an assistant superintendent on the construction of a breakwater and then worked for the Tennessee Valley Authority for four years on the construction of a number of their earth dams. In 1939 Mr. Miles joined the Shell Development Company as a research engineer engaged primarily in research on the engineering applications of asphalt. He obtained a leave of absence from Shell Development Company in July, 1942, to become Senior Liaison Representative for the National Roster where he has been work-



W. H. PICKERING

ing primarily on problems dealing with the personnel situation in the field of engineering.



William H. Pickering (A'41) was born in New Zealand on December 24, 1910. He received the Ph.D. degree from the California Institute of Technology in 1936, and since then has been on its staff and is now assistant professor of electrical engineering. His research work has been chiefly in the field of cosmic radiation. Recently he has been working with R. A. Millikan and H. V. Neher in making a high-altitude survey of cosmic-ray intensities at various latitudes. Mr. Pickering is a member of the American Institute of Electrical Engineers, Physical Society, and Sigma Xi.



E. R. PIORE

E. R. Piore (A'38-M'42) received the B.A. in physics in 1930 and the Ph.D. degree in physics in 1935 from the University of Wisconsin. He was assistant instructor in physics at the same University from 1930 to 1935, and from 1935 to 1938 he was a research physicist at the electronic research laboratories of the RCA Manufacturing Company, Inc. From 1938 to 1942 Dr. Piore was a member of the Columbia Broadcasting System television engineering department as engineer-in-charge of the television laboratories. Since April, 1942, he has been in the radio division, Bureau of Ships, Navy Department. He is a member of the American Physical Society and Sigma Xi.



James J. Reeves (A'40), was born at Sao Paulo, Brazil, on February 1, 1911, and was educated in East Stroudsburg, Pennsylvania.

From 1926 to 1930 he served in the United States Navy as a radio operator, and from 1930 to 1934 in the United States Coast Guard as a radio operator and instructor. In 1932 he was graduated from the U. S. Navy Radio Engineering School at Anacostia Station, D. C.

From 1934 to 1939 he was active in radio and television work joining the television engineering department of the



JAMES J. REEVES

Columbia Broadcasting System in 1939. He participated in several phases of the early television field tests and was assigned to research in the television laboratories soon thereafter.

Mr. Reeves is now taking an active part in the war work in which the laboratories are now engaged.



Browder J. Thompson (A '29-M '32-F '38) received the B.S. degree in electrical engineering from the University of Washington (Seattle) in 1925. He entered the research laboratory of the General Electric Company in 1926, working on vacuum-tube research and development problems. In 1931 Mr. Thompson transferred to the RCA Radiotron Company in Harrison, New Jersey, in charge of the electrical research section of the research and development laboratory. In 1940 he was appointed associate director of the research laboratories of the RCA Manufacturing Company, Inc. Since 1942 he has been associate director of general research, RCA Laboratories, Princeton, New Jersey. He is a Fellow of the American Physical Society.



For biographical sketches of E. W. Herold and L. Malter, see the PROCEEDINGS for August, 1943.



BROWDER J. THOMPSON

FOR ACCURATE MEASUREMENT  
OF POWER AND IMPEDANCE

*Specify...*

## DAVEN OUTPUT POWER METERS

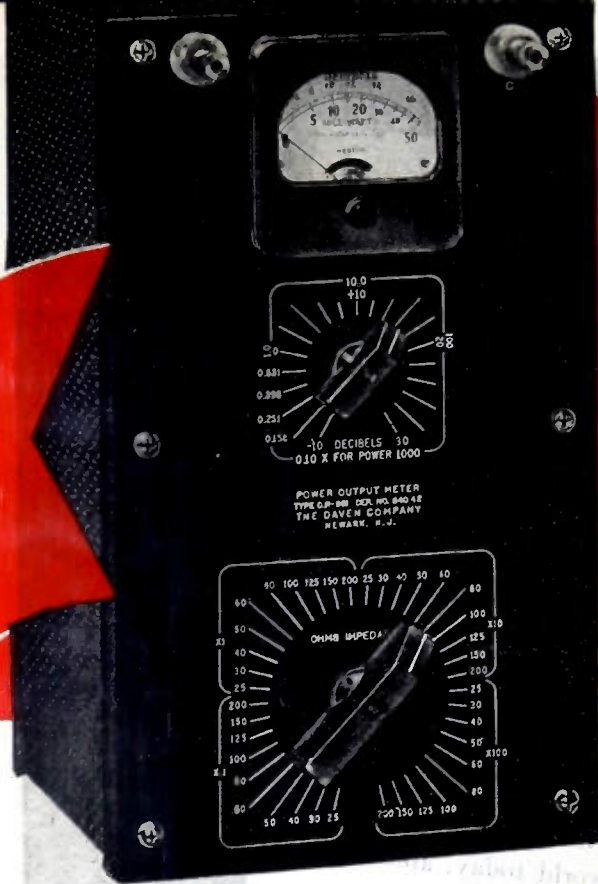

**OP-961:** A rugged, handy Output Meter for accurate measurements of audio signal systems having a maximum power output up to 50 watts.

Reliable readings of power at impedances from 2.5 to 20,000 ohms are guaranteed by a meter multiplier network of constant impedance, in combination with a carefully designed impedance changing network that remains essentially resistive throughout virtually the entire audio range.

Power ranges cover from 0.1 mw. to 50 watts in steps of 0.1 mw. indicating meter is calibrated from 0 to 50 mw., and from 0 to 17 db., with a 1 mw. zero level. A 20 step multiplier extends the meter power reading from 0.1x to 1,000x scale value, and the db. reading in steps of 2 db., from -10 to +30 db., with full scale at 47 db. Accurate within 2% at midscale.

**OP-182:** Convenient meter reading is provided in this compact, space-saving OP-182 Output Power Meter. It is admirably suited for many power and impedance measurements, such as determining actual power delivered by an audio system to a given load, characteristic impedance or load variation effect on an A.C. source.

Terminal impedance remains essentially resistive over the audio frequency range of 30 to 10,000 cps. Impedances from 2.5 to 20,000 ohms in 40 convenient steps are available.

The indicating meter is calibrated from 0 to 50 mw., and from 0 to 17 db. Zero level at 1 mw. Four ranges of full scale readings from 5 mw. to 5 watts, and from -10 to +37 db. are provided by the meter multiplier. Accuracy within 5% at midscale.

The DAVEN Company has long been a dependable source of supply for engineers seeking precise equipment for laboratory and production tests. Experience has taught these men that the DAVEN laboratory produces instruments whose degree of accuracy and reliability have successfully and consistently met every rigid requirement.



**THE DAVEN COMPANY**  
191 CENTRAL AVENUE  
NEWARK 4, NEW JERSEY

# Norelco

**Creates new aids to Victory  
—and to American industry**

**B**ACK of the Norelco name and trademark is a deep heritage of technical research in the electrical field, and a reputation for electronics development which has earned the respect of engineers the world over.

Today, Norelco products are dedicated exclusively to Victory. This is the biggest job in the world today, and one to which all our efforts and resources are directed.

Tomorrow, Norelco products will make today's aids to Victory profitably available to the peacetime pursuits of American industry. Tomorrow, Norelco precision and craftsmanship will help American industry achieve new standards of perfection wherever electronic devices are used.

Be sure you share in these new developments by asking us to put your name on the Norelco mailing list today. Your inquiries and problems will be welcomed by Norelco engineers.

Products for Victory include: Cathode Ray Tubes; Amplifier Tubes; Rectifier Tubes; Transmitting Tubes; Oscillator Plates; Tungsten and Molybdenum in powder, rod, wire and sheet form; Tungsten Alloys; Fine Wire of all drawable metals: bare, plated and enameled; Diamond Dies, Searchray (X-Ray) Apparatus for industrial and research applications; X-Ray Diffraction Apparatus; Electronic Temperature Indicators; Direct Reading Frequency Meters.

**Norelco ELECTRONIC PRODUCTS  
NORTH AMERICAN PHILIPS COMPANY, INC.**

*Main factory and offices in Dobbs Ferry, N. Y.; other factories at Lewiston, Maine (Elmet Division); Mount Vernon, N. Y. (Philips Metalix Corp.) Industrial Electronics Division, 419 Fourth Avenue, New York 16, N. Y.*

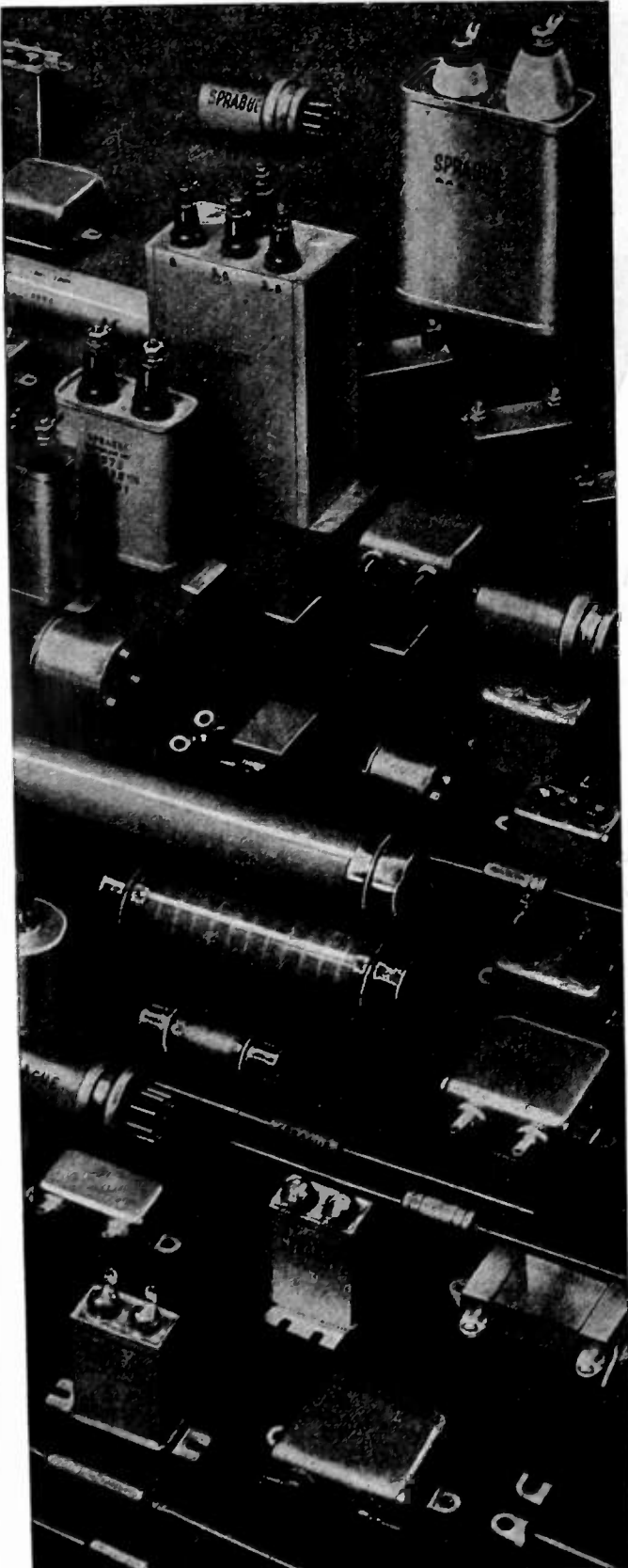

**“Plus ça change  
plus c’est la  
même chose”\***

**\*(THE MORE IT CHANGES,  
THE MORE IT IS THE  
SAME THING)**

Over 95% of Sprague capacitors being produced today are different from those of pre-war days—and a lot of hard, painstaking and fast work has gone into making the necessary changes to meet wartime conditions. The primary insulation, the basic dielectric, the fundamental processes—these did not spring full fledged over night, but are “the long result of time.” These processes produced good condensers before the war, are producing good condensers now to meet war specifications—and will produce good post-war condensers. Specifications change, the condensers change to meet them, but always Sprague condensers are good condensers. ‘Plus ça change—’”

**SPRAGUE SPECIALTIES COMPANY, NORTH ADAMS, MASS.**



### **NOTE TO SUPPLIERS**

Just as we do our best to make Sprague a good place from which to buy, so do we aim to make it a good place to which to sell. We are always open to suggestions, new ideas, and all the other helps that suppliers are often so well equipped to give. Although we buy carefully—just as we manufacture carefully—we aim to back this buying with the same courtesy, consideration, and loyalty we ourselves like to receive.

# **SPRAGUE**

**CAPACITORS KOOLOHM  
RESISTORS**

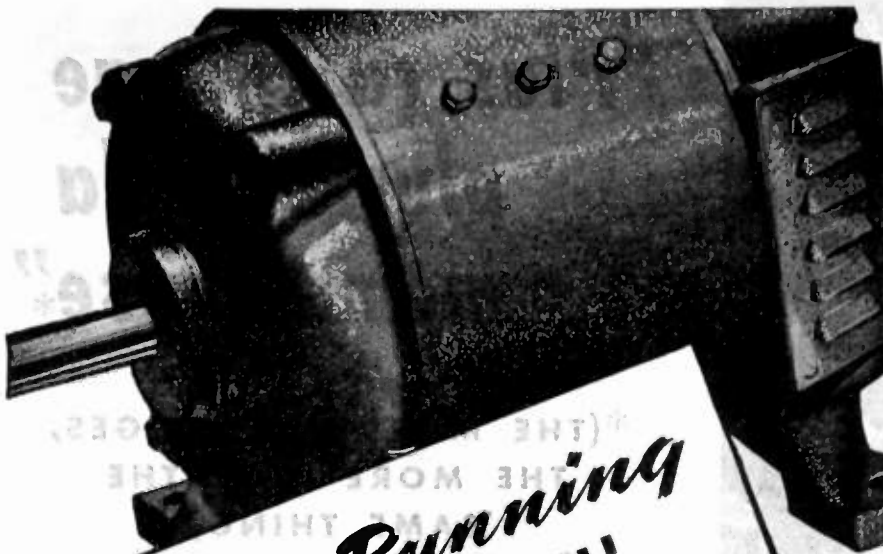

# Keep 'Em Running FOR THE DURATION!

It is difficult to secure new Generating Sets or new Rotary Converters . . . Pioneer is devoting all of its resources toward winning the war . . . but we can, and will, help you keep your present equipment running for the duration. Send your service problems, by letter, to Pioneer's Customer Service Department.

DYNAMOTORS · CONVERTERS · GENERATORS · DC MOTORS · POWER PLANTS  
GEN-E-MOTORS

## PINCOR Products

PIONEER GEN-E-MOTOR  
CHICAGO, ILLINOIS · EXPORT ADDRESS: 25 WARREN STREET, NEW YORK CITY  
CABLE ADDRESS: SIMONTRICE, NEW YORK CITY

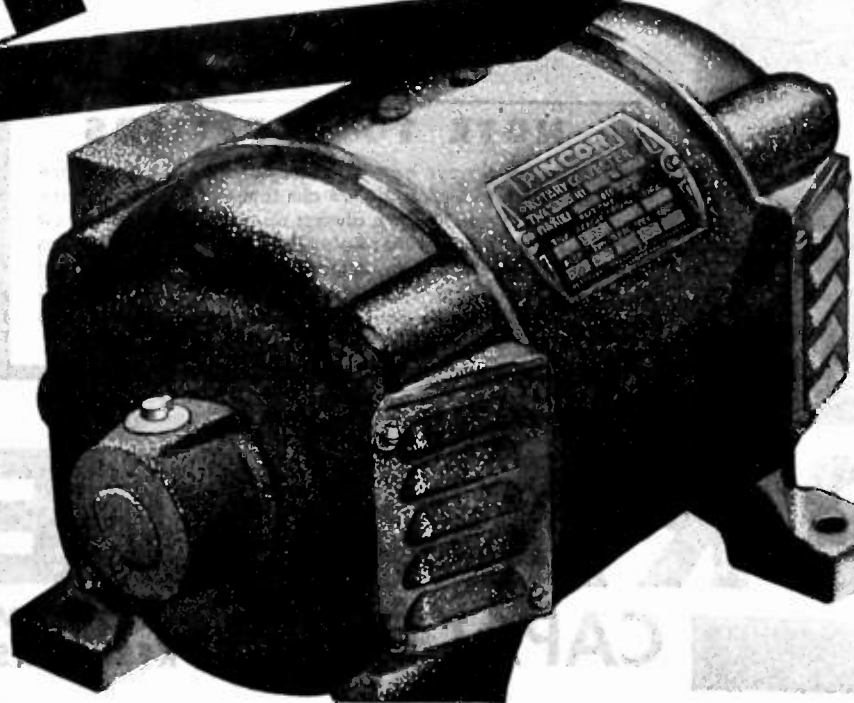

### POSITIONS OPEN

The following positions of interest to I.R.E. members have been reported as open. Apply in writing, addressing reply to company mentioned or to Box No. . . . .

The Institute reserves the right to refuse any announcement without giving a reason for the refusal.

PROCEEDINGS of the I.R.E.  
330 West 42nd Street, New York 18, N.Y.

#### RADIO ENGINEERS

Transcontinental & Western Air, Inc. has openings at Kansas City for three Radio Engineers in the Communications Department. Applicants should have completed an electrical or radio engineering course, or should have had one to two years of practical experience. These openings are permanent.

For additional details and application forms, write to Personnel Department, Transcontinental & Western Air, Inc., Kansas City, Missouri.

#### PATENT ATTORNEY

Patent attorney to join small Patent Department and electrical or radio engineering graduates who have maintained contact with the field of high-frequency electronics, radio manufacture, carrier-current telephony, and light-current circuit design and computing, can make a substantial contribution in research or development jobs with one of the National Defense Research Committee laboratories located in the East. The project is secret but is one of the most urgent of all research jobs now under way for the Government.

An electrical engineering background in light currents is essential, and amateur radio experience, inventive ability and ingenuity in the design and layout of radio equipment would be of considerable help.

Facilities for specialized refresher training and orientation in the particular field may be available. Anyone who possesses these qualifications and is interested in a vital wartime development job for the duration may get further details on request. All inquiries will be held confidential. Address Box 299.

#### AUDIO ENGINEER OR EXPERIMENTAL PHYSICIST

Work: Design of microphones, earphones, vacuum-tube hearing aids, general audio-development work. Essential war work and manufacturing on peacetime products.

Experience Preferred: Some electroacoustical design and manufacturing with enough general audio experience to be useful when there are no acoustical problems on hand. College degree. Over five years experience along these lines.

Would also consider a man with moderately broad audio-frequency design and experimental experience, good technical education, and good practical common sense. Over three years of good experience along these lines.

Location: Minneapolis, Minnesota.  
Salary: Depends entirely on qualifications.  
Interview: Will pay traveling expense of qualified applicants. Address letter of application to Box 300.

#### PATENT ATTORNEYS

Patent attorneys, who are electronic physicists of mid-western concern engaged in development and production of electronic and allied equipment. Experience in electronics, acoustics or sound-recording field highly desirable. Salary open. Candidate must be citizen with proof of same. Write Personnel Director, The Brush Development Company, 3311 Perkins Avenue, Cleveland, Ohio.

(Continued on page 38A)



# CRYSTALS

*Quickly*

Your temperature coefficient and absolute frequency specifications for crystals will be met quickly, in small or large quantities, by our Special Crystal Division. Such service—with speed and without red tape—is of definite assistance to those industries engaged in special war work.

Just reach out and  
PHONE PLYMOUTH (Indiana) 33

**JOHN MECK INDUSTRIES**  
**PLYMOUTH, INDIANA**



# DEPENDABLE



Accuracy and dependability  
are built into every Bliley  
Crystal Unit. Specify BLILEY  
for assured performance.

**BLILEY ELECTRIC COMPANY**  
ERIE, PENNSYLVANIA

**BLILEY ELECTRIC COMPANY · · · ERIE, PA.**

# Bliley Crystals

## POSITIONS OPEN

(Continued from page 36A)

### ELECTRONIC ENGINEER

Electronic engineer with M.A., Ph.D., or the equivalent in physics, for research and design in geophysics. Experience in filter design and sound recording is desirable. Write to Independent Exploration Company, 901 Esperson Building, Houston, Texas.

### ENGINEER

AAA-1 eastern manufacturer, over 75 years operation and leader in growing industry, has immediate permanent position for chemical, electrical, electronic or chemical-metallurgical engineer to organize and increase efficiency of production activities. Send full details of experience to Box 301.

### RADIO OR ELECTRICAL ENGINEER

Capacitor manufacturer located in New Bedford, Mass., wants an electrical or radio engineer—man or woman—for equipment- and circuit-development work.

Permanent postwar future for right person. This firm has excellent laboratory facilities and is a leader in its field.

Applicant should be college graduate with a degree—or equivalent experience—in radio engineering or electrical engineering.

Interview in Boston, New Bedford or New York can be arranged. Traveling expenses paid to place of interview.

Write fully, giving age, education, experience, etc. Address reply to Box 302.

### RADIO ENGINEERS

Well-established international corporation, 100% in war work with definite postwar possibilities, needs several radio engineers who are familiar with the construction or use of automatic-receiving equipment. Also two transmitter engineers familiar with 40 k.w. equipment.

Applicants should have college degree or approximately ten years experience in radio. Openings in Chicago and New York. Salaries from \$100.00 a week dependent upon experience and ability.

In reply please give complete details of experience, age, education, present and former employers, present earnings and your telephone number. Enclose recent photo if available. Address reply to Box 303.

### RADIO ENGINEERS

Qualifications should consist of a Class A "ham" license, good electrical background, and knowledge of building your own transmitter, receiver and test equipment.

Positions available in laboratory, testing and design work with a mid-west manufacturer engaged 100 per cent in production of war equipment. "Ham's Paradise" with annual salary ranging from \$3000 to \$5000.

Applicants, not now employed at highest skill and able to obtain release, are requested to send full data including draft status, salary required, and a small photo (which will not be returned). Address Box 295.

### ENGINEER

Electrical or electrochemical engineer, thoroughly versed in the theory of liquid and solid dielectrics, to direct a research and development program in the development and application of dielectrics to capacitors. This is an unusual opportunity for a capable engineer interested in his present and post-war future. Write to Industrial Condenser Corporation, 1725 W. North Avenue, Chicago, Ill.

### ENGINEERING RESEARCH DIRECTOR

A leading manufacturer of small compact electrical parts, widely used in communication equipment and industry in general, seeks engineer to direct its research activities leading to development of new products.

Qualifications must include thorough knowledge of fundamental physical sciences, ability to do and direct research work, resourcefulness, originality, and a sufficiently practical slant to conserve time and energy.

Interesting work. Remuneration depending on the individual. Location in eastern Pennsylvania.

In reply, state complete qualifications which will be kept confidential. Those engaged in war work cannot be considered. Address Box 296.

(Continued on page 42A)



**MEASURING STRESS  
AT 60 M.P.H.**

## **CALLS FOR IRC RESISTORS**

A locomotive driving-rod packs plenty of power as it hurtles its heavy load over the rails. To detect and accurately measure stress changes in driving rods, under actual running conditions, presented an exciting challenge to engineering ingenuity. Heretofore such data was approximated through polaroid means or empirical formulas, based on scale models.

### **ANOTHER IRC DEVELOPMENT**

Research on the intricate device finally evolved, indicated the need for a very thin resistance ele-

ment of uniform characteristics . . . sensitive enough to accept every stress modification yet sufficiently stable so that readings made from time to time would be comparable. I R C engineers solved the problem by a unique application of I R C's exclusive Metallized coating to a non-conductive plastic strip.

*If you are confronted with a question involving resistances, why not consult I R C, the company that makes resistors of more types, in more shapes, for more uses than any other manufacturer in the world?*



**INTERNATIONAL RESISTANCE COMPANY**  
401 N. BROAD STREET • PHILADELPHIA

★ *In a Hurry . . .*

# REMLER Plugs and Connectors

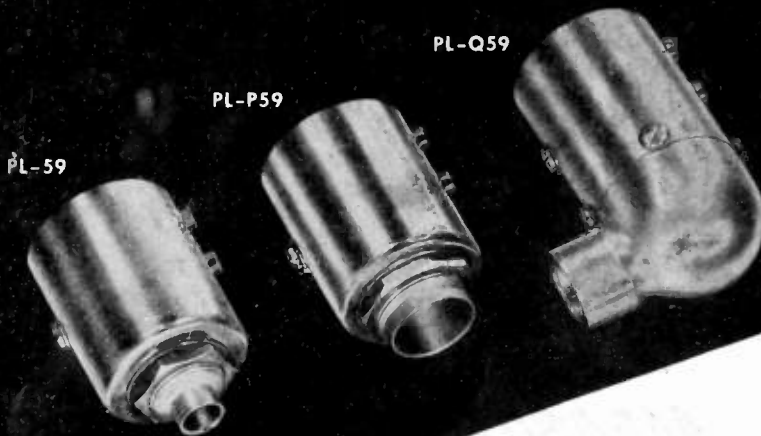

**Made to  
ARMY SIGNAL  
CORPS SPECIFICATIONS**

Remler made plugs and connectors of the following types are used by more than fifty concerns engaged in manufacturing communications equipment for the U. S. Army Signal Corps:

| Types:             | PL     | PLP    | PLQ    | PLS |
|--------------------|--------|--------|--------|-----|
| 50-A 61 74 114 150 | 56 65  | 56 65  | 56 64  |     |
| 54 62 76 119 159   | 59 67  | 59 67  | 59 65  |     |
| 55 63 77 120 160   | 60 74  | 60 74  | 60 74  |     |
| 56 64 104 124 354  | 61 76  | 61 76  | 61 76  |     |
| 58 65 108 125      | 62 77  | 62 77  | 62 77  |     |
| 59 67 109 127      | 63 104 | 63 104 | 63 104 |     |
| 60 68 112 149      | 64     | 64     |        |     |

### Special Designs to Order

Remler is equipped to manufacture other plugs and connectors of special design—in large quantities. Submit specifications.

### Prompt Delivery • Inspection

Signal Corps inspectors in attendance. Uniformity assured—no rejects. Write, wire or telephone if we can be of assistance.

**Remler facilities and production techniques frequently permit quotations at lower prices**

*Manufacturers of Communication Equipment  
SINCE 1918*

**REMLER COMPANY, Ltd. • 2101 Bryant St., • San Francisco, Calif.**

## CAN YOU FILL ONE OF THESE MOST IMPORTANT WAR JOBS?

If you have a college education (not necessarily a graduate) and know theory and practice, you are urgently needed by a non-profit, non-commercial organization assigned to vital war research.

- Electronic Engineers
- Radio Engineers
- Electrical Engineers
- Physicists
- Mechanical Engineers
- Electrical Designers
- Electronic Designers
- Acoustical Specialists
- Communication Engineers
- Geophysicists
- Seismograph Technicians

*If you are in one of the above categories and your highest skill is not being utilized to help save lives and materials, to help shorten the war, please write! ACT NOW!*

Salaries range from \$3,000 to \$8,000, depending upon experience, ability, education and past earnings. In addition, we will pay all expenses of transportation, moving, etc., for you and your family. You must be free to travel. Living quarters will be made available. If granted an interview, we will compensate you for all expenses incurred in coming to New London. Don't wait! Write, stating background and experience to . . .

**PERSONNEL DEPT.**  
P. O. BOX 271, NEW LONDON, CONN.

## ENGINEER RADIO TRANSFORMER

Wanted by one of the largest manufacturers of radio and communication equipment in the world now engaged in 100% war work making vitally needed equipment for our fighting forces.

We can use a capable, experienced man to great advantage in contributing to the advancement of electronics in war and in peace to come, covering the field of aircraft instrument landing, direction finders, shipboard communication equipment, industrial U. N. F. Selenium rectifiers, transformers, etc.

Remuneration depends upon ability and experience. Consider the post-war permanency and the importance of the work today and then make application to join this progressive organization.

Apply personally or write to

**FEDERAL  
TELEPHONE & RADIO CORP.,**  
591 BROAD ST., NEWARK, N.J.

The manufacturing unit of the  
International Telephone &  
Telegraph Co.

Those in war or essential industry not considered without statement of availability.

# STUPAKOFF

FOUNDED IN 1897

*Ceramics for the World of Electronics*

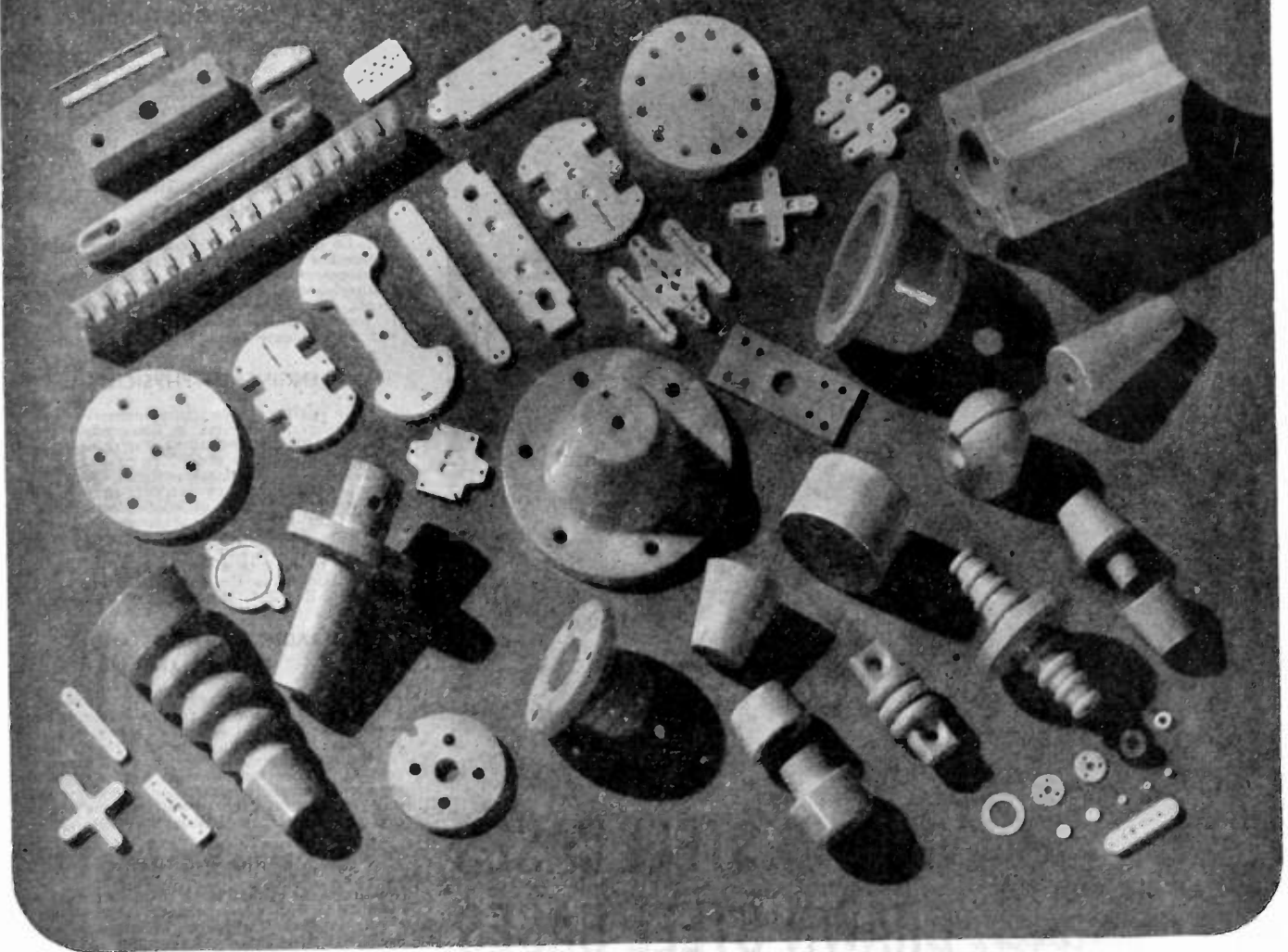

## Insulators for Ultra High Frequencies

FOR years we have been closely associated with the rapidly progressing electronic industry and during this time have produced insulators for practically every type of electronic device.

Our knowledge . . . years of experience . . . engineering and manufacturing facilities permit us to meet your most exacting specifications. Every day we produce millions of precision made insulators for the electronic industry.

*For the duration 100 per cent of our attention—  
all personnel and equipment—is being  
used to hasten Victory.*



★ INVEST TODAY IN ★  
BONDS FOR VICTORY

**STUPAKOFF CERAMIC AND MANUFACTURING CO., LATROBE, PA.**



(Continued from page 38A)

#### ELECTROACOUSTIC ENGINEERS

One experienced in laboratory development and research activities. New position open in the development of war-production items. Situation includes excellent opportunities for post-war employment. Salary open. Write Personnel Manager, Universal Microphone Co., Box 299, Inglewood, California.

#### ELECTRICAL ENGINEERS— PHYSICISTS

Radio or ultra-high frequency experience desirable but not essential. Interesting radio tube development work. Good location, Lancaster, Pennsylvania. Address replies to Personnel Dept., RCA, Victor Division, Harrison, N.J. If you are using your full skill, full time on war work, please do not apply.

#### ENGINEERS—PHYSICISTS

Radio engineers, electronic engineers, electrical engineers, physicists. A non-profit research laboratory engaged in urgent war research must increase its scientific staff. Men or women (college graduates) with experience in vacuum tube circuit design, construction of aircraft radio equipment and design of small electromechanical devices are needed. Salaries range from \$3,000 to \$8,000 depending upon experience, ability, education and past earnings. Apply by mail to Airborne Instruments Laboratory, Columbia University Division of War Research, Box 231, Mineola, N.Y.

#### RADIO ENGINEERS AND TECHNICIANS

A progressive company with a sound background in radio and electronics needs, at once, several men with training and experience in any phase of the radio industry. The work open is vital to the war effort but offers a promising post-war future for the right men. College degree or equivalent experience necessary. Men now engaged at highest skill on war production should not apply. Write Box 294.

#### RADIO ENGINEER

Wanted for general work covering design and installation with major communication company chiefly in New York area. Technical graduate preferred. Must have car. Position not limited to duration. Address Box 298.

#### RADIO ENGINEERS AND TECHNICIANS

In critical war industry. Opportunity for several competent men in research and production engineering on Government contracts. Work is with a company well known in the radio industry, located in a Michigan city. Send full particulars of your experience and photo. Address Box 284.

#### RADIO ENGINEER

Experienced in the manufacture and testing of ultra-high-frequency apparatus; must be capable of taking complete charge of war projects. Splendid opportunity. War workers at highest skill need not apply. Inquiries will be kept confidential. Please state age, experience, and salary expected. Write Box 288.

#### RADIO INSTRUCTION-BOOK WRITERS

Thorough knowledge of radio principles and ability to describe in simple terms the operation of UHF circuits required. Work relates to instruction books for electrical apparatus. Excellent opportunity to do essential work in very essential war industry. Salary depends upon qualifications and experience.

Replies solicited from Engineers, Patent Attorneys, Teachers and others qualified. Write complete qualifications and salary desired to Hazeltine Electronics Corporation, 1775 Broadway, New York 19, N.Y.

(Continued on page 48A)

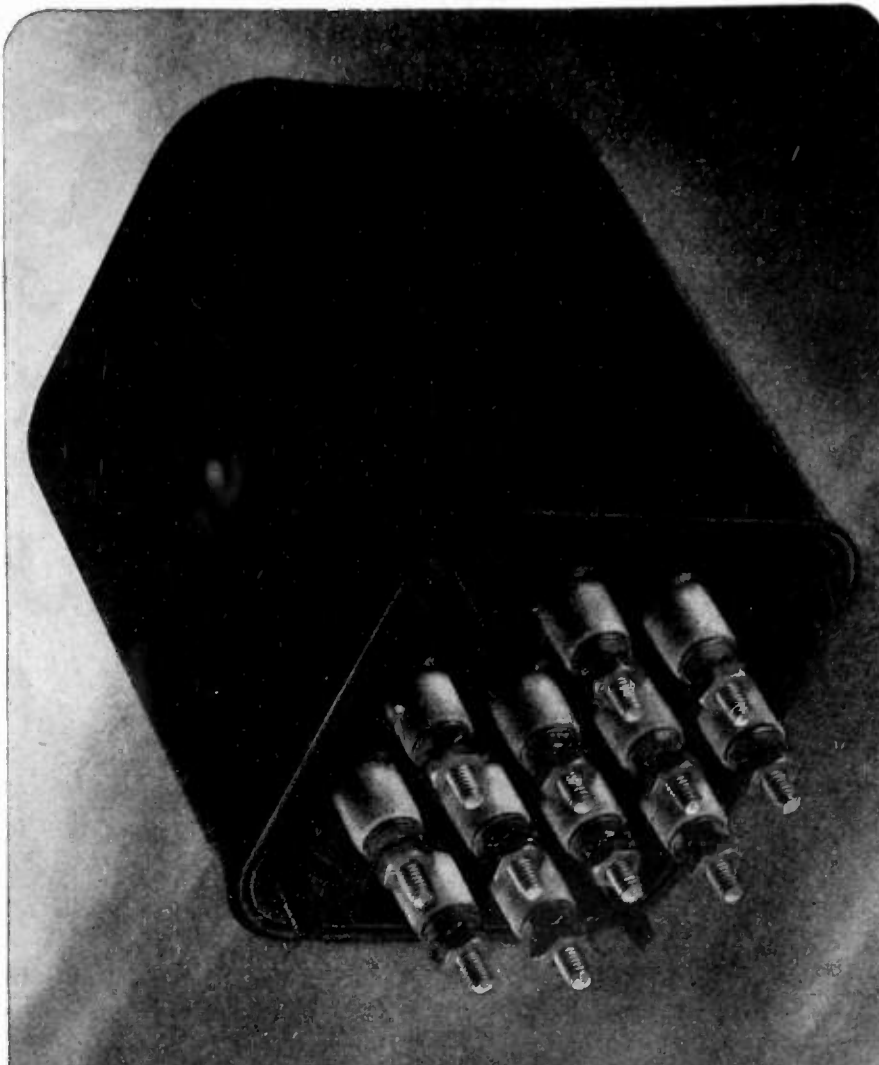

## Use DRAWN STEEL CASES with DRAWN STEEL BASES For Better Sealing and Shielding

A recently developed type of base for drawn steel case transformers has greatly improved sealing and shielding.

The new drawn steel base has a deep lip that is stamped to close tolerance with the case interior and press fitted to position.

The results are a deeper internal seal, stronger and more uniform, due to solder seepage into the fitted seams, and better shielding because true metal to metal—case to base contact has been established.

If your problem is one of finding transformers that will withstand unusual conditions—Write Today.



**CHICAGO TRANSFORMER  
CORPORATION**  
3501 WEST ADDISON STREET • CHICAGO

*Another*  
**TAYLOR Triumph!**  
 "Processed Carbon Anodes"

**New Metalizing Method...  
 Eliminates Loose Graphite Particles**

Taylor's exclusive Processed Carbon Anodes allow higher anode voltages. These amazing new type anodes open new fields for tube design.

Seamless, and without high resistance weld spots, they are accurately machined from solid graphite, then entirely metalized to combine the desirable characteristics of carbon with the advantages of other type anodes. Because they do not warp, they provide insurance against efficiency loss due to changing electrical characteristics. A special method of fusing lead wire to anode assures positive continuity between tube connection and anode. And too, this new Taylor Process allows complete and permanent degassing of the anode.

You will hear more about this far-reaching development as its applications continue to increase Taylor Tube efficiency on a "More Watts Per Dollar" basis.

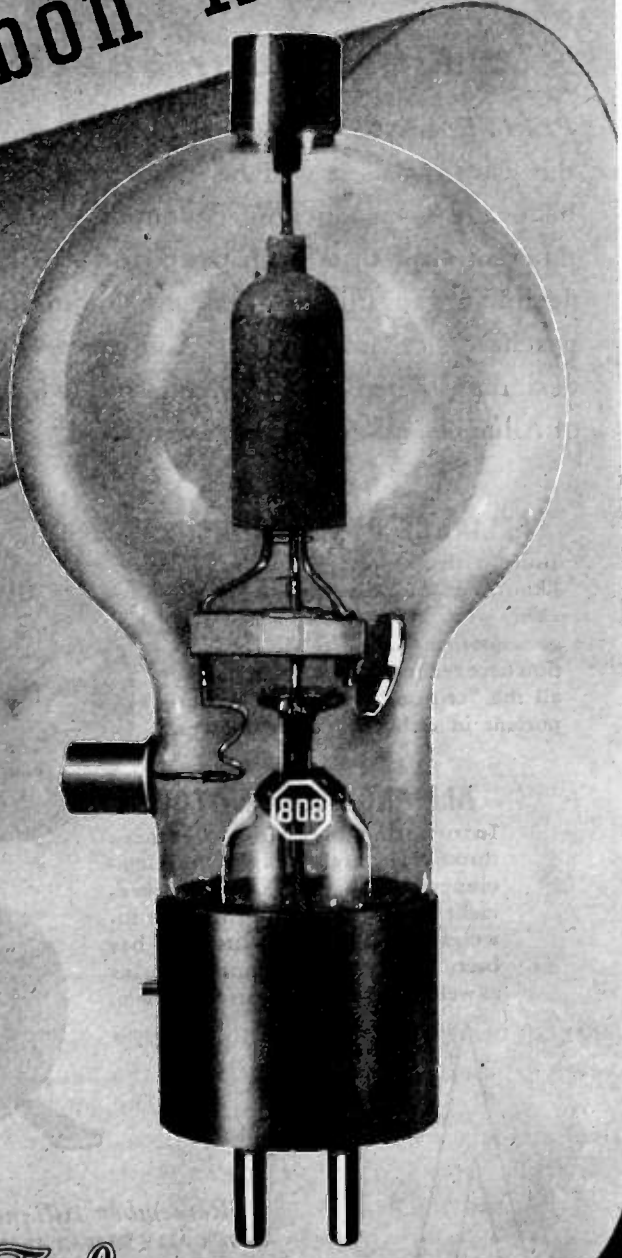

*Taylor* **HEAVY** **CUSTOM BUILT** **DUTY** *Tubes*

**TAYLOR TUBES, INC.,  
 2312-18 WABANSIA AVE., CHICAGO, ILL.**

*Means*  
**LONGER TUBE LIFE!**

# SKILL

## To Meet Your Specifications

*PERFORMANCE* is the real measure of success in winning the war, just as it will be in the post-war world. New and better ideas—production economies—speed—all depend upon inherent **skill and high precision** . . . For many years our flexible organization has taken pride in doing a good job for purchasers of small motors. And we can help in creating and designing, when such service is needed. Please make a note of Alliance and get in touch with us.

### ALLIANCE DYNAMOTORS

Built with greatest precision and "know how" for *low ripple—high efficiency—low drain and a minimum of commutation transients*. High production here retains to the highest degree all the "criticals" which are so important in airborne power sources.

### ALLIANCE D. C. MOTORS

Incorporate precision tolerances throughout. Light weight—high efficiency—compactness. An achievement in small size and in power-to-weight ratio. Careful attention has been given to distribution of losses as well as their reduction to a minimum.

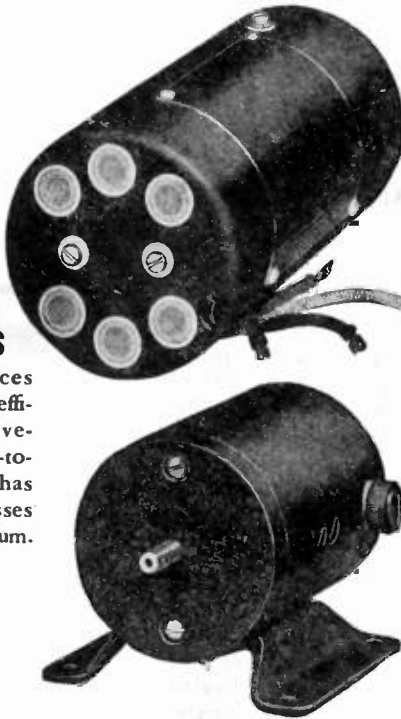

*Remember Alliance!*  
—YOUR ALLY IN WAR AS IN PEACE

**A**  
**ALLIANCE**  
**MANUFACTURING CO.**  
**A L L I A N C E . O H I O**

## Wanted—Engineers and Technicians

A well established Tulsa, Oklahoma, concern is in urgent need for:

Engineers who have had experience in design and development of electronic equipment;

Engineers who are experienced in the mechanical design of small precision equipment, and are familiar with shop practice and tools;

Engineers who are experienced in laboratory development of both electrical and mechanical equipment and their components;

Technicians for assembly and construction of electrical and mechanical instruments.

If your abilities are not being fully utilized in War Industries, write us today giving full details of past experience, education, age, draft status and salary expected. Recent graduates and female applicants will be given full consideration. All applicants must be Citizens of the United States, and must have W. M. C. certificate of availability. Box 305, The Institute of Radio Engineers, 330 W. 42nd St., New York 18, N.Y.

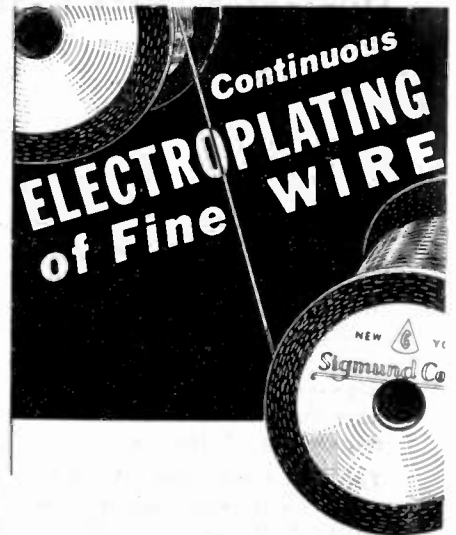

Complete equipment and staff of specialists for the continuous electroplating of fine wire. We can now plate a wide range of metals either on your own wire or on wire supplied by us . . .

Your inquiry is invited

**SIGMUND COHN & CO.**  
44 GOLD ST. NEW YORK  
SINCE  1901



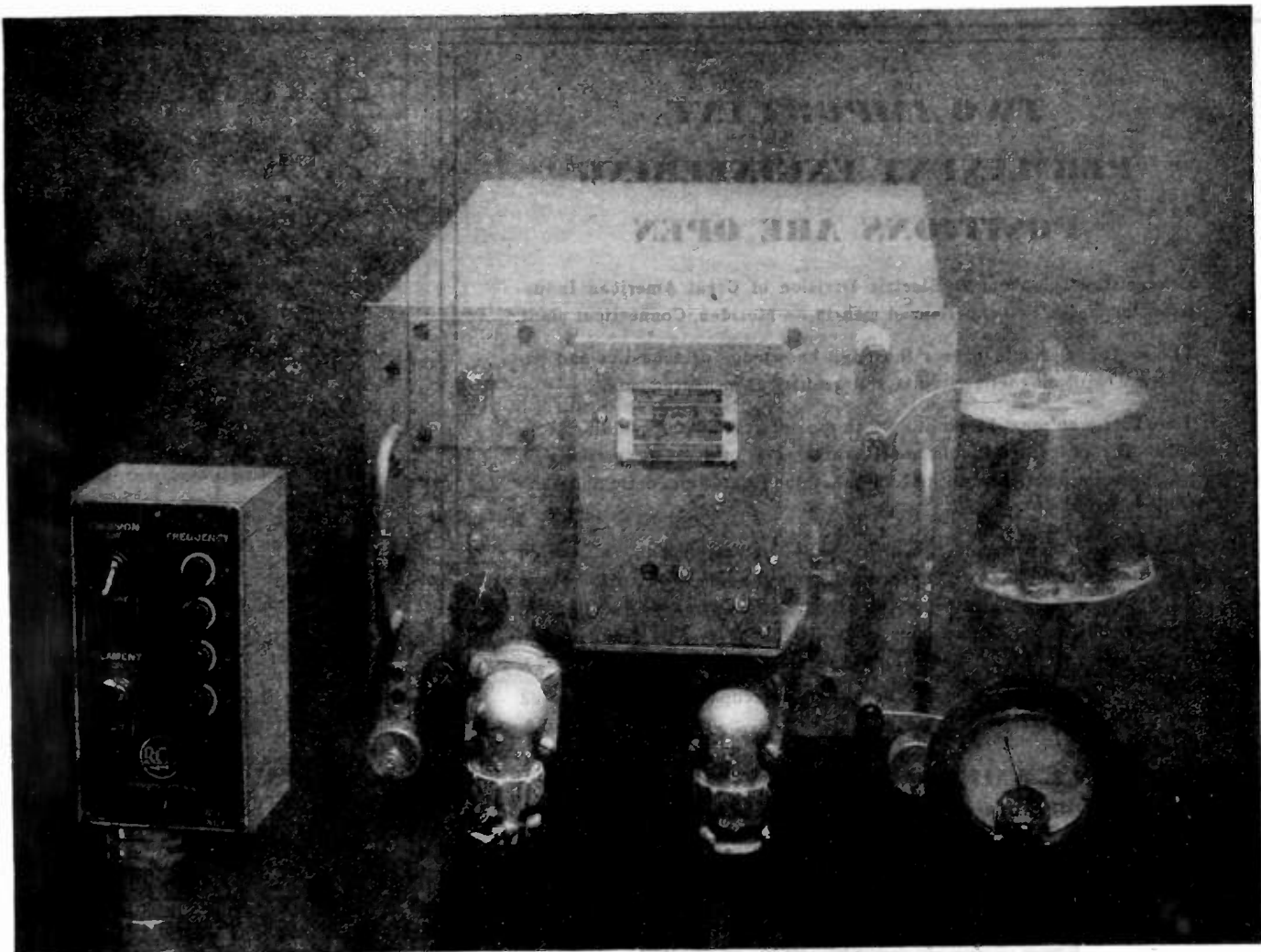

## READY FOR THE "GREEN HELL"

**H**HEAT-LADEN moisture is a deadly enemy of electrical installations—and aircraft radio equipment is no exception.

Yet the radio apparatus of America's fighting planes and bombers *must* function perfectly in landing fields and dispersal areas hacked from the "green hell" of Pacific jungles.

The ability of RCA aircraft radio units to meet these conditions is proved by test—and confirmed in service.

The picture above shows such a test—an RCA laboratory "sweat-room" in which RCA aviation radio equipment is exposed to steam-saturated atmosphere at 60° C. (140° F.) and 95% humidity.

There the equipment is prepared for the ordeal of rain-drenched Guadalcanal or New Guinea.

Such procedures are typical of RCA radio engineer-

ing and manufacturing. At every step theory is supplemented by severe and exhaustive tests to make sure that *stamina* accompanies efficiency.

These characteristics, essential to war planes, will be equally valued for postwar transports. Then, as now, efficiency and stamina will be "built-in" qualities of RCA Aviation Radio.



# RCA AVIATION RADIO

RCA VICTOR DIVISION • RADIO CORPORATION OF AMERICA • CAMDEN, N. J.

**TWO IMPORTANT  
PERMANENT ENGINEERING  
POSITIONS ARE OPEN**

Connecticut Telephone & Electric Division of Great American Industries, Inc. needs two experienced men in its Meriden, Connecticut plant.

The first man should have a thorough knowledge of acoustics and experience with magnetic circuits and acoustical measurements.

The other man must be familiar with the application and molding technique of plastics. He should have several years of design experience on small electrical apparatus, and an understanding of magnetic and electrical circuits.

"Connecticut Telephone" is a prime war contractor with an assured peacetime future. The two engineers described above will work on both wartime and postwar projects. Write, phone or wire Mr. William R. Curtiss, Chief Engineer, Connecticut Telephone & Electric Division, Great American Industries, Inc., Meriden, Connecticut.

Persons in Essential Activity or Critical Occupation not considered without statement of availability.

**GREAT AMERICAN INDUSTRIES, INC.**  
70 Britannia Street, Meriden, Connecticut

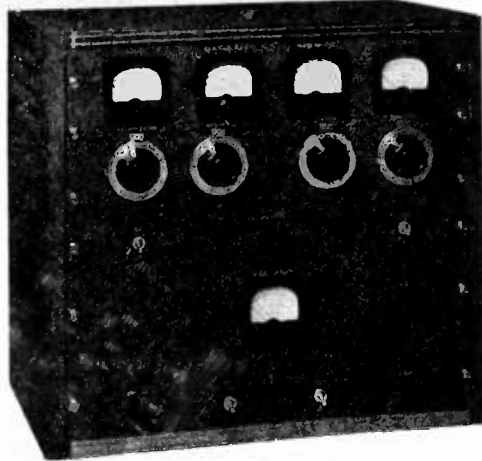

**HARVEY 100-T  
TRANSMITTER**

Compact . . . High Efficiency

100 Watt Transmitter . . . Telephone and Telegraph

**HARVEY** *Radio Laboratories, Inc.*  
448 CONCORD AVENUE - CAMBRIDGE - MASS.

**ENGINEERING  
OPENING**

**PROJECT SUPERVISOR**

PERMANENT POSITION WITH AN ESTABLISHED CONNECTICUT CONCERN MANUFACTURING COMMUNICATIONS EQUIPMENT.

PREFER TOP-NOTCH MAN WITH UHF EXPERIENCE WHO CAN TAKE CHARGE OF DEVELOPMENT OR DESIGN PROJECT.

SALARY COMMENSURATE WITH ABILITY.

ADDITIONAL COMPENSATION FOR ASSIGNMENT OF PATENTS.

PLEASANT WORKING CONDITIONS.

THOSE NOW EMPLOYED IN ESSENTIAL ACTIVITY MUST BE ABLE TO OBTAIN A RELEASE.

ADDRESS:

DALE POLLACK  
TEMPLETONE RADIO CO.  
MYSTIC, CONNECTICUT

**ESPEY**

MANUFACTURING  
COMPANY, INC.

**DOING A  
WAR JOB!**

SIGNAL GENERATORS - AUDIO OSCILLATORS  
TEST EQUIPMENT - RADIO RECEIVERS  
TRANSMITTERS - ELECTRONIC DEVICES  
Licensed by RCA - HAZELTINE - ARMSTRONG

305 EAST 63rd STREET  
NEW YORK 21, N. Y.  
Telephone: REgent 7-3090

# WANT TO MEASURE THE INDIVIDUAL COMPONENTS OF A COMPLEX WAVE?

**hp** Model 300A will do this and make many another measurement.

Variable selectivity feature makes this instrument outstanding . . . permits measurements that would otherwise be impractical. Examples: measuring distortion of sound recordings on film, disc and in other cases where there may be slight frequency modulation; integrating noise spectrum in acoustic measurements or for other purposes where a wider pass band gives a more representative integration. The wider pass band permits more rapid measurement of filter characteristics in the laboratory or in production. The maximum selectivity is sufficient for measurements as low as 30 cycles.

**FULL SCALE METER READINGS FROM 1 MV TO 500 VOLTS**  
The wide voltage range covers the values encountered in nearly

every application. The meter, which is fully protected against overloads, is linear and the various scales have ample overlap for accurate readings. A built-in calibrating system enables you to standardize the voltage measurements. Calibrating controls and meter are at bottom of the panel as can be seen in the illustration.

The overall voltage accuracy is  $\pm 5\%$ , the input impedance is 200,000 ohms, the voltage regulated power supply operates from 110 volts 60 cycles. Here is an instrument designed throughout for ease of operation and for accuracy which will be maintained over long periods of time. Write for further particulars. A 24-page catalog of **-hp-** instruments contains much valuable information relative to electronic measurement devices. A copy of this fully illustrated catalog will be sent you upon request. No obligation, of course, but mail your request early for the edition is limited.

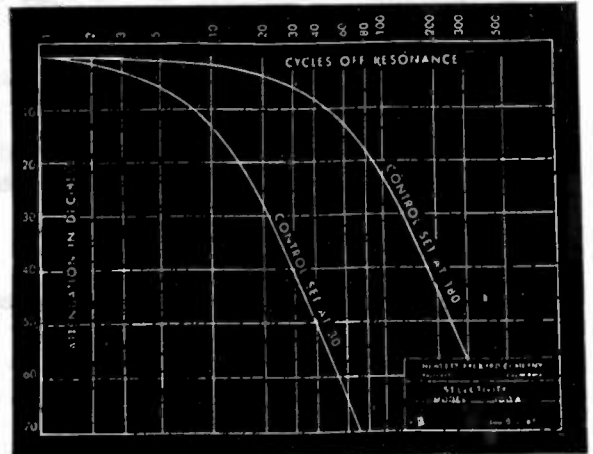
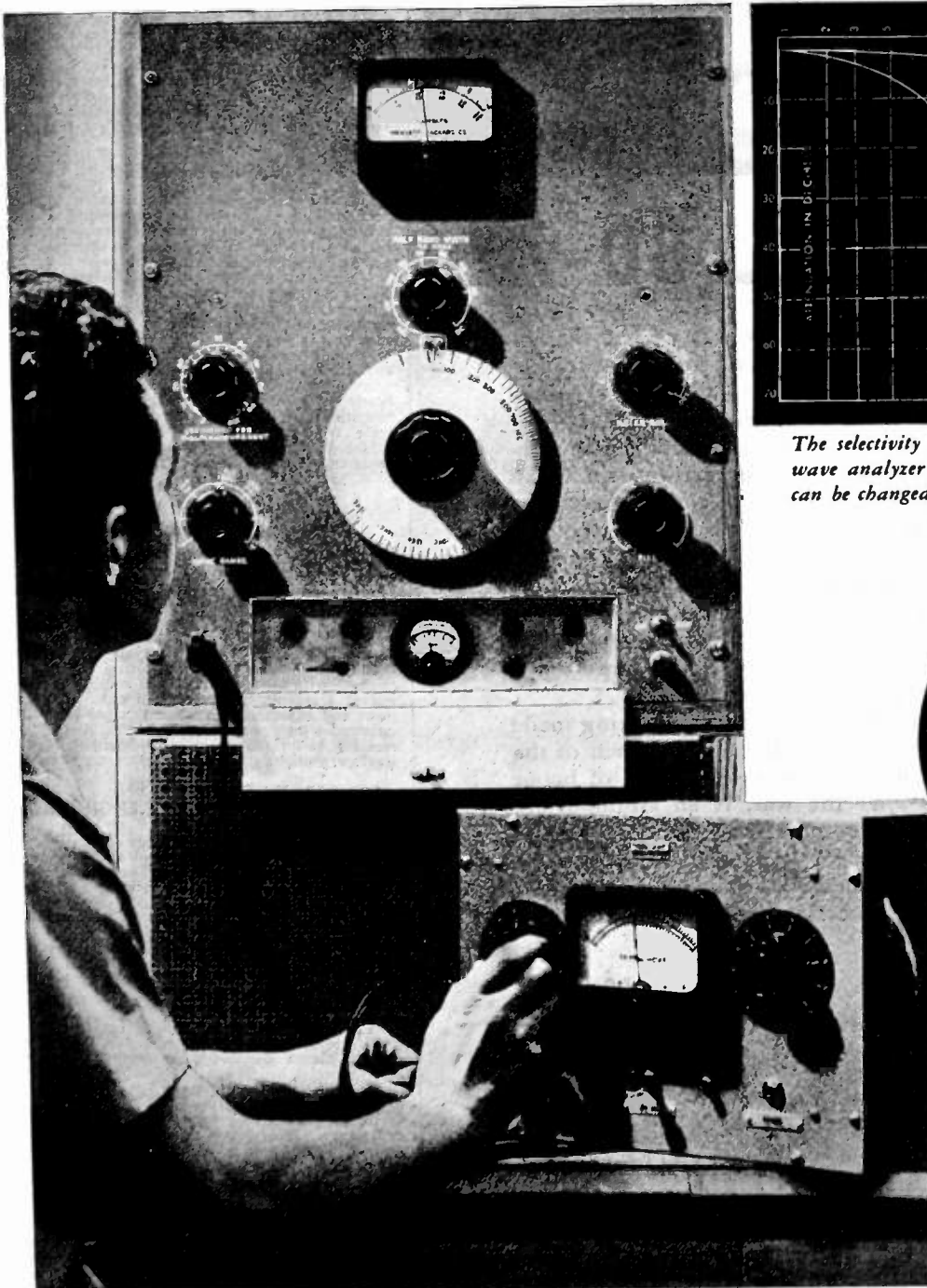

The selectivity characteristic of the Model 300A wave analyzer is shown above. The band width can be changed to any value between these curves by a turn of a knob



**HEWLETT-  
PACKARD  
COMPANY**

BOX 1135J, STATION A  
PALO ALTO, CALIFORNIA

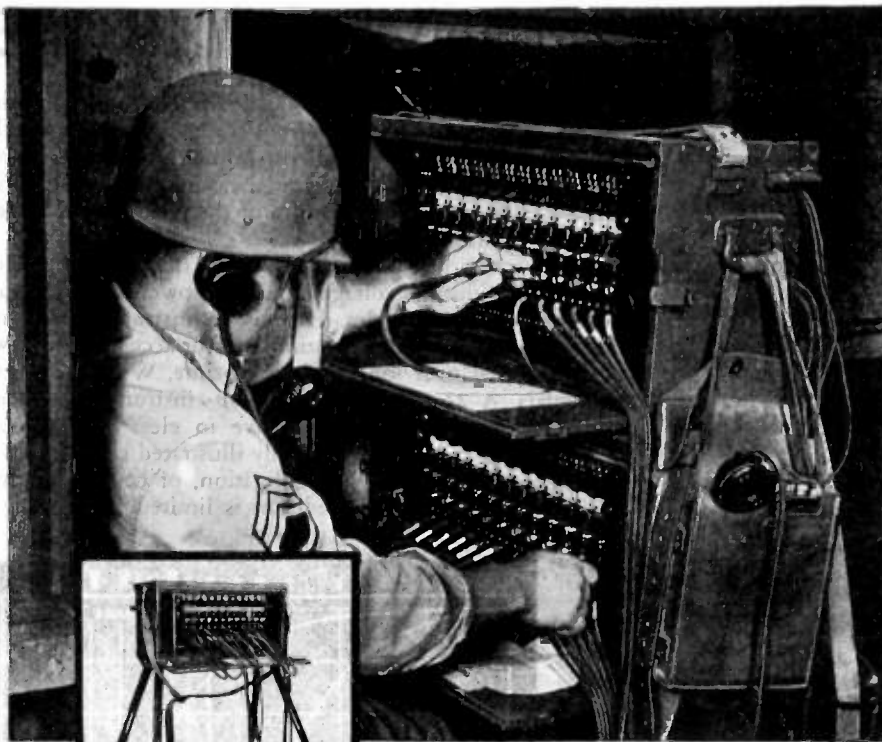

## BD-72

● Military authorities doubt that the war will be won by any secret super weapon. They count on fighting efficiency developed out of many small things—advantages gained from foresight and painstaking attention to detail.

For example, take the BD-72 portable military switchboard developed at *Connecticut*, in cooperation with Signal Corps engineers. It has many features we can't tell you about, but we can say that the BD-72 was designed to save space, to get into operation faster, to stand a lot of rough usage under fighting conditions. Small things? Not if its small size permitted getting one more machine gun aboard the truck. Not if it helps "get the message thru" even *seconds* sooner. Small things sometimes loom large when the job is to get the jump on the enemy.

All over America, the doom of the Axis is being made more and more certain by giving the fighting men of the United Nations better fighting tools. The birth of better ways of doing things *after* the war, is an all-important by-product of this effort. *Connecticut Telephone & Electric* is an excellent source of ideas for developing your postwar product or manufacturing methods, if they involve communications, or the engineering and manufacture of precision electrical devices.

### CONNECTICUT TELEPHONE & ELECTRIC DIVISION



MERIDEN, CONNECTICUT



*For the second time within a year, the honor of the Army-Navy Production Award has been conferred upon the men and women of this Division.*

© 1943 Great American Industries, Inc., Meriden, Conn.

## POSITIONS OPEN

(Continued from page 42A)

### RADIO ENGINEER

Mathematical knowledge to include trigonometry and elementary calculus. Must be familiar with all types of circuits for reception and transmission on frequencies up to 200 mc/s. Knowledge of transmission lines, aerial arrays, television and cathode-ray-tube technique desirable. Must also have knowledge of radio test equipment and must understand any circuit diagram.

Prefer man conversant with manufacture, repair and fault location on all types of transmitters and receivers. Address Box 289.

### RADIO ENGINEER

**EDUCATION:** Minimum of two years college in Electrical Engineering.

**EXPERIENCE:** Minimum of two years in radio test or engineering, or five years in electrical control work (power station or telephone central-office wiring, etc.).

Must be of a type qualified to interpret and clarify with inspectors and responsible executives electrical specifications, problems of manufacture, test and inspection. Address Box 290.

### RADIO ENGINEER

Opening in engineering department of concern making communication apparatus. Prefer college graduate with ultra-high-frequency experience, but lack of experience in this field will not bar an adaptable man.

Duties involve developing, designing and carrying the product through the shop with a minimum of supervision. If inexperienced, the duties would be the same under supervision. The company is engaged in war activity exclusively at the present time and does not expect any curtailment of its activity after the war.

Salary \$2,500 to \$10,000 depending upon qualifications. Pleasant surroundings and working conditions. If now employed in war work, a release from the employer must be obtainable. Address: Chief Engineer, Templeton Radio Company, Mystic, Conn.

### INSTRUCTORS IN ADVANCED ARMY-NAVY PROGRAM

Prominent Eastern technical institute needs additional instructors in officer training program in modern electronics and radio applications. An excellent opportunity to acquire advanced knowledge and to render important service in war effort. Men having various degrees of qualifications are needed, from recent graduates in Electrical Engineering or Physics to those with long experience in radio engineering or teaching. Salary according to qualifications and experience. Applicants must be U. S. citizens of unimpeachable reputation. Any inquiries will be treated as highly confidential. Please send personnel data and photograph to Box 292.

### RADIO AND ELECTRONIC ENGINEERS

First, we are seeking the services of one or two trained engineers who have had ample experience in electronic engineering. The men selected will not only be concerned with present war production, but should eventually develop key positions in postwar operation.

Second, we are also looking for a few young engineers who have had good schooling and background to be trained for specialized work with us.

This is an excellent opportunity for men who qualify to connect with a progressive, highly regarded manufacturer of transmitting tubes. Many special benefits will be enjoyed in your association with this company.

Write at once giving complete details of past experience. Interviews will be promptly arranged. Persons in war work or essential activity not considered without statement of availability. Chief Engineer, United Electronics Company, 42 Spring Street, Newark, New Jersey.

The foregoing positions of interest to I.R.E. members have been reported as open. Apply in writing, addressing reply to company mentioned or to Box No. ....



*Some were*

**REPAIRMEN...  
STENOGRAPHERS**

... and some have been with us for a good many years. Now they form a solid battle-front behind the fighting front. Thanks to these men and women, the Kenyon Transformer Co. is building not only more transformers but even better transformers... something which, in view of the excellence of our product, we thought was impossible.

Valiant People... their hands are tough, their eyes are sharp, and their minds are determined. And, when day is done, you will find them at a Red Cross blood bank, or tending a Victory Garden, or collecting scrap-metal—doing just what America expects us all to do in this monumental struggle for human rights and dignity.

Your war bonds help the war effort—  
buy more

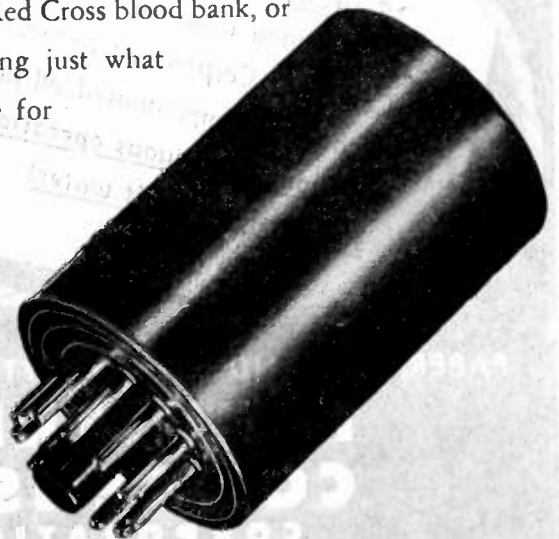

THE MARK OF EXCELLENCE

**KENYON TRANSFORMER CO., Inc.** 840 BARRY STREET  
NEW YORK, U. S. A.

**INCCO**  
INDUSTRIAL CONDENSER  
CORP.

0.5 MFD. 50,000 VOLTS DC WORKING  
CONTINUOUS OPERATION

**.5 MFD. 50,000 Volts DC Working**  
28 inches high, weight 175 pounds,  
 extra heavy duty unit built by Industrial  
 Condenser Corporation to meet navy spec-  
 ification; oil impregnated, oil filled. Built for  
24 hour continuous operation, and total  
submersion in salt water!

PAPER, OIL AND ELECTROLYTIC CAPACITORS  
**INDUSTRIAL  
 CONDENSER  
 CORPORATION**  
 1725 W. NORTH AVE., CHICAGO 22, U. S. A.

DISTRICT OFFICES IN PRINCIPAL CITIES  
 QUICK DELIVERY FROM DISTRIBUTOR'S STOCKS

*"No bombers  
lost..."*

★ Clarostat reputation is taken for a ride, night after night, in those bombing planes that go out—and come back. The maker of critical navigational instruments wanted *supreme dependability* in an illumination control. That control must be absolutely immune to extreme temperature variations, the worst humidity and other climatic trials, intense vibration and all-round tough usage.

And so Clarostat engineers developed this precision dimmer. Tapped winding with silver-soldered connections and rivets. Silver contact points lapped to precise height above bakelite support. Silver contact shoe on phosphor-bronze rotor. Cast-metal frame and snug-fitting bushing with shaft. Corrosion-proof casing. Fussy? Of course; but right down Clarostat's alley!



★ Send your problem to . . .

**CLAROSTAT**  
Controls and Resistors

CLAROSTAT MFG. CO., Inc. • 285-7 N. 6th St., Brooklyn, N. Y.

Proceedings of the I.R.E. September, 1943

# Certainly, POWERSTAT

variable voltage transformers

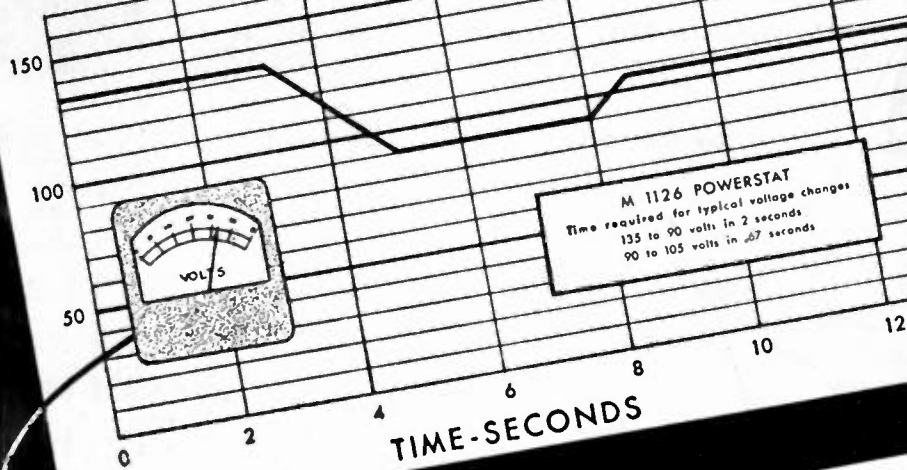

## for REMOTE CONTROL

SECO'S Motor-Driven POWERSTAT Variable Transformers offer a highly efficient and accurate method of controlling AC power. It is unnecessary to bring heavy cable to cumbersome tap changers on switch boards or control desks. Simple wiring from your automatic control device or push button station to the pilot terminals of a Motor-Driven POWERSTAT Variable Transformer will enable the operator to control kilowatts of power safely and smoothly.

Where a self-contained piece of apparatus is required for rapidly controlling voltage to any desired value — investigate Motor-Driven POWERSTAT Variable Transformers. This equipment is used in radio transmitters, vacuum tube manufacture, electrical testing, induction heating, electric furnace temperature control, automatic voltage regulators and other applications where an efficient high quality control is required.

Standard types are available in sizes up to 75 KVA for 115, 230 or 440 volt operation on single or polyphase circuits.

FOR FURTHER INFORMATION  
SEND FOR THESE BULLETINS  
POWERSTAT Variable Voltage Transformers 149 ER  
SECO Automatic Voltage Regulators 163 ER

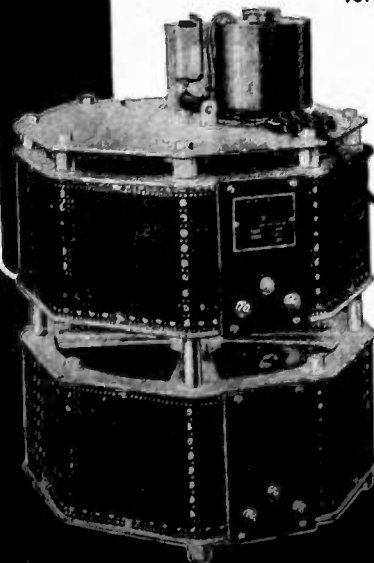

**SUPERIOR ELECTRIC COMPANY**  
175 LAUREL STREET, BRISTOL, CONNECTICUT

**SUPERIOR** *Electric Company*

# CRYSTALS

BY

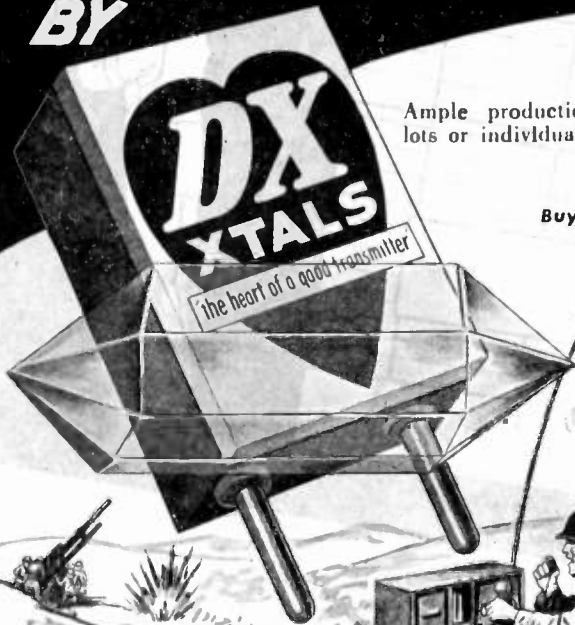

Ample production facilities available for lots or individual crystal orders—Priorities, of course.

Buy More Bonds!

**DX CRYSTAL CO.**

GENERAL OFFICES: 1841 W. CARROLL AVE., CHICAGO, ILL., U.S.A.

**DX  
XTALS**

the heart of a good transmitter!

TRADE MARK

## LABORATORY STANDARDS

ACCURATE - RELIABLE

- Standard Signal Generators
- 
- Square Wave Generators
- 
- Vacuum Tube Voltmeters
- 
- U. H. F. Noisemeters
- 
- Pulse Generators
- 
- Moisture Meters

# VICTORY...in the Making

Here, at Doolittle, we are coordinating every effort and skill to help provide the communications equipment so essential for Victory. This will mean better peace-time communications after our battles are won.



To Assure Victory  
Buy More U. S. War  
Bonds and Stamps

*Doolittle*  
**RADIO, INC.**

Builders of Precision Radio Communications Equipment  
7421 S. Loomis Blvd., Chicago, U. S. A.



**MEASUREMENTS  
CORPORATION**

Boonton, New Jersey



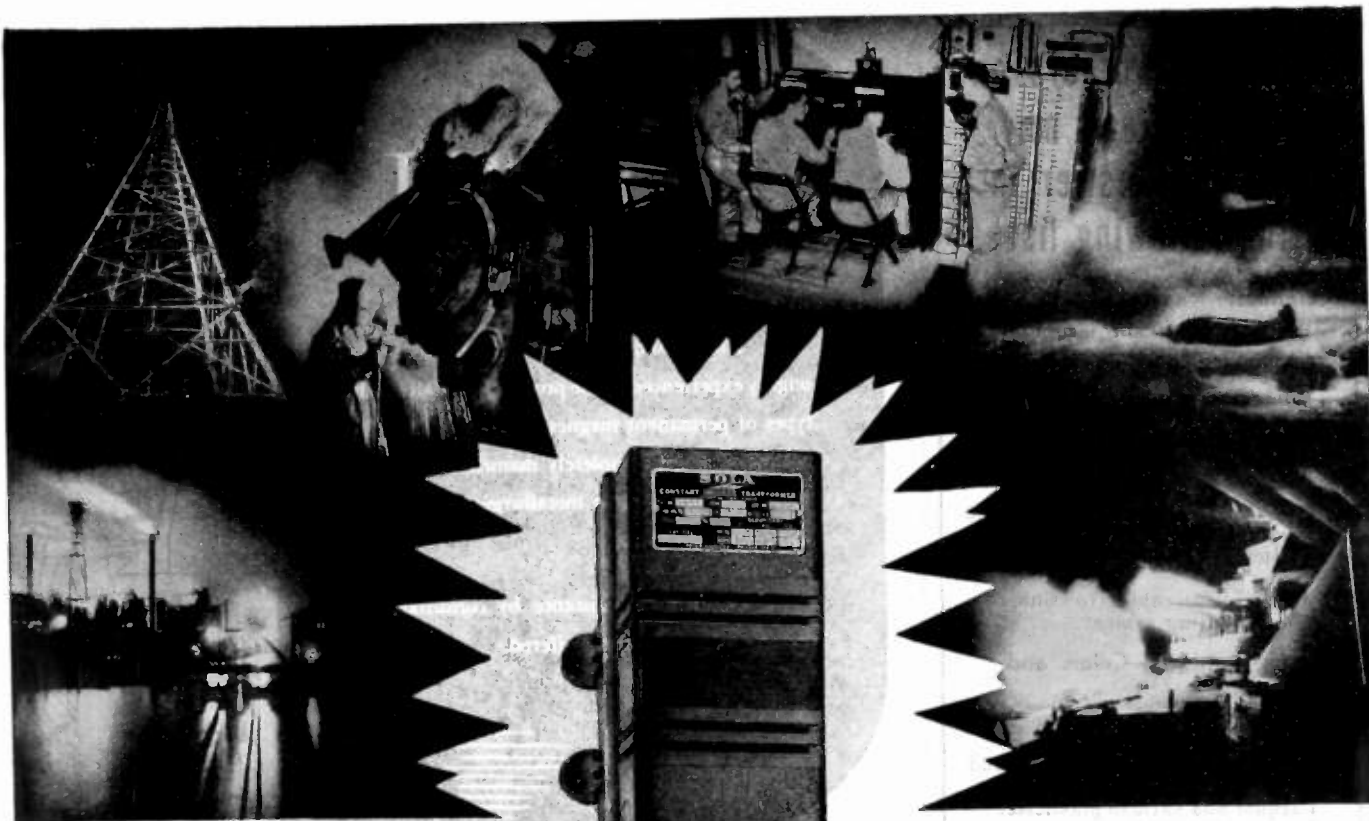

*From blast furnace to battle front...*

# Constant Voltage guides the Tools of War

NEVER before in the history of warfare has precision production been so important as it is today. From the trigger group of an M-1 rifle to the fire control of a 16-inch battery, split-hair tolerances are demanded in millions of intricate munitions parts. Producing to uncompromising standards requires the finest type of machine tools ever designed—operated at a constant level of electric power.

But *constant voltage* is almost non-existent on today's overcrowded power lines. Wartime consumers are busier. Huge volumes of electrical energy are being intermittently used and released. Heavy sags and destructive surges inevitably occur. For that reason, manufacturers in every

field are stabilizing power themselves with SOLA CONSTANT VOLTAGE TRANSFORMERS.

Sola "CVs" equalize voltage sags and surges, absorb variations as great as 30%, feed a controlled flow of power to machines. And they protect the *very life* of sensitive instruments and electronic tubes.

*Engineered for long, trouble-free service, Sola "CVs" are instantaneous in action, without moving parts, self-protecting against short circuit. They have a place on your production lines—the life lines of American victory.*

**Note to Industrial Executives:** Sola "CV" transformers are available in standard 10VA to 15KVA units. Special units built to specification. Ask for bulletin KCV-74

# SOLA

## Constant Voltage Transformers

Transformers for: Constant Voltage • Cold Cathode Lighting • Mercury Lamps • Series Lighting • Fluorescent Lighting • X-Ray Equipment • Luminous Tube Signs  
 Oil Burner Ignition • Radio • Power • Controls • Signal Systems • Door Bells and Chimes • etc. SOLA ELECTRIC CO., 2525 Clybourn Ave., Chicago, Ill.

## Research workers on war problems may find the answer in the following list

### Ceramics:

- Binder for ceramic insulation
- Protective coating against mechanical abuse
- Binder for vitreous enamels
- Binder for abrasive wheels
- Binder for porcelain enamel frit

### Adhesives:

- "Cellophane" and cellulose acetate adhesive
- Tissue paper to aluminum adhesive
- Adhesive for rubber to cloth
- Thermosetting cement

### Paints, Varnishes, Colors and Pigments:

- Pulp color and pigment dispersing agent
- Flattening agent for paints and varnishes
- Lacquer and varnish plasticizer
- Non-mar enamels
- Water and ink resistant lacquers

### Rubber and Synthetic Rubber:

- Gasoline resistant finish
- Rubber gasket lubricant
- Rubber to cloth adhesion
- Polishing of hard rubber
- Plasticizing synthetic rubber

### Metals:

- Aluminum castings corrosion protection
- Foundry cores
- Joint seals for pipes
- Aluminum drawing lubricant
- Tin stamping lubricant
- Nickel alloy stamping rust prevention
- Metal surface protection
- Drawing and stamping of nickel alloys
- Sintered bearing lubricant

### Paper:

- Transparent coating
- Waterproofing liquid
- Flameproofing agent
- Translucent paper
- Wax coating

### Wood:

- Warpage prevention
- Flameproofing

### Plastics:

- Plasticizer and lubricant
- Polishing
- Lubricant for molding



The answers to these and many other problems are given in our manual, "Chemicals by Glyco." Send for it today.

**GLYCO PRODUCTS CO., INC.**

26 Court Street

Brooklyn 2, N.Y.

## PERMANENT MAGNETS

The Arnold Engineering Company is thoroughly experienced in the production of all ALNICO types of permanent magnets including ALNICO V. All magnets are completely manufactured in our own plant under close metallurgical, mechanical and magnetic control.

Engineering assistance by consultation or correspondence is freely offered.

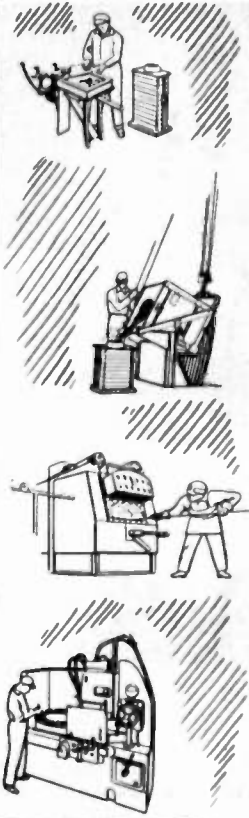

## THE ARNOLD ENGINEERING COMPANY

147 EAST ONTARIO STREET, CHICAGO 11, ILLINOIS

## TOUGH and VERSATILE as a "JEEP" TURNER 22-D Dynamic

WORKS EQUALLY WELL INDOORS OR OUT

A streamlined Dynamic, rugged enough for the toughest job, Model 22D is the answer for the man who expects much at low cost. Withstands bad climatic conditions and rough handling, performing equally well indoors or out. Amplifies smoothly at all frequencies. Long lines of 100 feet possible with high impedance, and thousands of feet with low. The built-in transformer is free from hum pick-up, and operation is smooth at all frequencies. Gunmetal or chrome type finish. Output level — 54 DB at high impedance. Range 40-8,000 cycles. Also available in 200 ohm or 500 ohm models. Write today for complete information.

**THE TURNER CO.**  
CEDAR RAPIDS, IOWA



**FREE** Write for new Turner Microphone Catalog Today

ABOVE

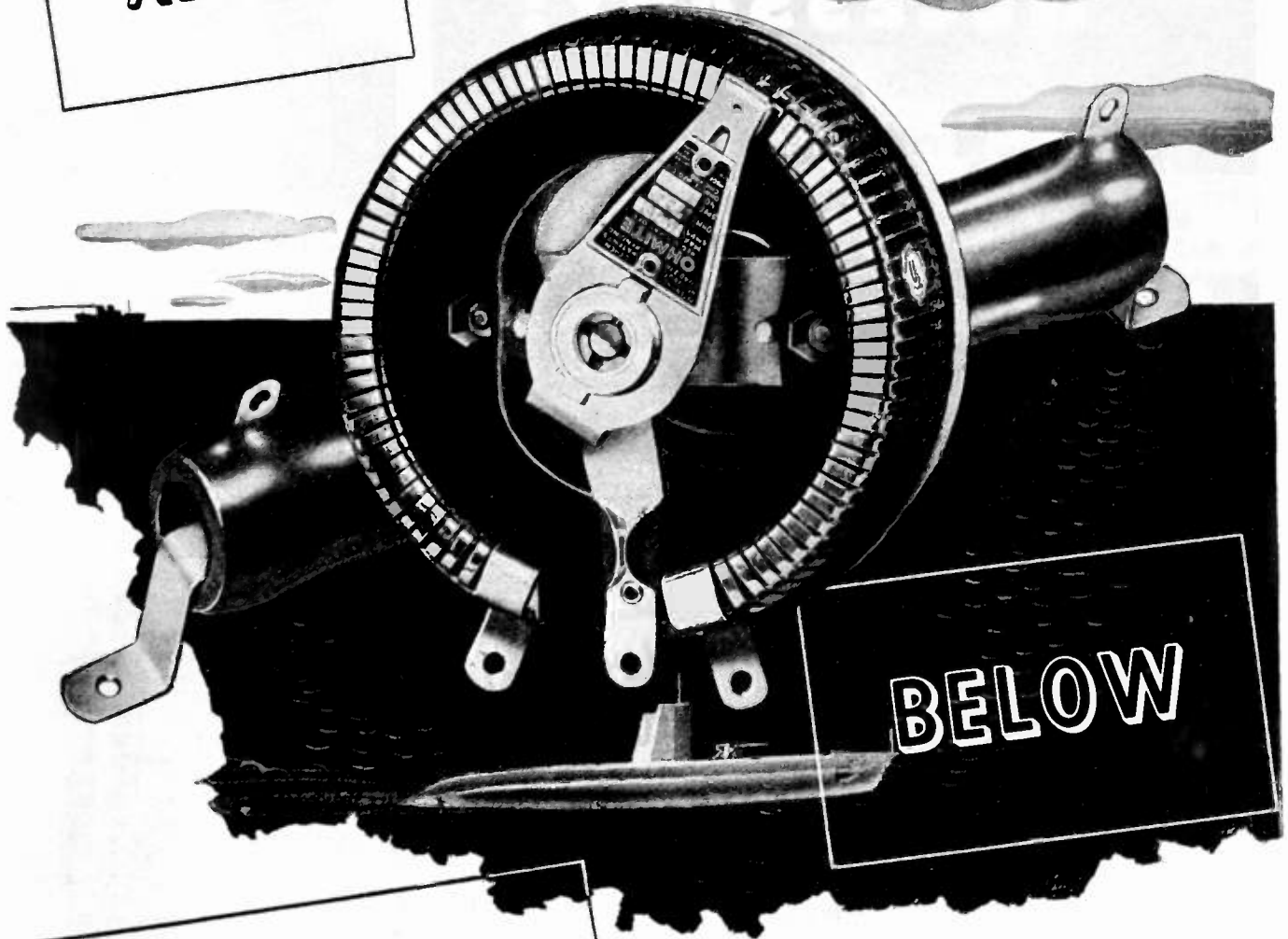

BELOW

# OHMITE Resistance Units

*do the job...  
and do it well!*

Consistent performance day-after-day in all types of critical applications . . . that's the story of Ohmite Rheostats and Resistors. This time-proved dependability has enabled them to meet the toughest requirements of military service. Today, they "carry on" above the clouds and below the waves—on land and on sea—in planes, tanks, warships and submarines—to help speed Victory. Tomorrow, these rugged units will be ready to meet new peacetime needs. Widest range of types and sizes assure the right unit for each purpose. Experienced Ohmite Engineers are glad to assist you on any resistance-control problem.

Send for Catalog and Manual No. 40  
Write on company letterhead for 96-page  
Catalog and Engineering Manual No.  
40. Gives helpful data on the selection  
and application of rheostats, resistors, tap  
switches.



### Handy Ohm's Law Calculator

Helps you figure ohms, watts, volts, amperes—quickly. Solves any Ohm's Law problem with one setting of the slide. All values are direct reading. Send for yours—enclose only 10c in coin for handling and mailing.

OHMITE MANUFACTURING CO.  
4862 Flournoy St • Chicago, U. S. A.

# DELAYS *Are Not* NECESSARY!



**...get vital radio and electronic parts and equipment - Quickly!**

Research in electronics is now devoted almost exclusively to wartime applications—and every minute counts in war!

Electronic engineers and research technicians need not delay completion of vital projects for lack of parts or equipment. Lafayette Radio Corp. is headquarters for every nationally known manufacturer in the field.

The reputation of Lafayette Radio Corp. for complete stocks and prompt deliveries is well known to thousands of electronic engineers. We can fill your needs—quickly!



Write today for **FREE** 130 page Radio and Electronic Parts and Equipment Catalog ...  
Address Dept. 9113



## LAFAYETTE RADIO CORP.

★ 901 W. JACKSON BLVD.

★ 265 PEACHTREE STREET

CHICAGO, ILLINOIS

ATLANTA, GEORGIA



## Stratosphere, Troposphere or Aquasphere

*... N.Y.T. engineering  
can meet transformer needs*



The ingenuity of the N.Y.T. Sample Department is represented in practically every point above and below the four corners of the earth.

Specializing exclusively in the design and development of audio and power transformers, chokes and filters for highly critical requirements, these custom-built units experience every conceivable electrical and mechanical operating condition.

Abrupt and extreme temperature fluctuations, moisture, acid fumes, concussion, humidity, etc.—yet maximum performance is assured at all times. Too, substantial savings in weight, area and mounting space attest to the resourcefulness of N.Y.T. engineering.

The Sample Department, now devoted 100% to problems pertaining to Army, Navy and Air Corps applications, will be available later, for peacetime needs.

## NEW YORK TRANSFORMER COMPANY

24-26 WAVERLY PLACE, NEW YORK, 3, N. Y.



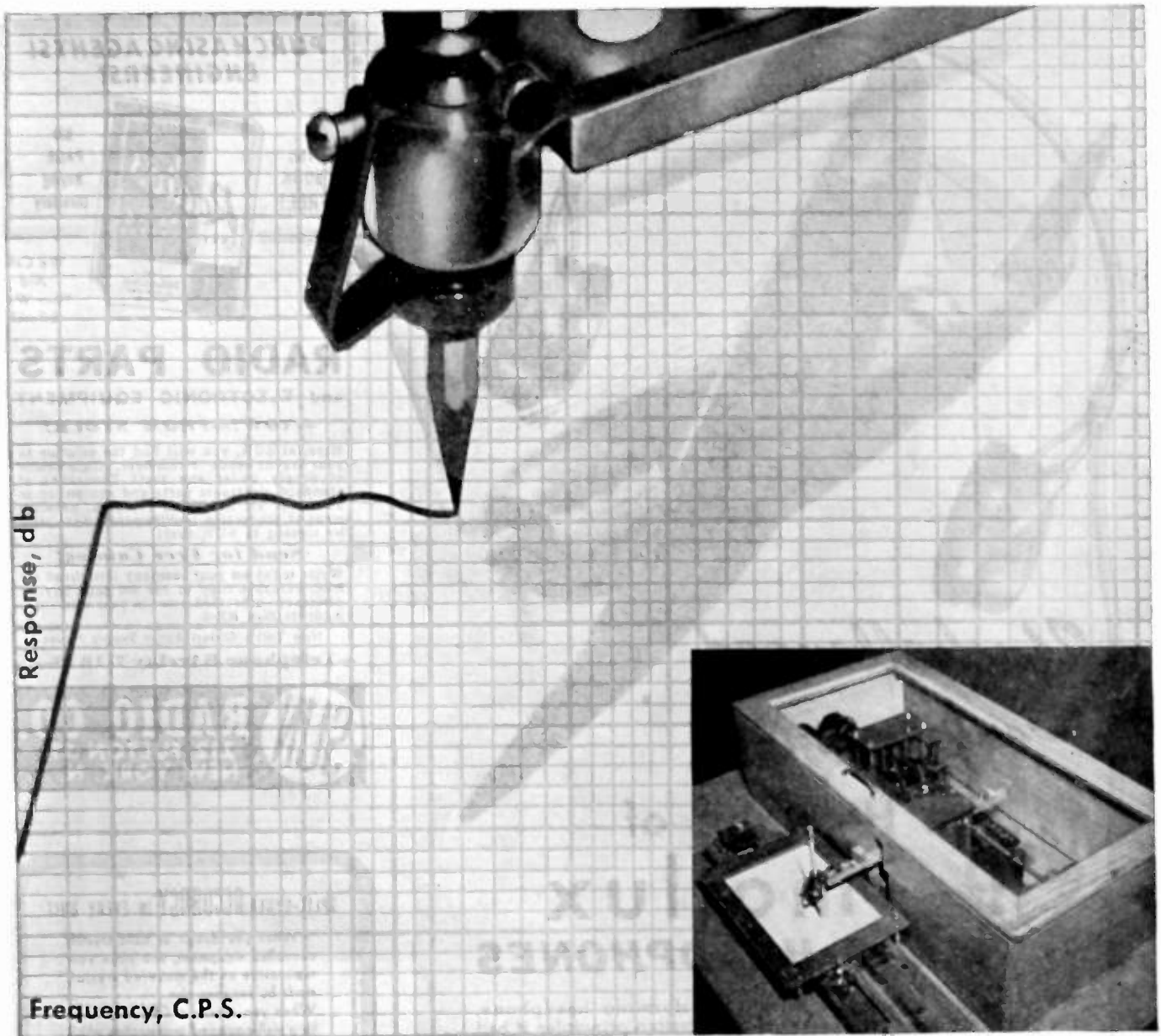

## *It writes by ear...*

For years, Shure Engineers have relied upon accurate and scientific measurement in determining microphone performance. They do not rely, alone, upon listening or point by point measurement.

Shure Engineers designed this Automatic Curve Recorder to plot the operating characteristics of our microphones. It writes by ear.

This and other advanced testing techniques have enabled Shure to meet and often exceed the rigid requirements of microphone design demanded by the Army and Navy. You will have every right to expect new standards in microphone performance after the war is won.



SHURE BROTHERS, 225 West Huron Street, Chicago  
*Designers and Manufacturers of Microphones and Acoustic Devices*

*Unchallenged  
Performance!*

... the Heritage of

# Permoflux DYNAMIC HEADPHONES

When the need came for a better performing headphone, Permoflux applied advanced sound reproduction principles it had developed years before.

The same efficient designs which had established Permoflux Acoustical Products as leaders in many fields, provided in Permoflux Dynamic Headphones an increased measure of sensitivity and improved signal audibility under every operating condition.

While Permoflux Dynamic Headphones are today completely in the service of our fighting forces, the coming of Victory will make them available to all.

TRADE MARK

# PERM-FLUX

CORPORATION  
4916-22 W. Grand Ave., Chicago, Ill.

PIONEER MANUFACTURERS OF PERMANENT MAGNET DYNAMIC TRANSDUCERS

**PURCHASING AGENTS!  
ENGINEERS!**

This  
BOOK  
FREE!

800  
PAGE  
Buying  
Directory

We Can  
Aid  
Your War  
Effort!

## RADIO PARTS and ELECTRONIC EQUIPMENT

—NOW!—FROM STOCK!

Here, at SUN, you will find the solution to your urgent needs—a complete, single source of supply under one roof! Thousands of standard electronic parts and equipment in stock for all industrial research, development or production requirements. Save time by coming to SUN first!

**Send for Free Catalog!**

Write today on your company letterhead for free, valuable copy of our 800 page buying directory—a decided asset in your war work. Address Box RE-8.

New York's Oldest Radio Supply House  
—Telephone BARclay 7-1840—

**RADIO CO.**  
212 FULTON ST.  
NEW YORK, N. Y.

**SPLIT-CYCLE ACCURACY IN EVERY UNIT**

When you design or build crystal-controlled equipment, you stake your reputation on the mounted crystal, made by someone else.

When you specify a CRL unit, made by a well-equipped organization which gives precedence to long life and accuracy in your equipment, you can stake your reputation on the results. Speed is a plus, precision the must, of CRL.

Write for illustrated literature which shows why CRL can meet your demands and which contains a chart of crystal application data.

**C R Y S T A L  
R E S E A R C H  
L A B O R A T O R I E S**  
INCORPORATED

Said the War Correspondent to the Folks Back Home:

**"Tanks storm rail center  
—smash counterattack"**

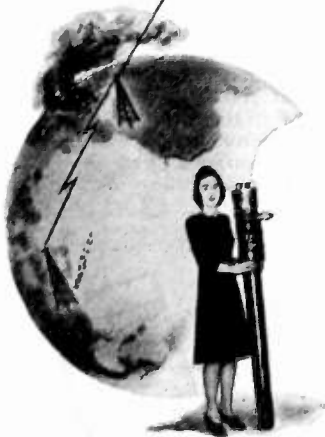

Whether for beaming a headline across the world or bringing it into your home, Federal is a leading manufacturer of radio transmitting and receiving tubes, including the giant tubes used by Mackay Radio in its world-wide Communications Service

In your morning paper  
It's only an arrow  
Creeping toward a dot on the map . . .

But out there  
Where the angry earth  
Convulses under your feet  
From the thundering steamroller charge  
It's hell on wheels  
As the tanks attack at dawn

And close on their clawing heels  
Spattered with the same mud and lead  
As the mopping-up forces  
Comes the soldier with the typewriter . . .  
The war correspondent

When you read his eye-witness account  
Of how this town was taken  
Read between the lines  
And give a thought  
To the man under the helmet

Whose only command is . . .  
*Get the story!*

Helping him get the story *through*  
Relaying it from field radio  
To command outpost  
To towering Mackay Radio  
Trans-Atlantic radio telegraph station  
Is the voice and ear of electronics  
*The vacuum tube . . .*  
Giving wings to his words  
Just as it helps plane and tank  
*"Work together better  
Because they can talk together"*

Here at I. T. & T.'s manufacturing associate  
Federal Telephone and Radio Corporation  
Where a great many of these tubes are made  
Our hats are off  
To the men who use them  
To speed victory . . .  
Some day they'll help men  
Build a better world

**IT&T**

INTERNATIONAL TELEPHONE AND TELEGRAPH CORPORATION 67 Broad St., New York 5, N. Y.

Manufacturing Associate:

FEDERAL TELEPHONE AND RADIO CORPORATION

# No RF Circuits and plenty of output

in this stable, accurate  
audio frequency oscillator

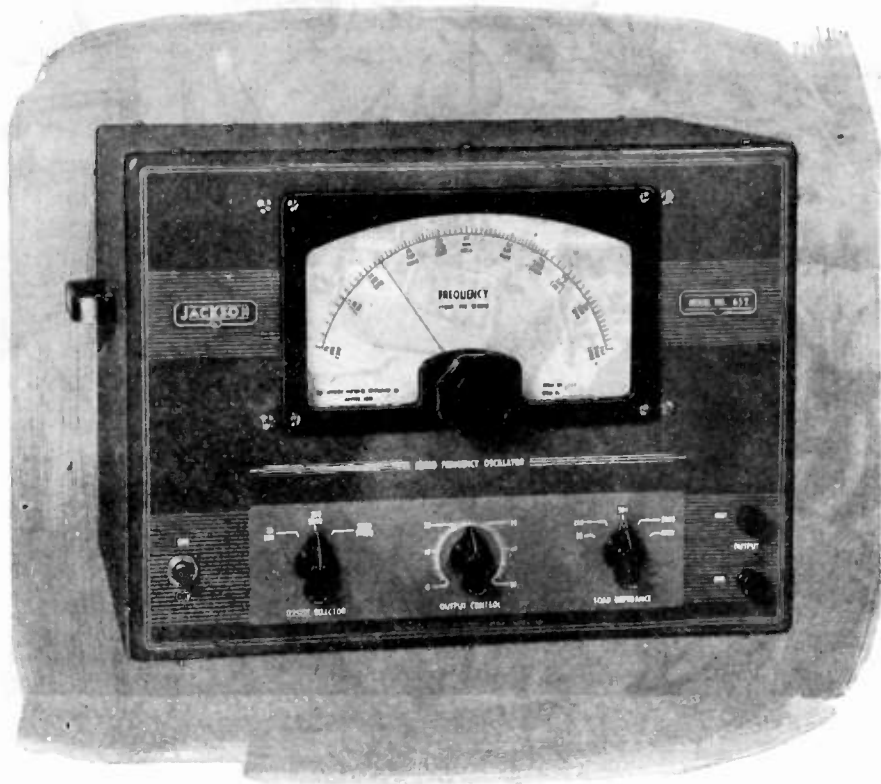

Here's an A.F. oscillator that gets down to fundamentals: sound in electrical and mechanical design—convenient to use—reliable in service. Entirely different from beat frequency oscillators, it develops output voltage directly at the desired fundamental frequency, free of any spurious signals or beats. There's no zero adjustment. Original calibration is permanently "locked."

Range: from 20 to 20,000 cycles. Waveform: excellent through entire frequency range, even with large changes in line

voltage. Accuracy: within 3% or 1 cycle. Output impedance: five convenient values—10,250,500,5000 ohms and high (controlled by selector switch). Output control: continuously variable from zero to maximum. Output power: approximately .5 watts, ample for all ordinary purposes.

This truly fine instrument may be the answer to many of your problems in audio frequency measurements. It, and many others from the Jackson line, are "in the service" now. They'll again be widely available when victory has been won.

All Jackson employees—a full 100%—are buying War Bonds on a payroll deduction plan. Let's All go all-out for Victory.

# JACKSON

*Fine Electrical Testing Instruments*

JACKSON ELECTRICAL INSTRUMENT COMPANY, DAYTON, OHIO

# NEW



The new General Electric line of ELECTRONIC MEASURING INSTRUMENTS is designed in the famous G-E Electronic Laboratory. It provides an extensive choice of compact apparatus for service, maintenance, or research.

For measuring electronic circuits and component parts, these modern G-E unimeters, capacitometers, audio oscillators, wide band oscilloscopes, square wave generators, signal generators, power supply units, and other utility measuring instruments assure accurate, dependable service.

Planned for easy, error-free reading, the units are sturdy, stable, shock-resistant, and compact.

G-E testing equipment is now in production primarily for the Armed Forces; it may be purchased on a priority if you are engaged in war work. After the war, the full line will again be available to everybody. . . . Electronics Dept., General Electric, Schenectady, N. Y.

• We will welcome your inquiry for G-E electronic measuring equipment made to your specific requirements.

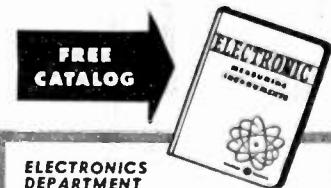

**ELECTRONICS DEPARTMENT**  
**GENERAL ELECTRIC CO.**  
Schenectady, N. Y.

Please send, without obligation to me, the General Electric Measuring Instrument Catalog, P-1 (loose-leaf), for my information and files.

Name \_\_\_\_\_  
Company \_\_\_\_\_  
Address \_\_\_\_\_

**GENERAL ELECTRIC**  
ELECTRONIC MEASURING INSTRUMENTS



INDEX  
**DuMONT**  
 DISPLAY ADVERTISERS

# Oscillography

...from **A** to **X**, **Y** and **Z**

➔ The new DuMont Type 241 oscillograph is literally an enlarged version of the 3-inch Type 224 already meeting the more critical requirements of oscillograph users.

The 5-inch tube means larger oscillograms for more detailed studies. The added Z-axis amplifier for beam modulation permits use of timing signals or blanking impulses for further applications.

Both instruments—Type 224 (3-inch) and the new Type 241 (5-inch) set new standards for commercial-grade oscillographs. Wide-band Y-axis amplifiers permit study of sig-

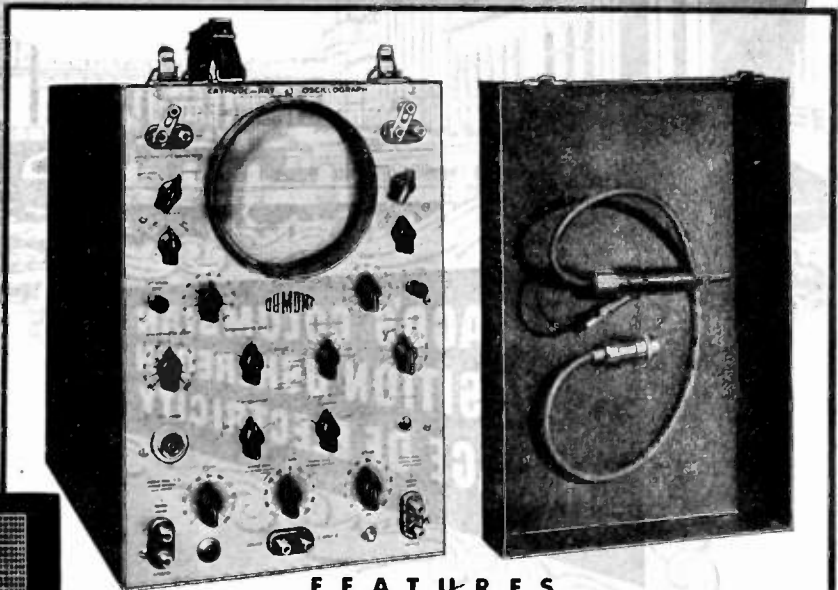

## FEATURES

DuMont Type 5JPI intensifier-type cathode-ray tube for brilliant, easy-reading oscillograms.

Y-axis or vertical deflection response uniform from 20 c.p.s. to 2 mc. Comparable faithful square and sinusoidal wave response.

X-axis or horizontal deflection amplifier with uniform response to 100 kc.

Both amplifiers have input attenuators and distortionless gain controls.

Y-amplifier has input connection for test probe and shielded cable supplied with instrument, reducing input capacitance and eliminating usual stray pickup.

Z-axis amplifier modulates electron beam with external signal applied to input terminal post, or with return trace-blanking pulse produced by linear-time-base generator.

All high-voltage electrolytic capacitors eliminated from circuit. 17½" high; 10¼" wide; 21" deep. 65 lbs.



50 c.p.s.

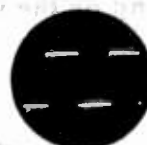

500 c.p.s.

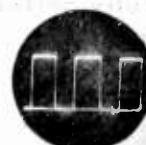

25 KC.



100 KC.

# DUMONT

**ALLEN B. DU MONT  
 LABORATORIES, Inc.**

Passaic • New Jersey  
 Cable Address: Wespealin, New York

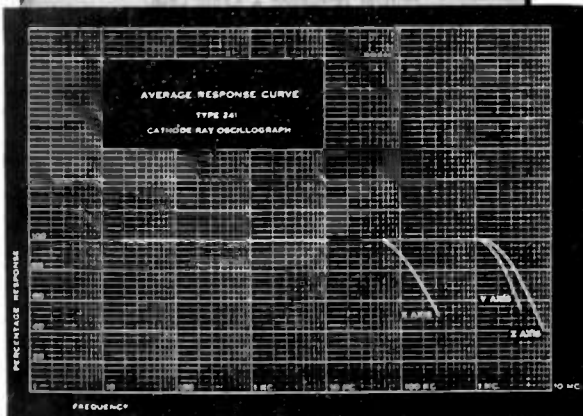

nals of frequencies far beyond the range of usual instruments. Both have a comparably wide-band square and sinusoidal wave response. Both permit a wide choice of panel connections for extreme flexibility in applying signals to the cathode-ray tube. Both are ruggedly housed and supplied with removable front cover for added protection in transit or when not in actual use.

These two expanded-range-expanded-versatility DuMont Oscillographs, along with other DuMont types, round out an outstanding choice of instruments for your particular kind of oscillography.

➔ Write for literature



**CHICAGO'S COLUMBIAN EXPOSITION USHERED IN THE AGE OF ELECTRICITY**

**in 1895, just two years later, Thordarson ushered in the age of transformer specialization**

Consistently since that date . . . year in and year out, Thordarson engineers have always been a step ahead in developing the newest and most needed types of transformers. Today, in practically every country on the face of the earth, Thordarson leadership is an established fact, proven by the manifold tasks which transformers bearing the trade-mark "Thordarson" are successfully performing on the war fronts of the world.



*Transformer Specialists Since 1895*  
**.. ORIGINATORS OF TRU-FIDELITY AMPLIFIERS**

## INDEX

Positions Open ..... 36A

### DISPLAY ADVERTISERS

|  |           |
|--|-----------|
| Aerovox Corporation .....                      | 3A        |
| Aircraft Accessories Corp. ....                | 27A       |
| Alliance Mfg. Company .....                    | 44A       |
| American Lava Corporation .....                | 10A, 11A  |
| American Telephone & Telegraph Co. ....        | 14A       |
| American Transformer Company .....             | 29A       |
| Amperex Electronic Products, Inc. ....         | Cover II  |
| Arnold Engineering Company .....               | 54A       |
| Bendix Aviation Corp. ....                     | 12A, 13A  |
| Biley Electric Company .....                   | 38A       |
| Centralab .....                                | 8A        |
| Chicago Transformer Corp. ....                 | 42A       |
| Clarostat Manufacturing Co. ....               | 50A       |
| Sigmund Cohn & Co. ....                        | 44A       |
| Connecticut Telephone & Electric .....         | 48A       |
| Cornell-Dubilier Electric Corp. ....           | Cover III |
| Crystal Research Laboratories, Inc. ....       | 58A       |
| Daven Company .....                            | 33A       |
| DeJur-Amsco Corporation .....                  | 16A       |
| Tobe Deutschmann Corp. ....                    | 63A       |
| Doolittle Radio, Int. ....                     | 52A       |
| Allen B. DuMont Laboratories, Inc. ....        | 61A       |
| DX Crystal Company .....                       | 52A       |
| Eitel-McCullough, Inc. ....                    | 64A       |
| Electronic Corp. of America .....              | 22A       |
| Electro-Voice Mfg. Co., Inc. ....              | 21A       |
| Espey Manufacturing Co., Inc. ....             | 46A       |
| Federal Telephone & Radio Corp. ....           | 40A       |
| General Electric Company .....                 | 2A, 60A   |
| General Radio Company .....                    | Cover IV  |
| Glyco Products Co., Inc. ....                  | 54A       |
| Great American Industries, Inc. ....           | 46A       |
| Hallicrafters Company .....                    | 24A       |
| Harvey Radio Laboratories, Inc. ....           | 46A       |
| Heintz & Kaufman, Ltd. ....                    | 26A       |
| Hewlett-Packard Company .....                  | 47A       |
| Hytron Corporation .....                       | 5A        |
| Industrial Condenser Corp. ....                | 50A       |
| International Resistance Co. ....              | 39A       |
| International Telephone & Telegraph Corp. .... | 59A       |
| Jackson Electrical Instrument Co. ....         | 60A       |
| Kenyon Transformer Co., Inc. ....              | 49A       |
| James Knights Company .....                    | 19A       |
| Lafayette Radio Corporation .....              | 56A       |
| Measurements Corporation .....                 | 52A       |
| John Meck Industries .....                     | 37A       |
| National Company, Inc. ....                    | 18A       |
| National Union Radio Corp. ....                | 9A        |
| New York Transformer Co. ....                  | 56A       |
| North American Philips Company, Inc. ....      | 34A       |
| Ohmite Manufacturing Company .....             | 55A       |
| Permoflux Corporation .....                    | 58A       |
| Pioneer Gen-E-Motor Corp. ....                 | 36A       |
| Radio Corp. of America, Victor Div. ....       | 25A, 32A  |
| RCA Aviation Radio .....                       | 45A       |
| Rauland Corporation .....                      | 31A       |
| Raytheon Manufacturing Company .....           | 20A       |
| Remler Company, Ltd. ....                      | 40A       |
| Rola Company .....                             | 17A       |
| Shure Brothers .....                           | 57A       |
| Sola Electric Company .....                    | 53A       |
| Sprague Specialties Company .....              | 35A       |
| Stackpole Carbon Company .....                 | 28A       |
| Standard Transformer Corp. ....                | 30A       |
| Stupakoff Ceramic & Mfg. Co. ....              | 41A       |
| Sun Radio Company .....                        | 58A       |
| Superior Electric Company .....                | 51A       |
| Taylor Tubes, Inc. ....                        | 43A       |
| Templetone Radio Company .....                 | 46A       |
| Thordarson Elec. Mfg. Co. ....                 | 62A       |
| Triplett Electrical Instrument Co. ....        | 23A       |
| Turner Company .....                           | 54A       |
| United Transformer Company .....               | 6A        |
| Utah Radio Products Company .....              | 4A        |
| Westinghouse Elec. & Mfg. Co. ....             | 7A        |
| Wilcox Electric Company .....                  | 15A       |

# A Long Life

## AND A USEFUL ONE

On the job doing their duty all the time—that's the reputation of Tobe Capacitors, earned through an almost complete absence of "returns!"

This record, far from making Tobe engineers complacent, acts as a spur to even higher quality, through constant research in materials and methods. Each Tobe Capacitor continues to be rated with ultra-conservatism.

The Tobe Oil-Mite Capacitor, shown here, is impregnated and filled with mineral oil. It is performing day-in, day-out duty as a filter condenser in war equipment. Inquiries in connection with your condenser problems will receive our prompt attention.



### LONG LIFE ASSURED

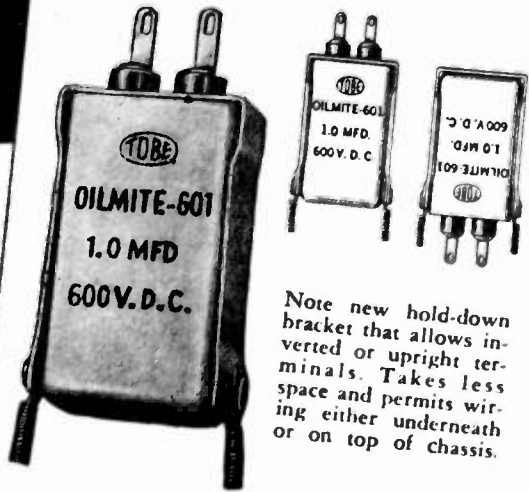

Note new hold-down bracket that allows inverted or upright terminals. Takes less space and permits wiring either underneath or on top of chassis.

### CHARACTERISTICS OF TOBE OIL-MITE CAPACITORS

- STANDARD CAPACITY TOLERANCE. = 10%
- TEST VOLTAGE Twice D.C. rating
- SHUNT RESISTANCE .05 to 0.1 mfd. 20,000 megohms. .25 to 0.5 mfd. 12,000 megohms. 1.0 to 2.0 mfd. 12,000 megohms
- RATINGS .05 mfd. to 2.0 mfd. 600 V.D.C. .05 mfd. to 1.0 mfd. 1,000 V.D.C.
- GROUND TEST 2,500 Volts D.C.
- POWER FACTOR At 1,000 cycles—.002 to .005



**A SMALL PART IN VICTORY TODAY—A BIG PART IN INDUSTRY TOMORROW**

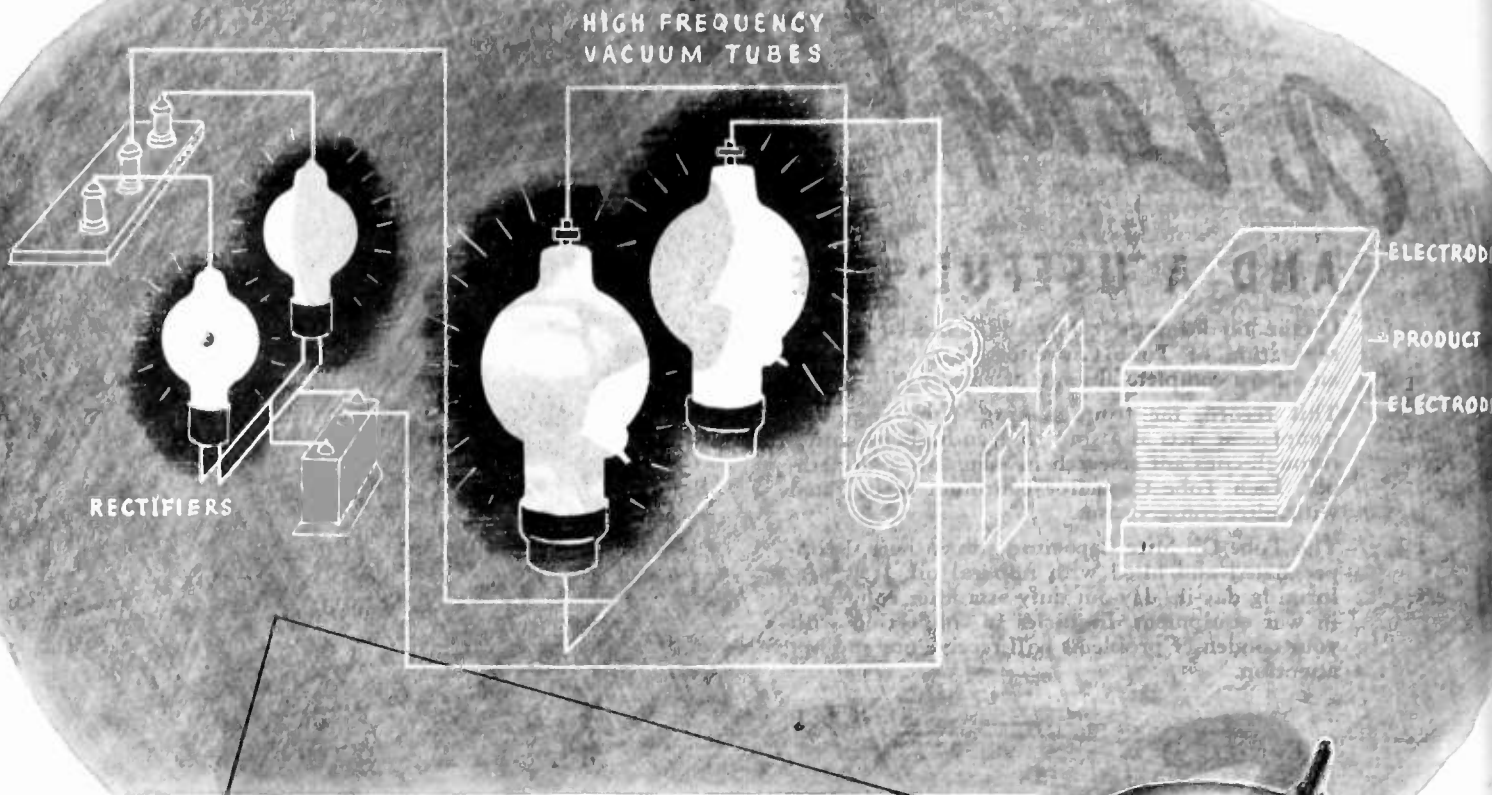

## ELECTRONIC BRIEFS: Electrostatic Heating

High frequency electrostatic heating is simply the use of electricity to create friction between the molecules of a substance. The generation of heat in non-metallic substances by molecular friction is accomplished by the application of high frequency current, which is converted from a standard power supply. The equipment used employs the basic electronic circuit used in radio transmitters. The output of the power amplifier is connected directly to the material to be heated exactly as the output of a transmitter is connected to antenna and ground. The energy is sufficient to cause the molecules within the material to distort and rub against one another very rapidly. The friction thus caused creates heat within the material.

As with all things in the field of electronics, Electrostatic heating is wholly dependent upon the vacuum tubes employed. Eimac tubes are first choice of the world's leading engineers, first in the key sockets of the important new developments in electronics. You'll get long life, dependability and superior performance with Eimac tubes in the key sockets. Today Eimac tubes are proving their superiority in the most gruelling test — WAR.

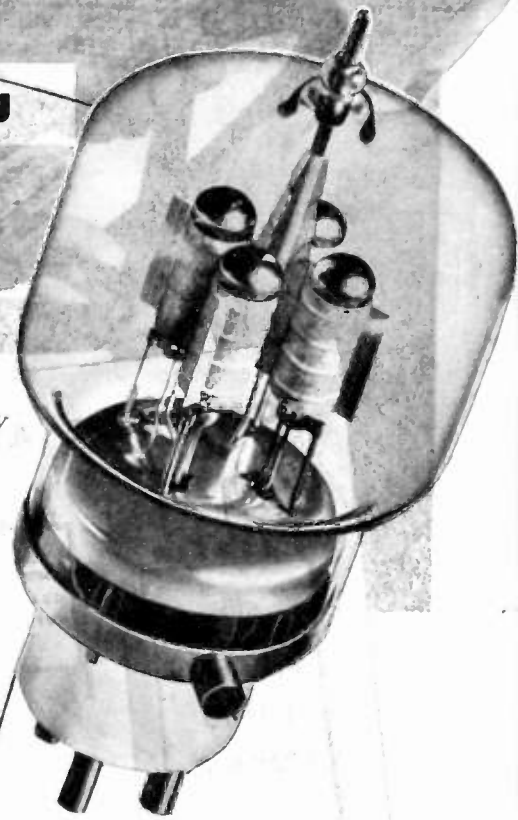

**EITEL-McCULLOUGH, INC.**

SAN BRUNO, CALIFORNIA

Export Agents: FRAZAR & HANSEN  
301 Clay St., San Francisco, California, U.S.A.

Follow the leaders to



Army-Navy "E" flag awarded for high achievement in the production of war material.

**Eimac**  
REG. U.S. PAT. OFF.  
**TUBES**

# THE CHAIN THAT MUST NOT BE BROKEN

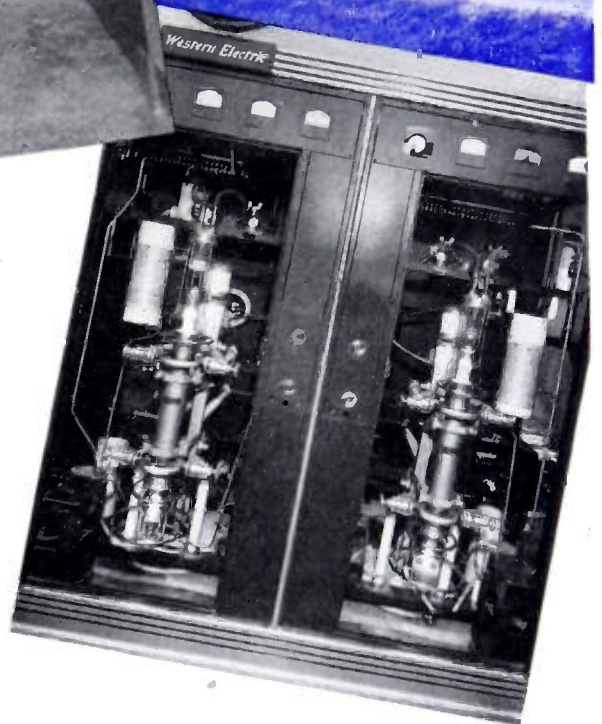
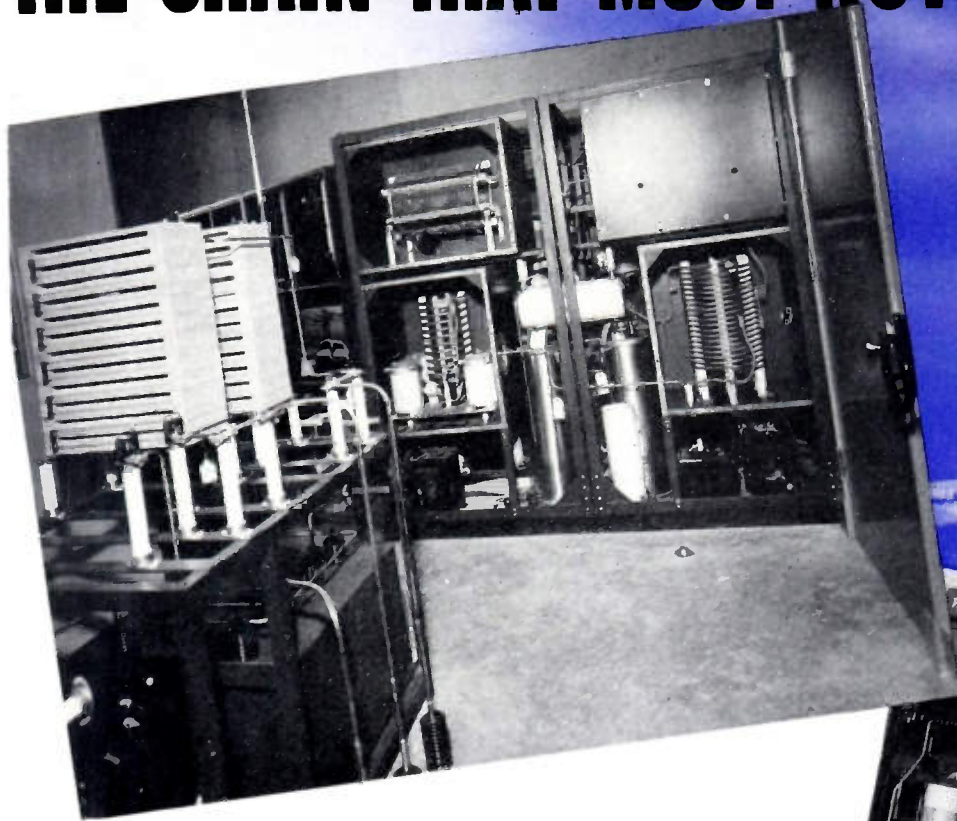

**T**HE continued private operation of America's radio network rests upon the satisfactory performance of individual stations. Forged together, these stations form a mighty chain that secures Freedom of the Air. . . . But each station can remain an organ of Freedom only as long as it discharges all the terms of its license . . . a license that must be underwritten by the assured life and dependability of the many components of a modern transmitter.

Like many of America's great stations, WLAC's transmitter, built by Western Electric Company, uses Cornell-Dubilier capacitors. Today, there are more C-D capacitors in use in broadcast station equipment than those of any other make. This universal acceptance has been won by the *extra* life, *extra* uniformity and *extra* dependability built into every C-D capacitor. Thirty-three years' exclusive specialization in capacitor manufacture is a significant guarantee of fine performance. Cornell-Dubilier Electric Corporation, South Plainfield, N. J.

*A complete range of C-D capacitors is available for all transmitting, receiving and electronic applications. Send for catalog No. 160R describing the complete line of C-D CAPACITORS.*

## Cornell-Dubilier Capacitors

MICA • DYKANOL • PAPER • WET AND DRY ELECTROLYTICS



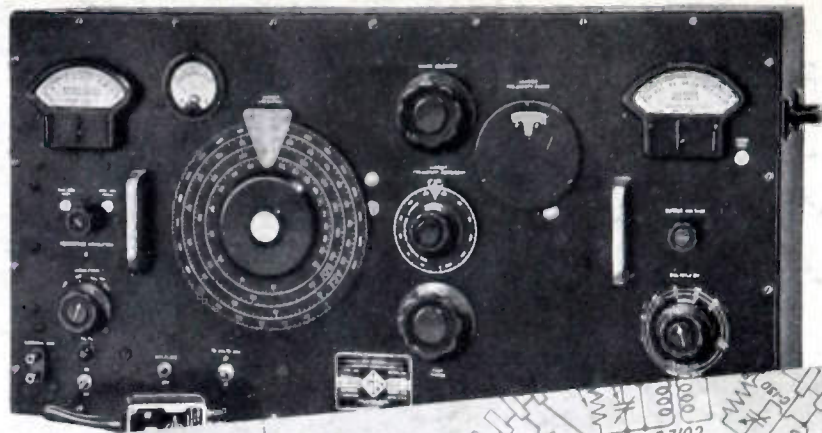

# STANDARD-SIGNAL GENERATORS

## by General Radio

SINCE General Radio pioneered the first commercial standard-signal generator in 1928, it has been the aim of our design engineers to make available signal generators for testing all types of home, commercial and military receivers.

In addition to standard catalog models, many specialized instruments have been designed and built for the armed services, in

peace time as well as in war.

Present designs collectively cover a frequency range of 300,000:1. While many of these are not at present available for general use, because of wartime secrecy requirements, they contribute to the stock of engineering design experience that will be applied to the production of commercial models after the war.

The country's leading radio receiver laboratories are equipped with General Radio signal generators, backed by 28 years' experience in building high-quality instruments.

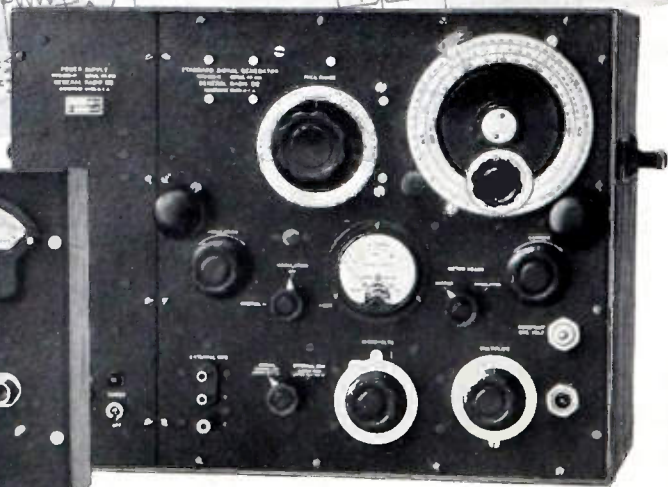
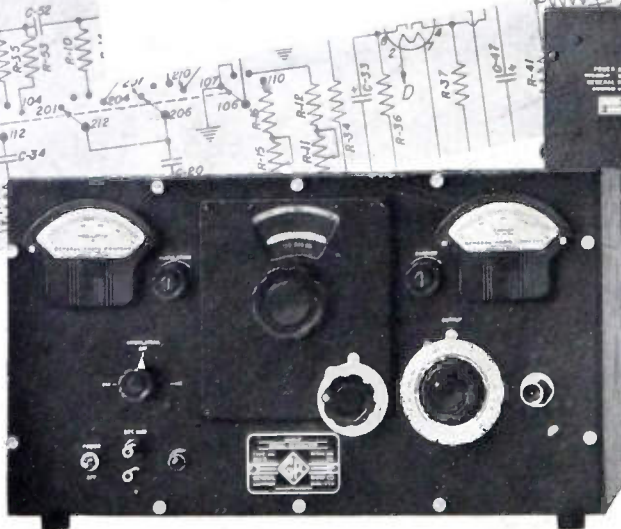
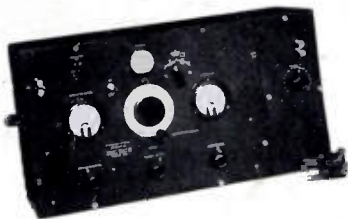

GENERAL RADIO COMPANY



Cambridge 39, Mass.  
NEW YORK 6 · LOS ANGELES 38