

# Proceedings



*of the*

# I · R · E



*Official U. S. Navy Photograph*

STRATOSPHERE RADIO SURVEY

## JUNE 1943

VOLUME 31 NUMBER 6

PART I

Postwar Research  
F-M Converter Unit  
Electrostatic Loop Shielding  
Frequency-Stabilized  
Oscillators  
Delhi Field Strength  
R-F Transmission Lines  
Hartley Oscillator  
Network Theory—Part III  
Convention Address  
Wartime Radio Engineering

# Institute of Radio Engineers



# Designs for War... Transformers

The requirements in war transformers differ considerably from those of commercial units. The UTC engineering staff has pioneered many of the design features which make possible modern war transformers. A few typical designs are illustrated.

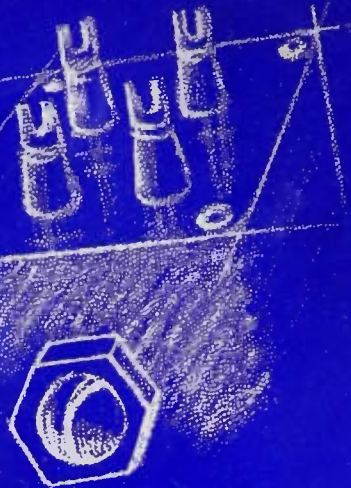

This transformer is tunable . . . ideal for signal frequency amplifiers.

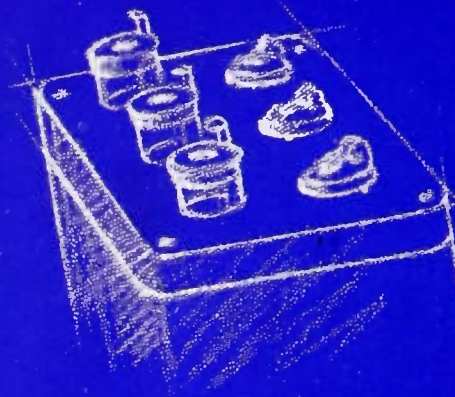

This oil filled transformer is hermetically sealed with glass high voltage terminals solder-sealed to case.

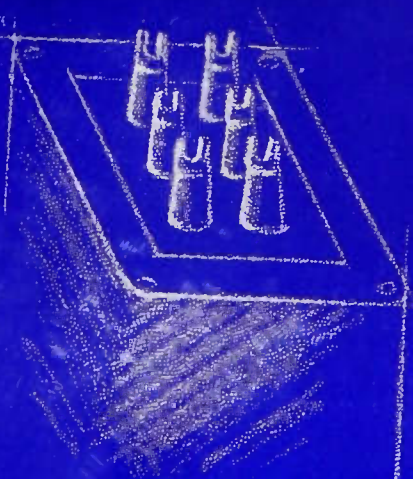

Designed for minimum amplitude distortion . . . this unit has distortion under .01% for a power range of 100:1 . . . Q over 150.

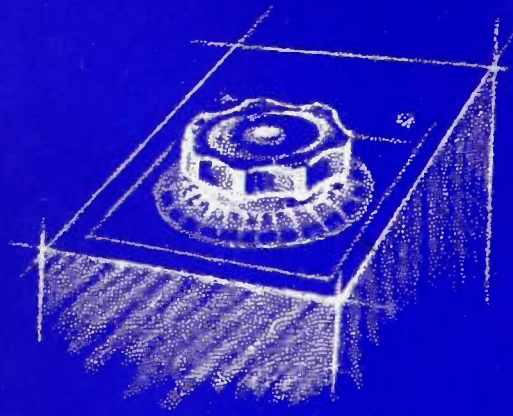

This Varitran supplies fixed filament and bias voltages, as well as variable plate voltage all in one unit.

May we design a War Unit to your application?

## UNITED TRANSFORMER CO.

150 VARICK STREET ★ NEW YORK, N. Y.  
EXPORT DIVISION: 100 VARICK STREET NEW YORK, N. Y. CABLES: "ARLAB"

BOARD OF DIRECTORS  
1943

Lynde P. Wheeler, *President*  
F. Sherbrooke Barton,  
*Vice President*  
Raymond A. Heising, *Treasurer*  
Haraden Pratt, *Secretary*  
Alfred N. Goldsmith, *Editor*  
Stuart L. Bailey  
Wilmer L. Barrow  
E. Finley Carter  
Adolph B. Chamberlain  
Ivan S. Coggeshall  
William L. Everitt  
Harold T. Friis  
Gilbert E. Gustafson  
O. B. Hanson  
Frederick B. Llewellyn  
Frederick E. Terman  
Browder J. Thompson  
Hubert M. Turner  
Arthur F. Van Dyck  
Harold A. Wheeler  
William C. White

Harold R. Zeamans,  
*General Counsel*

BOARD OF EDITORS

Alfred N. Goldsmith, *Editor*  
Ralph R. Batcher  
Philip S. Carter  
Lewis M. Clement  
Elmer W. Engstrom  
William L. Everitt  
Peter C. Goldmark  
Frederick W. Grover  
C. M. Jansky, Jr.  
John D. Kraus  
Frederick B. Llewellyn  
Samuel S. Mackeown  
Edward L. Nelson  
Harry F. Olson  
Greenleaf W. Pickard  
Haraden Pratt  
Conan A. Priest  
Lynne C. Smeby  
Browder J. Thompson  
Harold A. Wheeler  
Laurens E. Whittemore  
Gerald W. Willard  
William Wilson  
Charles J. Young

Helen M. Stote,  
*Associate Editor*  
William C. Copp,  
*Advertising Manager*  
William B. Cowlich,  
*Assistant Secretary*

# Proceedings

## of the I·R·E

*Published Monthly by*

The Institute of Radio Engineers, Inc.

VOLUME 31

*June, 1943*

NUMBER 6

Maintain Postwar Research at Wartime Level.....	S. C. Hooper	247
Albert W. Hull.....		248
260- to 350-Megacycle Converter Unit for General Elec- tric Frequency-Modulation Station Monitor.....	H. R. Summerhayes, Jr.	249
A Method of Measuring the Effectiveness of Electro- static Loop Shielding... Dudley E. Foster and Charles W. Finnigan		253
Variable-Frequency Bridge-Type Frequency-Stabilized Oscillators.....	W. G. Shepherd and R. O. Wise	256
A Note on Field Strength of Delhi 3 and Delhi 4 at Cal- cutta During the Solar Eclipse of September 21, 1941.....	S. P. Chakravarti	269
Open-Wire Radio-Frequency Transmission Lines... Edmund A. Laport		271
An Analytical Demonstration of Hartley Oscillator Action.....	F. A. Record and J. L. Stiles	281
Network Theory, Filters, and Equalizers—Part III.....	Frederick E. Terman	288
Corrections to "Network Theory, Filters, and Equal- izers—Part I," by Frederick E. Terman.....		302
Address to the Conference.....	Noel Ashbridge	302
Radio Engineering in Wartime.....	James Lawrence Fly	303
Institute News and Radio Notes.....		305
Television Prospects.....		305
Board of Directors.....		305
Executive Committee.....		306
Election Notice.....		307
Correspondence: Proposed Constitutional Amendments.....		307
Books: (For list of Book Reviews see page 287).....		309
Contributors.....		313
Section Meetings.....		xx
Membership.....		xxii
New Equipment Notes.....		xxx
Army-Navy "E" Honor Roll.....		xxxiv
Current Literature.....		xliv
Booklets.....		xliv
Radio Education Notes.....		xlvi
Positions Open.....		liv
Advertising Index.....		lxii

Responsibility for the contents of papers published in the PROCEEDINGS rests upon the authors. Statements made in papers are not binding on the Institute or its members.



Entered as second-class matter October 26, 1927, at the post office at Menasha, Wisconsin, under the Act of February 28, 1925, embodied in Paragraph 4, Section 538 of the Postal Laws and Regulations. Publication office, 450 Ahnaip Street, Menasha, Wisconsin. Editorial and advertising offices, 330 West 42nd St., New York, N. Y. Subscription \$10.00 per year; foreign, \$11.00.  
This issue of the PROCEEDINGS of the I.R.E. for June, 1943, is published in two parts. The price of Part I, which contains the technical papers and related material, is \$1.00 per copy; the price of Part II of this issue, which includes the Cumulative Index of the PROCEEDINGS from 1913 through 1942, is \$1.00 per copy.

Copyright, 1943, by The Institute of Radio Engineers, Inc.

# THE INSTITUTE OF RADIO ENGINEERS

INCORPORATED



## SECTION MEETINGS

<b>ATLANTA</b> June 18	<b>CHICAGO</b> June 18	<b>CLEVELAND</b> June 24	<b>DETROIT</b> June 18
<b>LOS ANGELES</b> June 15	<b>PITTSBURGH</b> June 14		<b>WASHINGTON</b> June 14

## SECTIONS

- ATLANTA**—Chairman, J. M. Comer; Secretary, Ivan Miles, 554—14 St., N. W., Atlanta, Ga.
- BALTIMORE**—Chairman, G. J. Gross; Secretary, A. D. Williams, Bendix Radio Corp., E. Joppa Rd., Towson, Md.
- BOSTON**—Chairman, R. F. Field; Secretary, R. O. Oberg, Northeastern Univ., Boston, Mass.
- BUENOS AIRES**—Chairman, J. P. Arnaud; Secretary, Alexander Nadosy, Florida St. 1065, Dept. C-16, Buenos Aires, Argentina.
- BUFFALO-NIAGARA**—Chairman, F. H. Scheer; Secretary, A. J. Dybowski, Dymac Radio, Inc., 1531 Main St., Buffalo, N. Y.
- CHICAGO**—Chairman, A. B. Bronwell; Secretary, W. O. Swinyard, Hazeltine Electronics Corp., 325 W. Huron St., Chicago, Ill.
- CINCINNATI**—Chairman, Howard Lepple; Secretary, J. L. Hollis, 6511 Betts Ave., North College Hill, Cincinnati, Ohio.
- CLEVELAND**—Chairman, F. C. Everett; Secretary, Hugh B. Okeson, 4362 W. 58 St., Cleveland, Ohio.
- CONNECTICUT VALLEY**—Chairman, W. M. Smith; Secretary, R. E. Moe, Radio Dept., General Electric Co., Bridgeport, Conn.
- DALLAS-FORT WORTH**—Chairman, H. E. Applegate; Secretary, P. C. Barnes, WFAA-WBAP, Grapevine, Texas.
- DETROIT**—Chairman, F. M. Hartz; Secretary, E. J. Hughes, 14209 Prevost, Detroit, Mich.
- EMPORIUM**—Chairman, R. K. Gessford; Secretary, H. D. Johnson, Sylvania Electric Products, Inc., Emporium, Pa.
- INDIANAPOLIS**—Chairman, S. E. Benson; Secretary, B. H. Rinehart, 1920 Park Ave., Indianapolis, Ind.
- KANSAS CITY**—Chairman, H. K. Morgan; Secretary G. L. Taylor, Midland Radio School Power and Light Building, Kansas City, Mo.
- LOS ANGELES**—Chairman, Lester Bowman; Secretary, R. C. Moody, Don Lee Broadcasting System, 5515 Melrose, Hollywood, Calif.
- MONTREAL**—Chairman, L. T. Bird; Secretary, J. C. R. Punchard, Northern Electric Co., 1261 Shearer St., Montreal, Que., Canada.
- NEW YORK**—Chairman, H. M. Lewis; Secretary, H. F. Dart, 33 Burnett St., Glen Ridge, N. J.
- PHILADELPHIA**—Chairman, J. B. Coleman; Secretary, H. J. Schrader, Bldg. 8, Fl. 10, RCA Manufacturing Co., Camden, N. J.
- PITTSBURGH**—Chairman, D. A. Myer; Secretary, A. P. Sunnergren, West Penn Power Co., Rm 1304, West Penn. Bldg., Pittsburgh, Pa.
- PORTLAND**—Chairman, K. G. Clark; Secretary, E. D. Scott, Rt. 14, Box 414, Portland, Ore.
- ROCHESTER**—Chairman, O. L. Angevine, Jr.; Secretary, G. R. Town, Stromberg-Carlson Tel. Mfg. Co., Rochester, N. Y.
- ST. LOUIS**—Chairman, P. S. McDaniel; Secretary, H. D. Seielstad, 1017 S. Berry Rd., Oakland, St. Louis, Mo.
- SAN FRANCISCO**—Chairman, Karl Spangenberg; Secretary, David Packard, Hewlett-Packard Co., Palto Alto, Calif.
- SEATTLE**—Chairman, L. B. Cochran; Secretary, H. E. Renfro, 4311 Thackeray Pl., Seattle, Wash.
- TORONTO**—Chairman, T. S. Farley; Secretary, J. T. Pfeiffer, Erie Resistor of Canada, Ltd., Terminal Warehouse Bldg., Toronto, Ont., Canada.
- TWIN CITIES**—Chairman, R. E. Allison; Secretary, A. G. Peck, Twin-Cities Studios, Columbia Broadcasting System, 625 Second Ave., Minneapolis, Minn.
- WASHINGTON**—Chairman, C. M. Hunt; Secretary, H. A. Burroughs, Rm. 7207, Federal Communications Commission, Washington, D. C.



# Meeting the mica-capacitor shortage . . .

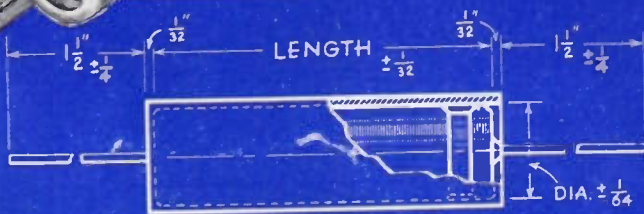
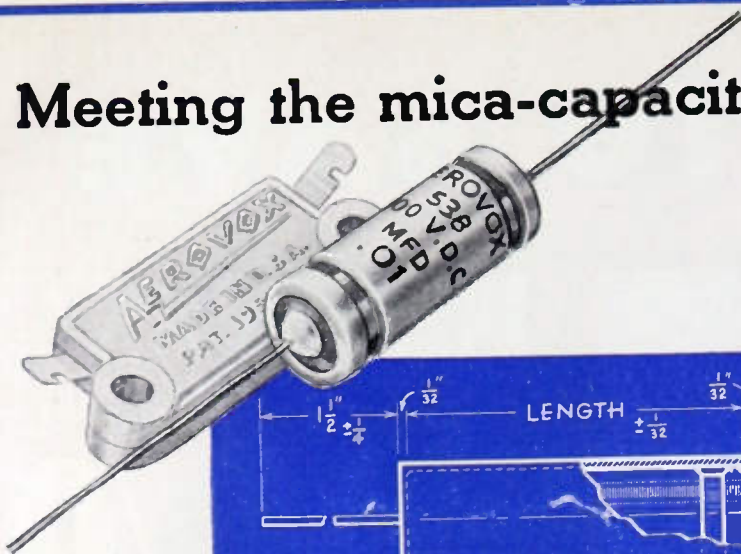

In three sizes:  
5/16 x 1-3/16"  
7/16 x 13/16"  
7/16 x 1"

FOR INSULATING TUBE: ADD  $\frac{1}{16}$ " TO DIA. AND  $\frac{1}{16}$ " TO LENGTH

## MICA-CAPACITOR

# Alternates

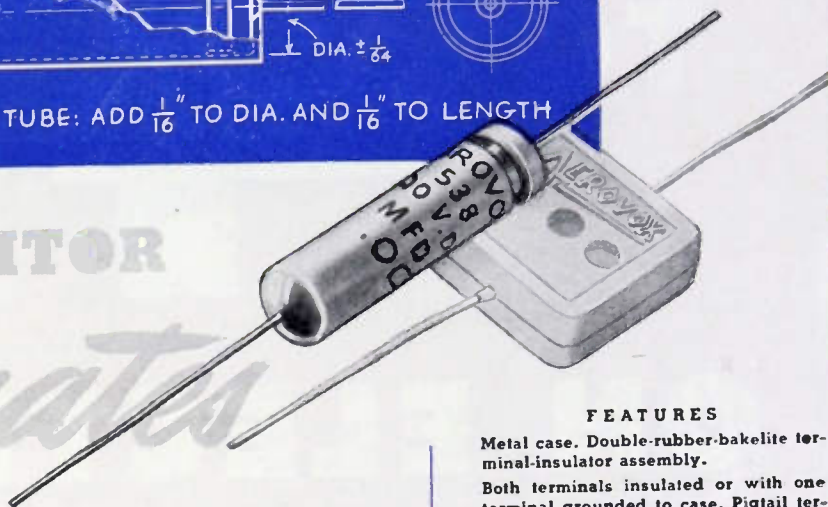

### FEATURES

Metal case. Double-rubber-bakelite terminal-insulator assembly.

Both terminals insulated or with one terminal grounded to case. Pigtail terminals.

Normally without outer sleeve. Can be had with insulated sleeve, adding 1/16" to diameter and length. Note dimensional drawing.

Vegetable (Hyvol) or mineral oil impregnant and fill.

300 to 800 v. D.C.W. Capacities of .001 to .01 mfd.

Capacitance tolerances up to but not including .01 mfd. -20% +50%; .01 mfd. -10% +40%.

### OUR WAR EFFORT

From January 1941 to December 1942, Aerovox . . .

- Stepped up production output 500% for our armed forces.
- Increased production floor space 300%.
- Sought, hired, trained and put to work additional workers—a 300% increase in productive personnel.
- Opened second plant in Taunton, bringing work to available workers there.
- And—doing more and more; growing week by week!

• An alternate choice for those hard-to-get mica capacitors in most applications—that was the problem put up to Aerovox engineers.

Various applications were studied. Voltages, capacitances, frequencies, power factor—these and other factors were considered along with dimensional limitations, after the manner of A.A.E.\* Out of it all evolved this new Aerovox Type 38 mica-capacitor alternate now in production.

Here is a miniature oil-filled metal-case tubular. Ideal for assemblies where both space and

weight are at absolute minimum. Requires no more space than mica capacitor it replaces. Conservatively rated. No skimping of insulation or oil-fill despite minute dimensions (see drawing). Meets all standard specifications for paper-dielectric capacitors used as mica alternates. (See brief specifications.)

Type 38 mica-capacitor alternate is but one of several new wartime capacitors described and listed in our latest Capacitor Catalog. Write on business letterhead for your registered copy.

\*Aerovox Application Engineering.



# Capacitors

INDIVIDUALLY TESTED

AEROVOX CORPORATION, NEW BEDFORD, MASS., U. S. A. • SALES OFFICES IN ALL PRINCIPAL CITIES  
Export: 100 VARICK ST., N. Y. C. • Cable: 'ARLAB' • In Canada: AEROVOX CANADA LTD., HAMILTON, ONT.

**HOW TO SAVE**

**UP TO 47%**

**ON ELECTRICAL  
COIL FORMS!**

**NEW**  
**CORNING**  
**MULTIFORM**  
**GLASS**  
**INSULATORS**



**"YOU HAVE DONE A GOOD JOB  
OF SENDING GLASS TO WAR"**

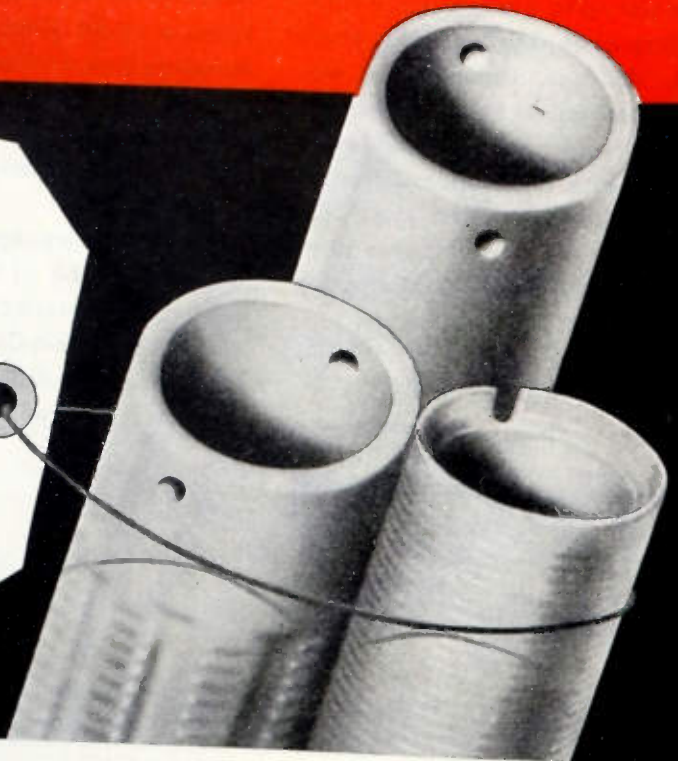



# HERE'S ALL YOU DO TO MAKE ROCK BOTTOM SAVINGS



**READ THIS QUICK CHECK LIST  
THEN MAIL COUPON FOR  
COMPLETE STORY!**

## YOU ENJOY LOWEST PRICES WHEN YOUR COIL FORMS COME WITHIN THESE STANDARDS

- \*1. OUTSIDE DIAMETERS between 1 inch and 3 inches.
- \*2. WALL THICKNESSES between 5/32 inch and 9/32 inch.
- \*3. LENGTHS up to 9 inches (with better prices for shorter lengths).
- \*4. MAXIMUM of 20 holes for coil forms 1/4 inch and 9/32 inch thick with maximum of 4 holes tapped.
- \*5. MAXIMUM of 10 holes for coil forms 5/32 inch to 7/32 inch thick with maximum of 2 holes tapped.
- \*6. MAXIMUM of 14 grooves to the inch.
- \*7. TOLERANCES on general dimensions  $\pm 2.0\%$ , but not less than  $\pm 0.010$  inches.

*In addition to low-cost standard types, Corning Multiform Insulators may be had in almost any other size or shape.*

**CLIP THIS COUPON TO YOUR  
BLUE PRINT-MAIL TODAY  
FOR ACCURATE QUOTATION!**

Corning Glass Works  
Insulation Division, Dept. P-66, Corning, N.Y.

Please send us estimate on coil forms as per attached blueprint and data below:

Quantity.....

When Needed (date).....

Electrical Characteristics.....

Acceptable Revisions.....

Name.....

Company.....

Street.....

City..... State.....

**Pyrex Insulators**  
BRAND

"PYREX" is a registered trade-mark and indicates manufacture by Corning Glass Works.



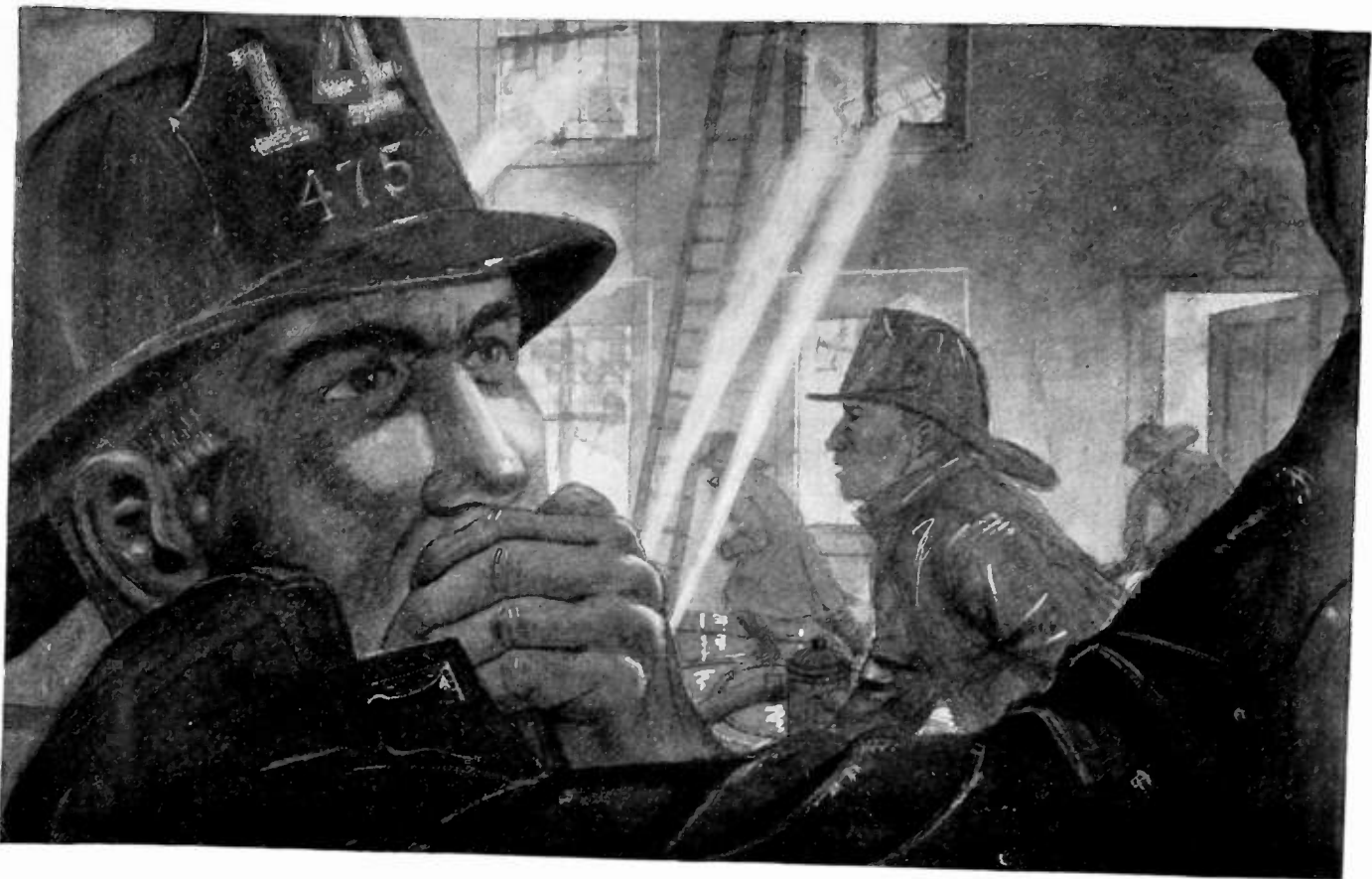

## For tough assignments

Above the din of engine motors and excited spectators, a Fire Chief directs his men. The microphone in his hand has a tough assignment. Upon its ability to transmit clear, undistorted orders, free from extraneous noises, depends much of the action of the fire-fighters.

Some day the standard equipment of all fire departments will probably include Electro-Voice Microphones specifically designed for such applications. Right now, however, these new developments, like your boy, are away from home . . . in the thick of battle.

Meanwhile, if your limited quantity needs may be filled by any of our Standard Model Microphones, with or without minor modifications, we suggest that you contact your local radio parts distributor. His knowledge of our products will be of invaluable aid in helping you to solve your problems. He can also be a vital factor in expediting your smaller orders.

Any model Electro-Voice Microphone may be submitted to your local supplier for TEST and REPAIR at our factory.



# Electro-Voice MICROPHONES

ELECTRO-VOICE MANUFACTURING CO., INC.

1239 SOUTH BEND AVENUE, SOUTH BEND, INDIANA

Proceedings of the I.R.E. June, 1943

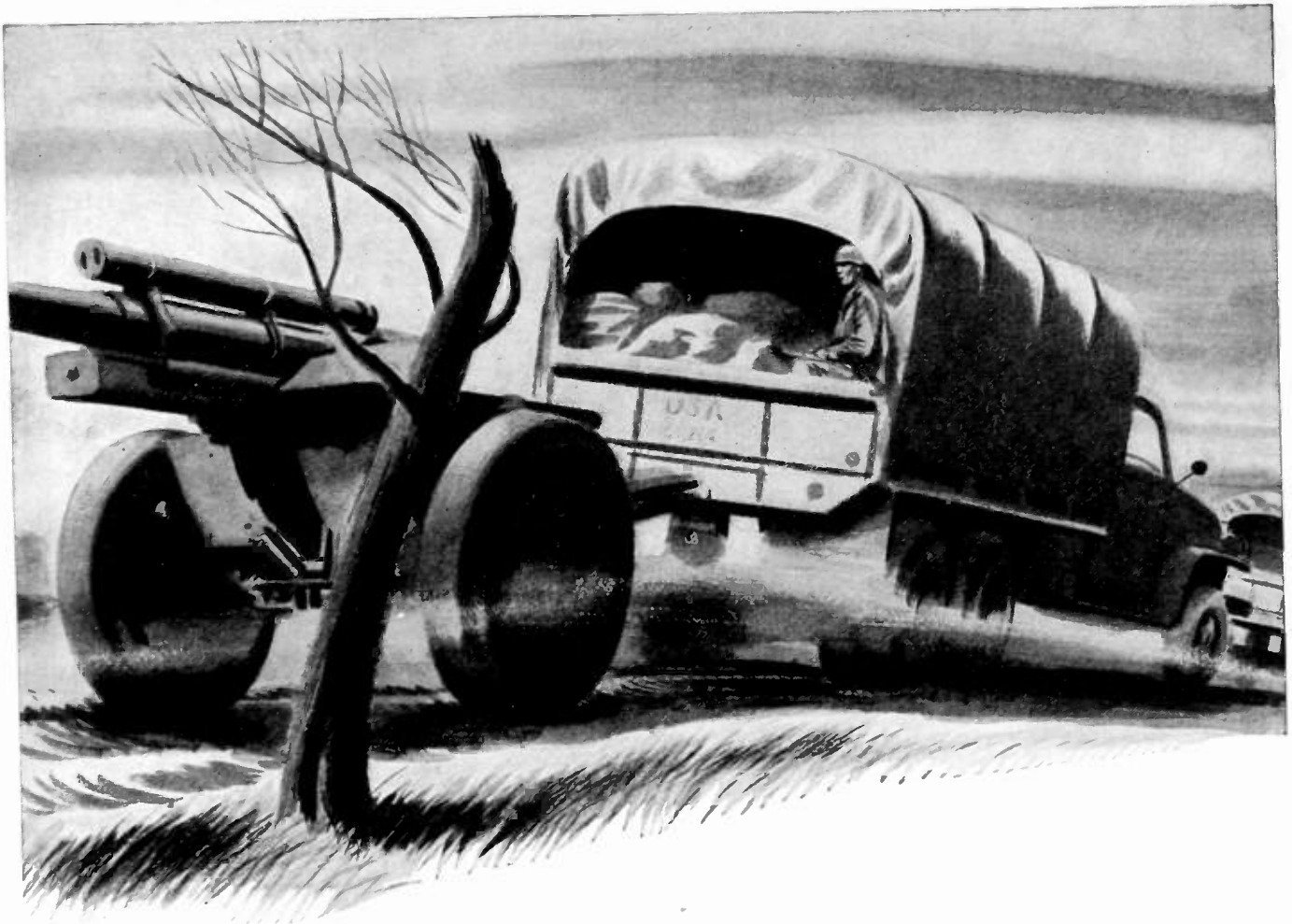

## Speaking of superior races . . .

**E**VERY WHEEL that rolls on the battle-field turns in a polished bearing race. ruggedly built to take the terrific shock of combat service.

To withstand such punishment, bearing races must be hardened by heat-treatment. Hard and soft spots occasionally occur. Such races may fail—at times when failure means disaster.

Recognizing the vital need, Westinghouse Research Engineers set to work to develop a quick, sure method of detecting these flaws.

Their ingenious electromagnetic flaw-detector is based upon the fundamental law that the *permeability* of a heat-treated steel part varies with the degree of hardness.

In actual practice, the bearing race is *completely* demagnetized. Then it is rapidly rotated and strongly magnetized. While the race is still turning at high

speed, its magnetic field is explored with a specially designed electromagnetic "pick-up."

Variations in the magnetic field of the bearing race, due to hard or soft spots, induce feeble currents in the pick-up system. These currents are amplified and shown visibly on a cathode-ray oscilloscope.

A uniformly heat-treated bearing race traces a *luminous straight line* on the oscilloscope screen. Faulty heat-treating shows up as a pattern of *hills and valleys*.

The electromagnetic flaw-detector is now being used commercially—a typical example of Westinghouse *electronics at work*.

*It assures quality in millions of bearing races for our armed forces, to keep 'em rolling on to victory!*

Westinghouse Electric & Manufacturing Company, Pittsburgh, Pennsylvania.



**Electronic fingerprints** — A Westinghouse Research Engineer demonstrates the principle of the electromagnetic flaw-detector. Hard spots in the steel test piece show up as an irregular line on the oscilloscope screen.

# Westinghouse

PLANTS IN 25 CITIES... OFFICES EVERYWHERE

*Electronics at Work*





ele



# Eimac

## ENGINEERING

The cornerstone in Eimac's existence has been their advanced electronic engineering. The development of the gas-free tube, pioneering in the use of new materials, radical changes in existing tube design... all these things are the results of their research. During today's accelerated business situation Eimac engineers have developed and put to work many outstanding innovations. Number one on this list is the actual achievement of mass production of a product that heretofore was hand-made in a scientific laboratory. Today the most interesting of other developments must be kept secret but the heads-up engineering is going forward apace. The services of this organization are available only for war problems now but will be offered to industry at large when peace comes. If you have a problem, the solution to which might involve vacuum tubes, write direct to factory.

EITEL - McCULLOUGH, INC. • SAN BRUNO, CALIFORNIA



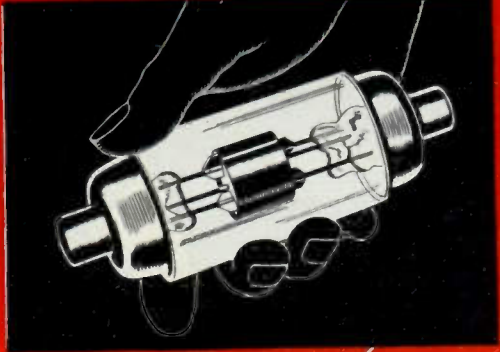

# ronic telesis\*

\* Progress consciously planned and produced by intelligently directed effort.  
— Century Dictionary and Cyclopedia

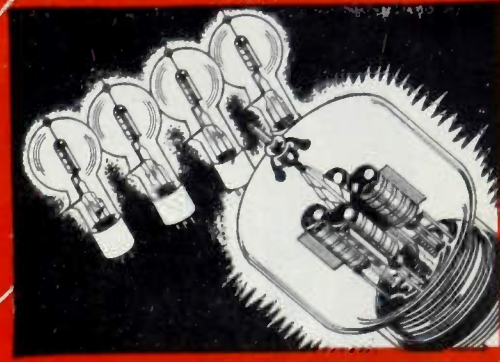

● **Eimac Tubes in the Ground Stations of the Major Airlines.** The economy, stamina and superior performance capabilities of Eimac tubes helped make the operation of complex multi-frequency transmitters practical for aircraft ground stations. Eimac 450T tubes are in use by practically every major airline today.

● **Eimac Tubes in Instrument Landing Equipment.** Airline pilots no longer need to "fly by the seat of their pants" for blind landing equipment is in regular service. There are several of these systems in existence which use Eimac tubes.

● **Eimac Tubes and Frequency Modulation.** Close cooperation between Eimac and the leading engineers throughout the world has made Eimac first choice in the important new development in radio, FM and Eimac tubes have been close companions from the very start of Major Armstrong's experiments.

● **Eimac Tubes in Police Radio Communications.** Where dependability, stamina and superior performance are extremely vital you'll find Eimac tubes every time. Police radio engineers from Connecticut to California are loud in their praise of the service of Eimac tubes.

● **Eimac Engineered the Vacuum Condenser.** Small, compact tank circuits, made possible with the Eimac vacuum condensers helped increase the efficiency of many types of radio transmitters. Since plate spacing is determined by mechanical rather than voltage limitations, actual plate area is reduced to the very minimum.

● **Eimac Developed the Vacuum Relay.** Over two years ago Eimac developed this single pole double throw vacuum relay. It handles 20,000 volts of RF potential without internal breakdown. Air pressure and humidity have no effect on it. Actually flashover will occur across outside terminals first even though contact spacing is but .015". A tribute to Eimac engineering.

● **Eimac Developed the Multi-Unit Tube.** Triode units so neatly packed that two or more can be placed in a single envelope. Power capabilities are determined by multiplying the capabilities of the single triode unit by the number of units employed in the tube. A revolutionary vacuum tube typical of Eimac's engineering leadership.

● **Power Transmission with Vacuum Tubes?** In the days to come many new uses for Eimac tubes will be announced. The use of vacuum tubes for power transmission may be one of them. Of one thing you can be sure, Eimac engineering and development will be in the forefront.

● **Eimac Tubes have gone to War.** With almost machine gun rapidity, Eimac tubes have been adopted by one after another of the peacetime services. Naturally Eimac was among the first to be drafted into war. The important job they are accomplishing today must remain secret for the duration. When the shooting is over, you'll find out why the armed services turned to Eimac so quickly.

● Coveted Army-Navy "E" award for high achievement in production for war



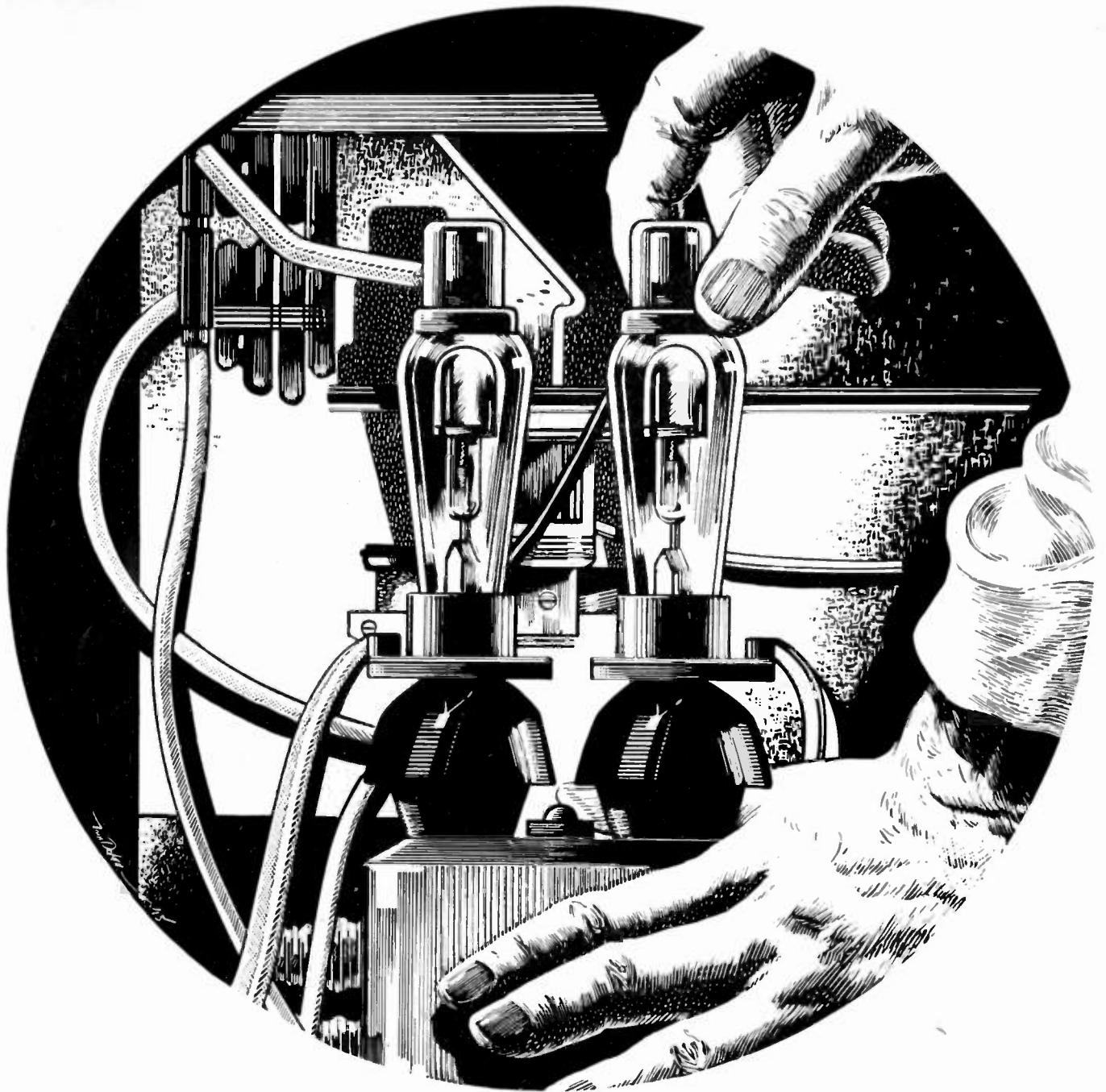

## WHEN THE LAST SHOT IS FIRED!

... and industry resumes its peacetime production for civilian life ... our boys will return to a better place to work ... made possible by new uses for electronic tubes in highly efficient air-conditioning

systems using the principle of electrical precipitation ... New tube developments are almost a daily occurrence as Raytheon progresses in its wartime and postwar programs.



# RAYTHEON

**Raytheon Manufacturing Company**

*Waltham and Newton, Massachusetts*

DEVOTED TO RESEARCH AND THE MANUFACTURE OF TUBES AND EQUIPMENT FOR THE NEW ERA OF ELECTRONICS

*Proceedings of the I.R.E.*

*June, 1943*



OUT OF TODAY'S RESEARCH . . . TOMORROW IS ENGINEERED

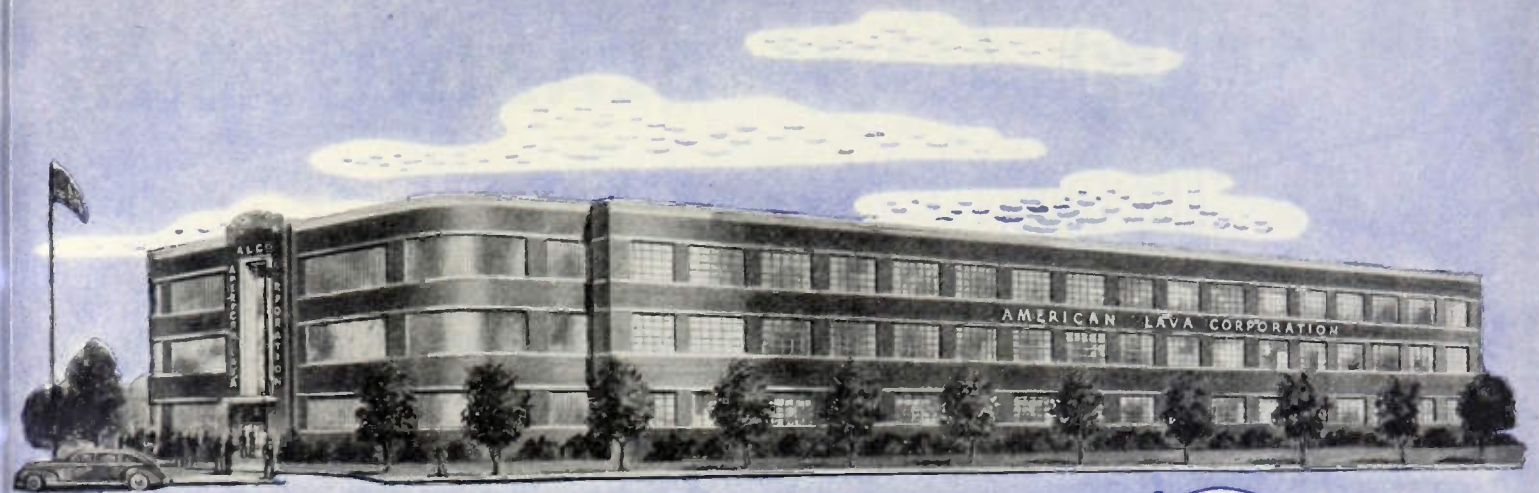

AWARDED JULY 27, 1942

# AN IMPORTANT ANNOUNCEMENT

FROM THE NATION'S LEADING PRODUCER  
OF STEATITE CERAMIC INSULATORS

DUE TO TREMENDOUS EXPANSION IN CAPACITY AND

PLENTIFUL RAW MATERIALS...THE STEATITE CERAMIC INDUSTRY

CAN SUPPLY STEATITE INSULATION FOR ALL NEEDS.

THE TRADE CAN RELY ON STEATITE

SUBSTITUTE MATERIALS ARE NOT NEEDED

**ALSI MAG**  
TRADE MARK REGISTERED U. S. PATENT OFFICE

STEATITE CERAMIC INSULATION

AMERICAN LAVA CORPORATION

CHATTANOOGA • TENNESSEE



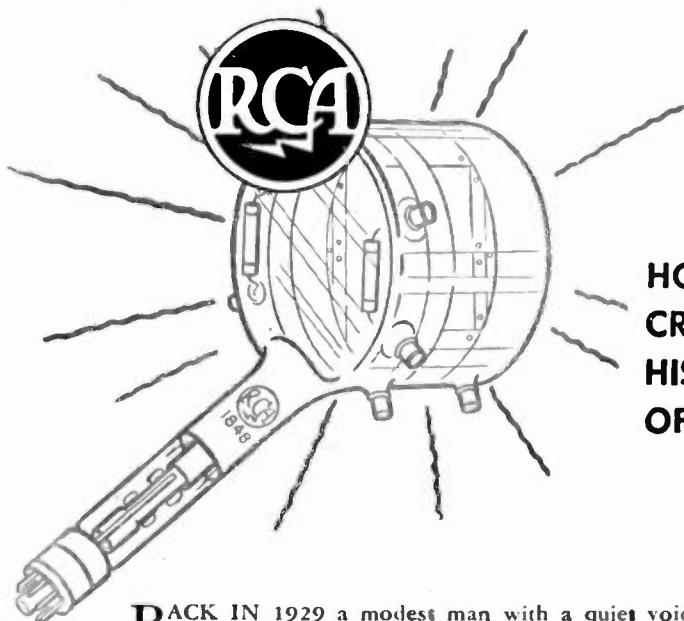

# BLAZING THE

## HOW ELECTRONIC TELEVISION WAS CREATED BY RCA LABORATORIES . . . HISTORIC STEPS IN THE EVOLUTION OF THIS NEW SCIENCE

**B**ACK IN 1929 a modest man with a quiet voice calmly announced two inventions . . . two amazing almost magic devices that made it possible for radio to "see" as well as to "hear."

This man was Dr. V. K. Zworykin of RCA Laboratories. And his research in electronics gave radio its electronic "eyes" known as the Iconoscope and the Kinescope. The former is the radio "eye" behind the camera lens; the latter is the receiver's screen.

Since that red-letter day in television history, ceaseless research in the science of radio and electron optics has established RCA Laboratories as the guiding light of television.

The decade of the thirties saw television's coming-of-age. It brought new scientific instruments and discoveries; it developed new techniques of showmanship; it even created new words—televise, telecast, televue, and telegenic.

In the evolution of television there have been "high spots"; historic milestones of progress; definite "firsts"—made possible by the services of RCA.

### 1928—1932—FROM THE FIRST

#### EXPERIMENTAL STATION TO ALL-ELECTRONIC TELEVISION



Station W2XBS, New York, was licensed to RCA in 1928 to conduct television experiments. Transmitter located at laboratory in Van Courtlandt Park, was later moved to Photophone Building, 411 Fifth Avenue; then to New Amsterdam Theatre until 1931, when operations were transferred to Empire State Building.

On Jan. 16, 1930, Television pictures were transmitted by RCA from W2XBS at 411 Fifth Avenue and shown on 6-foot screen at RKO-Proctor's 59th Street Theatre, New York.

Television station W2XBS, operated by National Broadcasting Company, atop New Amsterdam Theatre, New York, opened for tests July 7, 1930, with the images whirled into space by a mechanical scanner.

Empire State Building, the world's loftiest skyscraper, was selected by RCA as the transmitter and aerial site for ultra-short-wave television experiments using both mechanical and electrical scanners. Operation began October 30, 1931.

Field tests of 240-line, all-electronic television were made by RCA at Camden, N. J., with television signals relayed

by radio from New York through Mt. Arney, N. J., for the first time, May 25, 1932.

### 1936—OUTDOOR TELEVISION



Television outdoors was demonstrated by RCA at Camden, N. J., on April 24, 1936, with local firemen participating in the program broadcast on the 6-meter wave.

All-electronic television field tests of RCA began June 29, 1936, from ultra-short-wave transmitter in Empire State Building and aerial on the pinnacle releasing 343-line pictures.

Radio manufacturers saw television demonstrated by RCA on July 7, 1936, with radio artists and films used to entertain.

### 1937—ELECTRON "GUN"

Electron projection "gun" of RCA was demonstrated on May 12, 1937, to Institute of Radio Engineers, with pictures projected on 8 x 10-foot screen.

Television on 3 x 4-foot screen was demonstrated by RCA to Society of Motion Picture Engineers on October 14, 1937; pictures were transmitted from Empire State Building to Radio City.

Mobile television vans operated by RCA-NBC appeared on the streets of New York for first time, December 12, 1937.

### 1938—BROADWAY PLAY TELEVISED



Scenes from a current Broadway play, "Susan and God," starring Gertrude Lawrence, were telecast on June 7, 1938, from NBC studios at Radio City.

RCA announced on October 20, 1938, that public television program service would be inaugurated and commercial receiving sets offered to the public in April, 1939.

### 1939—BASEBALL—KING GEORGE VI— FOOTBALL

Opening ceremonies of the New York World's Fair televised by NBC on April 30, 1939, included President Roosevelt as first Chief Executive to be seen by television.

"A first from the diamond." Columbia vs. Princeton, May 17, 1939, televised by NBC.

# TELEVISION TRAIL

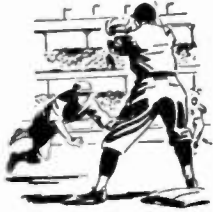

Improved television "eye" named the "Orthicon," introduced by RCA on June 8, 1939, added greater clarity and depth to the picture.

Television spectators in New York area on June 10, 1939, saw King George VI and Queen Elizabeth at the World's Fair, telecast by NBC.

Brooklyn Dodgers-Cincinnati game telecast by NBC on August 26, 1939, was the first major-league baseball game seen on the air.

First college football game—Fordham-Waynesburg—televised by NBC, September 30, 1939.

Television from NBC station in New York was picked up by RCA receiver in plane 20,000 feet over Washington, D. C., 200 miles away, October 17, 1939.

Television cameras of NBC scanned the scene in front of Capitol Theatre and in lobby at premiere of motion picture "Gone With The Wind," December 19, 1939.

## 1940—HOCKEY—COLOR—TRACK BIRD'S-EYE TELEVISION



Color television was demonstrated on February 6, 1940, to Federal Communications Commission by RCA at Camden, N. J.

First hockey game was televised by NBC camera in Madison Square Garden, February 25, 1940.

Basketball: Pittsburgh-Fordham, also NYU-Georgetown at Madison Square Garden were televised by NBC, February 28, 1940, as first basketball games seen on the air.

First Intercollegiate track meet at Madison Square Garden telecast on March 2, 1940.

Using RCA's new, compact and portable television transmitter, a panoramic view of New York was televised for the first time from an airplane on March 6, 1940. Television sightseers as far away as Schenectady saw the bird's-eye view of the metropolis.

Premiere of television opera on March 10, 1940, featured Metropolitan Opera stars in tabloid version of "Pagliacci."

First telecast of religious services on March 24, 1940, from NBC Radio City studios, were seen as far away as Lake Placid.

Ringling Brothers-Barnum and Bailey circus viewed on the air, April 25, 1940, through NBC electric camera in Madison Square Garden.

Television pictures on 4½ x 6-foot screen were demonstrated at RCA annual stockholders meeting May 7, 1940, at Radio City.

Republican National Convention was televised on June 24, 1940, through NBC's New York station via coaxial cable from Philadelphia.

Democratic National Convention films rushed by plane from Chicago for NBC were telecast in New York, July 15, 1940.

President Roosevelt was seen by television throughout the Metropolitan areas as he addressed Democratic rally, October 28, 1940, at Madison Square Garden.

Election returns on November 5, 1940, televised for first time by NBC, showed teletypes of press associations reporting the news.

## 1941—COMMERCIAL TELEVISION



Television progress demonstrated to FCC on January 24, 1941, included: home-television receiver with 13½ x 18-inch translucent screen; television pictures 15 x 20 feet on New Yorker Theatre screen; pictures relayed by radio from Camp Upton, Long Island, to New York; also facsimile multiplexed with frequency modulation sound broadcast.

Television pictures in color were first put on the air by NBC from Empire State Building Transmitter on February 20, 1941.

Large-screen television featuring Overlin-Soose prize fight on May 9, 1941, at Madison Square Garden was demonstrated by RCA at New Yorker Theatre; also, on following days, baseball games from Ebbets Field, Brooklyn.

Commercial operation of television began July 1, 1941, on a minimum schedule of 15 hours a week. NBC's station WNBT, New York, the first commercially licensed transmitter to go on the air, issued the first television rate card for advertisers, and instituted commercial service with four commercial sponsors.

Entry of the United States in World War II, enlisted NBC television in New York to aid in illustrating civilian defense in air-raid instructions in the New York area.

## 1943—AMERICA AT WAR!

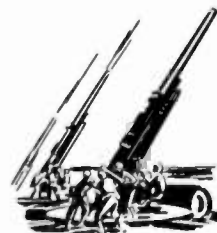

Today RCA Laboratories, pioneer in the science of electronics, is devoting all its efforts to the war.

Yet, from the discoveries, developments and inventions made under the urgency of war, will come greater wonders for the Better Tomorrow of a peacetime world.

# RADIO CORPORATION OF AMERICA

RCA BUILDING, NEW YORK

## CREATOR OF ELECTRONIC TELEVISION



# Ceramics by Centralab

## STEATITE . . .

★ Centralab's Steatite plant can furnish coil forms up to 5" diameter and pressed pieces to approximately 6 inches square. Centralab's engineering, laboratory and production experience in Ceramics extends back to 1930. In addition to Steatite, Centralab also produces other types of Ceramics.\* Consult our engineering dept. on your Ceramic problems.

\*Cordierite: a low thermal expansion type of ceramic.  
Hy Dielectric: a ceramic suitable for capacitors and special application.

# Centralab

Division of GLOBE-UNION INC., Milwaukee

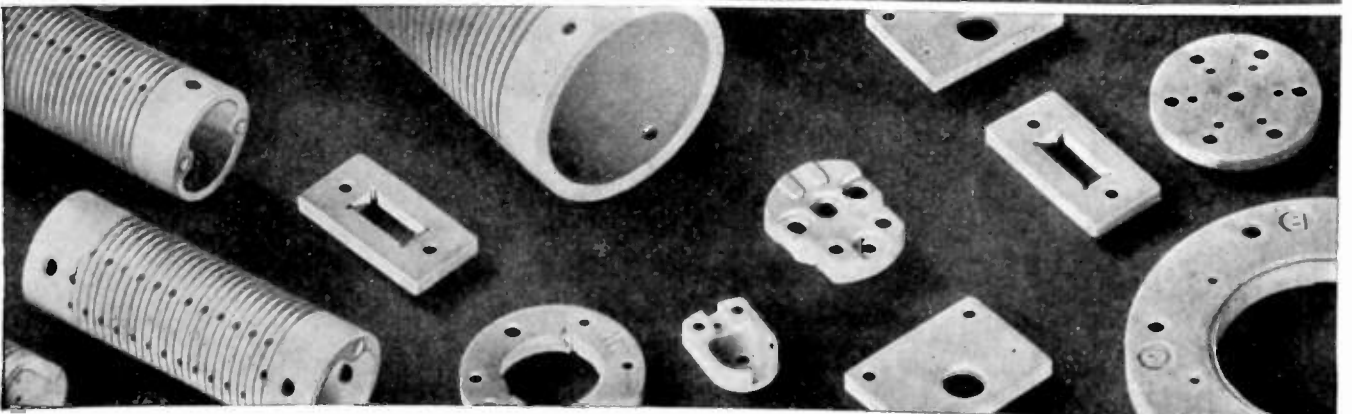





Photo, Courtesy Mid-Continent Airlines showing current Wilcox installations

## Uninterrupted Service IS Vital to Safe Air Transportation

Dependable communications are the keynote. There must be no failure. For years, Wilcox has made radio equipment to help carry on flight control safely. Today, the "know-how" of Wilcox facilities is entirely devoted to manufacture for military needs. After peace is secured, the marvels of radio development will be working for better living.

**There MUST Be Dependable Communications**  
 Communication Receivers    Aircraft Radio  
 Transmitting Equipment    Airline Radio Equipment



# WILCOX ELECTRIC COMPANY

*Quality Manufacturing of Radio Equipment*

14TH & CHESTNUT

KANSAS CITY, MISSOURI



DO THINGS BETTER, FASTER, MORE ACCURATELY—THE ELECTRONIC WAY

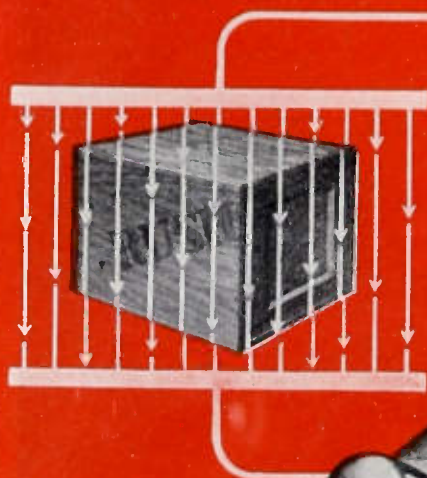

**TYPICAL ELECTRONIC JOBS DONE  
BY RCA TUBES**

Communicating • Heating • Dehydrating  
Measuring • Checking • Analyzing • Actuating  
Protecting • Testing • Detecting • Matching  
Controlling • Guiding • Sorting • Magnifying  
Rectifying • Counting • Transforming  
"Seeing" • "Feeling"

# INDUCTION HEATING

... the electronic answer to many industrial problems

## RCA TUBE PUBLICATIONS

Following are a few of the Tube publications available from RCA Commercial Engineering Section, 418 South Fifth St., Harrison, N. J.:

**RCA TRANSMITTING (Power) TUBE GUIDE** . . . 72 pages of data and circuits for popular RCA Power Tubes, U-H-F Acorn and Midget types, Gas-triodes, and Gas-tetrodes. Single copy, 35c.

**TT-100 TRANSMITTING AND SPECIAL-PURPOSE TUBES BULLETIN** . . . Illustrated catalogue information on RCA air- and water-cooled transmitting tubes, rectifiers, television tubes, voltage regulators, and special amplifiers. Single copy, no charge.

**RCA PHOTOTUBE BOOKLET** . . . Provides a clear understanding of theory, construction, and operation. Single copy, no charge.

High on the list of Electronic developments that have seen tremendous expansion under impetus of war requirements is Induction Heating.

This Electronic method has meant important savings in time and cost on jobs ranging from case hardening, annealing, riveting, and tin-plating, to food dehydration, plywood glueing and others. It has meant better heat control and greater uniformity. It has meant simplified handling of materials to be treated—and much more.

Here, as in other phases of

RADIO CORPORATION OF AMERICA



Electronic development, the radio tube is the "magic brain" of the process—and the fountainhead of modern tube development and production is RCA.

Made in varied lines for almost any Electronic application, RCA tubes afford a broad engineering selection of types, each with a background of proved performance that assures long life, utmost dependability, and high efficiency.

In the Electronics of the future, as in the Radio of today, RCA Tube engineering will continue to lead the way—all the way!

RCA Victor Division, Camden, N. J.

# RCA RADIO-ELECTRONIC TUBES

High-vacuum, gas, and vapor tubes • Voltage amplifiers • Low-power and medium-power tubes • Cathode-ray tubes • Rectifiers • Voltage regulators • Relay tubes

As the war progresses and the day of victory of the United Nations steadily approaches, it is natural that the thoughtful leaders in the field of radio planning should consider certain major procedures which may prove helpful in peacetime and which will contribute to national insurance of safety in the regrettable but conceivable event of a later recurrence of hostilities.

Prominent among the constructive thinkers in the radio field for more than a generation is Admiral S. C. Hooper of the United States Navy. Both Naval and commercial communications owe much to his devoted and untiring efforts. These facts give added weight to the timely and analytic conclusions he has presented in the following statement which he has prepared for the PROCEEDINGS of the I.R.E. It is to be hoped that his recommendations will receive the careful consideration which they fully merit.

*The Editor*

## Maintain Postwar Research at Wartime Level

REAR ADMIRAL S. C. HOOPER, U.S.N. (RETIRED)

Everyone interested in research knows that by far the greatest advances in the applications of new ideas have occurred during war time. That was true in World War I and again in the present war. Advances in aviation and electronics have been especially noteworthy during these periods. After war is over, the public, through industry, profits by such developments.

The ideas for new inventions seem to come with about the same frequency, be it in war or peace; but for some reasons there is not the same intense interest in developing these ideas in peacetime as in war. One reason for this difference is because nations at war are willing and anxious to spend unlimited funds for developments during wartime; whereas in peacetime, the money goes to other things.

In wartime, funds can be easily obtained to push even those developments which have hardly a hope of being successful, whereas in peacetime this is not usually the case.

Again, during war, the research groups are given great encouragement and expanded manifold; then when peace comes a large percentage of young and promising research talent is lost forever to other activities.

In studying postwar plans, it seems to me that those interested in this subject should conduct a serious study, perhaps under the sponsorship of the National Research Council (with the assistance of technical societies such as The Institute of Radio Engineers) and endeavor to change the old-time custom of having research "slough off" at the end of the war.

Another point to consider is that it took nearly a year to perfect the organization and molding of nongovernment owned research facilities and personnel into a co-operative machine engaged in war research, and to knit and co-ordinate this machine with the War and Navy Departments. Even now such operation and co-ordination are not perfect. The question of preserving the present arrangements, or providing a better substitute, should also be studied.

The Naval and Military laboratories are usually cut to the bone after a war. This is literally not "good business." These laboratories should be preserved for the particular function of carrying on such original research as cannot be obtained by contract or otherwise from nongovernment laboratories, and for research necessary to apply commercial discoveries to Military and Naval purposes. A farsighted policy should be adopted on this feature. Whatever policy is decided upon should be such that the nongovernment laboratories should be depended upon to the utmost and the closest possible co-operation between government and private laboratories assured.

The progress and prosperity of our nation, as well as the readiness of its forces for war, are in no small measure dependent upon keeping peacetime research going full speed.



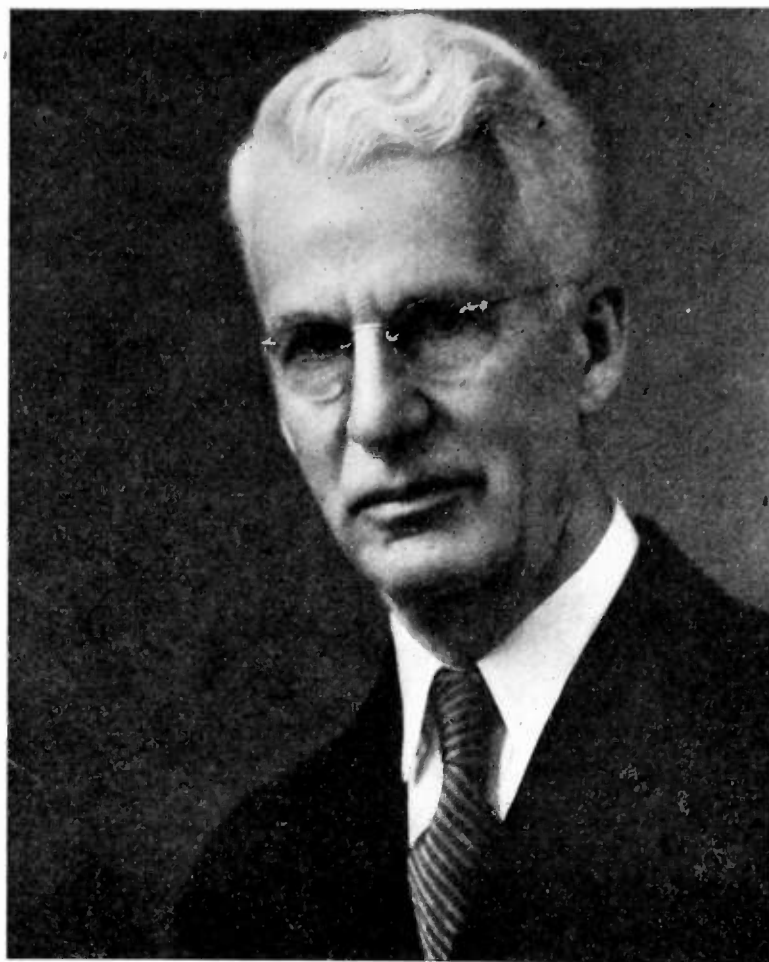

## Albert W. Hull

His fellow members in The Institute of Radio Engineers will note with pleasure the elevation of Dr. Albert W. Hull to the Presidency of the American Physical Society for 1943. They have followed his career in the radio-and-electronic field since its earliest days and are aware of his major contributions to that field. The society which he now heads includes about 4000 physicists and workers in allied fields.

Dr. Hull joined the Institute in 1916, and is now a Member of that body. His notable contributions to the vacuum-tube art include the following papers to which frequent reference is made and which have appeared in the PROCEEDINGS of the I.R.E.:

"The Dynatron, A Vacuum Tube Possessing Negative Resistance," volume 6, pages 5-37; February, 1918.

"The Dynatron Detector—A New Heterodyne Receiver for Continuous and Modulated Waves," volume 10, pages 320-344, October, 1922.

"A Combined Kenotron Rectifier and Plotron Re-

ceiver Capable of Operation by Alternating Current Power," volume 11, pages 89-97; April, 1923.

Dr. Hull was born in Southington, Connecticut, in 1880. He received the degree of Ph.D. from Yale University in 1909 and the degree of Sc.D. from Union College in 1930. From 1909 to 1914 he was an instructor in physics at Worcester Polytechnic Institute, then joining the Research Laboratory staff of the General Electric Company and in 1928 rising to the post of Assistant Director of the Laboratory, which post he now holds.

His work in the field of X-ray crystal analysis won him the Howard N. Potts medal of the Franklin Institute in 1923. The many contributions made by him to existing knowledge of vacuum tubes and electronic methods led to the award to him in 1930 of the Morris Liebmann Memorial Prize of The Institute of Radio Engineers. He also holds the honorary degree of Sc.D. from Union University.

# 260- to 350-Megacycle Converter Unit for General Electric Frequency-Modulation Station Monitor\*

H. R. SUMMERHAYES, JR.†, ASSOCIATE, I.R.E.

**Summary**—The development of an ultra-high-frequency converter unit is described. This unit is used in conjunction with a General Electric frequency-modulation station monitor to measure the characteristics of frequency-modulation transmitters operating in the 260- to 350-megacycle frequency range. Particular emphasis is placed upon a discussion of the variable inductance-tuning elements which were developed for use in the ultra-high-frequency mixing stage of the converter unit.

## I. INTRODUCTION

THE constant advance of the art of radio communications has been characterized in recent years by the use of higher and higher frequencies. As the useful frequency range has been pushed upward, new circuit components and new techniques have been utilized to solve the new problems presented by these higher frequencies. Up to frequencies in the order of 300 megacycles, coils and tuning capacitors can usually be made to give sufficiently high impedances in tube circuits to enable reasonable amplification to be realized. However, at still higher frequencies the tube must be treated as an integral part of some sort of transmission-line-type structure or resonant cavity.

There is a border line of frequency somewhere in the region of 30 to 300 megacycles where it becomes uncertain for any particular application as to which type of structure, lumped constant, or distributed constant, may be used to the best advantage. In this paper an application is described in which especially designed lumped-constant variable inductors are used to tune a 260- to 350-megacycle mixing circuit. This application represents a border-line case where it is felt that the lumped-constant elements have been pushed to the maximum frequency of their usefulness and yet where they still exhibit the advantages of small size and ease of tuning over a range as compared with transmission-line structures.

The need for these special tuning inductors was encountered during the development of an ultra-high-frequency converter unit used in the 260- to 350-megacycle frequency range.

The requirements for the converter unit will be listed and then a discussion of the design will follow with particular emphasis on the mixer stage and on the variable-inductance tuners. The specifications and performance of a commercial unit will be given.

## II. REQUIREMENTS FOR 260- TO 350-MEGACYCLE CONVERTER UNIT

Frequency-modulation programs are often relayed from the studio to the main transmitter by low power,

ultra-high-frequency radio-relay stations. These are the so-called ST (studio-to-transmitter) stations. The Federal Communications Commission requires that monitoring facilities be provided at these stations to indicate the center frequency and the percentage modulation of the radiated signal. Since a frequency-modulation monitor capable of accomplishing these tasks in the 42- to 50-megacycle high-frequency broadcasting band had already been developed, it was thought well to extend the usefulness of this unit by the addition of a frequency converter to enable monitoring these ultra-high-frequency studio-to-transmitter relay stations.

The studio-to-transmitter band extends from 330.4 to 343.6 megacycles but the operating-frequency range of the converter unit was designed to extend over a broader range from 260 to 350 megacycles so as to include television sound relaying and other services as well as the studio-to-transmitter service. The converter-monitor combination may be used as a companion unit to the General Electric Type GF-8-A studio-to-transmitter transmitter which uses  $\pm 75$  kilocycles swing as 100 per cent modulation.

The design of the General Electric frequency-modulation station monitor establishes the 100 per cent modulation limit which can be monitored by the combined converter-monitor unit to be  $\pm 75$  kilocycles frequency swing. This is what is most commonly used in these studio-to-transmitter services at the time of writing although the Federal Communications Commission allows a maximum of  $\pm 200$  kilocycles swing to be used.

Considerations of the transmitter power available for monitoring and of the losses which would be encountered in a maximum of 1000 feet of radio-frequency connecting cable led to a specification of 0.3 volt root-mean-square in 72 ohms as the minimum radio-frequency power available at the input to the converter.

The tolerance on the frequency of transmitters in this service as prescribed by the Federal Communications Commission is  $\pm 0.01$  per cent of the assigned frequency. This requirement applied to the maximum frequency to be monitored, 350 megacycles, fixes the frequency indication required in the converter-monitor combination at  $-35$  to  $+35$  kilocycles full scale with respect to the assigned frequency. Fortunately, the frequency-discriminator circuit in the existing monitor

\* Decimal classification: R254XR414. Original manuscript received by the Institute, January 4, 1943.

† General Engineering Laboratory, General Electric Company, Schenectady, New York.



has a linear-detection characteristic over a band broad enough to accommodate both the normal  $\pm 75$ -kilocycle swing of the instantaneous frequency during modulation and also the permissible  $\pm 35$ -kilocycle deviation of the mean frequency of the transmitter.

It was also desired to provide in the converter unit a means for measuring relative transmitter power.

### III. PRINCIPLE OF OPERATION

The main function of the converter unit is essentially very simple. It is to convert the nominal frequency of the incoming frequency-modulated wave from its original value in the ultra-high-frequency

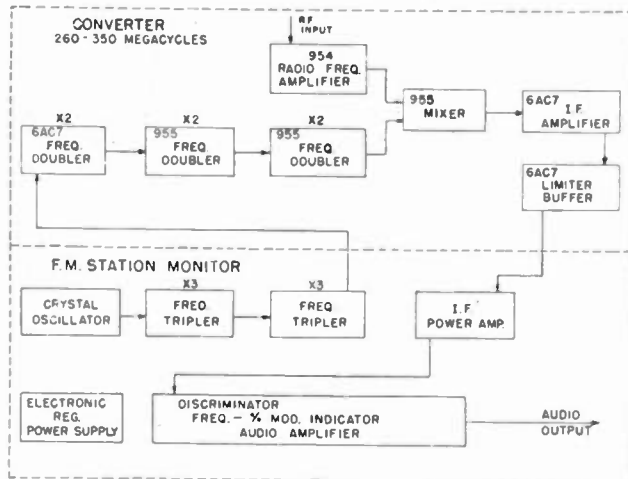

Fig. 1—Block diagram of 260- to 350-megacycle converter and frequency-modulation station monitor.

region down to 5.4 megacycles and to supply this signal to the monitor unit for measurement and indication. The frequency conversion is accomplished by heterodyning the incoming wave against the 72nd harmonic of a precision crystal oscillator which is adjusted to give exactly 5.4 megacycles frequency difference between its 72nd harmonic and the nominal frequency of the particular transmitter to be monitored. The crystal oscillator used for this purpose already exists in the monitor unit where it is followed by two frequency-tripling stages (see Fig. 1). From the second of these tripler stages, the ninth harmonic signal is supplied to the converter unit where there are three additional  $L$ - $C$  frequency-doubling stages which bring the multiplied crystal frequency up to the required value for heterodyning with the incoming signal to be monitored.

The choice of three doubling stages to accomplish the frequency multiplication was determined by the available frequency range in the existing monitor stages, the range of frequency of the signals to be monitored, and the allowable degree of multiplication per stage consistent with sufficient output. The first two factors established the over-all multiplication to be approximately eight, and the last one favored the use of three doubler stages rather than two tripler stages. The ninth harmonic of the crystal frequency is

transferred from the monitor unit to the adjacent converter unit by means of a short coaxial cable link joining a low-impedance tap on the tuned coil in the monitor to a low-impedance tap on a similar tuned coil at the input to the converter.

The first two doubler stages in the converter exhibit no unusual design problems; there is no difficulty in obtaining sufficiently high impedance to get good output with ordinary variable air capacitors and air-core inductance coils. A 6AC7 tube is used in the first doubler stage since the output frequencies here are relatively low (64 to 86 megacycles). In the second doubler stage, a 955 acorn-type triode tube with a very small coil and a low minimum variable air capacitance in its plate circuit is made to tune without difficulty over the 127- to 172-megacycle range. But in the next doubler stage where the frequency range in the plate circuit is 255 to 345 megacycles, the ordinary coil and capacitor tuning methods break down because their minimum inductance and capacitance are too high, especially when means are also provided here for mixing the input signal with the output of the final doubler. The design of the mixing stage will be considered in a succeeding section.

Following the mixer stage is a grid-rectifying type 955 acorn-tube detector which causes the 5.4-megacycle intermediate-frequency signal to appear across its plate load. It is to be remembered in this connection that the process of heterodyning does not affect the bandwidth of the incoming frequency-modulated wave so that the frequency swing remains unchanged after conversion to 5.4 megacycles.

The plate circuit of the 955 detector is coupled to the grid of the next stage through a broad-band, tuned-intermediate-frequency transformer.

This next stage gives amplification sufficient to produce limiting action by simple overload of the grid circuit of the output tube. The intermediate-frequency signal is then coupled from the plate circuit of the output tube back into the monitor unit through a short length of low-capacitance cable in parallel with 350 ohms plate-load resistance. This impedance combination has a flat frequency characteristic over the required bandwidth at 5.4 megacycles.

In the monitor unit the functions of measuring and indicating percentage modulation and mean carrier frequency and of providing audio output are performed.<sup>1</sup>

### IV. RADIO-FREQUENCY AMPLIFIER STAGE

Other factors besides the very high-frequency requirement in the mixing stage add to the difficulty of the design. One of these factors is the requirement of indicating relative transmitter output level. As previously mentioned, the specified radio-frequency operating level for the converter is 0.3 volt root-mean-square

<sup>1</sup>H. R. Summerhayes, Jr., "A frequency-modulation station monitor," Proc. I.R.E., vol. 30, pp. 399-404; September, 1942.

across 72 ohms. The method which first presents itself for measuring the level of this signal is to terminate the incoming transmission line with a properly matched, tuned, radio-frequency transformer to step up the voltage to a value more suitable for measurement with a grid-rectifying-type vacuum-tube voltmeter. However, the gain of such a transformer is quite limited, due to the grid loading effects of dielectric losses, cathode lead inductance, and transit time. These factors all operate to decrease the high-frequency input resistance of tubes to values far below their low-frequency resistance. The input resistance of a Type 954 acorn pentode at 350 megacycles is probably in the order of 1000 ohms due to these factors. Thus, the maximum theoretical voltage gain is only in the order of  $\sqrt{1000/72}$  or about 3.7 unless recourse is made to an elaborate bridge circuit for neutralizing input conductance. Furthermore, the physical size and shape of such an input transformer is such as to make its performance difficult to predict and even more difficult to measure.

Any mechanically reasonable tuning capacitor tends to have too high a minimum capacitance to tune with a mechanically reasonable inductance coil. Lead inductance gets to be more important than the coil inductance. The frequency range is approaching the border line beyond which it is no longer meaningful to talk about, or fruitful to use, lumped-constant circuit elements.

These considerations indicated that the testing procedure involved in lining up a properly matched, tuned step-up transformer over the required frequency range would be too costly to justify the relatively small voltage gain which could be realized. Thus, it was decided to omit the input transformer and to provide approximate radio-frequency signal-level indication by terminating the input cable in a 72-ohm resistor followed directly by a simple grid rectifying-type vacuum-tube voltmeter (see Fig. 2). Since the zero-signal, initial electron velocity bias of this tube may be an appreciable part of the voltage to be measured and since this bias is affected by changes in cathode temperature and by ageing, a front panel control is provided for resetting the zero-level indication.

In addition to providing an indication of relative radio-frequency signal level, this tube also acts as a buffer or impedance changer for the incoming signal. This stage has a voltage gain of 0.5 from grid to plate.

## V. MIXING STAGE

It is now in order to consider the means of mixing the incoming radio-frequency signal and the crystal-oscillator multiplier signal and the means of coupling them into the detector. Here again in the mixing stage, as previously in the radio-frequency amplifier stage, we are confronted with a low tube-input resistance, this time due to the 955 detector-tube input. But even more hampering than this loading effect is the difficulty

of tuning the combined capacitances of the tubes involved in the mixing process, i.e., the output capacitances of the multiplier and radio-frequency amplifier tubes and the input capacitance of the detector tube. The sum of these capacitances with some additional allowance for wiring capacitance is approximately 9 micromicrofarads. This has a reactance of only 50 ohms at 350 megacycles. The shunt inductance required to tune this capacitance is 0.023 microhenry

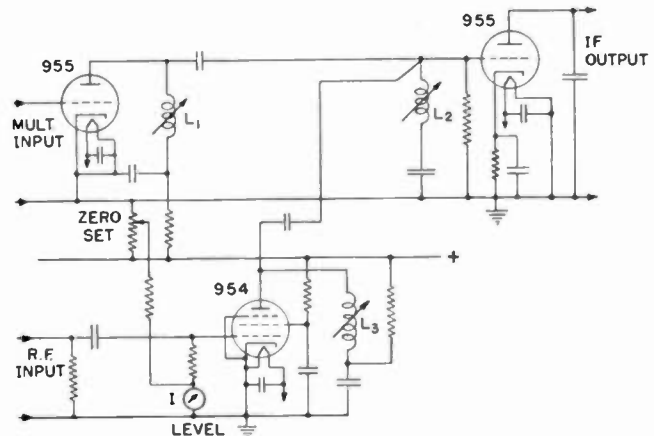

Fig. 2—260- to 350-megacycle mixing stage.

and when it is realized that a single turn of No. 18 copper wire  $\frac{1}{2}$  inch in diameter has this much inductance, it is easy to visualize the difficulties in obtaining resonance. Clearly no such single-turn coil can be expected to tune the capacitances of all three tube elements since the distance between the tubes is necessarily such as to create inductive loop impedances of the same order of magnitude as that of the single tuning coil itself.

And yet, in spite of these limitations, it was felt that it would be much easier to accomplish the mixing by simply connecting together the tube elements rather than by a tuned mixing transformer or a tuned line. Analysis like the above and experiments indicated that this result could only be accomplished by tuning each tube capacitance separately with some sort of shunt inductance which must be variable in order to cover the required range. Accordingly, three specially designed variable inductors were used in the mixing stage, one of each connected as directly as possible from each tube element involved and thence through a tiny blocking capacitor to the metal chassis ground. The inductors are shown as  $L_1$ ,  $L_2$ , and  $L_3$  in Fig. 2, which is a schematic of the mixing stage.

The success of this solution was largely dependent upon the special design features of the inductors, features which result in extremely low minimum inductance and in relative ease of construction. A perspective view of the essential parts of one of the inductors is shown in Fig. 3. The design of these inductors is a modification and development of an earlier receiver-inductor design. The inductors consist essentially of a standard variable air capacitor in which the central



portion of the stator plates has been removed, leaving only the outer edges. Thus, each stator plate forms a one turn coil. The inductance may then be progressively reduced by turning the rotor plates to increase the coupling, thereby introducing in effect a short-circuited secondary turn on each side of the stator in-

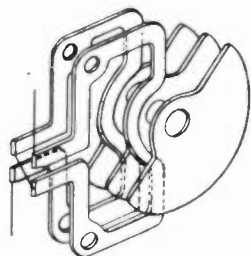

Fig. 3—Perspective view of main parts of special tuning inductor.

ductance turn. Several stator turns may be connected in parallel to reduce inductance or in series to increase inductance. Fig. 3 illustrates the series connection.

At 350 megacycles, all three parallel connected inductors tune near minimum inductance, i.e., with the rotor plates rotated nearly all the way in. From 350 down to 300 megacycles resonance is obtained by adjusting each inductor to the proper value. Although several combinations of settings of the three are possible, there is in general only one combination which gives a maximum output at any particular frequency. From 300 down to 260 megacycles, resonance is obtained by disconnecting one of the inductors, thus increasing the total inductance of the parallel combination. Adjustment of the two remaining ones will then give resonance in this lower part of the frequency range.

The losses in the mixing stage cause the resonance to have a broad enough impedance maximum to include, without additional damping, both the local oscillator signal and the incoming signal. However, this is not surprising since these signals are only separated in frequency by 1.5 to 2 per cent.

The multiplier signal appearing at the detector grid has a peak value of 2.6 volts and the radio-frequency signal from the buffer amplifier tube appearing simultaneously at the detector grid has a peak value of 0.25 volt for 0.5-volt peak input to the radio-frequency amplifier stage.

#### VI. DESCRIPTION OF COMMERCIAL UNIT

Figs. 4 and 5 show top and bottom views, respectively, of the chassis of the commercial converter unit. Fig. 6 shows a front view of the combined converter and monitor units mounted one above the other as they are supplied in a standard cabinet.

Plate power for the converter unit is obtained from the electronically regulated supply which is part of the monitor unit. The power-supply section in the monitor was originally designed with this objective in mind. The modifications necessary in the monitor to adapt

it to this service are the addition of one regulator tube in the space provided, the change in the radio-frequency input connections, and the change of the sensitivity and the scale marking of the frequency indicating instrument.

The design of the original monitor unit was such as to insure adequate stability and precision of frequency indication for transmitter signals in the range of 42 to 50 megacycles. In this range the full-scale mean-frequency deviation indication is only  $\pm 2000$  cycles

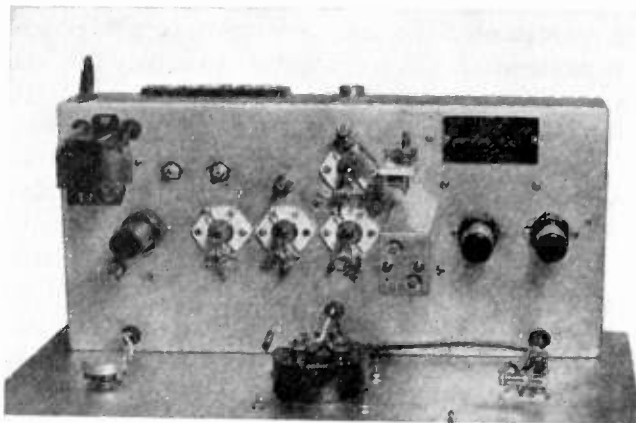

Fig. 4—Top view of chassis of General Electric converter unit.

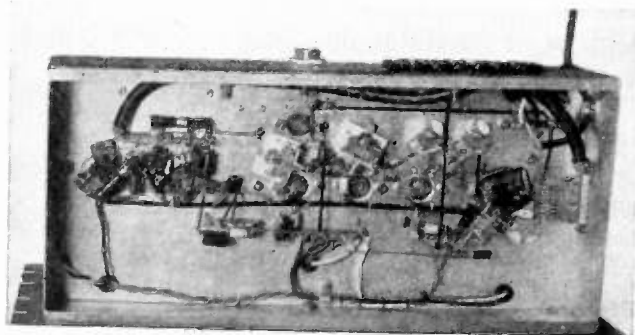

Fig. 5—Bottom view of chassis of General Electric converter unit.

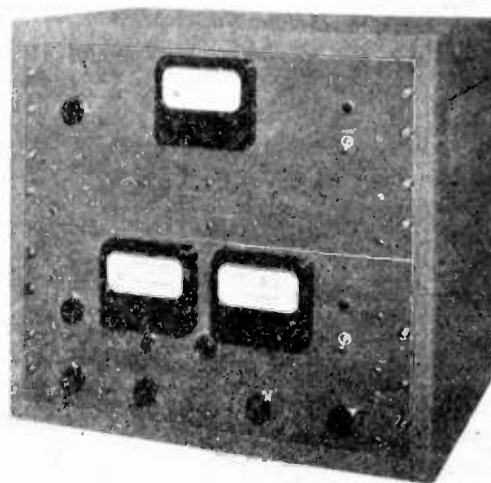

Fig. 6—Front view of General Electric converter unit and General Electric frequency-modulation station monitor unit in cabinet.

which corresponds to  $\pm 50$  microamperes change in discriminator output average current. When the monitor unit is used in combination with a converter unit to indicate frequency drifts of  $\pm 35,000$  cycles, the only change required in the frequency-discriminator circuit consists in a proportionate decrease in the full-scale current sensitivity of the indicating instrument from  $\pm 50$  microamperes to  $\pm 875$  microamperes. The stability of the discriminator circuit is, of course, represented by the same number of microamperes or cycles indication in each application but in the converter application, the stability in terms of percentage of full-scale frequency indication is  $17\frac{1}{2}$  times better than in the monitor application.

This results in extremely good stability of the fre-

quency indication (about 1 per cent of full scale) as far as this is affected by drifts in the constants of the discriminator circuit. Thus, it is only infrequently necessary to use the built-in calibrating crystal oscillator to check the discriminator-frequency indication.

The service record on those units installed prior to the inauguration of the priority system for the procurement of material has been entirely satisfactory.

#### ACKNOWLEDGMENT

The author would like to acknowledge the help and co-operation of his associates in the General Engineering Laboratory of the General Electric Company and in particular of W. A. Ford in the development of the tuning inductors.

## A Method of Measuring the Effectiveness of Electrostatic Loop Shielding\*

DUDLEY E. FOSTER†, MEMBER, I.R.E., AND CHARLES W. FINNIGAN‡, ASSOCIATE, I.R.E.

*Summary*—In the design of radio receivers employing electrostatically shielded loops, difficulty in measuring the effectiveness of the loop shielding in the laboratory is usually encountered. This paper describes a method using a short rod antenna connected to a conventional standard-signal generator which has been found to be convenient to operate and capable of producing consistent results.

The effectiveness of shielding is determined as the ratio of the effective height of the loop as a magnetic field collector to its effective height as an electric-field collector.

#### INTRODUCTION

ELECTROSTATIC shielding of loop antennas is efficacious in decreasing electrical noise interference in many instances. The desired broadcast signal, being a radiation field, has equal magnetic and electric components. On the other hand, the noise source, being close to the receiving location, is predominantly an induction field. The ratio of electric to magnetic component of the induction field depends upon the type of radiator and the majority of noise sources have a predominant electric component. Consequently, reduction of the pickup of the electric field by shielding greatly decreases the noise effect on the receiver.

Radio-compass shielded loops are designed for the ultimate in noise reduction, but such complete shielding is generally unnecessary in broadcast receivers. In

\* Decimal classification: R201.5. Original manuscript received by the Institute, June 23, 1941; revised manuscript received, February 8, 1943.

† Formerly, RCA License Laboratories, New York, N. Y.; now, Majestic Radio and Television Corporation, Chicago, Ill.

‡ Formerly, RCA License Laboratories, New York, N. Y.; now, Stromberg-Carlson Telephone Manufacturing Company, Rochester, N. Y.

order to secure the most economical shielding that is effective in reducing the induction pickup, a test of the shielding is necessary. It is desirable that the test method be applicable in the laboratory where conditions can be controlled and results duplicated, rather than in the field where signal and noise conditions may both vary. This paper describes a method which has been found to be the most satisfactory of five methods tested in determining the effectiveness of loop shielding.

#### DESCRIPTION OF TEST METHOD

The extent to which a tuned loop antenna responds to the influence of an electric-field component of an electromagnetic wave may be designated as its effective height with regard to the electric component. Designating that effective height  $h_e$ , it may be defined by

$$h_e = \frac{V}{EQ}$$

where

$V$  = the voltage developed across the loop circuit

$E$  = the electric-field intensity

$Q$  = the circuit figure of merit

The value of  $h_e$  is a direct measure of the effectiveness of the loop shielding. Unfortunately the electric field from either local or distant sources is subject to wide variations inside the laboratory, so that  $h_e$  is not easy to evaluate directly.

The effective height of the loop with regard to the magnetic component of the field may be designated  $h_h$ , as the effective height for the electric component is



designated  $h_e$ . For geometrically simple loops  $h_h$  may be readily computed, while for more complex types  $h_h$  may be measured without difficulty by known laboratory methods.

Since  $h_e$  is a measure of the undesired pickup of the loop and  $h_h$  a measure of the desired pickup, the factor of merit of a loop as to its noise-reducing properties may be expressed by the ratio  $h_h/h_e$ . The method described herein is one which has been found best adapted to laboratory determination of that ratio.

The magnetic field from a coil may be used in the

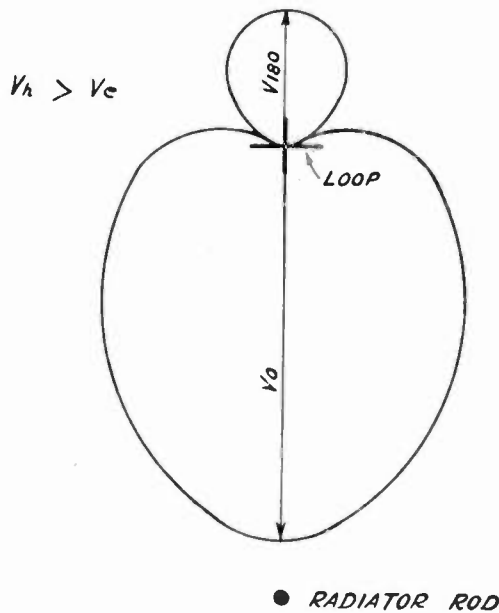

Fig. 1—Polar pattern of loop voltage, electromagnetic-field layer.

laboratory with little disturbance of its calculated performance due to surrounding objects. Experience with electric fields in the laboratory however, has indicated that they are much more susceptible to field distortion. The use of an artificial ground plane with all the apparatus except the radiator and loop under measurement located beneath the plane, and with relatively small spacing between the radiator and loop, have been found to be the best means of providing a uniform and reproducible field. A vertical rod antenna projecting through the ground plane and connected directly to a signal generator provides a suitable radiator.

In the field from a vertical radiator, the electric-field vector  $E$  is vertical and the magnetic-field vector  $H$  is horizontal. Near the radiator, where the induction field is predominant, the magnitude of  $E$  is much greater than  $H$  for such a radiator. A large ratio of  $E$  to  $H$  is desirable when measuring the effectiveness of shielding so that small differences in shielding may be observed.

At the higher frequencies the area of predominant induction field is greatly reduced because of the relatively greater radiation field. This, in conjunction with the afore-mentioned distance requirement, limits the usefulness of the method to the lower frequencies. Suc-

cessful measurements are possible, however, up to at least 3 megacycles.

The ratio of  $E$  to  $H$  is not constant but is a function of the distance from the rod, decreasing as the distance becomes greater. From this standpoint, operation with the loop near the rod is desirable, but if too close, slight displacement of the apparatus will cause large variations in the field intensity, with consequent inaccuracy of measurement. Likewise, there is an error in determining the magnetic component in a field which varies appreciably in the distance of a loop width. A distance of a few loop diameters should therefore be used for best accuracy of measurement.

In the induction field near a rod radiator  $E$  and  $H$  are in time quadrature. Under this condition the resulting loop voltages  $Eh_e$  and  $Hh_h$  will be in time phase.

As the loop is rotated the resonant voltage at its terminals is given by

$$V = (Eh_e + Hh_h \cos \theta)Q \quad (1)$$

where  $\theta$  is the angle between the direction of the magnetic field and the plane of the loop. For angles greater than 90 degrees,  $\cos \theta$  is negative, so that the voltage due to the second term in the parentheses opposes that due to the first term.

Let

$$Eh_e = V_e \quad (2)$$

$$Hh_h = V_h \quad (3)$$

Then, if  $V_e = 0$  the variation of loop voltage with rotation takes the form of the familiar double-lobed pat-

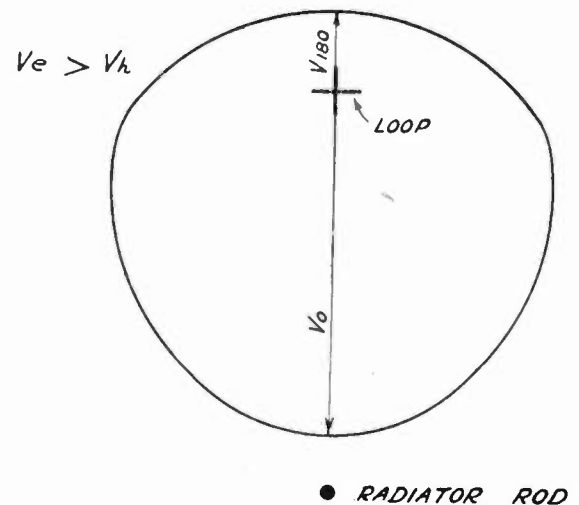

Fig. 2—Polar pattern of loop voltage, electric-field voltage layer.

tern, with two equal voltage maxima occurring when  $\theta$  is 0 degrees and when  $\theta$  is 180 degrees. If  $V_e$  is not zero but is smaller than  $V_h$  the pattern is two-lobed but with unequal maxima. If  $V_e$  is equal to  $V_h$  the loop becomes unidirectional with one maximum and one minimum. If  $V_e$  is larger than  $V_h$  the pattern has only one lobe but has no angle where the terminal voltage becomes zero.

The condition when  $V_h > V_e$  is shown in Fig. 1 and when  $V_e > V_h$  in Fig. 2. From the voltage relations at 0 degrees and at 180 degrees the ratio of  $V_h$  to  $V_e$  may be found and when  $E$  and  $H$  are known  $h_h$  and  $h_e$  may be calculated. For the condition shown in Fig. 1, where the voltage due to the magnetic component is larger than that due to the electric component,

$$\frac{h_h}{h_e} = \frac{V_0 - V_{180}}{V_0 + V_{180}} \frac{E}{H} \quad (4)$$

and for the condition of Fig. 2, where  $V_e$  is larger than  $V_h$ ,

$$\frac{h_h}{h_e} = \frac{V_0 + V_{180}}{V_0 - V_{180}} \frac{E}{H} \quad (5)$$

These expressions show that a relative measure of shielding effectiveness as given by the ratio  $h_h/h_e$  may

loops. The rod may be of the order of 2 or 3 feet long. With a rod 1 meter long and a 4-foot separation a ratio of  $E/H$  of 13.5 to 1 was measured.

The loop under measurement is connected to the input terminals of the calibrated receiver. It is important that the leads from the receiver to the point of connection of the loop be shielded by means of a brass or copper pipe. The loop must be rotatable through 180 degrees at least, and it has been found convenient to have a disk about 1 foot in diameter, rotating with the loop, to act as a support.

The receiver should be provided with an indicating meter, preferably one operating on carrier. It need not be calibrated as the signal-generator voltage may be used as a measure of  $V_0$  and  $V_{180}$ . Furthermore the receiver need only maintain constant gain for sufficient period of time to read  $V_0$  and  $V_{180}$ .

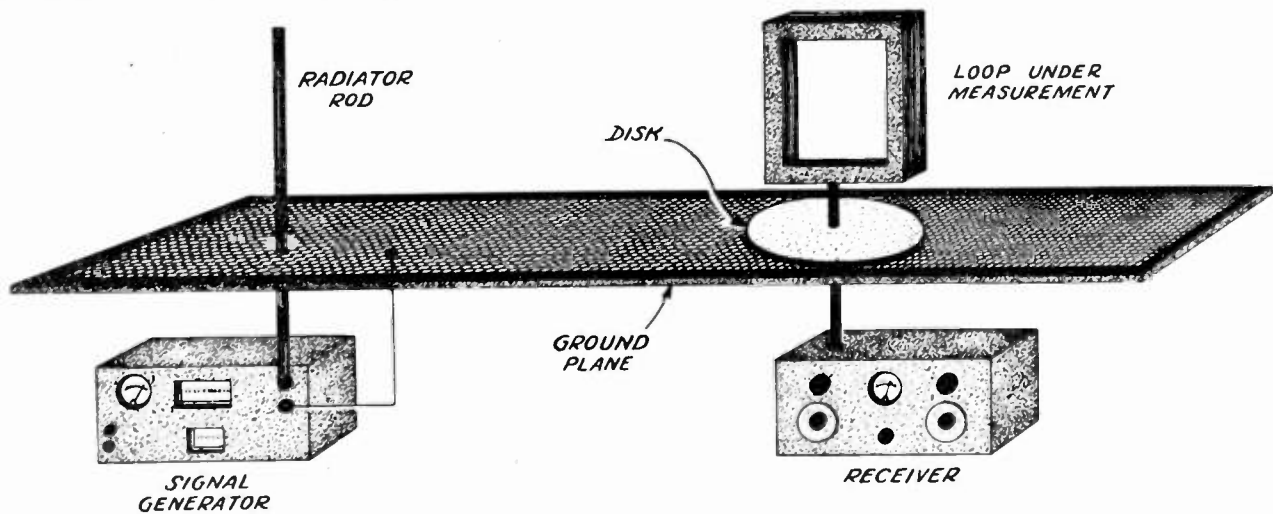

Fig. 3—Setup of apparatus.

be obtained without knowing  $E$  and  $H$  specifically, since the ratio  $E/H$  is a constant multiplying factor. In order to obtain an absolute value for  $h_h/h_e$  it is necessary to know the ratio  $E/H$ . The value of  $H$  may be obtained by measurement using a calibrated, totally shielded loop. The value of  $E$  may be determined with a field-intensity meter using a rod antenna.

#### ARRANGEMENT OF APPARATUS

The general setup of apparatus for measuring efficiency of loop shielding is depicted in Fig. 3. The ground plane is necessary and may consist of screen wire on a light framework. A screen  $3 \times 4\frac{1}{2}$  feet has been found satisfactory with a separation between the rod and loop of 4 feet. The ground plane should not be smaller than this.

A separation of 4 feet between rod and loop has been found to be a good distance for ordinary size receiving

#### TECHNIQUE OF MEASUREMENT

With the apparatus arranged as in Fig. 3 the loop is rotated through 360 degrees; if the loop voltage drops to substantially zero at two angles,  $V_h > V_e$  and expression (4) should be used, whereas if the loop voltage does not drop to zero with rotation,  $V_e > V_h$  and expression (5) applies. The loop is then rotated to obtain maximum voltage, which is  $V_0$ , then rotated 180 degrees to find  $V_{180}$ . Reversal of loop polarity also changes the relative sign of  $V_e$  and  $V_h$ , but usually does not give the same results as rotation because of the increased shielding effect when the outside turns are connected to ground.

#### Reference

- (1) Stanford Goldman, "A shielded loop for noise reduction in broadcast reception," *Electronics*, vol. 2, pp. 20-22; October, 1938.



# Variable-Frequency Bridge-Type Frequency-Stabilized Oscillators\*

W. G. SHEPHERD†, ASSOCIATE, I.R.E., AND R. O. WISE†, NONMEMBER, I.R.E.

*Summary*—Results are given of a theoretical and experimental investigation into two types of bridge-stabilized oscillators incorporating a thermal device for amplitude control. One circuit employs only resistances and capacitances in the frequency-determining network and consequently is useful for low-frequency operation. The other circuit uses an inductance-capacitance network which is well adapted to the higher-frequency network. Conditions for optimum stability and the variation of the stability with frequency determined experimentally are found to be in general agreement with theoretical results.

INCREASING precision of measurements has necessitated the development of variable-frequency oscillators of greatly improved frequency stability and reduced harmonic content. Many of the means employed in achieving these desirable characteristics for fixed-frequency oscillators cannot be adapted to oscillators of wide frequency range in which requirements of constancy of output, simplicity of control, portability, and ease of construction must be met.

In achieving frequency stability it is of course necessary that circuit elements be chosen which are affected as little as possible by temperature and humidity. Even assuming ideal circuit elements, however, variation in frequency with supply voltage and with unavoidable changes in transconductance of tubes will remain in most variable-frequency oscillators. It is this variation in frequency with gain which constitutes the circuit problem in the design of wide-range frequency-stabilized oscillators and to which a solution is presented in this paper.

In many oscillator investigations undertaken in the past a complete solution of the circuit problem has been found impossible because of the complication introduced by the nonlinearity of the vacuum tubes in the oscillator. Recently, however, the separation of the functions of amplification and amplitude limitation has made it possible to treat any oscillator so controlled as a linear-network problem and thereby to obtain complete expressions for the conditions and stability of oscillation. The present work deals with two oscillators of this type.

Early efforts in the direction of improved oscillator circuits attempted to refine the method of amplitude limitation. One of the first of these was the use of a grid leak and condenser which provide an automatic bias for the oscillator tube. Such an arrangement tends to reduce the nonlinear behavior required of the grid circuit in comparison with that necessary for the case

of a fixed bias. The grid leak and condenser do, however, require that grid current be drawn which results in the production of harmonics. Furthermore, the tube input and output impedances depend to a considerable extent on the supply voltages which in turn affect the oscillating circuit. Some of the methods<sup>1</sup> undertaken to eliminate these effects consisted principally in providing sufficient loss between the tube and the oscillating circuit so that the effect of changes in the impedances of the tube on this circuit were reduced more or less in the ratio of the amount of loss allowable.

Llewellyn has indicated<sup>2</sup> how it is possible to improve the stability of oscillators under certain conditions by including appropriate impedances in the grid or plate circuits or both. These impedances were such as to reduce the phase shift in the oscillating circuit to zero at the operating point. The analysis however is limited in that it assumes that the oscillating circuit offers a negligible reactance to any harmonics generated. It is also necessary in most cases to change these impedances with frequency which complicates the networks.

In recent years many investigators<sup>3-6</sup> have recognized that harmonics produced by the nonlinear behavior of the tubes affect the frequency of oscillation. This effect occurs since any changes in the supply voltages which produce relative changes in the amplitude of the harmonics will cause a change in the reactance at the fundamental frequency and hence a shift in that frequency.

Moullin<sup>4</sup> proposed to eliminate the harmonic effects by building up the oscillating circuit in such a fashion that the harmonics were short-circuited. This work was applied particularly to a dynatron oscillator but the same results should apply equally well to a triode or pentode oscillator. Moullin found that the residual instability which remained could be blamed principally upon the changes in the interelectrode capacitances with the supply voltages.

Arguimbau<sup>3</sup> recognized the effect of harmonics and proposed to eliminate them by operating the vacuum

<sup>1</sup> J. W. Horton, "Vacuum tube oscillators—A graphical method of analysis," *Bell Sys. Tech. Jour.*, vol. 3, pp. 508-524; July, 1924.

<sup>2</sup> F. B. Llewellyn, "Constant frequency oscillators," *PROC. I.R.E.*, vol. 19, pp. 2063-2094; December, 1931.

<sup>3</sup> L. B. Arguimbau, "An oscillator having a linear operating characteristic," *Proc. I.R.E.*, vol. 21, pp. 14-28; January, 1933.

<sup>4</sup> E. B. Moullin, "The effect of the curvature of the characteristics on the frequency of the dynatron generator," *Jour. I.E.E. (London)*, vol. 73, pp. 186-195; September, 1933.

<sup>5</sup> J. Groszkowski, "Oscillators with automatic control of the threshold of regeneration," *PROC. I.R.E.*, vol. 22, pp. 145-150; February, 1934.

<sup>6</sup> C. J. Bakker and C. J. Boers, "On the influence of the nonlinearity of the characteristics on the frequency of dynatron and triode oscillators," *Physica*, vol. 3, pp. 649-665; July, 1936.

\* Decimal classification: R355.9XR133. Original manuscript received by the Institute, March 2, 1942; revised manuscript received, January 30, 1943. Presented, Winter Convention, New York, N. Y., January 13, 1942.

† Bell Telephone Laboratories, Inc., New York, N. Y.

tube as a linear amplifier. This was done by rectifying a portion of the output to furnish grid bias to the vacuum tube in order to limit the amplitude. This accomplishes the effect of the grid leak and condenser without the disadvantage caused by grid current. A somewhat similar idea was suggested later by Groszkowski<sup>6</sup> who used an automatic volume control to maintain a dynatron oscillator at the optimum operating condition on the threshold of oscillation. While both of these are steps in the proper direction they are still open to the objection that in order to control the amplitude a tube parameter, namely the grid bias, must be varied, leading to associated changes in the tube capacitances.

Meacham<sup>7</sup> has recently proposed a fundamental improvement in oscillator design which has led to a remarkable betterment in performance. By utilizing a thermal element as an amplitude control the non-linearity of the amplifier becomes an unnecessary evil, since the amplitude limitation is completely external to the amplifier. When the thermal element is suitably chosen for the frequencies involved, it is a quasilinear circuit component so that disturbing harmonics are not produced.

In addition to attaining the possibility of linear operation of the vacuum tubes, Meacham used a bridge network to determine the frequency of the oscillator. By incorporating the control as a component of the bridge he was then able to make use of the full gain of the amplifier. The bridge network has the property that the  $Q$  of the coil is multiplied by the gain of the amplifier. Hence any changes in the gain or phase of the amplifier produce a minimum of frequency variation. Thermal control, moreover, eliminates changes of the tube capacitances which are inherent in automatic volume control involving vacuum tubes. With these improvements Meacham has constructed fixed-frequency oscillators whose stability compares with the best standards available.

### Scope

This paper discusses variable-frequency oscillators which function in a manner similar to those described by Meacham but employing electrical-frequency-determining networks better adapted to the necessity of covering a range of frequencies. It should be realized that the requirement that an oscillator cover a range of frequencies imposes difficulties not present for fixed-frequency oscillators. Thus, at a fixed frequency it is a relatively simple matter to adjust the phase shift in the amplifier to an optimum value while over a wide range of frequencies elaborate circuits become necessary. In addition, physically larger elements are necessary because of the variability requirement so that larger parasitic capacitances may be expected. It must be accepted, therefore, that the stability of the oscillators

to be discussed will be considerably inferior to the stability which can be achieved with single-frequency networks. However, while the discussion which follows considers these circuits from a variable-frequency standpoint it will be seen that they may be employed for fixed-frequency applications and under such circumstances are capable of a very high degree of stability.

The circuits employed are two examples of a class of bridged-T and parallel-T circuits whose advantages have been discussed recently by Tuttle<sup>8</sup> and Honnell.<sup>9</sup> One of the circuits employed is particularly applicable to low frequencies because only capacitances and resistances are employed. This is a major advantage at low frequencies where it is usually necessary to use large coils which are much less stable than those used at high frequencies. This results from the fact that they must either be very bulky or use iron cores. In the latter case the inductance may be a function of the current density. It is possible, however, to obtain resistances which are as stable as the best coils available for high frequencies so that this network offers the possibility of much better performance at low frequencies. The other network has a capacitance-inductance frequency-determining network which may be adapted to any frequency range. In the present work it has been applied particularly to frequencies above the audio range. The two types of oscillators together cover a frequency scale from a few cycles per second to several megacycles per second. In each circuit the amplitude is controlled by means of a thermal device which is an element of the network. This amplitude control permits the analysis of these circuits to be made by linear-circuit methods.

In the following, the general operating conditions for the oscillators will be considered. A theory for the frequency stability of these oscillators for conditions of large amplifier gain and for the low-frequency oscillator under actual operating conditions has been developed. The results of a comparison of the theoretical results with those obtained with experimental oscillators will be shown. A description will be given of oscillators for laboratory use which were adapted and modified from the experimental models.

### Oscillator Circuits

The circuit schematics for the two types of oscillators are shown in Figs. 1 and 2. Fig. 1 shows a resistance-capacitance parallel-T network which for brevity will be referred to as the  $CR$  oscillator. A similar parallel-T network has been described by Augustadt<sup>10</sup> for use as a filter and by Scott<sup>11</sup> for use

<sup>8</sup> W. N. Tuttle, "Bridged-T and parallel-T null circuits for measurements at radio frequencies," *PROC. I.R.E.*, vol. 28, pp. 23-29; January, 1940.

<sup>9</sup> P. M. Honnell, "Bridged-T measurement of high resistances at radio frequencies," *PROC. I.R.E.*, vol. 28, pp. 88-90; February, 1940.

<sup>10</sup> U. S. Patent 2,106,785.

<sup>11</sup> H. H. Scott, "A new type of selective circuit and some applications," *PROC. I.R.E.*, vol. 26, pp. 226-235; February 1938.

<sup>7</sup> L. A. Meacham, "The bridge-stabilized oscillator," *PROC. I.R.E.*, vol. 26, pp. 1278-1294; October, 1938.

as a selective analyzer and, with the addition of another regenerative path, as an oscillator circuit. In the network as used in the present case the elements are so altered as to make any additional path unnecessary, and further, one of the elements is made a function of the oscillating amplitude so as to provide automatic amplitude control. This control adjusts the feedback

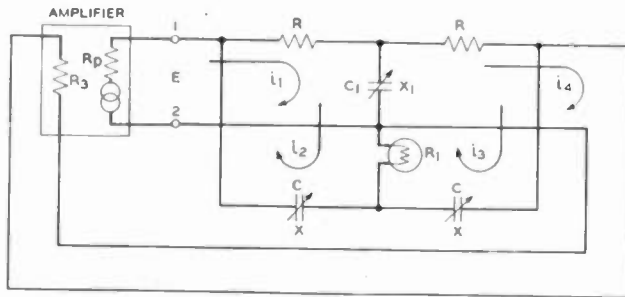

Fig. 1—Schematic circuit diagram of capacitance-resistance parallel-T oscillator.

to the proper value so that the tube functions as a linear amplifier, resulting in better frequency stability.

Fig. 2 shows a bridged-T type of network which will be referred to as the LC oscillator. This circuit which is well adapted for high-frequency oscillators has characteristics somewhat better but similar to those of the CR circuit. The schematic indicates that the shunt resistance is a thermally controlled resistance which automatically balances the feedback and controls the amplitude. Another circuit arrangement which has the same type of loss and phase characteristic is obtained by employing a fixed resistance in place in the thermally variable element R and using as an amplitude control a thermal element indicated by  $R_T$  and connected as shown by the dashed lines. The amplitude controls  $R_T$  and R must have opposite thermal char-

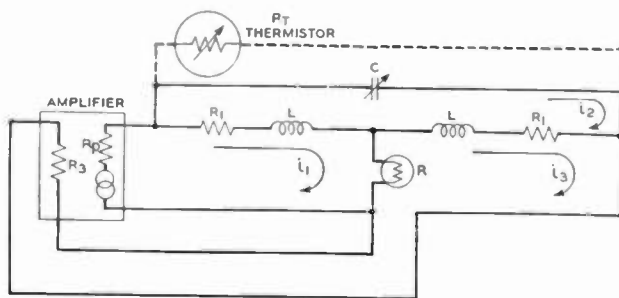

Fig. 2—Schematic circuit diagram of bridged-T oscillator.

acteristics. For reasons which will be mentioned later the circuit employing the control  $R_T$  is the more useful for variable-frequency applications of the LC oscillator.

The phase and attenuation characteristics of the two types of networks are similar. Sample characteristics for purposes of illustration are given in Figs. 3

and 4 for the parallel-T network of Fig. 1. In this case for a critical value of the shunt resistance the network offers an infinite loss to the frequency for which the phase shift is 180 degrees. For all values of this resistance less than the critical value the loss of the 180-degree point is finite and its value depends upon how nearly the critical condition is approached. The phase shift passes through 180 degrees at the critical frequency for a shunt resistance less than the critical value, but for larger resistances the phase shift passes through zero. In order to make the circuit automatic

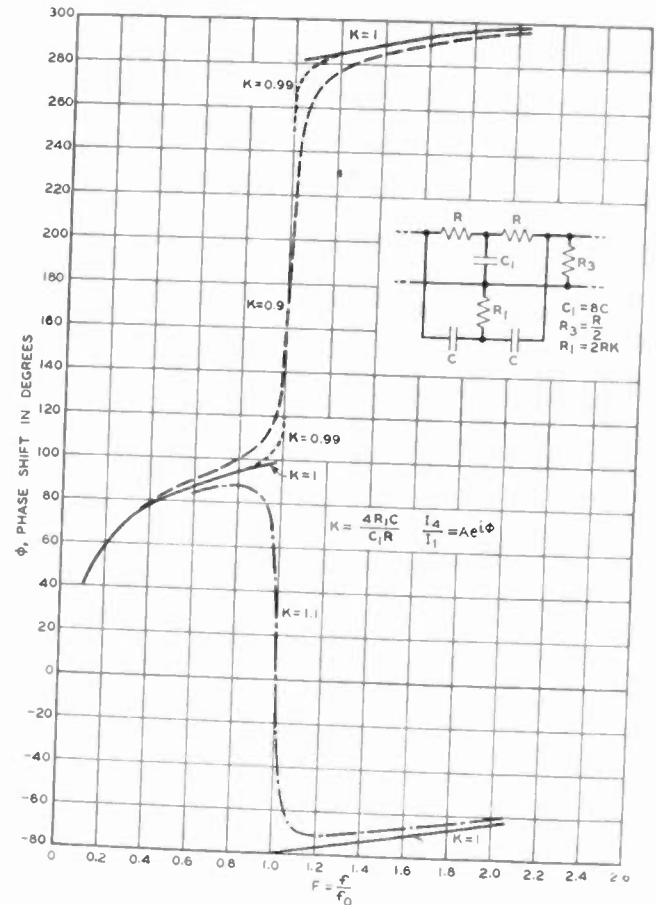

Fig. 3—Phase characteristic of parallel-T network.

the shunt-resistance arm is an element whose resistance increases with temperature. The cold resistance must be sufficiently low so that the network loss is less than the amplifier gain at the 180-degree phase point. The amplifier phase shift is assumed to be nearly 180 degrees. From Fig. 4 it will be noticed that the network loss at frequency  $f_0$  increases with increasing shunt resistance. Thus when the amplifier is turned on, oscillations build up, simultaneously increasing the shunt resistance until the network loss is just equal to the amplifier gain.

One of the most desirable features of circuits having these characteristics, as will be apparent from these figures, is that all harmonics are fed back degeneratively; that is, in such a manner as to reduce their net value over that present with no feedback. Since the



generated harmonics are at a very low level as a result of the linear operation of the amplifier, this further reduction by feedback results in a very nearly sinusoidal output.

It is useful to consider the conditions which lead to a null for transmission through the networks. For a reasonable amplifier gain these conditions will be approximately satisfied when oscillation occurs. Also, the expressions which result are useful in understanding the operation of the circuits. Table I lists the important conditions for an infinite transmission loss through the networks. The plus or minus signs of (1) indicate that the same behavior may be obtained with either inductances or capacitances. If one assumes the more useful case for a variable-frequency oscillator that all the reactances are capacitive, (1) may be solved for

TABLE I

RC $i_1/i_1=0$ Positive Coefficient Control	LC $i_1/i_1=0$	
	Positive Coefficient Control	Negative Coefficient Control
$X = \pm \sqrt{2RR_1}$	$R_1 \leq \frac{Q\rho_0 L}{2}$ (5)	$R \leq \frac{Q_0' \rho_0 L}{2}$ (5a)
$X_1 = 2 \pm \frac{R^2}{\sqrt{2RR_1}}$ (1)	$f_0^2 \leq \frac{1}{8\pi^2 LC}$ (6)	$f_0^2 \leq \frac{1}{8\pi^2 LC}$ (6a)
$f_0 = \frac{1}{2\pi R \sqrt{2C_1 C}}$ (2)	$Z_{in} \leq Q\rho_0 L$ (7)	$R_{T_0} \leq \frac{4R}{1 - \frac{2R}{Q L_0 \rho_0 L}}$ (6b)
$R = K \frac{RC_1}{4C}$ (3)		
$K = 1$ for null $K < 1$ for oscillation		
$Z_{in} = \frac{R \left( 1 - j \sqrt{\frac{2C}{C_1}} \right)}{\left( 1 + \frac{2C}{C_1} \right)}$ (4)		
where $X$ and $X_1$ are the reactances of the series and shunt capacitances at null frequency $f_0$ . $Z_{in}$ is the impedance appearing between the input terminals at null frequency	$R_0$ = value of $R$ for a null $\rho_0 L$ is the reactance of each coil at the null frequency $f_0$ $\rho_0 = 2\pi f_0$ $R_1$ = resistance of each coil	$R_{T_0}$ = thermistor resistance for a null $R$ = value of shunt resistance which must be less than $R_1$ if $R_{T_0}$ is to be finite
	$Q = \frac{\rho L}{R_1}$	$Q_0' = \frac{QC_0 Q L_0}{Q L_0 + Q C_0}$ $QC_0 = R_{T_0} \rho_0 C$ $Q L_0 = \frac{\rho_0 L}{R_1}$

the frequency of the transmission null  $f_0$ , given by equation (2), which is for practical purposes the frequency of oscillation. The equations (1) may also be combined to give the condition for a null in terms of the circuit constants, as expressed by (3) when  $K = 1$ .

From (2) it is seen that the frequency of oscillation may be varied by changing  $R$ ,  $C_1$ , or  $C$ . The amplitude of oscillation will be determined by the value of  $R_1$  required to make the loss through the bridge just equal to the gain of the amplifier. This gain should be constant over the frequency range. The value of  $R_1$  then depends upon the circuit constants and the amplifier gain. Thus, if the frequency is varied by changing  $C$ ,  $C_1$ , or  $R$  individually,  $R_1$  will be a function of frequency.

This is true first because the value of  $R_1$  to produce a given loss in the network will be changed and second because the input impedance of the network as given by (4) will be altered and produce a variation in the amplifier gain which must be balanced by the network loss. If the frequency is varied by changing the capacitances simultaneously with a fixed ratio between them

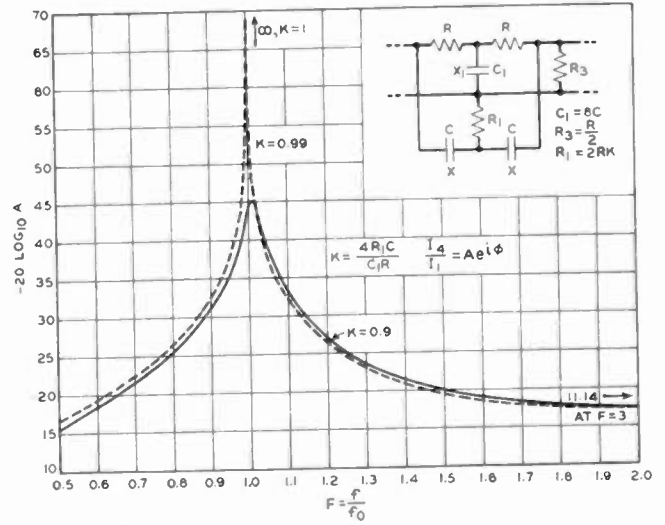

Fig. 4—Loss characteristic of parallel-T network.

and a constant value for  $R$ , then both the control resistance  $R_1$  and the input impedance  $Z_{in}$  will be independent of frequency. It may be demonstrated also that the attenuation-phase characteristics of the circuit depend only on the ratio of these capacitances. As a result, the fundamental and harmonic levels and frequency stability of the oscillator will be independent of the frequency, provided that the amplifier characteristics are independent of frequency. For some applications it may not be advantageous to vary frequency by capacitance variation but to change  $R$  instead. In order to do this a wide-range control resistance is required which is very sensitive to current changes. Such resistances will be discussed in a later section.

A typical set of phase characteristics for the bridged-T oscillator with a positive temperature-coefficient control at  $R$  is given in Fig. 5. It may be noted that when  $R$  is zero the circuit becomes a Hartley oscillator, the phase characteristics of which are also shown on Fig. 5. The rate of change of phase with frequency is much more rapid for the bridged-T oscillator than for the Hartley oscillator. As a result any changes in the amplifier phase shift will have less effect than in the Hartley circuit. A circuit with similar characteristics which degenerates into a Colpitts oscillator is obtained by exchanging inductance for capacitance and vice versa.

For the  $LC$  oscillator the problem of maintaining a constant amplitude over a range of frequencies is more difficult than in the case of the  $CR$  circuit. The value of the control resistance of the positive thermal-coefficient type necessarily varies with frequency unless the

$Q$  of the coil varies inversely with the frequency. The difficulty is especially serious for this type of resistance since the most suitable of these which are readily available require relatively large changes in amplitude to produce the necessary resistance variations. For this reason the circuit utilizing the negative temperature-coefficient resistance  $R_T$  is more advantageous. The resistance  $R$  is then fixed at a value sufficiently below the null value so that the gain around the loop is greater than zero. The parallel-T network with a

in the Appendix. In the analysis it is assumed that the oscillator amplifier is a constant-current generator and all parasitic capacitances are neglected.

It is perhaps well to repeat at this point that we are not considering in this paper the effects of temperature on the circuit elements but are restricting ourselves to the effects of changes in the supply voltages.

*Resistance-Capacitance Oscillator*

The asymptotic analysis for the  $RC$  oscillator shows that

$$\frac{d}{dE} \frac{\delta f}{f_0} = \frac{9}{\sqrt{2}} \frac{\sin \theta}{Rg^2} \frac{dg}{dE} \tag{8a}$$

- where  $f_0$  = the frequency at the null
- $\delta f$  = the operating departure from  $f_0$
- $\theta$  = the amplifier phase shift
- $g$  = the transconductance of the amplifier
- $E$  = any supply voltage

Equation (8a) indicates that the frequency stability against supply-voltage shifts should be independent of the frequency of oscillation if  $R$  and the amplifier phase shift are fixed and should be infinite if the phase shift of the amplifier is zero.<sup>12</sup> It also predicts that the greater the transconductance of the amplifier the more stable the oscillator becomes.

Experimentally the frequency stability against changes of transconductance varies more rapidly with transconductance than (8a) predicts. There is also a discrepancy in the optimum phase angle. These discrepancies may be ascribed to the failure experimentally to meet the theoretical conditions. These require that the departure of the control resistance under operating conditions from the null value should be small. To fulfill this condition required a considerably higher value of transconductance than that experimentally realized.

A more rigorous analysis of the  $RC$  circuit leads to the following equations:

$$\frac{\frac{K^2 R^2}{4} \left(1 - \frac{1}{F^2}\right)^2 + \frac{R^2}{2F^2} \left(\frac{1}{F^2} - K\right)^2}{\left[R \left(\frac{K}{2} + 3\right) + R_3(1 - K)\right]^2 + \frac{R_3^2(K + 8)^2}{2}} = \frac{1}{g^2 R_3^2}$$

and

$$\tan \theta = - \tan (\phi_1 - \phi_2).$$

where

$$\tan \phi_1 = \frac{2(1 - KF^2)}{\sqrt{2} K(F^2 - 1)}$$

$$\tan \phi_2 = \frac{-R_3(K + 8)}{\sqrt{2} \left[ R_3(1 - K) - R \left(\frac{K}{2} + 3\right) \right]}$$

<sup>12</sup> Zero amplifier phase shift with reference to the required 180 degrees.

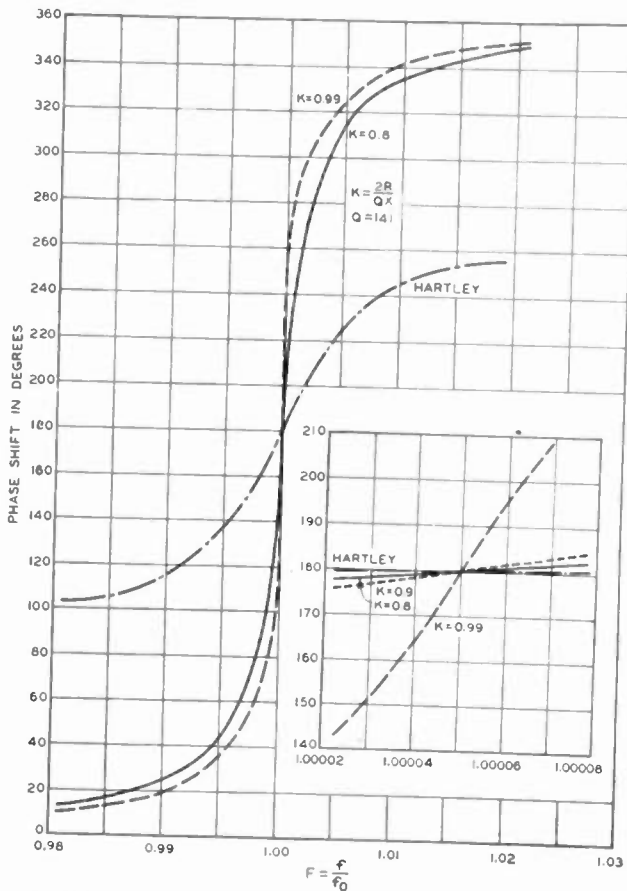

Fig. 5—Phase characteristic of bridged-T oscillator. The phase plot for a Hartley circuit is shown for comparison.

fixed shunt resistance  $R$  feeds back the fundamental regeneratively while the resistance shunting the coil supplies a degenerative feedback just sufficient to satisfy the conditions for oscillation.

**STABILITY THEORY**

An analysis for both oscillators has been carried through which is valid for the limiting conditions of very large amplifier gain. In the case of the  $RC$  network by a more exact treatment this analysis has been extended to cover the gain achieved experimentally. While the latter theory gave a more complete agreement with the experimental results the expressions obtained are cumbersome. They indicate, moreover, the limiting correctness of the asymptotic expressions which will therefore be given since they are instructive for design purposes. The method of analysis is illustrated

$$X = \frac{1}{F} X_0 \quad R_1 = KR_{10}$$

$X_0, R_{10}$  are the null values.

These expressions apply for the case of equal capacitances.

A numerical solution of these equations for a given set of circuit parameters leads to a series of curves which are given in Fig. 6. These show the frequency of oscillation referred to the frequency for an exact null for transmission through the network as a function of the transconductance of the amplifier. The amplifier phase shift is taken as parameter. The curves indicate that for small values of transconductance the optimum amplifier phase shift is not zero. They also show that as the transconductance becomes very large the stability tends to become independent of

gain so that the optimum phase shift depends on the operating region. The optimum crossover phase changes very slowly with the gain as indicated by the curves of Fig. 6.

In order to test the foregoing theory, an experi-

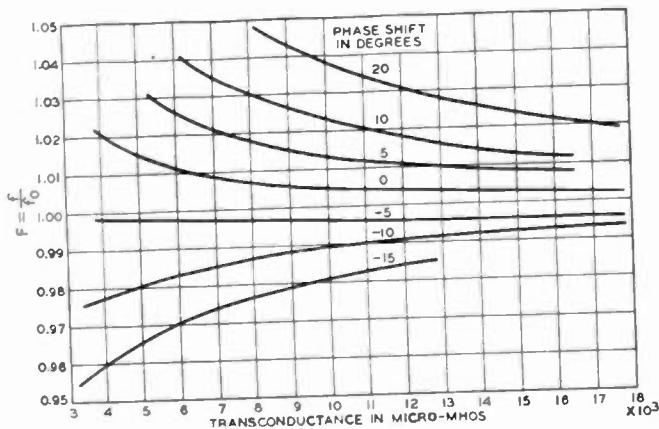

Fig. 6—Theoretical relation of the frequency of oscillation to the frequency of zero transmission as a function of the amplifier phase shift and transconductance. These data were computed for the circuit constants of the experimental model of the CR oscillator.

phase shift. Moreover since these curves depend only on the ratio of the shunt and series capacitances, the stability should be independent of frequency when frequency changes are produced with fixed ratio.

It is illuminating to consider the phase-shift-versus-frequency curves of Fig. 7. These curves display on an extended scale a section of the curves of the type previously shown in Fig. 3. The curves are plotted for a series of values of  $K$ . The significance of  $K$ , as can be seen by inspecting the attenuation curves of Fig. 4, is that the more nearly  $K$  approaches unity the larger the gain must be in order that oscillations may be sustained. Thus for any particular frequency at which the amplifier phase shift is fixed, any change in gain will mean a shift from one of these curves to another. From this it can be seen that the optimum operating phase shift will be that which results in the smallest change in frequency for small changes in  $K$  about the operating value. If the crossover were common for all values of  $K$  then the stability could be made infinite for any gain by incorporating the proper phase shift. Actually the region of crossover is a function of the

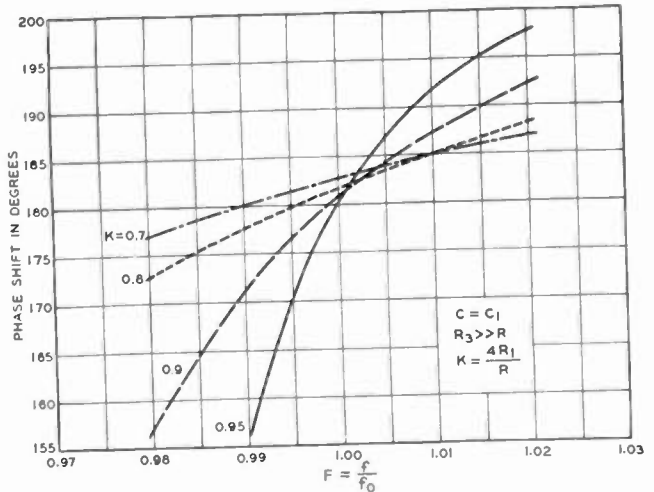

Fig. 7—An expanded section of the phase characteristic for the parallel-T network.

mental oscillator was built according to the schematic of Fig. 1. The control element was composed of 12 Western Electric C-2 switchboard lamps in series. These lamps were found to have the most suitable characteristics of any available control of this type. The frequency was varied by changing the three capacitances simultaneously with the resistances  $R$  fixed.

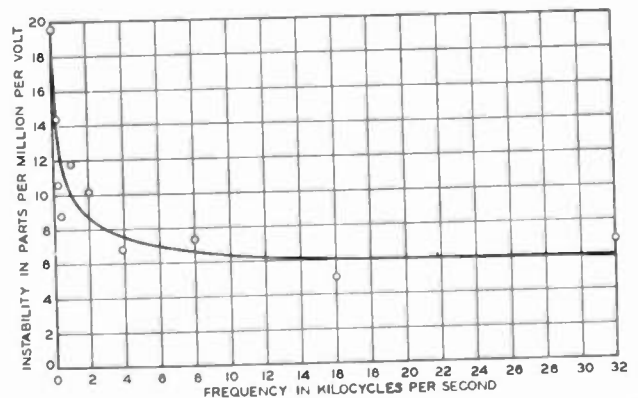

Fig. 8—The variation of the frequency instability of the CR oscillator against line-voltage fluctuations as a function of the frequency of oscillation. These measurements are for an oscillator in which frequency changes were produced by simultaneously varying the three tuning condensers and maintaining a constant ratio between them.

The amplitude of oscillation for the model was not absolutely constant with frequency as expected for this type of control but varied about 2 decibels over a frequency range of 50 to 20,000 cycles. Fig. 8 gives the frequency stability as a function of frequency. It will be observed that the stability tends to become independent of frequency as the frequency increases. The deviations from the predicted performance may be ascribed to phase shift in the amplifier. This will become evident in particular for the frequency stability



at low frequencies where the phase shift caused by the plate-supply choke, cathode-bias network, and other elements becomes pronounced.

Several experiments were carried out to test the theory of stability. In one of these the oscillator was operated at an intermediate frequency sufficiently low so that effects from the input capacitances of the tubes

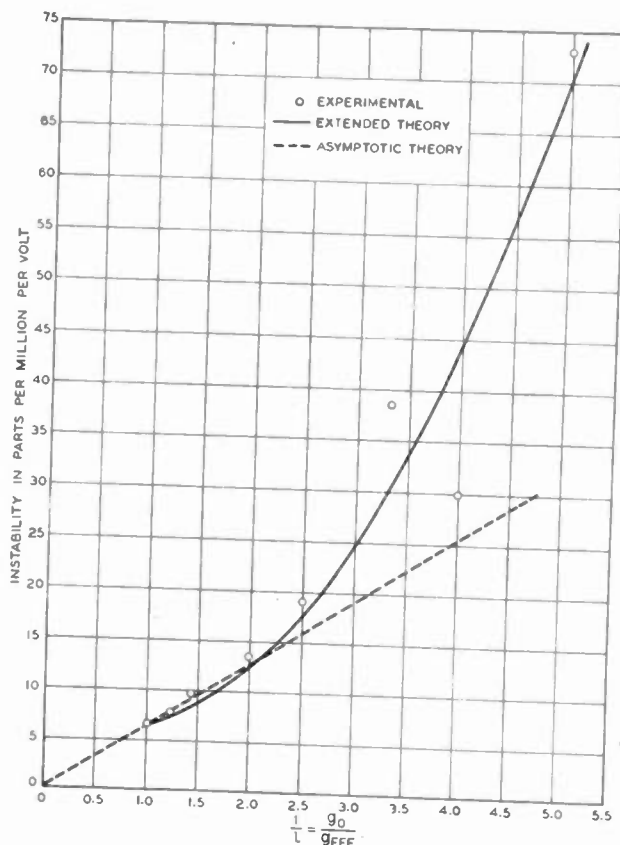

Fig. 9—CR oscillator. A comparison of the theoretical and experimental variation of the frequency instability against line-voltage fluctuations as a function of the amplifier transconductance. The curve marked asymptotic theory was fitted to the experimental results for  $g_0 = g_{\text{eff}}$ .

could be neglected and high enough so that the low-frequency phase shift was negligible. The effective transconductance of the amplifier was then varied by using a potentiometer grid leak. The frequency change of the oscillator for changes in the supply voltage with reference to the oscillating frequency  $f \cong f_0$  will be according to the asymptotic theory,

$$\frac{d}{dE} \left( \frac{\delta f}{f_0} \right) = \frac{9}{2} \frac{\sin \theta}{X_0 g_{\text{eff}}^2} \frac{d g_{\text{eff}}}{dE}, \quad (10)$$

on the assumption that  $\theta$  is independent of  $E$ . For the CR oscillator this assumption is justified since any changes in the tube capacitances are negligible in comparison with the circuit capacitances. For this method of varying the transconductance,  $g_{\text{eff}} = l g_0$  where  $l$  is determined by the potentiometer tap. Hence

$$\frac{1}{g_{\text{eff}}^2} \frac{d g_{\text{eff}}}{dE} = \frac{1}{l^2 g_0^2} \frac{d g_0}{dE} = \frac{N}{l} \quad (11)$$

where  $N$  is a constant. The expression indicates that the stability should be proportional to  $1/l$ . Fig. 9 shows the results of this test in which the frequency stability is plotted against  $1/l$ . For comparison the theoretical result predicted by (11) is indicated by the curved marked asymptotic theory. The experimental and theoretical curves were made to coincide for  $l=1$ . For large values of the transconductance the experimental results approach a linear variation as (11) predicts but deviate for small values. The data for the curve marked extended theory were calculated from the curves of Fig. 6 which were computed for the circuit constants of the experimental model. For the range of data available from the curves of Fig. 6 the agreement between experimental and theoretical results is good. In this case the data are not fitted, the agreement being numerical. This indicates how well the oscillation amplitude control is removed from the tube since in the theoretical analysis the tube was treated as a linear element.

As a second test, it was desired to investigate the stability for changes in the supply voltage as a function of the amplifier phase shift. Unfortunately no means were readily available which permitted phase shift to be produced without simultaneously changing the gain. The following experiment was carried out which does not constitute an adequate test but for which the results are thought to be significant.

The test was made at such a frequency that the impedance of the plate-supply choke was very high compared to the input impedance of the network so that the phase shift from the choke was negligible. This was also true of phase shifts from other sources such as the cathode bias and the grid by-pass condenser and leak. The amplifier phase shift was assumed to be zero in the normal operating state. Phase shift was then produced by shunting the input of the network with reactance.

Curve C of Fig. 10 shows the experimental frequency stability against changes in the supply voltages plotted against the phase shift. Curve A gives the theoretical results calculated from the curves of Fig. 6 upon the assumption that the phase shift in the amplifier was produced without changing the gain. Curve B was calculated on the same basis as curve A but assumed the gain as half the gain for curve A. At the frequency of oscillation a capacitive reactance given approximately by (4) appears between the input terminals of the network. Thus a shunting inductance tends to increase the amplifier gain and a capacitance to reduce the gain. This explains the unsymmetrical character of curve C. It is also significant that the optimum condition, even for a reduced gain, occurred when a lagging phase shift was produced, agreeing in sign with the theoretical result.

The addition of a shunt capacitance to produce the optimum phase shift offers a convenient and simple method of obtaining high-frequency stability even

with a low-gain amplifier. It is useful chiefly for fixed-frequency oscillators since it would be necessary to vary the shunting capacitance inversely with frequency for a variable oscillator. However, for a variable-frequency oscillator the desirable characteristic of an improving frequency stability as the frequency increases may be obtained by shunting the network with a fixed capacitance which will produce the optimum condition at the maximum frequency.

*Inductance-Capacitance Oscillator*

In the case of the *LC* oscillator using a control with a negative thermal characteristic, the asymptotic analysis shows that

$$\frac{d}{dE} \left( \frac{\delta f}{f_0} \right) \cong - \frac{\rho_0 L \sin \left( \theta + \frac{\rho_0 L}{2R'} \right)}{4g^2 R'^2} \frac{dg}{dE} \quad (9a)$$

where  $\delta f$  and  $f_0$  are defined as for (8)

- $X_0 = \rho_0 L =$  the impedance of each of the coils at the null frequency
- $R' = R + (R_1/2)$  where  $R$  is the value of the shunt resistance
- $\theta =$  the amplifier phase shift
- $g =$  the amplifier transconductance

The expression obtained from an asymptotic analysis of the *LC* oscillator in which the amplitude control is a positive temperature-coefficient resistance is

$$\frac{d}{dE} \left( \frac{\delta f}{f_0} \right) \cong - \frac{\rho_0 L \sin \left( \theta - \frac{\rho_0 L}{2R_0} \right)}{4g^2 R_0^2} \frac{dg}{dE} \quad (9a')$$

Now  $R'$  must always be less than  $R_0$ , the value of shunt resistance required to produce a transmission null in the absence of  $R_T$ . Hence a sacrifice in stability is entailed in the use of a negative temperature-coefficient thermistor, but this is outweighed by the gains achieved in other directions. The stability expressions are similar in other respects except for the sign of the optimum phase shift.

It is assumed in this that the angle  $\theta$  is independent of changes in  $E$ . For the higher-frequency ranges of this oscillator where the tube capacitances become important this will not be strictly justified and one may expect deviations in performance from the theoretical predictions.

Equation (9a) indicates the optimum stability occurs for a small phase shift  $\theta = -(\rho_0 L/2R')$ . For an amplifier for which  $\theta$  is very small

$$\frac{d}{dE} \left( \frac{\delta f}{f_0} \right) \cong - \frac{\rho_0^2 L^2}{8g^2 R^3} \frac{dg}{dE} \quad (9b)$$

At first sight (9b) appears to indicate that for any given frequency the stability will be greater the smaller

the inductance. However the conditions for oscillation require that  $R$  should vary approximately proportionally with  $L$  on the assumption of a fixed value of  $Q_L$ . Hence the inductance should be chosen as large as possible consistent with other circuit requirements. For an amplitude control in which a negative thermal-coefficient resistance shunts the coil,  $R$  is fixed. Thus

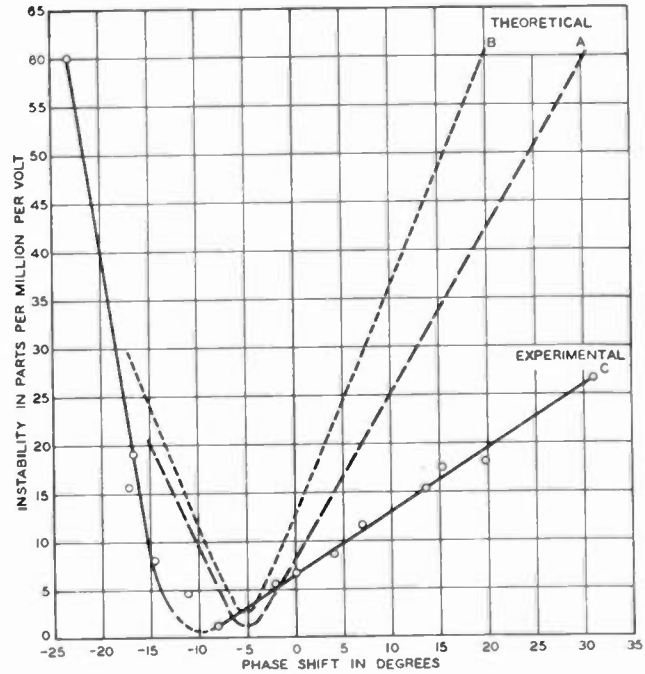

Fig. 10—*CR* oscillator. Frequency instability against line-voltage fluctuations as a function of the amplifier phase shift.

the frequency stability in this case is inversely proportional to the square of the frequency.

The small phase shift for optimum operation corresponds to the region of crossover for the phase curves similar to that discussed for the *CR* oscillator. In the case of the *LC* oscillator the crossover region is much more restricted as is evident from the inset of Fig. 5 and less dependent upon the amplifier gain than for the *CR* oscillator. This, as would be expected, results in better stability against gain changes. The *LC* circuit gives results an order of magnitude better than the *CR* oscillator with the same amplifier gain.

No complete experimental investigation of the stability of the *LC* oscillator to check the stability theory was made. The arrangement in which a positive temperature-coefficient resistor in the shunt arm serves as a control element is impracticable because of large variations of amplitude which result in covering a reasonable frequency range for any existing thermal elements. Hence all the experimental investigations of the high-frequency oscillator were made with the control provided by a negative temperature-coefficient thermistor shunting the coil as a "Q control." It has been found that the experimental stability curves can be well fitted in form by curves of the type of (9b). This is indicated by the curves of Fig. 11 which apply

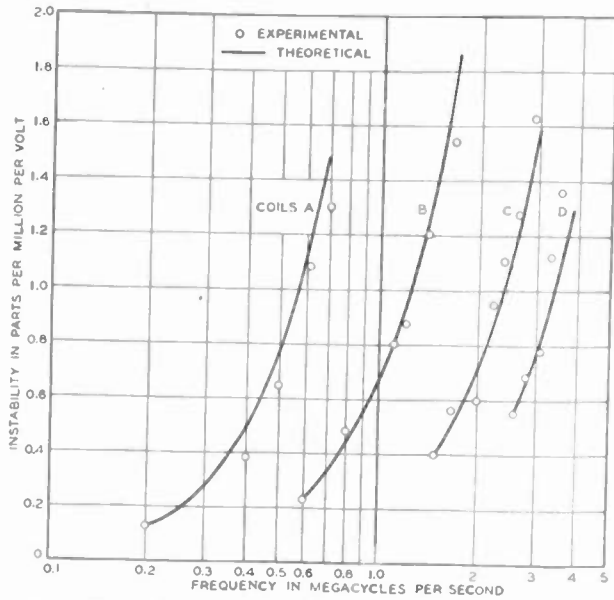

Fig. 11—LC oscillator. Frequency instability against line-voltage fluctuations as a function of the frequency of oscillation for an experimental model.

to an experimental model utilizing a negative coefficient thermistor control.

LABORATORY MODELS

General Requirements

Figs. 12 and 13 show the circuit details of the two types of oscillators discussed above.

In each case the oscillator proper is followed by a broad-band feedback amplifier to obtain a stable source of amplification and to prevent reactions between the oscillator and the load circuits. The problem of singing in such a single-stage feedback amplifier is usually not a serious one. In the present case, however, the difficulties are increased by the fact that the coupling network has a high loss at the frequency of

desired oscillation and a small loss at other frequencies. If, therefore, a source of spurious phase shift of the order of 180 degrees combined with low coupling loss exists between the grid and plate, oscillation will occur at the frequency of this phase shift rather than at the desired frequency of oscillation. In general, because the frequency of this spurious oscillation is not governed by the control provided, it is undesirable for it

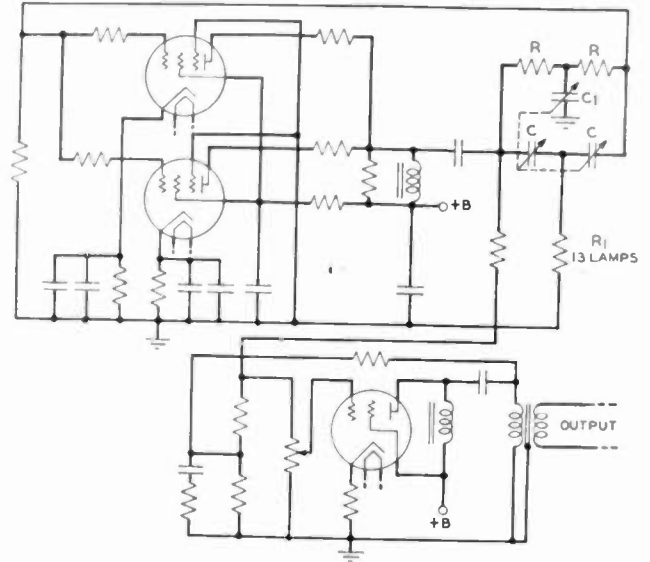

Fig. 12—Circuit diagram for a laboratory model of the CR oscillator including an output stage incorporating negative feedback. Frequency changes are accomplished by simultaneous variation of the three condenser arms.

will produce nonlinear behavior in the tubes. An elegant but very effective cure for this trouble was found in the use of a small resistance (10 to 100 ohms) at the grid and plate-socket prongs of the tube.

Other general design considerations consist chiefly in producing an amplifier section for the oscillator

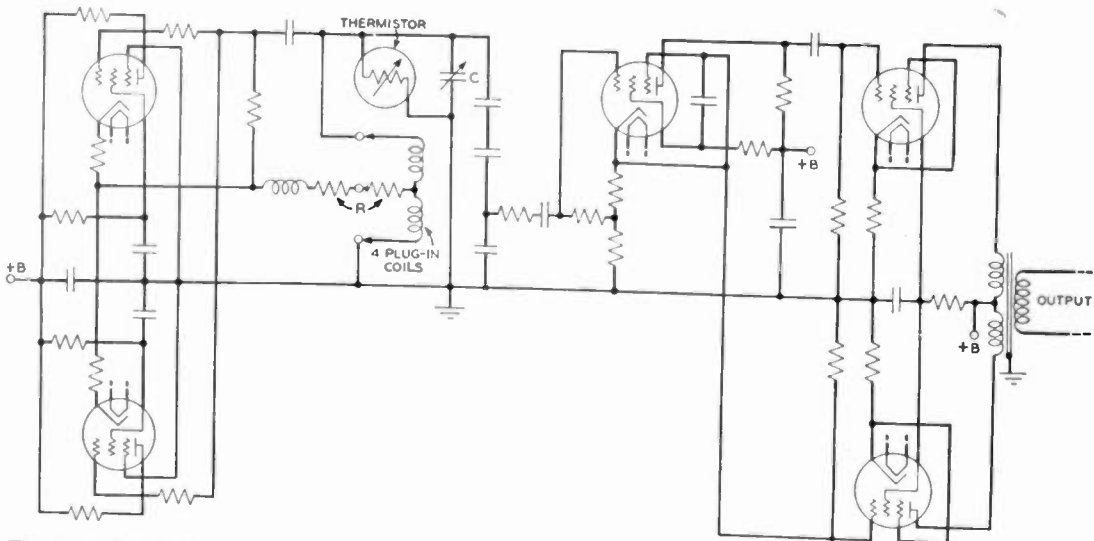

Fig. 13—Circuit diagram for a laboratory model of the LC oscillator. The output amplifier consists of an inverter stage and a push-pull stage. The oscillator amplifier in this application was operated with the plates at alternating potential ground in order to reduce the effects of the parasitic capacitances of the tuning elements.



having reasonably flat phase and gain characteristics over the wanted range of the oscillator.

*Amplitude-Control Characteristics*

The use of the tungsten-filament lamps for a control places some restrictions upon the oscillator circuits. The most suitable lamps commercially obtainable require about 2 milliamperes of current flowing through them in order to operate on a steep portion of their resistance-current characteristic. For a permissible plate swing of the oscillator this limits both the shunt- and series-resistance arms of the network if the condensers are to be equal. An inspection of (8a) shows that this restricts the stability of the oscillator. Physically it means that an upper limit is imposed by the possible amplifier gain. If the shunt and series condensers are not made equal then more amplifier gain may be attained but this requires more capacitance to cover a given frequency range if frequency changes are produced by simultaneous variation of the condensers.

The control resistance, as may be seen, is an important factor for the successful operation of both the CR and LC oscillator circuits so that it is appropriate to mention some of the characteristics required of it. It is necessary that this resistance should be linear in the sense that it should not vary over a cycle of the oscillation.

A satisfactory solution to the problem of a highly sensitive control is obtained by fixing  $R_1$  at the largest value possible for the range desired and connecting a resistance having a very large negative temperature coefficient between the grid and plate as a separate feedback path. These negative resistance-coefficient thermistors are obtainable in a wide range of impedance and current ratings and have a very high rate of change of resistance with current.<sup>13</sup> Their simplicity and compactness also makes them highly useful for circuit applications. A typical characteristic is shown in Fig. 14.

The method of applying these thermistors may be exemplified by reference to the LC oscillator. As an approximation to the impedance facing the amplifier one may take the value  $Q_{L_0}p_0L$ . One then chooses a value for this as large as is consistent with the requirements of the broad-band amplifier considering stray capacitances, etc. The value of the thermistor for a null is given by (6b) as

$$R_{T_0} = \frac{4R}{1 - \frac{2R}{Q_{L_0}p_0L}}$$

The departure from this value at the operating point is

$$\frac{\delta R_T}{R_{T_0}} = \frac{R_{T_0}}{4gR^2} \tag{6c}$$

Combining (6b) and (6c) we obtain

$$\frac{\delta R_T}{R_{T_0}} = \frac{1}{gR \left( 1 - \frac{2R}{Q_{L_0}p_0L} \right)} \tag{6d}$$

Now, referring to the stability condition (9b), it will be seen that it is desirable to make  $R$  as large as possible. However the whole analysis is dependent upon the assumption that  $\delta R_T/R_{T_0} \ll 1$  and we therefore choose a value so that this is satisfied. We can make  $\delta R_T/R_{T_0}$  small by making the amplifier transconductance large and this is more desirable than manipulating  $R$  which cannot in any event be made greater than

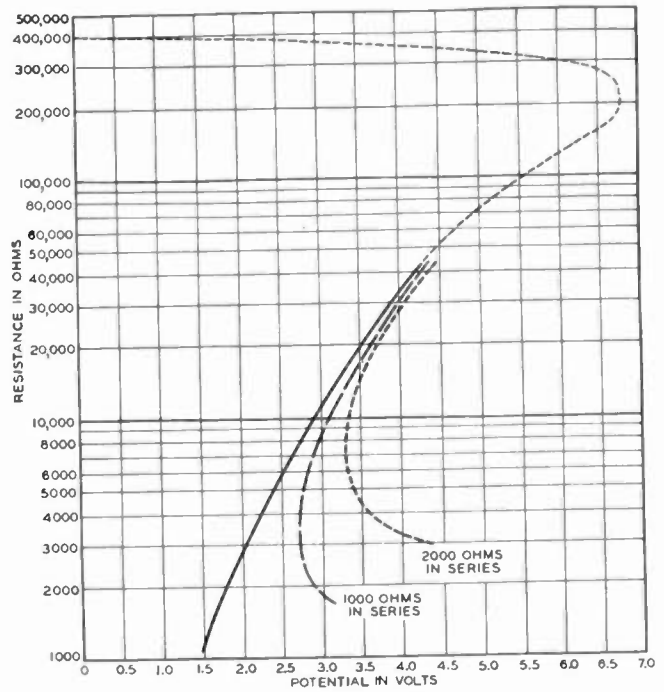

Fig. 14—An example of a resistance-voltage characteristic for a bead thermistor. The effect of adding series resistances on the characteristic is also illustrated.

$Q_{L_0}p_0L/2$ . For any given value of  $g$  a maximum for (6d) will be obtained for  $R = Q_{L_0}p_0L/4$ . How much greater than this value  $R$  is made will be determined by the transconductance. When  $R$  is thus fixed a value of  $R_{T_0}$  is determined. The foregoing calculations should be made for the low-frequency end of the band for any given coil since this will be the worst case. A thermistor for which a typical characteristic is shown in Fig. 14 is then selected such that the operating range of resistance required will lie in the region where the resistance changes most rapidly with the voltage in order to minimize variations of amplitude. The resistance characteristic may be further improved by the addition of a fixed resistance in series with  $R_T$ . The effect of this is shown in Fig. 14.

The negative temperature-coefficient thermistor may also be applied to the RC oscillator. This application makes possible alternative methods of frequency control without the wide variations of amplitude which

<sup>13</sup> G. L. Pearson, "Thermistors, their characteristics and uses," *Phys. Rev.*, vol. 57, p. 1065; June 1, 1940. Presented, American Physical Society, Washington, D. C., April 10, 1940.

would result with these methods if lamps are employed. The negative coefficient thermistors are bridged across the frequency-determining network as in the *LC* oscillator.

There is one undesirable feature involved in a thermal amplitude control which for certain applications may make its use impractical. When sudden variations occur in the supply voltages or any other disturbances which suddenly upset the gain-loss balance of the circuit a fluctuation of the amplitude of the oscillation will occur. This fluctuation is the result of the thermal

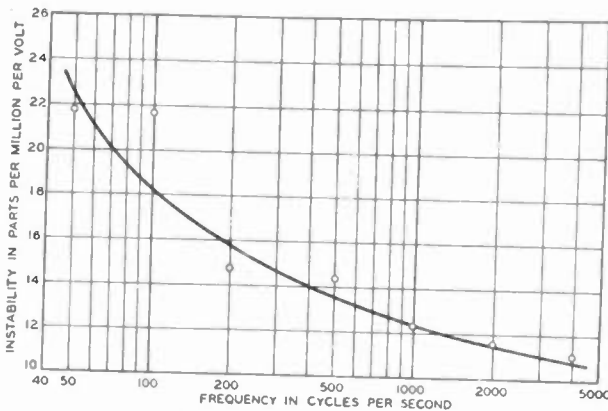

Fig. 15—Frequency instability against changes in the supply voltage as a function of the oscillating frequency for the laboratory model of the *CR* oscillator illustrated in Fig. 12. Frequency changes are accomplished by gang variation of the condenser arms. The thermal control consisted of tungsten lamps.

lag of the thermistor and it damps out with a decrement determined by the thermal and electrical constants of the thermistor in combination with the constants of the rest of the circuit. The effect is minor for the *LC* circuit but is most severe as might be expected for the *CR* circuit at very low frequencies where the time constants are long. Such fluctuations for many purposes, while annoying, may not be so serious as to militate against the desirable quasi-linear characteristic of a thermal element. In other cases it has been found that a successful substitute for the thermistors may be obtained by using such elements as diodes, copper-oxide varistors, or gas tubes. The suggested elements are all for the case of the negative temperature-coefficient thermistors.

#### Condenser-Resistance Oscillator

In one low-frequency oscillator, illustrated in Fig. 12, the three condensers in the network were made equal and varied simultaneously to change the frequency. As pointed out previously this means that the positive coefficient thermistor  $R_1$  should have a value independent of frequency and hence may be adjusted to remain at the steepest point of its current-resistance characteristic resulting in good amplitude control. The amplitude variation of the oscillator proper was found to be less than  $\pm 0.5$  decibel over a frequency range of 40 cycles to 50 kilocycles with most of this variation caused by phase shift at the extremes of frequency.

Fig. 15 illustrates frequency stability as a function of frequency. Decreasing stability at low frequencies resulted from phase shift introduced by the plate-supply choke.

The harmonic content of the oscillator proper was found to be principally second harmonic and was about 50 decibels below the fundamental over the entire frequency range. The output feedback amplifier when supplied from a pure sinusoidal source had a harmonic content 60 decibels below the fundamental at full power output of 20 decibels above 1 milliwatt. A switch is provided to remove the feedback for use where harmonic content is of lesser importance, in which case an output of over 1 watt is available.

Another type of low-frequency oscillator made practicable by the use of a negative coefficient thermistor is one in which the frequency is varied by changing the resistance arms simultaneously. It has been pointed out that under these circumstances the network input impedance and hence the amplifier gain will change. However, the wide range of resistance change for a small change of voltage across the negative coefficient thermistor makes it possible to cover a 10-to-1 frequency range without undue amplitude variation.

Fig. 16 illustrates a model of this type where three resistances are ganged together and are continuously variable over a 10-to-1 range. The position of the range is changed by varying the condensers together in

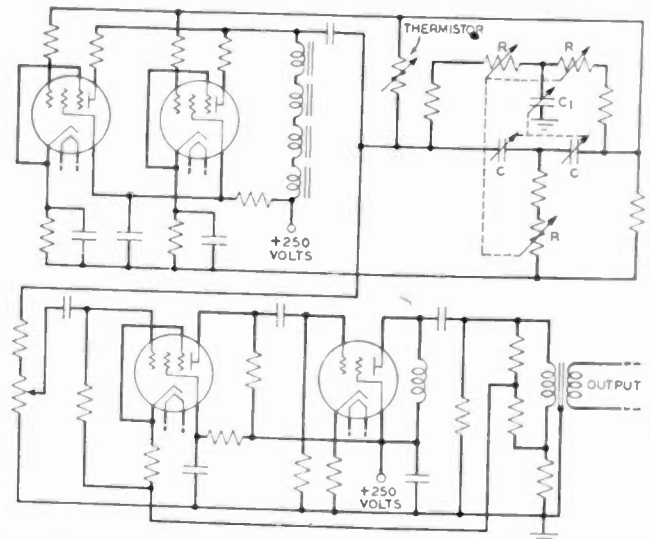

Fig. 16—Circuit diagram for a laboratory model of a *CR* oscillator with a two-stage output amplifier. Frequency variation in this case is accomplished by a continuous variation of the three resistance arms over a limited range. Four separate ranges are covered by switching the three condenser arms. The resistance arms permit a 10-to-1 frequency range and the over-all range of the oscillator is from 14 to 50,000 cycles.

decade steps. Here a range of 12 to 50,000 cycles was obtained in four steps. The negative coefficient amplitude control made it possible to increase the gain and hence reduce the harmonic content of the oscillator circuit to a value of 60 decibels below the fundamental at the high-frequency end of each range, and about 80 decibels at the low-frequency end.

Inductance-Capacitance Oscillator

In the high-frequency bridged-T oscillator, shown in Fig. 13, continuous frequency control over a restricted range is obtained by varying the capacitance. A range control using four coils covered in steps the frequency range from 12 kilocycles to 6 megacycles.

In the laboratory models of the LC circuit the large parasitic capacitances associated with a wide-range variable condenser make it preferable to place the plate end of the condenser array at ground with the tube cathode off ground. It will be observed that under these conditions the tube acts as a triode since the suppressor and screen grids are at the same alternating potential as the plate.

Reference to the stability criterion (9b) shows that for greatest stability the  $L/C$  ratio and  $Q_L$  should be kept as large as possible. The desirability of the large  $L/C$  ratio, which is contrary to conventional oscillator practice, arises from the fact that the impedance of the network and hence the gain and permissible feedback increase with  $L$ . In practice, where the frequency of operation was such that the plate-cathode and grid-cathode capacitance limited the gain, a low  $L/C$  ratio was found to be preferable in order to minimize phase shifts.

Figs. 17 and 18 show the amplitude- and plate-voltage-stability characteristics of this oscillator. It will be noted that the stability curve for the highest frequency coil shows a point of very high stability at about 4.6 megacycles. This result was accomplished by correcting the phase shift of the amplifier-network characteristic to an optimum value by inserting a 10-microhenry coil in series with  $R_1$ . This coil tends to compensate for the phase shift introduced by the upper cutoff of the amplifier caused by parasitic capacitances.

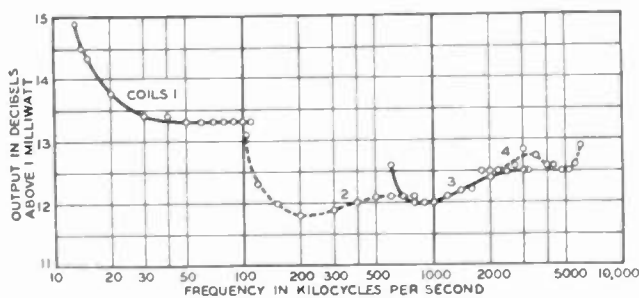

Fig. 17—Amplitude-versus-frequency characteristics of the LC laboratory oscillator illustrated in Fig. 13.

The mean value of the amplitude characteristics of the four coils could have been adjusted to equality by an adjustment of  $R_1$ . A more uniform response can be obtained by using five or six coils instead of four. The harmonic content of this oscillator and its associated feedback amplifier is about 60 decibels below the fundamental for power outputs up to 13 decibels above 1 milliwatt.

Multistage amplifiers may be used for the oscillator proper when very high stabilities are needed. The

difficulties of high-gain, high-feedback amplifier design and construction however discourage any great excursion in this direction. An oscillator employing a two-stage amplifier was built for the same frequency range as the one discussed above and showed a stability improvement of two to three times. The harmonic content was correspondingly improved.

It may be well to repeat that the oscillators as built were for variable-frequency work. The electrical and

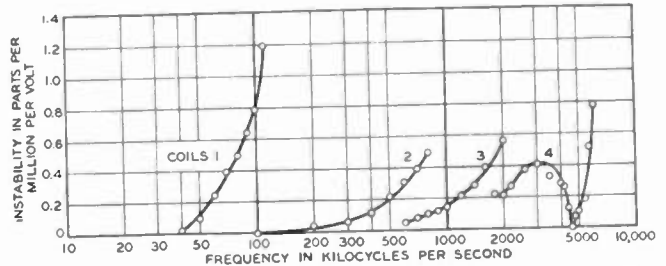

Fig. 18—Frequency instability against changes in the supply voltage as a function of the oscillating frequency of the LC laboratory oscillator of Fig. 13.

mechanical considerations necessary to obtain the wide frequency range make some sacrifice in stability necessary. Fixed-frequency or narrow-band oscillators of the same basic design would show still better stabilities since the lead inductance of the capacitance and the amplifier phase shift could be reduced or corrected.

ACKNOWLEDGMENT

The authors wish to express their indebtedness to Dr. Eugene Peterson of these laboratories under whose guidance this work was carried on. In particular we are indebted to him for the basic method of the asymptotic analysis. We also wish to express our appreciation to Mr. G. L. Pearson for his co-operation in supplying the negative temperature-coefficient thermistors and to Dr. H. W. Bode for many helpful discussions on the theory of the feedback amplifier.

APPENDIX

It is assumed that the amplifier is a constant-current generator. Then the mesh equations for the circuit of Fig. 4 may be written

$$\begin{aligned}
 (R_1 + jX_L) &= [2R_1 + j(2X_L - X_C)] \frac{i_2}{i_1} \\
 &- (R_1 + jX_L) \frac{i_3}{i_1} + jX_C \frac{i_4}{i_1} \\
 0 &= jX_C \frac{i_2}{i_1} + 0 + (R_T - jX_C) \frac{i_4}{i_1} \\
 R &= - (R_1 + jX_L) \frac{i_2}{i_1} \\
 &+ (R + R_3 + R_1 + jX_L) \frac{i_3}{i_1} + 0.
 \end{aligned} \tag{1}$$



These may be solved to give

$$\frac{\Delta i_3}{i_1} = R_1 R_T (R_1 + 2R) + X_L X_C (2R_1 + 2R) - R_T X_L^2 + j [R_T X_L (2R_1 + 2R) - R_1 X_C (R_1 + 2R) - R_T R X_C + X_L^2 X_C]. \quad (2)$$

Let

$$R_1 + 2R = 2R', \quad Q_C = pCR_T, \quad Q_L = \frac{pL}{R_1}$$

$$Q' = \frac{Q_C Q_L}{Q_C + Q_L}$$

$R_1 X_L X_C$  is neglected in comparison with  $R_T X_L^2$  and  $2R_1 R' X_C$  in comparison with  $R_T R X_C$ . Then the conditions for  $\Delta i_3 / i_1 = 0$  are

$$R \cong R' = \frac{Q_0' X_{L_0}}{2}, \quad f_0^2 = \frac{1}{8\pi^2 LC} \frac{1 - \frac{1}{Q_0' Q_{L_0}}}{1 + \frac{1}{Q_0'^2}} \quad (3)$$

At the operating point

$$p = p_0 + \delta p, \quad Q' = Q_0' + \delta Q$$

Then upon utilizing the null conditions, (2) may be written, if products of small quantities are neglected, as

$$\frac{\Delta i_3}{i_1} = \delta Q' \frac{2p_0 R' R_T L}{Q_0'^3} [-Q_0' - j] + \delta p \left[ -\frac{2R' R_T L}{Q_0'} + j \left[ \frac{4R' R_T L}{Q_0'^2} + 2R_T R' L + \frac{2R_T R L \left[ 1 + \frac{1}{Q_0'^2} \right]}{1 - \frac{1}{Q_0' Q_{L_0}}} \right] \right] \quad (4)$$

Equation (6) is of the form

$$\delta Q' [\alpha_1 + j\alpha_2] + \delta p [\beta_1 + j\beta_2]. \quad (5)$$

Equation (1), when solved for  $\Delta$  at the null condition denoted by  $\Delta_0$ , yields, if  $R$  and  $R_1$  are neglected in comparison with  $R_3$ , and  $R_1$  in comparison with  $R_T$  and if we assume  $X_{C_0} \cong 2X_{L_0}$ ,

$$\Delta_0 = 2R_3 R_1 R_T \left[ 1 + \frac{Q_{L_0}}{Q_{C_0}} + \frac{Q_{L_0} X_{L_0}}{2R_3} \right] + j R_T R_3 \left[ 2X_{L_0} - X_{C_0} \left( 1 - \frac{X_{L_0}^2}{R_T R_3} \right) \right] \cong \frac{4R_3 R_T R'}{Q_0'^2} \quad (6)$$

An inspection of the equation for  $\Delta$  shows that  $\Delta$  changes slowly near the null and hence we are justified in assuming  $\Delta \cong \Delta_0$  at the operating point.

Further conditions for oscillation are

$$i_3 R_3 = V, \quad i_1 = gV$$

where  $g$  may be complex. Combining,

$$\frac{gR_3}{|\Delta|} \left| \frac{\Delta i_3}{i_1} \right| = 1 \quad \text{and} \quad \theta + \tan^{-1} \left| \frac{\Delta i_3}{i_1} \right| = 0, \quad (7)$$

where  $\theta$  is the phase shift produced by the amplifier. In order to write (7) as above it is necessary that  $\Delta$  shall be real which to a very good approximation will be true near the null. From (7) one may derive the two equations

$$\delta Q' = -\delta p \frac{\beta_2 + \beta_1 \tan \theta}{\alpha_2 + \alpha_1 \tan \theta} \quad (8a)$$

$$\delta p = \frac{\Delta_0 \cos \theta (\alpha_2 + \alpha_1 \tan \theta)}{gR_3 (\alpha_1 \beta_1 - \alpha_1 \beta_1)} \quad (8b)$$

When the values of  $\alpha_1, \alpha_2, \beta_1, \beta_2$ , and  $\Delta_0$  are inserted

$$\frac{\delta p}{p_0} = \frac{2 \sin \left( \theta + \tan^{-1} \frac{1}{Q_0'} \right)}{gp_0 L Q_0'^2 \left[ 1 - \frac{1}{Q_0'^2} + \frac{R}{R'} \frac{1 + \frac{1}{Q_0'^2}}{1 - \frac{1}{Q_0' Q_{L_0}}} \right]} \quad (9)$$

Now

$$\frac{R}{R'} \cong 1, \quad \frac{1}{Q_0'^2} \ll 1, \quad \text{and} \quad \frac{1}{Q_0' Q_{L_0}} \ll 1.$$

Hence

$$\frac{\delta p}{p_0} \cong -\frac{p_0 L \sin \left( \theta + \tan^{-1} \frac{1}{Q_0'} \right)}{4gR'^2} \quad (10)$$

which is the equation given in the text since  $1/Q_0'$  is small.

Equation (10) may be combined with (8a) to determine  $\delta R_T$ .

# A Note on Field Strength of Delhi 3 and Delhi 4 at Calcutta During the Solar Eclipse of September 21, 1941\*

S. P. CHAKRAVARTI†, MEMBER I.R.E.

**Summary**—The signal field strengths of two Delhi, India, stations on frequencies of approximately 15.3 and 11.8 megacycles were measured during a morning solar eclipse in Calcutta 900 miles away. Changes related to the eclipse were found.

**F**IELD strengths of Delhi 3 (5 kilowatts aerial power and 19.62 meters day wavelength) and Delhi 4 (5 kilowatts aerial power and 25.26 meters wavelength) were simultaneously measured at Calcutta situated at about 900 miles to the southeast of Delhi during the hours of the solar eclipse (i.e., between 8:15 A.M. and 10:30 A.M., Calcutta time) on Sunday, September 21, 1941. The receiving point was located in Camac Street, Calcutta, and the field-

time, the ordinates representing quantities proportional to the strength of the horizontal component of the electric vector. Similarly, Fig. 2 shows the observation on Delhi 4 between 8:34 A.M. and 10:30 A.M., Calcutta time. The variation in modulation percentage in these channels during the period of observation as read from an indicator was inappreciable, and the same program was transmitted through both the channels during the period.

It will be seen from Figs. 1 and 2 that over the greater portion of the period under observation the average signal intensity is higher than the average noneclipse intensity (over the same period) and that to-

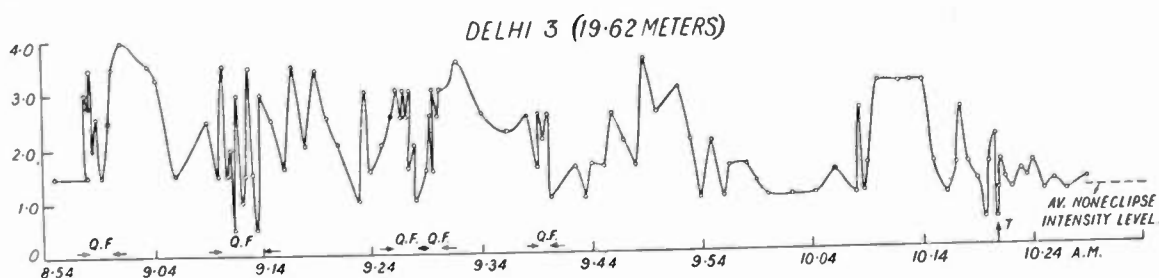

Fig. 1

strength-measuring equipments consisted of Mullard-Philips superheterodyne receivers with the automatic volume control removed and other necessary accessories fitted up for the purpose, connected to horizontal aerials cut for the wavelengths.

The relative values of the horizontally (abnormally)

wards the end of the period it falls almost to the noneclipse intensity level.

## FADING OF DELHI 3 (19.62 METERS)

It will be seen from Fig. 1 that during the first half of the period of observation (i.e., roughly the first 45

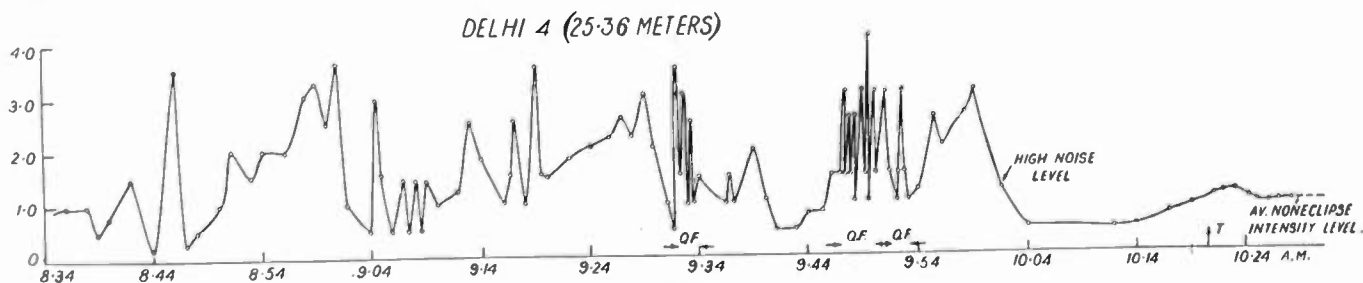

Fig. 2

polarized component of the electric-field intensity were ordinarily observed every minute and at certain times every 5 or 10 seconds. Fig. 1 shows the observations on Delhi 3 between 8:54 A.M. and 10:30 A.M., Calcutta

minutes) there are several indications of "quick fading" having a period of 10 to 30 seconds and of an amplitude such that in some cases the signal intensity ranged from about one-half or full (average) noneclipse value to over twice or thrice that value, and in others it ranged from  $2\frac{1}{2}$  to 3 times the value or from 3 to  $3\frac{1}{2}$  times the value. "Q.F.'s" on the figures indicate the occasions of quick-fading. Fig. 3 shows a typical

\* Decimal classification: R270×R113.55. Original manuscript received by the Institute, March 23, 1942.

† Kanodia Electrical Communication Engineering Laboratories, Department of Applied Physics, University of Calcutta, Calcutta, India.

curve of quick fading drawn on an enlarged time scale. The second half of the period of observation until a few minutes before the termination of eclipse is characterized by "slow fading" having a period of 1 to 3 minutes and of an amplitude such that the signal

and a half times the average noneclipse value to three and a half or four times that value. Fig. 4 shows the typical curves (showing quick fading) drawn on an enlarged time scale. A rough periodicity related to the maximum values of signal intensity can also be noticed

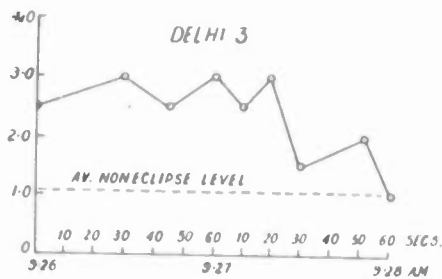

Fig. 3—Quick fading.

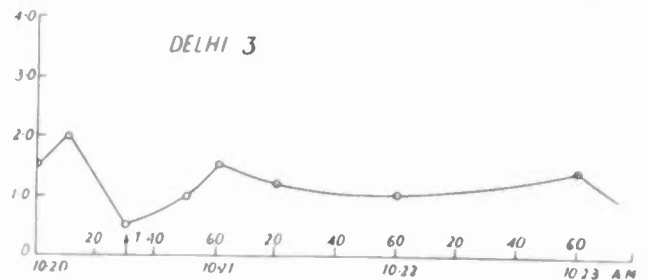

Fig. 5—Termination of the eclipse.

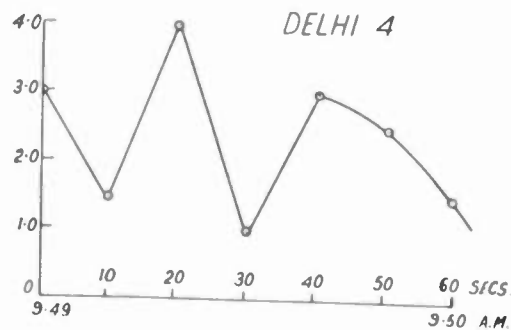
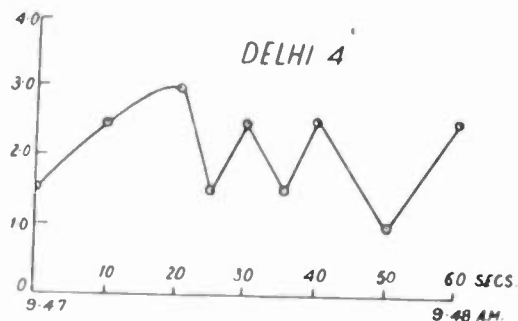
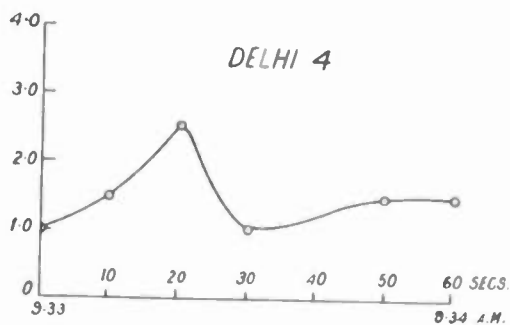

Fig. 4—Quick fading.

intensity ranged from about full noneclipse value to two or three times that value.

#### FADING OF DELHI 4 (25.36 METERS)

It will be seen from Fig. 2 that for the case of the longer wave the first half of the period of observation is characterized by slow fading having a period of 1 to 5 minutes and of an amplitude such that the signal intensity ranged from one fifth or one half of the average noneclipse value to three and a half times that value. During 25 minutes of the second half of the observation period, there are a few indications of quick fading having a period of 5 to 30 seconds and of an amplitude such that the signal intensity varied from full or one

from Fig. 2. The highest values of signal intensity can be seen to be reached after a period varying from 13 to 18 minutes.

#### CONDITIONS NEAR TERMINATION OF THE ECLIPSE

$T$  on the time scale in Figs. 1 and 2 represents roughly the termination of the eclipse. Fig. 5 shows the termination conditions for Delhi 3 on an enlarged time scale. It will be seen, therefrom, that near about or at the termination time there is a considerable reduction in the strength of the signal followed by a quick or slow rise in strength one or more times in course of next 2 to 3 minutes.



# Open-Wire Radio-Frequency Transmission Lines\*

EDMUND A. LAPORT†, MEMBER I.R.E.

*Summary*—Design formulas for several types of open-wire transmission lines, both balanced and unbalanced, are developed and listed in a simplified form suitable for most engineering applications. The method of logarithmic potentials is used. Its utility in connection with certain aspects of low-frequency antenna design is briefly outlined.

## INTRODUCTION

SINGLE-PHASE open-wire radio-frequency transmission lines have been widely used in engineering practice, yet there seems to be no comprehensive compilation of design formulas available. The present paper is a collection of a few which are of frequent practical utility. The method by which design formulas are developed is outlined briefly in the various type cases, from which one can readily proceed to other cases of a special nature.

Both balanced and unbalanced lines are discussed, together with the extension of line formulas to certain important aspects of low-frequency antenna design. These formulas are not exact but they are accurate enough for most engineering applications, where it is simply desired to transfer from one point to another. The conditions under which the equations are developed are stated, and departure from these basic conditions will modify the formulas in various degrees and determine the practicality of any given design for any particular application.

Characteristic impedance and transmission efficiency are the first values one wishes to know for any particular line. Otherwise, one knows these values and wishes to find the line configuration which will provide them. The characteristic impedance can be calculated with great accuracy under ordinary circumstances, but the transmission efficiency is very difficult to predict precisely under the many empirical conditions encountered in reality. It is, therefore, more convenient to consider attenuation in relative or comparative terms from some known standard. For instance, in the case of an unbalanced line (where one or more wires of the system are at ground potential and the others connected in parallel as the other side of the circuit) the controlling factor in the attenuation is the proportion of the total return current which is conducted in the earth. In all such cases, some current is conducted in the earth since the ground-wire current never equals that in the high-potential wires. This is because not all of the lines of force originating on the high-potential wires terminate on the grounded wires but some are completed to earth. The amount of flux reaching earth is dependent upon the line configuration in cross sec-

tion. The relative figure of merit of an unbalanced line design can, therefore, be indicated by the ratio of total ground-wire current to the total high-potential wire current. The larger this ratio, the lower the attenuation, other things remaining equal. This current ratio is the same as the charge ratio and is a convenient factor to use because it can be readily found by solving the fundamental potential-charge equations from which the other line characteristics are derived.

The qualitative fact that there are some lines of force completed to earth has been an objection which has impeded the more general adoption of open-wire lines. The matter must, of course, be decided on quantitative considerations. The attenuation and radiation characteristics of a line are within the control of the designer and he can go as far as he wishes in minimizing both. The many years of successful world-wide experience with open-wire lines for communication and power-transmission purposes, the system reliability, straightforward construction, and relatively low construction cost and maintenance, are features of importance to the radio engineer.

Simple principles of electrostatics provide the tools for predicting the characteristic impedance, the charge ratios, the capacitance and inductance per unit length, and the field of force in space, from the cross-sectional geometry of the line. The theory of logarithmic potentials for cylindrical parallel conductors is used to derive the line equations in terms of potentials, charges per unit length, conductor sizes, and spacings. Experience has proved these principles to be valid for radio frequencies when the cross-sectional dimensions, including image distances, are so small with respect to the wavelength that retarded potentials are not involved. On the other hand, the frequency must be high enough and the losses low enough to justify the familiar approximation that  $Z_0 = (L/C)^{1/2}$  or, more conveniently,  $Z_0 = 1/vC$ . Practical open-wire-line construction dictates conductor spacings large with respect to the wire diameter so that proximity effect is negligible. In addition to the above, the formulas herein are based on the assumptions that the wires have the same size, that they run parallel to each other and at uniform height over a perfectly conducting plane ground, and that the differences in heights of the individual wires are negligible in proportion to the total height. The line is considered to be uniform in all respects throughout its length and in the structural design it is quite necessary to attempt to realize this. These restrictions can be readily removed at the expense of greatly increased labor of formulation and computation, when circumstances justify.

There are many desirable line configurations but

\* Decimal classification: R116. Original manuscript received by the Institute, September 30, 1942.

† RCA Victor Company, Ltd., Montreal, Quebec, Canada.

ordinarily economy and operating reliability dictate constructions using a small number of wires or the least copper in an arrangement using a minimum of poles, insulators, pole hardware, and installation labor. Where large amounts of power are to be transmitted, line potentials are reduced by reducing  $Z_0$ . Gradients are reduced by increasing wire sizes or using 2 or more small wires in parallel. In the case of unbalanced lines, the ground-wire to high-potential-wire charge ratio  $k$  diminishes as the number of wires is reduced; for minimum attenuation we wish to keep  $k$  as large as possible, especially on long lines and at the higher frequencies.  $k$  increases as the wire configuration is made more compact, but to avoid swinging wires, excessive tension, or excessive sag, the pole span can be reduced with consequent increase in the number of poles and attachments. Optimum electromechanical design must compromise all these factors to the point where the law of diminishing returns acts. Practical construction usually requires a minimum clearance height of 10 feet and prevailing wind and ice loadings and temperature variations dictate minimum wire sizes and maximum spans. With these factors at work it is very helpful to have simple formulas at hand to reveal quickly the essential characteristics with minimum expenditure of engineering time.

Occasionally one desires to know the field configuration in space around the line, the potential at some point in space due to the line, or the potential gradient at some point. Equations are included for several cases which enable the space potentials to be determined. Solving these for many points, the equipotential contours can be mapped in as great detail as may be desired.

In a recent paper,<sup>1</sup> Brown explained an unusually direct method by which the line equations are developed. The present paper follows this method. He also studies in detail the matters of attenuation and radiation, and gives data on three types of unbalanced open-wire lines, the results of which are included here because they apply to lines which are relatively common in practice. His equations for attenuation for unbalanced lines are repeated here for reference as they are of great utility in relation to the contents of this paper.

#### Attenuation Due to Losses in the Earth from Earth Return Currents

$$\alpha_e = \frac{13,720}{Z_0 h_{FT}} (1 - k)^2 \sqrt{\frac{10^{-13} f_{mc}}{\sigma_{emu}}} \text{ (decibels per 1000 feet)}$$

#### Attenuation Due to Copper Losses in the Line

$$\alpha_c = \frac{2.17 \sqrt{f_{mc}}}{\rho_{in} Z_0} \left[ \frac{1}{m} + \frac{k^2}{n} \right] \text{ (decibels per 1000 feet)}$$

<sup>1</sup> G. H. Brown, "Characteristics of unbalanced overhead transmission lines," *Broadcast News*, May, 1941.

(This is for a symmetrical line configuration where  $m$  is the number of high-potential wires and  $n$  the number of grounded wires.)

#### Symbols Used in this Paper

- $Q$  = root-mean-square charge in coulombs per centimeter  
 $\lg = \log_{10}$   
 $\ln = \log_e$   
 $k$  = ratio of total ground-wire currents (or charges) to total high-potential wire currents (or charges)  
 $Z_0$  = characteristic impedance in ohms  
 $C$  = capacitance in farads per centimeter  
 $v$  = velocity of propagation of charges in the wires of  $3 \times 10^{10}$  centimeters per second for uniform linear overhead conductors  
 $\rho$  = radius of wire  
 $a, b, c, \text{ etc.}$  = center spacings between various wires  
 $h$  = mean height of wires above ground plane  
 $r_1, r_2, r_3, \text{ etc.}$  = distances from various conductors to a point in space  
 $r_{11}, r_{22}, r_{33}, \text{ etc.}$  = conjugate distances from the images of the conductors to the point in space

All dimensions are in the same units.

$\alpha$  = attenuation in decibels per thousand feet of line.

Indicated equalities (=) should be read "very nearly equal to."

#### CASE I

##### Single-Wire Line with Ground Return<sup>2</sup>

The potential of the wire in terms of its charge per centimeter of length is written, after conversion to practical units and common logarithms,

$$E_1 = 138v \left( Q_1 \lg \frac{1}{\rho} - Q_1 \lg \frac{1}{2h} \right) \text{ (volts).}$$

The potential coefficients  $\lg(1/\rho)$  and  $\lg(1/2h)$  are due to the wire and its image respectively. The reciprocal dimensions are used for mathematical convenience so that each term can have the same sign as that of its charge. This condenses to  $E_1 = 138v Q_1 \lg(2h/\rho)$ .

The capacitance  $C$  per unit length is the charge per unit length divided by the difference of potential so that,

$$C = \frac{Q_1}{E_1} = \frac{1}{138v \lg \frac{2h}{\rho}}$$

and

$$Z_0 = \frac{1}{vC} = 138 \lg \frac{2h}{\rho}$$

<sup>2</sup> C. A. Boddie, "Telephone communication over power lines by high frequency currents," *PROC. I.R.E.*, vol. 15, pp. 578-590; July, 1927.

The potential at a near-by point in space above the ground is

$$E_p = 138v \left[ Q_1 \lg \frac{1}{r_1} - Q_1 \lg \frac{1}{r_{11}} \right] \equiv 138v Q_1 \lg \frac{r_{11}}{r_1}$$

so that

$$\frac{E_p}{E_1} = \frac{\lg \frac{r_{11}}{r_1}}{\lg \frac{2h}{\rho}}$$

CASE II

Two Elevated Wires, One Grounded

The potential equation for wire No. 1 is written

$$E_1 = 138v \left[ Q_1 \lg \frac{1}{\rho} - Q_1 \lg \frac{1}{2h} + Q_2 \lg \frac{1}{a} - Q_2 \lg \frac{1}{2h} \right]$$

The first term is the potential on the wire due to its own charge, the second the induced potential due to

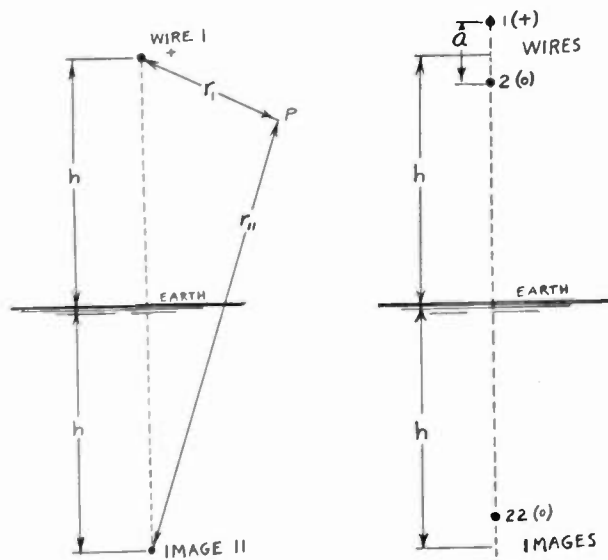

Fig. 1—Diagram for Case I. Fig. 2—Diagram for Case II.

its own image, the third the potential induced by the charges on wire No. 2 and the fourth the potential induced by the image of No. 2.

Similarly, for wire No. 2, which is grounded,

$$E_2 = 138v \left[ Q_1 \lg \frac{1}{a} - Q_1 \lg \frac{1}{2h} + Q_2 \lg \frac{1}{\rho} - Q_2 \lg \frac{1}{2h} \right] = 0.$$

From the latter the ratio of the charges can be found to be

$$k = \frac{Q_2}{Q_1} = - \frac{\lg \frac{2h}{a}}{\lg \frac{2h}{\rho}}$$

(Note that  $k$  is a negative fraction.) The equation for  $E_1$  is then condensed to

$$E_1 = 138v Q_1 \left[ \lg \frac{2h}{\rho} + k \lg \frac{2h}{a} \right]$$

To obtain the reciprocal of the capacitance per unit length this is divided through by  $Q_1$  which gives

$$\frac{1}{C} = \frac{E_1}{Q_1} = 138v \left[ \lg \frac{2h}{\rho} + k \lg \frac{2h}{a} \right]$$

and

$$Z_0 = 138 \left[ \lg \frac{2h}{\rho} + k \lg \frac{2h}{a} \right]$$

The potential at a near-by point in space with respect to that of the wire is written

$$E_p = 138v \left[ Q_1 \lg \frac{1}{r_1} - Q_1 \lg \frac{1}{r_{11}} + Q_2 \lg \frac{1}{r_2} - Q_2 \lg \frac{1}{r_{22}} \right]$$

and condensed to

$$E_p = 138v Q_1 \left[ \lg \frac{r_{11}}{r_1} + k \lg \frac{r_{22}}{r_2} \right]$$

The ratio of this potential to that on the wire is

$$\frac{E_p}{E_1} = \frac{\lg \frac{r_{11}}{r_1} + k \lg \frac{r_{22}}{r_2}}{\lg \frac{2h}{\rho} + k \lg \frac{2h}{a}}$$

CASE III

Three Wires in Elevated Horizontal Plane, Equispaced, with Two Outer Wires Grounded

From obvious electric symmetry,  $Q_1 = Q_3$  so that the

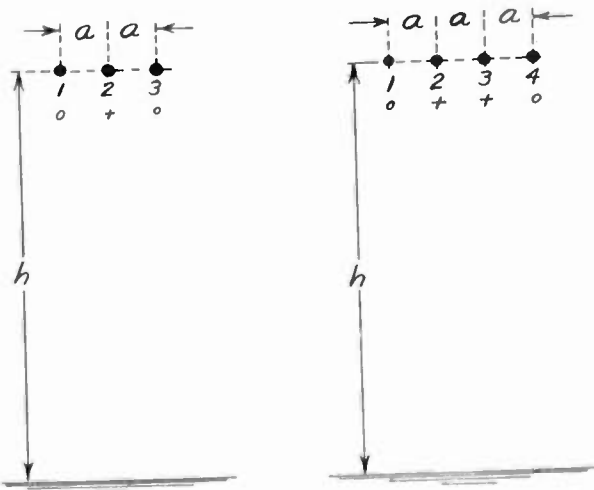

Fig. 3—Diagram for Case III. Fig. 4—Diagram for Case IV.

potential equations can be written in simplified form immediately



$$E_1 = 138v \left[ Q_1 \lg \frac{2h^2}{a\rho} + Q_2 \lg \frac{2h}{a} \right] = 0$$

Taking into consideration that there are two grounded wires

$$E_2 = 138v \left[ Q_1 \lg \frac{4h^2}{a^2} + Q_2 \lg \frac{2h}{\rho} \right]$$

$$k = \frac{Q_1 + Q_3}{Q_2} = -2 \frac{\lg \frac{2h}{a}}{\lg \frac{2h^2}{a\rho}}$$

Since wires No. 1 and No. 3 are both at the same potential, the equation for No. 3 will lead to an identity

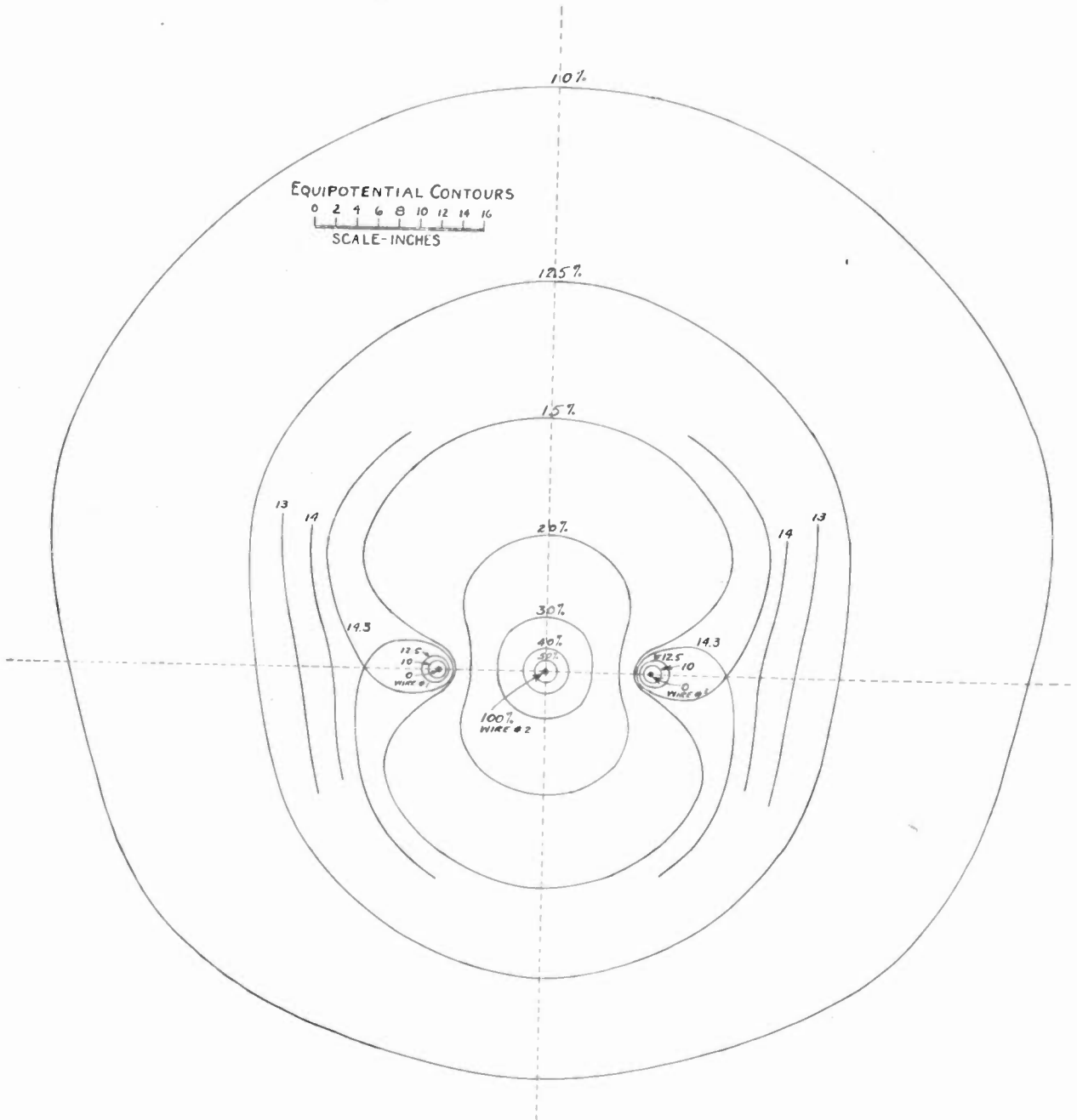

Fig. 3(a)—Field plot for Case III.

with that for No. 1 so need not be written. The charge ratio is solved out of the first equation

Rewriting, substituting, and condensing

$$\frac{Q_1}{Q_2} = \frac{\lg \frac{2h}{a}}{\lg \frac{2h^2}{a\rho}}$$

$$E_2 = 138vQ_2 \left[ k \lg \frac{2h}{a} + \lg \frac{2h}{\rho} \right]$$

from which the reciprocal capacitance is found to be

$$\frac{1}{C} = \frac{E_2}{Q_2} = 138v \left[ k \lg \frac{2h}{a} + \lg \frac{2h}{\rho} \right]$$

and

$$Z_0 = 138 \left[ k \lg \frac{2h}{a} + \lg \frac{2h}{\rho} \right]$$

In the same manner as for Case II, the ratio of the potential at a near-by point in space with respect to that on the wire No. 2 is

$$\frac{E_p}{E_2} = \frac{\frac{k}{2} \lg \frac{r_{11}r_{33}}{r_1r_3} + \lg \frac{r_{22}}{r_2}}{k \lg \frac{2h}{a} + \lg \frac{2h}{\rho}}$$

Fig. 3(a) is a map of the equipotential contours in the vicinity of the wires for a transmission line of this type, where the height above ground is 120 inches, the wire spacing 10 inches, and the wire radius 0.064 inch. The map was plotted from this equation.

Some sample characteristic values for transmission lines of this type are shown in Table I.

TABLE I

h height inches	ρ radius inches	a spacing inches	k charge ratio	Z <sub>0</sub> impedance ohms
120	0.064	5	-0.678	336
120	0.064	10	-0.592	380
120	0.064	15	-0.537	413

CASE IV

Four Wires in Elevated Horizontal Plane, Equispaced, with Two Outer Wires Grounded and Two Inner Wires Connected in Parallel

Electrical symmetry indicates that  $Q_1=Q_4$  and  $Q_2=Q_3$ .

Writing the potential equations and solving for the charge ratio yields

$$k = \frac{Q_1}{Q_2} = - \frac{\lg \frac{2h^2}{a^2}}{\lg \frac{4h^2}{3a\rho}}$$

From the equation for  $E_2$ , taking into account that there are two wires charged to potential  $E_2$ , the reciprocal capacitance is found to be

$$\frac{1}{C} = \frac{E_2}{2Q_2} = 69v \left[ k \lg \frac{2h^2}{a^2} + \lg \frac{4h^2}{a\rho} \right]$$

and

$$Z_0 = 69 \left[ k \lg \frac{2h^2}{a^2} + \lg \frac{4h^2}{a\rho} \right]$$

The potential at a near-by point in space relative to that of the high-potential wires is

$$\frac{E_p}{E_2} = \frac{k \lg \frac{r_{11}r_{44}}{r_1r_4} + \lg \frac{r_{22}r_{33}}{r_2r_3}}{k \lg \frac{2h^2}{a^2} + \lg \frac{4h^2}{a\rho}}$$

Sample values are shown in Table II.

TABLE II

h	ρ	a	k	Z <sub>0</sub>
144	0.064	5	-0.652	232
144	0.064	10	-0.561	252

CASE V

Five Wires in Elevated Horizontal Plane, Equispaced, with Two Outer and the Middle Wire Grounded, and with Other Two Wires in Parallel

Symmetry indicates that  $E_1=E_3=E_5$ ,  $E_2=E_4$ ,  $Q_1=Q_5$ , and  $Q_2=Q_4$ . From the potential equations

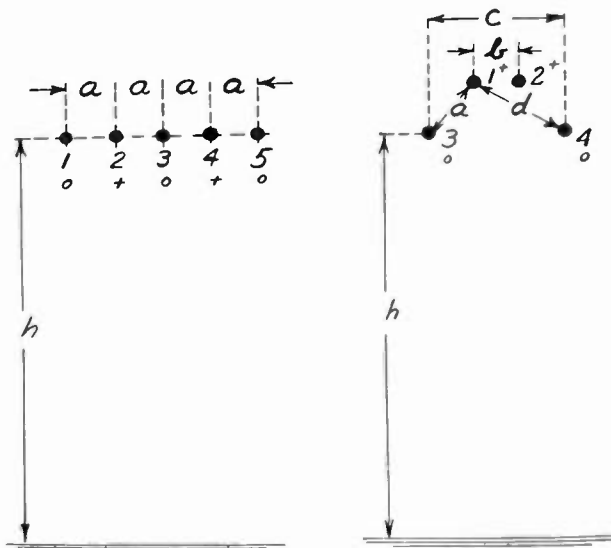

Fig. 5—Diagram for Case V.

Fig. 6—Diagram for Case VI.

written around these conditions it is necessary to solve for two different ratios which are

$$\begin{aligned} \frac{Q_1}{Q_2} &= + \frac{\lg \frac{4h^2}{3a^2} \lg \frac{2h}{\rho} - \lg \frac{4h^2}{a^2} \lg \frac{h}{a}}{\lg \frac{h^2}{a^2} \lg \frac{h}{a} - \lg \frac{h^2}{a\rho} \lg \frac{2h}{\rho}} = A \\ \frac{Q_3}{Q_2} &= + \frac{\lg \frac{4h^2}{3a^2} \lg \frac{h^2}{a^2} - \lg \frac{4h^2}{a^2} \lg \frac{h^2}{a\rho}}{\lg \frac{2h}{\rho} \lg \frac{h^2}{a\rho} - \lg \frac{h}{a} \lg \frac{h^2}{a^2}} = B \\ k &= \frac{2Q_1 + Q_3}{2Q_2} = \frac{2A + B}{2} \end{aligned}$$

The reciprocal capacitance is

$$\frac{1}{C} = \frac{E_2}{2Q_2} = 69v \left[ A \lg \frac{4h^2}{3a^2} + B \lg \frac{2h}{a} + \lg \frac{2h^2}{a\rho} \right]$$

and

$$Z_0 = 69 \left[ A \lg \frac{4h^2}{3a^2} + B \lg \frac{2h}{a} + \lg \frac{2h^2}{a\rho} \right]$$

A sample set of line values are shown in Table III.

TABLE III

<i>h</i>	$\rho$	<i>a</i>	<i>A</i>	<i>B</i>	<i>k</i>	<i>Z<sub>0</sub></i>
144	0.064	5	-0.46	-0.614	-0.767	187
144	0.064	10	-0.396	-0.548	-0.670	210

CASE VI

Four Wires in Two Elevated Horizontal Planes, Symmetrically Disposed, with Two Lower Wires Grounded and Two Upper Wires Connected in Parallel

Except for geometry, this case is similar to that of Case IV.

$$k = \frac{Q_3 + Q_4}{Q_1 + Q_2} = - \frac{\lg \frac{4h^2}{ad}}{\lg \frac{4h^2}{\rho c}}$$

The reciprocal capacitance is

$$\frac{1}{C} = \frac{E_1}{Q_1 + Q_2} = 69v \left[ \lg \frac{4h^2}{\rho b} + k \lg \frac{4h^2}{ad} \right]$$

and

$$Z_0 = 69 \left[ \lg \frac{4h^2}{\rho b} + k \lg \frac{4h^2}{ad} \right]$$

The potential at a near-by point in space with respect to that of the high-potential wires is

$$\frac{E_p}{E_1} = \frac{\lg \frac{r_{11}r_{22}}{r_1r_2} + k \lg \frac{r_{33}r_{44}}{r_3r_4}}{\lg \frac{4h^2}{\rho b} + k \lg \frac{4h^2}{ad}}$$

Some characteristic values for this type of line are given in Table IV.

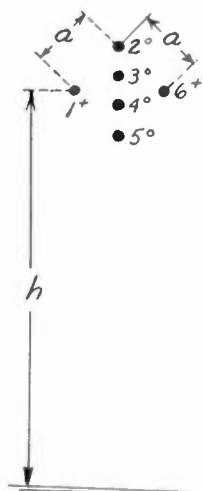
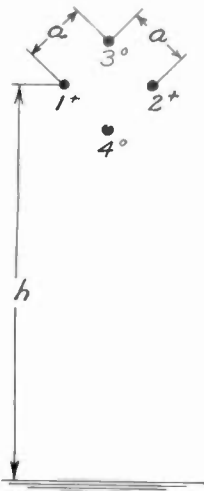

Fig. 7—Diagram for Case VII. Fig. 8—Diagram for Case VIII.

TABLE IV

<i>h</i>	$\rho$	<i>a</i>	<i>b</i>	<i>c</i>	<i>d</i>	<i>k</i>	<i>Z<sub>0</sub></i>
144	0.064	4.19	2.5	5	5.48	-0.655	235
144	0.064	5.50	2.5	10	7.45	-0.647	247
144	0.064	6.00	2.5	12	8.00	-0.643	251
120	0.064	6.00	2.5	12	8.90	-0.554	256

This type of line can be built with 1 pin insulator per pole with the 2 high-potential wires attached to opposite sides of the insulator groove.

CASE VII

Four Wires at Corners of a Square, with Two Diagonal Wires Grounded and Two Others in Parallel<sup>1</sup>

$$k = - \frac{\lg \left( \frac{2h}{a} \right)^2}{\lg \frac{4h^2}{a\rho\sqrt{2}}}$$

$$C = \frac{1}{69v \left[ \lg \frac{4h^2}{a\rho\sqrt{2}} + k \lg \left( \frac{2h}{a} \right)^2 \right]} \text{ (farads per centimeter)}$$

$$Z_0 = 69 \left[ \lg \frac{4h^2}{a\rho\sqrt{2}} + k \lg \left( \frac{2h}{a} \right)^2 \right] \text{ (ohms)}$$

when

$$\rho = 0.064 \text{ inch} \quad a = 15 \text{ inches} \quad h = 144 \text{ inches}$$

$$\alpha = \left[ 1.1 \sqrt{\frac{10^{-13}}{\sigma_{\text{emu}}}} + 0.0925 \right] \sqrt{f_{\text{me}}} \text{ (decibels per 1000 feet)}$$

and

$$k = 0.526$$

$$Z_0 = 234.$$

CASE VIII

Six Wires, Four in a Vertical Plane Grounded, with One Wire Symmetrically Disposed on Each Side and Connected in Parallel

To simplify the work, advantage can be taken of symmetry. So far as wire No. 1 is concerned, the presence of No. 6 is immaterial. The charges induced on the grounded wires by No. 1 are the same whether No. 6 is present or not; only their distribution is affected. Thus the problem can be solved from the left side alone and the effect of the total introduced later.

From this point on with No. 6 absent there is no symmetry to simplify the work so the five different *Q*'s must be solved from the five potential equations. If solved symbolically, the work quickly runs to considerable proportions. It is much more convenient to solve the particular configuration by immediately substituting the numerical values of the various



logarithmic potential coefficients in the potential equations. The equations for the various characteristics are so bulky as hardly to justify the expenditure of space for them. Lines of this type have been constructed for broadcast use and with No. 8 wire (0.064-inch radius), a mean height of 12 feet, with wires 1, 2, 6, 5 spaced 15 inches and wires 2, 3, 4, 5 equispaced, measured values of  $Z_0$  were 190.5 ohms. This compares with a theoretical value of 190 ohms for the configuration. The value of  $k$  is calculated to be  $-0.644$  distributed as follows:

Per Cent	10.5 in No. 2
	19.4 in No. 3
	18.6 in No. 4
	15.9 in No. 5

CASE IX

Five Wires, Four at Corners of a Square at Ground Potential, with Fifth at Center of Square<sup>1</sup>

$$k = - \frac{\lg \frac{2\sqrt{2} h}{a}}{\lg \frac{2h}{(\rho\sqrt{2})^{1/4} a^{3/4}}}$$

$$C = \frac{1}{138v \left[ \lg \frac{2h}{\rho} + k \lg \frac{2\sqrt{2} h}{a} \right]} \text{ (farads per centimeter)}$$

$$Z_0 = 138 \left[ \lg \frac{2h}{\rho} + k \lg \frac{2\sqrt{2} h}{a} \right] \text{ (ohms)}$$

When

$$\rho = 0.064 \text{ inch} \quad a = 15 \text{ inches} \quad h = 144 \text{ inches}$$

$$k = -0.785 \quad Z_0 = 350$$

$$\alpha = \left[ 0.151 \sqrt{\frac{10^{-13}}{\sigma_{\text{emu}}}} + 0.11 \right] \sqrt{f_{\text{mc}}} \text{ (decibels per 1000 feet)}$$

CASE X

Six Wires, Four Grounded Wires at Corners of a Square with Other Two Wires in Parallel at the Center<sup>1</sup>

$$k = - \frac{\lg \frac{2h}{\sqrt{cd}}}{\lg \frac{2h}{\rho^{1/4} a^{1/2} (a\sqrt{2})^{1/4}}}$$

$$C = \frac{1}{69v \left[ \lg \frac{4h^2}{\rho b} + k \lg \frac{4h^2}{cd} \right]} \text{ (farads per centimeter)}$$

$$Z_0 = 69 \left[ \lg \frac{4h^2}{\rho b} + k \lg \frac{4h^2}{cd} \right] \text{ (ohms)}$$

When

$$\rho = 0.081 \text{ inch} \quad h = 144 \text{ inches}$$

$$a = 15 \text{ inches} \quad b = 2.5 \text{ inches}$$

$$k = -0.792 \quad Z_0 = 231$$

$$\alpha = \left[ 0.214 \sqrt{\frac{10^{-13}}{\sigma_{\text{emu}}}} + 0.0755 \right] \sqrt{f_{\text{mc}}} \text{ (decibels per 1000 feet)}$$

This line represents one of the optimum configurations available using six wires. The value of  $k$  could be

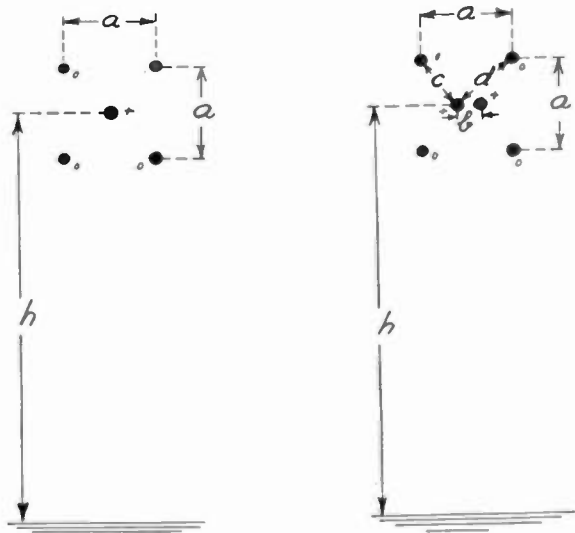

Fig. 9—Diagram for Case IX. Fig. 10—Diagram for Case X.

further increased by adding more grounded wires to enclose the high-potential wires.

CASE XI

Balanced Two-Wire Line Above Perfect Ground

This type of problem is developed in the same manner as the previous types but the physical considerations are different in certain respects. The potentials are reckoned with respect to ground, and are equal but opposite in sign.

$$E_1 = 138v \left[ Q_1 \lg \frac{1}{\rho} - Q_1 \lg \frac{1}{2h} + Q_2 \lg \frac{1}{a} - Q_2 \lg \frac{1}{\sqrt{4h^2 + a^2}} \right]$$

Symmetry, characteristic of balanced-line problems, indicates that  $Q_1 = -Q_2$  so that

$$E_1 = 138v Q_1 \lg \frac{2ha}{\rho\sqrt{4h^2 + a^2}}$$

The reciprocal capacitance is

$$\frac{1}{C} = \frac{2E_1}{Q_1} = 276v \lg \frac{2ha}{\rho\sqrt{4h^2 + a^2}}$$

and

$$Z_0 = 276 \lg \frac{2ha}{\rho\sqrt{4h^2 + a^2}}$$

As  $h$  becomes very large with respect to  $a$

$$Z_0 \rightarrow 276 \lg \frac{a}{\rho}$$

This latter is the form usually used for this type of line by neglecting the effect of ground.

The potential at a near-by point in space with respect to that on wire No. 1 is

$$\frac{E_p}{E_1} = \frac{\lg \frac{r_{11}r_{22}}{r_{12}r_{21}}}{\lg \frac{2ha}{\rho\sqrt{4h^2 + a^2}}}$$

CASE XII

*Four-Wire Balanced Line in a Square Configuration with Opposite Wires Connected in Parallel*

It is found in problems of this type that if the assumption is made that  $h$  is the same for all wires and image distances, the heights cancel out when the potential equations are developed. This is equivalent to

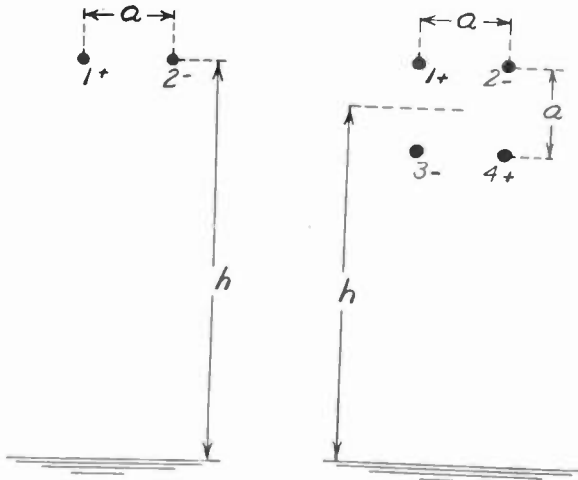

Fig. 11—Diagram for Case XI. Fig. 12—Diagram for Case XII.

neglecting the presence of ground. So far as the line constants and the characteristic impedance are concerned, they can be derived as for a line in free space with great simplification of formulation. However, in the development of the field potentials the presence of ground cannot be neglected and it is then necessary to hold rigorously to the actual spacial dimensions for accuracy.

In free-space conditions, all the  $Q$ 's have the same magnitude and one quickly arrives at

$$E_1 = 138vQ_1 \lg \frac{a}{\rho\sqrt{2}}$$

from which

$$\frac{1}{C} = \frac{2E_1}{2Q_1} = 138v \lg \frac{a}{\rho\sqrt{2}}$$

and

$$Z_0 = 138 \lg \frac{a}{\rho\sqrt{2}}$$

In the presence of perfect ground, the potential at a point in near-by space with respect to that of wire No. 1 is

$$\frac{E_p}{E_1} = \frac{\lg \frac{r_{21}r_{31}r_{41}}{r_{12}r_{13}r_{14}}}{\lg \frac{a}{\rho\sqrt{2}}}$$

CASE XIII

*Six-Wire Balanced Line in Regular Hexagon Configuration, Alternate Wires Connected in Parallel*

For free-space conditions, or where  $h$  is very large with respect to  $a$ ,

$$E_1 = 138vQ_1 \lg \frac{2a^3}{\rho b}$$

Taking into account three wires charged to potential  $E_1$ , the reciprocal capacitance is

$$\frac{1}{C} = \frac{2E_1}{3Q_1} = 92v \lg \frac{2a^3}{\rho b}$$

and

$$Z_0 = 96 \lg \frac{2a^3}{\rho b} \approx 96 \lg \frac{1.15a^2}{\rho}$$

The potential at a near-by point in space with respect to the potential at wire No. 1 is

$$\frac{E_p}{E_1} = \frac{\lg \frac{r_{21}r_{31}r_{41}r_{51}r_{61}}{r_{12}r_{13}r_{14}r_{15}r_{16}}}{\lg \frac{1.15a^2}{\rho}}$$

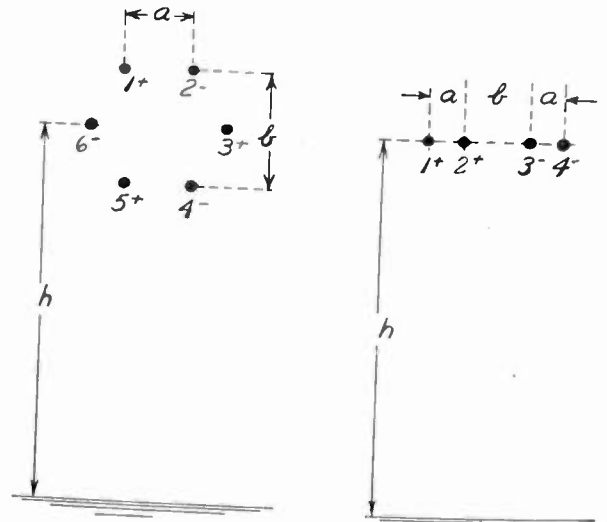

Fig. 13—Diagram for Case XIII. Fig. 14—Diagram for Case XIV.

CASE XIV

Four-Wire Balanced Line in Planar Configuration, with Two Wires in Parallel on Each Side

Where very high power is transmitted over a balanced line it is sometimes desirable to reduce the potential on the line by reducing the characteristic impedance below that practicable with a two-wire line. A planar configuration of four wires is more economical than that of Case XII. The two wires on each side can often be supported by a common insulator.

In this case there is symmetry which makes  $Q_1 = Q_4$  and  $Q_2 = Q_3$ . However, we must solve for the ratio  $Q_2/Q_1 = K$ .

After substitution and manipulation the potential equations reduce to

$$E_1 = 138v \left[ Q_1 \lg \frac{2a+b}{\rho} + Q_2 \lg \frac{a+b}{a} \right]$$

$$E_2 = 138v \left[ Q_1 \lg \frac{a+b}{a} + Q_2 \lg \frac{b}{\rho} \right] = E_1.$$

After solution

$$K = \frac{Q_2}{Q_1} = \frac{\lg \frac{a(2a+b)}{\rho(a+b)}}{\lg \frac{ab}{\rho(a+b)}}$$

(note that  $K$  is now positive. The reciprocal capacitance is

$$\frac{1}{C} = \frac{2E_1}{Q_1 + Q_2} = \frac{2E_1}{Q_1(1+K)}$$

$$= \frac{276v}{1+K} \left[ \lg \frac{2a+b}{\rho} + K \lg \frac{a+b}{a} \right]$$

and

$$Z_0 = \frac{276}{1+K} \left[ \lg \frac{2a+b}{\rho} + K \lg \frac{a+b}{a} \right].$$

The potential at a near-by point in space with respect to that on wire No. 1 is

$$\frac{E_p}{E_1} = \frac{\lg \frac{r_{11}r_4}{r_{1r_{44}}} + K \lg \frac{r_{3r_{22}}}{r_{2r_{33}}}}{\lg \frac{2a+b}{\rho} + K \lg \frac{a+b}{a}}$$

CASE XV

Four-Wire Balanced Line in Planar Configuration, Equispaced, with Alternate Wires Connected in Parallel

Another method of reducing the characteristic impedance of a balanced line is shown in this case.

The potential equations reduce to

$$E_1 = 138v \left[ Q_1 \lg \frac{3a}{\rho} + Q_2 \lg \frac{1}{2} \right]$$

$$E_2 = 138v \left[ Q_1 \lg 2 + Q_2 \lg \frac{\rho}{a} \right] = -E_1$$

from which

$$K = \frac{Q_2}{Q_1} = \frac{\lg \frac{6a}{\rho}}{\lg \frac{2a}{\rho}}$$

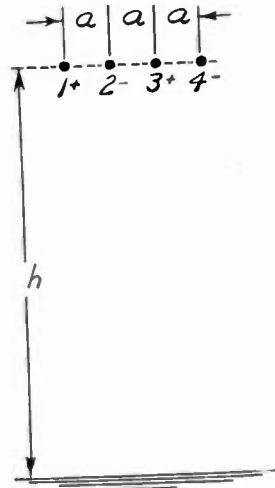

Fig. 15—Diagram for Case XV.

The reciprocal capacitance is

$$\frac{1}{C} = \frac{2E_1}{Q_1 + Q_2} = \frac{2E_1}{Q_1(1+K)}$$

$$= \frac{276v}{1+K} \left[ \lg \frac{3a}{\rho} + K \lg \frac{1}{2} \right]$$

and

$$Z_0 = \frac{276}{1+K} \left[ \lg \frac{3a}{\rho} + K \lg \frac{1}{2} \right].$$

The potential at a near-by point in space with respect to that of wire No. 1 is

$$\frac{E_p}{E_1} = \frac{\lg \frac{r_{4r_{11}}}{r_{1r_{44}}} + K \lg \frac{r_{2r_{33}}}{r_{3r_{22}}}}{\lg \frac{3a}{\rho} + K \lg \frac{1}{2}}$$

APPLICATION TO LOW-FREQUENCY ANTENNA DESIGN<sup>3</sup>

The low-frequency antenna appears again and again in daily engineering work and the problem is always to build the maximum antenna with given size and height limitations. Lacking height, the horizontal part of the antenna is proportioned to give maximum capacitance to increase the effective height and to minimize the input reactance. Since the mechanical problems are inextricably related to the electrical, to say nothing of the economic, it remains in each case to determine maximum results from minimum material.

From given lineal dimensions in an electrically short

<sup>3</sup> F. W. Grover, "Methods, Formulas and Tables for the Calculation of Antenna Capacity," Bureau of Standards Scientific Paper No. 568; *Bur. Stand. Bull.*, vol. 22, pp. 568-629; January, 1928.



antenna, the reduction of base reactance is dependent upon reduction of the characteristic impedance of the antenna from a transmission-line viewpoint. This is accomplished by maximizing the capacitance per unit length by a multiwire configuration. The cage and the planar flat-top arrangements are well known for this purpose.

Logarithmic potential theory is helpful in deriving economically optimum designs for multiwire low-frequency antennas. While the horizontal portion lends itself to the mathematical circumstances with ease, the vertical portion does not. However, it seems, from

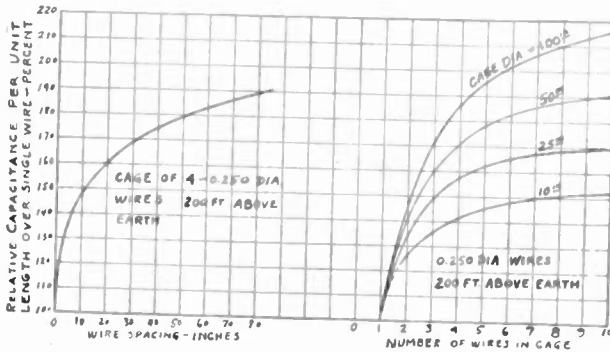

Fig. 16—Curves of capacitance per unit length for cage flat-tops.

experience, to be physically justifiable to treat any unit length of the vertical portion as though it were horizontal at the mean height of that particular unit of length. In this way the entire antenna can be worked out satisfactorily, leaving only end effects to be estimated.

#### THE CAGE ANTENNA

From previous procedure it is seen that we can choose any desired cross-sectional configuration for a system of elevated horizontal wires and solve the potential-charge equations to derive the capacitance per unit length provided the dimensions involved are small with respect to the wavelength. We can then compare this with the capacitance of one wire at the same mean location. Take for example a four-wire cage, where the interwire spacing is very small with respect to the height above earth. All wires are at the same potential and with small error we can say the charges are the same on all wires. In these circumstances the potential-charge equations reduce to

$$E_1 = 138vQ_1 \lg \frac{16h^4}{\rho a^3 \sqrt{2}}$$

from which the capacitance per centimeter is

$$C_1 = \frac{1}{34.5v \lg \frac{16h^4}{\rho a^3 \sqrt{2}}}$$

The capacitance for a single wire is

$$C_0 = \frac{1}{138v \lg \frac{2h}{\rho}}$$

so that

$$\frac{C_1}{C_0} = \frac{4 \lg \frac{2h}{\rho}}{\lg \frac{16h^4}{\rho a^3 \sqrt{2}}}$$

The data of Fig. 16 were computed in this manner and enable one to determine quickly a reasonable cage configuration.

#### MULTIWIRE FLAT-TOP ANTENNA

Take, for example, a four-wire flat-top with a uniform spacing  $a$  between wires at a height  $h$  above ground. While all wires are at the same potential, the charges on the 2 inner wires are not the same as those on the 2 outer wires. It is therefore necessary to solve for the ratio of charges. From the potential-charge equations (wires numbered 1 to 4 left to right)

$$K = \frac{Q_2}{Q_1} = \frac{\lg \frac{2a}{3\rho}}{\lg \frac{2a}{\rho}}$$

The capacitance per centimeter becomes

$$C = \frac{2(Q_1 + Q_2)}{E_1} = \frac{2Q_1(1 + K)}{E_1} = \frac{1}{\frac{69v}{1 + K} \left[ \lg \frac{4h^2}{3a\rho} + K \lg \frac{2h^2}{a^2} \right]}$$

Compared with a single wire of same size and height

$$\frac{C_1}{C_0} = \frac{138 \lg \frac{2h}{\rho}}{\frac{69}{1 + K} \left[ \lg \frac{4h^2}{3a\rho} + K \lg \frac{2h^2}{a^2} \right]}$$

# An Analytical Demonstration of Hartley Oscillator Action\*

F. A. RECORD†, ASSOCIATE, I.R.E., AND J. L. STILES‡, ASSOCIATE, I.R.E.

**Summary**—An analytical solution of the Hartley oscillator circuit is made to determine the amplitude of the alternating voltage of the output wave in terms of the tube and circuit parameters. The approach to the solution makes use of a rotating vector, which alternately gains and decays in amplitude, applied to idealized tube characteristics. The growth and decay of the vector points up the regions of amplification and nonamplification of the oscillation.

The paper is divided into sections:

I. The differential equation of the circuit is set up with the aid of certain simplifying assumptions and put in a form for convenient use.

II. The equation is applied to a class C condition using an idealized tube characteristic without saturation. The points of demarcation between amplification and nonamplification are determined and the amplitude of the alternating output voltage is calculated.

III. The equation is applied to a class C condition using an idealized tube characteristic with saturation but otherwise following the procedure of Section II.

## INTRODUCTION

WITH THE notable exceptions of van der Bijl's early analysis of the tuned plate oscillator and the later work of Prince<sup>1</sup> and van der Pol,<sup>2</sup> English-language literature on the subject has largely consisted of the determination of the conditions necessary for oscillation.

The present paper is an attempt to present a reasonably comprehensive analysis of the Hartley oscillator circuit in such a manner that the action of the circuit is demonstrated as the analysis proceeds. This demonstration is built around a method of determining the amplitude of oscillation due to Guillemin.<sup>3</sup> This method emphasizes the regions of amplification and non-amplification of the oscillation and their relation to the action of the circuit.

Certain simplifying assumptions are made in forming the original equations not only because these conditions may be approximated in practice but also to obtain a more concise initial statement of the action of the circuit.

\* Decimal classification: R355.9×R133. Original manuscript received by the Institute, October 7, 1940; revised manuscript received, February 3, 1943.

† Clarkson College, Potsdam, New York; on leave at the Radio Research Division, Harvard University, Cambridge, Massachusetts.

‡ Clarkson College, Potsdam, New York.

<sup>1</sup> D. C. Prince, "Vacuum tubes as power oscillators," *Proc. I.R.E.*, vol. 11, pp. 275-313; June; pp. 405-459; August; and pp. 527-551; October, 1923.

<sup>2</sup> Balth. van der Pol, "The nonlinear theory of electric oscillations," *Proc. I.R.E.*, vol. 22, pp. 1051-1086; September, 1934.

<sup>3</sup> E. A. Guillemin, "An analytical method of predetermining behavior of vacuum-tube oscillator, which yields regions of oscillation and nonoscillation, the amplitude of oscillation, and wave form," presented, Boston Section, Harvard University, Cambridge, Massachusetts, October 25, 1935.

## SECTION I

### Formation of the Differential Equation of the Circuit

Reference to the schematic diagram of the Hartley circuit, Fig. 1, shows that

$$i_{L_0} + i_p = i_{L_p} \quad (1)$$

In this and the following

$e$  = instantaneous alternating components of voltage

$i$  = instantaneous alternating components of current.

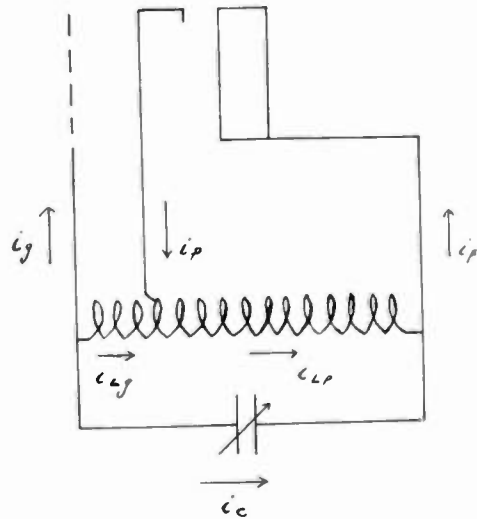

Fig. 1—Schematic diagram of Hartley circuit.

But, approximately,  $i_{L_p} = Qi_p$  since this is a parallel circuit condition.  $Q$  has the usual definition of  $\omega L/R$ . Therefore,  $i_{L_0} = i_{L_p} = i_L$ , approximately, where  $i_L$  is taken as the approximate magnitude of the current throughout the coil, based on the assumptions that  $Q \gg 1$  and  $i_0 \ll i_{L_0}$ . If the coefficient of coupling is nearly unity the ratio of  $e_0$  to  $e_p$  becomes, without regard to sign,

$$\left. \begin{aligned} \frac{e_0}{e_p} &= \frac{n_0}{n_p} = \rho \\ i_p &= i_L + i_0 \end{aligned} \right\} \quad (2)$$

and

Here  $n_0$  and  $n_p$  are, respectively, the number of turns on the grid side of the tap and on the plate side. If  $e_p$  and  $e_0$  are tube voltages, then the coil voltages will be  $-e_p$  and  $-e_0$  and

$$i_c = C \frac{d}{dt} (-e_p - e_0).$$

Whence

$$i_p = i_L + C \frac{d}{dt} (-e_p - e_o).$$

Also

$$(-e_p - e_o) = i_L R + L \frac{di_L}{dt}.$$

Letting  $d/dt = p$ ,  $i_p$  becomes

$$\begin{aligned} i_p &= -\frac{e_p + e_o}{R + Lp} - Cp(e_p + e_o) \\ &= -\frac{e_p + \rho e_p}{R + Lp} - Cp(e_p + \rho e_p) \\ i_p &= -\left\{ \frac{\rho + 1}{R + Lp} + Cp(\rho + 1) \right\} e_p. \end{aligned} \quad (3)$$

For convenience,  $e_p$  is considered a voltage rise and  $e_o$  a voltage drop, although both are normally considered rises. This yields the equation for the combined control voltage

$$e = \frac{e_p}{\mu} - e_o = \left( \frac{1}{\mu} - \rho \right) e_p. \quad (4)$$

Substituting (4) in (3)

$$i_p = \frac{-\left\{ \frac{\rho + 1}{R + Lp} + Cp(\rho + 1) \right\} e}{\frac{1}{\mu} - \rho} = g_m e$$

or

$$\left\{ \frac{\rho + 1}{R + Lp} + Cp(\rho + 1) + g_m \left( \frac{1}{\mu} - \rho \right) \right\} e = 0. \quad (5)$$

Arranging (5) as a polynomial in  $p$  gives

$$\left[ p^2 + p \left\{ \frac{R}{L} - \frac{g_m}{C} \left( \frac{\rho - \frac{1}{\mu}}{\rho + 1} \right) \right\} + \left\{ \frac{1}{LC} - \frac{g_m R}{LC} \left( \frac{\rho - \frac{1}{\mu}}{\rho + 1} \right) \right\} \right] = 0 \quad (6)$$

which is a suitable form for the differential equation of the circuit in accordance with the various approximations and assumptions.

### SECTION II

*Application of the Equation to a Class C Condition Using an Idealized Tube Characteristic without Saturation. Determination of the Points of Demarcation Between Amplification and Nonamplification and of the Amplitude of the Alternating Output Voltage.*

The coefficient of the linear term of (6) represents the decay or damping factor, hence,

$$\alpha = \frac{R}{2L} - \frac{g_m}{2C} \left\{ \frac{\mu\rho - 1}{\mu(\rho + 1)} \right\}. \quad (7)$$

Following the method of Guillemin, the tube characteristic is idealized by considering it to be made up of straight lines, Fig. 2. Class A, B, and C operating points are indicated although only class C will be considered. It can be seen from the figure that under class C conditions, unsaturated, Fig. 2(b), the tube and

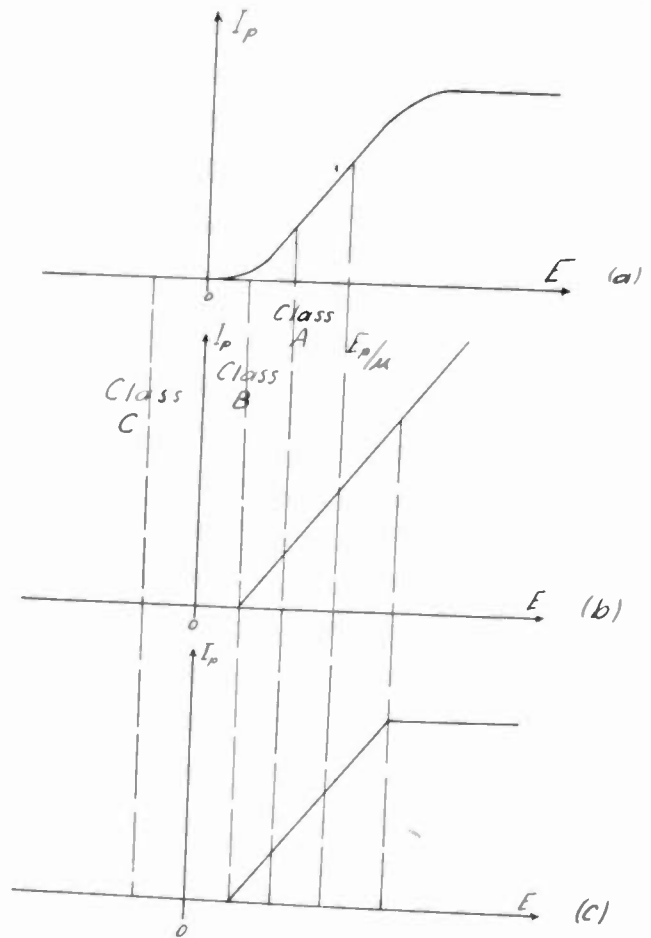

Fig. 2  
 (a) Plate-current combined control-voltage transfer characteristic of actual tube.  
 $E$  = the sum of instantaneous alternating- and direct-current values  
 $I$  = the sum of instantaneous alternating- and direct-current values  
 (b) Idealized transfer characteristic without saturation.  
 (c) Idealized transfer characteristic with saturation.

circuit operate over a range of zero plate current and a range of rising plate current. This means that two damping factors obtain. One, during zero plate current, when  $g_m$  is zero, is

$$\alpha_1 = R/2L. \quad (7a)$$

The other, during rising plate current, is given in (7). It seems clear that these two damping factors apply, respectively, to the regions of nonamplification and amplification of the oscillation.

Although it is known that class C operation is unstable without the limiting effects of saturation, the unsaturated case will be considered as an outline of the method used to determine the amplitude.

Reference to Fig. 3 shows a linear tube characteristic with an operating combined control voltage  $E_{a1}$ . Below the characteristic the instantaneous combined control voltage  $e$  is represented as the horizontal projection of a variable length vector  $A$ , rotating in a counterclockwise direction with a constant angular velocity  $\omega$ . Thus  $A$  represents the amplitude of the oscillation in terms of the combined control voltage.

As the vector rotates from  $A$  to  $A_1$  the  $g_m$  is zero and  $A$  will decrease exponentially with the damping factor  $\alpha_1$ , thus marking a region of nonamplification. From  $A_1$  to  $A$  the amplitude must, for stability, increase exponentially with the factor  $\alpha$  to its original value, thus marking a region of amplification. This means that the factor  $\alpha$  must be negative; that is,

$$\left| \frac{g_m}{2C} \left\{ \frac{\mu\rho - 1}{\mu(\rho + 1)} \right\} \right| > \left| \frac{R}{2L} \right| \quad (9)$$

The amplitude at an angle  $\gamma$ ,  $A\gamma$ , is

$$A\gamma = A \exp \left\{ -\frac{\gamma}{\omega} \alpha_1 \right\}.$$

Thus

$$A_1 = A \exp \left\{ -a(2\pi - \phi_1 - \phi_2) \right\} \quad (10)$$

and

$$A = A_1 \exp \left\{ b(\phi_1 + \phi_2) \right\} \quad (11)$$

where

$$a = \frac{\alpha_1}{\omega} \quad \text{and} \quad b = \frac{-\alpha}{\omega} \quad (11a)$$

The condition that the vector shall return to its original length after one complete revolution, is, from Fig. 3,

$$\exp \left\{ -a[2\pi - (\phi_1 + \phi_2)] + b(\phi_1 + \phi_2) \right\} = 1$$

and, therefore,

$$\frac{\phi_1 + \phi_2}{2} = \frac{\pi a}{a + b} \quad (12)$$

But since  $A_1$  is only slightly smaller than  $A$ ,  $\phi_1$  is nearly equal to  $\phi_2$ , and from (12)

$$\phi_1 = \phi_2 = \phi = \frac{\pi a}{a + b}, \text{ approximately.} \quad (13)$$

Returning to Fig. 3, it can be seen that

$$E_{a1} = A \cos \phi_1 = A \cos \phi.$$

Hence the amplitude of oscillation  $A$  is

$$A = \frac{E_{a1}}{\cos \phi_1} \quad (14)$$

Also from (4) and (14),

$$e = \text{Re} \{ A \exp(j\omega t) \} = \left( \frac{1}{\mu} - \rho \right) e_p$$

in which "Re" means "real part of," or

$$e_p = \text{Re} \left\{ \frac{A}{\left( \frac{1}{\mu} - \rho \right)} \exp(j\omega t) \right\} = V_p \cos \omega t \quad (15)$$

and

$$V_p = \frac{A}{\left( \frac{1}{\mu} - \rho \right)} \quad (16)$$

which together with (2), (7), (7a), (11a), (13), and (14), gives the maximum amplitude of the alternating com-

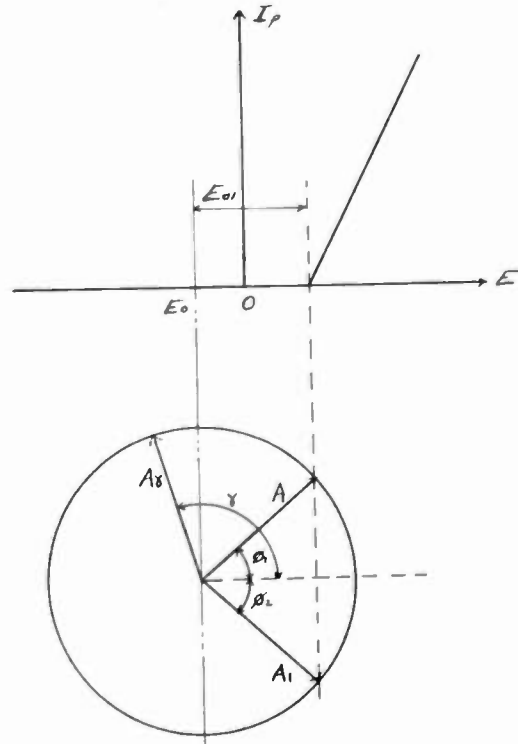

Fig. 3—Amplitude of oscillation projected on transfer characteristic without saturation.

ponent of the plate voltage in terms of the tube and circuit parameters and the operating tube voltage  $E_{a1}$ .

### SECTION III

*Application of the Equation to a Class C Condition Using an Idealized Tube Characteristic with Saturation, with the Same Determinations as in Section II.*

The practical idealized characteristic, including the effects of saturation is shown in Fig. 2(c). It is due to the combined effects of grid and plate saturation that



operating stability of amplitude is obtained under class C conditions.

The transfer characteristic and vector diagram is shown in Fig. 4 for this case. As before, the instantaneous combined control alternating voltage  $e$  is represented as the horizontal projection of a variable-length vector  $A$ , rotating in a counterclockwise direction with a constant angular velocity  $\omega$ .

As the vector rotates from  $A$  to  $A_1$ , the  $g_m$  is zero, and  $A$  will decrease exponentially with the damping factor  $\alpha_1$ , thus marking a region of nonamplification. As it moves from  $A_1$  to  $A_2$  the amplitude, for stability, must increase exponentially with the negative factor  $\alpha$ , thus marking a region of amplification. At  $A_2$  the saturated condition is met, the main point of difference between this section and the preceding. As  $A$  moves from  $A_2$  to  $A_3$ ,  $g_m$  is again zero and  $A$  decreases with the factor  $\alpha_1$ , marking a second region of nonamplification. In order that the oscillations be sustained and stable  $A$  must return to its original length. The meeting of this condition is completed by an increase from  $A_3$  to  $A_4$  similar to the one from  $A_1$  to  $A_2$ , thus marking the second region of amplification. From the foregoing it can be seen that

$$\left. \begin{aligned} A_1 &= A \exp \{-a(2\pi - 2\theta)\} \\ A_2 &= A_1 \exp \{b(\theta - \phi)\} \\ A_3 &= A_2 \exp \{-2a\phi\} \\ A_4 &= A_3 \exp \{b(\theta - \phi)\} = A \end{aligned} \right\} \quad (17)$$

Again the condition for closure for the vector diagram requires that the sum of the exponentials be zero. Whence

$$\theta - \phi = \frac{\pi a}{a + b} \quad (18)$$

Again, from Fig. 4,

$$E_{a1} = A \cos \theta. \quad (19)$$

Also

$$E_{a2} = A_3 \cos \phi = A \exp \{-b(\theta - \phi)\} \cos \phi. \quad (20)$$

Dividing (20) by (19) and substituting (18)

$$\frac{\cos \phi}{\cos \theta} = \frac{E_{a2}}{E_{a1}} \exp \left\{ \frac{\pi ab}{a + b} \right\}. \quad (20a)$$

Solving<sup>4</sup> this for  $\cos \theta$  gives

$$\cos \theta = \frac{\sin \left( \frac{\pi a}{a + b} \right)}{\sqrt{\left( \frac{E_{a1}}{E_{a2}} \right)^2 \exp 2 \left\{ \frac{\pi ab}{a + b} \right\} - 2 \frac{E_{a1}}{E_{a2}} \cos \frac{\pi a}{a + b} \exp \left\{ \frac{\pi ab}{a + b} \right\} + 1}} \quad (21)$$

<sup>4</sup> See Appendix for a solution of (20a).

As before

$$A = \frac{E_{a1}}{\cos \theta} \quad (22)$$

From (4) and (22)

$$e = \text{Re} \{ A \exp(j\omega t) \} = \left( \frac{1}{\mu} - \rho \right) e_s$$

or,

$$e_p = \text{Re} \left\{ \frac{A}{\left( \frac{1}{\mu} - \rho \right)} \exp(j\omega t) \right\} = V_p \cos \omega t$$

and

$$V_p = \frac{A}{\left( \frac{1}{\mu} - \rho \right)} \quad (23)$$

which gives  $V_p$  in the same form as before except that the operating tube voltage  $E_{a2}$  is included.

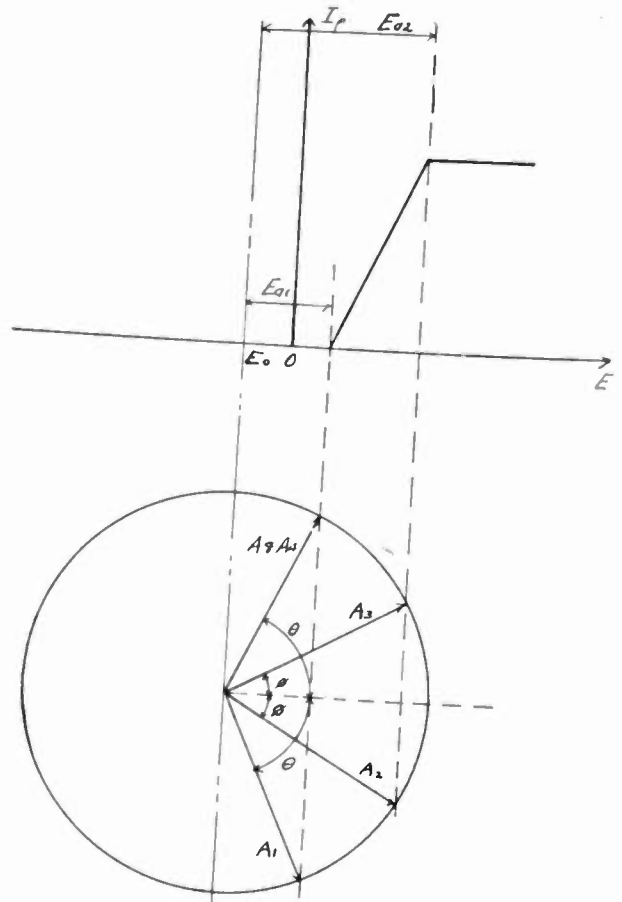

Fig. 4—Amplitude of oscillation projected on transfer characteristic with saturation.

COMPARATIVE DISCUSSION

Numerical Comparison between Values of  $A$  Calculated by the Method of the Paper and the "average  $g_m$ " Method is Offered for the Unsaturated Class C Case.

Perhaps the first as well as one of the best ways in which to examine an equation or a method of analysis critically is by direct comparison with another method of approach to the same problem.

Aside from the demonstration of the action of the circuit, one of the alternative methods of determining the amplitude of oscillation  $A$  involves the averaging of the  $g_m$  over the working cycle. Fortunately there is available a direct comparison between the values of  $A$  calculated for the unsaturated class C case by each method.

Reference to Fig. 5 shows the following relationships:

$$g_m = \frac{h}{A - E_{a1}} \tag{24}$$

$$g_{m \text{ average}} = \frac{h}{2A} = \frac{g_m(A - E_{a1})}{2A} \tag{25}$$

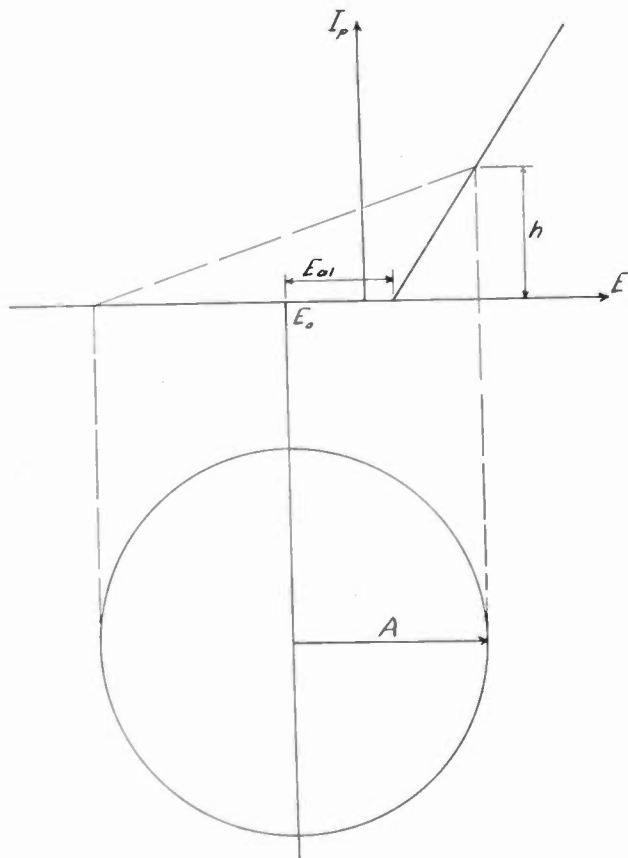

Fig. 5—Relations between average and actual mutual conductance.

The closure condition suitable with this case is

$$\alpha = 0. \text{ Or } \frac{R}{2L} = \frac{g_{m \text{ avg}}}{2C} \left\{ \frac{\mu\rho - 1}{\mu(\rho + 1)} \right\} \tag{26}$$

Thus

$$g_{m \text{ avg}} = \frac{RC}{L \left\{ \frac{\mu\rho - 1}{\mu(\rho + 1)} \right\}} = \frac{g_m(A - E_{a1})}{2A}$$

by combining (25) and (26).

From the above

$$A = \frac{E_{a1}}{1 - \frac{2RC}{g_m L \left\{ \frac{\mu\rho - 1}{\mu(\rho + 1)} \right\}}} \tag{27}$$

Also from (11a)

$$b = \frac{-\alpha}{\omega} \text{ and } a = \frac{\alpha_1}{\omega}$$

Thus

$$\frac{b}{a} = \frac{\text{rate of gain}}{\text{rate of decay}} = \frac{-\alpha}{\alpha_1} = \frac{-\frac{R}{2L} + \frac{g_m}{2C} \left\{ \frac{\mu\rho - 1}{\mu(\rho + 1)} \right\}}{\frac{R}{2L}} \tag{28}$$

$$= -1 + \frac{Lg_m}{RC} \left\{ \frac{\mu\rho - 1}{\mu(\rho + 1)} \right\}$$

Rearranging (28)

$$\frac{b}{a} + 1 = \frac{a + b}{a} = \frac{Lg_m \left\{ \frac{\mu\rho - 1}{\mu(\rho + 1)} \right\}}{RC} \tag{28a}$$

Combining (27) and (28a) gives the value of  $A$  by the "average  $g_m$ " method,

$$A = \frac{E_{a1}}{1 - \frac{2a}{a + b}} \tag{29}$$

This value of  $A$  may now be compared numerically with the value obtained with the method of the paper for differing values of  $b/a$  as a common independent variable.

TABLE I

Column 1 $b/a$ rate of gain rate of decay	Column 2 $ A $ by Guillemin method (14) $\frac{E_{a1}}{\cos \pi/1 + b/a}$	Column 3 $ A $ by "average $g_m$ " method (29) $\frac{E_{a1}}{1 - 2/1 + b/a}$	Column 4 Percentage difference $\frac{(3) - (2)}{(3)} \times 100$
0	$\frac{E_{a1}}{1.000}$	$\frac{E_{a1}}{1.00}$	0
1/4	1.235	1.67	26
1/2	2.000	3.00	33
3/4	4.450	7.15	38
1	indeterminate	—	—
2	2.000	3.00	33
4	1.235	1.67	26
9	1.050	1.25	16
$\infty$	1.000	1.00	0

Examination of Table I shows that the quality of the circuit is a linear function of the value of  $b/a$ . The cases of  $b/a$  equal to zero and infinity are obviously limiting ones of the worse possible and the best possible circuit conditions neither of which would be reached in fact. The range between 1 and infinity is the most

practical and a considerable percentage difference is found over the probable operating range of 2 to 9.

GENERAL DISCUSSION

The expressed purpose of the paper, to "present an analysis in such a manner that the action of the circuit is demonstrated as the analysis proceeds" has been portrayed in Section II. Regions of amplification and nonamplification of the oscillation are clearly denoted both by the figures and by the values of  $\alpha$  and  $\alpha_1$ .

The values of  $V_p$  given in (16) and (23) are so arranged as to be in a concise form even though considerable numerical calculation may underlie them. For the purpose of numerical calculation the value of (23) would be improved if some reasonable approximation for  $\cos \theta$  (21) were available. A suggestion in this direction is given in the Appendix where  $\cos \theta$  is determinable as the ratio of the sides of a triangle from (21a). Naturally the forms leave nothing to be desired from the standpoint of simplicity if the values of the operating angles  $\phi$  and  $\theta$  are known. Unfortunately, oscillator analysis as it nears exactitude always seems to become numerically complicated as was remarked by van der Pol.<sup>2</sup>

Some discussion of the various terms may be in order.  $V_p$  is perhaps the correct answer to the problem of oscillator analysis representing as it does the maximum amplitude of the alternating voltage across the plate coil. It is to be noted that the value of  $\rho$  is made negative in fact by the assumption of a positive  $\mu$  and the assumptions in (4). The values of  $E_{a1}$  and  $E_{a2}$  may be readily determined from a study of the actual characteristic of the tube and a knowledge of the practical operating voltage  $E_0$ , desired. The value of  $R$  must of course include the reflected value of any load.

ACKNOWLEDGMENT

The writers wish to acknowledge the many helpful suggestions given them by Professor E. A. Guillemin during the preparation of the paper.

APPENDIX

From (20a) let

$$P = \frac{\cos \phi}{\cos \theta} = \frac{E_{a2}}{E_{a1}} \exp \left\{ \frac{\pi ab}{a+b} \right\}. \quad (30)$$

Then

$$\frac{P-1}{P+1} = \frac{\cos \phi - \cos \theta}{\cos \phi + \cos \theta} = \frac{\sin \left( \frac{\theta + \phi}{2} \right) \sin \left( \frac{\theta - \phi}{2} \right)}{\cos \left( \frac{\theta + \phi}{2} \right) \cos \left( \frac{\theta - \phi}{2} \right)}$$

$$\cos \theta = \frac{2 \cos \frac{\pi a}{2(a+b)}}{\sqrt{P^2 \left\{ 1 + \operatorname{ctn}^2 \frac{\pi a}{2(a+b)} \right\} + 2P \left\{ 1 - \operatorname{ctn}^2 \frac{\pi a}{2(a+b)} \right\} + \left\{ 1 + \operatorname{ctn}^2 \frac{\pi a}{2(a+b)} \right\}}}$$

$$= \tan \left( \frac{\theta + \phi}{2} \right) \tan \left( \frac{\theta - \phi}{2} \right) \quad (31)$$

or,

$$\tan \left( \frac{\theta + \phi}{2} \right) = \frac{P-1}{P+1} \operatorname{ctn} \left( \frac{\theta - \phi}{2} \right). \quad (32)$$

Therefore,

$$\frac{\theta + \phi}{2} = \tan^{-1} \left[ \frac{P-1}{P+1} \operatorname{ctn} \left( \frac{\pi a}{2(a+b)} \right) \right]. \quad (33)$$

Solving (33) and (18) for  $\theta$  and  $\phi$

$$\theta = \frac{\pi a}{2(a+b)} + \tan^{-1} \left[ \frac{P-1}{P+1} \operatorname{ctn} \left( \frac{\pi a}{2(a+b)} \right) \right] \quad (34)$$

$$\phi = -\frac{\pi a}{2(a+b)} + \tan^{-1} \left[ \frac{P-1}{P+1} \operatorname{ctn} \left( \frac{\pi a}{2(a+b)} \right) \right]. \quad (35)$$

Fig. 6 shows a right-angle triangle constructed from (33).

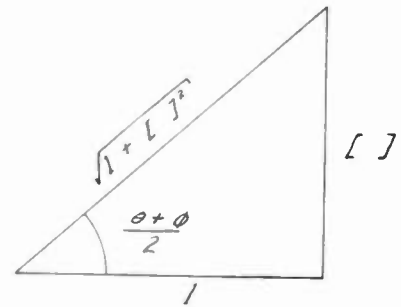

Fig. 6

Then from (34), the relation in the triangle, and the relation  $\cos(x+y) = \cos x \cos y - \sin x \sin y$

$$\cos \theta = \cos \left[ \frac{\pi a}{2(a+b)} \times \frac{1}{\sqrt{1 + [ ]^2}} \right] - \sin \left[ \frac{\pi a}{a+b} \times \frac{[ ]}{\sqrt{1 + [ ]^2}} \right] \quad (36)$$

or,

$$\cos \theta = \frac{\cos \frac{\pi a}{2(a+b)} - \frac{P-1}{P+1} \cos \frac{\pi a}{2(a+b)}}{\sqrt{1 + \left( \frac{P-1}{P+1} \right)^2 \operatorname{ctn}^2 \frac{\pi a}{2(a+b)}}} \quad (37)$$

Simplifying (37),

$$\cos \theta = \frac{2 \cos \frac{\pi a}{2(a+b)}}{\sqrt{(P+1)^2 + (P-1)^2 \operatorname{ctn}^2 \frac{\pi a}{2(a+b)}}}$$

and, since,

$$1 + \text{ctn}^2 \frac{\pi a}{2(a+b)} = \frac{1}{\sin^2 \frac{\pi a}{2(a+b)}}$$

and

$$2 \cos \frac{\pi a}{2(a+b)} \sin \frac{\pi a}{2(a+b)} = \sin \frac{\pi a}{a+b}$$

$$\cos \theta = \frac{\sin \frac{\pi a}{(a+b)}}{\sqrt{P^2 + 1 - 2P \cos \frac{\pi a}{(a+b)}}} \quad (38) \text{ or } (21a)$$

which, on substituting the value of  $P$ , (30), yields (21). By the cosine law the denominator of (21a) may be

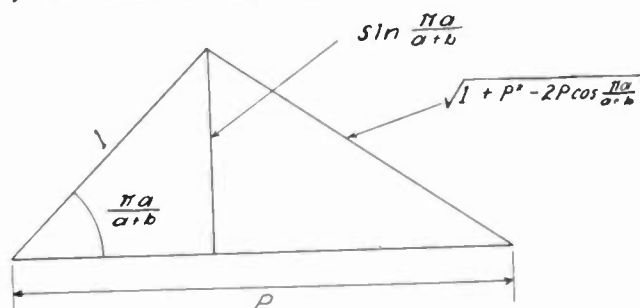

Fig. 7

represented as shown in Fig. 7. Thus  $\cos \theta$  becomes the ratio of the altitude to the side opposite angle  $\pi a / (a+b)$ .

### Book Reviews

“Ultra-High-Frequency Techniques,” Edited by J. G. Brainerd in collaboration with Glenn Koehler, Herbert J. Reich, and L. F. Woodruff . . . . . L. E. Whittemore 309

“Short Wave Radio,” by J. H. Reyner . . . . . Ralph R. Batcher 310

“Television Standards and Practice,” Edited by Donald G. Fink . . . . . Peter C. Goldmark 310

“Electromechanical Transducers and Wave Filters,” by Warren P. Mason . . . . . Harold A. Wheeler 310

“Electronics,” by Jacob Millman and Samuel Seeley . . . . . W. G. Dow 310

“Experimental Electronics,” by Ralph H. Müller, R. L. Garman, and M. E. Droz . . . . . Harley Iams 311

“Gaseous Conductors, Theory and Engineering Applications,” by James Dillon Cobine . . . . . Dayton Ulrey 311

“A Guide to Cathode Ray Patterns,” by Merwyn Bly . . . . . R. R. Batcher 312

“The Mathematics of Wireless,” by Ralph Stranger . . . . . Frederick W. Grover 312

“American Standard Definitions of Electrical Terms,” Published by the American Institute of Electrical Engineers . . . . . Haraden Pratt 312

“Introduction to Electricity and Optics,” by Nathaniel H. Frank . . . . . H. M. Turner 312

“The Radio Amateur’s Handbook, Twentieth (1943) Edition,” by the Headquarters Staff of the A.R.R.L. . . . . E. B. Ferrell 313





The Institute desires to present to the readers of the PROCEEDINGS effective material of timely value having major tutorial aspects. In pursuance of this policy there are included in the two preceding issues of the PROCEEDINGS and in this issue, installments covering a portion of the text of a forthcoming volume entitled: "Radio Engineers Handbook." Through the courtesy of its author, Professor Frederick E. Terman (at present Direc-

tor of the Radio Research Laboratory operating under the supervision of the Office of Scientific Research and Development at Harvard University) and of the publishers, the McGraw-Hill Book Company, New York, N. Y., permission has been granted to the PROCEEDINGS to place this material before our readers. Appreciation of this co-operation is here expressed.

The Editor

# Network Theory, Filters, and Equalizers\*

FREDERICK E. TERMAN†, FELLOW, I.R.E.

## PART III

**Summary**—Part III is concerned with ladder and lattice filters, attenuation and phase equalizers, and dividing networks.

The fundamental equations and design procedures involved in both ladder and lattice filters are reviewed. Tables and charts are given for aiding in the design of  $M$ -derived filters having terminal half sections. It is possible in this way, without making calculations other than placing numbers in simple formulas, to design filters having characteristics that will meet most requirements.

Consideration is given to filters terminated with other than half sections, particularly  $MM'$  and fraction terminations. A chart is given for the design of  $MM'$  terminating sections, which give unusually good impedance characteristics at the terminals. Fractional terminations, which are used when filters are to be placed in series or in parallel, are considered with particular reference to complementary filters.

The factors controlling the cutoff frequencies, attenuation and phase characteristics, and impedance characteristics of lattice filters are reviewed. The attenuation and phase behavior of such filters can be given almost any desired characteristic by suitably locating an adequate number of critical frequencies (i.e., zeros and poles of impedance) in the pass bands, while the behavior of the image impedances can be similarly controlled by the location and number of the critical frequencies in the attenuating bands. Particular consideration is given to the requirements that the critical frequencies in the pass band must satisfy in order to obtain a substantially linear phase-shift characteristic in the pass band.

The relationship between ladder and lattice filters is reviewed. The transformation whereby any ladder can be converted to a lattice is given, and it is shown that under certain conditions a lattice can be developed into a physically realizable ladder or bridged-T network. The lattice is the most general type of four-terminal network, whereas the ladder type is more specialized so that in some cases a lattice cannot be reduced to a ladder having physically realizable arms.

Attenuation equalizers are considered, and it is shown that all of the common types have a common insertion-loss formula in which the transmission characteristic is determined by the nature of one impedance arm. A design chart is given whereby a variety of insertion-loss characteristics can be realized, based on simple impedance arms. More complicated insertion-loss characteristics

are obtained by placing a number of simple equalizer sections in tandem.

All-pass filters for phase equalizers are considered briefly, and it is shown that the phase-shift characteristics are controlled by the number and location of the internal zeros and poles of the lattice impedances.

Two types of dividing networks for such applications as dual-channel loudspeakers are considered. One of these is a constant-resistance type of network, which provides constant input resistance for all frequencies. The other is based upon complementary filters, and leads to slightly different, but substantially equivalent, results.

### XI. $M$ -DERIVED (LADDER) FILTERS<sup>22</sup>

A FILTER can be considered as a four-terminal network in which the image transfer constant has a value that is either small or zero in a particular range of frequencies and a value that is relatively large for other frequencies.

#### Fundamental Filter Equations

Practical filters of the ladder type consist of symmetrical T or  $\pi$  sections composed of reactive elements. When the impedance arms are designated as in Fig. 35, then the image transfer constant  $\theta$  and the image impedances  $Z_T$  and  $Z_\pi$  for the T and  $\pi$  sections are

$$\cosh \theta = 1 + \frac{Z_1}{2Z_2} \quad (50a)$$

or

$$\sinh \frac{\theta}{2} = \sqrt{\frac{Z_1}{4Z_2}} \quad (50b)$$

$$Z_T = \sqrt{Z_1 Z_2 + \frac{1}{4} Z_1^2} \quad (51)$$

$$Z_\pi = \frac{Z_1 Z_2}{\sqrt{Z_1 Z_2 + \frac{1}{4} Z_1^2}} = \frac{Z_1 Z_2}{Z_T} \quad (52)$$

Half sections have an image transfer constant exactly half of the transfer constant of a full section. The image

<sup>22</sup> Otto J. Zobel, "Theory and design of uniform and composite electric wave-filters," *Bell. Sys. Tech. Jour.*, vol. 2, p. 1; January, 1923.

\* Decimal classification: R142×R390. Original manuscript received by the Institute, February 17, 1943. Prepublished by permission from "Radio Engineers Handbook," by Frederick E. Terman and the McGraw-Hill Book Company, New York, N. Y.

† Director, Radio Research Laboratory, Harvard University, Cambridge, Massachusetts.

impedances of the two sides of the half sections differ, being  $Z_T$  on one side and  $Z_\pi$  on the other (see Fig. 35).

An ideal filter in which the impedance arms are pure reactances with zero loss has zero attenuation (i.e., the real part of  $\theta$  is 0) for all frequencies that make  $Z_1/4Z_2$  lie between 0 and  $-1$ . Such frequencies are termed *pass frequencies* and the range in which they lie is termed the *pass band*. The phase constant  $\beta$  of the image transfer constant in the pass band is

$$\cos \beta = 1 + \frac{Z_1}{2Z_2} \quad (53)$$

The image impedance in the pass band is a pure resistance.

All frequencies other than those which make  $Z_1/4Z_2$  lie between 0 and  $-1$  suffer attenuation (i.e., the real part  $\alpha$  of  $\theta$  is not zero). Such frequencies are termed *stop frequencies*, and are said to lie in the *stop band* of the filter. The phase shift in the stop bands is either

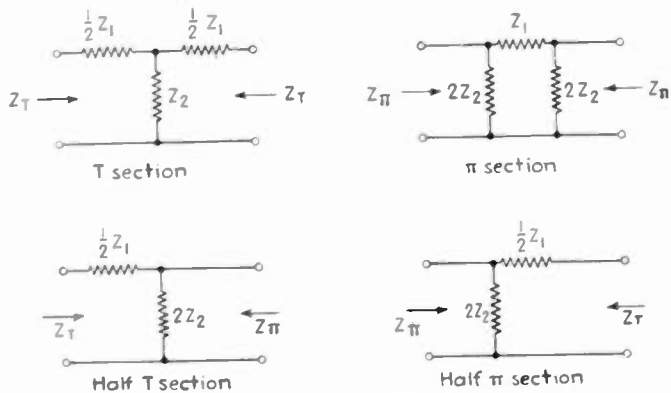

Fig. 35—Filter sections, showing nomenclature.

zero or  $\pm 180$  degrees, and the image impedance is a pure reactance. The magnitude of the attenuation constant  $\alpha$  for the stop frequencies is

$$\cosh \alpha = \left| 1 + \frac{Z_1}{2Z_2} \right| \quad (54)$$

### Filter Designs

Practical ladder filters are built up in the manner illustrated in Fig. 36. The middle portion of the filter is composed of a series of symmetrical T or  $\pi$  sections connected in cascade, and at each end of the filter there is a half section as shown. All sections in the filter are matched together at each junction on an image-impedance basis.

The intermediate sections used in constructing a practical filter are of a class in which one can vary the attenuation characteristics of the section by suitably designing the series and shunt arms, without at the same time affecting in any way the image impedance. This makes it possible to arrange matters so that the frequencies for which one section gives only small attenuation are then strongly attenuated by some other section. Sections of this class, however, have an image impedance that is far from constant in the pass band

of the filter. This means that a filter consisting only of such sections as might be used in the intermediate portion of a filter would not operate satisfactorily in association with a load resistance having a value independent of frequency. This difficulty is overcome by employing suitably designed terminal half sections, as shown in Fig. 36, that match the intermediate portion

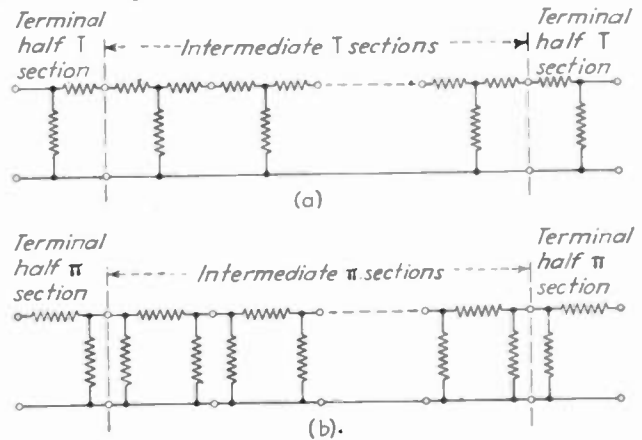

Fig. 36—Method of building up an  $M$ -derived filter.

of the filter on an image-impedance basis on one side, but offer a more desirable type of image impedance at their external terminals.

Sections suitable for use in low-pass, high-pass, and band-pass filters, together with the necessary design formulas, are given in Tables I, II, and III. All the sections illustrated in these tables are suitable for use in the intermediate portion of the filter except those sections specifically designated as end sections. All intermediate sections designed from one of these tables for given cutoff frequencies, and for the same load resistance, will have identical image-impedance characteristics, and so can be connected in cascades on an image-impedance basis. The image transfer constant, i.e., the attenuation and phase-shift characteristics, of the individual sections will, however, depend upon the type of section involved and upon the value assigned to the design parameter  $m$  (or  $m_1$  and  $m_2$ ).

The terminal half sections are designed according to the formulas given in the respective tables, with the design parameter  $m$  assigned a value of approximately 0.6. When the terminal half sections are designed by the tables for the same cutoff frequencies and same load resistance as the intermediate sections, their image impedances will match the intermediate sections at one pair of terminals. Also, when the appropriate value of  $m$  is used in the design, the image impedance at the other terminals will be substantially constant over almost the entire pass band of the filter. This is illustrated in Fig. 37, where the effect of using various values of  $m$  is shown. Examples of actual filters designed according to Tables I, II, and III are given in Figs. 38, 39, and 40.

The procedure involved in the design of a filter to meet a given set of conditions falls into several well-defined steps, as follows:

**TABLE I**  
DESIGN OF LOW-PASS SECTIONS  
Fundamental Relations  
 $f_c$  = cutoff frequency  
(highest frequency transmitted)

$R$  = load resistance

$$L_k = \frac{R}{\pi f_c}$$

$$C_k = \frac{1}{\pi f_c R}$$

Design of Sections

$f_\infty$  = a frequency of very high attenuation

$$m = \sqrt{1 - \left(\frac{f_c}{f_\infty}\right)^2}$$

Type	Attenuation characteristic	A. Filters having T intermediate sections		B. Filters having $\pi$ intermediate sections	
		Configuration	Formulas	Configuration	Formulas
End (m of approximately 0.6)			$L_1 = mL_k$ $L_2 = \frac{1 - m^2}{4m} L_k$ $C_2 = mC_k$		$L_1 = mL_k$ $C_1 = \frac{1 - m^2}{4m} C_k$ $C_2 = mC_k$
I			$L_1 = mL_k$ $L_2 = \frac{1 - m^2}{4m} L_k$ $C_2 = mC_k$		$L_1 = mL_k$ $C_1 = \frac{1 - m^2}{4m} C_k$ $C_2 = mC_k$
II ( $f_\infty = \infty$ )			$L_1 = L_k$ $C_2 = C_k$		$L_1 = L_k$ $C_2 = C_k$

1. Determine the cutoff frequencies, i.e., the frequencies that mark the edge of the pass band, and the load resistance that will meet the design requirements, and decide whether T or  $\pi$  intermediate sections are to be used.

2. Design the terminating sections according to the proper table, using the load resistance and cutoff frequencies selected in step 1.

3. Decide on the number of intermediate sections to be used. The more sections selected the greater will be the attenuation that can be obtained in the stop band. One intermediate section will give a moderately good filter, and will be sufficient for many requirements.

More than two intermediate sections are seldom required.

4. Select the frequencies at which the different intermediate sections will have their maximum attenuation, and then design these sections for the chosen load resistance and cutoff frequencies, using formulas in the appropriate tables.

The choice between T and  $\pi$  sections for the middle portion of the filter is primarily based upon considerations of convenience. Electrically, the performance of the two types will be identical.

The location of the frequencies for which the intermediate sections have high attenuation must be

**TABLE II**  
DESIGN OF HIGH-PASS SECTIONS  
Fundamental Relations  
 $f_c$  = cutoff frequency  
(lowest frequency transmitted)

$R$  = load resistance

$$L_k = \frac{R}{4\pi f_c}$$

$$C_k = \frac{1}{4\pi f_c R}$$

Design of Sections

$f_\infty$  = a frequency of very high attenuation

$$m = \sqrt{1 - \left(\frac{f_\infty}{f_c}\right)^2}$$

Type	Attenuation characteristic	A. Filters having T intermediate sections		B. Filters having $\pi$ intermediate sections	
		Configuration	Formulas	Configuration	Formulas
End (m of approximately 0.6)			$C_1 = \frac{C_k}{m}$ $C_2 = \frac{4m}{1 - m^2} C_k$ $L_2 = \frac{L_k}{m}$		$L_1 = \frac{4m}{1 - m^2} L_k$ $C_1 = \frac{C_k}{m}$ $L_2 = \frac{L_k}{m}$
I			$C_1 = \frac{C_k}{m}$ $C_2 = \frac{4m}{1 - m^2} C_k$ $L_2 = \frac{L_k}{m}$		$L_1 = \frac{4m}{1 - m^2} L_k$ $C_1 = \frac{C_k}{m}$ $L_2 = \frac{L_k}{m}$
II ( $f_\infty = 0$ )			$C_1 = C_k$ $L_2 = L_k$		$C_1 = C_k$ $L_2 = L_k$

TABLE III  
DESIGN OF BAND-PASS SECTIONS  
Fundamental Relations

$R$  = load resistance  
 $f_{1\infty}$  = a frequency of very high attenuation in low-frequency attenuating band  
 $f_1$  = lower frequency limit of pass band  
 $f_2$  = higher frequency limit of pass band  
 $f_{2\infty}$  = a frequency of very high attenuation in high-frequency attenuating band

$$L_{1k} = \frac{R}{\pi(f_1 - f_1)}$$

$$L_{2k} = \frac{(f_1 - f_1)R}{4\pi f_1}$$

$$C_{1k} = \frac{f_1 - f_1}{4\pi f_1 R}$$

$$C_{2k} = \frac{1}{\pi(f_1 - f_1)R}$$

Design of Sections

Type	Attenuation characteristic	A. Filters having T intermediate sections	B. Filters having $\pi$ intermediate sections	Notation for both T and $\pi$ sections	
		Configuration	Configuration	Formulas	
End ( $m_1 = m_2$ = approximately 0.6)				$L_1 = \frac{L_{2k}}{b}$ $L_2 = \frac{L_{2k}}{m_2}$ $C_1' = \frac{C_{2k}}{m_2}$ $C_2 = m_1 C_{2k}$	$\sigma = \sqrt{\left(1 - \frac{f_{1\infty}^2}{f_1^2}\right)\left(1 - \frac{f_{1\infty}^2}{f_2^2}\right)}$ $h = \sqrt{\left(1 - \frac{f_{1\infty}^2}{f_1^2}\right)\left(1 - \frac{f_{1\infty}^2}{f_2^2}\right)}$ $\frac{f_1 f_2}{f_{2\infty}^2} + h = \sigma + \frac{f_{1\infty}^2}{f_1 f_2} h$ $m_1 = \frac{1 - \frac{f_{1\infty}^2}{f_1^2}}{1 - \frac{f_{1\infty}^2}{f_2^2}}$ $m_2 = \frac{1 - \frac{f_{1\infty}^2}{f_2^2}}{1 - \frac{f_{1\infty}^2}{f_1^2}}$ $a = \frac{(1 - m_1^2) f_1 f_2}{4\sigma f_1 f_2} \left(1 - \frac{f_{1\infty}^2}{f_2^2}\right) = \frac{4\sigma f_{1\infty}^2}{4\sigma f_1 f_2} \left(1 - \frac{f_{1\infty}^2}{f_2^2}\right)$ $b = \frac{(1 - m_2^2)}{4\sigma} \left(1 - \frac{f_{1\infty}^2}{f_1^2}\right)$ $c = \frac{(1 - m_1^2)}{4h} \left(1 - \frac{f_{1\infty}^2}{f_2^2}\right)$ $d = \frac{(1 - m_2^2) f_1 f_2}{4h f_1 f_2} \left(1 - \frac{f_{1\infty}^2}{f_1^2}\right) = \frac{(1 - m_2^2) f_1 f_2}{4h f_1 f_2} \left(1 - \frac{f_{1\infty}^2}{f_1^2}\right)$ when ( $m_1 = m_2$ ), $g = h, a = d, b = c, f_{1\infty} = \frac{f_1 f_2}{f_{2\infty}}, m_1 = m_2 = \frac{h}{1 - \frac{f_{1\infty}^2}{f_2^2}}$ and $f_{2\infty}^2 = \frac{f_1^2 + f_2^2 - 2m_1^2 f_1 f_2}{2(1 - m_1^2)} + \left[ \left( \frac{f_1^2 + f_2^2 - 2m_1^2 f_1 f_2}{2(1 - m_1^2)} \right)^2 - f_1^2 f_2^2 \right]^{1/2}$
I				$L_1 = \frac{L_{2k}}{b}$ $L_2 = \frac{L_{2k}}{m_2}$ $C_1' = \frac{C_{2k}}{m_2}$ $C_2 = m_1 C_{2k}$	These formulas apply for both end and $\pi$ sections
II $f_{1\infty} = 0$ $f_{2\infty} = f_2$				$L_1 = \frac{f_1 R}{\pi f_2 (f_2 - f_1)}$ $L_2 = \frac{(f_1 + f_2) R}{4\pi f_1 f_2}$ $C_1 = C_{2k}$	
III $f_{1\infty} = f_1$ $f_{2\infty} = \infty$				$L_1' = \frac{R}{\pi(f_1 + f_2)}$ $L_2 = \frac{(f_2 - f_1) R}{4\pi f_1^2}$ $C_2 = C_{2k}$	
IV $f_{1\infty} = 0$ $f_{2\infty} = \infty$				$L_1 = L_{2k}$ $L_2 = L_{2k}$ $C_1 = C_{2k}$ $C_2 = C_{2k}$	
V $f_{2\infty} = f_2$				$L_1 = \frac{4m_2}{1 - m_2^2} L_{2k}$ $L_2 = \frac{L_{2k}}{m_2}$ $C_1 = \frac{(1 - m_2^2)}{4m_1} C_{2k}$ $C_2 = \frac{m_1 C_{2k}}{1 - m_2^2}$ See notation for $m_1$ and $m_2$	
VI $f_{1\infty} = f_1$		Same circuit as above for Type V	Same circuit as above for Type V	Same formulas as above for Type V See notation for $m_1$ and $m_2$	
VII $f_{1\infty} = 0$				$L_1' = \frac{h}{4} L_{2k}$ $L_2 = L_{2k}$ $C_1 = a C_{2k}$ $C_2 = m_1 C_{2k}$ $C_1' = \frac{(1 - m_1^2)}{4h} C_{2k}$	
VIII $f_{2\infty} = \infty$				$L_1 = \frac{4g}{1 - m_2^2} L_{2k}$ $L_2 = \frac{L_{2k}}{m_2}$ $L_1' = \frac{L_{2k}}{d}$ $C_1 = \frac{d}{g} C_{2k}$ $C_2 = C_{2k}$	

carefully selected, for upon this choice rest the attenuating properties of the filter. These frequencies of high attenuation should in general be different for the different sections, and should be so staggered throughout the attenuating bands that every frequency suffers considerable attenuation by at least one section. Inasmuch

as the terminal half sections determine one frequency of high attenuation in each attenuating band, these sections should be designed before the intermediate sections in order that the attenuation of the central portion of the filter may best supplement that of the end sections.



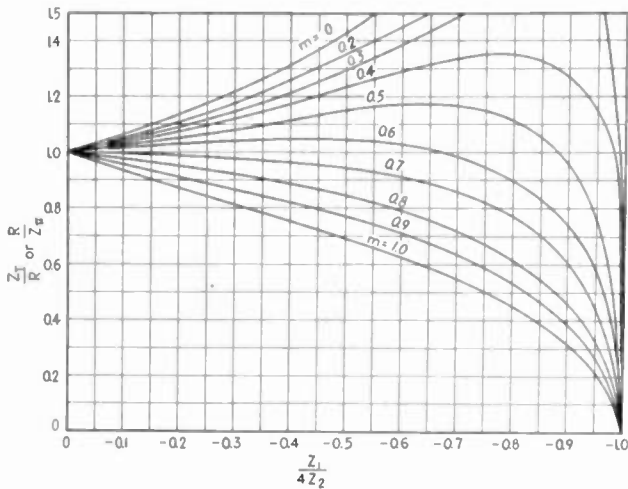
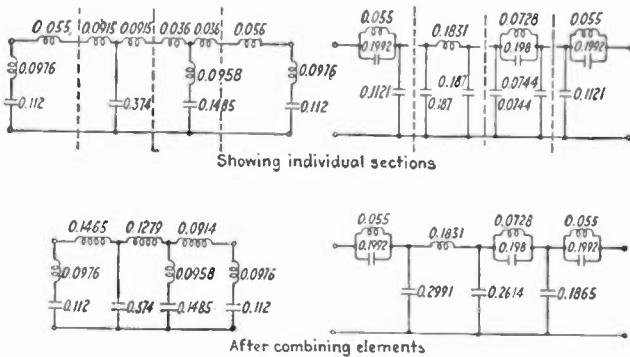
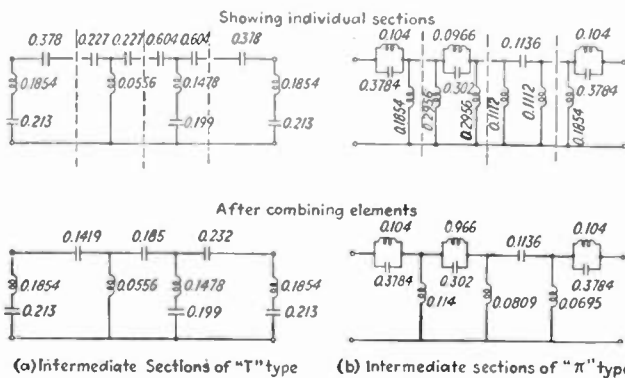

Fig. 37—Effect of design parameter  $m$  on image-impedance characteristics in the pass band.



(a) Intermediate sections of "T" type (b) Intermediate section of "π" type

Fig. 38—Example of a low-pass filter having a cutoff frequency of 1213 cycles, two intermediate sections, and proportioned to operate with a load resistance of 700 ohms.



(a) Intermediate Sections of "T" type (b) Intermediate sections of "π" type

Fig. 39—Example of a high-pass filter having a cutoff frequency of 1000 cycles, two intermediate sections, and proportioned to operate with a load resistance of 700 ohms.

It is sometimes desirable to obtain a very rapid rise of attenuation at the edge of the pass band of the filter. Although it is theoretically possible in the ideal case of perfect reactances to obtain a frequency of high attenuation as close to the cutoff frequency as desired, practical considerations require that such frequencies of high attenuation be not too close to the cutoff frequencies. There are two reasons for this. In the first place, as the frequency of high attenuation is moved closer and closer to the cutoff frequency, the attenua-

tion characteristics become narrower, as shown in Fig. 41. The result is that a section designed to attenuate frequencies extremely close to cutoff will be of little use in attenuating frequencies appreciably different from cutoff. In the second place, the reactance arms required in a filter having a frequency of high attenua-

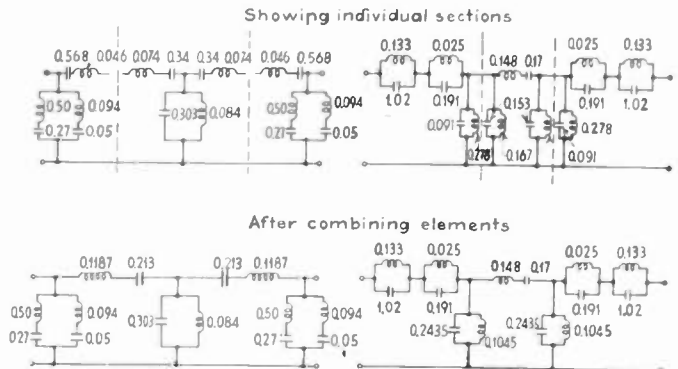

Fig. 40—Examples of band-pass filters having cutoff frequencies of 500 and 2000 cycles, one intermediate section, and proportioned to operate with a load resistance of 700 ohms, for designs based on T intermediate sections and on π intermediate sections.

tion very close to cutoff assume impractical proportions, and if these impractical circuit elements are built, it will be found that their losses prevent the high attenuation that is theoretically possible from being actually realized. This is illustrated in Fig. 41. In the

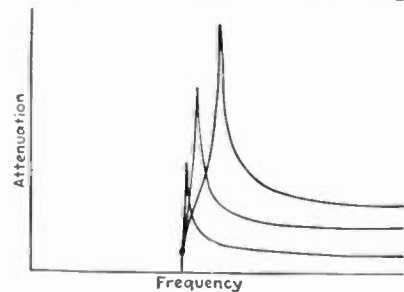

Fig. 41—Attenuation characteristics obtained in a low-pass filter section as the frequency of high attenuation is placed closer and closer to cutoff.

case of ordinary coils with reasonably high  $Q$ , the frequencies of infinite attenuation should differ from cutoff by not less than 2 to 5 per cent. Where quartz crystals are used as filter elements, the higher  $Q$  of such resonators permits this difference to be reduced greatly.

*Filters with MM' and Fractional Terminations, Filters in Series and Parallel*

Filters such as are described above, employing terminating half sections designed for  $m \approx 0.6$ , provide an image-impedance characteristic for the external terminals of the filter that is sufficiently constant over the pass band to meet most requirements. Where a closer approximation to a constant resistance image impedance is required, more elaborate terminating sections can be employed. The next steps in complexity beyond the simple sections already discussed, are given

in Fig. 42 and are termed  $MM'$  terminations.<sup>23</sup> These arrangements give a decided improvement in image impedance at the external terminals. Thus, in the case of a low-pass filter, the usual  $m = 0.6$  termination gives an image impedance constant to within 4 per cent over 90 per cent of the pass band, and the  $MM'$  termination

intermediate sections. The shunting reactances of all the filters in parallel then can be thought of as forming a single shunting reactance, which can then be modified as required to make the equivalent impedance seen when one is looking toward the paralleled terminals approximate a resistance in the pass band of all filters.

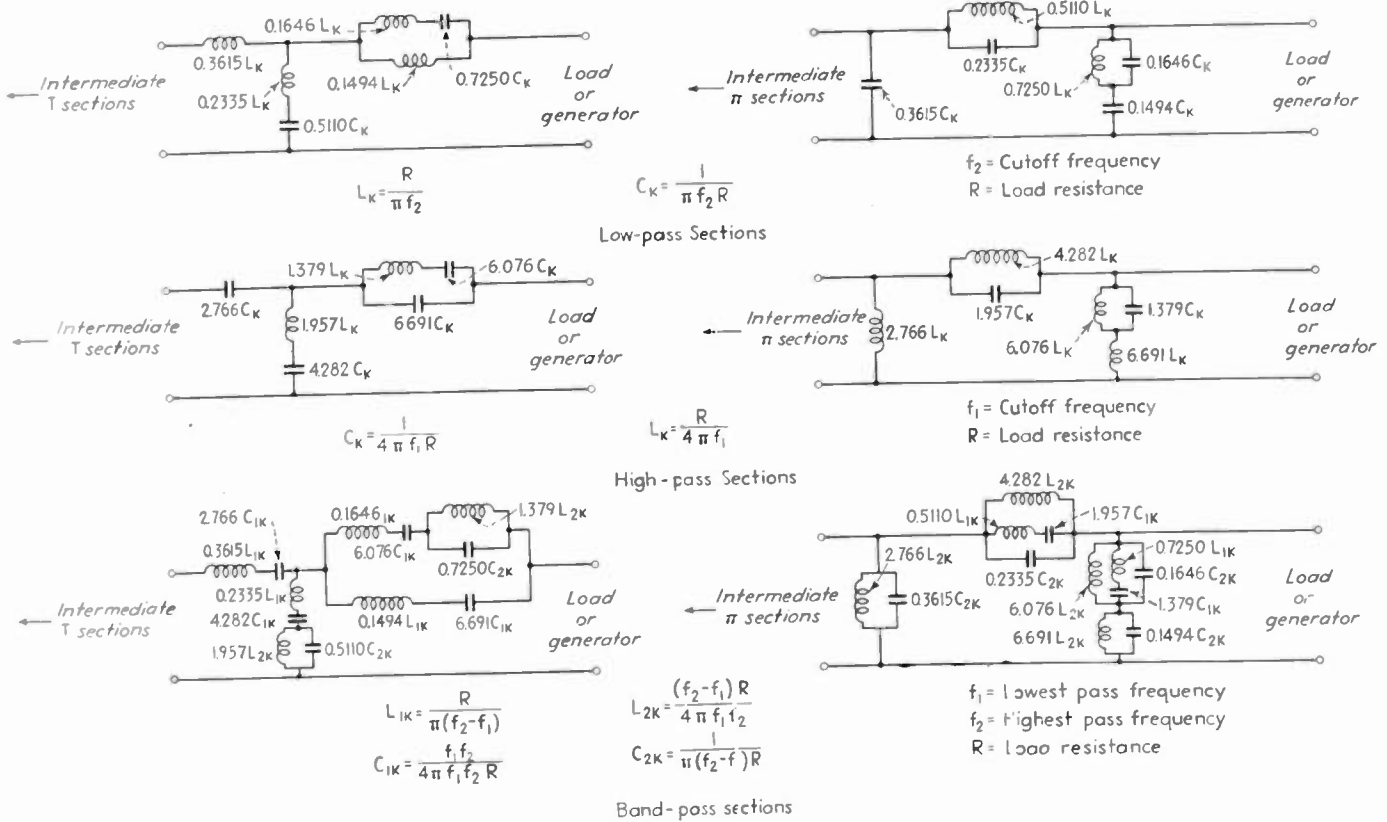

Fig. 42—Termination sections of  $MM'$  type.

gives an image impedance constant to within 2 per cent over 96 per cent of the pass band.

The  $MM'$  terminating section is characterized by having two frequencies of infinite attenuation in each stop band, as shown in Fig. 43.

It is sometimes necessary to parallel the input or the output terminals of a number of filters. In such an arrangement, each filter shunts its own image impedance across the common terminals. If one then considers the situation at a particular frequency, it is apparent that the filters that have a pass band for this frequency offer a resistance impedance, whereas the remaining filters, i.e., those for which this frequency is in the stop band, provide a reactive shunting impedance that varies with frequency. This modifies the impedance presented by the combination of filters in parallel, and affects the insertion loss in an unfavorable manner.

This difficulty can be handled practically by employing filters in which the external terminals are shunted by a reactive arm, i.e., by using a filter having T in-

termediate sections. This requires, in some instances, merely that the magnitude of the combined shunting impedance be modified in size; in other cases, an additional shunting reactive network must be placed across the common terminals.<sup>24, 25</sup>

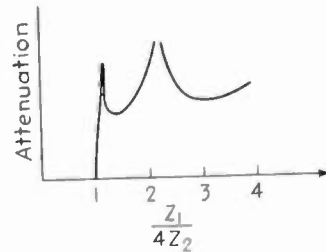

Fig. 43—Attenuation characteristic of  $MM'$  terminating section.

A particularly important case of filters in parallel is furnished by complementary filters, i.e., where those frequencies that lie in the stop band of one filter are the pass frequencies of the other filter. In such an arrangement, it is found that if the terminating half

<sup>23</sup> Otto J. Zobel, "Extensions to the theory and design of electric wave-filters," *Beil Sys. Tech. Jour.*, vol. 10, p. 284; April, 1931.

<sup>24</sup> Further discussion is given by E. A. Guillemin, "Communication Networks," vol. 1, John Wiley and Sons, New York, N. Y., 1931, pp. 356-366.

<sup>25</sup> O. Zobel, U.S. Patents Nos. 1,557,229 and 1,557,230.

sections are originally both designed on the basis  $m=0.6$  and the same load resistance, then the reactive input impedance of one filter in its stop band is almost exactly equal to the reactive impedance that should be provided by the first shunting impedance of the complementary filter in its pass band, and vice versa. The result is that, if the shunting impedances at the inputs of both filters are simply omitted, then the normal impedance relations will be maintained at all frequencies. Such an arrangement is termed a *fractional* or *x termination*, and is illustrated in Fig. 44(a).

Filters that are connected in series at one side, such as the input, present a problem analogous to that of

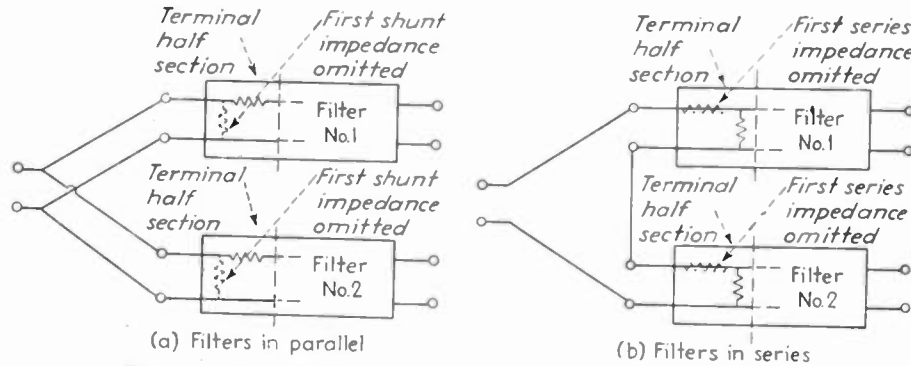

Fig. 44—Schematic illustration of complementary filters in parallel and series ( $x$  terminations).

filters in parallel. Here each filter in its stop band places a reactance in series with the other filter or filters. The proper method of attack here consists in employing filters that have reactances in series with the external terminals, i.e., filters with  $\pi$  intermediate sections. These series reactances are then lumped together to form a single series impedance, which is then modified as required to take into account the reactances contributed by the filters in the stop bands. In the case of complementary filters in series, one designs the terminating half sections for  $m=0.6$ . The series elements of the sections are then omitted, as shown in Fig. 44(b), and the input reactance of the filter in the stop band is used to supply the series reactance required by the complementary filter in its pass band, and vice versa.

#### Losses

The ideal filter with pure reactive elements discussed above can never be fully realized in practice, for although condensers can be made with negligible losses, this is never true with inductances. Experience shows, however, that when the  $Q$  of the coils is of the order of 15 or higher, the effect of the losses is only secondary and the essential conclusions and design procedures based on an ideal filter with zero losses are not seriously invalidated.

The principal effects of a moderate amount of energy loss in a filter are:

1. A small attenuation is introduced in the pass band.

2. Frequencies for which infinite attenuation would otherwise be obtained are found to have only finite attenuation.<sup>26</sup>

3. The abrupt transitions occurring at the cutoff frequencies in an ideal filter are rounded off by the losses.

## XII. LATTICE FILTERS<sup>27,28</sup>

### Fundamental Relations

A lattice will act as a filter when the impedance arms are suitably designed reactances. The lattice structure provides the most general type of symmetrical filter section that can be devised, and includes T

and  $\pi$  sections (including  $m$ -derived types) as special cases.

The image impedance  $Z_I$  and image transfer constant  $\theta$  of a lattice are

$$Z_I = \sqrt{Z_a Z_b} \quad (55)$$

$$\tanh\left(\frac{\theta}{2}\right) = \sqrt{\frac{Z_a}{Z_b}} \quad (56)$$

Here  $Z_a$  and  $Z_b$  are the lattice impedances, as shown in Fig. 14, which appeared in Part I. Since the image impedance of a lattice depends upon the product of the two lattice impedances, whereas the image transfer constant depends upon the quotient of these impedances, it is possible to specify the image impedance and the image transfer constant of a lattice filter independently of each other.

A pass band is obtained in a lattice network whenever the two reactances  $Z_a$  and  $Z_b$  have opposite signs. Under these conditions the attenuation constant  $\alpha$  is zero, the image impedance is a resistance, and the phase shift  $\beta$  is

<sup>26</sup> It is, however, possible in many cases to obtain infinite attenuation by addition of a resistance to the network in such a manner as to cancel out the residual transmission at this particular frequency. See Vernon D. Landon, "M-derived band-pass filters with resistance cancellation," *RCA Rev.*, vol. 1, pp. 93-102; October, 1936.

<sup>27</sup> H. W. Bode, "A general theory of electric wave filters," *Jour. Math. and Phys.*, vol. 13, p. 275; November, 1934; Monograph B-843, Bell Telephone System.

<sup>28</sup> H. W. Bode and R. L. Dietzold, "Ideal wave filters," *Bell Sys. Tech. Jour.*, vol. 14, p. 215; April, 1935.

$$\tan \frac{\beta}{2} = -j \sqrt{\frac{Z_a}{Z_b}} \tag{57}$$

The lattice filter has a stop band whenever the two reactances  $Z_a$  and  $Z_b$  have the same sign. Under these conditions, the image impedance is a pure reactance, the phase shift is either zero or  $\pi$  radians, and the attenuation constant  $\alpha$  is

For  $Z_b > Z_a$  ( $\beta = 0$ ):

$$\tanh \left( \frac{\alpha}{2} \right) = \sqrt{\frac{Z_a}{Z_b}} \tag{58}$$

For  $Z_b < Z_a$  ( $\beta = \pi$ ):

$$\tanh \left( \frac{\alpha}{2} \right) = \sqrt{\frac{Z_b}{Z_a}}$$

The pass bands, cutoff frequencies, and stop bands of a lattice filter can be given the desired locations by properly arranging the zeros and poles of the lattice impedances  $Z_a$  and  $Z_b$ . The zeros and poles possessed by the impedance  $Z_a$  that lie within the pass band must coincide with poles and zeros, respectively, of impedance  $Z_b$ . At each cutoff frequency, one of the lattice impedances must contain either a pole or a zero that is not matched by a corresponding critical frequency in the other impedance. In the stop or attenuating band, zeros and poles of one of the lattice impedances must coincide, respectively, with the zeros and poles of the other lattice impedance. When these requirements are met, the impedances  $Z_a$  and  $Z_b$  will be of opposite sign throughout the pass band, but will have the same sign in the desired stop band. Arrangements of poles and zeros for several typical cases are shown in Fig. 45.

It is apparent that there is a great variety of possibilities for any particular type of filter. Thus the number of critical frequencies in the pass and stop bands may be varied, as well as the position of these critical frequencies in relationship to cutoff. Likewise, the cutoff frequencies may be delineated by zeros or poles in impedance  $Z_a$  or by corresponding critical frequencies in  $Z_b$ .

Formulas for the image impedance and image transfer constant of a lattice filter can be readily derived in any particular case by substituting for the lattice impedances  $Z_a$  and  $Z_b$  that appear in (55) and (56) the corresponding expressions for these impedances in terms of zeros and poles given by (7a) and (7b). When such expressions are derived, it will be found that the image impedance will depend *only upon the number and location of the critical frequencies that are present in the stop band of the filter* and upon the cutoff frequencies, while the image transfer constant, i.e., the phase shift in the pass band and the attenuation in the stop band, will depend *only upon the number and location of the critical frequencies that appear in the lattice impedances in the pass band* and upon the cutoff frequencies.

The procedure for setting up formulas for image transfer constant and image impedance in a particular

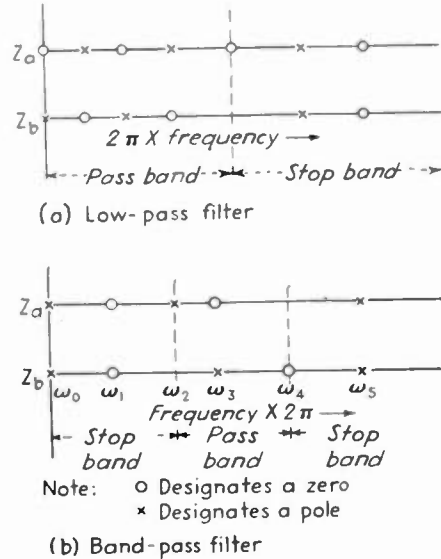

Fig. 45—Examples of arrangements of zeros and poles in lattice filters.

case can be illustrated by considering Fig. 45(b). Impedances of the lattice, by (7a) and (7b), are

$$Z_a = -j \frac{H_a}{\omega} \frac{(\omega^2 - \omega_1^2)(\omega^2 - \omega_3^2)}{(\omega^2 - \omega_2^2)(\omega^2 - \omega_5^2)} \tag{59}$$

$$Z_b = -j \frac{H_b}{\omega} \frac{(\omega^2 - \omega_1^2)(\omega^2 - \omega_4^2)}{(\omega^2 - \omega_3^2)(\omega^2 - \omega_5^2)} \tag{60}$$

Substituting these values for  $Z_a$  and  $Z_b$  into (55) and (56) gives

$$Z_I = -\sqrt{H_a H_b} \frac{(\omega^2 - \omega_1^2)}{\omega(\omega^2 - \omega_5^2)} \sqrt{-\frac{(\omega^2 - \omega_4^2)}{(\omega^2 - \omega_2^2)}} \tag{61}$$

$$\tanh \frac{\theta}{2} = \sqrt{\frac{H_a}{H_b}} \frac{(\omega^2 - \omega_3^2)}{(\omega^2 - \omega_5^2)} \frac{1}{\sqrt{(\omega^2 - \omega_2^2)(\omega^2 - \omega_4^2)}}$$

In these equations,  $H_a$  and  $H_b$  represent the values of the constant  $H$  in (7) for the impedances  $Z_a$  and  $Z_b$ , respectively.

If the lattice impedances  $Z_a$  and  $Z_b$  are interchanged, the only effect upon the behavior of the lattice network is to reverse the polarity of the output voltage, i.e., to introduce a phase shift of  $\pi$  radians. If *either* one of the lattice impedances (but not both) is replaced by its reciprocal impedance with respect to a constant value  $R$ , the effect is to interchange the pass and stop bands, i.e., the new filter is complementary to the original filter.

### Design of Lattice Filters

The transmission characteristics of a lattice filter, which are the phase shift in the pass band and the attenuation in the stop band, are determined by the number and location of the critical frequencies within the pass band and by the ratio  $H_a/H_b$ . By employing



a sufficient number of critical frequencies and properly disposing them within the pass band, it is possible to realize almost any desired phase and attenuation characteristics. Similarly, the design factors controlling the image impedance of the filter are the critical frequencies of the lattice impedances that lie in the stop band and the value of the product  $\sqrt{H_a H_b}$ . As before, by employing a sufficient number of such critical frequencies and properly distributing them, it is possible to realize almost any desired image-impedance characteristic.

An ideal filter would have constant image impedance

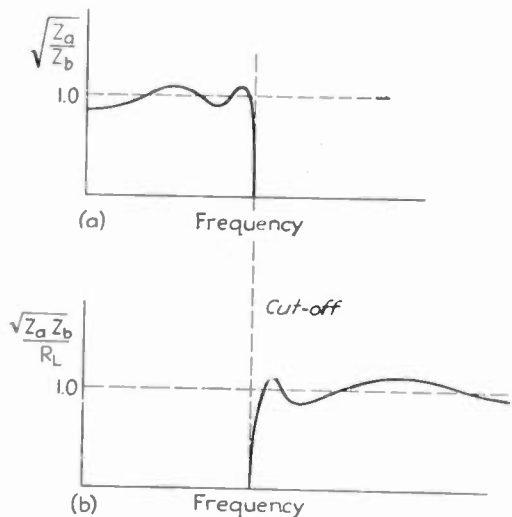

Fig. 46—Variation of design factors  $\sqrt{Z_a/Z_b}$  and  $\sqrt{Z_a Z_b}/R_L$  corresponding to optimum attenuation and optimum characteristic-impedance characteristics.

throughout the pass band, a phase shift proportional to frequency within the pass band, and a very high attenuation in the stop band. It is, accordingly, customary to distribute the critical frequencies within the stop band in such a manner as to maintain the image impedance as nearly constant as possible over most of the pass band. In distributing the critical frequencies within the pass band, one may either give maximum weight to linearity of the phase characteristic or place the greatest emphasis upon obtaining the highest possible attenuation within the stop band. Designs that give the most linear phase-shift characteristics with a given number of critical frequencies within the pass band do not have such desirable attenuation characteristics as can be obtained with the same number of critical frequencies and some sacrifice in linearity of the phase curve.

The attenuation of a lattice filter will be infinite whenever  $\sqrt{Z_a/Z_b}=1$ , and will be smaller the farther the departure of  $\sqrt{Z_a/Z_b}$  from unity. Accordingly, the attenuation characteristics for a given number of critical frequencies will approach most closely the ideal when the critical frequencies within the pass band are so distributed that the value of  $\sqrt{Z_a/Z_b}$  oscillates with equal amplitudes above and below the value unity, as shown in Fig. 46(a). A systematic procedure

for selecting critical frequencies to accomplish this result has been developed by Cauer and is described in some detail by Guillemin.<sup>29</sup> When the design parameters are selected in the Cauer manner to provide the best attenuation characteristic, the phase characteristic is far from linear.

The image impedance of a lattice filter will be constant to the extent that the quantity  $\sqrt{Z_a Z_b}/R_L$  approximates unity, where  $R_L$  is the load resistance. This ideal is most closely realized for a given number of critical frequencies when  $\sqrt{Z_a Z_b}/R_L$  oscillates about the value unity with equal positive and negative deviations, as shown in Fig. 46(b). The procedure for locating the critical frequencies within the stop band in order to accomplish this is similar in every respect to the procedure for locating the critical frequencies in the pass band to provide an oscillatory approximation to the ideal attenuation characteristic. The detailed steps are given by Cauer and Guillemin.

A phase-shift characteristic that is substantially linear over most of the pass band, combined with an attenuation characteristic that rises rapidly beyond cutoff, can be obtained by locating the critical frequencies within the pass band according to the manner devised by Bode,<sup>28</sup> and illustrated in Fig. 47. Here the

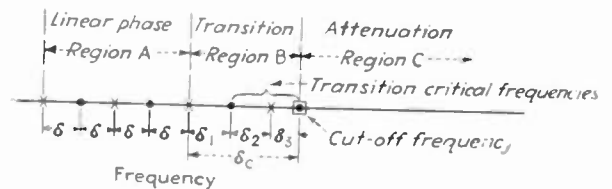

Fig. 47—Distribution of critical frequencies in a Bode-type lattice filter.

pass band is divided into two parts, region *A* and region *B*. Region *A*, which comprises most of the pass band, is to have a substantially linear phase-shift characteristic; region *B* is a transition region in which the phase shift is not linear. In region *A*, critical frequencies are located at a uniform frequency interval  $\delta$  as shown. Region *B* is provided with at least one critical frequency, corresponding to cutoff, and often one or more additional critical frequencies. In order to obtain the most favorable phase characteristic in region *A*, these critical frequencies in the transition region *B* must be located in accordance with Table IV. When this is done, the phase characteristic will be almost

TABLE IV  
SPACING INTERVALS\*

Number of transition frequencies	$\delta_1/\delta$	$\delta_2/\delta$	$\delta_3/\delta$	$\delta_4/\delta$	$\delta_5/\delta$	$\delta_c/\delta$
1	0.500	—	—	—	—	0.500
2	0.853	0.354	—	—	—	1.207
3	0.950	0.727	0.278	—	—	1.955
4	0.981	0.880	0.630	0.231	—	2.723
5	0.992	0.946	0.810	0.555	0.197	3.501

\* See Fig. 47.

<sup>29</sup> See pages 394–412 of footnote reference 24.

perfectly linear in region *A*, provided that there are not too few critical frequencies in region *A*. The associated attenuation characteristic is as shown in Fig. 48,

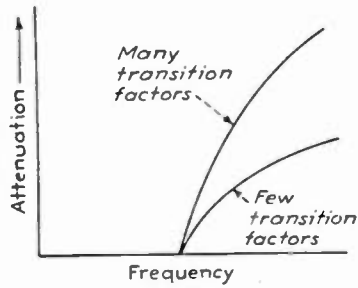
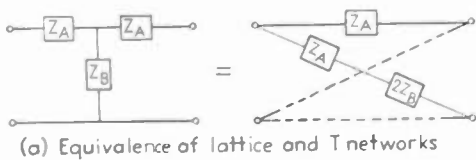

Fig. 48—Attenuation characteristics of a Bode-type lattice filter.

and rises with a rapidity that increases as more transition factors are employed in region *B*. The attenuation in a Bode design never goes to infinity, although it quickly becomes quite large.

*Relation between Ladder and Lattice Structures*

Any symmetrical T or  $\pi$  section can be converted to an equivalent lattice section by so selecting the lattice impedances that the open- and short-circuit impedances of the lattice are the same as for the T (or  $\pi$ ) arrangement. The transformations necessary to accomplish this are illustrated in Fig. 49.



(a) Equivalence of lattice and T networks

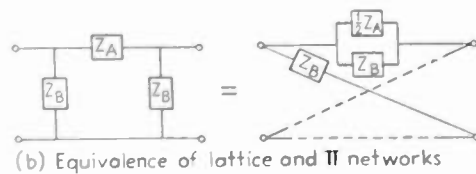

(b) Equivalence of lattice and  $\pi$  networks

Fig. 49—Equivalence of lattice, T, and  $\pi$  networks.

The reverse transformation, i.e., the representation of a lattice network by a symmetrical T (or a symmetrical  $\pi$ ) will not necessarily lead to a physically realizable T or  $\pi$ . Examination of Fig. 49 shows that the conversion to a symmetrical T will result in a realizable structure only when it is possible to subtract the series arm  $Z_a$  of the lattice from the lattice diagonal and have a physically realizable remainder. Similarly, the conversion from a lattice to a symmetrical  $\pi$  will result in a physical network only when it is physically possible to subtract the admittance  $1/Z_b$  of the diagonal lattice impedance from the admittance of the series-impedance arm and have a physically realizable remainder.

A series impedance that is common to both arms of a lattice can be removed from the lattice and placed in

series with the external terminals, as shown in Fig. 50(a). The resulting combination of series impedance and modified lattice has exactly the same properties as the original lattice. Similarly, an impedance that is in shunt with both arms of a lattice may be removed from the lattice and placed in shunt across the external terminals, as shown in Fig. 50(b). The validity of these transformations is based on the fact that the open- and short-circuit impedances possessed by the modified lattice and its external series (or shunt) impedances are exactly the same as the corresponding open- and short-circuit impedances of the original lattices.

Successive applications of these transformations can be used to transform a lattice having complicated impedance arms into a ladder network of alternate series and shunt impedances in association with a simpler lattice. In some cases, the residual lattice degenerates into a pair of shunt arms in parallel, or into two series

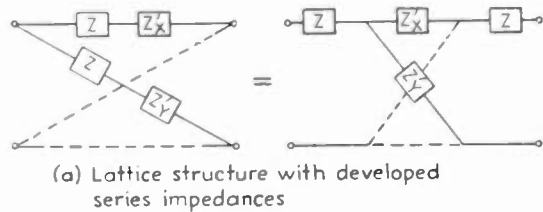

(a) Lattice structure with developed series impedances

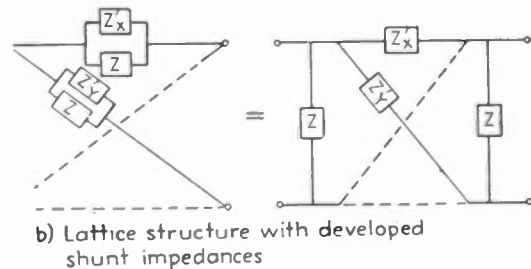

(b) Lattice structure with developed shunt impedances

Fig. 50—Development of lattice network into lattice plus series (or shunt) impedances.

arms, in which case the conversion from the original lattice to a ladder network is complete.

A lattice that cannot be converted to a ladder network can sometimes still be transformed into a bridged-T section. This is illustrated in Fig. 51, where by considering inductances  $L_1$  as bridging the terminals 1-3 and 2-4, the lattice reduces to arms  $C_1$  and  $C_2L_2$ , and when  $C_1 > C_2$  can be developed into a ladder network, shown in Fig. 51(d), that, when bridged by the inductance  $2L_1$ , is equivalent to the original lattice.

*Comparison of Lattice and Ladder Filters*

The lattice structure provides the most general form of symmetrical section that it is possible to realize, and so provides the greatest possible choice of characteristics that can be obtained in a filter. At the same time, the lattice generally requires more coils and condensers than does the corresponding *m*-derived type of filter, and does not provide an input and output terminal at

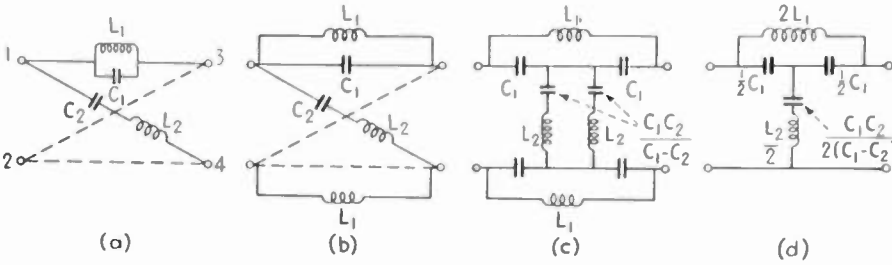

Fig. 51—Development of a lattice which can be transformed into a bridged-T network.

Name	Circuit	Insertion loss for $R_L = R_0$ and $Z_1 Z_2 = R_0^2$
Type I		$\frac{\text{Current without equalizer}}{\text{Current with equalizer}}$
(a) Series		$\frac{R_0 + Z_1}{R_0}$ (Generator resistance assumed equal to $R_0$ )
(b) Shunt		$\frac{R_0 + Z_2}{Z_2} = \frac{R_0 + Z_1}{R_0}$ (Generator resistance assumed equal to $R_0$ )
Type II - Constant input impedance		
(a) L		$\frac{R_0 + Z_1}{R_0}$
(b) L		$\frac{R_0 + Z_1}{R_0}$
Type III - Simple equalizers with constant input and constant output impedances		
(a) T		$\frac{R_0 + Z_1}{R_0}$
(b) pi		$\frac{R_0 + Z_1}{R_0}$
(c) Bridged T		$\frac{R_0 + Z_1}{R_0}$
(d) Lattice		$\frac{R_0 + Z_1}{R_0}$
Type IV - General forms of constant-resistance bridged-T networks		
(a)		$\frac{1 + (C+1) \frac{Z_1}{2R_0}}{1 + (C-1) \frac{Z_1}{2R_0}}$
(b)		$\frac{1 + \frac{Z_1}{2R_0} + C \left( \frac{Z_1}{2R_0} \right)^2}{1 - \frac{Z_1}{2R_0} + C \left( \frac{Z_1}{2R_0} \right)^2}$
Type V - General lattice of constant-resistance type		
		$\frac{1 + \frac{Z_1}{2R_0}}{1 - \frac{Z_1}{2R_0}}$

Fig. 52—Equalizer networks and corresponding insertion loss formula.

a common ground potential unless the lattice can be fully developed into a ladder or bridged-T network. It is found that for most communications purposes calling for filters, the *m*-derived structure is quite adequate.

### XIII. EQUALIZERS

An equalizer is a network placed between the generator and load such that the current that the generator produces in the load will vary in some desired manner with frequency. An *attenuation* equalizer is an equalizer that is inserted in order to control the magnitude of the load current as a function of frequency, without any particular regard to phase relations. A *phase* equalizer is an all-pass filter designed to introduce a desired phase shift as a function of frequency in the load current.

For most purposes it is sufficient to equalize only for attenuation. If, however, circumstances require phase as well as attenuation equalization, the procedure followed is first to equalize for attenuation and then afterward to add a phase equalizer to the system to correct for any undesired features in the phase characteristic of the original system plus the attenuation equalizer.

#### Attenuation Equalizers<sup>30</sup>

The networks commonly used as attenuation equalizers are shown in Fig. 52, which also gives the insertion loss of these networks when the load impedance  $R_L$  has the design value  $R_L = R_0$ .

These networks are conveniently divided into classes as indicated. The simple series and shunt equalizing networks designated as Type I find some use because of their simplicity, but have the very serious disadvantage of causing the impedance seen by the generator in looking toward the load, and also the impedance seen by the load in looking toward the generator, to depend upon the amount of attenuation introduced by the equalizer.

The L equalizers, designed as Type II, partially overcome this disadvantage of the Type I equalizer, since when  $Z_1 Z_2 = R_0^2 = R_L^2$ , i.e., by making  $Z_1$  and  $Z_2$  reciprocal networks with respect to  $R_0 = R_L$ , the impedance on the input side of the equalizer will be a constant resistance equal to  $R_L$ , irrespective of the amount of attenuation introduced. The resistance as seen by the load when one looks toward the generator will, however, depend upon the attenuation.

<sup>30</sup> Much of the material given here is based upon "Motion Picture Sound Engineering," D. Van Nostrand Co., New York, N. Y., 1938, chap. 16.

	a	b	c	d	e	f
Z <sub>1</sub> network						
Z <sub>2</sub> network						
Insertion loss characteristic in db						
Insertion loss in db	$10 \log_{10} \left[ 1 + \left( \frac{f}{f_a} \right)^2 \right]$	$10 \log_{10} \left[ 1 + \left( \frac{f_a}{f} \right)^2 \right]$	$10 \log_{10} \left[ 1 + \frac{K^2 - 1}{1 + K \left( \frac{f_b}{f} \right)^2} \right]$	$10 \log_{10} \left[ 1 + \frac{K^2 - 1}{1 + K \left( \frac{f}{f_b} \right)^2} \right]$	$10 \log_{10} \left[ 1 + \frac{K^2 - 1}{K \left( \frac{f}{f_R} \right)^2 \left[ \frac{b - \frac{1}{b}}{b} \right]} \right]$	$10 \log_{10} \left[ 1 + \frac{K^2 - 1}{K \left( \frac{b - \frac{1}{b}}{f} \right)^2 \left[ \frac{f}{f_R} \right]} \right]$
Design formulas	$L_A = \frac{R_0}{2\pi f_a} = \frac{R_0}{\omega_a}$ $C_A = \frac{1}{2\pi f_a R_0} = \frac{1}{\omega_a R_0}$ $f_a = \frac{1}{2\pi \sqrt{L_A C_A}}$ $R_0 = \sqrt{\frac{L_A}{C_A}}$		$L_1 = L_B \frac{K-1}{\sqrt{K}}$ $L_2 = L_B \frac{\sqrt{K}}{K-1}$ $C_1 = C_B \frac{\sqrt{K}}{K-1}$ $C_2 = C_B \frac{K-1}{\sqrt{K}}$		$L_1 = L_B \frac{K-1}{\sqrt{K}} \frac{b^2-1}{b^2}$ $L_2 = L_B \frac{\sqrt{K}}{K-1} \frac{1}{b^2-1}$ $C_1 = C_B \frac{\sqrt{K}}{K-1} \frac{1}{b^2-1}$ $C_2 = C_B \frac{K-1}{\sqrt{K}} \frac{b^2-1}{b^2}$	
			$R_0 = \sqrt{\frac{L_B}{C_B}}$ $R_1 = R_0 (K-1)$ $R_2 = R_0 \frac{1}{K-1}$			
			$L_B = \frac{R_0}{2\pi f_b} = \frac{R_0}{\omega_b}$ $C_B = \frac{1}{2\pi f_b R_0} = \frac{1}{\omega_b R_0}$ $f_b = \frac{1}{2\pi \sqrt{L_B C_B}}$			
Notes	<p>f<sub>R</sub> = Resonant frequency of Z<sub>1</sub> and Z<sub>2</sub> arms      R<sub>0</sub> = Equalizer resistance</p> <p>f<sub>a</sub> = Frequency of 3db insertion loss</p> <p>f<sub>b</sub> = Frequency where loss is one half maximum value (loss measured in db)</p> <p>f = Any frequency</p> <p>b = <math>\frac{f_R}{f_b}</math> = defined as greater than unity</p> <p>Pad loss = maximum loss = 20 log<sub>10</sub> K</p> <p>L = Inductance in henries</p> <p>C = Capacity in farads</p>					

Fig. 53—Design information for fundamental equalizer types.

The Type III equalizer networks are the types most widely used in practical work. They are characterized by the fact that if the impedances Z<sub>1</sub> and Z<sub>2</sub> are reciprocal networks with respect to the resistance R<sub>0</sub>, i.e., if Z<sub>1</sub>Z<sub>2</sub> = R<sub>0</sub><sup>2</sup>, then the equalizer has both image impedances equal to R<sub>0</sub> at all frequencies. Such a network is said to be of the *constant-resistance* type. Insertion of such an equalizer in a system therefore does not disturb the impedance relations, provided that the load impedance matches the image impedance of the equalizer.

The equalizers indicated as Type IV represent more general forms of bridged-T networks of the constant-resistance type, and Type V represents a general lattice network of the constant-resistance type. The

networks III(c) and III(d) are special cases of the more general Types IV(a) and V, respectively.

### Design of Attenuation Equalizing Networks<sup>21</sup>

The most important equalizers from a practical point of view are the Type III networks of Fig. 52, with the Type II sections also finding some application. The attenuation formulas are the same for Types I, II, and III, so that the insertion loss obtained with any one type can be duplicated in the other types by using the same R<sub>0</sub> and Z<sub>1</sub> (or Z<sub>2</sub>). The choice between types is accordingly based on convenience in

<sup>21</sup> An excellent set of design curves is given in chaps. 16 and 17 of footnote reference 30.



construction, cost, and the importance of maintaining the impedance relations.

The bridged-T structure designated as Type III(c) in Fig. 52 is the most widely used unbalanced structure; while if symmetry with respect to ground is required, Types III(c) and III(d) networks are best. The bridged-T is superior to the Types III(a) and III(b) sections, since it requires fewer reactive elements. Compared with the Type II L sections, the bridged-T

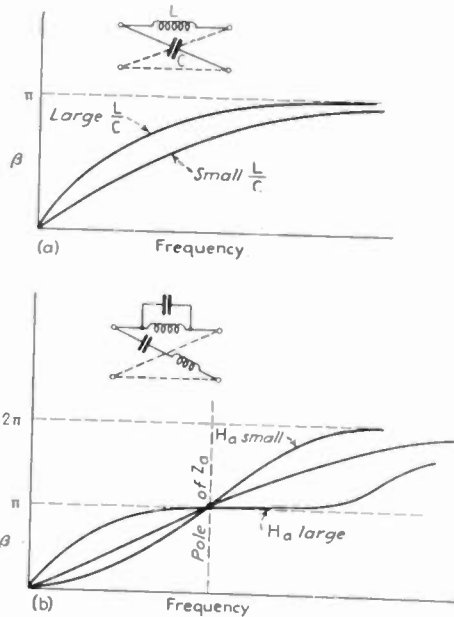

Fig. 54—Examples of phase characteristics of simple all-pass sections (phase equalizers).

requires only one additional fixed resistance, and, in return, gives a constant resistance irrespective of attenuation from both sides, instead of from only one side.

Formulas arranged in convenient form for designing equalizers having simple impedance configurations for  $Z_1$  are given in Fig. 53 for Types I(a), II, and III sections.

The simple Type I, II, and III equalizer sections are capable of meeting most practical requirements. This is true even when relatively complicated equalization characteristics are desired, since one may break up the required attenuation characteristic into the sum of several simpler characteristics, and then obtain each simpler attenuation characteristic from a Type I, II, or III section with a relatively simple  $Z_1$ .

The general lattice network (Type V) is the most general form of symmetrical equalizer that can be devised. All other symmetrical equalizers, such as Types I(a), III, and IV, are equivalent to special cases of the peak at the parallel resonant frequency, with the magnitude of the peak determined by the shunting resistance. Such an arrangement is sometimes referred to as a "dip pad." When the impedance  $Z_1$  is supplied by a series-resonant circuit shunted by a resistance, as in Fig. 53(f), the result is an attenuation at low and

high frequencies determined by the shunting resistance, with negligible attenuation at the series-resonant frequency.

The types of attenuation characteristics obtainable with Type II and Type III sections when  $Z_1$  has simple configurations are shown in Fig. 53. When  $Z_1$  is supplied by an inductance, the attenuation rises at high frequencies, while if it is a capacitance, as in Fig. 53(b), the attenuation rises at low frequencies. If the inductance is shunted with a resistance, as in Fig. 53(c), the attenuation at high frequencies first rises and then levels off to a limiting value determined by the shunting resistance. Similarly, a resistance in shunt with a capacitance as in Fig. 53(d) causes a corresponding leveling off of the rise in attenuation that would otherwise occur at low frequencies. Constructing the impedance  $Z_1$  as a parallel resonant circuit shunted by a resistance, as in Fig. 53(e), results in an attenuation general lattice. It is accordingly possible to base the design of all equalizers upon the general lattice even though the network may be built in the form of a

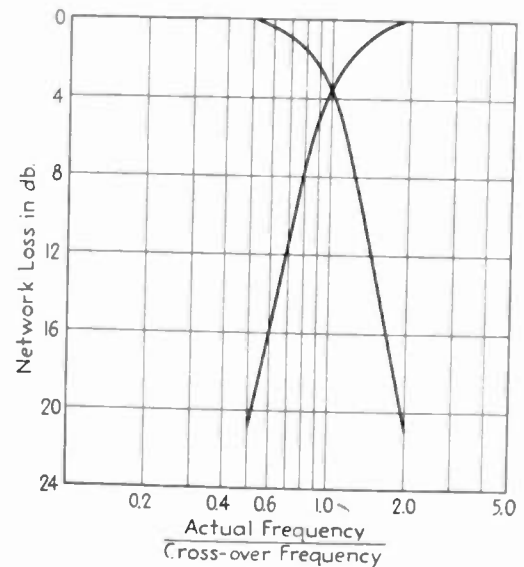

Fig. 55—Characteristics of a typical dividing network.

bridged-T where this conversion leads to a physically possible structure.<sup>32,33</sup>

#### Phase Equalizers—All-pass Filters

An all-pass filter is a filter having zero attenuation for all frequencies from zero to infinity. Such filter sections introduce phase shift without affecting attenuation, and so are employed as phase equalizers to correct phase distortion introduced by other parts of a system, and can also be used to introduce a time delay.

<sup>32</sup> A discussion of this approach to equalizer design, together with design information on a considerable variety of configurations for the lattice impedances, is given by Otto J. Zobel, "Distortion correction in electrical circuits with constant resistance recurrent networks," *Bell Sys. Tech. Jour.*, vol. 7, p. 438; April, 1928.

<sup>33</sup> A very clear discussion of the theoretical basis of the design method developed by Zobel for the general lattice equalizer is given by Everitt, footnote reference 12, in Part I, pp. 287-293.

All-pass action can be obtained by making use of a lattice network in which the lattice impedances  $Z_a$  and  $Z_b$  are reactances that are reciprocal with respect to the desired image impedance  $R$ . This leads to an image impedance that is constant at the desired value for all frequencies.

The phase shift  $\beta$  introduced by an all-pass section under image-impedance operation is

$$\tan \frac{\beta}{2} = \pm j \sqrt{\frac{Z_a^2}{R^2}} \quad (62)$$

where  $R$  is the desired-image impedance.

The variation of the phase shift  $\beta$  with frequency can be controlled by the number and location of the internal zeros and poles in the impedance  $Z_a$ , and by the value assigned to the quantity  $H$  in the expression for  $Z_a$  given by (7). Typical phase-shift characteristics for several simple cases are illustrated in Fig. 54.

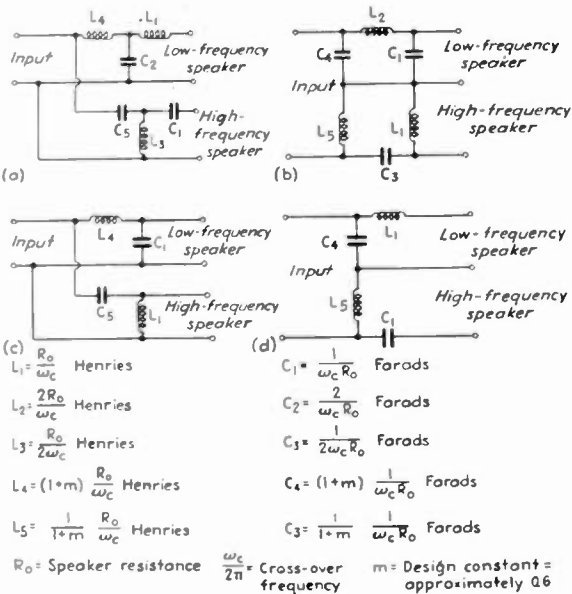

Fig. 56—Dividing networks of the filter type.

XIV. DIVIDING NETWORKS<sup>34,35</sup>

The term *dividing network* is applied to a coupling system so arranged that at low frequencies power is delivered to a low-frequency loudspeaker, while at high frequencies it is delivered to a high-frequency speaker. The transmission characteristics of a typical dividing network are shown in Fig. 55. The frequency at which the power delivered to the two outputs is equal is termed the *crossover* frequency. Experience indicates that the dividing network should provide at least 12 decibels attenuation one octave away from the crossover frequency, as compared with the crossover attenuation, whereas attenuations of more than 18 decibels per octave are not necessary or desirable.

There are two basic types of dividing networks. The

first consists of complementary low- and high-pass filters connected with inputs either in parallel or in series. Such networks are shown in Fig. 56, which also gives the necessary design formulas. The different parts are designed as complementary low- and high-pass filters with fractional terminations. The networks shown at (a) and (b) in Fig. 56 consist of one full section of the  $m=1$  network type, with an input half section designed for  $m \cong 0.6$ . The input shunting im-

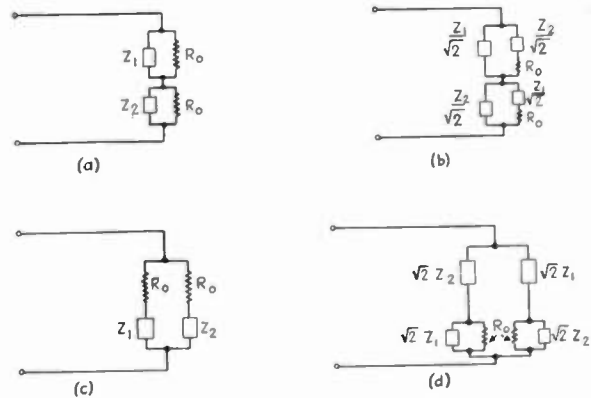

Fig. 57—Constant-resistance types of dividing network.

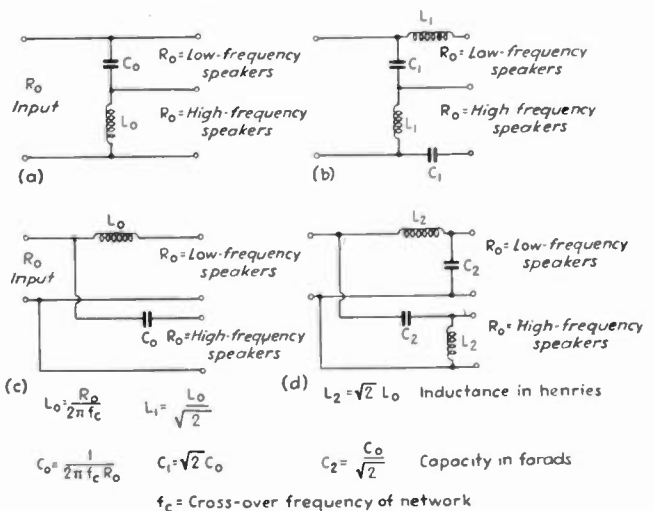

Fig. 58—Practical constant-resistance dividing networks.

pedance called for in the design of (a) and the series input impedance called for in the design of (b) are then omitted to provide the fractional termination. Such an arrangement provides an attenuation of approximately 18 decibels for the first octave beyond crossover. Sections shown at Fig. 56(c) and 56(d) differ from those at (a) and (b) in that the final half section of the  $m=1$  network type is omitted. This reduces the attenuation to approximately 12 decibels for the first octave beyond the crossover frequency. It would be possible to design the dividing network so that the output terminals were also provided with an  $m=0.6$  termination, but this is never done, because satisfactory performance can be obtained with the simpler arrangement.

Dividing networks of another kind, referred to as the *constant-resistance* type, are shown in Fig. 57. These are characterized by possessing an input impedance that

<sup>34</sup> See chap. 20 of footnote reference 30.

<sup>35</sup> John K. Hilliard, "Loud speaker dividing networks," *Electronics*, vol. 14, p. 26; January, 1941.

is a constant resistance equal to  $R_0$  when the two impedances  $Z_1$  and  $Z_2$  are so related that  $Z_1 Z_2 = R_0^2$ . Practical dividing networks making use of these circuit arrangements are shown in Fig. 58, together with the necessary design formulas. The simple circuits (a) and (c) have an attenuation of approximately 6 decibels for the first octave beyond cutoff, and since this is smaller than desirable, such arrangements are seldom used. The two-element dividing networks of (b) and (d) are similar to those of Figs. 56(d) and 56(c), respectively, but because of slightly different circuit proportions provide an exactly constant input resistance, whereas the circuits of Fig. 56 only approximate a constant resistance. The attenuation provided by the networks of Figs. 57(b) and (d) is about 10 decibels for the first octave beyond cutoff.

Dividing networks carry the full output power that the amplifier operating the loudspeaker system is

capable of developing, and so must be designed to have a low transmission loss. When care is taken to employ coils of the lowest practical resistance, this loss is of the order of 0.5 decibel in systems providing from 12 to 18 decibels per octave of attenuation.

### Corrections

Dr. Frederick E. Terman has brought to the attention of the Editor the following corrections to Part I of his paper "Network Theory, Filters, and Equalizers" which appeared on pages 165 to 175 of the April, 1943, issue of the PROCEEDINGS.

1. Page 170, second column, first sentence under the heading "Insertion Loss": Substitute the word "network" for the word "generator."
2. Page 172, the first equation under (32) should have an equals sign between  $Z_{11}$  and  $Z_{12}$  instead of the plus sign shown.
3. Page 172, the left-hand side of the second equation under (33) should be  $Z_6$ .

## Address to the Conference\*

NOEL ASHBRIDGE†, FELLOW, I.R.E.

FIRST I want to say how much I appreciate the opportunity of speaking to so large a gathering of members of The Institute of Radio Engineers, on the occasion of your country-wide Winter Conference.

I wish you every success in the work you are doing, work which is well known to be a key factor in the grim struggle of our Armed Forces in all services. Never before has so much responsibility rested on the shoulders of radio engineers, but never has there been the slightest doubt that they would continue to meet this responsibility with enterprise and energy, always a move or more ahead of anything the enemy may contrive.

As a fellow member of The Institute of Radio Engineers may I say how proud I am to belong to a body of engineers whose contribution to the war effort has been great, and whose potential contribution is far greater. Before I pass on to other matters I would like to refer to a letter recently addressed to your President by the President of The Institution of Electrical Engineers in England, offering any facilities which the latter can provide to the considerable number of I.R.E. members visiting this country. The Institution of Electrical Engineers has a section dealing exclusively with radio work of all kinds, and I hope your members

will find time to make contact while in this country.

I should like to tell you something of our war experiences on the technical side of the British Broadcasting Corporation. For example, the technical arrangements were planned three and a half years ago to put in operation in the event of an air raid. It so happened that the sirens got to work a matter of minutes after the declaration of war so we were soon provided with a chance at a sort of dress rehearsal. After that air-raid warnings were for a time few and far between. And we felt rather pleased with the arrangements we had made, elaborate and perhaps laborious as they were. However, when the Battle of Britain started some months later, we frequently had four or five air-raid warnings a day. And this showed us clearly enough that any elaborate technical changes to meet air-raid conditions was somewhat unworkable.

The only solution of being within seventy miles of the enemy was to be ready all the time, even though carrying on as usual between times. Of course, all this meant more and more equipment, and how to produce it quickly enough was for some time one of our great problems.

Then there was the problem of how to avoid giving navigational assistance to enemy aircraft, through the many stations we have up and down the country. We just had time to work out a plan for avoiding this in the few weeks before the war when the crisis threatened, but more than this I cannot say now.

Of course, there were several unpleasant incidents during the blitz of 1940-1941; some of those present

\* Decimal classification: R060XR560. Original manuscript received by the Institute, February 4, 1943. Presented by transcription previously made by Sir Noel, Winter Conference, New York, N. Y., January 28, 1943.

† Chief Engineer, British Broadcasting Corporation, London, England.

may have heard already of one of them when broadcasting continued in one part of our building, while a bomb, one of the heavy high-explosive type, blew a considerable part of one side of the building into the street. This affair was tragic in some of its effects, but in other respects so to speak, highly successful, in that the service was maintained without a break.

It might be a mistake to say too much about the details of these happenings at the present time. However, I remember only too well another awkward instance of quite a different kind, which happened a little over ten years ago, and which I think may be of interest to radio engineers. Although I do not think it has ever been published before, it certainly is no secret. It gave me just thirty minutes of the most acute discomfort. And when you hear about it, some of those present may have a fellow feeling.

We had just celebrated the tenth anniversary of the opening of our short-wave service. It was in fact, ten years ago last December that we completed and opened for service our first short-wave broadcast station. In those days it was a fairly elaborate affair with aerial arrays to cover all parts of the British Commonwealth. It had been built in a great hurry to be ready for the first special Christmas Day program, which has been somewhat of an event in our organization ever since. In short this program consists of a world-wide hookup, bringing in items from remote parts of the Empire, and culminating in a speech by His Majesty the King. For these programs there is always a lot of preparation and a very elaborate system of cuing. In this case there had been plenty of advance publicity and organization of the local broadcasting by public loudspeakers and relaying of all kinds. However, the new station which had been open a few days seemed to be working well and there seemed to be no serious risk of anything approaching complete failure. Just about twenty minutes

before the start I thought I would pay a visit to our main control room to see that all was well and that everybody was happy. I was met at the door with the news that a message had just been received from the new short-wave station that a fault had developed on the power-control gear, which affected the main power supply to all the transmitters and at the moment none of them could even be started up. The engineer in charge of the new station reported that he did not exactly know what was the matter, but he was trying to sort out the trouble among the control gear just to make the circuit breakers stay in somehow. He said he thought he would take at least half an hour, and by that time there was about ten minutes to go, and it was no use coming up late. There was nothing I could do, I just had to sit down for ten minutes or so and picture the loudspeakers in market places and clubs and towns and villages all over the Empire, with crowds waiting and nothing coming through. Then I began to wonder what sort of an explanation to put out.

Well, to cut a long story short, the carrier waves came up exactly one minute before the zero hour. The engineer in charge immediately admitted afterwards that he had only a very vague idea of what the effect would be of cutting out a great deal of the control circuits. He just took a few shots in the dark and got away with it. I have always remembered this incident in vivid detail, trivial as it certainly seems against the background of war, and the experiences it has brought with it.

In conclusion I want to send my cordial greetings to your conference, and in particular, to your President, Doctor Lynde P. Wheeler, and to wish him every success in his year of office. Finally, I want to thank you all for listening so patiently to this somewhat distant message.

## Radio Engineering in Wartime\*

JAMES LAWRENCE FLY†, NONMEMBER, I.R.E.

EARLIER today, at meetings of radio engineers all over the United States, you heard technical papers on many aspects of radio engineering for war. Tonight, with these meetings all linked together through the courtesy of the Columbia Broadcasting System, I should like to tell you engineers at home one of many dramatic stories of radio engineering on the fighting fronts. It comes from war correspondent William Merriam of the Australian Broadcasting Com-

pany, as monitored via London by the Federal Communications Commission's Foreign Broadcast Intelligence Service.

Last February, the Island of Timor, a few hundred miles north of Australia, was seized by the Japanese. Several detachments of commandos were left stranded on the Portuguese portion of the island, with little equipment and no communications to the Australian mainland. But the commandos did not surrender.

Their only hope was to establish contact with a home base, and, as their own transmitter was almost completely demolished, the five radio engineers in the detachment had an apparently impossible task.

\* Decimal classification: R560. Original manuscript received by the Institute, March 4, 1943. Presented, Winter Conference, New York, N. Y., January 28, 1943.

† Chairman, Federal Communications Commission, Washington, D. C.



Scouting parties brought back two heavy pieces of radio equipment across 40 miles of enemy terrain. Both were receivers, and not in working condition.

By planning a new transmitter circuit and tinkering, however, they made an agglomeration of parts salvaged from the old transmitter and the two newly acquired receivers. This when combined with scraps of wire, solder, and old pieces of tin would transmit.

But they still lacked electrical power. Their batteries were run down. A charger improvised from an old automobile generator geared to a hand-turned wooden wheel worked, but not well enough. And at this juncture the Japanese, always close at hand, began closing in. So the men had to load the precious parts on their backs and move into a new hideout.

A midnight raid behind the Jap lines netted a Japanese battery charger. But another obstacle arose; the charger would not run on Diesel oil, the only liquid fuel available. A second raid yielded kerosene; and after much experimenting the battery charger was made to run on a mixture of kerosene and Diesel oil.

When after two months they at last went on the air, they got no answer. Their signal was picked up and relayed to Darwin, but not answered for fear it was a Japanese booby trap. All radio transmitters in Northern Australia, however, were ordered off the air to make sure that nothing interfered with further signals from Timor.

The next night Radio Timor tried again and succeeded. The makeshift transmitter, built from salvaged parts and thrown together in a mountain hideaway, successfully reopened communications with the mainland. As a result, we learned from last week's paper that the commandos on Timor are still fighting on. And we are told that the five radio engineers celebrated their success by smoking the last tin of tobacco they had been saving during the 59 days of their isolation.

This story of ingenuity and perseverance in war production on the battlefield is not without its counterpart at home. The problems you engineers face in inventing, designing, and manufacturing the necessary equipment for the armed forces of ourselves and our allies, while less stirring than those besetting the commandos, are equally difficult, as seemingly impossible and as demanding in ingenuity and plain hard work. Less dramatic, perhaps, but of basic importance are the day-to-day accomplishments in radio laboratories and factories all over the country. In this war of speed and movement, radio equipment which you are turning out is as essential as arms and ammunition. The stakes which hinge upon your doing the best possible job are nothing less than victory or defeat.

Just as transport is the bloodstream of modern warfare, so communications is its nerve system. Every bomber, every tank, every submarine is radio-equipped today and relies on radio for its efficacy in battle. Nor is your work limited to communications. There are

other fields in which radio plays an important role, such as radio location devices.

Your newly elected national president, Dr. Lynde P. Wheeler, who assumed office this afternoon, and of whom we in the Federal Communications Commission are justly proud, has done his bit of research, for example, in undersea communications.

The research problems which radio engineers must conquer today would have baffled any scientist a generation ago. We need microphones, for example, which will transmit the human voice but not the engine noises of a four-motored bomber hurtling through the air at high speeds. We need direction-finding apparatus which will locate the plane, ship, or land station from which a given radio signal emanates. We need walkie-talkie radios, light enough to be carried into battle. Even the common variety of radio receiver must be re-engineered if it's to be used on board ship, in order to prevent telltale radiations from revealing the location of the ship to enemy raiders. Above all, we need absolute dependability in all war communications apparatus. Such design problems as these are daily being met and solved.

After such equipment has been invented and designed, it must be manufactured. It's one thing to invent a new radio circuit or design a new piece of apparatus; it's something else again to put that apparatus into mass production, with a minimum of delay and a maximum saving of scarce raw materials.

During the comparatively peaceful 1920's and 1930's the radio-manufacturing industry turned out ordinary radio receivers by the million, and indeed by the tens of millions, to meet popular demand. With the coming of war and our own war program, you were called upon to convert, almost overnight, an industry geared to peacetime radio listening into an industry turning out tools of war. You radio engineers are to be congratulated on the completeness, the efficiency, and the smoothness with which you have done the job. The results are known not only to our own fighting forces and to our allies, but to the enemy as well.

Though the job to date fully merits your digging into that can of tobacco, you ought to save the greater part yet awhile. The efforts of radio engineers cannot be relaxed. Just the contrary. In no war has technical progress moved as rapidly as in this. The engineering marvel of January may be the obsolete technique of December. The enemy, too, has skilled engineers, and must not be underrated. If American forces are to advance with superior communications equipment, the rate of engineering progress must be maintained and indeed accelerated. If the enemy engineers are good, our own are and must be even better. It is with that thought that I would leave you, secure in the knowledge that in every radio laboratory, every factory, and every communications office in the land, all of us will give our utmost, now, and for the duration.

# Institute News and Radio Notes

## Television Prospects

If television did nothing more before the war than train engineers in the art of high-frequency work, it was well worth while, for this knowledge has been extremely important to the Allies in the war now being fought, Dr. W. R. G. Baker, General Electric vice president, told the Schenectady, N. Y., Advertising Club on April 7, 1943.

When peace comes, radio manufacturers, now devoting all their facilities to war production, will be prepared to build reasonably priced television sets in large volume, he said. They will be clamoring for work, but before they can produce these sets a decision must be made on standards, just as such a decision was reached in the prewar era by the National Television System Committee. The place of television in the frequency spectrum must be determined, he said. What the standards should be will be the big problem to decide, for the decision will affect the industry for many years.

High frequencies never before available to the television engineer have been brought into use as a result of war research, he said, comparing the prewar television frequency band with a small boat. "Let us imagine this small boat as the only means of contact between two countries on opposite sides of a river, and the amount of trade and intelligence passing between the countries being limited by the boat's capacity. War research has broadened the usable television frequency band just as a bridge built across the river between the countries would provide greater capacity for traffic between these countries."

The television sets built after the war probably will produce pictures in black and white because color television may be too expensive and still has not been worked out to the engineer's satisfaction. Color television will come, he said, but probably not for some time after the war ends. Then, too, any immediate adoption of color television would make obsolete much of the transmitting equipment of the nation's eight television stations which will form the nucleus for immediate postwar television broadcasting. These stations probably will start branching out with full-scale programs shortly after the war ends, it was explained.

When peace comes, manufacturers will have tremendous capacities to make television tubes in America. Large-scale production and other developments will drastically reduce the prewar price of these tubes which will be among the elements that will bring about reasonably priced television sets, he said.

Postwar relaying of programs will be done with coaxial cables or television relay stations, or possibly a combination of both, it was explained, and only developments

will tell who will operate these relay links. The General Electric Company has had a relay station in operation for over three years. Located in the Helderberg Mountains outside Albany, N. Y., the station picks up programs from the NBC television station in New York City and relays them to the Albany-Schenectady-Troy area through General Electric's WRGB transmitter. This is the nation's pioneer television network, he pointed out, being in service since January 12, 1940.

Television is essentially a line-of-sight operation from transmitter to receiver. Stations, therefore, will probably be located in the larger cities, with transmitters located where they can reach the most receivers, he said.

The size of the picture produced by a television set will depend on public demands, the advertising audience was told, but in Dr. Baker's opinion the American people will not want a picture the size of the wall in their living rooms. The average person probably will want a picture from 12 to 15 inches square so that he can sit seven or eight feet away from the television set and enjoy the program, it was explained.

There is no technical reason why motion-picture houses cannot receive and project special television pictures on their screens after the war if such a procedure can be made economically sound and if managers can attract audiences to the theaters to see these pictures.

Dr. Baker left to the audience's imagination the effect of television on people's lives, quoting the old Chinese proverb that a picture is worth 10,000 words.

## Board of Directors

The regular meeting of the Board of Directors took place on April 7, 1943, and those present were: L. P. Wheeler, president; S. L. Bailey, W. L. Barrow, I. S. Coggeshall, H. T. Friis, Alfred N. Goldsmith, editor; G. E. Gustafson, O. B. Hanson, R. A. Heising, treasurer; F. B. Llewellyn, Haraden Pratt, secretary; F. E. Terman, B. J. Thompson, H. M. Turner, A. F. Van Dyck, W. C. White, and W. B. Cowilich, assistant secretary.

Approval was granted to the 151 applications for Associate, 144 for Student, and 4 for Junior grades.

The following Bylaws amendment was voted:

"Section 50: The President, the Secretary, the Treasurer, the Editor, and at least two other members of the Board of Directors shall comprise the Executive Committee. The President shall be Chairman, the Treasurer shall be Vice Chairman and the Secretary shall be Secretary of the Executive Committee. The terms of appointments of all members of the Executive Committee, except the President, shall start with the first

meeting of the Committee after appointment and shall continue notwithstanding any change in status on the Board until the first meeting of the succeeding Executive Committee."

It was noted that letters, with reference to the proposed Constitutional amendments published in the April, 1943, issue of the PROCEEDINGS, had been received and that they would soon be included in the PROCEEDINGS, under the section headed "Correspondence."

Treasurer Heising, in his capacity as chairman of the Constitution and Laws Committee, reported that the proposed Constitutional amendments comply with the law in the opinion of the Institute's General Counsel Harold R. Zeamans.

The decision was made to mail the ballots relative to the Constitutional amendments, on or before July 1, 1943.

It was announced that the committee consisting of President Wheeler, chairman; and Messrs. Gustafson, Hanson and White, had been formed to make further investigation and recommendation relative to the Institute's study of postwar problems of the radio industry.

The following personnel of the Technical Committees were appointed to serve for the annual term beginning May 1, 1943:

## Technical Committees

### ANNUAL REVIEW

L. E. Whittemore, *Chairman*

R. S. Burnap	R. F. Guy
C. R. Burrows	Keith Henney
W. G. Cady	I. J. Kaar
J. L. Callahan	G. G. Muller
C. C. Chambers	H. M. Turner
C. J. Franks	A. F. Van Dyck

H. A. Wheeler

### ELECTROACOUSTICS

G. G. Muller, *Chairman*

S. J. Begun	G. M. Nixon
F. V. Hunt	Benjamin Olney
V. N. James	H. F. Olson
Knox Mellwain	H. H. Scott

L. J. Sivan

### ELECTRONICS

R. S. Burnap, *Chairman*

E. L. Chaffee	J. A. Morton
H. P. Corwith	I. E. Mourmtseff
K. C. DeWalt	L. S. Nergaard
W. G. Dow	G. D. O'Neill
L. A. DuBridge	H. W. Parker
R. L. Freeman	H. J. Reich
T. T. Goldsmith, Jr.	A. C. Rockwood
L. B. Headrick	J. B. Russell
D. R. Hull	Bernard Salzberg
S. B. Ingram	C. M. Wheeler
Ben Kievit, Jr.	J. R. Wilson
J. M. Miller, Jr.	Irving Wolff
	Jack Yolles
	H. A. Zahl

## FACSIMILE

J. L. Callahan, *Chairman*

Maurice Artzt	P. A. Lefko
E. P. Bancroft	H. J. Lavery
J. C. Barnes	B. V. Magee
F. R. Brick, Jr.	Pierre Mertz
W. A. R. Brown	G. D. Robinson
G. V. Dillen-	L. A. Smith
back, Jr.	F. T. Turner
J. V. L. Hogan	R. J. Wise
L. C. Horn	C. J. Young

## FREQUENCY MODULATION

C. C. Chambers, *Chairman*

J. E. Brown	V. D. Landon
W. F. Cotter	H. B. Marvin
M. G. Crosby	D. E. Noble
W. L. Everitt	B. E. Schackelford
R. F. Guy	D. B. Smith
C. M. Jansky, Jr.	L. P. Wheeler
	W. D. White

## RADIO RECEIVERS

C. J. Franks, *Chairman*

G. L. Beers	David Grimes
W. M. Breazeale	J. K. Johnson
W. F. Cotter	Garrard Mountjoy
Harry Diamond	H. O. Peterson
W. L. Dunn	E. K. Stodola
H. B. Fischer	A. E. Thiessen
H. C. Forbes	H. P. Westman
D. E. Foster	R. M. Wilmette

## RADIO WAVE PROPAGATION

C. R. Burrows, *Chairman*

S. L. Bailey	H. R. Mimno
J. L. Barnes	K. A. Norton
J. H. Dellinger	H. O. Peterson
W. A. Fitch	H. P. Thomas
G. D. Gillett	W. D. White

## STANDARDS

H. A. Wheeler, *Chairman*

R. S. Burnap	C. J. Franks
C. R. Burrows	R. F. Guy
W. G. Cady	I. J. Kaar
J. L. Callahan	G. G. Muller
C. C. Chambers	H. M. Turner

## SYMBOLS

H. M. Turner, *Chairman*

R. R. Batcher	E. T. Dickey
M. R. Briggs	H. S. Knowles
R. S. Burnap	O. T. Laube
C. R. Burrows	Allen Pomeroy
J. H. Dellinger	E. W. Schafer

## TELEVISION

I. J. Kaar, *Chairman*

H. S. Baird	P. C. Goldmark
J. E. Brown	T. T. Gold-
A. B. DuMont	smith, Jr.
D. E. Foster	A. G. Jensen

L. M. Leeds	A. F. Murray
H. M. Lewis	R. E. Shelby
A. V. Loughren	D. B. Sinclair
H. T. Lyman	D. B. Smith

## TRANSMITTERS AND ANTENNAS

R. F. Guy, *Chairman*

Andrew Alford	W. E. Jackson
R. Asserson	R. W. P. King
M. R. Briggs	J. F. Morrison
W. W. Brown	J. C. Schelleng
Harry Diamond	Robert Serrell
W. S. Duttera	D. B. Sinclair
Sidney Frankel	W. D. White
F. A. Gunther	J. E. Young

Editor Goldsmith reported that, if no exception were obtained, the modified WPB Paper Limitation Order L-244 As Applied to Magazines, issued March 26, 1943, would require the Institute to make drastic reductions in the number of pages and copies of future issues of the PROCEEDINGS. It was also stated that, on the other hand, a sharp increase in the use of paper for the PROCEEDINGS had taken place mainly as the result of a gratifyingly large gain in members and papers.

President Wheeler and Institute's General Counsel Zeamans were chosen to present the appeal to the War Production Board at Washington, with the supporting data being prepared by Editor Goldsmith and Assistant Secretary Cowilich.

President Wheeler called attention to the six recent letters requesting information on the Institute's policy relative to the inactive status of members in the armed services, and to the continued application of the Executive Committee's previous recommendation in such cases.

Mr. Coggeshall, chairman of the 1943 Winter Conference Committee, announced that the expenses of the recent conference amounted to \$365.61.

The subject of conventions during the war period was discussed, and it was voted to hold no summer convention this year.

It was pointed out by President Wheeler that a review is being made of the Institute Representatives on Other Bodies.

Appointment was made of Mr. G. R. Schull to serve as Institute Representative at Rose Polytechnic Institute.

Approval was given to a matter pertaining to the Institute's investments.

## Executive Committee

The Executive Committee met on April 6, 1943, and those in attendance were L. P. Wheeler, chairman; Alfred N. Goldsmith, editor; R. A. Heising, treasurer; F. B. Llewellyn, A. F. Van Dyck, H. R. Zeamans, general counsel; Haraden Pratt, secretary; and W. B. Cowilich, assistant secretary.

The Audit Bureau of Circulations'

statement, relative to the distribution of the PROCEEDINGS during the last six months of 1942, was discussed.

The 151 applications for Associate, 144 for Student, and 4 for Junior grades were approved for confirming action by the Board of Directors.

Consideration was given to a change in the payroll system and a review of other accounting methods of the Institute. Arrangements for beginning the Institute's 1943 financial audit were also discussed.

Provision was made to mail the December dues' bills of members in foreign countries, exclusive of those in North America, to reach those members about December first, with due allowance for transit time.

It was noted that in accordance with the Bylaws Section 16, the "Notice of Termination of Membership," dated April 1, 1943, was sent to those members whose dues had failed to reach the Institute.

General Counsel Zeamans approved, from the legal standpoint, the Constitutional Amendments which were recently proposed and which were published in the April, 1943, issue of the PROCEEDINGS.

Letters relative to the proposed Constitutional Amendments, which had been received, were discussed and it was noted that they would soon be published in the PROCEEDINGS.

Editor Goldsmith reported on the modified WPB Paper Limitation Order L-244 As Applied to Magazines, issued March 26, 1943. If no exception from this order were granted, drastic reductions would have to be made in the planned number of pages and copies to be printed of the future issues of the PROCEEDINGS.

It was also stated that, according to the current trend, the printing rate of the PROCEEDINGS would approach 16,000 to 17,000 copies an issue, possibly with as many as 150 pages to an issue, before the end of this year. This rate would be practically double that of last year.

Chairman Wheeler announced that he and General Counsel Zeamans would present the Institute's appeal, in behalf of the PROCEEDINGS, to the War Production Board, at Washington, and submit the supporting data and other material being prepared by Editor Goldsmith and Assistant Secretary Cowilich.

The list of the Technical Committee personnel, to serve for the annual period beginning May 1, 1943, was submitted by Dr. Llewellyn, who is charged with this phase of the Institute's activities. This list was recommended to the Board of Directors for approval.

As a policy, it was decided to confine the distribution of the Institute's Yearbook to members, with the possible exception that it would be supplied on bona fide requests from Government departments, and thus copies will not be made available to any other organizations or individuals.

Government requests for permission to have envelopes addressed from the Institute's membership stencils were approved.

In the case of requests from new members, the decision was reached to make a nominal charge for the Institute's

Standards, which had been published prior to their election to membership. However, the new standards, published during the period of a member's affiliation, would as in the past be mailed automatically and without any charge beyond the dues for that year.

A report was made on six additional inquiries for information relative to the Institute's policy on the inactive status of members in the Armed Services. It was noted that in most of the cases, the members had arranged to maintain their memberships on an active basis and, where it was not satisfactory for them to receive the PROCEEDINGS direct, had requested that the copies be forwarded to relatives or held in reserve by the Institute, as recommended by the Institute.

The subject of a life membership in the Institute was discussed and it was agreed that no such arrangement could be favorably considered for the present.

Assistant Secretary Cowilich reported that the expenses for the 1943 Winter Conference amounted to \$365.61.

Editor Goldsmith announced that the publication of the 1913-1942 Cumulative Index of the PROCEEDINGS had been delayed solely as the result of the printer being shorthanded because of wartime conditions. The Index has been scheduled for distribution with an early issue.

The subject of conventions was discussed but the matter was referred to the Board of Directors.

It was agreed to review the entire list of Institute Representatives on Other Bodies.

## Election Notice

Article VII, Section 1, of the Institute's Constitution is reprinted below as it contains all of the information pertinent to the election of Officers and Directors. Following it will be found the names of the candidates nominated by the Board of Directors. The names of these nominees will appear on the ballot to be mailed to the membership between August 15 and September 1.

"On or before July first of each year, the Board of Directors shall submit to qualified voters a list of nominations containing at least one name each for the office of President and Vice President and at least six names for the office of elected Director and shall call for nominations by petition.

"Nominations by petition may be made by letter to the Board of Directors setting forth the name of the proposed candidate and the office for which it is desired he be nominated. For acceptance a letter of petition must reach the executive office before August fifteenth of any year and shall be signed by at least thirty-five voting members.

"Each proposed nominee shall be consulted and if he so requests his name shall be withdrawn. The names of proposed nominees who are not eligible under the Constitution shall be withdrawn by the Board.

"On or before September first, the Board of Directors shall submit to the voting members as of August fifteenth, a list of nominees for the offices of President, Vice President, and elected Director, the names of the nominees for each office being arranged in alphabetical order. The ballots shall carry a statement to the effect that the order of the names is alphabetical for convenience only and indicates no preference.

"Voting members shall vote for the candidates whose names appear on the list of nominees, by written ballots in plain sealed envelopes, enclosed within mailing envelopes marked "Ballot" and bearing the member's written signature. No ballots within unsigned outer envelopes shall be counted. No votes by proxy shall be counted. Only ballots arriving at the executive office prior to October twenty-fifth shall be counted. Ballots shall be checked, opened, and counted under the supervision of the Teller's Committee between October twenty-fifth and the first Wednesday in November. The result of the count shall be reported to the Board of Directors at its first meeting in November and the nominees for President and Vice President and the three nominees for Director receiving the greatest number of votes shall be declared elected. In the event of a tie vote the Board shall choose between the nominees involved."

For President—1944

H. M. Turner

For Vice President—1944

E. M. Deloraine

For Directors—1944-1946

S. I. Bailey

R. K. Potter

G. E. Gustafson

F. X. Rettenmeyer

R. F. Guy

W. C. White

## Correspondence Concerning Proposed Constitutional Amendments

From: B. J. THOMPSON

The proposed amendments of the Constitution of the Institute which were published in the April PROCEEDINGS (pages 182 and 183) have come to my attention. I am writing this letter in support of the amendments establishing a new grade of membership.

I have had the opportunity to participate in discussions leading to some of the earlier amendments of the Constitution affecting the membership structure, as well as in those concerning the present proposal. It may be of interest to review the situation as I have seen it develop. At one time all members of the Institute other than Juniors and Students had the right to vote in Institute affairs. Eighty per cent or more of the voting membership was in the Associate grade, the only Constitutional quali-

fications for which were that the applicant be over twenty-one years of age and be "interested" in radio. It was believed that a considerable majority of the voting membership of the Institute were not professional radio engineers. (I use the term "radio" to include all allied fields served by the Institute.) As a result, the Board of Directors did not feel free to take actions which were likely to secure the support of only the professional radio engineers, even though they felt very strongly that it was the primary purpose of the Institute to serve this group. Because of this situation and in an attempt to concentrate the voting rights in the hands of the professional members, an amendment was proposed and was adopted on March 1, 1939, under which new Associates and all Associates who at any time allowed their memberships to lapse would no longer have voting rights.

This measure was remarkably effective. At the end of 1942 there were approximately thirty-six hundred nonvoting Associates as compared with about twenty-six hundred voting Associates. Of the nonvoting Associates a large minority are professional radio engineers, while of the voting Associates probably more than half are professional men. These professional Associates with voting rights constitute one of the Institute's serious problems. Annually they are in danger of allowing their memberships to lapse with consequent loss of voting rights and almost equally consequent ill feeling.

There are approximately a thousand Members and Fellows of the Institute, whose voting rights are assured. The Member grade is expanding very slowly. The voting Associate grade is contracting rather rapidly. As time goes on the voting control of the Institute is passing into the hands of a continually shrinking fraction of the professional membership of the Institute. This is a very dangerous situation. While it is very desirable to have the voting control of the Institute in the hands of only the professional members, it is equally desirable that this voting control be in the hands of as large a fraction as possible of these professional members.

This serious difficulty would be removed by transferring the professional members into a professional grade of membership with assured voting rights, but this is not possible at present. While many of the present Associates are qualified to transfer to the present Member grade, they have persistently failed to do so for a variety of reasons. There is no reason to expect an early change in this situation.

Many more of the present Associates are not qualified for the present Member grade, even though they are professional radio engineers. Let us examine briefly the typical requirements. A man must be twenty-six years old and must "have performed and taken responsibility for important radio engineering or scientific work." The Admissions Committee and the Board of Directors interpret "responsibility" and "important" strictly in accordance with the high standards which have been set for Membership in the Institute. Very many professional radio engineers never



meet these qualifications. Even of those who apply for admission or transfer to the Member grade, a large fraction is found unqualified. Further, many men who may be qualified do not apply for transfer because they are not sure that their applications will be approved and doubtless many others do not wish to take the initiative in advancing their claims to such qualifications.

The solution to this problem of getting the professional members of the Institute into the professional grades lies in the proposed amendment establishing a new Member grade, a typical qualification for which is that the Member be at least twenty-four years old and that as an engineer or scientist "he shall have demonstrated competence in (radio) engineering or science of professional character." The admission fee and dues for this new Member grade are to be the same as for the present Associate grade. Thus, if a man is a professional radio engineer he is almost surely qualified for this new grade. And there is no obstacle to his transfer in the nature of increased dues.

Upon the adoption of this amendment there will be no reason why the Board of Directors cannot transfer all qualified Associates to the new Member grade without application on their part; thus, the way will be open for the separation of professional members from nonprofessional, independent of the outcome of a campaign for voluntary transfer to the new Member grade.

As a matter of clarification, it might be pointed out that the qualifications for the proposed Senior Member grade are almost identical with those of the present Member grade so that doubtless the Board of Directors will automatically transfer the present Members to the grade of Senior Member upon the adoption of this amendment, thus maintaining the significance and prestige of this class of membership.

In conclusion, I wish to state that I regard the adoption of this amendment as highly important to the future welfare of the Institute, particularly with respect to its development as a professional society of expanding influence.

From: H. M. TURNER

For some time it has been thought that a larger proportion of our members should be in the Member grade and the fact that we have only 12 per cent in this grade compared with 24 per cent for the American Institute of Electrical Engineers tends to confirm this view. Although older societies place a greater value on professional recognition than do younger ones this does not account for so large a difference. It has been suggested that our requirements are too high, but I do not believe this is true. However, you will soon be asked to vote upon a constitutional amendment lowering the standards of the Member grade. This proposal should receive your most thoughtful consideration to determine whether or not, over a period of years, it will be to the advantage of the Institute to adopt it. Logic rather than emotion should govern your vote.

Why should an engineer desire to be-

come a Member? Because of the distinction and prestige this grade confers, as a result of high standards built up over more than a quarter of a century. That recognition and prestige will come as a result of a "yes" vote is an illusion. Were it so simple, why not vote still greater honor by advancing all Associates and Members to the Fellow grade? In grasping for the form the substance vanishes. The very thing that makes the Member grade attractive would be lost by its indiscriminate bestowal. The term of Member should remain a badge of honor.

The Institute of Radio Engineers should not become a Radio Electricians Club. To avoid this, care should be exercised to make sure that only qualified engineers are admitted as Members. This is the only possible way that the term can retain any significance. However, the higher grades should not stand for exclusiveness but should be open to those who qualify and it is my conviction that large numbers do so now without lowering the standards at all. This conclusion is confirmed by Mr. H. P. Westman, former secretary, who has intimate knowledge of the membership situation based on a dozen years' experience, and it is his belief that the suggested amendment misses completely the most important problem, namely, getting in those who meet the present constitutional requirements.

Why then, it may be asked, do not these qualified Associates apply for advancement. There are several reasons given in order of increasing importance: not interested in higher grade of membership; do not want to pay the higher dues; fear of not being accepted; lack of appreciation of professional recognition. It should be pointed out that our dues are extremely low as compared with other comparable societies. The service rendered its members is very great, in fact, the positions held by radio engineers were created largely through technical advances made public through the PROCEEDINGS, thus placing a professional obligation on the engineers to support the Institute. Fear of rejection should not influence one against making application for very few persons, other than the sponsors, know that an application has been made, and they are most sympathetic. The most important duty of the Admissions Committee is to facilitate admission to the proper grade and the greatest difficulty is to get from the sponsors an evaluation of the applicant's qualifications rather than an enumeration of the positions he has held. It is frequently necessary to write for further information which delays final approval; this is annoying to the applicant but it is necessary in the interest of the Institute to secure facts on which to base recommendations to the Board of Directors. No doubt some of this delay could be avoided by the Institute providing better instructions to the applicant regarding the selection of sponsors and to the sponsors as to the type of information desired. Appreciation of the value of professional recognition will come with time but the Institute has an obligation to bring its importance to the attention of the younger engineers.

As is well recognized, too few Associates now apply for advancement to Member grade. If the amendment is adopted still fewer will apply for they will be Members in name and, without any increase in dues over what they are now paying, will have all the rights and privileges of the proposed new Senior Members, except that of being Director. Obviously, this is not fair to our present Members.

If the amendment is adopted, there will be fewer transferring to the grade paying the higher dues and undoubtedly it will be necessary to raise the dues of all in order to meet expenses.

After many years of experience, the American Institute of Electrical Engineers, which most closely parallels our own Institute, and many other technical societies, have adopted three grades of membership: Fellow, Member, and Associate. These designations have definite meaning and value. To introduce a new grade will only add confusion. The Associate grade connotes professional standing and a dignity in keeping with the maturity and experience of the younger members. While it is true that in the early days many Associates were merely interested in radio, but the number in this group has been decreasing for a number of years until now there are very few in it. Most Associates now make radio their profession.

Professional standing is an elusive quality and cannot be achieved by so simple a device as changing the name of a grade by a constitutional amendment. This is a matter of more importance to the younger members than to the older ones. A delay of a year or so, until they acquire the necessary experience and prestige, is involved; this delay is of small importance compared to maintaining the prestige of your Institute. If one were about to have a major operation, would a surgeon from a "diploma factory" inspire the same confidence as one from a school of recognized standing?

G. W. PIERCE

In recognition of "his outstanding inventions and contributions to the fields of electrical communications, and his inspiring influence as a great teacher," George Washington Pierce was awarded the Franklin Medal at the annual Medal Day ceremonies of The Franklin Institute, in Philadelphia, on April 21, 1943.

Professor Pierce, who is a Fellow of the Institute of Radio Engineers, formerly held the chairs of Rumford Professor of Physics and the Gordon McKay Professor of Communications Engineering at Harvard University. He is the author of the two standard works, "Principles of Wireless Telegraphy" and "Electric Oscillations and Electric Waves," and numerous technical papers.

In the announcement of the award to Professor Pierce, the Franklin Institute adds that "his interest in electric oscillations led Professor Pierce to experiment with mercury-vapor arcs and the outcome of his research was the mercury-vapor detector and amplifier. This tube was the equivalent to the 'Thyratron' developed

later in the laboratories of the General Electric Company. The chief difference is in the 'Thyratron's' use of a hot cathode in a gaseous atmosphere as a source of electrons instead of the mercury tube and "keep-alive" circuit employed by Professor Pierce, but Pierce in his patents in this field also disclosed the hot cathode as source.

"After Cady had pointed out that the piezoelectric effect of quartz crystals could be used to control the frequency of electrical vacuum-tube oscillators, Professor Pierce began the study of suitable oscillator circuits for use with quartz crystals. He produced three fundamental types of circuits employing one tube and one set of electrodes on the crystal. Cady had employed two tubes and two sets of electrodes, so that Pierce's circuits were a considerable simplification and led to the use of the crystal as an essential frequency-producing element instead of a mere resonant stabilizer of the oscillator.

"This discovery is one of the most important made in radio during the past twenty years. Because of the necessity for holding frequencies to narrow limits, all broadcast stations are required by law to employ quartz-crystal stabilization.

"When a bar of iron or nickel is magnetized it changes shape due to the effect called magnetostriction. Also, when a bar of iron is deformed it generates a magnetic moment by a converse effect. These two effects may be compared to the direct and converse piezoelectric effects in a quartz crystal. Professor Pierce recognized that the phenomenon of magnetostriction could be used to control the frequency of oscillators by mechanical resonance in the same way as with quartz crystals. Near the frequency of mechanical resonance, bars of proper composition exhibit a considerable reaction on the electric impedance of a coil wound around them. Pierce devised a number of circuits for making use of this property.

"Professor Pierce has also made and published a large number of inventions in sound and supersonic devices for use in transmitting and detecting underwater acoustic vibrations.

"His profound knowledge of theoretical and practical physics, and his ability to design workable equipment have been a source of constant amazement to Professor Pierce's associates. His influence has been widely impressed upon the field of electrical communications, for the majority of men who are engaged upon important work in radio engineering all over the world have studied in his classes. His courses in wireless telegraphy were among the first to be given anywhere and for years were a standard on which other schools based their curricula. Pierce recognized that electrical communication was neither physics nor engineering, but a combination of the two. He always insisted upon a liberal groundwork of mathematics and usually left the engineering part to be developed by the student himself as he went along. Professor Pierce worthily takes his place among men like Einstein, Marconi, Planck, Thomson, and Rutherford, who are former recipients of the Franklin Medal."



G. E. GUSTAFSON



KARL E. HASSEL



J. E. BROWN

#### ZENITH ELECTS NEW OFFICERS

A group of new officers of the Zenith Radio Corporation was elected at the last meeting of the board of directors, it was announced on April 13 by Commander E. F. McDonald, Jr., Zenith president. Among them are the following.

G. E. Gustafson, Fellow of the I.R.E., who has been with the company since 1925, has held the post of chief engineer since

1933, and has been assistant vice president since 1940, was elected vice president in charge of engineering.

Karl E. Hassel, Member of the I.R.E., engineering executive, who with Commander McDonald and Ralph Mathews was an original founder of the company and who has been a director of the corporation since 1932, was elected assistant vice president.

J. E. Brown, Member of the I.R.E., Zenith's engineer specialist in television and frequency modulation since 1937, was elected assistant vice president.

#### DUDLEY E. FOSTER

Mr. Dudley E. Foster, Member of the Institute of Radio Engineers, has been named vice president in charge of engineering of the Majestic Radio and Television Corporation, it was announced on April 10, 1943, by Mr. E. A. Tracey, president and general manager of the corporation.

Mr. Foster has had a long association with the radio industry beginning in 1913. He is a graduate of Cornell University in electrical engineering and was formerly chief engineer of the Case Electric Company of Marion, Indiana, and later the U. S. Radio and Television Corporation. In 1934, he joined the RCA License Laboratories as division engineer in charge of the engineering division of those laboratories. He then became vice president of Rogers-Majestic, Ltd., in Toronto, Canada.

Mr. Foster has contributed many technical articles to a number of the technical trade journals. He holds over 40 patents in the radio and television field and, in 1940, was given the Modern Pioneer award by the National Association of Manufacturers for his inventive contributions to the electronic field.

#### Books

**Ultra-High-Frequency Techniques, Edited by J. G. Brainerd in collaboration with Glenn Koehler, Herbert J. Reich, and L. F. Woodruff**

Published, 1942, by D. Van Nostrand Company, Inc., 250 Fourth Avenue, New York, N. Y. 519 + xi pages + 14-page index. 316 figures. 6 1/2 x 9 1/2 inches. Price, \$4.50.

This book presents in a unified manner the material required as a minimum basis for advanced technical work in the ultra-high-frequency field. Its subject matter covers a course outlined by representatives of some forty institutions who met at the Massachusetts Institute of Technology to consider means for creating an immediate source of men trained on a high level for work in electrodynamics and especially the ultra-high-frequency field. The specialized knowledge covered is that which was considered important for men who would be working with the Army, Navy, and Marine

Corps, in training electronic technicians in Government research and development, and in industrial activities devoted to the meeting of military and naval requirements in this branch of technology.

The general level of the book is that of senior students in electrical engineering and physics. Sufficient theoretical and other material from ordinary communication courses is presented (in condensed form) to enable the student to progress through the chapters containing newer subject matter without the necessity for frequent reference to other texts. While the mathematical background of the subject matter is quite fully covered, particularly in such fields as radiation and hollow wave guides where the student is likely to meet new material, the authors have so organized their presentation as to make the text very useful to a person seeking specific information who does not wish to become involved in more detailed mathematical theory.

The text deals with elements rather than systems. It covers no specific military material but presents the subjects covered from a viewpoint which is useful in its application to specialized requirements. In addition to chapters covering the standard fundamentals, such as circuit analysis, electron tubes, amplification, modulation, transmitters, receivers, transmission lines, radiation and propagation, the book includes chapters on the following subjects which are unusually interesting and timely: Trigger circuits (gates), pulse-sharpening circuits and oscillators; cathode-ray tubes and circuits, and hollow wave guides. The concluding chapter consists of a laboratory manual of twenty-five pages. The last half of the chapter on hollow wave guides also deals with practical aspects and applications.

The co-ordination of the work of the several authors is excellent. The bibliographic references in the various chapters have been carefully chosen.

L. E. WHITTEMORE  
American Telephone and  
Telegraph Company  
New York, N. Y.

### Short Wave Radio, by J. H. Reyner

Published by the Pitman Publishing Corporation, 2 West 45 St., New York, N. Y. Third (revised) edition, 1942. 183 pages+3-page index+xiv pages. 97 figures. 5×7½ inches. Price, \$3.25.

This book presents a nonmathematical account of basic high-frequency practice and technic. Its "pocket" size permits its study whenever time permits and its presentation of the subject is such that it provides excellent supplementary reading for sound technicians and low-frequency operators who are now engaged in high-frequency work. The book, however, contains no reference to the most recent developments in ultra-high-frequency operation, since unfortunately that information must await the removal of publicity restrictions.

The treatment of the various items is

concise and clear and is mainly descriptive. Unusual terms are separately defined or described in a glossary. A chapter has been added to this edition on the subject of frequency modulation.

RALPH R. BATCHER  
Hollis, L. I., N. Y.

### Television Standards and Practice, Edited by Donald G. Fink

Published by the McGraw-Hill Book Company, 330 West 42 Street, New York, N. Y. 391 pages+13-page index+x pages. 115 figures. 6¼×9 inches. Price, \$5.00.

This book is a compilation of abstracts from the Proceedings of the National Television System Committee which has been carefully edited. Many of the important technical reports which represented the backbone of the standards finally arrived at are introduced in this work. Practically every phase of television engineering has been analyzed, bringing forth the latest information from many laboratories. Mr. Fink deserves much credit for having assembled these somewhat dry records on individual systems into subject groups covering synchronization, polarization, etc.

It is because this book is addressed to a great extent to those who participated in these meetings that the index—which is, of course, not a novel feature in a book of this sort—is so valuable, for it is often not easy to find just what one may be looking for in these voluminous records.

To the uninitiated this book will reveal the work that goes on behind the scenes in the creation of certain communications standards, and will indicate the amount of engineering knowledge and information which is required.

Anyone interested in the technical phases of television will be interested in such an accurate compilation of the past as well as current status of standards criteria.

PETER C. GOLDMARK  
Columbia Broadcasting System, Inc.  
New York, N. Y.

### Electromechanical Transducers and Wave Filters, by Warren P. Mason

Published by D. Van Nostrand Company, 250 Fourth Avenue, New York, N. Y. 329 pages+3-page index+xii pages. 119 figures. 6¼×9¼ inches. Price \$5.00, cloth binding.

This volume is a monumental text and reference on the subject of wave filters in general, with intensive treatment of the problems of distributed parameters, mechanical analogs of electrical parameters, and electromechanical coupling. While the treatment is self-sufficient beyond elementary knowledge of alternating-current networks, it is directed to those who already have some familiarity with the concepts peculiar to transmission lines and wave filters.

After an interesting historical outline,

there is a 60-page concentrated treatment of electrical wave filters, with a brief table of the simpler types, their formulas and characteristics. Part of this section is an introduction to filters including transmission lines with their distributed constants. The principal subjects involve the analogy between electrical and mechanical systems, and the problems are treated from this point of view. Nearly half of the space is devoted to an excellent treatment of acoustic waves and devices such as telephone receivers, horns, and loudspeakers. The final section is devoted to the field in which the author ranks highest as a specialist, the use of quartz crystals in wave filters to secure great selectivity and frequency stability.

HAROLD A. WHEELER  
Hazeltine Electronics Corporation  
Little Neck, L. I., N. Y.

### Electronics, by Jacob Millman and Samuel Seeley

Published by the McGraw-Hill Book Company, 330 West 42 Street, New York, N. Y., 1941. 689 pages+5-page appendix+27-page index+xxi pages. 425 figures. 6¼×9¼ inches. Price, \$5.00.

Probably the most difficult problem in teaching electronics to engineering students is that of attaining a proper balance between emphasis on the fundamental physical principles on which the operation of electronic devices depends and emphasis on the use of electronic devices in practical engineering circuits.

The authors of this book have attempted, with considerable success, to reach such a balance. They begin their treatment at the level of fundamentals, and carry it through to discussions in the field of useful engineering practice.

The introduction is followed by an unusually good coverage of the behavior of electron beams under the influence of electric and magnetic fields, that is, cathode rays. The subsequent discussion of the behavior of electrons in metals and of electronic surface phenomena is also very good, and differs from the great majority of similar texts in that it tells the story from the beginning. The discussion of space-charge-limited current in diodes, triodes, and pentodes follows the conventional pattern fairly closely.

The treatment of gaseous conducting principles starts with two chapters on the fundamental physics of conducting gases, one having to do with kinetic theory, the other with energy level diagrams and excitation and ionization processes. The subsequent chapter on electrical discharges in gases follows the pattern of treatment customary among physicists. The discussion of commercial gas tubes, which outlines the ways in which the various fundamental physical principles are employed, is of necessity chiefly descriptive in nature.

The three chapters having to do with gas-tube rectifier circuits, including grid-control techniques, ignitron control, and filters, are very well planned, and constitute one of the best parts of the text.

The five chapters on circuit properties and uses of high-vacuum tubes cover equivalent alternating-current-circuit methods of analysis very well. The treatment of feedback is simple, direct, and covers the subject effectively without too much elaboration.

The authors purposely omit treatment of oscillators, modulators, detectors, etc., as being better suited to books or courses devoted definitely to the communication arts.

Very little attention is paid to the industrially important subject of transient behavior of electronic circuits. The text phraseology of the book as a whole seems a little wordy, and mathematical manipulations of circuit relations are in some cases carried further than is necessary to illustrate principles involved. Ultra-high-frequency principles and techniques are not discussed.

In order to use this book intelligently a student must start with a good knowledge of basic physics, but no advanced physics background is necessary. He must, however, have a good background in both direct-current- and alternating-current-circuit theory, including familiarity with the use of the  $j$  operator.

The book is pleasing to this reviewer in that it treats electronics as a subject requiring thorough analytical study, on a level with advanced alternating-current-circuit theory. Its whole pattern implies that an electrical engineer must be expected to acquire as thorough a working knowledge of fundamental electronic principles as he does of fundamental electric-circuit principles. Too many books on electronics either try to side-step or apologize for this necessity, and it is pleasing to find one that does neither. This book should prove to be a very useful contribution among texts in its field.

W. G. Dow  
University of Michigan  
Ann Arbor, Mich.

### Experimental Electronics, by Ralph H. Müller, R. L. Garman, and M. E. Droz

Published by Prentice-Hall, 70 Fifth Avenue, New York, N. Y. 322 pages+8-page index+ xv pages. 177 figures.  $6\frac{1}{2} \times 9$  inches. Price, \$4.65.

A series of experiments suitable for familiarizing newcomers to the field of electronics with the characteristics and noncommunications applications of commercial electron tubes is given in this book. Sufficient explanation is included to enable the student to understand how the tubes function, how the circuits operate, and how to select the component parts needed to make satisfactory apparatus. The important results which are to be expected from the tests are presented in the form of curves and data, so that they are available for reference.

The book includes descriptions of most-used small vacuum tubes, gas-filled tubes, cathode-ray tubes, and photoelectric devices. Among the many applications which are considered are voltage-stabilized power supplies, time-delay relay

circuits, equipment for measuring small currents and voltages, photoelectric photometers, apparatus for counting articles, negative-feedback amplifiers, beat-frequency oscillators, and deflection circuits for cathode-ray tubes. The title of the book, "Experimental Electronics," is much broader than the scope of its contents. Physicists doing experimental work in such fields as electron-emission phenomena, electron optics, electron acceleration, gaseous discharges, or electron-tube design will not find discussions of their specialties.

The text is clearly written and the figures numerous and well drawn. The chapters on photoelectric cells and their applications (pages 51 to 85 and 205 to 235) are unusually well done; they contain a wealth of practical information. Throughout the book there are some typographical errors, which are easily recognized. Somewhat more obscure are the connections to the lower end of  $C$  and  $R_1$ , in Figs. 4 to 16. On page 11, the statement that laminated iron cores "Do not work satisfactorily at high frequencies, since the iron becomes saturated at very low current densities" may be viewed with suspicion; on page 118 "space charge of the electrodes" should refer to electrons, instead. However, mention of these points should not be allowed to confuse the over-all impression that the material is very well presented.

The book is recommended as the basis for a laboratory course in electronics, for students with some knowledge of physics. Professional laboratory workers, even those familiar with some of the applications of electron tubes, will find it a handy tabulation of ways to make tubes do the work, and a source of information about the proper values of resistance, capacitance, inductance, and voltage to use in circuits they assemble. The general reader will find that the continuity is sufficient for easy reading, and that he can obtain considerable practical information without performing all the experiments.

HARLEY IAMS  
Radio Corporation of America  
New York, N. Y.

### Gaseous Conductors, Theory and Engineering Applications, by James Dillon Cobine

Published 1941 by the McGraw-Hill Book Company, Inc., 330 West 42 Street, New York, N. Y., 593 pages+12-page index+xix pages. 354 figures.  $6\frac{1}{2} \times 9\frac{1}{2}$  inches. Price, \$5.50.

This is a book particularly appreciated by the physicist as well as by the electrical engineer and is unquestionably one of the best texts that has been offered on this general subject. While written with the primary object of providing an engineering text in the field of gaseous conduction, Professor Cobine has seen fit to include a remarkably well-developed though concise account of the physics of electron and positive-ion production. The introductory chapters devoted to a résumé of the Kinetic Theory of Gases, Motion of Ions and

Electrons, Atomic Structure and Radiation, Ionization and Deionization, and the Emission of Electrons and Ions by Solids are avowedly treated from the "classical" standpoint because of the author's belief that a group of engineering students are the better able to grasp the concepts involved. This position is no doubt well founded but the omission of the theories of electron emission based upon the Fermi-Dirac statistics is a regrettable consequence of this approach, since the student is thereby not informed of the inadequacies of the older method in many fields perhaps not directly concerned with gaseous conduction.

Considerable space is, of course, devoted to a discussion of the consequences of space charge, the applicability to ions of both signs being particularly stressed, a point which is all too frequently not appreciated by the student. After a treatment of plasma and probe theory, the author attacks the problem of cumulative ionization and spark breakdown. The important effect of metastable atoms in contributing to the formation of a glow discharge is acknowledged and the possibility is mentioned on several occasions although recent contributions in the literature have been overlooked.

The treatments of the glow discharge, corona, and the electric arc are unusually stimulating chapters in this book. The author possesses the happy faculty of illustrating the physical effect by example in such fashion as to make clear the practical application of these chapters. Lack of definition of terms is too often the stumbling block over which an otherwise clear account falls. Professor Cobine is particularly careful to avoid this danger. The conflicting theories which attempt to explain the transition from a glow discharge to an arc are mentioned but no definite conclusion is drawn. The student should thereby be encouraged to set about forming his own opinion.

How many texts leave one with the impression that the answer to everything has been obtained!

The latter third of the book is devoted to an explanation of the action of such devices as gas rectifiers, grid-controlled rectifiers, circuit breakers, and gas-filled lamps. The readers of this journal might wish that the treatment of grid-controlled rectifiers had been more extensive, but it must be remembered that the text is a general one and extensive treatment of specific phases of the subject must be found in articles or texts of more limited scopes. A whole chapter is however devoted to the cathode-ray oscillograph. For this to be of real value to the student supplementing the text with experimental work this chapter should be studied earlier than indicated by its position at the end of the book. One would readily admit that the cathode-ray oscillograph is a *sine qua non* in the study of gaseous discharges. Several tables of relevant data and experiments complete a work which is a welcome contribution to the subject of gaseous conduction.

DAYTON ULREY  
RCA Manufacturing Company  
Harrison, N. J.



## A Guide to Cathode Ray Patterns, by Merwyn Bly

Published by John Wiley and Sons, Inc., 440 Fourth Ave., New York, N. Y. 39 +vii pages. 185 figures.  $8\frac{1}{2} \times 11$  inches. Price, \$1.50.

This manual shows the distinctive features of typical cathode-ray diagrams that result in common laboratory and test-bench experimental projects that require the use of an oscillograph. Each of the 185 reproductions listed is provided with a concise caption which describes the conditions under which it was produced. It may be used as a laboratory guide for students, service men, and others in getting acquainted with an oscillograph.

There are several pages devoted to a simple discussion of graphic analysis of some of the diagrams. A few patterns are shown that occur when nonlinear sweeps, false pickups, stray fields, and other distortional conditions produce patterns that differ widely from the simple forms that are usually expected. It is considered by this reviewer that too little attention is paid to the analysis of these abnormal patterns or to improvements in the setup so that the oscillograms become more regular.

R. R. BATCHER  
Hollis, L. I., N. Y.

## The Mathematics of Wireless, by Ralph Stranger

Published by the Chemical Publishing Company, 234 King St., Brooklyn, N. Y. 210 pages + 5-page index. 113 figures.  $5\frac{1}{2} \times 8\frac{1}{2}$  inches. (Completely revised and enlarged as the first American edition.) Price \$3.00.

This book has been written for those who are deterred from reading technical books by a lack of familiarity with the language of mathematical formulas and graphs. The illustrative material relates to electrical circuits and the simpler aspects of radio applications; hence the title. This fact, however, in no wise limits the usefulness of the book, which is fundamentally an introduction to mathematics. The treatment advances in a logical sequence from arithmetic to algebra, geometry, trigonometry, calculus, and logarithms. A chapter, beautifully illustrated, is devoted to the use of the slide rule.

The author is an electrical engineer with a wide experience in teaching in the London evening technical institutes. This experience is reflected in the easy, colloquial style of the text, and in the clear and attractive presentation of the material. No claim is, of course, made to completeness of treatment of any of these branches of mathematics. The author is at pains, throughout, to encourage his readers to further study, and to suggest textbooks to this end. In the attempt to convince the reader that mathematics is not the repellent subject he has supposed, the author has been particularly successful.

FREDERICK W. GROVER  
Union College  
Schenectady, N. Y.

## American Standard Definitions of Electrical Terms

Published by the American Institute of Electrical Engineers, 33 West 39 Street, New York, N. Y. 254 pages + 57-page index. 3 figures.  $8 \times 11$  inches. Price, \$1.00.

This book embodies the results of over twelve years of effort on the part of the American Standards Association's "Sectional Committee on Definitions of Electrical Terms."

Organized in 1928 under the sponsorship of the American Institute of Electrical Engineers, this committee of forty-six members represented thirty-four organizations operated with eighteen working subcommittees involving about one hundred twenty persons. It has been estimated that, including assistance secured from many nonmember experts, over three hundred men have contributed, reflecting the interests of national engineering, scientific and professional societies, trade associations, government departments, and miscellaneous groups.

This project was initiated as a sort of "Supreme Court" to gather together in one glossary definitions of technical terms used in electrical engineering theretofore scattered in many separate places, to originate new definitions, and, more important, to correlate and unify definitions and terms in existing standards. One of the natural consequences was the generalizing of many definitions so that different specific interpretations in particular applications would be included as far as feasible. Another was the elimination of duplication so that a definition is given in only one place with a cross reference where the identical definition appears in some other group or section. In those instances where more than one term is in use for the same concept the preferred term is given in bold-face type with synonyms in light-face type, deprecated synonyms being footnoted. Many definitions are followed by helpful amplifying notes in small type.

The contents are classified into nine-teen groups covering general and fundamental terms and the fields of rotating machinery; transformers, regulators, reactors and rectifiers; switching equipment; control equipment; instruments, meters and meter testing; generation, transmission, and distribution; transportation; electromechanical applications; electric welding and cutting; illumination; electrochemistry and electrometallurgy; electrocommunication; electronics; radiology, electrobiology including electrotherapeutics; and miscellaneous. The classification and numbering system follows that adopted in 1927 by the International Electrotechnical Commission's Advisory Committee on Nomenclature and was employed in the international vocabulary of some eighteen hundred and sixty terms issued in 1938.

This important and well-indexed volume does not purport to include all terms in usage. The emphasis has been given to terms in greatest use justifying treatment from the electrical standardization viewpoint. Widespread use of this vocabulary by all engineers and students in the radio

field, and particularly by authors and writers of technical papers, books, specifications, and instruction manuals should bring valuable benefits to both the individual and the whole engineering profession in the direction of stabilization of nomenclature and should also develop viewpoints of much assistance to those that will carry this work forward in the future. This new American Standard ought to be of value to the general public because it constitutes an extension of the function of the recognized dictionaries into specialized fields not hitherto covered.

HARADEN PRATT  
Mackay Radio and Telegraph Co.  
New York, N. Y.

## Introduction to Electricity and Optics, by Nathaniel H. Frank

Published 1940 by the McGraw-Hill Book Company, 330 West 42 Street, New York, N. Y. 387 pages + 10-page index + xii pages. 240 figures.  $6\frac{1}{2} \times 9\frac{1}{2}$  inches. Price, \$3.00.

With the growing interest in ultra-high-frequency electromagnetic waves and in the electron microscope, Frank's "Introduction to Electricity and Optics" is most timely for it provides the necessary foundation in basic principles. It was written for second-year students specializing in physics or electrical engineering, but it also will be particularly useful as a reference for advanced students and practicing radio engineers. I consider it an excellent book. It is unusually free from ambiguities. The presentation is characterized by simplicity, thoroughness, and precisely formulated principles. The author has anticipated the student's troubles and has provided the necessary detail to give him a thorough understanding of the subject. He shows the advantage of certain methods of solving problems over others. The illustrative problems have been selected with care and, where approximations have been made in the preliminary consideration, they are always clearly indicated.

The chapter on "Dispersion and Scattering," which extends the basic ideas developed for the electrostatic behavior of dielectrics to the case of fields varying with time, is particularly good. This explanation is based on the theory that polarization of a dielectric by an electrostatic field results from the orientation of the permanent molecular dipoles and from the atomic dipole moments induced by the field. As the frequency is increased the contribution of the permanent dipoles to the dielectric constant (or index of refraction) decreases on account of their extremely large mass as compared to the electronic mass until finally the dielectric constant depends only on the induced atomic dipoles. The anomalous behavior of the dielectric at certain frequencies is thus explained.

The author is to be commended for the very satisfactory way he has harmonized the interests of those interested primarily in high-frequency radio phenomena and those interested primarily in optical phenomena.

H. M. TURNER  
Yale University  
New Haven, Conn.



## The Radio Amateur's Handbook, Twentieth (1943) Edition, by the Headquarters Staff of the A.R.R.L.

Published by the American Radio Relay League, Inc., West Hartford, Conn., 592 pages, including a 103-page catalog section and a 9-page topical index. 552 photographs or diagrams and numerous charts and tables. Price, paper bound, \$1.00 in continental U.S.A., \$1.50 elsewhere; buckram bound, \$2.50.

"Someday the war will be over. . . ."  
"Someday we'll be on the air again."

And in preparation for that day, the A.R.R.L. continues its policy of publishing, annually, the Radio Amateur's Handbook. The current edition is much like its recent predecessors. It contains two chapters on fundamentals, an eight-chapter section on principles and design, a ten-chapter section on construction and data, and two concluding chapters on operating practices.

Characteristic of the Handbook is its generous use of photographs showing construction details. These, with complete lists of parts, convey a great amount of design information with minimum require-

ments as to exact duplication of parts or skill in blueprint reading.

A short section on microwave oscillators has been added, and the seven-page chapter on emergency equipment has grown up to be fifty pages on War Emergency Radio Service.

The Handbook will continue to be a much-used reference, not only among amateurs but among professionals, including those who borrow the tools and techniques of radio for quite different purposes.

E. B. FERRELL  
Bell Telephone Laboratories, Inc.  
New York, N. Y.

## Contributors



SIR NOEL ASHBRIDGE

Sir Noel Ashbridge (F'38) was born on December 10, 1889, at London, England. He received the B.S. degree in 1911 from London University and his engineering training with Yarrow and Company, Ltd., and the British Thomson-Houston Company, Ltd. During 1914-1919 he served in the Royal Fusiliers and the Royal Engineers. He was six years with Marconi's at the Writtle Experimental Station. In 1926, Sir Noel joined the British Broadcasting Corporation as assistant chief engineer becoming chief engineer in 1929, and Controller of Engineering 1935.

He is president of the Institution of Electrical Engineers and a member of the Radio Research Board. In 1934 he was a member of the Television Committee and in 1935, the Television Advisory Committee. He was created a knight in 1935.

He is the author of various technical and scientific papers and in 1931 published "The Acoustical Problem of Broadcasting Studios." In 1923, with R. D. Bangay, Sir Noel published "Wireless Valve Receivers and Circuits." He is a member of the Institution of Civil Engineers, member of the Institution of Electrical Engineers, and a Knight of the Royal Order of Dannebrog (Danish).

❖

Charles W. Finnigan (A'35) was born on August 31, 1913, at Baltimore, Maryland. He received the B.S. degree in electrical engineering from the Massachusetts Institute of Technology in 1934. During 1935-1936, Mr. Finnigan was in the production development engineering department of the Philco Radio and Television Corporation, and from 1937 to 1941, he was a laboratory engineer at the RCA License Laboratories. Since 1941, he has



CHARLES W. FINNIGAN

been a radio engineer with the Stromberg-Carlson Telephone Manufacturing Company.

❖

Dudley E. Foster (A'26-M'37) was born at Newark, New Jersey, on December 12, 1900. He was graduated from Cornell University in 1922 with the E.E. degree. Following his graduation he became associated with the Electrical Alloy Company and Driver-Harris Company. In 1925 he joined the Malone-Lemmon Products Company and the next year became chief engineer of the Case Electric Company. Two years later that company was merged with the United States Radio and Television Company and soon thereafter Mr. Foster was promoted to chief engineer.



DUDLEY E. FOSTER

In 1933 he became chief radio engineer of the General Household Utilities Company and from 1934 to 1941 he was division engineer in the RCA License Laboratory. He was also a lecturer in television engineering in the Graduate School of Stevens Institute of Technology. Mr. Foster then spent a year in Canada as executive vice president and technical director of Rogers Majestic, Limited. He is now director of engineering for Majestic Radio and Television Corporation of Chicago. He is a member of Eta Kappa Nu.

❖

Edmund A. Laport (A'25-M'27) was born at Nashua, New Hampshire, on July 2, 1902. He was a commercial radio operator at KDKF, New York City, in 1921, and a receiver service engineer for the Westinghouse Electric and Manufacturing Company in 1922. In 1923, he was a laboratory assistant in the radio engineering department of the General Electric Company, working on transmitter development. From 1924 to 1932 Mr. Laport was a transmitter engineer with the Westinghouse Electrical and Manufacturing Company. He installed three high-frequency communication stations for the Chinese Ministry of Communications,



EDMUND A. LAPORT

Peking, China, in 1928, and two 50-kilowatt broadcast stations at Rome and Milan, Italy, 1929-1930 and 1932. He also installed several broadcast stations from 1 to 50 kilowatts in the United States and Canada. During 1933 and 1934 he was associated with Paul F. Godley as consulting engineer. From 1934 to 1936 he was employed as a transmission engineer for Wired Radio, Inc., working on variable and suppressed-carrier asymmetric-sideband transmission development. Since 1936 he has been a section engineer, working in high-power transmitters with the RCA Manufacturing Company at Camden, New Jersey. Mr. Laport was transferred to Montreal in December, 1938, as manager of the engineering and development engineering products division of the RCA-Victor Company, Ltd.



Frank A. Record (A'40) was born on February 19, 1912, at Colorado Springs, Colorado. He received the degree of B.S. in electrical engineering from the Massachusetts Institute of Technology in 1933. During 1933 and 1934 he was an assistant engineer at the Hygrade Sylvania radiotube plant at Salem, Massachusetts. From 1934 to 1939 he was associated with the Raytheon Production Corporation, first as



FRANK A. RECORD

production engineer, and later as design and development engineer. Since 1939, Mr. Record has been on the staff of the electrical engineering department of Clarkson College of Technology. During 1941-1942, he was on leave to the Radiation Laboratory at M.I.T., and is at present on leave to the Radio Research Laboratories at Harvard University.



John L. Stiles (A'37) was born December 21, 1907, at Dekalb Junction, New York. He received his B.S. degree in electrical engineering from Clarkson College in 1928; the M.S. degree in 1930; the E.E. degree in 1933; and a N. Y. State Professional License in 1937.



JOHN L. STILES

Progressively Mr. Stiles was graduate assistant, instructor, assistant, and now is associate professor of electrical engineering at Clarkson, having developed the communications option. His summer positions include: 1927, test work with the New York Edison Company in electrolysis, substation, and radio; 1928, with the same company and in similar work; 1929, with the Westinghouse Lamp Company at Bloomfield in lamp development; 1930, with the New York Telephone Company at Albany in the transmissions engineer's office; and, 1941, with Westinghouse Lamp Division in high-frequency research. Four summers of advanced study were spent at the Massachusetts Institute of Technology mainly in the communications option of the electrical department. On leave, Mr. Stiles served as instructor in the department of electrical engineering of New York University in 1941. He is an associate member of the American Institute of Electrical Engineers and a member of Tau Beta Pi.



Harry R. Summerhayes, Jr. (A'36) was born at Schenectady, New York, on February 19, 1914. He received a B.S. degree in physics from Union College in 1935 and after a year of graduate work he received an M.S. degree in science from the



HARRY R. SUMMERHAYES

same institution. Since that time he has been employed in the General Engineering Laboratory of the General Electric Company where he has been engaged in various television and radio engineering projects. Mr. Summerhayes is an associate member of Sigma Xi.



R. O. Wise was born at Detroit Lakes, Minnesota, on August 9, 1905. He received a B.S. degree in electrical engineering from Iowa State College in 1926 and an M.S. degree from the same school in 1927. He then joined the technical staff of the Bell Telephone Laboratories where for a short time he was concerned with early work on television and feedback amplifiers. From 1930 to 1940 he devoted his time to studies of modulators and modulating systems for carrier telephone work. At present he is engaged in the design and development of special electronic equipment for the Armed Forces.



For a biographical sketch of James Lawrence Fly, see the PROCEEDINGS for January, 1943; for W. G. Shepherd, see February, 1943; and for Frederick E. Terman, see April, 1943.



R. O. WISE

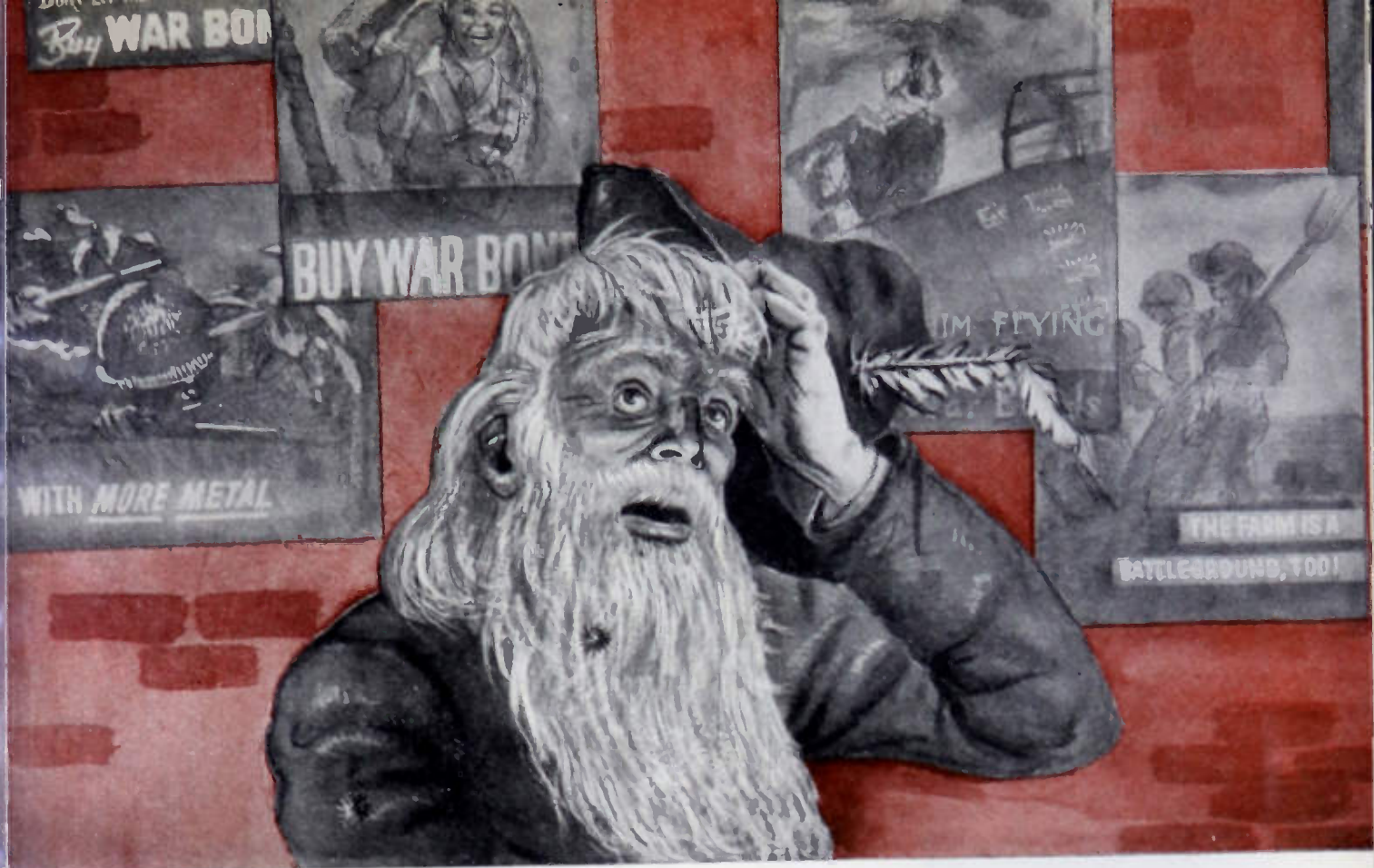

## You've been sleeping a long time, Rip—

Today's dizzy pace must seem frightfully strange to you. Don't feel too badly about it though, because a lot of us are looking at it with similarly unbelieving eyes.

We were awakened from our peaceful sleep by some big-time heels who decided they were of a master race, destined to lord it over an enslaved world. We were to be the slaves.

Now look at this factory. It's one of the many thousands in this country alone, that are designing and building tools required to win the most shameful and bloodiest of all wars.

Come on, Rip, snap out of it. We're all needed. Our specific job is to continue producing the most complete line of precision attenuators in the world. There's a war job for you, too.

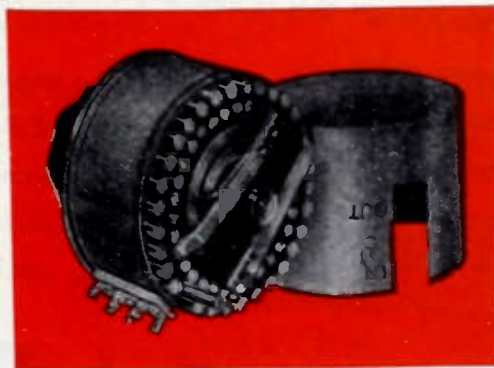

Ordering standard components and equipment may facilitate deliveries.

# THE DAVEN COMPANY

158 SUMMIT STREET

NEWARK, NEW JERSEY



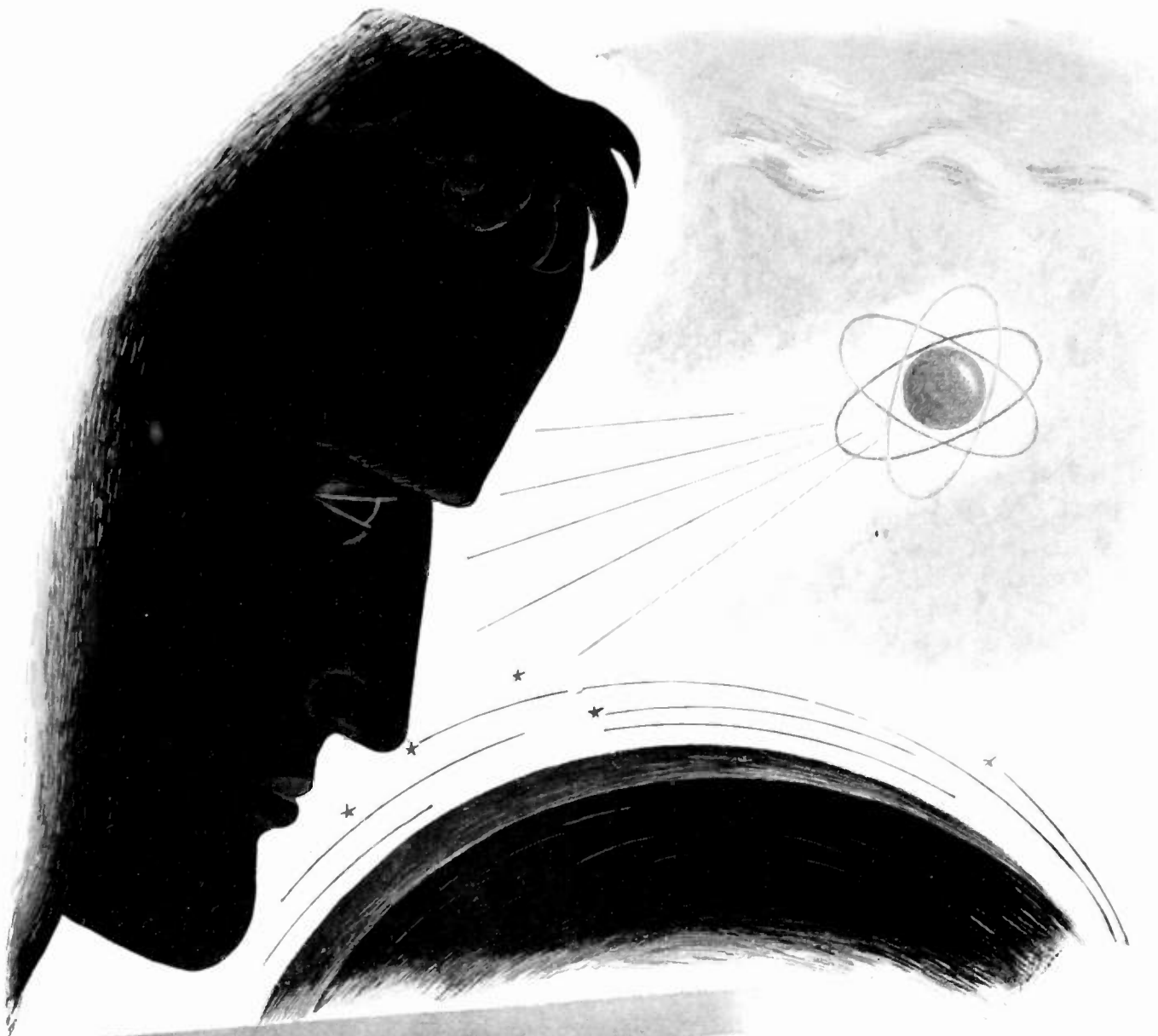

## **NOSE TO THE GRINDSTONE**

"Our noses are held to the grindstone of war production . . . but our eyes are fixed on the future." This is how one Stancor engineer described our present operating policy.

War problems are urgent, challenging, and stimulating. To solve them calls for midnight oil; but the lessons learned and discoveries made apply also to the problems of peace. When the war is won, industry will be confronted by a revolutionary development of electronic engineering . . . and Stancor engineers, seasoned by war demands, will be ready to serve you.

# **S T A N C O R**

STANDARD TRANSFORMER CORPORATION  
1500 NORTH HALSTED STREET • CHICAGO





# More than ever

With the struggle becoming increasingly fierce . . . now, more than ever . . . the quality of American men and equipment stand out in bold relief. We cannot tell you where . . . but we do know that somewhere on all the fronts . . . the quality of DeJur Aircraft and Electrical Instruments, Potentiometers and Rheostats is being subjected to the severest of tests. Thanks to 25 years of experience and research, our products will not be found wanting.

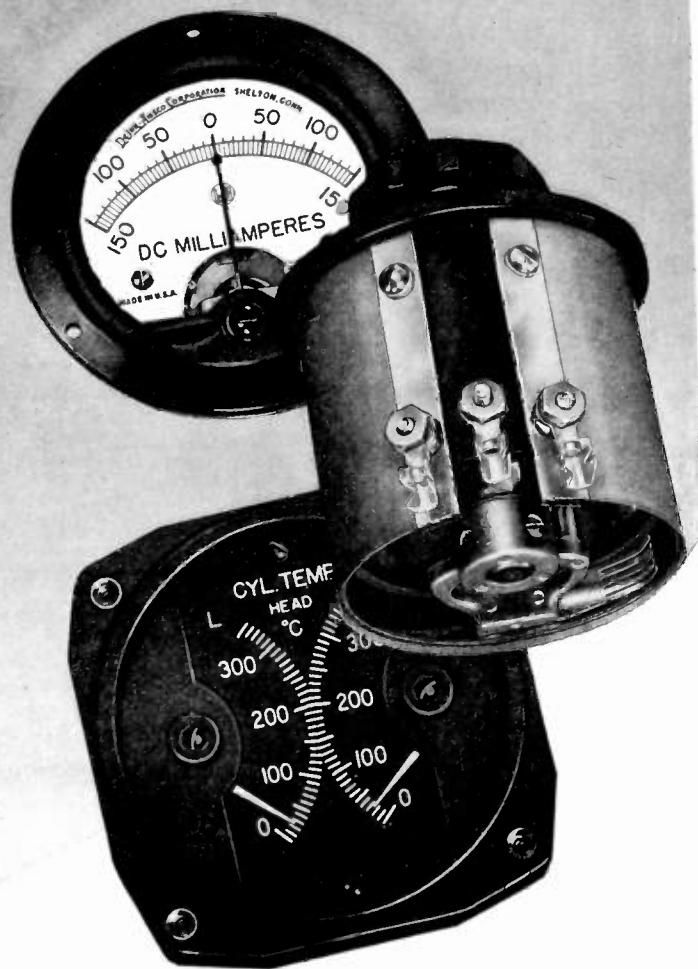

Awarded for Excellence in Production and Quality of Materiel



## DeJUR-AMSCO CORPORATION

SHELTON, CONNECTICUT

NEW YORK PLANT:  
99 Hudson Street, New York City

CANADIAN SALES OFFICE:  
560 King Street West, Toronto

**MORE THAN EVER . . . it's important to keep buying War Bonds and Stamps**



**"OVER TO YOU - OVER - - - -"**

*"The listening is often as important in this man's war as the doing or the talking—so when I throw it over to a reconnaissance plane, an observation post or general headquarters—this headset better work and work right."*

**R**OGER—soldier, it *will* work okay! It will work as right as precision manufacturing, careful inspection and the determination of Utah workmen can make it.

Headphones are only one of the many products now being manufactured by Utah for the armed forces. A wide range of electrical and electronic devices is now being built in the Utah factories—important parts that must be made with split-hair precision in order to take their vital places on the fighting or war production fronts.

It may be that you have a wartime problem that can be solved with Utah parts. Utah engineers are experienced in electrical and electronic problems. Utah production men are familiar with all the angles of producing precision work in quantity and on time. Write today for full information.



**UTAH RADIO PRODUCTS COMPANY**

842 Orleans Street • Chicago, Illinois

Canadian Office: 838 King St., W., Toronto • In Argentine: UCOA Radio Products Co., SRL, Buenos Aires • Cable Address: UTARADIO, Chicago



**UTAH WIRE-WOUND CONTROLS, RELAYS, JACKS, RESISTORS, PLUGS, SWITCHES, MOTORS**

xx

**Section Meetings**

**BOSTON**

"Electronics of the Atmosphere," by Dr. H. T. Stetson, Massachusetts Institute of Technology; March 26, 1943.

**BUFFALO-NIAGARA**

"New Method of Broadcasting Television and Audio on One Carrier," by J. H. Robinson Sterling Engine Company; March 31, 1943.

"Electron Microscopy," by C. H. Bachman, General Electric Company; April 21, 1943.

**CHICAGO**

"Electronic Musical Instruments," by Lloyd Loar, Northwestern University; March 19, 1943.

"Panoramic Radio Spectroscopes and Their Application," by Dr. Marcel Wallace, Panoramic Radio Corporation; March 19, 1943.

"Television Today," by A. H. Broly, Balaban and Katz, Television Station W9XBK; April 16, 1943.

"Frequency and Time Standards," by R. J. Donaldson, Commonwealth Edison Company; April 16, 1943.

**CINCINNATI**

"The Engineer in Business," by A. J. Allen, Cincinnati and Suburban Bell Telephone Company; April 1, 1943.

**CLEVELAND**

"Electronics in a Tube Mill," by Cecil Farrow, Republic Steel Corporation; April 22, 1943.

**DALLAS-FORT WORTH**

"Frequency-Modulated Equipment" by J. K. Chatfield, Porter Burgess Company; April 10, 1943.

**DETROIT**

"The Use of Radio and Electronics by the Detroit Edison Company," by A. B. Buchanan, F. L. Taylor, H. A. Boltz, H. G. Hammond, A. R. Hellwarth, W. A. Hirt, and H. A. Wallhausen, Detroit Edison Company, April 16, 1943.

**MONTREAL**

"The Technician at War," by Dr. H. G. Littler, Canadian Industries, Ltd.; March 11, 1943.

"Impedance Matching," by E. Legris, McGill University; March 31, 1943.

"Frequency Conversion in Superheterodyne Receivers," by G. B. MacKimmie, McGill University; March 31, 1943.

**NEW YORK**

"Tubes for High-Power Short-Wave Broadcasting Stations," by Georges Chevigny, Federal Telephone and Radio Laboratories; March 3, 1943.

"Acoustics for Broadcasting Studios for Speech versus Music," by E. J. Content, Station WOR; April 7, 1943.

"Material and Construction of Speech Broadcasting Studios," by Lonsdale Green, Jr., Acoustical Construction Corporation; April 7, 1943.

**PHILADELPHIA**

"Bombs for Berlin—Terror for Tokyo—  
(Continued on page xxii)





# E·L IS OUT THERE, TOO...

Out where the "fighting front" becomes grim reality instead of a glib phrase, *E·L* units are powering the "Walkie-Talkie" that serves as the voice and ears of our advance forces.

It's a marvelously efficient two-way radio, of course. But the Signal Corps knew that it couldn't be the useful, reliable instrument it is, unless it had a power supply that would keep it operating, under all conditions . . . whether in the destructive heat and grit of the desert, the paralyzing arctic cold, or the corroding humidity of the jungle.

Such a power supply did not exist until Electronic's engineers designed a special, high-voltage vibrator power supply, combined with storage battery, in a single, incredibly light and compact unit.

Behind this and other *E·L* power supply achievements are years of intensive development of the technique of vibrator type power supplies, and the most extensive research anywhere on power supply circuits. They have not only produced amazing advances for many military purposes, but promise revolutionary benefits for products of peace.

Wherever electric current must be changed, in voltage, frequency or type—for war or peace—*E·L* Vibrator Converters will give the same outstanding service that has singled them out for battle duty today.



Power Supply using rechargeable, non-spill storage battery for operation of "Walkie-Talkie" radio equipment. Input Voltage: 4 Volts; Output: Numerous Voltages, supplying plate and filament requirements of the equipment. Width, 3 1/2"; Length, 6 1/2"; Height, 4 3/8".

... AND *E·L* WILL BE HERE WHEN PEACE COMES!



● Mobile, two-way radio telephones will be at work in peace-time on big construction projects . . . on farms . . . in countless other places. *E·L* products will be on the job then, too, solving the power supply problem!

# Electronic

## LABORATORIES, INC.

*E·L* ELECTRICAL PRODUCTS—Vibrator Power Supplies for Communications . . . Lighting . . . Electric Motor Operation . . . Electric, Electronic and other Equipment . . . on Land, Sea or in the Air.

INDIANAPOLIS





*"Just getting the wire laid was a tough problem. Keeping it intact in bombings, shellings and adverse weather is a twenty-four-hour proposition. . . . Wire repair crews are made up of four men. Three stand guard while the other works."  
(From story by Sgt. James W. Hurlbut, Marine Corps Combat Correspondent)*

## Telephone Exchange on Guadalcanal

Marine communications men built it under fire. And it has been kept built. The "Guadalcanal Tel & Tel" covers well over a thousand miles of wire.

That is where some of your telephone material went. It's fighting on other fronts, too. We're getting along with less here so they can have more over there.

Telephone lines are life-lines and production lines in a war. Thanks for helping to keep the Long Distance wires open for vital calls to war-busy centers.

**WAR CALLS COME FIRST**

BELL TELEPHONE SYSTEM





# NEW WORLDS TO CONQUER!

**FOR ELECTRONICS  
ENGINEERS!**



## **PRECISION**

Under the guidance of highly skilled operators, the finest precision machines are employed to insure uniform high quality in all National Union tubes. In this photograph a bending machine in the Stem Department is shown doing its war job of helping to provide this year the largest number of the finest electronic tubes National Union has ever built.

Sure, winning the War is our big job right now. To that end we here at National Union are exerting our every thought and energy—both on our production lines and in our research laboratories. But after the war—what then? It is certain that for men trained in electronics there'll be new worlds to conquer. For from today's new applications of electronic tubes specifically developed to help win the war—will emerge countless new peacetime applications. It is here that American business will find invaluable assistance in designing, producing and packaging the better products its post war customers will want and demand. With the designers and producers of these new products National Union will welcome the opportunity to share its up-to-the-minute knowledge and research experience.

Transmitting Tubes • Cathode Ray Tubes • Receiving Tubes •  
Special Purpose Tubes • Condensers • Volume Controls • Photo  
Electric Cells • Exciter Lamps • Panel Lamps • Flashlight Bulbs

**NATIONAL UNION RADIO CORPORATION**  
NEWARK, NEW JERSEY      LANSDALE, PENNSYLVANIA

# NATIONAL UNION ELECTRONIC TUBES

# Check Up ON YOUR Microphone MANNERS



## Do You--

- Handle your mike with respect?
- Fasten it securely to the stand?
- Put cable where it won't be tripped?
- Clip cable to bottom of floor stands?
- Remember a cable's weight can pull a hand mike off a slick table?
- Send your microphone to the factory or its dealer if it gives trouble?
- Pack it carefully when traveling rough roads, or when subjecting it to vibrations in any way?
- Read the instructions very carefully?
- Make sure the circuit is correct for the type of mike you are using?
- Keep your crystal microphone away from radiators, sunny windows and closed cars sitting in the sun?
- Protect your microphone cable from contact with heat, light and oil, and keep it in a cool, dark place?
- Avoid pinching, twisting, pulling and kinking the cable?

### IF YOU CAN ANSWER YES

to all the above questions, you can logically expect long, useful service from your microphone. Remember, always, that microphones are sensitive instruments and will give you better service under all conditions when they are treated with respect. If your unit does not operate at peak performance, send it to the factory or to its dealer — don't try home repair jobs!

THIS FREE BOOK TELLS YOU  
HOW TO CARE FOR YOUR MIKE

Send NOW for your Free Copy of Turner's new 8-page, fully illustrated, colorful Microphone Catalog. Each unit is engineered for specific jobs and trouble-free performance. Select the one best suited to your needs at the price you want to pay.

The  
**Turner**  
Company

Cedar Rapids, Iowa

**Free**

THIS NEW TURNER  
MICROPHONE CATALOG

## Section Meetings

(Continued from page xx)

"Tires for You," by H. C. Roemer, Standard Oil Company of Pennsylvania; April 5, 1943.

### SAN FRANCISCO

"Microwave Electronics," by Dr. E. U. Condon, Westinghouse Electric and Manufacturing Company; March 3, 1943.

"Science and War," by Dr. J. H. Hildebrand, University of California; March 19, 1943.

### ST. LOUIS

"Electronics on Seagoing Units," by Lieutenant Commander R. T. Alexander, U. S. Coast Guard; March 29, 1943.

### TWIN CITIES

"Some Notes on Applications and Designs of Audio Transformers," by W. E. Lehnert, Audio Development Company; March 25, 1943.

### WASHINGTON

"Impedance and Phase-Angle Characteristics of Two-Terminal Networks," by V. L. Edutis, U. S. Naval Research Laboratory; April 12, 1943.

## Membership

The following indicated admission and transfers of membership have been approved by the Admissions Committee. Objections to any of these should reach the Institute office by not later than June 30, 1943.

### Transfer to Member

Ebel, A. J., 1113 W. Washington St., Champaign, Ill.  
Clark, R. G., 9 Christchurch Pl., Epsom, Surrey, England  
Dingley, E. N., JR., Bureau of Ships, Navy Dept., Washington, D. C.

### Admission to Member

Purgett, L. J., 463 West St., New York, N. Y.

The following admissions and transfers of membership were approved by the Board of Directors on May 5, 1943.

### Transfer to Member

Howes, F. S., Engineering Bldg., McGill University, Montreal, Que., Canada  
Koehler, G., Electrical Lab., University of Wisconsin, Madison, Wis.  
Kraus, J. D., Naval Ordinance Lab., Navy Yard, Washington, D. C.  
McConnel, W. G., Bendix Radio Corp., Baltimore, Md.

### Admission to Member

Schairer, O. S., Radio Corporation of America, 30 Rockefeller Pl., New York, N. Y.

(Continued on page xxiv)

Proceedings of the I.R.E. June, 1943



with but a  
**Single**  
thought



Gertrude Fontaine, mount operator  
at Hytron's Salem plant, and soldier  
in the Army of Production.

Miss Fontaine concentrates her nimble fingers and keen young eyes (assisted by a microscope) upon spot-welding and assembling minute parts of a 954.

On another floor, a Hytron engineer is giving lavishly, night and day, of his long training and experience as he designs and develops a new War tube in record time. The driving force urging them — and all of us at Hytron — on to superhuman effort, stems from a single thought, a single purpose: to supply our courageous fighting men with tools to win. Hytron employees have but one goal — a mounting flood of top-quality tubes to serve as the "hearts" of electronic and radio equipment helping our boys to blast the way to speedy and permanent Victory.

*Oldest Exclusive Manufacturer of Radio Receiving Tubes*

**Hytron**

ELECTRONIC AND  
RADIO TUBES



**Corporation**

SALEM AND

NEWBURYPORT, MASS.

## "SHORTING" Switches

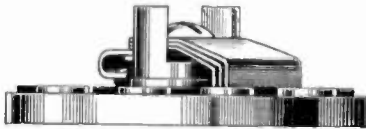

This is the shorting type. As the arm is rotated from one position to another the adjacent contact points are "shorted" (bridged).

or

## "NON-SHORTING" Switches

This is the non-shorting type. As the arm is rotated from one position to another, the arm lifts up, and only one contact is touched at a time.

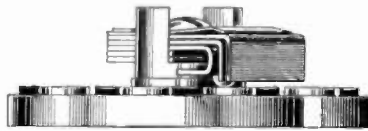

### OTHER SHALLCROSS

Switches are designed for use in your particular field.

Let Shallcross answer your problems.

Address Dept. C. 23

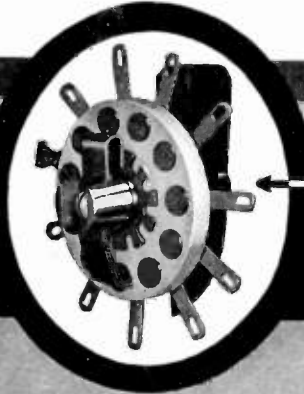

### THE No. 4605

is one of many Shallcross Switches extensively used in instruments and in many other applications.

## SHALLCROSS ROTARY SELECTOR SWITCHES USE SOLID SILVER CONTACTS, BECAUSE SOLID SILVER . . .

1. Has the highest conductivity of materials available.
2. Is superior to silver-plating which wears off, resulting in high resistance contacts.
3. Should it corrode the sulphide formed does not appreciably increase the contact resistance.

### Creators and Makers of

Accurate Resistors—Switches—Special Equipment and Special Measuring Apparatus for Production and Routine Testing of Electrical Equipment on Military Aircraft . . . Ships . . . Vehicles . . . Armament . . . and Weapons



# SHALLCROSS MFG. CO.

COLLINGDALE, PENNA.

## Membership

(Continued from page xxii)

### Admission to Associate

- Barnes, B. B., 124 Alden Ave., North Chattanooga, Tenn.  
 Baum, M. W., 31 W. 91 St., New York, N. Y.  
 Bereston, I. A., 2239 Eutaw Pl., Baltimore, Md.  
 Birnbaum, G., 830 S. Michigan Blvd., Chicago, Ill.  
 Bloom, A., Rumson Area, C.E.S.L., Rumson, N. J.  
 Bolljahn, J. T., 1260 Pleasant St., S.E., Washington, D. C.  
 Boyer, J. M., 4315 1/2 Ocean Dr., Manhattan Beach, Calif.  
 Brule, C. G., Detroit Institute of Technology, Detroit, Mich.  
 Burdsall, N. H., 1645 Blackhawk St., Chicago, Ill.  
 Carvagal, H. H., Radio Sound, Santiago, Chile  
 Charles, P., Hindustan Aircraft P. O., Bangalore, South India  
 Chatterjee, A., 24 D Mahesh Chandra Dutt La, Alipur, Calcutta, India  
 Coatney, A. E., R.F.D. 5, Bloomington, Ind.  
 Conner, R. E., 2131 F. St., Sacramento, Calif.  
 Cozzens, W. B., RTIC, USS *Tangier* (AV8) c/o Fleet P. O., San Francisco, Calif.  
 Crow, J. R., 5530 Corteen Pl., North Hollywood, Calif.  
 D'Alessandro, S. J., 891 Broadway, Newark, N. J.  
 Davis, H., 172 Avenel Blvd., Long Branch, N. J.  
 DeHaan, J., 10141 Parnell Ave., Chicago, Ill.  
 DeMarcos, E. C., R.C.A.F. Station, Scoudouc, N. B., Canada  
 DeMerritt, L. G., 6206 N.E. 28 Ave., Portland, Ore.  
 Deuring, W. G., Jr., 3411 Bader Ave., Cleveland, Ohio  
 Dollscheck, C. W., 2782 Constitution Rd., Camden, N. J.  
 Dougherty, J. D., 2474 Iroquois Ave., Detroit, Mich.  
 Eggleston, A. E., 426 1/2 W. Lovett St., Charlotte, Mich.  
 Eisenberg, M., 1928 W. Airdrie St., Philadelphia, Pa.  
 Ellis, P. V., 29 W. Kensington St., Astoria, Ore.  
 Eveland, E. H., 88 Kenwood Rd., Garden City, L. I., N. Y.  
 Farrell, L. H., 301 Washington St., Dover, N. H.  
 Flomenhoft, M., 41-60 Little Neck Pkway, Little Neck, L. I., N. Y.  
 Flynn, F. J., CRT (PA) USN, Navy Yard Pearl Harbor, T. H.  
 Fry, J. A., 1215 Pacific Highway, Turramurra, N. S. W., Australia  
 Furst, R. E., 540 W. Wellington Ave., Chicago, Ill.  
 Garoutte, C. D., 6921 Julian Ave., St. Louis, Mo.  
 Garri, M. E., Misiones 172 piso 2 dto. E., Buenos Aires, Argentina  
 Gauntlett, G. A. R., 8 Worthington Ave., Cross Roads, Jamaica, B.W.I.

(Continued on page xxvii)

Proceedings of the I.R.E. June, 1943



# SALUTE TO THE WOMEN OF TOMORROW!

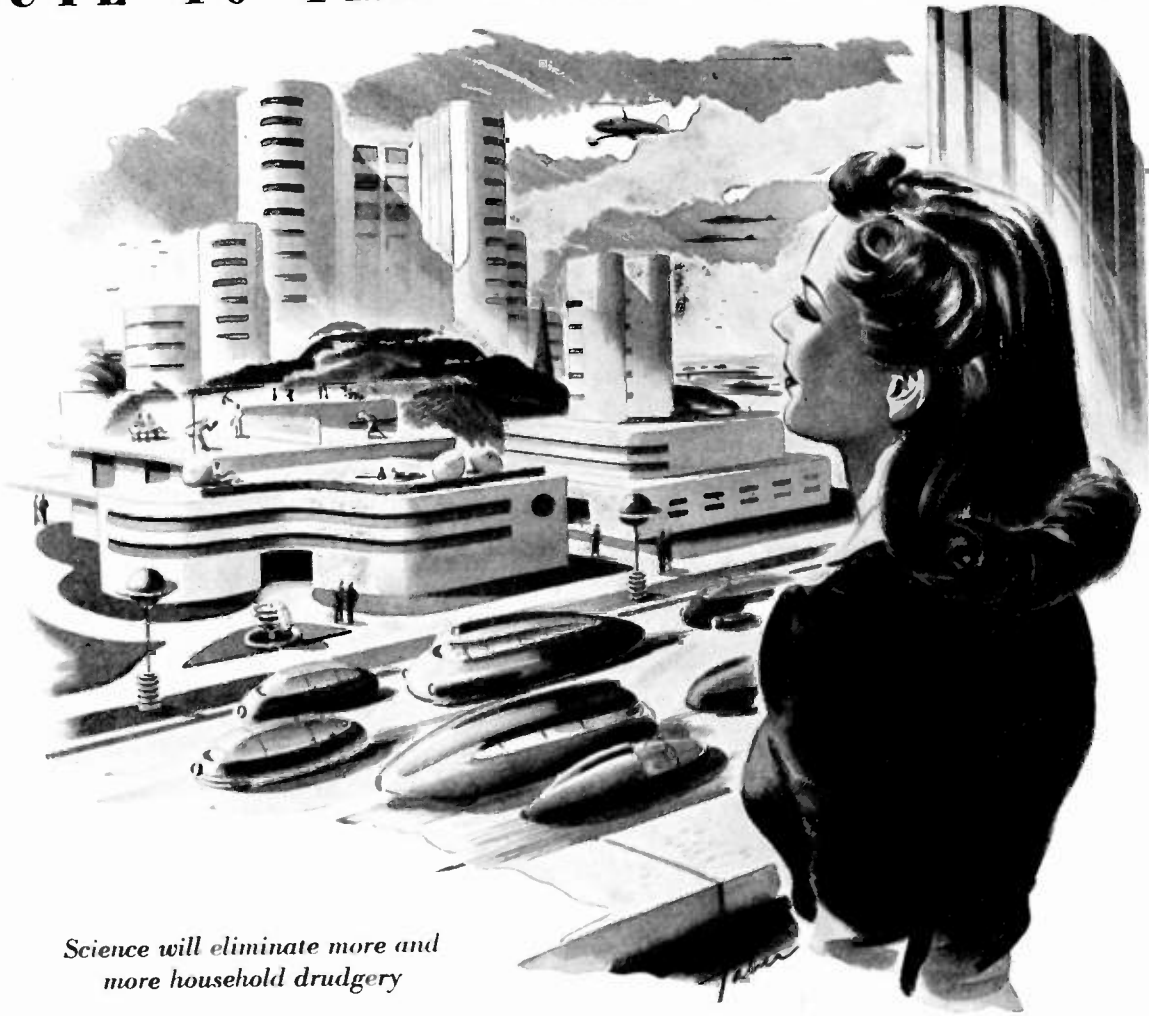

*Science will eliminate more and more household drudgery*

**R**ESearch AND INVENTION have been speeded up by the war — the tragedies of today will, in the not-too-far-distant future, be transformed into the blessings of peace.

The women of tomorrow will step out of the bondage of household chores into more zestful, more creative living. More and more, they will share with men in the re-making of this world.

Typical of the forward-looking companies which will translate the visions of today into the actualities of tomorrow is Small Electric Motors (Canada) Limited.

This virile, rapidly-expanding industrial organization, now engaged solely in war work, is planning an important post-war future. From its large, modern plant will come electrical equipment of revolutionary design — for ships and planes — for factories and homes!

## DESIGNERS AND MANUFACTURERS

of all types of precision electrical apparatus including

*D.C. & A.C. Motors for specialized purposes  
Aircraft Generators  
Aircraft Engine Starters  
Alternators  
Motor Generators  
Electric Pumps  
Motors with Governors  
Gyros, etc.*

## *Small Electric Motors (Canada) Limited*

and its subsidiary

*Semco Instruments Limited*

LEASIDE • TORONTO 12 • CANADA

2-43

**A tricky job,  
but-**

**CLAROSTAT  
solved it**



Clarostat is now 100% on wa-  
production. Greatly expanded  
plant facilities are keeping pace  
with rising requirements. An  
engineering and manufacturing  
background second to none, is  
solving many tricky problems  
these days.

## Multiple CONTROLS

★ An entirely new design for tandem controls. New molds provide unit casings that nest and lock together. Metal end pieces and tie rods insure rigid assembly—even up to 20 units in tandem. Single shaft passes through and locks with rotor of each control. Each control accurately

wound to precise circuit requirements — resistance, taper, taps, hop-off. Interlocking resistance ratios provide any desired voltage or current at given degree of rotation. These Multiple Controls are now in regular production and meeting the most rigid multi-control requirements.

### ★ Send Us Your Problem . . .

No matter how complex or how simple—provided it has to do with control by means of resistance. Let us quote on your high-priority resistance or control requirements. Literature on request.



**CLAROSTAT**

*Controls and Resistors*

CLAROSTAT MFG. CO., Inc. · 285-7 N. 6th St., Brooklyn, N. Y.

## Membership

(Continued from page xxiv)

- Gittens, R. N. W., Box 166, Barbados B.W.I.
- Glenn, A. B., 3155 Ave. I, Brooklyn, N. Y.
- Goodrich, H. C., Jr., 14375 Artesian, Detroit, Mich.
- Harrison, C. E., 4530a W. Papin St., St. Louis, Mo.
- Hoff, A. H., 375 E. Virginia St., Phoenix, Ariz.
- Holt, W., 39th Signal Co., A.P.O. 26, Fort Jackson, S. C.
- Howard, F., 24 Chapel Rd., Northenden, Manchester, England
- Howell, H. H., 1615 Second Ave., Seattle, Wash.
- Jackson, R. S., 368 W. Spazier Ave., Burbank, Calif.
- Johnson, R. L., 3503 Wallbrook Ave., Baltimore, Md.
- Keel, J. J., 3901 Yolando Rd., Baltimore, Md.
- Kern, A. W., 218 S. Adams, Spokane, Wash.
- Ketcham, A. R., The Toledo Edison Co. Meter Dept., Toledo, Ohio
- Koenigsberg, S., Box 316, Ft. Lauderdale, Fla.
- Koros, L., Calle Formosa 240, Buenos Aires, Argentina
- Kow, L., 9A Barnard Gdns., Hayes, Middlesex, England
- Kritzmire, A. D., 328 Customhouse, San Francisco, Calif.
- Kurlansky, S., 147½ Congress St., Milford, Mass.
- Lamb, D. B., 229 W. First St., Mesa, Ariz.
- Lanz, J. E., 37 Manville Ave., Box 276, Asbestos, Que., Canada
- Layne, C. N., 181 W. Fourth Sq., Logan, Utah
- Lindsay, W. F., 2340 Primorse St., Ft. Worth, Tex.
- Lippmann, B., 9 Jane St., New York, N. Y.
- Loretz, H. G., Ninth Service Command Signal Repair Shop, Ft. Lewis, Wash.
- Lucyk, J., Aerovox Canada, Ltd., Hamilton, Ont., Canada
- McAdam, J. C., Rt. 3, Allegan, Mich.
- McClellan, J. F., Box 291, Goshen, N. Y.
- Maeshner, E. A., 1870 Sunset Blvd., San Diego, Calif.
- Mathias, B., 738 Leonard St., Toledo, Ohio
- Miles, J. G., Sylvania Electric Products, Inc., Williamsport, Pa.
- Minton, R. W., 1037 Lucile Ave., S.W., Atlanta, Ga.
- Morlock, W. J., 3723 N. Denny St., Indianapolis, Ind.
- Morrison, H. G., Signal Section, 32nd Sub-Depot, Paine Field, Everett, Wash.
- Moss, T. M., 570 Oak Dr., Hapesville, Ga.
- Niles, J. G., 818 Tonawanda St., Buffalo, N. Y.
- Pader, A. F., 3334 S. Lowe Ave., Chicago, Ill.
- Patrick, W. L., Box 1131, Laurel, Mass.
- Potter, J. D., 2448 Hutchinson St., Chicago, Ill.
- Reed, R. D., 3625 Nottinghamway St., Hamilton Sq., N. J.

(Continued on page xxviii)

Proceedings of the I.R.E. June, 1943

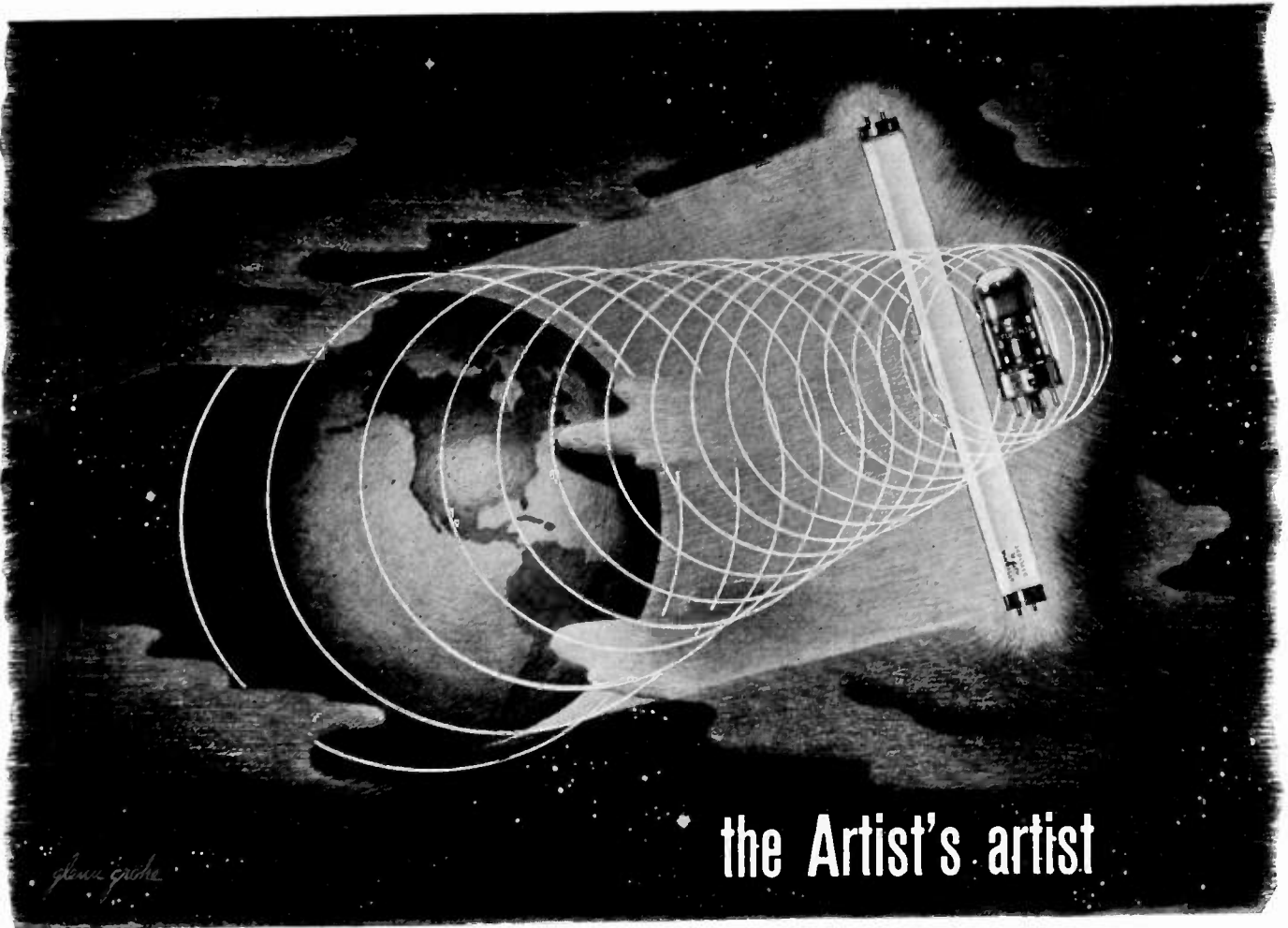

## the Artist's artist



We are not zealous here at Sylvania to be the largest in our field. We had rather be known for excellence than for size. You have heard of the man so painstaking that to his talented fellows of larger fame he is known as the writer's writer, or the painter's painter, or the singer's singer. We understand that, and it seems to us there could be no higher praise. So in all the things we build — incandes-

cent lamps, fluorescent lighting equipment, radio and electronic tubes — we aim uncompromisingly high, high as we possibly can. The function of these things, conceived as they are to amplify the indispensable miracles of human sight and hearing, seems to us to deserve the very best that can be given. So believing, it is only natural we should seek in all our work to attain the highest standards anywhere known.

# SYLVANIA ELECTRIC PRODUCTS INC.

EMPORIUM, PA.

MAKERS OF INCANDESCENT LAMPS, FLUORESCENT LAMPS, FIXTURES AND ACCESSORIES, RADIO TUBES, CATHODE RAY TUBES AND ELECTRONIC DEVICES

**INDUSTRIAL ELECTRONICS** is doing much to help win the war on the production front, but can do a great deal more by more widespread application. Sylvania Electronic Tubes for devices that can automatically gauge, count, control, actuate, test, detect, protect, guide, sort, magnify, heat, transform, "see," "feel" and even "decide" are tested and available. The more electronic "know how" is put to work to make precision war production speedier and more precise, the sooner the Victory.

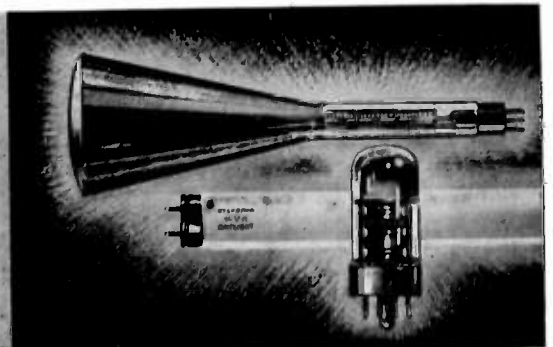

Now serving on

*all fronts*

★ In aircraft plants, engine shops, powder works, ballistic laboratories, radio, electrical and other plants; in research laboratories and engineering departments shaping the weapons and tools of today and tomorrow; on the fighting fronts afloat and ashore—yes, in every phase of this great Battle for Democracy, DuMont Cathode-Ray Oscillographs are in the service.

For the most part, standard type DuMont Oscillographs are employed. An adequate selection of standard types meets the wide range of requirements. But for the highly specialized needs arising out of the drastic industrial and military demands of the war, special models are constantly being developed and built. Regardless of the need, a DuMont Cathode-Ray Oscillograph or related instrument is available.



Write for Literature . . .

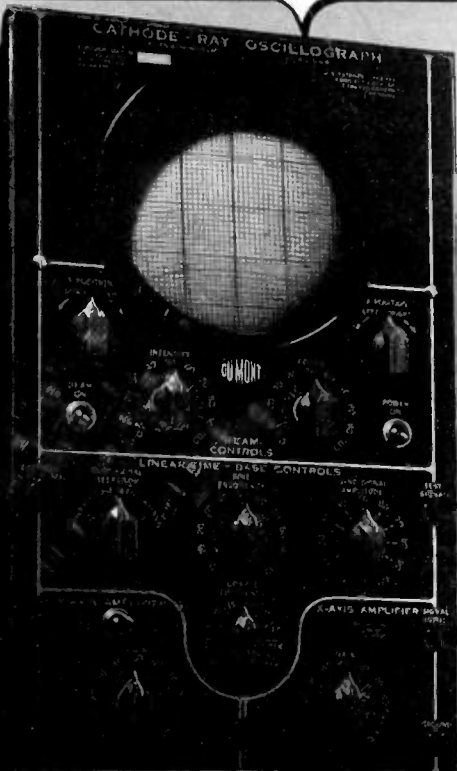

Wide selection of DuMont Oscillograph models—3" to 20".

DuMont Electronic Switch for placing two simultaneous signals on single tube screen.

DuMont Low-Frequency Linear-Time-Base Generator, providing sweeps as low as 1 cycle every few seconds.

Type 224 Oscillograph, with frequency response up to 2,000,000 cycles per second.

DuMont Cathode-Ray Tubes from 3" to 20". Choice of persistence screens.



DU MONT  
Type 208  
OSCILLOGRAPH

**DU MONT**

**ALLEN B. DU MONT  
LABORATORIES, Inc.**

Passaic • New Jersey  
Cable Address: Wespexlin, New York

## Membership

(Continued from page xxvi)

- Richards, A. W., 352 Hunter St., E., Hamilton, Ont., Canada
- Roach, F. T., 323-A Customhouse, San Francisco, Calif.
- Robinett, L. L. Jr., American Telephone & Telegraph Co., 32 Sixth Ave., New York, N. Y.
- Rogers, G. D., 224 High St., Berea, Ohio
- Scully, W., 823 W. Fourth, Spokane, Wash.
- Sheffield, J., Northern Electric Co., 1261 Shearer St., Montreal, Que., Canada
- Shoemaker, L. E., 3642 Horner Pl., S.E., Washington, D. C.
- Sill, K. B., c/o Postmaster, San Diego, Calif.
- Slusser, E. A., 51 Brattle St., Cambridge, Mass.
- Smolen, A., 35-36—76 St., Jackson Hts., L. I., N. Y.
- Spies, D., 383 Amherst St., East Orange, N. J.
- Stone, D. F., 1805 N. Eleventh Ave., Phoenix, Ariz.
- Strange, E. M., Box 94, Laramie, Wyo.
- Taylor, D. H. J., 225 Blossomfield Rd. Solihull, Birmingham, England
- Taylor, T. W., Box 5293, T. C. Station, Denton, Tex.
- Taylor, W. E., Jr., 2917 Graham Blvd., Wilkensburg, Pa.
- Terry, E., 108 Rutland Rd., West Bridgford, Nottingham, England
- Tousley, P., 816 Simpson, Evanston, Ill.
- Van Der Harst, J., Hillside Ter., Irvington, N. Y.
- Van Sleen, R., 508 W. Third Ave., Gastonia, N. C.
- Wadham, C. W., Telegraph Engineers Office, Box 81, Gisborne, N. Z.
- Ward, J. E., 47 Park Ave., Rumson, N. J.
- Watson, W. H., McGill University, Montreal, Que., Canada
- Whitman, A. J., 708 South Ave., Schenectady, N. Y.
- Widlar, W. L., Jr., 1299 Bonnieview Ave., Lakewood, Ohio
- Wiejek, A. J., 116 H St., West Belmar, N. J.
- Williams, G. T., 111 Galyan Dr., Bremer-ton, Wash.
- Wilson, F. R., 10519 Valley Spring La., North Hollywood, Calif.
- Wilson, T., Jr., Box 4364 Atlanta, Ga.
- Wyckoff, H. O., 1357 Jefferson St., N.W., Washington, D. C.
- Wyman, B. D., 119 Colonial Rd., Rochester, N. Y.



**BROADCASTING**  
More international than ever, after Victory. Increasing demand for electronic engineers.



**CHEMICAL MANUFACTURE**  
High-frequency currents can supply heat for chemical reactions—another field open to electronics.



**AVIATION INDUSTRY**  
Molding plones of plywood by electronic heating—industry of great post-war potentialities.



# GLOBAL BROADCASTS AND PLYWOOD PLANES WITH ELECTRONICS!



Listening to London *direct*, or Budapest, in a glider-train over Kansas is an accepted fact—in the electronic world of the future. And the plane itself, too, may be a development of electronics.

Already low-cost plywood aircraft roam the skies, flying the star of the U.S.A. Electronic heating of the plywood and resins in the molding process allowed rapid, uniform baking of thick sections, helped produce for warfare a practical, economical plane, and gave the aviation industry a pattern for the coming "family car of the air."

International broadcasting to molding plywood planes—could two industries, seemingly, be as unrelated? Yet the new science of electronics embraces both, and in the range from 1000 kilocycles to 10 megacycles—a mere fraction of the known frequency spectrum. Beyond lies an amazing variety of electronic applications and potentialities which will vastly improve peacetime living. It will be the rare industry that does not utilize electronic methods soon after the war's end.

For the electron tube of today can do just about everything. It measures thicknesses, controls temperature, detects fire. It can "see" in pitch dark, "hear" an insect's heart beat, "feel" a change in natural daylight. Taking up where electricity leaves off, electronics has opened a new industrial era.

Busier than ever now with war work, Isolantite is looking ahead, with the men of electronics, to the bright Tomorrow that will dawn with peace. For while it is impossible to predict the limits to which the science of putting the electron to work may go, much depends on the performance of the new electronic devices. And here insulation plays an important part.

## ISOLANTITE

CERAMIC INSULATORS  
ISOLANTITE INC., BELLEVILLE, N. J.

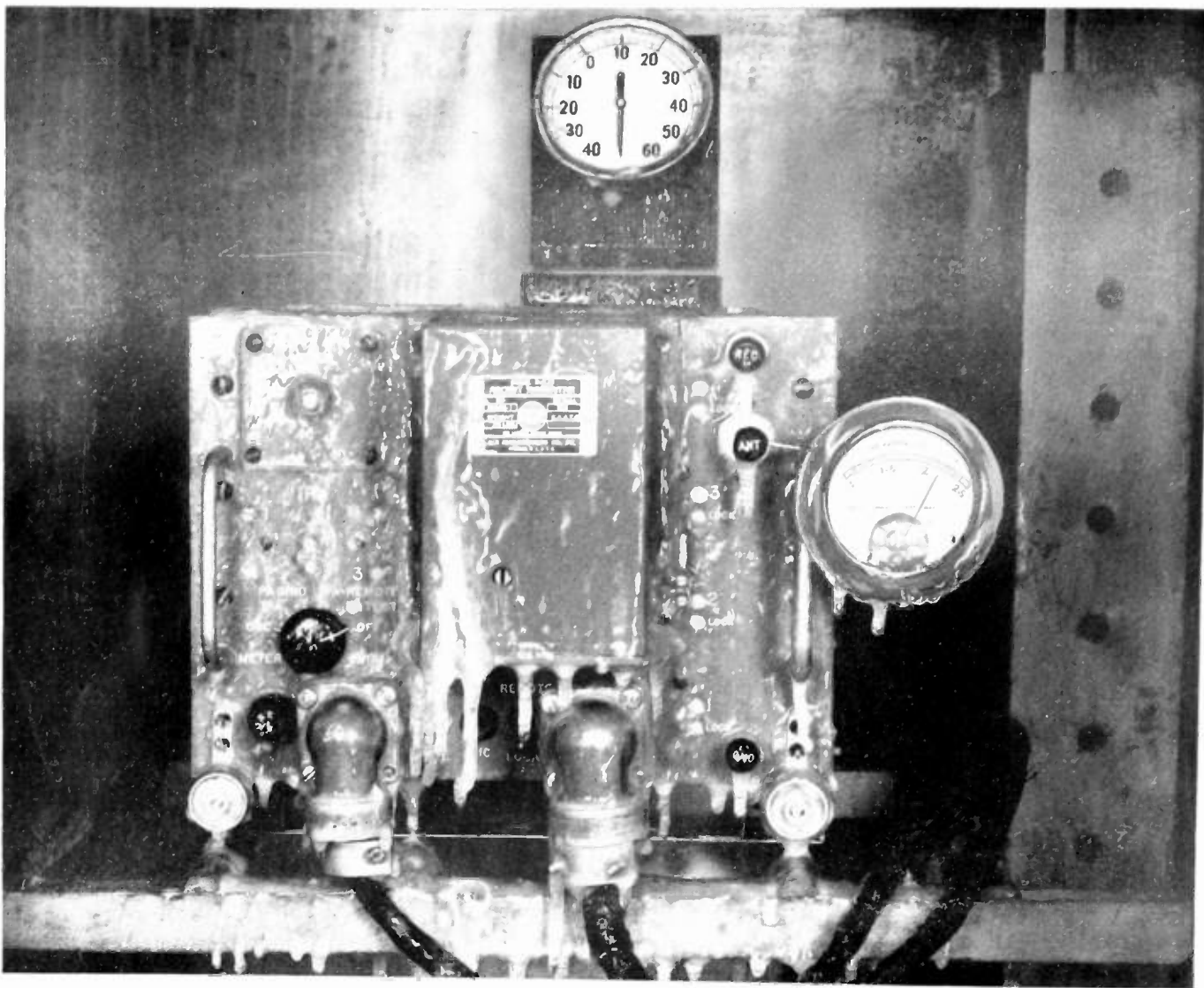

## ARCTIC REHEARSAL... AT 76° BELOW

Today's demands on men and planes and equipment are the most severe the world has ever known. Battle-grounds have advanced into the sub-stratosphere—where even over the equator temperatures are scores of degrees below zero.

No radio equipment could remain operative under such conditions until scientific research solved the problems of tuning controls freezing, sensitive relays jamming, electrical adjustments changing and wires snapping. Without research, radio and electronic systems fail in these frigid temperatures where our

men and planes are fighting in their conquest over cold and altitude and the enemy.

To permit accurate scientific investigation of these problems, RCA recreates this intense cold in its laboratories, cold that is 9° lower than the stratosphere temperature, cold that equipment such as the ice-sheathed transmitter shown above must withstand for endless hours. In these icy chambers RCA engineers are looking ahead to the future, solving the problems that will be encountered as our fighters and bombers operate higher and higher

into the stratosphere.

Daily these engineers patiently work, subjecting equipment to temperatures as low as -76°, testing and retesting until operation is satisfactory—until dependability is assured. Thus RCA research helps to make our aviation radio equipment more efficient, more powerful, and more reliable in performing its vital tasks.

That's one reason, too, experts say: "For results in aviation radio performance, consult RCA research."



### RCA AVIATION RADIO

RCA Victor Division • RADIO CORPORATION OF AMERICA • Camden, N. J.



# WE *Can* DO MORE!

With sleeves rolled up, Americans are determined to do the utmost to back up the boys at the fighting fronts. There seems to be almost no limit to American ingenuity, engineering know-how and mass production methods. Electronic Corporation of America is now in full production on 100% war work . . . but we can do more! ECA is pledged to do all in its power . . . and then a little more . . . to help win the war quicker!

### To Manufacturers and Government Agencies

The Electronic Corporation of America factory is perfectly set up for the manufacture and assembly of electronic devices and equipment. ECA invites inquiries from manufacturers and government agencies who can make use of our facilities and experience to help win the war sooner.

"Let's Win the War Now! . . . with the Utmost in Production"

Buy More — AND MORE — War Bonds!

**ECA**  
ELECTRONIC CORPORATION OF AMERICA

**ELECTRONIC CORPORATION OF AMERICA**  
45 WEST 18TH STREET, NEW YORK CITY • • • PHONE WAKing 9-1870



# Can An ENGINEER Be A Businessman?

Let's talk sense.

We know we're talking to high-type professional radio engineers who can't be kidded with a lot of meaningless words. . . .

But. . . .

We do think the average engineer is businessman enough to realize, and want to capitalize on, the opportunities that are now available to every radioman who wants to take advantage of them. . . .

The engineer who is looking for an important place in the postwar field of radio and industrial electronics, will find that by investing a few hours each week in a planned program of home study offered by CREI . . . he will bring his knowledge up-to-date . . . obtain practical help in his daily work . . . and develop his ability to cope with any technical radio problem.

In an industry that is expanding as rapidly as radio, CREI home study in Practical Radio Engineering takes on new importance. CREI offers a proven plan for personal advancement for the high calibre men to whom radio looks for its efficient operation and progressive development.

One CREI student, a broadcast engineer, recently wrote: "I found your course sufficiently advanced for a college graduate, and of an engineering nature."



*We will be glad to send our free descriptive booklet and complete details to you, or to any man whom you think would be interested.*

## CAPITOL RADIO ENGINEERING INSTITUTE

E. H. RIETZKE, President

Home Study Courses in Practical Radio Engineering for Professional Self-Improvement

Dept. PR., 3224—16th Street, N.W.  
WASHINGTON, D.C.

Contractors to the U. S. Signal Corps—U. S. Coast Guard  
Producers of Well-trained Technical Radiomen for Industry

## New Equipment Notes

### A Waterproofing Material for Radio Ceramic Forms

An invisible "raincoat" which can be formed on cloth, paper and many other materials by exposing them to chemical vapors from a new compound, thereby making them water-repellent, has been developed in General Electric's Research Laboratory at Schenectady, N. Y., by Dr. Winton I. Patnode who is studying many possible uses of this new method of waterproofing.

Called Dri-Film, one of its most important uses so far is the treatment of ceramic insulators for radio equipment being made for the armed forces of the United States. It is about nine times more effective than the wax used at present as a water repellent, and its results are permanent.

Dri-Film is a clear liquid composed of various chemicals which vaporize at a temperature below 100°C. Articles to be treated are exposed, in a closed cabinet, to the vapors for a few minutes. Then they are taken out and, if necessary, are exposed to ammonia vapor. This is to neutralize corrosive acids which may collect during treatment.

Dr. Patnode is not able to explain exactly what happens in the process, but the result is that an extremely thin film is formed on the surface. This "raincoat" is so thin that its structure cannot be determined by chemical analysis. It cannot be seen under a high-powered microscope. But, whatever its nature, it prevents water from spreading to form a continuous film. If moisture does collect, it is in the form of small isolated drops.

Probably the biggest use of ceramic forms today is in radio communications equipment where high electrical resistance between conductors is absolutely essential to successful performance. Ceramic insulators, when dry, provide extremely high electrical resistance. However, in service one of the adverse conditions frequently met has been condensation of moisture on the surfaces of the ceramic forms. Such condensation, if not controlled, forms a film of water and reduces the resistance between conductors to the point where excessive leakage of current results, and the performance of the equipment is impaired. Consequently, manufacturers have for years treated ceramic parts, built into this type of apparatus, with materials which to a greater or less degree reduce the effects of condensation. In the past, the best methods of treating these parts have been varnishing and waxing. Searching for a better and more effective method, there was developed the new and radically different treating material.

Laboratory tests show the wide difference in the water-repellent characteristics of ceramic surfaces when glazed or treated with wax, and with the new compound. These tests were made under conditions of temperature and humidity similar to those met by military forces in service from the arctic to the tropics. Tests of surface re-

(Continued on page xxxii)

## Electronic TRANSFORMERS

Acme electronic transformers are made-to-measure, for each application. That's why independent, unbiased tests give Acme first choice in performance. Acme engineers combine exact electrical specifications with mechanical limitations into precision-made transformers that provide for maximum performance of the electronic device.

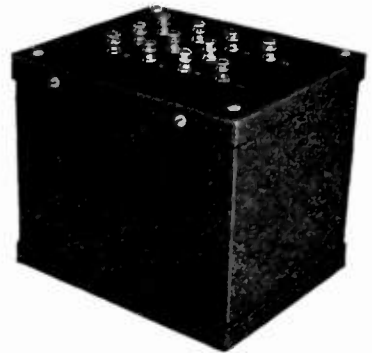

### POWER OR FILAMENT TRANSFORMERS

Acme case designs require minimum mounting area. May be mounted on bottom, or suspended from top or side. Produced to specifications in sizes from 50 VA to 500 VA.

### FILAMENT TRANSFORMERS

Type T-7025 Acme Filament Transformer for 2—866 Rectifier Tubes. Requires minimum mounting space; mounting centers for 25 VA, only 3" x 3 1/2", height 3 3/4". Precision-made to specifications in production quantities in ratings from 25 VA to 1 1/2 KVA.

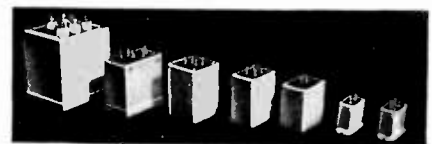

### MINIMUM WEIGHT AIR-BORNE TRANSFORMERS

Acme compound-filled, sealed case Audio, Driver, Interstage transformers, Reactors and Microphone input transformers are built to withstand and satisfactorily perform under extreme temperature variations. Bulletin 159 tells why. Write for your copy today.

THE ACME ELECTRIC & MFG. CO.  
44 WATER ST. CUBA, N. Y.

Acme **ACME** Electric  
TRANSFORMERS



# IRC VOLUME CONTROLS HAVE *All* THE FEATURES

No single attribute is responsible for the definite preference so often expressed by electronic engineers for IRC Volume Controls. Rather the fact that each unit embodies *all* the important factors which make for dependable operation has earned the regard of many of the largest users of potentiometers. . . . For preferred performance under severe conditions, for accuracy, stability and long life—specify IRC Volume Controls.

- 1—Metallized Element
- 2—Spiral Spring Connector
- 3—5 Finger Positive Contact
- 4—2 Sizes—1 1/8" and 1 1/4" diam.
- 5—2 Ratings—1/2 and 1 1/2 Watts
- 6—Available for Salt Spray, Sealed, and High Altitude Performance.



*First in the industry to win an E flag, IRC is first also to win a Star for sustained production*



**INTERNATIONAL  
RESISTANCE COMPANY**

401 N. BROAD STREET • PHILADELPHIA

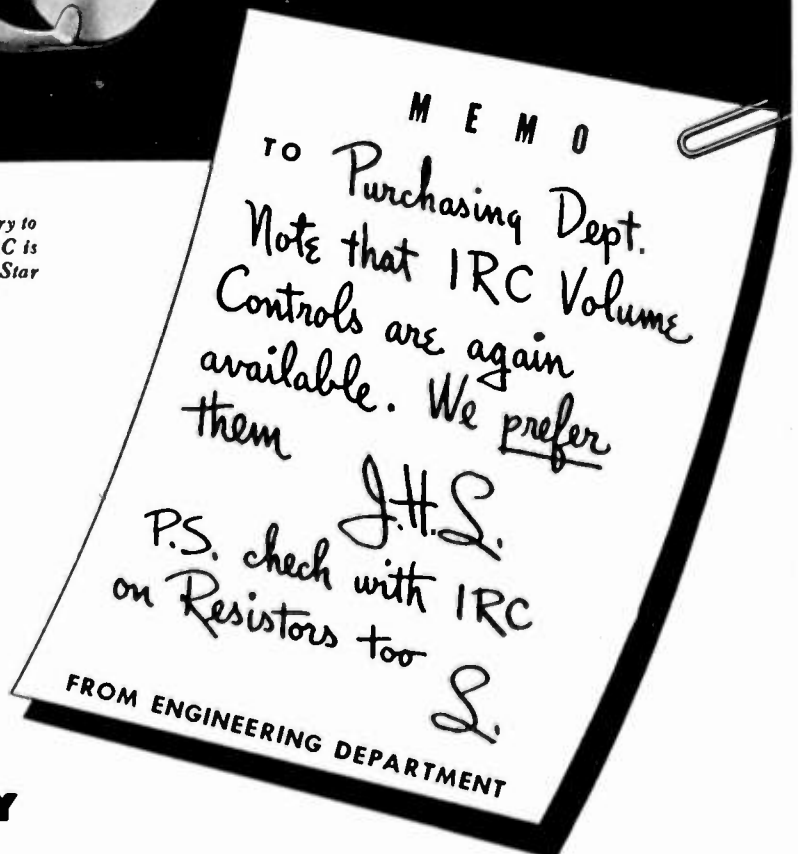

FROM ENGINEERING DEPARTMENT

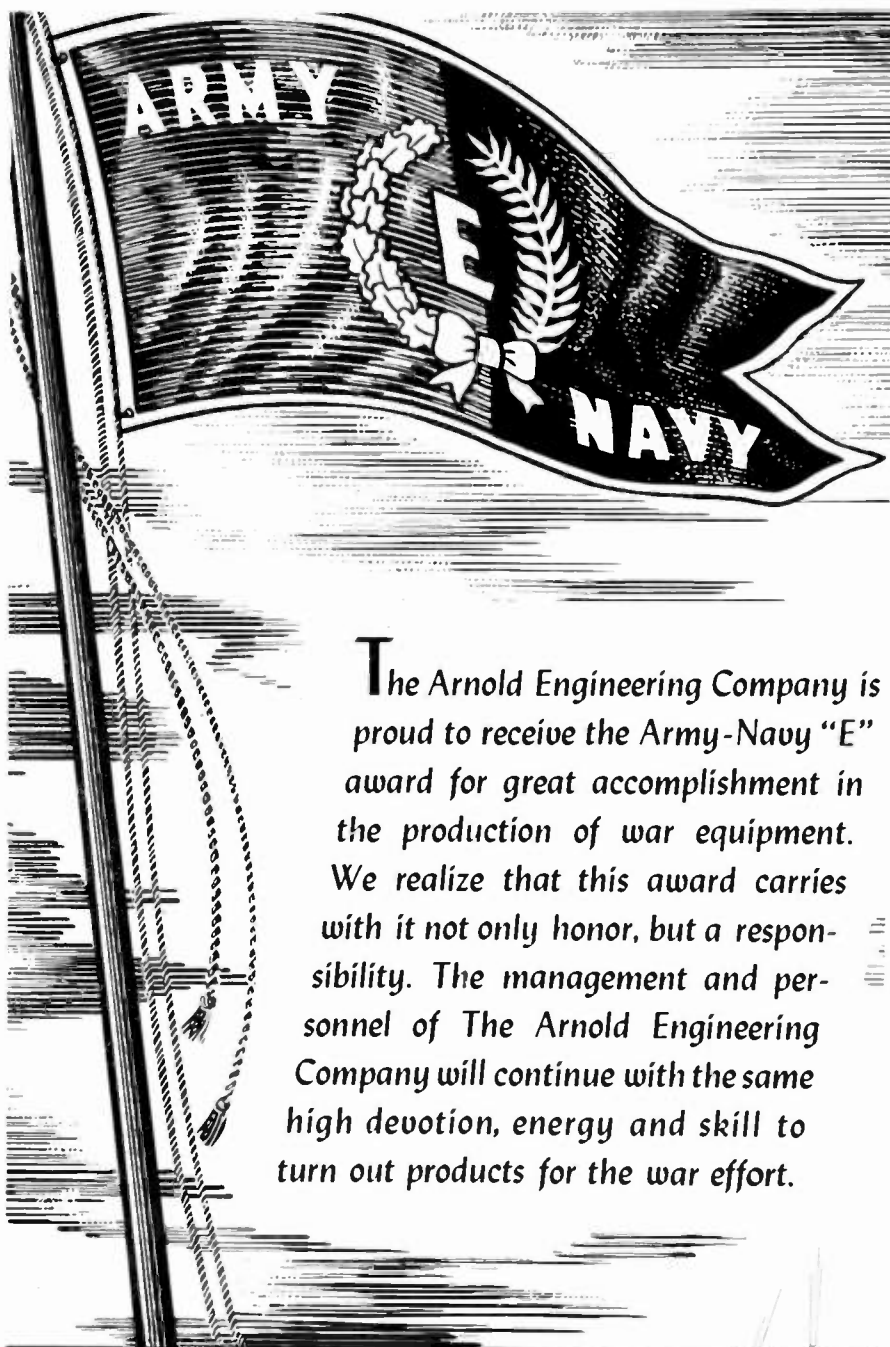

The Arnold Engineering Company is proud to receive the Army-Navy "E" award for great accomplishment in the production of war equipment. We realize that this award carries with it not only honor, but a responsibility. The management and personnel of The Arnold Engineering Company will continue with the same high devotion, energy and skill to turn out products for the war effort.

# THE ARNOLD ENGINEERING COMPANY

147 EAST ONTARIO ST. • CHICAGO, ILLINOIS

Specialists in the Manufacture of  
**ALNICO PERMANENT MAGNETS**  
**CAST ARMOR ★ SPECIAL ALLOYS**

## New Equipment Notes

(Continued from page xxx)

sistivity (a measure of resistance) were made on a number of closely controlled specimens which had been subjected to the condition of 100 per cent relative humidity at 25° C. with the ceramic parts precooled below the dew point. A value of 100 was arbitrarily assigned to the surface resistivity of unglazed ceramics that had been treated with wax. On the same basis of evaluation, parts treated with Dri-Film were found to have a surface resistivity of 870.

In addition to providing a high initial surface resistivity, the water-repellent treatment for ceramics must be able to withstand heat, handling, and cleaning. It should not increase the tendency of the surface to accumulate dust. Dri-Film, after application, is not adversely affected by heat up to 300° C. applied for short intervals. It is not susceptible to abrasion as the result of handling during assembly of apparatus or field maintenance. Finger prints and other dirt smudges can be easily removed from Dri-Film treated ceramics with a cloth or brush moistened with solvent.

Another use for the new compound is a laboratory one. The surface of water in laboratory glassware, such as measuring cylinders and hydrometers, is ordinarily curved, low in the center, because the liquid wets the walls and tries to climb up them. Such a curved surface, or "meniscus," is prevented if the inside of the container is treated with the water-proofing vapors from Dri-Film. Then the water surface is flat and its height may be read more easily.

### Radio-Frequency Riveting

Radio frequency energy now is used to detonate explosive rivets and speed production of aircraft, *E. I. du Pont de Nemours & Company* announced recently. The radio unit assures instant control of temperature in the firing tip, eliminating time consumed in heating an electric iron to operating degrees and in frequent changes from one tip temperature to another. This method is adaptable only to large scale production. The electric riveting iron, now used widely, is still preferred for many types of work.

Explosive rivets were introduced two years ago, breaking a bad bottleneck in fastening airplane sections where riveters could work from only one side. They are installed at a rate of 15 to 20 a minute, as contrasted with two to four a minute for most "blind" fasteners.

The rivet has a high explosive secreted in a cavity at the end of the shank. Heat applied to the rivet head detonates the charge. The explosion expands the charged end of the shank, forming a "blind" head and setting the rivet.

Engineers of *Radio Corporation of America* and of *Du Pont* developed the radio unit, which consists of an oscillator together with a specially prepared applicator to concentrate current directly into the

(Continued on page xl)

Proceedings of the I.R.E. June, 1943

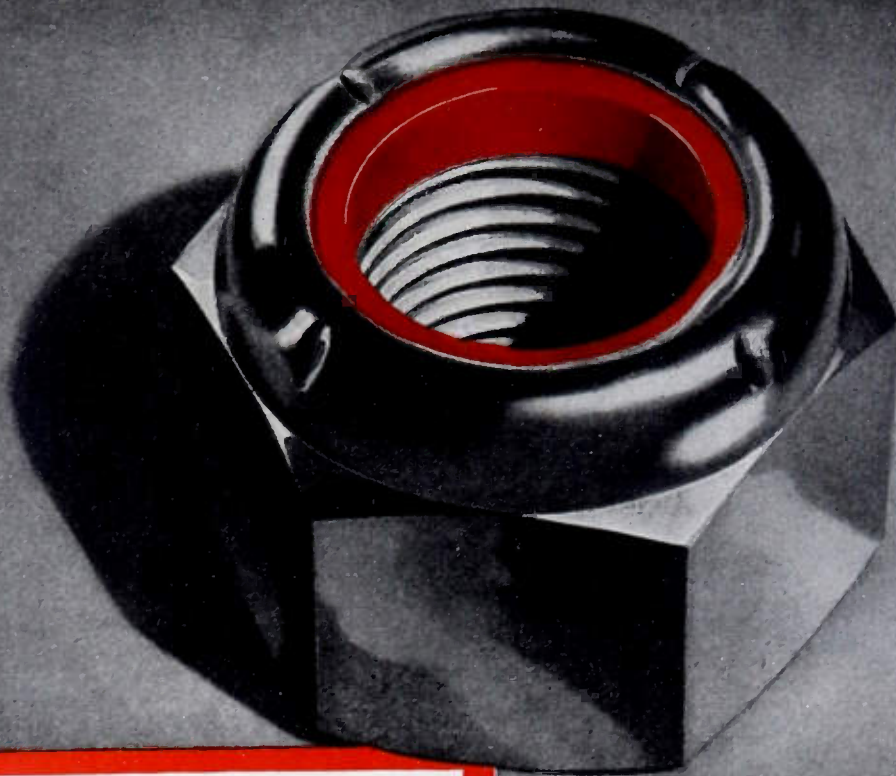

**IT'S THE NUT  
THAT LICKS  
FASTENING PROBLEMS**

**T**HINK of the tough jobs for nuts on planes, tanks, guns, naval vessels and production equipment.

And it's in these jobs you'll find Elastic Stop Nuts.

In fact, you'll find more of them than all other lock nuts combined.

The reason is, these nuts stay put.

Once on, they're set — don't shake loose even under severe vibration. And you can take them off and put them on many times and they won't lose their locking ability.

When peace returns, they're going to solve all kinds of manufacturing problems. They're going to relieve maintenance engi-

neers of frequent inspections and *save time and money in replacements.*

Our engineers have been solving fastening problems for years — the stickers of both peace and war.

Whenever you have a fastening detail to be met, feel free to call upon us. We'll gladly share our experience and recommend the right Elastic Stop Nut.

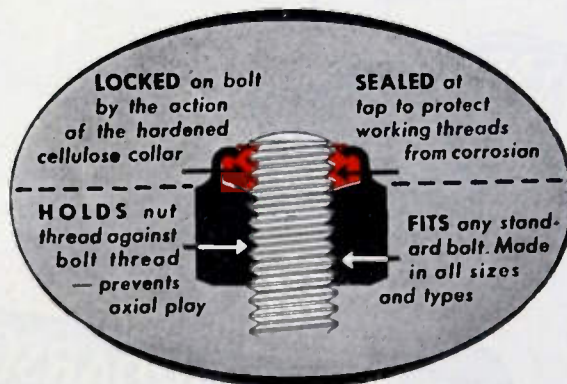

**ELASTIC STOP NUTS**

*Lock fast to make things last*

ELASTIC STOP NUT CORPORATION OF AMERICA  
UNION, NEW JERSEY





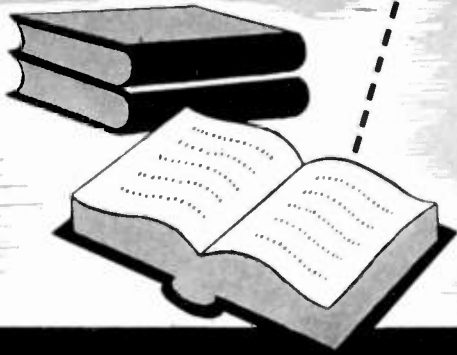

**LEADERSHIP**  
is just a word!

*but*  
**THORDARSON'S LEADERSHIP**  
IS AN ACCEPTED *fact!*

Today, in any language, the word Thordarson means the finest transformers that human skill can create. And, in almost every country, the leadership which Thordarson enjoys is reflected in the important services rendered by Thordarson transformers... services which have brought new comforts and enjoyments to peace-time, and which are helping more efficiently to consummate the jobs of war-time.



The prized Army-Navy "E" award has been granted to Thordarson for excellence in producing products for furthering the war effort.

**THORDARSON**

ELECTRIC MFG. COMPANY  
500 WEST HURON ST., CHICAGO, ILL.

*Transformer Specialists Since 1895*



**Army-Navy "E" Honor Roll**

**Solar Production Increased  
1200%, Receives Army-Navy "E"**

The Solar Manufacturing Corporation awarded the coveted Army-Navy "E" on April 10, 1943, has built up an outstanding record of performance since its inception. Founded in 1932, in the midst of a business depression, it has grown substantially and rapidly as a result of the fortunate combination of men. Originally, the company occupied several floors at 599 Broadway, New York City, turning out capacitors and electrical condensers principally for use in radio sets. It developed a large export business to all parts of the world.

Five years ago, the firm moved to larger quarters in its own office building and plant at Bayonne, New Jersey. A remarkable fact connected with Solar's move is that the majority of its workers went with the firm, traveling from their homes in Long Island, New York, Brooklyn, Westchester and surrounding communities. Today, after another large expansion, one-third of Solar's personnel is made up of the nucleus of New York residents who went along with the firm 5 years ago. Today Solar is turning out in one month twelve times the production it was turning out about the time of Pearl Harbor.

In the Spring of 1942 Solar opened a second large plant at West New York, N. J., to help break certain bottlenecks in production in critical industries. Organization of the new plant was rapid, and within a few months the firm was turning out units at a gratifying rate for use in the countless pieces of electrical apparatus used by our armed forces. The firm is currently readying a third large plant to open under its management in a large Mid-Western city this summer. Production here will equal the production in the Bayonne and West New York, N. J., plants combined.

The firm's personnel has always consisted of over 75 per cent women workers. Today it employs about 82 per cent women. Women have been highly satisfactory in handling most bench-work operations, assembling and stacking mica, etc. Men are employed only in the heavier jobs.

To reduce the inroads of the draft, the firm has made notable use of the specially developed talents and abilities of blind men and women, the deaf and other physically handicapped. Solar was the first firm to employ a blind woman after Pearl Harbor, and so successful was the experiment that today the firm employs more than a dozen totally blind workers as mica gaugers. Their highly developed sense of touch and dexterity enables them to gauge the thickness of tiny sheets of mica more quickly and efficiently than this operation was formerly done mechanically. The blind

*(Continued on page xxxviii)*



DESIGN  
ENGINEERS

CAN YOU USE A RESISTANCE MATERIAL  
IN WHICH  $I$  varies as  $E^4$ ?

# THYRITE

MAY BE THE ANSWER TO SOME  
OF YOUR CIRCUIT PROBLEMS

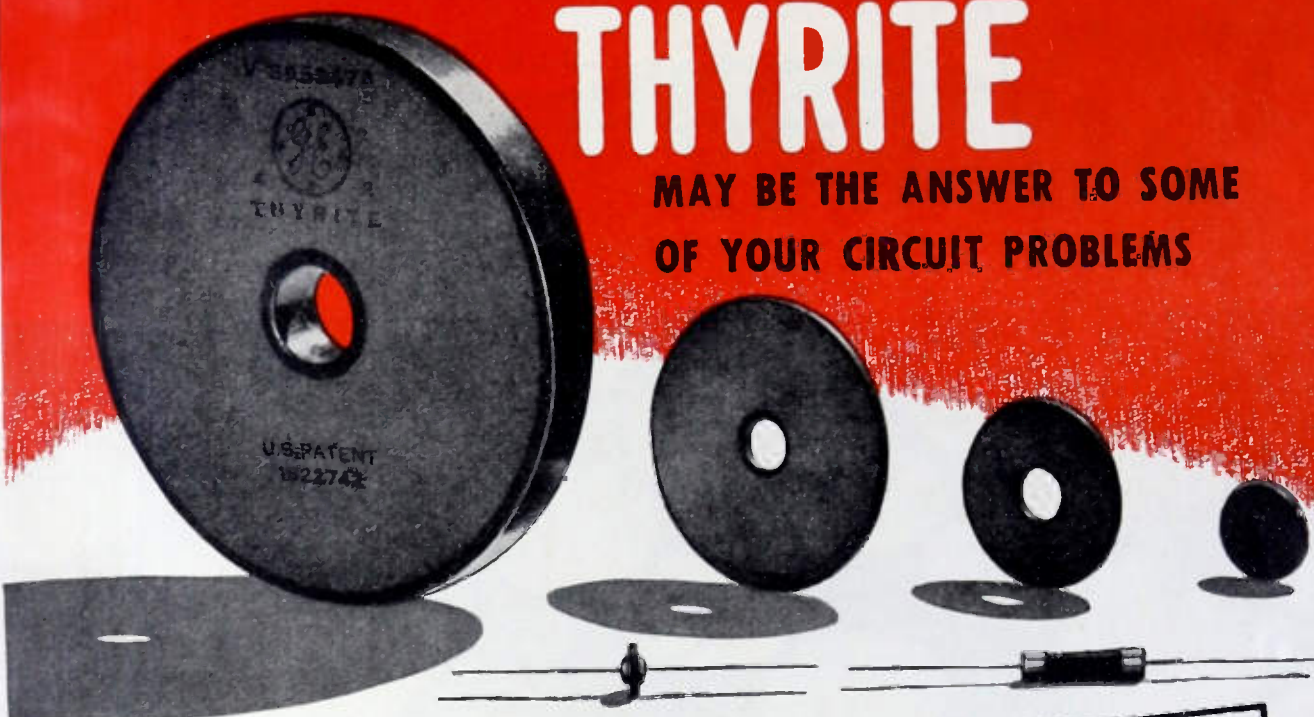

THYRITE\* is a silicon-carbide ceramic material, dense and mechanically strong, having nonlinear resistance characteristics—the resistance varying as a power of the applied voltage. Its resistance characteristic is stable, and substantially independent of polarity or frequency. Thyrite has been used for many years in many important applications, including electronic. Thyrite can be produced in various shapes and sizes (those which can be successfully molded).

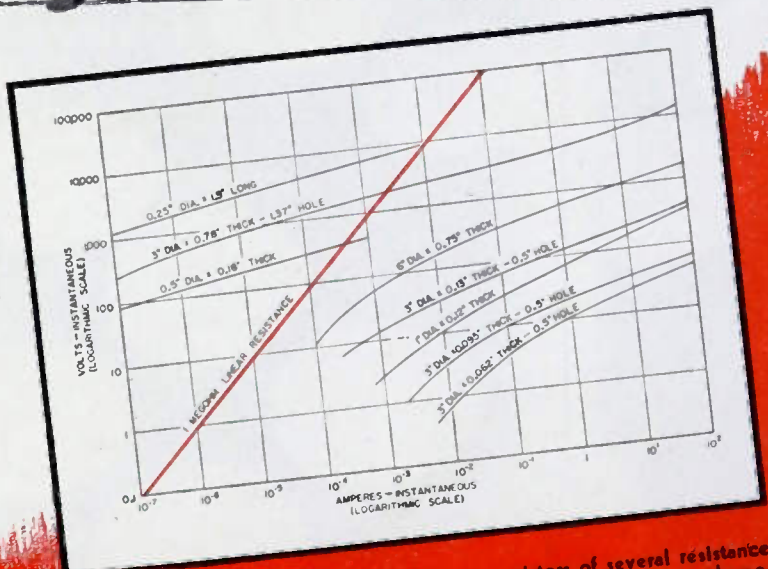

Typical volt-ampere characteristics of Thyrite resistors of several resistance levels and power ratings. Note that the nonlinear voltage-current characteristic extends over an extremely wide current range. Compare it with the characteristic (orange line) of a 1-megohm linear resistor.

The nearest G-E office can tell you what data should be submitted as a basis for a quotation. Or write direct to General Electric, Section 16-250, Pittsfield, Mass.

**GENERAL  ELECTRIC**  
406-12-5600

Here are some of its  
**MANY APPLICATIONS**

- For protective purposes (to limit voltage surges)
- As a stabilizing influence on circuits supplied by rectifiers
- As a potentiometer (The division of voltage can be made substantially independent of load current)
- For the control of voltage-selective circuits, either independent of or in combination with electronic devices

\*Reg. U.S. Pat. Off.

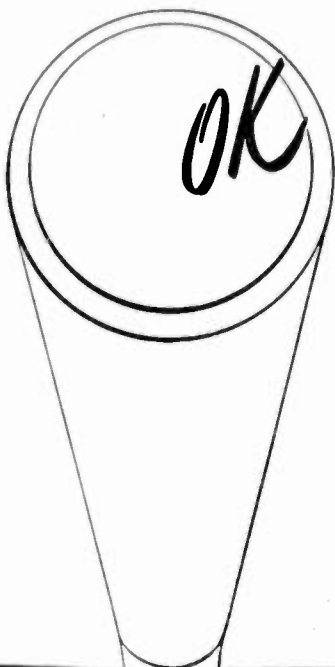

## FOR THE BIGGEST JOB IN THE WORLD!

**W**HETHER it's a simple strand of wire or a cathode ray tube, we at Philips have only one standard that merits the O. K. of our electronics engineering experts. That standard is perfection.

Today, our O. K.'s contribute towards the biggest job in the world. Today, Victory is our primary and exclusive concern.

Manufacturers for Victory — Cathode Ray Tubes; Amplifier Tubes; Rectifier Tubes; Transmitting Tubes; Electronic Test Equipment; Oscillator Plates; Tungsten and Molybdenum in powder, rod, wire and sheet form; Tungsten Alloys; Fine Wire of all drawable metals: bare, plated and enameled; Diamond Dies.

X-Ray Apparatus for industrial, research and medical applications.  
(Philips Metalix Corporation.)

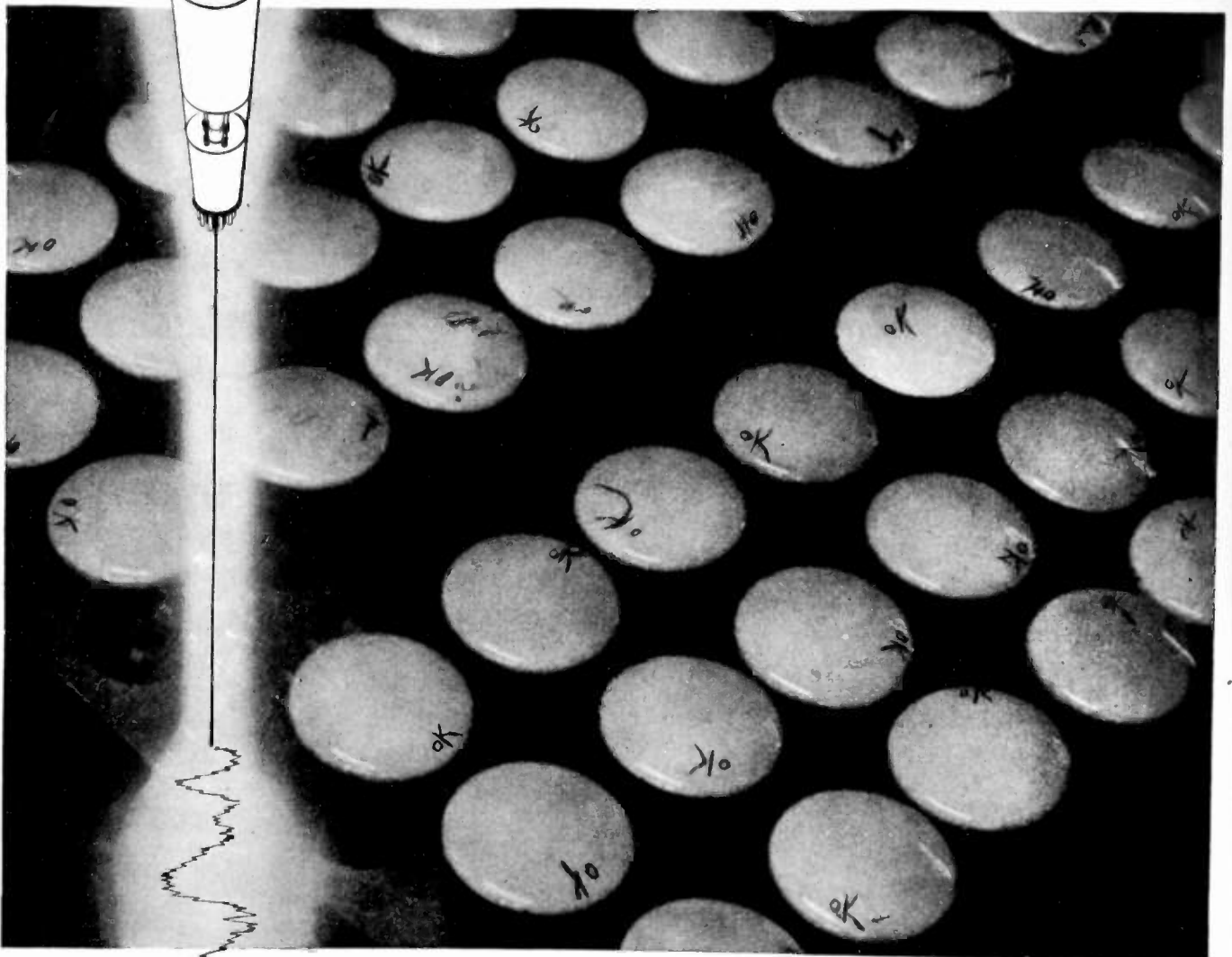

● **NORTH AMERICAN PHILIPS COMPANY, INC.**

*Electronic Research and Development*

Factories in Dobbs Ferry, N. Y.; Mount Vernon, N. Y. (Philips Metalix Corp.); Lewiston, Maine (Elmet Division)



# AMERTRAN helped Marconi send his first message across the Atlantic!



ONE of Marconi's headaches in the earlier development of long distance wireless communication was the lack of suitable transformers. It is, therefore, significant that he chose transformers manufactured by the AMERICAN TRANSFORMER COMPANY for the Nova Scotia station that sent his famous first message. Then only one year old, this Company had already acquired a reputation for solving the most difficult transformer problems. This is only one of the many historic applications of electric power in which AMERTRAN has been a participant.

Today, startling improvements are being incorporated in our products as a result of field reports of war service from the poles to the tropics. Many years of experience are being compressed into a few months. Details regarding these new economies, new characteristics, higher efficiencies with war-born ruggedness and ease of installation, will be revealed when peace comes. Meanwhile, the full production of our factories is being devoted to the war effort.

AMERICAN  
TRANSFORMER COMPANY  
178 EMMET STREET - NEWARK, N. J.



PIONEER MANUFACTURER OF  
TRANSFORMERS, REACTORS AND RECTIFIERS  
FOR ELECTRONICS AND POWER TRANSMISSION

# AMERTRAN

MANUFACTURING SINCE 1901 AT NEWARK, N. J.

## Army-Navy "E" Honor Roll

(Continued from page xxxiv)

workers being guided about the streets of West New York by their "Seeing Eye" dogs are a familiar sight to the townspeople.

The great powers of concentration of the deaf have proven valuable to the firm in all operations where the large number of deaf men and women are employed. Excellent results have also been secured in the cases where elderly men and women, formerly considered unemployable, are now working.

In awarding the Army-Navy "E" to Solar, the principal speakers, Brigadier-General A. A. Farmer, head of the Philadelphia Signal Corps Procurement District, and Rear-Admiral H. L. Brinser, Inspector of Naval Material, 3rd Naval District, New York City, praised management and labor for their complete understanding and spirit of cooperation. The impressive ceremonies were held in the grand ballroom of the Waldorf-Astoria Hotel in New York City on the evening of Saturday, April 10, 1943, before the 2,000 employees and their 2,000 guests. A unique feature of the ceremonies was the description of first-hand knowledge of the importance of electrical condensers by radio man Staff-Sergeant William J. Caldwell, just returned from Guadalcanal. His flying fortress, the "Goonie Bird," has a gallant record, and the young soldier is recovering from wounds sustained in service. He participated in the ceremonies by presenting silver "E" pins to the employees.

### Two Philco Divisions win White stars

The Storage Battery Division of Philco Corporation was awarded a white star for continued excellence of its war production on April 6th. The original Army-Navy "E" flag was awarded October 7, 1942.

The Chicago Division was awarded a white star April 28. This plant won its Army-Navy "E" flag November 5. Over 90 per cent of the employees at the Chicago plant are women.

### Remler Wins Army-Navy White Star Award

For maintaining its high production record for six months after winning the Army-Navy "E," Remler Company, Ltd., San Francisco, has been awarded a white star, according to E. G. Danielson, president of the company.

### Hallicrafters Again Receives Production Merit Award!

The Hallicrafters Company, Chicago who were awarded their Army-Navy "E" Burgee on September 9, 1942 have again been cited for continued excellence in the production of communications equipment by the addition of stars to their Army-Navy "E" Burgee.

This coveted award was accepted for the Hallicrafters Company by W. J. Halligan and R. W. Durst.

(Continued on page lii)

Proceedings of the I.R.E. June, 1943

**FOR OUTSTANDING ACHIEVEMENT  
IN MICROPHONE PRODUCTION  
AND ENGINEERING**

The Army and Navy "E," symbol of outstanding achievement, has been awarded to Shure Brothers. It is the highest badge of honor for the victories of the soldiers on the production front that must come before the victories of the soldiers at the fighting fronts. Shure Brothers are united in the determination to do their utmost to hasten the day of final victory for the democratic forces.

SHURE BROTHERS • 225 WEST HURON STREET, CHICAGO

**Throwing Rocks at the Axis**

In cutting quartz down into wafer-thin fighting Xtals the DX Crystal Company is pacing the industry. Speed, precision and dependability are prime watchwords of those who help make these vital parts.

**BUY MORE BONDS!**

**DX CRYSTAL CO.**  
GENERAL OFFICES: 1841 W. CARROLL AVE., CHICAGO, ILL., U.S.A.

**DX XTALS**  
the heart of a good transmitter



# RADIO RESISTORS for WAR SERVICE

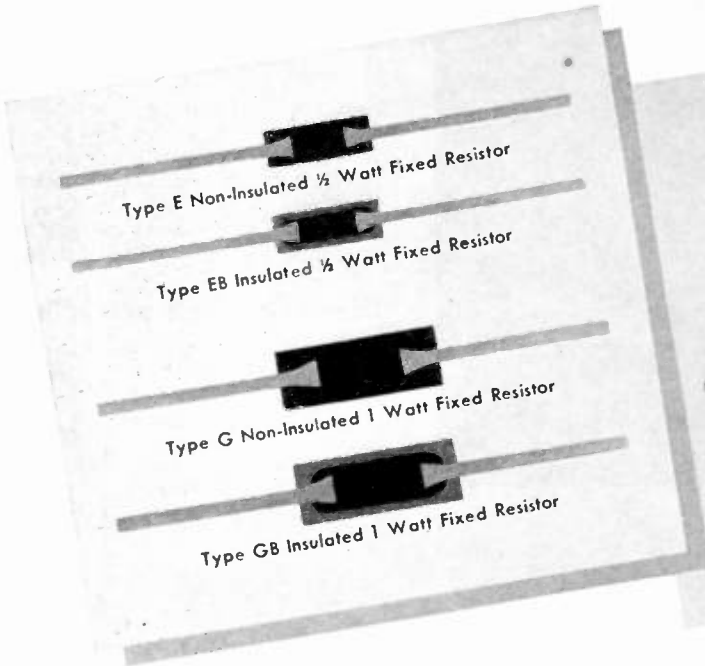

## FIXED

Available in standard RMA values from 10 ohms to 10 megohms

**BRADLEYUNITS**—These sectional views show the molded homogeneous resistor material, insulation, and imbedded lead wires which make these resistors especially suited for tough war service.

Actual experience in laboratory tests and war service has proved that Bradleyunits function perfectly through a temperature range from  $-60^{\circ}$  to  $+70^{\circ}$  C. Made of inert material, they do not require any special wax impregnation to pass the salt water immersion test. These fixed resistors will sustain an overload of ten times rating for a considerable period of time without failing. Bradleyunits are the smallest—rating for rating—fixed resistors available, the  $\frac{1}{2}$  watt unit being  $\frac{3}{8}$ " long and  $\frac{9}{64}$ " in diameter.

The manufacture of A-B fixed resistors is under continuous laboratory control. Uniformity of manufacture assures production of an exceptionally large proportion of resistors with  $\pm 5\%$  tolerance, while the remainder have the standard tolerances of  $\pm 10\%$  and  $\pm 20\%$ . Orders for resistors with  $\pm 5\%$  tolerance are solicited.

The A-B patented lead wire construction provides graduated tempering next to the resistor body and thus prevents sharp bends that would weaken the wire. Write for details today about Bradleyunits and Bradleyometers.



Type E  $\frac{1}{2}$  watt non-insulated Bradleyunit molded resistor

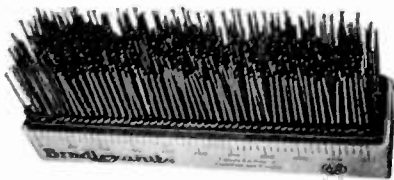

This indexed carton of 500 Allen-Bradley Fixed Molded Resistors speeds up production on the assembly line.

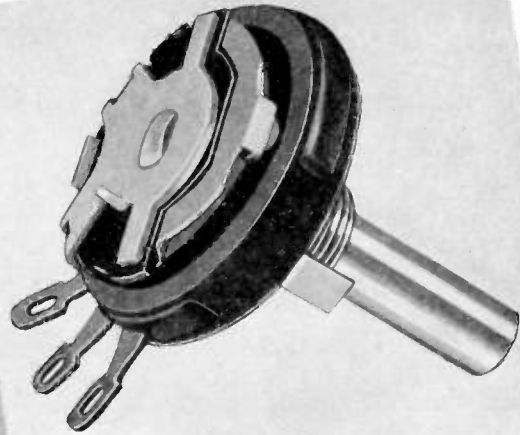

## VARIABLE

Total resistance values from 60 ohms to 2 megohms

**BRADLEYOMETER**—Here is the only continuously adjustable composition type resistor (only one inch in diameter) having a rating of two watts with a substantial safety factor.

The resistor material in a Type J Bradleyometer is molded with the insulation, terminals, face plate, and threaded bushing into a single unit. It is not a film, spray, or paint type resistor. During manufacture, the resistor material can be varied throughout its length to provide practically any resistance-rotation curve. Once the unit has been molded, its performance does not change. Heat, cold, moisture, or tough service do not affect it. Long life and quiet operation are assured by the use of a low resistance carbon brush which makes a smooth contact with the surface of the molded resistor.

Bradleyometers not only have a high rating and current carrying capacity, but, due to simple construction and few parts, are exceptionally reliable. There are no rivets, no soldered or welded connections, and no conducting paints. Can be supplied for rheostat or potentiometer uses, with or without a switch.



Sectional view of the resistor unit

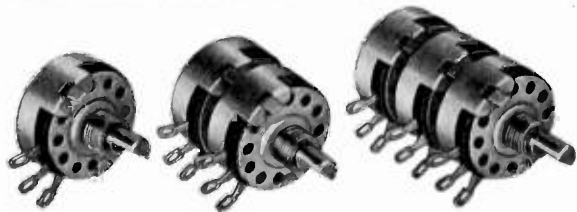

Type J Bradleyometer resistor units may be used separately or assembled to give dual or triple construction to fit any particular control need.

Allen-Bradley Co., 114 W. Greenfield Ave., Milwaukee, Wis.



# ALLEN-BRADLEY

## FIXED & VARIABLE RADIO RESISTORS

QUALITY

**You flick a  
switch up here . . .**



**S**AY you're "dropping in" unexpectedly on the Joneses for a visit some evening. Their "landing yard" is dark, so you push the button in your plane, and—presto!—the landing lights flash a welcome, and you alight smoothly and safely.

That's one of the logical and fascinating applications for radio remote control devices that you and I will need in the new age of flight that's dawning. There'll be countless others.

And so, while Jackson engineers are

working overtime on America's number one job, they're also planning ahead, thinking about the test equipment that will be needed to build, service, and maintain communications equipment, servomechanisms, and other powerful electrical tools of tomorrow's world.

Much of our present line of tube testers, oscillators, signal analysers, multimeters, etc., will change; some of it will not. In any case, it will be fine equipment, soundly engineered, sold at fair prices.

All Jackson employees—a full 100%—are buying War Bonds on a payroll deduction plan. Let's ALL go all-out for Victory.

  
**JACKSON**

*Fine Electrical Testing Instruments*

JACKSON ELECTRICAL INSTRUMENT COMPANY, DAYTON, OHIO

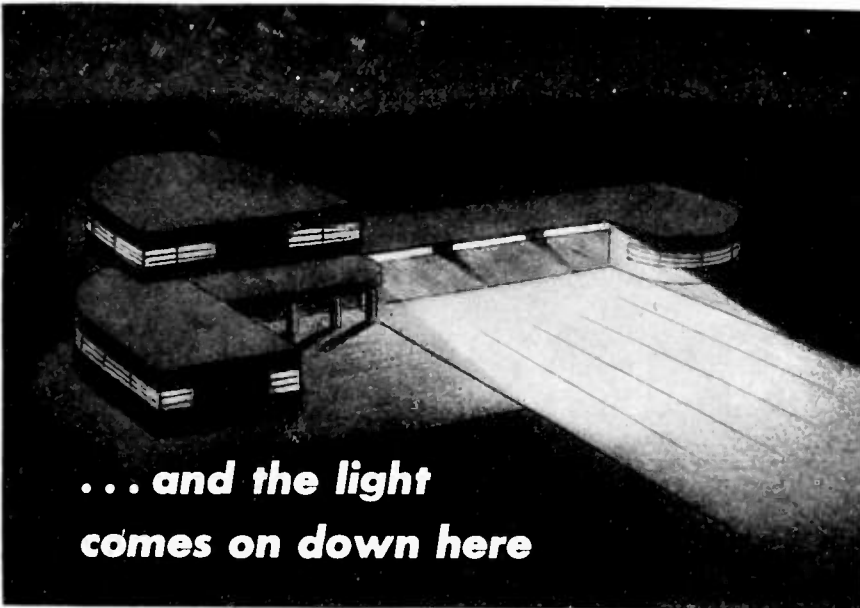

**. . . and the light  
comes on down here**

## New Equipment Notes

*(Continued from page xxxii)*

rivet head. As current is induced in the head, the heat it creates fires the charge. Radio energy not only gives instant temperature control but prolongs indefinitely the life of the firing tip. The tip is always cool, an important safety factor. The same tip can be used for any kind of rivet head.

### Improved Selenium Rectifier

An important addition to the I. T. & T. Selenium Rectifier line was recently announced by Henry H. Scudder, Manager of the Selenium Rectifier Division of Federal Telephone and Radio Corporation, manufacturing subsidiary in the United States of International Telephone and Telegraph Corporation.

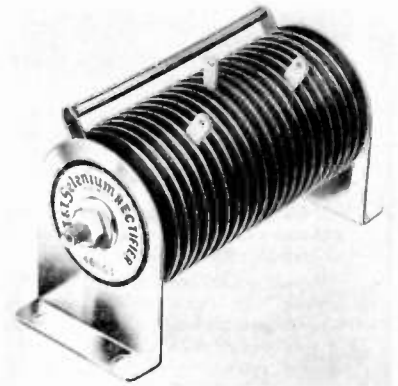

*I. T. & T. Selenium Rectifier  
Stack Assembly.*

The outstanding feature of this new rectifier is the protection provided against excessive humidity and moisture conditions, encountered particularly in marine service. This improvement is made possible by a special assembly, which lends itself more readily to moisture-proofing. The standard petal-shaped brass contact washer and pressure-limiting fibre washer are not used. Instead a single metal washer is employed, making it possible to apply the protective coating to all exposed surfaces.

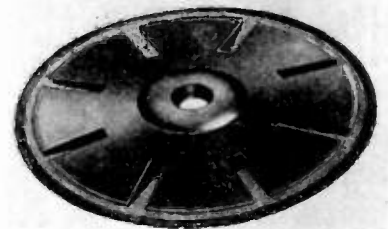

*Conventional Rectifier Disc with petal-shaped  
brass contact washer.*

The new rectifier incorporates, in addition, all the outstanding features of the conventional I. T. & T. Selenium Rectifier which was originated by I. T. & T. and

*(Continued on page xlii)*

# To Preserve the **FOUR FREEDOMS!**

... freedoms that are uppermost in the heart of every American. Workers in industry have toiled unceasingly to build peak production to enable their country to be the world's best equipped fighting forces to protect these freedoms.

The Hallicrafters employees have twice been cited by their country for excellence in production ... once with the Army-Navy "E" Burgee ... and now the addition of a star to this Burgee for continued excellence in producing communications equipment so vitally needed by our boys on all fronts.

This new honor will serve as an additional incentive to greater production.

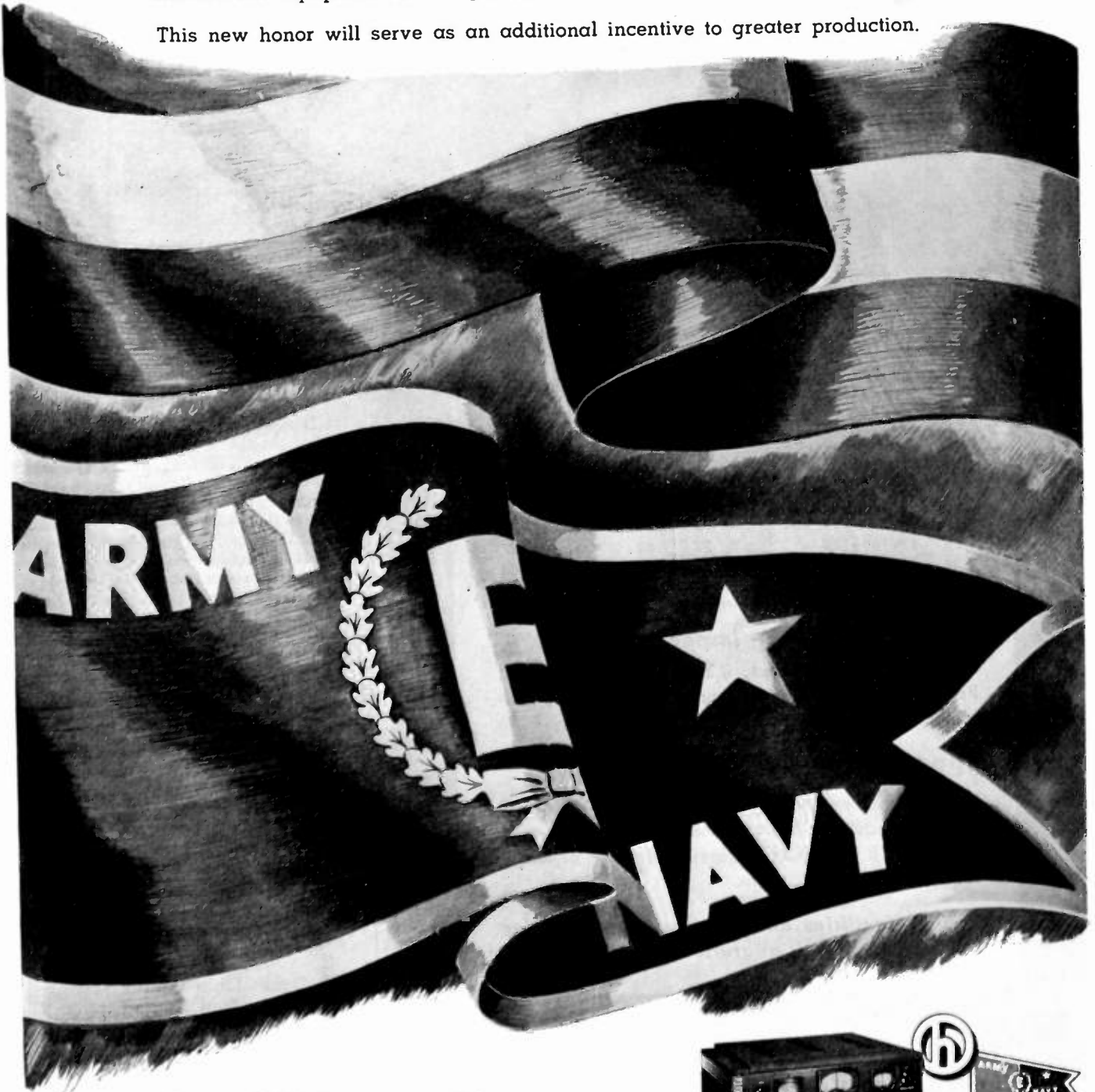

## hallicrafters

CHICAGO, U.S.A.



BUY  
MORE  
BONDS!

★ *In a Hurry...*

# REMLER

## Plugs and Connectors



Illustrations: PL-149 PL-114

### ARMY SIGNAL CORPS

#### Specifications

	PL				PLP		PLQ		PLS	
50-A	61	74	114	150	56	65	56	65	56	64
54	62	76	119	159	59	67	59	67	59	65
55	63	77	120	160	60	74	60	74	60	74
56	64	104	124	354	61	76	61	76	61	76
58	65	108	125		62	77	62	77	62	77
59	67	109	127		63	104	63	104	63	104
60	68	112	149		64		64			

#### Prompt Deliveries • Inspection

Army Signal Corps inspectors, in constant attendance at Remler plants, check parts in progress as well as completed units. This assures uniformity.

#### SPECIAL DESIGNS TO ORDER

Remler has the experience and is equipped to "tool-up" and manufacture plugs and connectors of special design — IN LARGE QUANTITIES. State requirements or submit blue-prints and specifications.

**Remler facilities and production techniques frequently permit quotations at lower prices**

*Manufacturers of Communication Equipment  
SINCE 1918*

REMLER COMPANY, Ltd. • 2101 Bryant St., • San Francisco, Calif.

## New Equipment Notes

(Continued from page xi)

often considered standard in the industry. Compactness, long life, light weight, and electrical and mechanical stability with no moving parts to wear out or cause failure are among the features retained in this special rectifier.

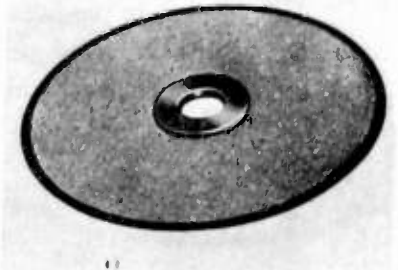

Rectifier Disc showing single metal washer which facilitates protective coating against corrosion.

Production of this special type of rectifier for the armed services is already under way, according to Mr. Scudder, and will be turned to the filling of commercial needs following the war

#### New Lightweight Thyatron Tube

Designed for applications where weight and space must be considered, a new thyatron tube with both a control and a shield grid for control applications, has been announced by the tube division of the *General Electric Electronics Dept.*, at *Schenectady, N. Y.* Designated as the GL-502, the new tube is a little over two and one-half inches long, weighs about two ounces, is inert-gas-filled and of all-metal construction. Applications for the new tube will be found in industrial welding and any general control equipment.

The control characteristic is stated to be practically independent of ambient temperature over a wide range. Since the grid current is low enough to permit the use of a high resistance in the grid circuit, the new thyatron has high sensitivity characteristics. The grid-anode capacitance is low enough so that the new tube is relatively unaffected by line-voltage surges. It has a maximum peak inverse anode voltage rating of 1300 volts, instantaneous current rating of 500 milliamperes, and an average current rating of 100 milliamperes. The cathode is quick heating and is rated at 6.3 volts, 0.6 ampere.

#### Dakar Linked With New York by New Radio Circuit

Extending direct radio communication service to another sector important in United Nations war strategy, a radiotelegraph circuit between New York and the West African key port of Dakar opened on March 10, 1943 by R.C.A. Communications, Inc.

(Continued on page lii)

Proceedings of the I.R.E. June, 1943





## LOOK FOR THE ANTENNA

Radio equipment has become the symbol of the modern instrument of war. The fast action, quick decisions and perfect coordination of today's war of movement demands perfect communications, and radio provides communication "on the move."

We are proud of the part that National Radio Equipment is playing.



NATIONAL COMPANY, INC., MALDEN, MASS.

# SKILL

## To Meet Your Specifications

**PERFORMANCE** is the real measure of success in winning the war, just as it will be in the post-war world. New and better ideas—production economies—speed—all depend upon inherent **skill and high precision** . . . For many years our flexible organization has taken pride in doing a good job for purchasers of small motors. And we can help in creating and designing, when such service is needed. Please make a note of Alliance and get in touch with us.

### ALLIANCE DYNAMOTORS

Built with greatest precision and "know how" for **low ripple—high efficiency—low drain and a minimum of commutation transients**. High production here retains to the highest degree all the "criticals" which are so important in airborne power sources.

### ALLIANCE D. C. MOTORS

Incorporate precision tolerances throughout. Light weight—high efficiency—compactness. An achievement in small size and in power-to-weight ratio. Careful attention has been given to distribution of losses as well as their reduction to a minimum.



*Remember Alliance!*  
—YOUR ALLY IN WAR AS IN PEACE

**A**  
**ALLIANCE**  
**MANUFACTURING CO.**  
**ALLIANCE . OHIO**

## Current Literature

The following books have been received by the Institute and submitted for review.

\***APPLIED ELECTRONICS**. By the Members of the Staff of the Department of Electrical Engineering, Massachusetts Institute of Technology \* \* \* *John Wiley & Sons, Inc., 440 Fourth Ave., New York, N. Y.* (738 pages+xxiii, cloth bound, 6×9½ inches, 342 figures.) Described as a first course in Electronics, Electron Tubes, and Associated Circuits, this book is one of the series of texts prepared by the M.I.T. staff as a revision of the entire presentation of basic technological principles of electrical engineering. To quote from the Foreword by Dr. Karl T. Compton, the book "should appeal to the student of ordinary preparation and also provide a depth and rigor challenging to the exceptional student and acceptable to the advanced scholar. It should comprise a basic course adequate for all students of electrical engineering regardless of their ultimate specialty. Restricted to material which is of fundamental importance to all branches of electrical engineering, the course should lead naturally into any one branch." Price \$6.50.

\***LABORATORY MANUAL IN RADIO**. By Francis E. Almstead, Kirke E. Davis and George K. Stone \* \* \* *McGraw-Hill Book Company, Inc., 330 W. 42nd Street, New York, N. Y.* (139 pages+vii, size 6×9 inches, paper covered, 50 figures.) This manual the authors state, is adapted for use with any elementary textbook in radio. The experiments are grouped under the broad topics found in all textbooks rather than as separate disconnected exercises. The book is particularly designed for high-school students in beginning classes and naval recruits. Price \$80.

## Booklets

### General Electric Issues New Bulletin on Power Package for Aircraft

The G-E power package for aircraft is described in a new, illustrated 4-page bulletin (GEA-3968) recently issued by the *General Electric Company, Schenectady, N. Y.* The bulletin illustrates and describes the three types in which the compact power package is furnished and explains the use for which each type is desirable.

The bulletin also describes in detail the unusual number of functions incorporated in each power package—motor, brake, gears, clutch, limit switch, and load release.

"TIPS ON MAKING TRANSMITTING TUBES LAST LONGER" is the title of a new booklet just issued by the *RCA Tube and Equipment Department*. The booklet is designed as an aid to all users of electronic tubes in the industrial field as

(Continued on page xlvi)

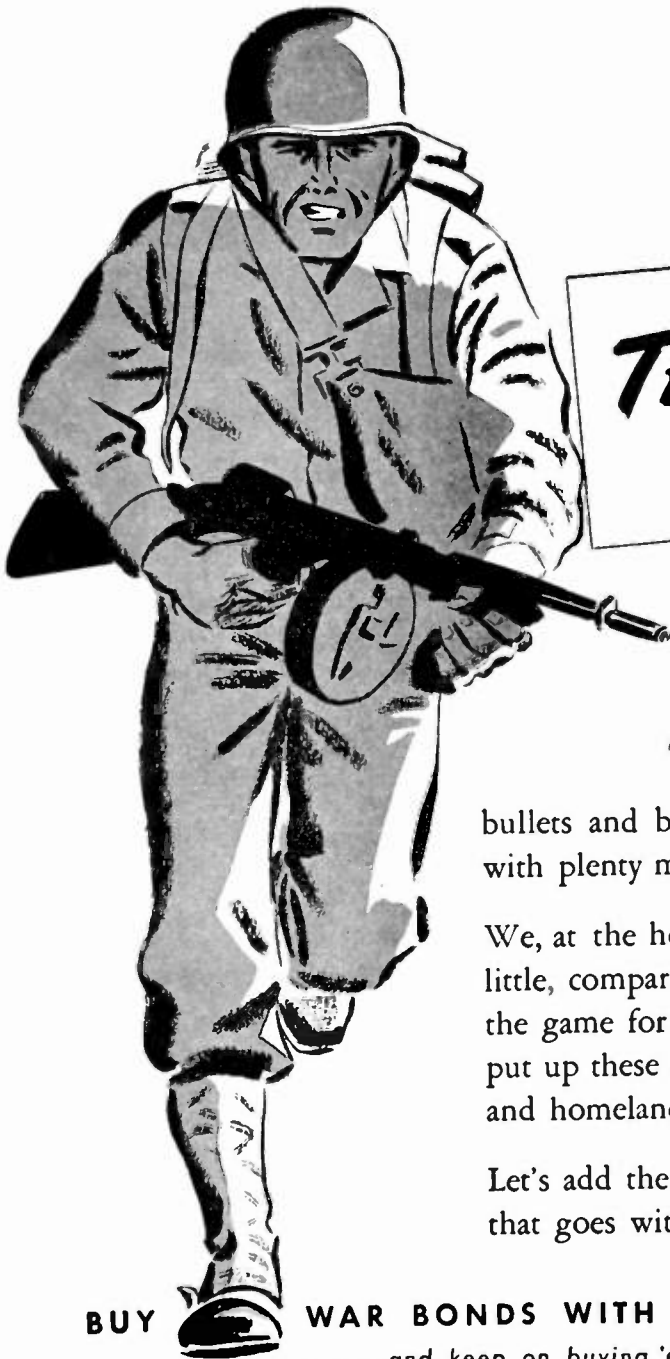

**THEY ASKED  
FOR IT!**

THEY CHALLENGED America's brains, brawn, bullets and bombs . . . now they're getting all *four* in *big doses*, with plenty more to come!

We, at the home producing end of the long supply line risk little, compared with our youth on the battle fronts, playing the game for the higher stakes of life itself . . . who willingly put up these stakes *every day* to preserve our cherished freedom and homeland.

Let's add the *extra steam* to increase production, and the power that goes with it, to insure a quick, complete victory!

**BUY WAR BONDS WITH EVERY UN-NEEDED DOLLAR . . .**

. . . and keep on buying 'em. They're the world's safest investment.



Cathode ray tubes



Weather-proof reproducers



Amplifier intercommunicating units



Transmitting type tuning condensers



Industrial sound control units

**RADIO . . . SOUND . . .**

**Rauland**

**. . . COMMUNICATIONS**

*Electroneering is our business*

**THE RAULAND CORPORATION . . . CHICAGO, ILLINOIS**

Rauland employees are all investing 10% of their salaries in War Bonds and will continue to do so.

# DEPENDABLE



## Bliley Crystals

**WE TOO, FIGHT  
... FOR PEACE!**



**Lafayette** is doing its part to win the war... and the peace that must surely follow. We play the important part of speeding the war effort by supplying emergency requirements of radio, sound and electronic parts to all branches of the armed forces as well as to manufacturers and sub-contractors. Lafayette is in there fighting to save you time by supplying all of your needs in one order—*quickly!*

**Now** it is no longer necessary to comb the field to find the various parts you need. Due to Lafayette's extensive buying facilities and large, diversified stocks, one order (no matter how large or how small) will bring quick deliveries on *all* of your requirements.

Free catalog—Radio, Sound  
and Electronic Parts—Dept. 6H3



**"Quick Deliveries on Radio, Sound and Electronic Parts"**

## Booklets

(Continued from page xlv)

well as among broadcasters. The tips, according to the booklet, have been proved in the most exacting applications of communications. (12 pages, illustrated, size 4½×7½ inches.)

Pointing up its message with the analogy of the good motor car tire that will stand up under the strain of operating at 100 miles an hour, but won't last as long, the booklet describes how radio tubes also wear out sooner when they are operated at maximum voltage capacity. It gives detailed instructions for the right method of putting tubes into operation by a slow start, explaining what happens to curtail the life of a tube when the full current is turned on at once.

Five general "good rules to follow" are listed; a chapter on how to double the life of hard-to-get tungsten filament tubes, another on six ways to make mercury-vapor rectifier tubes last longer, one on tube resting periods and one explaining why cooler tubes last longer. The final chapter explains how engineers are building longer life into transmitting tubes without raising their ratings. Single copies are available by request from *RCA Commercial Engineering Section, Harrison, N. J.*

### Type U Test Set

Of special interest to telephone and other communication engineers is a newly-revised catalog which describes the well-known Type U Test Set. This sturdy, portable Wheatstone bridge is designed especially for communication purposes in measuring resistance and capacitance. It is best adapted for locating faults on telephone and telegraph cables, for identifying faulty wires in a cable, for measuring conductor resistance, for locating grounds and crosses by Murray, Varley and Hilborn loop tests, and for locating opens by capacitance tests.

For a copy of this new 8-page illustrated catalog, address the *Leeds & Northrup Company, 4934 Stenton Ave., Philadelphia, Pa.*, and ask for Catalog E-53-441(1), "Type U Test Set."

### Type S Test Set

Manufacturers of wire, motor windings, electrical instruments and meters, and electrical household appliances, as well as many laboratories, repair shops and maintenance departments, where routine resistance tests are made, will be interested in a newly-revised, illustrated catalog describing the L&N Type S Test Set. It is a general-purpose Wheatstone bridge with self-contained galvanometer and battery. This test set is said to be simple in arrangement, easy to operate, thoroughly reliable, and conveniently portable for shop, laboratory and field.

A copy of this 8-page publication will be sent to anyone interested. Just address the *Leeds & Northrup Company, 4934 Stenton Avenue, Philadelphia, Pa.*, and ask for Catalog E-53-400(1), "Type S Test Set."



# THE "GLOBE" IN GLOBE WIRELESS



**G**LOBE WIRELESS has long been the major avenue of communication throughout the entire Pacific Basin, handling radio messages between continents, countries, islands, and ships at sea.

"Our equipment has transmitted millions of words since it was designed for us by Heintz and Kaufman," states Globe's President R. Stanley Dollar.

"Gammatron tubes form the heart of our transmitters, and many of these tubes have stood up under continuous operation as long as 12,000 hours before failing."

A typical Globe transmitter, such as daily puts San

*Proceedings of the I.R.E. June, 1943*

Francisco in contact with Chungking, has two HK-654 Gammatrons in the final. Operating on high frequencies with an output of 3 kilowatts, Globe's signals can readily be heard around the world.

To engineers designing military transmitters, we will gladly furnish data on the unique efficiency and stability of Gammatron tubes at high and ultra-high frequencies.

**HEINTZ AND KAUFMAN, LTD.**  
SOUTH SAN FRANCISCO • CALIFORNIA, U. S. A.

*Gammatron Tubes*

## Radio Education Notes

To promote a better understanding of electronics and its significance in the future of industrial development, *P. R. Mallory & Co., Inc.*, has scheduled a series of four lectures by Dr. Paul R. Heyl to be given in Indianapolis on March 1 and 29, May 3 and June 7.

The lectures will develop the history, theory and practical applications of electrons, and indicate the progress which the science of electronics has made in gaining control of nature's forces for employment by mankind. Dr. Heyl is one of America's foremost physicists, for many years known throughout the country for his work with the U. S. Bureau of Standards. Recently retired from the Bureau, he has been retained as consultant for Mallory.

Although the lectures are planned primarily for the Mallory engineering, sales and production personnel, a number of individuals from manufacturing plants, colleges, high schools, broadcast stations, training schools for the armed forces, and other interested organizations in the central Indiana area have been invited. A special invitation to attend has been issued to all Indiana members of the Institute of Radio Engineers. Reprints of all lectures will be available.

### Tube Picture Book

The Radio Corporation of America, RCA Victor Division, has prepared an assembly of charts for visual instruction in the constructional details of various types of vacuum tubes. This "Tube Picture Book" has been prepared especially for use in war training centers. Consisting of 16 large-size pages (17"×22"), it contains 8 charts which are reprinted on one side only of the sheets to facilitate their use for display mounting.

Such topics as the following are shown in graphic or textual form in the charts: electron beam sheets formed by grid wires, materials used in radio tubes (a strikingly comprehensive list), the structure of a transmitting beam tube, the structural parts of a typical metal tube, the structure of a single-ended metal tube, the internal structure of an acorn pentode and an illustration of its small dimensions, the schematic arrangement of electrodes in a cathode-ray tube, the structure of the electron gun in a cathode-ray camera tube, the structure of an electron-ray ("magic eye") tube, the structure of gas tetodes, and the structure of a typical glass tube. Thus there are shown structural details of representative receiving, transmitting, cathode-ray, and special tubes.

Individuals in the United States and Canada can obtain a copy of the RCA Tube Picture Book from RCA Tube Distributors or direct from the Commercial Engineering Section, Radio Corporation of America, Harrison, N. J. at a price of ten cents. These charts can be supplied only for the United States and Canada because of certain wartime restrictions.

(Continued on page 1)

Proceedings of the I.R.E. June, 1943



Industrial's high standard of quality parallels that of the famous Hallicrafters HT-4B transmitter in the field of communications.

**INDUSTRIAL  
CONDENSERS  
ARE ON EVERY  
BATTLEFRONT  
WITH THE  
WORLD-FAMOUS  
hallicrafters  
COMMUNICATIONS  
EQUIPMENT**

PAPER, OIL AND ELECTROLYTIC CAPACITORS

**INDUSTRIAL  
CONDENSER  
CORPORATION**

1725 W. NORTH AVE., CHICAGO, U. S. A.

DISTRICT OFFICES IN PRINCIPAL CITIES  
QUICK DELIVERY FROM DISTRIBUTOR'S STOCKS

# G. E. builds FM's future on these four facts

TRANSMITTERS

STUDIO EQUIPMENT

ELECTRONIC TUBES

ANTENNAS

RECEIVERS

**GENERAL  ELECTRIC**

NO OTHER MANUFACTURER  
OFFERS SO MUCH FM EXPERIENCE

COMPLETE STATION EQUIPMENT  
**FM • TELEVISION • AM**



### **G. E. Builds Both FM Transmitters and Receivers**

G.E. is the only manufacturer with experience in building the complete FM system — FM broadcasting equipment and FM home receivers. Radio research and volume production for war are yielding new possibilities for further improving FM equipment.



### **G. E. Has Program and Equipment Experience**

Three years of broadcast experience in its own proving-ground Station W85A, Schenectady, will enable G.E. to help new FM stations get started quickly. General Electric's experience also includes equipping more than a third of the 36 commercial FM broadcast stations now in operation.



### **G. E. is Telling Public the Advantages of FM**

A powerful G-E advertising campaign in the nation's big-circulation magazines and the thrice-weekly nation-wide G-E program over C.B.S.—Frazier Hunt and the News—are pre-selling the public on the advantages of FM—and are steadily building an expanding post-war market.



### **Survey Proves Vast Increase in FM Acceptance**

An independent consumer survey reports that: The public already strongly approves FM; 85% call it a definite improvement over conventional broadcasting; present owners of G-E FM receivers are the most enthusiastic of all FM owners! . . . Electronics Department, General Electric, Schenectady, N. Y.

## Radio Education Notes

(Continued from page xlviii)

### FM Radio Used in 80 San Francisco Public Schools

The San Francisco Board of Education for several years has been operating its own experimental frequency modulation station, KALW, located at the Samuel Compers Trade School. Foreseeing the possibilities of supplementary radio education, last fall the board purchased and installed an FM radio receiver of the General Electric Company in each of the city's 80 public schools to direct specially chosen educational and musical programs to school children. The broadcasts include current events, opera, musicals, symphony, plays and speeches by men prominent in world affairs. Not only are prearranged programs used during school hours, but the radios furnish entertainment to the pupils on rainy days when it is necessary for them to remain inside the buildings during their recess periods. When the weather permits, music is piped to the school yard for outdoor folk-dancing.

School executives and teachers are said to be enthusiastic about the results being obtained. Emerson School received the first of the FM radios to be delivered, and started at once participating in these educational broadcasts. Miss Pauline Ryder, principal, explains that the program most popular with the pupils is the "school-cast," a special arrangement of current events, broadcast three times a week by newscaster Dwight Newton of KYA, San Francisco.

"The children follow these school-casts with intense interest," Miss Ryder states. "They spend considerable time in previous class-room preparation and in review. Based on up-to-the-minute events, the newscaster asks five questions which he thoroughly discusses and answers. The pupils participate in the program by writing the questions on the blackboard for further discussion, and following geographically with a large map.

"We feel that in the future, particularly after the war is over, the type of specially directed educational broadcasts we are now using will be greatly expanded and improved. Children are familiar with radio entertainment and they have quickly adopted it in the class room. Here at Emerson School, we are pleased with the foresight of our Board of Education in realizing the future of radio education. I am sure teachers and pupils throughout our school system echo our sentiments."

The San Francisco Board of Education's FM transmitter, KALW, is one of seven such stations being operated by public school systems in the United States. Other stations owned by public schools in the country are: KSDS, San Diego; WBEZ, Chicago; WIUC, University of Illinois; WMBE, Memphis; WYNE, New York; and the Buffalo, N. Y. public schools.



**DELIVERIES FOR YOU...  
INSTEAD OF TO YOU...**

● Although everything we make today goes to war, it is going to work for you just as surely as though we could deliver it for your own use in your own plant. For today all of America is in business for Victory, and whatever helps the war effort helps us all. *✓ ✓ ✓* Right now "Connecticut" equipment is hard at work all around the globe — precision electrical products, different in detail, but not in basic design, from the ones you'll be using after victory. *✓ ✓ ✓* Once this war is won, and present military secrets become open knowledge, you'll know about "Connecticut" products from your partners, the boys who are using them today. Chances are you'll be using many electrical devices, born of this war, to speed and control peacetime production. We hope to continue working with you then.



**CONNECTICUT TELEPHONE & ELECTRIC DIVISION**



MERIDEN, CONNECTICUT



**THE ONLY REAL  
HERMETICALLY-SEALED RESISTORS**

*...that will stand the most severe salt water  
immersion and temperature shock tests*

STYLE "B"  
90 WATTS

STYLE "C"  
50 WATTS

STYLE "A"  
120 WATTS

STYLE "D"  
35 WATTS

STYLE "MFA"  
PRECISION  
7.5 MEGS. MAX.

STYLE "E"  
20 WATTS

STYLE "MFB"  
PRECISION  
4 MEGS. MAX.

STYLE "F"  
10 WATTS

**SPRAGUE**

**KOOLOHM**

**POWER WIRE WOUND RESISTORS AND METER MULTIPLIERS**

These Koolohms, designed for the toughest resistor applications facing the industry today, again emphasize the importance of exclusive Koolohm construction features combined with Koolohm engineering ingenuity in solving almost any wire wound resistor problem.

For Koolohms are entirely different from



conventional wire wounds. There are no other resistors like them. No other type of resistor can match their performance on exacting jobs. AVAILABLE WITH NON-INDUCTIVE WINDINGS. Get the facts! Write for catalog and sample Koolohms. SPRAGUE SPECIALTIES COMPANY (Resistor Division), North Adams, Mass.

## New Equipment Notes

(Continued from page xlii)

Formerly, telegraphic messages between the United States and French Africa were routed by way of London. With this direct radio circuit in operation, message traffic will move much faster and more cheaply since a 15 per cent reduction in the rate has been announced.

The new service is to be operated in cooperation with the Administration of Posts, Telegraph & Telephone of French West Africa. Other direct radiotelegraph circuits of the same company with African terminals link New York and Monrovia, Liberia; Leopoldville, Belgian Congo; Brazzaville, French Equatorial Africa, and Cairo, Egypt. A radiophoto circuit also operates between New York and Cairo.

A direct radiotelegraph circuit between New York and Quito, Ecuador, is being tested by the company preliminary to the start of regular commercial operations within the next few days. Until now, Ecuador, where a complete cable monopoly has existed, has been the only South American country closed to radiotelegraphic communication. The Government of Ecuador is cooperating with the company in setting up this new radio service. With the addition of Quito, sixteen Latin American nations will be linked with this country by its direct radiotelegraph circuits. It is stated that the radio equipment for the Quito station has been designed and built by the RCA Victor Division of Radio Corporation of America.

## Army-Navy "E" Honor Roll

(Continued from page xxviii)

### Shure Brothers Win "E" Pennant

On Sunday, April 18, the entire organization of Shure Brothers met at Thorne Hall, Northwestern University to receive the coveted Army-Navy "E" pennant and employee pins for excellence in war production. Lieut. Colonel Nathan Boruszak made the address and presentation, and Mr. S. N. Shure, General Manager, accepted the award. Lieut. Commander G. C. Norwood made the presentation of pins, and Marion De Block represented the employees in accepting the pins.

This company has been engaged in the engineering and manufacturing of special Microphones, for use in battle equipment by the U. S. Army and Navy.

### White Stars to RCA Divisions

Robert P. Patterson, Under Secretary of War, announces the awarding of a white star to the Radio Corporation of America's plant at Harrison, N. J., on April 12. The Harrison plant won its Army-Navy "E" flag on September 8, 1942. "The white star, which the renewal adds to your Army-Navy production Award Flag," said Under Secretary Patterson, "is the symbol of appreciation from our Armed Forces for your continued and determined effort and patriotism."

The same award has been won by the Radiomarine Corporation of America which originally won its Army-Navy "E" pennant in December, 1942. To its achievements in March, 1943, has been added the U. S. Maritime Commission "M" pennant and Victory Fleet Flag in recognition of its production record in supplying radio equipment to cargo vessels.

Proceedings of the I.R.E.

June, 1943

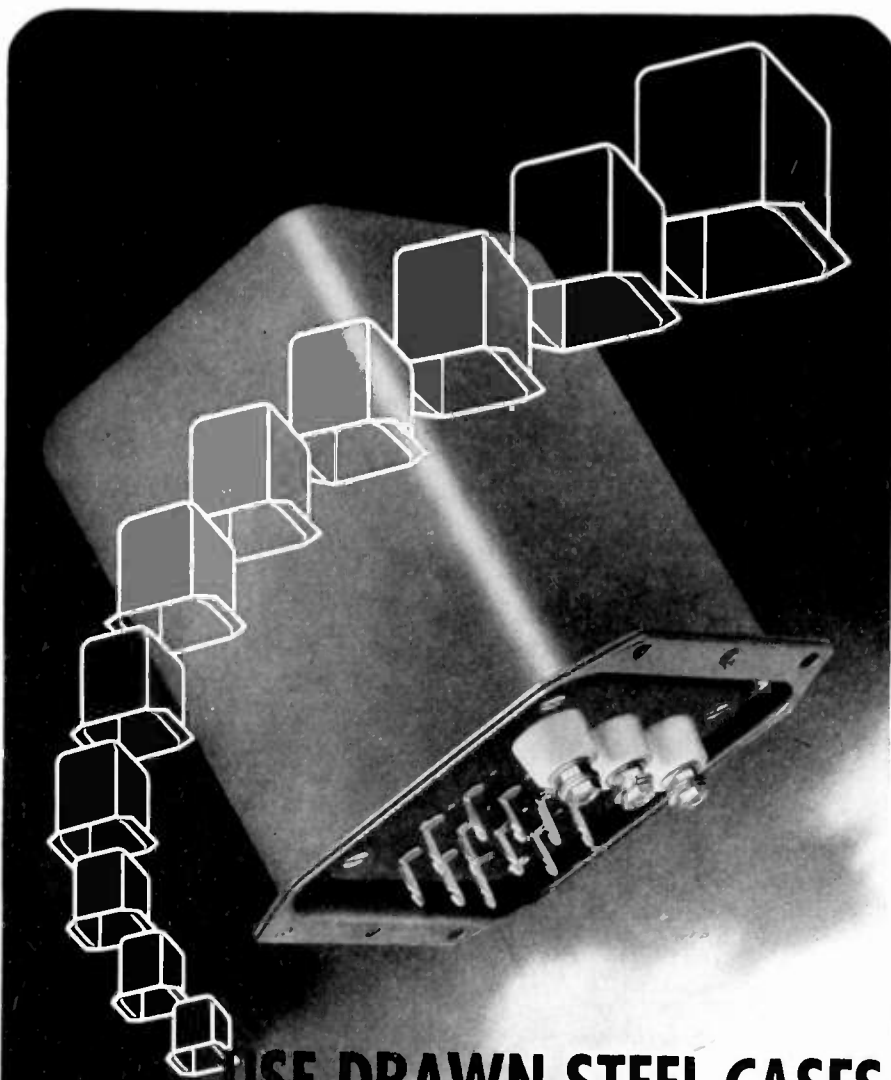

## USE DRAWN STEEL CASES For Toughness, Shielding and Better Sealing

A one-piece Drawn Steel Transformer Case without seams or spot welds is, because of its simplicity, the strongest type of mechanical construction. Then, too, the one-piece construction provides an unimpeded electrical and magnetic path resulting in better shielding from outside electrical disturbances. Absence of seams also assures maximum protection against atmospheric conditions—guarantees longer transformer life.

If your transformers have to pass the most rigid tests, Potted Transformers in Drawn Steel Cases are probably your answer. Write for information on this Drawn Steel Case line!

**Pioneers of the Compound Filled  
Drawn Steel Transformer Case**



**CHICAGO TRANSFORMER  
CORPORATION**  
3501 WEST ADDISON STREET • CHICAGO

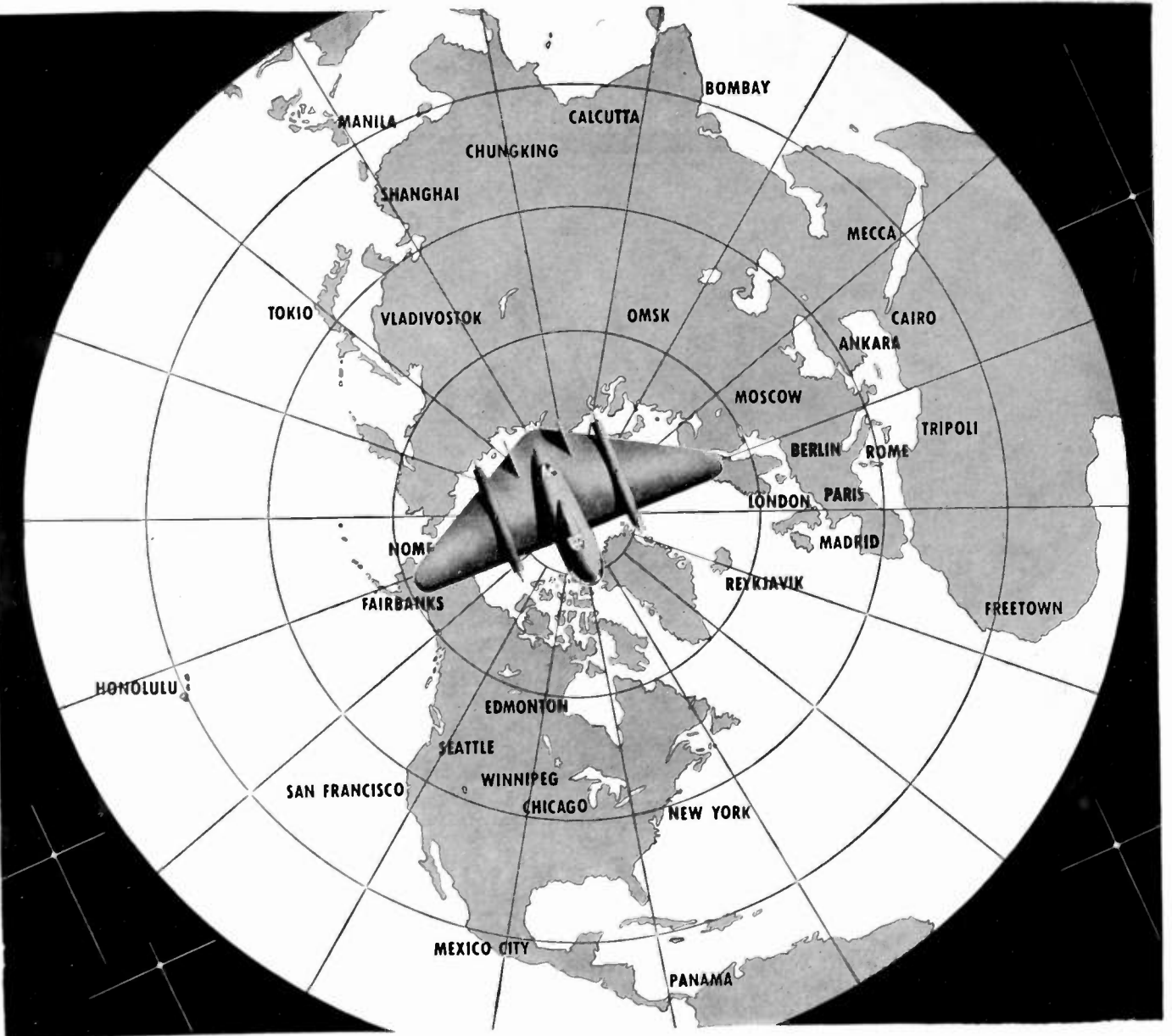

## WORLD CONCEPTS ARE CHANGING

*With the world map projected from over the North Pole, we see Seattle some 5,000 miles nearer to Calcutta and all of Asia and Europe as our next door neighbors. The World is unchanged . . . it is our concept that is new.*

Polar flying is changing our concepts of distance. So it is with every advancement in science. It alters our viewpoint and reflects itself in our daily lives. Electronics is one of the great scientific developments of our time.

The post-war world will be an age of electronics . . . new ways of living in which our industries, our communications, our transportation and even our personal activities and pleasures will be affected. Manufacturers who will produce the machinery, the goods and the equipment we will buy and use will have to think in terms of electronics to meet our new concepts.

TUNG-SOL looks forward to peacetime uses of the transmitting, receiving and amplifying electronic tubes that we are now making for our government. We will be glad to share our experience and knowledge with manufacturers who wish to incorporate electronics as part of their product. Our advisory staff of research engineers is at your service.



**TUNG-SOL**  
*vibration-tested*  
**RADIO TUBES**

# TRIPLETT

*Combat Line* INSTRUMENTS



*Thin  
Line*

MODEL

TRIPLETT

Deliveries under government requirements are facilitated by two large sub-contracting organizations combining to greatly increase Triplett output.

TRIPLETT ELECTRICAL INSTRUMENT CO. • BLUFFTON, OHIO

## WORK AT MAXIMUM SKILL

*Now Open for Electrical and Electronics  
Engineers and Physicists*

**I**F YOUR job is not equal to your highest skill, if you have creative ability which seeks expression—you will be interested in the openings we have.

Men who know electronics, the development and production of radio and electronic tubes, can find opportunity now in our Pennsylvania and Massachusetts plants.

Aggressive and independent research has made Sylvania one of the top producers of radio tubes in the United States.

This is a company with which an able man can grow.

These positions afford the opportunity to make a direct and important contribution to the war effort. And, for the right men, there are excellent post-war possibilities with a company well versed in the new and expanding field of electronics.

If you are not now working at your highest skill, write to the Industrial Relations Dept., Sylvania Electric Products, Inc., 500 Fifth Ave., New York, N.Y.



**SYLVANIA** ELECTRIC PRODUCTS, INC.

## POSITIONS OPEN

The following positions of interest to I.R.E. members have been reported as open. Apply in writing, addressing reply to company mentioned or to Box No. ....



PROCEEDINGS of the I.R.E.  
330 West 42nd Street, New York, N.Y.

### ELECTRICAL ENGINEERS— PHYSICISTS

Radio or ultra-high frequency experience desirable but not essential. Interesting radio tube development work. Good location, Lancaster, Pennsylvania. Address replies to Personnel Dept., RCA, Victor Division, Harrison, N.J. If you are using your full skill, full time on war work, please do not apply.

### RADIO AND COMMUNICATIONS

Commonwealth of Australia War Supplies Procurement requires high type man to take charge of Radio and Communications Department in Washington, D.C. Qualifications: general knowledge of radio and communications gained in either purchase or sales field. Draft exempt. Excellent opportunity for right man with salary commensurate. For interview, write Box 293.

### ENGINEERS—PHYSICISTS

Radio engineers, electronic engineers, electrical engineers, physicists. A non-profit research laboratory engaged in urgent war research must increase its scientific staff. Men or women (college graduates) with experience in vacuum tube circuit design, construction of aircraft radio equipment and design of small electromechanical devices are needed. Salaries range from \$3,000 to \$8,000 depending upon experience, ability, education and past earnings.

Apply by mail to Airborne Instruments Laboratory, Columbia University Division of War Research, Box 231, Mineola, N.Y.

### RADIO ENGINEERS AND TECHNICIANS

A progressive company with a sound background in radio and electronics needs, at once, several men with training and experience in any phase of the radio industry. The work open is vital to the war effort but offers a promising post-war future for the right men. College degree or equivalent experience necessary. Men now engaged at highest skill on war production should not apply. Write Box 294.

### INSTRUCTORS IN RADIO AND ELECTRICITY

50 civilian instructors needed immediately for Army Air Forces Radio Instructor School. Subjects of instruction: Direct current and alternating current electricity, vacuum tubes, standard radio receivers and transmitters; international Morse code, telegraph and radiotelephone procedure. Salaries follow Civil Service starting from \$2,000 per year. State experience, education, code speed, personal data. Positions open immediately. Saint Louis University, Army Air Forces Radio Instructor School, 221 N. Grand Boulevard, Saint Louis, Mo. A. H. Weber, Technical Director.

### RADIO ENGINEER

Junior engineer, preferably with amateur radio experience, needed as assistant in administrative office of important company. Must know radiotelegraph. Write Box 286.

### RADIO, MECHANICAL AND ELECTRICAL ENGINEERS

Several men needed immediately for work on government radio equipment. Men with at least three years experience in design and development of quality equipment desired. College degree or equivalent experience necessary. Any person now employed at highest skill on war production work should not apply. Address Box 280.

(Continued on page lvi)



# New! A MOTOR DRIVEN POWERSTAT

Now you can control large amounts of power with a simple push button

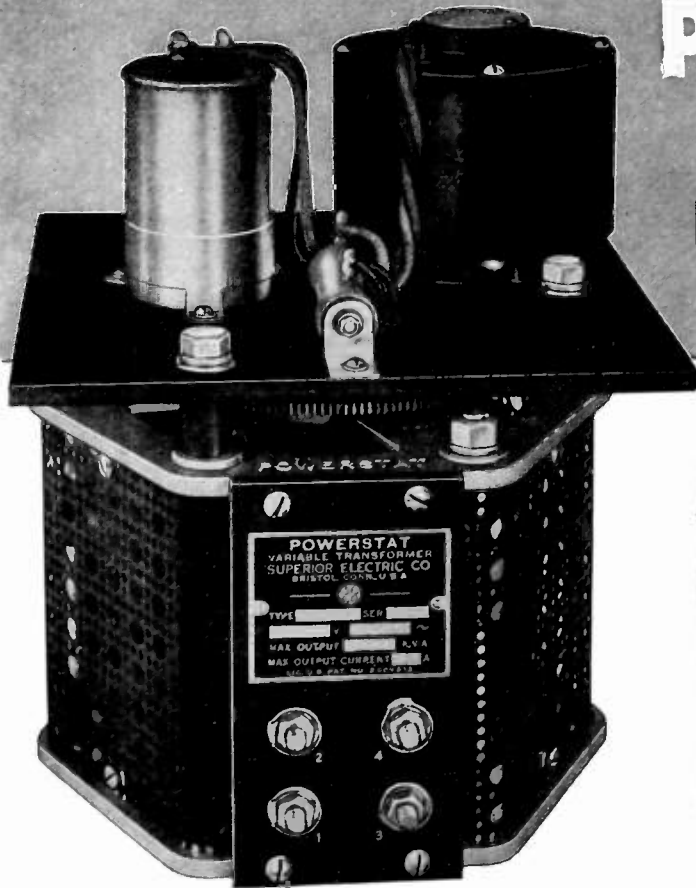

**N**O LONGER is it necessary to sacrifice range and smoothness of control by using antiquated, inflexible tap changing devices and heavy wiring to control A.C. voltage and power. SECO has solved the problem of obtaining a continuous, distortionless and simple control of large amounts of power. A standard line of MOTOR DRIVEN POWERSTATS in sizes up to 75 KVA for single or polyphase operation on 115, 230 or 440 volt circuits is available. You can select a standard unit for your application or where necessary, special designs can be manufactured to meet your requirements.

Engineered combinations of POWERSTAT VARIABLE VOLTAGE TRANSFORMERS and a HIGHLY DAMPED SYNCHRONOUS DRIVING MOTOR of low fundamental speed are the answer to efficient, quick, convenient and continuous control of power.

## STANDARD AIR COOLED POWERSTAT



For more than five years SUPERIOR ELECTRIC COMPANY has specialized in CONTINUOUSLY VARIABLE VOLTAGE TRANSFORMERS and has won the confidence of THE ARMED FORCES AND INDUSTRY. Investigate POWERSTAT VARIABLE TRANSFORMERS for your control problem. Standard types are manufactured for single or polyphase operation on 115, 230 or 440 volts.

## SECO AUTOMATIC VOLTAGE REGULATOR

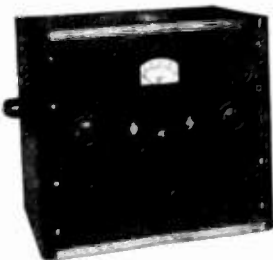

Incorporating a Synchronous Motor Drive, SECO DISTORTIONLESS AUTOMATIC VOLTAGE REGULATORS deliver constant output voltage with variations of applied voltage and frequency. The output is unaffected by changes in power factor or magnitude of load. Available in sizes up to 75 KVA.

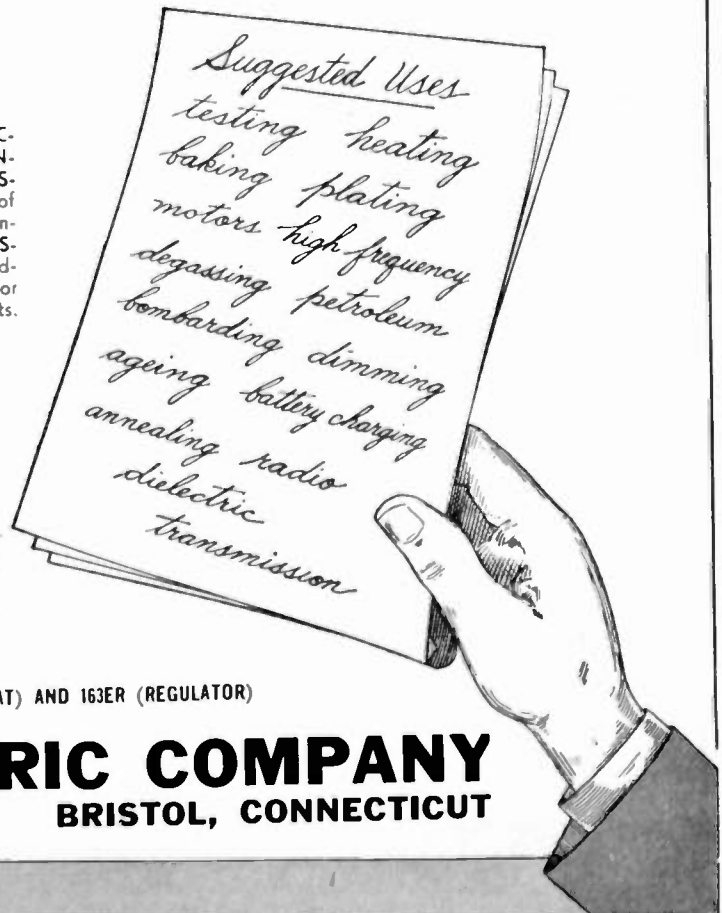

SEND FOR BULLETINS 149ER (POWERSTAT) AND 163ER (REGULATOR)

**SUPERIOR ELECTRIC COMPANY**  
172 LAUREL STREET  
BRISTOL, CONNECTICUT

**DO YOU NEED**  
*the "Impossible"*  
*in Deliveries*  
**OF PILOT LIGHT ASSEMBLIES?**

DIALCO WILL  
HELP YOU  
"DELIVER  
THE GOODS"  
ON TIME!



*Preferred where variable light intensity is required; Series D.V. uses superior mechanical shutter; Series D.P. uses polaroid discs.*

"Beat the Promise" with Dialco! Leaders in this field, we are geared for high-speed service!  
Request NEW Catalogue, attention Dept. D-41.

WHAT ARE YOUR DELIVERY SCHEDULES? LET US HELP YOU MEET THEM.

**DIALCO**

SEND SPECIFICATIONS, SAMPLES AND BLUEPRINTS WILL BE SUBMITTED PROMPTLY.

**DIAL LIGHT CO. of America INC.**

90 WEST STREET • NEW YORK, N. Y.

**2 BOOKS EVERY "WAR-TORN" ENGINEER NEEDS!**



**A-C CALCULATION CHARTS**

By R. LORENZEN

This new Rider Book greatly reduces the time required for alternating current engineering calculations—speeds up the design of apparatus and the progress of engineering students. Two to five times as fast as using a slide rule! Thousands of enthusiastic users.

A-C CALCULATION CHARTS are designed for use by civilian engineers and engineers of the armed forces who operate in the electrical—communication—power—radio—vacuum tube—telephone—and in general, the electronic field. Invaluable for instructors as well as students, and also administrative officers who check engineering calculations.

\$7.50

160 pgs.

(9 1/2 x 12 in.)

**CATHODE RAY TUBE AT WORK**

The Cathode Ray Tube at Work is the accepted authority on the subject. The cathode ray tube in the Oscillograph and its application to electronic and industrial work is fully discussed. Profusely illustrated. 338 pages . . . . . \$3.00

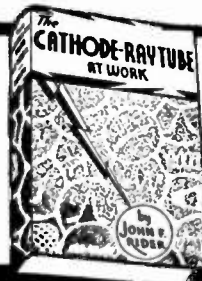

**JOHN F. RIDER PUBLISHER, Inc.**

404 FOURTH AVENUE, NEW YORK CITY

Export Division: Roche-International Elec. Corp., 100 Varick St., N. Y. C. • Cable: ARLAB

(Continued from page liv)

**RADIO ENGINEERS AND TECHNICIANS**

In critical war industry. Opportunity for several competent men in research and production engineering on Government contracts. Work is with a company well known in the radio industry, located in a Michigan city. Send full particulars of your experience and photo. Address Box 284.

**NAVAL ORDNANCE LABORATORY**

The Naval Ordnance Laboratory, located in Washington, D.C., is a research development agency of the Bureau of Ordnance, concerned with the design of new types of naval mines, depth charges, aerial bombs and other ordnance equipment, including measures for the protection of ships against mines.

This laboratory needs physicists and electrical engineers with electronics experience, mechanical engineers familiar with the design of small mechanical movements or mechanisms, and personnel for technical report writing and editing. Write to Naval Ordnance Laboratory, Navy Yard, Washington, D.C.

**RADIO ENGINEERS AND TECHNICIANS**

Technicians with specialized engineering knowledge. Perform efficient maintenance and adjustment of radiotelegraph operating office equipment. Technical knowledge of special radio and related equipment needed in the service. Must be capable of sending and receiving the International Morse Code at a minimum speed of 20 words per minute and must hold a Federal License as required by law.

Radio Instructor on operation and maintenance of radio transmitting equipment.

Maintenance Engineers to keep machinery, mechanical equipment, radio-communication operating machines, and radio instruments in good repair. Construct and install new apparatus. A combination of maintenance mechanic and machinist duties.

Maintenance Electricians to take charge of all plant maintenance pertaining to all the electrical facilities, wiring and machinery. Must be capable of doing mechanical construction of communication equipment and electrical wiring, and work from blueprints. Address Box 283.

**RADIO ENGINEERS AND MONITORING OFFICERS**

Applications for positions with the Federal Government of radio engineer at \$2,600 to \$8,000 a year, radio monitoring officer at \$2,600 and \$3,200 a year, and radio mechanic technician at \$1,440 to \$2,600 a year, will be accepted at the Washington, D.C., office of the United States Civil Service Commission. Qualified persons urged to apply immediately. No written tests. Applicants will be rated on the basis of their statements in the application, subject to verification by Commission. For full information, and application forms, write to United States Civil Service Commission, Washington, D.C.

**ENGINEERS**

The salary is open and depends only upon the ability and experience of the engineer.

1. Electronic and radio engineers to design electronic navigation and communication equipment for aircraft.
2. Mechanical engineers familiar with and interested in the design of small precision equipment and familiar with shop practice and tools.
3. Engineers familiar with the design of components for electronic equipment.
4. Technical men able to write technical material for instruction books.

These positions can be permanent for the right men. Excellent opportunities for advancement.

(Continued on page lviii)



*Where Sustained  
Power is Vital..*

Depend on

# TAYLOR TUBES

Wherever our boys are fighting, Taylor Tubes are daily proving their reliability, efficiency and extra stamina. In many battle positions they operate twenty-four hours a day — providing the power to help keep essential communications going through — delivering the same dependable service that established and maintained Taylor's peacetime reputation for high quality tube performance.

Taylor factories are turning out more tubes than ever before — supplying them where needed for the all out Victory program. After V Day, the same quality Taylor Tubes that are meeting today's urgent demands will provide "More Watts Per Dollar" service for all.

✓ TRANSMITTING    ✓ ELECTRONIC  
✓ RECTIFIER        ✓ INDUSTRIAL

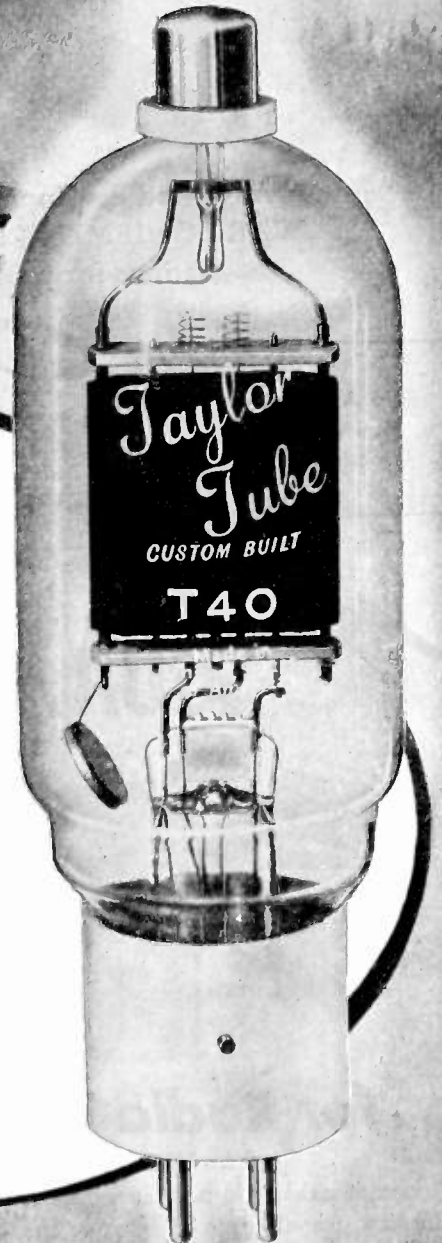

*Taylor*

HEAVY

CUSTOM  
BUILT

DUTY

*Tubes*

TAYLOR TUBES INC., 2312-18 WABANSIA AVE., CHICAGO, ILLINOIS

skilled hands and willing hearts . . .

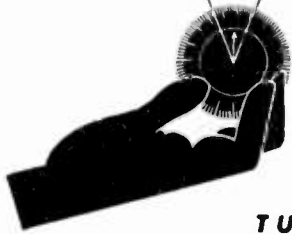

TUNED FOR BATTLE

Advanced developments by *Doolittle* for critical WAR EQUIPMENT today means better communications for your peacetime needs tomorrow.

*Doolittle*  
RADIO, INC.

Builders of Precision Radio Communications Equipment  
7421 S. Loomis Blvd., Chicago, U. S. A.

To Assure Victory  
Buy More U. S. War  
Bonds and Stamps



# COAXIAL CABLES

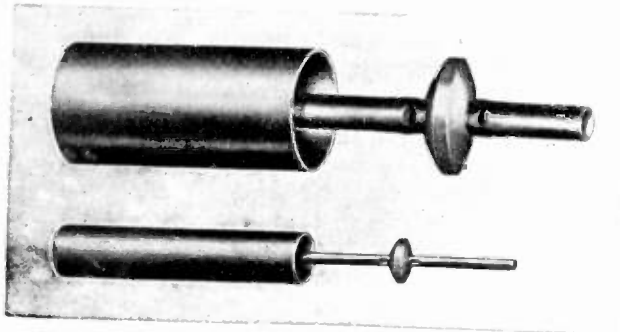

## ... for Radio Transmission Lines

The VICTOR J. ANDREW CO., pioneer manufacturer of coaxial cables, is now in a position to take additional orders, in any quantity, for all sizes of ceramic insulated coaxial cables and accessories. The Andrew Co. engineering staff, specialists in all applications of coaxial cables and accessories, will be pleased to make recommendations to meet your particular requirements.

### "Attention!"

If coaxial cables are your problem . . . write for new catalog showing complete line of coaxial cables and accessories.

*ANDREW*  
**VICTOR J. ANDREW CO.**  
363 East 75th Street, CHICAGO, ILLINOIS  
ANTENNA EQUIPMENT

(Continued from page lvi)

Engineers with experience are preferred, but the right persons do not need experience if they have the ability to learn and the required aptitude. Applicants may be male or female. Persons already engaged in war work cannot be considered.

Write directly to Chief Engineer, Bendix Radio Division, Bendix Aviation Corp., Baltimore, Maryland giving complete details of education and experience.

### ELECTRONIC ENGINEERS

Engineers with backgrounds for acoustics, supersonics, broadcasting, frequency modulation, or ultra-high frequencies. Applicants should not be subject to immediate draft call and should not be engaged at their highest skilled war work. An engineering degree is desirable but not required.

Women with similar technical knowledge and experience will be considered.

Company is a large electrical manufacturer and is within twenty minutes commuting distance of New York City. Salaries are commensurate with education and experience. Address Box 287.

### RADIO ENGINEER

Experienced in the manufacture and testing of ultra-high-frequency apparatus; must be capable of taking complete charge of war projects. Splendid opportunity. War workers at highest skill need not apply.

Inquiries will be kept confidential. Please state age, experience, and salary expected. Write Box 288.

### RADIO INSTRUCTION-BOOK WRITERS

Thorough knowledge of radio principles and ability to describe in simple terms the operation of UHF circuits required. Work relates to instruction books for electrical apparatus. Excellent opportunity to do essential work in very essential war industry. Salary depends upon qualifications and experience.

Replies solicited from Engineers, Patent Attorneys, Teachers and others qualified.

Write complete qualifications and salary desired to Hazeltine Electronics Corporation, 1775 Broadway, New York, N.Y.

### RADIO ENGINEER

Mathematical knowledge to include trigonometry and elementary calculus. Must be familiar with all types of circuits for reception and transmission on frequencies up to 200 mc/s. Knowledge of transmission lines, aerial arrays, television and cathode-ray-tube technique desirable. Must also have knowledge of radio test equipment and must understand any circuit diagram.

Prefer man conversant with manufacture, repair and fault location on all types of transmitters and receivers. Address Box 289.

### RADIO ENGINEER

EDUCATION: Minimum of two years college in Electrical Engineering.

EXPERIENCE: Minimum of two years in radio test or engineering, or five years in electrical control work (power station or telephone central-office wiring, etc.).

Must be of a type qualified to interpret and clarify with inspectors and responsible executives electrical specifications, problems of manufacture, test and inspection. Address Box 290.

### ELECTRO-MAGNETIC ENGINEER

Unusual opportunity for engineer with vision for new ideas in design work with nationally known, long established firm in Eastern Pennsylvania, now 100% on war work. Firm large enough to make remuneration attractive, small enough to insure recognition. Training in design of relays, timers and solenoids would be helpful. Write Box 285.

(Continued on page lx)



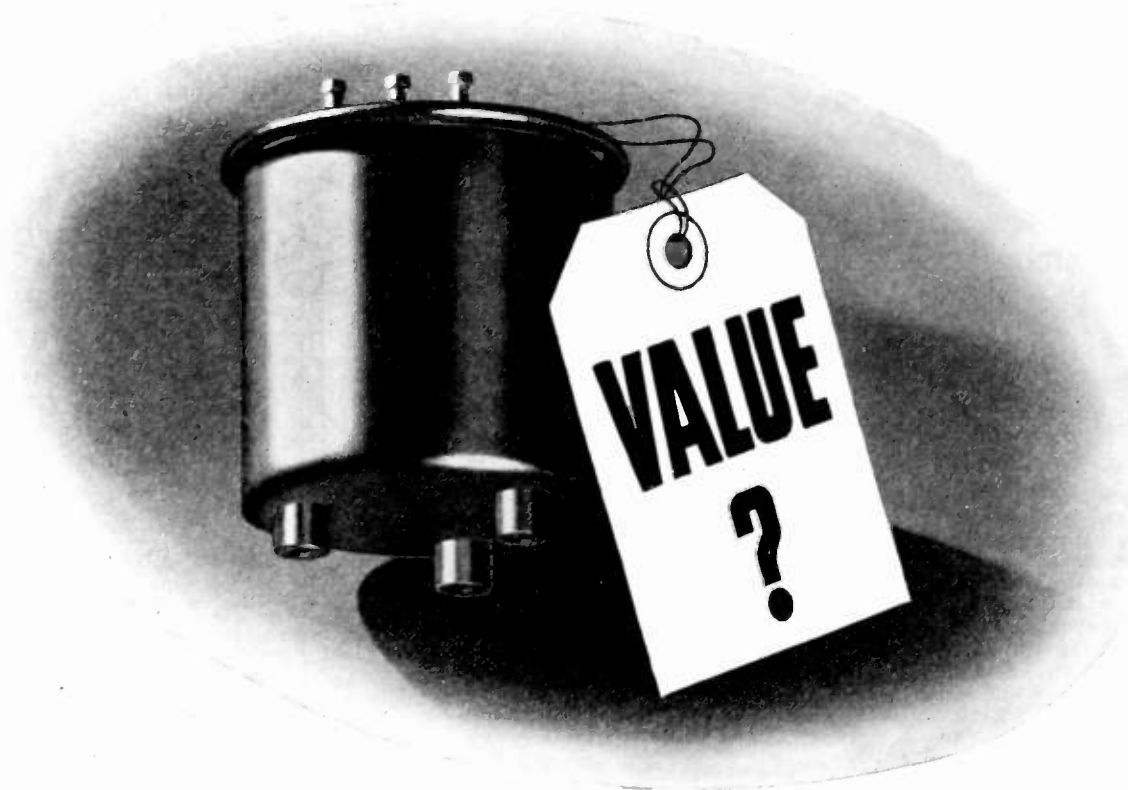

*W*ith the fate of a quarter-million-dollar airplane...and the precious lives of its crew...so dependent upon the performance of the Communications system, even so seemingly simple a part as a transformer becomes vitally important. Its value is not measured in dollars and cents, but in the service it performs.

ROLA, now streamlined for war work, is producing transformers, head sets, choke coils and other communications equipment for Army and Navy aircraft in unprecedented volume—built to standards of perfection never before

attempted "commercially." This has meant a transition in processes, in equipment, in testing and inspection, but thanks to the experience gained from twenty years of leadership in the radio field, the task has been accomplished, speedily and effectively.



**We can do still more:**

*Today, Rola's greatly expanded facilities are dedicated completely to making materials of war. If transformers... or related electronic items... are a part of the product you make, we're sure it would be to your advantage to discuss your requirements and your problems with us. The Rola Company, Inc., 2530 Superior Avenue, Cleveland, Ohio.*

★ **ROLA** ★

**MAKERS OF THE FINEST IN SOUND REPRODUCING AND ELECTRONIC EQUIPMENT**

**OUT and BACK by Radionics**

**EICOR**  
*Dynamotors*

Dynamotors go into action right from the take-off. They furnish the necessary high voltage and current for radio communications, direction finders, compasses, and other aircraft equipment which enable our men to reach their objective, attack and return safely.

EICOR DYNAMOTORS have earned their fine reputation through years of exacting service in both the commercial and military communications fields.

**EICOR INC.** 1501 W. Congress St., Chicago, U. S. A.  
DYNAMOTORS • D. C. MOTORS • POWER PLANTS • CONVERTERS  
Export: Ad Auriema, 89 Broad St., New York, U. S. A. Cable: Auriema, New York

## DEVELOPMENT—DESIGN

### Electro-Acoustical

Several communications engineers needed by progressive company in expanding engineering department.

### Telephone Development

Graduate electrical engineer needed; good theoretical knowledge of acoustics desirable; some experience with magnetic circuits, acoustical measurements.

### Laboratory Engineer

For laboratory measurements and tests on a-f communications apparatus, a graduate electrical engineer. To design and supervise equipment for production testing; must maintain laboratory standards. Familiarity with government specifications and inspections procedure desirable.

### Communications—Signaling

Design engineer familiar with application and molding technique of plastics. Should have several years of design experience on small electrical apparatus; understanding of magnetic and electrical circuits desirable.

### Permanent—Post-War

Positions concerned now with war contracts and planning post-war developments. Technically expert staff going places. Those now employed at highest skill in war industry need not apply. Communicate with Chief Engineer, giving background and salary requirements. Write, phone or wire.

**GREAT AMERICAN INDUSTRIES, INC.**

70 Britannia Street, Meriden, Connecticut

(Continued from page lviii)

### PATENT ATTORNEY

Patent Attorney to join small Patent Department. Write Personnel Director, Brush Development Company, 3311 Perkins Avenue, Cleveland, Ohio.

### RADIO ENGINEER

Opening in engineering department of concern making communication apparatus. Prefer college graduate with ultra-high-frequency experience, but lack of experience in this field will not bar an adaptable man.

Duties involve developing, designing and carrying the product through the shop with a minimum of supervision. If inexperienced, the duties would be the same under supervision. The company is engaged in war activity exclusively and expects to continue this work after the war.

Salary \$2,500 to \$5,000 depending upon qualifications. Pleasant surroundings and working conditions. If now employed in war work, a release from the employer must be obtainable. Address: Chief Engineer, Templeton Radio Company, Mystic, Conn.

### TECHNICAL AND SCIENTIFIC AIDS

Federal government needs aids for research and testing in the following fields: chemistry, geology, geophysics, mathematics, metallurgy, meteorology, physics, and radio. The positions pay \$1,620 to \$2,600, plus overtime.

For the assistant grade, applications will be accepted from persons who have completed 1 year of paid experience or a war training course approved by the U. S. Office of Education. One year of college study, including 1 course in the option applied for, is also qualifying. Persons now enrolled in war training or college courses may apply, subject to completion of the course. For the higher grades successively greater amounts of education or experience are required.

The majority of positions are in Washington, D.C., but some will be filled in other parts of the United States. There are no age limits, and no written test is required. Persons using their highest skills in war work are not encouraged to apply.

Applications will be accepted at the U. S. Civil Service Commission, Washington, D.C., until the needs of the service have been met.

### ELECTRICAL ENGINEER

Thoroughly familiar with the manufacture and design of capacitors. We have an unusual opportunity open for an engineer experienced in the above line of work and who can also assume responsibility. Industrial Condenser Corporation, 1725 West North Ave., Chicago, Ill.

### INSTRUCTORS IN ADVANCED ARMY-NAVY PROGRAM

Prominent Eastern technical institute needs additional instructors in officer training program in modern electronics and radio applications. An excellent opportunity to acquire advanced knowledge and to render important service in war effort. Men having various degrees of qualifications are needed, from recent graduates in Electrical Engineering or Physics to those with long experience in radio engineering or teaching. Salary according to qualifications and experience. Applicants must be U. S. citizens of unimpeachable reputation. Any inquiries will be treated as highly confidential. Please send personnel data and photograph to Box 292.



### Attention Employers . . .

Announcements for "Positions Open" are accepted without charge from employers offering salaried employment of engineering grade to I.R.E. members. Please supply complete information and indicate which details should be treated as confidential. Address: "POSITIONS OPEN," Institute of Radio Engineers, 330 West 42nd Street, New York, N. Y.

The Institute reserves the right to refuse any announcement without giving a reason for the refusal.

# Important Notice

## To All Users of STEATITE INSULATORS

*About a year ago*—there was a drastic shortage of Steatite insulators and a serious lack of adequate manufacturing facilities. Consequently, there was a clamor for substitutes. Government officials took immediate steps to remedy the situation by urging those with years of engineering experience and a thorough knowledge of Steatite manufacturing processes to expand their production.

*Today*—there is no shortage of Steatite or of manufacturing facilities. Steatite insulators are available for prompt delivery in all sizes, shapes, and quantities. The production capacity of the industry as a whole has expanded far beyond the critical state, and now there is no longer reason to consider substitute materials.

*Stupakoff engineers can help you solve your problems now. Stupakoff production facilities are available to fill your requirements now. Inquiries are given immediate attention.*

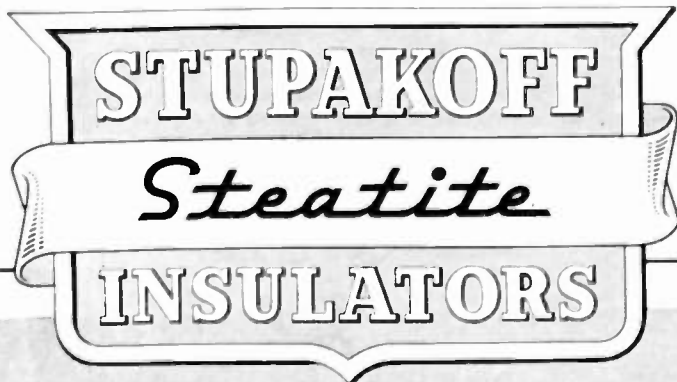

The Army-Navy "E" Flag  
"for great achievement" flies  
over the Stupakoff plant.



**STUPAKOFF CERAMIC AND MANUFACTURING CO., LATROBE, PA.**

*Ceramics for the World of Electronics*

A Comprehensive  
Volume Prepared for  
Engineers by  
M. I. T.

387  
illustrations

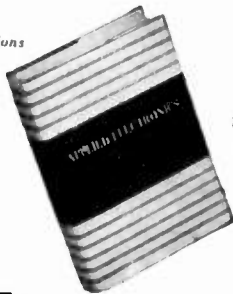

772 pages  
\$6.50

# APPLIED ELECTRONICS

by the Electrical Engineering  
Staff at the Massachusetts  
Institute of Technology

Here is an important book on electronics that treats physical processes in such detail as to provide a thorough understanding of the characteristics, ratings, and applicability of electronic devices. It is particularly designed for those whose interests are in power, communications, control, measurement, or other phases of electrical engineering.

The early chapters give a working knowledge of the physical phenomena involved in electronic conduction. The remainder of the book discusses applications common to various branches of engineering.

Noteworthy is the inclusion of up-to-date material on electron ballistics, electron optics, thermionic emission, limitation of current by space charge, and the electro-kinetic behavior of gases.

The more important electron tubes, both vacuum and gas-filled types, are comprehensively presented. Special tubes such as cathode-ray oscilloscopes, electron multipliers, electron microscopes, television tubes, ultra-high frequency tubes, phototubes, thyatron, cold-cathode tubes, ignitrons, and stroboscopes are included.

## ON APPROVAL COUPON

JOHN WILEY & SONS, INC.  
440 Fourth Avenue, New York, N.Y.

Please send me a copy of M. I. T.'s APPLIED ELECTRONICS on ten days' approval. At the end of that time, if I decide to keep the book, I will remit \$6.50 plus postage; otherwise I will return the book postpaid.

Name .....

Address .....

City and State .....

Employed by .....

IRE-6-43

## INDEX

Section Meetings	xx
Membership	xxii
New Equipment Notes	xxx
Army-Navy "E" Honor Roll	xxxiv
Current Literature	xliv
Booklets	xliv
Radio Education Notes	xlvi
Positions Open	liv

## DISPLAY ADVERTISERS

Acme Electric & Mfg Company	xxx
Aerovox Corporation	iii
Allen-Bradley Company	xxxix
Alliance Mfg. Company	xliv
American Lava Corporation	xi
American Telephone & Telegraph Co.	Facing xxi
American Transformer Company	xxviii
Victor J. Andrew Company	lviii
Arnold Engineering Company	xxxiii
Bliley Electric Company	xlvi
Capitol Radio Engineering Institute	xxx
Centralab	xiv
Chicago Transformer Corp.	lii
Clarostat Manufacturing Co.	xxvi
Connecticut Telephone & Electric Div.	1
Cornell-Dubilier Electric Corp.	Cover III
Corning Glass Works	iv, v
Daven Company	xvii
DeJur-Amsco Corporation	xi
Tobe Deutschmann Corp.	lxiii
Dial Light Co. of America, Inc.	lvi
Doalittle Radio, Inc.	lvii
Allen B. DuMont Laboratories, Inc.	xxviii
D X Crystal Company	xxxviii
Eicor, Inc.	lx
Eitel-McCullough, Inc.	vii, ix
Elastic Stop Nut Corp. of America	xxxix
Electronic Corp. of America	xxxix
Electronic Laboratories, Inc.	Facing xx
Electro-Voice Mfg. Company, Inc.	vi
Federal Telephone & Radio Corp.	lxiv
General Electric Company	xxxv, lxix
General Radio Company	Cover IV
Great American Industries, Inc.	lx
Hallicrafters Company	xli
Heintz & Kaufman, Ltd.	xlvi
Hytron Corporation	xxvii
Industrial Condenser Corp.	xlviii
International Resistance Co.	xxx
International Telephone & Telegraph Corp.	lxiv
Isolantite, Inc.	Facing xxviii
Jackson Electrical Instrument Co.	xl
Lafayette Radio Corporation	xlvi
National Company, Inc.	xlxiii
National Union Radio Corp.	xxi
North American Philips Co.	xxxvi
Radio Corporation of America, Victor Div.	xii, xiii, xvi
RCA Aviation Radio	Facing xxix
Rauland Corporation	xlv
Raytheon Manufacturing Company	x
Remler Company, Ltd.	xlvi
John F. Rider Publisher, Inc.	lvi
Rola Company	lix
Selenium Corp. of America	lxii
Shallcross Mfg. Company	xxiv
Shure Brothers	xxxviii
Small Electric Motors (Canada) Ltd.	xxv
Sprague Specialties Company	li
Standard Transformer Corp.	xxviii
Stupakoff Ceramic & Mfg. Co.	lxz
Superior Electric Company	lv
Sylvania Electric Products, Inc.	xxvii, liv
Taylor Tubes, Inc.	lvii
Thordarson Electric Mfg. Company	xxvii
Triplet Electrical Instrument Co.	liv
Tung-Sol Lamp Works, Inc.	lii
Turner Company	xxii
United Transformer Company	Cover II
Utah Radio Products Company	xi
Westinghouse Electric & Mfg. Co.	vii
Wilcox Electric Company	xv
John Wiley & Sons, Inc.	lxii

## EMBY SELENIUM

# Rectifiers

## ENGINEERED FOR ENGINEERS

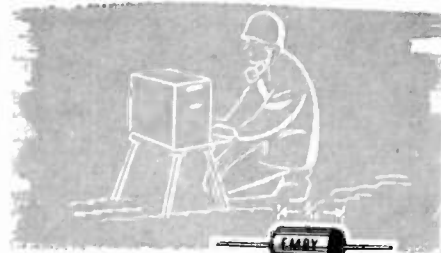

**N2** Input 5 volts. Half wave. Continuous dc current 1 ma. Used with meters, detector circuits, bias voltage.

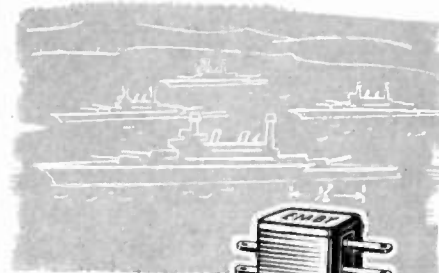

**DS** Input 10 volts. Full wave bridge. Continuous dc 10 ma. Unbreakable plastic case with mounting extension.

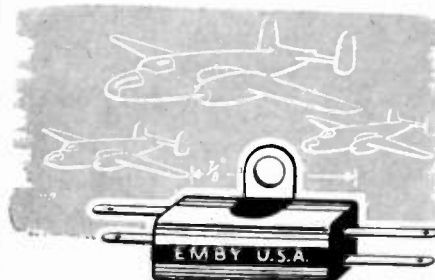

**DL** Input 10 volts. Full wave bridge. Continuous dc rating 35 ma. Mounted in aluminum case with mounting extension.

Permanent characteristics. Unlimited life. Temperature range,  $-70^{\circ}$  to  $+70^{\circ}$  C. Unaffected by severe atmospheric conditions. Increased efficiency with increased temperature. Sealed-off units supplied for aircraft services. Rectification is instantaneous, no warm up period required. No moving parts. Shock proof. Series N & S have satisfactory frequency characteristics and can be used in the frequency range up to 100 kc. Immediate delivery on many types. Available through your Electronic Parts Distributor or write:



## SELENIUM CORPORATION OF AMERICA

Manufacturers of EMBY Rectifiers,  
Photo-Electric Cells and allied  
scientific products.

1800-1804 WEST PICO BLVD.  
LOS ANGELES, CALIFORNIA

Eastern Sales Division: 2957 - 214th St., Bayside, L. I.  
Telephone: BaySide 9-8958

Proceedings of the I.R.E. June, 1943



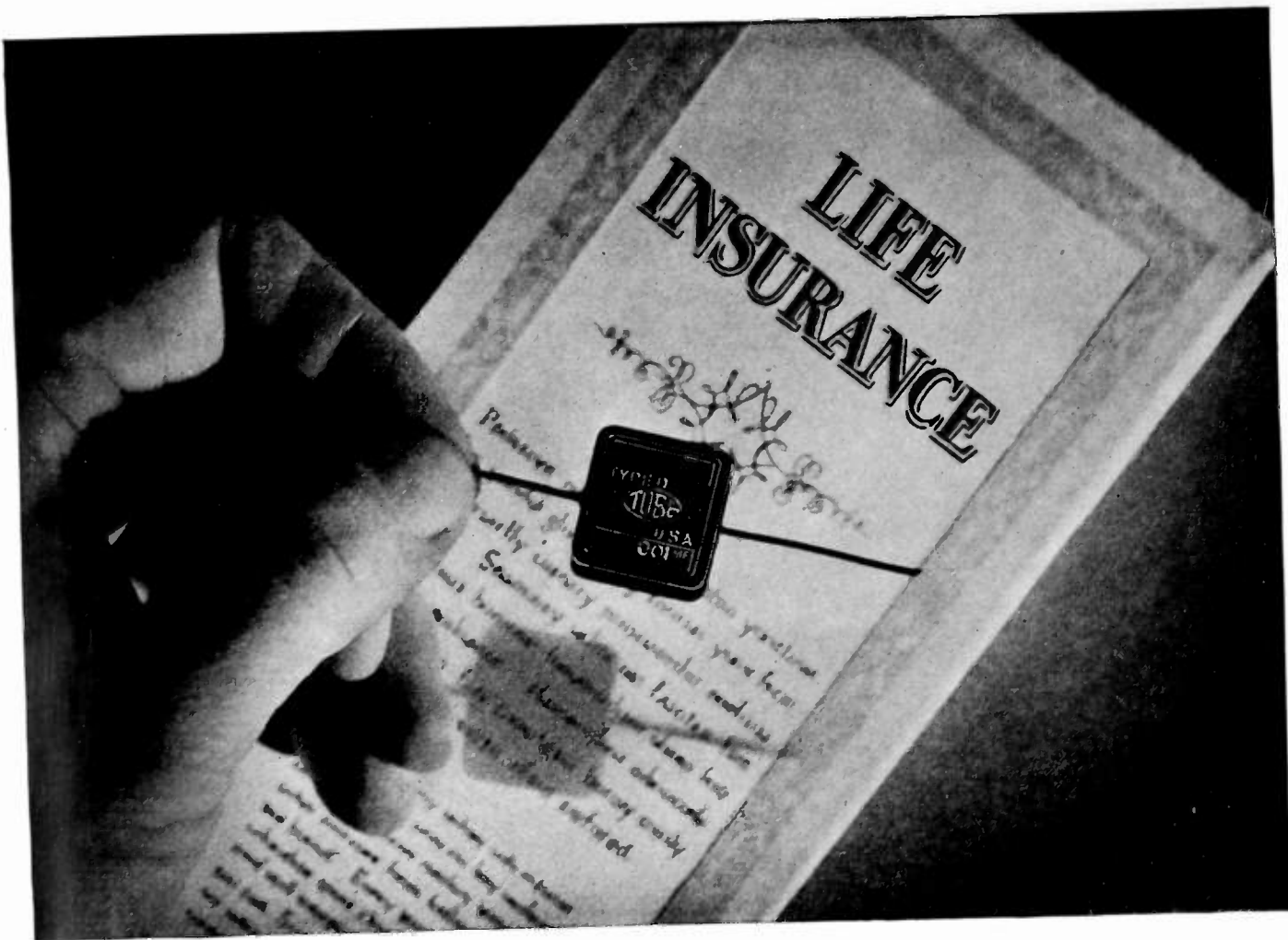

## NOW AVAILABLE FOR YOUR PRODUCTION REQUIREMENTS!

The first oil-impregnated condenser to be found physically and electrically interchangeable with the majority of mica capacitors used in the by-pass and coupling circuits of radio and radar equipment.

The Tobe Type DP Molded Paper Capacitor has *long life built into it* through every step of manufacture. Rigid inspections maintain a standard that is exceptionally

high—so high, in fact, that “returns” are almost completely unknown.

For the first time since its introduction we are *now* in a position to accept immediate orders for Type DP, with *prompt delivery assured*. They will be filled in order of receipt and we suggest you act promptly. For production samples or further information write TOBE DEUTSCHMANN CORP., CANTON, MASS.

### SPECIFICATIONS—TYPE DP CAPACITOR

CAPACITANCE .....	.001 to .01 mfd.
WORKING VOLTAGE .....	600 volts DC—flash test 1800 volts DC
SHUNT RESISTANCE .....	At 185° F.— 1000 megohms or greater At 72° F.—50000 megohms or greater
WORKING TEMPERATURE RANGE .....	Minus 50° F. to plus 185° F.
OPERATING FREQUENCY RANGE .....	Upper limit 40 megacycles Q at one megacycle—25 or better
POWER FACTOR .....	At 1000 cycles—.005 to .006

These capacitors meet Army and Navy requirements for immersion seal.





Said the Paratrooper to the Plane:

**“Snipers in woods—  
give 'em a burst!”**

They work together better . . .  
because they can talk together

From a thousand feet up  
The burning airdrome  
Looks like  
A “pushover” . . .

But  
When you get  
Right down to earth  
It turns out to be  
Anything but.

Suddenly the trees  
To the right  
Start throwing lead —  
And your men  
Are still hanging  
Like clay pigeons  
In their harnesses.

\* \* \*

What a break  
That you're equipped

With a  
Two-way  
Radio.

What a break  
That you can tell your trouble  
To a friendly  
Fighter plane.

\* \* \*

Today, communication equipment  
Designed and manufactured  
By I.T.&T. associate companies  
Is helping Uncle Sam's fighting forces  
Work together  
On land, sea and in the air . . .

Tomorrow, the broad experience  
Of I.T.&T.  
In the field of communications  
Will help build a better world  
For every man.

INTERNATIONAL TELEPHONE AND TELEGRAPH CORPORATION 67 Broad St., New York, N. Y.

**I T & T**

*Manufacturing Associate:*

FEDERAL TELEPHONE AND RADIO CORPORATION

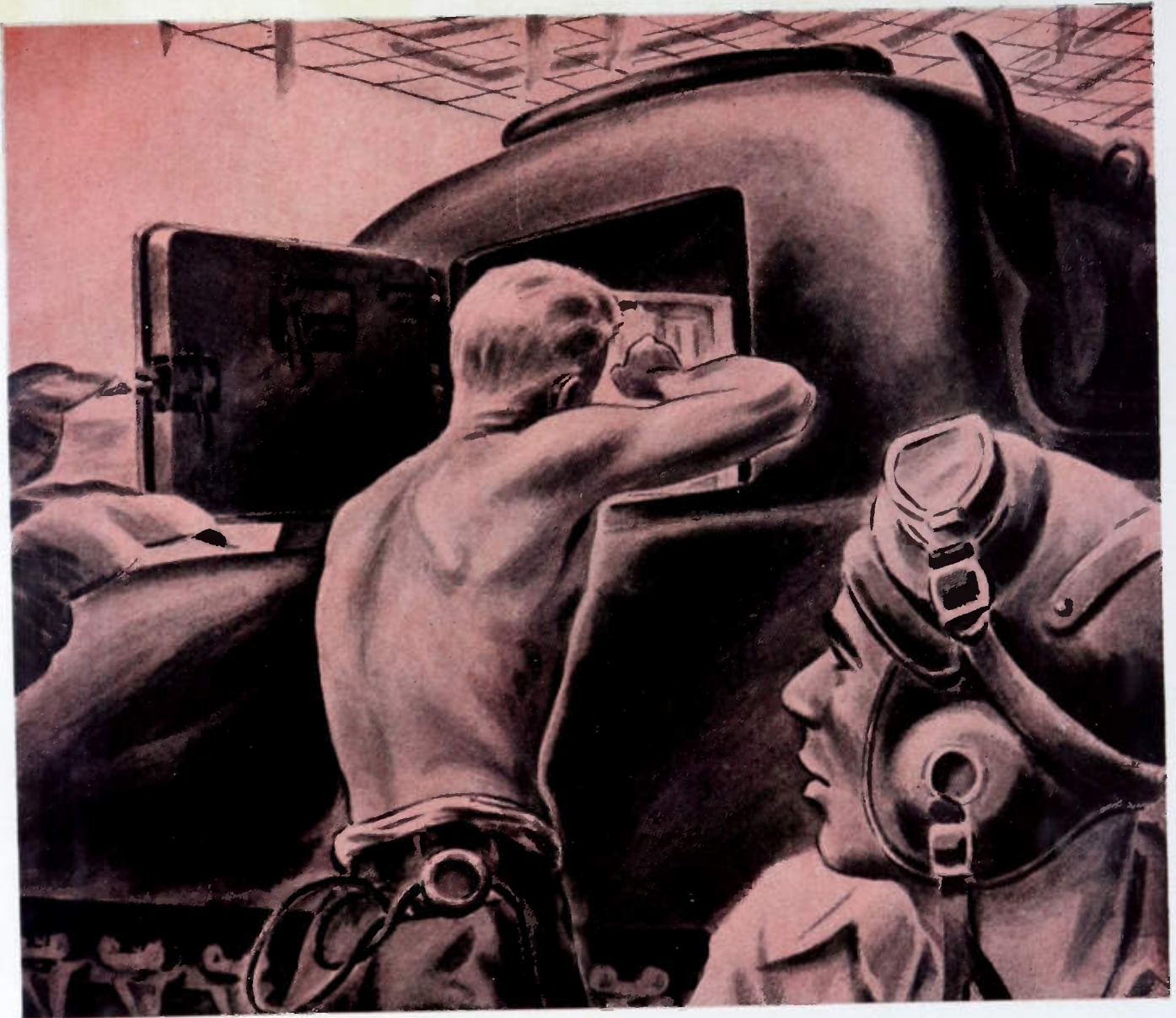

## "Hmm! Nothing wrong with the Capacitors anyhow"

In steaming swamps, icebound wastelands and arid desert—the fighting fronts of global war—Cornell-Dubilier capacitors are revealing the stout-hearted stamina that's in them. Today, as in peacetime, there are more C-D capacitors in use than any other make.

You can give your product this same measure of dependability by using C-Ds whenever the design calls for capacitors. Engineered by specialists and backed by 33 years of manufacturing experience, the C-D capacitor—as a *fighting tool* of World War II—is more reliable than ever. Cornell Dubilier Electric Corporation, South Plainfield, New Jersey.



### MICA CAPACITORS

for high frequency applications

The type 75A Mica Capacitor illustrated, was designed for high frequency, high current, continuous heavy-duty applications.

### CHECK THESE FEATURES:

*Completely oil-filled and hermetically sealed.*

*Heavy conical ceramic insulator provides maximum insulation and mechanical strength.*

*Employs C-D patented radial type, series stack construction. This results in low-losses, elimination of corona effects and power losses.*

*These capacitors as well as others in the complete C-D line are described in Catalog 160 T free on request.*

# Cornell Dubilier

## capacitors

MICA • DYKANOL • PAPER  
WET & DRY ELECTROLYTICS



M O R E   I N   U S E   T O D A Y   T H A N   A N Y   O T H E R   M A K E



# QUALITY CONTROL

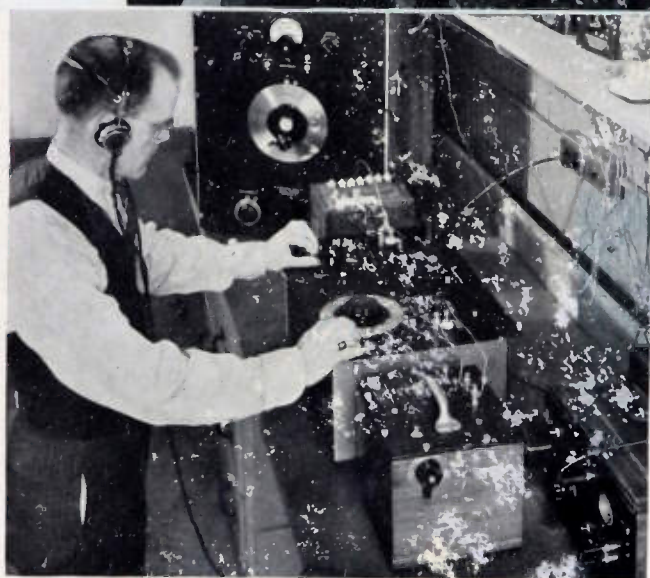
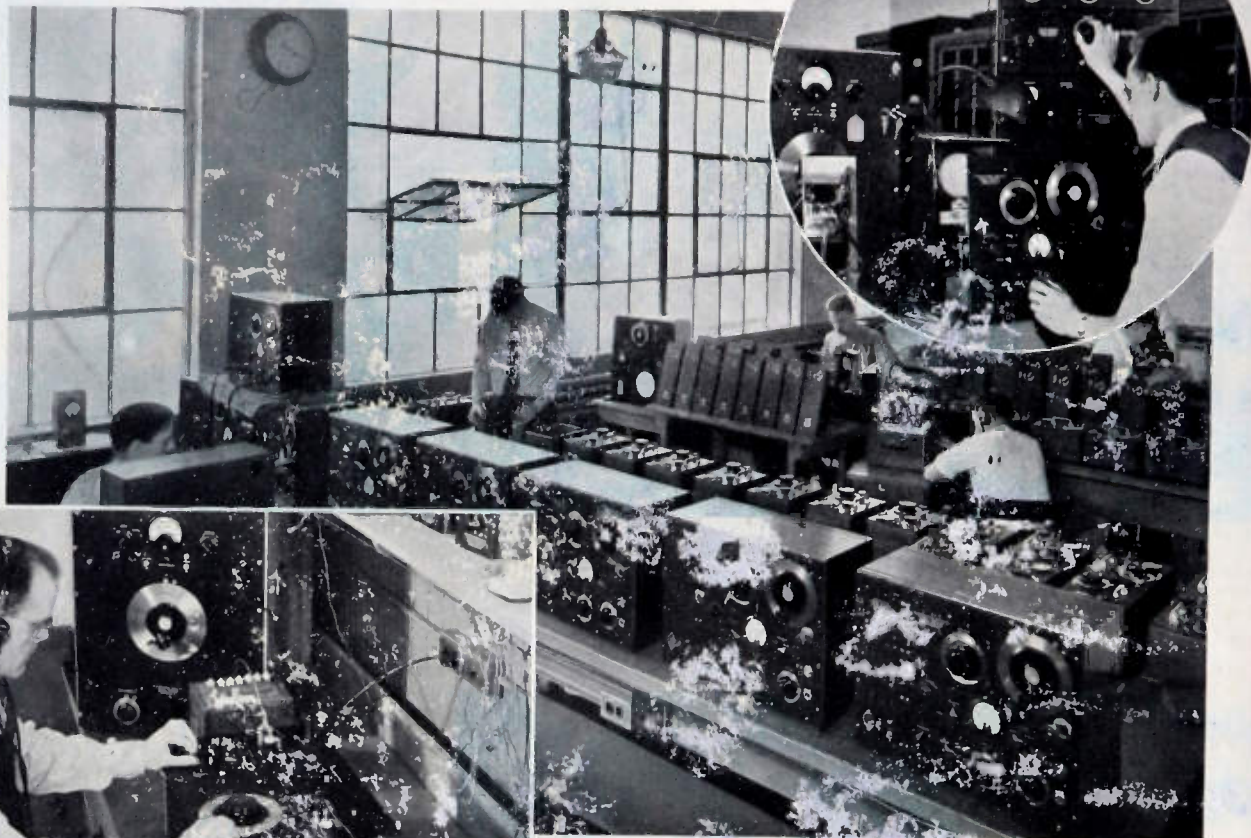

## in the GENERAL RADIO Standardizing Laboratory

**H**OWEVER well designed an instrument may be, accurate calibration and reliability in service determine its ultimate usefulness. Testing, therefore, has long been an important final step of our manufacturing; approximately 10% of the total man hours required to produce a General Radio instrument is spent in our standardizing laboratory. Here a carefully planned schedule of tests and measurements transforms an unadjusted, uncalibrated device into a precision instrument.

Testing specifications embody not only the rigid requirements imposed by the design objectives of the instrument, but also the field data collected in hundreds of case histories of similar instruments. Engineering test and calibration operations cover far more than meter reading and embrace a wide variety of precise electrical measurements.

To carry out these tests, capable personnel, adequate test equipment, and reliable standards are necessary. Many of the staff have engineering degrees or are graduates of engineering institutions. All are capable technicians. The laboratory equipment includes the entire line of General Radio instruments as well as those of many instrument manufacturers in other fields. As a basis for the measurements, the laboratory maintains precise, accurately-known standards of resistance, capacitance, inductance and voltage. Frequency measurements are based on the engineering department's primary standard.

Quality control in the General Radio Standardizing Laboratory is the result of years of experience in instrument manufacture; it is the customer's assurance of uniformly accurate and reliable instruments for his own testing department.



**GENERAL RADIO COMPANY · Cambridge, Massachusetts**

NEW YORK

LOS ANGELES