

Proceedings

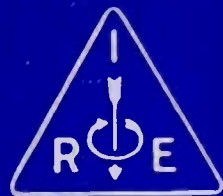

of the

I·R·E

FEBRUARY 1941

VOLUME 29

NUMBER 2

Phase-Shift Oscillators

Fluctuations in Grids at High
Frequencies

Distribution of Amplitude with Time
in Fluctuation Noise

Coupled Networks in Radio-
Frequency Circuits

Electron Motions in Electric Fields

Ionospheric Transmission

Institute of Radio Engineers



The Word Is Getting Around...

"For national defense or private industry . . . where dependability and adherence to specifications are essential . . . transformer users turn to UTC."

THERE IS NO SUBSTITUTE FOR EXPERIENCE

*Whether STANDARD or SPECIAL
UTC has a transformer for every purse and purpose*

UNITED TRANSFORMER CORP.

150 VARICK STREET ★ NEW YORK, N. Y.
EXPORT DIVISION: 100 VARICK STREET NEW YORK, N. Y. CABLES: "ARLAB"

BOARD OF DIRECTORS

- Frederick E. Terman, *President*
- Adolfo T. Cosentino,
Vice President
- Haraden Pratt, *Treasurer*
- Harold P. Westman, *Secretary*
- Austin Bailey
- Adolph B. Chamberlain
- Ivan S. Coggeshall
- Melville Eastham
- Harold T. Friis
- Alfred N. Goldsmith
- Virgil M. Graham
- O. B. Hanson
- Raymond A. Heising
- Lawrence C. F. Horle
- C. M. Jansky, Jr.
- Frederick B. Llewellyn
- Browder J. Thompson
- Hubert M. Turner
- Arthur F. Van Dyck
- Harold A. Wheeler
- Lynde P. Wheeler

BOARD OF EDITORS

- Alfred N. Goldsmith, *Chairman*
- Ralph R. Batcher
- Lloyd V. Berkner
- Philip S. Carter
- Lewis M. Clement
- Elmer W. Engstrom
- William L. Everitt
- Peter C. Goldmark
- Frederick W. Grover
- C. M. Jansky, Jr.
- John D. Kraus
- Frederick B. Llewellyn
- Samuel S. Mackeown
- Edward L. Nelson
- Harry F. Olson
- Greenleaf W. Pickard
- Haraden Pratt
- Conan A. Priest
- Leon J. Sivian
- Lynne C. Smeby
- Browder J. Thompson
- Harold A. Wheeler
- Lynde P. Wheeler
- Laurens E. Whittemore
- Gerald W. Willard
- William Wilson
- Charles J. Young

Helen M. Stote, *Assistant Editor*

John D. Crawford,
Advertising Manager

Proceedings

of the I·R·E

Published Monthly by

The Institute of Radio Engineers, Inc.

VOLUME 29

February, 1941

NUMBER 2

| | | |
|---|---------------------------------------|----|
| Phase-Shift Oscillators..... | E. L. Ginzton and L. M. Hollingsworth | 43 |
| Fluctuations Induced in Vacuum-Tube Grids at High Frequencies..... | Dwight O. North and W. Robert Ferris | 49 |
| The Distribution of Amplitude with Time in Fluctuation Noise..... | Vernon D. Landon | 50 |
| Coupled Networks in Radio-Frequency Circuits..... | Andrew Alford | 55 |
| Theoretical and Experimental Investigations of Electron Motions in Alternating Fields with the Aid of Ballis- tic Models..... | H. E. Hollmann | 70 |
| The Ionosphere and Radio Transmission, February, 1941, with Predictions for May, 1941..... | | 80 |
| Institute News and Radio Notes..... | | 82 |
| New Policy for Encouraging the Formation of In- stitute Sections..... | | 82 |
| Board of Directors..... | | 82 |
| I.R.E.-U.R.S.I. Meeting Canceled..... | | 83 |
| S. S. Kirby Dies..... | | 83 |
| United States Selective Service..... | | 83 |
| New York Meeting..... | | 83 |
| Sections..... | | 83 |
| Membership..... | | 86 |
| Books | | |
| "The Meter at Work," by John F. Rider..... | Harold A. Wheeler | 87 |
| "Television Receiving Equipment," by W. T. Cocking..... | Dudley E. Foster | 87 |
| Contributors..... | | 87 |

Entered as second-class matter October 26, 1927, at the post office at Menasha, Wisconsin, under the Act of February 28, 1925, embodied in Paragraph 4, Section 538 of the Postal Laws and Regulations. Publication office, 450 Ahnaip Street, Menasha, Wisconsin. Editorial and advertising offices, 330 West 42nd St., New York, N. Y. Subscription, \$10.00 per year; foreign, \$11.00.

THE INSTITUTE OF RADIO ENGINEERS

INCORPORATED



New York Meeting—May 7, 1941

Summer Convention—Institute of Radio Engineers—Detroit, Michigan
June 23, 24, and 25, 1941

SECTION MEETINGS

Buffalo—Emporium—Rochester Sections
Joint Dinner Meeting
April 25—Olean, N. Y.

DETROIT

April 18

PITTSBURGH

April 14

LOS ANGELES

April 15

WASHINGTON

April 14

ATLANTA

April 18

CLEVELAND

April 25

PHILADELPHIA

May 1

SECTIONS

- ATLANTA—Chairman, A. W. Shropshire, Secretary, G. M. Howard, 856 St. Charles Ave., N. E., Atlanta, Ga.
BALTIMORE—Chairman, Ferdinand Hamburger; Secretary, G. J. Gross, Pennsylvania Water and Power Co., 1611 Lexington Bldg., Baltimore, Md.
BOSTON—Chairman, W. L. Barrow; Secretary, P. K. McElroy, General Radio Co., 30 State St., Cambridge, Mass.
BUENOS AIRES—Chairman, A. T. Cosentino; Secretary, G. J. Andrews, Cia. Standard Electric Argentina, Cangallo 1286, Buenos Aires, Argentina.
BUFFALO-NIAGARA—Chairman, B. E. Atwood; Secretary, Leroy Fiedler, 53 Rosedale Ave., Hamburg, N. Y.
CHICAGO—Chairman, G. I. Martin; Secretary, R. A. Kay, RCA Institutes, Inc., 1154 Merchandise Mart, Chicago, Ill.
CINCINNATI—Chairman, J. M. McDonald; Secretary, W. L. Schwesinger, Crosley Corp., Cincinnati, Ohio.
CLEVELAND—Chairman, C. E. Smith; Secretary, W. G. Hutton, 7314 Dorothy Ave., Parma, Ohio.
CONNECTICUT VALLEY—Chairman, K. A. McLeod; Secretary, W. M. Smith, 250 Main St., Suffield, Conn.
DALLAS-FORT WORTH—Chairman, D. A. Peterson; Secretary, J. R. Sullivan, WRR, Dallas, Tex.
DETROIT—Chairman, M. Cottrell; Secretary, Paul Frincke, WJBK, 6559 Hamilton Ave., Detroit, Mich.
EMPORIUM—Chairman, R. K. Gessford; Secretary, C. W. Reash, Hygrade Sylvania Corp., Emporium, Pa.
INDIANAPOLIS—Chairman, Arthur Curtis; Secretary, B. V. K. French, P. R. Mallory & Co., E. Washington St., Indianapolis, Ind.
LOS ANGELES—Chairman, W. W. Lindsay, Jr.; Secretary, C. F. Wolcott, 1609 S. Western Ave., Los Angeles, Calif.
MONTREAL—Chairman, E. A. Laport; Secretary, W. A. Nichols, Canadian Broadcasting Corp., 1012 Keefer Bldg., Montreal, Que.
NEW ORLEANS—Chairman, G. H. Peirce; Secretary, D. W. Bowman, 8327 Sycamore St., New Orleans, La.
PHILADELPHIA—Chairman, C. M. Burrill; Secretary, R. L. Snyder, 103 Franklin Rd., Glassboro, N. J.
PITTSBURGH—Chairman, R. E. Stark; Secretary, M. G. Jarrett, Bell Telephone Company of Pennsylvania, Pittsburgh, Pa.
PORTLAND—Chairman, E. R. Meissner; Secretary, L. M. Belleville, 361 N. E. 75th Ave., Portland, Ore.
ROCHESTER—Chairman, H. C. Sheve; Secretary, O. L. Angevine, Jr., Stromberg-Carlson Telephone Manufacturing Co., Rochester, N. Y.
SAN FRANCISCO—Chairman, L. J. Black; Secretary, Karl Spangenberg, Electrical Engineering Dept., Stanford University, Calif.
SEATTLE—Chairman, K. H. Ellerbeck; Secretary, R. J. Gleason, Pacific Alaska Airways, Inc., 3314 White Bldg., Seattle, Wash.
TORONTO—Chairman, H. S. Dawson; Secretary, L. C. Simmonds, 301 King St., E., Toronto, Ont.
WASHINGTON—Chairman, M. H. Biser; Secretary, C. M. Hunt, WJSV, 817 Earle Bldg., Washington, D. C.

THE INSTITUTE serves those interested in radio and allied electrical communication fields through the presentation and publication of technical material.

THE PROCEEDINGS has been published without interruption since 1913 when its first issue appeared. The contents of each paper published in the **PROCEEDINGS** are the responsibility of the author and are not binding on the Institute or its members. Material appearing in it may be reprinted or abstracted in other publications on the express condition that specific reference shall be made to its original appearance in the **PROCEEDINGS**. Illustrations of any variety, however, may not be reproduced without specific permission from the Institute.

STANDARDS reports are published from time to time and are sent to each member without charge. The four current reports are on Electroacoustics, Electronics, Radio Receivers, and Radio Transmitters and were published in 1938.

MEMBERSHIP has grown from a few dozen in 1912 to more than five thousand. Practically every country in the world in which radio engineers may be found is represented in our roster. Dues for the five grades of membership range from \$3.00 to \$10.00 per year. The **PROCEEDINGS** is sent to each member without further payment

SECTIONS in twenty-four cities in the United States, Canada, and Argentina hold regular meetings. The chairmen and secretaries of these sections are listed on the opposite page.

SUBSCRIPTIONS are accepted for the **PROCEEDINGS** at \$10.00 per year in the United States of America, its possessions, and Canada; when college and public libraries order direct from the Institute, the subscription price is \$5.00. For other countries there is additional charge of \$1.00.

The Institute of Radio Engineers, Inc.
Harold P. Westman, Secretary
330 West 42nd Street
New York, N.Y.

The Institute of Radio Engineers

Incorporated

330 West 42nd Street, New York, N.Y.

To the Board of Directors

Gentlemen:

I hereby make application for ASSOCIATE membership in the Institute of Radio Engineers on the basis of my training and professional experience given herewith, and refer to the sponsors named below who are personally familiar with my work.

I certify that the statements made in the record of my training and professional experience are correct, and agree if elected, that I shall be governed by the Constitution of the Institute as long as I continue a member. Furthermore I agree to promote the objects of the Institute so far as shall be in my power.

.....
(Sign with pen)

.....
(Address for mail)

.....
(City and State)

.....
(Date)

SPONSORS

(Signatures not required here)

Mr.

Address

City and State

Mr.

Address

City and State

Mr.

Address

City and State

Phase-Shift Oscillators*

E. L. GINZTON†, ASSOCIATE, I.R.E., AND L. M. HOLLINGSWORTH‡, ASSOCIATE, I.R.E.

Summary—This paper describes a type of resistance-capacitance-tuned oscillator which operates with a single tube. A three- or more mesh phase-shifting network is connected between the output and input of an amplifier tube. When the gain of the amplifier is adjusted either manually or by an automatic-volume-control circuit barely to maintain oscillation, almost pure sine-wave output is obtained. Variations in the basic circuit have been analyzed and design formulas are included in this paper. Experimental work verified theoretical expectations. A typical oscillator was found to have a distortion of 0.1 per cent at an output voltage of 20 volts.

INTRODUCTION

THERE are many uses for audio-frequency oscillators in research laboratories and in industry for the testing of communication and other types of equipment. A variety of oscillators are in use, most of which depend upon inductance-capacitance resonant circuits for tuning and discrimination against harmonics. Simple oscillators of the Hartley type are satisfactory for medium and high audio frequencies because the coils and condensers that are required are small and may be easily constructed to have low losses. At very low audio frequencies such circuits become impracticable because it is difficult to construct the required large inductances to reduce sufficiently the losses. The difficulty of obtaining low-frequency oscillations can be overcome by means of heterodyning two high-frequency oscillators. Such beat-frequency oscillators have been used extensively in the past and are quite satisfactory for most applications. However, they have some disadvantages; namely,

1. Frequency stability is poor, since a small change in the frequency of one oscillator produces a large percentage change in the heterodyne frequency. This is especially true when the heterodyne frequency is low.
2. In order to prevent synchronization at low frequencies, the oscillators must be well shielded. This adds extra weight and increases the cost of construction.
3. Calibration is not constant and must be checked often.

Resistance-capacitance-tuned oscillators employing negative and positive feedback circuits have been developed in recent years to overcome these fundamental difficulties.^{1,2} In these circuits, negative feedback is introduced in a two-stage resistance-capacitance-coupled amplifier through a network equivalent to a Wien bridge. This eliminates negative feedback at a frequency determined by the resistance-capacitance

components of the Wien bridge. Consequently, the amplifier acts in a manner similar to a resonant circuit. If positive feedback is introduced in this amplifier, oscillation will take place at the frequency determined by the constants of the Wien bridge. Such an oscillator can be made to work at extremely low as well as at high frequencies. It is in many respects equivalent in performance to a good beat-frequency oscillator; and, in addition, it is simple, light, inexpensive, and does not need a calibrating adjustment.

The resistance-capacitance-tuned oscillator seems to have been described first by Scott¹ and later by Terman, Buss, Cahill, and Hewlett.² The authors of the present paper had the circuit of a single-tube resistance-capacitance-coupled oscillator suggested to them by J. R. Woodyard of Stanford University. This oscillator circuit and variations developed by the authors as described in this paper, accomplish the same things as Scott's and Terman's, but in a different and simpler manner. Its performance is about the same as that of other resistance-capacitance-tuned oscillators, with possibly a better frequency stability. Investigations by the authors revealed the fact that this oscillator circuit was not new but had been described by Nichols³ in 1921. Nichols also showed circuits in which the frequency of oscillation was determined by an inductance-resistance combination. While there are applications where inductance-resistance tuning may be superior to the capacitance-resistance tuning, the present authors feel that the general principles involved are so similar in the two cases that a discussion of such circuits is omitted from this paper.

BASIC CIRCUITS

In order to produce self-sustaining oscillations in an amplifier, two conditions must be satisfied. First, the voltage introduced from the output of the amplifier to its input must be in phase with the input voltage; second, the over-all amplification of the network must be equal to, or greater than, unity. That is, if

A = amplification parameter of the amplifier

β = fraction of the output voltage of the amplifier introduced into the input of the amplifier

then,

$$A\beta \geq 1 \quad (1)$$

this being a vector relationship.

Thus, if

$$A = |A| / \theta \quad (2)$$

$$\beta = |\beta| / \phi$$

³ H. W. Nichols, United States Patent 1,442,781, January 16, 1923. (Filed July 7, 1921.)

* Decimal classification: R355.9. Original manuscript received by the Institute, November 25, 1940.

† Stanford University, Calif.

‡ San Francisco Junior College, San Francisco, Calif.

¹ H. H. Scott, "A new type of selective circuit and some applications," *Proc. I.R.E.*, vol. 26, pp. 226-235; February, 1938.

² F. E. Terman, R. R. Buss, W. R. Hewlett, and F. C. Cahill, "Some applications of negative feedback with particular reference to laboratory equipment," *Proc. I.R.E.*, vol. 27, pp. 649-655; October, 1939.

then

$$|A| |\beta| \geq 1 \quad (3)$$

$$\theta + \phi = 0. \quad (4)$$

In other words, an oscillator must consist of an amplifier capable of developing a voltage amplification $1/|\beta|$ and a phase-shifting network which will satisfy (4).

Each one of the circuits shown in Fig. 1 is composed of a one-tube resistance-capacitance-coupled amplifier

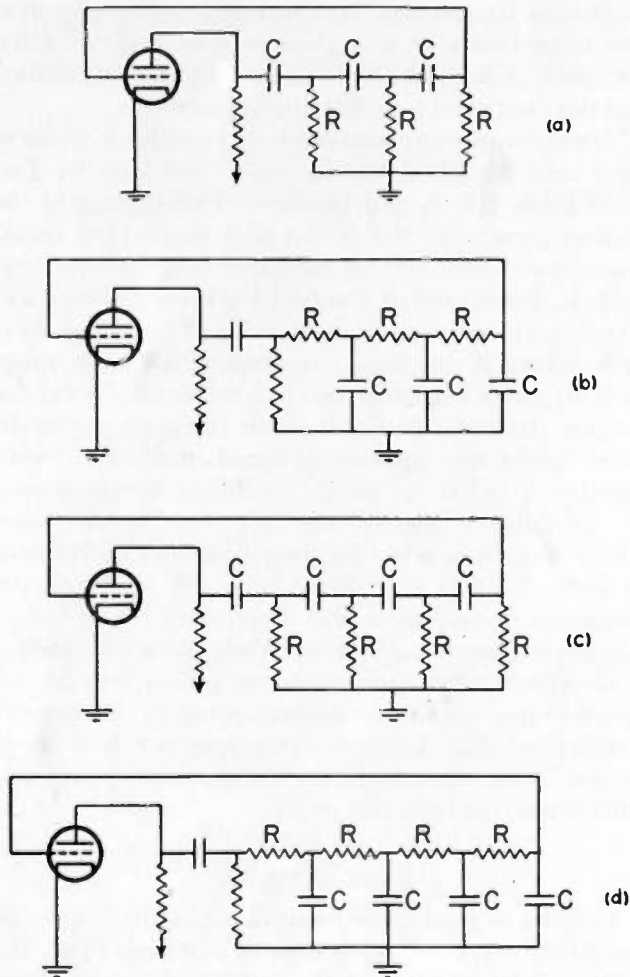

Fig. 1—Basic 3- and 4-mesh phase-shift oscillator circuits.

and a phase-shifting network. It is well known that such an amplifier produces a phase shift of 180 degrees in the frequency range where all shunting capacitances may be neglected. In order to satisfy (4), the phase-shifting network that follows the amplifier tube must produce another 180 degrees of phase shift. As will be easily seen, all networks shown in Fig. 1 are capable of producing this required phase shift.

The voltage amplification $|A|$ which the tube must possess depends upon the type of phase-shifting network used. For instance, in Fig. 1(a), there will be a 180-degree phase shift in the network when $X = \sqrt{6}R$, where $X = 1/2\pi fC$, and C and R are as shown in Fig. 1(a). This means that the required phase shift takes place at a frequency at which only $1/29$ of the output

voltage appears at the grid of the tube. If the tube possesses an amplification equal to or greater than 29, oscillation will start. The second and higher harmonics of the fundamental occur at frequencies at which the phase shift is not 180 degrees but is nearly zero. This means that the harmonics of the fundamental occur at frequencies at which the gain through the phase-shifting network is high (approaches unity) and the feedback becomes negative. The entire arrangement thus becomes equivalent to a negative-feedback amplifier with a feedback ratio of unity. This prevents excessive amplification of harmonics and tends to produce pure sine-wave output.

Fig. 1(b) shows another type of phase-shifting network. In this case, the required phase shift occurs when $X = R/\sqrt{6}$ or when the shunting capacitances have a reactance which is smaller than the resistances R . At the second and higher harmonics, the capacitances have even smaller reactances in comparison to R and the amplification of harmonics is small in comparison with the amplification of the fundamental.

In Fig. 1(c) an oscillator circuit is shown which is similar in principle of operation to that of Fig. 1(a) with the exception that a 4-mesh phase-shifting network is used instead of a 3-mesh network. This change merely requires a different amplification in the amplifier to cause oscillation. Fig. 1(d) is similar to Fig. 1(b) in the same way. In general, 3 or more meshes may be used. Two meshes cannot provide enough phase shift without requiring infinite amplification for oscillation.

THEORETICAL ANALYSIS OF A TYPICAL CIRCUIT

(a) Frequency of Oscillation and the Necessary Amplification

To illustrate how the frequency of oscillation and the required amplification may be determined the circuits of Fig. 2 are used. Fig. 2(a) shows an oscillator of the type illustrated in Fig. 1(a). Fig. 2(b) shows an equivalent circuit of Fig. 2(a), with the connection between the output and the input omitted. R_p and μ are the plate resistance of the tube and its amplification factor, respectively. In order to find the frequency of oscillation it is necessary to compute the total amplification of the circuit $A\beta$ and find the frequency at which this equals unity. Let the grid-to-ground voltage be equal to e_0 and the output voltage at the end of the phase-shifting network be equal to e . Then $e/e_0 = A\beta$, and this ratio must equal unity to cause the amplifier to oscillate.

The equivalent diagram may be simplified further by the use of Thevenin's theorem. The part of the circuit to the left of points $x-x$ in Fig. 2(b) may be replaced by an equivalent voltage in series with the impedance looking to the left of $x-x$ with the source of voltage e_0 short-circuited. This results in the equivalent diagram shown in Fig. 2(c) which may be analyzed in the conventional manner. Referring to Fig. 2(c) the following set of equations may be written:

$$\begin{aligned} i_1(R_1 + R - jX) - i_2R + i_30 &= E \\ -i_1R + i_2(2R - jX) - i_3R &= 0 \\ i_10 - i_2R - i_3(2R - jX) &= 0. \end{aligned} \tag{5}$$

Solving these simultaneously for i_3 , one finds that

$$i_3 = \frac{R^2}{R^3 - 5RX^2 + R_1(3R^2 - X^2) + j(X^3 - 6R^2X - 4RR_1X)} E. \tag{6}$$

The voltage appearing across the output of the phase-shifting network is $e = i_3R$. Hence,

$$\frac{e}{E} = \frac{1}{1 - 5\left(\frac{X}{R}\right)^2 + \frac{R_1}{R}\left[3 - \left(\frac{X}{R}\right)^2\right] + j\left[\left(\frac{X}{R}\right)^3 - 6\left(\frac{X}{R}\right) - 4\left(\frac{R_1}{R}\right)\left(\frac{X}{R}\right)\right]} \tag{7}$$

Equation (7) gives the ratio of the voltage across the output of the phase-shifting network to the voltage at its input. In order to satisfy the conditions for oscillation outlined before, this ratio must be a real negative number. Hence,

$$\left(\frac{X}{R}\right)^3 - 6\left(\frac{X}{R}\right) - 4\left(\frac{R_1}{R}\right)\left(\frac{X}{R}\right) = 0 \tag{8}$$

$$\frac{X}{R} = \sqrt{6 + 4\frac{R_1}{R}} \tag{9}$$

Or, since

$$\begin{aligned} X &= \frac{1}{2\pi fC}, \\ f &= \frac{1}{2\pi RC\sqrt{6 + 4\frac{R_1}{R}}} \end{aligned} \tag{10}$$

Equation (10) determines the frequency at which oscillation will take place in terms of the constants of the phase-shifting network. If $R \gg R_1$, then

$$f = \frac{1}{2\sqrt{6}\pi RC} \tag{11}$$

which was the formula used in the qualitative discussion.

The gain necessary for oscillation may be determined from (7). Since the imaginary part of this equation is zero at the frequency of oscillation,

$$\frac{e}{E} = \frac{1}{1 - 5\left(\frac{X}{R}\right)^2 + \frac{R_1}{R}\left[3 - \left(\frac{X}{R}\right)^2\right]} \tag{12}$$

But $E = Ae_0$. In order to produce oscillations, e_0 must equal e . Therefore,

$$-\frac{1}{A} = \frac{1}{1 - 5\left(\frac{X}{R}\right)^2 + \frac{R_1}{R}\left[3 - \left(\frac{X}{R}\right)^2\right]} \tag{13}$$

Combining (10) and (13),

$$A = 29 + 23\frac{R_1}{R} + 4\left(\frac{R_1}{R}\right)^2 \tag{14}$$

If $R \gg R_1$, (14) becomes

$$A = 29. \tag{15}$$

From (11) it is seen that the frequency of oscillation depends upon the first power of R and C , and not the

square root as would be the case with an inductance-capacitance resonant circuit. This is of particular interest in variable-frequency oscillators where it is often desirable to produce a 10:1 change in frequency in

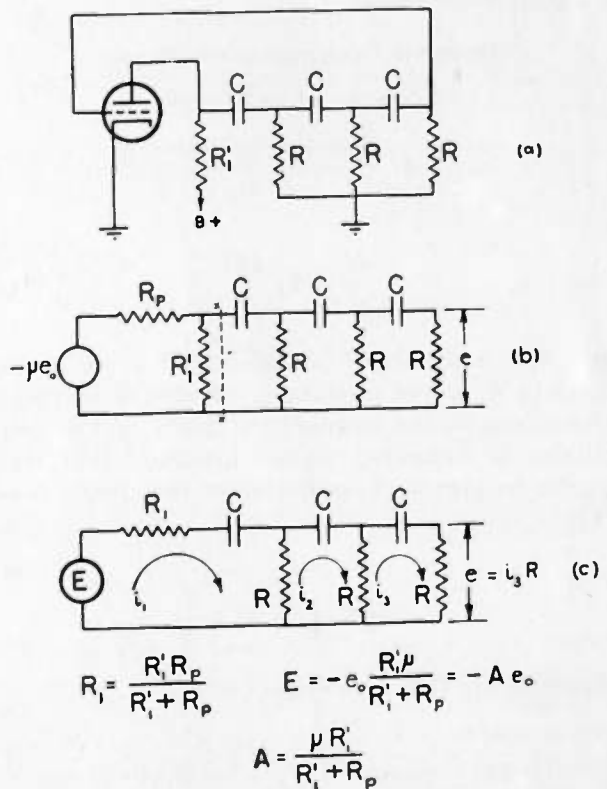

Fig. 2—Equivalent circuits for analysis of phase-shift oscillator.

one rotation of the tuning dial. Equation (15) states that if $R \gg R_1$, the gain required for oscillation is independent of frequency. Because of this fact, the output voltage from the oscillator remains constant regardless of the frequency of oscillation.

(b) Frequency Stability

The frequency of oscillation is determined by the constants of the phase-shifting network and the re-

sistance R_1 (see Fig. 2). In fact, all of the circuit equations show that the frequency of oscillation varies inversely with the product of R and C . Both of these quantities may change with temperature so that frequency stability depends upon the temperature coefficients of the resistors chosen for R and the condensers chosen for C . In the case of variable condensers the change of capacitance with temperature is low (about 15 parts per million per degree centigrade) so that its effect is negligible. Fixed condensers if used may be of recent types which have very nearly zero change of capacitance with temperature. The resistors R should also be chosen to have a low temperature coefficient of resistance.

Variations in supply voltage produce an inevitable change in the plate resistance of the tube which introduces a change in the resistance R_1 . The resultant change in the frequency of oscillation may be computed as follows: Let df be a small change in frequency f that takes place due to dR_1 , a small change in resistance that is a result of a variation in the plate resistance of the tube. Frequency stability may be defined on a percentage basis:

$$\frac{\text{change in frequency of oscillation}}{\text{frequency of oscillation}} = k_1 \frac{\text{change in resistance } R_1}{R_1}$$

or,

$$\frac{df}{f} = k_1 \frac{dR_1}{R_1} \quad (16)$$

where k_1 is a coefficient of stability. If $k_1=0$, a small change in R_1 would produce no change in frequency. As an example, the frequency stability of the simple oscillator is computed below. Equation (10) states that the frequency of oscillation of the circuit shown in Fig. 2 is

$$f = \frac{1}{2\pi RC \sqrt{6 + 4 \frac{R_1}{R}}} \quad (10)$$

Differentiating (10) with respect to R_1 ,

$$\frac{df}{dR_1} = \frac{1}{2\pi RC} \times \frac{-2}{R \left(6 + 4 \frac{R_1}{R}\right)^{3/2}} \quad (17)$$

or,

$$\frac{df}{f} = - \frac{R_1}{2R_1 + 3R} \times \frac{dR_1}{R_1} \quad (18)$$

By comparing (18) and (16),

$$k_1 = - \frac{R_1}{2R_1 + 3R} \quad (19)$$

Referring to the notation shown in Fig. 2,

$$R_1 = \frac{R_1' R_p}{R_1' + R_p} \quad (20)$$

Expressing frequency stability in terms of R_1' and R_p by making this change in variables, (18) becomes

$$\frac{df}{f} = - \frac{R_1'^2}{\left[2R_1' + 3R \left(1 + \frac{R_1'}{R_p}\right)\right] [R_1' + R_p]} \times \frac{dR_p}{R_p} \quad (21)$$

A stability coefficient k_2 may be defined as before, so that

$$\frac{df}{f} = k_2 \frac{dR_p}{R_p} \quad (22)$$

$$k_2 = - \frac{R_1'^2}{\left[2R_1' + 3R \left(1 + \frac{R_1'}{R_p}\right)\right] [R_1' + R_p]} \quad (23)$$

For example, a typical design might lead one to the following set of constants:

$$\begin{aligned} R_1' &= 10,000 \text{ ohms} & R &= 1,000,000 \text{ ohms} \\ R_p &= 1,000,000 \text{ ohms} & f &= 1000 \text{ cycles per second} \end{aligned}$$

Substituting these values in (23), one finds that $k_2 = -3.3 \times 10^{-5}$. Thus, a 10 per cent change in the plate resistance of the amplifier tube would result in a frequency change of 3.3×10^{-4} per cent, or 0.003 cycle per second. The frequency stability of such an oscillator is better at low than at high frequencies as can easily be verified by comparing (23) and (10).

Experiments with an oscillator similar to the one shown in Fig. 2 have demonstrated that 100 per cent increase in the supply voltage will not produce a noticeable change in the frequency as indicated by a Lissajous figure on a cathode-ray oscilloscope.

VARIABLE-FREQUENCY OSCILLATORS

The basic circuits shown in Fig. 1 are equally well suited for constant or for variable-frequency oscillators. If one wishes to construct a single-frequency oscillator the resistances can be approximately equal and the capacitances can also be approximately equal. The frequency may then be adjusted by small variation of one of the condensers or resistors in the phase-shifting network. Actually, the frequency of oscillation may be varied by a considerable amount in this manner.

If a variable-frequency oscillator is desired, the resistors R or the condensers C in Fig. 1 may be ganged together. In a laboratory oscillator it is often desirable to calibrate the tuning dial from 1 to 10 and change the frequency range by turning a decade switch. This can best be done by using variable condensers whose capacitance can be changed by 10:1 and arranging a switch which changes the resistances by decade steps.

The frequency of the oscillator circuits shown in Fig. 1 can also be changed by large amounts without ganging all the condensers or all the resistors. For instance, in Fig. 1(a), the first two condensers C have

a common point and, therefore, they may be replaced by a standard 2-gang variable condenser with the rotor insulated from ground. The third condenser C may have a value which is an average of the maximum and the minimum values of the ganged condenser. An oscillator of this type is easier to construct than one in which three condensers or resistors must be ganged. But two things happen as a result of this procedure. Obviously enough, for a certain change of capacitance in the variable condenser the tuning range is smaller if only two instead of three condensers are varied. The gain required for oscillation also changes in a manner depending upon how much the variable capacitances deviate from the fixed one. These undesirable results often are not too serious and it seems quite practical to use oscillators of this type.

Fig. 3 presents the various kinds of phase-shifting networks that seem to the authors to be most practicable, together with the frequency of oscillation and the necessary amplification. From this figure it will be seen that if all condensers are ganged together, the necessary gain is independent of frequency, whereas, if one of the condensers is fixed, the necessary amplification will change. This means that some sort of automatic

large change in amplification must be tolerated. On the other hand, if a smaller change in frequency is acceptable the necessary amplification does not change appreciably.

| PHASE SHIFTING NETWORK | FREQUENCY OF OSCILLATION | NECESSARY AMPLIFICATION |
|------------------------|---|--|
| | $\frac{1}{2\pi\sqrt{6}RC}$ | 29 |
| | $\frac{1}{2\pi RC\sqrt{15\left(5+\frac{C_1}{C_2}\right)}}$ | $16 + 10\frac{C_1}{C_2} + 3\frac{C_1^2}{C_2^2}$ |
| | $\frac{1}{2\pi RC\sqrt{15\left(1+\frac{C_1}{C_2}\right)}}$ | $14 + 3\left(\frac{C_1}{C_2} + 4\frac{C_1^2}{C_2^2}\right)$ |
| | $\frac{1}{2\pi RC\sqrt{\frac{3\left(\frac{C_1}{C_2}\right)^2 + 7\frac{C_1}{C_2} + 7}{4 + 3\frac{C_1}{C_2}}}}$ | $\frac{9\left(\frac{C_1}{C_2}\right)^2 + 33\left(\frac{C_1}{C_2}\right) + 55\left(\frac{C_1}{C_2}\right) + 90 + 84\left(\frac{C_1}{C_2}\right)}{4 + 3\frac{C_1}{C_2}}$ |
| | $\frac{\sqrt{6}}{2\pi RC}$ | 6 |
| | $\frac{\sqrt{6}}{2\pi RC}$ | 10.4 |

Fig. 3—Design equations for phase-shift oscillators.

volume control must be provided to maintain a constant amplitude and a low distortion.

For the sake of making the interpretation of some of the results given in Fig. 3 easier, the variation of frequency and the necessary amplification as a function of the tuning capacitances are shown graphically in Figs. 4 and 5. It will be noted that if a large tuning range for a certain capacitance variation is desired, a

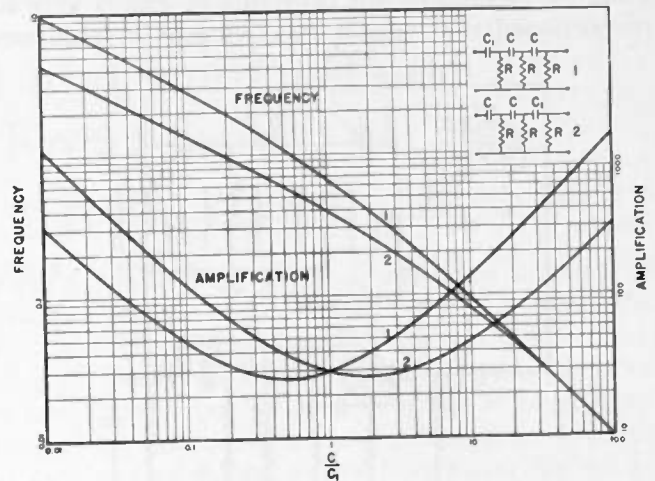

Fig. 4—Frequency of oscillation and required amplification as a function of capacitance ratio for a phase-shift oscillator employing a 3-mesh circuit.

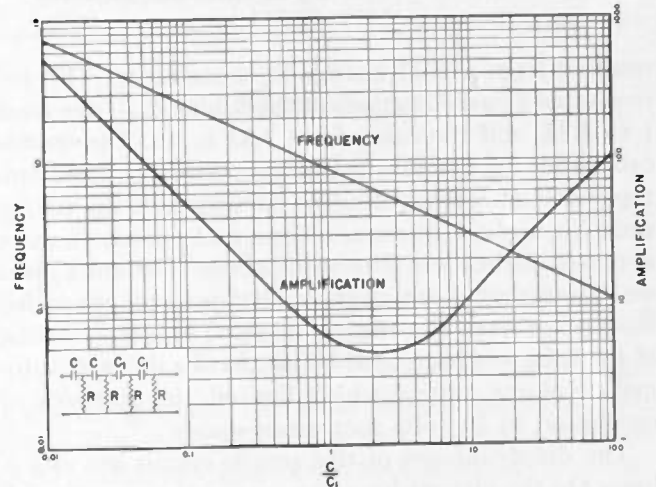

Fig. 5—Frequency of oscillation and required amplification as a function of capacitance ratio for a phase-shift oscillator employing a 4-mesh circuit.

TYPICAL DESIGNS

Fig. 6 shows a schematic diagram of a variable-frequency oscillator built by the authors intended for use in a communications laboratory. It consists of a pentode amplifier using an 1851 tube so that sufficient gain was developed without an excessively large coupling resistance R_1' . The phase-shifting network of the type shown in Fig. 1(a) was chosen because this particular circuit requires smaller R or C than other possible circuits for a given frequency. Physical limitations prevented the use of a variable capacitance much larger than 800 micromicrofarads. In order to produce a frequency of 30 cycles per second one finds that $R = 1/\sqrt{6}(2\pi \times 30 \times 800 \times 10^{-12}) = 2.7 \times 10^8$ ohms. This value of R is almost too high to be inserted in the grid circuit of a tube, and for this reason, circuits of the type shown in Fig. 1(a) are preferable.

As will be seen in Fig. 6, only the first two condensers in the phase-shifting network are variable. This, of course, decreases the tuning range that can be obtained from a single rotation of the condenser dial. As a matter of fact, circuit constants in Fig. 6 were so proportioned that only a 3.3:1 change in frequency

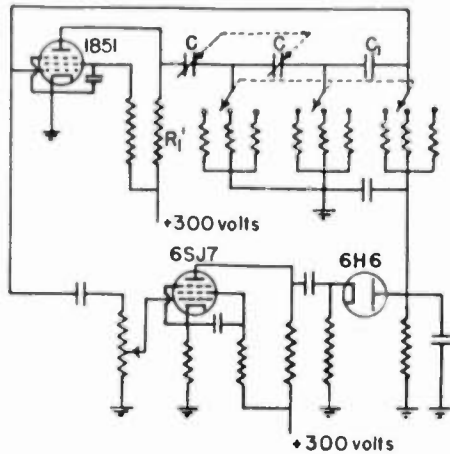

Fig. 6—Circuit of a phase-shift oscillator with automatic volume control.

resulted from a 10:1 change in capacitance. This necessitated two calibrations of the tuning dial, one from 1 to 3.33, and the other from 3.33 to 10. The double calibration of the dial is not necessarily a disadvantage for it effectively doubles the length of the tuning scale for a given frequency band and permits a more accurate calibration. The value of the constant C_1 was so chosen that a minimum variation in amplification took place over the tuning range. The amplification of the tube was controlled by means of a delayed automatic volume control which limited the strength of oscillation to 20 volts root-mean-square.

The disadvantages of this simple circuit are as follows: On the highest frequency range the resistance R has a value which is nearly the same as the resistance R_1' . This means that the frequency calibration of the tuning dial is different on the highest range from those ranges where R_1' is negligible in comparison with R . The fact that R shunts R_1' also means that a higher amplification must be developed by the tube which tends to introduce distortion on other ranges where the necessary gain is not affected by the presence of R . Also, frequency stability is not so good as it might be. This is obvious from (23).

These disadvantages may be largely eliminated by adding another tube to the circuit, as shown in Fig. 7. The first tube, a 6AB7-1853 supplies the gain necessary for oscillation. The next tube, a 6AG7, acts as an impedance transformer. The voltage developed between the cathode and ground is almost equal to the grid-to-ground voltage and is of the same phase. As far as frequency of oscillation and the necessary gain is concerned, this tube may be entirely neglected. But the impedance looking back from the phase-shifting net-

work is $[R_k(1/g_m)]/[R_k + (1/g_m)]$ where g_m is the transconductance of the tube, and R_k is the cathode-to-ground resistance. Since g_k for 6AG7 is approximately 5000 micromhos, this impedance is about 200 ohms, whereas, in the circuit shown in Fig. 6, the resistance seen by the phase-shifting network was about 15,000 ohms. Therefore, by using the impedance transformer of this type, the effect of the tubes on the performance of the circuit becomes negligible.

If a balanced output from such an oscillator is desired, a resistance equal to R_k may be introduced into the plate circuit of the 6AG7. Thus, the tube serves not only to separate the frequency-determining network from the tube which supplies the amplification but also acts as a phase inverter to provide a balanced output voltage which may be utilized to drive a push-pull output stage directly. An oscillator of this type built in the laboratory was found to be capable of delivering 15 volts root-mean-square from each side to ground with 0.5 per cent second-harmonic and 0.08 per cent third-harmonic distortion. A delayed automatic volume control of the type shown in Fig. 6 was also used in the oscillator shown in Fig. 7. The output voltage remained constant within ± 5 per cent over the fre-

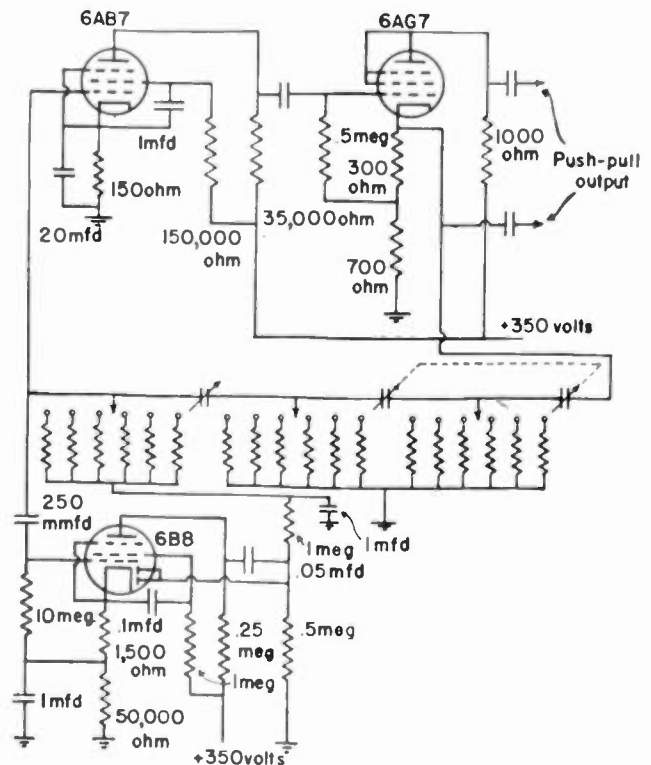

Fig. 7—Circuit of a phase-shift oscillator with automatic volume control and impedance-transformer tube.

quency range of the oscillator (50 to 40,000 cycles per second).

CONCLUSIONS

Two things can be said for the oscillators described in this paper. If one desires a constant audio-frequency oscillator, it is probably impossible to devise any

cheaper or simpler circuits than those shown in Fig. 1. If one desires a high-quality, variable-frequency oscillator, it will be found that an oscillator similar to the one shown in Fig. 7 is as good as any available on the

market or described in the literature. In certain applications it may actually prove to be superior, especially in cases where frequency stability (with reference to supply-voltage fluctuation) is an important factor.

Fluctuations Induced in Vacuum-Tube Grids at High Frequencies*

DWIGHT O. NORTH†, MEMBER, I.R.E., AND W. ROBERT FERRIS†, MEMBER, I.R.E.

Summary—A theoretical formula for the noise induced in the input circuit of vacuum-tube amplifiers by fluctuations in the electron stream is compared with measured values. The results are found to be in substantial agreement.

IT IS generally appreciated that a varying electron stream will induce alternating currents in near-by conductors. Therefore, it is to be expected that, in addition to the other well-known fluctuation phenomena found in vacuum tubes at moderately low frequencies,¹ the random variations in space current will induce current fluctuations in the control-grid circuit, giving rise to grid-voltage fluctuations proportional to the total input impedance (tube and circuit) and, for small transit angles, to the frequency. Indeed, Ballantine² predicted such an effect in 1928, and it was observed by R.C.A. Communications engineers at Riverhead in the course of a study of the sources of noise in receiving circuits operating in the neighborhood of 10 to 20 megacycles.

Nyquist's³ well-known formula for the mean-square short-circuit current fluctuations in a passive network exhibiting a shunt conductance g (any susceptance whatever) at the frequency in question is

$$\overline{i^2} = 4kTg\Delta f$$

in which T is the absolute temperature of the network; k , Boltzmann's constant; and Δf , the band width. The results of a theoretical investigation of induced grid-current fluctuations i_g by one of us (D.O.N.) may be expressed in similar form, thus

$$\overline{i_g^2} \approx \frac{20}{3} \left(1 - \frac{\pi}{4}\right) 4kT_k g_o \Delta f = 1.43(4kT_k g_o \Delta f)$$

in which T_k is the cathode temperature and g_o is that

* Decimal classification: R132. Original manuscript received by the Institute, January 13, 1941. In order to bring the practical aspects of this subject immediately before those interested in the design of high-frequency receivers, the usual description of analytical and experimental procedures has been omitted. It is the purpose of the authors to supply these details in a subsequent publication.
† RCA Manufacturing Company, Inc., RCA Radiotron Division, Harrison, N. J.

¹ B. J. Thompson, D. O. North, and W. A. Harris, "Fluctuations in space-charge-limited currents at moderately high frequencies," *RCA Rev.*, vol. 4, pp. 269-285; January; vol. 4, pp. 441-472; April; vol. 5, pp. 106-124; July; vol. 5, pp. 244-260; October; 1940; vol. 5, pp. 371-388; January, 1941.

² S. Ballantine, "Schrot effect in high-frequency circuits," *Jour. Frank. Inst.*, vol. 206, pp. 159-167; August, 1928.

³ H. Nyquist, "Thermal agitation of electric charge in conductors," *Phys. Rev.*, vol. 32, pp. 110-113; July, 1928.

portion of the tube input conductance traceable to electronic loading alone^{4,5} (as distinguished from leakage, dielectric losses, and particularly, feedback effects). The formula refers specifically only to tubes of conventional proportions, operating at frequencies such that transit angles are not greater than a radian or two, and exhibiting at low frequencies the space-charge-reduced, cathode-current shot effect discussed elsewhere.¹

For comparison with thermal agitation in passive networks at room temperature T_0 , the formula may be written

$$\overline{i_g^2} = \beta(4kT_0 g_o \Delta f)$$

where

$$\beta = 1.4 \frac{T_k}{T_0}$$

With $T_0 \approx 300$ degrees Kelvin and $T_k \approx 1000$ degrees Kelvin, a temperature representative of sleeve-type cathodes,

$$\beta \approx 4.8.$$

We have attempted experimental checks of this figure with tubes equivalent to standard tube types 6AB7, 6SK7, 6J5, and 6AC5. Measurements at 30 and at 100 megacycles showed values of β ranging from 3.5 to 6.5 and averaging about 5. Attempts to improve experimental accuracy by more careful determination of average cathode temperatures were not very significant. The indicated proportionality of β to T_k was confirmed in the range, 900 to 1200 degrees Kelvin.

An important part of the experimental procedure was the use of a bridge-balance scheme devised by one of us (W.R.F.) to eliminate feedback. This scheme made it possible to obtain a true measure of g_o with specially constructed tubes having regular production parts but provided with an additional pair of leads, to cathode and anode, respectively. Lead lengths and interelectrode capacitances in many tubes are such that failure to neutralize feedback results in an order-of-magnitude error in the experimental determination of β .

⁴ W. R. Ferris, "Input resistance of vacuum tubes as ultra-high-frequency amplifiers," *PROC. I.R.E.*, vol. 24, pp. 82-105; January, 1936.

⁵ D. O. North, "Analysis of the effects of space charge on grid impedance," *PROC. I.R.E.*, vol. 24 pp., 108-136; January, 1936.

It must be recognized that the fluctuation (i_v) may not be regarded as an independent noise source, to be compounded with other fluctuations in the usual fashion by summation of mean-square values; for the induced grid current is coherent with the fluctuation in space current. However, for small transit angles, the phase angle is obviously nearly 90 degrees, so that for resistive inputs mean-square compounding is essentially correct. In the event of large transit angles, or if there is appreciable feedback, computation of overall signal-to-noise ratios is not so simply accomplished because of the necessity for tracing the phase relations between the various noise currents which stem from

the same source and, hence, cannot be compounded in mean-square fashion.

But where feedback does not occur, the relative importance of induced grid noise may be appreciated by considering its maximum effect. If the entire conductance of an input circuit were due to electronic loading, as might nearly be the case if a high-impedance circuit were used with a conventional tube at a very high frequency, the noise-to-signal ratio would, at the worst, be $\sqrt{4.8} = 2.2$ times that of a passive network having the same characteristics. Since additional sources of noise will always contribute to the total, the factor, in practice, is always smaller.

The Distribution of Amplitude with Time in Fluctuation Noise*

VERNON D. LANDON†, MEMBER, I.R.E.

Summary—The purpose of this paper is to show that fluctuation noise has a statistical distribution of amplitude versus time which follows the normal-error law. This fact is also correlated with the measurements of crest factor made on the noise output of band-pass amplifiers by various investigators.

It is shown that the distribution of noise amplitude continues to follow the normal-error law, even after the noise has been passed through frequency-selective circuits. It is shown why the measurements of crest factor, made by various experimenters, group around the value 4, but it is pointed out that this is not a true crest factor because the voltage occasionally goes considerably higher. The ratio of the average to the effective voltage is shown to be 0.798. A discussion is given of the kinds of noise which do not follow this normal-error law.

FLUCTUATION noise is a name applied to thermal-agitation noise or to shot-effect noise.

Thermal-agitation noise is the noise caused by the thermal motion of electrons in conductors. Shot-effect noise is the noise caused by the granular structure of the plate current of a vacuum tube. The term is sometimes reserved for the condition of no space charge. In the presence of space charge the noise amplitude is reduced. For this condition the noise may be called shot-effect noise as before or simply tube noise. These various types of noise source produce noises which cannot be distinguished one from the other by any known test.

Several investigators,¹⁻⁴ have made experimental investigations of the "crest factor" of fluctuation noise. The crest factor is defined as the ratio of the

amplitude of the highest peaks to the root-mean-square voltage. Various values have been obtained ranging from 3.4 to 4.5. It now appears that the required data can best be obtained from purely theoretical considerations.

From the standpoint of theory the term "crest factor" would seem to be a misconception. It will be shown that the noise is made up of an infinite number of components differing in frequency by infinitesimal amounts. If all these components should get in phase, the voltage would rise to an indefinitely large value, but the probability of this happening is infinitesimal. Nevertheless, if any finite crest factor is chosen, the probability that it will be exceeded at a given instant is a finite fraction. This probability is another name for the fraction of the time that the voltage will exceed the chosen value in a given long period of time.

To make the conception clearer let it be supposed that the noise output of a high-gain band-pass amplifier is fed to a diode. An adjustable direct-current bias is applied to the diode simultaneously and a tape recorder is arranged to record the time during which the diode is drawing current. With a given direct-current bias on the diode it would be possible to determine, by examining the tape, the percentage of the time during which the diode was drawing current. A point-by-point curve could then be plotted of direct-current bias, against the probability that the bias would be exceeded at a given instant.

By letting r stand for the ratio between any given direct voltage V and the root-mean-square value of the noise E and letting p stand for the probability that the noise will exceed the given direct voltage, it should be possible to find an analytical relationship $p = F(r)$ which would determine the above curve from purely theoretical considerations.

* Decimal classification: R270. Original manuscript received by the Institute, October 29, 1940; revised manuscript received, January 22, 1941.

† RCA Manufacturing Company, Inc., Victor Division, Camden, N. J.

¹ V. D. Landon, "A study of the characteristics of noise," *Proc. I.R.E.*, vol. 24, pp. 1514-1521; November, 1936.

² M. G. Crosby, "Frequently modulation noise characteristics," *Proc. I.R.E.*, vol. 25, pp. 472-514; April, 1937.

³ Karl G. Jansky, "An experimental investigation of the characteristics of certain types of noise," *Proc. I.R.E.*, vol. 27, pp. 763-768; December, 1939.

⁴ E. H. Plump, "Storverminderung durch Frequenzmodulation," *Hochfrequenz. und Electroakustik*, vol. 52, pp. 73-80; September, 1938.

THE CONDITIONS OF THE PROBLEM

Following is a review of the facts which are known about the problem. The energy of the noise is distributed uniformly over the frequency spectrum. If the noise is passed through a frequency-selective network the root-mean-square value of the noises in the output is proportional to the square root of the effective band width of the network. The noise is made up of a continuous spectrum of frequency components. The relative phase of the various components is random.

The last statement requires some further explanation. Considering shot effect as a typical example of fluctuation noise, the noise unit is due to the arrival of one electron on the plate. This may be considered to be an infinitesimal unit impulse. Unit impulse (the first derivative of the unit step) is known to have a uniform distribution of energy over the frequency spectrum. However, the phase of these components is not random. The components are all in phase at the instant the unit impulse occurs. If two unit impulses occur at different times, the frequency components add with various phases. The resultant components have phases differing from the phases of components of the same frequency in either pulse alone. Exceptions are the few individual frequencies where the phases are the same for the two impulses. When the impulses occur at random times and the number of impulses is increased to an indefinitely large value, the relative phases of the various components have no discernible relationship and are said to be random. The term, random phase, is difficult to define accurately. As applied to only two incommensurable frequency components, the term is meaningless because the relative phase inevitably assumes all possible values as the two frequencies beat together. When speaking of a continuous spectrum of frequency components the phase may be said to be random if the following statement may be made about each frequency component. Let the phase of the component be observed every time the noise voltage passes through a certain value. The phase is as likely to have one value as another, regardless of what voltage is chosen for the measurements. Thus randomness of phase is seen to be a necessary condition to insure the accuracy of the relation that the root-mean-square value is proportional to the square root of the band width.

DERIVING THE ANALYTICAL RELATIONSHIP

The desired relation may be represented by

$$p = F(r) = F\left(\frac{V}{E}\right) = F\left(\frac{V}{\sqrt{n}}\right)$$

where $n = E^2$.

Let
$$p_{v'} = \frac{dp}{dV}$$

where dp is the probability of the voltage lying between V and $V+dV$.

Let the mean-square value of the noise be increased by adding an infinitesimal frequency component Δ .

This added component is assumed to be very small compared to E as are all the other components of the noise. The magnitude is not necessarily equal to that of the other components, however. The probability $p_{v'}$ will also be changed by the addition of this component. An equation relating this change in $p_{v'}$ to the change in the mean-square voltage is derived below:

Δ is the root-mean-square value of an oscillatory voltage. The instantaneous value is $\sqrt{2}\Delta \sin 2\pi ft$. At any value of the time t_0 the probability that the total resultant voltage will have the value V_0 is the value of $p_{v'}$ corresponding to $V = (V_0 - \sqrt{2}\Delta \sin 2\pi ft)$. Since the added component is negative just as much as it is positive, $p_{v'}$ will change only if the curve has curvature at the point under consideration.

The relationship can be seen more clearly by expanding the value of $p_{v'}$ as a Taylor's series.

Let $p_{0'}$ be the value of $p_{v'}$ corresponding to V_0 in the absence of Δ . Then with Δ added

$$p_{v'} = p_{0'} + \frac{dp_{v'}}{dV} \sqrt{2} \Delta \sin 2\pi ft + \frac{d^2 p_{v'}}{dV^2} \frac{1}{2} (\sqrt{2} \Delta \sin 2\pi ft)^2 + \dots \quad (1)$$

The second term does not affect the long-time value of $p_{v'}$ because the average value is zero. The third term does change the value of $p_{v'}$ because $\sin^2 2\pi ft$ is always positive. The higher-order terms are negligible if Δ is small. Hence,

$$\begin{aligned} dp_{v'} &= \frac{d^2 p_{v'}}{dV^2} \frac{1}{2} 2\Delta^2 \sin^2 2\pi ft \\ &= \frac{d^2 p_{v'}}{dV^2} \Delta^2 \frac{1 - \cos 2(2\pi ft)}{2} \end{aligned} \quad (2)$$

Averaged over a long time

$$dp_{v'} = \frac{\Delta^2}{2} \frac{d^2 p_{v'}}{dV^2} \quad (3)$$

Now $n = E^2$

$$n + dn = E^2 + \Delta^2.$$

Hence

$$\frac{dp_{v'}}{dn} = \frac{1}{2} \frac{d^2 p_{v'}}{dV^2} \quad (4)$$

This is a well-known differential equation. The solution is

$$p_{v'} = \frac{A}{\sqrt{n}} e^{-V^2/2n} = \frac{A}{E} e^{-V^2/2E^2} = \frac{A}{E} \exp\left(-\frac{V^2}{2E^2}\right) \quad (5)$$

Now

$$\int_{-\infty}^{+\infty} p_{v'} dV = 1. \quad (6)$$

But

$$\frac{A}{E} \int_{-\infty}^{+\infty} \exp\left(-\frac{V^2}{2E^2}\right) dV = \frac{A}{E} \frac{2\sqrt{\pi} E}{\sqrt{2}} = 1. \quad (7)$$

Therefore

$$A = \frac{1}{\sqrt{2\pi}}. \quad (8)$$

Therefore

$$p_v' = \frac{1}{\sqrt{2\pi} E} \exp\left(-\frac{V^2}{2E^2}\right) = \frac{1}{\sqrt{2\pi n}} \exp\left(-\frac{V^2}{2n}\right). \quad (9)$$

This solution may be checked by differentiating

$$\frac{dp_v'}{dn} = \frac{1}{\sqrt{2\pi n}} \exp\left(-\frac{V^2}{2n}\right) \left(\frac{V^2}{2n^2} - \frac{1}{2n}\right) = \frac{1}{2} \frac{d^2 p_v'}{dV^2}. \quad (10)$$

As might have been expected, the desired function turns out to be the probability integral. The probability that the noise amplitude will lie between zero and any given voltage at a given instant is

$$p_a = \frac{1}{\sqrt{2\pi}} \int_0^r \exp\left(-\frac{r^2}{2}\right) dr = \frac{1}{2} \operatorname{erf}(r/\sqrt{2}) \quad (11)$$

where *erf* means the error function.

The probability that the given voltage will be exceeded is

$$p_b = \frac{1}{\sqrt{2\pi}} \int_r^{+\infty} \exp\left(-\frac{r^2}{2}\right) dr = \frac{1}{2} \operatorname{erfc}(r/\sqrt{2}) \quad (12)$$

where *erfc* means the complement of the error function.

Since the probability that the given voltage will or will not be exceeded in a negative direction is the same as in a positive direction

$$2(p_a + p_b) = \sqrt{\frac{2}{\pi}} \int_{-\infty}^{+\infty} \exp\left(-\frac{r^2}{2}\right) dr = 1. \quad (13)$$

Functions described by the probability integral are said to follow the normal-error law. Other synonymous terms are the Maxwell-Boltzmann distribution or Maxwell distribution.

It has previously been demonstrated that a similar function applies to the velocity distribution of electrons emitted from a hot cathode.⁵⁻⁷ However, the behavior of the resultant current in an associated external selective circuit was not considered in any of this previous work. Dunn and White⁸ relate the function to noise amplitude but give no theory or details.

⁵ Irving Langmuir, "The effect of space charge and initial velocity on the potential distribution and thermionic current between parallel plane electrodes," *Phys. Rev.*, vol. 21, pp. 419-435; April, 1923.

⁶ Thornton C. Fry, "The thermionic current between parallel plane electrodes; velocities of emission distributed according to Maxwell's law," *Phys. Rev.*, vol. 17, pp. 441-452; April, 1921.

⁷ D. O. North, "Fluctuations in space charge limited currents at moderately high frequencies, part II—diodes and negative-grid triodes," *RCA Rev.*, vol. 4, pp. 441-472; April, 1940.

⁸ H. K. Dunn and S. D. White, "Statistical measurements on conversational speech," *Jour. Acous. Soc. Amer.*, vol. 11, pp. 278-288; January, 1940.

ADDITIVE PROPERTY OF NORMAL-ERROR LAW

An important property of the normal-error law is expressed by the following theorem:

When the normal-error law applies to each of two voltages it also applies to their sum.

When the normal-error law does apply, then in any electrical network, the probability that a given voltage will be exceeded at a certain instant is

$$p_1 = \frac{1}{\sqrt{2\pi}} \int_r^{+\infty} \exp\left(-\frac{r^2}{2}\right) dr \\ = \frac{1}{E_1 \sqrt{2\pi}} \int_V^{+\infty} \exp\left(-\frac{V^2}{2E_1^2}\right) dV \quad (14)$$

where *V* is any direct voltage and *E*₁ is the root-mean-square value of the noise.

In a second network

$$p_2 = \frac{1}{E_2 \sqrt{2\pi}} \int_V^{+\infty} \exp\left(-\frac{V^2}{2E_2^2}\right) dV. \quad (15)$$

When the noise outputs of the two networks are added algebraically the expression must retain the same form.

That is to say

$$p_3 = \frac{1}{E_3 \sqrt{2\pi}} \int_V^{+\infty} \exp\left(-\frac{V^2}{2E_3^2}\right) dV \quad (16)$$

where the subscript 3 refers to the two networks with outputs added.

Then *E*₃ should equal $\sqrt{E_1^2 + E_2^2}$.

This theorem is proved in the following paragraphs.

PROOF OF THE ADDITIVE THEOREM

Now the probability that a noise voltage will lie between any two finite values of voltage is a finite number. However, as one value approaches the other the value of the probability approaches zero. That is, the probability of the voltage having a certain definite value is zero, unless a certain tolerance or range is allowed. However, the relative probability of the voltage having one value or another has a real meaning. This is best expressed as the probability per voltage interval. That is, of course, equivalent to the slope of the curve or *dp/dV*.

Thus the relative probability that the voltage of network 1 will have a certain fixed value *V* within any small fixed tolerance is

$$\frac{dp_1}{dV} = \frac{-1}{E_1 \sqrt{2\pi}} \exp\left(-\frac{V^2}{2E_1^2}\right). \quad (17)$$

The relative probability that the voltage of network 2 will have a value *V*₀ - *V* is

$$\frac{-1}{E_2 \sqrt{2\pi}} \exp\left(-\frac{(V_0 - V)^2}{2E_2^2}\right).$$

The relative probability that both voltages occur simultaneously and add to the value *V*₀ is

$$\frac{1}{E_1 E_2 2\pi} \exp\left(-\frac{V^2}{2E_1^2}\right) \exp\left(-\frac{(V_0 - V)^2}{2E_2^2}\right).$$

The summation of this probability for all possible values of V is

$$\frac{dp_3}{dV} = \frac{1}{E_1 E_2 2\pi} \int_{-\infty}^{+\infty} \exp\left(-\frac{V^2}{2E_1^2} - \frac{(V_0 - V)^2}{2E_2^2}\right) dV. \quad (18)$$

Now

$$\begin{aligned} & \frac{V^2}{2E_1^2} + \frac{(V_0 - V)^2}{2E_2^2} \\ &= \frac{1}{2} \left[\frac{E_1^2 + E_2^2}{E_1^2 E_2^2} \left(V - V_0 \frac{E_1^2}{E_1^2 + E_2^2} \right)^2 + \frac{V_0^2}{E_1^2 + E_2^2} \right]. \end{aligned} \quad (19)$$

Hence

$$\begin{aligned} \frac{dp_3}{dV} &= \frac{1}{E_1 E_2 2\pi} \exp\left(-\frac{V_0^2}{2(E_1^2 + E_2^2)}\right) \\ & \int_{-\infty}^{+\infty} \exp\left[-\frac{E_1^2 + E_2^2}{2E_1^2 E_2^2} \left(V - V_0 \frac{E_1^2}{E_1^2 + E_2^2} \right)^2\right] dV \\ &= \frac{1}{E_1 E_2 2\pi} \exp\left(-\frac{V_0^2}{2(E_1^2 + E_2^2)}\right) \\ & \int_{-\infty}^{+\infty} \exp\left(-\frac{E_1^2 + E_2^2}{2E_1^2 E_2^2} S^2\right) dS \end{aligned} \quad (20)$$

where

$$S = V - V_0 \frac{E_1^2}{E_1^2 + E_2^2}$$

$$\frac{dp_3}{dV} = \frac{-1}{\sqrt{2\pi} \sqrt{E_1^2 + E_2^2}} \exp\left(-\frac{V_0^2}{2(E_1^2 + E_2^2)}\right) \quad (21)$$

$$p_3 = \frac{1}{\sqrt{2\pi} \sqrt{E_1^2 + E_2^2}} \int_{V_0}^{\infty} \exp\left(-\frac{V_0^2}{2(E_1^2 + E_2^2)}\right) dV_0. \quad (22)$$

This is the desired form of expression and E_3 in (16) is found to equal $\sqrt{E_1^2 + E_2^2}$ as required.

It has now been proved that when the normal-error law holds for each of two networks it will also hold for the sum of their outputs. (A similar theorem is proved by Scarborough.)⁹

The foregoing paragraphs prove that the summation of a large number of small sinusoidal components follows the normal-error law, regardless of the relative magnitudes of the various components, providing the phases are random. It is true, therefore, that the fluctuation-noise output of any frequency-selective network follows the normal-error law regardless of the shape of the selectivity curve.

This should not be taken to mean that the noise output of a vacuum tube follows this law at all times. Deviations from the law may be caused by a large hum component, microphonic noises, faulty insulation, flicker effect, etc. Nevertheless, if the noise is primarily

of the type called fluctuation noise or hiss then the normal-error law does apply.

Hence in the output of any network passing fluctuation noise the expression

$$p = \frac{1}{E\sqrt{2\pi}} \int_V^{\infty} \exp\left(-\frac{V^2}{2E^2}\right) dV \quad (23)$$

is the probability that the noise voltage at any given instant will exceed the voltage V chosen at random. This may also be written in the form

$$p = \frac{1}{2} [1 - \text{erf}(r/\sqrt{2})] \quad (24)$$

where $r = V/E$, and erf denotes the error function.

In Fig. 1 a curve is plotted of p versus r . The data for the curve were obtained from tables of the probability integral. The point on the curve at $r=0, p=0.5$

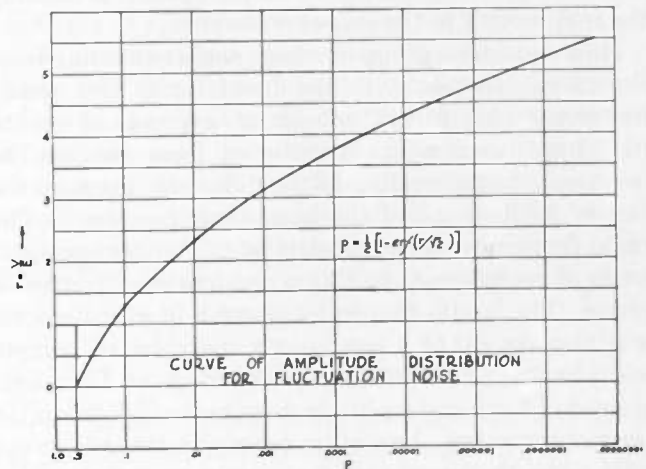

Fig. 1

indicates that the voltage is above the zero axis half the time. The point at $r=1, p=0.16$ indicates that the voltage exceeds the root-mean-square value (in a positive direction) 16 per cent of the time. The point at $r=4, p=0.000032$ indicates that the voltage exceeds 4 times the root-mean-square value for a total of 3.2 seconds out of 100,000 seconds. The curve is for one side of the wave only. For the probability that the absolute magnitude of the voltage will exceed a certain value, the probabilities given on the curve should be doubled.

AUDIO-FREQUENCY NOISE IN THE OUTPUT OF A DETECTOR

The foregoing applies only to the output of amplifiers or filters containing linear circuit elements. When radio-frequency noise from a band-pass network is applied to a detector the distribution of noise amplitude in the detector output circuit does not follow the normal-error law. If no signal is present the deviation from the normal-error curve is quite marked. This is due to the fact that the audio-frequency output is the envelope of the peaks on one side only. The zero audio-frequency level corresponds approximately to the average of the radio-frequency voltage. The audio-fre-

⁹ J. B. Scarborough, "Numerical Mathematical Analysis," Johns Hopkins, Baltimore, Md., 1930.

quency peaks in one direction correspond to zero radio-frequency voltage and thus are limited in amplitude to the value of the average radio-frequency voltage. Thus there is a distinct lack of symmetry. The voltage crests in one direction are definitely limited and in the other direction the voltage exceeds the values predicted by the normal-error law.

If a continuous-wave signal is applied to the detector at the same time as the radio-frequency noise, the audio-frequency noise in the output deviates less from the normal-error curve. If the carrier is considerably stronger than the highest peaks of the noise, the deviation becomes negligible. This statement is established by the following argument.

Consider a single-frequency component, differing from the signal carrier wave by a frequency interval f . This component will beat with the carrier, producing the frequency f in the detector output.

Now consider a group of components extending from the carrier frequency to the band limit. The audio-frequency output will consist of a group of audio-frequency components distributed from zero to the frequency corresponding to the difference between the carrier frequency and the band-limit frequency. The radio-frequency noise consists of a continuous spectrum of components having a random distribution of phase. The audio-frequency output of the detector will also consist of a continuous spectrum of components having a random distribution of phase. Therefore, it too will have an amplitude distribution following the normal-error law. Deviation from the law will occur only when the signal carrier does not exceed the noise sufficiently.

THE NUMBER OF CRESTS EXCEEDING $4E$ IN ONE SECOND

For convenience, in the following discussion, the response of an amplifier to unit impulse will be called a typical pulsation. In the low-pass case, the pulsation will have a shape of the general form of half a cycle of a sine wave or perhaps, roughly, the shape of the function $\sin 2\pi f_c t/l$. The exact shape depends on the attenuation characteristics. In the band-pass case the pulsation consists of a wave train. The intercepts of the zero line occur at the mean frequency of the pass band. The envelope of the wave train is the same as the pulsation wave shape of the low-pass case. In each case the time duration of the pulsation is about $1/f_c$, where f_c is the cutoff frequency in the low-pass case, and one half the band width in the band-pass case.

If the output of an amplifier consists of fluctuation noise, the wave form of the higher crests of the noise will be closely the same as the wave form of a pulsation due to unit impulse excitation. This statement is justified by the following reasoning. No peak can be narrower than a typical pulsation because this would require a wider pass band. The probability that a given peak will be much wider than a typical pulsation is

small, particularly at the higher amplitudes. This is supported by the following data taken from the curve. The probability that the voltage at a given instant will exceed $2E$ is 0.023. The probability that it will exceed $3E$ is 0.001.

Of those peaks which exceed $4E$ in amplitude the average height appears from the curve to be about $4.15E$. Using graphical methods, this leads to the following conclusion. The average peak which exceeds $4E$, exceeds it for about $1/6$ of the duration of a typical pulsation, or for $1/6f_c$ second. Thus the number of crests per second in excess of $4E$ is approximately $6f_c$ times 0.00003. When the band width is 10,000 cycles there will be an average of about 18 such peaks in 10 seconds.

The above brings out the following curious fact. When a noise which follows the normal-error law has an equal distribution of components at all frequencies, then the value of the voltage at a given instant is quite independent of its values at preceding instants. On the other hand, when the frequency range of the noise is limited and the preceding wave form is given, the wave form may be extrapolated into the future for a short distance. This is particularly true if the instant chosen coincides with the time of occurrence of an unusually high peak, since the peak will probably have the form of a typical pulsation of the circuit which was used to limit the frequency band. Nevertheless, the normal-error law still applies over a long period of time.

It should also be pointed out that when random impulses are the source of noise and the frequency range is practically unlimited, the number of impulses must be very large if the normal-error law is to apply. When the frequency range is limited, then a smaller number of impulses will suffice. The restricted frequency band is necessary to cause the individual pulsations in the output to overlap adjacent pulsations. Even ignition interference may cause a noise which approximately follows the law if the noise is coming from many cars simultaneously and if the received frequency band is sufficiently restricted.

VARIATIONS IN MEASURED CREST FACTOR

It follows from the above that the number of peaks exceeding $4E$ in a given time is proportional to the band width of the amplifier. Some observers might tend to set the limit at a certain number of peaks per second regardless of band width. If this were done, the "crest factor" derived on this basis would tend to be slightly greater for wide-band amplifiers than for narrow. This may account for the apparent variation in crest factor shown by Plump⁴ (Fig. 2 in his paper).

THE VALUE OF THE AVERAGE VOLTAGE

It may be of some interest to give the value of the average voltage using the error function. Sokolnikoff¹⁰

¹⁰ I. S. and E. S. Sokolnikoff, "Higher Mathematics for Engineers and Physicists," McGraw-Hill Book Company, New York, N. Y., 1934, p. 393.

shows how the average value of the error function is derived.

The mean absolute value of the voltage is twice the summation of all positive values of the voltage multiplied by the probability of occurrence of each. That is,

$$|\bar{V}| = 2 \frac{1}{\sqrt{2E\sqrt{\pi}}} \int_0^{\infty} V \exp\left(-\frac{V^2}{2E^2}\right) dV \quad (25)$$

$$= \sqrt{\frac{2}{\pi}} \frac{1}{E} \left[E^2 \exp\left(-\frac{V^2}{2E^2}\right) \right]_0^{\infty} = \sqrt{\frac{2}{\pi}} \frac{1}{E} E^2 \quad (26)$$

$$= E\sqrt{2/\pi} \quad (27)$$

$$\frac{|\bar{V}|}{E} = \sqrt{2/\pi} = 0.798. \quad (28)$$

The measured value obtained by Jansky³ is 0.85.

CONDITIONS FOR VALIDITY

As previously pointed out, the curve of Fig. 1 is valid regardless of the shape of the selectivity curve of the band-pass amplifier under consideration. The only requirement is that the noise-frequency spectrum be continuous and that the components have random phase angles.

It is well known that certain types of noise have a voltage distribution differing widely from that of the curve of Fig. 1. In any given case the reason for the departure can usually be found. Ignition noise is a prominent example and, of course, the reason for the deviation is at once apparent in this case. The cause of the noise is a series of discrete impulses. Each impulse causes its own independent wave train in the output. In general the wave trains do not overlap. The frequency components of a given wave train are not of random phase but start out all having the same

phase. Thus the normal-error law does not apply.

With other exceptions also, the reason for the failure to follow the law can usually be found after a moderate amount of study. For example, in Crosby's paper,² the "crest factor" of fluctuation noise is shown to rise under certain conditions in a frequency-modulated receiver. The required condition is that the root-mean-square value of the noise be in the neighborhood of one quarter of the peak voltage of the carrier. Certain noise peaks then exceed the "improvement threshold" of the receiver and come through unduly amplified.

CONCLUSION

It has been shown that the fluctuation-noise output of a band-pass amplifier has a distribution of voltage versus time following the normal-error law. Thus a theoretical basis is established for appraising the measurements of crest factor made on the noise output of band-pass amplifiers by various investigators.¹⁻⁴ It is shown that there is some slight justification for assigning the fixed value 4 to the crest factor, for convenience in making rough calculations. However, it must be remembered that it is not a true crest factor since occasional peaks go considerably higher. The ratio of the average to the effective voltage is shown to be 0.798. A discussion is given of the kinds of noise which do not follow the normal-error law.

ACKNOWLEDGMENT

The author wishes to acknowledge the invaluable suggestions and helpful criticism made by Dr. J. L. Barnes, Mr. B. J. Thompson, Dr. D. O. North and Dr. D. S. Bond.

² Loc. cit., p. 504, Fig. 11.

Coupled Networks in Radio-Frequency Circuits*

ANDREW ALFORD†, MEMBER, I.R.E.

Summary—The main object of this paper is to develop a theory and a physical picture of electromagnetic coupling between sections of open wire transmission line. The second object is to consider the induced currents in wires of nonresonant lengths when they are placed into an electromagnetic field.

WORKERS with radio-frequency open wire transmission lines have had an occasion to observe the phenomenon of electromagnetic coupling between a pair of such lines.

This coupling between two lines usually takes place when the lines pass within a short distance of each other and when there exists a region in which one line passes through the electromagnetic field of the other.

When it is attempted to make an estimate of the

magnitude of this kind of interaction it is almost natural to think in terms of inductive and capacitive coupling without perhaps fully appreciating the fact that such ideas are not really applicable in this case and that they merely lead to purely artificial complications.

If the problem is approached from this point of view, we are left completely unsuspecting of the possibility that beautifully simple laws govern such phenomena and that these laws can be so easily and completely visualized so that in many cases the result of interaction can be predicted in a qualitative way from a mere inspection of the geometrical configuration of conductors and that relatively very accurate quantitative results can be obtained after only a few minutes of calculation.

It is not so much the phenomenon itself, as our

* Decimal classification: R142. Original manuscript received by the Institute, August 30, 1938; revised manuscript received, December 13, 1940. Presented, Thirteenth Annual Convention, New York, N. Y., June 17, 1938.

† Mackay Radio and Telegraph Company, New York, N. Y.

mental picture of it, which is apt to be complicated. To simplify this picture, we must abandon our ideas of so-called magnetic coupling, to which we have become too well accustomed, and establish in our minds a concept of a somewhat different kind which is more basic from the physical point of view and which is therefore more universally applicable.

To do this we naturally must start from the beginning. We all know that a magnetic field exerts no

field and is always an electromotive force.

When the current in different parts of a coil is constant so that each charge in this current is subjected to the total value of this electromotive force, the value of the current can be found by dividing the electromotive force by the impedance.

But when, as at high frequencies, the current along wires and coils varies from place to place in magnitude and in phase not all of the charges in the circuit are subjected to the entire electromotive force given by the line integral. Some of the charges do not travel all the way around the circuit but are stopped short and stored in the distributed capacitances. It follows that if we are to take account of these phenomena we must break up the total electromotive force into a number of elementary electromotive forces arranged around the circuit and examine their action on the corresponding elementary parts of the circuit. The sum total of these elementary elec-

tromotive forces is no longer of any use and the concept of magnetic coupling which goes with it is no longer applicable.

Once we dispense with the idea of magnetic coupling only the electric field has to be known, for when once

force on a stationary electron. Likewise, the force produced by the magnetic field on a moving electron is always at right angles to the instantaneous direction of motion of the electron. Consequently, this force has no component along the direction of motion and therefore it can do no work. It follows that a magnetic field can deliver no energy to a stream of electrons. It makes no difference whether this stream is in a vacuum tube or in a wire. No energy is ever induced by the magnetic field alone.

Everyday experience with so-called magnetically coupled coils is due not to the presence of the magnetic field but to the presence of the electric field which always coexists when the magnetic field varies with time.

It is true that these two fields are sometimes so closely and simply related that one can be used as a measure of the other, but it always must be kept in mind that it is the electric field which does the work. Thus, for instance, we use the product of mutual inductance and the time derivative of the magnetic flux as the measure of the effect of the electric field. This quantity is equal to the line integral of the electric

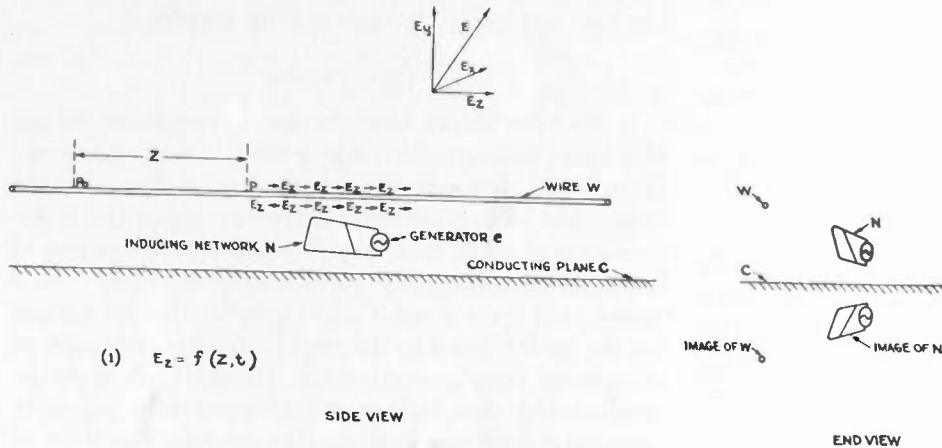
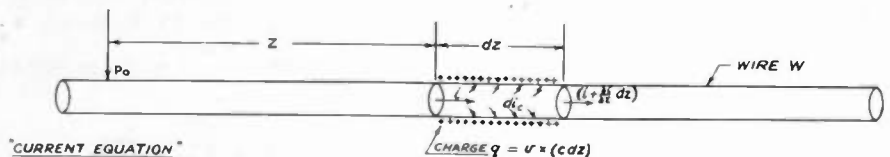

Fig. 1—Network *N* inducing currents in a long wire *W*.



"CURRENT EQUATION"

$$i - di_c = (i + \frac{\partial i}{\partial z} dz)$$

OR,
$$c \frac{\partial i}{\partial z} + \frac{\partial i}{\partial z} dz = 0$$

CHARGING CURRENT
$$di_c = \frac{\partial q}{\partial t} = c dz \frac{\partial v}{\partial t}$$

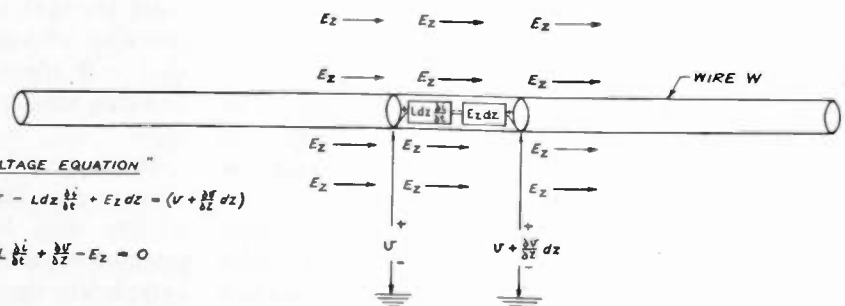

"VOLTAGE EQUATION"

$$V - L dz \frac{\partial i}{\partial t} + E_z dz = (V + \frac{\partial V}{\partial z} dz)$$

OR,
$$L \frac{\partial i}{\partial t} + \frac{\partial V}{\partial z} - E_z = 0$$

Fig. 2—This figure is used in deriving equations (1) and (2).

this field is known at every point in space, we can calculate the currents which it produces.

The problem to which we wish to apply this set of ideas is diagrammatically shown in Fig. 1. In this figure

W is a long thin wire which is placed parallel to and at a small distance from a large conducting plate C . This wire is located in the electromagnetic field of a network of conductors N which is assumed to be energized by a high-frequency generator e .

Network N produces at every point in space a magnetic field H and an electric field E . In accordance with what has been said above we may restrict our attention to the electric field. The total electric field E may be resolved into three components, namely, E_x parallel to the wire and E_y and E_z at right angles to the wire. The two components perpendicular to the wire produce no current along the wire and result in nothing but eddy currents which are negligible. When the wire is thin the component E_x along the wire is the only one which need be considered in detail. This component is a function of time t and distance z measured along the wire from some arbitrary origin P .

If we restrict ourselves to purely alternating currents of one frequency f then we may write E_x in the following form:

$$E_x = \sum_{n=1}^{n=N} [a_n(z)e^{j\omega t} \cdot e^{+jb_n(z)} + a_n(z)e^{-j\omega t} \cdot e^{-jb_n(z)}]$$

where $a_n(z)$ and $b_n(z)$ are functions of z which can be readily determined when E_x is known.

The current which is induced in the long wire is subject to the following conditions: 1. the current equation and 2. the voltage equation.

Both of these differential equations follow from well-known principles. (See Fig. 2.) The current equation says that the current which flows out of a wire element dz is equal to the current which flows into it, less the current which goes into increasing the electrical charge stored on the element. If the capacitance per unit length of the wire is C and the potential of the element at a given instant is v then the charge on the element is

$$(Cdz) \cdot v.$$

The rate of change of this charge is equal to the charging current

$$di_c = (Cdz) \cdot \frac{\partial v}{\partial t}.$$

If the current entering element dz is i and the current leaving the element is

$$i + \frac{\partial i}{\partial z} dz$$

then the current equation is

$$i - di_c = i + \frac{\partial i}{\partial z} dz$$

or

$$C \cdot \frac{\partial v}{\partial t} + \frac{\partial i}{\partial z} = 0. \tag{1}$$

The voltage equation is equally simple. Its meaning

is this: the potential at the end of an element dz differs from the potential at the beginning of this element by the sum of the potential drops in the impedance and in the electromotive force located in the element.

If we neglect the resistance, which is usually small in comparison with inductive reactance, the total drop of voltage between the ends of element dz is

$$v - \left(v + \frac{\partial v}{\partial z} dz \right) = Ldz \frac{\partial i}{\partial t} - (E_x dz)$$

or

$$\frac{\partial v}{\partial z} + L \frac{\partial i}{\partial t} - E_x = 0 \tag{2}$$

where L is the inductance per unit length of the wire and $(E_x dz)$ is the elementary electromotive force located in the element. This electromotive force $E_x dz$ is due to the fact that our element is located in the electric field E_x .

Elimination of V between (1) and (2) leads to the following differential equation for current i :

$$\frac{\partial^2 i}{\partial z^2} - CL \frac{\partial^2 i}{\partial t^2} = C \frac{\partial E_x}{\partial t} \tag{3}$$

If we restrict ourselves to purely alternating currents of one frequency we may put

$$i = u_1 e^{j\omega t} + u_2 e^{-j\omega t} \tag{4}$$

$$E_x = \sum_{n=1}^{n=N} [a_n(z)e^{j\omega t} \cdot e^{+jb_n(z)} + a_n(z)e^{-j\omega t} \cdot e^{-jb_n(z)}] \tag{5}$$

where u_1 and u_2 are functions of z . Under these conditions (4) reduces to the following two ordinary differential equations for u_1 and u_2 :

$$\begin{aligned} \frac{du_1^2}{dz^2} + \omega^2 LC u_1 &= \sum_{n=1}^{n=N} jC \cdot a_n(z) e^{+jb_n(z)} \\ \frac{du_2^2}{dz^2} + \omega^2 LC u_2 &= \sum_{n=1}^{n=N} -jC a_n(z) \cdot e^{-jb_n(z)}. \end{aligned} \tag{6}$$

Both of these equations can be readily solved by the method of variation of constants due to Lagrange.

Since the general solution of each of these two differential equations of the second order contains two arbitrary constants the general expression for current i obtained from (6) contains four arbitrary constants. This is exactly as it should be because the general solution should leave us free to specify the magnitudes and the phase angles of the impedances into which wire W may be terminated at its two ends. There are four quantities which we may specify and there are four arbitrary constants to take care of them.

The complete solution of these equations without limitations as to wire length is as follows:

$$\begin{aligned} i &= (A_1 + \hat{A}_1) \cos(\omega t + Kz) \\ &+ (A_2 + \hat{A}_2) \sin(\omega t + Kz) \\ &+ (A_3 + \hat{A}_3) \cos(\omega t - Kz) \\ &+ (A_4 + \hat{A}_4) \sin(\omega t - Kz) \end{aligned} \tag{7}$$

in which

$$\begin{aligned} A_1 &= + \frac{1}{z_0} \int_z^{n=N} \sum_{n=1} \cos [-Kz + b_n(z)] a_n(z) dz \\ A_2 &= + \frac{1}{z_0} \int_z^{n=N} \sum_{n=1} \sin [Kz - b_n(z)] a_n(z) dz \\ A_3 &= + \frac{1}{z_0} \int_z^{n=N} \sum_{n=1} \cos [Kz + b_n(z)] a_n(z) dz \\ A_4 &= - \frac{1}{z_0} \int_z^{n=N} \sum_{n=1} \sin [Kz + b_n(z)] a_n(z) dz \quad (8) \\ z_0 &= \sqrt{\frac{L}{C}} \end{aligned}$$

and $\dot{A}_1, \dot{A}_2, \dot{A}_3, \dot{A}_4$ are constants of integration to be determined from the boundary conditions existing at the two ends of the wire. When the wire in question extends from $z=0$ to $z=a$ and is open at both ends, these boundary conditions are particularly simple, namely,

$$\begin{aligned} i &= 0 \quad \text{at } z = 0 \\ i &= 0 \quad \text{at } z = a \end{aligned} \quad (9)$$

for all values of t .

The actual application of the above procedure can be best illustrated by the following examples:

Example 1.

Currents induced in wire of length a which is located in uniform field $E_z = E_0 \cos \omega t$ parallel to the wire.

The first step is to find $a_n(z)$ and $b_n(z)$. Since

$$E_z = E_0 \cos \omega t = \frac{E_0}{2} e^{j\omega t} + \frac{E_0}{2} e^{-j\omega t} \quad (10)$$

it is clear from comparison with (5) that in the present case

$$\begin{aligned} a_1(z) &= \frac{E_0}{2}, & a_2(z) &= 0, \dots \\ b_1(z) &= 0, & b_2(z) &= 0, \dots \end{aligned} \quad (11)$$

consequently,

$$\begin{aligned} A_1 &= + \frac{E_0}{2z_0} \int_z^a \cos Kz dz = - \frac{E_0}{2z_0} \frac{\sin Kz}{K} \\ A_2 &= + \frac{E_0}{2z_0} \int_z^a \sin Kz dz = + \frac{E_0}{2z_0} \frac{\cos Kz}{K} \\ A_3 &= + \frac{E_0}{2z_0} \int_z^a \cos Kz dz = + \frac{E_0}{2z_0} \frac{\sin Kz}{K} \\ A_4 &= - \frac{E_0}{2z_0} \int_z^a \sin Kz dz = + \frac{E_0}{2z_0} \frac{\cos Kz}{K} \quad (12) \end{aligned}$$

The next step is to find the constants of integration. This may be done by substituting values of A_1, A_2, A_3, A_4 as given by (12) into (7) and by making use of the boundary conditions. Thus the requirement that $i=0$ at $z=0$ results in

$$\begin{aligned} i &= \dot{A}_1 \cos \omega t + \left(\dot{A}_2 + \frac{E_0}{2z_0 K} \right) \sin \omega t \\ &+ \dot{A}_3 \cos \omega t + \left(\dot{A}_4 + \frac{E_0}{2z_0 K} \right) \sin \omega t = 0 \end{aligned}$$

which must hold good for all values of t and in particular for $\omega t = 0$ and $\omega t = \pi/2$. By putting $\omega t = 0$ and then $\omega t = \pi/2$ we get

$$\dot{A}_1 + \dot{A}_3 = 0 \quad \text{and} \quad \dot{A}_2 + \dot{A}_4 = - \frac{E_0}{z_0 K} \quad (13)$$

Similarly, the condition that $i=0$ at $z=a$ results in the following equation:

$$\begin{aligned} &\left(\dot{A}_1 - \frac{E_0}{2z_0} \frac{\sin Kz}{K} \right) \cos (\omega t + Ka) \\ &+ \left(\dot{A}_2 + \frac{E_0}{2z_0} \frac{\cos Kz}{K} \right) \sin (\omega t + Ka) \\ &+ \left(\dot{A}_3 + \frac{E_0}{2z_0} \frac{\sin Kz}{K} \right) \cos (\omega t - Ka) \\ &+ \left(\dot{A}_4 + \frac{E_0}{2z_0} \frac{\cos Kz}{K} \right) \sin (\omega t - Ka) = 0 \end{aligned}$$

which also must hold for all values of t . By letting $\omega t = 0$, we obtain

$$(\dot{A}_1 + \dot{A}_3) \cos Ka + (\dot{A}_2 - \dot{A}_4) \sin Ka = 0 \quad (14)$$

which, in view of (13), reduces simply to

$$(\dot{A}_2 - \dot{A}_4) \sin Ka = 0. \quad (15)$$

From the last equation it follows that

$$\dot{A}_2 - \dot{A}_4 = 0 \quad (16)$$

except in the special case when $\sin Ka = 0$. By putting $\omega t = \pi/2$ we get

$$\begin{aligned} &(\dot{A}_3 - \dot{A}_1) \sin Ka + \frac{E_0}{z_0 K} \sin^2 Ka \\ &+ \left(\dot{A}_2 + \dot{A}_4 + \frac{E_0}{z_0 K} \cos Ka \right) \cos Ka = 0 \end{aligned}$$

which, in view of (13), reduces to

$$- \dot{A}_3 + \dot{A}_1 = \frac{E_0}{z_0 K} \frac{1 - \cos Ka}{\sin Ka} \quad (17)$$

From (13), (16), and (17) it follows that

$$\begin{aligned} - \dot{A}_3 &= \dot{A}_1 = \frac{E_0}{2Kz_0} \frac{1 - \cos Ka}{\sin Ka}; \\ \dot{A}_2 &= \dot{A}_4 = - \frac{E_0}{2Kz_0} \quad (18) \end{aligned}$$

By substituting these values of \dot{A} 's and A 's from (12) into (7) for the current, we find that

$$i = \frac{E_0}{z_0 K} \left[1 - \frac{1}{\cos \frac{Ka}{2}} \cos K \left(z - \frac{a}{2} \right) \right] \sin \omega t. \quad (19)$$

The current distributions given by (19) have been plotted in Fig. 3 for several typical values of a . From this figure it appears that in general the current distribution produced in the wire is not sinusoidal. When the length of the wire is small in comparison with $\lambda/2$ the current at the center of the wire increases approximately as the square of the wire length. The general shape of the current distribution for wires shorter than $\lambda/2$ reminds one of the well-known distribution along a half wave, but in our case the distribution is not sinusoidal. At $a = \lambda/2$, (19) breaks down (because $\cos (Ka/2) = 0$) and gives an infinite value of current.

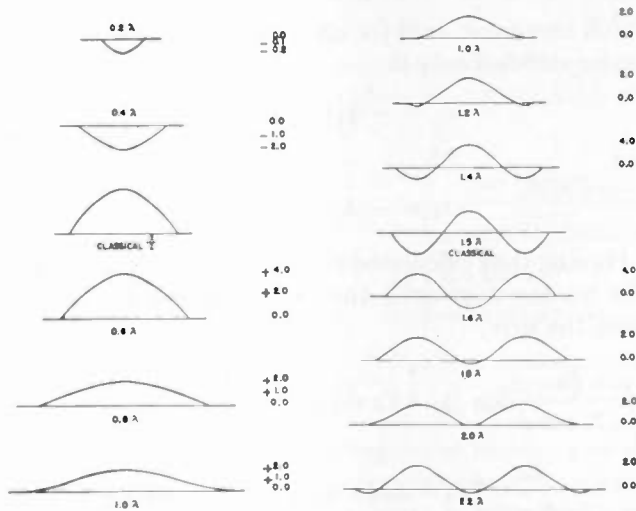

Fig. 3—Calculated distribution of induced currents in wires of various lengths when these wires are placed parallel to an arriving wave front.

This is as it should be as may be seen from the following considerations: As a approaches $\lambda/2$ the current induced in the wire rapidly increases. The maximum value to which this current is built up is limited by radiation resistance which is due to the action of the electric field of current i on this current itself. We have neglected the field which is contributed by this current¹ and assumed that the total field is equal to the external field $E_z = E_0 \cos \omega t$. As long as the induced current is limited by factors other than the radiation resistance and is small, its field is also small in comparison with the inducing external field and (19) is a fair approximation. But when the boundary conditions are such that resonance occurs, $\cos (Ka/2) = 0$ and (19) breaks down. Fortunately, these are the only cases when the current distribution becomes sinusoidal and which have been exhaustively treated by the classical theory found in any textbook on radio. Equation (19) may thus be regarded as showing what happens when currents are induced in wires which are not an integral number of half

¹ Some of this field is taken into account by term $(\partial i / \partial t) L$ in voltage equation (2); other terms have been neglected.

waves long and which are therefore not ordinarily considered.

A very interesting special case is $a = \lambda$. In accordance with the concept to which we are accustomed we might expect a current distribution shown in Fig. 4. This is not the case. The actual distribution is instead as in Fig. 3. This is due to the fact that there is no resonance in this case. In accordance with the classical theory a

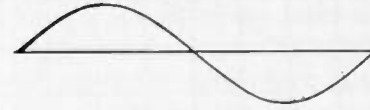

Fig. 4—Sinusoidal distribution of current in a wire one wavelength long.

wire one wavelength long does not radiate at right angles to itself and conversely no current is induced by waves arriving at right angles to the wire. This is not true as we see from (19) and Fig. 3. The classical theory is correct in that the assymmetric distribution of Fig. 4 is not present.

The current distribution given by (19) may be regarded as a sum of two parts: (a) A constant current E_0/Kz_0 which is in the same phase along the entire wire which we shall call the primary part and (b) a sinusoidally distributed current which we shall designate the secondary part.

The first part may be regarded as the primary result of the inducing field while the second part, as the resultant of two traveling waves which start from

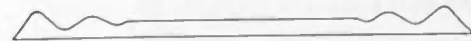

Fig. 5—Distribution of induced current in a very long wire which is placed parallel to an arriving wave front. This figure is not to scale and is only diagrammatic.

the two ends of the wire. If the wire were very long so that the waves reflected from its ends could not reach the center the induced current would be as shown in Fig. 5.

Example 2.

Under this heading we shall consider briefly a more general case in which a wire of length a is placed at an angle ϕ to the arriving wave front of an electromagnetic wave. In this case the component of the electric field along the wire is (see Fig. 6)

$$E_z = E_0 \cos \phi \cdot \cos (\omega t - Kz \sin \phi) = \frac{E_0 \cos \phi}{2} e^{j\omega t} \cdot e^{-jKz \sin \phi} + \frac{E_0 \cos \phi}{2} e^{-j\omega t} \cdot e^{+jKz \sin \phi} \quad (20)$$

so that

$$a_1(z) = \frac{E_0 \cos \phi}{2}; \quad a_2(z) = 0, \dots$$

$$b_1(z) = -Kz \sin \phi; \quad b_2(z) = 0, \dots \quad (21)$$

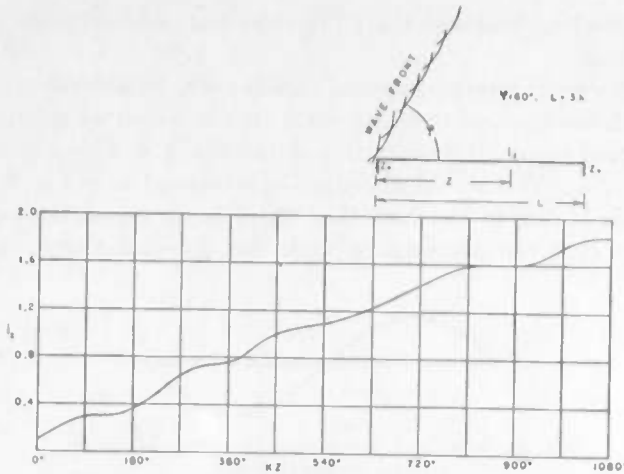

Fig. 6—Calculated distribution of induced current in a wire 3 wavelengths long which is placed at an angle of 60 degrees to an arriving wave front. The wire is terminated by z_0 at both ends.

The values of the A 's are

$$\begin{aligned} A_1 &= -\frac{E_0 \cos \phi}{2z_0} \frac{\sin [Kz(1 + \sin \phi)]}{K(1 + \sin \phi)} \\ A_2 &= +\frac{E_0 \cos \phi}{2z_0} \frac{\cos [Kz(1 + \sin \phi)]}{K(1 + \sin \phi)} \\ A_3 &= +\frac{E_0 \cos \phi}{2z_0} \frac{\sin [Kz(1 + \sin \phi)]}{K(1 + \sin \phi)} \\ A_4 &= +\frac{E_0 \cos \phi}{2z_0} \frac{\cos [Kz(1 + \sin \phi)]}{K(1 + \sin \phi)}. \end{aligned} \quad (22)$$

By substituting these values into the equation for current we find that

$$\begin{aligned} i &= \frac{E_0}{z_0 K \cos \phi} \sin(\omega t - Kz \sin \phi) + \dot{A}_1 \cos(\omega t + Kz) \\ &+ \dot{A}_2 \sin(\omega t + Kz) + \dot{A}_3 \cos(\omega t - Kz) \\ &+ \dot{A}_4 \sin(\omega t - Kz) \\ &= \frac{E_0}{z_0 K \cos \phi} \sin(\omega t - Kz \sin \phi) \\ &+ \dot{d}_1 \sin(\omega t + Kz + s_1) + \dot{d}_2 \sin(\omega t - Kz + s_2) \end{aligned} \quad (23)$$

in which \dot{d}_1 , \dot{d}_2 , s_1 , s_2 are constants of integration yet to be calculated from the boundary conditions. The boundary conditions which will be assumed this time are those which correspond to a wire terminated into its own surge impedance. Accordingly, at $z=0$, $v = -z_0 i$. Similarly at $z=a$, $v = z_0 i$.

In order that we may take account of these boundary conditions we have to derive an expression for v . This may be done by making use of (1) and (2). The result is

$$\begin{aligned} v &= \frac{E_0}{K \cos \phi} \sin \phi \cdot \sin[\omega t - Kz_0 \sin \phi] \\ &- z_0 \dot{d}_1 \sin[\omega t + Kz + s_1] \\ &+ z_0 \dot{d}_2 \sin[\omega t - Kz + s_2]. \end{aligned} \quad (24)$$

The boundary condition at $z=0$ demands that

$$\frac{E_0}{K \cos \phi} (1 + \sin \phi) \cdot \sin \omega t + 2z_0 \dot{d}_2 \sin(\omega t + s_2) = 0$$

for all values of t . It follows that

$$\dot{d}_2 = -\frac{1}{2} \frac{E_0}{z_0 K \cos \phi} (1 + \sin \phi)$$

and

$$s_2 = 0.$$

The second boundary condition, namely, at $z=a$, reduces to

$$\begin{aligned} -\frac{E_0}{K \cos \phi} (1 - \sin \phi) \cdot \sin(\omega t - aK \sin \phi) \\ + 2z_0 \dot{d}_1 \sin(\omega t + Ka + s_1) = 0 \end{aligned}$$

which also must hold for all values of t . This equation can be satisfied only if

$$\dot{d}_1 = -\frac{1}{2}(1 - \sin \phi)$$

and

$$s_1 = -Ka(1 + \sin \phi).$$

Having thus calculated the four constants of integration we can now write the expression for the current along the wire.

$$\begin{aligned} i &= \frac{E_0}{z_0 K \cos \phi} \sin(\omega t - Kz \sin \phi) \\ &- \frac{E_0}{2z_0 K \cos \phi} (1 - \sin \phi) \cdot \sin[\omega t + Kz - Ka(1 + \sin \phi)] \\ &+ \frac{E_0}{K \cdot 2z_0 \cos \phi} (1 + \sin \phi) \cdot \sin(\omega t - Kz). \end{aligned} \quad (25)$$

A special case of this expression, namely, the current at one end of the wire, is of interest. At $z=a$ the current is

$$\begin{aligned} i_a &= -\frac{E_0}{z_0 K \cos \phi} (1 + \sin \phi) \cdot \sin \left[\frac{Ka(1 - \sin \phi)}{2} \right] \\ &\cos \left[\omega t - \frac{Ka(1 - \sin \phi)}{2} \right]. \end{aligned} \quad (26)$$

If in place of ϕ we introduce $\theta = (\pi/2) - \phi$ which is the angle between the wire and the normal to the arriving wave front (26) transforms into the reciprocal of the well-known field equation for the terminated wire.²

Next we shall consider an important special case of the general theory. In this special case it is assumed: (a) that wire W is long enough so that it extends beyond the region in which there is electric field from network N and (b) that wire W is terminated into its surge impedance at both ends.

² For example see, Andrew Alford, "A discussion of methods employed in calculation of electromagnetic fields of radiating conductors," *Elec. Comm.*, vol. 15, pp. 70-88; July, 1936.

These assumptions result in the following expression for induced current i :

$$i = A_1 \cos(\omega t + Kz) + A_2 \sin(\omega t + Kz) + A_3 \cos(\omega t - Kz) + A_4 \sin(\omega t - Kz) \quad (27)$$

where $K = \omega/c$ (c is the velocity of light) and

$$\begin{aligned} A_1 &= \frac{1}{z_0} \int_{z_0}^{\infty} \sum_{n=1}^{n=N} \cos[-Kz + b_n(z)] a_n(z) dz \\ A_2 &= \frac{1}{z_0} \int_{z_0}^{\infty} \sum_{n=1}^{n=N} \sin[Kz - b_n(z)] a_n(z) dz \\ A_3 &= \frac{1}{z_0} \int_{-\infty}^z \sum_{n=1}^{n=N} \cos[Kz + b_n(z)] a_n(z) dz \\ A_4 &= -\frac{1}{z_0} \int_{-\infty}^z \sum_{n=1}^{n=N} \sin[Kz + b_n(z)] a_n(z) dz. \end{aligned} \quad (28)$$

Equation (27) has a very simple physical interpretation. In order to make this clear let us consider the expression for the current, term by term, starting, for example, with the last one. This term obviously represents a traveling wave along the wire. This wave propagates from left to right with velocity of light c . The amplitude of this wave is A_4 . This amplitude is a function of z which means that the traveling wave increases or decreases in magnitude as it progresses along the wire.

The third term also represents a traveling wave which progresses from left to right. The current in this wave is 90 degrees out of phase with the current in the wave given by the fourth term.

Similarly, the first and the second terms represent traveling waves which progress in the opposite directions, that is, from right to left.

The two waves which travel from left to right may be added together so that a resultant wave is obtained. Such a resultant wave, however, has a variable phase in addition to variable amplitude. Thus, the resultant wave which proceeds from left to right is

$$\begin{aligned} A_3 \cos(\omega t - Kz) + A_4 \sin(\omega t - Kz) \\ = \sqrt{A_3^2 + A_4^2} \sin(\omega t - Kz + \phi_2) \end{aligned} \quad (29)$$

where

$$\phi_2 = \tan^{-1} \frac{A_3}{A_4}$$

Similarly, the resultant wave which travels from right to left is

$$\begin{aligned} A_1 \cos(\omega t + Kz) + A_2 \sin(\omega t + Kz) \\ = \sqrt{A_1^2 + A_2^2} \sin(\omega t + Kz + \phi_1) \end{aligned} \quad (30)$$

$$\phi_1 = \tan^{-1} \frac{A_1}{A_2}$$

From the expressions for A_1, A_2, A_3, A_4 , it may be seen that these quantities are variable only when E_z is different from zero. This means that once the traveling waves emerge into the part of wire W which is outside the inducing field they become ordinary traveling waves of constant amplitude. (See Fig. 7.)

Thus we have a picture of the mechanism of induction of currents in a long wire. The picture is this: Along the portion of the wire which is exposed to the electric field there originate two traveling waves which proceed toward the opposite ends of the wire. The amplitudes of these waves increase from zero and then vary up and down ending with certain constant values, which are reached when the waves emerge from the field.

The following example was chosen to illustrate the application of this special case of the general theory.

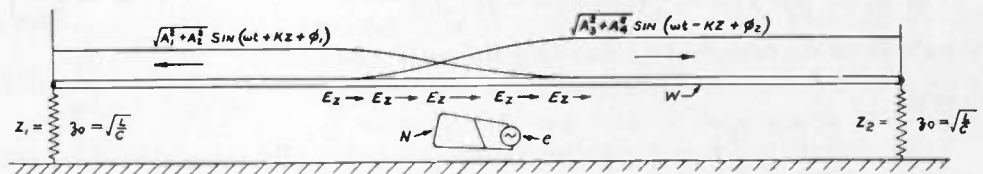

Fig. 7—A schematic diagram which shows 2 traveling waves which emerge from that portion of the long wire which is exposed to the electric field of inducing network N .

The problem is to calculate the current which is induced in a long wire which is placed parallel to an energized half-wave antenna. The E_z component of the electric field at a point P due to a half-wave antenna is well known.³

$$E_z = -\frac{I_0}{c} \frac{\sin(\omega t - Kr_1)}{r_1} - \frac{I_0}{c} \frac{\sin(\omega t - Kr_2)}{r_2} \quad (31)$$

in which r_1 and r_2 are distances measured from point P to the ends of the half-wave antenna, $K = \omega/c$, and I_0 is the loop current.

If for convenience we let $\omega t = \omega t' - \pi/2$

then

$$\begin{aligned} E_z &= \frac{I_0}{c} \left[\frac{\cos(\omega t' - Kr_1)}{r_1} + \frac{\cos(\omega t' - Kr_2)}{r_2} \right] \\ &= \frac{I_0}{2c} \left[\frac{1}{r_1} e^{j\omega t'} \cdot e^{-jKr_1} + \frac{1}{r_1} e^{-j\omega t'} \cdot e^{+jKr_1} \right] \\ &= \frac{I_0}{2c} \left[\frac{1}{r_2} e^{j\omega t'} \cdot e^{-jKr_2} + \frac{1}{r_2} e^{-j\omega t'} \cdot e^{+jKr_2} \right] \end{aligned} \quad (32)$$

³ A. A. Pistolkers, "The radiation resistance of beam antennas," PROC. I.R.E., vol. 17, pp. 562-579; March, 1929.

from which by comparing with (5) we see that in this case and

$$\begin{aligned} a_1(z) &= \frac{I_0}{2cr_1} & a_2(z) &= \frac{I_0}{2cr_2} & a_3(z) &= 0, \dots \\ b_1(z) &= -Kr_1 & b_2(z) &= -Kr_2 & b_3(z) &= 0, \dots \end{aligned} \quad (33)$$

Since this time the wire in which currents are induced is assumed to be very long we may make use of (28)

$$\begin{aligned} A_1 &= \frac{1}{z_0} \int_z^\infty \frac{I_0}{2c} \left[\cos(-Kz - Kr_1) \frac{1}{r_1} dz \right. \\ &\quad \left. + \cos(-Kz - Kr_2) \frac{1}{r_2} dz \right] \\ A_3 &= \frac{1}{z_0} \int_z^\infty \frac{I_0}{2c} \left[\cos(Kz - Kr_1) \frac{1}{r_1} dz \right. \\ &\quad \left. + \cos(Kz - Kr_2) \frac{1}{r_2} dz \right] \end{aligned} \quad (34)$$

$$r_1^2 = \rho^2 + z^2; \quad r_2^2 = \rho^2 + (z - e)^2$$

and somewhat similar equations for A_2 and A_4 .

If in A_3 we put $z = l - z'$, then $dz = -dz'$ and $r_1^2 = \rho^2 + (l - z')^2$, $r_2^2 = \rho^2 + z'^2$, $Kz = lK + Kz' = \pi/2 - Kz'$ so that

$$\begin{aligned} A_3 &= \frac{1}{z_0} \int_\infty^{z'} \frac{I_0}{2c} \left[\cos(-Kz' - Kr_2') \frac{1}{r_2'} dz' \right. \\ &\quad \left. + \cos(-Kz' - Kr_1) \frac{1}{r_1} dz' \right] \end{aligned} \quad (35)$$

We see that A_3 is equal to $-A_1$ when z in the latter has been replaced with $z' = l - z$. The same substitution

$$\begin{aligned} &| A_1 \cos(\omega t + Kz) + A_2 \cos(\omega t + Kz) + A_3 \cos(\omega t - Kz) + A_4 \sin(\omega t - Kz) | \\ &= \sqrt{[(A_1 + A_3) \cos Kz + (A_2 - A_4) \sin Kz]^2 + [(-A_1 + A_3) \sin Kz + (A_2 + A_4) \cos Kz]^2} \end{aligned} \quad (41)$$

may be used to prove that A_4 is equal to $-A_2$ in which z has been replaced by $l - z$. It follows that only A_1 and A_2 need be calculated from the beginning and that A_3 and A_4 can then be obtained by simple substitutions.

Calculation of A_1 .

Integral A_1 may be subdivided into a sum of two integrals

$$A_{11} = \frac{I_0}{2z_0} \int_z^\delta \cos(-Kz + Kr_1) \frac{1}{r_1} dz \quad (36)$$

and

$$A_{12} = \frac{I_0}{2z_0} \int_z^\delta \cos(-Kz + Kr_2) \frac{1}{r_2} dz. \quad (37)$$

Let

$$u = r_1 - z, \quad u' = l + r_2 - z$$

then

$$-dz = \frac{r_1}{u} du = \frac{r_2}{u'} du'$$

$$A_{11} = -\frac{I_0}{2z_0} \int_u^\alpha \frac{\cos Ku}{u} du$$

$$A_{12} = +\frac{I_0}{2z_0} \int_{u'}^{\alpha'} \frac{\cos Ku}{u} du$$

so that

$$A_1 = -\frac{I_0}{2z_0} \int_u^{\alpha'} \frac{\cos Ku}{u} du + \frac{I_0}{2z_0} \int_\alpha^{\alpha'} \frac{\cos Ku}{u} du. \quad (38)$$

When

$$\begin{aligned} \alpha &= r_1 - z & \text{and } z &\rightarrow \infty \\ \alpha' &= l + r_2 - z \end{aligned}$$

the second integral approaches zero as

$$\frac{I_0}{2z_0} \log_e \frac{r_1 - z}{l + r_2 - z} \rightarrow 0$$

when $z \rightarrow \infty$. Hence,⁴

$$\begin{aligned} A_1 &= -\frac{I_0}{2z_0} \int_u^{\alpha'} \frac{\cos Ku}{u} du \\ &= \frac{I_0}{2z_0} [\text{sil}(Ku') - \text{sil}(Ku)]. \end{aligned} \quad (39)$$

By using similar substitutions it is found that⁴

$$A_4 = -\frac{I_0}{2z_0} [\text{col}(Ku') - \text{col}(Ku)] \quad (40)$$

from which A_2 is obtained by interchanging signs and replacing z with $(l - z)$. For future reference, the amplitude of

When both the inducing half-wave antenna and the long wire in which currents are induced are placed above a conducting plane it is necessary to calculate the contribution of the image. This may be done by using (39) and (40) to calculate A_1' and A_4' and then A_3' and A_2' which are due to the image. The total values of $\bar{A}_1, \bar{A}_2, \bar{A}_3, \bar{A}_4$ to be then used in (41) are

$$\begin{aligned} \bar{A}_1 &= A_1 - A_1' \\ \bar{A}_2 &= A_2 - A_2' \\ \bar{A}_3 &= A_3 - A_3' \\ \bar{A}_4 &= A_4 - A_4'. \end{aligned} \quad (42)$$

In order to make this procedure more concrete, a numerical case has been worked out.

⁴ Definition and a table of sil and col may be found in the appendix to "Transient Electric Phenomena and Oscillations" by C. P. Steinmetz, McGraw-Hill Book Company, New York, N. Y., 1920.

Frequency = 19,540 kilocycles, $\lambda = 50.36$ feet.

The half wave and the long wire are placed at the same height of 72 inches above ground and are separated from each other by 47 inches. It follows that ρ to be used in the calculation of the A 's due to the wire is $\rho = 47$ inches = 0.078λ . The value of ρ' to be used in calculating the A 's due to the image is $\rho' = \sqrt{47^2 + (2 \times 72)^2}$ inches = 0.251λ . The values of A_1 and A_1' , have been plotted in Fig. 8(a) while the values of A_2 , and A_2' are given in Fig. 8(b). The total current induced in the long wire by the half wave and its image are represented by the solid curve in Fig. 9. The points were obtained from measurements made to check this theory. The measured currents were multiplied by a fixed factor so that the peaks of the calculated and measured currents would agree. The absolute value of the induced peak current found by measurement was $0.123 I_0$. The calculated value, on the basis of surge impedance of $138 \log_{10}(4H/d) = 407$ ohms using $d = 0.162$ and $H = 72$ inches, is $0.145 I_0$ and is too high by 18 per cent. On the whole, the agreement between measured and calculated values is probably sufficiently good to estab-

lish the fact that the unorthodox result calculated above is much closer to the true nature of induced currents than sinusoidal distribution often assumed for the purpose of calculating so-called mutual radiation impedances. It may be added in passing that during the experiments with the described arrangement it was found that the length of the long wire in which currents were induced was not critical in any way so long as the wire was long enough to extend beyond the region in which the induced current was appreciable. For example, it made no appreciable difference whether an additional quarter wave was added to the wire about 4 wavelengths long. The induced distribution remained the same whether the long wire was open-ended, grounded, or terminated into its surge impedance. In all of these cases the induced current was to be found only in the limited region opposite the inducing half

wave in accordance with Fig. 9. On either side of this region the current was very small. The sinusoidal distribution of current over the entire length of the wire was not observed whether the center of the wire was opposite the center of the half wave or not.

The above remarks are made here to emphasize the fact that there is a class of phenomena which is different from those discussed in the now classical theory of

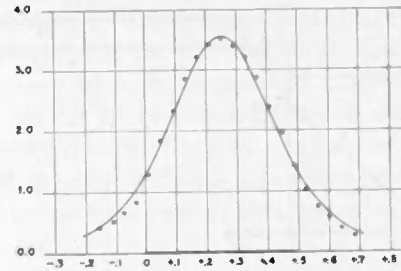

Fig. 9—The total current induced by a half-wave antenna and its ground image in a long wire placed parallel to the half-wave antenna. The solid curve was calculated; the points show measured values.

mutual interaction originated by Pistolokors. It is this second type of radiation interaction outlined above which is responsible for the fact that a wire $2\frac{1}{2}$ wavelengths long will act as a reflector as well as a wire $2\frac{3}{4}$ wavelengths long without any regard for its so-called self-impedance. It is only when the induced current distribution extends to the ends of the wire that reflection of current at the ends and therefore resonance phenomenon can and does take place, and the classical concept of mutual impedance begins to assume significance. But even when this has taken place the primary current of the type shown in Fig. 9 still plays a part which is sometimes obscured by larger resonance currents and for this reason is difficult to recognize but it is just as real as if it were present, alone.

So far we have been concerned with examples in which, except under special conditions of resonance, the induced currents were small enough so that their field could be neglected in the first approximation. We now undertake to discuss a different type of a problem in which the effects of the field due to the induced current must be taken into account. The problem is to calculate the interaction between an open wire line and a quarter-wave section arranged as is shown in Fig. 10. This configuration is equivalent to another, which consists of one half of the configuration in Fig. 10, together with a conducting plane which takes place of the neutral plane of Fig. 10. This equivalent arrangement is shown in Fig. 11. The arrangement of Fig. 11 is of the same type as the one already discussed in connection with Fig. 1.

The system of Fig. 11 may be studied in two different ways: (1) We may regard the quarter-wave section as the inducing network N and calculate the induced currents in wire W and (2) we may regard wire W as

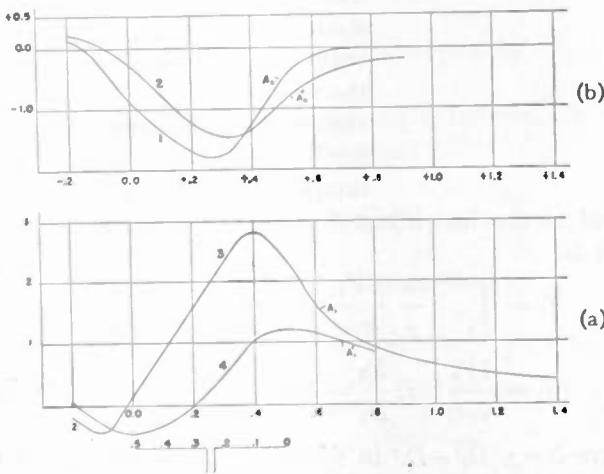

Fig. 8—Amplitudes A_1 , A_1' , A_2 , and A_2' of the traveling waves induced by a half wave and its ground image, in a long wire placed parallel to the half wave.

lish the fact that the unorthodox result calculated above is much closer to the true nature of induced currents than sinusoidal distribution often assumed for the purpose of calculating so-called mutual radiation impedances. It may be added in passing that during the experiments with the described arrangement it was found that the length of the long wire in which currents were induced was not critical in any way so long as the wire was long enough to extend beyond the region in which the induced current was appreciable. For example, it made no appreciable difference whether an additional quarter wave was added to the wire about 4 wavelengths long. The induced distribution remained the same whether the long wire was open-ended, grounded, or terminated into its surge impedance. In all of these cases the induced current was to be found only in the limited region opposite the inducing half

the inducing network and calculate the currents induced in the quarter-wave section.

Both of these aspects have to be considered when a complete picture of the interaction is desired.

Let us first consider the wire *W* as the inducing network and calculate the induced currents in the quarter-

field along the quarter-wave section, is zero, it follows that the waves which travel along the quarter-wave section must be ordinary traveling waves with constant amplitudes and fixed phases. In view of the fact that at the open end of the section there must take place a complete reflection it follows that the ampli-

tudes of the traveling waves which traverse the section in opposite directions must be equal. For this reason the distribution of current and voltage along the section must be sinusoidal except near the open end where the surge impedance is a little less than elsewhere because of the increased capacitance per unit length.

There is only one place where the radial field can have any effect, namely, along the short-circuiting bar *B*. This field has a component E_B along the bar. The phase of this field is constant along the bar. If this bar is very short in comparison with the wavelength, as it usually is, the action of this field along the bar is the same as that of a lumped electromotive force

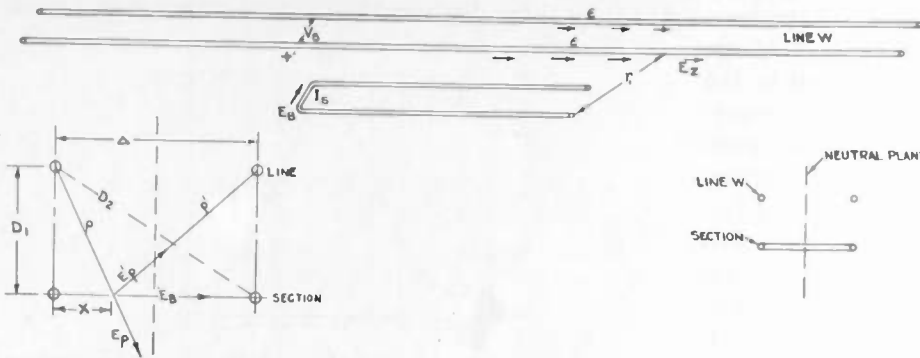

Fig. 10—A schematic diagram used in deriving equations applicable to coupled sections.

$$E_{\rho} = \frac{1}{\rho} \frac{2}{c'z_0} V_S, \quad E_{\rho}' = \frac{1}{\rho'} \frac{2}{c'z_0} V_S$$

$$V_c = \int_0^{\Delta} E_B dx = 2SV_S$$

where $S = \frac{1}{z_0 c'} \log_e \frac{D_2}{D_1}$
 c' is the velocity of light
 V_S is the potential of wire *W*
 ρ is the distance from the center of the wire

wave section. For the sake of simplicity we shall assume that the ends of wire *W* are far away from the quarter-wave section and that the wire is straight. Under these circumstances the equations which give the electric field near the wire reduce to particularly simple form. The complete equations for the electric field produced by a wave traveling along a wire were derived elsewhere.²

When applied to the present problem these equations lead to the following conclusions:

(1) That the tangential component of the electric field along a very long wire is zero. Consequently, there is nothing but radial field.

(2) That the radial field is equal to

$$E_{\rho} = (2/c\rho z_0) V_s \tag{43}$$

where c is velocity of light, V_s is the potential of wire *W*, and ρ is the distance from the center of this wire. In addition, there is a similar field due to the image of wire *W*.

We need not restrict ourselves to the assumption that wire *W* carries one traveling wave. On the contrary, we may assume the most general distribution of currents. Such a distribution can always be resolved into two traveling waves with unequal amplitudes and progressing in opposite directions. Under these more general assumptions the longitudinal component of the electric field is still zero and (43) is still correct.

Since E_z , the longitudinal component of electric

equal to the line integral of the field along the bar; that is,

$$V_c = \int_0^{\Delta/2} \frac{x}{\rho} \frac{2V_s}{cz_0\rho} dx + \int_{\Delta/2}^{\Delta} \frac{x}{\rho} \frac{2V_s}{cz_0\rho} dx$$

$$= \frac{2V_s}{z_0c} \log_e \frac{D_2}{D_1} = 2SV_s \tag{44}$$

where $\Delta = \sqrt{D_2^2 - D_1^2}$ in which D_1 is the distance between the section and wire *W* and D_2 is the distance between the section and the image of wire *W*.

We have thus seen that so far as the induction from

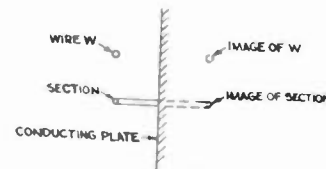

Fig. 11—A schematic diagram showing an arrangement which is equivalent to that of Fig. 10.

the line into the section is concerned it is highly localized. It takes place at the short-circuiting bar and when this bar is relatively short it is equivalent to an electromotive force in the bar.

Let us now discuss the action of the quarter-wave section on the line. We have already shown that the distribution of current along the quarter-wave section must be sinusoidal in spite of the reaction of the line back on the section because this reaction is confined to

producing a virtual generator in the short-circuiting bar.

The electric field due to a quarter-wave line with sinusoidal distribution may be obtained from the general equations given by the author for the field of a traveling wave.² In this case we need to know only the component of the field parallel to the wire. The principal part of this component is found to be

$$E = -\frac{I_0}{2r_1c} e^{j\omega t} \cdot e^{-Kr_1j} - \frac{I_0}{2r_1c} e^{-j\omega t} \cdot e^{+Kr_1j} + \frac{I_0}{2r_2c} e^{j\omega t} \cdot e^{-Kr_2j} + \frac{I_0}{2r_2c} e^{-j\omega t} \cdot e^{+Kr_2j} \quad (45)$$

when $I = I_0 \sin \omega t$ is the current in the short-circuiting bar, r_1 is the distance measured from the open end of the section, and r_2 is the distance measured from the end of the image.

The final amplitudes of the two waves as they leave this region are $\sqrt{A_{10}^2 + A_{20}^2}$ and $\sqrt{A_{30}^2 + A_{40}^2}$ in which

$$A_{10} = \frac{I_0}{z_0} \int_{-\infty}^{+\infty} \sum_{n=1}^{n=N} \cos [-Kz + b_n(z)] a_n(z) dz, \\ A_{20} = \frac{I_0}{z_0} \int_{-\infty}^{+\infty} \sum_{n=1}^{n=N} \sin [+Kz + b_n(z)] a_n(z) dz, \text{ etc. } \dots$$

These integrals may be calculated as follows. By comparing (45) with (5) we find that

$$a_1(z) = -\frac{I_0}{2r_1c}, \quad a_2(z) = +\frac{I_0}{2r_2c} \\ b_1(z) = -Kr_1, \quad b_2(z) = -Kr_2.$$

Then by putting $u_1 = r_1 - z$ and $u_2 = r_2 - z$ we get

$$A_{10} = \frac{I_0}{2cz_0} \int_{\infty}^{\alpha} \frac{\cos Ku}{u} du - \frac{I_0}{2cz_0} \int_{\infty}^{\alpha} \frac{\cos Ku}{u} du + \frac{I_0}{2cz_0} \int_{\alpha}^{\alpha'} \frac{\cos Ku}{u} du = \frac{I_0}{2cz_0} \int_{\alpha}^{\alpha'} \frac{\cos Ku}{u} du$$

in which both α and α' approach zero but not independently and namely, in such a way that $\alpha = r_1 - z$, $\alpha' = r_2 - z$, while $z \rightarrow \infty$. In the region between α and α' , u is infinitesimally small so that $\cos Ku = 1$ and

$$A_{10} = \frac{I_0}{2cz_0} \int_{\alpha}^{\alpha'} \frac{\cos Ku}{u} du = \frac{I_0}{2z_0c} \int_{\alpha}^{\alpha'} \frac{1}{u} du \\ = \frac{I_0}{2cz_0} \log_e \frac{\alpha'}{\alpha} = \frac{I_0}{2cz_0} \log_e \frac{r_1 - z}{r_2 - z} = \frac{I_0}{cz_0} \log_e \frac{D_2}{D_1} = s.$$

In a similar way we find that

$$A_{20} = 0, \quad A_{40} = 0, \quad A_{30} = sI_0$$

and

$$\sqrt{A_{10}^2 + A_{20}^2} = sI_0, \quad \sqrt{A_{30}^2 + A_{40}^2} = sI_0. \quad (46)$$

The remarkable feature about the longitudinal field given by (45) is that it is confined to the region in the

immediate neighborhood of the open ends of the quarter-wave section. The extent of this field is comparable with the distance between the end of the section and wire W . Because of this limited extent of the field its action is very similar to that of a generator placed in series with the wire at the point opposite the open end of the section. This fact is of considerable utility because it enables one to make use of what may be termed an equivalent virtual generator with the electromotive force $\epsilon = jz_0sI$, in place of the relatively complicated concept of two current waves discussed above. In accordance with this simplified mode of interpretation the action of the quarter-wave section on the transmission line in Fig. 11 consists of there being "induced" in series with the line and opposite the open ends of the section two generators with the electromotive force ϵ .

Having arrived at the qualitative and quantitative picture of the fundamental features of the phenomenon we are now in position to calculate several subsidiary quantities which are usually wanted for practical applications. Perhaps the most important quantities are "the counter electromotive force" and the "induced impedance." Both of these have a rather special and limited meaning which will be made clear as we proceed.

Let us assume that line W is terminated at its ends into impedances Z_1 and Z_2 and consider what happens when a generator of electromotive force ϵ is inserted in series with the short-circuiting bar of the quarter-wave section and establishes a flow of current in the section.

We have already seen that under these circumstances there appears a highly concentrated field around the open end of the section, and that the effect of this field is equivalent to an electromotive force placed in series with line W just above the open end of the section.

This virtual electromotive force produces currents in line W which, in turn result in a voltage across the line at the point opposite the short-circuiting bar of the section and consequently a field along this bar. This field along the bar is equivalent to an electromotive force in series with the bar. This last electromotive force we shall call the "counter electromotive force" because it is proportional to the current in the section and is the reaction of the current induced in the line on the inducing section.

The effect of this counter electromotive force is equivalent to the effect of an imaginary impedance placed in series with the bar. This impedance will be referred to as the "impedance induced into the section" or simply the "induced impedance." When the impedances Z_1 and Z_2 at the ends of line W are both equal to the surge impedance of the line, the expression for the induced impedance is particularly simple. In this case the current produced in the line by current I in the section is sI . This current in the line at the point

above the open end is 90 degrees out of phase with the current in the section. By the time this current reaches the point above the short-circuiting bar of the section it is delayed another 90 degrees. The potential across the line at the point above the short-circuiting bar is thus $z_0 I$. In accordance with (44) the electromotive force induced in the bar is therefore $V_o = 2s^2 z_0 I$. This counter electromotive force is obviously equivalent to induced impedance

$$\frac{V_o}{I_s} = \frac{2s^2 z_0 I_s}{I_s} = 2s^2 z_0 \quad (47)$$

When either Z_1 or Z_2 or both are different from z_0 the calculation of the voltage which is produced above the short-circuiting bar is a little more complicated.

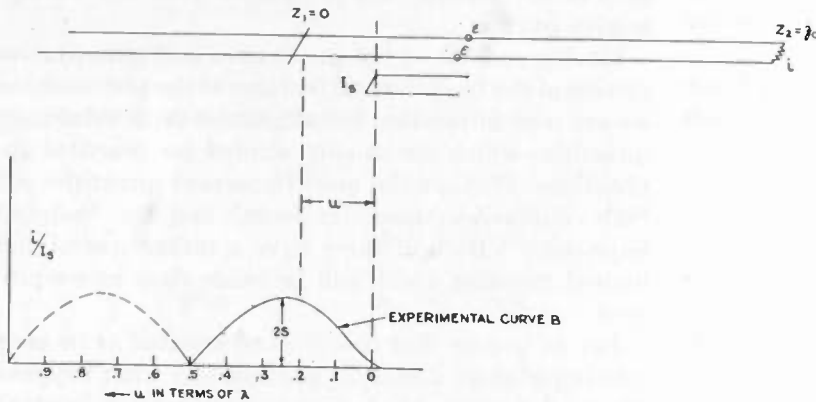

Fig. 12—This figure shows how current in z_0 at the end of the line varies with distance u between the short-circuiting bar along the line and the short-circuiting bar of the coupled section.

Theoretical relation is

$$i/I_s = 2s \sin u'$$

in which $u' = (2\pi/\lambda)u$

$$z_i = 4s^2 z_0 \sin^2 u' + j4s^2 z_0 u' \sin u'$$

where $u' = (2\pi/\lambda)u$.

In order to illustrate a case of this kind we shall assume that $Z_1 = 0$ and that $Z_2 = z_0$. The distance between the open end of the section and Z_1 will be u electrical degrees as shown in Fig. 12. The first step is to calculate the currents and voltages which are produced in the transmission line by the virtual generators $+\epsilon$ and $-\epsilon$ in series with the line. As there is nothing particularly interesting about this calculation we shall state

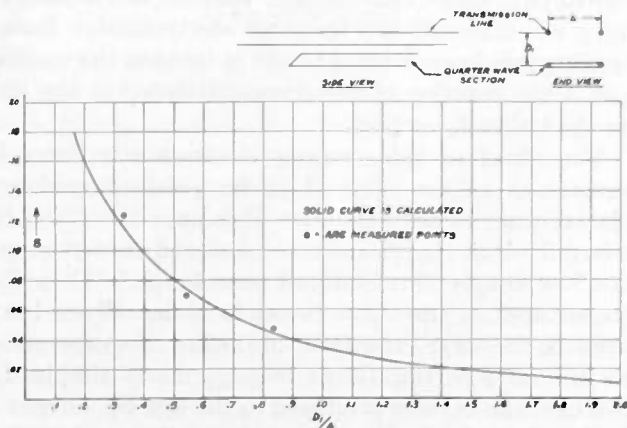

Fig. 13—A comparison of calculated and measured values of s .

only the result. The potential across the line at the point above the short-circuiting bar is

$$V_e = 2jz_0 s I_s (-j \cos^2 u - \sin u \cdot \cos u)$$

It follows that the counter electromotive force is therefore

$$V_c = j(2s)^2 z_0 I_s (-j \cos^2 u - \sin u \cdot \cos u)$$

and the induced impedance is

$$Z_i = \frac{V_c}{I_s} = 4s^2 z_0 \cos^2 u - j4s^2 z_0 \sin u \cdot \cos u \quad (48)$$

It is interesting to observe that in the special case when $u = \pi/2$, $Z_i = 0$ so that no energy is transferred to z_0 . In this case the two virtual generators in the line above the open ends of the quarter-wave section start two traveling waves in opposite directions. The amplitudes of these two waves are equal. The wave which proceeds toward the short-circuited end of the section is reflected back toward z_0 . When this wave catches up with the one which proceeded directly toward z_0 it cancels the latter because the two waves are 180 degrees out of phase.

Fig. 12 shows how current in z_0 produced by unit current in the section varies with u . The curve was obtained from measurements in which the quarter-wave section was connected to a transmitter by means of an open wire line with very close spacing between conductors. This narrow line was tapped across a part of the short-circuiting bar of the quarter-wave line.

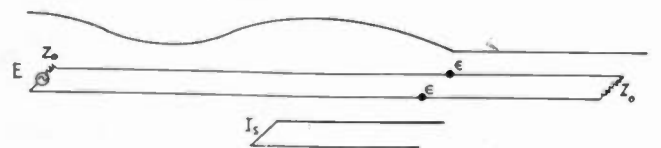

Fig. 14—Current distribution in a transmission line with a coupled section when $X > 0$. The standing wave starts above the open ends of the section.

Fig. 13 shows the values of s .

In Figs. 14, 15, 16, and 17 are illustrated some additional examples of the action of the virtual generators.



Fig. 15—Current distribution in a transmission line with a coupled section when $X > 0$. The standing wave starts above the open ends of the section.

In all of these figures the current in the sections is induced current. This induced current results in the production of the two virtual generators which in turn

produce the changes in the current distributions along the transmission line. The bend in Fig. 16 behaves just like the open end in Fig. 14. These current distributions can be calculated by making use of the concept of virtual generators which we have discussed above. A calculation of this kind is outlined in United States Patent 2,159,648.

The first step in such a calculation is to find current I which flows in the section. In order to do this we first

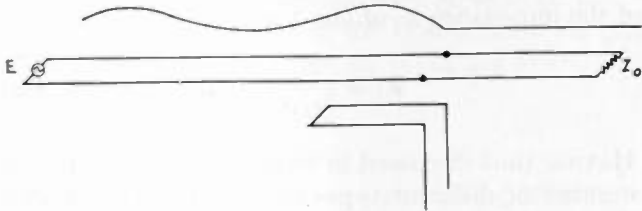

Fig. 16.—Current distribution in a transmission line with a bent section. The standing wave starts above the bend.

consider an auxiliary arrangement shown in Fig. 18. In this arrangement the generator of voltage E produces the current.

$$I_s = \frac{E}{r + jX + 2s^2z_0} \quad (49)$$

in the short-circuiting bar of the section. The total impedance against which the generator functions consists of self-impedance $r + jX$ and the induced imped-

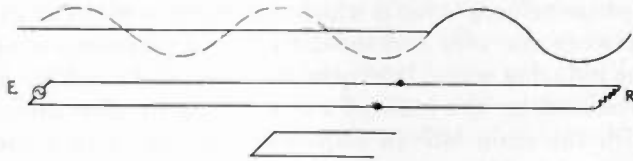

Fig. 17.—Coupled section is so placed and the value of X is so chosen that the section "matches" the line.

ance $2s^2z_0$. The current which flows in one of the z_0 terminals of the transmission line is equal to $i = sI_s$. If now by the general reciprocity theorem we interchange generator E and current i we find that in Fig. 14 the current in the section is

$$I' = \frac{sE}{r + jX + 2s^2z_0} \quad (50)$$

In this figure generator E sends out a forward wave in which the current is $E/2z_0$. The two virtual generators are responsible for the back wave in which the current is

$$\frac{s^2E}{r + jX + 2s^2z_0} \quad (51)$$

The reflection coefficient, therefore, is equal to

$$\rho = \frac{2z_0s^2}{r + jX + 2s^2z_0} \quad (52)$$

while the ratio of current maximum to current minimum is

$$Q = \frac{1 + \rho}{1 - \rho} \quad (53)$$

The phase of the back wave is clearly a function of the self-reactance of the section. When this self-react-



Fig. 18—Auxiliary arrangement in which generator E is in series with the short-circuiting bar.

ance is zero the back wave sent back by the section is maximum. If, while the self-reactance of the section is zero, its self-resistance is gradually reduced to zero, the phase of the back wave does not change. When self-resistance of the section is zero then the back wave is equal to the forward wave and no energy can be delivered to the load beyond the section. It follows that the current to the right of the virtual generators must be zero. Since current along a wire cannot suddenly vanish it follows that the phase of the back wave in this case must be such that the current minimum must be just above the open end of the section. When the self-resistance of the section is not zero the current minimum is still above the open end of the section because the phase of the back wave remains constant when $X = 0$ and r is varied.

When X is different from zero the phase of I , and hence also of the back wave, depends on the value of X . In order to visualize the relation which exists between X and the phase of the back wave we shall again make use of the auxiliary arrangement in Fig. 18. If in this arrangement we call the phase of current i in z_0 the reference zero phase, then for any other value of X the phase of current i in z_0 will be

$$\theta = -\tan^{-1} \left[\frac{X}{r + 2s^2z_0} \right]$$

By interchanging current i with generator E we find that in Fig. 14 the phase of current I is also

$$\theta = -\tan^{-1} \left[\frac{X}{r + 2s^2z_0} \right] \quad (54)$$

with respect to the phase of I which exists when $X = 0$. Thus we see that when X is negative, current I and therefore also the back wave are advanced in phase by amount θ defined by (54) and the current minimum is therefore translated toward the generator end of the line by $\theta/2$ degrees. When X is positive the back wave is retarded by θ degrees and the current minimum is translated by $\theta/2$ degrees in the direction away from the generator in Fig. 14.

All of these conclusions apply without modification to the arrangement in Fig. 16 except that in this figure

the voltage of the virtual generators is not $\epsilon = j2sI_0$, but $\epsilon' = j2s \sin \phi \cdot I_0$, and the radial field of the line is now inducing not only a virtual generator in the short-circuiting bar of the section but also one in each of the two vertical wires at the bend in the section. The voltage of each of these two additional generators is $e = sV_0$, or exactly half of that of the virtual generator in the short-circuiting bar; voltage V_0 , which appears in the expressions for these generators is, of course, the

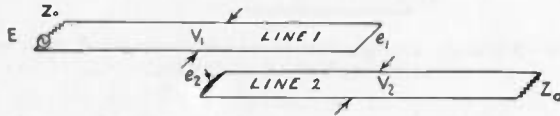

Fig. 19—"Short to short" type of coupling.

potential across the line just above the bend in the section.

When there are two bends in the section so that not only the open end but also the short-circuited end is bent away from the transmission line, there are two sets of virtual generators not only in the section but also two sets of virtual generators in the transmission line.

Next we shall consider the coupling of the type illustrated in Fig. 19. In accordance with the deductions already explained in connection with (44), the interaction between the transmission lines of Fig. 19 takes place at the short-circuiting bars. Line 1 induces a virtual generator e_2 in the short-circuiting bar of line 2 and conversely line 2 induces a virtual generator e_1 in line 1. The electromotive forces of the two virtual generators are $e_1 = 2sV_1$ and $e_2 = 2sV_2$ in which V_1 and V_2 are respectively the voltages across lines 1 and 2 opposite the two short-circuiting bars as shown in the figure. Potential V_1 is the sum of three potentials:

- potential due to the wave started by E , which is $E/2$
- potential due to the reflected wave, which is $E/2 \cdot e^{-2uj}$
- potential due to the forward wave from e_1 , which is $e_1 e^{-uj}$.

Thus

$$V_1 = \frac{E}{2} (1 - e^{-2uj}) + e_1 e^{-uj}.$$

In this equation the phase of the forward wave at V_1 was assumed to be zero. Since $V_2 = e_2 \cdot e^{-ju}$ it follows that $e_1 = (2s)^2 V_1 e^{-ju}$ and hence

$$V_1 = \frac{E}{2} (1 - e^{-2uj}) + (2s)^2 V_1 \cdot e^{-2uj}$$

$$V_1 = \frac{E}{2} \frac{1 - e^{-2uj}}{1 - (2s)^2 \cdot e^{-2uj}} \quad (55)$$

In a similar way we can find the current which flows in line 1 at V_1

$$i_1 = \frac{E}{2z_0} \frac{1 + [1 - 2(2s)^2] e^{-2uj}}{1 - (2s)^2 e^{-2uj}} \quad (56)$$

The special case when $u = \pi/2$ is of some interest. In this case

$$V_1 = \frac{E}{2} \frac{2}{1 + (2s)^2}, \quad i_1 = \frac{E}{2z_0} \frac{2(2s)^2}{1 + (2s)^2} \quad (57)$$

the current in z_0 is

$$i_2 = \frac{E}{z_0} \frac{4s}{1 + (2s)^2}$$

and the impedance Z_1 of line 1 at V_1

$$Z_1 = \frac{z_0}{(2s)^2} \quad (58)$$

Having thus discussed in some detail the theory of a number of different types of coupled networks we wish now to pass to certain other aspects of this subject. Because of the variety of the coupled networks considered it will be convenient to divide the following observations into four sections.

(1) The induced current distributions illustrated in Fig. 3 are such that the field which these induced currents themselves produce in space is similar in many respects to that of a broadside directional array. It follows that a wire placed at right angles to the direction of propagation of an electromagnetic wave radiates at right angles to itself.

(2) Radiation from a current distribution of the type given by (25) is at an angle to the wire. Here the principal term is not in phase but is propagating with a phase velocity $c/\sin \phi$ which is a function of the angle between the wire and the direction of propagation of the inducing wave. It may be shown that the radiation produced by the induced current is quite directional with the main lobe of radiation directed so that the angle of incidence is approximately equal to the angle of reflection. Here then, is the beginning of the optical laws of reflection. In substance, they are already applicable to wires. As the surge impedance of a wire is decreased by making the wire into a band and then into a sheet, the resonance phenomena become less and less important while the principal term becomes more prominent.

(3) The current distribution which is induced in a long wire by a half wave explains the experimental fact, which is probably known to those who have worked with short waves, that a long wire when placed a quarter wavelength away from a half wave acts as a reflector and that the exact length of the wire has little to do with this action. As the surge impedance of the wire is reduced by making the wire into a band and then into a sheet the reflecting action is improved and the resonance phenomena become less and less important even when the expanded wire approaches a half wavelength. It is for this reason that a sheet only slightly longer than a half wavelength acts in practically the same way as a sheet several times as long.

(4) Some of the coupled networks which have been discussed have been very useful in solving certain practical problems. Most of these practical applications so far have been made at high frequencies between about 5 megacycles and 140 megacycles. Below 5 megacycles these networks become rather large and somewhat unwieldy. Above 140 megacycles there has not been much need as yet for solving the particular type of problems for which these networks are most suited.

Broadly speaking, there are two types of service for which coupled networks of the transmission line type are particularly well adapted, (a) filters and (b) impedance transformers.

(a) Coupled Network Filters.

A coupled section is a very simple and efficient rejection-type filter which transmits every frequency but those to which the section is resonant. When the section is coupled loosely, that is when s is small, the

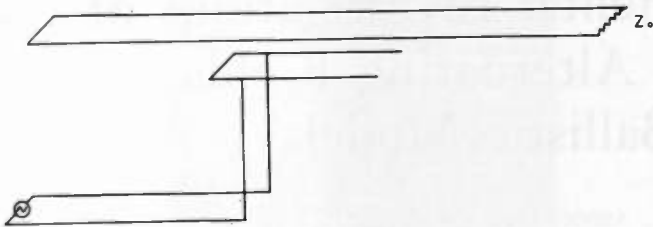

Fig. 20—A coupled-section band-pass filter.

rejected band is narrow. When the network is coupled tightly, the rejection band is relatively broad. Since the bands of rejection occur when the section is $\frac{1}{4}\lambda$, $\frac{3}{4}\lambda$, etc., long it is clear that these bands are very far apart so that a section of this kind can generally be used to reject just one frequency without disturbing any other.

A coupled section when connected as shown in Fig. 20 acts as a band-pass filter which transmits only the frequencies to which the section is tuned and rejects all others. Again, as in the previous case, the bands at which the section is in tune are very far apart so that in practice a filter of this type may often be employed to transmit just one frequency, others not coming within the scope of the frequencies used, or rejected by other elements in the circuit. When using the arrangement of Fig. 20 it is ordinarily convenient to select the points at which the line is connected to the section in such a way that this line from the transmitter is matched at the frequency which is passed by the network. Several transmitters operating at different frequencies may be connected to the same antenna, each through its own section, so that all can deliver their power into the line simultaneously without interfering with each other. When the frequencies to be delivered simultaneously to the same antenna are separated by 6 per cent or so, it is best to employ two stages of filtering. Fig. 21 illustrates a two-stage filter

of the kind used to feed three frequencies into the same antenna. In this figure the sections are in the same plane with the transmission line rather than below it. This particular form is more convenient from the practical point of view and also greatly reduces the radiation resistance of the sections and thus reduces

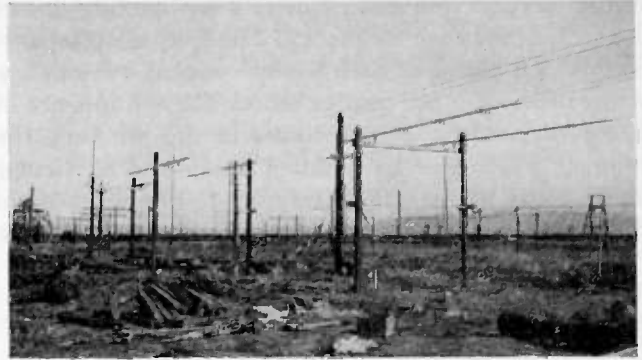

Fig. 21—A group of two-stage coupled-section filters used in feeding the same antenna from three 50-kilowatt high-frequency transmitters simultaneously. This picture was taken in 1938 at Mackay Radio and Telegraph transmitting station at Palo Alto, California.

the loss. The value of s to be used, when the spacing of the line is Δ_1 , the spacing of the section conductors is Δ_2 , and the spacing between the plane of the line and the plane of the conductors is D , may be calculated from the following formula:

$$S = \frac{60}{z_0} \log_e \frac{\sqrt{D^2 + \frac{1}{4}(\Delta_1 + \Delta_2)^2}}{\sqrt{D^2 + \frac{1}{4}(\Delta_1 - \Delta_2)^2}} \quad (59)$$

in which z_0 is the surge impedance of the line, not of the section.

(b) Coupled Sections as Impedance Transformers.

The coupled networks may be employed as transformers as shown for example in Fig. 17 in which a coupled section is used to eliminate the standing waves along a transmission line. This application is based on the reciprocity law for standing waves which has already been stated elsewhere.⁵ In accordance with this law any network with zero dissipation which is capable of producing standing waves along a transmission line may be used to eliminate them. While no passive network is free of all losses the transmission-line networks in general and coupled networks in particular have such small losses (unless abused) that this law may be applied to them without appreciable error. When this law is used the calculations which were made in connection with Fig. 14 become directly applicable to Fig. 17 and the position of the section with respect to the standing waves as well as the required reactance X may be readily predicted.

⁵ A. Alford, "High frequency transmission line networks," *Elec. Comm.*, vol. 17, pp. 301-312; January, 1939.

Matching sections of this type have the singular advantage in that they are essentially single-frequency devices which function on one frequency and become practically nonexistent in so far as the propagation of waves of other frequencies is concerned. Thus, it is possible with these sections to match the transmission line at several frequencies merely by making use of one section for each frequency. The frequency separations which admit of such use of coupled sections are of the order of 6 per cent or more. These limits are of course, dependent on the losses in the sections, the voltages which can be handled under the particular working conditions, the maximum-to-minimum ratio of the standing wave to be eliminated, and the degree

of match which is desired (which in itself depends on what other apparatus may be connected to the line such, for example, as a filter). A full discussion of this subject would take us outside the bounds of this paper.

Additional References

- (1) J. R. Carson and R. S. Hoyt, "Propagation of periodic currents over a system of parallel wires," *Bell. Sys. Tech. Jour.*, vol. 6, pp. 495-545; July, 1927.
- (2) R. Bechmann, "Calculation of electric and magnetic field strengths of any oscillating straight conductors," *PROC. I.R.E.*, vol. 19, pp. 461-466; March, 1931.
- (3) R. Bechmann, "On the calculation of radiation resistance of antennas and antenna combinations," *PROC. I.R.E.*, vol. 19, pp. 1471-1480; August, 1931.
- (4) P. S. Carter, "Circuit relations in radiating systems and applications to antenna problems," *PROC. I.R.E.*, vol. 20, pp. 1004-1041; June, 1932.

Theoretical and Experimental Investigations of Electron Motions in Alternating Fields with the Aid of Ballistic Models*

H. E. HOLLMANN†, ASSOCIATE, I.R.E.

Summary—The motion of electrons and the exchange of energy in ultra-high-frequency transverse and longitudinal fields is investigated theoretically and experimentally by means of ballistic models in which single balls or a beam of balls roll over potential slopes whose gradients change with time. In this way there are represented by models, first a cathode-ray tube, then the Heil two-field generator, and finally the Klystron.

As is well known, the motion of electrons in electric fields may be imitated in gravitation models in which the potential fields are represented by surfaces whose heights everywhere correspond to the potential lines. The electrons are replaced by balls which roll over the surfaces. In the case of complicated potential fields, for example, the fields in multiple-grid tubes, a sheet of rubber may be stretched out horizontally. By means of supports located below the rubber sheet, its surface, at places corresponding to the electrodes, may be provided with height adjustments corresponding to the electrode potentials at those places. When the surface tension of the membrane is constant, each point obeys the Laplace differential equation, provided that the surfaces do not have too steep slopes in order that the three-dimensional model can, without great error, be regarded as the equivalent of the two-dimensional electric field. There is a further slight difference because of the fact that the balls cannot be regarded as frictionless sliding mass points, but, through the rolling friction, transform part of their energy of motion into rotation energy.

Heretofore, such tube models have only been employed for illustrating and investigating stationary phenomena. The rubber membrane is stretched over stationary supports and its form remains unaltered while the balls roll. However, dynamic phenomena can also be imitated in this manner. For this purpose the height adjustments of the membrane must be periodically altered and in a rhythm whose period is comparable with the transit time of the balls. Fundamentally it is immaterial in which direction the balls roll over such a dynamic membrane, that is to say, whether in the same direction as, or normal to, the direction of the field lines which are altering with time; consequently, the model may provide for a transverse or a longitudinal control or for a resultant of the two components.

* Decimal classification: R139XR339. Original manuscript received by the Institute, October 8, 1940; translation received, November 18, 1940.

† Laboratorium für Hochfrequenz und Elektromedizin, Berlin-Lichterfelde, Germany.

I. THE CATHODE-RAY TUBE

A. Dynamic Roll Paths

AS THE simplest phenomenon there will first be investigated the dynamic electron motion between the deflection plates of a cathode-ray tube¹. The ballistic model shown in Fig. 1 contains a black rubber membrane stretched across a horizontal

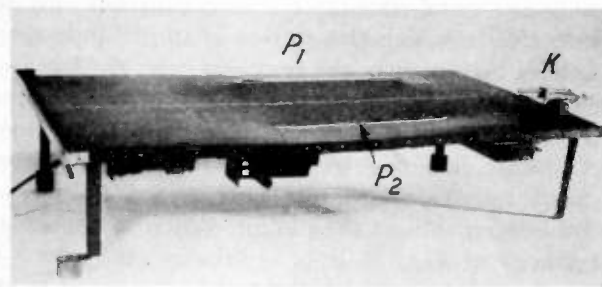

Fig. 1—Ballistic model of the cathode-ray tube.

frame. The longitudinal strips P_1 and P_2 in Fig. 1 correspond to the deflection plates of the condenser. P_1 and P_2 are periodically deflected up and down by equal amounts (plate voltages) by means of a motor-driven tilting mechanism. The electrons in the beams entering the transverse field generated between P_1 and P_2 are

¹ H. E. Hollman and A. Thoma, *Zeit. für Tech. Phys.*, vol. 1., p. 475, 1938.

simulated by polished metal balls which are shot out from a "gun" K actuated by spring power. In order that the phase of the shooting may be selected and defined with precision, the gun is provided with an electric release which is actuated through a contact mounted on the tilting mechanism.

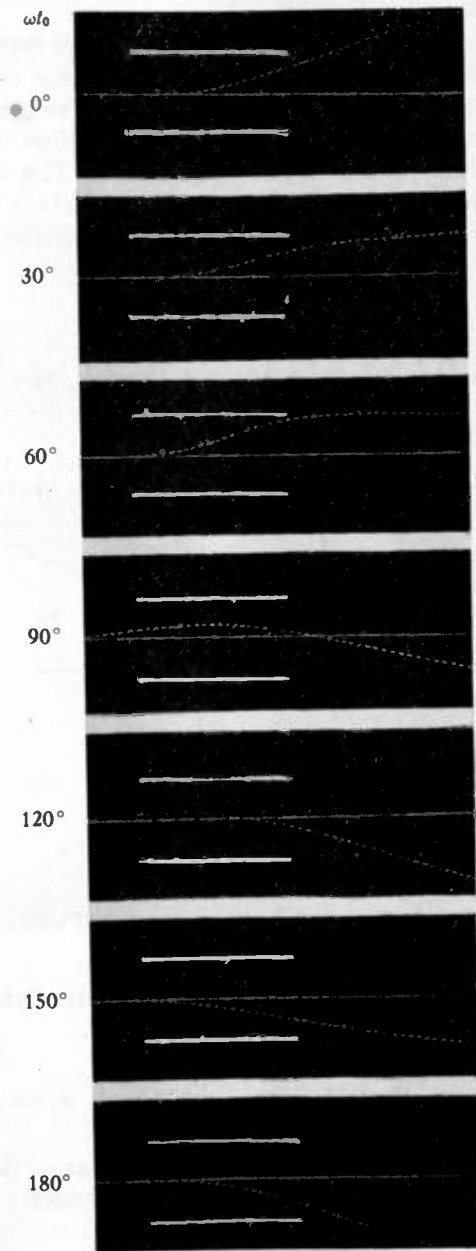

Fig. 2—Experimentally obtained rolling paths of balls.

The model is photographed in plan with lateral illumination from above so that the individual ball leaves behind a trace on the photographic plate. Simultaneously a time scale is embodied in the record by means of intermittent exposure, reference notches having been provided along the roll paths at appropriate points with known time spacings.

In Fig. 2 are reproduced some records of roll paths photographed with shooting phases at 30-degree intervals. The tilting frequency amounted to $\frac{5}{6}$ of a cycle

per second and the nozzle velocity was 1 meter per second. When the model conditions are applied to a cathode-ray tube, then for a wavelength of 1 meter, there must be applied an anode voltage of 920 volts in order to obtain the same transit angle and the same electron path.

Special interest naturally attaches to the question of the extent to which the observed roll paths may be theoretically reconciled. When the dynamic electron motions between deflection plates are calculated without taking the stray fields into account,²⁻⁶ the photographs show that there is a notable additional deflection caused by the stray fields. In order to bring the stray fields into the dynamic calculation, Hintenberger⁷ introduced linear approximations by means of which the two broken-line roll paths in Fig. 3 have been calculated for the shooting phases 0 and 90 degrees. Cubic parabolas⁸ give a better approximation which lead to the roll paths shown by the solid lines in Fig. 3.

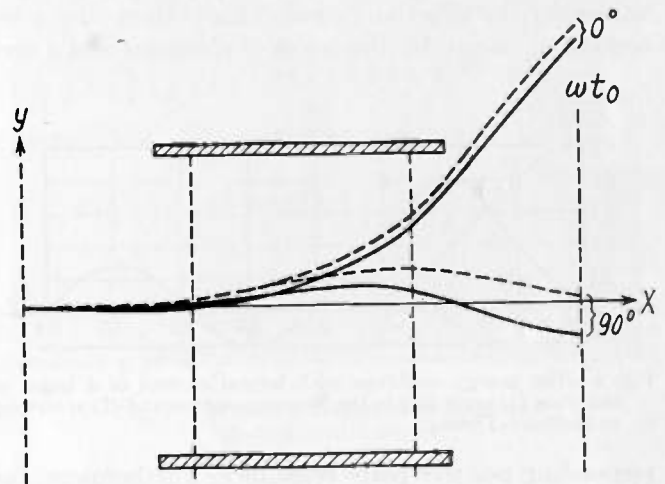

Fig. 3—Calculated rolling paths.

Particularly in the case of the 90-degree shooting phase, there is shown a better agreement with the corresponding experimental record.

It should also be mentioned that by the introduction of the above-mentioned stray-field parabolas the dynamic deflection sensitivity of a cathode-ray tube can be determined with an exactness of a few per cent as the author has shown in thorough experimental investigations.⁹

B. The Energy Exchange

In the case of dynamic transverse control, interest attaches not only to the geometric path of the electrons and the dynamic deflections resulting therefrom, but

² McGregor-Morris and Mines, *Jour. I. E. E.* (London), vol. 63, p. 1096, 1925.

³ H. E. Hollmann, *Zeit. für Hochfrequenz. und Elektroakustik*, vol. 40, p. 97, 1932.

⁴ H. E. Hollmann, *Zeit. für Tech. Phys.*, vol. 19, p. 261, 1938.

⁵ H. E. Hollmann, *Wireless Eng.*, vol. 10, p. 429, 1933.

⁶ L. L. Libby, *Electronics*, p. 15, September, 1936.

⁷ H. Hintenberger, *Zeit. für Tech. Phys.*, vol. 18, p. 256, 1937.

⁸ H. E. Hollmann and A. Thoma, *Elek. Nach. Tech.*, vol. 15, p. 145, 1938.

⁹ H. E. Hollmann, *Elek. Nach. Tech.*, vol. 15, p. 241, 1938.

there also arises the even more important question of the energy exchange in the condenser field. This concerns the reaction which is exerted on the potential of the plates by the induction effect of the electrons of the beam. The problem was first considered by Benner.¹⁰ For effective power obtained by the beam, Benner derived the formula

$$W = \frac{I_0 V_0^2 F^2}{4V_a} \left(\frac{1 - \cos \phi_0}{\phi_0^2} \right) \quad (1)$$

in which

I_0 = the electronic current
 V_0 = the amplitude of the plate voltage
 V_a = the voltage velocity
 $F = l/d$, the "size" of the deflection field, and
 $\phi_0 = \omega l / V_a = l\pi / \lambda \sqrt{V_a} \cdot 10^3$, the transit angle between the plates.

In the dotted curve in Fig. 4 the Benner angle function is plotted against ϕ_0 . There appear only positive values for the effective power. This is shown by a reception of energy by the beam of electrons and a cor-

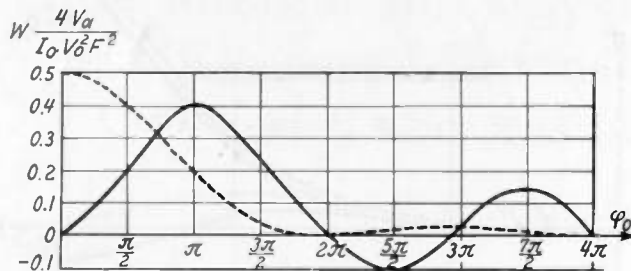

Fig. 4—The energy exchange with lateral control of a beam of electrons (1) according to the Benner equation and (2) according to Hollman-Thoma.

responding positive plate resistance. Furthermore, for $\phi_0 = 0$, i.e., for quasi-static or static transverse control, the Benner formula gives a finite plate resistance, which is in conflict with the law of energy.

The author and Thoma¹¹⁻¹⁴ have continued their study of the problem and, by consideration of the dynamic longitudinal control laws, derived the equation

$$W = \frac{I_0 V_0^2 F^2}{4V_a} \left[\frac{\sin \frac{\phi_0}{2} - \frac{\phi_0}{2} \cos \frac{\phi_0}{2}}{\left(\frac{\phi_0}{2} \right)^2} \right] \sin \frac{\phi_0}{2} \quad (2)$$

which, corresponding to the solid-line curve in Fig. 4, shows the typical inversion character. That is, at certain flight angles it leads to negative energy values and correspondingly indicates a dynamically negative plate resistance. Notwithstanding objections which were at

¹⁰ S. Benner, *Ann. der Phys.*, vol. 3, p. 993, 1939.

¹¹ H. E. Hollmann and A. Thoma, *Zeit. für Hochfrequenz. und Elektroakustik*, vol. 49, p. 145, 1937.

¹² H. E. Hollmann and A. Thoma, *Zeit. für Hochfrequenz. und Elektroakustik*, vol. 52, p. 94, 1938.

¹³ H. E. Hollmann and A. Thoma, *Ann. der Phys.*, vol. 32, p. 459, 1938.

¹⁴ H. E. Hollmann and A. Thoma, *Wireless Eng.*, vol. 15, p. 370, 1938.

first raised against the new inversion formula,¹⁵⁻¹⁷ the above equation in the meantime has been again derived by Recknagel.¹⁸

In view of the general significance attaching to the extension of the widely used Benner theory, it will be of interest to present the following simple derivation of the inversion formula.

We shall proceed from the diagrammatic representation in Fig. 5, in which a plate condenser is closed off from the field-free external space by a simple longitudinal stray field of the small longitudinal extent a and with a linear decrease of potential. The strength of this longitudinal field is, then, a function of time and place and may be described by the equation

$$\mathcal{E}_x = - \frac{V_0 y}{da} \cos(\omega t_0 + \phi_0)$$

in which t_0 denotes the entrance time of the electrons into the condenser. If for y there is taken the dynamic

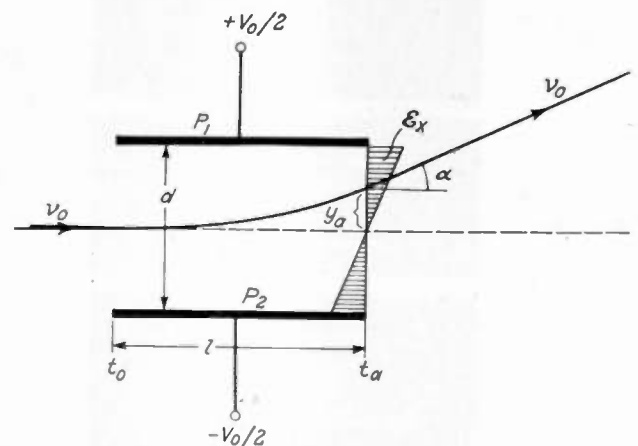

Fig. 5—The effect of the exit stray field with lateral deflection.

beam displacement at the moment of exit of the individual electrons then

$$y_a = \frac{e}{m} \frac{V_0}{d\omega^2} [\cos \omega t_0 - \cos(\omega t_0 + \phi_0) - \phi_0 \sin \omega t_0]$$

and there is obtained for the x component of the electron velocity at their exit from the stray field

$$v_x^2 = v_0^2 \left\{ 1 - \frac{V_0 F}{2V_a \phi_0} [\cos \phi_0 - 1 + \cos(2\omega t_0 + \phi_0) - \cos 2(\omega t_0 + \phi_0) - \phi_0 \sin(2\omega t_0 + \phi_0) + \phi_0 \sin \phi_0] \right\}$$

If in this manner and with the help of the deflection angle

$$\tan \alpha = \frac{e}{m} \frac{V_0}{dv_0 \omega} [\sin(\omega t_0 + \phi_0) - \sin \omega t_0]$$

¹⁵ F. W. Gundlach, *Zeit. für Hochfrequenz. und Elektroakustik*, vol. 50, p. 50, 1938.

¹⁶ E. Brüche and A. Recknagel, *Zeit. für Hochfrequenz. und Elektroakustik*, vol. 50, p. 65, 1937.

¹⁷ F. M. Colebrook and P. Vigoureux, *Wireless Eng.*, vol. 15, p. 441, 1938.

¹⁸ A. Recknagel, *Zeit. für Tech. Phys.*, vol. 19, p. 74, 1938.

there is obtained the mean square of the exit velocity

$$\overline{v^2} = \overline{v_x^2} + v_0^2 \overline{\tan^2 \alpha} = \overline{v_x^2} + v_0^2 \left(\frac{V_0 F}{2V_a \phi_0} \right)^2 (1 - \cos \phi_0),$$

then there results for the energy, directly from the preceding inversion formula (2)

$$W = N - \frac{m}{2} \overline{v^2} = \frac{I_0}{2} \frac{e}{m} \overline{v^2}.$$

(N = number of electrons per unit of time.)

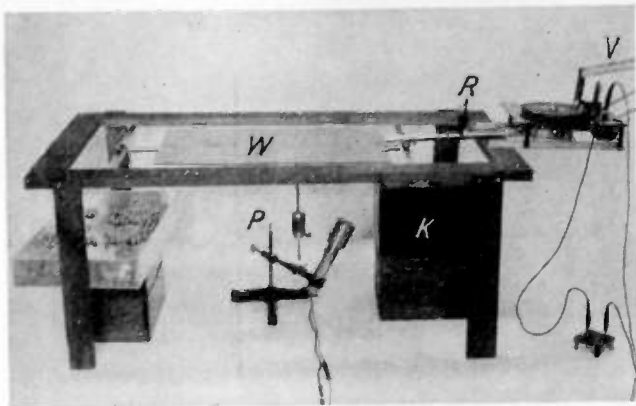

(a)

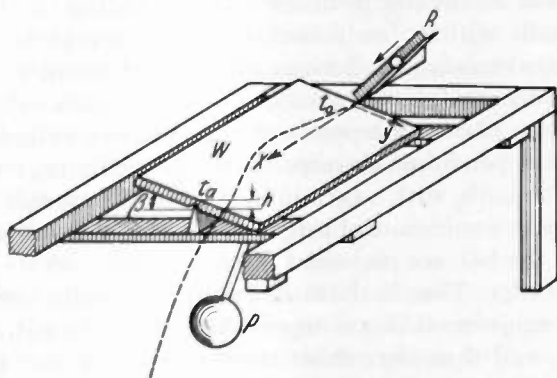

(b)

Fig. 6—Ballistic model for investigating the energy exchange with lateral control.

The derivation explains clearly the difference from the Benner theory by the inclusion of the effect of the stray field at the exit side of the plates. This acts on the electrons on their way to the field-free external space.

Since, in the energy questions which we are considering, it is no longer sufficient to consider single electrons, it becomes necessary, in studying the subject by means of models, to deal with a "beam of balls." Thus we must replace by a "machine gun" the gun used in the earlier investigations.¹⁹ As a simplification, let us arrange for many metal balls to reach, by way of a steeply inclined channel or runway, the tilting mechanism and fittings which simulate the field between the

¹⁹ H. E. Hollmann, *Zeit. für Tech. Phys.*, vol. 20, p. 340, 1939.

plates. We easily recognize the energy exchange between the beam of balls and the tilting plate when we set the latter not in forced but in free oscillations, which, according to the attendant conditions, become more or less damped or undamped.

A photograph of a model of this kind is shown in Fig. 6(a) and again, diagrammatically at (b). The metal balls fall from the magazine V in a mechanically controlled sequence into the inclined runway R and roll from the latter, at a determined initial velocity, over the tilting plate W whose axis is supported on knife-edges. The platform is weighted with a pendulum P . From the left-hand edge of the plate the balls fall off freely, thus providing in principle the same effect as that achieved in a short exit stray field. In

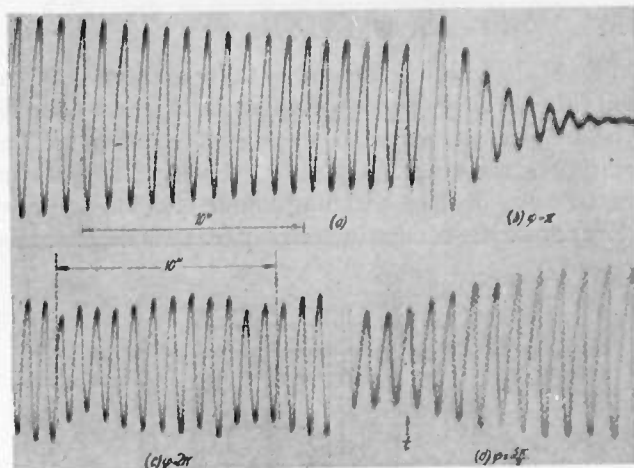

Fig. 7—Oscillation diagrams obtained with various transit angles.

order to make exact observations of the plate oscillations, they are optically registered on a traveling strip of photographic paper contained in the compartment K .

Aside from the rolling friction, the only difference between the model theory and the above-stated electrical theory relates to the replacement of the electrical acceleration by the product of gravitational acceleration and tilting angle. The sum of the potential and kinetic energies which the balls have acquired or lost at the instant of their fall from the left-hand edge of the plate leads again to the inversion formula (2).

In Fig. 7 there are reproduced several oscillation diagrams which were obtained experimentally. First (a) shows the self-damping of the tilting plate. The diagram (b) corresponds to the transit angle π , for which the plate oscillations are most strongly damped, corresponding to Fig. 4. Diagram (c) was taken with the transit angle 2π and reveals the pulsing of positive and negative damping which is explained by the variations in the tilting frequency caused by the beam of balls. Finally, (d) shows, commencing with the instant t , just where the beam of balls was "switched on." It is seen from the diagram that the "switching on" occa-

sioned a distinct increase of the plate oscillations; the model acts in this instance as a "transit-time generator."

II. SPEED-CONTROLLED, TRANSIT-TIME MODEL

In the manner shown by the example of the transverse-control model, there may be investigated fundamentally the energy exchange in an electrically controlled transit-time tube, as for example, in a dynamically operating diode or in braking-field tubes. At this time, the most interesting are the transit-time devices working with velocity modulation, the drift tubes of Hahn and Metcalf²⁰ and also the Klystron.²¹ As precursor of these tubes, there will first be considered a model of the oldest speed-controlled transit-time device, namely the two-field generator of Arsenjewa Heil.²²

A. The Heil Two-Field Generator

Fig. 8(a) shows the fundamental construction of the Heil tube. From the anode diaphragm A_1 there emerges a beam of electrons with the initial velocity v_0 . The beam then traverses the hollow cylinder Z and is conducted away by the catching anode A_2 . The cylinder Z lies above the oscillating circuit S at anode potential

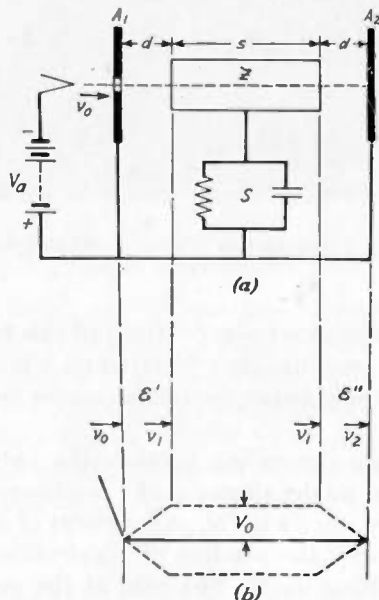

Fig. 8—(a) Diagram of the Heil two-field generator.
(b) Potential diagram.

and carries the high-frequency voltage $V_0 \sin t$ induced in S . Thus in the gaps E' and E'' located on both sides of the cylinders, the electrons undergo alternating accelerations and retardations. Let it be assumed for simplicity that the two gaps are planarly parallel and have linear potential drops.

The potential distribution between the end electrodes may be seen from the potential diagram indi-

²⁰ W. C. Hahn and G. F. Metcalf, "Velocity-modulated tubes," *Proc. I.R.E.*, vol. 27, pp. 106-118; February, 1939.

²¹ R. H. Varian and S. F. Varian, *Jour. Appl. Phys.*, vol. 10, p. 321, 1939.

²² A. Arsenjewa-Heil and O. Heil, *Zeit. für Phys.*, vol. 93, p. 752, 1935.

cated in Fig. 8(b). Its amplitude fluctuates periodically about the horizontal. An energy exchange over the gaps takes place between the electrons and the cylinder so that the oscillation circuit S is subjected to impulses by an induced current or else the induced-current resistance may become negative.

If, furthermore, we assume that the transit angles in the two gaps are negligibly short, then the exchange of energy is determined exclusively by the transit angle Φ_0 through the cylinder. The potential diagram in Fig. 8(b) leads to the transit-time model shown in the

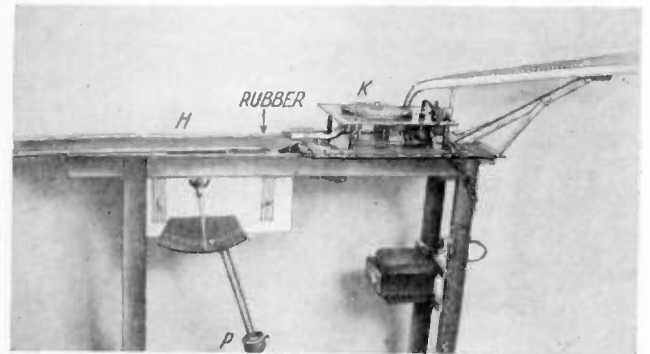

Fig. 9—Ballistic model of the Heil two-field generator.

photograph in Fig. 9, which is a combination of the system K already mentioned for providing the beam of balls with a freely oscillating balance plate. The latter consists of a horizontally guided balance plate H and a pendulum P attached to the balance rod. The balance plate corresponds to the field-free cylinder Z and the pendulum corresponds to the oscillating circuit S . The balls, with a certain initial velocity v_0 , roll over a rubber membrane of length d upwards or downwards over the balance plate and fall freely down off its left-hand edge. Thus in the model there is actually fulfilled the requirement of a short exit field while the entrance field, and thus the rubber membrane, must not have too short a length if its angle of inclination is not to be greater than is permissible.

The calculation of the model commences with the velocity v_1 with which the balls arrive at the balance plate. If h_0 is the balance amplitude, then this speed is

$$v_1 = v_0 \left(1 + \frac{M}{2} \sin \omega t_0 \right),$$

when the "modulation," i.e., electrically V_0/V_a , is denoted by

$$M = \frac{2gh_0}{v_0^2}$$

In order to represent clearly the motion of the balls on the balance plate, the ball-roll chart shown in Fig. 10 has been prepared. It is a graphic timetable for the individual balls, and there has been taken, as the example, the case $M=0.5$. As abscissas there have been taken, instead of the distance traversed, the angle

length of the balance plate, i.e., the "transit angle" $\Phi_0 = \omega s / v_0$. The ordinates are the angle ωt . Thus the roll plan is applicable to any frequencies, balance lengths s , and rolling speeds v_0 .

The inclinations fluctuating periodically by 45 degrees with reference to a traveling beam are determined by the velocity v_1 fluctuating with the time. As a consequence the traveling beams become periodically denser and less dense, and even intersect one another. In this way the manner in which the time sequences of the balls, which, at the time t_0 arrive equisquentially on the balance, become more or less densely related to each other, can be recognized at once. This shows how the "space charge" of the beam of balls is alternately compressed or rarefied; a phenomenon which we can appropriately term "transit-time" bunching.

With respect to the energy aspects, our model discloses the following relations: At the moment when the balls fall from the balance plate, the potential energy received or given up becomes free. If the balance plate is quite short, or if it oscillates only weakly, then practically no transit-time bunching takes place; the balls again roll from the balance plate equisquentially, and the portions of energy pertaining to the positive and negative half periods are maintained in equilibrium. But this equilibrium is disturbed by the transit-time bunching. Corresponding in each case to the transit angle, more balls can fall from the balance plate when its position of rest is exceeded, so that the balance plate loses oscillation energy in each period and becomes damped, or else the balls which, on the balance plate, have passed below their position of rest, outweigh the others, in which case oscillation energy is delivered to the balance plate.

It may be seen at once from the ball-roll chart in Fig. 10, that with transit angles of less than π there occurs a densification while the balance plate is sinking. Under these conditions, negative damping evidently must take place. At the transit angle $\Phi_0 = \pi$ the bunching occurs exactly at the same time as the passage of the balance-plate oscillation through the zero position so that there can be no energy exchange. With transit angles greater than π the bunching occurs in the oscillation phase above the rest position so that the balance plate is damped.

Webster²³ has developed the transit-time bunching into a Fourier series whose coefficients are Bessel functions. If we break off this development after the first term, on the ground that there shall be no higher harmonics, then we obtain for the ball sequence at the time t_2 of their falling from the balance plate

$$N(t_2) = N[1 + 2J_1(P) \cos \omega t_0] \quad (3)$$

in which J_1 denotes the Bessel function of the first kind and first order, and

$$P = \frac{1}{2} M \Phi_0$$

²³ D. L. Webster, *Jour. Appl. Phys.*, vol. 10, p. 501, 1939.

is the so-called "bunching factor." The potential energy of the balls at the time t_2 amounts to

$$W = - mgh$$

$$= - \frac{m}{2} M^2 v_0^2 \sin(\omega t_0 + \phi_0). \quad (4)$$

By multiplication of (3) and (4), averaging over the period, and division by the power ($W_0 = N(m/2)v_0^2$) of

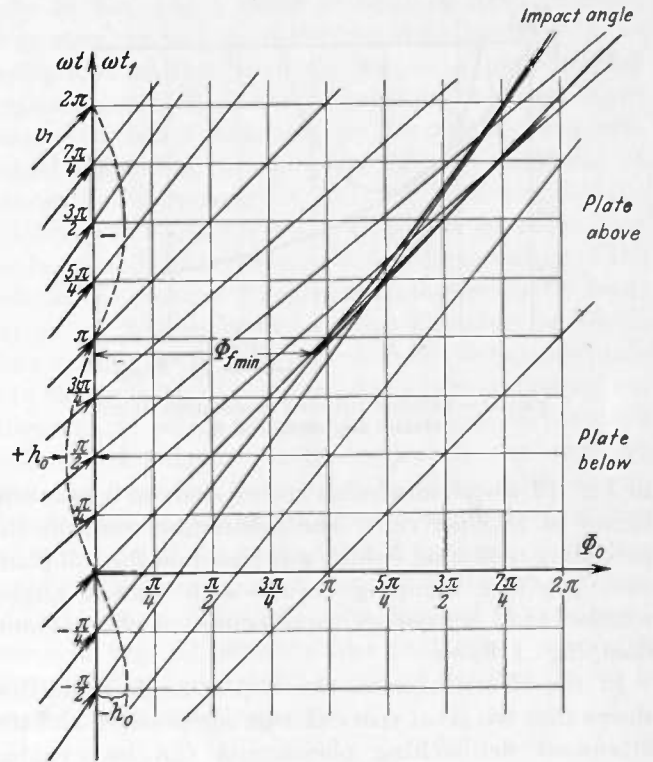

Fig. 10—Rolling path of balls for illustrating transit-time compression.

the beam of balls at their position of energy equilibrium there is obtained the efficiency formula

$$\eta \text{ per cent} = - 100 M J_1(P) \sin \Phi_0. \quad (5)$$

The equation represents the efficiency as a function of the two quantities M and Φ_0 , which are interlinked with one another in the following manner.

The intersecting of two beams indicates that two balls on the balance plate collide and exchange their kinetic energy in accordance with the impulse law, without being able to overtake one another. The overtaking of electrons is, indeed, electrically possible, but such an occurrence of too close proximity of two electrons or of too great density of the space charge is opposed by the electrostatic forces (debunching). This disturbance in the model may be excluded by introducing the so-called "impact angle" Φ_f in place of any transit angle; that is to say, the angular length at which, at a prescribed modulation M , exactly two traveling beams intersect which are separated from one another by infinitely small time differences. The relation between Φ_f and M is given by

$$\Phi_f = \frac{4(1 - \frac{1}{2}\sqrt{1 + 3M^2})^{3/2}}{\sqrt{\sqrt{1 + 3M^2} - M^2 - 1}} \quad (6)$$

and is plotted in the solid line curve in Fig. 11.

The efficiency function (5) passes through its negative maximum at the transit angle $\Phi_0 \approx 2\pi/3$ for which we obtain from Fig. 11 an M maximum of about 60 per cent. With this value, (5) gives the solid-line curve

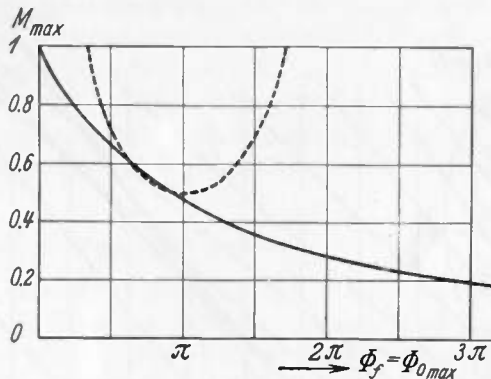

Fig. 11—Relation between modulation M and transit angles Φ_0 and Φ_f .

in Fig. 12 whose maximum corresponds to a best efficiency of 15.5 per cent. The calculation confirms the preceding reasoning (which was based on the roll plan) that negative damping occurs with transit angles smaller than π ; energy equilibrium at $\Phi_0 = \pi$; and damping at $\Phi_0 > \pi$.

In the electrical case, the impact-angle limitation shows that too great space-charge compression and the attendant debunching phenomena can be avoided with certainty. The following reasoning leads to the same result: the theory proceeds from the assumption that all the electrons reach the "catcher" anode A_2 without the occurrence of a temporary stoppage. If in accordance therewith we conclude that the impact velocity

$$v_2^2 = v_0^2 [1 + M(\sin \omega t_0 - \sin (\omega t_0 + \Phi_0))]$$

cannot be imaginary, then for the maximum modulation there results

$$M_{max} = \frac{1}{2 \sin \frac{\Phi_0}{2}} \quad (7)$$

This relation between M max and Φ_0 is shown in the dotted curve in Fig. 11. It is seen that, within the angular range under consideration, the two curves are nearly superposed.

As already stated, the theoretical assumptions for the model cannot be strictly fulfilled to the extent that the transit angle $\phi_0 = \omega d/v_0$ on the rubber membrane leading to the balance plate cannot be maintained negligibly small. If we admit small values for ϕ_0 , the efficiency formula then assumes the following more complicated form:

$$\eta \text{ per cent} = 100M \left\{ \frac{M}{4} \frac{\sin \frac{\phi_0}{2} - \frac{\phi_0}{2} \cos \frac{\phi_0}{2}}{\left(\frac{\phi_0}{2}\right)^2} \sin \frac{\phi_0}{2} - J_1(Q) \cos \frac{\phi_0}{2} \left[\sin (\phi_0 + \Phi_0) - \frac{\sin^2 \frac{\phi_0}{2}}{\frac{\phi_0}{2}} \right] \right\} \quad (8)$$

with the effective bunching factor

$$Q = \frac{1}{2} M \left(\frac{\phi_0}{2} + \Phi_0 \right) \frac{\sin \frac{\phi_0}{2}}{\frac{\phi_0}{2}}$$

As of particular interest, attention should be called to the first term in the curved brackets, which contains

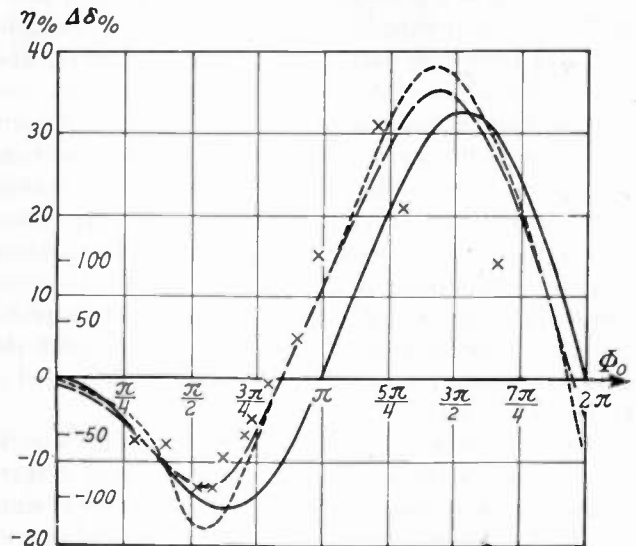

Fig. 12—The efficiency functions of the Heil generator. xxx are test values.

the inversion function already deduced in (2) for the transverse control and which takes into account the load of the balance-plate oscillations, i.e., the effective voltages developed by the entrance field. In the model under consideration, the transit angle ϕ_0 amounts to about 0.075π , and the broken-line curve in Fig. 12 has been calculated for this value. Because of the somewhat less favorable transit-time bunching and of the power loss which has been mentioned, the new curve lies below the previously calculated solid-line curve. This indicates practically that it is desirable to work with the smallest possible transit angles in both sides of the cylinder.

The efficiency function deduced theoretically was tested experimentally by taking as the measure for the energy exchange observed values of the change in the logarithmic damping decrement. Let δ_0 be the decrement of the freely oscillating balance plate and

let δ_k be the decrement with the "switched-in" beam of balls. The change in per cent is then

$$\Delta\delta \text{ per cent} = 100 \frac{\delta_0 - \delta_k}{\delta_0}.$$

The decrements were determined by the oscillation amplitudes, which were taken in part from corre-

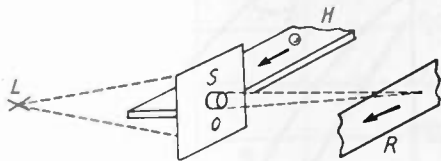

Fig. 13—Diagrammatic representation of the apparatus for the oscillographic recording of the balance oscillations and of the transit-time bunching.

sponding oscillograms and in part were read directly from a scale. In Fig. 12 are plotted the decrement changes determined in the way described above. The scale was so adjusted as to obtain agreement with the maximum value of the dashed-line curve. The observed points follow the theoretical curve satisfactorily; deviating considerably only in the damped range, be-

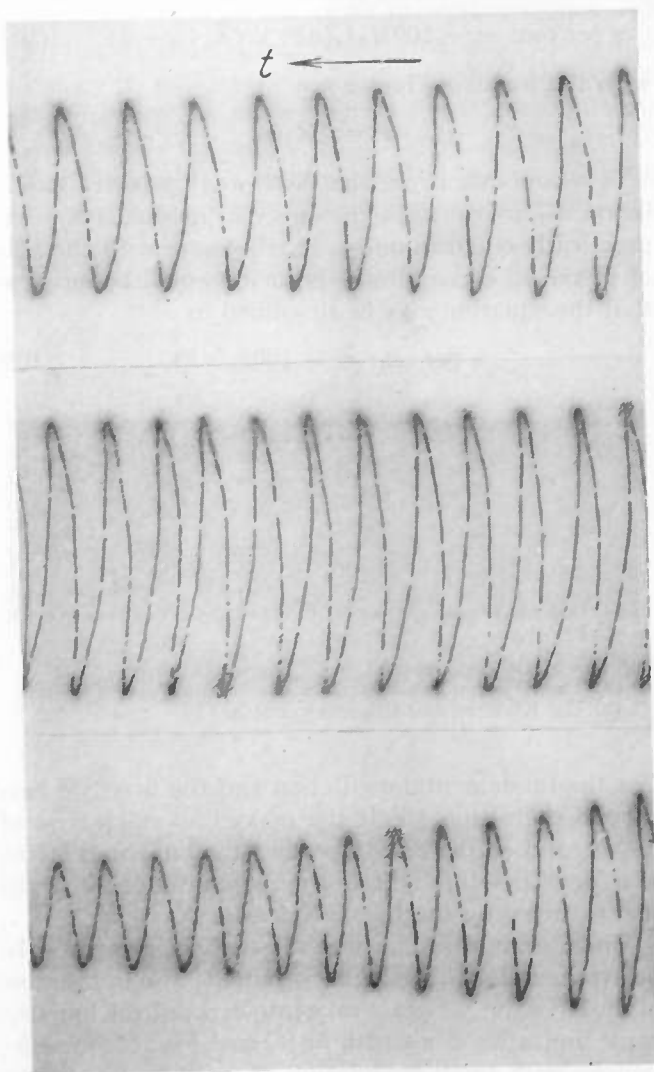

Fig. 14—Modol oscillograms.

cause in that range, the impact angle was exceeded and individual balls on the balance plate collided irregularly.

The transit-time bunching occurring under the various working conditions may be seen clearly on the balance plate. In order to make a record, the passage of the balls through the end of the balance plate together with the balance-plate oscillations were registered by means of the arrangement shown diagrammatically in Fig. 13. A beam of light directed immediately over the surface of the balance plate records the oscillations of the balance plate on a photographic registering strip *R*. The record also shows the interruptions of the beam occasioned by the transit of the individual balls. Fig. 14 shows three such diagrams as follows: (a) with energy equilibrium, during which the balance plate oscillates freely without much effect from the beam of balls and during which the crowding of the balls at the passage through zero may be clearly seen; (b) an oscillogram with negative damping, in which the crowding of the balls occurs while the balance plate is in the position of rest; and finally (c) a damped oscillogram, in which is seen the crowding of the balls with raised balance plate. Apparently the negative damping from the beam of balls is not sufficient to occasion self-excitation, in view of the relatively strong self-damping of the balance-plate system.

When the same transit angle of 0.075π is also employed in the exit field, calculations lead to the dotted curve in Fig. 12, which shows that the unfavorable effect of the first transit angle in the input field is partly compensated again.

B. The Klystron

The efficiency of the Heil generator is indicated in (5) and (8) to be limited to relatively low values, not only because it is dependent upon the sine of the transit angle but also because the Bessel function occurs in the argument. The Klystron removes the disadvantage associated with these conditions, while the velocity modulation and excitation by induced current are accomplished in two separate gaps where the fields are completely independent of one another in magnitude and phase.

Fig. 15(a) shows the fundamental construction of the Klystron. An input gap (buncher), which causes the velocity modulation, is provided between the two grids G_1 and G_1' by the control voltage $V_0 \sin \omega t_0$, while the output field (catcher) is generated by the voltage $V_0 \sin(\omega t_0 + \Phi_0 + \psi)$ induced in the oscillation circuit between the second pair of grids $G_2 - G_2'$. The symbol ψ denotes the phase position of the output voltage. Thus we can represent the field distribution by the potential diagram in Fig. 15(b) and, in view of the small field strengths outside of the two gaps, we can, without serious error, replace Fig. 15(b) by Fig. 15(c).

For our investigations, the Klystron was imitated by the model construction shown in Fig. 16. This

model Klystron, in addition to the system *K* for providing the beam of balls, comprises the single-arm control rocker *W*₁ (the "buncher") which provides the forced oscillations and the output rocker *W*₂ (i.e., the

With the potential energy at the time *t*₂, (i.e., at the instant when the balls fall from the output rocker),

$$W = - mgh_2 \sin n(\omega t_0 + \Phi_0 + \psi),$$

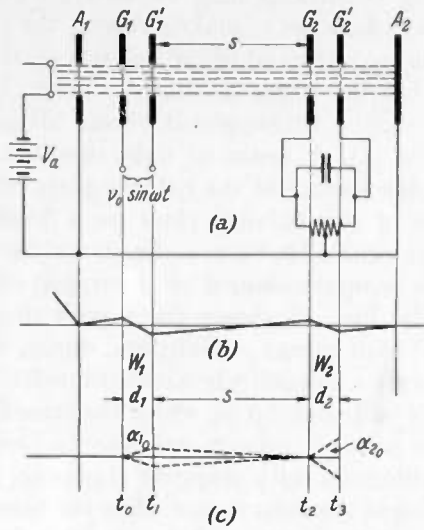

Fig. 15—(a) Diagrammatic representation of the Klystron (b) and (c) Potential distribution diagrams.

"catcher") which is also single-armed, onto which, over the practically field-free rubber membrane of length *s*, the balls roll. The control rocker is driven from a motor through an eccentric and provides sinusoidal oscillations with the angular amplitude α_{10} . The output rocker carries a pendulum *P* which simulates the power circuit and oscillates freely with the angular amplitude α_{20} .

As a preliminary simplification of the model theory let us again neglect the two transit angles on the

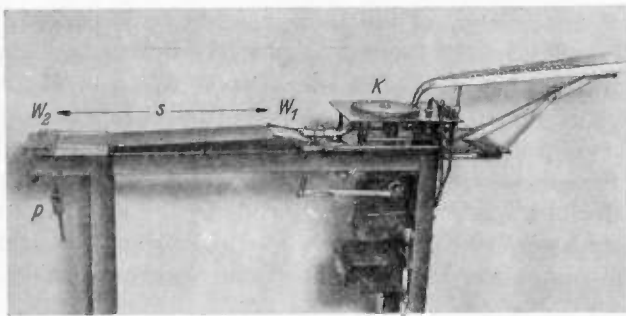

Fig. 16—Ballistic model of the Klystron.

rockers. Differing from the case of the Heil generator, let us now introduce the two modulations

$$M_1 = \frac{2gh_{10}}{v_0^2} = \frac{v_0}{V_a}$$

and

$$M_2 = \frac{2gh_{20}}{v_0^2} = \frac{V_0}{V_a},$$

while we generalize the bunching formula (3) to permit the higher harmonics

$$N(t_2) = N[1 + 2 \sum J_n(nP) \cos n\omega t_0]. \quad (9)$$

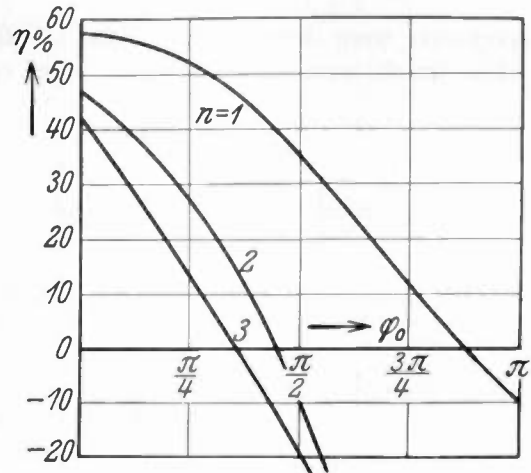

Fig. 17—Decrease in the efficiency with increasing transit angles.

we obtain the Webster efficiency formula

$$\eta \text{ per cent} = - 100M_2J_n(nP) \sin n(\Phi_0 + \psi) \quad (10a)$$

with the bunching factor

$$P = M_1\Phi_0.$$

It is now easy to see that with weak primary modulation *M*₁, we can take the effective modulation *M*₂ as practically equal to unity. Furthermore with the help of ψ , the sine can always be made equal to unity so that the equation may be simplified to

$$\eta \text{ per cent} = - 100J_n(nP). \quad (10b)$$

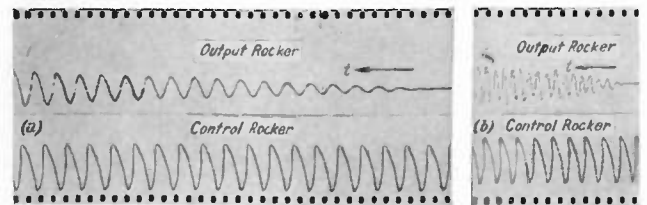

Fig. 18—Model oscillograms.
(a) The Klystron as an amplifier.
(b) The Klystron as a frequency doubler.

For the fundamental oscillation and the first two harmonics there thus result the maximum efficiencies of 58, 49, and 43 per cent, provided the bunching factor is in each case brought to the maximum of the argument carried by the Bessel function.

Under practical conditions these efficiencies can only be attained if no debunching occurs. If also in the case of the Klystron, we again take into account the impact-angle limitation dealt with in (6) and Fig. 11, the efficiencies with small modulation *M*₁, will be seen to be decreased to 46, 35, and 30 per cent.

When appreciable transit angles ρ_0 occur in the two gaps and on the two rockers, (10a) may be generalized to

$$\eta \text{ per cent} = 100M_2 \left\{ \frac{M_2}{4} \frac{\sin n \frac{\phi_0}{2} - n \frac{\phi_0}{2} \cos n \frac{\phi_0}{2}}{\left(n \frac{\phi_0}{2} \right)^2} \sin n \frac{\phi_0}{2} - J_n(nQ) \cos n \frac{\phi_0}{2} \sin n \left(\frac{3}{2}\phi_0 + \Phi_0 + \psi \right) \frac{\sin n \frac{\phi_0}{2}}{n \frac{\phi_0}{2}} \right\} \quad (11)$$

with the bunching factor

$$Q = \frac{1}{2} M_1 \left(\frac{\phi_0}{2} + \Phi_0 \right) \frac{\sin \frac{\phi_0}{2}}{\frac{\phi_0}{2}}$$

In Fig. 17 it is shown how the efficiencies behave for the fundamental wave and the first two harmonics ($n=1, 2,$ and 3) when the Bessel function for a primary modulation of 10 per cent, with the help of Φ_0 , is maintained in each case at its maximum values. All three curves show a rapid falling off from the initial efficiency as ϕ_0 increases. Fundamentally, nothing in this conclusion is altered when the impact-angle limitation is introduced.

In describing the tests on models, we are limiting ourselves to two particularly impressive examples. The

model was, as in Fig. 13, provided with a registering attachment which recorded the oscillations of both rockers as well as the sequence of the transit of balls on the same time scale.

Fig. 18(a) reproduces the action of the model as an amplifier. The lower curve shows the forced oscillations of the control rocker and the upper curve the oscillations of the output rocker. As soon as the beam of balls is "switched in," the output rocker commences to oscillate and rocks itself up to the amplitude corresponding to $M_2=1$.

Fig. 18(b) shows the model as a frequency doubler, which, with the help of the control frequency and of the output oscillation, is balanced approximately to the most favorable running condition. The record reveals very beautifully the impact excitation caused by the space-charge waves of the beam of balls which occur at each second period.

CONCLUSIONS

The actual purpose of the models and researches which have been discussed is not only to derive the efficiency functions from the mechanical premises but especially to provide the exact insight into the excitation phenomena which is not so easy to obtain in the region of microwaves with a 10^8 time refinement. Furthermore, by means of the ballistic model, there can be obtained exact data for the suitable proportioning of the electrical apparatus initiated by the mechanical models.

The Ionosphere and Radio Transmission, February, 1941, with Predictions for May, 1941*

NATIONAL BUREAU OF STANDARDS, WASHINGTON, D.C.

AVERAGE critical frequencies and virtual heights of the ionospheric layers as observed at Washington, D. C., during February are given in Fig. 1. Critical frequencies for each day of the month are given in Fig. 2. Fig. 3 gives the February average

Ionospheric storms are listed in Table I. The details of the ionospheric storm day of February 13 are shown in Fig. 1. The open circles in Fig. 2 indicate the noon and midnight critical frequencies observed during the ionospheric storms listed in Table I. The sizes of

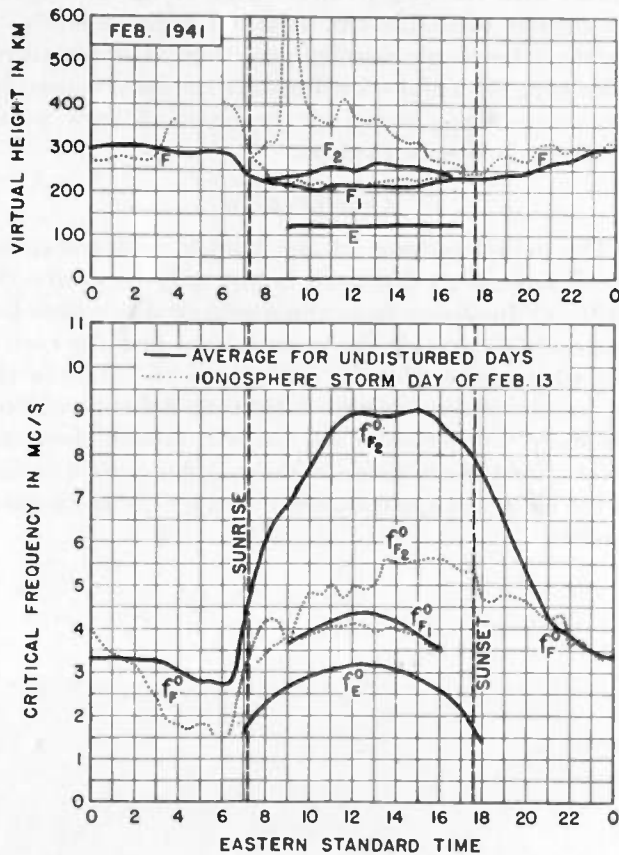

Fig. 1—Virtual heights and critical frequencies of the ionospheric layers, observed at Washington, D. C., February, 1941.

values of maximum usable frequencies, for radio transmission by way of the regular layers. The maximum usable frequencies were determined by the F layer at night and by the F₂ layer during the day. Fig. 4 gives the expected values of the maximum usable frequencies for radio transmission by way of the regular layers, average for undisturbed days, for May, 1941. All of the foregoing are based on the Washington ionospheric observations, checked by quantitative observations of long-distance reception.

* Decimal classification: R113.61. Original manuscript received by the Institute March 7, 1941. These reports have appeared monthly in the PROCEEDINGS starting in vol. 25, September, 1937. See also vol. 25, pp. 823-840: July, 1937. Report prepared by T. R. Gilliland, N. Smith, F. R. Gracely, A. S. Taylor, and H. V. Cottony.

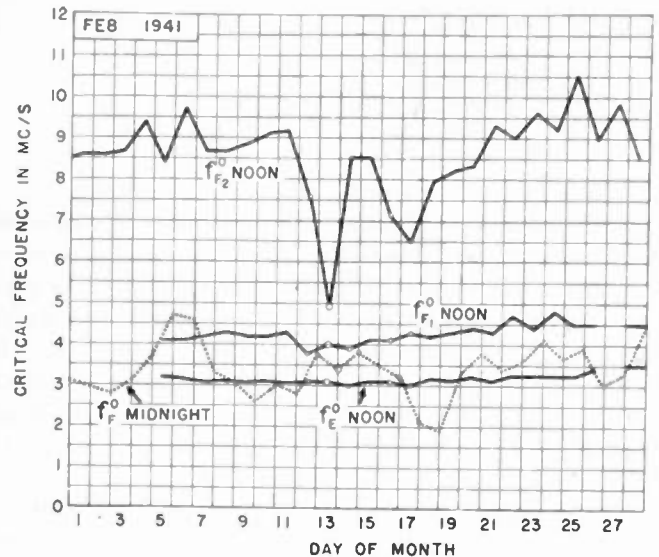

Fig. 2—Midnight $f_{F_1}^0$ and noon f_{E^0} , $f_{F_1}^0$, and $f_{F_2}^0$, for each day of February.

the circles roughly represent the severity of the storm. A severe ionospheric storm began about 0100 E.S.T.

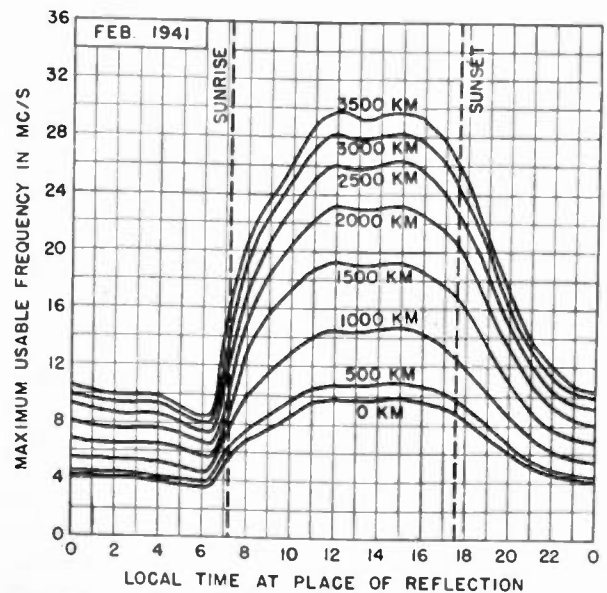

Fig. 3—Maximum usable frequencies for dependable radio transmission via the regular layers, average for February, 1941. These curves and those of Fig. 4 also give skip distances, since the maximum usable frequency for a given distance is the frequency for which that distance is the skip distance.

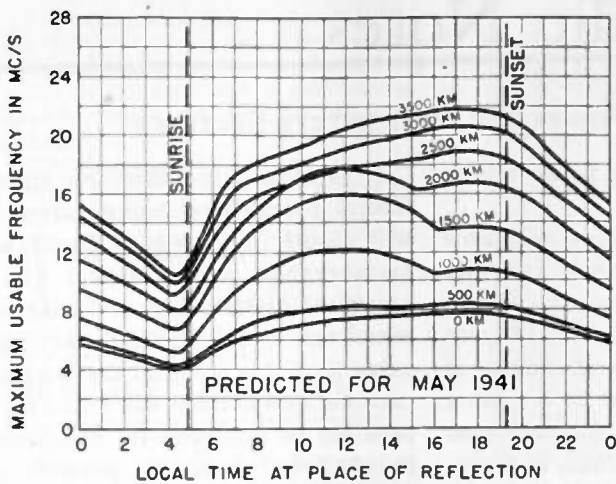

Fig. 4—Predicted maximum usable frequencies for dependable radio transmission via the regular layers, average for undisturbed days, for May, 1941. The values shown will be considerably exceeded during irregular periods by reflections from clouds of sporadic E layer. For information on use in practical radio transmission problems, see Letter Circulars 614 and 615 obtainable from the National Bureau of Standards, Washington, D. C., on request.

TABLE I
IONOSPHERIC STORMS (APPROXIMATELY IN ORDER OF SEVERITY)

| Day and hour E.S.T | h_f before sunrise (km) | Minimum f_{p^o} before sunrise (kc) | Noon f_{p^o} (kc) | Magnetic character ¹ | | Ionospheric character ² |
|--|---------------------------|---------------------------------------|---------------------|---------------------------------|--------------|------------------------------------|
| | | | | 00-12 G.M.T. | 12-24 G.M.T. | |
| February 12 (from 1200) | — | — | 7600 | 0.0 | 0.1 | 0.5 |
| 13 | 290 | 170 | 4900 | 0.7 | 1.1 | 1.3 |
| 14 | 273 | < 1700 | 8500 | 0.7 | 0.4 | 0.7 |
| 15 (through 0700) | 282 | < 1700 | — | 0.9 | 0.5 | 0.2 |
| 16 (from 0200) | 290 | 1700 | 7200 | 0.1 | 0.4 | 0.5 |
| 17 | 292 | 1700 | 6500 | 0.6 | 0.6 | 0.6 |
| 18 (through 0700) | — | 1900 | — | 0.1 | 0.1 | 0.2 |
| For comparison: Average for undisturbed days | 294 | 2710 | 8930 | 0.3 | 0.4 | 0.0 |

¹ American magnetic character figure, based on observations of seven observatories.
² An estimate of the severity of the ionospheric storm at Washington on an arbitrary scale of 0 to 2, the character 2 representing the most severe disturbance.
³ h_f not measurable.

on March 1. Details of the storm will be given in the March report.

The sudden ionospheric disturbances listed in Table II are the first observed since October 18, 1940.

TABLE II
SUDDEN IONOSPHERIC DISTURBANCES

| Day | G.M.T. | | Locations of transmitters | Relative intensity at minimum ¹ | Other Phenomena |
|-------------|-----------|------|---------------------------|--|--|
| | Beginning | End | | | |
| February 26 | 1911 | 2100 | Ohio, Ont., D.C. | 0.0 | Terr. mag. pulse ² (1911 to 1956) |
| 27 | 1544 | 1820 | Ohio, Ont., D.C. | 0.0 | Terr. mag. pulse (1543 to 1630) |
| 28 | 1526 | 1605 | Ohio, Ont., D.C. | 0.0 | Terr. mag. pulse (1526 to 1540) |

¹ Ratio of received field intensity during fade-out to average field intensity before and after, for station WLWO, 6080 kilocycles, 650 kilometers distant.
² As observed on Cheltenham magnetogram of United States Coast and Geodetic Survey.

TABLE III
APPROXIMATE UPPER LIMIT OF FREQUENCY IN MEGACYCLES OF THE STRONGER SPORADIC-E REFLECTIONS AT VERTICAL INCIDENCE

| Day | 00 | 01 | 02 | 03 | 04 | 05 | 06 | 07 | 08 | 09 | 10 | 11 | 12 | 13 | 14 | 15 | 16 | 17 | 18 | 19 | 20 | 21 | 22 | 23 | |
|--------|----|----|----|----|----|----|----|----|----|----|----|----|----|----|----|----|----|----|----|----|----|----|----|----|--|
| Feb. 1 | | | | | | | | | | | | | | | | | | | | | | | | | |
| 2 | | | | 3 | 3 | | | | | | | | | | | | | | | | | | | | |
| 3 | | | | | | 8 | 8 | 7 | 9 | 5 | | | | | | | | | | | | | | | |
| 4 | | | | | | | | 6 | 5 | 4 | 4 | | | | | | | | | | | | | | |
| 5 | | | | | | | | 6 | 5 | | | | | | | | | | | | | | | | |
| 9 | | | | | | | | | | | | | | | | | | | | | | | | | |
| 10 | | | | 3 | | | | | | | | | | | | | | | | | | | | | |
| 11 | | | | | | | | | | | | | | | | | | | | | | | | | |
| 13 | | | | | | | | | | | | | | | 4 | 4 | | | | | | | | | |
| 15 | | | | | | | | | | | | | | | | | | | | | | | | | |
| 17 | | | | | | | | | | | | | | | | | | | | | | | | | |
| 18 | | | | | | | | | | | | | | 3 | | | | | | | | | | | |
| 19 | | 7 | 5 | | | | | | | | | | | | | | | | | | | | | | |
| 20 | | | | | | | | | | | | | | | | | | | | | | | | | |
| 21 | | | | | | | | | | | | | | | | | | | | | | | | | |
| 22 | | | | | | | | | | | | | | | | | | | | | | | | | |
| 23 | | | | | | | | | | | | | | | | | | | | | | | | | |
| 24 | | | | | | | | | | | | | | | | | | | | | | | | | |
| 25 | | | | | | | | | | | | | | | | | | | | | | | | | |
| 26 | | | | | | | | | | | | | | | | | | | | | | | | | |

It is worthy of note that this burst of activity presaged the severe ionospheric storm of March 1. Table III gives the approximate upper limit of frequency of strong sporadic-E reflections at vertical incidence.

Institute News and Radio Notes

NEW POLICY FOR ENCOURAGING THE FORMATION OF INSTITUTE SECTIONS

New policies affecting sections are now in effect, and will be of particular interest to members of the Institute who live in areas where a section might be formed.

These policies can be briefly summarized as follows: (1) The Board of Directors has indicated by a resolution that it favors the formation of a new section "whenever the number of Associates, Members, and Fellows residing within a reasonable section area is enough to indicate that the proposed section will be able to maintain a membership in excess of 25"; (2) The Board of Directors has approved a Bylaw to the Constitution to the effect that a section will be placed on probation if it fails to hold five meetings during a year, or to maintain a membership of 25 Associates, Members, and Fellows. A section on probation

for three consecutive years will be disbanded.

Under this arrangement, new sections can be approved promptly by the Board of Directors whenever it appears that an adequate number of Institute members is available in the area. At the same time, the Institute is protected against inactive sections, and sections so small as to be a financial liability.

These new policies have already made it possible since the first of the year to authorize Institute sections at Dallas and Kansas City. A petition to form a Twin Cities Section has been received and will be approved as soon as enough of those who have already applied for Associate membership from that area become Associates in the Institute. At least one other section is also in prospect.

It is anticipated that the more liberal course now being pursued will result in increased Institute membership, and a better geographical distribution of Institute members and activities. At the same time it is realized that an occasional new section will find it impossible to continue its activities indefinitely. Such a possibility does not appear to be a serious matter, however, since after the loss of such a section the situation in the area becomes the same as before the formation of the section.

Anyone interested in investigating the possibility of forming a new section should write to the Secretary of the Institute, who is prepared to supply a list of Institute members in the proposed area, information on financial assistance that is given sections, etc.

Frederick Emmons Terman, President

Board of Directors

The regular monthly meeting of the Board of Directors was held on March 5 and those present were F. E. Terman, president; Austin Bailey, A. B. Chamberlain, I. S. Coggeshall, Alfred N. Goldsmith, Virgil M. Graham, O. B. Hanson, R. A. Heising, L. C. F. Horle, B. J. Thompson, H. M. Turner, H. A. Wheeler, L. P. Wheeler, and H. P. Westman, secretary.

Applications for transfer to Member grade in the following names were approved: C. A. Cady, P. K. Chatterjea, Hermann Florez, N. L. Kiser, J. D. Mathis, R. K. McClintock, L. E. Packard, J. L. Roemisch, C. R. Smith, D. J. Tucker, C. D. Tuska, and I. R. Weir. The following individuals were admitted to Member grade: R. S. Doak, R. V. Howard, F. D. Langstroth, and I. G. Wilson.

One hundred and forty-two applications for Associate, four for Junior, and one hundred and sixty-five for Student grade were approved.

A schedule was adopted for the preparation of the program and the release of publicity material on our Summer Convention to be held in Detroit on June 23, 24, and 25.

Professor L. B. Cochran was named chairman of the committee to take charge

COMING MEETINGS
Summer Convention
Institute of Radio Engineers
Detroit, Michigan
June 23, 24, and 25, 1941

of the Pacific Coast Convention. The final decision on the place and date of the meeting has not yet been reached.

A petition for the establishment of a section centering at Kansas City, Missouri, was accepted, and the section established.

A request for the establishment of a section centering about Minneapolis and St. Paul, Minnesota, had an insufficient number of member signers. A number of those signing have applications for membership pending and action was taken to establish the section automatically when the required number of applications are completed so as to provide a minimum of twenty-five signers who are members of the Institute.

Two new sections were added to the Institute Bylaws and read as follows:

"The Nominating Committee shall submit more than one name for each elective office."

"The President, with the consent of the Board of Directors is authorized to appoint teachers of science or engineering who are Institute members as Institute Representatives. Each such Institute Representative is charged with promoting the welfare of the Institute at his school, particularly in matters relating to student membership."

It was agreed that members located in foreign countries who are unable to obtain licenses for the forwarding of funds for the payment of dues, may upon request be placed on an inactive list. The names of those on the inactive list may be included in future Yearbooks and on resuming membership the payment of a new entrance fee will not be required.

The publication of a Yearbook to contain the names of all members as of December 31, 1941, was ordered and provision made for the gathering of the information to appear in the book. A questionnaire to gather these data will be mailed to the membership shortly.

The Committee on Special Papers reported that it had already received promises for the writing of about a dozen papers for the review type.

Progress was recorded in the establishment of a special committee to solicit papers on engineering subjects for publication in the PROCEEDINGS.

It is anticipated that the two committees discussed above will stimulate the writing of a sufficient number of papers to permit the PROCEEDINGS to get back on schedule within the next six or eight months.

The Report of the Secretary covering the year ended December 31, 1940, was accepted and an abridgement of it was approved for publication in the March issue of the PROCEEDINGS.

I.R.E.-U.R.S.I. Meeting Canceled

The joint meeting of the Institute and the American Section of the International Scientific Radio Union (U.R.S.I.) which has been held annually in Washington, D. C., for many years and which was announced for May 2, 1941 has been canceled. An inadequate supply of papers makes this action necessary. This condition is doubtless the result of the general absorption of laboratories in emergency activities.

United States Selective Service

Undoubtedly, many members of the Institute are eligible to be called for a year of military training under the Selective Service Act. Some fears have been expressed that their radio training would not be recognized as important and they may be placed in branches of the service doing other types of work. It is interesting to note that in the classification cards which will be prepared for each trainee, special provision is made for checking two hobbies and a blank space for the entry of all others. The two hobbies in which the Army is most interested are radio and photography.

New York Meeting

"General Properties of Cavity Resonators" was the subject of a paper by W. W. Hansen of Stanford University and the Sperry Gyroscope Company.

Dr. Hansen pointed out that resonators are becoming increasingly important in the microwave field. As those shapes which are most useful in practice are not amenable to mathematical treatment and as the experimental technique is poor, there is little precise information on them. Data were given on a number of shapes which could be treated mathematically. Certain important factors were considered and the possibility of estimating from these data the characteristics of shapes which were not readily computable was indicated.

March 5, 1941, F. E. Terman, president, presiding.



S. S. KIRBY DIES

Samuel S. Kirby (A'27) died on January 26 of a heart ailment which had affected him for several years.

Mr. Kirby was born on October 27, 1893, at Gandy, Nebraska. He received an A.B. degree from the College of Emporia in 1917 and the M.A. degree from the University of Kansas in 1921. He served with the Signal Corps of the American Expeditionary Force from 1918 to 1919.

He taught high school from 1919 to 1921 and for the next five years served as a professor of physics at Friends University in Wichita, Kansas.

He joined the staff of the National Bureau of Standards in 1926 as an assistant physicist. From 1930 to 1938 he was an associate physicist being advanced to the rating of physicist in 1938. His work at the Bureau was principally on radio wave propagation. During the past few years he was particularly concerned with studies of the ionosphere and its relation to wave propagation.

He served for many years as secretary-treasurer of the American Section of the International Scientific Radio Union (U.R.S.I.).

Sections

Baltimore

F. W. Fischer, engineer for the Westinghouse Electric and Manufacturing Company (Baltimore), presented a description of "The New Five-Kilowatt Westinghouse Broadcast Transmitter."

The principal features of this transmitter were stated to be low audio-frequency distortion, compactness, and accessibility. There are three main units, the exciter, amplifier, and modulator. They are built on a common base which provides air and wire ducts.

Indicating instruments and master controls are located on the panel front. The transmitter may be put in operation step by step or entirely automatically in proper sequence by an interlocking control sys-

tem. On the failure of any step, the sequence stops and indicating lights show the location of the trouble.

The plate-power supply is provided by six 872-A copper-oxide rectifiers which show only slight aging after about a thousand hours of service. Failures are practically unknown as long as cooling air is supplied. The 828 and 891-R tubes in the power amplifier and modulator are air-cooled. Protective relays remove power in the event of failure.

Balanced feedback is employed and utilizes resistance-capacitance combinations to keep the gain constant and avoid phase shift throughout the audio-frequency range. The response of the transmitter is flat to within 1 decibel from 30 to 10,000 cycles modulation. Distortion is very low. Over-all efficiency is of the order of 32 per cent.

The transmitter can be put on the air in about 1½ minutes.

February 21, 1941, Ferdinand Hamburger, chairman, presiding.

Buffalo-Niagara

The "Technique of Square-Wave Analysis" was the subject of a paper by Jerry Minter of Measurements Corporation.

A square-wave generator was described in detail. The output wave of the generator was shown graphically and the effects on it of passing it through amplifiers having limited frequency ranges were illustrated.

A demonstration was given in which the output of a radio-frequency oscillator modulated by the square-wave generator was passed through a receiver. The output was impressed on a cathode-ray oscilloscope and the response-frequency characteristic could be readily noted. The effect of tuning the intermediate-frequency amplifier was clearly demonstrated.

February 12, 1941, B. A. Atwood, chairman, presiding.

Chicago

W. Bergman, lieutenant, United States Naval Reserve, of the Northern Illinois Public Utilities Company, discussed "The Amateur and National Defense."

A brief history of amateur radio both before and immediately following the World War was presented. The organization and plan of the Naval Communications Reserve, which was established in 1925, was then outlined. The activities were presented in detail. It was pointed out that advancement depends on a knowledge of radio and seamanship. The amateur obtains the former in his normal activity but must be taught the latter.

At the regular session, David Hewlett of the Hewlett-Packard Company, presented a paper on "Square-Wave Testing."

A brief history of square-wave testing was presented. In operation, a square wave is impressed on the input of an amplifier and the wave form of the output is examined with a cathode-ray oscillograph. The response of amplifiers having various characteristics was shown by slides and included not only frequency deficiencies but phase shifts. A comparison was given of the behavior of "good" and "bad" amplifiers.

The use of square waves in studying the

damping effect of circuits containing inductance, capacitance, and resistance was shown. Other applications included the analysis of feedback amplifiers, the transient operation of attenuation networks, transmission lines, and leakage at high frequencies.

The use of square-wave testing in the production of radio equipment and the ease of marking out deviation limits on the cathode-ray oscilloscope, concluded the paper.

January 24, 1941, G. I. Martin, chairman, presiding.

At the preliminary session, Marvin Hobbs, engineer of the Scott Radio Laboratories, presented a paper on "Circuit Differences Between Amplitude- and Frequency-Modulation Receivers."

The subject was introduced with a presentation of the noise and program interferences encountered in amplitude-modulated broadcasting. A block diagram of a typical frequency-modulated receiver was then shown and the main purpose of each section described. The circuits, design characteristics, limitations, and constructional details of the various parts of a receiver were covered and included the radio-frequency amplifier, the frequency converter with its associated oscillator, the intermediate-frequency amplifier, the limiter, and the frequency detector. The latter part of the paper was devoted to the audio-frequency system. The wide frequency range employed was pointed out and some discussion of pre-emphasis and methods of obtaining and compensating for it were discussed. Some attention was also given to "side-circuit" types of detectors and automatic volume control suitable for frequency modulation.

At the regular meeting, "New Types and Trends in Transmitting Tubes" were discussed by E. E. Spitzer, transmitter tube engineer for the RCA Manufacturing Company (Harrison). It was pointed out that the trend is toward increasingly higher frequencies and that the tube interelectrode reactances limit the frequency of operation. Although the tube requirements for oscillation and amplification are practically the same at low frequencies, at high frequencies the respective requirements are radically different.

The ratings, operating characteristics, and frequency limitations of various power tubes were then presented graphically. The advantages of beam tubes were made clearly evident.

Air-cooled high-power transmitting tubes were discussed. Their construction to permit cooling by forced air and the air-supply requirements were treated. The type 1628 was stated to have an upper experimental frequency limit of around 500 megacycles.

The inductive-output tube, type 825, was then discussed. The mechanical and electrical design and operating characteristics were presented. Although the output is limited to about 35 watts at the higher frequencies, the tube has been operated at frequencies of 1000 megacycles.

This design permits the control and collector elements to be widely separated

without reducing the transconductance. This gives extremely low feedback capacitance and simplifies the design of wide-band amplifiers for television and frequency-modulation systems.

February 21, 1941, G. I. Martin, chairman, presiding.

"The Electron Microscope" was the subject of a paper by V. K. Zworykin, associate director of the research laboratories of the RCA Manufacturing Company. A summary of the paper is given in the report of the February 5 meeting of the Philadelphia Section in this issue.

This meeting was held jointly with the members of Sigma Xi of Northwestern University.

March 4, 1941.

Cincinnati

The Cincinnati section participated in the sixth annual joint meeting of the Technical and Scientific Council of Cincinnati at which L. A. Codd, lieutenant-colonel, United States Army Ordnance Reserve, presented a paper on "Rearmament Program." It was devoted to a discussion of the military aspects of the rearmament program.

February 19, 1941.

Cleveland

"Some Aspects of the RCA Television System" were discussed by Albert Preisman of RCA Institutes.

The features and principles of a television system which are not required in audio-frequency broadcasting were stressed.

It was pointed out that for a specified band width for transmission, flicker may be reduced by the use of odd-line interlacing. Methods of obtaining this type of scanning were described. Other signals, the production of which were discussed, included shading, blanking, and synchronizing. The production of square wave forms by a process of amplifying and clipping was also described. The use of differentiating and integrating circuits to separate the synchronizing component from the signal was discussed as the concluding part of the paper.

This was the annual meeting of the section and C. E. Smith of the Radio Air Service Corporation was named chairman; H. C. Williams of the Ohio Bell Telephone Company was elected vice chairman; and W. G. Hutton of WGAR becomes the new secretary-treasurer.

December 17, 1940, R. L. Kline, chairman, presiding.

"Color Television" was the subject of a paper by P. C. Goldmark, chief television engineer of the Columbia Broadcasting System. A summary of this paper is given in the report of the November 13, 1940, meeting of the Washington Section which appears in the December, 1940, PROCEEDINGS.

January 21, 1941, C. E. Smith, chairman, presiding.

Connecticut Valley

"The Application of Electron Tubes to the Measurement of Velocity and Time of

Flight of Bullets" was the subject of a paper by R. E. Evans, P. E. Lowe, and C. I. Bradford of the Remington Arms Company.

The device was originally developed to measure the velocity of rifle bullets. Dr. Evans pointed out that the intervals of time which must be measured vary between 2 and 175 milliseconds with an accuracy of within 1 per cent.

The instrument used to record the passage of the projectile is called a disjuncter and several types are in use. These were described in detail.

Mr. Lowe then demonstrated the equipment. It is suitable for measuring other things than bullets in flight and the demonstration included that for timing the operation of fuses and relays. The operation of the disjuncter and its associated electrical wave-forming circuit was demonstrated by passing bullets enclosed in bakelite tubes through the coil. Oscillograms of the pulse and its differentiated form were superimposed to show that the signals supplied to the equipment correspond to the center section of the original pulses.

January 21, 1941, K. A. McLeod, chairman, presiding.

Dallas-Forth Worth

D. L. Bunday, radio engineer for the Civil Aeronautics Authority, presented a paper on the "Radio Control Equipment at the new Washington, D. C., Airport."

All traffic on the airport is controlled from a tower in which the windows are arranged to avoid reflections or glare and still provide a wide-angle view upward.

The 20 receivers are located about a mile from the airport and their outputs are brought to the control tower through a 26-pair telephone cable. In addition, 6 emergency receivers are located in the control tower and may be used in case of a failure of the remote equipment.

Both medium- and high-frequency receivers are equipped with automatic frequency control which is capable of responding to signals varying from the desired frequency by as much as 50 kilocycles. In normal operation, they are adjusted to permit reception of carriers as much as 7.5 kilocycles from the assigned frequency.

A 64-tube superheterodyne receiver is used for reception at 130 megacycles. It has three intermediate frequencies of 30, 7, and 0.47 megacycles. The intermediate-frequency amplifier operating at the lowest frequency has a pass band of 8 kilocycles and a loss of 80 decibels at each edge of the band.

The receivers are tested to insure operation over a temperature range of from -40 to +50 degrees centigrade. They are tested also for operation at 100 per cent humidity and for a given input, under the most severe conditions the output must not vary more than 10 decibels.

To avoid glare in lighting the equipment, Lucite panels and rings are used with the light being transmitted through them.

February 20, 1941, D. A. Peterson, chairman, presiding.

Emporium

C. M. Jansky, Jr., consulting radio engineer, presented a paper on "Some Aspects of Frequency Modulation."

The paper was limited to a discussion of the differences between frequency and amplitude modulation, the effects of these differences, and the potentialities of frequency modulation. The first comparison was between the propagation characteristics of high frequencies and those used for standard broadcasting. The fundamental differences in the methods of modulation were then considered. The improved signal-to-noise ratio that can be obtained with frequency modulation was then covered and its relationship to the quality of reception was pointed out.

The day and night service areas of frequency-modulated transmitters were treated. The number of stations which could operate without interference was then discussed. The rules and regulations which the Federal Communications Commission has set up to govern the operation of these stations were mentioned. The paper was concluded with a description of a low-power frequency-modulated transmitter.

February 6, 1941, R. K. Gessford, chairman, presiding.

Indianapolis

"Present-Day Studio Broadcast Facilities" was the subject of a paper by E. E. Lewis and J. Colvin, chief engineer of WIRE and engineer for the RCA Manufacturing Company (Indianapolis), respectively.

A history of the radio broadcast technique from its inception in 1920 to the present day introduced the subject of the paper. As an example of the requirements of a small station, the WIRE installation was described. Its large studio, piano studio, and an announcement-transcription studio provide minimum facilities for adequately handling all types of broadcasting.

The architectural arrangement of the three studios in relation to the master-control equipment was described. The acoustic treatment of these studios was then discussed.

The requirements for switching to provide for programs from the local studios, from network lines, and from remote pickup points, were covered in detail. Interlocked push-button controls were employed. Announcements may be made to override a program supplied from the network without silencing the network program. Switching between local programs and remote pickups and the provisions for talkback and cuing were discussed.

The paper was presented by Mr. Colvin and at its conclusion Mr. Lewis conducted those present on a tour through the studios.

February 28, 1941, A. N. Curtiss, chairman pro tem, presiding.

Los Angeles

Austin Bailey of the American Telephone and Telegraph Company presented

his paper on "Coastal Harbor Stations of the Bell System." This paper was summarized in the report of the meeting of the Seattle Section on page 40 of the January PROCEEDINGS.

The "New Microphone Steel-Tape Recorder" was described and demonstrated by H. J. Hogan, assisted by J. M. Cunningham, both of C. C. Langezin Company. Most of the paper was devoted to a discussion of the applications of the device. It was pointed out that in voice work, whether it be singing, articulation, or proper emphasis in expression, the instrument could be maintained in a recording position and would retain only the last minute's records. This permits the teaching to be continued until the preliminary nervousness of the student is overcome and then the last recorded material can be reproduced. Its use in permitting those who are partially deaf to adjust their speaking to a proper intensity was discussed.

In the demonstration, a previously recorded musical selection was reproduced to illustrate the frequency range of the recording. This was followed by voice recordings and immediate playback. At the end of the discussion many of those present tested their voices.

February 11, 1941, C. R. Daily, presiding.

Philadelphia

"The Electron Microscope" was the subject of a paper by V. K. Zworykin, associate director of the research laboratories of the RCA Manufacturing Company (Camden).

With the help of diagrams and pictures, Dr. Zworykin showed the analogy existing between the electron microscope and the conventional light compound microscope. In the new device the object is illuminated with a beam of high-velocity electrons instead of light and magnetic fields are used for focusing in place of glass lenses.

With the electron microscope it is possible to resolve details 1/50th of the dimensions of those possible with light because in the new instrument the "illuminating" electrons have a wavelength 1/100,000 that of light, which is the limiting factor in the optical instruments. The great increase in the resolving power permits a useful magnification of 100,000, depending on the object examined.

Pictures were shown of the complete instrument, which includes a novel radio-frequency system for generating high direct accelerating voltages and currents for operating the magnetic lenses. The voltages and currents are stabilized to within 1 part in 50,000. The magnifying power of the microscope is controlled by dials on the power panel.

Lantern slides of some objects so far examined were shown and illustrated clearly the great resolving power of the microscope.

This meeting was held jointly with the Franklin Institute.

February 5, 1941, H. B. Allen, secretary of the Franklin Institute, and C. M. Burrill, chairman of our Philadelphia Section, presided jointly.

Pittsburgh

E. U. Condon, associate director of research for the Westinghouse Electric and Manufacturing Company, presented a paper on "Klystrons."

There was first presented a history of research in the field of higher radio frequencies starting with the 5-centimeter-wave work of Hertz. The many desirable characteristics of microwaves has resulted in intense research activities in this field. These waves make possible additional communication channels, higher directivity of transmission, compact radiating elements, the guiding of the waves through simple structures, and diathermy.

The Klystron makes use of the principle of cavity resonance. These principles were discussed and it was pointed out that the quality of such circuits was excellent since Q values of the order of tens of thousands can be obtained. The operation of the Klystron was described. A tube capable of supplying 500 watts at 40 centimeters was available for examination.

February 12, 1941, R. E. Stark, chairman, presiding.

Portland

Dr. Bailey of the American Telephone and Telegraph Company, presented his paper on "Coastal Harbor Stations of the Bell System" which is described in the report of the Seattle Section on page 40 of the January PROCEEDINGS.

This was the annual meeting and E. R. Meissner of the United Radio Supply, Inc., was voted chairman; Earl Schoenfeld, United States Forest Service Radio Laboratory, was elected vice chairman; and L. M. Belleville, United States Forest Service Radio Laboratory, was named secretary-treasurer.

January 30, 1941, Marcus O'Day, chairman, presiding.

F. E. Terman, president of the Institute and head of the department of electrical engineering at Stanford University, presented a discussion of "Some Considerations in the Design of Resistance-Coupled and Feedback Amplifiers." It was based on material from the paper "Calculation and Design of Resistance-Coupled Amplifiers Using Pentode Tubes" by F. E. Terman, W. R. Hewlett, C. W. Palmer, and W. Y. Pan recently published by the American Institute of Electrical Engineers.

Dr. Terman also discussed some material from a paper by H. W. Bode entitled "Relations Between Attenuation and Phase in Feedback Amplifier Design" which was published in the July, 1940, issue of the *Bell System Technical Journal*.

February 12, 1941, E. R. Meissner, chairman, presiding.

Rochester

R. H. Manson, vice president and general manager of the Stromberg-Carlson Telephone Manufacturing Company, presented a discussion of "The Most Recent Developments in Radio," at a joint meeting with The Rochester Engineering Society.

December 10, 1940, E. C. Karker, presiding.

"General Electric House of Magic" was presented by W. A. Gleusing of the General Electric Company at a meeting held jointly with the Rochester Engineering Society.

December 18, 1940, L. A. Waasdorp, president, Rochester Engineering Society, presiding.

San Francisco

The paper on "Coastal Harbor Stations of the Bell System" was presented by Austin Bailey of the American Telephone and Telegraph Company.

In addition, motion pictures of the manufacture and installation of coaxial cable were shown.

February 7, 1941, L. J. Black, chairman, presiding.

Toronto

"The Havana Agreement and Its Effect on Canadian Broadcasting" was the subject of a paper by J. W. Bain, chief of standards and the international section of the radio division of the Department of Transport, Canada.

The North American Regional Broadcasting Agreement of Havana, 1937, is commonly referred to as the "Havana Agreement" and was signed by representatives of Canada, Cuba, Dominican Republic, Haiti, Mexico, and the United States of America.

In 1924, an arrangement was made whereby Canada would use 7 exclusive channels and 11 which would be shared with the United States. As a result of a basic defect in the existing licensing system in the United States, one of the Canadian exclusive channels was appropriated by a United States broadcaster. After the United States Congress had passed legislation to control radio transmission in 1927, a conference was held in Washington and a few years later another in Mexico City. These were ineffective. The 1937 Havana Conference brought about an agreement for the distribution of channels among the signatory nations. The final ratification was by Mexico on March 29, 1940, and the Treaty will go into effect one year later.

The agreement defines objectionable interference and provides for four principal classes of stations, each class of which is guaranteed protection from interference to a specified extent. With 1234 stations operating on 106 channels, it is impossible to eliminate entirely all interference in the North American region. Under the previous arrangement, Canada had 6 "clear" channels and 15 shared channels. The new treaty gives her 15 clear, 41 regional, and 6 local channels.

February 17, 1941, G. J. Irwin, past chairman, presiding.

Washington

D. E. Noble, director of research of the Motorola Company and former radio consultant for the Connecticut State Police,

presented a paper on the "Application of Frequency Modulation to Communication Service."

A comparison of frequency and amplitude modulation was first presented. A description of the Connecticut installation and of various experiences which were had with it were then presented. A recent survey made of Louisiana with the thought of installing similar facilities was discussed.

February 10, 1941, M. H. Biser, chairman, presiding.

Membership

The following indicated admissions and transfers of memberships have been approved by the Admissions Committee. Objections to any of these should reach the Institute office by not later than April 30, 1941.

Transfer to Member

- Beshgetoor, R. V., c/o RCA-Victor Argentina, Bartolome Mitre 1961, Buenos Aires, Argentina.
 Bourland, L. T., 1916-15th St., S.E., Washington, D. C.
 Larsen, P. J., 44 Beverly Rd., Summit, N. J.
 Morgan, H. K., 6447 Sagamore, Kansas City, Mo.
 Rowe, T. L., 2240 Estes Ave., Chicago, Ill.
 Simpson, L. C., c/o RCA-Victor Argentina, Bartolome Mitre 1961, Buenos Aires, Argentina.

Admission to Member

- Klenk, L. M., P.O. Box 83, Little Silver, N. J.
 Nelson, A. L., 815 W. Lexington, Fort Wayne, Ind.
 Pray, G. E., 1701-29th St., S.E., Washington, D. C.
 Stokes, E. D. C., 24 Butternut Ter., Rockcliffe, Ottawa, Ont., Canada.

Admission to Associate (A), Junior (J), and Student (S)

- Allison, S. H., (A) 687 S. Geranium Ave., St. Paul, Minn.
 Allison, W. M., (A) 294 State Rd., North Adams, Mass.
 Anderson, I. H., (A) 1709-3rd Ave., S., Anoka, Minn.
 Aro, L. J., (A) 721 Bradford Ave., N., Minneapolis, Minn.
 Babcock, W. L., (A) 1816 Arona Ave., St. Paul, Minn.
 Bach, H. M., (A) c/o Premier Crystal Labs., Inc., 53 Park Row, New York, N. Y.
 Barker, F. L., (A) 322 S. Jefferson, Springfield, Mo.
 Beach, H. W., (A) 468 S. College Ave., Valparaiso, Ind.
 Beck, B. G., (A) Radio Station WBOC, Salisbury, Md.
 Cassidy, B. F. R., (A) 63 Norwood Ave., Long Branch, N. J.
 Cole, B. R., (S) 119 Prairie Ave., Park Ridge, Ill.
 Crowl, J. M., (A) 2236 Hickam Dr., Kansas City, Kan.

- Dawley, R. L., (A) 1108 Santa Barbara St., Santa Barbara, Calif.
 Eglin, J. M., (A) Bell Telephone Labs., Inc., 463 West St., New York, N. Y.
 Esler, E. H., (A) 3675 Madison, Kansas City, Mo.
 Evans, C. W., (A) c/o KHQ Transmitter, 4102 S. Regal, Spokane, Wash.
 Finch, T. L., Jr., (A) 407 S. Superior St., Angola, Ind.
 Gillespie, E. R., (A) 1615 Admiral Blvd., Kansas City, Mo.
 Gspann, C. J., (J) 238 E. Blancke St., Linden, N. J.
 Hausler, W. B., (S) 121 Modisette Ave., Donora, Pa.
 Henderson, A. B., (A) 1541 Morris Pl., Hillside, N. J.
 Hill, J. L., (A) 1138 Fauquier Ave., St. Paul, Minn.
 Holmboe, L. W., (S) 2508 E. 73rd Pl., Chicago, Ill.
 Janiszewski, F. A., (S) c/o Bell Telephone Labs., Inc., 180 Varick St., New York, N. Y.
 Jarrard, J., (A) 2922 Victor, Kansas City, Mo.
 Jensen, W., (A) 655 Como Blvd., St. Paul, Minn.
 Kile, R. L., (A) U.S.S. *Avocet*, San Diego, Calif.
 Krakora, J., Jr., (A) 5465 Iowa St., Chicago, Ill.
 Laitinen, W. R., (A) 46 Highland Ave., N., Minneapolis, Minn.
 Larson, H. G., (A) 415 Rice St., Anoka, Minn.
 Lester, B. R., (S) Box 196, Rutgers University, New Brunswick, N. J.
 Levy, M. L., (S) 5635 Hempstead Rd., Pittsburgh, Pa.
 Lower, R., (A) New Carlisle, Ohio.
 Marshall, J. W., (S) 386 S. Hill Ave., Pasadena, Calif.
 Mendenhall, F. S., (A) Route 3, Grand Junction, Colo.
 Merrill, R. L., (A) Fort Monmouth, Red Bank, N. J.
 Miller, E., (A) Visual Education Service, University of Minnesota, Minneapolis, Minn.
 Moran, R. R., (J) "Scaffell," Hartley Park, Pontefract, Yorks, England.
 Munn, A. J., (A) 151 Jay Ave., Lyndhurst, N. J.
 Nelson, N. A., (A) 206 E. Redwood Ave., Dayton, Ohio.
 Nelson, T. L., (A) 1956 S. Figueroa St., Los Angeles, Calif.
 Person, R. P., (A) 116 Gray St., Anoka, Minn.
 Phil, G. E., (A) 609 S. St., Roslindale, Mass.
 Randall, E. L., (A) 82 Edgecliffe Rd., Watertown, Mass.
 Russell, H. E., (A) 822 Indiana, Kansas City, Mo.
 Sarasohn, H. M., (A) 3214 The Paseo, Kansas City, Mo.
 Sayer, W. H., (A) Allen B. DuMont Labs., Inc., Passaic, N. J.
 Schock, J. O., (S) Mendenhall Lab., Ohio State University, Columbus, Ohio.
 Schwerin, E. B., (A) 1217 W. 47th St., Kansas City, Mo.

- Steber, W. C., Jr., (A) Bell Telephone Company of Pennsylvania, 416-7th Ave., Pittsburgh, Pa.
- Sultany, S. J., (A) 3354 Washburn, N., Minneapolis, Minn.
- Thompson, G. L., (S) Box 27 Buxton Hall, Corvallis, Ore.
- Thompson, P., (A) 1112-17th Ave., S.E., Minneapolis, Minn.
- Walz, M. E., (A) Pierce Hotel, Anoka, Minn.
- Watterberg, J., (A) Route 2, Excelsior, Minn.
- Weissbluth, M., (A) 6100-14th St., N.W., Washington, D.C.
- Wright, D. I., (J) 257 Nassau St., Princeton, N. J.
- Wyman, A. W., (A) 150 W. Main St., Westboro, Mass.
- Zeidler, H. M., (S) 1721 Laramie, Manhattan, Kan.

Books

The Meter at Work, by John F. Rider

Published by John F. Rider Publisher, Inc., 404 Fourth Ave., New York, N. Y. 152 pages, 138 figures. Price, \$1.25.

This volume is highly recommended as a readable practical textbook and ready reference on the properties and uses of the meters most commonly used in radio. The classes covered are moving-ion, moving-

coil, electro-dynamometer, electrostatic, and thermal. The treatment is mainly descriptive, with sufficient theoretical background but no mathematics. Simple experiments are given to illustrate the theory and the methods of calibration. The text concludes with an excellent digest of practical applications, including devices such as shunts, multipliers, and the ohmmeter.

The book has an unusual feature in its page construction. The pages are cut horizontally in upper and lower sections, the upper sections carrying the figures and the lower sections the text. Any desired figure can be held in view while reading any part of the text.

HAROLD A. WHEELER
Hazeltime Service Corporation
Little Neck, L. I. N. Y.

Television Receiving Equipment, by W. T. Cocking

Published by the Nordeman Publishing Company, Inc., 215 Fourth Ave., New York, N. Y. 298 pages. 181 figures. Price, \$2.25.

As the title indicates, this book deals with principles and practice involved in television receivers. The treatment is essentially from the design rather than from the purely theoretical standpoint, and treats British practice primarily.

The earlier chapters discuss the general principles of television and the television signal in a clear, nonmathematical

manner. The various parts of the receiver with their functions and requirements are next considered. There are chapters also on complete receivers, antennas, faults, and servicing.

Since the author has dealt with receivers for British signals, which have opposite polarity to those which have been used in the United States, and have been transmitted on one frequency only, those portions of the text not influenced by specific signal characteristics are likely to be of most interest to American readers. These are the chapters on cathode-ray-tube voltage supplies, deflection, and saw-tooth oscillators.

The book will have greatest interest to engineers concerned with receiver design and development, because of its discussions of the advantages and disadvantages of a large number of circuits which are illustrated in the text. The design principles and expressions for oscillation and output transformers are given also.

The approach throughout is eminently practical and bears evidence that the author speaks from experience in the discussions of specific circuits and difficulties likely to be encountered. The book should prove of value to any engineer concerned with television receiver development or design.

There are twenty chapters, many circuit illustrations, and an adequate index.

DUDLEY E. FOSTER
RCA License Laboratory
New York, N. Y.

Contributors

Andrew Alford (A'35-M'40) was born on August 5, 1904, at Samara, Russia. In 1924 he was graduate from the University of California, and from 1925 to 1927 he was a university Fellow and graduate student there. During 1927-1928, Mr. Alford was a teaching Fellow in physics at the California Institute of Technology. He was a research engineer with the Fox Film Corporation, West Coast division, from 1929 to



ANDREW ALFORD



W. ROBERT FERRIS

1931; a geophysical prospecting and consulting engineer from 1931 to 1934; and an engineer with the Mackay Radio and Telegraph Company from 1934 to date.

W. Robert Ferris (A'29-M'31) was born at Terre Haute, Indiana, on May 14, 1904. He received the B.S. degree from Rose Polytechnic Institute in 1927 and the M.S. degree from Union College in 1932.

Mr. Ferris was in the research laboratory of the General Electric Company from 1927 to 1930; since that date he has been a member of the research laboratories, RCA Radiotron Division, of the RCA Manufacturing Company, Inc.

Edward Leonard Ginzton (S'39-A'40) was born on December 27, 1915, in Russia.



EDWARD L. GINZTON

He received the B.S. degree in 1936 and the M.S. degree in 1937 from the University of California; the E.E. degree in 1938 and the Ph.D. degree in 1940 from Stanford University. From 1937 to 1939 Dr. Ginzton was an assistant in teaching and research at Stanford University and during 1939-1940, a research assistant in physics there. In 1940 he joined the Sperry Gyroscope Company Inc., as an assistant project engineer. He is a member of Sigma Xi and an Associate member of the American Institute of Electrical Engineers.



Lowell M. Hollingsworth (A'37) was born at Portland, Oregon, on January 8, 1907. He received the B.S. degree in electrical engineering from Oregon State Col-



LOWELL M. HOLLINGSWORTH

lege in 1930; and the E.E. degree in 1935 and the Ph.D. degree in 1940 from Stanford University. From 1930 to 1932, Dr. Hollingsworth was with the Bell Telephone Laboratories, Inc. Since 1936 he has been an instructor in engineering at the San Francisco Junior College.



Hans Erich Hollmann (A'39) was born on November 4, 1899, at Solingen, Germany. From 1918 to 1920 he served in the army. Dr. Hollmann began the study of electrotechnics at the Technische Hochschule of Darmstadt in 1920 and received



HANS ERICH HOLLMANN

the degree of doctor in 1928. From 1924 to 1926 he was a laboratory engineer at the Darmstadt Radio Works. He continued his investigations on microwaves at the Physikalischen Institut of the Technische Hochschule of Darmstadt as a scholar for the Notgemeinschaft der Deutschen Wissenschaft, transferring in 1930 to the Institut für Schwingungsforschung in Berlin. In 1932 Dr. Hollmann became assistant in the high-frequency department; from Easter of 1932 to 1934 he was a scientific assistant at Telefunken Gesellschaft. During 1934-1936 he worked on ultra-short waves. Since then he has been occupied



VERNON D. LANDON

with microwaves and electrocardiography in the private laboratory of Inhaber and Leiter.



Vernon D. Landon (A'27-M'29) was born on May 2, 1901. He attended Detroit Junior College. From 1922 to 1929 he was in charge of the radio-frequency laboratory of the Westinghouse Electric and Manufacturing Company. In 1931 he was assistant chief engineer of the Radio Frequency Laboratories, and from 1931 to 1932 he was assistant chief engineer of the Grigsby Grunow Company. Since 1932 he has served as an engineer in the advance development section of the RCA Manufacturing Company, Inc., Victor Division.



DWIGHT O. NORTH

Dwight O. North (A'35-M'38) was born at Hartford, Connecticut, on September 28, 1909. He received the B.S. degree from Wesleyan University in 1930 and the Ph.D. degree from the California Institute of Technology in 1933. From 1930 to 1933 Dr. North was a teaching Fellow at the California Institute of Technology. From 1933 to 1934 he was a research assistant at Wesleyan University. Since 1934 he has been a member of the research laboratories, RCA Radiotron Division, RCA Manufacturing Company, Inc., Dr. North is a member of the American Physical Society.

You are cordially invited to THE CONDENSER THIRD DEGREE

● Yes, if by chance you are up New Bedford way, by all means drop in and see for yourself how Aerovox grills its own and competing condensers in its Life Test Department, so as to judge the performance and life expectancies for any given type or production run. We believe our life-test equipment and facilities to be second to none in the industry, for the thorough testing and checking of all types under all manner of operating conditions. Thousands of units are sacrificed each month in ascertaining what they can be expected to do in actual usage. For example:

1. Here's a general view of the Aerovox life-test department. Tests are made in their respective "cages" or compartments protected by heavy iron grilles, doors and safety switches. Red lights indicate "live" rooms.

2. To provide both working voltages for life tests and peak voltages for breakdown tests, many power packs such as these are found in the Life Test Department, with bus-bar connections to the condenser test racks.

3. Here are just a few of the many motor-generators supplying various voltages for the life tests.

4. Hundreds of run-of-production condensers are connected to these supporting hooks and subjected to a choice of operating voltages. These life-test racks provide all voltages—200 volts up—for testing the condensers at room temperature and room humidity.

5. Humidity tests are made to determine how condensers will fare with regard to

humidity and climatic conditions. Here is a view inside the humidity chamber.

6. From this control board, operating conditions can be ascertained for any condensers under test in the heat rooms. Elevated temperatures up to 220° F. and higher are applied and, obviously, the readings must be taken outside. Plug-in jacks establish connections with any condenser test position. A recording thermometer indicates temperature in the heat rooms.

7. Oil dielectrics and other impregnating materials are tested for voltage breakdown (dielectric strength) in a standard A.S.T.M. cup. This cup is connected across the terminals of a transformer which can deliver up to 40,000 volts rms.

8. Mica transmitting capacitors are subjected to tests at rated frequencies by means of several frequency-testing positions. Here are several Type 1550 mica transmitting units undergoing a radio-frequency current-carrying-capacity heat run. Every transmitting capacitor must pass this test before shipment.

In addition to life tests, Aerovox production test routine insures the *individual* testing of every condenser that leaves the plant. And that, together with the life-test checkups, means much to you.



AEROVOX CORPORATION

New Bedford, Mass.

Sales Offices in All Principal Cities



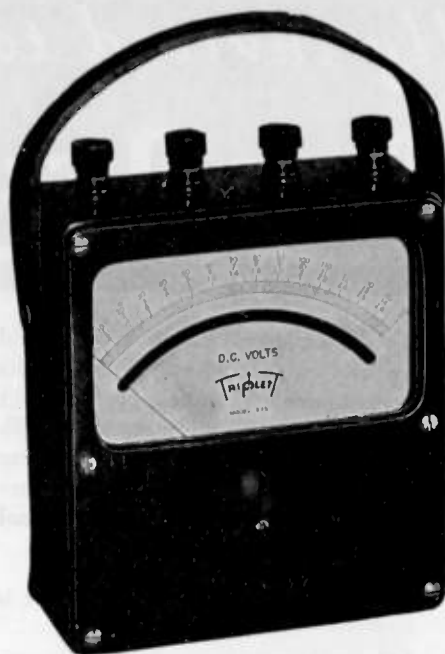

NEW PRECISION PORTABLES



MODEL 625
Clear Readability

Models 625 (DC—Moving Coil Type)—635 (AC—Movable Iron Vane Type) and 665 (Electrodynamometer Type) . . . new molded case portables, may be obtained with extreme sensitivity for laboratory use—as well as those for general commercial and industrial testing purposes. Have mirror scale and knife-edge pointer to assure quick, accurate readings. Scale length is 4.58"—Accuracy within 1%. Attractive black molded case, 6" x 5½" x 2½". Attached leather strap handle.

MODEL 725

Model 725—Another popular line of portables includes Models 725 (DC)—735 (AC). This popular style has a precision instrument with long 6" mirror scale. Oak case is 11" x 9" x 4".



MODEL 626

Model 626—Another of the new panel instrument case styles being added constantly to the Triplet line. This 6" rectangular molded case instrument offers unusually long readable scales—5.60" DC; 5.30" AC—One of Triplet's 25 case styles.

Write for Catalog—Section 212 Harmon Dr.

TRIPLET ELECTRICAL INSTRUMENT CO.
Bluffton, Ohio

Current Literature

New books of interest to engineers in radio and allied fields—from the publishers' announcements.

A copy of each book marked with an asterisk (*) has been submitted to the Editors for possible review in a future issue of the Proceedings of the I.R.E.

* **ADVANCED ELECTRICAL MEASUREMENTS** (Second Edition). BY WALTER C. MICHELS, Associate Professor of Physics, Bryn Mawr College. New York: D. Van Nostrand Company, 1941. x+335+11 index pages, illustrated, 5½×8½ inches, cloth. \$3.50.

* **ELEKTRISCHE KIPPSCHWINGUNGEN: Wesen und Technik** (Electrical Relaxation Oscillations: Their Character and Techniques). BY HEINZ RICHTER. Leipzig: Verlag Von S. Hirzel, 1940. 149+5 index pages, illustrated, 6×9 inches, paper. 11.50 rm.

* **VACUUM TUBE VOLTMETERS.** BY JOHN F. RIDER, New York: John F. Rider, Inc., 1941. xi+176+3 index pages, illustrated, 5½×8 inches, cloth. \$1.50.

* **YOUR CAREER IN RADIO.** BY NORMAN V. CARLISLE, Associate Editor of Radio Showmanship and CONRAD RICE, Newscaster for WEMP. New York: E. P. Dutton & Company, Inc., February, 1941. 189 pages, illustrated, 5½×8 inches, cloth. \$2.00.

* **NEMA STEATITE ELECTRIC INSULATION STANDARDS.** New York: National Electrical Manufacturers Association, January, 1941. 11 pages, 8×10½ inches, paper. 10 cents.

POSITIONS OPEN

The following positions of interest to I.R.E. members have been reported as open on March 20. Make your application in writing and address to the company mentioned or to

Box No.

PROCEEDINGS of the I.R.E.
330 West 42nd Street, New York, N.Y.

Please be sure that the envelope carries your name and address

SALES MANAGER

Opening for an aggressive sales manager with a progressive and expanding manufacturer of industrial and electronic equipment. Salary basis. Box 239.

ENGINEERING ASSISTANT

There is an opening in an eastern manufacturer's laboratory for an engineering assistant with some college engineering education and with some familiarity with high-power test-instrument construction for radio transmitters up to 1 kilowatt. Ability to pursue development of electronic control circuits desirable. Present staff knows of this opening. Box 238.

(Continued on page iv)



MEMBERSHIP EMBLEMS

The I.R.E. emblem is available to members in 3 useful forms: the lapel button, the pin, and the watch charm. Each is of 14-karat gold, enameled in color to designate the grade of membership.

| Grade | Background Color |
|-----------|------------------|
| Fellow | Gold |
| Member | Blue |
| Associate | Maroon |
| Junior | White |
| Student | Green |

LAPEL BUTTON—\$2.75



Supplied with a screw back having jaws which grip the cloth of the coat.

PIN—\$3.00



Provided with a safety catch.

WATCH CHARM—\$5.00



Enameled on both sides and equipped with a suspension ring for attaching to a watch charm or fob.

Prices are the same for all grades of membership and include postage and insurance or registered-mail fee.

INSTITUTE OF RADIO ENGINEERS, INC.

330 West 42nd Street
New York, N.Y.

The COLONEL'S LADY and JUDY O'GRADY Are NOT Sisters Under Their Skins!



1. A glass tube, continuously drawn with utmost precision to the size of a small pencil lead, is the beginning of an IRC Type BT Insulated Resistor.



2. The tube with a coating of Metallized type resistance material permanently bonded to its outer surface, and stabilized by a baking process.



3. Special leads for easy soldering have enclosed, positive contact to element which cannot open. Insertion of leads *inside* the element tube aids rapid heat dissipation, drawing heat out of the resistor.



A finished 1-watt unit. Element is completely sealed by molded insulating phenolic. Moisture cannot enter. No possibility of grounding. Leads anchored *inside* insulation cannot turn or pull loose.

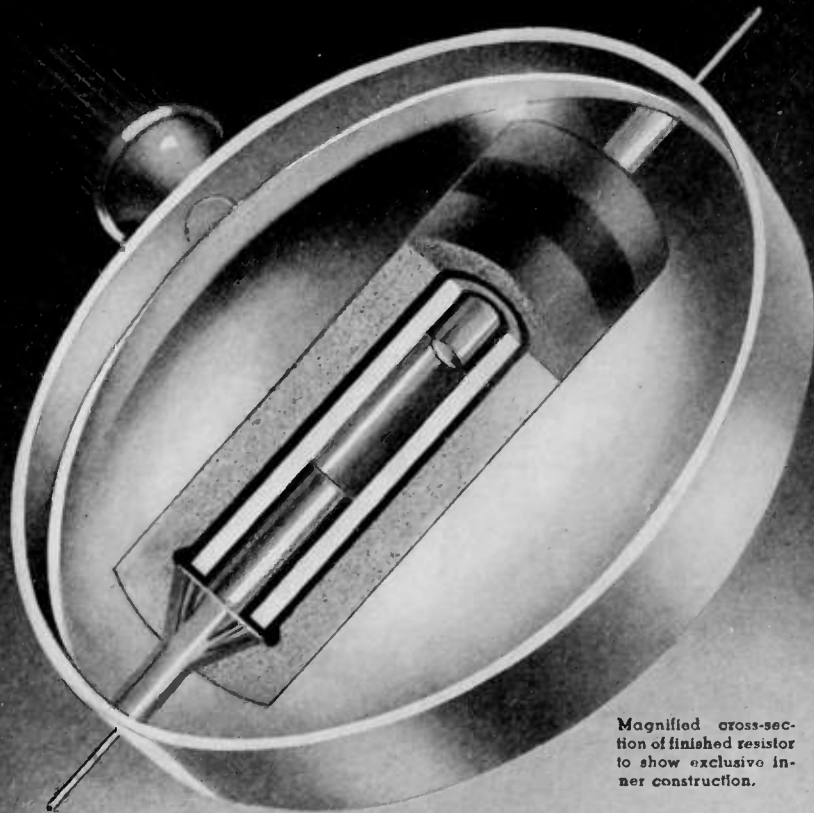

Magnified cross-section of finished resistor to show exclusive inner construction.

Flattering and widespread imitation following IRC's development of the Insulated Resistor with its obvious advantages as compared with old-style, non-insulated units has resulted in such uniformity of appearance that it is difficult to distinguish one make from another. *This similarity, however, is only skin deep—only as deep as the insulation.*

What lies beneath is of the utmost importance from the standpoint of performance. The outside insulation is important only because it protects the inside resistance element, prevents shorting and facilitates rapid and economical assembly. Not this protection *but what it protects* is the final determining factor of quality—and it is *underneath* this insulation that insulated resistor similarity ends.

As an outstanding example, the IRC type BT insulated resistors, comprising the unique "Metallized" filament element and specially developed insulating phenolic covering, have humidity characteristics hitherto unobtainable. More than 10 cycles of alternate two hour immersions in 100°C. and 0°C. salt solution followed by two hour loadings at normal rating result in an average change in resistance value of less than 10%.

In connection with the present defense program such performance is essential for dependable communication equipment but it is also obviously very important for all commercial applications.

TYPE BT INSULATED RESISTORS

INTERNATIONAL RESISTANCE CO., 401 N. BROAD ST., PHILA.

POPULAR DAVEN SERIES 750 DECADE RESISTANCE BOX

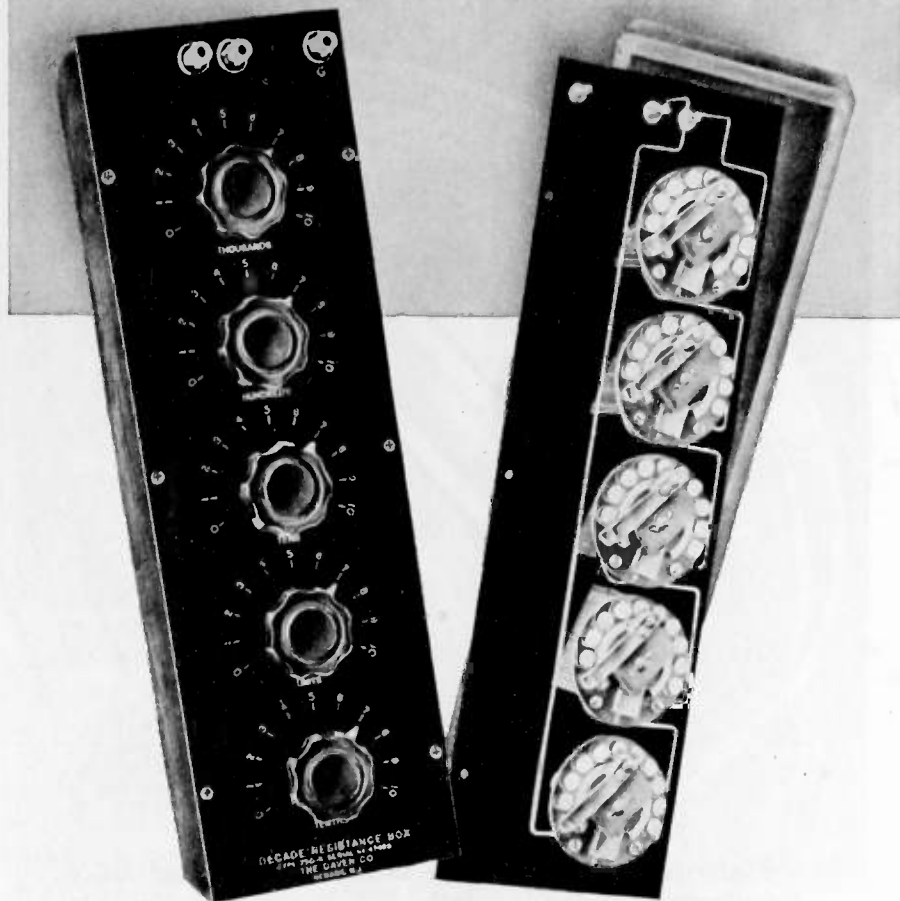

Designed for use as Laboratory Standards, as components in Bridge Circuits, and in other types of precision measuring equipment . . . the Decade Resistance Boxes are complete assemblies consisting of two or more Type 225 DAVEN Decade Units mounted on an engraved metal panel and enclosed in a shielded walnut cabinet.

Three terminals are provided, two for the resistance circuit, and a third as a ground connection. There is no electrical circuit between the resistance elements and the metal panel. Available in 12 models with resistances from 11 to 1,111,100 ohms, in from 0.10 to 10. ohm steps.

DECADE RESISTOR UNITS

Type 225—For Precision Laboratory Standards

These Decade Resistor Units are precision type resistors and can be used individually in equipment . . . when complete Decade Boxes (Series 750) are not required. Each unit is completely enclosed in an aluminum shield and supplied with pointer-type knob and aluminized dial plate. Seven standard models covering the range from 0.10 to 10,000 ohms per step or a total of 1.0 to 1,000,000 ohms in accuracies of from 1.0 to 0.10%.

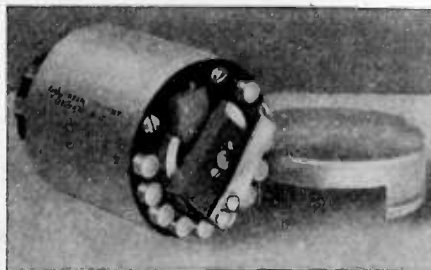

THE DAVEN COMPANY
158 SUMMIT STREET • NEWARK, NEW JERSEY

POSITIONS OPEN

(Continued from page ii)

JUNIOR ENGINEERS

The United States Civil Service Commission is announcing a new examination for junior engineers in any branch of engineering. The salary is \$2000 per year and college education is required, although under some conditions, applications will be received from senior students. Applications may be filed until December 31, 1941, but positions are open now and applications will be rated as received. For further information and application forms, consult the Secretary of the Board of U. S. Civil Service Examiners at any first- or second-class post office.

ENGINEERING DRAFTSMEN

Engineering draftsmen in several branches, including radio, are being recruited by the United States Civil Service Commission. Salaries range from \$1620 to \$2600 per year. For further information and application forms, consult the Secretary of the Board of U. S. Civil Service Examiners at any first- or second-class post office.

RECEIVER DESIGN ENGINEERS

A large midwestern radio receiver manufacturer has openings for experienced automotive and household radio-receiver-design engineers. Applicants should state education, experience, and give references. Our own employees know of these openings. Box 233.

ELECTRICAL ENGINEERS

For transmitter or receiver designing on radio or special apparatus. Opening for U.S. Citizens only. Offering excellent opportunities to men with experience in the design of radio or special electrical apparatus. In reply state experience, education, age, present salary, etc. Box 228.

MECHANICAL DESIGNERS

Needed by radio manufacturer. Splendid opportunities for men with radio or equivalent experience such as required for designing the mechanical features of speakers, receivers, transmitters or special apparatus. Steady work, large manufacturer located in Eastern part of United States. Write for interview, giving full qualifications. Box 229.

PHYSICISTS

The Civil Service Commission has modified the requirements for the positions of physicist (various grades) and extended the application deadline to December 31, 1941. These positions pay from \$2,600 to \$5,600 per year. For further information, consult the Secretary of the Board of Civil Service Examiners at any first- or second-class post office.



Attention Employers . . .

Announcements for "Positions Open" are accepted without charge from employers offering salaried employment of engineering grade to I.R.E. members. Please supply complete information and indicate which details should be treated as confidential. Address: "POSITIONS OPEN," Institute of Radio Engineers, 330 West 42nd Street, New York, N.Y.

The Institute reserves the right to refuse any announcement without giving a reason for the refusal.



Your Voice Is You...

Do you realize the value of a smile when telephoning? It helps a lot. Of course, the other person can't see you but the smile is there just the same. It's in your voice. And it reflects a friendly, cordial personality.

In times like these, "The Voice with a Smile" is especially important and worth while. It is a characteristic of the American people. And one of the fine traditions of the Bell telephone business.



BELL
TELEPHONE
SYSTEM

"...NO STRONGER THAN ITS WEAKEST LINK!"

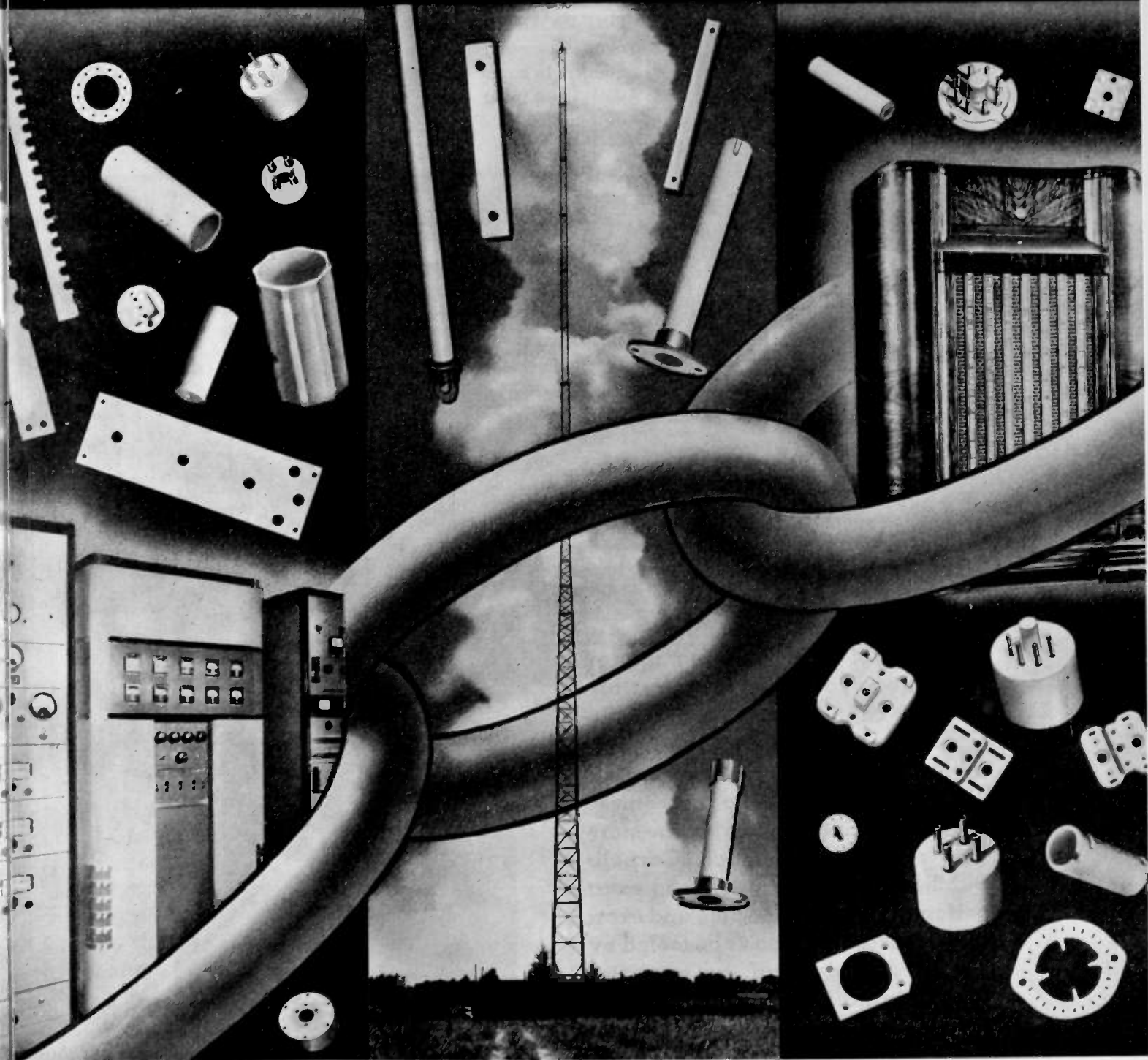

AISiMag steatite ceramic insulation combines these outstanding properties: high dielectric strength with low dielectric loss, high mechanical strength with excellent resistance to atmos-

pheric conditions. ● If you use AISiMag from microphone to loudspeaker, you can be sure that insulation is NOT the weak link in the chain of materials used in your radio equipment.

AISI MAG

Trade Mark Reg. U.S. Pat. Off.

FROM CERAMIC HEADQUARTERS

AMERICAN LAVA CORPORATION • CHATTANOOGA • TENNESSEE
CHICAGO • CLEVELAND • NEW YORK • ST. LOUIS • LOS ANGELES • SAN FRANCISCO • BOSTON • PHILADELPHIA • WASHINGTON, D. C.



ONE VIOLIN looks like another. It takes a skilled musician to recognize the Stradivarius. He sees the *hidden* quality. In capacitors, too, *quality* lies hidden. The thing that gives you extra service is found in capacitor ingredients.

EXTRA SERVICE!

That's the reason..

THERE ARE MORE CORNELL-DUBILIER CAPACITORS IN USE THAN ANY OTHER MAKE

YOU get more for your money when you specify Cornell-Dubilier capacitors. An extra measure of value that's hidden in C-D ingredients. Thirty years of experience put it there. And the longer these capacitors remain in service, the more you realize how much Cornell-Dubilier experience means—in extra performance, extra long life and extra savings. Next time, don't be fooled by "looks" . . . demand the capacitor that's different where difference counts—and get the extra service built into modern C-D's.

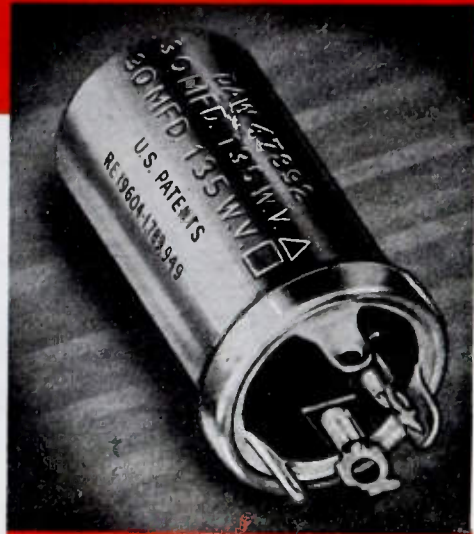

Only Cornell-Dubilier Electrolytics offer all these **EXTRA** FEATURES!

- Special high voltage paper separator
- C-D etched plate
- Special C-D electrolyte
- Special high formation process



For complete technical information, write for engineering bulletin.

**CORNELL-DUBILIER
ELECTRIC CORPORATION**

1006 HAMILTON BLVD. • SO. PLAINFIELD, N. J.

REMEMBER! Only C-D union-made capacitors give you the EXTRAS at no extra cost.

Get the extras

— WITH CORNELL-DUBILIER CAPACITORS!

Admiral
DEWALD

Andrea

AUTOMATIC

Detrola
Gilfillan

Emerson

FADA

Farnsworth

**...RCA
PREFERRED TYPE TUBES
PROGRAM ROLLS ON**

GAROD

Sentinel

Hallicrafters
Radiola
Sonora



PACKARD-BELL

RCA Victor

Stromberg-Carlson

Pilot

WURLITZER

IN 1940, for the first time in history, over 5,000,000 new radio receivers used *Preferred Type Tubes* . . . 27 million Preferred Type Tubes. These 5,000,000 radio receivers represented nearly half the Industry's total output in 1940.

What are the *results* of this tremendous trend toward standardization? Inventories are simplified: for distributors, dealers and servicemen, as well as for the manufacturers who have endorsed and adapted this Program. Deliveries have been speeded up...for the tube manufacturer can ship from *stock*.

Mass-production concentrated on more tubes of fewer types means tubes of better and more uniform quality at the lowest possible cost.

The more widespread the adoption of this Program, the more the Industry gains. The RCA Preferred Type Tubes Program is not only the best suggestion ever advanced to solve the problem of "too many tube types"... it is a really constructive step! It deserves the support of the entire industry...for it *benefits* the entire industry.



Feature the radio receivers that are equipped with Preferred Type Tubes!



Preferred Type Tubes

With This NEW R-F Measuring Circuit

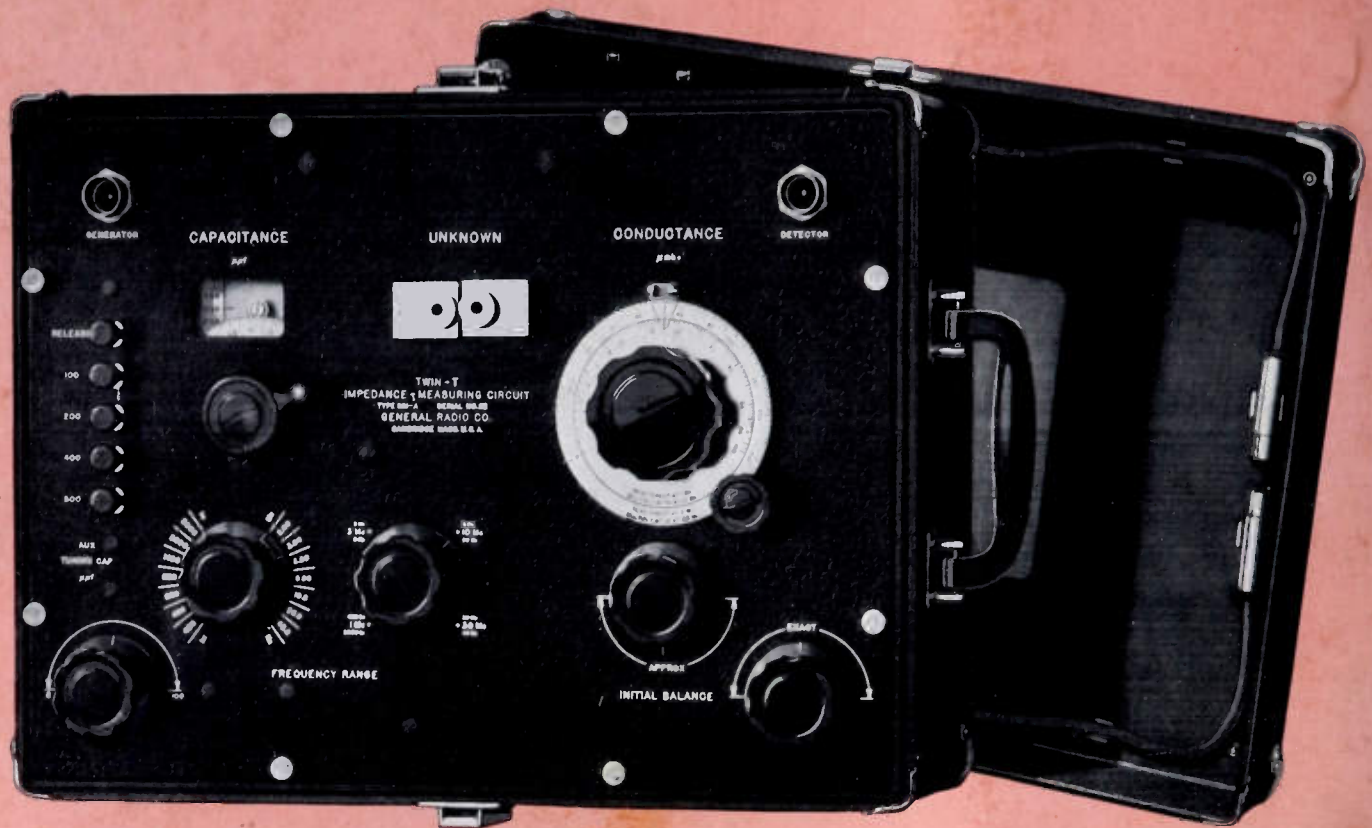

Up to 30 Mc You Can Measure

- CAPACITANCE OF CONDENSERS
- POWER FACTOR OF CONDENSERS
- INDUCTANCE OF COILS
- Q OF COILS
- RESONANT IMPEDANCE OF PARALLEL CIRCUITS
- SERIES TUNED CIRCUITS
- HIGH AND LOW RESISTANCES
- GROUNDED ANTENNAS
- COAXIAL TRANSMISSION LINES
- TERMINATED AND UNTERMINATED LINES
- MATCHING SECTIONS

THIS NEW G-R circuit is a null instrument for measuring impedances at high frequencies. While null methods give the most accurate comparisons, until now it has been impossible to use them for measurements at the higher radio frequencies since the accuracy of these measurements depends, among other things, upon the accuracy with which the impedance standards can be constructed and calibrated. The inadequacy of existing standards at the higher frequencies has restricted the use of bridge circuits to audio and the lower radio frequencies.

The new instrument is a parallel-T circuit which is used for a parallel-substitution measurement of the unknown admittance. Measurements can be made with satisfactory accuracy up to at least

30 Mc. The parallel-T circuit provides several features which make it particularly useful for r-f measurements: (1) a ground common to many points of the circuit eliminates the need for the shielded transformer required in bridge circuits and renders harmless many residual circuit capacitances; (2) the conductive component is measured in terms of a fixed resistor and a variable condenser which provide the equivalent of a continuously variable resistance standard. This combination is much freer from residual parameters than any variable resistor available.

Measurements with the new circuit are simple. The frequency range is 420 kc to 30 Mc and the capacitance range 110 to 1100 $\mu\mu\text{f}$, direct reading. The instrument has direct-reading conduc-

tance ranges at four frequencies: 0 to 100 μmho at 1 Mc; 0 to 300 μmho at 3 Mc; 0 to 1000 μmho at 10 Mc and 0 to 3000 μmho at 30 Mc. For other frequencies the range of the conductance dial varies as the square of the frequency.

Accessories required for operation comprise a suitable r-f generator (such as the G-R Type 684-A Modulated Oscillator with addition of a coaxial output jack, or the Type 605-B Standard-Signal Generator) and a well shielded radio receiver covering the desired frequency range.

Users of this new G-R instrument are enthusiastic over its performance, its ease of operation, its accuracy and its extended frequency range.

TYPE 821-A TWIN-T IMPEDANCE MEASURING CIRCUIT \$340.00

Write for Bulletin 682 for Complete Data

GENERAL RADIO COMPANY
CAMBRIDGE, MASSACHUSETTS
Branches in New York and Los Angeles