



Rochester Fall Meeting  
Rochester, N. Y., November 11, 12, and 13, 1940

Sixteenth Annual Convention  
New York, N.Y., January 9, 10, and 11, 1941

New York Meeting—October 2, 1940

SECTION MEETINGS

<b>ATLANTA</b> October 18	<b>DETROIT</b> October 18	<b>PITTSBURGH</b> October 14
<b>CLEVELAND</b> October 24	<b>LOS ANGELES</b> October 15	<b>WASHINGTON</b> October 14
	<b>PHILADELPHIA</b> October 3	

SECTIONS

- ATLANTA**—Chairman, P. C. Bangs; Secretary, Adolph Andersen, Federal Communications Commission, 411 Federal Annex, Atlanta, Ga.
- BALTIMORE**—Chairman, Ferdinand Hamburger; Secretary, G. J. Gross, Pennsylvania Water and Power Co., 1611 Lexington Bldg., Baltimore, Md.
- BOSTON**—Chairman, W. L. Barrow; Secretary, P. K. McElroy, General Radio Co., 30 State St., Cambridge, Mass.
- BUENOS AIRES**—Chairman, A. T. Cosentino; Secretary, W. J. Andrews, Cia. Standard Electric Argentina, Cangallo 1286, Buenos Aires, Argentina.
- BUFFALO-NIAGARA**—Chairman, B. E. Atwood; Secretary, Leroy Fiedler, 98 West Ave., Lockport, N. Y.
- CHICAGO**—Chairman, E. H. Kohler; Secretary, P. C. Sandretto, United Air Lines Transport Co., 5936 S. Cicero Ave., Chicago, Ill.
- CINCINNATI**—Chairman, C. H. Topmiller; Secretary, W. L. Schwesinger, WSAI, Cincinnati, Ohio.
- CLEVELAND**—Chairman, R. L. Kline; Secretary, J. D. Woodward, WGAR, Hotel Statler, Cleveland, Ohio.
- CONNECTICUT VALLEY**—Chairman, K. A. McLeod; Secretary, W. M. Smith, 250 Main St., Suffield, Conn.
- DETROIT**—Chairman, J. D. Kraus; Secretary, Paul Frincke, WJBK, 6559 Hamilton Ave., Detroit, Mich.
- EMPORIUM**—Chairman, C. R. Smith; Secretary, H. L. Ratchford, Hygrade Sylvania Corp., Emporium, Pa.
- INDIANAPOLIS**—Chairman, Arthur Curtis; Secretary, B. V. K. French, P. R. Mallory & Co., E. Washington St., Indianapolis, Ind.
- LOS ANGELES**—Chairman, A. C. Packard; Secretary, J. N. A. Hawkins, 3239 Laclede Ave., Los Angeles, Calif.
- MONTREAL**—Chairman, H. M. Smith; Secretary, W. A. Nichols, Canadian Broadcasting Corp., 1012 Keefer Bldg., Montreal, Que.
- NEW ORLEANS**—Chairman, G. H. Peirce; Secretary, D. W. Bowman, 8327 Sycamore St., New Orleans, La.
- PHILADELPHIA**—Chairman, C. M. Burrill; Secretary, R. L. Snyder, 103 Franklin Rd., Glassboro, N. J.
- PITTSBURGH**—Chairman, R. E. Stark; Secretary, M. G. Jarrett, Bell Telephone Company of Pennsylvania, Pittsburgh, Penna.
- PORTLAND**—Chairman, Marcus O'Day; Secretary, Earl Schoenfeld, 1627 S. E. Elliott Ave., Portland, Ore.
- ROCHESTER**—Chairman, H. C. Sheve; Secretary, O. L. Angevine, Jr., Stromberg-Carlson Telephone Manufacturing Co., Rochester, N. Y.
- SAN FRANCISCO**—Chairman, Carl Penther; Secretary, H. E. Held, 420 Market St., San Francisco, Calif.
- SEATTLE**—Chairman, R. M. Walker; Secretary, L. B. Cochran, University of Washington, Seattle, Wash.
- TORONTO**—Chairman, G. J. Irwin; Secretary, L. C. Simmonds, 301 King St., E., Toronto, Ont.
- WASHINGTON**—Chairman, L. C. Young; Secretary, E. M. Webster, Federal Communications Commission, Rm. 5319, New Post Office Bldg., Washington, D. C.

# Proceedings

## of the I·R·E

Published Monthly by

The Institute of Radio Engineers, Inc.

VOLUME 28

August, 1940

NUMBER 8

### BOARD OF DIRECTORS

- Lawrence C. F. Horle, *President*
- Frederick E. Terman, *Vice President*
- Melville Eastham, *Treasurer*
- Harold P. Westman, *Secretary*
- Austin Bailey
- W. R. G. Baker
- Frederick W. Cunningham
- Henry C. Forbes
- Alfred N. Goldsmith
- Virgil M. Graham
- O. B. Hanson
- Raymond A. Heising
- C. M. Jansky, Jr.
- Frederick R. Lack
- Frederick B. Llewellyn
- Haraden Pratt
- Browder J. Thompson
- Hubert M. Turner
- Arthur F. Van Dyck
- Harold A. Wheeler
- Lynde P. Wheeler

### BOARD OF EDITORS

- Alfred N. Goldsmith, *Chairman*
- Ralph R. Batcher
- Philip S. Carter
- Elmer W. Engstrom
- Frederick W. Grover
- J. Warren Horton
- Greenleaf W. Pickard
- Benjamin E. Shackelford
- Karl S. Van Dyke
- Harold P. Westman, *ex officio*
- Harold A. Wheeler
- Lynde P. Wheeler
- Laurens E. Whittemore
- William Wilson

### PAPERS COMMITTEE

- William Wilson, *Chairman*
- Frederick B. Llewellyn, *Vice Chairman*
- Herman A. Affel
- Edmond Bruce
- Howard A. Chinn
- James K. Clapp
- Tunis A. M. Craven
- Robert B. Dome
- Paul O. Farnham
- Enoch B. Ferrell
- Elmer L. Hall
- Dorman D. Israel
- Loren F. Jones
- De Loss K. Martin
- Harry B. Marvin
- Harry R. Mimno
- Albert F. Murray
- Harold O. Peterson
- Ralph K. Potter
- Hubert M. Turner
- Dayton Ulrey
- Arthur F. Van Dyck
- Paul T. Weeks
- William C. White
- Irving Wolff

Quality in Television Pictures . . . . .	P. C. Goldmark and J. N. Dyer	343
Portable Equipment for Observing Transient Response of Television Apparatus . . . . .	Heinz E. Kallmann	351
Ultra-Short-Wave Transmission Over a 39-Mile "Opti- cal" Path . . . . .	C. R. Englund, A. B. Crawford, and W. W. Mumford	360
Some Factors Affecting the Choice of Lenses for Tele- vision Cameras . . . . .	H. B. DeVore and Harley Iams	369
A Frequency-Modulation Monitoring System . . . . .	Roger J. Pieracci	374
The Ionosphere and Radio Transmission, July, 1940, with Predictions for October, 1940 . . . . .		378
Institute News and Radio Notes . . . . .		380
Sections . . . . .		380
Membership . . . . .		384
Correspondence: "Transconductance," by F. B. Llewellyn, H. A. Wheeler, and B. J. Thompson . . . . .		385
Books . . . . .		386
"Electrotechnik," by F. Bergtold . . . . .	H. A. Affel	386
"The Oscillator at Work," by John F. Rider . . . . .	Arthur Van Dyck	386
"Mathematics Applied to Electrical Engineer- ing," by A. G. Warren . . . . .	L. P. Wheeler	386
"Moderne Kurzwellen-Empfangstechnik" (Mod- ern Short-Wave Receiving Technique) by M. J. O. Strutt . . . . .	Irving Wolff	387
Contributors . . . . .		387

Helen M. Stote, *Assistant Editor*

John D. Crawford,  
*Advertising Manager*

Entered as second-class matter October 26, 1927, at the post office at Menasha, Wisconsin, under the Act of February 28, 1925, embodied in Paragraph 4, Section 538 of the Postal Laws and Regulations. Publication office, 450 Ahnaip Street, Menasha, Wisconsin. Subscription, \$10.00 per year; foreign, \$11.00.

## THE INSTITUTE

The Institute of Radio Engineers serves those interested in radio and allied electrical-communication fields through the presentation and publication of technical material. In 1913 the first issue of the PROCEEDINGS appeared; it has been published uninterruptedly since then. Over 1800 technical papers have been included in its pages and portray a currently written history of developments in both theory and practice.

### STANDARDS

In addition to the publication of submitted papers, many thousands of man-hours have been devoted to the preparation of standards useful to engineers. These comprise the general fields of terminology, graphical and literal symbols, and methods of testing and rating apparatus. Members received a copy of each report. A list of the current issues of these reports follows:

Standards on Electroacoustics, 1938  
Standards on Electronics, 1938  
Standards on Radio Receivers, 1938  
Standards on Radio Transmitters and Antennas, 1938.

### MEETINGS

Meetings at which technical papers are presented are held in the twenty-three cities in the United States, Canada, and Argentina listed on the inside front cover of this issue. A number of special meetings are held annually and include one in Washington, D. C., in co-operation with the American Section of the International Scientific Radio Union (U.R.S.I.) in April, which is devoted to the general problems of wave propagation and measurement technique, the Rochester Fall Meeting in co-operation with the Radio Manufacturers Association in November, which is devoted chiefly to the problems of broadcast-receiver design, the Pacific Coast Convention, which is held each year during the summer months and is supervised by a joint committee of our four Pacific Coast sections, and the Annual Convention, which will be held in New York City during January.

### MEMBERSHIP

Membership has grown from a few dozen in 1912 to more than five thousand. Practically every country in the world in which radio engineers may be found is represented in our membership roster. Approximately a quarter of the membership is located outside of the United States. There are several grades of membership, depending on the qualifications of the applicant. Dues range between \$3.00 per year for Students and \$10.00 per year for Members. PROCEEDINGS are sent to each member without further payment.

### PROCEEDINGS

The contents of each paper published in the PROCEEDINGS are the responsibility of the author and are not binding on the Institute or its members. Material appearing in the PROCEEDINGS may be reprinted or abstracted in other publications on the express condition that specific reference shall be made to its original appearance in the PROCEEDINGS. Illustrations of any variety may not be reproduced, however, without specific permission from the Institute.

Papers submitted to the Institute for publication shall be regarded as no longer confidential. They will be examined by the Papers Committee and Board of Editors to determine their suitability for publication. Suggestions on the mechanical form in which manuscripts should be prepared may be obtained from the Secretary.

### SUBSCRIPTIONS

Annual subscription rates for the United States of America, its possessions, and Canada, \$10.00; to college and public libraries when ordering direct, \$5.00. Other countries, \$1.00 additional.

The Institute of Radio Engineers, Inc.

Harold P. Westman, Secretary

330 West 42nd Street

New York, N.Y.



# Quality in Television Pictures\*

PETER C. GOLDMARK†, MEMBER, I.R.E., AND JOHN N. DYER†, ASSOCIATE, I.R.E.

*Summary*—Present television standards specify certain factors which determine the appearance of a television picture only to a limited extent. Other factors, however, such as contrast, gradation, brilliance, and the shape of the scanning spot, are fully as important.

A photographic method for producing artificial television pictures which permits varying several of these factors has been developed. Pictures are shown which were obtained by this method and which approach ideal quality within a given set of standards.

THIS paper is a summary of recent investigations and experiments aiming to determine the best possible television picture quality that would be available within the so-called Radio Manufacturers Association television standards.

Equipment has been designed to duplicate photographically the appearance of a television picture with predetermined characteristics, such as definition, contrast, and gradation.

The factors which chiefly determine the quality of a television picture are 1. definition, 2. contrast range, 3. gradation, 4. brilliance, 5. flicker, 6. geometric distortion, 7. size, 8. color, and 9. noise.

Of the nine factors determining the picture quality only the first, definition, and the fifth, flicker, are subject to standardization, and these will be dealt with first.

## DEFINITION

When viewing objects which are comparatively dimly lighted, such as television pictures, the iris of the human eye is expanded in order to allow maximum light to enter the eye, resulting in reduced visual acuity.

Under ordinary conditions the over-all resolving power of the eye is limited to the spacing of the cones on the fovea, which has been found<sup>1</sup> to be about 0.01 millimeter. As a result the resolving power of the eye will not be better than 1 minute. Tests have shown that on the average the minimum resolving angle is between 1.3 and 1.5 minutes of arc at light intensities to be expected in television.

For motion pictures the most satisfactory viewing angle, that is, the angle subtended by the eye of the observer and the edges of the picture in the horizontal direction, has been found to be not more than 20 degrees. This corresponds to 15 degrees in a vertical plane for a picture ratio of 3:4. Due to the limited angle of sharp vision, all parts of the picture could not be seen satisfactorily at the same time if the viewing angle were larger.

\* Decimal classification: R583. Original manuscript received by the Institute, February 20, 1940. Presented, Spring Meeting, Society of Motion Picture Engineers, Atlantic City, N. J., April 23, 1940.

† Columbia Broadcasting System, New York, N. Y.

<sup>1</sup> Arthur C. Hardy and Fred H. Perrin, "The Principles of Optics," McGraw Hill Book Company, New York, N. Y., 1932, p. 190.

Visual acuity varies from one individual to another and so does the most satisfactory viewing distance. A relationship between visual acuity, number of lines per picture, and various ratios of viewing distance to screen height was developed on the assumption that the vertical and horizontal detail are approximately equal (Fig. 1). Regardless of whether the line structure is apparent due to improper scanning-spot size or shape, this relationship must be applied in view of the limitation on detail imposed by the available frequency band of the television system.

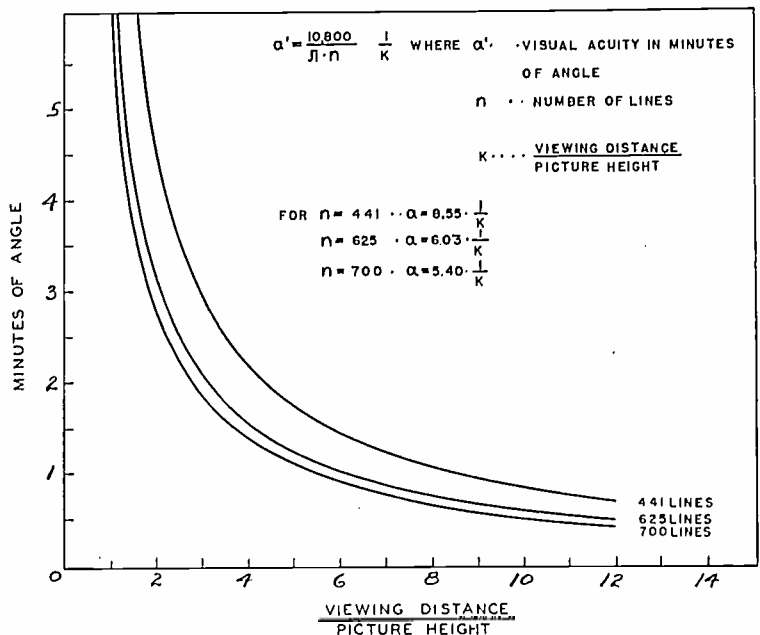

Fig. 1—Visual acuity versus ratio of viewing distance to picture height.

The diagram in Fig. 1 indicates that for a 441-line picture and a visual acuity of 1.5 minutes, a viewing-distance-to-height ratio of 5.7:1 is desirable. Design characteristics of modern motion-picture theaters show that satisfactory viewing conditions are obtained up to distances as much as 12 times the picture height.

It is desirable to determine how much visual detail may be reproduced by a television system with a given number of lines and frequency response. This may be analyzed mathematically, but for some purposes it would be more satisfactory actually to produce an idealized television picture. Such pictures, though they could probably not be duplicated by commercial receiving and camera tubes today, would be very useful tools in indicating the capabilities of a given set of television standards.

The maximum definition that a television system is capable of reproducing is determined not only by the frequency response of the entire system but also by the receiving and transmitting scanning spots, the number of scanning lines and frames, and the fine-detail contrast. Electron scanning beams of circular cross section

and nonuniform current distribution are ordinarily used at present in the camera and at the receiver. The shapes of these scanning spots, therefore, become important factors in determining definition. The effect of a particular frequency-response characteristic on the fine detail has been shown to be the same as that of an equivalent scanning spot. For example, the effect of an infinitely narrow scanning spot and a given finite frequency characteristic could be duplicated by a properly designed scanning spot used with an amplifier with a flat response to an infinite frequency. Such a scanning spot may not always be physically realizable, particularly in cases where there is a sharp cut-off in the frequency characteristic of the electrical system, as shown in Fig. 2.

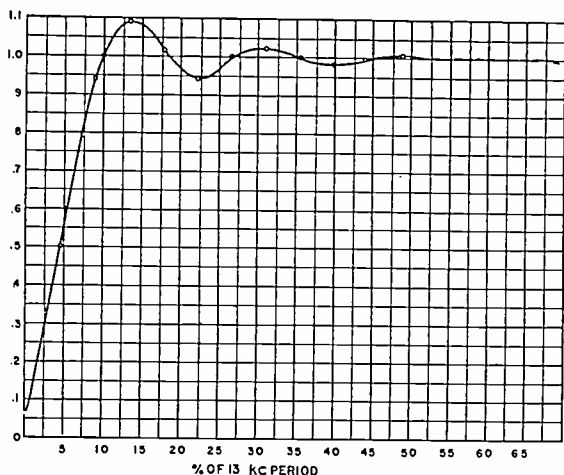

Fig. 2—Calculated response to suddenly applied voltage of idealized 75-kilocycle low-pass filter.

It has been shown that if the frequency response of a television system follows the shape of a probability curve  $e^{-x^2}$ , the equivalent scanning-spot distribution will follow a similar curve.<sup>2,3</sup> It was decided to use this type of characteristic to produce the synthetic pictures. The cutoff point of any frequency characteristic has been defined as the upper limit of a rectangular characteristic of equivalent area. Under present-day television standards the receiver band width is limited to about 4.25 megacycles and the response must be zero at 4.5 megacycles. The pictures which have been produced have assumed a cutoff frequency as previously defined of 4.25 megacycles with a response characteristic which follows a probability curve. The closest approach to this characteristic which can be made with the present standards would follow the probability characteristic to the cutoff frequency and would then drop rapidly to zero. This would result in small oscillatory transients which would only be about plus or minus 5 per cent of the peak signal value on scanning from a black to a white area. (It must be noted that the transient may build up to larger ampli-

<sup>2</sup> Harold A. Wheeler and Arthur V. Loughren, "The fine structure of television images," *PROC. I.R.E.*, vol. 26, pp. 540-575; May, 1938.

<sup>3</sup> Pierre Mertz and Frank Gray, "A theory of scanning and its relation to the characteristics of the transmission signal in telephotography and television," *Bell Sys. Tech. Jour.*, vol. 13, pp. 464-515; July, 1934.

tudes if the picture consists of a number of parallel vertical lines at the proper spacing.) It is difficult to say whether or not this is a desirable or tolerable condition since most practical experience up to this time has been with television systems where the scanning spots have been large enough to mask transients of this type which otherwise might be seen.

The frequency-response characteristic of the electrical system today is responsible for only a small part of the total loss in detail if the 4.25-megacycle band width is being fully utilized. Major causes for loss of definition today are incorrect scanning-spot shapes at the receiving tube and, to a lesser degree, in the pickup tube. Low contrast in the fine detail reduces the apparent definition at the receiver. Variation in spot size with current intensity impairs the resolution of the final image and limits the maximum useful brilliance of the picture.

#### CONTRAST RANGE

It has been found that a projected motion picture or a good photograph can provide a satisfactory rendition of most subjects with a contrast range of about 35 to 1.

Measurements of present-day cathode-ray tubes as used in television receivers show that the maximum contrast range is usually about 30 to 1. (Such ranges are only obtained in darkened rooms and between widely separated areas on the tube screen.) The contrast range between two adjacent points on the screen is not ordinarily more than 10 to 1. Extension of the contrast range to 30 to 1 in the fine detail would certainly more than double the subjective quality of present-day pictures. Observations indicate that more contrasty pictures seem to create the impression of better definition.

The most important factors impairing a satisfactory contrast range are halation on the fluorescent screen, curvature of the screen, and reflections within the bulb itself.<sup>4</sup> The contrast range is reduced if extraneous light falls on the cathode-ray-tube screen as is often the case under average viewing conditions. In order to extend the contrast range under such conditions it is necessary to increase the maximum brilliance of the picture.

Cathode-ray tubes of today achieve fairly good horizontal resolution by employing a small round spot, the diameter of which is less than the theoretical width of one line. The theoretically correct shape for a spot would be that of a rectangle, its height being equal to approximately 1/400 of the picture height and its width, that is, its dimension in the horizontal direction, being a fraction of its height. Since the area of such an ideal spot is greater than that of the small circular spot of the same width the brilliance of the narrow rectangular spot would be greater by the ratio

<sup>4</sup> R. R. Law, "Contrast in kinescopes," *PROC. I.R.E.*, vol. 27, pp. 511-523; August, 1939.



of the respective areas, provided the current densities remain the same.

#### GRADATION AND BRILLIANCE

It is ordinarily assumed that the eye response is logarithmic. A picture cannot represent reality in all respects and usually it is impracticable to reproduce the average brightness of the original scene. Under such conditions it is important that correct rendition of brightness differences be obtained over the entire contrast range. This condition is satisfied when the gradient of the television system is constant regardless of the brightness.

The gradient of a television system may be defined as the ratio  $(\Delta \log B_r)/(\Delta \log B_t)$  where  $B_r$  is the brightness of the receiver cathode-ray tube and  $B_t$  is the brightness of the transmitted scene. The gamma of a television system is equal to the gradient over the straight-line portion of the log- $B_r$ -versus-log- $B_t$  characteristic.

Television systems today do not necessarily maintain a constant gradient over the entire operating characteristic. This results in the appearance of crowding of the tone range in the blacks or whites, or both. Pictures have been produced in the laboratory where the gradation was approximately correct and it can be expected that an improvement in this respect may be achieved without great difficulty.

The average brightness of a television picture should probably be about 8 apparent foot-candles. This would correspond to high lights of the order of 17 apparent foot-candles, depending on the composition of the picture. Though visual acuity improves somewhat with brilliance, an increase in illumination of 2:1 will change only slightly the relationship between visual acuity and number of lines. An increase in picture brilliance will automatically extend the contrast range and improve the gradation.

#### FLICKER

It is recognized that the brilliance of present cathode-ray pictures is inadequate for viewing in undarkened rooms. Television pictures scanned at a rate of 15 or even 24 frames per second (interlaced scanning), which do not display flicker up to approximately 6 foot-candles, will show conspicuous flicker at higher brilliancies. The frame repetition rate of 30 per second (interlaced) as used in television today is well justified because flicker is a more serious problem in television than in motion pictures for the following reasons. First, assuming that the integrated light is constant, flicker will increase in proportion to the ratio of the dark period to the light period.<sup>5-7</sup>

<sup>5</sup> H. E. Ives, "Critical frequency relations in scotopic vision," *Jour. Opt. Soc. Amer.*, vol. 6, pp. 254-268; May, 1922.

<sup>6</sup> H. E. Ives, "A theory of intermittent vision," *Jour. Opt. Soc. Amer.*, vol. 9, pp. 343-361; September, 1924.

<sup>7</sup> Percy W. Cobb, "The dependence of flicker on the dark-light ratio of the stimulus cycle," *Jour. Opt. Soc. Amer.*, vol. 24, pp. 107-113; April, 1934.

Second, it is desirable to view television in undarkened rooms and therefore brilliancies greater than found on motion-picture screens will be required. Third, the higher the illumination of the surroundings in which the television picture is viewed, the more flicker will be perceptible. The diagram shown in Fig. 3, which is based on experimental results,<sup>8</sup> shows that with 0.001 foot-candle illumination of the surroundings and 0.87 foot-candle illumination of the picture under test flicker just becomes perceptible at about 21 field changes per second. With the same picture illumination but with a surrounding illumination of 1 foot-candle, the field repetition rate has to be increased to 34 per second in order to eliminate flicker. Low frame frequencies can only be employed successfully in con-

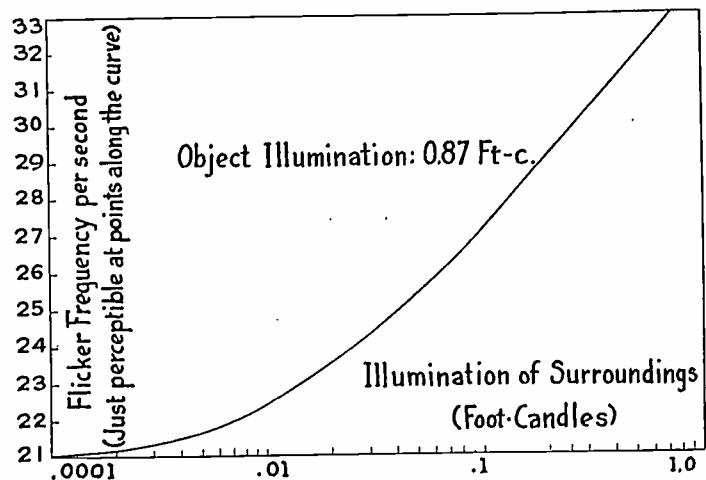

Fig. 3—Perceptible flicker frequency versus illumination of surroundings.

junction with a storage method which retains the received image for the duration of a complete frame (including the blanking period).

There is some difference of opinion as to whether a reduction in picture-repetition rate may be desirable if complete storage were possible. There will be some sacrifice in the appearance of motion as the repetition rate is reduced, but with a given frequency band increased detail will result. When satisfactory storage methods are found experiments will undoubtedly show the most desirable repetition rate under any given set of conditions.

#### GEOMETRIC DISTORTION, SIZE, AND COLOR

Geometric distortion can be caused by lens distortion in the cameras, scanning distortion in the cameras, scanning distortion, and curvature of screen at the receiving tube. The trend towards cathode-ray tubes with flat screens in conjunction with accurate scanning will eliminate most of the distortion existing at present.

The minimum height of a 441-line television picture is about 2 inches since it is determined by the minimum comfortable viewing distance of about 15 inches

<sup>8</sup> R. J. Lythgoe and K. Tansley, "The adaptation of the eye: its relation to the critical frequency of flicker," Medical Research Council, Special Report Series No. 134, 1929.

(Fig. 1). The upper limit is determined by how much viewing distance is available. Moving-picture experience has shown that for minimum eye strain the screen height should be not more than 0.27 times the viewing distance regardless of the amount of detail. This value is therefore independent of the number of lines in a television picture.

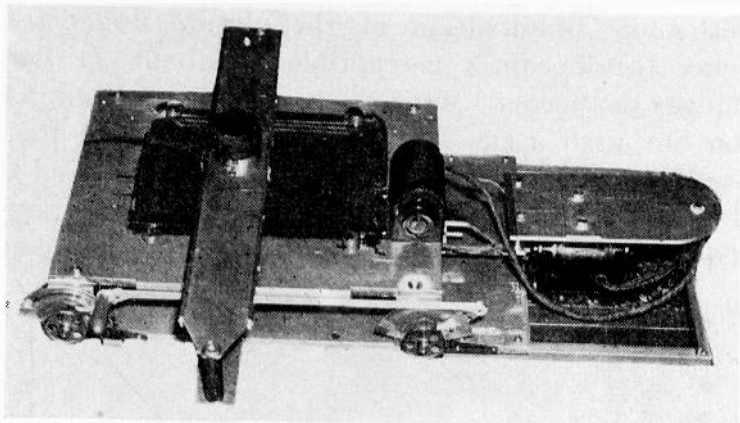

Fig. 4—Artificial television scanner.

Most television picture tubes today have a screen material which is satisfactory from a color point of view, that is, high lights are reproduced as pure white. Though greater efficiency can be obtained from other than white screen materials, the latter is preferable for the sake of their color in projection tubes.

#### ARTIFICIAL TELEVISION SCANNER

An apparatus was constructed to duplicate the behavior of an ideal television system by photographic

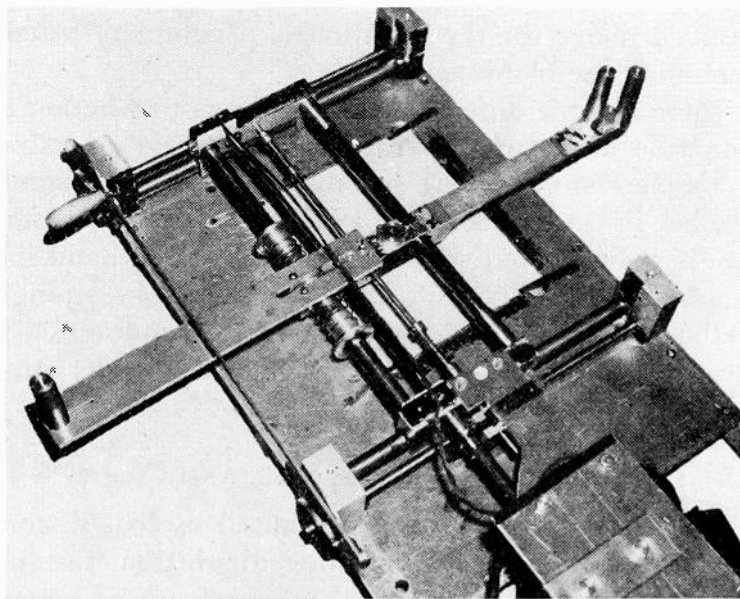

Fig. 5—Artificial television scanner partially disassembled.

methods. Positive transparencies of desired subjects were prepared on 8- $\times$ 10-inch glass plates. These positives were then scanned with a moving-light source and optical system, one line at a time, and were reproduced on a sensitized photographic plate. The horizontal scanning was motor-driven with automatic limit switches and braking. The change in the direction of scanning at the end of each line and the ad-

vancement in the vertical direction were manual and the latter was adjustable for any desired number of lines. Figs. 4 and 5 show that alternate lines could be scanned in opposite directions since the defining apertures were symmetrical.

The definition was determined by the apertures in the optical system. The optical system consisted of a light source with a condenser lens above the positive plate to be scanned and two lenses of  $\frac{1}{2}$ -inch focal length assembled in a housing and located between the positive and the sensitive plate. Two apertures were used in the optical system with one aperture placed just above the lower  $\frac{1}{2}$ -inch lens and one just below the upper lens. The image of the positive was focused on the lower aperture which might be termed the frequency-response aperture. The upper aperture represented the receiver or transmitter spot size and was focused on the photographic plate (Fig. 6).

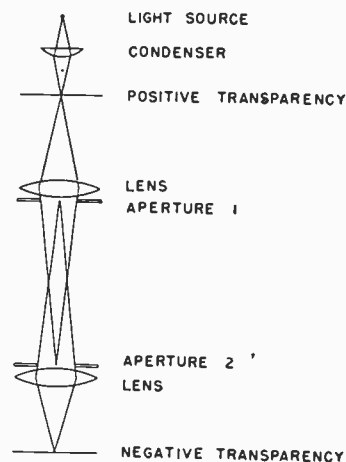

Fig. 6—Optical system.

The number of lines was determined by the size of the spot in the vertical direction and by the amount by which it was advanced vertically at the end of each line. The optical system was arranged to give a 2:1 reduction of the image of the upper aperture and a corresponding enlargement of the image focused on the lower aperture. This made it possible to make the very small apertures twice the size they otherwise would have been.

Some of the fundamental requirements of apertures designed to reproduce the effect of a given frequency response have already been described. The ideal aperture of the  $\epsilon^{-x^2}$  type would be rectangular and of a height equal to one scanning line with a light transmission across its width corresponding to a probability curve (Figs. 7 and 8). (Note: Fig. 8 shows aperture dimensions for the particular optical system described above.)

Attempts were made to produce apertures by photographing large-scale models. However, it was immediately apparent that the dispersion of even the finest grained emulsion could not be tolerated because of the great loss in light. An alternative approximation was to shape the leading and trailing edges of the aperture so that the desired characteristic could be

obtained. The characteristic could be quite well approximated by assuming it to be a straight line. It was essential that the density in the vertical direction across a scanning line be constant in order to minimize the line structure. The aperture shape that immediately suggested itself was a parallelogram. A comparison between the theoretical aperture  $e^{-x^2}$  and

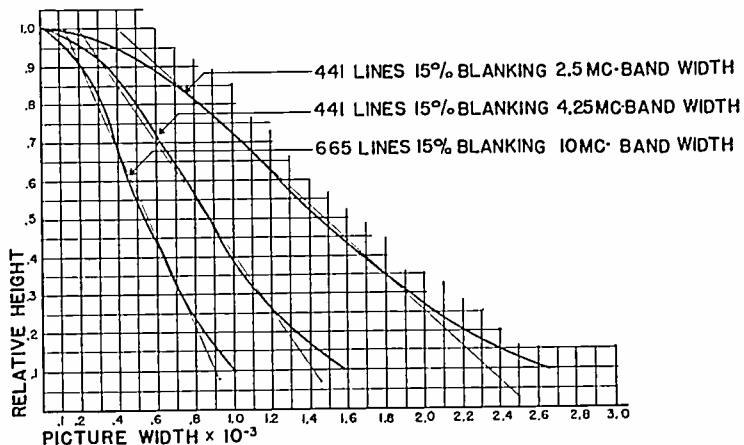

Fig. 7—Aperture shapes for duplicating receiver response based on response shaped like probability curve  $e^{-x^2}$ .

the parallelogram apertures which were used shows that there is little difference in their behavior (Fig. 9).

The parallelogram would give the desired effect when scanning across vertical lines, but on encountering a line tilted at the same angle as the edges of the aperture, it would produce too much detail. This effect could be minimized by dividing up the aperture into several parallelograms. An infinite number of parallelograms would be ideal, but practically it was found that three would give adequate results (Fig. 10).

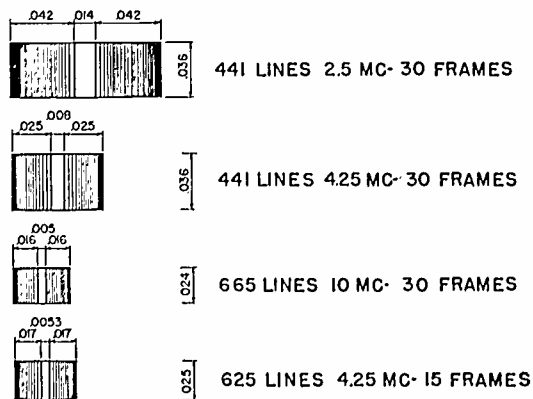

Fig. 8—Aperture sizes for duplicating receiver response based on probability function  $e^{-x^2}$ .

Simulated television photographs were made of several typical subjects and two conditions were studied with the aid of the scanner. The first condition is the very ideal situation where the receiver and the transmitter spots are rectangular slits exactly one line high and where the frequency response is duplicated by one probability aperture (Fig. 11).

For the second condition, which might be considered to be more realizable today, it was assumed that only the transmitting aperture was of the ideal narrow rectangular shape and that the receiving aperture,

while considerably better than in most present-day tubes, was not ideal. The current in the transmitting scanning beam is ordinarily very low and it can be

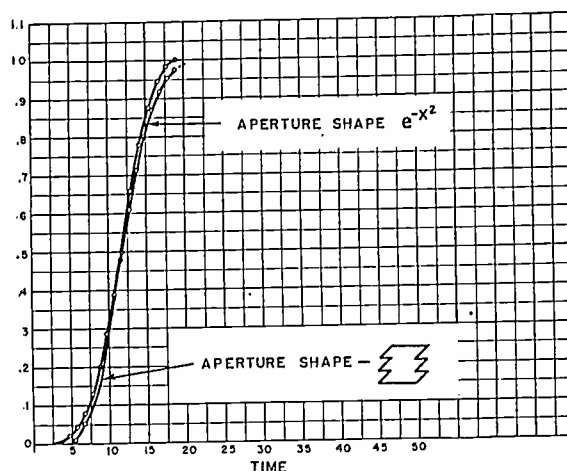

Fig. 9—Calculated aperture response for a suddenly encountered white picture area.

expected that the ideal shape might be approached. It was assumed that the receiving-spot intensity could be made uniform in the vertical direction and approxi-

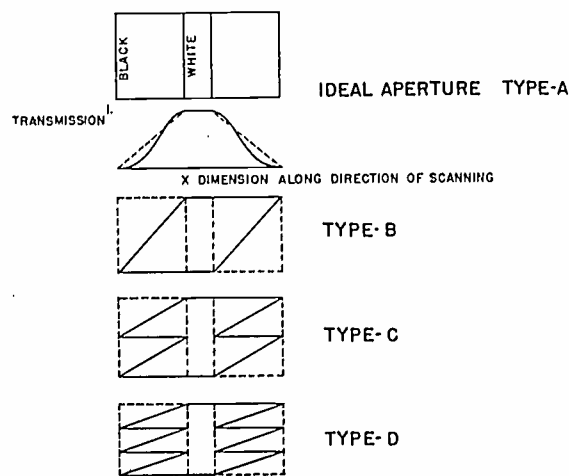

Fig. 10—Types of apertures for duplicating receiver response.

mately one line width high, but the horizontal distribution was the same as in the frequency-response aperture (Fig. 12).

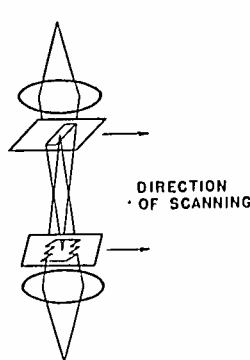

Fig. 11—Arrangement of apertures to simulate effect of frequency response (receiver and transmitter spots narrow rectangles).

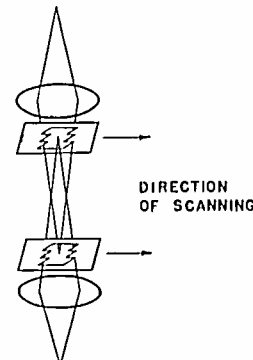

Fig. 12—Arrangement of apertures to simulate effect of frequency response and receiver spot size.

Reproductions of pictures produced by the artificial method are shown in Figs. 13 to 16. A 441-line scan-





Fig. 13—Original photograph from which Fig. 14 was produced.

*Fairchild Aerial Surveys*

ning standard was used with a cutoff frequency of 4.25 megacycles, assuming 30 frames per second. Fig. 14 was produced with the apertures arranged as in Fig. 11 and assumed that the receiver and the transmitter spots were narrow slits, exactly one line high. The pictures shown in Figs. 15 and 16 were produced using the aperture arrangement of Fig. 12 and simu-

lated a television system where the horizontal distribution of the receiving spot followed the  $\epsilon^{-x^2}$  shape. The distribution across the spot in the vertical direction was uniform. Some of the pictures show spurious patterns of the type predicted by Mertz and Gray, but it should be realized that this effect is not uncommon since it is produced by all half-tone processes. Defects



Fig. 14—Scanned reproduction of Fig. 13 (441 lines, 30 frames, 4.25 megacycles, slit aperture).

of this type will be less noticeable when objects are in motion.

#### CONCLUSIONS

The synthetic pictures seem to indicate that television pictures as received today have to be improved a great deal before the capabilities of present 441-line standards are fully utilized.

#### ACKNOWLEDGMENT

The authors would like to express their appreciation of the large amount of work contributed to this project by Messrs. Doncaster, Hollywood, Piore and the other members of the Columbia Broadcasting System Television Department.



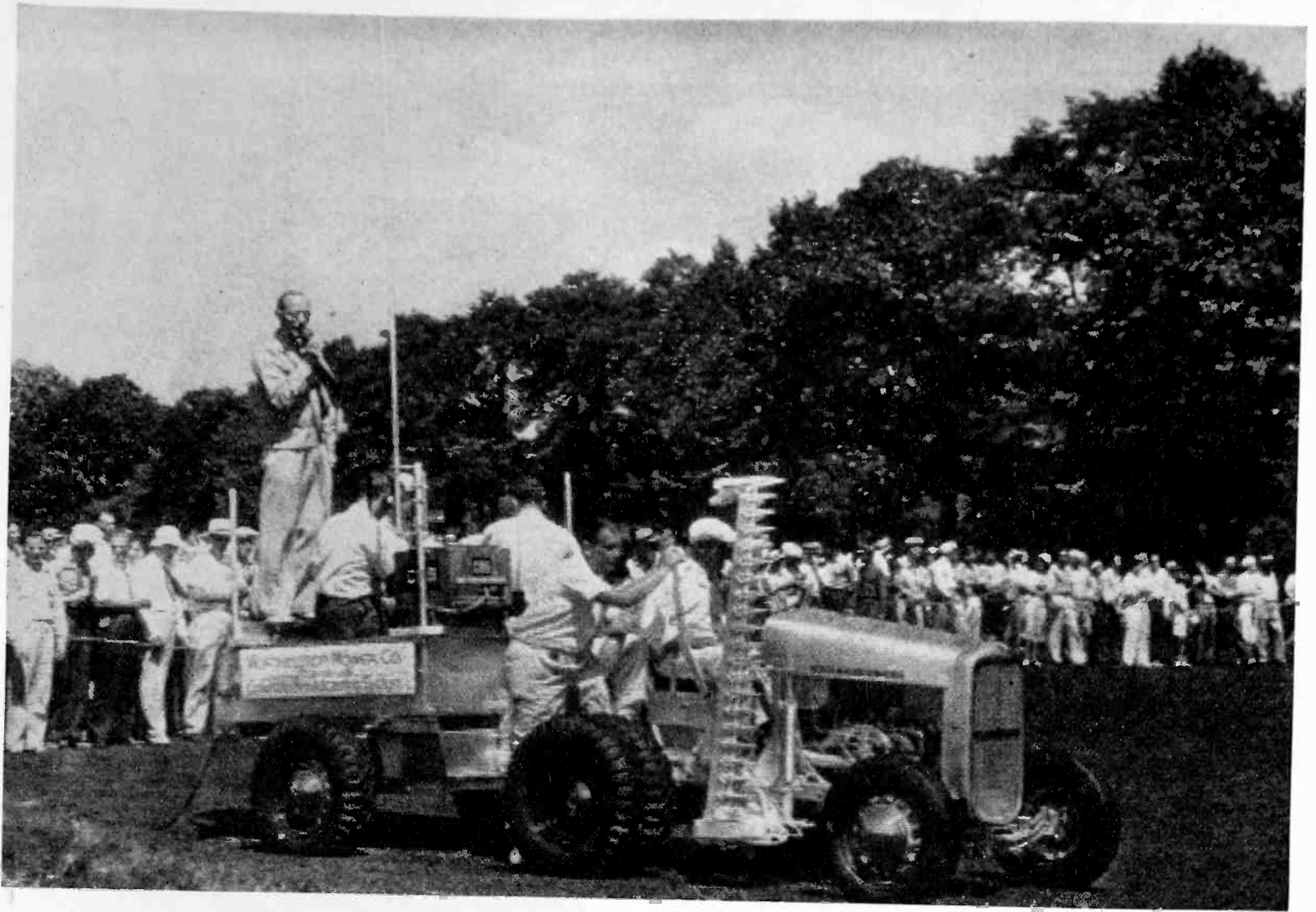

Fig. 15—Scanned picture (441 lines, 30 frames, 4.25 megacycles,  $\epsilon^{-x^2}$  aperture).

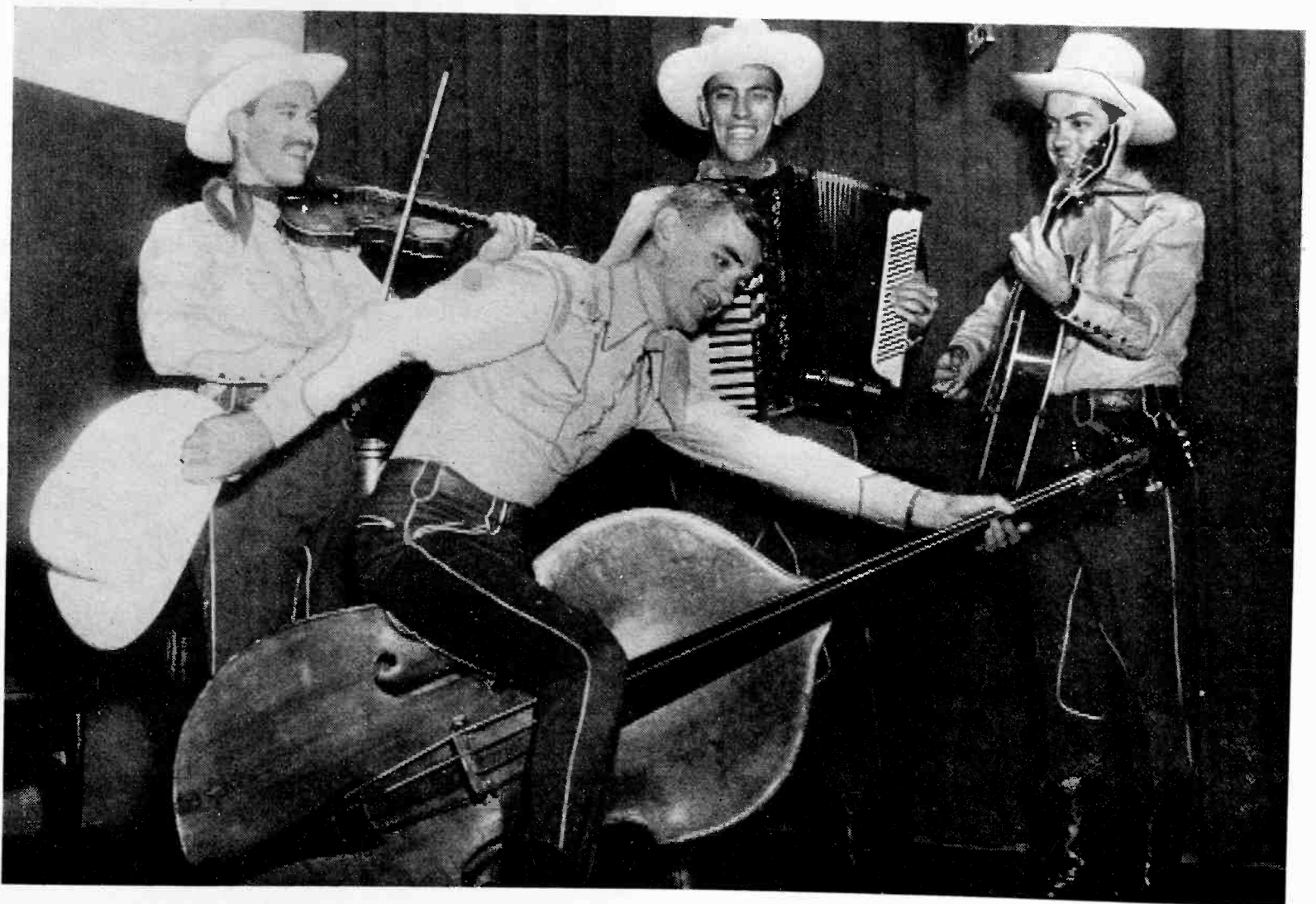

Fig. 16—Scanned picture (441 lines, 30 frames, 4.25 megacycles,  $\epsilon^{-x^2}$  aperture).

# Portable Equipment for Observing Transient Response of Television Apparatus\*

HEINZ E. KALLMANN†, ASSOCIATE, I.R.E.

**Summary**—An apparatus which supplies a perfect transient, either directly or as the modulation of an ultra-high-frequency carrier, to a television amplifier or receiver and records its transient response on the screen of a synchronized oscilloscope is described. Performance requirements are discussed and some design details described, among these a carbon-disk attenuator suitable for ultra-high frequencies, also a single-lever position control and a scale projection for the oscilloscope.

THE criterion for the performance of a television amplifier is its transient response, i.e., its ability to reproduce a sudden change of signal voltage as a steep and straight transition with little overshoot and subsequent oscillations. The transient response of an amplifier is known to be the steeper the wider the frequency range passed by it without attenuation and phase distortion; yet it is difficult to calculate its steepness and shape from a given amplitude and phase response. Oscilloscopic observation of the transient response offers a direct and much easier performance test of television amplifiers; thus in their design and production a single apparatus for the observation of the transient response must be expected to become the most important piece of equipment. Such an apparatus must apply a perfect recurrent transient to the input of the amplifier under test and record the deteriorated shape of the transient at its output. Similar instruments are known in electrical engineering as recurrent impulse oscillographs<sup>1</sup> and square-wave testing<sup>2</sup> is no longer unusual in communication technique. Neither is the apparatus here described<sup>3</sup> the first of its kind. It merely offers improved performance and considerable reduction in size by designing each part for highest efficiency rather than versatility and its use is simplified by reducing the number of controls to a minimum. The gear consists, as shown in Fig. 1, of four main parts: (1) the cathode-ray oscilloscope with sweep circuit, (2) the square-wave generator, synchronized via a timing-pulse delay filter, (3) the ultra-high-frequency carrier oscillator, modulator, and attenuator, and (4) the output amplifier. The perfect transients are fed from the square-wave generator either directly to the television amplifier under test or, as the modulation of an ultra-high-frequency carrier, to a television receiver. The output of either is amplified in the output amplifier and fed to the vertical deflection plates of the oscilloscope.

\* Decimal classification: R583. Original manuscript received by the Institute, April 25, 1940; revised manuscript received, July 18, 1940.

† New York, N. Y.

<sup>1</sup> H. M. Turner, "The transient visualizer," *Trans. A.I.E.E.*, vol. 43, pp. 805-813; June, 1924.

<sup>2</sup> L. B. Arguimbau, "Audio-frequency testing with square waves," *Electronics*, vol. 12, pp. 23-24, December, 1939. (Abstract.)

<sup>3</sup> This apparatus was built and used in the Design Laboratories of the Electric and Musical Industries Ltd., Hayes, Middlesex, England.

## GENERAL DESIGN CONSIDERATIONS

### Choice of Sweep Frequency, Picture Size, and Brightness

The design of the whole gear is dominated by the choice of the sweep frequency, that is, the frequency with which the test of applying and recording the transients is repeated. Since the brightness of the superimposed traces on the oscilloscope screen is, for a given writing speed, directly proportional to the sweep

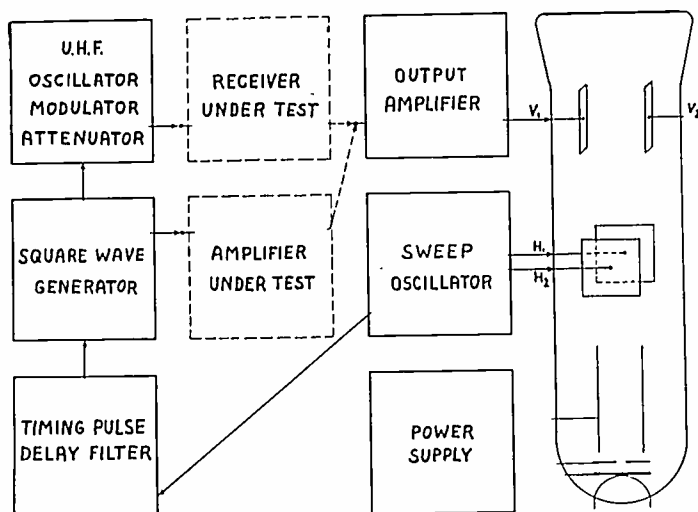

Fig. 1—Parts of the test equipment and their connections.

frequency, it appears desirable to make this frequency very high. On the other hand, the shape of the transient response will be falsified unless the sweep frequency  $f_s$  is low compared with the band width of the amplifier under test. A recurrent unit-step transient, i.e., a

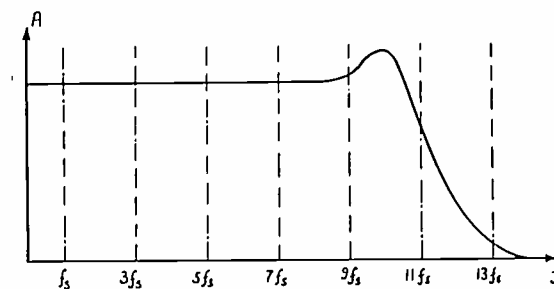

Fig. 2—Exploring harmonics of a square wave of the frequency  $f_s$ .

square wave of the frequency  $f_s$ , is equivalent to the sum of the basic frequency  $f_s$  and all its odd harmonics, which are thus spaced  $2f_s$  apart. All these harmonics may be imagined to explore simultaneously the amplitude and phase response characteristic of the amplifier under test. Evidently the result cannot be more accurate than an amplitude response characteristic would be when plotted from single readings spaced  $2f_s$  apart and thus neglecting possible sudden changes between them, as shown in Fig. 2. Thus the value  $2f_s$  is the measure of the electrical resolving power and should

be kept small compared with the frequency range over which the amplitude or phase cutoff of the amplifier under test extends. In terms of transients this means that a transient should have completely settled at its final value before a new one is applied; the time necessary for this depends on the band width, which determines the transition time, and on the relative sharpness of cutoff, which determines the duration of "ringing," i.e., the decaying oscillation following the transition.

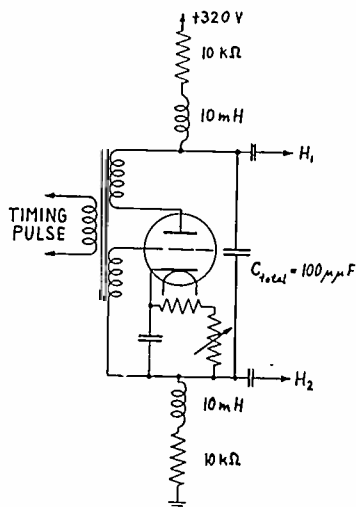

Fig. 3—Saw-tooth generator for push-pull deflection.

Other considerations pertaining to the choice of the sweep frequency are that preferably it should be a multiple of the line frequency (i.e., 13,260 kilocycles in current American practice and 10,125 kilocycles in the British standard) to permit visual examination of the transient response of television sets on the edges of vertical bars. The number of these bars should be at least two and, perhaps, not more than six to assure good synchronization of the set under test with these bars in spite of their representing timing pulses of unusual shape. For the gear here described a sweep frequency of 26 to 30 kilocycles was chosen, yielding two vertical bars for American usage ( $2 \times 13,260 = 26,520$ ) and three bars for the British standard ( $3 \times 10,125 = 30,375$ ). This corresponds to spacing the exploring harmonics of  $f_s$  52 to 60 kilocycles apart and requires that a recorded transient shall have settled in less than half of the repetition period of 33 to 38 microseconds. The criterion as to whether this requirement is satisfied is that considerable variation of the repetition frequency  $f_s$  should not result in any change of shape or slope of the recorded transient.

For a given repetition frequency, the size of the whole gear depends mainly on the size and brightness of the recorded curve, suggesting rigorous economy in this respect if the gear is to remain portable. On the assumption that the number of simultaneous observers seldom exceeds two, their minimum comfortable viewing distance of 10 inches was incorporated within the gear to exclude external light from their field of view. At this distance a curve trace of 0.5-millimeter thickness can be tolerated, obtainable with adequate bright-

ness with a cathode-ray-tube plate voltage of about 1000 volts. As an alternative it was considered to make the picture smaller and sharper by using a higher plate voltage and to make use of optical magnification; but no detail could be gained since the thickness of the trace was found to be inversely proportional to the plate voltage.

Under the viewing conditions provided, a 3-inch cathode-ray-tube screen with a maximum curve height of 2 inches was deemed adequate, requiring for a tube a deflection sensitivity of 0.55 millimeter per volt and a maximum output signal of 92 volts.

The recording speed should be high enough to resolve details of, perhaps, 0.02 microsecond; yet 1 microsecond, the transition time of the worst likely television transient response, must not exceed the width of the cathode-ray-tube screen. Thus a sweep deflection speed of 50 millimeters per microsecond seemed the highest worth attempting.

#### THE SWEEP GENERATOR

The sweep generator serves to provide this rapid horizontal deflection at a repetition rate of 26 to 30 kilocycles per second. Its circuit, Fig. 3, comprising a single small triode of high mutual conductance, is a modification of a well-known saw-tooth oscillator.<sup>4</sup> Its plate load is split into two equal parts of 10,000 ohms and 10 millihenrys each, the one between reaction coil and plate supply, the other between grid return and ground. Both together are shunted by a capacitance consisting of the distributed-wiring and electrode capacitances and of a small condenser making up a total of 100 micromicrofarads. The tube "floats" between the two points of equal and opposite deflection potential, feeding short pulses to them every 38 microseconds.

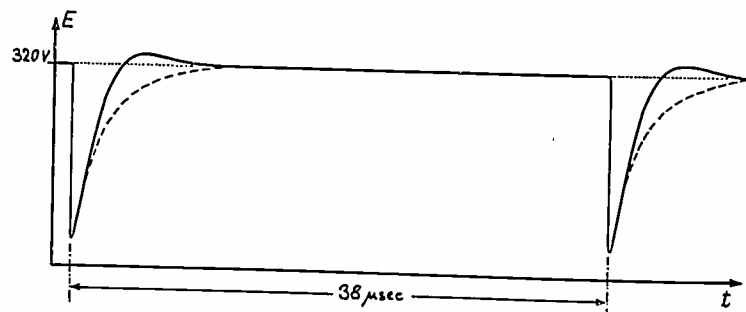

Fig. 4—Improvement of the saw-tooth shape through insertion of series inductances.

Without the inserted inductances the deflection potential would decay exponentially, dropping to  $1/e = 0.37$  after a time  $T = R_{total} \cdot C_{total} = 2$  microseconds. The exponential decay would result in a very nonlinear time scale and furthermore would be fast enough only at the very beginning of the stroke. By completing the circuit as a resonant circuit a straighter transient response can be produced which will start

<sup>4</sup> British Patent No. 471737; for a description see Heinz E. Kallmann, "Stroboscopic light source," Proc. I.R.E., vol. 27, p. 691; November, 1939.



with, and maintain, the same high initial writing speed. A value of  $Q = 1/R \cdot \sqrt{L/C} = 0.71$  was selected, offering a fairly straight transient response with only a small overshoot of 6 per cent past the final level and no further oscillations, Fig. 4. The time scale of the sweep is nearly linear up to about  $T = CR = 2$  microseconds, as compared with the exponential decay shown as a broken line in Fig. 4.

The plate load resistance of 20,000 ohms is so large compared with the residual plate impedance of the triode during its working stroke that the load capacitance is rapidly discharged to a very low voltage. Thus from a plate supply of 320 volts, nearly 260 volts are available as deflecting voltage, Fig. 4.

Most of the light available from the oscilloscope is unavoidably wasted during the long waiting period until the next transient is recorded; only the small fraction during the initial straight part of each return stroke is utilized, occupying about 5 per cent of the whole sweep period. The total deflection of the beam, according to the saw-tooth voltage of 260 volts, is about 140 millimeters or nearly 6 inches and exceeds by far the diameter of a 3-inch cathode-ray-tube screen on which only a part of the curve is visible at a time.

#### POSITION CONTROL

An efficient position control thus becomes imperative for accurate alignment of the important parts of the curve with a fixed scale or to inspect the remainder of the curve. The deflection plates of the cathode-ray

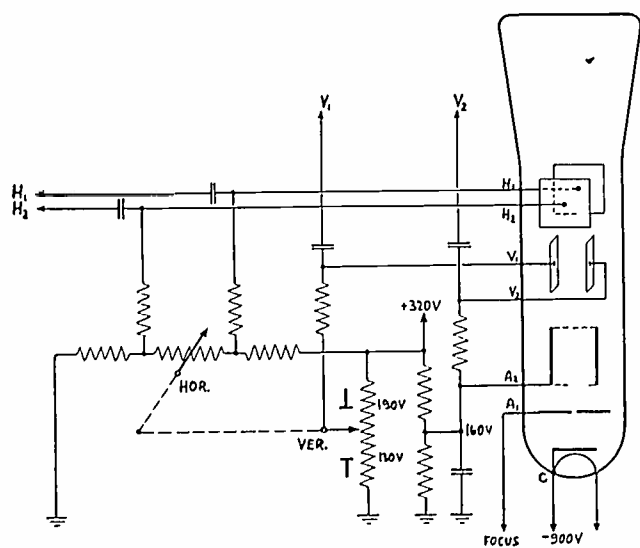

Fig. 5—Position-control circuit.

tube are insulated for direct current from the sweep oscillator and the position of the image is controlled by their direct-current potentials, Fig. 5. The horizontal-position control, yielding a very large displacement of the image, is provided by a group of three resistors connected in series between the plate-supply potential of +320 volts and ground. The outer resistors are fixed, the middle variable from zero to a comparatively very high value. The horizontal-deflec-

tion plates  $H_1$  and  $H_2$  are returned to its ends and may assume any potential difference between 0 and 90 per cent of the plate-supply potential of 320 volts, yet invariably maintaining their average potential at 160 volts, i.e., half the plate-supply potential. Thus the longitudinal field between them and the electron gun is unaffected by the position control and sharp focus is maintained for all visible parts of the image.

The vertical position is controlled by the direct-current potentials of the vertical-deflection plates  $V_1$  and  $V_2$ . Since the total picture height never exceeds 50

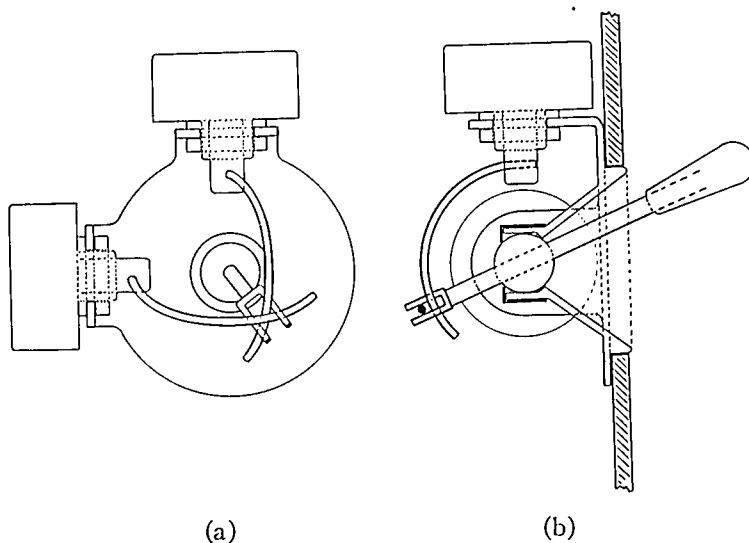

Fig. 6—Single-lever control for horizontal and vertical position.

millimeters, a vertical shift of at most 30 millimeters is provided which does not require any push-pull arrangements. The direct-current potential of one plate,  $V_2$ , is fixed at 160 volts, that of the other,  $V_1$ , varied by a potentiometer from 130 to 190 volts, Fig. 5.

When using the position control to shift the image about in the plane of the screen, the usual separate adjustment of the abscissa and the ordinate by turning potentiometer knobs is an irritating artificiality, due merely to the mechanism of the electrical deflection. It is avoided by the use of a single control lever—"joy stick"—which is swiveled in a ball joint to swing in any direction. By this the image is moved regardless of co-ordinates as if the lever were mechanically connected to it; and this operation is thus reduced to a subconscious action of the observer.

Actually the swivel lever controls the sliders of the horizontal-control resistor and of the vertical-control potentiometer by means of a simple mechanical coupling, as shown in Fig. 6. The resistor and potentiometer are standard components having 320-degree turning angles of which however only 60 degrees are utilized. Thus the former, for a variation of about 1.5 megohms, requires a total value of 4 megohms ("logarithmic" law assumed), the latter for a variation from 130 to 190 volts, a total voltage of 320 volts. The two are arranged in planes perpendicular to each other and to that of the front plate. Their spindles point towards the ball joint and each carries an extension lever, a stiff

wire bent in a semicircle around the ball joint. Both these levers are gripped simultaneously by the two-pronged fork at the end of the swivel lever and thus each is moved in proportion to the swivel movement in either co-ordinate. One prong is built as a spring and takes up any possible backlash.

#### TIMING-PULSE DELAY FILTER AND SQUARE-WAVE GENERATOR

The required recurrent "perfect" transients, i.e., square waves, are generated in a multivibrator circuit, followed by a limiting cathode-follower stage. The

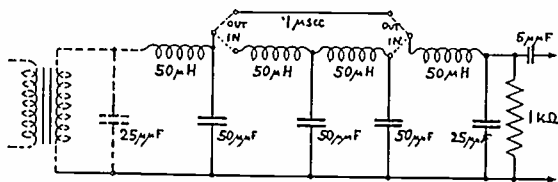

Fig. 7—Timing-pulse delay filter.

multivibrator is kept in synchronism by short steep pulses derived from a third winding on the reaction transformer of the sweep oscillator.

In deciding which of the two oscillating systems is to be used to trigger the other, it must be kept in mind that the initial part of the transient-response curve is the most important one. The output of the amplifier under test must thus arrive at least about 0.5 microsecond later at the oscilloscope than the beginning of the sweep. There is little time delay in, e.g., a single-stage amplifier; and to avoid the alternative of inserting an additional perfect delay filter in the path of the perfect transient, the sweep oscillator is made to initiate the whole process. Even so, the little delays contributed by the multivibrator and the output amplifier are hardly sufficient to delay the transient-response curve of a single stage well past the starting of the sweep. A short-delay filter in the path of the timing pulse is thus helpful, although it actually is recommended for quite another reason.

The merits of a transient response are expressed by a time, e.g., that required for the rise from 0.10 to 0.90 of the final level. An exact time scale is therefore of prime importance. The horizontal sweep deflection of the transient image does not offer enough precision for an absolute calibration, since the speed of deflection depends not only on the constants of the sweep circuit but also on the emission of the triode and its plate-supply voltage; neither is it quite constant over the observed range. For the purpose of occasional absolute calibration it has proved useful to insert a calibrated time delay in the path of the timing pulse. A suitable quantity for this is 0.1 microsecond which corresponds to about 4.5 millimeters horizontal displacement. For an impedance  $Z = 1000$  ohms and a nominal cutoff frequency of 6.4 megacycles, two low-pass filter sections suffice, which, as shown in Fig. 7, can be short-circuited by a switch.

It is to be suspected that changes in the shape of the crest of the timing pulse would affect the triggering of the multivibrator. To avoid resulting errors in the time calibration the calibrated delay-filter sections are inserted between similar sections, so that the shape of the timing pulse is very nearly the same with and without the calibrated sections. The short-circuiting switch requires special attention as regards low capacitances and very good contacts.

The 2- to 4-section delay filter contributes enough delay to shift any transient response past the initial nonlinearity of the sweep. Yet it is not so large as to move the transient response of a very long cascade beyond the useful range of about 2 microseconds, since the time delay of usual television sets is of the order of, and seldom exceeds, one microsecond.

The delay filter is properly terminated on the far end and coupled to the multivibrator through a very small capacitance. The voltages, biases, and grid and plate resistors of the multivibrator, Fig. 8, are most conveniently found experimentally by observing the cleanness and steepness of the obtained transitions. It is recommended to hold all screen-grid potentials near the desired level by means of bleeder resistors. An additional small shunt capacitance on the triggered grid somewhat delays the triggering without, otherwise, doing any evident harm.

Of the two strokes of the multivibrator only that immediately after triggering needs to be "perfect"; only this is ever observed, excepting only the visual inspection of vertical bars on the screen of a television set.

The output of the multivibrator is trimmed to a square wave shape by grid-current limiting and by subsequent limiting in a cathode-follower ("cathode-loaded") output stage, which is driven past the cutoff of its anode current.

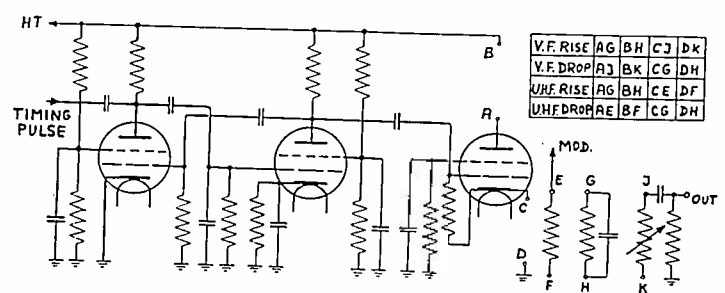

Fig. 8—Square-wave-generator circuit.

Four switch positions are provided for the output of the cathode-follower stage. In positions 1 and 2 the square wave itself is fed to an output terminal, for the testing of passive filter networks and amplifiers; in positions 3 and 4 the square wave is used to modulate an ultra-high-frequency carrier, used for the test of television receivers. In the "normal" positions 1 and 3 the signal is taken from the cathode load, as from a source<sup>5</sup> of the very low impedance  $1/g_m$ . They offer,

<sup>5</sup> For a discussion of the low output impedance and the apparent reduction in input capacitance of a cathode-loaded stage see, among others, the appendixes of a paper by Allen A. Barco, "An iconoscope pre-amplifier," *RCA Rev.*, vol. 4, pp. 89-107; July, 1939.

in position 1, a sudden rise of voltage, adjustable from 0.1 to 2 volts by a variable resistor and, in position 3 a sudden rise in amplitude of an ultra-high-frequency carrier. Switch positions 2 and 4 provide a useful check by reversing the sign of the signal and observing a sudden drop of voltage or carrier amplitude; the signals are taken off the anode of the cathode-follower tube, sacrificing the invariably low output impedance. A dummy load, changing place with and simulating the load resistances, maintains the working conditions of the tube unchanged.

#### ULTRA-HIGH-FREQUENCY OSCILLATOR, MODULATOR, AND ATTENUATOR

The ultra-high-frequency part of the gear is utilized only in switch positions 3 and 4. In these cases the ultra-high-frequency carrier is modulated by the square-wave generator and may be used for the testing of complete television receivers. The ultra-high-frequency part of the gear resembles a standard-signal generator except that instead of modulating at the grid of the oscillator a separate modulator stage is required, because modulation of the oscillator itself would require an oscillator circuit damped to a  $Q \leq 5$  at a carrier frequency near 40 megacycles, to enable it to follow the high modulation frequencies. On the other hand, a linear modulation characteristic is of little importance for the quick transitions between the two amplitude levels of a square wave.

An acorn triode 955 serves as an oscillator with inductive reaction in the cathode circuit, Fig. 9, and with its anode tied to ground potential by a large capacitance. Since the transient response of a receiver is not likely to vary much with different ultra-high-frequency channels, a single tuning range seems sufficient, extending, e.g., from 38 to 50 megacycles. This range is covered with a variable air-dielectric condenser of silvered invar and a self-supporting coil of thoroughly annealed copper. The grid of the modulator tube, an acorn pentode 954, is coupled to the oscillator circuit via a small capacitance of 5 micromicrofarads. The direct-current and modulation path to that grid is blocked for the carrier frequencies by two chokes in series, the first one of smaller inductance and of low loss, so that the oscillator circuit is not noticeably damped nor detuned by its presence. Then follows another choke of higher inductance, but damped by a parallel resistance to prevent any resonance at modulation frequencies. Thus neither choke will, together with the grid capacitance and the grid condenser of the modulator tube, form a series-resonant circuit of sufficiently high  $Q$  to cause "ringing," i.e., distortion of the square-wave modulation. There is no cathode bias resistor since the direct-current drop in the large grid resistor provides a self-adjusting bias voltage.

The amplitude of the modulation is set to change the carrier amplitude by about 6 decibels, i.e., between the 50 per cent level and the peak level. The standing

carrier of 50 per cent serves to lift the signal above the initial curvature of any detector, which region is often unsuited for the observation of the transient response because (1) the circuit preceding the rectifier may be deprived of any damping provided by the rectifier load, and (2) overshooting cannot correctly be observed after a drop to zero current in a rectifier.

The grid and plate circuits of the modulator are arranged in separate insulated screen boxes. The output is taken from the anode via a closely coupled step-

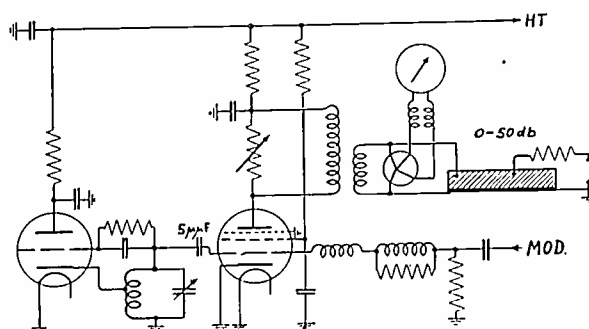

Fig. 9—Ultra-high-frequency oscillator, modulator, and attenuator.

down transformer, the primary stray inductance of which resonates with the tube capacitance in the middle of the tuning range. This resonance peak is extremely flat due to damping by a shunt resistance, made variable to adjust the output to the calibration of the output meter. The secondary of the transformer delivers the output, which is substantially constant over the range from 38 to 50 megacycles, to two loads in parallel. The one, of about 130 ohms, is a 5-milliamper thermocouple acting as a voltmeter. It is of the insulated-heater type and is connected via two concentric chokes to a direct-current microammeter, serving as the output meter. Connected in parallel to the thermocouple is a short concentric feeder cable leading to, and terminated by, the 90-ohm input impedance of the attenuator.

In order to allow absolute calibration in microvolts, and to avoid distortion of the transient modulation, the attenuator of an ultra-high-frequency signal generator should present to the receiver the same impedance characteristic as the combination of antenna and feeder for which the receiver is designed, e.g., purely resistive 90 ohms for many of the usual concentric feeder cables. As a steadily variable attenuator with constant and purely resistive output impedance the scheme of Fig. 10 has proved useful. A two-dimensional continuum of resistance material, such as a strip of graphite-coated paper, is connected to ground by a metallic conductor along the whole length of one of its edges. Signal energy is fed to the point  $P_1$  from a matched generator  $G$ . The arrangement may be likened to a piece of cable with negligible inductance and capacitance but having large leakage and series resistance. The rapid attenuation of such a cable is proportional to its length. If an output circuit is connected to a contact  $P_3$  sliding along the resistance

strip, then the signal in it will be attenuated proportionally to the distance between the points  $P_3$  and  $P_1$ . Excluding the cases where  $P_3$  approaches either end of the strip, the input impedance will evidently be unaffected by the position of  $P_3$  and the output impedance between  $P_3$  and ground will also be constant as long as the distance between  $P_3$  and the grounded edge is kept constant. The far end of the attenuator either may be terminated by a resistance between the point  $P_2$  and ground or a short, unused tail portion

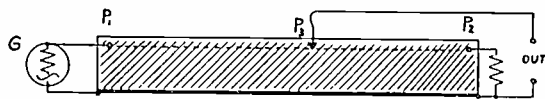

Fig. 10—Straight resistance strip as attenuator.

will, due to its high attenuation, adequately simulate an infinitely long one. The inductance of the attenuator system can be neglected for all practical cases. The distributed capacitance may not be quite negligible; but it will not cause noticeable errors since the potential distribution in the medium, assuming a high dielectric constant, is of just the same shape as that produced by the passage of a direct current through the leakage and series resistance. In either case a sounding electrode moving along a line parallel to the grounded edge will derive a fraction of the input voltage decreasing according to exponential law.

Little additional deviation from the exponential law is encountered if, for practical purposes, the resistance strip is bent in almost a complete circle, as shown in Fig. 11. The inner edge is grounded by a circular metal disk. A slot in the resistance material near the input terminal allows the input matching impedance to be

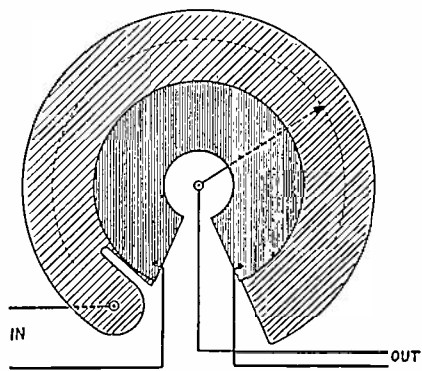

Fig. 11—Circular resistance strip as attenuator.

increased, its approximate value having been established by the choice of the conductivity of the material. The attenuation per unit angle depends only on the ratio of the radii of the outer and the inner edge of the resistance strip. The output impedance then depends on the distance of the moving contact from the grounded edge and on the contact area.

A cross section of a suitable design is sketched in Fig. 12, showing the close resemblance of such an attenuator to a volume-control potentiometer. There are only two essential differences: (1) the inner edge

of the resistance strip is grounded and (2) in order to prevent capacitive stray coupling at high frequencies, the contact arm is separated from the resistor, except for a hole at the point of contact, by a grounded screen rotating together with it.

One advantage of such an attenuator is that it can very reliably be calibrated with direct current. Little deviation is observed from the exponential law, unless the resistance material is inhomogeneous, for attenuations from about 10 to about 50 to 60 decibels. At greater values the attenuation usually tails out and seldom reaches 80 decibels because of the residual coupling between the input and output circuit in the common impedance between the grounded edge and chassis. This impedance may be of the order of 0.01 ohm and thus ceases to be negligible beyond 60 decibels

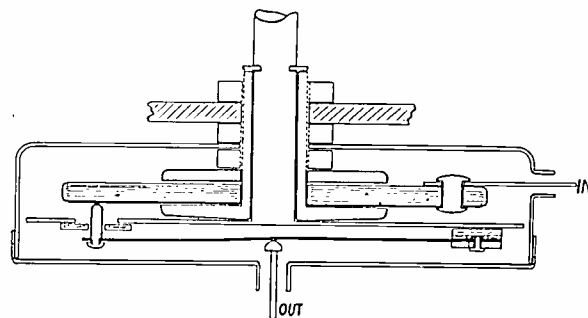

Fig. 12—Cross section through ultra-high-frequency attenuator.

attenuation in an attenuator of 90-ohms matching impedance. This difficulty would not occur in a symmetrical design in which the input terminals are at one end of a resistance strip and both output terminals move parallel to its length.

The calibration of an attenuator embodying a graphite-coated insulator varies slightly with humidity. For applications requiring greater accuracy than a transient-test gear, a modification has also proved useful embodying a thin disk of resistive material similar to that used in "carbon" resistors. Since a contact gliding on such material is very noisy, insertion

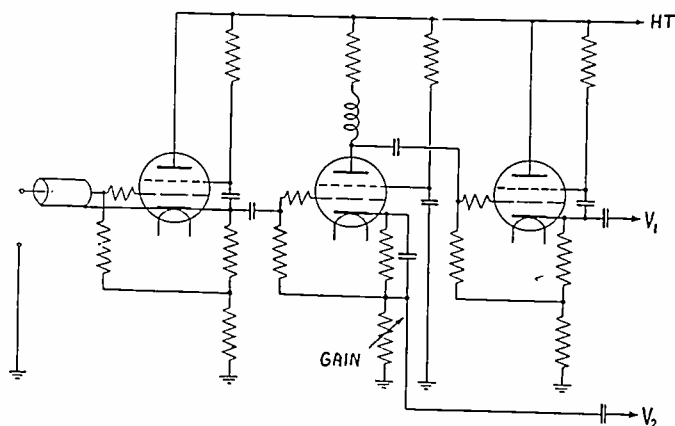

Fig. 13—Output amplifier circuit.

of metal contact studs in metal-sputtered holes is suggested, perhaps in steps of 10 decibels each. Fine adjustment is then attained by varying the shunt resistor in the modulator plate circuit, reading intermediate decibel values on the thermocouple voltmeter.

## THE OUTPUT AMPLIFIER

The output of the tested network or amplifier or receiver is fed via the output amplifier to the vertical-deflection plates of the cathode-ray tube. Both together have a maximum sensitivity of 10.5 millimeters per volt, giving a satisfactory image from a signal of 2 volts. But the amplifier is designed to handle without distortion signals up to 40 volts, as may occur at the grid of the cathode-ray tube of television projection receivers. The output amplifier, Fig. 13, contains three power pentodes of the high mutual conductance of 10.5 milliamperes per volt, each operated at about 30 milliamperes plate current. Only the second tube serves as an amplifier. The first and last tubes are cathode-loaded, to present a low input capacitance to the preceding and a low output impedance to the following stage.<sup>5</sup>

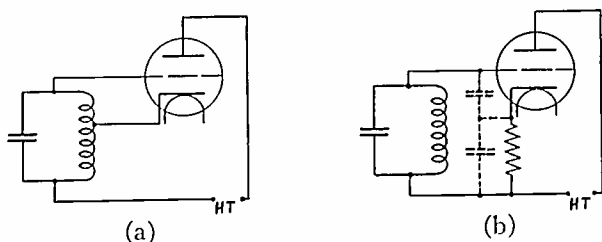

Fig. 14—(a) Cathode-coupled oscillator circuit; (b) cathode follower as oscillator circuit.

The use of this circuit as an input stage of a test gear is far from safe, since it is apt to oscillate at the resonant frequency of the grid circuit. The mechanism of this oscillation is evident from the similarity of Fig. 14 (b) to Fig. 14 (a). But the risk was taken for the sake of presenting to the amplifier under test the lowest possible extra load capacitance and especially to reduce the often considerable lead capacitance as much as possible by cathode-connected screening. The step proved so successful that no change in amplifier response could be detected wherever the test gear was connected and the danger of oscillations was minimized by the insertion of a small series resistor at the grid; occasional extra-long leads required some additional external series resistor to keep the ratio  $L/R$  below the threshold of oscillations.

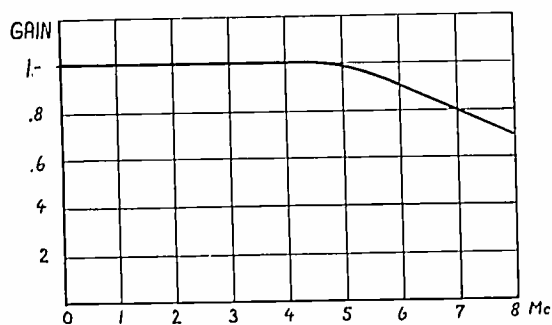

Fig. 15—Amplitude response of the output amplifier.

The output of the first tube is fed to the amplifier stage proper which provides a gain of 26 decibels. Its anode in turn delivers the signal to the grid of another cathode-loaded stage whence it is fed to the  $V_1$  deflection plate of the oscilloscope tube. Fig. 15 shows that

the over-all amplitude response is flat to about 5 megacycles; phase distortion was balanced to a minimum, as is confirmed by the symmetry of the transient response.

The gain of the amplifier is controlled by degeneration; a resistor which is variable to a maximum of 500 ohms is inserted in the cathode lead of the amplifier stage, reducing the gain to 10 decibels. The picture height for very large input signals and low gain may be allowed to be somewhat larger than for low input and full gain. Push-pull deflection is provided for such cases by feeding the signal voltage on the degenerating resistance to the  $V_2$  deflection plate. This push-pull arrangement assures a sharp focus for the largest deflections and gives a larger undistorted picture without calling upon the amplifier to handle a larger control voltage.

Even with such economies in its handling capability the output amplifier consumes much more power than the whole rest of the gear and thus largely accounts for

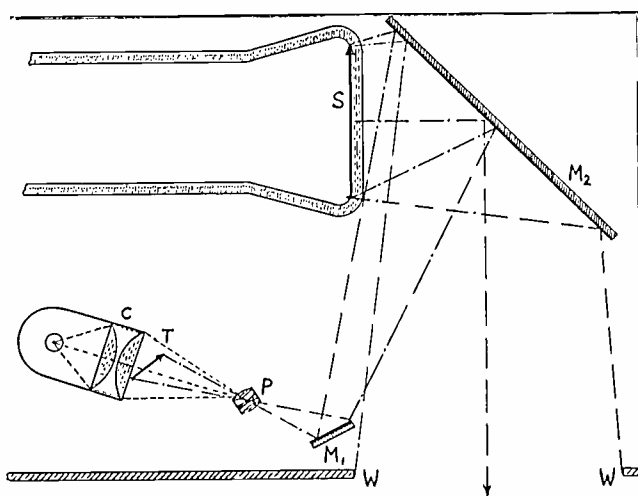

Fig. 16—Space-saving arrangement of scale projection.

the size and weight of the power supply. Any increase in the size of the image or of its absolute brightness by increasing the cathode-ray-tube plate voltage requires larger deflection voltages and reflects immediately in a rapid increase in the size of the output amplifier and the necessary power supply.

## OPTICAL ARRANGEMENTS, SCALE PROJECTION, AND SELECTIVE COLOR FILTERS

Attention to the optical arrangements of an oscilloscope will make even faint images appear surprisingly brilliant. Thus the image is shown in a well-darkened field of view, at the far end of a 10-inch tunnel, which is actually the box of the gear itself. To avoid a very deep box, the cathode-ray tube is arranged with its axis parallel to the front, occupying the back of the box over nearly its whole length. The image is viewed with negligible loss via a surface-aluminized mirror, Fig. 16. The viewing window is closed against dust with a glass plate which is tilted so as never to reflect the image of an external object into any possible direction of observation. In fact it "shows" the reflection from the



matte black inside of the tunnel walls. Even these, though, are not dark enough, if, as the side walls and the bottom, they are exposed to external light sources. Only the inside of the tunnel roof is dark enough; consequently, the top of the glass window is, against first expectations, tilted inwards.

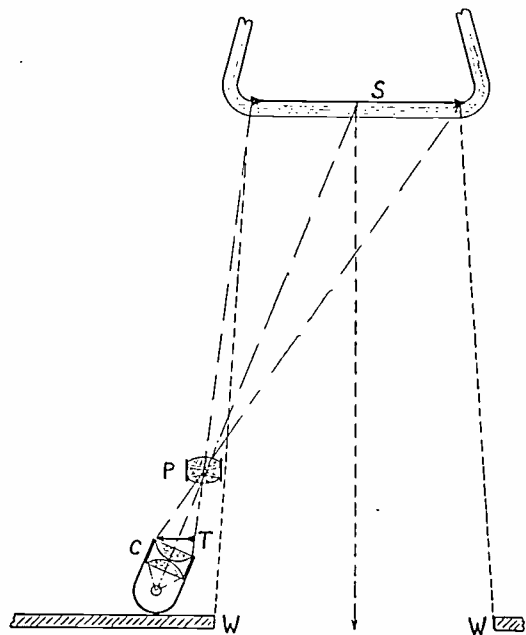

Fig. 17—Scale projection for cathode-ray tubes.

The image appears on a practically black background and the problem of a proper scale arises for the quantitative assessment of the transient response. This scale should have no parallax relative to the fluorescent image and must be luminous itself to be seen on the dark screen. A complete little optical projector is incorporated in the gear; it throws the image of a scale on the front of the cathode-ray tube, using the matte white screen substance itself as a projection screen. The scale projector must be so placed as not to obstruct the line of view of the observers. As back projection through the cone of the tube is not possible with standard tubes, a very oblique projection from the front was adopted, based on the scheme of Fig. 17. The projector approaches the axis of the tube as closely as the window  $W-W$  allows. A photographic negative image serves as the transparency  $T$ , taken with a miniature camera from a scale drawn with black lines and figures on a white background. Unless a specially distorted scale is prepared, the transparency  $T$ , the screen  $S$ , and the projection lens  $P$  will have to be arranged in parallel planes, requiring some rays to pass through the lens under a very oblique angle. The lens must be corrected for this, but slight tilting of the lens towards the center of the screen may be tolerated, as long as the transparency remains within the zone of sharp focus. The transparency is dyed, or backed by a color filter, contrasting with the color of the fluorescent image. For a green image, a light orange filter seems best suited, e.g., Kodak Wratten filter No. 22.

The transparency is illuminated by a bicycle-type lamp in a small lamp house. A double condenser  $C$

focuses the light into the aperture of the projection lens, whereby the cross section of its cone of light must cover the area of the transparency. It is not necessary that the condenser be parallel to the projection lens; this would require a very large condenser of which only a small area would be utilized. Fig. 17 illustrates how a suitably oblique arrangement concentrates all light through the transparency into the lens without in any way affecting the optics of the projection proper. An enlarger lens of 2-inch focal length was used, an aperture  $f/4.5$  being amply sufficient. The transparency of  $22 \times 22$  millimeters is enlarged 4.5 times to  $4 \times 4$  inches, showing a scale of 16 lines per inch at a brightness well below that of the fluorescent image.

The actual layout is shown in Fig. 16, differing from that of Fig. 17 only by the insertion of two mirrors  $M_1$  and  $M_2$ . The optical path is folded into narrow space but otherwise unaffected. The lamp house with condenser, the transparency with color filter, the projection lens and the first mirror are each mounted in the center of movable U-shaped brackets whose side walls are held by screws and nuts through crossed slots between the parallel walls of a U-shaped subassembly chassis.

The optical arrangements described allow comfortable observation of the image from a fair distance and under any likely room illumination. Yet the absolute brightness of the trace is less than in the "black" parts of an average television picture. This is confirmed by photographic comparison; the apparently brilliant image required an exposure of at least 10 seconds at  $f/4.5$  on the fastest available film.

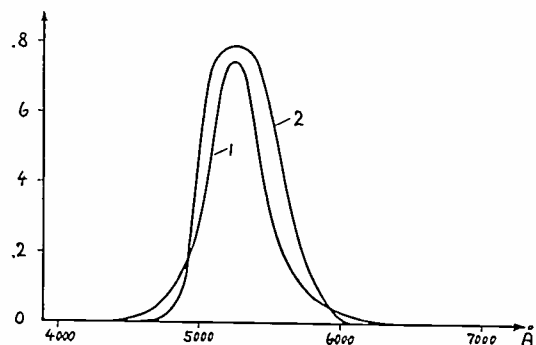

Fig. 18—Color characteristics of a willemite screen (1) and of a selective green filter (2).

In some cases, especially for observation of the image from widely varying angles, the more usual arrangement must be adhered to, where the cathode-ray-tube screen is mounted flush with the front of the apparatus. Under such conditions, use of selective color filters will yield considerable increase in apparent image brightness. It presupposes that the light of the fluorescence is concentrated in a relatively narrow spectral band, e.g., the green for willemite screens, Fig. 18, curve 1. Yet the light from the screen consists not only of this but also of the white external light reflected by the matte white screen material. If now a color filter is arranged in front of the screen, with a characteristic as Fig. 18, curve 2, so chosen that

nearly all the green light is passed, nearly all the other wavelengths are absorbed, then the green image remains almost unattenuated and all the other colors appear blacked out, since the external light has to pass through the color filter twice, once incident and once reflected. Thus the fluorescent image will now appear on a very dark greenish background, provided by the green light waves contained in the external light. But the advantage is even greater than simply due to the optical analogue of the selectively tuned radio link, because the eye sees as green also many combinations of colors other than green which the filter suppresses. Therefore even the apparent content of green in the background light is reduced by the filter. Kodak Wratten filter No. 58 has proved suitable in conjunction with green willemite screens.

### PERFORMANCE

The gear is housed, with ample space, in a box  $23 \times 10 \times 15$  inches, the dimensions dictated by the length of the cathode-ray tube. It contains a total of 9 amplifier tubes, besides the oscilloscope and 2 rectifiers. All controls are brought to the front though most of them are seldom used. The focus control (1) of the cathode-ray tube is a preset control, and so is the shunt in the ultra-high-frequency modulator plate circuit (2). The control of the sweep frequency (3) is variable only over a narrow range; its only purpose is to make a television-receiver synchronizing unit hold onto the square waves without altering its controls when visual inspection of the edges of vertical bars is desired. The other controls are the ultra-high-frequency tuning (4) and attenuator (5), the square-wave-generator output control (6), the 4-position switch (7), and the output-amplifier gain

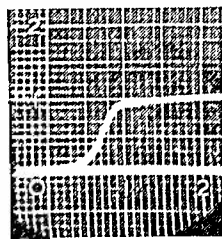

Fig. 19—Transient response of the test equipment itself; 3 divisions = 0.1 microsecond.

control (8). The switch for insertion of the calibrated timing-pulse delay filter (9) is only used to check the calibration. Thus the position control (10) to align the image with a suitable scale division is actually more often used than all others together.

Two immediate tests are available to check the proper working of the apparatus. By connecting the output of the square-wave generator with the input of the output amplifier the "perfect" transient can be observed. It is shown in Fig. 19, rising from 0.10 to 0.90 of its final value in 0.10 microsecond without overshooting.

This minimum transition time is that of the gear itself; its value is to be taken into consideration if

amplifiers of unusually good performance are tested. Yet transition times are not simply additive. The value of the over-all transition time of several amplifiers in cascade is governed by the shape of the individual transient responses; it increases to about 1.4 if two amplifiers with equal transient responses of good and usual shape are cascaded.<sup>6</sup> Thus an amplifier with a transition time of 0.10 microsecond would, with the gear described, result in a measured transition time of 0.14 microsecond.

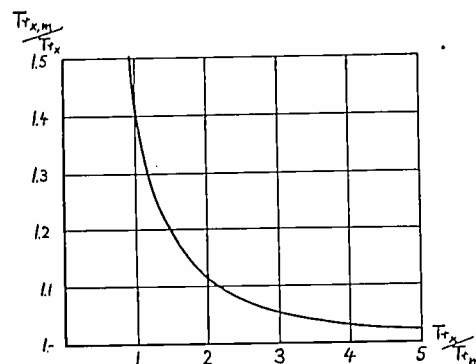

Fig. 20—Correction required by the observed value  $Tr_{x,m}$  if the transition time  $Tr_x$  of the tested amplifier is comparable to that of the measuring equipment  $Tr_m$ .

The correction decreases quickly for amplifiers having longer transition time, as shown by Fig. 20, in which  $Tr_x$  is the transition time of the amplifier under test,  $Tr_m$  the known transition time of the measuring gear, and  $Tr_{x,m}$  is the over-all transition time of both in cascade. The curve shows, that for the gear described, the ratio  $Tr_{x,m}/Tr_x$  is 1.11, indicating a correction of 11 per cent, if the true transition time of the amplifier under test is 0.20 microsecond.

A test object according to Fig. 21 is provided for checking the time scale of the sweep. The simple filter section, used as a link between the output of the

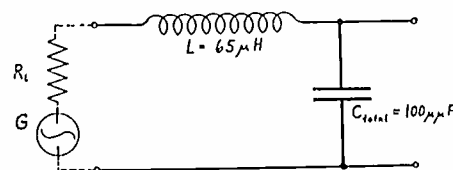

Fig. 21—Test object for time scale calibration.

square-wave generator and the input of the output amplifier, consists of a series coil and a load condenser and constitutes together with the output impedance of the square-wave generator a damped resonant system tuned to 2 megacycles. When excited by the square waves, it will oscillate with slowly decaying amplitude, the crests of the oscillation providing timing marks of 0.5 microsecond separation. This is shown in Fig. 22 which is pieced together from three photographs, taken with three settings of the position control so as to show the whole trace of the sweep. (The trace appears about twice as thick on the picture as to

<sup>6</sup> Heinz E. Kallmann, R. E. Spencer, and C. P. Singer, "Transient response in television," *PROC. I.R.E.*, vol. 27, p. 613; September, 1939. (Summary.)

the eye, due to overexposure of the image in favor of the projected scale.) The sweep is adequately linear up to about 2 microseconds, then retards quickly, overshoots a few per cent and then remains stationary until the—unobserved—down transition starts. The base line is due to the discharge of the sweep-circuit capacitance when the sweep-oscillator tube starts conducting.

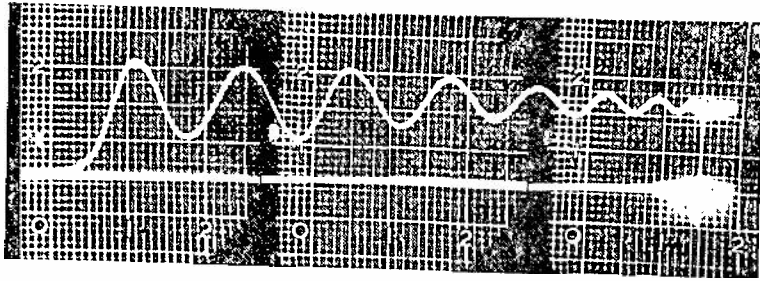

Fig. 22—Transient response of a test object resonating at 2 megacycles per second.

Insertion of the calibrated time-delay filter distorts the image; the right half and the base line remain unchanged, but the rise on the left and the beginning of the oscillation are moved to the right 0.1 microsecond, i.e., about 3 scale divisions.

#### SOME RESULTS

A variety of television receivers (England, 1938) was tested with the gear described and the results compared with the values implied by the television stand-

ards. It has been shown elsewhere<sup>6</sup> that, for equal vertical and horizontal definition, a transition time from 0.1 to 0.9 final height of 0.15 microsecond is implicitly prescribed by the British Standard of 405 lines, a transition time of 0.10 microsecond by the present American usage of 441 lines. It was found that

- (1) the best commercial receiver, rendering every transmitted detail, had a transition time of 0.22 microsecond, i.e., 70 per cent of the standard response;
- (2) some cheap models had a transition time of 0.75 microsecond, i.e., 20 per cent of the standard response; yet their owners were quite satisfied provided the program matter was interesting; in no case was any disproportion between horizontal and vertical definition noticeable;
- (3) overswing exceeding 4 per cent is annoying in receivers with good gradation, though it may remain unnoticed in "soot-and-whitewash" pictures; and
- (4) flattening of the amplitude response without regard for phase distortion invariably yielded disappointing transient responses since frequencies at and above the beginning of noticeable phase distortion never contributed to the picture. Good phase response and steadily dropping amplitude response were always found best.

## Ultra-Short-Wave Transmission Over a 39-Mile "Optical" Path\*

C. R. ENGLUND†, FELLOW, I.R.E., A. B. CRAWFORD†, ASSOCIATE, I.R.E.,  
AND W. W. MUMFORD†, ASSOCIATE, I.R.E.

**Summary**—Continuous records of ultra-short-wave transmission on wavelengths of 2 and 4 meters, over a good "optical" path, have shown variations in the received signal strength. These variations can be explained as being due to wave interference; an interference which varies with the changes in the composition of the troposphere.

Some of the variations are due to changes in the dielectric-constant gradient of the atmosphere near the earth. Other variations are explicable in terms of reflections from the discontinuities at the boundaries of different air masses. The diurnal and annual meteorological factors which affect the transmission are discussed.

#### INTRODUCTION

THIS paper gives the results of a two-year study of ultra-short-wave transmission over the McCatharn's Hill-Beer's Hill "optical" path. The work was planned for the purpose of finding out what signal stability might be expected in communication

\* Decimal classification: R113. Original manuscript received by the Institute, May 14, 1940. Presented, Fifteenth Annual Convention, Boston, Mass., June 28, 1940; presented, joint meeting, I.R.E.-U.R.S.I., Washington, D. C., April 28, 1940, under title of "A note on the diurnal variation of ultra-short-wave "optical" path transmission.

† Bell Telephone Laboratories, Inc., New York, N.Y.

over a good "optical" path, with well-elevated terminals, and to determine the factors producing instability.

Some experimental work had already been done<sup>1</sup> on this path in 1931 and 1932. In fact, continuous observations were made during the night of April 24–25, 1931, in an effort to discover whether or not any signal variations were present. None were observed. Considering the results described in this report, that night was indeed an exceptional one.

#### LOCATIONS, APPARATUS, AND OPERATION

Fig. 1 shows a map and Fig. 2 shows a profile of the McCatharn's Hill-Beer's Hill path. McCatharn's Hill is 2½ miles north of Lebanon, N.J., and Beer's Hill is 2 miles northwest of the Holmdel laboratory building; their spatial separation is 39.2 miles. The earth

<sup>1</sup> Carl R. Englund, Arthur B. Crawford, and William M. Mumford, "Some results of a study of ultra-short-wave transmission phenomena," *Proc. I.R.E.*, vol. 21, pp. 464–492; March, 1933.

curvature shown on the profile map is based on a radius of four thirds the actual earth radius; this is the effective earth radius for the condition of average atmospheric refraction. The resulting air line connecting the two hilltops clears the intervening terrain by at least 200 feet; with no correction for atmospheric refraction the clearance would still be 150 feet.

### Transmitters

The transmitters, operating on wavelengths of approximately 4 meters and 2 meters, were installed at the Lebanon site. These transmitters were not crystal-controlled but were operated from a regulated source of voltage so that their frequency and power output were independent of line-voltage fluctuations. Half-wave radiators, placed at the optimum heights above ground, 9.15 meters for the 4-meter wavelength and 4.33 meters for the 2-meter wavelength, were connected with the transmitters by a rubber-covered 2-wire transmission line. This line had a surge impedance of 90 ohms, and a loss of about 0.3 decibel per meter at 4 meters wavelength. The antenna currents were measured by means of thermocouples connected at the antenna centers. The radiated powers were about one-half watt for the 4-meter wavelength, and from 2 to 4 watts for the 2-meter wavelength. These were convenient values; the power radiated on the 2-meter wavelength was greater than was necessary.

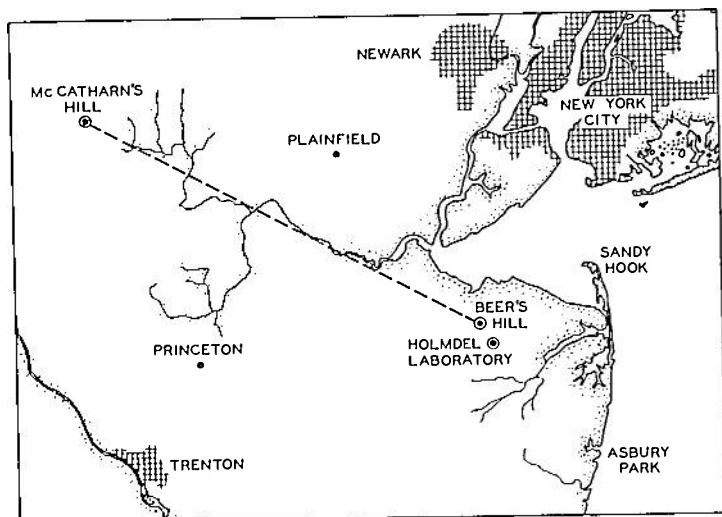

Fig. 1—Map showing location of McCatharn's Hill-Beer's Hill path.

### Receivers

The receivers, located at Beer's Hill, had antennas and transmission lines identical with those at the transmitter site. Here the optimum heights above ground were 6.1 meters for the 4-meter wavelength and 3.45 meters for the 2-meter wavelength. The receivers were of the double-detection type with linear second detectors and were equipped with automatic tuning devices for the beating oscillators. Direct-current amplifiers connected with the receiver outputs were used to drive recording milliammeters (5 milliamperes, full scale). The recorded outputs were proportional to the received signal strengths over a range of 40 decibels.

### Operation

The 4-meter channel was put in operation on January 6, 1937, and the 2-meter channel on January 14, 1937. Most of the recording was done with horizontal polarization for both wavelengths. The 2-meter circuit remained unchanged for the duration of the experiment. The 4-meter channel was shifted to 4.7 meters during October and November, 1937, then back to 4 meters until June, 1938. The receiver was then moved to the Holmdel laboratory. A horizontal rhombic re-

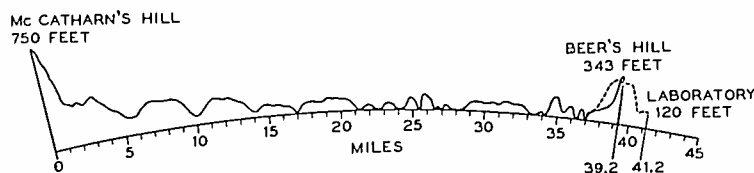

Fig. 2—Profile map of McCatharn's Hill-Beer's Hill path.

ceiving antenna, each leg 21.6 meters long and 8.23 meters above ground, was used here. During June this channel was set on 4 meters. It was then changed to 2 meters for July, August, and September. In October the receiver was converted to a portable receiving set and was used to obtain the data necessary to calculate the signal attenuation over the McCatharn's Hill-Beer's Hill path at the 2-meter wavelength. Following these calibration measurements it was returned to Beer's Hill and was used to record vertically polarized 2-meter transmission for the remainder of the year (1938).

Very little attention was required to keep the circuits in operation. The transmitting site was inspected about once each month. During some months, additional trips were required to make repairs or adjustments on the transmitters or the remote-control receiver. The antenna currents were noted on these trips and were found to be quite constant. The 4-meter-antenna current was recorded continuously for a few weeks with no variations observed. The receiving site was visited on most working days, and on some weekend days as well. At these times the receivers and their antenna systems were checked by means of standard-signal generators located a short distance down the hill from the receiving antennas. (These signal generators were installed July 21, 1937.) The over-all gains of the receivers varied but little from day to day and were not affected by rain or moisture on the antennas and transmission lines.

### Remote-Control Equipment

Apparatus was provided to turn the transmitters off and on by remote control from Beer's Hill. This control circuit operated on a wavelength of 3.5 meters. A motor-driven condenser in the tank circuit of the control transmitter varied the frequency over a range of about 6 megacycles. This frequency-modulated signal was received at the Lebanon site and operated relays which turned the plate supplies for the transmitters on and off. It was found necessary to install

a time-delay relay so that the frequency-modulated signal would have to be received for about 30 seconds before the relays in the plate supplies would operate. This was done after it was found that ignition noise from airplanes and static impulses could shut down the transmitters.

A telephone line connected the Beer's Hill receiving shack with the Holmdel laboratory and the care-

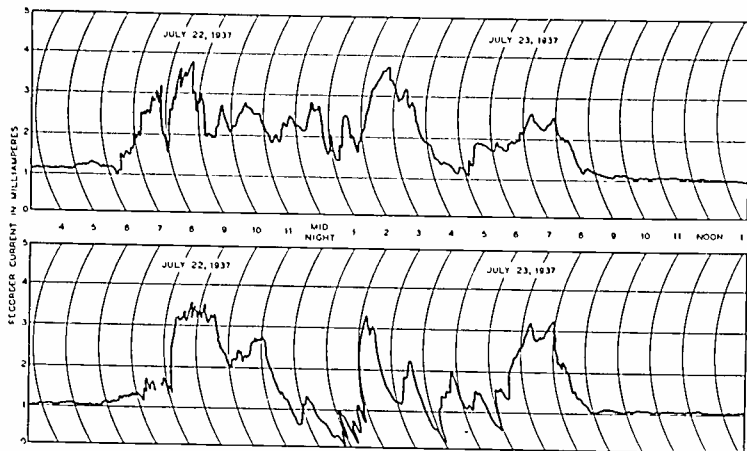

Fig. 3—Reproduction of a section of the original records. Top record is for 4 meters wavelength, bottom record is for 2 meters wavelength. Note the unusual dropout on 2 meters wavelength about 1 A.M. on July 23.

taker's house, where alarm buzzers were located. These buzzers operated when the 4- or 2-meter signals were higher or lower than certain predetermined values. There was therefore a check on the operation of the circuits at all times.

#### Meteorological Equipment

A recording hygrothermograph, located at Beer's Hill, made a continuous record of the temperature and relative humidity of the atmosphere. A recording barometer was located at the Holmdel laboratory. From these records it was possible to calculate and to plot charts showing the variation with time of the dielectric constant of the atmosphere, at the ground.

#### Frequency-Sweep Apparatus

The frequency-sweep apparatus, which was used to measure the heights of reflecting layers affecting the Highlands-East Moriches transmission,<sup>2</sup> was set up on the McCatharn's Hill-Beer's Hill path. No evidence of layers was found on the few nights that observations were made. The pass band of the receiver was flat over about 2 megacycles, so that path differences of less than 75 meters (corresponding to layer heights of less than 1.7 kilometers for this path) could not be measured.

#### EXPERIMENTAL DATA

Fig. 3 is a reproduction on a reduced scale of a section of the original records where the time scale was  $\frac{3}{4}$  of an inch per hour. The ordinate (recorder milliamperes) is proportional to the received signal strength. This sample was not chosen as a representative or an

<sup>2</sup> Englund, Crawford, and Mumford, "Ultra-short wave transmission and atmospheric irregularities," *Bell Sys. Tech. Jour.*, vol. 17, pp. 489-519; October, 1938.

average one but as an extreme one. The ratio of maximum to minimum signal for this night was the largest observed on the 2-meter wavelength. Also, the difference between the fading on the two wavelengths was much greater than usual. The fine-structure fading is unusually pronounced in this record.

The record charts were cut off every two weeks and the data were transcribed in notebooks together with the data from the meteorological instruments. The field-strength data were then replotted with a greatly reduced time scale. (One inch per day compared with  $\frac{3}{4}$  of an inch per hour.) Figs. 4 to 7 are samples of these replots and will be discussed later. Except for a few cases (such as the record shown in Fig. 3), practically all of the signal variations could be reproduced on the reduced-time-scale graphs.

In the paragraphs to follow, data are presented to illustrate diurnal effects, comparison of the 2- and 4-meter wavelengths, seasonal effects, comparison of two receiving sites, comparison of horizontal and vertical polarizations, and the effects of weather conditions. Finally, a time-distribution curve of signal level on 2 meters wavelength for the year 1938 is given.

#### Diurnal Effect

An examination of the records reveals at once that the signal variations were mainly confined to the

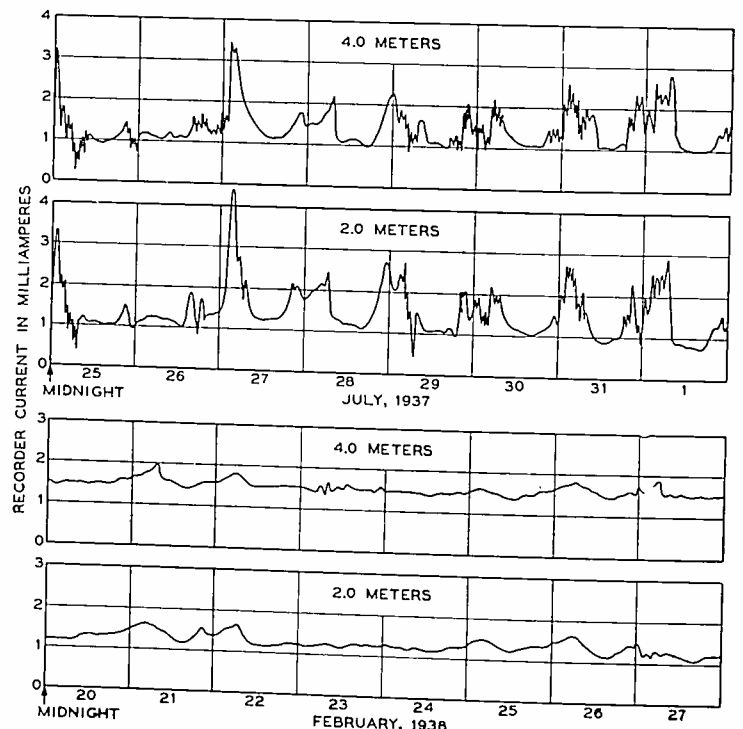

Fig. 4—Replot showing similarity of fading on two wavelengths; also a comparison of summer and winter fading.

nighttime hours with the disturbed periods centered at or a little after midnight. Ordinarily the signals were higher at night than during the day, although occasionally there occurred deep minima or "dropouts," when the signal practically disappeared. These "dropouts" always occurred at night and were usually of very short duration, say 10 minutes. During the daytime, for a period of 4 to 8 hours in length, the signal was usually steady. For example, in Fig. 3 the signal



variations were less than 1 decibel after 9 A.M.; the evening before, the fading did not begin until 6 o'clock. The variation of fading with time of day is shown in Fig. 8. In preparing this figure, the ratios (expressed in decibels) of the highest and lowest signal levels during the 2-hour periods indicated were obtained for each day of the month. The median<sup>3</sup> values of these ratios were then found and are plotted as ordinates. Thus for the month of August, 1938, there was a period of six hours, 10 A.M. to 4 P.M., when the median signal

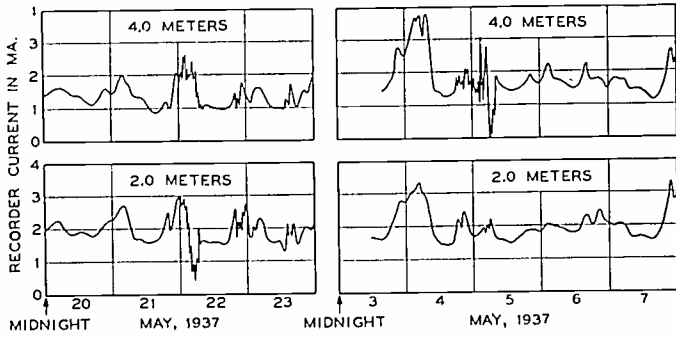

Fig. 5—Replot showing two instances when fading was different on two wavelengths.

variations over a 2-hour period were less than 1 decibel. Similarly in February, the bihourly fading range was smaller during the daytime hours with the minimum coming about two hours later than in August.

*Comparison of Two and Four Meters Wavelength*

The 2-meter and 4-meter signals were usually very similar in their major variations. This may be seen in Fig. 4 and in the two upper curves of Fig. 7. Ordinarily, the fine structure, i.e., the smaller and more rapid variation, was different on the two wavelengths. Occasionally, and particularly when one or the other signal experienced a "dropout," there was no similarity between the two. Fig. 3 has a good example of one of

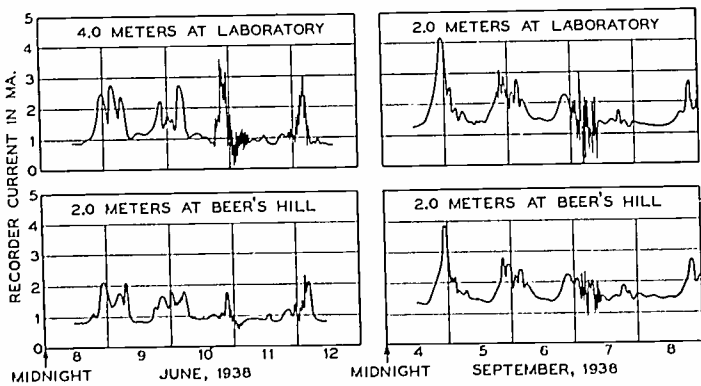

Fig. 6—Replot showing comparison of fading observed at Beer's Hill and the Holmdel laboratory, 220 feet lower than Beer's Hill and shielded by hills. A difference in the amplitude variations of the fine structure is evident.

these times. Fig. 5, shows two other occasions when fading was markedly different on the two wavelengths. There were only 14 such occasions between February 1, 1937, and June 1, 1938, at which time the 4-meter receiver was moved to the Holmdel laboratory, as already stated.

<sup>3</sup> The signal is half of the time greater and half of the time less than the median value.

*Seasonal Effects*

The amount and the severity of fading varied greatly with the time of year, being greatest during the summer months. Fig. 4 gives a comparison of the

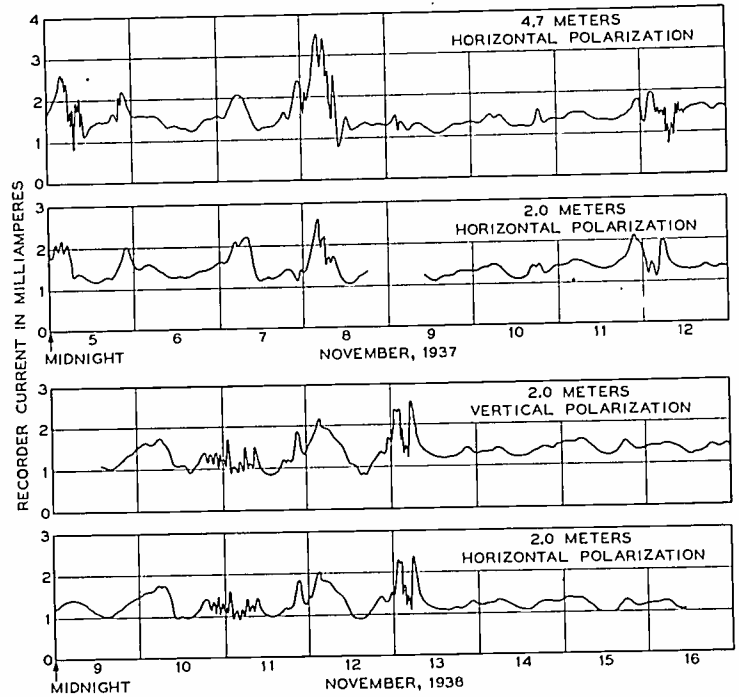

Fig. 7—Above: Replot showing the similarity between the fading on 4 and 2 meters wavelength. Below: Replot showing the similarity of fading on horizontal and vertical polarization on 2 meters wavelength.

signal variations observed in July, 1937, and February, 1938. Another comparison may be made in Fig. 8 between the bihourly fading ranges for August, 1938, and February, 1938.

In discussing the diurnal effect it was pointed out that for a period of a few hours during the daytime the signals were quite steady. The value of this steady field strength was chosen for each day and expressed

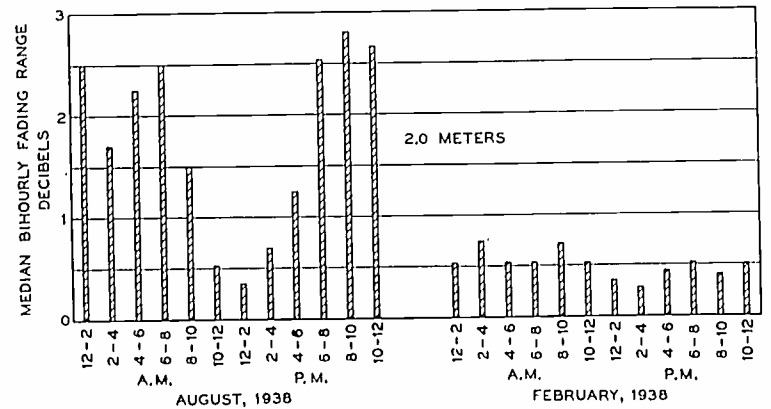

Fig. 8—Chart showing that the fading was greater during the night than during the day and was worse in summer than in winter.

in decibels above the free-space field strength. The solid curves in Fig. 9 show the day-to-day variations of this midday signal level. The vertical lines connect the highest and lowest signal values for the day. The absence of a vertical line indicates that the record was incomplete or that the receiver was not calibrated with the standard-signal generator on that day. The lower graph is for 2 meters wavelength, horizontal

polarization, and runs from June 21, 1937 (when the standard-signal generators were installed), to January 1, 1939. The upper graph is also for horizontal polarization but for different wavelengths and receiver locations, as indicated on the drawing.

may be observed that practically all of the deep fades and "dropouts" came during the summer months.

Fig. 10 shows more clearly the seasonal trend in the fading ranges. Here are plotted the median values of the daily fading ranges for each month. The summer-

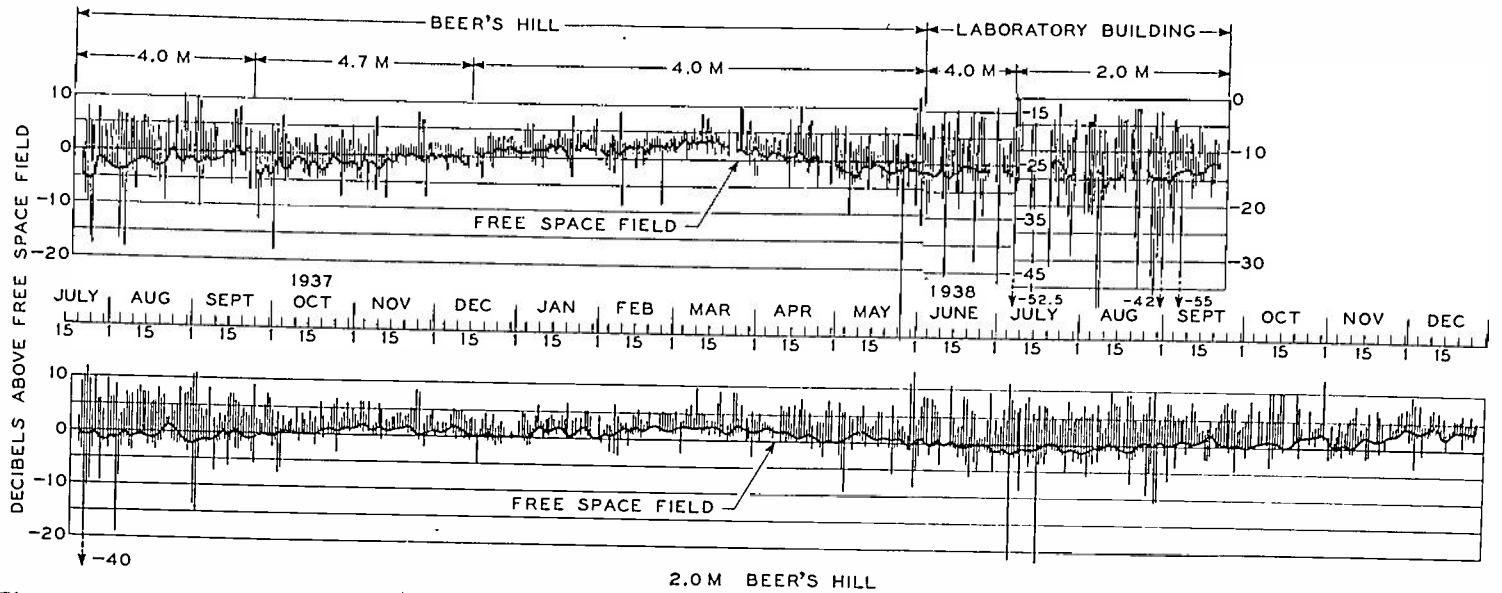

Fig. 9—Chart showing daily fading range and steady midday level. The vertical lines terminate on points indicating the highest and the lowest signals observed for the day. The steady midday level is indicated by the solid curves.

The solid curves (midday signal levels) show a definite seasonal trend. The 2-meter wavelength curve lies below the free-space value in the summer of 1937 and above the free space value in the fall and winter; the cycle repeats in 1938. This seasonal variation is

time maximum and wintertime minimum are apparent for both wavelengths. This figure also gives a comparison of the fading on 4 meters with that on 2 meters wavelength. The median fading ranges are very nearly the same (February, 1937, to June, 1938).

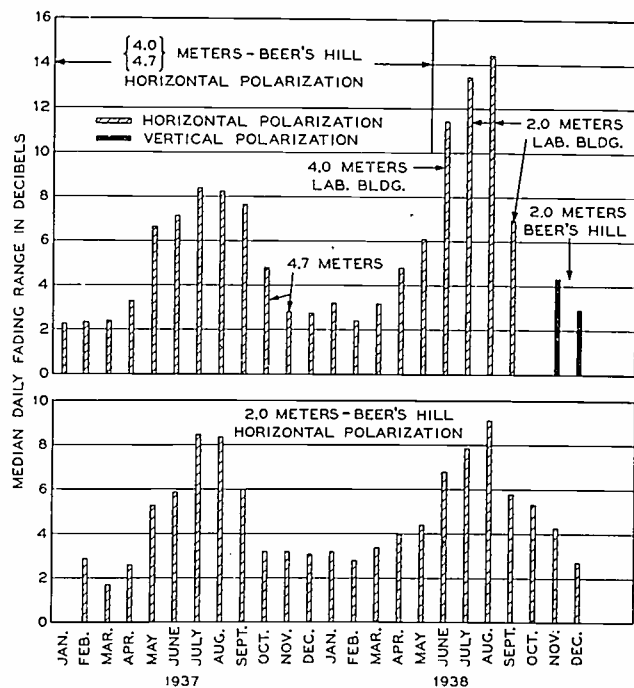

Fig. 10—Chart showing the seasonal trend of the fading on both wavelengths. The ordinates for July, August, and September, 1938, show that the fading was greater at the Holmdel laboratory (120 feet elevation) than at Beer's Hill (343 feet elevation). The ordinates for November and December, 1938, show that the fading was practically independent of polarization.

even more pronounced for 4 meters wavelength. The vertical lines, representing daily fading ranges, also show a seasonal variation, with the greatest daily fading ranges concentrated in the summer months. It

#### Comparison of Two Receiving Sites

In June, 1938, the 4-meter receiver was moved to the Holmdel laboratory, thereby increasing the transmission path by two miles and decreasing the receiving antenna height by about 220 feet (see Fig. 1). Also in the new location the receiver was screened from the transmitter by the Mount Pleasant Hills. The signal level here was about 24 decibels below that at Beer's Hill. The difference in signal level was about 14 decibels after the receiver was shifted to 2 meters wavelength. The fading at the new location was worse than that at Beer's Hill. While the general shape of the signal variation was similar, the amplitude range was larger, and the fine-structure fading was greatly increased. This is illustrated in the replots of Fig. 6. A comparison of the daily fading ranges at the two locations may be made from Fig. 9 for the months of June, July, August, and September in 1938. A comparison of the median daily fading ranges for the same months may be made in Fig. 10.

#### Comparison of Horizontal and Vertical Polarizations

During November and December, 1938, simultaneous records were made of vertically and horizontally polarized 2-meter waves. The 2-meter transmitter was connected to crossed antennas and at Beer's Hill the receiving antennas were located at the same height above ground. The signal variations were practically

identical for the two polarizations. The two bottom curves of Fig. 7 are replots of the original data for a somewhat disturbed period in November, 1938. The coincidence is very good; much better than that of the two upper curves of the same figure which are both for horizontal polarization but different wavelengths, and which were obtained during a similar disturbed period in November, 1937.

The median daily fading ranges for the two polarizations were nearly the same as may be seen in Fig. 9 (November and December, 1938).

*Weather Effects*

A relationship between the stability of the signals and the weather was observed. For example, the large signal variations and "dropouts" occurred on clear summer nights when there was little or no wind; often there was a slight fog layer over the low-lying land. The reverse was not true however; severe fading was not always present on nights answering the above description. Wind and rain seemed to decrease the amount of fading. According to the Monthly Meteorological Summaries for New York City, there were 106 nights during 1938 when a trace or more of precipitation was recorded between the hours of 6 P.M. and 6 A.M. On only fifteen of these nights was the 2-meter fading range as great as the median value for the month and on eight of these fifteen nights the amount of rainfall was very slight; only a trace during four hours or less of the 12-hour period. The fading on these fifteen exceptional nights was never severe and no "dropouts" occurred.

Local thunderstorms over the transmission path sometimes caused noticeable signal variations during the midday hours. One example of this may be seen in Fig. 4. On July 26, 1937, a thunderstorm occurred

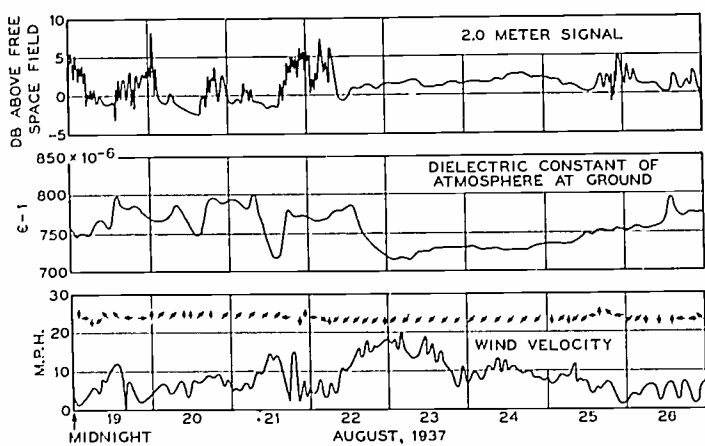

Fig. 11—A relationship between weather and fading occurring during the northeaster of August 22-25, 1937.

Top Curve: Observed 2-meter signal strength.  
 Middle Curve: Dielectric constant of the air at Beer's Hill.  
 Bottom curve: Wind velocity at Newark airport. The arrows indicate the direction of the wind.

in the afternoon and both signals showed variations at a time of day when they were usually steady.

A more general storm had a blanketing effect on the fading. This is illustrated in Fig. 11. The top curve is

a replot of the 2-meter signal data which, for this figure, have been converted to decibels above the free-space field strength. The variation of the dielectric constant at Beer's Hill and the velocity and direction of wind as measured at Newark airport are given in the curves at the bottom of the figure. The fading was about normal for August until the twenty-second when a northeaster arrived and lasted for three days. During this time the fading was absent and did not

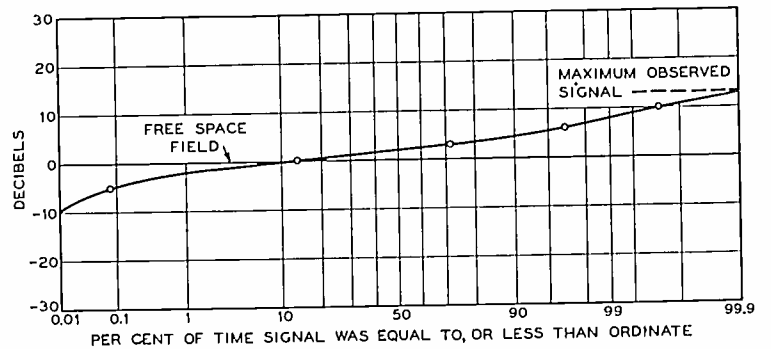

Fig. 12—Time distribution of the signal strength on 2 meters wavelength for the year 1938.

return until the night of August 25 when the storm was over. There were several other occasions when a decrease in the daily fading range coincided with bad weather conditions. A few of these were in 1937, August 23-24 (the northeaster), September 13 and 28, and October 27-28. In 1938, March 16-17, April 6-7-8-9, May 14-15, June 26-27-28, August 10-11, and September 21, the day of the New England hurricane.

*Distribution of Signal Strengths*

Fig. 12, shows the time distribution of signal strength on 2 meters wavelength for the year 1938.

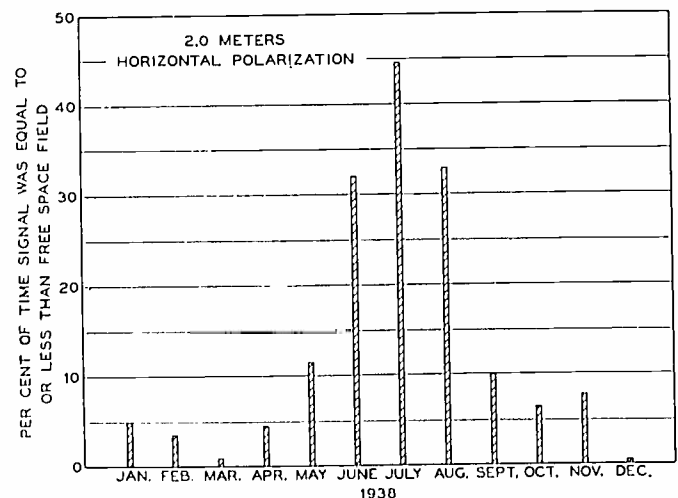

Fig. 13—Chart which shows the per cent of time that the signal was equal to or less than the free-space field for each month of 1938.

The median value of the field strength was 2 decibels above the free-space field. The signal was less than the free-space field for 13 per cent of the time, and was 5 decibels below the free-space field for only 0.1 per cent of the time. Practically all of this 0.1 per cent came at night during the summer months. Fig. 13 shows how 13 per cent of the total time (representing the time

the signal was below the free-space level) was distributed among the months of the year. This curve indicates that most of the lower signal levels were concentrated in the summer months.

#### DISCUSSION OF RESULTS

The results just described agree in essentials with the theory which was developed to explain the observations made on the 70 mile Highlands-East Moriches transmission path,<sup>2</sup> although the fading characteristics of the two paths are different. This theory assumes that the received signal consists of a directly propagated component and one or more components which have been reflected at boundaries existing between different air masses. By the directly propagated component is meant the diffracted field for the case of a long "nonoptical" path and the combined direct and middle-distance ground-reflected radiations for the case of an "optical" path. For both cases, the amplitude of this component will vary with the amount of refraction introduced by the lower atmosphere.

The long indirect path will be affected by air-mass boundary reflections which will not influence the "optical"-path transmission because of the difference in the amplitudes of the directly propagated component in the two cases. For example, the directly propagated (diffracted) field for the Highlands-East Moriches path was some 50 decibels below the free-space value. The reflection coefficient of an air-mass boundary could, therefore, be quite small and still give rise to a reflected component of the same order of magnitude as the diffracted field. Discontinuities in the dielectric constant of the atmosphere of the order of  $10^{-5}$  occurring at boundaries at heights of 1 to 3 kilometers could influence the received signal strength. The situation is much different for the McCatharn's Hill-Beer's Hill circuit. Here the directly propagated field component is not very much different from the free-space value. This means that the reflection coefficient of a boundary must be nearly unity to produce a reflected component equal to the directly propagated component. For this to happen the layer must be quite low so that the angle of incidence at the layer is very near grazing, or the discontinuity must be very large. A discontinuity of  $10^{-5}$  would have to be lower than an altitude of 275 meters (900 feet) to have a reflection coefficient of unity. Even for a discontinuity of  $10^{-4}$  (which may occur at times) the boundary has to lie below 490 meters (1600 feet) to give unity reflection coefficient. For a layer at this height, the path difference between the direct and boundary-reflected components will be less than 3 meters (10 feet) and the presence of the layer cannot be detected with our frequency-sweep apparatus.<sup>4</sup>

#### *Diurnal and Seasonal Effects: Wavelength Comparison*

The outstanding diurnal effect for the McCatharn's

Hill-Beer's Hill path was the rise in the general signal level and the concentration of the signal variations in the nighttime hours. This signal rise and the slow fading can be explained satisfactorily by variations in the amount of atmospheric refraction during the day. The effects of atmospheric refraction may be taken into account by substituting for the actual earth radius an "effective" radius which increases with the amount of atmospheric refraction, i.e., with the negative gradient of the dielectric constant of the atmosphere.<sup>5</sup> An increase in this fictitious earth radius decreases, in effect, the height of the earth bulge between the transmitter and the receiver, thereby increasing the path difference between the direct and the middle-distance ground-reflected radiations. For the McCatharn's Hill-Beer's Hill path, an increase in this path difference increases the received signal strength on both 2 and 4 meters wavelength.

According to calculations based on free-air data taken at Mitchel Field, L. I., and at Lakehurst, N. J., negative gradients of dielectric constant as large as  $200 \times 10^{-6}$  may occur within the first half kilometer of the atmosphere, during the summer months. These free-air data were taken in the early morning hours (usually between 4 and 6 o'clock) when the dielectric-constant gradient might be expected to have a large value because of surface cooling throughout the night. During the day, surface winds and vertical convection, due to surface heating, tend to produce a more or less thorough mixing of the atmosphere near the ground, and the dielectric-constant gradient should then have a minimum value (approximately  $30 \times 10^{-6}$ , due to the normal pressure gradient). For this path, a change from minimum atmospheric refraction to that corresponding to a dielectric-constant gradient of  $200 \times 10^{-6}$  per kilometer should increase the received signal strength 7.7 decibels on 4 meters wavelength, and 7.0 decibels on 2 meters wavelength. The largest observed diurnal variations were greater than these values; evidently reflections at low-lying air-mass boundaries also produce an increase in the received signal during the night. Vertical convection in the daytime will dissipate any low-altitude reflecting layers that may have formed during the night, just as it will prevent large dielectric-constant gradients in the daytime. This turbulent condition of the atmosphere will reach a maximum after midday, coinciding with the time of least fading as shown in Fig. 8.

Occasionally a degree of correlation was observed between the signal level and the dielectric constant of the atmosphere at the ground. Since the received signal increases with the gradient of the dielectric constant, and since, as shown by the Weather Bureau data, the dielectric constant at an altitude to say one-half kilometer does not change very much from day to day, particularly during settled weather conditions,

<sup>4</sup> Neither can the presence of the layer be detected with pulses that cannot resolve a delay of  $10^{-8}$  second.

<sup>5</sup> J. C. Schelleng, C. R. Burrows, and E. B. Ferrell, "Ultra-short-wave propagation," *PROC. I.R.E.*, vol. 21, pp. 427-463; March, 1933.

such a correlation might be expected except when masked by boundary-reflected signal components. One of these periods of good correlation is illustrated in Fig. 14. The curve at the top is the observed 2-meter signal, and the bottom curve is a plot of the dielectric constant. The dielectric constant at an altitude of one-half kilometer was obtained from the free-air data taken by the Weather Bureau at Mitchel Field and Lakehurst. Only one value was available for each day, but this did not change much from day to day, and for the purpose of calculation it was assumed to remain constant during the day. The dielectric-constant gradient was then obtained and a calculation was made of the received 2-meter signal. This is the middle curve of the figure. The agreement with the observed signal variation is fairly good.

For an over-water path, such as the Highlands-East Moriches one, there is little vertical convection, the temperature of the ocean surface remaining nearly constant throughout the day. The dielectric-constant gradient of the air over the ocean is then probably the same, day and night. Moreover, air-mass boundaries at altitudes of from 1 to 3 kilometers, which affected the Highlands-East Moriches transmission, are likely to be present in the daytime as well as the night. A diurnal effect for over-water transmission is therefore likely to be less than for over-land transmission. This was our observation.

The variations in dielectric constant shown in Fig. 14 for December, 1937, are small compared with those shown in Fig. 11 for August, 1937. These data are more or less typical of the variations observed in

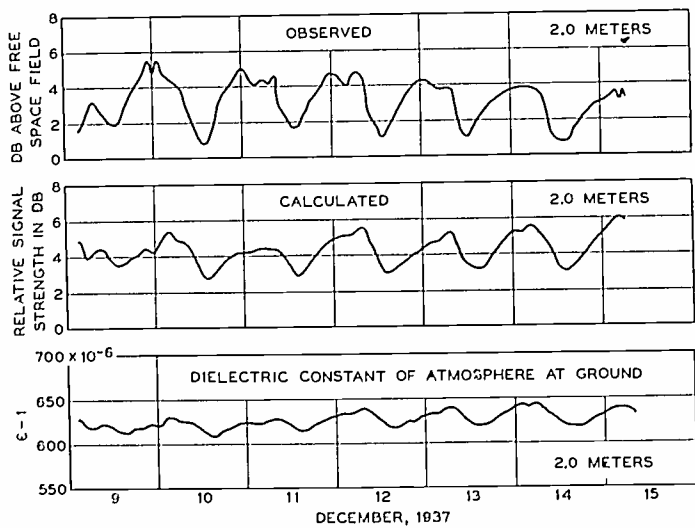

Fig. 14—There were times when a degree of correlation was observed between the signal strength and the dielectric constant of the air at Beer's Hill. The top curve shows the observed signal, the bottom curve, the dielectric constant of the air at Beer's Hill, and the middle curve shows the calculated value of field strength as explained in the text.

summer and winter. Not only the dielectric-constant at the ground but also the dielectric-constant gradient varies more in the summer than in the winter. The free-air data show that the gradient varies from 0 to  $200 \times 10^{-6}$  per kilometer in the summer and from  $50 \times 10^{-6}$  to  $100 \times 10^{-6}$  in the winter. On the McCath-

arn's Hill-Beer's Hill path and at 2 meters wavelength, the corresponding signal-strength levels for these gradients are  $-7.1$  decibels to  $+1.1$  decibels above the free-space field in the summer, and  $-4.8$  decibels to  $-2.6$  decibels above the free-space field in the winter. The observed larger diurnal variations in the summer and the higher midday signals in the winter can thus be explained.

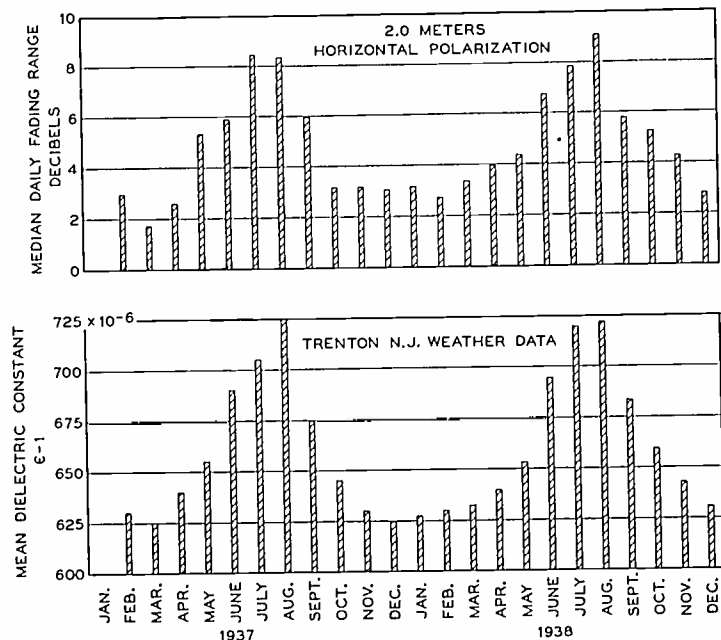

Fig. 15—Chart showing correlation of the median daily fading range with the mean dielectric constant of the air calculated from the Trenton, N. J., weather data.

The observed seasonal variations of the fine-structure fading and the dropouts can be accounted for by air-mass boundary reflections. The effect of these boundaries is greater when the water-vapor content of the atmosphere is high. This occurs in the summertime; the dielectric-constant gradient, as well as the dielectric constant of the atmosphere at the ground, is also larger during the summer months. Thus the fading in the summertime should be greater for two reasons: larger variations in (atmospheric) refractivity, and greater effects from air-mass boundary reflections. The correlation between fading range and the dielectric constant at the ground is shown in Fig. 15. The graph at the top of the figure shows the median daily fading ranges on 2 meters wavelength for each month of 1937 and 1938 (replotted from Fig. 10). The bottom graph gives the mean value of the dielectric constant (minus one) of the atmosphere at the ground. These were calculated from the mean temperature, relative humidity, and atmospheric pressure for each month as reported in the Monthly Meteorological Summaries of Trenton, N. J.

It was stated earlier that, for the McCatharn's Hill-Beer's Hill path, variations in atmospheric refraction should have practically the same effect on 2 and 4 meters wavelength, and the observed major signal variations were about the same. To account for the times when the fading was markedly different (Fig. 5 for example), the presence of an air-mass



boundary-reflected component is required. Reflecting layers will explain the more rapid fine-structure fading, which was different for the two wavelengths, and will also account for the exceptionally high signal levels occasionally observed. Discontinuities of something less than  $100 \times 10^{-6}$  at heights below 1600 feet can explain the few times when maximum signal was observed on one wavelength and minimum signal on the other. Smaller discontinuities, or those existing at somewhat higher altitudes will account for the faster, smaller fine-structure fading. Low-lying layers, for which the path difference between the directly propagated and the boundary-reflected components is very small, have much the same effect on 2 and 4 meters.

On one night, July 22–23, 1937, the 2-meter signal had a maximum of 11 decibels above and a minimum of 40 decibels below the midday level (see Fig. 3). Evidently the direct and the boundary-reflected components were nearly of the same amplitude so that with a change in the height of the boundary, the two components moved from a condition of phase addition to one of opposition. A rough calculation indicates that a change in layer height from 1050 feet to 1300 feet could accomplish this.

#### *Comparison of Two Receiving Sites*

If the amplitude of the directly propagated component is reduced, the presence of boundary reflections should be more clearly exhibited and an increase in fading should result. When one of the receivers was moved from Beer's Hill to the Holmdel laboratory, the directly propagated component was reduced about 14 decibels (at 2 meters wavelength) due to the low antenna height and the screening effect of the Mount Pleasant Hills. The boundary-reflected components should not have suffered so much attenuation since they arrived at a greater angle above the horizontal, and should, therefore, be more nearly equal to the direct component at this location than they were at Beer's Hill. The fine-structure fading should then be more pronounced and deep fades and dropouts should be more numerous. These effects were observed (see Figs. 6 and 9). During July, August, and September, 1938, there were seven nights when the 2-meter signal at the laboratory had fades as much as 20 decibels below the daytime level, compared with two such occasions for the Beer's Hill reception; on three of the seven nights the depth of the fades was more than 40 decibels.

It may be observed in Fig. 10, that the difference in the median daily fading ranges at Beer's Hill and the laboratory building was much smaller in September than in July and August. As winter approached, the number and the size of reflecting boundaries would be expected to decrease, so that during the winter months the fading ranges at the two locations should be nearly the same.

#### *Comparison of Horizontal and Vertical Polarization*

The effect of polarization on the McCatharn's Hill-Beer's Hill transmission is of second-order importance. The reflection coefficient of the earth near the middle of the path is almost the same for horizontal and vertical polarization at the small angles of incidence involved. The directly propagated signal component, as well as the variations of that component caused by changes in atmospheric refraction, should, therefore, be the same for the two polarizations. This is also true for the case of reflections from low-lying air-mass boundaries, since, for near-grazing incidence, the reflection coefficient of the boundary is the same for both polarizations.

For near-grazing reflection at an ocean surface, the reflection coefficient of a horizontally polarized radiation is greater than that of a vertically polarized one. Consequently for the nonoptical, Highlands-East Moriches path, the directly propagated component was much weaker with horizontal polarization than with vertical polarization. On the other hand, the air-mass boundary-reflected components were much the same on the two polarizations, particularly for boundaries below about 2.5 kilometers. The observations were that horizontal polarization generally showed the worse fading on the over-water path, while the two polarization records were nearly identical for the McCatharn's Hill-Beer's Hill path.

#### *Weather Effects*

During periods of stormy weather, one would expect the lower atmosphere to undergo thorough mixing. Large dielectric-constant gradients and low-lying air-mass boundaries should not be present, and the usual diurnal effect should be absent. Our observations were in agreement with this.

#### CONCLUSION

It has been shown that the ultra-short-wave transmission phenomena observed during studies conducted on the "optical" McCatharn's Hill-Beer's Hill path can be accounted for by changes in the composition of the lower atmosphere. The different transmission characteristics of the longer, over-water, Highlands-East Moriches path is another phase of the same phenomenon.

In elaborating this explanation we have used the data obtained by the Weather Bureau airplanes at Mitchel Field, L. I., and at Lakehurst, N. J. These data consist of pressure, temperature, and relative-humidity readings taken at "significant levels" which are relatively well spaced in altitude. There is probably some instrument lag; it is difficult to detect air-mass boundaries without continuous recording, and only one air-sounding is made each day. Moreover, the air fields are not in our immediate neighborhood. It is therefore to be expected that, until "on-the-spot"

soundings with continuous-recording apparatus can be carried out, anything like an accurate check of our theory is out of the question.

Since, for an optical path such as the one here described, that portion of the air-mass lying below 1

kilometer is the more important, it is possible that a considerable amount of pertinent data could be obtained by means of captive-balloon technique. This would permit the "micrometer" traverse of an air-mass boundary, if necessary.

## Some Factors Affecting the Choice of Lenses for Television Cameras\*

H. B. DEVORE†, MEMBER, I.R.E., AND HARLEY IAMS†, MEMBER, I.R.E.

**Summary**—The design of a television camera for a particular use involves the selection of a lens which, under the poorest conditions of illumination which are expected, will form a sufficiently bright image to meet the requirements of the pickup tube used. When the size and sensitivity characteristics of the pickup tube and video-frequency amplifier, the required signal-to-noise ratio, and the angle of view of the camera are known, the specifications of the lens can be computed.

If a tube having a sensitive surface of width  $W$  inches and an operating sensitivity of  $s$  microamperes per lumen is to be used in picking up a scene having a surface brightness  $B$  candles per square foot, with a horizontal angle of view  $\alpha$ , the following equations can be used to determine the lens to be used:

$$\text{focal length: } F = \frac{W}{2} \cot \frac{\alpha}{2} \text{ inches}$$

$$\text{numerical aperture: } f = \frac{0.064 W \sqrt{TBs}}{\sqrt{10^6 I_n N}}$$

in which  $T$  is the light-transmission factor of the lens,  $I_n$  is the equivalent root-mean-square noise current at the input of the amplifier used with the tube, and  $N$  is the required signal-to-noise ratio.

The paper discusses the derivation of these equations and includes charts to facilitate computations.

Comparison of predicted results with the observed performance of the apparatus have shown good correlation.

THE public would like to see television pictures of many events, sometimes of subjects that are difficult to transmit. The engineer often wishes to know beforehand whether the camera available will produce the desired results, or how to design one which will. The purpose of this discussion is to outline the factors involved in such a design, particularly matters related to the choice of a lens suitable for the pickup tube which is to be used.

The specifications of the lens are determined by the size and sensitivity characteristics of the pickup tube to be used, the brightness of the scene, the noise characteristics of the pickup tube and the video-frequency amplifier, the required signal-to-noise ratio, and the angle of view of the camera. These factors determine the focal length and diameter of the lens. The lens having thus been specified, it is of interest to determine the depth of field for the system. However, as increasing depth of field and brightness of image impose contradictory requirements on the aperture of a lens, the depth of field can only be increased with a

given pickup tube at the expense of signal-to-noise ratio in the transmitted picture.<sup>1</sup>

The operating sensitivity of a pickup tube may be affected by a number of factors and a direct quantitative comparison of different tubes is, therefore, quite difficult to make. This operating sensitivity, depending on the manner in which the tube operates, may differ greatly from the photosensitivity of the sensitive surface. By the choice of somewhat simplified conditions, measurements may be made which permit a useful estimate of the operating sensitivity. The method of measurement has been described in a recent publication.<sup>2</sup>

A spot of light is made by forming on the sensitive surface of the pickup tube an image of a slit illuminated by a lamp operated at a color temperature of 2870 degrees Kelvin. This color temperature had become standard for phototube data, and so has also been adopted for pickup-tube measurements. The signal from the output of the video-frequency amplifier is observed on an oscillograph which has its horizontal sweep synchronized with the horizontal scanning of the pickup tube. The signal from the slit then appears as a narrow peak superimposed on the base line which represents the signal from the black area of the picture. The amplifier-oscillograph system is calibrated by applying a known alternating current through a small standard resistor in series with the amplifier input. By varying the intensity of illumination in the slit and observing the corresponding signal currents delivered to the amplifier, it is possible to obtain a curve showing the performance of the tube. If the spot of light is moved to any part of a uniformly sensitive surface, the signal output remains constant. Hence, the amplitude of the short pulse of current due to a small spot of light can be taken as a measure of the signal current which would flow continuously if the whole target were lighted.

It has been found convenient to express the operating sensitivity of a pickup tube under given conditions

<sup>1</sup> Harley Iams, G. A. Morton, and V. K. Zworykin, "The image iconoscope," *Proc. I.R.E.*, vol. 27, pp. 541-547; September, 1939.

<sup>2</sup> R. B. Janes and W. H. Hickok, "Recent improvements in the design and characteristics of the iconoscope," *Proc. I.R.E.*, vol. 27, pp. 535-540; September, 1939.

\* Decimal classification: R583. Original manuscript received by the Institute, May 21, 1940.

† Research and Engineering Department, RCA Manufacturing Company, Inc., Harrison, N. J.

as the quotient of the signal current produced at the amplifier input by scanning the slit of light, divided by the light flux required to illuminate the entire picture at the intensity of the slit image. The sensitivity (within a substantially linear part of the characteristic curve) may be expressed in units of microamperes per lumen. This form of expression for tube sensitivity has two advantages. The curves for different tubes may be compared directly; size or type of tube is immaterial. Second, computation of the signal output is simplified. Since the output impedances of nearly all pickup tubes in general use are high compared with normal amplifier input impedances, the signal, expressed in microamperes of modulated current, is independent of the amplifier input resistance which is used. (The noise level in the amplifier, how-

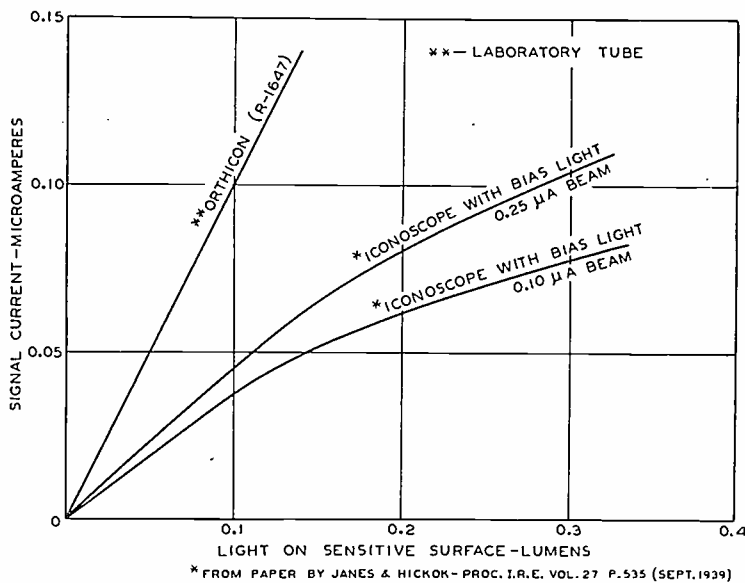

Fig. 1

ever, depends upon the capacitance of the pickup tube and input circuit.) The curves of Fig. 1 represent the performances of some typical pickup tubes.

The tubes for which the characteristics are given in this figure are laboratory models, and the curves are not necessarily to be taken as being representative of these classes of tubes. They are, rather, presented to illustrate a convenient form for representing the sensitivity of a pickup tube.

These curves will not necessarily be accurate for subjects other than a light spot on a black background, but it is believed that the relative forms and positions of the curves will be maintained for other typical scenes.

The signal output which is required of a pickup tube is determined by the background "noise" originating in the pickup tube and amplifying system used with the tube. Since signal and noise will be amplified together, an initially unsatisfactory signal-to-noise ratio can never be improved. The noise generated in the pickup tubes which do not use electron multipliers is small compared with that originating in the amplifier. The simplest input for the amplifier is that in which the signal current of the pickup tube flowing through

an input resistor produces a potential drop which is applied to the grid of the first tube, usually a high-transconductance pentode. The noise current originating in this type of amplifier consists of two significant components: thermal-agitation noise developed in the input impedance, and current fluctuations in the plate circuit of the tube. The mean-square, thermal-agitation-noise current is given by

$$d\bar{i}_t^2 = \frac{4kT}{R} df \quad (1)$$

for a frequency band  $df$ , in which  $R$  is the input resistance,  $T$  the temperature in degrees Kelvin, and  $k$  the Boltzmann constant. The tube noise may be conveniently expressed in terms of the equivalent resistance which, connected between grid and cathode, would cause mean-square current fluctuations of the same magnitude in the plate circuit by reason of thermal agitation, the resistor being assumed to be at 300 degrees Kelvin. Data giving values of this equivalent resistance for a number of tubes are available in the literature. If this resistance is denoted by  $R_t$ , the equivalent mean-square fluctuation current in the input circuit resulting from the tube is

$$d\bar{i}_s^2 = 4kTR_t \left[ \frac{1}{R^2} + (\omega C)^2 \right] df \quad (2)$$

in which  $C$  is the total input capacitance (pickup tube, amplifying tube, and circuit).

The total equivalent input noise current caused by the tube and circuit is obtained by adding (1) and (2)

$$d\bar{i}_n^2 = d\bar{i}_t^2 + d\bar{i}_s^2 = 4kT \left\{ \frac{1}{R} + \frac{R_t}{R^2} + R_t(\omega C)^2 \right\} df. \quad (3)$$

The second term  $R_t/R^2$  is, for any probable values of  $R_t$  and  $R$ , entirely negligible. The total current is obtained by integrating (3) over the pass band of the amplifier and is

$$\bar{I}_n^2 = \int_0^{f_m} \bar{i}_n^2 df = \frac{4kT}{R} f_m \left\{ 1 + \frac{R_t R (\omega_m C)^2}{3} \right\}. \quad (4)$$

The root-mean-square noise current will then be

$$\bar{I}_n = 2 \sqrt{\frac{kT}{R} f_m \left\{ 1 + \frac{R_t R (\omega_m C)^2}{3} \right\}}. \quad (5)$$

Analyses of more complicated input circuits have indicated that these do not give any appreciable reduction in noise level as compared with this simple one.

When part of the amplification is obtained by means of an electron multiplier, as in some dissector tubes, a different expression should be used to determine the effective noise current. In this case, the noise originates predominantly at the photocathode. The expression for equivalent noise current at the cathode as

given by Larson and Gardner<sup>3</sup> has the form

$$i\Delta_t = \sqrt{\frac{i_0 e}{\Delta t}}$$

where

- $i\Delta_t$  = the current responsible for the noise,
- $i_0$  = the current for one picture element,
- $e$  = the electronic charge, and
- $\Delta t$  = the time for the transmission of one picture element.

This expression may be converted to the following formula for root-mean-square noise current at the input of the multiplier

$$\overline{I_n} = \sqrt{2ei_0f_m}$$

The signal-to-noise ratio ( $N$ ) which is required for a television picture has been discussed by Zworykin, Morton, and Flory.<sup>4</sup> Their conclusions are that for an average picture, the ratio of peak picture signal to root-mean-square noise of 3 to 1 is highly objectionable; 10 to 1 gives an acceptable picture, while 30 to 1 is excellent. A ratio of 10 to 1 may be assumed to be the minimum useful value. For this ratio, the signal current which the pickup tube must deliver can be computed, and from the sensitivity of the tube, the total light which must be projected on its sensitive surface can be calculated. For the case of the conventional amplifier

$$L = \frac{10 \overline{I_n}}{s \times 10^{-6}} = 10^7 \frac{\overline{I_n}}{s} \quad (6)$$

$L$  being the light flux in lumens and  $s$  the operating sensitivity in microamperes per lumen.

The first consideration in the selection of a lens which will deliver this amount of light to a given television pickup tube is the field that must be covered. This may be expressed as the angle of view of the transmitted picture measured in a horizontal plane. The specification of the angle of view determines the focal length of the lens, which may be computed from the formula

$$f = \frac{W}{2} \cot \frac{\alpha}{2} \quad (7)$$

in which  $W$  is the width of the sensitive area of the tube and  $\alpha$  is the horizontal angle of view.

The choice of the angle of view determines the effective magnification of the picture. It is generally accepted that the most favorable viewing distance for a television picture is about five times the height of the picture. At this point the distance between two successive scanning lines in a 441-line picture subtends an angle of about 1.7 minutes, which is approximately the resolution limit of the eye. The width of the picture subtends an angle of about 15 degrees. If the camera

<sup>3</sup> C. C. Larson and B. C. Gardner, "The image dissector," *Electronics*, vol. 12, pp. 24-27 and 50; October, 1939.

<sup>4</sup> V. K. Zworykin, G. A. Morton, and L. E. Flory, "Theory and performance of the iconoscope," *Proc. I.R.E.*, vol. 25, pp. 1071-1092; August, 1937.

uses a lens which covers this angle of view, the reproduced image will have the same appearance as the original scene viewed from the camera. With a lens which gives an angle of view of 30 degrees, the reproduced picture will have the same appearance as the original scene viewed by an observer at a distance from the scene about twice that of the camera. The perspective will, of course, be somewhat faulty, but considerable distortion of the perspective is tolerable, as photographic experience has shown.

The angle of view being given, the diameter which a lens must have to enable a scene of specified brightness to be picked up satisfactorily is determined by the amount of light which must fall on the sensitive area of the tube.

The intensity of illumination in the image formed on a plane surface by a lens has been worked out by a number of people. A useful expression has been given by Goodwin.<sup>5</sup> For a uniform source having a brightness of  $B$  candles per square foot, the intensity in the image is

$$E = \frac{\pi BT}{4f^2} \cos^4 \theta \quad (8)$$

lumens per square foot, where  $T$  is the transmission factor,  $f$  is the  $f$  number of the lens, and  $\theta$  is the angle to the axis of the system made by a light ray striking the area under consideration. For large angles of view, the intensity at the edges of the image falls off rapidly compared with that at the center. While observing that such a decrease in intensity across the field is present, it is convenient for the purposes of calculation to assume that the field is uniformly illuminated at the intensity that exists at the center. This is, to some extent, justified by the fact that the center of interest in a picture is in general in the center of the field.

In a tube in which the sensitive surface has a width  $W$  and an aspect ratio 4:3, the area of this surface is  $3/4 W^2$ , and the light falling on it is

$$L = \frac{3\pi}{16} \frac{BTW^2}{f^2} \quad (9)$$

Solving (9) for the numerical aperture, we obtain

$$f = \frac{0.77W\sqrt{T}}{\sqrt{L/B}} \quad (10)$$

As  $B$  is given in candles per square foot and  $L$  is in lumens, then  $W$  must be expressed in feet. A more convenient expression is

$$f = \frac{0.064W\sqrt{T}}{\sqrt{L/B}} \quad \text{with } W \text{ given in inches.} \quad (11)$$

The transmission coefficient of the lens  $T$ , which represents chiefly losses by reflection at the air-glass surfaces in the lens, depends on its structure. Values

<sup>5</sup> W. N. Goodwin, Jr., "The Photronic photographic exposure meter," *Jour. Soc. Mol. Pic. Eng.*, vol. 20, pp. 95-118; February, 1933.

given in the literature for typical lenses range from 40 to 70 per cent transmission, being generally lower as the lens aperture increases. For purposes of calculation a value of 60 per cent may be taken as a reasonable mean. For this value,

$$f = \frac{0.050W}{\sqrt{L/B}} \quad (12)$$

This relationship is plotted in the curves of Fig. 2.

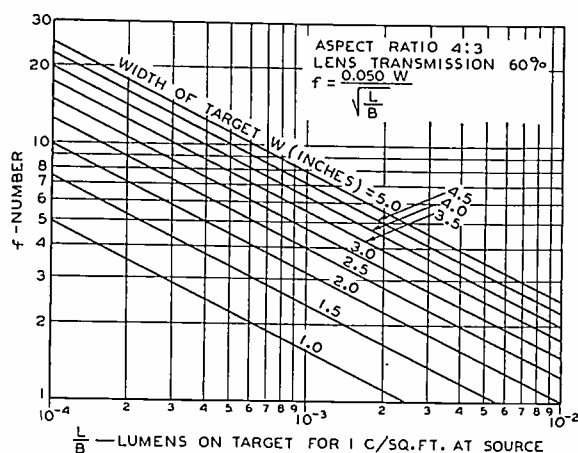

Fig. 2

The lens diameter may be found from the expression

$$A = \frac{F}{f} \quad (13)$$

The angle of view and image brightness required by the tube determine completely the lens which must be used for a given brightness of scene. It is also desirable to be able to estimate the depth of field of the system.

If a lens of diameter  $A$  and focal length  $F$  forms on a plane surface at  $F_1$  an accurately focused image of an object at a distance  $P_1$ , then for any other object distance the image of a point source of light will be a circle having a diameter depending on the object distance. If the maximum tolerable diameter of this "circle of confusion" is  $\delta$ , then the limiting distances from the lens between which the image will be considered satisfactorily focused will be given by

$$P_2 = \frac{\frac{FA}{\delta}}{\frac{FA}{\delta P_1} + 1} \quad \text{and} \quad P_3 = \frac{\frac{FA}{\delta}}{\frac{FA}{\delta P_1} - 1} \quad (14)$$

In photographic technique, it has long been accepted that the limit of the tolerable circle of confusion is 0.010 inch on a picture to be viewed at 10 inches distance. That is,  $\delta$  may subtend an angle of 0.001 radian or about 3.5 minutes. In a television picture the problem of choosing a suitable value for  $\delta$  is complicated by the scanning process. As the angle subtended by the width of a scanning line at normal viewing distance (1.7 minutes) is about half of the size of the photographically tolerable circle of con-

fusion, it might be expected that the effect on  $\delta$  of the scanning process should be relatively small.

In an attempt to determine a suitable magnitude for the permissible circle of confusion in the case of television pickup, the following experiment was made. A photograph was made of a number of men located over a range of measured distances from a camera which was accurately focused for infinity. In the picture so obtained, the size of the circle of confusion corresponding to each man's position was calculated from the constants of the camera lens. Reference lines were drawn to take care of subsequent magnification and a lantern slide made from the photograph. This was projected on a number of pickup tubes at several magnifications. In each case judgment was rendered by a number of observers as to the man in the transmitted picture who appeared to represent a dividing point between those in acceptable focus and those definitely out of focus. From these observations the acceptable circle of confusion was calculated. Values were obtained ranging from about 1/120 to 1/180 of the height of the scanning pattern. No differences were noticed among the different types of tubes tested, all of which were capable of better than 450-line resolution, as observed from transmission of a standard test pattern.

It seems evident that the departure from perfect focus which is tolerable depends to a considerable extent on the type of subject being transmitted. Much more latitude is certainly permissible in pictures of people than in subjects having high detail contrast, such as a resolution pattern, to take an extreme case. More work along this line is needed before accurate statements can be made concerning depth of field. For the present, it is believed that a useful estimate can be made by assuming the tolerable circle of confusion to be 1/200 of the picture height, i.e., about two scanning lines. With the standard aspect ratio 4:3,

$$\delta = \frac{3W}{4 \times 200} = \frac{W}{267} \quad (15)$$

Substituting this in (14) for depth of field, we obtain

$$P_2 = \frac{\frac{267 FA}{W}}{\frac{267 FA}{WP_1} + 1} \quad P_3 = \frac{\frac{267 FA}{W}}{\frac{267 FA}{WP_1} - 1} \quad (16)$$

or, since from (7),

$$\frac{F}{W} = \frac{\cot \frac{\alpha}{2}}{2}$$

$$P_2 = \frac{133 A \cot \frac{\alpha}{2}}{\frac{133 A \cot \frac{\alpha}{2}}{P_1} + 1} \quad P_3 = \frac{133 A \cot \frac{\alpha}{2}}{\frac{133 A \cot \frac{\alpha}{2}}{P_1} - 1} \quad (17)$$



A convenient concept in depth-of-field calculations is that of hyperfocal distance ( $HD$ ). This is the distance beyond which all objects are in good focus when the lens is focused accurately for infinity. Placing  $P_1 = \infty$  in the expression for  $P_2$  in (14), we obtain

$$HD = \frac{FA}{\delta} = 133 A \cot \frac{\alpha}{2} \quad (18)$$

The expressions for the near and far limits of focus can be rewritten in terms of the hyperfocal distance as follows:

$$P_2 = \frac{HD}{\frac{HD}{P_1} + 1} \quad P_3 = \frac{HD}{\frac{HD}{P_1} - 1} \quad (19)$$

It is seen that when a lens is focused accurately for the distance  $HD$ , all objects from  $HD/2$  to infinity are in good focus. Further, when the lens is focused for a distance  $P_1 = HD/k$  in which  $k$  is any constant, the region of good focus extends from  $HD/(k+1)$  to  $HD/(k-1)$ .

For a given lens aperture and angle of view, the hyperfocal distance may be read on the chart of Fig. 3.

By way of summary, it might be well to run through a representative series of calculations. Assume that an iconoscope which has a mosaic 4.75 inches wide and a sensitivity of 0.4 microampere per lumen is to be used. The camera is to cover a 30-degree angle of view and is to be used at a baseball park where the brightness of the players is expected to be at least 50 candles per square foot.<sup>6</sup>

From the angle of view and the width of the mosaic, it is found that the required lens must have a focal length of

$$F = \frac{W}{2} \cot \frac{\alpha}{2} = 2.38 \times 3.73 \quad (7)$$

$$= 8.9 \text{ inches.}$$

The preamplifier to be used with the iconoscope uses a type 6AC7/1852 input tube (equivalent grid resistance for noise, 500 ohms) with a 200,000-ohm input resistor. The total tube, circuit, and iconoscope capacitance may be 26 micromicrofarads.

The amplifier has a 4-megacycle pass band. Then the root-mean-square noise current will be

$$\begin{aligned} \bar{I}_n &= 2 \sqrt{\frac{kT}{R} f_m \left\{ 1 + \frac{R_i R (\omega C)^2}{3} \right\}} \\ &= 2 \sqrt{\frac{1.37 \times 10^{-23} \times 3 \times 10^2 \times 4 \times 10^6}{2 \times 10^6} \left\{ 1 + \frac{5 \times 10^2 \times 2 \times 10^6 (6.28 \times 4 \times 10^6 \times 2.6 \times 10^{-11})^2}{3} \right\}} \\ &= 2.2 \times 10^{-9} \text{ ampere.} \end{aligned} \quad (5)$$

<sup>6</sup> Data relative to the brightness of some typical scenes are given by Harley Iams, R. B. Janes, and W. H. Hickok, "The brightness of outdoor scenes and its relation to television transmission," PROC. I.R.E., vol. 25, pp. 1034-1047; August, 1937.

If the entire mosaic were uniformly illuminated at the brightness of the high lights, the luminous flux required to produce a satisfactory signal-to-noise ratio of 10 to 1 would be

$$L = 10^7 \frac{\bar{I}_n}{s} = \frac{10^7 \times 2.2 \times 10^{-9}}{0.4} \quad (6)$$

$$= 0.056 \text{ lumen}$$

and for a scene having a brightness of 50 candles per square foot, the ratio  $L/B = 0.056/50 = 1.12 \times 10^{-3}$  lumen per candle per square foot.

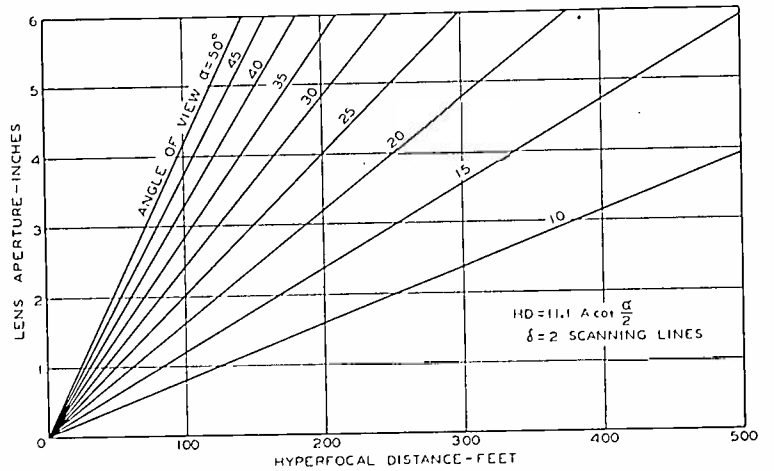

Fig. 3

From the curves of Fig. 2 the  $f$  number of this lens will be

$$f = 7.1$$

and the lens will have a diameter

$$A = \frac{F}{f} = \frac{8.9}{7.1} = 1.25 \text{ inches.} \quad (13)$$

We find then that the use of an  $f/7$  lens of 8.9 inches focal length will permit a picture to be transmitted under the above conditions which will have a just passable signal-to-noise ratio.

From Fig. 3 we find the hyperfocal distance of this lens to be

$$HD = 52 \text{ feet.}$$

When this lens is focused at a distance of 52 feet the depth of field will include all objects from 26 feet to infinity. When the lens is focused on an object 20 feet away, the field will include objects between 14.5 feet and 32.5 feet from the camera.

Improvement in the quality of the picture with respect to noise may be obtained by increasing the aperture of the lens. For example, to obtain a signal-to-noise ratio of 30 to 1 would require an  $f/4$  lens of

the same focal length. This improvement, however, will be accompanied by a corresponding decrease in depth of field ( $HD = 88$  feet).

Checks on the usefulness of computations such as those given above have been made in a number of cases, involving several different pickup tubes. The tests were made by observing television pictures trans-

mitted under a variety of conditions, and comparing the picture quality with that which the formulas would lead one to expect. From these tests it was found that the computations led to conclusions which were reasonably close to the observer's judgment of picture quality.

# A Frequency-Modulation Monitoring System\*

ROGER J. PIERACCI†, ASSOCIATE, I.R.E.

*Summary*—In operation of a frequency-modulated station it is necessary to monitor the frequency deviation accurately so that the signal remains within the allocated band. This is important from the standpoint of adjacent-channel interference and the distortion produced in a receiver when the frequency deviation exceeds the limits of the detector.

This paper presents an analytical discussion and computed charts of the spectra produced by frequency-modulated waves.

A monitor which plots the amplitude and frequency distribution of the spectrum on the screen of a cathode-ray oscilloscope is described and calibration of the monitor is discussed. Photographs taken from the screen of the monitor are presented and compared with computed patterns.

## INTRODUCTION

THE rapid advance of frequency modulation into the field of commercial broadcasting has brought with it many attendant problems which must be solved before operation on the large scale anti-

It is the purpose of this paper to analyze and describe a frequency-modulation monitoring system which presents the spectrum of a frequency-modulated wave on the screen of a cathode-ray oscillograph tube for visual inspection.

## SPECTRUM ANALYSIS OF A FREQUENCY-MODULATED WAVE

In order to predict the spectrum of a frequency-modulated signal mathematically, it is necessary to examine the equation of voltage for this type of modulation. The monitoring system to be described is based on this equation. Roder<sup>1</sup> has shown that the sideband equation for a frequency-modulated wave is

$$e = A \left\{ (J_0(m_p) \sin \omega t + J_1(m_p) [\sin (\omega + \rho)t - \sin (\omega - \rho)t] + J_2(m_p) [\sin (\omega + 2\rho)t + \sin (\omega - 2\rho)t] + J_3(m_p) [\sin (\omega + 3\rho)t - \sin (\omega - 3\rho)t] + \dots + J_n(m_p) [\sin (\omega + n\rho)t + (-1)^n \sin (\omega - n\rho)t] \right\} \quad (1)$$

pated can begin. One important problem in this connection is that of accurately and continuously monitoring the frequency deviation or band width of a frequency-modulated wave. It is important that practically all of the energy be confined within the band allocated for this type of service. If 200-kilocycle bands are used the signal should not exceed this width under all modulating conditions.

In order to monitor during the continuous operating of a frequency-modulated transmitter, it should be possible to observe visually the band width or total frequency spectrum produced at every instant when a complex voice or music wave is applied to the input terminals. Modulation with sinusoidal frequencies produces spectra which can be predicted mathematically. If visual observation of these spectra were possible, it would give valuable information regarding modulating conditions.

\* Decimal classification: R414X R213. Original manuscript received by the Institute, May 31, 1940.

† Formerly Graduate Assistant, Ohio State University, Columbus, Ohio. Now, Collins Radio Company, Cedar Rapids, Iowa.

where

- $A$  = amplitude of unmodulated carrier wave
- $\omega = 2\pi f_c$  where  $f_c$  = carrier frequency
- $\rho = 2\pi F_m$  where  $F_m$  = modulating audio frequency
- $m_p = F_d / F_m$  where  $F_d$  = frequency deviation
- $J_n(m_p)$  = Bessel functions of the first kind of order  $n$  for the argument  $m_p$

Equation (1) describes the spectrum of a frequency-modulated wave for any value of deviation ratio ( $m_p$ ) chosen, and is the basis of the monitoring system to be described. It can be seen from (1) that the spectrum consists of a carrier [ $J_0(m_p)$ ] and an infinite number of side frequencies above and below the carrier [ $J_1, J_2, J_3, \dots, J_n(m_p)$ ]. The frequency distance between adjacent components in the spectrum is equal to the audio frequency ( $F_m$ ). The amplitude of each of these for different values of  $m_p$  may be evaluated

<sup>1</sup> Hans Roder, "Amplitude, phase, and frequency modulation," PROC. I.R.E., vol. 19, pp. 2145-2176; December, 1931.

from tables of Bessel functions.<sup>2,3</sup> Plots of the spectrum showing amplitude and frequency distribution of these components are shown in Fig. 1 for  $m_p$ 's varying from 0.5 to 24. It will be observed that beyond the maximum frequency deviation the amplitude of the components dies off quite rapidly so that most of the energy in the spectrum is contained in a band approximately equal to twice the frequency deviation instead of an infinite band width as predicted by (1). This is a fortunate state of affairs and makes frequency modulation practicable. It can be seen from Fig. 1(D), assuming a constant frequency deviation (60 kilocycles), that at low audio frequencies (2500 cycles,  $m_p = 24$ ) the band width is approximately equal to twice the frequency deviation or 120 kilocycles, while in Fig. 1(C) at high audio frequencies (15,000 cycles,  $m_p = 4$ ) the components have an appreciable amplitude up to a band width of 210 kilocycles. In general for the same deviation a wider band is required for the higher audio frequencies than for the lower audio frequencies.

**THEORY OF OPERATION OF THE MONITOR**

It is the function of this monitor to make an instantaneous plot of the component frequencies shown in Fig. 1, and present them on the screen of a cathode-ray oscilloscope. It may be considered as an automatic evaluator of (1). The screen can be calibrated by limit

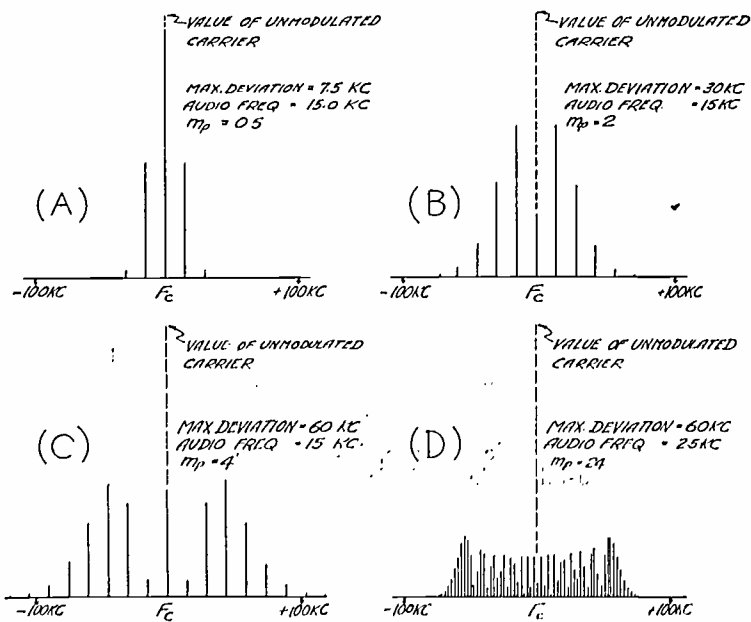

Fig. 1—Computed spectrum for values of  $m_p = 0.5$  to  $m_p = 24$ .

lines to indicate the predetermined band width or frequency deviation which has been selected. The frequency deviation or maximum modulation ( $F_d$ ) has been arbitrarily set at 75 kilocycles at present. After this calibration is made, components of a complex speech or music wave falling outside these lines are regarded as overmodulation and the audio-frequency gain is adjusted accordingly. Thus, continuous monitoring of instantaneous frequency deviation is possible.

<sup>2</sup> N. W. McLachlan, "Bessel Functions for Engineers," Oxford Press, London, pp. 41-42, 1934.

<sup>3</sup> Jahnke and Emde, "Tables of Functions," B. G. Teubner, Berlin, 1933.

**CIRCUIT DESCRIPTION**

Fig. 2 shows the elements of the system.

1.  $T_1$ ,  $T_2$ ,  $T_3$ , and  $T_4$  are essentially a simplified amplitude-modulation superheterodyne receiver capable of operating at 40 megacycles.

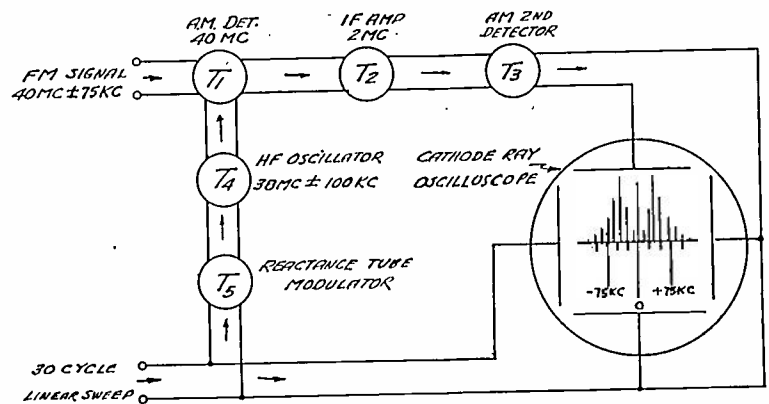

Fig. 2—Block diagram of monitoring system.

2. The high-frequency oscillator circuit  $T_4$  is frequency-modulated and swept across a band of  $\pm 100$  kilocycles or more by means of the reactance-tube modulator  $T_5$  at the rate of 30 cycles per second using a linear sweep circuit. This "scans" the spectrum 100 kilocycles above and below the carrier frequency and "reports" to the intermediate-frequency amplifier  $T_2$  any signals it encounters during its excursion.

3. A frequency-modulated signal of  $\pm 75$  kilocycles deviation more or less is applied to the input of the monitor.

4. This produces the sideband components mentioned above which beat with the local frequency-modulated signal from  $T_4$ . The components are all translated to the intermediate frequency and pass through the intermediate-frequency amplifier  $T_2$ .

5. These components are detected by  $T_3$ . The output of the detector provides a sharp unidirectional pulse for each component in the spectrum. These pulses are similar in shape to a steep resonance curve as can be seen from Figs. 3-11. They are applied to the vertical deflection plates of the oscilloscope.

6. These components are properly spaced on the oscilloscope screen by applying to the horizontal plates the same 30-cycle linear sweep voltage applied to the high-frequency oscillator reactance-tube modulator  $T_5$ .

7. The resulting pattern on the screen shows the amplitude of the carrier and all of the side frequencies with their relative spacing and band width. Actual photographs of these are shown in Figs. 3-11.

8. Another concept of the circuit operation is that the spectrum shown on the screen is produced by the mixture of two frequency-modulated signals whose carrier frequencies differ by the value of the intermediate frequency. One is modulated with a saw-tooth wave at high values of  $m_p$  and the other with a sinusoidal wave at relatively lower values of  $m_p$  depending on the audio frequency used. When the two are in proper phase the spectrum viewed on the screen of the cathode-ray tube is produced. It might also be pointed

frequency and 75 kilocycles deviation. This produces components on the screen spaced 15 kilocycles apart. The horizontal gain on the oscilloscope is then adjusted until the fifth components on each side of the carrier fall on the limit lines. The fifth component is 75 kilocycles from the carrier frequency, which is the desired calibration point. Other audio frequencies which are integral submultiples of 75 kilocycles may be used and the same procedure followed. The monitor is then ready to be used with voice or music modulation.

This system provides a continuous and accurate check on the band width of a frequency-modulated signal under all modulating conditions.

### CONCLUSIONS

Despite the seeming complexity of this monitoring system, the apparatus and operation are quite simple. The actual apparatus used, exclusive of the cathode-ray oscilloscope, is simpler than a modern superheterodyne receiver. The adjustments are few and not extremely critical. The cost of producing this apparatus should not be excessively high.

The operating technique, using an instrument of this kind in a frequency-modulated station, would probably be to use it as a standard at the transmitter from which secondary monitors in the control rooms could be calibrated. A secondary monitor might be a volume indicator in the audio-frequency circuits used in the manner that is at present customary in amplitude modulation.

Other secondary standards using a discriminator and volume indicator might be used. In any case, they would have to be checked quite frequently by the monitor at the transmitter to insure accuracy. With this technique, the major part of the monitoring would be done by secondary instruments, and the screen of the oscilloscope referred to only at periodic intervals or when it is desired to ascertain the instantaneous deviation accurately.

### ACKNOWLEDGMENT

The author wishes to acknowledge the co-operation and advice of Dr. W. L. Everitt in the experimentation and preparation of this paper.

# The Ionosphere and Radio Transmission, July, 1940, with Predictions for October, 1940\*

NATIONAL BUREAU OF STANDARDS, WASHINGTON, D. C.

DATA on the ordinary-wave critical frequencies and virtual heights of the ionospheric layers as observed at Washington, D. C., during July are given in Fig. 1. Fig. 2 gives the monthly average values of the maximum usable frequencies for undisturbed days.

TABLE I  
IONOSPHERIC STORMS (APPROXIMATELY IN ORDER OF SEVERITY)

Day and hour E.S.T.	$h_F$ before sunrise (km)	Minimum $f_F^0$ before sunrise (kc)	Noon $f_F^0$ (kc)	Magnetic character <sup>1</sup>		Ionosphere character <sup>2</sup>
				00-12 G.M.T.	12-24 G.M.T.	
July 13	370	3200	<4800	0.7	1.4	1.3
14	No data	No data	No data	0.7	0.6	1.0
15	No data	No data	No data	0.4	0.5	0.7
10	317	3000	5300	0.8	0.6	0.7
11	330	3700	5800	0.5	0.1	0.3
12 until 0500	No data	No data	—	0.1	0.0	0.1
21 after 1600	—	—	—	0.2	0.4	0.6
22	334	3100	5500	0.7	0.5	0.5
23 until 0500	325	2900	—	0.1	0.2	0.2
29 after 0700	—	—	6900	0.3	0.4	0.4
30	318	3700	5900	0.6	0.8	0.3
31	308	3300	5300	0.7	0.5	0.5
3 after 0700	—	—	5800	0.1	0.6	0.5
4	310	3300	5900	0.9	0.6	0.4
5 until 0500	No data	No data	—	0.5	0.5	0.2
For comparison: average for undisturbed days	296	3720	6430	0.2	0.1	0.0

<sup>1</sup> American magnetic character figure, based on observations of seven observatories.

<sup>2</sup> An estimate of the severity of the ionospheric storm at Washington on an arbitrary scale of 0 to 2, the character 2 representing the most severe disturbance.

\* Decimal classification: R113.61. Original manuscript received by the Institute, April 15, 1940. These reports have appeared monthly in the PROCEEDINGS starting in vol. 25, September, 1937. See also vol. 25, pp. 823-840; July, 1937. Report prepared by S. S. Kirby, N. Smith, and F. R. Gracely.

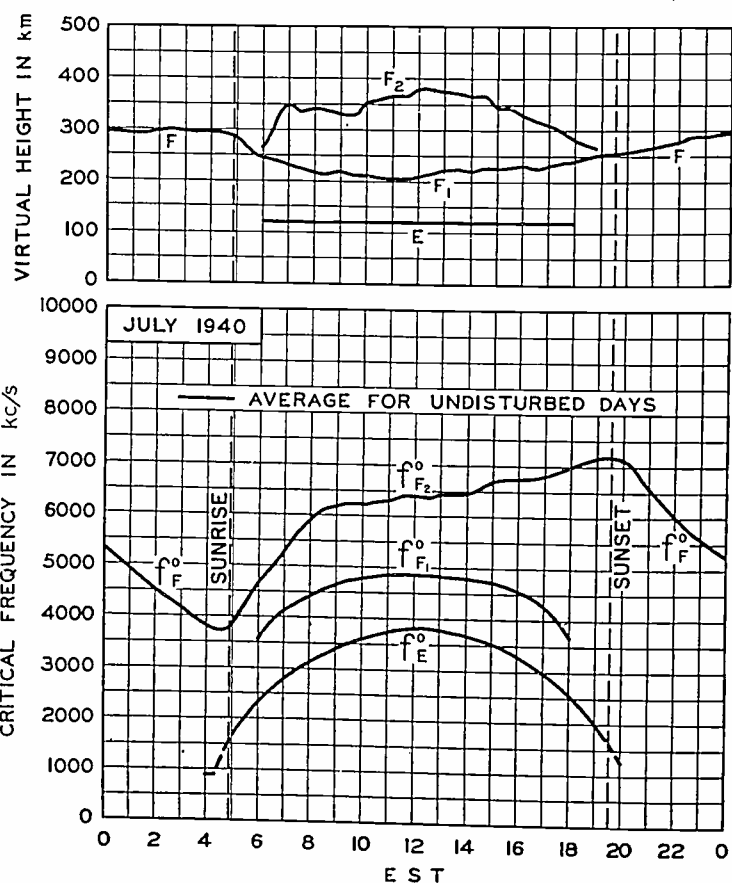

Fig. 1—Virtual heights and critical frequencies of the ionospheric layers, observed at Washington, D. C., July, 1940.

turbed days, for radio transmission by way of the regular layers. The maximum usable frequencies were de-

terminated by the F layer at night and by the E, F<sub>1</sub>, and F<sub>2</sub> layers during the day. Fig. 3 gives the distribution of hourly values of F and F<sub>2</sub> critical frequencies about the undisturbed average for the month. Fig. 4 gives the expected values of the maximum usable frequencies

for radio transmission by way of the regular layers, average for undisturbed days, for October, 1940. All of the foregoing are based on the Washington iono-

TABLE II  
SUDDEN IONOSPHERIC DISTURBANCES

Day	G.M.T.		Locations of transmitters	Relative intensity at minimum <sup>1</sup>	Other phenomena
	Beginning	End			
July 9	1139	1210	Ohio, Cuba, Italy	0.0	Ter. mag. pulse, <sup>2</sup> (1138 to 1225)
11	1842	1850	Cuba, England	0.0	Ter. mag. pulse, (1840 to 1900)
13	1455	1525	Ohio	0.02	—
15	1623	1650	Cuba, D. C., Italy	0.0	—
15	1850	1910	Cuba, D. C., Italy	0.01	—
19	1520	1540	Cuba	0.02	—

<sup>1</sup> Ratio of received intensity during fade-out to average field intensity before and after; for stations WLWO, 6060 kilocycles, and COCQ, 9720 kilocycles.  
<sup>2</sup> As observed on Cheltenham magnetogram of United States Coast and Geodetic Survey.

TABLE III  
APPROXIMATE UPPER LIMIT OF FREQUENCY OF THE STRONGER SPORADIC-E REFLECTIONS AT VERTICAL INCIDENCE

Midnight to noon												
Day	Hour											
	00	01	02	03	04	05	06	07	08	09	10	11
July 3	8	8	8			5				9		10
23		5	5					5	7	7	5	5
29	4	3			4	4	4	5	10	6	10	6

Noon to midnight												
Day	12	13	14	15	16	17	18	19	20	21	22	23
	July 2							5	10	8	5	4
3	10	10	10		9	7						
6	4			7	5	7						5
9		5	4	9	6	5	7	6	5			
15			4	6	6	7	7	6	3			
17			7	5	7	3	3			3	3	5
18	6	7	4	4	6	5	5	5	7	5	6	
20		6	5		6	10	8	7	6	4	5	
24	4	4			9	7	6	6			4	
30		5	5			7	7	7	10	6	4	4

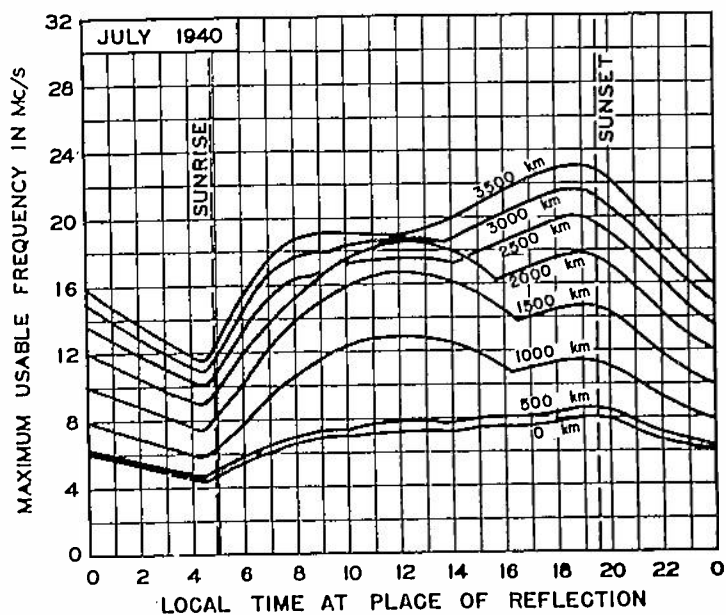

Fig. 2—Maximum usable frequencies for dependable radio transmission via the regular layers, average for undisturbed days for July, 1940. The values shown were considerably exceeded during frequent irregular periods because of reflections from patches of sporadic-E layer.

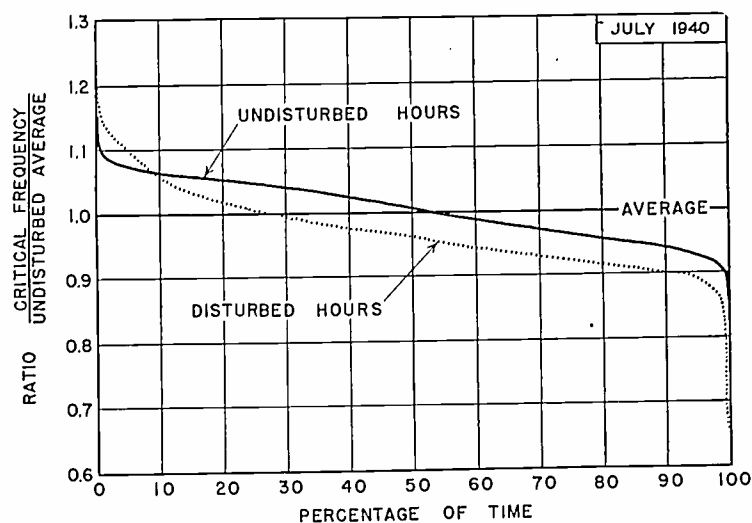

Fig. 3—Distribution of F- and F<sub>2</sub>-layer ordinary-wave critical frequencies (and also approximately of maximum usable frequencies) about the monthly average. Abscissas show percentages of time for which the ratio of the critical frequency to the undisturbed average exceeded the values given by the ordinates. The solid-line graph is for 388 undisturbed hours of observation; the dotted graph is for the 179 disturbed hours of vertical-incidence observations listed in Table I.

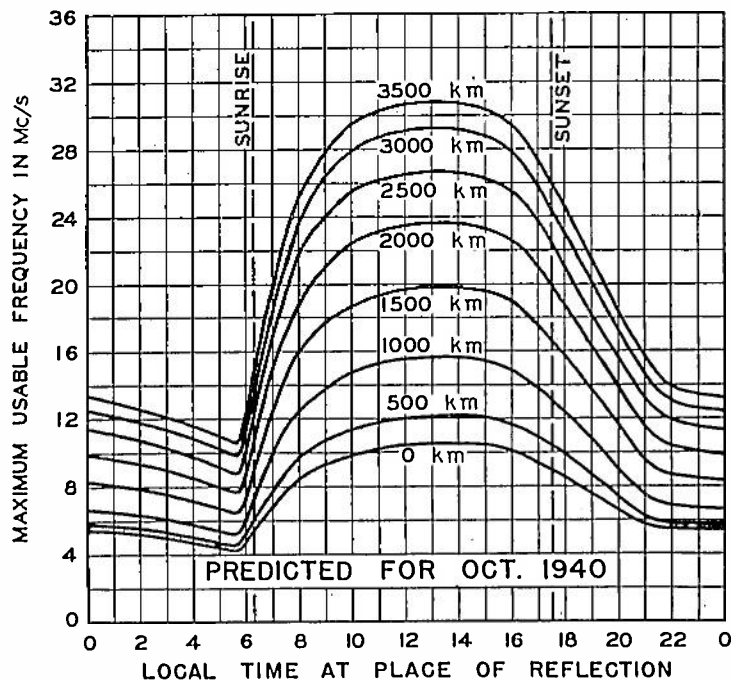

Fig. 4—Predicted maximum usable frequencies for dependable radio transmission via the regular layers, average for undisturbed days, for October, 1940. For information on use in practical radio transmission problems, see Letter Circular 575 obtainable from the National Bureau of Standards, Washington, D. C., on request.

spheric observations, checked by quantitative observations of long-distance reception.

Ionospheric storms and sudden ionospheric disturbances are listed in Tables I and II, respectively. Table III gives the approximate upper limit of frequency of strong sporadic-E reflections at vertical incidence for the days during which these reflections were most prevalent at Washington.



# Institute News and Radio Notes

## Sections

### Atlanta

A review of the Third Annual Broadcast Conference held at Ohio State University was given by several members of the Atlanta Section. Ben Akerman, chief engineer of WGST, introduced the subject by outlining the material presented at the technical sessions and describing the inspection trip to WHAS.

J. M. Comer, then reviewed the paper on "Transcription Recording and Reproduction" which was given by R. A. Lynn of the National Broadcasting Company. Various factors such as record material and its aging, the effect of the pitch of the groove and its diameter in both recording and reproducing, flutter effects, cutting needles, and methods of driving turntables were considered. Some recommended standards on groove pitch, size, and number of lines to the inch were recommended.

The next speaker, M. K. Toalson, transmitter engineer of WSB, described the paper on "Microphones" which was given by R. N. Marshall of the Bell Telephone Laboratories. The ribbon and dynamic types of microphones were considered. It was pointed out that the output of the dynamic type was a function of frequency and that acoustic resistance is added to flatten the response. In the ribbon type, the impedance increases with frequency. By proper phasing, the energy on both sides of the ribbon at the higher frequencies may be made to reinforce and the output response becomes more nearly uniform. Combining these two types in a single unit with suitable switching permits various directive response patterns to be obtained.

A. W. Shropshire, transmitter engineer of WSB, reviewed the papers on "Frequency-Modulated-Wave Transmission and Reception" which were given by E. H. Armstrong of Columbia University; P. A. de Mars of the Yankee Network; and by H. P. Thomas, I. R. Weir, and R. F. Shea of the General Electric Company. The reduction of noise which may be obtained through this system was described. It was pointed out that unlike amplitude-modulated-wave systems, it is more important to have linear circuit elements than to operate the vacuum tubes on the linear portions of their characteristics. The distortion which may occur in the system results principally in the modulation and detection of the signal.

A demonstration was given by students of the Ohio State University and showed the effect of interference between two stations operated on adjacent channels and also when operated on the same channel. The strongest signal controls the receiver and the weaker signals are not heard at all.

The meeting was closed by Mr. Akerman with a few general observations on

some of the other papers and discussions which were heard.

March 15, 1940, G. S. Turner, vice chairman, presiding.

S. A. Flemister, transmission and protection engineer of the Southern Bell Telephone Company, presented a paper on "Coastal and Harbor Radiotelephone Systems."

The subject was introduced by a brief review of the present radio services which are supplied by the Bell System. The coastal and harbor service furnishes a means of extending the land telephone system to small craft operating along the coast and in the harbors. Stations are located in a number of ports on the Atlantic, Gulf, and Pacific coasts. The importance of choosing a suitable site for the transmitter and receivers was stressed. The antenna systems used were described. The equipment is unattended and usually remotely located. A number of receivers are used and the one providing the most satisfactory signal is selected for operation. This permits the use of low power in the boat installations.

April 19, 1940, P. C. Bangs, chairman, presiding.

"Vacuum Tube Pioneering Over the Last 25 Years" was the subject of a paper by H. E. Mendenhall, vacuum tube development engineer of the Bell Telephone Laboratories. The early history of vacuum tubes starting with the development of the incandescent-filament lamp by Edison in 1876 was outlined. In the early tubes, there was considerable gas after evacuation and this affected their performance considerably.

By 1915 the development of tubes permitted New York and San Francisco to be joined by telephone service. By using a large number of tubes in parallel it became possible to communicate with Europe.

In discussing the rectifier tubes it was pointed out that the inefficiency of the early designs resulted from large spacing between the elements and poor cathodes. The improved mercury rectifier has an efficiency of about 99 per cent.

High-frequency air-cooled tubes were then discussed. The technique of molding the glass was described. Because the time required for an electron to pass through one element to another is important in this range of frequency, the leads to the tubes must be short. To reduce common impedances which may cause uncontrollable oscillation, many tubes are made double ended and more than one lead connects to a given electrode. Tubes which will operate at frequencies as high as 3000 megacycles have been built.

In 1920 satisfactory technique was developed for sealing metal to glass and it permitted the development of high-power tubes cooled by water. By means of the induction furnace the gases could be driven out of the tube elements.

The structure of tube filaments was described. The use of coatings of material which liberates electrons at low temperatures was covered. By measuring the filament resistance, it is possible to judge the age of a tube.

The problem of insulating the elements of a tube from each other is of great importance in view of the high temperatures which are encountered.

May 17, 1940, P. C. Bangs, chairman, presiding.

### Baltimore

A. E. Thiessen of the General Radio Company, presented a paper on "Recent Developments in Radio Measuring Instruments." It treated both the ultra-high-frequency developments and the use of square waves as a means of testing amplifier performance.

In the ultra-high-frequency region it was pointed out that there is freedom from static and the limited range of transmission permits duplication of services at relatively short distances. Wide-band services thus become practical. Methods of generating ultra-high-frequency waves were described.

The use of square waves to determine amplifier performance was described and demonstrated. Small differences in the response-frequency characteristic of an amplifier could readily be detected. The presence of transients in the output of an amplifier may usually be noted.

April 19, 1940, C. A. Ellert, chairman, presiding.

This was the annual meeting of the section and in the election of officers for the forthcoming year, Ferdinand Hamburger of Johns Hopkins University, was named chairman; V. D. Hauck, of the Bendix Radio Corporation, was elected vice chairman; and G. J. Gross, of the Pennsylvania Water and Power Company, became secretary-treasurer.

W. B. Kouwenhoven, professor of electrical engineering at Johns Hopkins University spoke on "Some Interesting Effects of Electric Shock." It included the results of his researches on such topics as tissue burning, muscular reaction, heart fibrillation, the path taken by the current through the body, current density, skin resistance, and the effects of direct and alternating current.

May 17, 1940, C. A. Ellert, chairman presiding.

### Boston

The first paper of the evening was on "Emergency Radio Equipment" and was by C. A. Harvey of Harvey-Wells Communications, Inc. In the design of portable and emergency radio equipment the type and quantity of available power is of prime importance. The transmission range required will affect the frequency range employed. Consideration also must

be given to whether continuous or intermittent services will be demanded. In many cases, the transmitter and receiver are operated as a unit and the control circuits are interconnected.

If a good antenna system can be used, the power for both the transmitter and receiver may be a minimum. A poor antenna requires increased power for the same effective range. The conditions of operation vary so greatly that good design may dictate either low-power, lightweight, and small-size equipment or apparatus which is bulky and heavy. Whether continuous wave or radiotelephone transmission is to be used is another important factor.

As an example of a highly portable and extremely compact emergency set, a unit of approximately 7 inches square by 8 inches high was shown operating between 1.5 and 4 megacycles. The four-tube crystal-controlled transmitter had an output of 0.6 watt, the superheterodyne receiver used four tubes. This unit together with a French-type handset and a coil of antenna wire constitutes a complete emergency station.

The second paper was on "Emergency Radio Equipment" and was by J. M. Henry of the New England Telephone and Telegraph Company. The equipment first described was for use and maintenance of public telephone services across gaps in the telephone wire plant, caused by hurricane, flood, fire, or other disasters.

The equipment is designed to be connected at each end of a wire break in any two-wire or four-wire circuit and operates as though the original circuit were intact. The system operates in both directions on the same carrier frequency. High-speed voice-operated mechanisms are used for starting and stopping the transmitters. The Codan, which operates the receiver only in the presence of an incoming carrier and does not function when receiving noise alone, is used to control the receiver.

The apparatus described was on display and was demonstrated.

February 23, 1940, W. L. Barrow, chairman, presiding.

B. J. Thompson of the Research Department of the RCA Manufacturing Company (Harrison) presented a paper on "More Work for the Electron." This was the same paper given before the Washington Section on March 11 and reported in the April issue of the PROCEEDINGS.

March 29, 1940, W. L. Barrow, chairman, presiding.

## Buenos Aires

A. T. Cosentino, Director of Radio Communications of the Argentine, presented some "Comments on the South and Inter-American Radio Conferences at Santiago, Chile."

In regard to South America, it was stated that faulty organization and geographical distribution prevent the medium- and high-frequency broadcast stations from fulfilling their requirements. According to the reports presented at the Conferences in Rio de Janeiro and in Cairo most of the stations are below the stand-

ards established by modern practice.

Reports presented by the Argentine delegation at Cairo described for the first time the variation of frequency of the emissions from many stations over a long period of time as well as variations of their field intensity, giving a clear view of the interference situation.

In considering the frequencies assigned for broadcasting it was pointed out that observations during 1937 indicated 100 high-frequency stations were operating outside of the bands assigned for broadcasting which total 1850 kilocycles. In 1939 the band width was expanded to 2950 kilocycles and there were 126 stations operating outside of these bands. This amounted to 31 per cent of all the stations received. Although the South and Inter-American Radio Conferences could not solve the problem entirely, much has been done. More uniform agreement appears possible in the near future.

The relative importance of various services was considered and it is possible that less important services may be curtailed providing more space for broadcasting.

March 29, 1940, A. M. Stevens, chairman, presiding.

At the Annual Meeting, A. T. Cosentino, Director of Radio Communications of the Argentine, was elected chairman; P. J. Noizeux, of the Transradio Internacional, was named vice chairman; and W. J. Andrews, of the Cia Standard Electric Argentina, became secretary-treasurer. No technical paper was presented.

May 20, 1940, A. M. Stevens, chairman, presiding.

## Buffalo-Niagara

"The Doherty High-Efficiency Amplifier" was the subject of a paper by W. H. Doherty of the Bell Telephone Laboratories.

The conventional linear radio-frequency power amplifier when supplying peak power for 100 per cent modulation shows a plate efficiency not greater than 33 per cent.

By connecting the plates and grids of two tubes by suitable networks, one may be made to operate at full plate voltage and take all the load for the unmodulated carrier while the other tube is prevented from contributing to the output by a high grid bias. The second tube contributes power as it is demanded by the modulation conditions and at the same time, the first tube increases its output. As the per cent modulation increases the demands on both tubes increase with the second tube supplying power at a faster rate of increase. At the point of maximum instantaneous peak power both tubes contribute evenly. At 100 per cent modulation an efficiency of about 60 per cent results.

The operation and adjustment of the equipment was demonstrated using a low-power amplifier, an electric lamp as a dummy antenna, and a cathode-ray oscillograph. By means of plugs and jacks the oscillograph could be connected to various parts of the circuit.

April 3, 1940, Karl Hoffman, chairman, presiding.

A symposium on frequency modulation was presented by three speakers from the Colonial Radio Corporation engineering staff. The "Historical Review" was given by F. H. Scheer. The second paper was by H. C. Tittle, who outlined the "Theoretical Considerations" which included comparison with amplitude modulation. In the third paper J. L. Taylor treated the "Receiver Design." A visual method of indicating the proper tuning of a receiver was described.

May 8, 1940, Karl Hoffman, chairman, presiding.

This meeting was held jointly with the Rochester and Emporium Sections at Olean, New York. It was presided over by L. C. F. Horle, president of the Institute.

A paper on the "Rhumbatron Resonator and Klystron Oscillator" was presented by F. E. Terman, head of the electrical engineering department at Stanford University.

Dr. Terman discussed the Rhumbatron resonator and its application in the Klystron oscillator in which it becomes a part of the oscillating tube. The frequency of the resonator is determined by its shape and size and its simplest form is merely a cylinder in which the oscillating voltage is generated between the ends. The diameter of the cylinder determines the frequency and the length controls the impedance. Values of  $Q$  may vary between 10,000 and 60,000 or higher and with a Rhumbatron of 10 centimeters it approximates 30,000.

The Klystron oscillator consists of two Rhumbatrons coupled so that an electron stream passes through them lengthwise. The stream is bunched by the first Rhumbatron and collected by the second. The second Rhumbatron is tuned to the frequency of the bunching of the electrons and oscillation results. A theoretical efficiency of 78 per cent is obtained. The cathode of the electron emitter is usually operated at negative potential to keep the high voltage off the bulky parts of the circuits.

This type oscillator can be built very compactly and its radiations may be highly directive. It is used in aeronautical radio and certain types of therapy work.

June 8, 1940.

"Acoustics of Broadcast Studios and Their Measurement" was the subject of a paper by L. G. Hector, professor of physics at the University of Buffalo.

The history of the development of practical sound measurements introduced the subject. Sound waves leave the source and reflect back and forth from the surfaces of a room until all of the energy is absorbed. The time required for the average sound energy in a room to drop to one millionth ( $-60$  decibels) of its original value after the source is shut off is known as the reverberation time.

If the sound produced is of a single frequency, standing waves or beat notes will result and reverberation measurements may be unsatisfactory. If several musical and speech records are played simultaneously the combined result is called warbling. This type of source gives fairly stable

conditions and measurements may be reproduced. The circuit used in the measuring instrument was described. Measurements made in several rooms and broadcast studios were shown and their interpretations discussed.

This was the annual meeting and B. E. Atwood, of the Colonial Radio Corporation, was elected chairman; E. H. Roy, of Station WBEN, was designated vice chairman; and Leroy Fiedler, of Stations WKBW-WGR, became secretary-treasurer.

June 26, 1940, B. E. Atwood, vice chairman, presiding.

## Chicago

A panel discussion on "Frequency Modulation" was participated in by Marvin Hobbs, chief engineer of the Scott Radio Laboratories; D. W. Gellerup, chief engineer of WTMJ; and H. S. Knowles, vice president and chief engineer of the Jensen Radio Manufacturing Company.

Mr. Gellerup opened the discussion with data on a field survey of the frequency-modulation-wave station of the *Milwaukee Journal*. The survey covered southern Wisconsin and the northern part of Illinois as far south as Chicago and showed encouraging results. The problems of frequency allocation and transmission range were discussed. Data were presented on the second and third horizon and the problem of interference. It was stated that a front-to-back ratio of 2 to 1 on the receiving antenna would solve most of the interference problem.

The problems of receiver design were discussed by Mr. Hobbs. The fundamental requirements of the receiver were discussed and particular attention was given to the limiter circuit. Its limits of operation and sensitivity were considered. Automatic volume control was also considered. Stress was placed on the fact that a signal-to-noise ratio of approximately 2 to 1 results in reception practically free of noise.

Mr. Knowles treated the acoustical problem. In it he traced the development of acoustical analysis and discussed the various psychological studies to discover human desires in sound reproduction. It was pointed out that the "high-fidelity" phase might succumb to the desire for low-price models. At the present time the public is not enthusiastic about high fidelity and in many cases prefers highly distorted bass reproduction.

February 21, 1940, E. Kohler, chairman, presiding.

H. A. Rahmel, recording engineer for Blackett-Sample-Hummert, Inc., presented a paper on "Techniques of Instantaneous Recording." The various terms and equipment used in disk recording were first defined. A comparison of vertical and lateral recording was made. The differences in response caused by crowding at the inside of the record were discussed. Consideration was then given to the proper pattern for the cutting stylus and the play-back needle and correct needle pressure.

Difficulties encountered in obtaining satisfactory speed regulation were outlined and various methods for obtaining constant speed were discussed. The types of

cutting heads commonly used were described and their response-frequency characteristics were considered. The correct volume levels for recording were discussed and methods of compensating for variations in the characteristics of the cutting heads were included.

Emphasis was placed on the need for a better acetate disk and also for standards on recording such as the correct pressure, the number of lines per inch, and the response-frequency characteristics of the recording and reproducing mechanisms.

An interesting innovation for the session was the holding of a preliminary session, the purpose of which was to discuss radio topics in a manner which would interest the younger members and provide an opportunity for new members and visitors to become acquainted. At this session, which was about an hour in length and which preceded the regular meeting, Alfred Crossley, consultant, spoke on "Measuring Transmission Losses with a Q Meter."

March 27, 1940, E. Kohler, chairman, presiding.

The preliminary session was devoted to the "Theory of Frequency Modulation" which was presented by A. W. Sear of the Armour Institute of Technology.

The main session was devoted to a "Demonstration of Frequency Modulation" by J. E. Brown and G. E. Gustafson of the Zenith Radio Corporation. Mr. Brown first showed some oscillograms of the performance characteristics of frequency-modulated-wave receivers utilizing both narrow and wide bands for transmission. He then illustrated the performance of receivers of both types at gradually increasing distances from the transmitters and subjected to the same signal levels.

The performance of amplitude- and frequency-modulated-wave receivers was demonstrated. A program was furnished by a phonograph which was used to modulate both types of transmitters. Rapid switching could be made from one receiver to the other and they were compared on the basis of noise, quality of reproduction, and sensitivity.

April 26, 1940, E. Kohler, chairman, presiding.

The preliminary session was devoted to the "Design of Wide-Band amplifiers" by A. B. Brownwell of the department of engineering of Northwestern University. A thirty-two page pamphlet of notes and diagrams was prepared by Mr. Brownwell and distributed to those present.

At the regular meeting a paper on the "Importance of Phase Shift in Low-Frequency Amplification" was presented by H. R. Johnston of the Automatic Electric Company.

Methods of measuring phase shift in resistance-coupled amplifiers were outlined. Design considerations which will make allowance for or correct the shift in these amplifiers was discussed.

The meeting was held in the Chicago Lighting Institute, and Mr. Oberhausen of that organization demonstrated the exhibits of the Institute.

May 27, 1940, E. Kohler, chairman, presiding.

## Cincinnati

D. E. Foster of the RCA License Laboratory, presented a paper on "Frequency-Modulated-Wave Receivers." The fundamentals of amplitude and frequency modulation were first described and some of the terms used in the latter were defined.

It was pointed out that the deviation in frequency determines the volume level in frequency modulation and the rapidity of this change establishes the modulation frequency. The relations between these factors were outlined.

Pre-emphasis, the strengthening of the higher audio frequencies at the transmitter, and de-emphasis, compensation in the receiver to make the over-all system linear, were described. It assists in reducing the effects of atmospherics and is applicable to either amplitude- or frequency-modulation systems.

Two methods of frequency modulating a transmitter were described. In one, part of the carrier wave is phase modulated and recombined with the unmodulated part. Some amplitude modulation results from this and must be removed at the receiver by the use of a limiting circuit. The second method utilizes the reactance of a vacuum tube for obtaining frequency modulation.

In discussing the signal-to-noise ratio, it was demonstrated graphically that until the input signal of a receiver reaches a certain value, only noise is heard. From that value the signal-to-noise ratio rises almost vertically and then drops off at about a 45-degree slope. This characteristic is a function of the deviation ratio and the greater that ratio, the larger the input signal required to operate the receiver and the higher the signal-to-noise ratio becomes before falling off.

The elements of a frequency-modulated-wave receiver were covered and methods of obtaining suitable characteristics were discussed.

March 19, 1940, C. H. Topmiller, chairman, presiding.

A paper on "Photosynthesis" was presented by O. L. Inman, director of the C. F. Kettering Research Foundation on Photosynthesis of Antioch College. This paper dealt with the utilization of the energy received from the sun through its effects on growing plants and animals.

April 16, 1940, P. B. Taylor, vice chairman, presiding.

D. K. Martin of the Bell Telephone Laboratories, presented a paper on "The Western Electric Terrain-Clearance Indicator." The terrain-clearance indicator is a special form of altimeter which measures the distance between an aeroplane and the terrain over which it is flying. The normal altimeter indicates the distance above sea level or some other arbitrary altitude.

A 420-megacycle oscillator is frequency modulated over a range of 25 megacycles. The wave is transmitted to the ground, reflected, and picked up on a receiver. The transmitted wave is also impressed on the receiver and a beat note between the two depends on the sweep rate of frequency modulation, the distance traveled by the wave from the plane to ground and return, and the speed of propagation.

At low altitudes the reflected signal is very strong and a feedback circuit prevents overloading and inaccurate readings.

The possibility of plotting land contour maps to permit the pilot to stay close to his course in landing even in the absence of a landing beacon at an airport was discussed. Such maps would be similar to those developed from ocean depth findings and used by mariners.

May 14, 1940, C. H. Topmiller, chairman, presiding.

"The Case for Television Standards" was discussed by J. L. Hollis, a television engineer for the Crosley Corporation. The development work during the past decade which has gone into the production of a practical television system was outlined. In September, 1938, proposals for commercial television standards were presented to the Federal Communications Commission. Lack of complete agreement by all members of the industry prevented the adoption of these standards. The steps being taken to bring about a consensus were discussed.

June 18, 1940, C. H. Topmiller, chairman, presiding.

## Cleveland

S. J. Begun, research engineer for The Brush Development Company, presented a paper on "General Considerations in Disk Recording and Playback." This paper will be published in full in the next issue of the PROCEEDINGS.

January 25, 1940, Robert Kline, chairman, presiding.

J. R. Weske, associate professor of Aerodynamics of the Case School of Applied Science, presented a paper on "Radio Aids in Air Navigation."

Seven uses of ultra-high frequencies in aviation radio were discussed. They included airport boundary markers, airport traffic control, airline communication systems, radio ranges, weather teletype service, instrument landing beams, and the ground-clearance indicator.

One of the small transmitters and automatic recording devices carried by a small balloon for obtaining data on upper-air conditions was available for inspection. Another device which was available for inspection was designed and constructed by Dr. Weske and his associates to measure the air turbulence and its relation to the design of airfoils. The use of this equipment is largely responsible for the development of the modern flat rivet surface on planes.

Brief abstracts were given of several papers which were presented at a recent meeting of the Institute of Aeronautical Sciences.

February 29, 1940, C. E. Smith, vice chairman, presiding.

"Tubes in Industry" was the subject of a paper by Rex McDill of the Inspection Machinery Company. The basic circuits used in most industrial applications of photoelectric devices were described. Various ways in which the relays controlled by the photoelectric cell may operate other

equipment were outlined. A machine that sorted resistors was described. A precision of within about one-half per cent obtained for values up to ten megohms on alternating-current operation may be extended to twenty megohms by using direct-current operation.

Among various other methods of utilizing photoelectric devices which were described were the measurement of the speed at which a baseball is pitched, an oil sludge analyzer, the sorting of fruit, automatic door openers, and counting machines.

March 28, 1940, R. L. Kline, chairman, presiding.

## Connecticut Valley

"Application of Radio to Vibration Stresses in Propeller Measurements" was the subject discussed by C. M. Kearns, W. Arnonvi, and E. Mueller, of the engineering department of Hamilton Standard Propellers.

The research described resulted from the introduction of the metal propeller which at times failed in service resulting in forced landings or destruction of the plane. Crystallization of the metal resulted from the repeated stressing beyond the endurance limit. Data were necessary on the vibration of the blades if failures were to be avoided.

Various types of piezoelectric, capacitive, and electromagnetic microphones were tried without success. A serious limitation was that of weight as the units were required to be located toward the tips of the propellers.

A carbon stack exhibits a variation in resistance with compression and in the tests a carbon bar is cemented to the propeller. Calibration is obtained by stressing the bar by means of a standard cam.

The variation in resistance is converted into changes in voltages which are impressed on an amplifier. A 12-element oscillograph and a similar number of carbon bars permit vibrations in various parts of the blade to be recorded simultaneously.

In a direct-coupled amplifier leakage from the plate supply of one stage to the grid circuit of the succeeding stage is eliminated by using two coupling condensers between the plate and grid and grounding their common point through a resistor.

The various modes of vibration of propeller blades were then described and the influence of the motor driving the blades was considered.

March 28, 1940, R. N. Ferry, chairman, presiding.

Austin Bailey, of the operating and engineering department of the American Telephone and Telegraph Company, presented the paper "Harbor and Coastal Radiotelephony."

There was first presented a historical outline of the early work in the development of a system to link harbor and coastal craft with the land telephone system.

The present system was then described and photographs of a number of installations shown. Operating procedures were covered. A steady increase in the number of vessels registered for this service showed

a peak of over 1500 in 1939 and the number of messages handled in that year exceeded 3000.

April 25, 1940, R. N. Ferry, chairman, presiding.

"The Electric Eye as Applied to Automatic Wrapping Machinery" was the subject of a paper by E. F. Cornock, engineer for the Package Machinery Company.

A brief history was first given of the photoelectric effect. This was followed by an outline of the structure and material used in photoelectric devices and the characteristics which result from the different photosensitive materials.

In automatic wrapping of any product, it is cheaper to print on a continuous ribbon of wrapping material than on individual sheets. Some of the newer wrapping materials are difficult to separate in sheets for manual packaging.

Most manufacturers buy preprinted stock for wrapping and errors such as those occurring in printing or resulting from shrinkage caused by humidity and temperature variations must be corrected in wrapping. High-speed machines require rapid correction as errors are cumulative. The simplest method of operation is to retard slightly the speed of the paper and have the photoelectric regulator operate in only one direction, to advance the speed of the paper feed as required. Transparent wrappers use transmitted light for control and opaque paper requires utilization of reflected light.

At the close of the paper an inspection tour of the Package Machinery Company plant was made.

May 23, 1940, R. N. Ferry, chairman, presiding.

An inspection trip of the United States Coast Guard Training Station at New London occupied almost a full day. The steam engineering, radio, and armory sections were visited.

A paper was presented by M. H. Griffith of the resident school at the end of the inspection trip. It was pointed out that the training station provides resident training for several types of skilled personnel and teaches by correspondence about 7000 students who are studying in forty subjects.

Radio operating students receive only sixteen weeks of training. In that short time they learn to copy code by touch typewriting at a minimum speed of twenty words per minute. Both typing and code reception are taught simultaneously. Additional training is given in Navy, Coast Guard, and commercial procedure as well as in elementary radio theory.

At the close of the paper, officers for the succeeding year were elected. K. A. McLeod of WDRC in Hartford, was elected chairman; F. G. Webber of the F. W. Sickles Company, was named vice chairman; and W. M. Smith was re-elected secretary-treasurer. A group supper was served at the Hotel Mohican, and G. W. Pickard, consultant, gave a talk on the effects of several factors on the transmission of signals at frequencies between 30 and 100 megacycles. Poorest transmission conditions occur at midday and the

annual variations show greatest fading during the summer. It was pointed out that many of the factors affecting propagation at these frequencies were known many years ago and also that experimental data recently obtained supports older mathematical prognostications.

The meeting was closed with the showing of a motion picture illustrating the activities of the Coast Guard.

## Membership

The following indicated admissions to membership have been approved by the Admissions Committee. Objections to any of these should reach the Institute office by not later than September 30, 1940.

### Transfer to Member

- Appel, H. W., 40-07—41st St., Sunnyside, L. I., N. Y.  
 Burnett, C. E., RCA Manufacturing Co., Inc., Harrison, N. J.  
 Bushby, T. R. W., 6 Keswick, 17A, Penkivil St., Bondi, N.S.W., Australia.  
 Cooke, N. M., Naval Research Laboratory, Bellevue, Anacostia, D. C.  
 de Neuf, D. K., Press Wireless, Inc., 1475 Broadway, New York, N. Y.  
 Haller, C. E., RCA Manufacturing Co., Inc., Harrison, N. J.  
 Henry, T. J., 69 N. 9th St., Newark, N. J.  
 James, W. M., RCA Manufacturing Co., Inc., Harrison, N. J.  
 Kauzmann, A. P., RCA Manufacturing Co., Inc., Harrison, N. J.  
 Kelly, R. L., RCA Manufacturing Co., Inc., Harrison, N. J.  
 Leeds, L. M., General Electric Co. Schenectady, N. Y.  
 Lutz, S. G., Southern Methodist University, Dallas, Tex.  
 Nelson, P. H., Box 3890, Chicago, Ill.  
 Walker, R. M., 2600—26th Ave., S.E., Seattle, Wash.

### Admission to Member

- Downie, J. W., 2535 Van Vranken Ave., Schenectady, N. Y.  
 Farley, T. S., 74 Hyde Park Ave., Hamilton, Ont., Canada  
 Kreer, J. G., Jr., 114 Mountain Ave., Bloomfield, N. J.  
 Schade, O. H., 32 Francisco Ave., West Caldwell, N. J.  
 Vandegrift, R. B., 122 Hedden Terr., North Arlington, N. J.

- White, Sidney, Jr., 185 Orient Way, Rutherford, N. J.  
 Wood, Ross, 20 Brigham Rd., Waltham, Mass.

### Admission to Associate (A), Junior (J), and Student (S)

- Aaron, B. D., (S) 6811 Huntington Ave., Newport News, Va.  
 Andrews, M. G., (S) Box 234, c/o Bucknell University, Lewisburg, Pa.  
 Baller, Howard, (S) 351 S. Wilson Ave., Pasadena, Calif.  
 Barco, A. A., (A) RCA License Laboratory, 711-5th Ave., New York, N. Y.  
 Blackman, R. B., (A) Bell Telephone Laboratories, 463 West St., New York, N. Y.  
 Blunt, A. F., (A) 3010 Guilford Ave., Baltimore, Md.  
 Bollinger, W. P., (S) 511 W. Chestnut St., Mason City, Ill.  
 Burmester, E. R. R., (A) 401 Madero Ave., Buenos Aires, Argentina  
 Butterworth, J. W., (A) 34 Katz Ave., Paterson, N. J.  
 Cipperly, W. L., (A) 2512 Lavin Ct., Troy, N. Y.  
 Cirulli, Adolfo, (A) Andres Ferreyra 3481, Olivos FCCA, Argentina  
 Cleland, Thomas, (A) 34 Steele Blvd., Baldwin, L. I., N. Y.  
 Davies, J. E., (A) 16 Watson Ave., Mansfield, Notts., England.  
 De Leon, John, (A) 144 Walnut St., Ridgewood, N. J.  
 DuVal, Herbert, Jr., (A) General Electric Co., Schenectady, N. Y.  
 Faison, C. F., (A) 715 Adair, Dallas, Tex.  
 Favre, Marcel (A) Chateau de Duillier, Duillier, (Vaud), Switzerland.  
 Giansante, D. P., (J) 201 S. Darling St., Angola, Ind.  
 Gillespie, H. C., (A) 207 Pleasant Valley Ave., Moorestown, N. J.  
 Goacher, H. T., (A) 5 Broadgate Ave., Beeston, Notts., England.  
 Gould, R. V., (S) 27 Ross Rd., Scarsdale, N. Y.  
 Greig, A. W., (A) 13 Newton Ave., Halifax, N. S., Canada.  
 Griffith, D. J., (S) R.R. 1, Box 172, Moline, Ill.  
 Hansen, J. D., (S) 819 Poplar St., Waukegan, Ill.  
 Haycock, O. C., (A) University of Utah, Salt Lake City, Utah.  
 Hinojosa, J. A., (A) c/o The First National Bank of Boston, Sec. Remesas, Florida 99, Buenos Aires, Argentina.  
 Hirszbant, A. A., (A) 166 Hicks St., Brooklyn, N. Y.  
 Hopkins, R. U. F., (S) 124½ Magnolia Ave., Long Beach, Calif.  
 Hough, R. R., (S) 1465 Pennington Rd., Trenton, N. J.  
 Hunt, J. T., (A) 714 Paulus Ave., Dallas, Tex.  
 Johnson, J. F., (S) 2617 University Ct., Cincinnati, Ohio.  
 Kline, W. F., (A) 205 E. Gale St., Angola, Ind.  
 Lawrance, R. B., (S) 99 Summer St., Kingston, Mass.  
 Litchford, G. B., (S) 5629 S.E. 44th Ave., Portland, Ore.  
 Magnuski, Henry, (A) 105 Montclair Ave., Buffalo, N. Y.  
 Maile, A. W., (A) Sierra Leone Railway, Sierra Leone, West Africa.  
 McKinney, Arley, (A) Hq. & Hq. Squadron, 20th Pursuit Group, Moffett Field, Calif.  
 Norman, Wayne, (J) Box 233, Ritzville, Wash.  
 Orzabal, Raul, (A) Juncal 223F, Buenos Aires, Argentina.  
 Peters, M. K., (A) 2312 Kemper Lane, Cincinnati, Ohio.  
 Prusinowski, W. D., (J) 433 E. Erie St., Chicago, Ill.  
 Purkis, W. F., (A) 41 Gloucester St., Ottawa, Ont., Canada.  
 Rogers, T. W., (S) Staff of Destroyer Squadron 26, San Diego, Calif.  
 Samsel, R. W., (S) 2408 Grant St., Evanston, Ill.  
 Sarett, S. P., (A) 1520-39th St., Brooklyn, N. Y.  
 Selig, B. L., (J) 505 E. Chicago, Valparaiso, Ind.  
 Sise, A. F., (A) 4 Putney Rd., Wellesley Hills, Mass.  
 Sproule, D. O., (A) 30-5th Ave., New York, N. Y.  
 Svanascini, A. L., (A) Triumvirato 4333, Buenos Aires, Argentina.  
 Tandan, R. K., (A) 55 Melody Rd., London S.W. 18, England.  
 White, R. N., (S) 1410 N. 2nd St., St. Joseph, Mo.  
 Wildberger, J. P., (A) c/o Titan A.G., Stauffacherstr. 45, Zurich, Switzerland.  
 Wright, David, (A) 1510 Fort Myer Dr., Arlington, Va.  
 Yorke, L. J., (A) 288 Queen's Ave., London, Ont., Canada.  
 Zeigler, B. F., Jr., (A) 1517 Bella Vista Dr. Dallas Tex.



# Correspondence

## Transconductance

In the work of several of the Technical Committees of The Institute the question has arisen as to the proper algebraic sign for the transconductance of vacuum tubes. In attempting to arrive at an answer it was decided to publish the following two letters which have been received presenting both sides of the question and to invite discussion from the membership. Lack of space in the PROCEEDINGS will probably prevent the publication of further letters on the subject and it is therefore requested that they be addressed to the Sub-Committee on Ultra-High-Frequency Vacuum Tubes where they will receive the closest attention.

F. B. LEWELLYN  
Chairman, Subcommittee  
on Ultra-High-Frequency  
Vacuum Tubes

In the analysis of vacuum-tube circuits, there has been much confusion because an increase in the plate current is accompanied by a decrease in the plate voltage. This differs from ordinary load circuits in which the current and voltage are proportional. Those of us who have thought about this difficulty now appreciate the reason for it. It is because we have not been expressing the plate current going out of the tube but rather the plate current flowing backward in the output circuit. We should express the plate current as the current leaving the tube from the plate terminal. This is certainly the only logical way of expressing the output current from a repeater tube, the plate being the output electrode. Expressed in this manner, it appears that the plate current is negative. Therefore an increase in the plate current is a negative change in the plate current and is accompanied by a negative change in the plate voltage.

These questions also have a bearing on whether the transconductance and amplification factor of an ordinary triode should be regarded as positive or negative. It is an historical fact that this question has not been given any real attention. The value of the transconductance has been stated as a number and likewise the value of the amplification factor, but no attention has been paid to the question of whether this number is positive or negative.

The development of special tubes which have opposite kinds of transconductance makes it desirable at this time to standardize by calling one kind of transconductance positive and the opposite kind negative. It should be appreciated that this is not a change of any previous standards, but is merely assigning a polarity to quantities which were formerly regarded as numbers. The following recommendation is in accord with the present practice of some laboratories but differs from the present practice of some other laboratories. There need be no confusion caused by this stand-

ardization. Whichever group of engineers may be required to change their present practice are so well versed in the subject that the change will not be difficult. In any case, one group will have to change, so the resistance to change is not an argument for or against the following proposal.

In order to standardize the expression of transconductance and amplification factor on a basis better adapted for circuit analysis, it is proposed that these quantities in an ordinary triode be defined as negative. The negative transconductance is based on the fact that a positive change of the grid voltage produces a negative change in the current out of the tube from the plate terminal. The negative amplification factor is based on the fact that a positive change of grid voltage produces a negative change of plate voltage.

Beyond the reasonableness of this proposal, a strong argument in its favor is that it fits in with the accepted conventions in the analysis of electric circuits. The concept of transconductance is an outgrowth of the general concept of transfer admittance from the input side to the output side of a 4-terminal network. The accepted convention defines this transfer admittance as the quotient of the current out of the output side of the network divided by the applied voltage on the input side. If the lower terminals are considered as joined together and grounded, this becomes more precisely the quotient of the current out of the ungrounded output terminal divided by the voltage applied to the ungrounded input terminal. It is also true that a positive transfer admittance gives an output voltage of the same polarity as the applied input voltage.

The concept of transadmittance in a vacuum tube differs from the concept of transfer admittance only to the extent that transadmittance has to be specified from one electrode to another since it is not a reciprocal property between two electrodes. There is nothing in this difference which should cause us to define transadmittance as having a polarity different from the accepted polarity of transfer admittance.

Therefore I urge that the transadmittance and other terms such as transconductance be defined as the quotient of the current out of the output electrode divided by the applied voltage on the input electrode, the input and output electrodes being specified. Also the amplification factor becomes merely the quotient of the output voltage divided by the input voltage when these voltages are adjusted to produce no change of the output current. The formulas for defining the amplification factor and the ordinary formulas expressing the amplification of an amplifier stage all lose their negative signs, the reversal of polarity then being included in the negative sign of the transconductance or the amplification factor which appears in the formula. The fictitious internal voltage generated in a triode becomes merely equal

to the grid voltage multiplied by the amplification factor.

It is concluded that these recommendations are fundamentally sound and logical. They do not involve a departure from long-established practice but rather the establishment of a new convention where none existed before. Those who have given this proposal a fair trial have found that its advantages in circuit analysis far outweigh the mental resistance to regarding the transconductance and amplification factors as negative numbers where we have previously regarded them just as numbers. The advantages are most appreciated in the study of the more complicated circuits and it is there that the benefit of standardization is most needed. These recommendations should be adopted without delay because we are coming closer to the general use of special tubes which involve both kinds of transconductance.

HAROLD A. WHEELER

A proposal is being advanced that the definition of transconductance of a vacuum tube be altered so that the transconductance of a conventional triode would become negative in sign. I have been invited to write a letter opposing this proposal. The proposal astonishes me; I oppose it heartily.

A plausible case can be made for either of the two possible definitions determining the sign of the transconductance, reasoning logically from fundamentals.<sup>1</sup> To an engineer working with filter theory, it seems proper that the definition should correspond to filter theory conventions. To others the logic which led to the original definition seems satisfactory.

But we are not faced with the problem of deciding how we should define a new quantity. The definition was made—correctly or incorrectly—years ago and has been widely accepted. It is now proposed that the definition be changed.

I submit that the only grounds for making a change of this nature would be the finding that the old definition was unworkable or not widely accepted. With the possible exception of work on filters, it is apparent that the old definition is workable and universally accepted. It does not appear that great hardship has been caused for filter designers. Correct results can readily be obtained by clear thinking, using the present definition. With the proposed definition, correct results could not be had without clear thinking.

Changes have lightheartedly been made in definitions and symbols before without very serious consequences except the bringing of standardization into disrepute. It might therefore be argued that it is a small matter whether or not this change is made and that it would be reasonable to please the filter designers. But this proposed change is of a different nature from those which have previously been made.

<sup>1</sup> See G. W. O. Howe, "The phase convention of currents and voltages in valve circuits," *Wireless Eng.*, vol. 17, no. 198, pp. 95-96; March, 1940.

Suppose that the Institute of Radio Engineers, the American Institute of Electrical Engineers, and the American Standards Association by some miracle should act promptly and in complete agreement to effect this proposed change in the near future (it usually takes several years to get even a noncontroversial change through the mill). Effective January 1, 1941, (let us say) when we say "negative transconductance" we should mean positive transconductance, old style. This would be somewhat cumbersome and inconvenient but would not be overwhelmingly serious if everyone made the change at the same time and if all written material were dated. But anyone who has observed the course of standardization must have seen that it takes years to change even a good majority of the radio workers over to a new standard and that there are always a great

many die-hards who continue as before. Including the present proposal, the possibilities of representing a given quantity using well-supported conventions would be about as follows:

$$\left. \begin{matrix} g_m \\ s_m \\ S \end{matrix} \right\} = \left\{ \begin{matrix} + \\ - \end{matrix} \right\} 1500 \begin{cases} \text{micromhos} \\ \text{microamperes per volt.} \end{cases}$$

A further interesting variation is obtained by the choice between "transconductance" and "mutual conductance." It is apparent that the symbols, the name of the dimension, and the name of the quantity itself can be chosen to suit the individual's fancy without obscuring his meaning. But the introduction of a choice in signs would bring about complete ambiguity. Unless I know which definition a man accepts, I cannot know what he means.

There are many organizations, large and small, which issue data on tubes. Many—probably most—will not accept a change justified by such esoteric arguments as are advanced in this case. They could hardly do so in any case, for they have so many valuable data already in print which they cannot afford to replace.

There are many books which could not be changed. Papers by the hundreds are now in print which conform to the old standard. All of these would suddenly be rendered in error and therefore misleading.

The adoption of this proposal by the Institute of Radio Engineers could have little other effect than to produce confusion and to injure the cause of standardization. It seems certain that the proposal will not be generally accepted.

B. J. THOMPSON

## Books

### Elektrotechnik, by F. Bergtold.

Published by Weidmannsche Verlagshandlung, Berlin, Germany. 294 pages + 3-page index. 373 figures.  $6\frac{1}{2} \times 8\frac{1}{2}$  inches.

This is a commendable effort to present the fundamentals of electrical science to radio and amplifier technicians. It is an ambitious undertaking,—to attempt to carry a person of modest technical background from the elementary conception of currents, potentials, etc., through to a complete exposition of vacuum tubes and networks in 297 pages. The book does this well, with no apparent sacrifice in rigidity of thought or accuracy of principles. The mathematics are limited to arithmetic and simple algebra. There are numerous good diagrams. The latter, especially made for the book, are 373 in number and they are simple and pointed.

It must again be emphasized that this is a book of fundamentals. There is not a single circuit diagram of the usual radio instruction type nor are there practical operating hints for the equipment which a technician may be called upon to handle. The book sticks to its objective. It is presumably intended as a textbook for those who have no more than, say, a high-school education. It would not serve badly as a review book for those who have struggled through college courses in physics and electrical engineering.

The terminology has been brought up to date in accordance with present German practice. Thus, non-German word roots are avoided, and "Permeabilität" has become "magnetischer Verhältnswert." This revision of terminology may prove inconvenient or confusing to non-German readers.

Lest the reader obtain the impression that this volume lacks nothing in perfection, let it be noted that there is even a short section on frequency modulation but, unfortunately, the author completes the discussion with only reference to its dis-

advantages as compared with amplitude modulation. Apparently frequency modulation, with all its implications for the future, has not yet reached or impressed the author, or perhaps the manuscript of the book was written before it did.

H. A. AFFEL

Bell Telephone Laboratories, Inc.  
New York, N. Y.

### The Oscillator at Work, by John F. Rider.

Published by John F. Rider Publisher, Inc., 404 Fourth Ave., New York, N. Y. 243 + xi pages. 159 figures.  $5\frac{3}{4} \times 8\frac{1}{4}$  inches. Price, \$1.50.

The vacuum-tube oscillator confronts the serviceman in many forms and varieties, not only in the apparatus upon which he is operating, but in the instruments with which he works. This book is intended to provide a description and explanation of all those ordinarily encountered. It is arranged in two parts, the first giving general principles of various types of oscillators, and the second a description of and instruction on specific circuits and instruments.

Part II is excellent and contains much "meat." There is some question as to whether Part I succeeds in getting across the ideas which are there. It is difficult to teach more-advanced principles, such as those involved in oscillator performance, to persons not thoroughly grounded in the basic principles, and the method of presentation may not overcome this difficulty. For example, it is not stated simply anywhere that a tuned circuit is affected by hanging a tube on it, and affected by what is in the plate circuit of that tube. The effects are described, but unless that simple fact is in mind first, the whole situation may not be clear to the reader. Nevertheless, Part II alone makes the book well worth while.

The book is carefully edited and only two errors were noticed, both minor. Figure 7-5 omits point D referred to in text,

and on page 53, 3000 megacycles should be 300 megacycles.

ARTHUR VAN DYCK  
RCA License Laboratory  
New York, N. Y.

### Mathematics Applied to Electrical Engineering, by A. G. Warren.

Published by D. Van Nostrand Company, Inc., 250 Fourth Avenue, New York, N. Y. 384 + xv pages.  $5\frac{1}{4} \times 8\frac{1}{2}$  inches. Price, \$4.50.

As stated in the foreword by Professor Alexander Russell, this book will be found of use to two classes of readers: (1) those who may desire a general review of their college mathematics and electrical theory and (2) those who are looking for the more advanced methods of solution for particular problems met with in practice. For the first class of readers the material contained in the first eight chapters will be found an admirable summary. For the second class of readers the remaining fourteen chapters will be most interesting. They treat for the most part the methods of solution of Ordinary and Partial Linear Differential Equations by both classical and operational methods with particular attention to solutions defined by infinite series. There are also chapters on Simultaneous Differential Equations, Harmonic Analysis, and Conjugate Functions.

Numerous examples of the use of these methods in concrete engineering problems are given. These examples are chosen from a wide range of electrical engineering applications, of which the majority will be found of interest to radio engineers.

The author's style, while terse, is nevertheless lucid. Very little attention is given to matters of formal mathematical rigor, a feature which will probably recommend the book to the engineering reader. In the appendices will be found lists of the principal formulas and a short bibliography.

An adequate subject index concludes the volume.

The reviewer finds this one of the most satisfactory compendiums of this nature with which he is familiar.

L. P. WHEELER  
Federal Communications Commission  
Washington, D. C.

### Moderne Kurzwellen-Empfangstechnik (Modern Short-Wave Receiving Technique), by M. J. O. Strutt.

Published by Julius Springer, Berlin, Germany. 245 pages. 176 illustrations.  $6\frac{3}{8} \times 5\frac{1}{8}$  inches. Price, RM 18.60.

This book covers, in particular, what

have been called the "Ultra-Short-Wave and Decimeter-Wave Fields" up to the highest frequencies at which conventional types of tubes can be used.

Chapters in order cover Receiving Antennas, Transmission Lines, Measurement Methods, Amplification of Currents and Potentials, Conversion and Detection, Receiving Systems, Mathematical Appendix and List of References.

Although the treatment of the fundamental theory of receiving antennas is good, the discussion of practical antenna design is rather incomplete, particularly as regards to the different types of arrays and wave antennas such as the rhombic type.

Chapters III and IV covering Measurements and Amplification are particularly to be recommended. They contain con-

siderable of new material, particularly that which the author has contributed to the art, in order to obtain which, it has been necessary to refer to the original articles previously.

With minor exceptions, the treatment is descriptive rather than mathematical, and the book can be used by a person with very meager mathematical knowledge. For those who have the facility, appendixes cover some of the derivations which are omitted from the text.

The language used is much less involved and easier read than in many German books.

IRVING WOLFF  
RCA Manufacturing Company  
Camden, N. J.

## Contributors



ARTHUR B. CRAWFORD

Arthur B. Crawford was born on February 26, 1907 at Graysville, Ohio. He received the B.S. degree in 1928 from Ohio State University. Since 1928 he has been with the research department of Bell Telephone Laboratories and has been engaged chiefly in ultra-short-wave propagation studies.



HENRY B. DE VORE

Henry B. De Vore was born on December 20, 1907. He received the B.S. degree in physics in 1926 and the M.S. degree in 1927 from the Pennsylvania State College. From 1927 to 1931 he was employed at the experimental station of E. I. du Pont de Nemours and Company. Dr. De Vore received the Ph.D. degree in 1934 from the California Institute of Technology. Since that date he has been engaged in research with the RCA Manufacturing Company.



JOHN N. DYER

John N. Dyer was born in Haverhill, Massachusetts, on July 14, 1910. He received the B.S. degree in 1931 from Massachusetts Institute of Technology. In September, 1933, he joined the Columbia Broadcasting System staff and was assigned to the Byrd Antarctic Expedition as chief communications engineer to handle the Columbia Broadcasting System broadcasts. Returning in 1935, he did ultra-high-frequency work in the general engineering department. At the close of 1936 he was transferred to the television engineering department and is now assistant chief engineer.

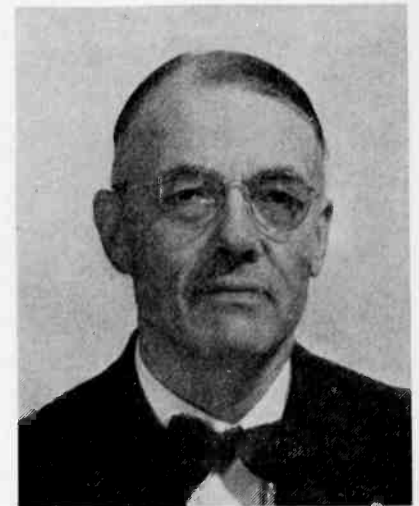

CARL R. ENGLUND

Carl R. Englund was born on November 13, 1884 in Sioux City, Iowa. He received the B.S. degree in chemical engineering from the University of South Dakota in 1909. He was a graduate student at the University of Chicago during the next two years and in 1912 and 1913 was professor of physics and geology at West-

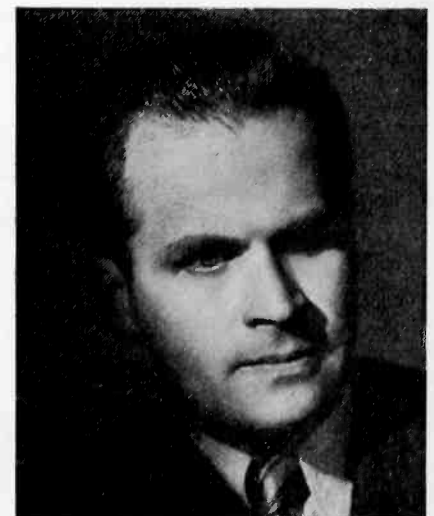

PETER C. GOLDMARK

ern Maryland College. He was a laboratory assistant at the University of Michigan in 1913 and 1914. In the latter year he entered the employ of the Western Electric Company laboratory which in 1925 became known as Bell Telephone Laboratories. His work has been in radio-frequency and field-strength measurements and measuring apparatus and in ultra-short-wave transmission.



Peter C. Goldmark (A'36-M'38) was born on December 2, 1906, at Budapest, Hungary. He received the B.Sc. degree in 1930 from the University of Vienna and the Ph.D. degree in physics in 1931. Dr. Goldmark was in charge of the Television Department of Pye Radio, Ltd., Cambridge, England, from 1931 to 1933; consulting engineer in New York City, 1933 to 1935. Since 1935 he has been Chief Television Engineer at the Columbia Broadcasting System.

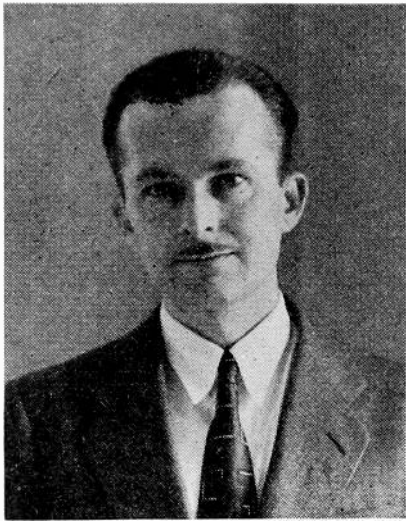

HARLEY IAMS

Harley Iams (A'31-M'38) was born on March 13, 1905, at Lorentz, West Virginia. In 1927 he received the A.B. degree from Stanford University. Mr. Iams took the student course from 1927 to 1928, and from 1928 to 1930 was in the facsimile and television research department of the Westinghouse Electric and Manufacturing Company. Since 1931 he has been doing television research for the RCA Manufacturing Company.



W. W. MUMFORD

W. W. Mumford was born on June 17, 1905, at Vancouver, Washington. In 1930 he received the B.A. degree from Willamette University. Previously, in 1923 he served as a radio operator on the United States Coast Guard Cutter *Algonquin*. From 1924 to 1926 he was a clerk-operator and manager for the Western Union Telegraph Company. From 1928 to 1930 he was an assistant at the Oregon State Highway Testing Laboratories. Since 1930 he has been engaged in research work on ultra-



ROGER J. PIERACCI

short-wave transmission phenomena for the Bell Telephone Laboratories.



Roger J. Pieracci (S'40-A'40) was born at Yoder, Iowa, on March 19, 1911. He received the B.S. degree in electrical engineering from Iowa State College in 1932. From 1934 to 1939 he was a member of the engineering staff of the Collins Radio Company, and during 1939-1940 he took a year's leave of absence to resume study in communication engineering at Ohio State University, serving as Graduate Assistant to Dr. W. L. Everitt during this period. At the present time he is on the engineering staff of Collins Radio Company, where he is carrying on research in the field of frequency modulation. Mr. Pieracci is an associate member of Sigma Xi.



For a biographical sketch of Heinz E. Kallmann see the PROCEEDINGS for April, 1940.





FOR MODERN OSCILLOGRAPHIC RESEARCH!

# RCA Oscillographs



Model 304-A

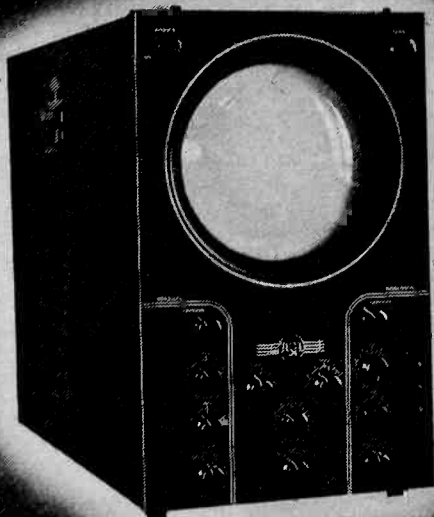

Model 305-A



ADMIRABLY ADAPTED to a wide range of new laboratory applications are these two new and versatile RCA Laboratory Oscillographs. Extremely wide ranges of operating characteristics, plus unusual associated circuits, permit accurate, rapid determination of complex electrical values . . . Each embodies a 9-inch tube; blanking-amplifier for visual indication of elapsed time over any portion of the trace; electrically-regulated power supply to insure pattern stability unaffected by line-voltage fluctuations.

The 304-A meets medium and low frequency requirements of both industrial and experimental

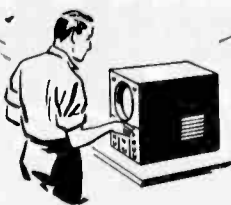

work; the 305-A equals those capabilities and has an extended operating response reaching to more than 10 megacycles. It is especially useful for observation of fast transient phenomena.

Fast photographic recording of square wave forms, frequency characteristic traces, out-of-phase voltages, and other unusual types of photographic measurement are easily handled by these capable modern instruments. Write for complete descriptive data and specifications.

*Use RCA Tubes in your Test Equipment for greatest precision.*



## Measuring Equipment

RCA MANUFACTURING CO., INC., Camden, N. J. • A Service of the Radio Corporation of America





Sections of finest grade India ruby mica, made to very close tolerances to equalize loading of series-connected sections. Vacuum-impregnated sections are imbedded in low-loss filler which reduces stray-field losses and safeguards against moisture entrance. Mica stacks rigidly clamped in low-loss non-magnetic clamps and heat-treated for maximum capacity-temperature stability.

Special cylindrical low-loss glazed ceramic case for long creepage path between terminals. Corona losses eliminated inside and out. Uniform voltage gradient.

Cast-aluminum terminal ends provide low-contact-resistance between stacked units. Units may be stacked and connected in series, parallel or series-parallel, providing all operating voltage ratings and capacity values. Bolts slipped through holes in aluminum caps for secure electrical and mechanical connections.

Ceramic insulating containers available as stand-offs in supporting and insulating active units away from frame, or for isolating and separating active units in stack.

Available in five sizes. Capacity values of from .00001 to .5 mfd. Voltage ratings of 1000 to 35,000 v. D.C.W.

● These stack-mounted mica capacitors and other transmitting types are listed in new Aerovox Transmitting Capacitor Catalog. Copy sent only to professional engineers, designers and builders of commercial-grade equipment, writing us on their business letterhead.



## HEAVY-DUTY

# Mica Capacitors

● Yes, the Aerovox line includes these stack-mounted mica capacitors for transmitting applications such as grid, plate-blocking, coupling, tank and by-pass functions.

Also many other transmitting-type mica capacitors in cast-aluminum cases, in bakelite cases, and in molded-in-bakelite cases. There are more capacities and voltage ratings offered than ever before, to meet the exact requirements of the critical worker.

Again, the Aerovox transmitting capacitor line includes an expanded choice of oil ca-

pacitors with still higher voltage ratings to take care of cathode-ray tube circuits and television receivers; heavy-duty immersion-proof paper capacitors in various styles of cans, mountings and terminals; plug-in electrolytics and paper capacitors for constant-duty service where replacements must be facilitated; etc. etc.

What were special capacitors yesterday thus become standard transmitting-capacitor numbers today in taking care of the requirements of the most critical buyers of radio components.

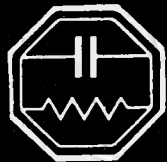

# AEROVOX CORPORATION

## New Bedford, Mass.

Sales Offices in All Principal Cities

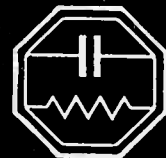

# Constancy of Purpose

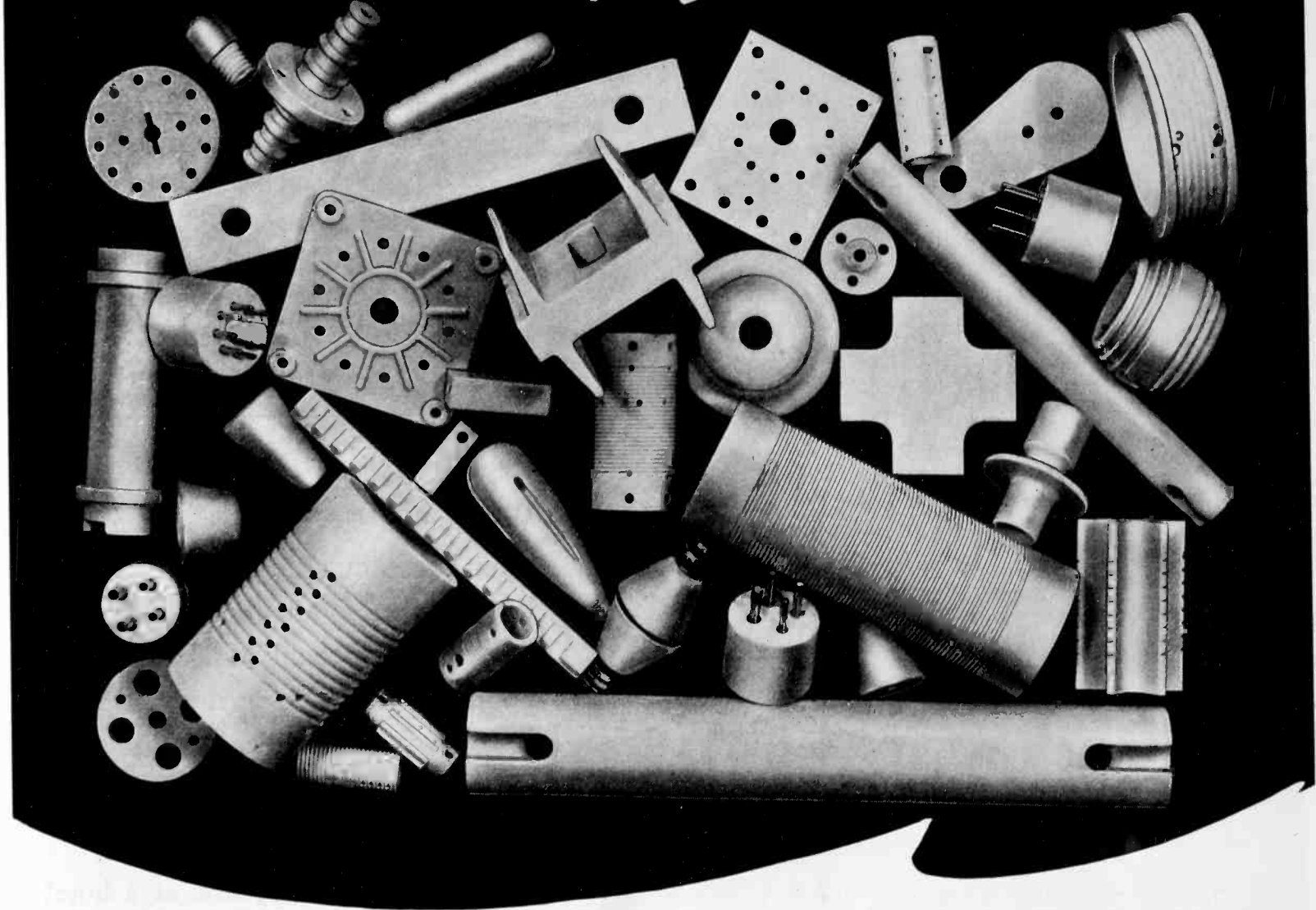

FOR 38 years the American Lava Corporation has spared neither time nor expense in developing Steatite Ceramic products ahead of the times. The laboratory and engineering staffs are constantly at work on problems vital to every industry using ceramics. We count it a privilege that these men are frequently consulted by America's foremost engineers. Continued research and development is the cornerstone upon which the American Lava Corporation stakes its future.

## ALSIMAG

Trade Mark Reg. U. S. Pat. Off.

FROM CERAMIC HEADQUARTERS

**AMERICAN LAVA CORPORATION • CHATTANOOGA • TENNESSEE**

CHICAGO • CLEVELAND • NEW YORK • ST. LOUIS • LOS ANGELES • SAN FRANCISCO • BOSTON • PHILADELPHIA • WASHINGTON, D. C.



# The Voice with a Smile

“We hold,” says a well-known writer, “that the young ladies of the American long distance telephone wires make up what is probably the most efficient public service crew in the world. They have profound patience and that capacity for taking pains that some one once said is all that genius amounts to.

“We once called a fellow at a hotel in Philadelphia but he had just departed on an automobile trip in a westerly direction. A few days later the long distance operator caught up with him in a little town in Missouri and he was the most surprised man in all but one of the States of the Union. The exception was New York. We were the most surprised there. To this day we have no idea how the operator did it.”

DAMON RUNYON  
in the *New York Mirror*

## BELL TELEPHONE SYSTEM

*The Bell System cordially invites you to visit its exhibits at the New York World's Fair and the Golden Gate International Exposition, San Francisco.*



# IRE membership offers many services to the radio engineer

**Proceedings**—An outstanding publication in the radio engineering field. Over a quarter of a century of service to the world in publishing important radio engineering discoveries and developments, the PROCEEDINGS presents exhaustive engineering data of use to the specialist and general engineer. A list of its authors is a "Who's Who" of the leaders in radio science, research, and engineering.

**Standards**—Since 1914 our standards reports have stabilized and clarified engineering language, mathematics, graphical presentations, and the testing and rating of equipment. They are always in the process of revision and thus remain up to date.

**Meetings**—In twenty-two cities in the United States and Canada, meetings of the Institute and its sections are held regularly. Scores of papers on practically every branch of the field are presented and discussed. Several convention meetings are sponsored by the Institute and add materially to its effectiveness in distributing data of value to engineers.

## The Institute of Radio Engineers

Incorporated  
330 West 42nd Street, New York, N.Y.

To the Board of Directors  
Gentlemen:

I hereby make application for ASSOCIATE membership in the Institute of Radio Engineers on the basis of my training and professional experience given herewith, and refer to the sponsors named below who are personally familiar with my work.

I certify that the statements made in the record of my training and professional experience are correct, and agree if elected, that I shall be governed by the Constitution of the Institute as long as I continue a member. Furthermore I agree to promote the objects of the Institute so far as shall be in my power.

.....  
(Sign with pen)  
.....  
(Address for mail)  
.....  
(City and State)  
.....  
(Date)

### SPONSORS (Signatures not required here)

Mr. ....  
Address .....  
City and State .....  
Mr. ....  
Address .....  
City and State .....  
Mr. ....  
Address .....  
City and State .....





# POSITIONS OPEN

The following positions of interest to I.R.E. members have been reported as open on September 15. Make your application in writing and address to the company mentioned or to

Box No. ....

PROCEEDINGS of the I.R.E., 330 West 42nd Street, New York, N.Y.

Please be sure that the envelope carries your name and address

## INSPECTORS, NAVY RADIO MATERIALS

The Civil Service Commission is holding examinations for the positions of inspector and senior inspector of radio materials at salaries of \$2000 and \$2600 per year, respectively.

Further information regarding the examination is contained in the formal announcement, which with the proper application forms may be obtained from the Secretary of the Board of U. S. Civil Service Examiners at any first- or second-class post office, or from the U. S. Civil Service Commission, Washington, D.C.

## AUTO RADIO DESIGNERS

An established manufacturer needs men who have had experience with the electrical and mechanical design of automobile radio receivers. Experience is an essential prerequisite. Box 212.

## ELECTRO-MECHANICAL ENGINEER

Leading parts manufacturer has opening for electro-mechanical engineer with knowledge and experience in the design of attenuators for communication systems, and of other component parts. Position affords worthwhile opportunity. Give full details. All replies confidential. Our own organization knows of this advertisement. Box 213.

## DESIGN AND PRODUCTION ENGINEERS

Midwest plant wants several experienced men for design, development, and production engineering on transmitting and receiving apparatus. Experience on government equipment highly desirable. Box 214.

## RADIOSONDE TECHNICIANS

In connection with the National Defense Program the Civil Service Commission has announced an examination to secure radiosonde technicians for Government Service. The salary of the position is \$2000 a year.

Persons appointed will have responsibility for the installation, inspection, and maintenance of radiosonde ground equipment at new stations in Alaska, the continental United States, and the Caribbean area. Applicants will be rated on their experience as shown in their applications, and on corroborative evidence. While experience in the installation, maintenance and repair of radio equipment forms the greater part of the requirement, applicants must have had at least 6 months of experience in the installation, maintenance and repair of radiosonde ground receiving and recording equipment.

Further information regarding the examination is contained in the formal announcement, which with the proper application forms may be obtained from the Secretary of the Board of U. S. Civil Service Examiners at any first- or second-class post office, or from the U. S. Civil Service Commission, Washington, D.C.

## DESIGN ENGINEER

A long-established manufacturer of communication equipment has an opening in

# Attention Employers . . .



Announcements for "Positions Open" are accepted without charge from employers offering salaried employment of engineering grade to I.R.E. members. Please supply complete information and indicate which details should be treated as confidential. Address: "POSITIONS OPEN," Institute of Radio Engineers, 330 West 42nd Street, New York, N.Y.

The Institute reserves the right to refuse any announcement without giving a reason for the refusal

Chicago for a man with at least two years of direct design and development experience in the immediate past on automobile or aircraft receivers, including a comprehensive familiarity with design factors leading to production economy. This is an opportunity for a man who is now employed directly as a designer, to enter a stable organization. This opening is known to associated employees. Box 215.

## JUNIOR RADIO ENGINEER

Wanted for permanent position near Washington, D.C. Must be university graduate, good mathematician and draftsman. Prefer single young man with some experience in broadcast work on antennas, transmission lines and field-intensity surveys. Necessary to travel considerably; expenses will be allowed. State details of qualifications, references, and salary required. Box 216.

## INSPECTORS OF SIGNAL CORPS EQUIPMENT

Applications are being received and rated until further notice by the Civil Service Commission for the positions of Inspector, three grades, Signal Corps Equipment, salaries ranging from \$2000 to \$3200 a year. These examinations are announced for the Signal Corps, War Department, for duty in the field. Applicants must show 4 years of college study leading to a bachelor's degree in electrical or radio engineering. In addition, for the Senior Inspector and Inspector grades, they must have had experience in the inspection and/or testing of varied signal corps equipment, radio, telephone, telegraph, and power units, etc., to determine compliance with specification.

Application forms and information may be obtained from the Secretary, Board of U. S. Civil Service Examiners, at any first- or second-class post office, or from the Commission's Washington office.

## BROADCAST FIELD ENGINEER

An engineer with some experience in the broadcast field is wanted for field-strength measurements and other outside work by a firm of consulting engineers. He will be expected to work without detailed supervision. Box 217.

## PRODUCTION ENGINEER

A man with general radio-engineering experience, preferably one familiar with receiver production, is wanted by a manufacturer in the East. He must be mature and capable of assuming responsibility for his own work and that of others with only a small amount of technical supervision. Some traveling. Present staff knows of this opening. Box 218.

## RADIO ENGINEERS FOR GOVERNMENT SERVICE

Word has been received that the civil-service examinations for 4 grades of engineer (including radio, telegraph and telephone specialists) mentioned in the June Proceedings and described in Announcement No. 83 of the Civil Service Commission has been extended to June 30, 1941.

# TRIPOLETT POCKET SIZE

"Little Triplets"  
The Little Testers with the  
Big 3-Inch Instruments

Model  
666



AC-DC Pocket size Volt-Ohm-Milliammeter. Black molded case and panel, completely insulated. Dealer Net Price \$14.00

Model  
670



AC Ammeter  
—0-1; 0-2.5;  
0-5; 0-10;  
0-25. Dealer  
Net Price \$9.00

Model  
671



Five ranges:  
0-5; 0-10; 0-25;  
0-50; 0-100;  
0-250; 0-500;  
0-1000 AC Milliamperes. Dealer Net Price \$9.00

The "Little Triplets" comprise a series of matched instruments available in single units or in combination to answer every servicing or electrical analyzing problem. Models available in addition to the above are as follows:

Model 672—0-150; 0-300; 0-750 AC Volts—\$9.00 Dealer Net.

Model 673—0-5; 0-10; 0-25; 0-50; 0-100; 0-250; 0-500; 0-1000 AC Volts (Rectifier type)—\$9.00 Dealer Net.

Model 674—0-1; 0-2.5; 0-5; 0-10; 0-25 DC Amperes, \$9.00 Dealer Net.

Model 675—0-1; 0-5; 0-10; 0-25; 0-100; 0-250; 0-500; 0-1000 DC Milliamperes, \$9.00 Dealer Net.

Model 676—0-50; 0-100; 0-250; 0-500; 0-1000 DC Microamperes, \$9.00 Dealer Net.

Model 677—0-1; 0-2.5; 0-5; 0-10; 0-25; 0-50; 0-100; 0-250; 0-500; 0-1000 DC Volts at 1000 ohms per volt—\$9.00 Dealer Net.

Model 678 Ohmmeter. Self-contained batteries for 0-1000 Ohms (10 Ohms Center Scale); 0-10,000 Ohms (100 Ohms Center Scale); 0-100,000 Ohms; 0-1 Megohm; 0-10 Megohms—\$9.00 Dealer Net.

Write for Catalog—Section 218, Harmon Dr.

TRIPOLETT ELECTRICAL INSTRUMENT CO.  
Bluffton, Ohio



## Formula for Success!

It is probable that the radioman who supplements his own experience with CREI technical training in Practical Radio and Television Engineering, will find more opportunities for advancement.

*Our proof* is a large file of letters from students and graduates reporting pay raises, promotions and more satisfactory positions.

*Your proof* is the unquestioned fact that the better positions in Radio go to the men who are equipped with modern technical training to handle them.

CREI training develops in the student that sure confidence in his own ability which enables him to go after the better positions—and get them!

May we send you our new illustrated booklet?



This booklet outlines in detail our Home Study and One-Year Residence courses in Practical Radio and Television Engineering. In writing please state briefly your radio experience, education and present position.

**Capitol Radio**  
ENGINEERING INSTITUTE

E. H. RIETZKE, Pres.  
Dept. PR-8  
3224 Sixteenth St., N.W.  
Washington,  
D.C.

## INDEX

POSITIONS OPEN .....vii

## DISPLAY ADVERTISERS

### A

Aerovox Corporation ..... ii  
American Lava Corporation ..... iii  
American Telephone & Telegraph Company ..... iv  
Amperex Electronic Products, Inc. .... ix

### B

Bliley Electric Company .....viii

### C

Capitol Radio Engineering Institute ..... viii  
Cornell-Dubilier Electric Corporation ..... x

### G

General Radio Company ..... Cover IV

### R

RCA Manufacturing Company ..... i, Cover III

### T

Triplett Electrical Instrument Company .....vii



**BLILEY ELECTRIC COMPANY**

UNION STATION BUILDING

ERIE, PA.

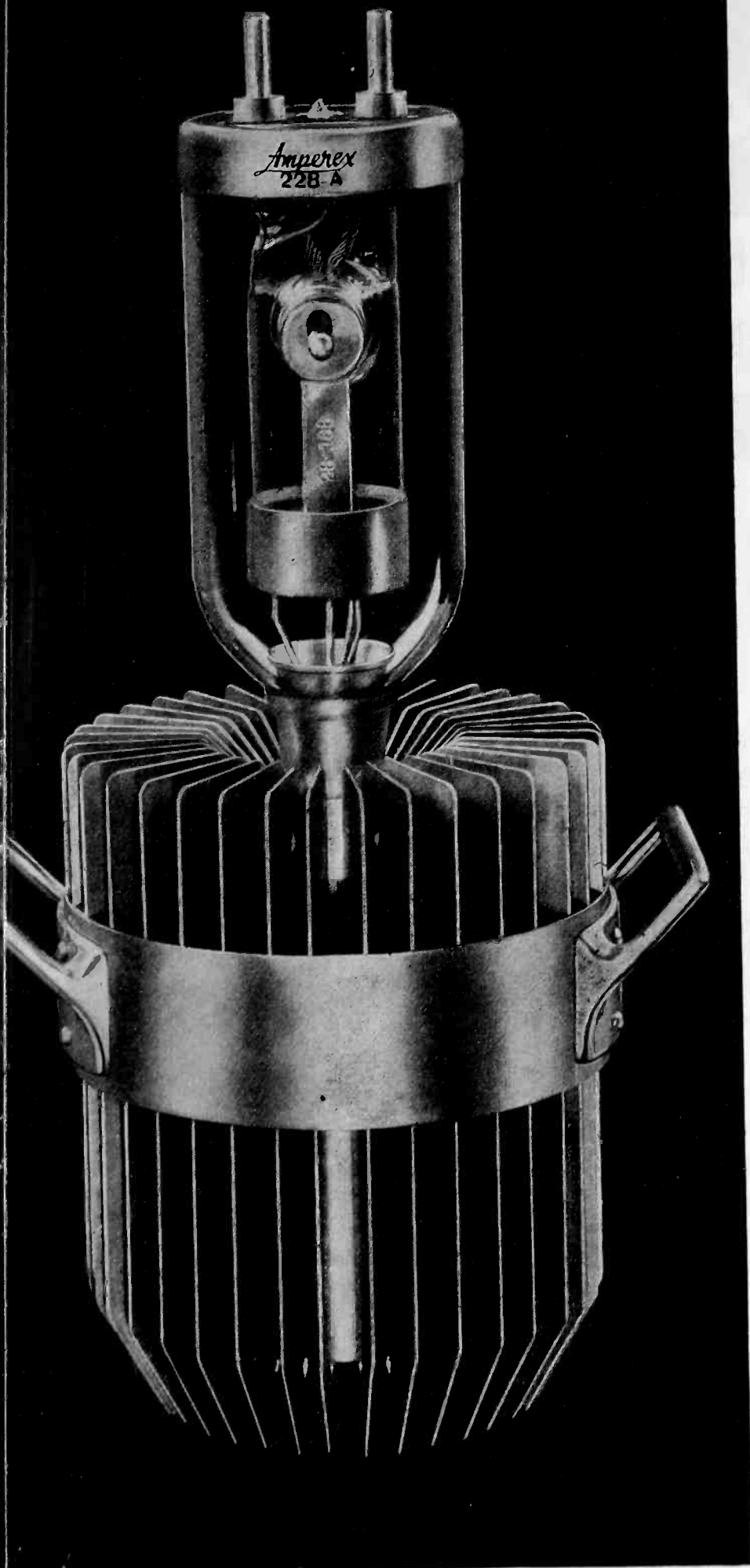

# AMPEREX

## AIR RADIATORS For Water Cooled Tubes

AMPEREX engineers have developed a series of Radiators suitable for the forced air cooling of metal anode power tubes which are ordinarily water cooled.

These Radiators are scientifically designed for the greatest transfer of heat to the air stream. Their structures are simple, yet they are remarkably efficient. In fact, for some high frequency uses, they are far more desirable than water cooling systems.

AMPEREX Radiators are available with the 891, 892, 342A, 343A, 232C, 220C, 228A and can be readily manufactured for many other types of tubes.

Because of the technical skill required for imbedding the anode into the radiator well, these radiators can only be supplied as an integral part of the tube.

**AMPEREX ELECTRONIC PRODUCTS, Inc.**

79 WASHINGTON STREET

BROOKLYN, NEW YORK

DIVISION DE EXPORTACION: 100 VARICK STREET, NEW YORK, E. U. A. CABLEGRAMAS: "ARLAB".



they may  
look alike



but what a difference  
in performance!

### Bird dogs or capacitors . . .

LOOKING AT THEM, it's hard to distinguish a green dog from a veteran game-getter. But on range bird hunting—what a difference in performance! Then there is no mistaking an old bird dog. He is eager, fast . . . knows a bird scent, how to untangle a trail, how to point. That takes experience.

This moral is pointed because capacitors, too, look alike. It is the hidden ingredients that makes the difference. That's why you get a finer performing, longer lasting, more dependable capacitor when you specify Cornell-Dubilier. C-D engineers are capacitor specialists, with the backing of the broadest experience in the industry—over thirty years. The superiority of today's Cornell-Dubilier capacitors is nobody's mere say-so, but proven performance, time-tested and most significant—acknowledged by the fact that there are more C-Ds in use today than any other make.

\*C-D ETCHED FOIL—NOT FABRICATED PLATE

**CORNELL-DUBILIER ELECTRIC CORPORATION**  
1012 Hamilton Blvd., South Plainfield, N. J.

PHOTOGRAPH COURTESY HUNTING AND FISHING MAGAZINE



Only Cornell-Dubilier  
Electrolytics offer  
all these **REAL**  
features

**Type BR\***  
Reg. U. S. Pat. Off.

### These Features:

- Special high-voltage paper separator
- C-D etched plate
- Special C-D electrolyte
- Special high formation process

### Result in:

- Minimum capacity change over wide temperature range.
- Great reduction in physical size—up to 40% for some types.
- Increased useful life.
- Reduced direct current leakage.
- Reduced equivalent series resistance.
- Higher breakdown voltage.
- Improved audio and radio frequency impedance characteristics.

The Type BR etched foil electrolytics are available in both single and dual capacity combinations. For complete technical information, send for engineering bulletin.

Remember! All C-D capacitors are union made and competitively priced.

*specify* **CORNELL-DUBILIER!**

**THE WORLD'S LARGEST MANUFACTURER OF CAPACITORS**



# 60% EFFICIENCY AT 500 Mc

THE basically-new principle employed in the multi-electrode RCA-825, wherein the electron stream is inductively coupled to the output circuit, has resulted in removal of many of the present day limitations to u-h-f operation. Designed for use as a power amplifier at frequencies above 300 megacycles, the RCA-825 is capable of handling power outputs up to 35 watts, depending on the band width and type of service. It is also useful as an oscillator and harmonic generator, being employed in these applications in the same manner as conventional-type tubes.

By separating the functions of the output electrode and of the current-collecting electrode, and by making use of high-velocity focused electrons, electron transit-time effects are minimized without increased dissipation and loss in efficiency. This separation of functions makes it possible to utilize an output circuit of low effective capacitance and high efficiency. Thus, because of its high transconductance and its adaptability to tank circuits having low effective capacitance, the 825 is especially suited for wideband services, such as television and frequency modulation.

Sound and practical in design, the 825 is an RCA engineering achievement which suggests vast new possibilities for the advancement of u-h-f use. Complete technical information will gladly be sent upon request. Inquiries regarding special applications above 300 megacycles are solicited. Write to RCA MFG. CO., Commercial Engineering Section, Harrison, N. J.



## RCA-825 INDUCTIVE- OUTPUT AMPLIFIER



● A developmental r-f amplifier stage using the RCA-825 at 500 Mc. The photograph shows the resonator, the tube, the electromagnet and general arrangement of parts. In use at RCA Communications, Rocky Point, Long Island, N. Y.

### MAXIMUM RATINGS, RCA-825 as R-F Power Amplifier and Oscillator—(Class C Telegraphy.) (Key-down conditions per tube without modulation.)\*

D-C COLLECTOR VOLTAGE	2000 max. Volts
D-C GRID No. 4 VOLTAGE	1500 max. Volts
D-C GRID No. 3 VOLTAGE	3600 max. Volts
D-C GRID No. 2 VOLTAGE	3600 max. Volts
D-C COLLECTOR CURRENT	-100 max. Volts
D-C GRID No. 1 CURRENT	50 max. Milliamperes
COLLECTOR INPUT	2.5 max. Watts
GRID No. 4 INPUT	100 max. Watts
GRID No. 3 INPUT	7 max. Watts
GRID No. 2 INPUT	5 max. Watts
COLLECTOR DISSIPATION	7 max. Watts
GRID No. 1 DISSIPATION	50 max. Watts
	0.15 max. Watts

\*Modulation essentially negative may be used if the positive peak of the audio-frequency envelope does not exceed 115% of the carrier conditions.

NOTE: In an inductive-output tube, the power input is equal to the product of the collector voltage and the d-c collector current, exactly as in the case in conventional tubes. The power dissipated at the collector is the difference between the power input to the collector and the power which is taken from the electron stream by the loaded tank circuit.

LIST PRICE, \$34.50



# Radio Tubes

PROVED IN RADIO'S MOST EXACTING APPLICATIONS

RCA MANUFACTURING CO., INC., CAMDEN, N. J. • A Service of The Radio Corporation of America



# At 2 A.M. You'll be glad you have

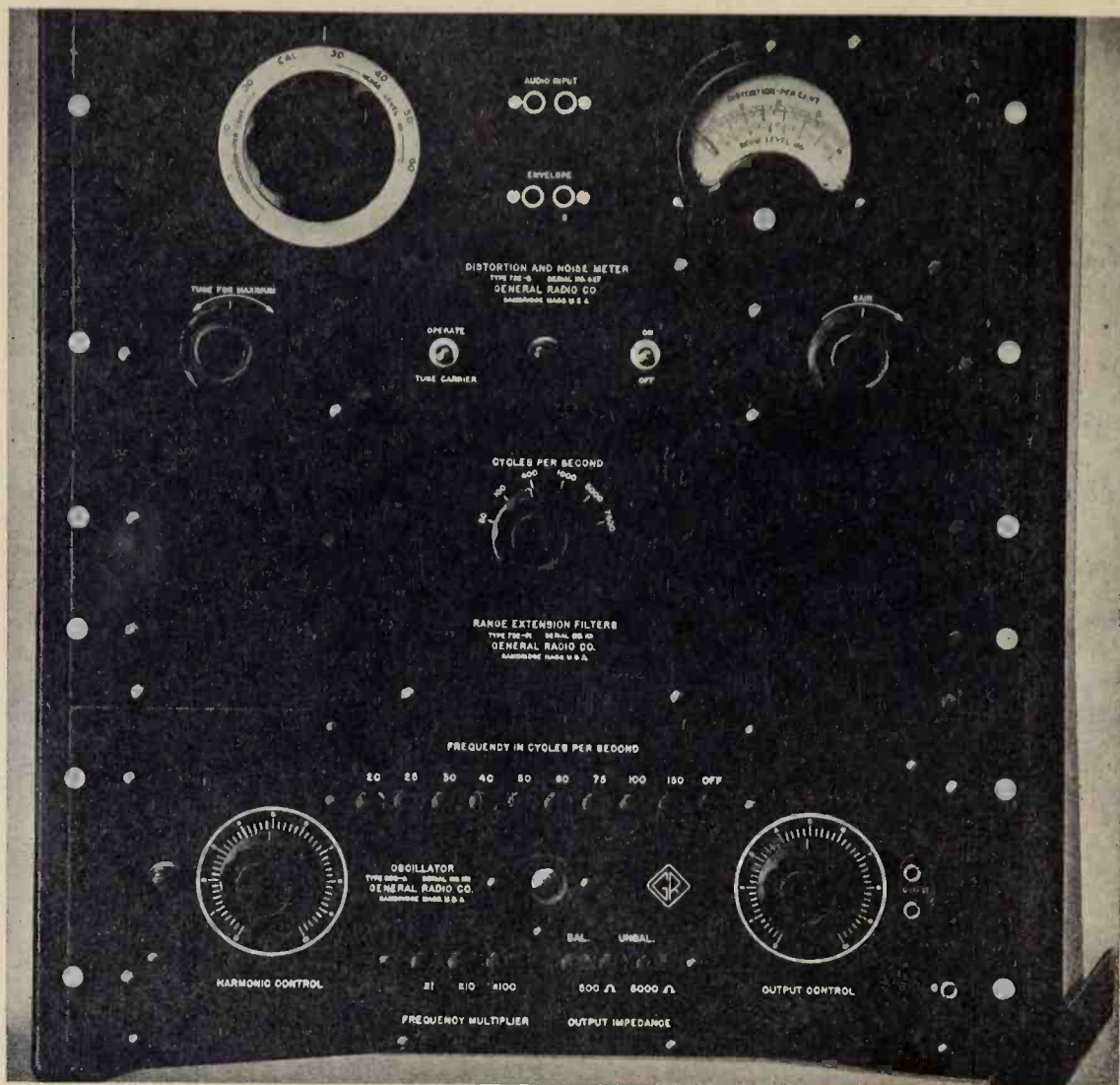

## G-R Distortion and Noise Measuring Equipment

WHEN IT'S TIME to put the transmitter to bed, after a long day of it, you will be glad your equipment is made by G-R, for with the Type 732-B Distortion and Noise Meter and its associated equipment, you can make a complete distortion run on your transmitter in less than a minute!

Here are several other reasons you will be glad yours comes from G-R:

1. **VERY SIMPLE TO OPERATE**—all critical adjustments (balance) are eliminated—it's pretty difficult to make any mistakes even after a long session working in a cold transmitter room.
2. **ACCURATE**—it's direct reading in all the answers you want
3. **INEXPERIENCED PERSONNEL CAN USE IT**—the chief doesn't have to worry about turning runs over to young technicians—they will get the right answer.

4. **MEETS ALL THE F.C.C. REQUIREMENTS**—with the F.C.C. 6 test frequencies.

The Type 732-B Distortion-Noise Meter is designed to operate with the Type 732-P1 Range-Extension Filters for measurements at 50, 100, 400, 1000, 5000 and 7500 cycles—the six test frequencies recommended by the F.C.C. At distortions greater than 0.5% the error is less than 10% of the true value  $\pm 0.15\%$  distortion. The r-f input operates over carrier ranges from 0.5 to 8 Mc or from 3 to 60 Mc and requires very little power.

The Type 608-A Oscillator is of the discrete-frequency type with two sets of push-button switches supplying frequencies of 20, 25, 30, 40, 50, 60, 75, 100 and 150 cycles with multipliers of 1, 10 and 100 times these frequencies. The output is exceptionally low in distortion.

Type 732-B Distortion and Noise Meter . . . \$245.00  
 Type 732-P1 Range Extension Filter . . . . . 150.00  
 Type 608-A Oscillator . . . . . 260.00

Write for Bulletin 583

**GENERAL RADIO COMPANY** CAMBRIDGE MASSACHUSETTS

