

Proceedings

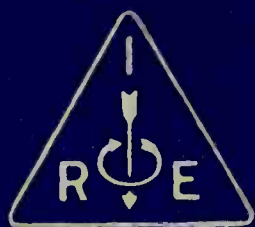

of the

I · R · E

M A Y

1940

VOLUME 28

NUMBER 5

Fifteenth Annual Convention

Large-Screen Television Reception

Ultra-High-Frequency Oscillography

GT Quartz-Crystal Plate

Reciprocity Theorem

Current Division in Triodes

Ionospheric Characteristics

Institute of Radio Engineers

Fifteenth Annual Convention

June 27, 28, and 29, 1940

Boston . . . Massachusetts

CONDENSED PROGRAM

● THURSDAY, JUNE 27

- 8:00 A.M. Registration
- 10:00 A.M. Official Welcome by President Horle
Technical Session, General
- 1:00 P.M. Inspection Trips to Hygrade Sylvania, U. S. Coast Guard Air Base,
Harvard University, General Radio Company, WBZ, and Massachusetts
Institute of Technology.
- 8:00 P.M. Technical Session, Ultra-High-Frequency Developments

● FRIDAY, JUNE 28

- 10:00 A.M. Technical Session, Vacuum Tubes and General
- 10:00 A.M. Technical Session, Measurements
- 2:00 P.M. Technical Session, Aircraft Radio
- 2:00 P.M. Technical Session, Vacuum Tubes
- 4:00 P.M. Informal Conference, Large Vacuum Tubes
- 6:30 P.M. Banquet

● SATURDAY, JUNE 29

- 10:00 A.M. Technical Session, Television
- 1:45 P.M. Technical Session, Frequency Modulation
- 4:30 P.M. Inspection Trip to the Yankee Network Station at Paxton

● A PROGRAM of entertainment for the women has been arranged for each day of the convention. Details are given in the full program published elsewhere in this issue.

Eastern Daylight Saving Time

Proceedings

of the I·R·E

Published Monthly by

The Institute of Radio Engineers, Inc.

VOLUME 28

May, 1940

NUMBER 5

A System of Large-Screen Television Reception Based on Certain Electron Phenomena in Crystals.....	A. H. Rosenthal	203
Ultra-High-Frequency Oscillography.....	H. E. Hollmann	213
A New Quartz-Crystal Plate, Designated the GT, Which Produces a Very Constant Frequency Over a Wide Temperature Range.....	W. P. Mason	220
A General Reciprocity Theorem for Transmission Lines at Ultra-High Frequencies.....	Ronald King	223
Current Division in Plane-Electrode Triodes.....	Karl Spangenberg	226
Characteristics of the Ionosphere at Washington, D. C., March, 1940, with Predictions for June, 1940... ..	T. R. Gilliland, S. S. Kirby, and N. Smith	236
Institute News and Radio Notes.....		239
Fifteenth Annual Convention.....		239
Election Notice.....		254
Membership.....		254
Books		255
"Principles of Television Engineering" by Donald G. Fink.....	Alfred F. Murray	
"Production and Direction of Radio Programs" by John S. Carlile.....	L. E. Whittemore	
"The Victory of Television" by Philip Kerby.....	Alfred F. Murray	
Contributors		256

BOARD OF DIRECTORS

Lawrence C. F. Horle, *President*
 Frederick E. Terman,
Vice President
 Melville Eastham, *Treasurer*
 Harold P. Westman, *Secretary*
 Austin Bailey
 W. R. G. Baker
 Frederick W. Cunningham
 Henry C. Forbes
 Alfred N. Goldsmith
 Virgil M. Graham
 O. B. Hanson
 Raymond A. Heising
 C. M. Jansky, Jr.
 Frederick R. Lack
 Frederick B. Llewellyn
 Haraden Pratt
 Browder J. Thompson
 Hubert M. Turner
 Arthur F. Van Dyck
 Harold A. Wheeler
 Lynde P. Wheeler

BOARD OF EDITORS

Alfred N. Goldsmith, *Chairman*
 Ralph R. Batcher
 Philip S. Carter
 Elmer W. Engstrom
 Frederick W. Grover
 J. Warren Horton
 Greenleaf W. Pickard
 Benjamin E. Shackelford
 Karl S. Van Dyke
 Harold P. Westman, *ex officio*
 Harold A. Wheeler
 Lynde P. Wheeler
 Laurens E. Whittemore
 William Wilson

PAPERS COMMITTEE

William Wilson, *Chairman*
 Frederick B. Llewellyn,
Vice Chairman
 Herman A. Affel
 Edmond Bruce
 Howard A. Chinn
 James K. Clapp
 Tunis A. M. Craven
 Robert B. Dome
 Paul O. Farnham
 Enoch B. Ferrell
 Elmer L. Hall
 Dorman D. Israel
 Loren F. Jones
 De Loss K. Martin
 Harry B. Marvin
 Harry R. Mimno
 Albert F. Murray
 Harold O. Peterson
 Ralph K. Potter
 Hubert M. Turner
 Dayton Ulrey
 Arthur F. Van Dyck
 Paul T. Weeks
 William C. White
 Irving Wolff

Helen M. Stote, *Assistant Editor*

John D. Crawford,
Advertising Manager

Entered as second-class matter October 26, 1927, at the post office at Menasha, Wisconsin, under the Act of February 28, 1925, embodied in Paragraph 4, Section 412 of the Postal Laws and Regulations. Publication office, 450 Alhambra Street, Menasha, Wisconsin. Subscription, \$10.00 per year; foreign, \$11.00.

THE INSTITUTE

The Institute of Radio Engineers serves those interested in radio and allied electrical-communication fields through the presentation and publication of technical material. In 1913 the first issue of the PROCEEDINGS appeared; it has been published uninterruptedly since then. Over 1800 technical papers have been included in its pages and portray a currently written history of developments in both theory and practice.

STANDARDS

In addition to the publication of submitted papers, many thousands of man-hours have been devoted to the preparation of standards useful to engineers. These comprise the general fields of terminology, graphical and literal symbols, and methods of testing and rating apparatus. Members received a copy of each report. A list of the current issues of these reports follows:

- Standards on Electroacoustics, 1938
- Standards on Electronics, 1938
- Standards on Radio Receivers, 1938
- Standards on Radio Transmitters and Antennas, 1938.

MEETINGS

Meetings at which technical papers are presented are held in the twenty-three cities in the United States, Canada, and Argentina listed on the inside front cover of this issue. A number of special meetings are held annually and include one in Washington, D. C., in co-operation with the American Section of the International Scientific Radio Union (U.R.S.I.) in April, which is devoted to the general problems of wave propagation and measurement technique, the Rochester Fall Meeting in co-operation with the Radio Manufacturers Association in November, which is devoted chiefly to the problems of broadcast-receiver design, the Pacific Coast Convention, which is held each year during the summer months and is supervised by a joint committee of our four Pacific Coast sections, and the Annual Convention, which will be held in New York City during January.

MEMBERSHIP

Membership has grown from a few dozen in 1912 to more than five thousand. Practically every country in the world in which radio engineers may be found is represented in our membership roster. Approximately a quarter of the membership is located outside of the United States. There are several grades of membership, depending on the qualifications of the applicant. Dues range between \$3.00 per year for Students and \$10.00 per year for Members. PROCEEDINGS are sent to each member without further payment.

PROCEEDINGS

The contents of each paper published in the PROCEEDINGS are the responsibility of the author and are not binding on the Institute or its members. Material appearing in the PROCEEDINGS may be reprinted or abstracted in other publications on the express condition that specific reference shall be made to its original appearance in the PROCEEDINGS. Illustrations of any variety may not be reproduced, however, without specific permission from the Institute.

Papers submitted to the Institute for publication shall be regarded as no longer confidential. They will be examined by the Papers Committee and Board of Editors to determine their suitability for publication. Suggestions on the mechanical form in which manuscripts should be prepared may be obtained from the Secretary.

SUBSCRIPTIONS

Annual subscription rates for the United States of America, its possessions, and Canada, \$10.00; to college and public libraries when ordering direct, \$5.00. Other countries, \$1.00 additional.

The Institute of Radio Engineers, Inc.

Harold P. Westman, Secretary

330 West 42nd Street

New York, N.Y.



A System of Large-Screen Television Reception Based on Certain Electron Phenomena in Crystals*

A. H. ROSENTHAL†, ASSOCIATE, I.R.E.

Summary.—A new method for the transformation of electron images into optical transparency pictures is described. The importance of storage for television reception and the prospects of applying the new method to large-screen television projection are discussed.

I. SCREEN BRIGHTNESS AND OPTICAL STORAGE

THE problem of large-screen television pictures is essentially one of providing sufficient light for any desired size of the received picture. The various methods which have been proposed and partly developed to obtain television pictures of high definition comparable in size and brightness with cinema standards, can be divided into two different groups:

(a) A Small Self-Luminous Image is Optically Enlarged

The image is usually obtained by scanning a fluorescent or incandescent screen with a modulated cathode-ray beam. The energy of the cathode-ray beam is converted by the screen material into light energy, which is radiated from the screen according to the Lambert cosine law. Therefore only a small fraction of the total modulated light flux can be collected by the projecting lens system and contribute to the picture (less than 6 per cent with an $f:2$ lens). These systems thus work with a very low optical efficiency. Whilst by using intense electron beams accelerated by very high voltages, and projection lenses with a wide aperture, it has been possible to project fluorescent pictures with a moderately satisfactory brightness, the picture quality and appearance leave much to be desired, when compared with the relatively small direct-view cathode-ray-screen pictures.

(b) The Light Intensity of a Standard Light Source is Controlled by the Picture Signals

The light originates from a standard light source such as used for cinema projection, for instance, an incandescent or arc lamp, and is controlled in its intensity by the received television signals by means of a light modulator and is distributed over the picture surface by scanning devices. Practically all the controlled light energy can be collected towards the screen in these systems.

All the early methods of television reception, generally using a Kerr cell as the light modulator and optical-mechanical scanning means, were unsuccessful even for moderate definition standards of over say

120 lines, mainly because each picture element was active only for a very short time during which it was scanned by a light spot of element size, or, in other words, at any moment the area of only one picture element was illuminated. By introducing the *supersonic-wave light modulator* which, by *optical storage* of the received signals over the duration of several hundred elements, enables the simultaneous illumination of this number of elements on the screen to be achieved, the *Scophony system* could obtain by optical-mechanical means television pictures for the present-day high-definition standards of over 400 lines of pleasing picture quality and appearance and of a size and brightness adequate for motion-picture theaters.¹

The importance of the *simultaneous illumination* of many picture elements for obtaining bright pictures will be appreciated by regarding the light flux I falling onto the picture screen P (Fig. 1). If F is the total picture area on this screen, f the area simultaneously

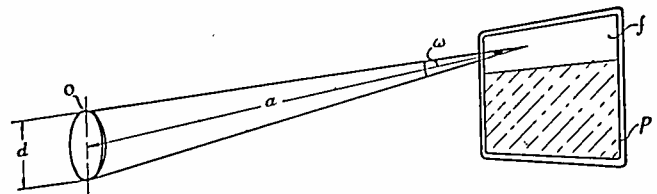

Fig. 1

illuminated at a certain moment through the lens 0, $r = f/F$ the ratio of the two areas, which may be called the *storage ratio*, ω the solid angle of the cone from a point of the screen P to the lens 0, e the brightness of the light source, p a factor representing the total optical losses, then

$$I = p f \omega e = p r \omega e F,$$

and the screen illumination

$$E = p r \omega e.$$

For a given light source, the screen illumination E is proportional to the storage ratio r and the solid angle of illumination ω . This relation shows that for a desired screen brightness an increase of the storage ratio would allow a reduction of the active lens aperture, or an increased projection distance. For example, if a picture of medium cinema-screen brightness of say

¹ D. M. Robinson, "The supersonic light control and its application to television with special reference to the Scophony television receiver," PROC. I.R.E., vol. 27, pp. 483-487; August, 1939.

* Decimal classification: R583. Original manuscript received by the Institute, February 15, 1940.

† Scophony Laboratories, London, England.

10 foot-lamberts^{2,3} is desired, using a high-intensity arc of a brilliance of 50,000 stilb (candles per square centimeter) with a total optical loss of 50 per cent ($p=0.5$) we have

$$E = 10 = pr\omega c = 0.5 \cdot r \cdot \omega \cdot 50,000 \cdot 2,919 \text{ foot-lamberts}$$

or $r\omega = 1.37 \cdot 10^{-7}$.

Regarding as examples three systems of television reception for high definition of say, 200,000 elements for the whole picture, with n elements active simultaneously, where $n=1$, or 200, or 200,000 (i.e., all elements), i.e., with storage ratios $r=5 \cdot 10^{-6}$, or 10^{-3} , or 1, respectively, we obtain the values shown in Table I.

TABLE I

n Simultaneously Active Elements	r Storage Ratio	ω Illumination Angle	$a:d$ Projection Ratio	Maximum Projection Distance a (for $d=2.5$ inches)
1	$5 \cdot 10^{-6}$	$2.7 \cdot 10^{-2}$	5.4	13.5 inches
200	10^{-3}	$1.4 \cdot 10^{-4}$	76	16 foot
200,000 (all)	1	$1.4 \cdot 10^{-7}$	2400	500 foot

The fourth column gives the ratio of the projection distance a to the diameter of the projecting lens d , $a:d = \sqrt{(\pi/4)(1/\omega)}$, and the fifth column shows the maximum projection distances which must not be exceeded in order to obtain the screen brightness of 10 foot-lamberts with a projection lens of an aperture 2.5 inches in diameter. It is obvious that the first case of only one element active at a time cannot be realized practically, since, for any convenient picture size, it would lead either to impossible apertures or to an impossible angle of coverage of the projecting lens, whereas a system with a storage ratio of 100 per cent would allow with projection apparatus of a moderate optical efficiency projection distances up to 500 feet. (These considerations can apply equally to cylindrical lens systems; ω is then the product of the aperture angles, in each of the two planes.)

These estimates will be sufficient to illustrate the importance of optical storage for television reception, which is analogous to the importance of electrical storage for television transmission. A necessary condition for obtaining a large and bright television picture with economical optical means is as large as possible a storage ratio r and an ideal system would be one with a storage ratio of 100 per cent, in which all picture elements would contribute simultaneously to the screen brightness.

There is a further advantage of a high storage ratio r , of approximately 100 per cent, i.e., of the retention of the intensity values of picture elements for substantially the frame period. According to Karolus⁴ a reduction of the frame frequency to 17 to 20 (compared to 25 to 30 with present interlaced systems) would be

possible in a system of a high storage without causing undue flickering, and without the necessity for interlacing.

A television system with a high storage ratio is the intermediate-film process, but it has the serious disadvantages of a time delay of some minutes between the reception of a picture and its projection, and of being very uneconomical on account of the high costs of the consumed film.

II. TRANSPARENCY IMAGES

A more promising approach towards a system with a high storage ratio is made in proposals in which the received signals are used to produce on a small screen an image of varying transparency which can be projected like a lantern slide on to a large picture screen, and which lasts for a considerable fraction of the frame period.

The use of various effects has been proposed to obtain such a varying transparency on a screen by scanning it with a modulated cathode-ray beam. For instance, potentials set up by the electric charge of the cathode-ray beam may cause the movement of small mechanical shutters⁵ or the attraction and orientation of small particles⁶ or double refraction in suitable substances.⁷

There is no evidence that any of these proposals have been successfully realized, and in most of them the difficulties both in principle and construction seem to be very considerable.

III. ELECTRON OPACITY

A most desirable and simple solution to the above problem would result from a screen made of a material which could be rendered more or less opaque by being subjected to the electron bombardment of a cathode-ray beam. Materials which can be strongly and directly affected in their optical properties by electron bombardment actually exist. In the early days of cathode-ray research, in 1894, E. Goldstein^{8,9} discovered that various alkali halides which were enclosed in the form of powder or crystals in cathode-ray tubes, were intensely colored as soon as the cathode rays were directed on them by a magnet.

In his splendid experimental investigations Goldstein found that the colors adopted were characteristic for each salt, that some salts could assume different colors depending on the intensity and duration of the cathode-ray irradiation and on thermal treatment, and that many of those alterations were reversible,

⁵ V. K. Zworykin, British Patent No. 376,498.

⁶ L. M. Myers and E. F. Goodenough, British Patent No. 466,031.

⁷ J. L. Baird, British Patents No. 454,589 and No. 470,347.

⁸ E. Goldstein, "Über die Einwirkung von Kathodenstrahlen auf einige Salze," *Ann. der Phys. und Chem.*, vol. 54, pp. 371-380; January, 1895.

⁹ E. Goldstein, "Über die durch Kathodenstrahlen hervorgerufenen Färbungen einiger Salze," *Ann. der Phys. und Chem.*, vol. 60, pp. 491-499; February, 1897.

² "The problem of the projection screen brightness committee," *Jour. Soc. Mot. Pic. Eng.*, vol. 26, p. 489; May, 1936.

³ "Report of the projection screen brightness committee," *Jour. Soc. Mot. Pic. Eng.*, vol. 27, pp. 127-139; August, 1936.

⁴ A. Karolus, "Fernsehen," Julius Springer, Berlin, 1937.

which latter fact led him to the conclusion that the salts are transformed to a different physical state by the cathode-ray treatment without undergoing any chemical changes.

Later research by various investigators revealed that these and other materials could be changed in a similar manner by X rays, ultraviolet light, and radiations from radioactive substances, and that they exhibited photoconductive properties and sometimes phosphorescence. The whole confusing complex of facts was investigated and brought nearer to an understanding by the extended research work of R. W. Pohl and his collaborators^{10,11} which revealed the electronic nature of these effects and their primary importance in relation to the theory of electron conductivity and photochemical processes. By using artificially grown crystals mainly of the alkali halides, and sometimes the alkaline earth halides, these investigators found many quantitative relations governing these effects. Such a crystal was found to represent a model for a photographic plate by which the electronic nature of the latent photographic image could be quantitatively investigated.

Though in most of this research work light was used because of the simpler experimental procedure and the better-defined energy quanta, it is obvious that the results can be also applied if the crystals are irradiated by cathode rays.^{8,9,12-14} The following theoretical considerations are even further simplified in this case.

If an alkali halide crystal which is subjected to an electric field is struck by a beam of electrons, these electrons tend to travel as free electrons towards the anode of the electric field through the crystal lattice which is composed of alternate positive alkali ions and negative halogen ions, but after a certain time of free travel an electron will be captured by a positive alkali ion. These captures seem to occur at places where the crystal lattice is disturbed and has certain defects as compared to the ideal form. As a result, some sort of loosely bound alkali atoms are formed which absorb light of the visible spectrum, and which are known as "Farbzentren," or *color centers*. By the thermal oscillations of the lattice, these color centers are after some time split up again into alkali ions and electrons, and each free electron proceeds through the lattice towards the anode until it is captured again by another alkali ion somewhat nearer to the anode, and is thus made visible once more as a color center absorbing light of the visible spectrum. If the anode is

in direct metallic contact with the crystal, each electron after having traversed the crystal and having on its way through the lattice been repeatedly captured and made visible as a color center, will enter the anode and thus disappear. Thus *the stream of electrons shot*

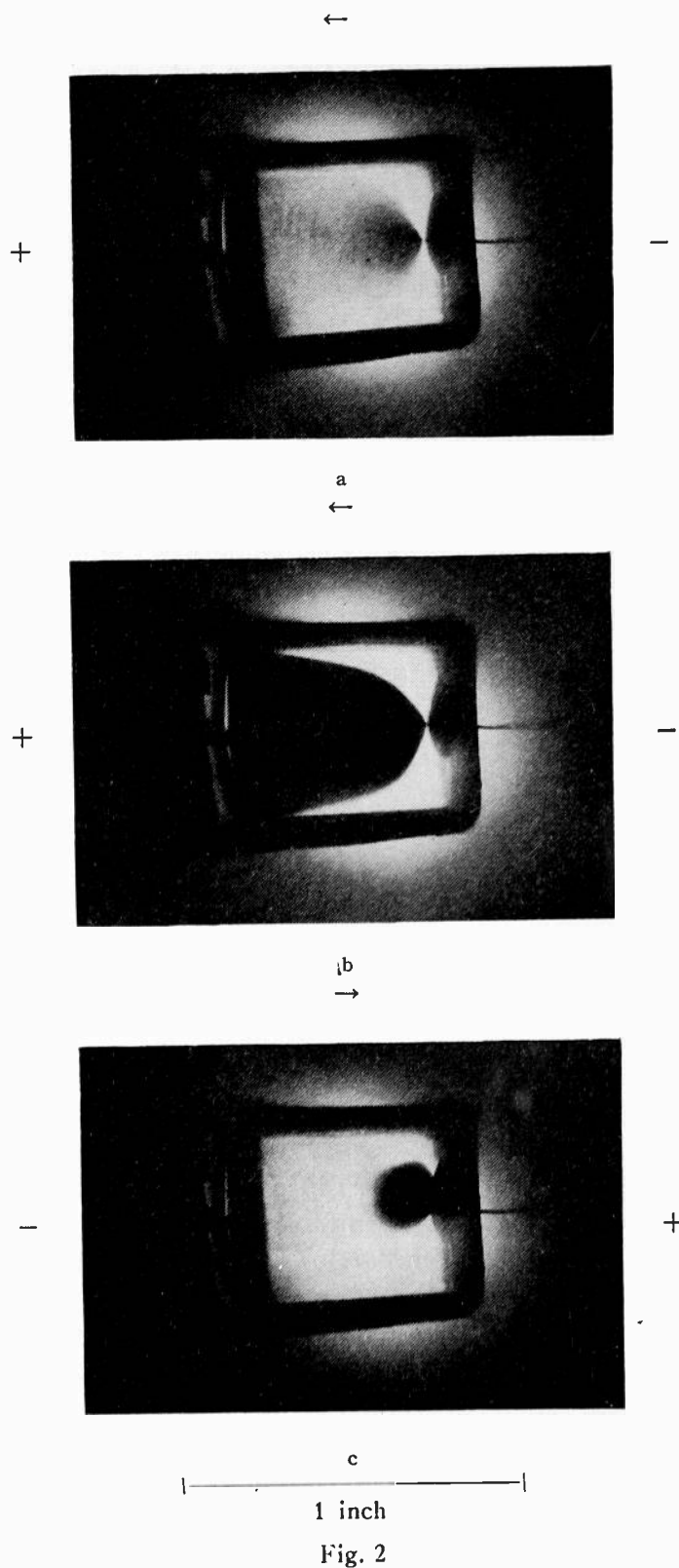

Fig. 2

into the crystal appears as an opaque deposit moving inside the crystal towards the anode and disappearing there.

These effects which we shall refer to as *electron opacity* are characterized very strikingly by Pohl.^{10,11} "Only during these rest periods during which the electron is bound in the Farbzentrum (color center), is the location of the electron rendered visible and in this way the path of the electron towards the anode can be followed. Apparently, visible Farbzentren, i.e., neutral

¹⁰ R. W. Pohl, "Electron conductivity and photochemical processes in alkali-halide crystals," *Proc. Phys. Soc. (London)*, vol. 49, pp. 3-31; August, 1937.

¹¹ R. W. Pohl, "Zusammenfassender Bericht über Elektronenleitung und photochemische Vorgänge in Alkalihalogenid Kristallen," *Phys. Zeit.*, vol. 39, pp. 36-54; January, 1938.

¹² E. Mollwo, "Zur additiven Färbung der Alkalihalogenidkristalle," *Gött. Nach.*, no. 25, pp. 1-7; June, 1932.

¹³ R. W. Pohl and E. Rupp, "Über Alkalihalogenidphosphore," *Ann. der Phys.*, vol. 81, pp. 1161-1166; December, 1926.

¹⁴ R. W. Pohl, "Das latente photographische Bild," *Naturwiss.*, vol. 21, pp. 261-264; April, 1933.

metal atoms, migrate; in reality, however, the migration is that of invisible electrons."

The *velocity of migration* of the deposit through the crystal is proportional to the field strength and increases exponentially with the temperature of the crystal. *Mobilities of the color centers* of various crystals have been measured optically by O. Stasiv,¹⁵ and we have measured such mobilities in a potassium chloride crystal with an arrangement which allows at the same time to demonstrate in a simple and striking way, without vacuum apparatus, the *high absorption of these color-center deposits*. A small potassium chloride crystal of $12.5 \times 12.5 \times 4$ millimeters is held by a metal frame in an electric oven and imaged through mica windows on to a screen by a simple projection arrangement. The path of the electrons entering the crystal from a platinum point acting as a cathode becomes immediately visible as a cloud of dark-blue color centers spreading along the electric-field lines towards the anode which consists of a platinum sheet in loose contact with the crystal. Fig. 2a shows the deposit a short time after the field had been applied, Fig. 2b some time later when a stationary electron stream had

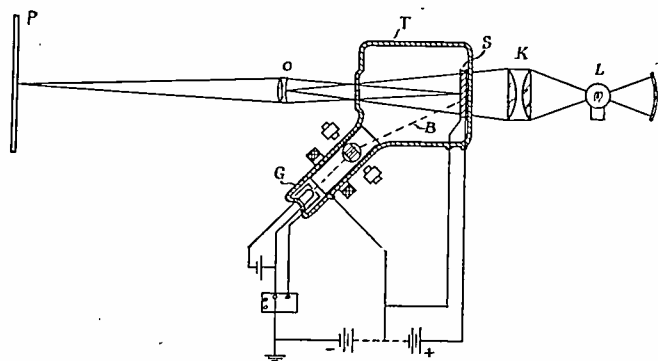

Fig. 3

been established. A change of the polarity of the field which makes the point positive and the sheet negative causes the deposit to return into the point (anode), as shown in Fig. 2c, and ultimately to disappear therein, leaving the crystal completely clear again. As had been also observed by Stasiv, the front of the deposit towards the anode is blurred due to a spread in the velocities of the electrons, which can be clearly seen in Fig. 2a, whereas, when the sheet is made cathode, the back of the deposit towards the cathode soon becomes sharp, as can be seen in Fig. 2c. Figs. 2a, b, and c are photographs of the image of the potassium chloride crystal projected on to a white screen by white light. The mobilities can be easily determined from the dimensions of the crystal, the voltage, and the time needed to draw the deposit a certain distance through the crystal, as measured by a stop watch. For instance for potassium chloride at 550 degrees centigrade the mobility of the color centers is about $4 \cdot 10^{-4}$ centimeter per second per volt per centimeter.

¹⁵ O. Stasiv, "Zur elektrischen Wanderungsgeschwindigkeit der Farbzentren in Alkalihalogenidkristallen," *Gött. Nach.*, no. 50, pp. 387-393; November, 1933.

The mobilities vary widely also for different anions and cations. The absorption spectrum or the color of the color centers, as already found by Goldstein, is also a characteristic of each alkali halide and depends on the temperature. The bell-shaped absorption bands shift with increasing temperature towards longer wavelengths and become flatter and wider (see for instance Figs. 5 and 9 of references 10 and 11).

IV. APPLICATION OF ELECTRON OPACITY TO TELEVISION RECEPTION

The effects of electron opacity briefly described in the previous paragraph constitute the tools with which to arrive at what appears to be an ideal solution of the problem of producing large and bright television pictures. Fig. 3 shows the principles of operation of a television projection receiver employing the effects described above.¹⁶

The optical system is practically identical with one customarily used for the projection of lantern slides or films. A lamp *L* illuminates the screen *S* through a condenser *K*, the image of which is projected by the object lens *O* on to the projection screen *P*. The screen *S* consists in this example of a flat single crystal of an alkali halide. This screen is enclosed in a cathode-ray tube *T* and can be scanned by a cathode-ray beam *B* which originates in the electron gun *G* and is focused and deflected in the usual manner. The intensity modulation is somewhat different from that in normal procedure as will be described later. The faces of the crystal are provided with partly transparent conducting layers which are connected with terminals and serve to maintain an electric field inside the crystal, whereby the side facing the electron gun is the cathode. The crystal can be heated and held at desired temperatures by special heating means, if desired.

When the modulated cathode-ray beam impinges upon a surface element of the crystal, injecting electrons into the crystal at this area, an opaque deposit of color centers of a density depending on the instantaneous intensity of the beam is produced at this part of the crystal. After the beam has left this area, the deposit still persists, moving slowly through the crystal toward the anode, where it disappears. Since the thickness of the crystal is small compared with the optical distances of the projection system, the displacement of the cloud of color centers through the crystal is not noticeable in the projection and the effect is that the image of the deposit on the picture screen *P* persists for just the transit time of the cloud through the crystal.

The scanning and modulated cathode-ray beam thus produces successively at one screen element after the other an opaque deposit, which persists for a certain time, after which it disappears, leaving the screen ready for a new deposit to be produced. The result is

¹⁶ British Patent No. 513,776.

a picture of varying transparency or opacity similar to a lantern slide, which can be projected on an enlarged scale by a standard projection apparatus on to a picture screen. This opacity picture persists for a certain time in the screen and is thereafter wiped out, point after point, just as it was created, leaving the screen ready for the drawing of a new picture by the returning cathode-ray beam.

Obviously it would be necessary and most desirable to arrange for the transit time of the picture through the crystal to be equal to (or a little longer than) the time between two successive scans, i.e., the picture repetition or frame period (1/30 of a second for the American,—1/25 of a second for the British Standard), thus securing a full storage (storage ratio r of 100 per cent).

Having a crystal of the thickness d (distance between the surface electrodes in the above example) and with a mobility of the color centers m , it is necessary to apply a potential difference V between the surface electrodes, in order to obtain a transit time t of the electron cloud through the crystal, where

$$V = \frac{1}{m} \frac{d^2}{t}$$

Taking for example as an average value for the mobility in suitable alkali halide crystals $M = 5 \cdot 10^{-4}$ centimeter per second per volt per centimeter, and taking a crystal 1 millimeter thick, we find from the equation that a potential difference at the crystal faces of 500 volts would be sufficient to draw the deposit through the crystal in 1/25 of a second, equal to the frame period of the British television system. This is a quite reasonable order of magnitude. The above equation also shows that the required voltage increases with the square of the crystal thickness, so that from these considerations it appears desirable to use *thin crystal layers*; this should also be advantageous for high definition, since any diffusion of the cloud during its transit through the crystal will be the smaller the shorter the transit path (see Figs. 2a and b).

It would also be of interest to get some idea of the absorption values which may be expected by the cathode-ray irradiation. But there are unfortunately no quantitative data available on this question in the publications dealing with the related effects.

The following rough estimate may throw some light on this question:

Given a beam of current i , scanning the screen area F in the frame period t , each square centimeter of the screen obtains during the frame period a charge

$$Q = it/F,$$

and since the electron charge $e = 1.59 \cdot 10^{-10}$ coulomb, a number of electrons

$$n = \frac{1}{1.59 \cdot 10^{-10}} \frac{it}{F}$$

Specially designed electron guns can provide sharply focused beams of more than $i = 10$ milliamperes.¹⁷ From optical consideration it is desirable to use a small screen F , for instance equal to the area of a normal cine film picture, 24×18 millimeters, i.e., $F = 4.3$ square centimeters; then with a frame period $t = 1/25$ of a second we obtain $n = 5.8 \cdot 10^{14}$ electrons per square centimeter of the screen during the frame period. According to Pohl^{10,11} 10^{14} color centers under 1 square centimeter are "capable of investigation both optically and electrically." On the basis of this calculation it seems possible by using the results of modern electron-optical design to arrive at reasonable absorption values.

The fact that experiments under somewhat different conditions, which will be described in the following, lead with much smaller beam currents and larger screen areas to reasonable absorption values, shows that the above calculations are unduly simplified, and that there must be other effects which increase the absorption (one of them probably being secondary electrons released in the screen material).

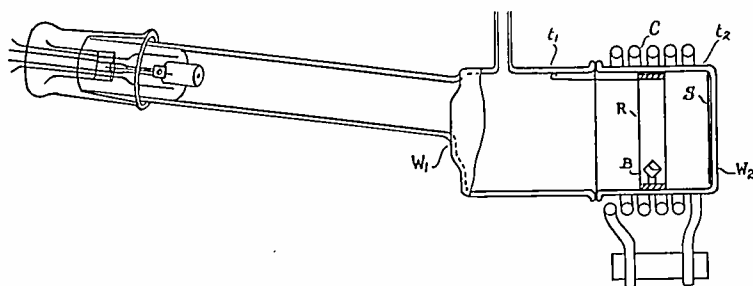

Fig. 4

V. EXPERIMENTS

Up to now only some crude, and mainly qualitative experiments, have been undertaken in order to realize an apparatus of the kind described. Difficulties in obtaining single crystals of suitable dimensions, and of suitable constitution, as well as practical considerations have led to an experimental technique differing somewhat from the example of the preceding section.

As already mentioned the formation of color centers seems to take place preferably at or near defects in the crystal lattice. For instance it had been found in the case of photochemical colorations¹⁸ that many more color centers can be formed in a crystal which had been grown and cooled quickly, than in a more perfect specimen grown with all the precautions necessary for the optical application of those crystals. These considerations led to the use of *microcrystalline layers* instead of single crystals as screen material in the following experiments.

Demountable cathode-ray tubes were used of a form shown diagrammatically in Fig. 4. Fig. 5 shows a

¹⁷ P. T. Farnsworth, "Television by electron image scanning," *Jour. Frank. Inst.*, vol. 218, pp. 411-444; October, 1934.

¹⁸ R. Hilsch and R. W. Pohl, "Zur Photochemie der Alkalihalogenid Kristallen," *Gött. Nach.*, no. 52, pp. 406-419; November, 1933.

photograph of such a tube with part of the projection arrangement. The cathode and grid structure, and sometimes a first anode of the electron-optical system, were mounted on an assembly which could be removed by a ground joint for necessary alterations and replacements. In most cases a directly heated hairpin-shaped tungsten wire was used as the cathode. The flat ground ring-shaped end of the tube part t_1 allowed the application either of a flat glass plate, ground as a ring-shaped part, and provided with some holes into which metal bolts were sealed with apiezon wax to hold various targets, or of a pot-shaped part t_2 with a similarly ground ring-shaped end and an optically flat glass disk as screen carrier sealed to the other end. The ground joints were kept vacuumtight by apiezon grease, and sometimes cooled. The inside walls of the tube, with the exception of the light-transmitting

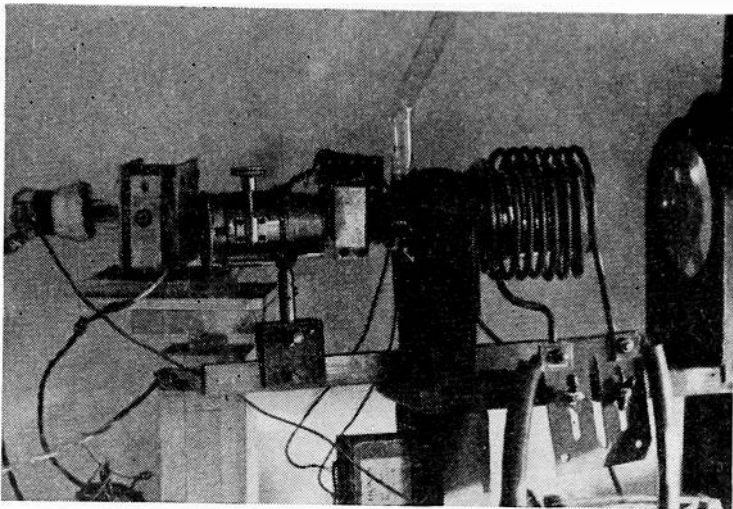

Fig. 5

windows W_1 and W_2 , were covered with a conductive layer of colloidal graphite or silver which also formed the anode. The tube was continually pumped. The neck of the tube was surrounded by a focusing coil and two deflection coils. The electron beam could be directed either by an external magnet or by the deflection coils to any desired part of the flat end plates, which carried various targets, or to the screen.

In early experiments several test-tubelike extensions were sealed to a ring-shaped ground adaptor fitting the ground end of part t_1 , each test tube containing a sample of a salt, and various alkali halides or alkaline earth halides were investigated by directing the cathode-ray beam in any of these test tubes. Or, the salts were fixed by a binder, similar to those used for fluorescent materials, to the flat glass plate. In this way it was easy to get a quick survey of the various colors produced by the cathode-ray beam and of the strength, reversibility, or persistence of these colors.

The colorations are characteristic for each salt, for instance, at room temperature potassium chloride is rendered mauve, potassium bromide blue, potassium iodide green, sodium chloride amber; at higher temperatures potassium chloride, for instance is rendered

gray-blue. The colors usually disappear some time after the irradiation has been stopped or if the salts are heated.

By very strong cathode-ray beams or by raising the salts to higher temperatures during or after the irradiation, a different coloration can be produced, for instance, blue instead of amber in sodium chloride crystals. It is known that these colors are not caused by the color centers but by colloidal particles of the cation metal, each colloidal particle being formed by the agglomeration of many color centers. These colloidal particles have not the high mobilities of the color centers, and therefore the colorations due to them are usually more difficult to remove.

These early experiments revealed potassium chloride and potassium bromide as the most suitable substances with which to continue. Mainly potassium chloride was used as screen substance in the further investigations.

In order to obtain uniform and not too small screens of alkali halide crystals the salts were evaporated on

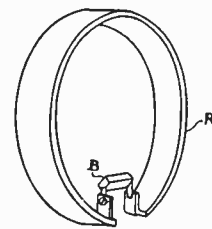

Fig. 6

to the flat glass end plate of the demountable tube. It is known that by evaporating those salts a microcrystalline scaly structure can be obtained, and it is obvious that such a screen has a *very high number of lattice defects*, compared with a single crystal and should therefore be favorable for obtaining deposits of color centers of high densities.

In order to evaporate the salt, a known amount was melted into a small boat B of platinum, which was clamped to the ends of a thick ring-shaped copper strip R of a diameter slightly smaller than that of the pot-shaped part t_2 of the demountable tube, so that it fitted closely into it (Fig. 6). The opening of the boat was directed towards the flat end plate. The salt was evaporated by a bombarder, the coil C of which was fitted around part t_2 of the tube adjacent to the copper ring R with the boat B . The structure of the film can be influenced to a certain extent by the bombarder current which affects the speed of evaporation. Differences in structure manifest themselves by differences in the light-scattering qualities of the salt layer. Approximate average thicknesses of the films were determined by weighing the amount of the evaporated salts (weight of the boat before and after evaporation) and ranged from 1 to 5 microns.

To obtain films of the desired qualities a suitable bombarder current was chosen, and the light absorption of the film was measured by a photoelectric

photometer during evaporation and the bombarder stopped at predetermined values of the absorption.

The thickness of the layer varies somewhat along its surface if, as in most experiments, one boat is used which is placed eccentrically near the screen; and thus the effect of varying thickness can be studied at one screen.

Screens obtained in this way were subjected to the electron beam from the cathode-ray gun, which was able to provide without serious defocusing about 300 microamperes. If the spot is deflected over the screen by a magnet or by current changes in the deflection coils, its path becomes immediately marked by a sharp line of coloration (mauve in the case of potassium chloride) depending in intensity on the beam current. The pattern obtained can be projected in any desired size on to a screen by the above-described projection arrangement (Fig. 3). The coloration fades away quickly, except in the case of very thick layers, the speed being greatest with thin screens and at higher temperatures. It can be often observed that a certain percentage of the coloration disappears much faster than a slower residual opacity, this fact probably being caused by a certain nonuniformity of the layer.

The speed of the disappearance of the opacity was roughly measured by modulating the cathode-ray beam with the 50 cycles from the alternating-current mains, and deflecting the spot quickly by a magnet, thereby producing a dotted line as the path of the spot. The dots corresponding to an earlier position of the spot disappear after a certain time, so that the total number of dots visible simultaneously, multiplied by the alternating-current period (1/50 of a second) gives a good approximation to the time constant of the persistence of the coloration. At the thinner parts of the screen, these times are of the order of 1/20 to 1/15 of a second with potassium chloride at room temperature, and tend to decrease when the screen temperature is raised by an oven surrounding the tube near the screen.

In further experiments the modulated cathode-ray beam was caused to scan a rectangular part of the screen of about 45×36 millimeters, by feeding the deflection coils with saw-tooth currents derived from television time bases. The uniform raster was clearly visible and projectable as a uniform coloration, its intensity depending on the beam current. The weak fluorescence excited by the cathode rays can be used to focus the beam with low beam currents before operating the projecting apparatus.

Some preliminary measurements of the absorption and gradation were made. The intensity of the light transmitted through the uniformly scanned screen was measured by a photovoltaic light meter as a function of the grid voltage or of the beam current of the cathode-ray tube. In the light path was inserted a Wratten filter No. 59A the transmission of which in

the visible range is nearly complementary to that of the color centers of potassium chloride at room temperature. Figs. 7 and 8 show examples of the intensity of the light transmitted by potassium chloride screens of about 3 and 4 microns thickness plotted against the grid voltage and beam current, respectively; the latter could not be raised to more than about 400 microamperes with the available apparatus.

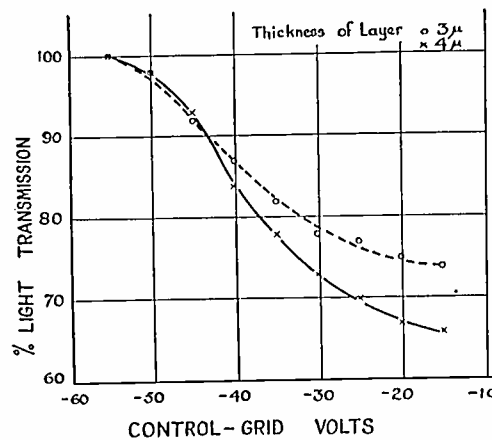

Fig. 7

In view of the above calculation, it is somewhat astonishing to obtain such relatively high absorption values. Also, *a priori* one would not expect to find the relatively small time constants of the coloration under these conditions though these are rather different from those of the idealized case of Section IV.

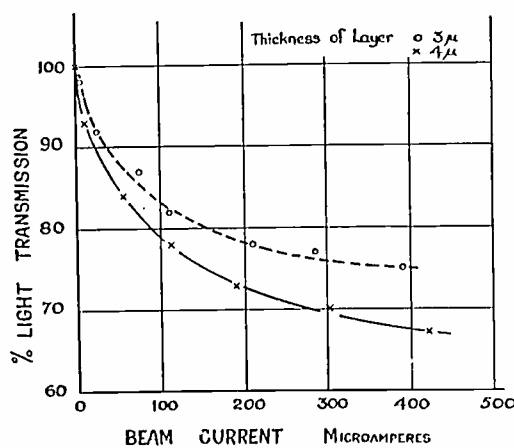

Fig. 8

Without going deeply into these questions one can only assume that the evaporated salt layers behave in a quite different—and, for our proposed application, very promising—way as compared to single crystals; the scaly structure of the layers may increase considerably the probability of the formation of color centers, as a consequence of the large number of lattice defects, and the efficiency is probably further increased by the formation of color centers by secondary electrons, as in cathode-luminescence phenomena; the thinness of the layers may facilitate the migration of the electrons towards the anode. The latter assumption is strengthened by the observation that under similar conditions a somewhat smaller time constant of the opacity results if the layer is evaporated on a semitransparent film of platinum or rhodium, sputtered on the glass

plate and forming part of the anode. The electric field necessary to draw the electrons through the crystal layer to the anode is probably automatically maintained through the layer by the equilibrium potential which the surface of the layer adopts under the influence of the cathode-ray beam, and which renders this surface negative with respect to the anode. The thickness of the layers should also be favorable for obtaining a high definition; actually the width of any patterns drawn by the electron spot appeared to be determined only by the size of the spot, and *no blurring of contours* could be observed.

To investigate further the possibility of applying these results to television technique, signals from monoscope test-pattern tubes were used. Several of those tubes were made. The patterns were drawn on aluminium foil with pencil, or colloidal graphite solution (aquadag) or printed, and tested in a demountable tube. Several patterns were used, from special ones designed to test definition and gradation to half-tone pictures obtained from photographs. The signals were amplified by a three-stage video-frequency amplifier and applied to modulate the grid of the demountable projection tube. *Opacity pictures corresponding to the monoscope patterns were thus obtained on the crystal screen, and could be projected*; they are convenient for judging the effect on the reproduced picture of various modifications of the apparatus.

With suitable layers the *pictures followed instantly any alteration in the signals* or in the scanning of the screen, produced for instance by distortions of the raster by a magnet moved about near the monoscope, or near the picture tube, or changes of the amplitude of the line or frame scan in one of those tubes.

Some tests were made with signals received from the Alexandra Palace television transmitter while it was still operating. Though the obtained projected television pictures were not yet of a satisfactory entertainment value (which was probably due a great deal to the improvised nature of the electrical and electron-optical apparatus), the results were very promising.

Since the opacity at a certain picture point increases with increasing beam current, the grid modulation must be negative; i.e., for a brighter picture point the grid must be more negative than for a darker one, so that the beam current is strongest for the darkest picture points and is suppressed for the high lights. This *negative modulation* can be easily obtained by a suitable number of stages in the amplifier. In the adopted television standards the synchronizing impulses correspond to a modulation value of "blacker than black," which automatically leads to a suppression of the synchronizing signal during the flyback when a positive modulation is used in the receiver, i.e., where picture black results from a suppression of the signal. But in our case of a negative modulation where picture white results from a suppression of the signal it is necessary, in order to suppress the flyback, to

provide the grid during this time with signals which correspond to white or whiter than white. This can be effected by *an inversion of the synchronizing signals with respect to the picture signals*, for instance, by superimposing an inverted synchronizing signal, taken from the time bases, on to the picture signal modulating the grid.

For the first experiments an anode voltage of 5000 volts was used but it was found that the absorption and contrast increased considerably with higher voltages, and for the later experiments a 10,000-volt power pack was used. It seems very probable that it might be advantageous to use still higher anode potentials.

It is proposed to use the name "*skiatron*" from Greek *skia*, shadow) to denote such apparatus providing projectable pictures by making use of electron-opacity effects.

VI. REMARKS

(a) *Low Opacities*

Instead of using the variation in the opacity of the screen created by the cathode-ray scanning for the direct projection of the picture, in some cases of low opacities it might be advantageous to use the variation of the refractive index, or of the optical path, of the screen layer caused by the cathode-ray scan to produce a projected picture, by means of the well-known Töpler Schlieren method or by means of total-reflection methods. It would lead too far off the main subject of this article to enter into details of the modes of operation necessary in these cases which differ in some respects from that described previously.¹⁹

(b) *Low Mobilities*

As already mentioned the electron bombardment can produce, apart from the easily movable color centers, a second kind of deposit, consisting of colloidal metal particles, which is much more persistent, but can be removed or transformed to the atomic color centers by a suitable temperature cycle. For instance, a layer of sodium iodide is rendered gray to absolutely black by the cathode-ray beam, but the deposit does not easily disappear.

Materials in which a satisfactory opacity is coupled with an unsatisfactory mobility might still be used for television reception, if the screen is deposited on a movable support,²⁰ for instance on the peripheral parts of a circular disk. The picture area takes but a small fraction of the peripheral ring-shaped area of this disk. The disk rotates, preferably intermittently, and any part of it passes successively through a field where it is scanned by the cathode-ray beam and the opacity picture is thus created, then through the field of the projecting light, and then through a field where means are arranged to remove the picture, or even the whole crystal layer, for instance, by heat radiators, and in

¹⁹ British Patent No. 514,155.

²⁰ British Patent Application No. 16,141/39.

the latter case through another field where a new salt layer is evaporated on to the disk, whereupon this area enters again the field of the scanning cathode-ray beam.

This process is similar to the intermediate-film method in so far as a succession of projectable pictures is alternately created on a carrier and thereupon removed after having been projected.

(c) Color of Deposit

As previously stated the absorption spectra are characteristic for the different salts. For instance in potassium chloride, which was mostly used for the experiments, a mauve to blue, and in potassium bromide a blue deposit is obtained. It was found that with a screen evaporated from a mixture of 75 per cent potassium chloride + 25 per cent potassium bromide a practically black-and-white picture can be obtained.

It is planned to investigate further screens obtained by evaporation of mixtures of several salts, and by successive evaporation of different salts above each other, not only with the color of the deposit in view, but also with a view to determining the density and mobility of the color centers obtained in such mixed crystal screens and in such composite screens of materials of different lattice constants.

(d) Color Television

The differences of the absorption spectra of the color centers in different crystals can be utilized in a system of color television. In present-day color photography there are two alternative methods in use, namely, the additive and subtractive methods. In a three-color process using the additive method the colored image is obtained by superimposing three partial pictures in suitable primary colors (red, green, and blue) in which the transparency of each partial picture varies from black to a maximum value for the color concerned. At points of maximum transmission each partial picture transmits in the ideal case only one third of the illuminating white light. Since picture white results from the superposition of the maximum red, green, and blue transmissions of the three partial pictures, only one third of the incident white light can be utilized.

Subtractive methods work with a much higher light efficiency. Here the projecting light successively transmits the three partial images, each of which subtracts certain spectral parts from it. The transparency of each partial image here varies from maximum color absorption to white; and picture white results at places where each of the partial images is free from any color absorption, i.e., is completely transparent, so that practically the full intensity of the illuminating light can be utilized.

The partial subtractive images contain deposits of colors complementary to the primary colors; thus

for a red-green-blue color process, the deposits are blue-green (minus red), magenta (minus green), and yellow (minus blue), respectively.

Most of the proposed methods for color television are based on additive color mixture and thus suffer from the same disadvantages as the additive processes of color photography.

By making use of screens exhibiting electron opacity the more efficient subtractive methods of color mixture can be applied to color television.²¹ As can be seen from Fig. 9 the light of a white-light source L is projected successively through three cathode-ray tubes $T_1 T_2 T_3$ with picture screens $S_1 S_2 S_3$, in such a way that screen S_1 is imaged by the lens O_1 on to screen S_2 , screen S_2 by the lens O_2 on to screen S_3 , and finally screen S_3 by lens O_3 on to the projection screen P . The beam of each cathode-ray tube is modulated in a negative sense by signals representative of one of the primary colors re-

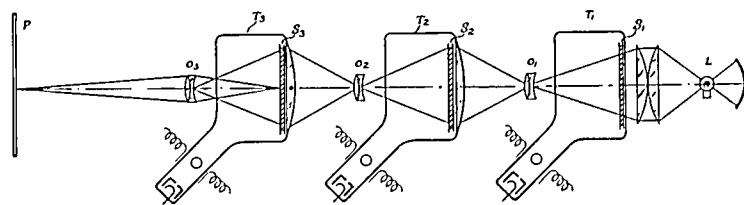

Fig. 9

ceived from a transmitter, and the three beams are deflected in synchronism and with such amplitudes and directions that the three pictures are imaged by the lenses O_1 and O_2 in register upon each other. The picture screens are similar to those described in the preceding paragraphs, consisting of materials exhibiting electron opacity, i.e., in which colored deposits can be formed by the scanning electron beam. The materials are chosen so that the deposits formed therein are colored in the required complementary colors (minus red, minus green, and minus blue). Using alkali halides at room temperature examples for suitable screen materials would be potassium bromide, having the maximum of its absorption band in the red at about 6300 angstrom units for the minus-red screen; potassium chloride, with an absorption maximum in the green at about 5600 angstrom units for the minus-green screen; and sodium chloride, with an absorption maximum in the blue at about 4700 angstrom units for the minus-blue screen. At the transmitter the three sets of signals are derived from the picture to be transmitted by any suitable color-separation method.

A three-color-television system of this kind, besides having the optical efficiency of a subtractive process, would have the other advantage of the high-storage ratio of the electron-opacity screens, and with a reduced frame period of about 17, which as stated by Karolus⁴ should be sufficient in high-storage systems, would require a signal spectrum having a band width

²¹ British Patent No. 514,776.

which is only about twice that necessary for a black-and-white picture with a low-storage ratio needing 25 frames per second, for the same definition.

(e) Other Applications

It is obvious that an opacity image can be produced also by projecting an electron image on to the electron-opacity screen, instead of scanning this screen by a modulated cathode-ray beam. The electron image may be derived from a photocathode, or a secondary-emission screen, and focused on to the opacity screen. This apparatus would represent an image converter for large-screen projection and should have various applications, for instance the projection of the enlarged picture of a public speaker.

VII. CONCLUSION

The application of electron opacity to television reception leads to a method similar to the intermediate-film process in so far as there are produced varying transparency pictures which can be projected on a large scale on to a screen by standard optical projection arrangements. There exists an even deeper physical analogy between the two methods, because the electron-opacity effects in polar crystals are closely related to the photochemistry of silver-salt emulsions used in photography. Therefore the electron-opacity images of the present method may be regarded as fugitive pseudo-photographic images, recorded by the scanning cathode-ray beam on the sensitive screen, lasting thereon for substantially the duration of one frame period, and being replaced after this time by an image of the following frame, the interchange of the consecutive images being caused by a directed diffusion of electrons. It is most striking to observe the crystal screen in operation, the colored parts of its area shifting and moving and resembling a constantly

changing lantern slide. But none of the disadvantages of the intermediate-film process, which made its use impracticable, are present in this method since no time is lost between the formation of the picture by the cathode-ray beam and its projection, and since one frame is replaced by the following one on the same carrier the costly film consumption is eliminated.

The large storage ratio of the method would allow a reduction of the frame frequency and therewith of the band width of the signal spectrum, and could provide satisfactory pictures with a straight scanning system and thus eliminate the various complications (especially in film transmitters) inherent in interlaced scanning systems.

In a manner analogous to that of film or lantern-slide projection, the large storage ratio of the present system, as outlined in Section I, permits of a large projection distance, and the television projector could be placed in the projection room of a motion picture theater.

The experimental results described in this paper, which were obtained without any specially developed electrical and electron-optical systems, seem to justify the expectation that, as a result of more extended research and development work on the various physical conditions governing the properties of these electron-opacity screens, and on the various accessory components, electron-opacity methods will find many successful applications in large-screen television and the related arts.

ACKNOWLEDGMENT

I am indebted to Mr. S. Sagall, Managing Director of Scophony, Ltd., for his interest in and encouragement of this work. I wish also to express my appreciation to my assistants Messrs. Bacon, Cook, and Alford for their active co-operation in this development.

Ultra-High-Frequency Oscillography*

H. E. HOLLMANN†, ASSOCIATE, I.R.E.

Summary.—Starting from the transit-time effects of the first and second kind, occurring in a cathode-ray tube, two methods are described for the oscillographic examination of ultra-high-frequency oscillations. First, we have the inversion spectrograph which supplies, by means of a white and spectrally dispersed electron beam, sinusoidal and complex inversion spectrograms. Second, we may use ultradynamic Lissajous figures which differ from the classical Lissajous figures in that the two pairs of plates, receive the same voltages which within the tube are displaced in phase between the two deflecting elements. By a simple process, the wave shape of the applied voltage can be obtained from any given ultradynamic Lissajous figure. In order to show the practical usefulness of both methods, the ultra-high-frequency voltages which contain strong harmonics with integral and rational frequency ratios supplied by a magnetron oscillation are examined.

Finally, a microwave oscillograph is described for the centimeter-wave range, which operates with a submicroscopic electron probe and is provided with deflecting plates of extremely small dimensions. The ultradynamic Lissajous figures produced are observed and photographed by means of a microscope.

THE direct resolution of ultra-high-frequency voltages or currents with respect to time, for instance by means of a synchronized sweep oscillator, with a conventional oscillograph is, as is well known, not yet possible. It will always be difficult for waves in the decimeter or centimeter range. One must, therefore, depend on other means in order to observe the wave shape of such a high-frequency oscillation.

As is well known, there appear in a cathode-ray tube of the customary design two transit-time effects. The transit-time effect of the "first kind" depends on the finite time taken by an electron to pass a particular deflecting field. The transit time of the "second kind" is due to the time lag between two separate deflection fields when the two pairs of plates are spaced along the direction of the beam. While the first effect makes possible the electron-optical spectral analysis in the

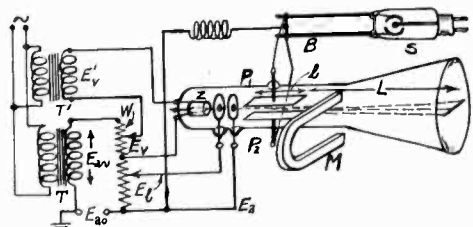

Fig. 1—Diagram of the inversion spectrograph for the examination of the ultra-high-frequency voltage of a magnetron transmitter.

inversion spectrograph, the second effect leads to ultradynamic Lissajous or transit-time figures, which make it possible to ascertain the harmonic content and the wave shape of the voltage.

I. ELECTRON-OPTICAL SPECTRAL ANALYSIS OF ULTRA-HIGH-FREQUENCY OSCILLATIONS

(a) The Inversion Spectrograph

In Fig. 1, there is shown diagrammatically an inversion spectrograph.¹ It consists mainly of an ordinary

* Decimal classification: R388. Original manuscript received by the Institute, September 26, 1939; translation received, December 6, 1939.

† Laboratorium für Hochfrequenztechnik und Elektromedizin, Berlin-Lichterfelde, Germany.

¹ H. E. Hollmann, *Zeit. für Tech. Phys.*, vol. 19, p. 259, 1938.

cathode-ray tube, on the plates P_1 and P_2 of which the ultra-high-frequency voltage to be examined is applied, coming, for instance, from a magnetron oscillator S . In order to record the course of the deflection with the variation of the transit angle as a standing pattern on the screen, the beam velocity is modulated

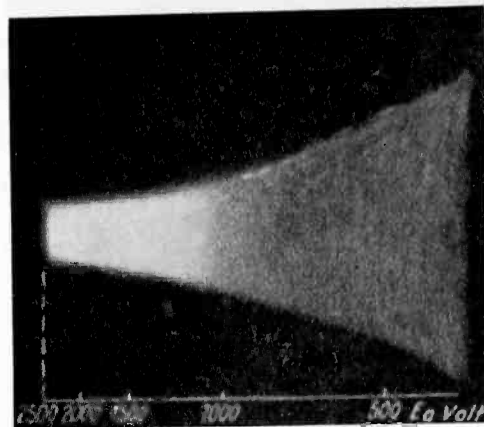

Fig. 2—Quasi-static deflecting spectrum.

within the widest possible limits, by superimposing alternating component E_a of, say, 50 cycles on a suitable fixed value E_{a0} of the anode voltage. Instead of a monochromatic beam with electrons of practically only one velocity, a polychromatic or "white" beam is thus produced which contains electrons whose velocity varies over wide limits in rapid succession. This beam is now "spectrally" dispersed horizontally somewhat in the same manner as light is dispersed in passing through a glass prism, by a magnetic prism consisting of the field of the permanent magnet M mounted outside of the tube.

In order to explain more clearly the action of the inversion spectrograph, there is shown in Fig. 2 a quasi-static spectrum, the plate voltage being of such low frequency that the transit angles are not yet noticeable. The spectrum, the abscissas of which measure directly the anode voltage, shows an increasing broadening in the direction of lower beam velocity, and in this way clearly shows the relation between sensitivity and anode voltage.

(b) Harmonic Inversion Spectra

In Fig. 3(a), a so-called inversion spectrum is reproduced which is generated by the sinusoidal ultra-high-frequency voltage of the magnetron connected to the spectrograph, as shown in Fig. 1, and corresponds to a frequency of 418 megacycles. In place of the steady broadening there now occur alternating maxima and minima, which follow, to a first approximation, the inversion formula²⁻⁷

$$C = (\sin \phi/2)/(\phi/2)$$

² R. Mines, *Jour. I.E.E.* (London), vol. 63, p. 1096, 1925

³ H. E. Hollmann, *Zeit. für Hochfrequenz- und Elektroakustik*, vol. 40, p. 97, 1932.

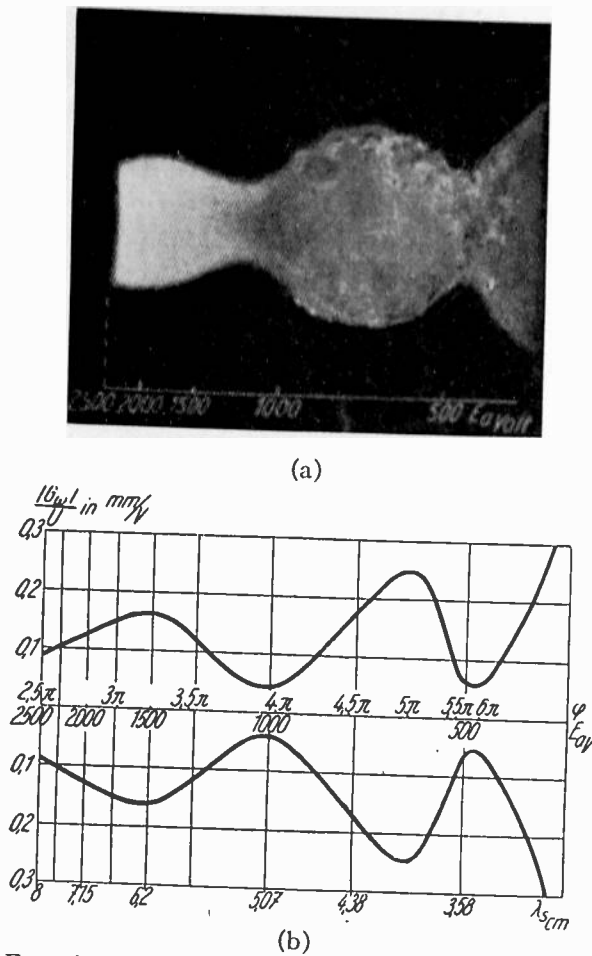

Fig. 3—Experimental and computed inversion spectrum of a harmonic ultra-high-frequency oscillation at 418 megacycles.

C is here the inversion factor, the ratio of the dynamic sensitivity to the static sensitivity. If ϕ is the transit angle,

$$\phi = \frac{\omega l}{v_0} = \frac{l\pi 10^3}{\lambda \sqrt{E_a}}$$

ω = frequency in radians

λ = wavelength of the oscillations

l = axial length of the deflecting field

$v_0 = 6 \times 10^7 \sqrt{E_a} =$ beam velocity.

The experimental spectrum differs from the above formula in so far as the sensitivity at the places $\phi = 2\pi, 4\pi \dots$ does not become completely zero, but only passes through minima. This is due to the fact that the beam still has a displacement parallel to the axis when the angular deflection is zero. The theoretical consideration of this effect requires the introduction of the length L of the free beam between the plates and the screen and leads to the more exact formula¹

$$C = \frac{2(1 - \cos \phi) + \phi^2 - 2\phi \sin \phi + 2\phi^2 \frac{L}{l} \left(1 + \frac{L}{l} \left((1 - \cos \phi) \right) \right)^{1/2}}{\phi^2 \left(\frac{1}{2} + \frac{L}{l} \right)}$$

For large values of L/l , the displacement due to angular deflection greatly exceeds the exit displacement and the equation passes into the above fundamental formula. Fig. 3(b) shows a spectrum computed by means of this formula. In order to obtain a still closer agreement between theory and experiment, it would be necessary to consider the stray deflecting fields.^{8,9}

If the plate voltage exceeds a definite critical value depending on the tube dimensions and the prevailing anode voltage, the tube becomes overmodulated so that the beam temporarily strikes the plates and is cut off. In the case of static and quasi-stationary deflection, this overmodulation always occurs at the exit edges of the plate; in the case of ultradynamic deflection, however, the overmodulation can also occur be-

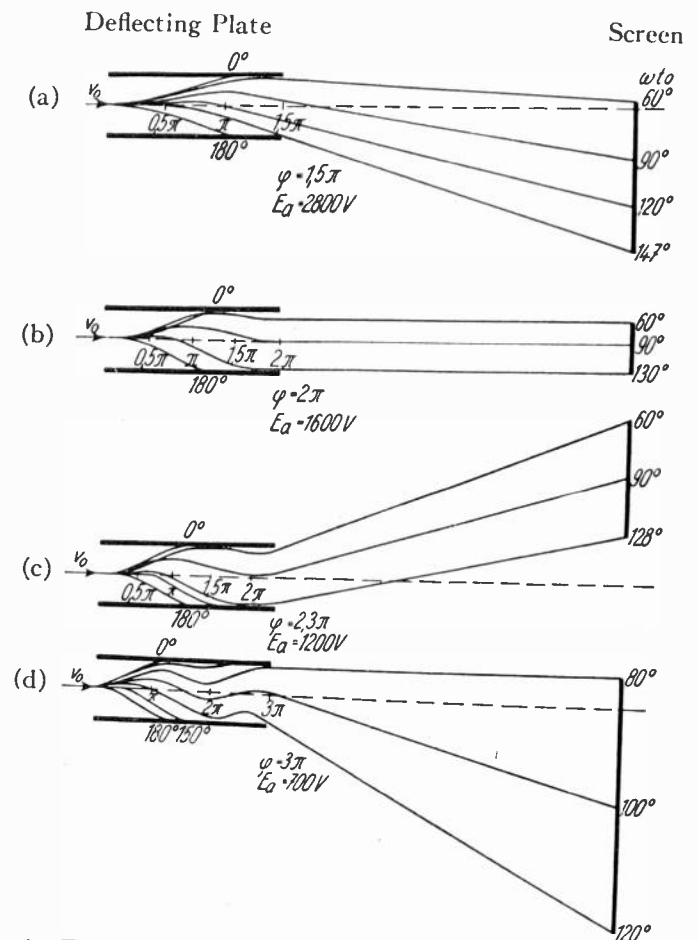

Fig. 4—Electron paths with different entrance phases ωt_0 and different transit angles with supercritical deflecting voltage.

tween the plates, namely whenever the beam becomes parallel to the plane of the plates in a deflection maximum.¹⁰

In order to show this more clearly, there are drawn in Fig. 4 numerous paths of electrons which enter the field with different entrance phases and pass through

⁴ H. E. Hollmann, *Wireless Eng.*, vol. 10, p. 430, 1933.

⁵ H. E. Hollmann, *Physik und Technik der ultrakurzen Wellen*, vol. 2, p. 239, 1936.

⁶ L. L. Libby, *Electronics*, vol. 9, p. 15, 1936.

⁷ F. Malcolm Gager, *Communications*, p. 10, March, 1938.

⁸ H. E. Hollmann und A. Thoma, *Elek. Nach. Tech.*, vol. 15, p. 145, 1938.

⁹ H. E. Hollmann, *Elek. Nach. Tech.*, vol. 15, p. 241, 1938.

¹⁰ H. E. Hollmann, *Zeit. für Hochfrequenz. und Elektroakustik*, vol. 52, p. 125, 1938.

with different transit angles, only a half period being shown for the sake of clarity. It is seen that the bright vertical line made by the beam, limited at both ends by the phase screening, should move over the screen in accordance with the temporary transit angle or anode voltage. Fig. 4(b) shows the displacement parallel to the axis, for the transit angle 2π shows well the displacement parallel to the axis. This phenomenon leads to the overmodulation spectrum shown in Fig. 5, the spectrum being composed of two interlaced strips.¹¹

(c) Complex Inversion Spectra

If the ultra-high-frequency voltage fed to the plates is not purely sinusoidal but contains harmonics, the inversion spectrum will noticeably change its appearance, and from the envelope the plate voltage can be obtained by graphic differentiation.¹² By varying the operating parameters of the magnetron, for instance the magnetic field or the anode voltage or the tuning of the Lecher wires β , the ultra-high-frequency voltage is easily distorted,^{13,14} for the reason that either the negative internal resistance of the magnetron becomes nonlinear or because the electrons, in their interweaving courses, enter simultaneously in resonance with different harmonics of the external circuit.

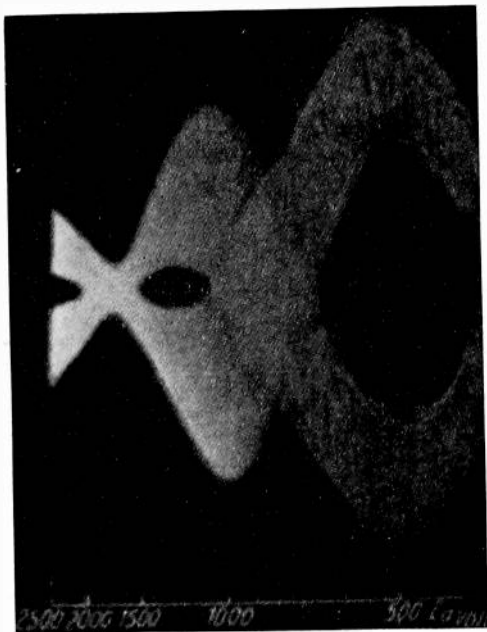

Fig. 5—Overmodulation spectrum.

In Fig. 6 are shown various simple and complex inversion spectra obtained in this manner. First, Fig. 6(a) shows a sinusoidal spectrum at a frequency of 161 megacycles. By slight variation of the magnetic field of the magnetron it passes over into Fig. 6(b), the analysis of which reveals a second harmonic of 27 per cent of the amplitude of the fundamental wave. Upon further variation of the magnetic field, there appears the spectrum (c), in which the fundamental wave is

¹¹ H. E. Hollmann, *Zeit. für Tech. Phys.*, vol. 20, p. 80, 1939.

¹² H. E. Hollmann und A. Thoma, *Zeit. für Phys.*, vol. 112, p. 377, 1939.

¹³ F. W. Gundlach, *Teleg. und Fernsprech-Techn.*, vol. 27, p. 177, 1938.

¹⁴ L. Lämmchen und L. Müller, *Elek. Nach. Tech.*, vol. 16, p. 37, 1939.

entirely replaced by a harmonic of the Lecher wires of 530 megacycles. Surprisingly, the transition between spectra (b) and (c), is practically continuous so that

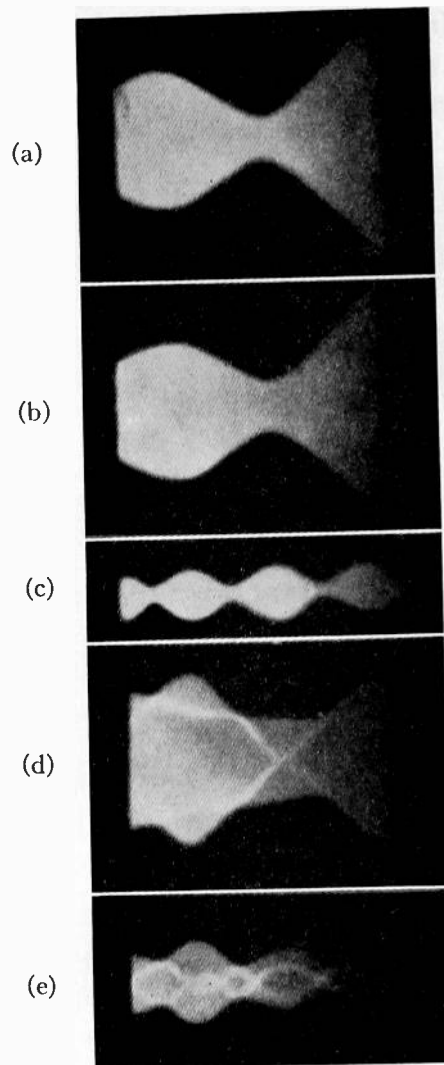

Fig. 6—(a) and (c) harmonic inversion spectra at 161 and 530 megacycles. (b) distorted spectrum with second harmonic. (d) and (e) double spectra.

the two oscillations occur simultaneously and produce the double spectra (d) and (e), which are formed by simple superimposition of the two individual spectra (a) and (c). The two images differ only in that in the case (e), the amplitude of the fundamental wave has dropped to one third before ceasing to exist entirely, and in (c) only the spectrum of the harmonics remains.

II. ULTRADYNAMIC LISSAJOUS FIGURES^{15,16,17}

(a) Experimental Arrangement

As already stated the production of ultradynamic Lissajous figures is based on the transit angle determined by the transit time of the electrons from one pair of plates to the other, i.e.,

$$\psi = \frac{\omega d}{v_0}$$

if d is the distance between the centers of the two pairs of plates. The plates are now made so short that the

¹⁵ L. S. Piggot, *Electrician*, vol. 116, pp. 316, 1936.

¹⁶ H. E. Hollmann, *Physik und Technik der ultrakurzen Wellen*, vol. 2, p. 247, 1936.

¹⁷ H. E. Hollmann, *Zeit. für Hochfrequenz. und Elektroakustik*, vol. 54, p. 19, 1939.

first transit-time effect is negligible within the frequency range to be examined; in other words, d should be as large as possible compared with l .

In Fig. 7 there is shown the arrangement used for the present investigations. Outside of the narrowed neck of an external control tube are mounted the two pairs of plates P_1 and P_2 . One pair P_1 can be displaced

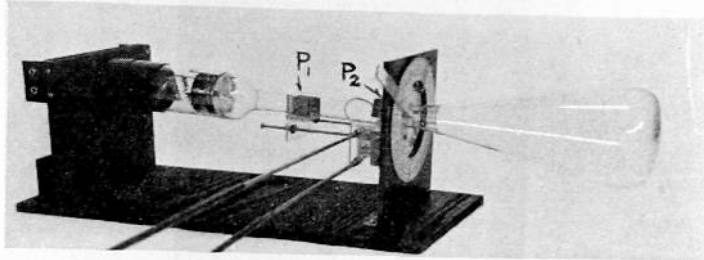

Fig. 7—External control tube for the recording of ultradynamic Lissajous figures.

in the direction of the beam, in order to change the transit angle ψ at constant anode voltage. The other pair P_2 is adjustable around the tube for improving the resolution of the figures produced. Both pairs of plates are otherwise simply connected in parallel to the Lecher wires of a magnetron oscillator. For the highest possible frequencies short connections and leads must be used although internal plates with internal connections are preferable.

(b) Production of Ultradynamic Lissajous Figures

Since like voltages are always impressed upon the two pairs of plates, the resulting trace is always a line at 45 degrees when the transit angle is negligible. If, however, the transit angles become appreciable, then it is as if the two plate voltages were displaced in phase with respect to each other. In the case of sinusoidal waves one obtains the well-known basic forms of the classic Lissajous figures.

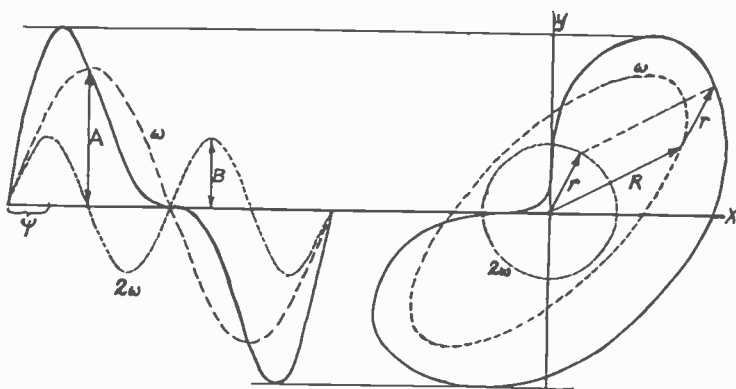

Fig. 8—Ultradynamic Lissajous figure of the first harmonic with the amplitude ratio $A:B=2:1$ and the transit angle $\psi=45$ degrees.

When the deflecting voltage is no longer purely sinusoidal, then *ultradynamic Lissajous figures* are produced, of a shape which is more or less complicated, depending on the conditions. Their occurrence can most easily be understood if one considers the figure which each harmonic alone would produce, the separate components then being combined in polar co-ordinates into the resulting Lissajous curve.

In Fig. 8 this process is shown in further detail by a simple example. The first harmonic is superimposed on the fundamental wave, with half the amplitude and with the transit angle $\pi/4$. The fundamental wave and the harmonic describe the ellipses in dashed and dotted lines, respectively. The vector sum of the rotating radius vectors R and r describes the solid curve. In

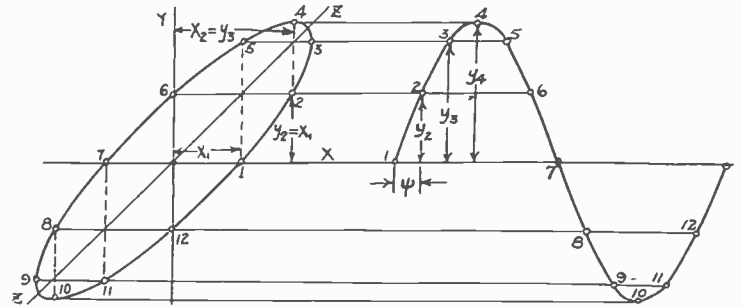

Fig. 9—Analysis of an ultradynamic ellipse.

this way any combination of harmonics with any desired transit angles can be derived, as hypocycloids or astroids or as classic Lissajous figures.

(a) Analysis of Ultradynamic Lissajous Figures

To determine the wave shape of a Lissajous figure produced by an ultra-high-frequency voltage, in the case now under consideration both deflecting co-ordinates are unknown. We know, however, that they are in all respects equivalent to each other, being only displaced in phase to the extent of the transit angle. Thus, we can start from the consideration that the abscissa of any desired point of the given Lissajous curve must be the ordinate of a corresponding point having a lag or advance of ψ , and vice versa.

In order to develop more clearly the process of analysis based on this rule, let us examine first the simple ellipse in Fig. 9 traced by a sinusoidal voltage.

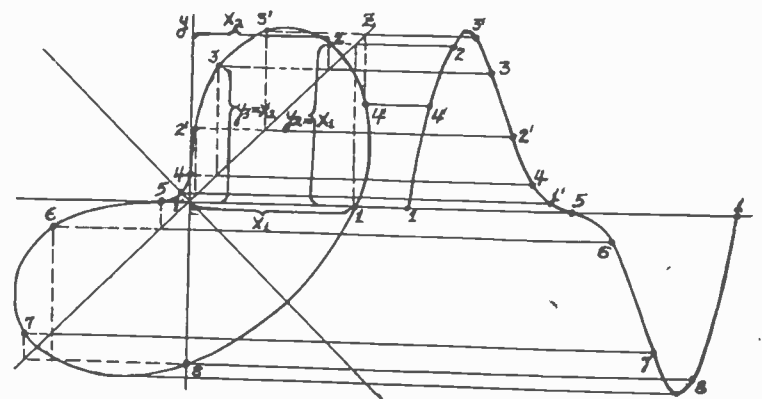

Fig. 10—Analysis of the transit-time figure of Fig. 8.

As starting point we select point 1 on the axis of the abscissas. Its abscissa x_1 is equivalent to the ordinate y_2 of the point 2 passed through with a lag of ψ , the abscissa of which is again equivalent to the ordinate of the following point 3 and so forth. In order to simplify the construction, we draw the auxiliary line $Z-Z$ bisecting the co-ordinate angles. Now it is only necessary to go from point 1 vertically up to the point of intersection with this auxiliary straight line, then

go horizontally and strike the Lissajous curve in point 2. From this point we again go vertically and horizontally to point 3, etc.

Having determined the peripheral course of the ellipse, we find the voltage-time curve by plotting the ordinates against equal intervals of ψ . Fig. 10 shows the analysis of the ultradynamic Lissajous curve constructed from Fig. 8 in accordance with the above explanations.

(d) Experimentally Recorded Ultradynamic Lissajous Figures

In the following there are reproduced and explained various ultradynamic Lissajous figures obtained with

90 degrees. The fundamental oscillation may be thought to produce a circular disk on which the harmonic circular disk slides. One can, however, also consider the figure produced by the harmonic circle rolling in the fundamental circle, the point P lying within or outside the harmonic circle describing a hypocycloid.

Besides integral harmonics, a magnetron oscillator supplies an entire spectrum of independent overtones with rational but not integral frequency relations. These give rise to transit-time patterns of the type reproduced in Fig. 13. The last two patterns (d) are so intertwined that an analysis is practically impossible. If the frequency ratio becomes irrational, then the closed curves are replaced by blurred ellipses.

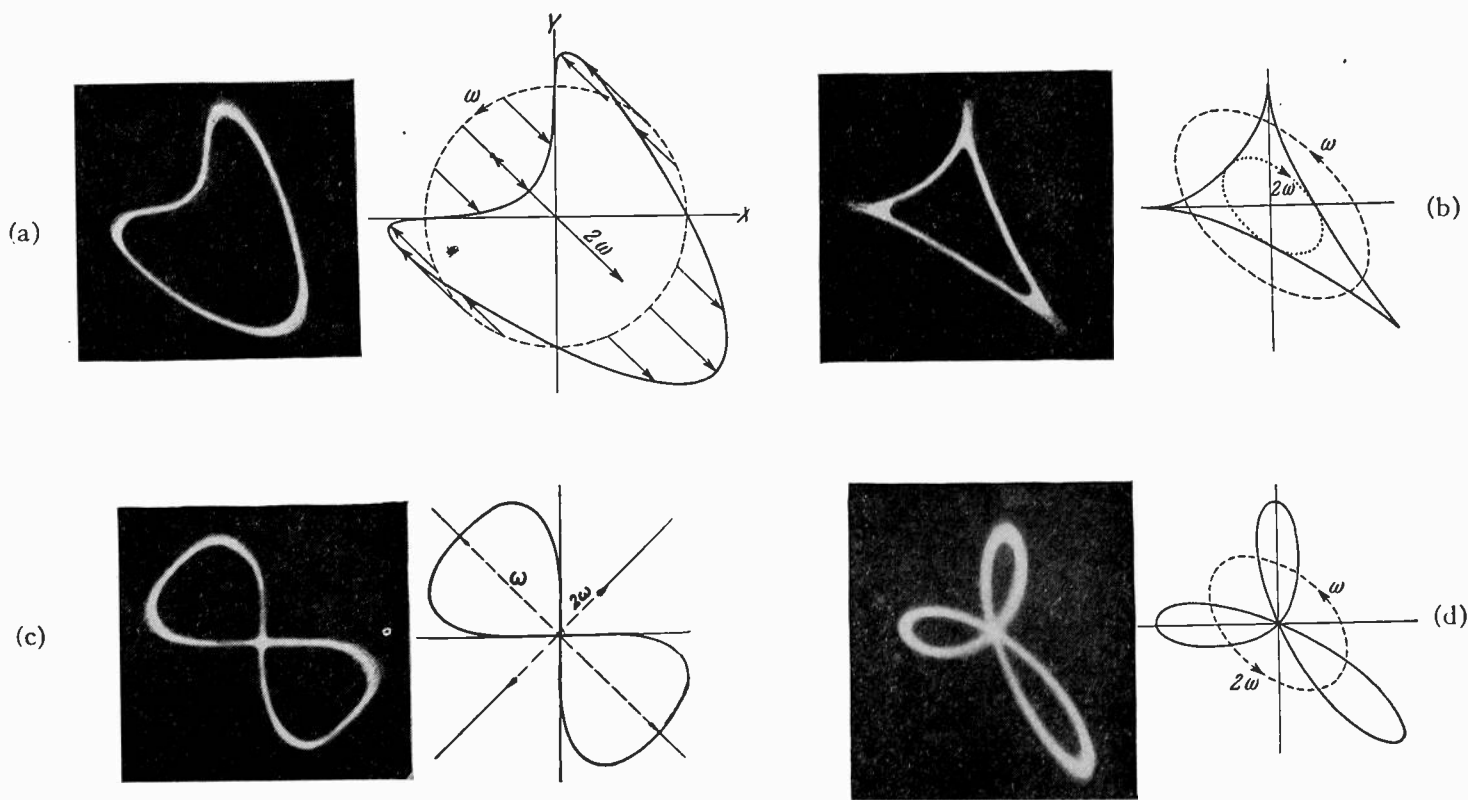

Fig. 11—Ultradynamic Lissajous figures containing the second harmonic.

- (a) $2 \sin \omega t + \sin 2\omega t$
 $\psi = 90$ degrees
- (c) $2 \sin \omega t + \sin 2\omega t$
 $\psi = 180$ degrees

- (b) $2 \sin \omega t + \sin 2\omega t$
 $\psi = 120$ degrees
- (d) $\sin \omega t + \sin 2\omega t$
 $\psi = 120$ degrees

(a-c) amplitude ratio $A:B=2$ and different transit angles. (d) $A:B=1$ and $\psi=120$ degrees.

a magnetron oscillator, varied by suitable tuning of the Lecher wires and by a suitable choice of operating parameters. The ratios of frequency and amplitude derived from the analysis, as well as the pertinent transit angles, are given in connection with each figure, as well as the graphically reconstructed figures.

Fig. 11 shows different ultradynamic Lissajous figures containing the first harmonic. Simply by changing the beam velocity, there are produced consecutively the patterns (a)–(c), in which the harmonic has half the amplitude of the fundamental. The pattern (d) is produced from (b) if the fundamental and harmonic have the same amplitudes.

Fig. 12 shows an ultradynamic Lissajous figure in which the amplitude of the second harmonic is 20 per cent of that of the fundamental, and the transit angle

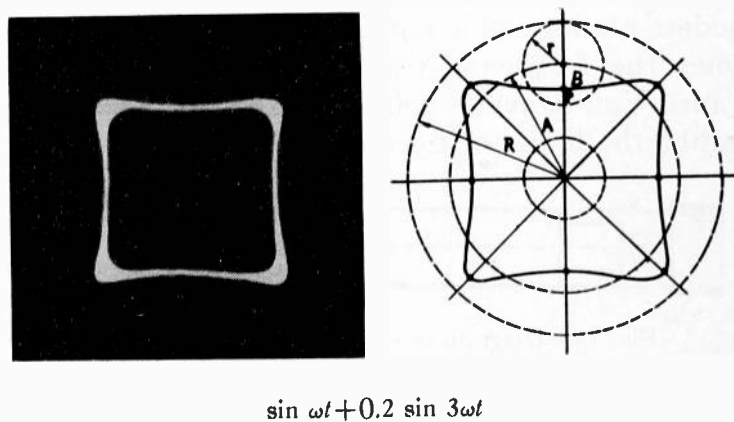

$\sin \omega t + 0.2 \sin 3\omega t$

Fig. 12—Ultradynamic Lissajous figure containing the third harmonic. $A:B=5$; $\psi=90$ degrees.

In the inside of the fundamental circle with the radius $R=4/3A$, the harmonic circle rolls with the radius $r=A/3$. The point P at a distance B from the center, describes the experimental hypocycloid.

(e) *The Microwave Oscillograph*

Transit-time oscillography can be applied as long as the transit-time effects of the "first kind" are negligible compared with those of the "second kind." In connection with wavelengths of a few decimeters, the external control tube with its large plate systems and excessive lead inductance can no longer be retained but must be greatly reduced in size.

An interesting possibility is offered by the sub-microscopic electron probe^{18,19} developed by M. von Ardenne. In his "micro-oscillograph," von Ardenne has used for oscillographic purposes²⁰ an electron beam of extreme fineness with a spot diameter of about 10^{-3} millimeter, with minute deflecting plates. He has

the field of amplifier and transmitter engineering, has led to the acorn tubes.

In order to extend transit-time oscillography as far as the lower decimeter range there was developed, in co-operation with the von Ardenne laboratory, the microwave oscillograph shown diagrammatically in Fig. 14.

From the gun system *K* an approximately parallel electron beam extends, the initial cross section of which is reduced by means of the short-focus electrostatic lens *O* in the ratio of $1:10^{-3}$. In view of the small focal distance of the reducing lens, the distance *L* between the lens and the fluorescent screen is also very small. The two pairs of deflecting plates *P*₁ and *P*₂ can, there-

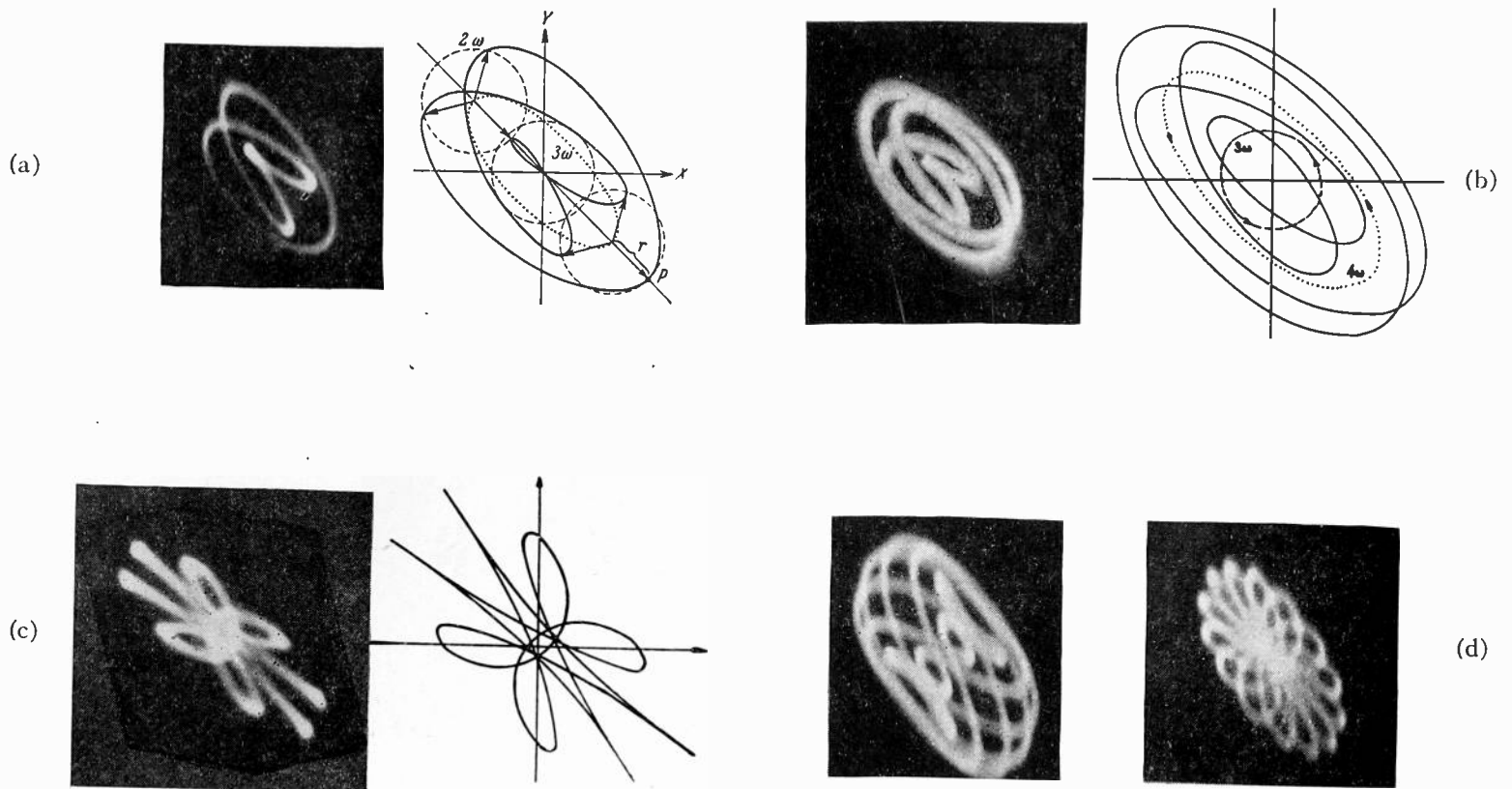

Fig. 13—Ultradynamic Lissajous figures with rational frequency ratios.
 (a) $2 \sin 2\omega t + 3 \sin 3\omega t$ $\psi_\omega = 45$ degrees
 (b) $\sin 3\omega t + 2.2 \sin 4\omega t$ $\psi_\omega = 35$ degrees
 (c) $\sin 3\omega t + \sin 5\omega t$ $\psi_\omega = 50$ degrees

traced microscopic oscillograms which, with very modest photographic equipment, achieved about 100 times the frequency resolution of ordinary oscillograms. Von Ardenne points out that in micro-oscillographs the limit set by the transit-time effect of the

fore, only be arranged *in front of* the reducing system. As the beam can be considered originally parallel, the deflection *A* is equal to the product of the refraction angle θ and the focal distance *f*,

$$A = \theta \cdot f = f \frac{l}{d} \cdot \frac{u}{2U}$$

l/d is the ratio of length to the separation of the plates, *u* is the plate voltage, and *U* is the volt velocity of the beam.

Fig. 15 is a photograph of the refractive system of the new microwave oscillograph. The size of the two pairs of plates *P*₁ and *P*₂, connected with each other within the tube, compares with the cross section of the match shown in the picture. With a beam velocity of 10 kilovolts, the sensitivity is $6 \cdot 10^{-3}$ millimeter per volt.

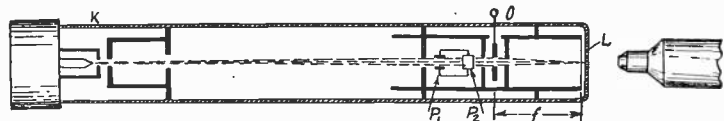

Fig. 14—Diagram of the microwave oscillograph.

first kind is changed by an order of magnitude in the direction of higher frequencies. In this way, the same road is followed with the cathode-ray tube, which, in

¹⁸ M. von Ardenne, *Zeit. für. Phys.*, vol. 109, p. 553, 1938.
¹⁹ M. von Ardenne, *Zeit. für. Tech., Phys.*, vol. 19, p. 407, 1938.
²⁰ M. von Ardenne, *Zeit. für. Tech. Phys.*

The transit angle of the first kind is 0.1π for a 20-centimeter wave and can be neglected for all practical purposes, while the transit angle of the second kind is 0.5π and leads to a useful fundamental-wave circle. Since the anode voltage, if need be, can be reduced to 1000 volts, waves up to about 1 meter can be oscillographed, while shorter waves require higher anode voltages.

The transit-time figures produced are observed and photographed microscopically on a *fine-grain* screen. The reduction in physical size of the system called for by the transit-time effects and line inductances is therefore compensated by optical magnification. Fig. 16 shows a view of the complete microwave oscillograph with the visual and photographic microscope

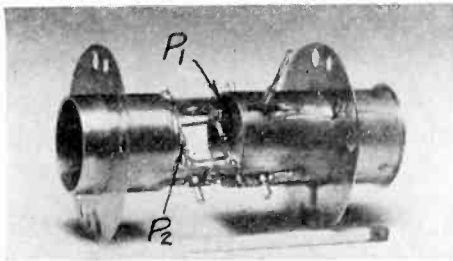

Fig. 15—Image-reproducing and refractive system of the microwave oscillograph.

and with the associated magnetron oscillator. With optical magnification of fifty times, the deflecting sensitivity amounts to about 0.5 millimeter per volt, as is customary with the ordinary low-voltage oscillograph tubes.

Fig. 17, shows some micropatterns in the lower decimeter range, obtained with a small magnetron at 4 kilovolts beam velocity. At high frequencies, the interlocking between independent overtones is extremely weak, so that double-wave figures can hardly be stopped during the time of exposure, amounting to a few seconds. In general, there are shown between figures (a) and (c) of the two individual waves merely indistinct transition images, (as in (b)). Sometimes a "fine structure" occurs when the transmitter is

tuned with extreme care by utilizing hand-capacitance effects. The two figures (d) and (e) show true double-frequency harmonics. Apart from details, the examples

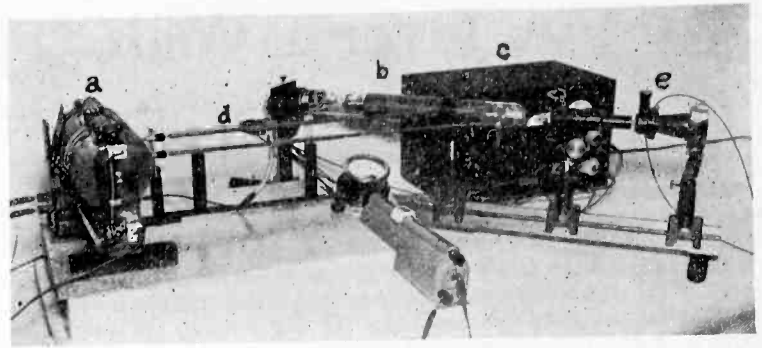

Fig. 16—Microwave oscillograph with magnetron generator.
(a) Magnetron (c) Power pack
(b) Microwave tube (d) Lecher wires
(e) Microscope with eyepiece and camera.

reproduced show that the microscopically small transit-time patterns are not inferior in sharpness to the previously shown pictures and can be analyzed with the same accuracy. The still-observable grains in the screen can be completely eliminated by the use of a single-crystal screen.

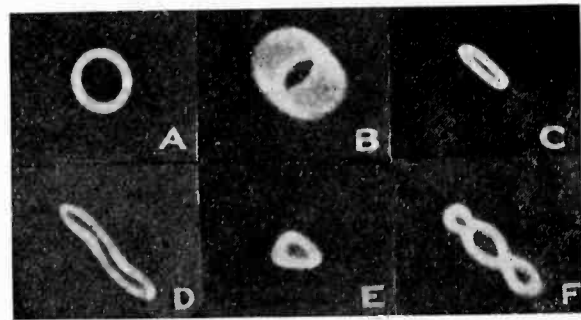

Fig. 17—Micro transit-time figures.
(a) $\lambda = 34$ centimeters; (b) $\lambda = 34 + 109$ centimeters; (c) $\lambda = 109$ centimeters; (e) $\lambda = 27 + 13.5$ centimeters.

The new transit-time oscillography can be considered an important contribution to the microwave-measuring technique. We may expect it to give us a deeper insight into phenomena which, up to the present time, were absolutely incomprehensible.

A New Quartz-Crystal Plate, Designated the GT, Which Produces a Very Constant Frequency Over a Wide Temperature Range*

W. P. MASON†, ASSOCIATE, I.R.E.

Summary—In this paper, a new quartz-crystal plate, designated the GT, is described which produces a very constant frequency over a wide temperature range. This crystal does not change by more than one part in a million over a 100-degree centigrade range of temperature. This crystal obtains its great temperature stability from the fact that both the first and second derivatives of the frequency by the temperature are zero. Both the frequency and temperature coefficient can be independently adjusted.

This crystal has been applied in frequency standards, in very precise oscillators, and in filters subject to large temperature variations. It has given a constancy of frequency considerably in excess of that obtained by any other crystal. A crystal chronometer, using this type of crystal, was recently lent to the Geophysical Union for measurements on the variation of gravity and the chronometer is reported to have kept time within several parts in 10 million, although no temperature control was used.

I. INTRODUCTION

ALL OF the zero-temperature-coefficient crystals¹ so far obtained have a zero temperature coefficient for one temperature only, while for temperatures different from this, the frequency increases or decreases in a parabolic curve with tem-

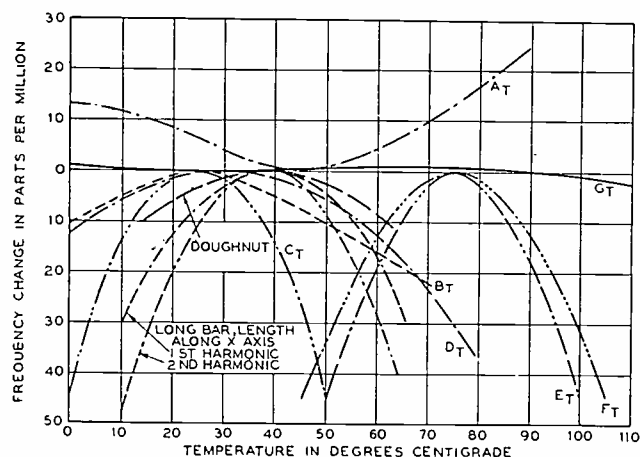

Fig. 1—Frequency-temperature relations for zero-temperature-coefficient crystals.

perature. This is well illustrated by Fig. 1 which shows a comparison of the frequency stability of the standard zero-temperature-coefficient crystals over a wide temperature range. What is plotted is the number of cycles change in a million from the zero-coefficient temperature. These curves show that for a 50-degree centigrade change from the zero-coefficient temperature the frequency of standard zero-temperature-coefficient crystals may change from 30 to 140 parts per million. For a frequency standard, particularly one that is portable, it is desirable to have a crystal which will maintain the frequency constant over a wide range of

* Decimal classification: R214. Original manuscript received by the Institute, October 26, 1939. Presented, New York Meeting, January 3, 1940.

† Bell Telephone Laboratories, Inc., New York, N. Y.

¹ W. P. Mason, "Low temperature coefficient crystals," *Bell. Sys. Tech. Jour.*, vol. 19, pp. 74-93; January, 1940, gives a description of standard types of low-coefficient crystals.

temperatures. It is the purpose of this paper to describe a crystal which will maintain the frequency of an oscillator constant to one part in a million when the temperature is varied over a 100-degree centigrade range. Furthermore, for a temperature change of 30 degrees centigrade there exists a region for which the frequency does not change by more than 1 part in 10 million. The crystal has been designated the GT crystal.

II. METHOD FOR OBTAINING LOW-TEMPERATURE-COEFFICIENT LONGITUDINALLY VIBRATING CRYSTALS

The study of this crystal grew out of an attempt to obtain a longitudinally vibrating crystal with a zero temperature coefficient for use in crystal filters. The method of arriving at this result was as follows. A low-frequency shear crystal, such as the CT or DT crystal, has a motion as shown on Fig. 2. One pair of corners stretches out from the center while the other pair is compressed in toward the center. If we rotate the direction of the principal axes by 45 degrees and cut a rectangular section, the vibration of the resulting crystal will consist of two longitudinal vibrations coupled together. This coupling will modify the action of each vibration separately by raising the frequency of the high-frequency mode and lowering that of the low-frequency mode. It will also modify the activity and temperature coefficient of each mode. If, however, we make one axis longer than the other, the frequencies will separate and the coupling between them will have less effect on each. If the axes differ in length by a large amount there will exist two longitudinal modes which will be but feebly coupled to each other and whose

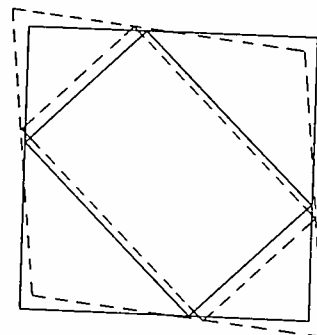

Fig. 2—Mode of motion of low-frequency shear crystals.

frequencies will be determined by the values of Young's moduli in the direction of vibration. Now it can be shown by calculation that all the Young's moduli in quartz have a negative temperature coefficient. If then

we regard a low-frequency shear vibration as two coupled longitudinal vibrations it follows that if the low-frequency shear mode has a positive temperature coefficient, this positive coefficient must be due to the coupling between the two modes, since both of the individual modes have negative coefficients. The vibration which corresponds to the low-frequency shear mode, will obtain a lower coefficient as the axis is ground down and will finally have a negative coefficient when the ratio of axes is sufficiently different from unity. At some ratio of axes therefore the coefficient will pass through zero.

In order to test out this conclusion a series of positive coefficient low-frequency shear crystals, similar to the CT and DT but with larger positive and negative angles, were obtained, crystals were cut at 45 degrees from the original axes, and one edge was ground down. As shown by Fig. 3, the higher-frequency longitudinal vibration for any angle of cut between +35 and +70 degrees could be given a zero coefficient by adjusting the ratio of axes properly. For the negative angles it was the lower frequency which was the stronger and corresponded to the low-frequency shear mode. For the negative angles, any angle between -50 degrees and an undetermined upper limit greater than -70 degrees would give a zero temperature coefficient at the proper ratio of axes. The ratios for zero coefficient are shown plotted on Fig. 3.

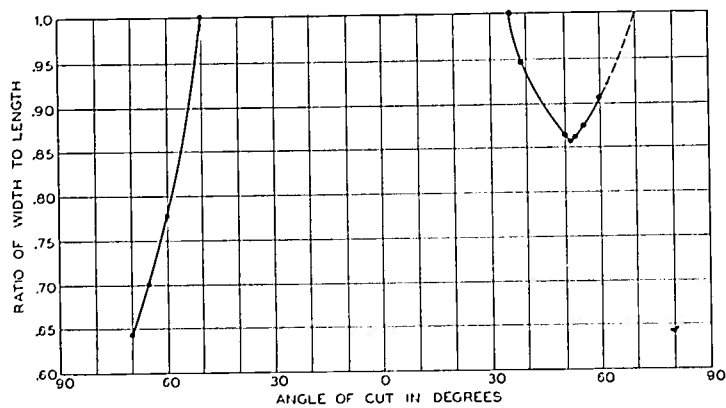

Fig. 3—Ratio of axes for rectangle of Fig. 2 for which coefficient is zero.

Fig. 4 shows the frequency-temperature relation for several of the positive-angle crystals over a wide range of temperatures. The resulting curves are nearly parabolas. This is what would be expected for in general we can write the frequency as a function of temperature by the series

$$f = f_0 [1 + a_1(T - T_0) + a_2(T - T_0)^2 + a_3(T - T_0)^3 + \dots] \quad (1)$$

where T_0 is any arbitrary temperature. Differentiating f with respect to T we have

$$\frac{df}{dT} = f_0 [a_1 + 2a_2(T - T_0) + 3a_3(T - T_0)^2 + \dots] \quad (2)$$

For a zero-coefficient crystal the change in frequency

will pass through zero at some temperature T_0 . Hence $a_1 = 0$. The frequency will then be

$$f = f_0 [1 + a_2(T - T_0)^2 + a_3(T - T_0)^3 + \dots] \quad (3)$$

and since a_2 will ordinarily be much larger than succeeding terms, a parabolic curve will be obtained. If a_2 is positive then on either side of the zero-coefficient

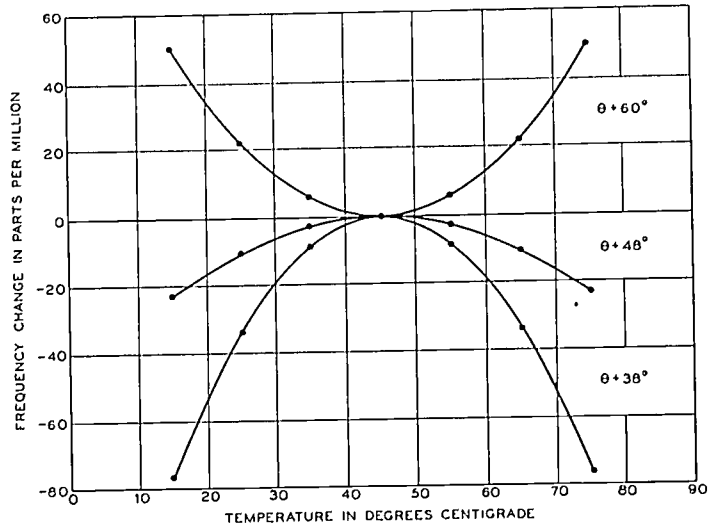

Fig. 4—Frequency-temperature curves for several angles of cut for the G-type crystal.

temperature T_0 the frequency will increase. If a_2 is negative it will decrease. By observing the curves of Fig. 4, we see that for angles greater than +51 degrees 30 minutes the value of a_2 is positive, while for angles less than +51 degrees 30 minutes the value of a_2 is negative. Fig. 5 is a plot of the value of the second derivative of the frequency with respect to the temperature of the zero-temperature-coefficient crystals for positive and negative angles. From Fig. 5 we see that the value of a_2 passes through zero at +51 degrees 30 minutes. Hence for such a crystal the large para-

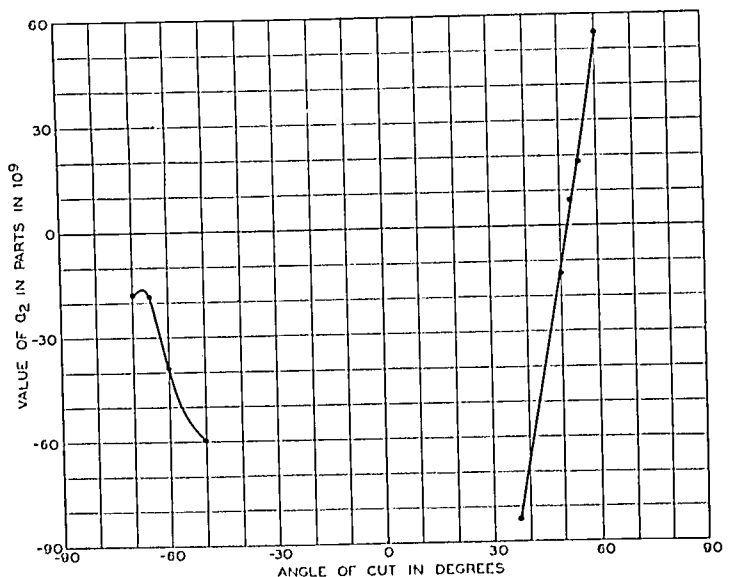

Fig. 5—Plot of the second derivative of the frequency by the temperature for G-type crystals.

bolic curvature that is present for most zero-coefficient crystals is absent and the only remaining variation is due to the third term which is very small.

III. TEMPERATURE VARIATION OF GT CRYSTALS

To show this effect a +51-degree 30-minute crystal with its edge rotated 45 degrees from the X axis and its ratio of axes equal to 0.855 was used to control an oscillator and the temperature of the crystal was varied over a wide range. The resulting frequency is shown in Fig. 6 and it will be observed that the frequency does not change more than one part in a million over a 100-degree centigrade range. In order to get this curve, however, two effects had to be eliminated, the acoustic

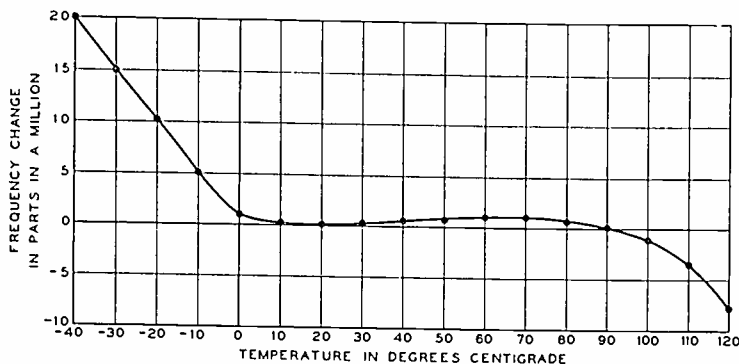

Fig. 6—Frequency-temperature curve for GT crystal.

resonance in the box and the temperature-gradient effect. When the crystal was measured in a closed box and the temperature changed, the frequency varied cyclically by as much as three parts in a million. This was found to be due to a change in resonance condition in the box due to temperature changes, probably due to the change in velocity of air waves with temperature, and it could be completely eliminated if the crystal were put in a vacuum. Another effect which probably occurs in all crystals but is not evident unless the temperature coefficient is very low is the temperature-gradient effect. If the temperature on the crystal is raised rapidly the frequency decreases by several parts in a million and then gradually comes back to the same value as the temperature approaches equilibrium. If the temperature is then rapidly lowered back to its initial value the frequency of the crystal increases by several parts in a million and then gradually comes back to its initial value. In order to eliminate this effect the temperature was changed very gradually and ascending and descending curves were averaged. In practice it appears desirable to heat-insulate this crystal so that a sudden ambient change will produce only a very slow temperature change in the crystal. If we plot the curve of Fig. 6 on Fig. 1, it is obvious that for a wide temperature range, the GT crystal is 30 to 150 times as constant in frequency as any other zero-temperature-coefficient crystal.

The values of a_3 as calculated from Fig. 6 is about

$$a_3 = -2.6 \times 10^{-11}. \quad (4)$$

Hence, if a_1 and a_2 are equal to zero, there is a range of ± 15 degrees centigrade for which the frequency does not change by more than one part in 10 million.

The GT crystal has the great advantage for frequency standards that both its frequency and temperature coefficient can be adjusted independently by

edge grinding. The frequency of the crystal is determined principally by the width while the temperature coefficient is determined by the ratio of axes. Hence the two can be adjusted separately.

The frequency of the 51-degree-30-minute crystal is nearly constant from a temperature of 0 to 100 degrees centigrade. Sometimes it would be desirable to change the temperature range to some lower mean range than this. This can be accomplished by changing the angle of cut slightly, as can be shown theoretically from (1), for if we expand (1) in powers of T we have

$$f = f_0 [1 + a_3 T^3 - T^2(3a_3 T_0 - a_2) + T(3a_3 T_0^2 - 2a_2 T_0 + a_1) - (a_3 T_0^3 - a_2 T_0^2 + a_1 T_0)]. \quad (5)$$

If we change the angle of cut and the ratio of axes slightly so that we satisfy the relation

$$3a_3 T_0 - a_2 = 3a_3 T_1 \quad \text{and} \quad 3a_3 T_0^2 - 2a_2 T_0 + a_1 = 3a_3 T_1^2 \quad (6)$$

(5) can be written in the form

$$f = f_0 [1 - a_3 (T_0 - T_1)^3 + a_3 (T - T_1)^3] = f_0' [1 + a_3' (T - T_1)^3] \quad (7)$$

and hence terms which vary with T will be eliminated up to the cubic term. Furthermore the variation is about a different temperature T_1 . In order that this shall be true we must satisfy the relations

$$a_2 = 3a_3 (T_0 - T_1); \quad a_1 = 3a_3 (T_0 - T_1)^2. \quad (8)$$

The first condition can be satisfied by changing the angle of cut slightly since as shown by Fig. 5, the value of a_2 is a function of the angle of cut. The second condition of (8) can be satisfied by changing the ratio of axes slightly so that we can conclude that by changing the angle of cut slightly the mid-point of the flat frequency-temperature range can be shifted up or down on the temperature scale. To have the center of the flat region come at 25 degrees centigrade, the calcula-

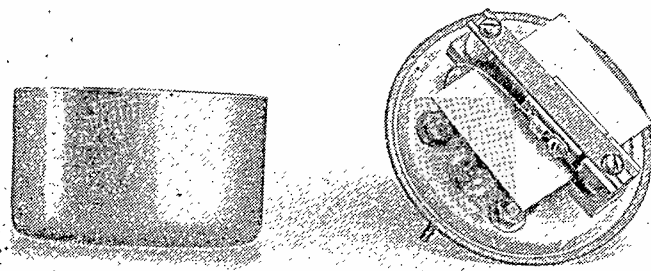

Fig. 7—Photograph of GT crystal mounted.

tion shows that the angle of cut should be 51 degrees 7.5 minutes and the ratio of axes should be about 0.859. The frequency constant is about 329.2 kilocycles for a centimeter width at this angle.

IV. APPLICATION TO CONSTANT-FREQUENCY OSCILLATORS

The crystal is a strong oscillator and can be used in the frequency range from 60 to 1000 kilocycles. A very

advantageous frequency on account of the size of the crystal and ease of adjustment is 100 kilocycles. In order to obtain the frequency constancy indicated above with the angular cuts given it is necessary to employ an oscillating circuit which works the crystal near its resonant frequency. This is a consequence of the fact that the resonance and antiresonance of the crystal do not vary in quite the same way with temperature. Other types of oscillators will not give this constancy for the angles given, but by changing the angles of cut, the crystal can be adapted to the oscillator circuit.

As pointed out above the GT crystal vibrates in a longitudinal mode and hence it has a nodal line parallel to the length of the crystal. This can be made use of in mounting the crystal for it can be clamped between small rectangular-shaped jaws ground flat on the end. One such mounting is shown on Fig. 7. In order to realize the stability that the crystal is capable of giving it is necessary to mount it in a vacuum container. This protects it from humidity, barometric, and acoustic resonance changes which may cause several parts in a million change. The elimination of the air also has a beneficial effect in eliminating dissipation in the crystal. With an etched and plated crystal, Q 's as high as 330,000 have been obtained with this crystal in a commercial holder in an evacuated container.

The Bell System frequency standard now employs crystals of this type used in an improved resistance-bridge oscillator,² which is particularly insensitive to

power-supply and other circuit-parameter variations. One of these oscillators was recently lent to the American Geophysical Union by the Bell Laboratories for measurements on the variation of gravity^{3,4} in the Caribbean Ocean. The oscillator had no temperature control or stabilized battery but was reported to have kept time within several parts in 10 million.

The GT crystal is also useful in narrow and moderately wide crystal filters for stabilizing the pass band of the filters over wide temperature ranges. There is a small secondary resonance due to the vibration along the length of the crystal which occurs about 16 per cent below the main resonance, but the effect of this is easily removed by the use of electrically tuned circuits. This type of crystal has been used at the intermediate frequency in oscillators and narrow-band filters for selecting out the carrier on the single-sideband short-wave transatlantic radio systems.⁵ It is also used in unattended radio receiving equipment, subject to wide temperature variations, for use in harbor and coastal radiotelephone systems.⁶

² L. A. Meacham, "The bridge-stabilized oscillator," *Proc. I.R.E.*, vol. 26, pp. 1278-1294; October, 1938.

³ M. Ewing, "Gravity measurements on the U.S.S. *Barracuda*," *National Research Council, Trans. Amer. Geophys. Union*, part I, pp. 66-69; July, (1937).

⁴ A. J. Hoskinson, "Crystal chronometer time in gravity surveys," *National Research Council, Trans. Amer. Geophys. Union*, part I, pp. 77-79; July, (1937).

⁵ F. A. Polkinghorn, "A single-sideband receiving system for commercial operation on transatlantic radiotelephone circuits," *Proc. I.R.E.*, vol. 28, pp. 157-170; April, (1940).

⁶ H. B. Fischer, "Remotely controlled receiver for radiotelephone systems," *Proc. I.R.E.*, vol. 27, pp. 264-269; April, 1939.

A General Reciprocity Theorem for Transmission Lines at Ultra-High Frequencies*

RONOLD KING†, ASSOCIATE, I.R.E.

Summary—The application of the general reciprocity theorem for low-frequency networks to circuits which do not satisfy the conditions of the near zone and which include distributed electromotive forces is examined for the case of the parallel line. It is shown that the reciprocity theorem is valid in general only if induced electromotive forces exhibit a cosine-symmetrical distribution along the wires (in which case they may be represented by a single pair of equivalent point generators) or if the line is terminated in its characteristic impedance.

A GENERAL reciprocity theorem for electric networks has been formulated and proved by Pierce.¹ It is: "If we have any system of ironless alternating-current circuits, however complicated and if we have in the system a sinusoidal impressed electromotive force applied at any point of the system, and an impedanceless ammeter at any other point of the system, the ammeter and the electromotive force

* Decimal classification: R390. Original manuscript received by the Institute, November 21, 1939.

† Harvard University, Cambridge, Mass.

¹ G. W. Pierce, "Electric Oscillations and Electric Waves," p. 204; McGraw-Hill Book Company, New York, N. Y., 1920.

are interchangeable without changing the amplitude or phase of the steady-state current through the ammeter." The proof of this theorem tacitly assumed that the individual circuit elements satisfied the conditions of the near zone, uniform current amplitude distribution and negligible retardation, and it specifically required applied electromotive forces to be concentrated at points. Its application to transmission-line networks in which the last condition is satisfied while the former are not appears legitimate to the extent that the parallel line may be treated as the limiting case of a recurrent network in which all of the conditions are satisfied. On the other hand, the case where an induced electromotive force is distributed over a significant fraction of a wavelength, such as is almost invariably the case when an ultra-high-frequency generator is coupled to a transmission line, is definitely not included in the reciprocity theorem as formulated

above. Consider, for example, the following case. An ultra-high-frequency oscillator is loosely coupled to a long transmission line with its center directly below a point x_1 , which will be assumed to be far from the ends of the line. The current at x_2 is I_2 . Now suppose the oscillator to be moved parallel to the line until its center is directly below the point x_2 , which is likewise not near the ends of the line. Then the current at x_1 is I_1 . If the reciprocity theorem applied, the two currents I_1 and I_2 should be alike in amplitude and phase. Superficially one might well take it for granted that this is generally true, since the induced electromotive force, even though distributed over a considerable part of the line, is essentially the same in the two cases. The following investigation will show, however, that this is not the case.

The analytical problem of handling a distributed induced electromotive force in a parallel line has been reduced to simple terms by a general coupling theorem.^{2,3} This states that the electromotive force induced in a parallel line by a loosely coupled oscillator, which maintains along the two conductors equal and opposite spatially distributed fields of any amplitude distribution whatsoever, is equivalent to three pairs of suitably placed point generators with properly adjusted amplitudes and phases. Let this theorem be applied to the general case of a parallel-line section of length s which is terminated by general admittances Y_0 and Y_s (which may include additional sections of line) and which is driven by a loosely coupled ultra-high-frequency oscillator which is placed with its center (any other reference point may be used) directly below the co-ordinate x . According to the coupling theorem the induced electromotive force is, in general, equivalent to the following arrangement of point generators in the line. One pair of equal and opposite generators, each supplying an amplitude $\frac{1}{2}V_x$, is placed at x with one generator in each conductor. A second pair of equal and opposite generators, each of amplitude $\frac{1}{2}W'$ is placed at $x-x_1$. A third pair just like the second is placed at $x+x_1$ with phases adjusted to be opposite to those of the second pair. The amplitudes V_x and W' and the distance x_1 are assumed to be properly chosen. If one writes

$$W_x = 2W' \sinh Kx_1, \quad (1)$$

the current amplitude I_0 at the terminals of Y_0 is given by⁴

$$I_0 = (Y_0/H) \{ V_x [Z_c Y_s \cosh K(s-x) + \sinh K(s-x)] + W_x [Z_c Y_s \sinh K(s-x) + \cosh K(s-x)] \}; \quad (2)$$

$$H = (Z_c^2 Y_0 Y_s + 1) \sinh Ks + Z_c (Y_0 + Y_s) \cosh Ks. \quad (3)$$

² Ronold King, "The application of low-frequency circuit analysis to the problem of distributed coupling in ultra-high-frequency circuits," *Proc. I.R.E.*, vol. 27, pp. 715-724; November, 1939.

³ Ronold King, "A generalized coupling theorem for ultra-high-frequency circuits," *Proc. I.R.E.*, vol. 28, pp. 84-87; February, 1940.

⁴ Reference 3, equation (16).

Here Z_c is the complex characteristic impedance of the line; K is the complex propagation constant.

In order to obtain an expression for I_x in terms of V_0 and W_0 a little manipulation is necessary. As a first step let Y_0 be the input admittance of a section of parallel line of length u terminated by a general admittance Y_u . Then Y_0 is given by⁵

$$Z_c Y_0 = N(u)/D(u); \quad (4a)$$

$$N(u) = Y_u Z_c \cosh Ku + \sinh Ku; \quad (4b)$$

$$D(u) = Y_u Z_c \sinh Ku + \cosh Ku. \quad (4c)$$

Upon substituting (4) in (3)

$$H(s, u) = (1/D)(Z_c Y_s N + D) \sinh Ks + (Z_c Y_s D + N) \cosh Ks. \quad (5)$$

With (4) it is readily shown that (5) reduces to

$$H(s, u) = (1/D) [(Z_c^2 Y_s Y_u + 1) \sinh K(s+u) + Z_c (Y_s + Y_u) \cosh K(s+u)]. \quad (6)$$

As a second step let (4) be substituted in (2) written for the case in which the oscillator is moved so that $s=x$. One then has for (2)

$$I_0 = [Y_x V_x / H(s') + W_x / Z_c H(s')] \cdot [Y_u Z_c \cosh Ku + \sinh Ku]. \quad (7)$$

Here

$$s' = s + u = x + u; \quad (8a)$$

$$H(s') = D(u)H(s, u) = (Z_c^2 Y_x Y_u + 1) \sinh Ks' + Z_c (Y_x + Y_u) \cosh Ks'. \quad (8b)$$

As a third and final step let the origin of a primed set of co-ordinates be placed at $s=x$ in the unprimed set. Then I_0 becomes $I_{x'}$, Y_x becomes $Y_{0'}$, Y_u becomes Y_{u+x} , V_x becomes $V_{0'}$, W_x becomes $W_{0'}$, and u becomes $s'-x'$. With this change of notation (6) may be written as follows:

$$I_{x'} = [Y_{0'} V_{0'} / H(s')] [Z_c Y_{s'} \cosh K(s'-x') + \sinh K(s'-x')] + [W_{0'} / Z_c H(s')] [Z_c Y_{s'} \cosh K(s'-x') + \sinh K(s'-x')]; \quad (9)$$

$$H(s') = (Z_c^2 Y_{0'} Y_{s'} + 1) \sinh Ks' + Z_c (Y_{0'} + Y_{s'}) \cosh Ks'. \quad (10)$$

By making all primed quantities in (9) and (10) equal to the corresponding unprimed quantities in (2) and (3), the circuit to which (9) applies is made identical with that to which (2) applies except that the co-ordinates locating, respectively, the current and the

⁵ Ronold King, "Amplitude characteristics of coupled circuits having distributed constants," *Proc. I.R.E.*, vol. 21, p. 1144, equation (6); August, 1933.

oscillator center have been interchanged. That is, the oscillator has been moved to where the current was first measured, and the current is now measured where the oscillator was originally placed. It is to be noted that Y_0 and Y_0' may stand for the input admittance of a section of parallel line, so that the positions x and 0 may be any points along a transmission line.

Upon comparing (2) with (10) (primes omitted) one observes at once that the two expressions are not alike. That is, the current at 0 with the oscillator coupled at x is not the same as the current at x with the oscillator coupled at 0 . Consequently one must conclude that the general reciprocity theorem for circuits with lumped constants and concentrated generators does not apply in general to circuits with distributed parameters and distributed electromotive forces. However, a closer scrutiny of (2) and (9) reveals that the contribution to the currents in the two cases due to the centrally located pair of point generators each of amplitude $\frac{1}{2}V$ is the same. One may conclude, therefore, that the reciprocity theorem is valid whenever it is possible to represent the entire distributed electromotive force by a single pair of point generators. This is always the case² if the oscillator sets up a field which is cosine symmetrical with respect to its center, and this is chosen as the reference point. The reciprocity theorem is not applicable if the oscillator maintains an unsymmetrical or a sine-symmetrical field except in one interesting special case when $Y_0 = 1/Z_c$. It follows from (4) that the input impedance $Z_0 = 1/Y_0$ of a section of parallel line of length u is equal to the characteristic impedance Z_c if it is terminated in $1/Y_u = Z_u = Z_c$. In this case there are no reflections from this end of the line, standing waves are not produced, and the reciprocity theorem is generally valid.

The above conclusions regarding the validity of the reciprocity theorem for a line with general terminations are easily verified experimentally. Two simple experiments will suffice. These depend upon the fact that a cosine-symmetrical oscillator induces a maximum voltage in a loosely coupled line when its center is placed below a current loop, while a sine-symmetrical oscillator must be placed below a current node for a maximum response.⁶ If a cosine-symmetrical

oscillator is coupled below a current loop at x_m the current amplitude at x_n , a quarter wavelength from x_m , will be a minimum. If the oscillator is moved to x_n the current at x_m is found to be reduced to a minimum as required by the reciprocity theorem. The same experiment repeated with a sine-symmetrical oscillator yields a different result. For a maximum response in the line this oscillator must be coupled at x_n . The current at x_m will then be a maximum. However, if the oscillator is now moved to x_m the current at x_n is found to remain a minimum instead of becoming a maximum as required by the reciprocity theorem.

In conclusion, the following reciprocity theorem may be formulated for a parallel line. Given a parallel line which is terminated at both ends in any way whatsoever, and which is loosely coupled to an oscillator placed above or below the line in such a way that the distributed induced electromotive forces in the two conductors are equal and opposite. With the oscillator coupled so that its center is below one co-ordinate along the line, while an impedanceless ammeter is connected in each conductor at any other, the relative positions of the oscillator and of the ammeters may be interchanged without altering the amplitude or phase of the steady-state current in each meter, provided the oscillator maintains a field distribution along the line which is cosine symmetrical with respect to the oscillator center, or provided the line is terminated at one end in its characteristic impedance. It is to be noted that for general terminations this theorem not only excludes unsymmetrical and sine-symmetrical fields, but also limits the possible location of a cosine-symmetrical oscillator to points not too near the ends of the line. This follows from the fact that the active field along the line will not be symmetrical in so far as the line is concerned if any significant part of it extends beyond the termination at one end.

Added in proof: Finally, it is perhaps well to repeat with emphasis that the theorem formulated above applies specifically to distributed induced electromotive forces which violate the requirements of the conventional reciprocity theorem. It serves, therefore, to supplement and extend the application of this latter. In fact, like the general coupling theorem³ it defines a class of ultra-high-frequency circuits in which, under specified conditions, the simpler and familiar methods and theorems of low-frequency theory may be used.

⁶ Ronold King, "A variable oscillator for ultra-high-frequency measurements," *Rev. Sci. Inst.*, vol. 10, pp. 325-331; November, 1939.

Current Division in Plane-Electrode Triodes*

KARL SPANGENBERG†, ASSOCIATE, I.R.E.

Summary—In this paper a law of primary-current division between a positive grid and plate which is believed to be more accurate than those previously presented is deduced from a study of the electron paths within the tube. It is found that the ratio of plate to grid current may be expressed in the form $i_p/i_g = (L + Me_p/e_g)/(P - Qe_p/e_g)$. When plotted on logarithmic paper against e_p/e_g the curve of the ratio i_p/i_g has a slope varying between $\frac{1}{3}$ and $\frac{2}{3}$ and assuming the slope of $\frac{1}{2}$ over a considerable range. This provides a theoretical justification for the previously observed form, $(i_p/i_g) = \delta(e_p/e_g)^{1/2}$.

The effective grid area for the condition of equal positive grid and plate voltages is found to vary between 120 and 180 per cent of the actual grid area for ordinary triodes. The effective grid area in terms of the electrode dimensions is conveniently expressed by means of a nomograph as is also the current-division factor. By means of these nomographs the essential factors related to positive grid currents may be rapidly determined for any tube.

An excellent check between the predicted and measured current-division law was obtained. Measured and observed values checked within two or three per cent for all factors.

The relations giving the current division in terms of electrode dimensions are applied in illustrative examples to show how grid currents in some typical tubes may be reduced by changing the electrode dimensions without reducing the amplification factor or mutual conductance of the tubes.

INTRODUCTION

IN the design of class C amplifiers and oscillators a knowledge of the static characteristics of the tube in the positive grid region is of great importance. In particular, a knowledge of the factors controlling the grid current is necessary for a determination of grid driving power, power amplification, and oscillator efficiency. Since the total space current in a triode is known as a function of the grid and plate potentials, the grid and plate current is known as a function of these same variables. With the grid- and plate-current forms known the design of class C amplifiers and oscillators may be greatly simplified.

The importance of this problem has led several experimenters to investigate the static characteristics of triodes in the positive-grid region. Tank¹ and Lange,² early German experimenters, recognized that the division of current between plate and grid for any given tube is a function of the ratio of plate and grid voltages only. They discovered that the current division in the absence of secondary emission was approximately given by the relation

$$\frac{i_p}{i_g} = \delta \left(\frac{e_p}{e_g} \right)^{1/2} \quad (1)$$

in which i_p and i_g are plate and grid currents, respectively, and e_p and e_g are plate and grid voltages.

This relation has been verified experimentally by

* Decimal classification: R139. Original manuscript received by the Institute, April 12, 1939; abridgment received, December 19, 1939. Presented, Pacific Coast Convention, San Francisco, Calif., June 28, 1939.

† Stanford University, California.

¹ F. Tank, "Zur Kenntnis der Vorgänge in Elektrodenröhren," *Jahr. der Draht. Tel. und Tel.*, vol. 20, p. 80, 1922.

² H. Lange, "Die Stromverteilung in Dreielektrodenröhren und Ihre Bedeutung für die Messung der Voltaspannung," *Zeit. für Hochfrequenz.*, pp. 1-18; June, 1928.

Myers³ and by Everitt and Spangenberg.⁴ The exponent in (1) is found to be in the vicinity of $\frac{1}{2}$ for all triodes, while the coefficient δ , which will be designated as a "current-division factor" since it measures the ratio of plate to grid current when the plate and grid voltages are equal, is different for each type of tube.

Tellegen^{5,6} has developed theoretically an expression for the ratio of plate to grid current similar to (1). It is

$$\frac{i_p}{i_g} = \frac{a}{2r_g} \sqrt{\frac{e_p + \mu e_g}{e_g \left(\frac{p+f}{f} + \mu \right)}} - 1 \quad (2)$$

where r_g is the grid-wire radius, a the distance between grid wires, p the grid-plate distance, f the grid-filament distance, and μ the amplification factor of the tube. For $e_p/e_g = (p+f)/f$ or the grid at its "natural potential" relative to the plate (2) reduces to

$$\frac{i_p}{i_g} = \frac{a}{2r_g} - 1 \quad (3)$$

which is the expression assumed by Lange and also that to which the relation given in this paper reduces for this condition of potentials. The above ratio is the ratio of projected intergrid to grid area expected from the straight-line motion of electrons occurring when the grid is at its natural potential. Tellegen gives no experimental verification of his formula. Although accurate in the vicinity of the "natural grid potential," (2) may be expected to be in error for considerable departures from this since Tellegen neglects the linear term in his potential expression. The present paper does consider the linear potential property as well as the radial potential property used by Tellegen and is thus accurate over a wider range of electrode potentials.

A comparison of the formulas of Tellegen, Lange, and that given in this paper for the condition of equal positive grid and plate potentials for a 210 tube gives the following:

$$\begin{aligned} \delta &= \left(\frac{i_p}{i_g} \right)_{e_p=e_g} = 8.77 \text{ Tellegen} \\ &= 5.69 \text{ Lange} \\ &= 6.25 \text{ Spangenberg} \\ &= 6.5 \text{ measured value} \end{aligned}$$

³ D. M. Myers, "Division of primary electron current between grid and anode of a triode," *Proc. Phys. Soc.*, vol. 49, part 3, pp. 264-278; May 1, 1937.

⁴ W. L. Everitt and Karl Spangenberg, "Grid-current flow as a factor in the design of vacuum-tube power amplifiers," *Proc. I.R.E.*, vol. 26, pp. 612-639; May, 1938.

⁵ B. D. H. Tellegen, "De Grootte van der Roosterstroom in een Triode," *Physica*, vol. 6, pp. 113-116; March, 1926.

⁶ B. D. H. Tellegen, "De Grootte van der Emissionstroom in een Triode," *Physica*, vol. 5, pp. 301-315; October, 1925.

Indication that the form of (1) is not exact is given by the fact that the exponent is only approximately constant and assumes a value as high as $\frac{3}{4}$ for some potential ratios. It will be shown in this paper, however, that the simple power form of (1) resembles somewhat the theoretical form developed here and is sufficiently accurate for many applications.

In this paper the current-division function is deduced by considering the paths of electrons as determined by the electrostatic fields within the tube. This determines immediately the current-division factor for any particular tube, as a function of the internal tube dimensions. The expression for the current-division factor is then modified to give the current-division law as a function of grid and plate voltages when these voltages are not equal.

ELECTROSTATIC FIELD OF A TRIODE

Use will be made of the potential relations developed by Maxwell⁷ for a grating of parallel wires modified to fit the case of a parallel-plane-electrode triode. These are the simplest existing relations which adequately describe the field within a triode. The approximations involved make the relations valid for tubes with screening fractions less than one tenth, and approximately correct for tubes with slightly greater screening fractions.

It is found that the potential at any point in the field of the plane triode of Fig. 1 is given by

$$E = -\lambda \ln \left(2 \cosh \frac{2\pi x}{a} - 2 \cos \frac{2\pi y}{a} \right) + \frac{4\pi x}{a} \left(q - \frac{\lambda}{2} \right) + C \quad (4)$$

in which the dimensions have the significance indi-

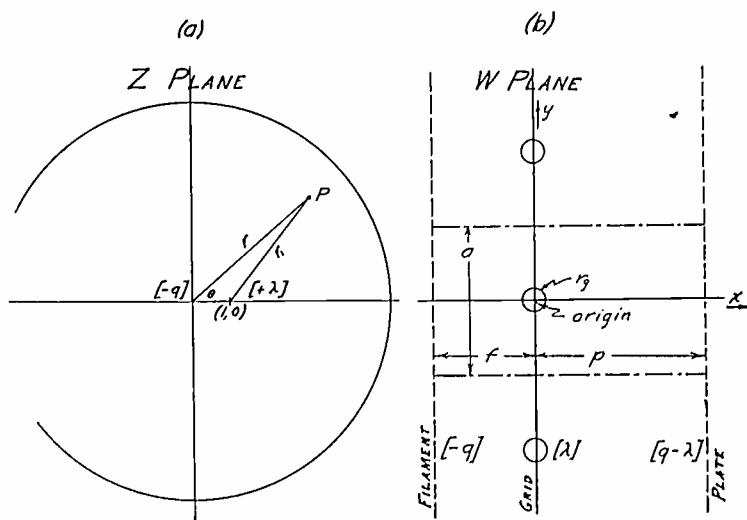

Fig. 1—Fundamental configuration of the plane triode.

cated in Fig. 1(a). The filament charge is $-q$ per centimeter depth of filament per grid-wire section. The charge per centimeter of grid wire is λ . The plate charge per centimeter depth of plate per grid-wire section is $q - \lambda$. The constant C is chosen to make the potential zero at the filament $x = -f$.

⁷ Clerk Maxwell, "Electricity and Magnetism, Vol. I," pp. 310-316. Clarendon Press, Oxford, England, 1904.

The relations between the charges and the electrode potentials are

$$\lambda = \frac{a\mu[(p+f)e_0 - fe_p]}{4\pi p(p+f+\mu f)} \quad (5)$$

$$q = \frac{a(e_p + \mu e_0)}{4\pi(p+f+\mu f)} \quad (6)$$

In these relations μ is the amplification factor which

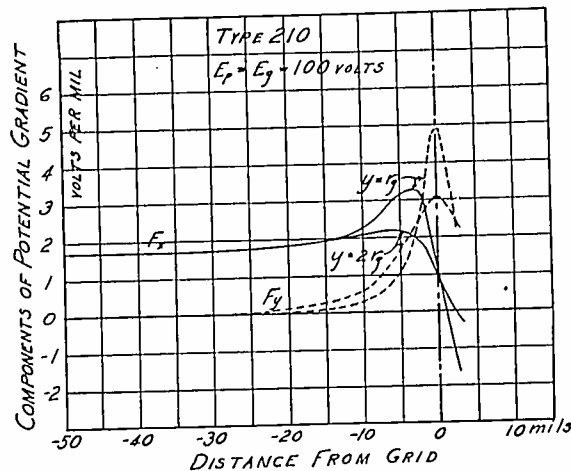

Fig. 2—Horizontal and vertical components of potential gradient of a triode with equal positive grid and plate voltages.

has the value

$$\mu = \frac{-2\pi p}{a \ln(2 \sin \pi r_0/a)} \quad (7)$$

To determine the paths of electrons in this field it is necessary to obtain expressions for the horizontal and vertical components of potential gradient. These are readily derived from (4) and are

$$F_x = -\frac{\partial E}{\partial x} = \frac{2\pi}{a} \left[\frac{\lambda \sinh(2\pi x/a)}{\cosh(2\pi x/a) - \cos(2\pi y/a)} + \lambda - 2q \right] \quad (8)$$

$$F_y = -\frac{\partial E}{\partial y} = \frac{2\pi}{a} \left[\frac{\lambda \sin(2\pi y/a)}{\cosh(2\pi x/a) - \cos(2\pi y/a)} \right] \quad (9a)$$

In Fig. 2 are shown the components of potential gradient as determined from (8) and (9a) along lines close to the grid wire perpendicular to the filament plane for values of y equal to r_0 and $2r_0$ for the case of equal positive grid and plate voltages.

DETERMINATION OF CRITICAL ELECTRON PATH FOR EQUAL GRID AND PLATE VOLTAGES

If the starting point of an electron which just grazes a grid wire can be found, all electrons leaving the filament can be grouped as either landing on the grid or on the plate. The grazing electron will be called the "critical electron."

Let the distance between the starting point of the critical electron and the point on the filament opposite the grid-wire center be designated by y . The difference between y and r_0 which measures the sidewise displacement of the electron on its flight to the grid is desig-

nated by y_0 . Since the critical electron leaves the filament at the point $(-f, y)$ the current division between plate and grid is given by

$$\delta = \left(\frac{i_p}{i_g} \right)_{c_p=c_g} = \frac{a/2 - y}{y} \quad (10)$$

$$\delta = \frac{a}{2(y_0 + r_g)} - 1. \quad (11)$$

This is because $y = y_0 + r_g$ and the emission per unit area of filament is assumed constant. Sample calcula-

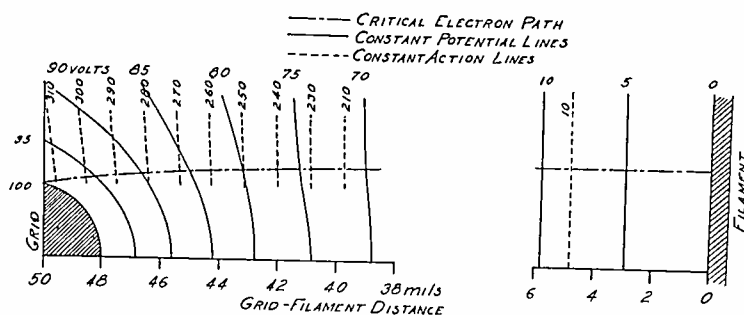

Fig. 3—Critical electron path as determined by constant-action lines.

tions have shown that it is sufficiently accurate to consider as critical the electron which strikes the side of the grid wire on the line of the wires instead of the actually grazing electron. Reference to Fig. 3 will show that this is reasonable.

The differential equations of motion of an electron are readily formulated but are not easily solved exactly. They are

$$\frac{d^2x}{dt^2} = \frac{-e}{m} F_x \quad (12a)$$

and

$$\frac{d^2y}{dt^2} = \frac{-e}{m} F_y. \quad (13)$$

In these equations e and m are the charge and mass of the electron and F_x and F_y are the x and y components of potential gradient.

Differential equations in which both F_x and F_y are functions of x and y (see (8) and (9a)) can be solved exactly only in rare cases. However, an examination of the curves of potential and gradient shows that certain simplifying approximations are justified. With these simplifying approximations the electron paths may be determined quite closely. This will now be undertaken for the case of equal positive grid and plate voltages.

Examination of Fig. 2 shows that the x component of gradient is almost constant along most of the lines parallel to the x axis near the grid wires. Thus an electron moving along a path parallel to the x axis which just grazes the grid wire experiences an almost constant acceleration in the x direction. Calculations show that the assumption of a constant x component of gradient results in an error of x component of veloc-

ity of only $\frac{1}{2}$ per cent at the grid. The x -component acceleration expression (12a), may therefore be simplified to

$$\frac{d^2x}{dt^2} = -\frac{e}{m} F_f \quad (12b)$$

where F_f is the potential gradient at the filament.

This last equation has the solution

$$x = kt^2 - f. \quad (14)$$

To determine the sidewise displacement of an electron grazing the grid, the electron may be presumed to be subject to the sidewise force which it would experience if it moved in a path along the straight line parallel to the x axis which is just tangent to the grid. Since the electron is to end its flight at the side of a grid wire this presumption will represent conditions quite accurately for the last portion of the electron's travel. The assumption is less accurate for the first portion of the electron's path but here the sidewise force is small compared to both the x component of force and the maximum component of sidewise force exerted so that any error introduced here is not great.

The equation for the y component of potential gradient, (9a), may be simplified by making use of the fact that the grid-wire radius r_g is small compared to the grid-wire spacing a . With this approximation (9a) reduces to

$$F_y = \frac{2\lambda r_g}{x^2 + r_g^2}. \quad (9b)$$

The curve of this approximate formula fits the actual curve so closely, within the width of a penline, that it could not be drawn with the actual curves of Fig. 2.

With this value of F_y one may solve for the sidewise displacement of an electron in traveling from filament to grid by expressing x in terms of t by means of (14) and then integrating (13) twice. These operations are quite straightforward but lengthy. For details of the integrations see Appendix I.

The resultant expression for the sidewise displacement of the critical electron in its flight from the filament to the grid is

$$y_0 = \frac{a\mu}{2\pi(\mu + 1)} \frac{r_g}{2f} \ln \frac{4ef}{r_g} \quad (15)$$

in which all the symbols have the previous significance and e is the Naperian base, 2.718.

Equation (15) represents the basic relation which has been sought and which has been the object of all the previous analysis. It tells how much the critical electron has been displaced sidewise in its flight from the filament to the grid in terms of the tube dimensions. From it the current-division factor of a tube is readily deduced in terms of the electrode configuration. From it an effective grid area for the condition of equal grid and plate voltages can be determined.

It was found desirable to check (15) by calculation in a typical case. A number of methods of calculation

of electron paths by numerical processes are available. The point-by-point calculation methods of McCarty⁸ and Salinger⁹ were tried and discarded because of the cumulative error to which these methods are subject. For the case in question in which the sidewise deflections are small the simplest and most accurate method of calculation seems to be one employing the action function as suggested by Lange.² This method makes use of the fact that electrons will move in paths at right angles to curves of constant action. Once the action curves are obtained either analytically or graphically with sufficient accuracy the orthogonal electron trajectories are readily drawn in. In this case the action curves were obtained approximately by assuming that the electrons moved in straight lines, and by calculating the action by $A = kfE^{1/2}dx$. This amounts to using the first step of a perturbation method applied to action and potential. The first step gives sufficient accuracy because the two errors involved are compensating.

In Fig. 3 are shown curves of constant potential and constant action and also the critical-electron path for an idealized 210 tube. From the electron path as determined by the action-function plot the value of y_0 is about 0.9 mil as compared with a value of 0.952 mil as calculated by (15).

DETERMINATION OF EFFECTIVE GRID RADIUS AND CURRENT-DIVISION FACTOR

The concept of an effective grid area for the condition of equal grid and plate voltages is a useful one.

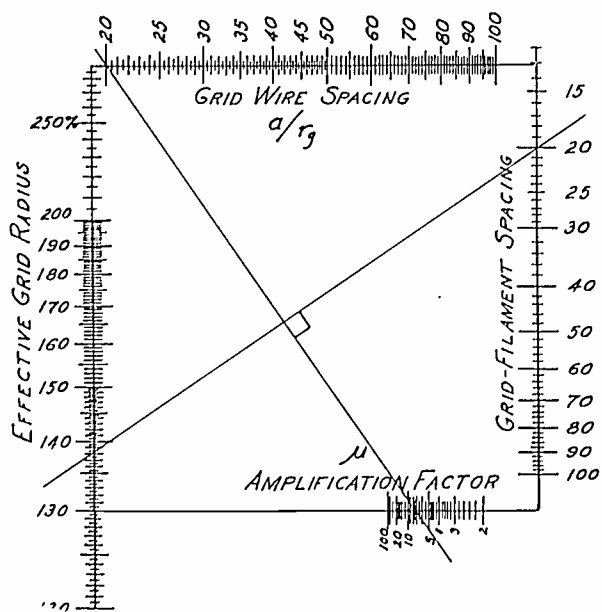

Fig. 4—Nomograph of effective grid radius.

Evidently, for this condition, the grid intercepts more current than it would if the electrons moved in straight lines from the filament toward the plate. For the discussion here the effective grid radius will be defined as the actual grid radius r_g plus the sidewise displacement

⁸ L. E. McCarty, "Relation between anode current and potential deduced from the orbital motion of the electrons," *Phys. Rev.*, vol. 30, series 2, pp. 878-892; December, 1927.

⁹ H. Salinger, "Tracing electric paths in electric fields," *Electronics*, vol. 10, pp. 50-54; October, 1937.

ment of the critical electron y_0 . For instance, if the critical electron is displaced a distance equal to 50 per cent of the actual grid radius then the effective grid radius is 150 per cent of the actual grid radius.

By virtue of the above definition and the relations developed above and in the appendix the effective grid radius expressed in terms of the actual grid radius is

$$\frac{r_{g \text{ off}}}{r_g} = \frac{r_g + y_0}{r_g} = 1 + \frac{a}{2\pi r_g} \frac{\mu}{\mu + 1} \frac{r_g}{2f} \ln \frac{4ef}{r_g} \quad (16)$$

The form of (16) makes it possible to express the effective

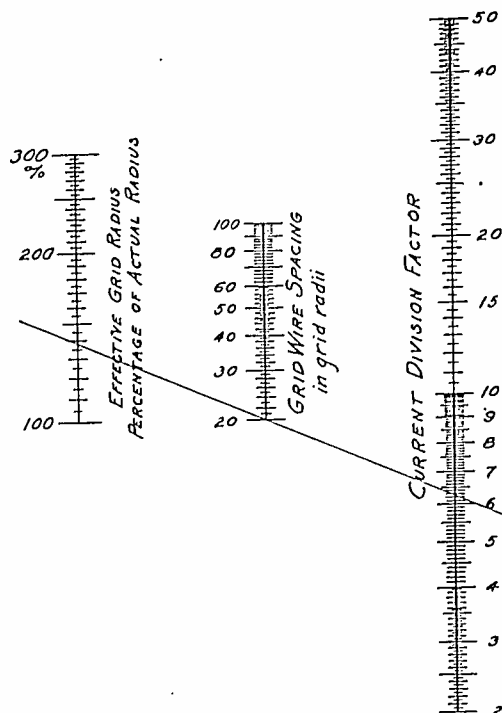

Fig. 5—Nomograph of current-division factor.

grid radius by means of the square nomograph given in Fig. 4. The effective grid radius is read at the intersection of the right-angled cross and the left-hand scale.

From the nomograph the relation between the factors is readily seen. The effective radius of the grid does not change much with μ especially for large values since the factor $\mu/(\mu + 1)$ becomes nearly unity. The radius is seen to decrease as the filament-grid distance is increased. It increases as the grid-wire spacing increases. The cross shown in Fig. 4 gives the effective grid radius for a 210 tube. It is seen to be about 138 per cent of the actual grid radius. For ordinary triodes the effective grid radius lies between 120 per cent and 180 per cent of the actual grid radius.

When the effective grid radius as defined above is known the current-division factor is readily determined. From (11) and (15) the effective grid radius and the current-division factor are related by

$$\delta = \frac{a}{2r_{g \text{ off}}} - 1 \quad (17)$$

$$\delta = \frac{a}{\frac{a\mu}{\pi(\mu + 1)} \frac{r}{2f} \ln \frac{4ef}{r_g} + 2r_g} - 1 \quad (18)$$

This constant δ is the coefficient sought in the empirical equation (1). From the above it is seen that the derived constant δ has all the properties observed experimentally. For a given tube it is a function of the tube geometry alone and is independent of the magnitude of the electrode potentials. The magnitude of the current-division factor is given by the simple nomograph of Fig. 5.

Figs. 4 and 5 together tell the whole story of the current-division factor. With these, given the electrode dimensions of any tube, the effective grid radius and the current-division factor are readily determined.

So far the discussion and development have been all concerned with the case of equal grid and plate potentials. Obviously the current-division factor is only one point on the curve which expresses the general current division as a function of the electrode potentials when these are not equal. This general current-division law will be developed in the next section.

LAW OF PRIMARY-CURRENT DIVISION

The law of current division is easily obtained from the equation for the sidewise displacement of a critical electron y_0 , which has been developed for the case of equal grid and plate voltages. This is done by generalizing the expression for the sidewise displacement of the critical electron to fit the cases in which the grid and plate potentials are not equal. This means that this sidewise displacement, which will be indicated by the symbol y_1 , can be expressed as a function of e_p and e_g . The law of current division is then

$$\frac{i_p}{i_a} = \frac{a}{2(y_1 + r_a)} - 1 \quad (19)$$

by an obvious extension of the expression for the current-division factor.

In the development of the expression for the sidewise displacement of the critical electron there was obtained an expression for this displacement in terms of the grid-wire charge and the filament gradient of potential which was perfectly general for all electrode potentials. This is (see Appendix I)

$$y_1 = \frac{2\lambda}{F_f} \frac{r_a}{2f} \ln \frac{4ef}{r_a} = \frac{2\lambda}{F_f} D \quad (20)$$

in which D has been written for the geometrical function of r_a/f , $D = r_a/2f \ln 4ef/r_a$. It will be recognized that D is a constant for any particular tube.

Since $F_f = 4\pi q/a$, (20) can be rewritten as

$$y_1 = \frac{a\lambda}{2\pi q} D. \quad (21)$$

But from (5) and (6), λ/q in terms of the electrode potential is

$$\frac{\lambda}{q} = \frac{\mu[(p+f)e_g - fe_p]}{2\pi p(e_p + \mu e_g)} \quad (22)$$

so that the general expression for y_1 becomes

$$y_1 = \frac{a\mu[(p+f)e_g - fe_p]D}{2\pi p(e_p + \mu e_g)}. \quad (23)$$

Substituting this relation into (19) the current-division law becomes

$$\frac{i_p}{i_a} = \frac{a}{2\left(\frac{a\mu[(p+f)e_g - fe_p]D}{2\pi p(e_p + \mu e_g)} + r_a\right)} - 1. \quad (24)$$

This may be rearranged to give the simpler form

$$\frac{i_p}{i_a} = \frac{L + Mc_p/e_g}{P - Qc_p/e_g} \quad (25)$$

in which $L = \pi a p \mu - a \mu (p + f) D - 2 \pi p r_a \mu$ (26a)

$$M = \pi a p - 2 \pi p r_a + a f D \mu \quad (26b)$$

$$N = a(p + f)\mu + 2\pi p r_a \mu \quad (26c)$$

$$Q = a f D \mu - 2\pi p r_a. \quad (26d)$$

The expression (25) gives the current-division law which was the object of the above development. It is seen that the expression is dimensionally correct inasmuch as it expresses the ratio of the currents as a function of the ratio of potentials. Furthermore it may be seen from (23) that when the grid is at its "natural potential" relative to the plate, by which is meant that $e_g = [f/(p+f)]e_p$ making the potential distribution from the filament through the grid to the plate linear and corresponding to a condition of zero charge on the grid, then the sidewise displacement is zero. For this condition then the critical electron moves in a straight line grazing the grid and the current ratio is determined by the ratio of the projected intergrid area to the projected grid area.

EXPERIMENTAL VERIFICATION

In the derivation of the above expressions for the current-division factor and the current-division law a number of simplifying assumptions have been made. These assumptions are

1. Filament is a plane unipotential surface.
2. Electrons are released from the filament with zero velocity.
3. Dissymmetries in the tube structure and field due to end effects are negligible.
4. Space-charge effects are negligible.
5. Secondary-electron effects are absent.
6. All of the electrons which initially miss the grid reach the plate.

With ordinary tubes and ordinary operating conditions the first three assumptions introduce no appreciable error except in some special cases.

Space-charge and secondary-emission effects are, however, present in most tubes. Fortunately it is possible to check the primary-current distribution by making measurements with small emission currents

so that space-charge effects are indeed negligible and by correcting for secondary-emission currents present.

As a result of the last assumption the expressions developed above are valid only for the region in which the plate voltage is greater than the grid voltage. It is only for this condition that one is sure that all the electrons which miss the grid reach the plate and that none are deflected so that they miss the plate and return to another grid wire. In spite of this the results may be expected to be reasonably accurate for ratios of plate to grid voltage of as low as 0.8. The above restriction on the theory presented here is not a serious limitation, however, because in application tubes are rarely operated so that the grid potentials exceed the plate potentials.

Measurements of the current-division factor were made on a number of tubes. These measurements are ordinarily made by varying the plate and grid potentials together so that these are at all times equal and then observing the ratio of plate to grid current. Except for small electrode potentials of the order of 10 volts or less the current-division factor is surprisingly constant being even more constant than the amplification factor of the tube.

In the measurements of current-division factor made here particular care was made to reduce secondary-emission and space-charge effects. The electrode potentials were kept low to reduce the number of secondary electrons. The filament current and emission were also kept low to reduce the errors due to the potential drop along the filament and to space charge. Some curves of the ratio of plate to grid current, i.e., current-division factor, against electrode potential for a 210 tube are shown in Fig. 6. Theoretically the curves

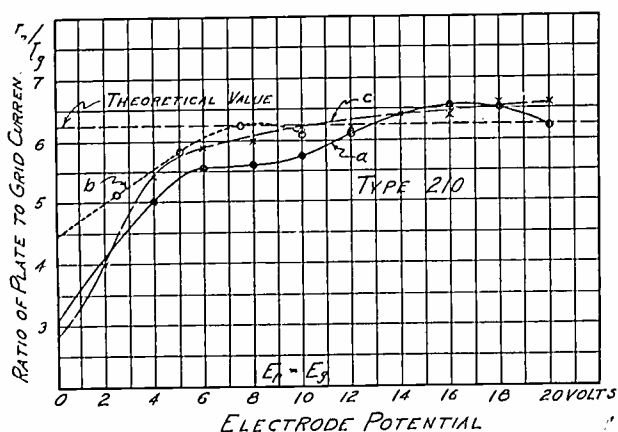

Fig. 6—Current-division factor in a 210 tube.

- a. $I_f = 0.1$ milliampere.
- b. Normal filament emission.
- c. $I_f = 0.05$ milliampere.

should be constant for all potentials greater than zero. Actually they rise from zero to an approximately constant value in a matter of a few volts. These curves illustrate the various effects encountered as the equal plate and grid potentials are varied. A knee is formed in the curves at a potential of about 5 volts at which potential the grid and plate are first positive with respect to all parts of the filament. Secondary electrons

are known to be released for striking potentials of about 9 volts or greater. It will be observed that the measured division factor exceeds the theoretical value of 6.25 for potentials somewhat greater than this. The measured values are in good agreement with the theory at the potentials at which secondary emission is just beginning.

Similar curves are shown in Fig. 7 for a type 45 tube. These curves show in a very striking manner the effect

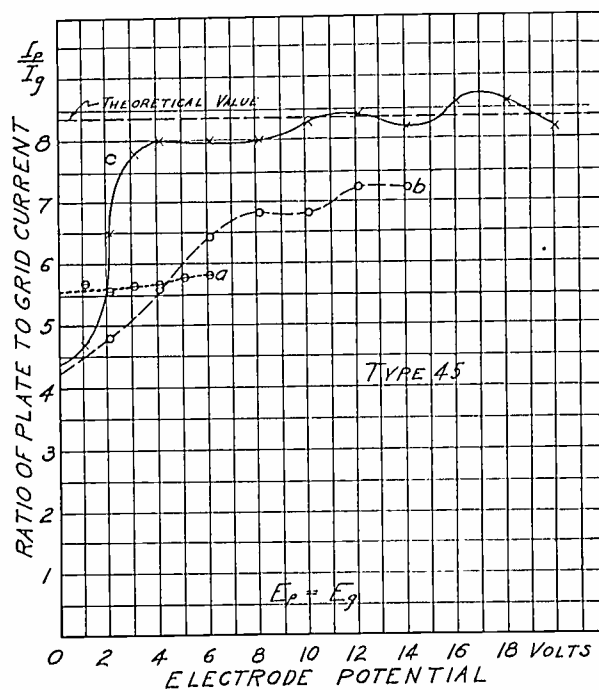

Fig. 7—Current-division factor in a 45 tube.

- a. Normal filament emission.
- b. $I_e = 1.6$ milliampere.
- c. $I_e = 0.9$ milliampere.

of space charge. It will be seen that it is only when the space current is dropped to a very small value that the measured division factor rises to the theoretical value of 8.35. This effect seems to be most pronounced in tubes in which the filament-grid distance is small.

It should be mentioned that the space-charge effects are greatly exaggerated for small electrode potentials because for this condition the virtual cathode moves much closer to the grid than it does for larger potentials. Because of space charge most of the electrons in effect leave a virtual cathode somewhere between the filament and grid plane with a zero velocity. This does not invalidate any of the theory developed here. Rather, it merely requires that a smaller filament-grid distance be used in (18). Langmuir¹⁰ has made a study of the location of the virtual cathode in terms of the space current and the electrode potentials. The results of his analysis can be applied directly to the problem of current division. In the case of the 45 tube it may be estimated from the curve for normal filament current that for low potentials the virtual cathode is located at a distance from the filament of about one third of the distance between the filament and

¹⁰ I. L. Langmuir, "The effect of space charge and initial velocities on the potential distribution and thermionic current between parallel plane electrodes," *Phys. Rev.*, vol. 21, series 2, pp. 419-435; April, 1923.

grid. For ordinary operation this reduction in the filament-grid distance introduces no great error because for the high potentials and space currents involved the virtual cathode recedes almost to the actual cathode.

In verifying the theoretical primary-current distribution as a function of electrode potentials all of the factors mentioned in the previous discussion must be considered. It is desirable, in checking the theory experimentally to keep the space current low to reduce space-charge effects and yet use fairly large electrode potentials to minimize the effect of the voltage drop along the filament. Under these conditions the number of secondary electrons produced may be considerable. However, de la Sabloniere¹¹ has shown how possible primary-electron distributions between plate

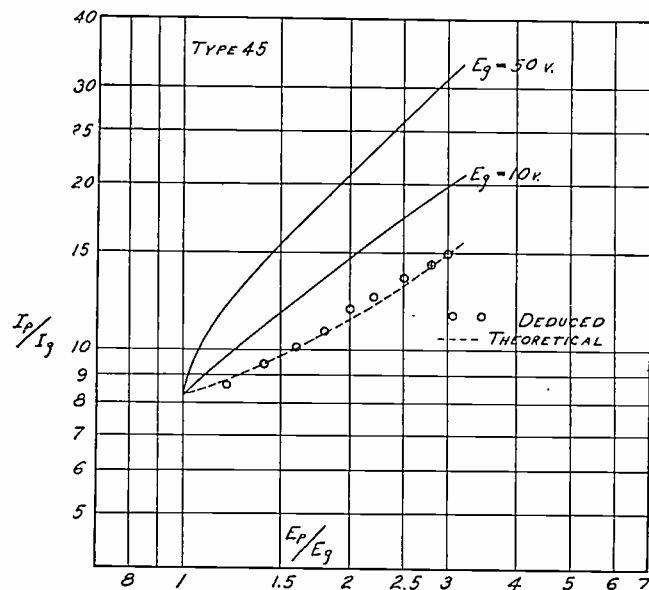

Fig. 8—Primary-current division in a 45 tube.

and grid may be deduced from the distributions existing with secondary emission. If one point on the true primary distribution curve is known then all points may be determined. The method of de la Sabloniere as modified for application here is described in Appendix II. In this verification a known point on the primary distribution curve was assumed to be that corresponding to the grid being at its natural potential relative to the plate, i.e., $e_g = [f/(p+f)]e_p$. For this condition the electrons move from the filament to the plate in parallel straight lines and the ratio of the primary plate to primary grid current is given by the ratio of the projected intergrid to grid wire area or $(a/2 - r_g)/r_g$.

A comparison of the theoretical and deduced current-division laws is given in Fig. 8 for a type 45 tube. The solid curves show the measured current distribution with secondary emission. The dashed curve shows the theoretical primary distribution curve calculated according to (25). The encircled points give the values of current division deduced by the method of de la Sabloniere from the solid curves. It is seen that the agreement is quite good.

¹¹ C. J. L. de la Sabloniere, "Die Sekundäremission in Schirmgitterröhren," *Hochfreq. und Audio.*, vol. 41, pp. 195-202; June, 1933.

The actual curve of theoretical primary-current distribution is not a straight line in the log-log plot of Fig. 13 but is a curve concave upwards with a slope varying from about $\frac{1}{4}$ to about $\frac{3}{4}$. In between these values the slope is about $\frac{1}{2}$ for quite a range. This gives the justification for the form given in (1). With slight amounts of secondary emission and the presence of space charge the current-distribution curve straightens out and assumes a more nearly constant slope. Thus the form previously given is seen to agree closely with the theoretical form given here and is a sufficiently good approximation for most applications.

It should be observed that the check obtained upon the theory developed here is as good as that ordinarily obtained for the theoretical determination of such constants as the amplification factor of the tube. Theoretical and experimental values agree within 2 or 3 per cent if space-charge and secondary-emission effects are properly accounted for.

APPLICATIONS

A few of the possible implications and applications of this analysis may be indicated. In checking the primary-current distribution secondary-electron effects were corrected for. Conversely the verified primary-current relations can be used as a basis for the study of secondary-emission effects as they actually occur within the tube. It was also found that the location of the virtual cathode had to be considered in verifying the primary-current distribution. Obviously departures of the measured distributions from the theoretical ones can be used to study the actual position of the virtual cathode. The triode analysis given here can be extended to include effects in screen-grid and pentode tubes. Most important of all the analysis given here can be applied directly to improve the operating characteristics of transmitting triodes for class C amplifier service.

In the design of triode transmitting tubes the results given above may be applied directly. Thus for class C operation it is desirable to have the tube characteristics such that the ratio of the output to input power is as high as possible for a maximum output. Obviously if the grid currents can be reduced without making other constants such as the amplification factor and the mutual conductance worse the tube will perform more capably as a power amplifier. From the above analysis it is seen that the grid currents are reduced if the filament-grid distance is made larger, and, since the amplification factor is independent of this dimension, the reduction may be achieved without changing the μ of the tube. The magnitude of the grid currents may also be reduced if the ratio of grid-wire spacing to grid radius is increased.

A brief example will illustrate how the changes indicated above may be achieved. Consider the 210 tube. This has a grid-filament distance of 50 mils, a grid-wire spacing of 50 mils, a grid-plate distance of 75 mils, and

a grid-wire radius of 2.5 mils. These dimensions result in an amplification factor of about 8.1 and a current-division factor of 6.25. Suppose it is desired to reduce the grid currents, i.e., increase the current-division factor, without changing the other constants of the tube. To achieve this let the grid-wire spacing be doubled for the same radius of grid wires. This makes the grid-wire spacing 100 mils. Consideration of the amplification-factor formula (2) shows that if the grid-wire spacing in grid radii is increased from 20 to 40 the amplification factor will be the same as before if p/a , the ratio of grid-plate distance to grid-wire spacing, is increased from 1.5 to 2.42. Thus if a grid-plate distance of 2.42 times the grid-wire spacing of 100 mils or 242 mils is used, the amplification factor of the tube will be 8.1 as before. To keep the mutual conductance the same as that of the ordinary 210 it is only necessary to adjust the grid-filament distance of the proposed tube to give the same equivalent diode spacing as before. The equivalent diode spacing of a triode is

$$d = f \left[1 + \frac{p + f}{\mu f} \right]. \quad (29)$$

In other words a diode with a filament-plate spacing given by d and with a voltage of $(e_p + e_n/\mu)$ on its plate would draw the same current from the filament as would the triode with potentials e_p and e_n . Tubes with equal equivalent diode spacings and amplification factors have the same mutual conductance. Our tubes have already been made to have the same amplification factors. The equivalent diode spacing of a 210 is 65.45 mils. To get this same diode spacing for the proposed tube it is necessary to make the filament-grid spacing 31.65 mils. The tubes now have the same amplification factor and the same mutual conductance. However, reference to the nomographs of Figs. 4 and 5 or to (18) shows that the current-division factor is now 12.8 whereas formerly it was 6.25. The current-division factor has thus been doubled without changing the amplification factor or mutual conductance of the tube. For class C operation this means that the proposed tube is capable of the same output with a greatly reduced driving power.

This same result can be achieved in other ways. For instance, by cutting the grid-wire diameter in half, increasing the grid-plate spacing about 65 per cent to 121 mils, and reducing the grid-filament spacing about 10 per cent to 44.9 mils the current-division factor is increased to 12.6 without changing the amplification factor or mutual conductance of the tube.

There has been much discussion as to whether a high-, medium-, or low- μ tube is best suited for class C operation. The above analysis makes possible a series of calculations with some real and hypothetical tube structures which should lead to an optimum design from the standpoint of power amplification and power output.

CONCLUSIONS

An expression for the effective grid area for the condition of equal plate and grid voltages is developed. This has the form

$$\frac{r_{o \text{ eff}}}{r_o} = 1 + \frac{a}{2\pi r_o} \frac{\mu}{\mu + 1} \frac{r_o}{2f} \ln \frac{4ef}{r_o}. \quad (16)$$

Examination of this expression shows that the effective grid radius varies little with the grid-plate spacing in the tube. The effective radius may be reduced by reducing the grid-wire spacing. It may also be reduced by increasing the filament-grid distance. In ordinary triodes the effective grid radius is between 20 and 80 per cent greater than the actual grid radius.

The law of primary-current division between plate and grid is found to be of the form

$$\frac{i_p}{i_o} = \frac{L + Me_p/e_n}{P - Qe_p/e_n} \quad (25)$$

in the region in which the plate voltage is greater than the positive grid voltage. A plot of this relation shows that the ratio of plate to grid current varies approximately as a power of the ratio of plate to grid voltage. The power of the ratio of voltages varies between $\frac{1}{4}$ and $\frac{3}{4}$ and assumes the value of $\frac{1}{2}$ for quite a range. This checks the previously given form

$$\frac{i_p}{i_o} = \delta \left(\frac{e_p}{e_o} \right)^{1/2} \quad (1)$$

which holds well for ordinary operating conditions even in the presence of slight amounts of secondary emission. *It is therefore possible to combine the empirical form with the theoretical value of the current-division factor δ given in this paper:*

$$\delta = \frac{a}{\frac{a\mu}{\pi(\mu + 1)} \frac{r_o}{2f} \ln \frac{4ef}{r} + 2r_o} - 1. \quad (18)$$

The relation between the current-division factor and the tube electrode dimensions is conveniently represented by means of a nomograph. The relation between the effective grid radius and the electrode dimensions is also expressed by means of a nomograph. These nomographs make it possible to determine rapidly the essential factors related to positive grid currents for any plane electrode triode.

The theoretical values of effective grid radius and current-division factor are verified experimentally and found to be in good agreement with measured values. A similar verification of the current-division law developed in this paper was obtained. Measured values check the theory within two or three per cent for all factors tested.

In checking the theoretical forms developed in the paper it was necessary to correct observed values for space-charge and secondary-emission effects. The cor-

rection methods used can be applied to a study of secondary-emission effects within actual tubes and also to a determination of the position of the virtual cathode between filament and grid.

The results of the analysis have been applied in some illustrative examples to show how grid currents may be reduced in transmitting tubes by increasing the grid-wire spacing and also increasing the grid-plate distance. This reduction in grid currents is obtained without reducing the amplification factor or mutual conductance of the tube. The same result may be achieved by reducing the grid-wire diameter and increasing the grid-plate distance, again without reducing the amplification factor or mutual conductance of the tube.

APPENDIX I

Determination of the Sidewise Displacement of the Critical Electron for the Case of Equal Grid and Plate Potentials.

As has already been shown the x component of displacement is given by (14) as

$$x = kt^2 - f \quad (30)$$

in which $k = -eF_f/2m$. From this the time of flight of an electron from filament ($-f$) to grid ($x=0$) is $t_0 = (f/k)^{1/2}$. It will be found convenient to use this symbol in subsequent expressions.

Substituting the expression for x above into the equation for the y component of acceleration, (13), and using the approximation of (9b), gives

$$\frac{d^2y}{dt^2} = \frac{k_1}{(kt^2 - f)^2 + r_0^2} \quad (31)$$

where $k_1 = -2e\lambda r_0/m$. Substituting the value for the time of flight t_0 gives

$$\frac{d^2y}{dt^2} = \frac{k_2}{(t^2 - t_0^2)^2 + r_0^2/k^2} \quad (32)$$

where $k_2 = -8\lambda r_0 m/e k_f^2$. Further substitutions and rearrangements give

$$\frac{d^2y}{dt^2} = \frac{k_2}{[(t^2 - t_0^2) + ir_0 t_0^2/f][(t^2 - t_0^2) - ir_0 t_0^2/f]} \quad (33)$$

from which

$$\frac{d^2y}{dt^2} = \frac{k_2}{[t^2 - t_0^2(1 + ir)][t^2 - t_0^2(1 - ir)]} \quad (34)$$

where $i = (-1)^{1/2}$ and $r = r_0/f$. This may be simplified still further to give

$$\frac{d^2y}{dt^2} = \frac{k_2}{(t^2 - r_1)(t^2 - r_2)} \quad (35)$$

where $r_1 = t_0^2(1 + ir)$ and $r_2 = t_0^2(1 - ir)$, r_1 and r_2 are conjugate complex quantities. The last expression is in the rational-fraction form and so can be written as

$$\frac{d^2y}{dt^2} = \frac{k_2}{r_1 - r_2} \left[\frac{1}{t^2 - r_1} - \frac{1}{t^2 - r_2} \right]. \quad (36)$$

This is readily integrated to give

$$\frac{dy}{dt} = \frac{k_2}{r_1 - r_2} \left[\frac{1}{2\sqrt{r_1}} \ln \frac{t - \sqrt{r_1}}{t + \sqrt{r_1}} - \frac{1}{2\sqrt{r_2}} \ln \frac{t - \sqrt{r_2}}{t + \sqrt{r_2}} \right] + C_1. \quad (37)$$

Physical considerations require that this reduce to a real quantity. Upon integration

$$y_0 = \frac{k_2}{4rt_0^2 i} \left[\frac{t}{r_1} \ln \frac{t - \sqrt{r_1}}{t + \sqrt{r_1}} - \frac{t}{r_2} \ln \frac{t - \sqrt{r_2}}{t + \sqrt{r_2}} - \ln(t^2 - r_1) + \ln(t^2 - r_2) \right] + C_1 t + C_2. \quad (38)$$

Making use of the fact that the function of the conjugate is the conjugate of the function, and that r is small compared to l , this reduces to

$$y_0 = \frac{2}{F_f} \left[\frac{t}{t_0} \left(\tan^{-1} \frac{rt_0}{t_0^2 - t^2 + r^2 t_0^2/2} - \pi \right) - \frac{tr}{2t_0} \ln \frac{[(t^2 - t_0^2)^2 + r^2 t_0^4]^{1/2}}{(t + t_0)^2} + \pi - \tan^{-1} \frac{rt_0^2}{t_0^2 - t^2} \right] + C_1 t + C_2. \quad (39)$$

C_1 is now evaluated from the expression for dy/dt . Use is made of the boundary condition that when $t=0$, $dy/dt=0$. By proper reduction of these expressions it follows that $C_1 = 2\pi/F_f t_0$. This constant, C_1 , will be seen to cancel the second term in the expression for y for all values of t .

To evaluate C_2 let $y=0$ when $t=t_0$. Then

$$C_2 = \frac{-2\lambda}{F_f} \left(\pi - \frac{r}{2} - \frac{r}{2} \ln \frac{r}{4} \right). \quad (40)$$

Thus when $t=0$, $y=y_0$ which has the form

$$y_0 = \frac{2\lambda}{F_f} \left(\frac{r}{2} - \frac{r}{2} \ln \frac{r}{4} \right) = \frac{2\lambda}{F_f} \frac{r}{2} \ln \frac{4e}{r}. \quad (41)$$

This is a perfectly general expression for the sidewise displacement of the critical electron. It will be evaluated, however, for the particular case of equal positive grid and plate potentials. Since $F_f = 4\pi q/a$ and remembering that $r = r_0/2f$ the last expression may be rewritten as

$$y_0 = \frac{a\lambda}{2\pi q} \frac{r}{2f} \ln \frac{4ef}{r_0} = \frac{a}{2\pi q} D \quad (42)$$

by obvious substitutions. If now the ratio λ/q is evaluated from (22) for $e_p = e_0$ this expression becomes

$$y_0 = \frac{a\mu}{2\pi(\mu + 1)} \frac{r_0}{2f} \ln \frac{4ef}{r_0} \quad (43)$$

which is the expression sought.

APPENDIX II

De la Sabloniere's Method of Deducing the Curve of Primary-Current Division from Curves of Current Division in the Presence of Secondary Emission.

The method of de la Sabloniere will be described here briefly. His method was originally developed for screen-grid tubes but is equally applicable to positive-grid triodes. It gives a means of determining the curves of the ratio of primary plate current to primary grid current against the ratio of plate to grid voltage from a family of curves of the ratio of plate to grid current, including secondary-emission currents.

The curves from which the deduction of the true primary distribution are made are taken as follows: Filament emission is first reduced to the point where the current is temperature-limited rather than space-charge-limited. The grid voltage is then set at some value and the ratio of plate to grid current is observed as a function of the ratio of plate to grid voltage by varying the plate voltage only. The grid voltage is then set at another positive value and another similar run is made. The two solid curves of Fig. 8 were made by this method.

Because of the various factors which have been held constant and relations between the various current components a number of relations exist which must be borne in mind. Before summarizing these relations the notation to be used must be indicated in detail. Let I_p and I_g be total plate and grid current, respectively, including secondaries. Let I_{p1} and I_{g1} be those parts of the plate and grid currents which are due to primary electrons, i.e., the primary plate and grid currents. Let I_{p2} and I_{g2} be the currents corresponding to all the secondary electrons which are knocked out of the plate and grid, respectively. This includes not only those secondary electrons which succeed in getting from one electrode to another but also those which are knocked out of one electrode and fall back into that same electrode. Let I_{gp} be that fraction of I_{g2} which does succeed in getting from grid to plate. Similarly, let I_{pg} be that fraction of I_{p2} which is able to get from plate to grid. Obviously if the plate is much more positive than the grid I_{gp} will be a large fraction of I_{g2} while I_{pg} will not exist as a component of I_{p2} because all of the secondary electrons knocked from the plate will be drawn back into the strongly positive plate.

Let $s = I_{gp}/I_{g1}$. The quantity s is a secondary-emission factor measuring the ratio of the number of secondary to primary electrons. Physical studies have shown that s depends only upon the velocity of the striking primary electrons for any given surface. Hence along any curve such as in Fig. 8 s will be constant since each curve is taken with a constant value of grid voltage.

Let $p = I_{p1}/I_{g1}$. This gives the division of primary current which from theoretical considerations is a function of the ratio of plate to grid voltage alone. Hence

for any particular value of E_p/E_g , p is a constant.

Let $d = I_p/I_g$. This is the ratio of plate to grid current including the secondary-emission effects. The curves of Fig. 8 are curves of d against E_p/E_g .

Let $t = I_{gp}/I_{g2}$. This is a kind of transmission factor for secondary electrons. It measures the fraction of secondaries liberated which succeeds in getting to the plate. Some secondary electrons from the grid have such a low velocity that they are unable to climb the small potential hill between the grid and the plate. De la Sabloniere has assumed that for any value of the abscissa E_p/E_g the value of t is constant. That is, for any value of E_p/E_g the same fraction of the secondary electrons knocked from the grid succeed in getting to the plate. This is perhaps the only assumption which is questionable. The matter is complicated by the velocity distribution of the secondary electrons which changes as the striking voltage of the primary electrons changes. For the assumption to be strictly true the velocity distribution curve of the secondary electrons must expand uniformly as the striking potential of the primary electrons increases. This is not strictly true, but for small ranges of primary-electron velocity is approximately so. In the curves of Fig. 8 the primary-electron velocities are 10 and 50 volts. It was not found possible to get a good check for velocities of 10 and 200 volts, this being too great a range of primary velocities.

It will be noted further that the space current for each of the experimentally determined curves is approximately constant.

$$\text{Consider the ratio } \frac{I_p}{I_g} = \frac{I_{p1} + I_{gp}}{I_{g1} - I_{gp}}. \quad (44)$$

Dividing both numerator and denominator by I_{g1} there results

$$\frac{I_p}{I_g} = \frac{I_{p1}/I_{g1} + I_{gp}/I_{g1}}{1 - I_{gp}/I_{g1}}. \quad (45)$$

$$\text{But } \frac{I_{gp}}{I_{g1}} = \frac{I_{gp}}{I_{g2}} \frac{I_{g2}}{I_{g1}} = ts \quad (46)$$

so that the above ratio of net currents can be written as

$$d = \frac{p + ts}{1 - ts}. \quad (47)$$

$$\text{Solving this for } ts = \frac{d - p}{d + 1}. \quad (48)$$

Let the various curves of d against E_p/E_g be numbered 1, 2, and so on as shown in Fig. 9. Let the various values of E_p/E_g have letters corresponding to them. Thus the abscissa of $E_p/E_g = 2$ might be lettered a , that of $E_p/E_g = 3$ might be lettered b , and so on. If we consider the four points formed by the intersection of the upper two curves of Fig. 9 and any two abscissa denoted by a and b , then it is possible to write four

equations of the form of that last given. These will be

$$t_{a s_1} = \frac{d_{a1} - p_a}{d + 1} \quad (49)$$

and

$$t_{a s_2} = \frac{d_{a2} - p_a}{d_{a2} + 1} \quad (50)$$

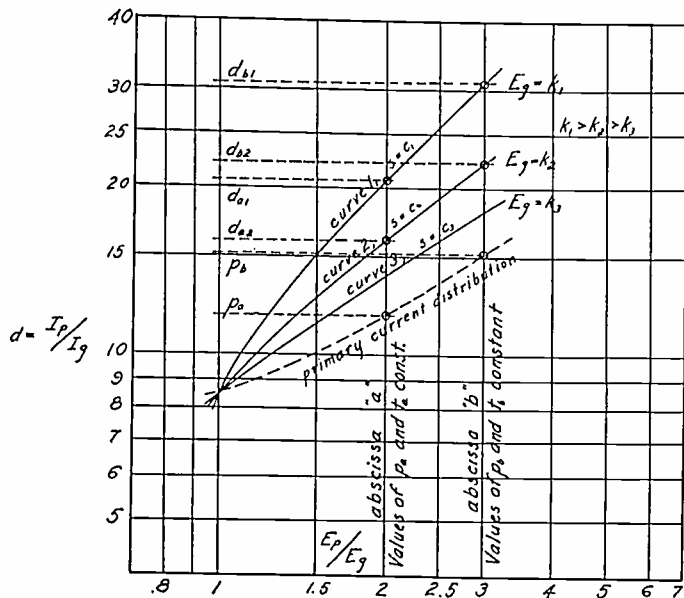

Fig. 9—Determination of primary-current distribution from current-division in the presence of secondary emission.

for the intersections of the curves 1 and 2 with the abscissa a and

$$t_{b s_1} = \frac{d_{b1} - p_b}{d_{b1} + 1} \quad (51)$$

$$t_{b s_2} = \frac{d_{b2} - p_b}{d_{b2} + 1} \quad (52)$$

for the other intersections. Since t and p are presumed constant for any particular value of E_p/E_g they are given only a lettered subscript. Since s is constant along any given curve it is given only a numbered subscript.

Dividing the two pairs of equations and equating them, gives

$$\frac{d_{a1} - p_a}{d_{a2} - p_a} = \frac{d_{b1} - p_b}{d_{b2} - p_b} \quad (53)$$

which is the relation which has been sought. This may be solved for p_b to give

$$p_b = \frac{d_{b1} - d_{b2} \left(\frac{d_{a1} - p_a}{d_{a2} - p_a} \right)}{1 - \left(\frac{d_{a1} - p_a}{d_{a2} - p_a} \right)} \quad (54)$$

From this last equation it may be seen that if one point on the true primary distribution curve p_a is known then points at any other abscissa b may be found from a pair of curves giving the net current division in the presence of secondary emission. The above treatment has been given for the case of E_p greater than E_g but a similar treatment can be applied when this is not so. In this particular instance the primary-current distribution which was taken as known was that corresponding to the condition of the grid being at its "natural potential" relative to the plate. For this case the electrons move in substantially parallel straight lines from filament to grid and plate and the ratio of plate to grid current is determined by the ratio of intergrid to grid area. For the 45 tube this ratio of currents is 14.3 when the ratio of voltages is 2.81.

Characteristics of the Ionosphere at Washington, D. C., March, 1940, with Predictions for June, 1940*

T. R. GILLILAND†, ASSOCIATE, I.R.E., S. S. KIRBY†, ASSOCIATE, I.R.E.,
AND N. SMITH†, NONMEMBER, I.R.E.

DATA on the ordinary-wave critical frequencies and virtual heights of the ionospheric layers during March are given in Fig. 1. Fig. 2 gives the monthly average values of the maximum usable frequencies for undisturbed days, for radio transmission by way of the regular layers. The F_2 and F layers ordinarily determined the maximum usable frequencies during the day and night, respectively, dur-

* Decimal classification: R113.61. Original manuscript received by the Institute, April 15, 1940. These reports have appeared monthly in the PROCEEDINGS starting in vol. 25, September, 1937. See also vol. 25, pp. 823-840; July, 1937. Publication approved by the Director of the National Bureau of Standards of the U. S. Department of Commerce.

† National Bureau of Standards, Washington, D. C.

ing ionospheric quiet periods. During ionospheric storms daytime maximum usable frequencies were often determined by the E and F_1 layers. Fig. 3 gives the distribution of hourly values of F and F_2 critical-frequency data about the undisturbed average for the month. Fig. 4 gives the expected values of the maximum usable frequencies for radio transmission by way of the regular layers, average for undisturbed days, for June, 1940.

Attention is called to the fact that Figs 1, 2, and 4 also implicitly give maximum ionization densities of the layers of the ionosphere. The equivalent electron density in electrons per cubic centimeter is 0.0124

times the square of the critical frequency in kilocycles. The critical frequency is shown directly in Fig. 1. It may be obtained from Figs. 2 and 4 by subtracting

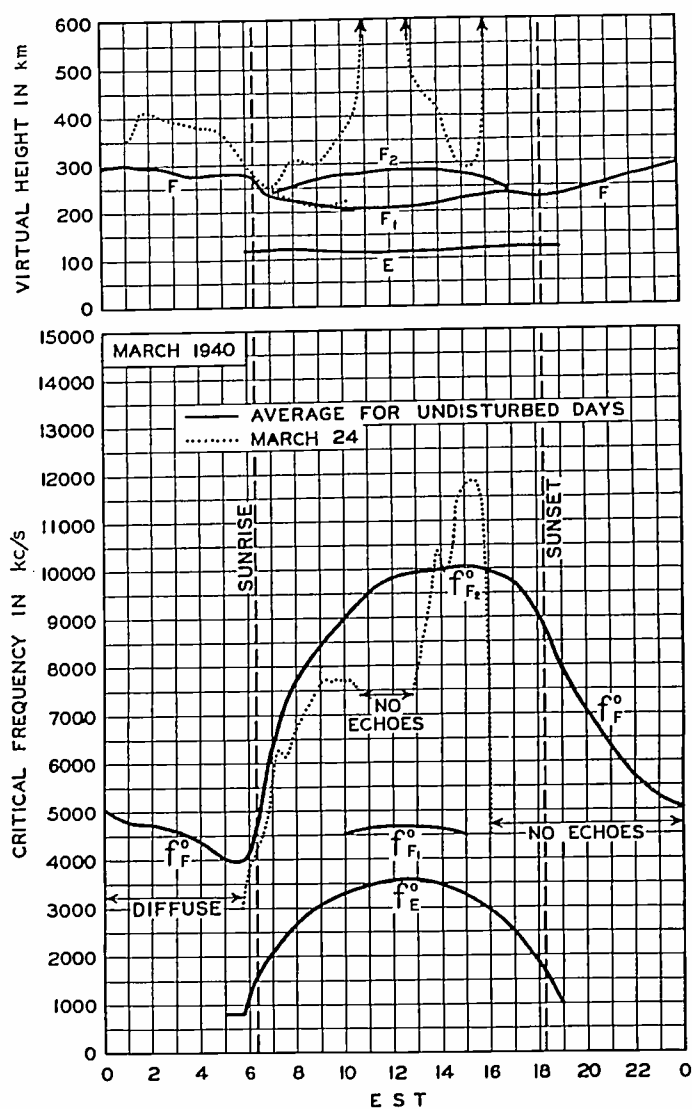

Fig. 1—Virtual heights and critical frequencies of the ionospheric layers, March, 1940. The solid-line graphs are the averages for the undisturbed days. The dotted-line graphs are for the ionospheric storm day of March 24.

TABLE I
IONOSPHERIC STORMS (APPROXIMATELY IN ORDER OF SEVERITY)

Day and hour E.S.T.	h _F before sunrise (km)	Minimum f _F before sunrise (kc)	Noon f _o F ₂ (kc)	Magnetic character ¹		Ionospheric character ²
				00-12 G.M.T.	12-24 G.M.T.	
March 23 (after 0100)	334	2500	11000	0.9	1.1	1.2
24	380	Diffuse	No reflections	1.1	2.0	2.0
25	No reflections	No reflections	5500	2.0	1.7	1.9
26	433	1600	8300	1.3	0.9	1.5
27	363	<1500	6400 at 1120 fade-out at 1200	1.1	0.8	1.1
28	338	3100	5700	0.8	0.5	1.4
29	316	3300	5600	0.5	2.0	1.7
30	No reflections	No reflections	4300 (f _{F1})	2.0	1.6	2.0
31	415	Diffuse	4300 (f _{F1})	1.8	1.8	2.0
19 (after 0700)	—	—	7700	0.5	0.9	0.7
20	332	3400	6400	0.9	0.8	1.0
21 (until 1300)	336	2700	8300	0.4	0.3	0.3
8 (after 2200)	—	—	—	0.2	0.6	0.2
9	330	4200	8000	0.9	0.2	0.7
10	312	3050	9200	0.1	0.0	0.5
11 (until 0600)	310	3800	—	0.0	0.0	0.3
For comparison: average for undisturbed days	289	4030	9830	0.1	0.1	0.0

¹ American magnetic character figure, based on observations of seven observatories.
² An estimate of the severity of the ionospheric storm at Washington on an arbitrary scale of 0 to 2, the character 2 representing the most severe disturbance.

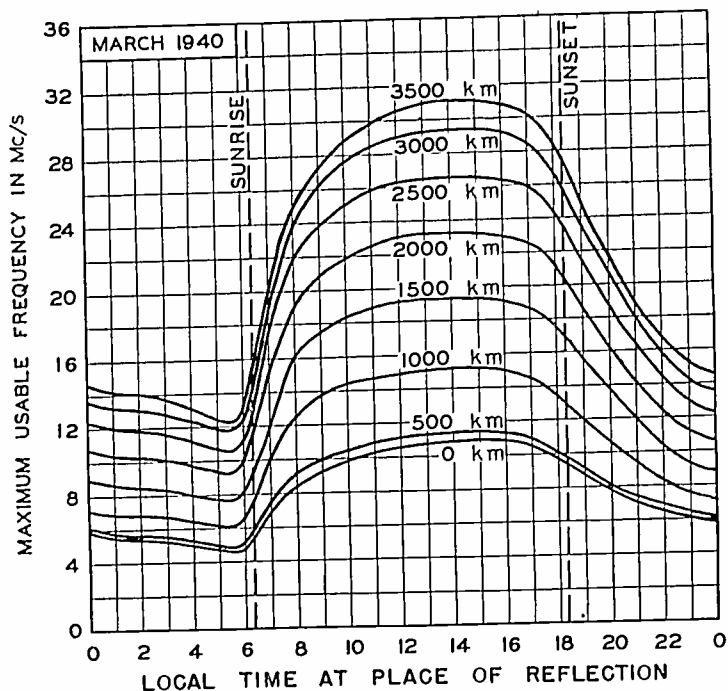

Fig. 2—Maximum usable frequencies for dependable radio transmission via the regular layers, average for undisturbed days for March, 1940. For information on use in practical radio transmission problems, see Letter Circular 575 obtainable from the National Bureau of Standards, Washington, D. C., on request.

800 kilocycles from the zero-distance maximum usable frequency.

Ionospheric storms and sudden ionospheric disturbances are listed in Tables I and II, respectively. Strong vertical-incidence sporadic-E reflections were observed above 8 megacycles on only four hours during the month, and above 6 megacycles on only five hours.

The sudden ionospheric disturbances of March 19, 27, and 29 were of great intensity and extended in time

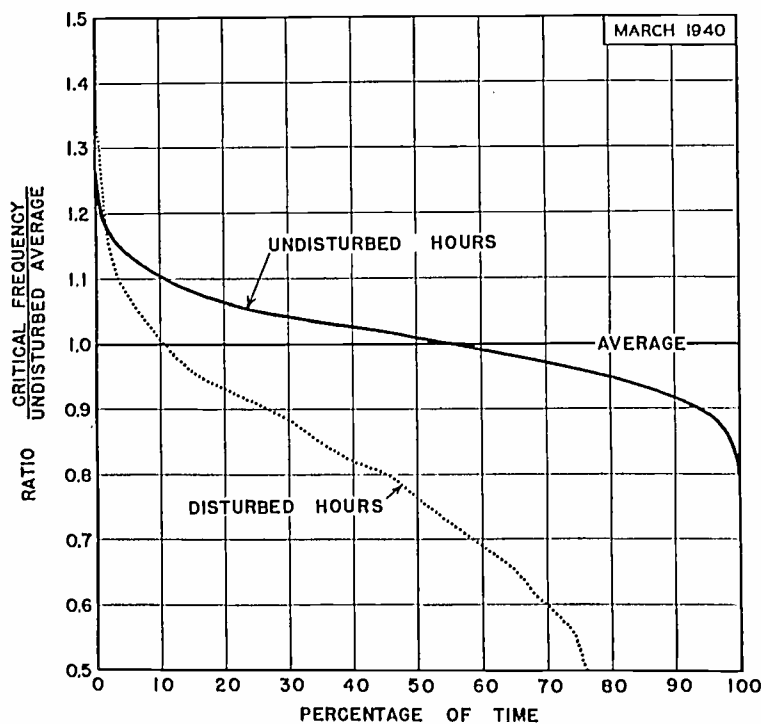

Fig. 3—Distribution of F- and F₂-layer ordinary-wave critical frequencies (and also approximately of maximum usable frequencies) about monthly average. Abscissas show percentages of time for which the ratio of the critical frequency to the undisturbed average exceeded the values given by the ordinates. The solid-line graph is for 399 undisturbed hours of observation; the dotted graph is for 269 disturbed hours of observation listed in Table I.

as indicated in Table II. The first of these occurred during a moderate ionospheric storm which was in progress from March 19 to 22. The others occurred during the series of severe ionospheric storms lasting from March 24 to 31. Attention is again called to the fact that, although the two phenomena occurred during the same general period of high sunspot activity, there was no well-defined period of approximately 26 hours from the occurrence of the intense sudden ionospheric disturbances to the beginning of the severe ionospheric storms as suggested by some writers. In one case, the severe storm of March 24 lagged the intense sudden disturbance of March 19 by five days.

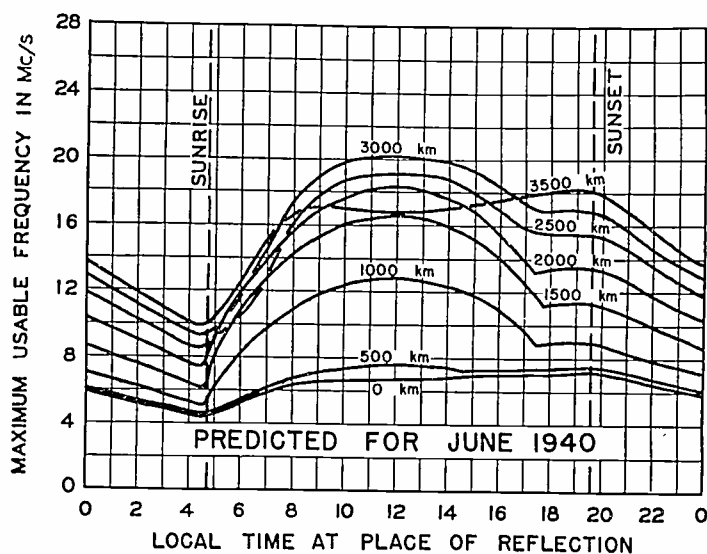

Fig. 4—Predicted maximum usable frequencies for dependable radio transmission via the regular layers, average for undisturbed days, for June, 1940. For information on use in practical radio transmission problems, see Letter Circular 575 obtainable from the National Bureau of Standards, Washington, D. C., on request.

The ionospheric storms from March 24 to 31 were among the most severe which have occurred since 1935 when the Bureau began making detailed reports of these phenomena. The March storms were comparable in intensity to those of January, 1938, the most severe previously observed. The storms, as usual, were marked by abnormally low critical frequencies, great virtual heights, high absorption, turbulence, and diffusion of the ionosphere especially in the F and F₂ layers. Radio sky-wave transmission was nonexistent or poor at all frequencies from the lower end of the broadcast band

up. During the most severe phases of the storms even static was scarcely propagated. This decrease of static occurred principally on the night of March 29–30 and to a smaller extent on March 24, 25, and 31. In the daytime the E and F₁ layers were present except during the most severely disturbed periods and supported some high-frequency transmission. High-frequency transmission returned to normal with the critical frequencies and virtual heights of the F and F₂ layers,

TABLE II
SUDDEN IONOSPHERIC DISTURBANCES

Day	G.M.T.		Locations of transmitters	Relative intensity ¹ at minimum	Other phenomena
	Begin-ning	End			
March 17	1602	1617	Ohio, Cuba, D. C.	0.1	Terr. mag. pulse 1600 to 1618 G.M.T.
19	1759	2020	Ohio, Cuba, Eng-land, D. C.	0.0	
21	1624	1657	Ohio	0.0	Terr. mag. pulse 1620 to 1730 G.M.T.
21	1927	1950	Ohio, D. C.	0.05	
22	1911	1933	Ohio, D. C.	0.01	
26	1738	1800	Ohio	0.0	
27	1610	2120	Ohio, D. C.	0.0	
29	1927	2050	Ohio, D. C.	0.0	
30	1329	1355	Ohio	0.0	

¹ Ratio of received field intensity during fade-out to average field intensity before and after; for station WLWO, 6060 kilocycles, 650 kilometers distant.

but the night sky wave at broadcast frequencies remained weak for several nights thereafter. Usually the storm periods were preceded by days of abnormally high F₂ critical frequencies. This phenomenon has been observed and reported by the Bureau on several previous occasions.^{1,2} The radiation producing the storm seems to increase the total ionization of the ionosphere not only in the layers but between layers. This permits violent currents to be set up which diffuse the ionization so that the ionization density of the layers is decreased and the stratification destroyed. The occurrence of intense sudden ionospheric disturbances, and abnormally high critical frequencies shortly before ionospheric storms suggests that both might be used along with sunspot turbulence to predict severe ionospheric storms.

¹ T. R. Gilliland, S. S. Kirby, and N. Smith, "Characteristics of the ionosphere at Washington, D. C., May, 1938," Proc. I.R.E., vol. 26, pp. 909–913; July, 1938.

² T. R. Gilliland, S. S. Kirby, and N. Smith, "Characteristics of the ionosphere at Washington, D. C., April, 1939," Proc. I.R.E., vol. 27, pp. 403–405; June, 1939.

Institute News and Radio Notes

FIFTEENTH ANNUAL CONVENTION

June 27, 28, and 29, 1940

Boston, Massachusetts

Our Fifteenth Annual Convention is scheduled for June 27, 28, and 29 at Boston and headquarters will be at the Hotel Statler. A full program has been prepared and because of the number of technical papers, it will be necessary to hold several duplicate sessions.

The American Institute of Electrical Engineers is holding its Summer Convention at the New Ocean House in Swampscott on June 24-28. On Tuesday, June 25, a morning session on electronic subjects will be held and in the afternoon there will be a conference

on communication networks. On Wednesday morning a group of communications papers will be read. For full details see the June issue of *Electrical Engineering*.

Those who are able to register on Wednesday will assist greatly by doing so and thus reduce the peak load which always occurs on the opening morning.

It is expected that only minor changes will be made in the program which follows. Eastern Daylight Saving Time, which is one hour later than Eastern Standard Time, is used throughout.

PROGRAM

Wednesday, June 26

7:30 P.M.—9:30 P.M.

Registration

8:00 P.M.—10:30 P.M., PARLOR C

Annual Meeting of the Sections Committee

Thursday, June 27

8:00 A.M.—6:00 P.M., MEZZANINE

Registration

9:30 A.M.—5:00 P.M., BALLROOM FOYER

Exhibition

10:00 A.M.—12:00 NOON, BALLROOM

Official welcome by L. C. F. Horle, President of the Institute.

GENERAL

1. "Marine Radiotelephone Design," by H. B. Martin, Radiomarine Corporation of America, New York, N. Y.
2. "50-Kilowatt Air-Cooled Broadcast Transmitter," by R. N. Harmon, Westinghouse Electric and Manufacturing Company, Baltimore, Md.
3. "RCA-NBC Orthacoustic Recording," by R. A. Lynn and B. F. Fredendall, National Broadcasting Company, New York, N. Y.
4. "Instrument Production," by E. H. Locke, General Radio Company, Cambridge, Mass.

1:00 P.M.—7:45 P.M.

Trip No. 1. Inspection trip to Hygrade Sylvania and United States Coast Guard Air Base at Salem.

1:15 P.M.—5:45 P.M.

Trip No. 2. Inspection trip to Harvard University and the General Radio Company.

1:30 P.M.—5:00 P.M.

Trip No. 3. Women's trip to the Isabella Stewart Gardner Museum.

1:45 P.M.—5:45 P.M.

Trip No. 4. Inspection trip to the new WBZ transmitter at Hall.

2:00 P.M.—5:45 P.M.

Trip No. 5. Sightseeing tour to Lexington and Concord.

6:00 P.M.—9:30 P.M.

Trip No. 6. Trip to the Massachusetts Institute of Technology at Cambridge.

8:00 P.M.—9:30 P.M. ROOM 10-250, HUNTINGTON HALL
MASSACHUSETTS INSTITUTE OF TECHNOLOGY
POPULAR LECTURE

5. "Microwaves—Present and Future," by a Massachusetts Institute of Technology Group, led by W. L. Barrow, Massachusetts Institute of Technology, Cambridge, Mass.

Friday, June 28

9:30 A.M.—3:00 P.M.

Trip No. 7. Women's Sightseeing tour of Cambridge, Lexington and Concord.

9:30 A.M.—5:00 P.M., BALLROOM FOYER

Exhibition

10:00 A.M.—5:00 P.M., MEZZANINE

Registration

10:00 A.M.—12:30 P.M., BALLROOM

VACUUM TUBES AND GENERAL

6. "Ultra-Short-Wave Transmission over a Fixed Optical Path," by C. R. Englund, A. B. Crawford, and W. W. Mumford, Bell Telephone Laboratories, Inc., New York, N. Y.

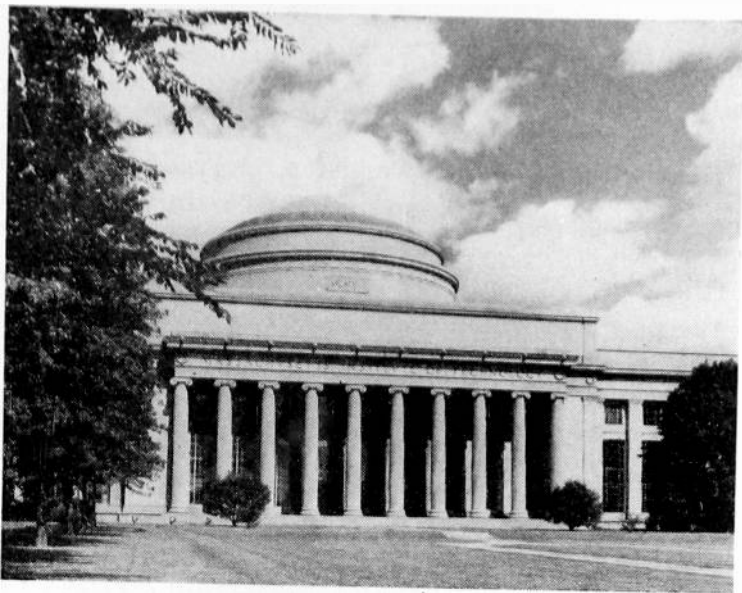

Massachusetts Institute of Technology, Cambridge

7. "Centimeter-Wave-Detector Measurements and Performance," by E. G. Linder and R. A. Braden, RCA Manufacturing Company, Inc., Camden, N. J.
8. "A New Ultra-High-Frequency Tetrode and its Use in a 1-Kilowatt Television Sound Transmitter," by A. K. Wing, Jr., and J. E. Young, RCA Manufacturing Company, Inc., Harrison, N. J., and Camden, N. J., respectively.
9. "Available High-Mutual-Conductance Tubes," by E. W. Schafer and E. R. Jervis, National Union Radio Corporation, Newark, N. J.
10. "An Ultra-High-Frequency Dosimeter-Diatherm," by J. D. Kraus and R. W. Teed, University of Michigan, Ann Arbor, Mich.
11. "Sparking of Oxide-Coated Cathodes in Mercury-Vapor-Filled Tubes," by J. W. McNall, Westinghouse Electric and Manufacturing Company, Bloomfield, N. J.

10:00 A.M.—12:30 P.M., GEORGIAN ROOM

MEASUREMENTS

12. "Recent Advances in the Design of Cathode-Ray Oscillographs," by P. S. Christaldi, Allen B. Du Mont Laboratories, Inc., Passaic, N. J.
13. "Oscilloscope Patterns of Damped Vibrations of Quartz Plates and Q Measurements with Damped-Wave Amplitudes," by H. A. Brown, University of Illinois, Urbana, Ill.
14. "A Method of Measuring the Magnetic Properties

of Small Samples of Transformer Laminations," by H. W. Lamson, General Radio Company, Cambridge, Mass.

15. "A Radio-Frequency Bridge for Measurements up to 30 Megacycles," by D. B. Sinclair, General Radio Company, Cambridge, Mass.
16. "The Measurement of Coil Reactance in the 100-Megacycle Region," by Ferdinand Hamburger, Jr., and C. F. Miller, Johns Hopkins University, Baltimore, Md.
17. "A New Electron Microscope," by L. Marton, M. C. Banca, and J. F. Bender, RCA Manufacturing Company, Inc., Camden, N. J.
18. "Stable Power Supplies for the Electron Microscope," by A. W. Vance, RCA Manufacturing Company, Inc., Camden, N. J.

2:00 P.M.—5:00 P.M., BALLROOM

AIRCRAFT RADIO

19. "Aircraft Antennas," by G. L. Haller, Aircraft Radio Laboratory, Wright Field, Dayton, Ohio.
20. "Rain and Snow Static," by H. K. Morgan, Transcontinental and Western Air, Inc., Kansas City, Mo.
21. "The Entrance of Ultra-High Frequencies into Air-Transport Communication," by J. G. Flynn, Jr., American Airlines, Inc., New York, N. Y.



Antiquarian House, Concord

Paul J. Weber

22. "Microwave Beams for Instrument Landing of Airplanes," by W. L. Barrow, Massachusetts Institute of Technology, Cambridge, Mass.
23. "A Microwave Receiver for Instrument Landing," by F. D. Lewis, Massachusetts Institute of Technology, Cambridge, Mass.
24. "Panoramic Reception," by Marcel Wallace, Panoramic Radio Corporation, New York, N. Y.
25. "Radio Navigation and the Omnidirectional Radio Range," by D. G. C. Luck, RCA Manufacturing Company, Inc., Camden, N. J.

2:00 P.M.—4:00 P.M., GEORGIAN ROOM

VACUUM TUBES

26. "Optimum Conditions for the Operation of a Class C Amplifier," by E. L. Chaffee, Harvard University, Cambridge, Mass.
27. "Power-Tube Performance as Influenced by Harmonic Voltage," by R. I. Sarbacher, Harvard University, Cambridge, Mass.
28. "High-Efficiency Frequency Doublers," by J. E. Shepherd, Harvard University, Cambridge, Mass.
29. "Space-Charge Relations in Triodes and the Characteristic Surface of Large Vacuum Tubes," by E. L. Chaffee, Harvard University, Cambridge, Mass.
30. "Equivalent Electrostatic Circuits for Vacuum Tubes," by W. G. Dow, University of Michigan, Ann Arbor, Mich.
31. "Water and Forced-Air Cooling of Vacuum Tubes with External Anodes," by I. E. Mouromtseff, Westinghouse Electric and Manufacturing Company, Bloomfield, N. J.
32. "Large Air-Cooled Tubes in 50-Kilowatt Transmitters," by I. E. Mouromtseff and W. G. Moran, Westinghouse Electric and Manufacturing Company, Bloomfield, N. J.



Arthur C. Haskell

Hartwell Farm, Lexington

4:00 P.M.—5:30 P.M., GEORGIAN ROOM

Informal discussion on "Power-Tube Operating Characteristics and Ratings," led by E. L. Chaffee, Harvard University, Cambridge, Mass.

6:30 P.M., BALLROOM

Fifteenth Annual Banquet. The Institute Medal of Honor and the Morris Liebmann Memorial Prize will be presented and newly elected Fellows will receive their certificates. Professor G. W. Pierce will be the Guest of Honor.

Saturday, June 29

9:30 A.M.—3:00 P.M., BALLROOM FOYER

Exhibition

9:45 A.M.—11:30 A.M.

Trip No. 8. Women's boat ride on the Charles River.

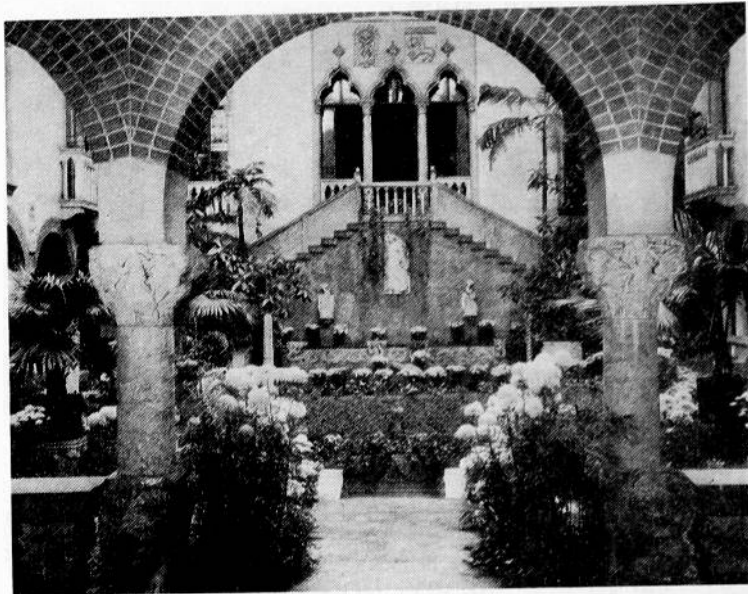

Flower Court of the Isabella Stewart Gardner Museum, The Fenway, Boston

10:00 A.M.—3:00 P.M., MEZZANINE

Registration

10:00 A.M.—12:30 P.M., BALLROOM

TELEVISION

33. "A Portable Television Transmitter," by C. D. Kentner, RCA Manufacturing Company, Inc., Camden, N. J.
34. "Small Iconoscopes of Recent Design," by W. H. Hickok, RCA Manufacturing Company, Inc., Harrison, N. J.
35. "A New Method of Synchronization for Television Systems," by T. T. Goldsmith, R. L. Campbell, and S. W. Stanton, Allen B. DuMont Laboratories, Inc., Passaic, N. J.
36. "Synchronizing and Deflection Circuits of a Television Receiver," by R. E. Moe, General Electric Company, Bridgeport, Conn.
37. "A Type of Light Valve for Television Reproduction," by J. S. Donal, Jr., and D. B. Langmuir, RCA Manufacturing Company, Inc., Harrison, N. J.
38. "Television Radio Relaying," by F. H. Kroger, Bertram Trevor, and J. E. Smith, RCA Communications, Inc., New York, N. Y.
39. "The Influence of Filter Shape-Factor on Single-Sideband Distortion," by J. C. Wilson and H. A. Wheeler, Hazeltine Service Corporation, Little Neck, L. I., N. Y.

40. "High Oscillator Stability without Crystals," by S. W. Seeley and E. I. Anderson, RCA License Laboratory, New York, N. Y.

1:45 P.M.—4:30 P.M., BALLROOM

FREQUENCY MODULATION

41. "Interference Between Stations in Frequency-Phase-Modulation Systems," by Dale Pollack, Cambridge, Mass.

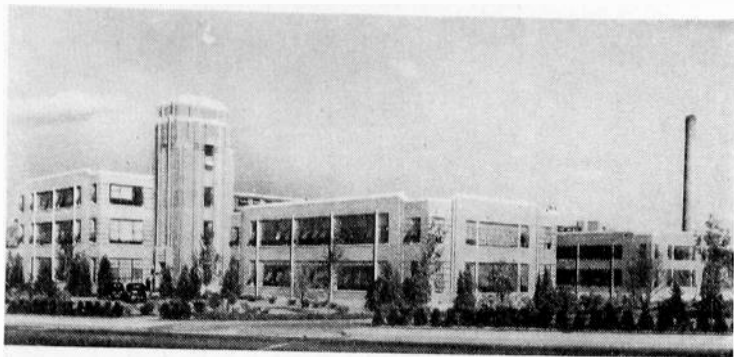

The Plant of Hygrade Sylvania Corporation, Salem

42. "Interference Between Two Frequency-Modulated Signals," by Stanford Goldman, General Electric Company, Bridgeport, Conn.
43. "A New Broadcast Transmitter Circuit Design for Frequency Modulation," by J. F. Morrison, Bell Telephone Laboratories, Inc., Whippany, N. J.
44. "Frequency-Modulation Systems Characteristics," by M. L. Levy, Stromberg-Carlson Telephone Manufacturing Company, Rochester, N. Y.
45. "National Broadcasting Company's Field Test of Frequency Modulation," by R. F. Guy and R. M. Morris, National Broadcasting Company, New York, N. Y.
46. "Demonstration of Frequency-Modulated-Wave Broadcast Systems," by E. H. Armstrong and P. A. de Mars, Columbia University, New York, N. Y., and The Yankee Network, Boston, Mass., respectively.

4:30 P.M.—9:30 P.M.

Trip No. 9. Inspection trip to the frequency-modulated-wave transmitter of the Yankee Network at Paxton.

GENERAL INFORMATION

The registration desk on the mezzanine floor will be open on Wednesday evening from 7:30 P.M. to 9:30 P.M. There will be no registration fee. The desk will be attended during the entire convention. There will be available at all times information concerning unique eating places in the Boston area, complete maps of Boston, and accurate registration information.

TRIPS

Transportation on all organized trips will be furnished by buses or taxicabs, without charge. Unless

otherwise noted, meals incidental to the trips will be served at prevailing prices. All buses departing from the Hotel Statler will leave from the Columbus Avenue entrance *promptly* at the times shown in the program.

Trips numbered 1, 2, 4, and 5 on Thursday afternoon are scheduled simultaneously and only one can be taken by an individual. The subjects of primary interest differ markedly and while many might like to go on more than one, time does not permit their being operated consecutively.

Trip 6 permits the women and any men who were unable to go on the other trips, which terminate at the Massachusetts Institute of Technology, to arrive there in time for supper, the inspection of the laboratories, and the popular lecture on ultra-high frequencies.

For each day of the convention, a trip has been arranged for the women and these are numbered 3, 7, and 8.

It is expected that both men and women will find the last feature of the convention, trip 9, of interest.

Detailed information on each trip is given in the following paragraphs. Any further information can be obtained at the registration desk.

Trip No. 1, Thursday, June 27

Hygrade Sylvania and United States Coast Guard Air Base

Starting from the hotel at 1:00 P.M. and terminating at the Massachusetts Institute of Technology at 7:45 P.M.

This trip is of both scenic and technical interest. Buses will convey the party to historical Salem, with visits to the Hygrade Sylvania tube-manufacturing plant and the United States Coast Guard Air Base. At the Air Base planes equipped with practically every type of radio aid to air navigation will be available for inspection. The return from Salem will be via Marblehead, where a seashore dinner will be served at the famous Adams House. The dining room is located on the water overlooking picturesque Marblehead Harbor. Buses will then take the party to Massachusetts Institute of Technology in Cambridge in time for the popular lecture at 8:00 P.M.

Trip No. 2, Thursday, June 27

Harvard University and the General Radio Company Starting from the hotel at 1:15 P.M. and terminating at the Massachusetts Institute of Technology at 5:45 P.M.

At Harvard University the following apparatus will be in operation and small groups will be conducted to each research project by guides: (1) Professor Pierce's apparatus for the generation and detection of super-sonic waves, (2) Professor Chaffee's equipment for obtaining the static and operating characteristics of power tubes, (3) Professor King's apparatus for making precision measurements at ultra-high frequencies, (4) Professor Hunt's and Mr. Pierce's equipment for

high-fidelity sound reproduction from disk recordings, (5) the 42-inch cyclotron employing 40-kilowatt demountable power tubes operating at 27 megacycles, (6) apparatus constructed under the direction of Mr. Pierce for the Harvard Ionosphere Eclipse Expedition soon to depart for Queenstown, South Africa, to observe the October, 1940, eclipse. Other researches in physics and communication engineering will be open for inspection.

At the General Radio Company organized small groups will be conducted through the laboratories and shop where a number of new instruments under development will be seen.

In the shop the groups will be conducted through the following departments: machine shop, parts assembly, mica-condenser manufacturing, precision condenser, instrument assembly, Variac winding, experimental shop, and calibration laboratory. After the formal tour, various engineers will be available to discuss individual instruments and their applications.

Trip No. 3, Thursday, June 27

Isabella Stewart Gardner Museum

Starting from the hotel at 1:30 P.M. and returning to the hotel at 5:00 P.M.

The ladies will be conducted in taxicabs leaving the Columbus Avenue entrance of the Hotel Statler at 1:30 P.M. sharp on a guided tour of the Isabella Stewart Gardner Museum in The Fenway, Boston. This Museum is one of the finest private collections of art in this country. Great paintings, tapestries, stained glass, enamels, and furnishings are displayed in the impressive setting of a building of Venetian style of architecture. At all seasons the flower-filled court is well worth seeing. The tour of the Museum will be made from 2:00 to 3:15 P.M. A musical program will be given at 3:15 in the Tapestry Room and tea will be served at 4:10 in the Dutch Room.

Trip No. 4, Thursday, June 27

WBZ

Starting from the hotel at 1:45 P.M. and terminating at the Massachusetts Institute of Technology at 5:45 P.M.

A guided tour to the transmitter site of the new 50-kilowatt broadcast station at Hull which is located on the Atlantic shore south of Boston. The return trip will terminate at the Massachusetts Institute of Technology at 5:45 P.M. in time for supper and the program which follows.

Trip No. 5, Thursday, June 27

Sightseeing Tour

Starting from the hotel at 2:00 P.M. and returning to the hotel at 6:00 P.M., or the Massachusetts Institute of Technology at 5:45 P.M.

This trip covers approximately fifty miles. The route to Concord is virtually that taken by Paul

Revere on the night of April 18, 1775. Guests will see the birthplace of American Liberty, the place where the shot "heard around the world" was fired; the homes of Longfellow, Lowell, Hawthorne, and Emerson will be seen. Stops will be made at the Agassiz Museum (glass flowers) at Harvard University, at the Lexington Battle Ground, at the Hancock-Clarke House, at the home of Louisa May Alcott, and at the Old North Bridge in Concord. This trip goes through Boston, Brookline, Cambridge, Arlington, Lexington, Lincoln, Concord, Weston, Kendall Green, and Waltham.

Trip No. 6, Thursday, June 27

Massachusetts Institute of Technology

Starting from the hotel at 6:00 P.M. and returning to the hotel at 10:00 P.M.

A sixty-cent supper will be served at the Walker Memorial dining hall of the Massachusetts Institute of Technology, at 6:00 P.M. After supper, guides will conduct small groups through the laboratories of the Electrical Engineering Department. Among these laboratories are: (1) high-frequency laboratories under Professor Bowles; (2) dielectric research under Professor Von Hippel; (3) sound-measurement laboratory under Professor Fay; (4) high-speed photography under Professor Edgerton; (5) the computing center under Professor Caldwell; (6) X-ray research under Professor Trump. Other Institute projects of interest to guests, such as the Van de Graaff high-voltage generator, the cyclotron, and the Wright wind tunnel, will also be open for inspection. The trip will be concluded before the start of the technical session on ultra-high frequencies.



Harold Orne

Yankee Network Transmitter Building, Paxton

Trip No. 7, Friday, June 28

Women's Sightseeing Tour

Starting from the hotel at 9:30 A.M. and returning to the hotel at 3:00 P.M.

Buses will take the ladies on a sightseeing trip to Cambridge, Lexington, and Concord. Luncheon will be served at Hartwell Farm at 1:30 P.M. Stops will be made at the Lexington Battle Green, Buckman Tavern, the Concord Antiquarian House, the North Bridge, and the Agassiz Museum in Cambridge. Other points of interest, such as Copley Square, the Massa-

achusetts Institute of Technology, Harvard University, and the homes of Longfellow and Lowell will be shown en route.

Trip No. 8, Saturday, June 29

Women's Boat Ride

Starts from the hotel at 9:45 A.M. and returns to the hotel at 11:30 A.M.

This trip is a boat ride on the Charles River. Taxis will leave the Hotel Statler at 9:45 A.M. for the boat landing. A one-and-one-quarter-hour sightseeing trip will be made. Taxis will return the guests to the hotel by 11:30 A.M.

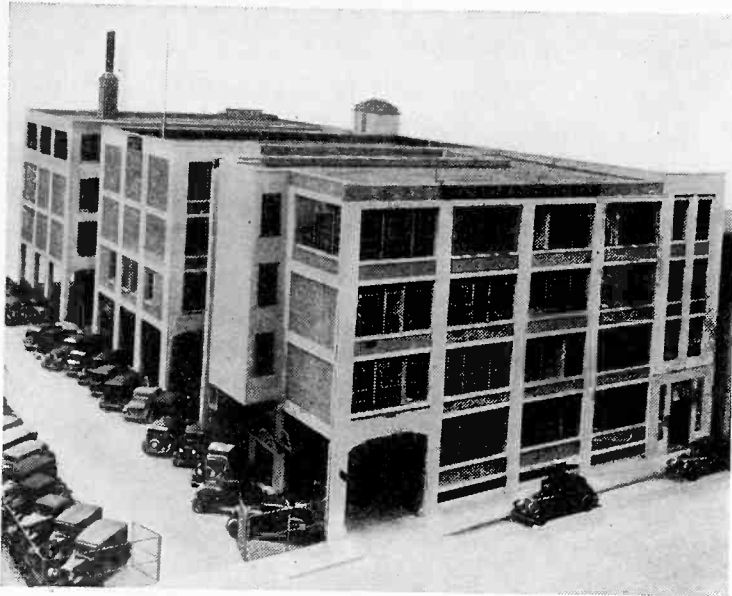

Laboratories and factory of the General Radio Company, Cambridge

Trip No. 9, Saturday, June 29

Frequency-Modulated-Wave Transmitter

Starts from the hotel at 4:30 P.M., or immediately following the final technical session, and returns to the hotel at 9:30 P.M.

Guests will be conveyed by bus to the new 50-kilowatt frequency-modulated-wave transmitter located at the top of Mount Asnebumskit at Paxton. Members of the technical staff of the Yankee Network will conduct the visitors through the station in small groups. This inspection trip is made possible through the courtesy of John Shepard, III, and the demonstration of frequency-modulated-wave reception and relay transmission will be staged by Technical Director Paul de Mars. Program material designed to illustrate the peculiar merit of frequency modulation will be arranged.

Arrangements have been made for serving a buffet supper at the transmitter. Guests driving to Paxton in their own cars will follow Route 9 from Boston to Worcester and Route 122 from Worcester to Paxton. Inquire at Paxton for directions to the transmitter. Paxton is about six miles beyond Worcester; the total distance from the Hotel Statler is about forty-six miles.

WOMEN'S PROGRAM

Boston offers so much of interest to women that the chief problem of the Committee was deciding what events would be most attractive. One trip has been scheduled for each day which leaves some time for special visits which can be arranged through the Women's Committee. Trips numbered 3, 7, and 8 have been prepared specifically for the women and they are invited also to the popular lecture and inspection trip to Massachusetts Institute of Technology on Thursday evening. While our women guests may not be interested in a frequency-modulated-wave transmitter, they will find the trip to Paxton on Saturday afternoon and evening most pleasant.

SECTIONS COMMITTEE ANNUAL MEETING

The annual meeting of the Sections Committee will be held on Wednesday evening preceding the opening of the convention. As trains from the more distant places generally reach Boston in the late afternoon and rapid train service is available from near-by cities, there should be little inconvenience to the representatives of Sections in attending the meeting. The program was considered to be too full to permit the meeting to be held during the convention days.

EXHIBITION

The exhibition of radio engineering equipment and materials will be immediately adjacent to the Ballroom. Booths will be in charge of men competent to discuss your engineering problems as they relate to the use of measuring equipment, component parts, and materials.

BANQUET

6:30 P.M., FRIDAY, June 28, BALLROOM

President Horle will be toastmaster at our Fifteenth Annual Banquet and will present the annual Institute awards to their recipients. The Medal of Honor will be given to Lloyd Espenschied for his accomplishments as an engineer, as an inventor, as a pioneer in the development of radiotelephony, and for his effective contributions to the progress of international radio coordination.

The Morris Liebmann Memorial Prize will be awarded to Harold A. Wheeler for his contribution to the analysis of wide-band high-frequency circuits particularly suitable for television.

For the first time in the history of the Institute, the Fellow grade of membership may be obtained only by invitation. On recommendation of the Awards Committee, the following eight Members have been elevated to Fellow grade by the Board of Directors and will receive certificates attesting thereto:

John A. Balch, Honolulu, T. H.
Lewis W. Chubb, East Pittsburgh, Pa.

Elmer W. Engstrom, Camden, N. J.
 Archibald J. Gill, London, England.
 Gilbert E. Gustafson, Chicago, Ill.
 Samuel S. Mackeown, Pasadena, Calif.
 Francis M. Ryan, New York, N. Y.
 William C. White, Schenectady, N. Y.

Our Guest of Honor will be Doctor G. W. Pierce, Professor Emeritus of Harvard University.

"Seeing the Unseen with Stroboscopic Light", in which art and electronics are brilliantly combined to produce unique effects, will be presented through the courtesy of Professor Harold E. Edgerton of Massachusetts Institute of Technology.

An opportunity will be presented for all camera enthusiasts to take startling "stop-motion" shots, with the aid of Professor Edgerton's speedlite equipment. Those who are interested in photography are urged to bring their cameras to the Banquet to take advantage of this unusual presentation.

As comfort is the keynote of the season, dress will be informal.

TECHNICAL PAPERS

The following summaries of the papers to be presented permit one to decide which papers will be of greatest interest. The summaries are given in alphabetical order by the names of the authors. Where there is more than one author, the first name determines the position of the summary. All papers are numbered in the order of their listing in the program and as the summaries also carry these numbers further cross-indexing is unnecessary.

SUMMARIES OF TECHNICAL PAPERS

46. DEMONSTRATION OF FREQUENCY-MODULATED-WAVE BROADCAST SYSTEMS

E. H. ARMSTRONG
 (Columbia University, New York, N. Y.)
 and P. A. DE MARS
 (The Yankee Network, Boston, Mass.)

Reception of the Yankee Network's 50,000-watt frequency-modulated-wave station W1XOJ at Paxton, Mass., will be demonstrated. Some programs of local origin and others from remote points relayed to Boston via frequency-modulated-wave stations will be included.

22. MICROWAVE BEAMS FOR INSTRUMENT LANDING OF AIRPLANES

W. L. BARROW
 (Massachusetts Institute of Technology, Cambridge, Mass.)

The system of instrument landing of airplanes developed at the Massachusetts Institute of Technology under the sponsorship of the Civil Aeronautics Authority employes microwave beams both for the pro-

duction of a straight-line landing path and for marker beacons along this path. This paper describes the radiation and propagation problems encountered in this development, including the following: Choice of polarization, wavelength, and power; design of electromagnetic horns; effect of earth on inclined beams; interference effects of overlapping beams. Theoretical work was followed by experimental tests, some with captive balloons. Flight tests verified the straightness and adequate range of the glide path. Flight tests on fantype marker beacons using horns demonstrated exceptionally sharp characteristics and indicated important applications.

13. OSCILLOSCOPE PATTERNS OF DAMPED VIBRATIONS OF QUARTZ PLATES AND Q MEASUREMENTS WITH DAMPED-WAVE AMPLITUDES

H. A. BROWN
 (University of Illinois, Urbana, Ill.)

This paper describes the manner in which the damped vibrations of a quartz plate, vibrating in a longitudinal mode, may be shown by a stationary pattern on the cathode-ray oscilloscope. This is accomplished by exciting the quartz plate as a resonator loosely coupled to an oscillator of variable frequency. A rotary commutator connected in shunt with the quartz-plate electrodes periodically short-circuits the plate through a low resistive or inductive path. During the short-circuit interval the mechanical vibrations in the quartz plate die out exponentially, producing currents in the short-circuit path which are also exponentially damped. The potential drop caused by these damped short-circuit currents is impressed upon the deflection plates of a standard cathode-ray oscilloscope, and the time-base deflection is easily adjusted to a point where a stationary pattern is obtained.

It has been found that the use of the oscilloscope connected across a resistance or reactance in series with the resonator-exciting circuit provides a very desirable means of indicating the frequency of series resonance in the quartz-plate equivalent circuit, the oscilloscope cathode-ray beam being very much more responsive and free from inertia limitations than is the deflecting needle of a milliammeter. When the frequency of the driving voltage differs slightly from the series-resonance frequency of the quartz the oscilloscope pattern, being of the solid light variety at ordinary time-base frequencies, has a serrated outline. This provides a very convenient indication that the exciting frequency is slightly out of resonance with the quartz.

The Q of the quartz plate may be obtained by measuring the amplitudes on the oscilloscope screen at two different points along the time axis, at which amplitude values a given number of cycles apart are

obtained. A simple formula is then developed for the value of the Q from the value of the two measured amplitudes and the number of cycles or time interval existing between the amplitudes being measured. A second method has been developed wherein a contactor attached to the commutator is arranged to give short-time impulses with the aid of a linear diode detector. The diode rectifies the high-frequency impulses obtained during the short-circuit interval and the rectified impulses are measured on the oscilloscope screen after passing through the voltage amplifier in the oscilloscope. The value of Q obtained for several typical quartz plates agrees in general with the values previously reported from direct measurements.

26. OPTIMUM CONDITIONS FOR THE OPERATION OF A CLASS C AMPLIFIER

E. L. CHAFFEE

(Harvard University, Cambridge, Mass.)

The operation of a class C amplifier at a prescribed direct plate potential depends upon the three following independent variables: direct grid potential E_c , alternating grid potential E_g , and alternating plate potential E_p . A method is described for obtaining the values of these three variables to give the greatest efficiency and power output P_b for any prescribed driving power P_d and any prescribed plate loss P_p . This optimum condition is expressed by the following equivalent relations:

$$\begin{aligned} \left(\frac{\partial P_b}{\partial E_c}\right)P_pP_b &= 0 && \text{maximum} \\ \left(\frac{\partial P_p}{\partial E_c}\right)P_bP_d &= 0 && \text{minimum} \\ \left(\frac{\partial P_d}{\partial E_c}\right)P_pP_b &= 0 && \text{minimum} \end{aligned}$$

Charts are presented enabling one to read off the optimum condition for any values of P_p and P_d .

29. SPACE-CHARGE RELATIONS IN TRIODES AND THE CHARACTERISTIC SURFACE OF LARGE VACUUM TUBES

E. L. CHAFFEE

(Harvard University, Cambridge, Mass.)

It is shown theoretically and experimentally that the plate, grid, and total currents, in the absence of secondary emission, vary as the $3/2$ power of the plate voltage along lines of constant $L = e_{p0}/e_{g0}$, where e_{p0} and e_{g0} are measured from a displaced origin. The three currents are then expressed in the form $i = Ae_p^{3/2}(1 + \mu L)^{3/2}F(L)$. The entire system of static curves for each current can be expressed by a single curve. A simplification in the experimental determination of the static curves is suggested, permitting the static curves to be plotted from a few measurements at low power. The effects of secondary emission are discussed and curves are given which aid in the design of tubes in which secondary emission from the plate is suppressed.

12. RECENT ADVANCES IN THE DESIGN OF CATHODE-RAY OSCILLOGRAPHS

P. S. CHRISTALDI

(Allen B. Du Mont Laboratories, Inc., Passaic, N. J.)

As more diversified uses are being found for cathode-ray oscillographs, the requirements of flexibility increase. Together with improvements in electrical design, improvements in mechanical design and convenience of operation are desirable.

A new general-purpose 5-inch cathode-ray oscillograph is described which embodies several new features of electrical and mechanical design. Low-frequency amplifier response and linear time-base generation have been improved, while the upper frequency limits of rating have been extended. Instantaneous positioning and improved stability add to ease of operation. A new functional front-panel design has been adopted.

37. A TYPE OF LIGHT VALVE FOR TELEVISION REPRODUCTION

J. S. DONAL, JR., AND D. B. LANGMUIR

(RCA Manufacturing Company, Inc., Harrison, N. J.)

Light control by means of modulation of a light source has been basic to most systems of television reproduction including the present RCA system using fluorescent materials. A light valve, a device whose light transmission can be varied by electrical means, would have obvious advantages. For television applications it would be desirable to have the area of the valve correspond to the picture which is to be transmitted. A thin layer of area several square centimeters is thus indicated and the potential gradient which varies the opacity should have the same direction as the light. The present paper describes a form of light valve consisting of a suspension of disk-shaped particles in an insulating liquid. When an electric field is applied the particles are oriented so as to present their minimum cross section and thus raise the transmission for light passing normally through the cell. The choice of suspended materials and suspending media is discussed.

For the cathode-ray control of a light valve of this type an electron beam, modulated by the picture signal, scans one surface of the valve, developing potentials corresponding to the light and shade of the picture. The other surface is maintained at a constant potential by a semitransparent conducting film deposited on it. The electric field produced is thus normal to the surfaces and parallel to the direction in which the light is projected through the valve and is proportional in intensity to the signal corresponding to each portion of the picture.

Methods are described whereby the surface of the valve may be charged to orient the suspended particles and subsequently discharged in preparation for the next scanning. The choice of these methods is influ-

enced by such considerations as the potential difference desired and the requirements as to optical efficiency.

30. EQUIVALENT ELECTROSTATIC CIRCUITS FOR VACUUM TUBES

W. G. DOW

(University of Michigan, Ann Arbor, Mich.)

A method of field analysis for conformal transformation is used to demonstrate that the electrostatic properties of a triode may be represented by three capacitances in star, whose magnitudes are related to tube geometry in simple fashion. The method is then extended to the construction of an equivalent electrostatic circuit for multigrid tubes.

It is shown how there can be derived from the electrostatic circuit (a) good approximations to the potential distribution in various parts of the tube and around these first approximations more accurate determinations of the local potential distribution; (b) a simple and rational expression of the dependence of cathode-current flow upon the various electrode potentials, for both parallel-plane and cylindrical geometry; (c) the ordinary interelectrode capacitances, as far as these are affected by the structure of the active portions of the electrodes.

The application of this general method to structures having nonregular geometry and to other problems of current and potential distribution is discussed.

6. ULTRA-SHORT-WAVE TRANSMISSION OVER A FIXED OPTICAL PATH

C. R. ENGLUND, A. B. CRAWFORD,
AND W. W. MUMFORD

(Bell Telephone Laboratories, Inc., New York, N. Y.)

Continuous records of ultra-short-wave transmission on wavelengths of 2 and 4 meters, over a good "optical" path, have shown variations in the received signal strength. These variations can be explained as being caused by wave interference; an interference which varies with the changes in the composition of the troposphere.

Some of the variations result from changes in the dielectric-constant gradient of the atmosphere near the earth. Other variations are explicable in terms of reflections from the discontinuities at the boundaries of different air masses. The diurnal and annual meteorological factors which affect the transmission are discussed.

21. THE ENTRANCE OF ULTRA-HIGH FREQUENCIES INTO AIR-TRANSPORT COMMUNICATION

J. G. FLYNN, JR.

(American Airlines, Inc., New York, N. Y.)

The discussion will cover the need for ultra-high-frequency communication in air transport as sufficient

medium-high-frequency channels are unavailable and the ultra-high-frequencies are less affected by atmospheric conditions. The design of equipment ordered by airlines will be considered and two-way ultra-high-frequency units and receivers for air navigation will be described. The choice of amplitude rather than frequency modulation will be discussed. Details will be given of aircraft and ground installations and the necessary modification of the present operating practices to accommodate ultra-high-frequency communication. A discussion of ultra-high-frequency air-navigation facilities being installed and the industry's need for further development of these lines will conclude the paper.

42. THE INTERFERENCE BETWEEN TWO FREQUENCY-MODULATED SIGNALS

STANFORD GOLDMAN

(General Electric Company, Bridgeport, Conn.)

A mathematical analysis of the above paper is presented together with formulas derived therefrom.

35. A NEW METHOD OF SYNCHRONIZATION FOR TELEVISION SYSTEMS

T. T. GOLDSMITH, R. L. CAMPBELL,
AND S. W. STANTON

(Allen B. Du Mont Laboratories, Inc., Passaic, N. J.)

Line- and frame-scanning frequencies in an all-electronic television system need not be frozen to a standard giving limited-definition performance if the synchronizing system is arranged so as to allow flexible operation. Automatic operation of receiver synchronizing circuits at variable line and frame frequencies is made possible with the aid of a new type of synchronizing wave form. Synchronizing standards which permit both flexible and automatic operation are discussed. Transmitter synchronizing apparatus for flexible synchronizing standards, receiver circuits for both non-automatic and automatic synchronizing operation are also discussed, and a "transition"-type receiver for operation on both old and new types of synchronizing signals is briefly described.

45. NBC FIELD TEST OF FREQUENCY MODULATION

R. F. GUY AND R. M. MORRIS

(National Broadcasting Company, New York, N. Y.)

In 1939 and 1940 the National Broadcasting Company conducted an engineering field test of frequency modulation, building for the purpose a 1-kilowatt transmitter, W2XWG, and four special receivers. The transmitter and receivers were specially built for either amplitude modulation or frequency modulation with various frequency swings. Comprehensive comparisons of the relative performance of these types of modulation were made at a number of receiving locations.

The paper describes the equipment, the measurements, and the field observations. By a series of figures

it shows the relative performance of the various types of modulation and analyzes the reasons for the differences. These differences result from the use of high-frequency pre-emphasis, the triangular noise spectrum of frequency modulation, and the deviation ratio, or index.

Considerable data will be shown on the frequency-modulation threshold. Measurements of fluctuation and impulse noise will be shown under a variety of conditions and data will also be presented covering the operation of two frequency-modulated-wave stations on the same channel and on adjacent channels. There will be a discussion of methods of calculating the advantage under various conditions of frequency modulation over amplitude modulation in the suppression of noise.

19. AIRCRAFT ANTENNAS

GEORGE L. HALLER

(War Department Aircraft Radio Laboratory, Dayton, Ohio)

This paper is a review of the general problem of aircraft antennas used for communication in the frequency range of 2 to 20 megacycles. Fixed antennas, shunt-fed wing antennas, and trailing-wire antennas are discussed and several typical curves of resistance and reactance are included. The icing problem is considered. The characteristics of several types of wire suitable for aircraft antenna are compared. Also included is a description of the army model-airplane set-up for measuring radiating characteristics of various types of antennas under flight conditions.

16. THE MEASUREMENT OF COIL REACTANCE IN THE 100-MEGACYCLE REGION

FERDINAND HAMBURGER, JR., AND C. F. MILLER

(Johns Hopkins University, Baltimore, Md.)

The paper describes apparatus and measuring technique which have been developed to permit more reliable measurement of reactance in the 100-megacycle region. Experimental data taken on single-layer solenoids indicate that the distributed capacitance is seriously reduced by skin effect and proximity effect. The results question the validity of the Palermo equation in the ultra-high-frequency region when large wire sizes are involved.

2. 50-KILOWATT AIR-COOLED BROADCAST TRANSMITTER

R. N. HARMON

(Westinghouse Electric and Manufacturing Company, Baltimore, Md.)

The paper describes a new 50-kilowatt air-cooled broadcast transmitter recently developed by Westinghouse. Advanced features include complete air-cooling of all tubes; automatic change-over of the power amplifier, modulator, and main rectifier to spare tubes;

all rectifiers except the main rectifiers are newly developed metal rectifiers. Circuit features include high-level plate modulation with class B modulation using inverse feedback, complete fuseless protection, and automatic or manual control with complete telltale supervisory control.

34. SMALL ICONOSCOPES OF RECENT DESIGN

W. H. HICKOK

(RCA Manufacturing Company, Inc., Harrison, N. J.)

The development of two new iconoscopes, the RCA-1847 and RCA-1848, is described. The first is a 2-inch inexpensive picture-pickup tube built primarily for the amateur. The tube is capable of giving a 120-line picture of adequate quality and utilizes relatively simple circuits for its operation. Shading and key-stoning circuits are eliminated. Unique constructional factors such as mosaic mounting and signal-output coupling are explained.

The RCA-1848 type iconoscope is designed for broadcast use in portable cameras. Its primary feature is reduced size, a 4½-inch face plate being used. A new type of gun whereby an electron image of a small rectangular aperture is focused upon the mosaic is used to improve the resolution of the image. The factors determining the physical arrangement of the tube component parts are briefly explained. Portability of equipment developed for this tube is compared to that of the equipment previously used for mobile applications.

33. A PORTABLE TELEVISION TRANSMITTER

C. D. KENTNER

(RCA Manufacturing Company, Inc., Camden, N. J.)

This paper describes a portable television transmitter capable of 25 watts peak (black level) power at a crystal-controlled frequency of 325 megacycles. A new triode and a new double-beam pentode are essential parts of the tube complement. The size and weight of the transmitter are consistent with the requirements imposed upon equipment to be used for remote program pickup.

The equipment handles the standard Radio Manufacturers Association television signal and has an overall frequency response which is essentially flat from 30 cycles to 7 megacycles. The design of transmission-line tank circuits is discussed and the modulation system, as well as the direct-current insertion circuits, are described.

A 2-inch cathode-ray tube is included in the transmitter unit which permits monitoring the signal at various points in the video-frequency system, as well as the rectified radio-frequency signal.

The paper concludes with a brief discussion of the various types of antennas which are suitable for use with this equipment.

10. AN ULTRA-HIGH-FREQUENCY DOSEMETER-DIATHERM

J. D. KRAUS AND R. W. TEED
(Ann Arbor, Mich.)

An ultra-high-frequency diathermy machine is described which provides a direct reading of the radio-frequency power, or dose, in watts received by the patient under treatment. The medical advantages of such dosage measurement are briefly outlined.

The patient is placed in the field of a pair of air-spaced electrodes and the problem of measuring the power absorbed by the patient only is analyzed from the engineering standpoint. The procedure used involved a measure of the "equivalent patient resistance." In making the initial calibration of the machine a calorimeter is substituted as the load in place of the patient. The advantages, limitations, and accuracy of the method are discussed. Tube, circuit, and radiation losses are also considered and the means used for minimizing the circuit and radiation losses are described.

38. TELEVISION RADIO RELAYING

F. H. KROGER, BERTRAM TREVOR,
AND J. E. SMITH
(R.C.A. Communications, Inc., New York, N. Y.)

This paper reviews development of a television radio relaying system by the laboratories of R.C.A. Communications, Inc. The development comprised setting up an experimental system by means of which television programs from the Empire State building in New York City were delivered to Riverhead, Long Island, through radio repeating stations near Hauppauge and Rocky Point. The repeating was done without demodulating and remodulating in the repeater equipment. Radio carrier frequencies between 450 and 500 megacycles were employed in the radio links. The carrier waves were modulated in frequency by the vision-modulating currents. The paper reviews some of the problems involved in designing television relaying networks for distributing programs to television broadcast stations and a discussion of means for solving these problems. As a result of the developments described it is now possible to provide networks by means of which television programs may be made available over much larger areas. Consequently television is now ready to provide a new national service.

14. A METHOD OF MEASURING THE MAGNETIC PROPERTIES OF SMALL SAMPLES OF TRANSFORMER LAMINATIONS

H. W. LAMSON
(General Radio Company, Cambridge, Mass.)

A special magnetic yoke utilizing small samples cut from ordinary transformer laminations is used in conjunction with a 60-cycle Maxwell bridge in which the magnetization H of the sample is directly proportional to the peak electromotive force applied to the bridge.

Thus, data for the permeability-versus-magnetization and the loss-versus-magnetization curves are obtainable. A convenient form of directional null detector is employed, consisting of a degenerative amplifier followed by a modulation rectifier bridge and a phase-shifting network. A current limiter gives the detector a pseudologarithmic character and eliminates the necessity of an adjustable shunt for the pointer galvanometer. If desired, a direct-current magnetization may be applied simultaneously to the sample. The sensitivity is sufficient to permit measurements with a magnetization of less than 1 millioersted, thus affording a close approach to initial permeability.

45. FREQUENCY-MODULATION-SYSTEMS CHARACTERISTICS

M. L. LEVY
(Stromberg-Carlson Telephone Manufacturing Company,
Rochester, N. Y.)

The paper will include discussion of measurements of four deviation systems with complete receivers developed for each deviation.

The various characteristics of the receiver will be discussed such as limiter, discriminator, harmonic distortion, frequency characteristic, and other characteristics necessary for the design of a frequency-modulated-wave receiver.

Adjacent-channel and common-channel measurements will be discussed with relation to deviation and necessary channel assignments to obtain the same interference on all systems.

23. A MICROWAVE RECEIVER FOR INSTRUMENT LANDING

F. D. LEWIS
(Massachusetts Institute of Technology, Cambridge, Mass.)

In work on a microwave instrument landing system carried out under the sponsorship of the Civil Aeronautics Authority it was necessary to develop suitable receiving equipment. In constructing 40-centimeter receivers for this application, it is essential to satisfy requirements with respect to stability, microphonics, and sensitivity. This paper describes a superheterodyne-type receiver which performs satisfactorily under flight conditions. Waves of this length call for unconventional circuits and circuit elements. The complete receiver has an estimated sensitivity of approximately 15 microvolts.

7. CENTIMETER-WAVE-DETECTOR MEASUREMENTS AND PERFORMANCE

E. G. LINDER AND R. A. BRADEN
(RCA Manufacturing Company, Inc., Camden, N. J.)

A special signal generator for operation in the frequency region from 3000 to 4000 megacycles will be described. Several special features will be discussed including methods of filtering and shielding, frequency

and power calibration, and the method of modulation. The construction and use of several types of wave-meters will be described. Measurements of centimeter-wave-detector characteristics, including sensitivity, resistance, and band width, will be presented. Detector data, in the frequency range 3000 to 4000 megacycles, will be given for diode, magnetron, crystal, and velocity-modulation detectors, which have been developed in this laboratory. The use of the signal generator for this work will be discussed.

4. INSTRUMENT PRODUCTION

E. H. LOCKE

(General Radio Company, Cambridge, Mass.)

This paper discusses the production methods of a company which manufactures measuring instruments covering a large number of individual catalog items over a wide price range. Starting with the preliminary drawings and specifications for a new instrument on which engineering design has been completed, the scheduling of orders through purchasing and manufacturing departments, inspection, final assembly, testing, and calibration are described. A brief explanation is given of the application of an incentive system to a large number of productive operations. Flexible inventory of raw materials, small parts, and finished instruments provide reservoirs on which to draw in busy times and to fill up in periods of declining sales, the final result being greater continuity of employment.

25. RADIO NAVIGATION AND THE OMNI-DIRECTIONAL RADIO RANGE

D. G. C. LUCK

(RCA Manufacturing Company, Inc., Camden, N. J.)

The problem of navigation and the means at hand for its solution are described. Some principles of radio direction finding are set forth and shown to lead to three main systems of use which are compared as to operating properties. The operation of a development of one system, giving direct omnidirectional bearing indications, is explained. Experimental omnidirectional range equipment is described. Finally, the actual use of the range in flight is explained and some results of flight tests of experimental omnidirectional ranges are presented as indicative of their present performance.

3. RCA-NBC ORTHACOUSTIC RECORDING

R. A. LYNN AND B. F. FREDENDALL

(National Broadcasting Company, New York, N. Y.)

An explanation is presented of the factors considered in "orthacoustic" operation as a standard for the recording and reproduction of lateral transcriptions. Several problems of reproduction are outlined pertaining to the differences obtained when using various reproducer heads and disk materials.

1. MARINE RADIOTELEPHONE DESIGN

H. B. MARTIN

(Radiomarine Corporation of America, New York, N. Y.)

The marine radiotelephone communication field is considered generally. The types of service which are required for both large and small vessels are discussed. An outline is given of the factors which affect the choice and design of equipment and some typical designs and general results obtained are shown.

17. A NEW ELECTRON MICROSCOPE

L. MARTON, M. C. BANCA, AND J. F. BENDER

(RCA Manufacturing Company, Inc., Camden, N. J.)

The paper describes the magnetic electron microscope which has been built in the Electronic Research Laboratory of the RCA Manufacturing Company. This instrument, which is useful in the fields of bacteriology, colloidal chemistry, and other industrial research, incorporates a number of new features as well as those previously described by one of the authors. A resolving power considerably better than 100 angstrom units has been shown in preliminary tests. The "stage" carrying the specimens can be moved vertically and horizontally independently of the alignment of the electron-optical system. It is introduced between the pole pieces of the objective coil in order to take full advantage of the improvement in performance obtained by having the specimen as close as possible to the objective lens. Provision is also made for cooling specimens, when necessary, with liquid air or other refrigerant. The object and photographic chambers are provided with air locks which do not require greased joints, thus facilitating the rapid changing of specimens and photographic plates.

5. MICROWAVES—PRESENT AND FUTURE

MASSACHUSETTS INSTITUTE OF TECHNOLOGY

GROUP LED BY W. L. BARROW

This will be a popular presentation, with demonstrations, of some of the latest apparatus and techniques for the generation, reception, and utilization of microwaves. Some of the diverse possibilities of this important field, as accelerated by recent developments from industrial and academic laboratories, will be discussed.

11. SPARKING OF OXIDE-COATED CATHODES IN MERCURY-VAPOR-FILLED TUBES

J. W. MCNALL

(Westinghouse Electric and Manufacturing Company, Bloomfield, N. J.)

A square-wave surge of current of short duration (0.02 second) was employed to eliminate heating of the cathode by the anode current. The voltage drop across the tube for the various magnitudes of tube current and at the critical state of cathode sparking

was obtained for cathodes of different quality, temperature, and area and for various pressures of mercury vapor. The tube-drop-versus-tube-current characteristic was found to be linear and had an appreciable positive slope. These slopes are definite indications of the relative qualities of cathodes. The tube drop and tube current at the critical condition of cathode sparking lie on a smooth curve of the form $I_s(E_s - a) = b$. This sparking curve was found to be independent of cathode temperature, quality, and area if I_s is in amperes per unit area of the cathode.

The results should make possible a better and more complete theory of the mechanism of cathode sparking.

36. SYNCHRONIZING AND DEFLECTION CIRCUITS OF A TELEVISION RECEIVER

R. E. MOE

(General Electric Company, Bridgeport, Conn.)

The synchronizing and deflection circuits of a commercial television receiver are described with schematic diagrams, design constants, wave shapes at important points, and performance under actual operation conditions.

The purpose of this paper is to present some recent developments in television receiver circuits applied to picture tubes using wide-angle deflection.

20. RAIN AND SNOW STATIC

H. K. MORGAN

(Transcontinental and Western Air, Inc., Kansas City, Mo.)

Precipitation static of all kinds and dust static have been investigated. Two methods of static reduction have been employed:

- (1) The shielded loop
- (2) The static-discharge wire

Transcontinental and Western Air first investigated the shielded loop in 1935 while United Air Lines conceived the static-discharge wire a few years later. Both methods are now employed on air transports. Tests which are discussed show the loop to be more effective at low frequencies and the discharge wire at high frequencies.

43. A NEW BROADCAST TRANSMITTER CIRCUIT DESIGN FOR FREQUENCY MODULATION

J. F. MORRISON

(Bell Telephone Laboratories, Inc., Whippany, N. J.)

The problem of generating wide-band frequency-modulated waves is first reviewed in order to ascertain specifically the desired performance capabilities for a commercial transmitter circuit. The factors which influence or limit these performance capabilities in the two methods available for the generation of frequency-modulated waves, compensated phase modulation, and direct frequency modulation, are then explored. It is found that each method possesses desirable funda-

mental characteristics not present in the other but with the circuits now generally employed with either method the modulation characteristics and carrier frequency stability are interrelated so that one has a limiting effect upon the other.

A new circuit is described in which these two important characteristics are independent of each other. Owing to this independence and to other circuit refinements the modulation capabilities are unrestricted with low distortion over an exceedingly wide range, so that critical circuit adjustments are not required to obtain consistently good modulation capabilities over the smaller range required in practice. The carrier frequency stability is that of the crystal-controlled oscillator and is independent of any other circuit variations. A carrier frequency stability of ± 0.0025 per cent is possible without the use of temperature-controlled crystals or apparatus.

31. WATER AND FORCED-AIR COOLING OF VACUUM TUBES WITH EXTERNAL ANODES

I. E. MOUROMTSEFF

(Westinghouse Electric and Manufacturing Company, Bloomfield, N. J.)

General laws of heat transfer from a hot wall to a moving fluid are applied to water and forced-air cooling of vacuum tubes. The calculated data are compared with experimental results. The practical importance of various factors constituting the mechanism of heat transfer is analyzed; the rôle of the internal structure of the tube on the dissipation limits is discussed generally. Rules for designing finned air coolers are outlined, and the "optimum" design is discussed. Numerical examples are given. Some limiting factors in cooler design are analyzed.

32. LARGE AIR-COOLED TUBES IN 50-KILOWATT TRANSMITTERS

I. E. MOUROMTSEFF AND W. G. MORAN

(Westinghouse Electric and Manufacturing Company, Bloomfield, N. J.)

Forced-air versus water cooling in application to large vacuum tubes is discussed. An air-cooler design for a tube with 20 to 30 kilowatts of anode dissipation is described; practical results are compared. Feasibility of a demountable model and also of the use of other than copper structures are discussed.

40. HIGH OSCILLATOR STABILITY WITHOUT CRYSTALS

S. W. SEELEY AND E. I. ANDERSON

(RCA License Laboratory, New York, N. Y.)

Heretofore, oscillator frequency stability of the order of 1 cycle per megacycle per degree centigrade has been considered possible only with a crystal oscillator. With components which are available today and proper

care in circuit design, such stability may be obtained in conventional oscillators. Means for obtaining these results will be discussed and the effects of various circuit components on oscillator stability will be demonstrated.

41. INTERFERENCE BETWEEN STATIONS IN FREQUENCY-PHASE-MODULATION SYSTEMS

DALE POLLACK
(Cambridge, Mass.)

Recently considerable discussion of the effects of interference between stations in frequency-modulation systems has taken place. In this paper the results of a study of these phenomena in both frequency modulation and in combination frequency-phase modulation such as employed in the Armstrong system are presented.

A simplified theory of the disturbance-reducing properties of frequency-phase modulation, applicable to the explanation of noise reduction as well as of interference between stations is given. This analysis is supplemented by a comprehensive mathematical analysis of the interference phenomenon.

The results of this analysis are compared with a group of measurements made on frequency- and frequency-phase-modulation systems and are contrasted with the interference which would be obtained in amplitude-modulation systems. Conclusions are drawn regarding the optimum deviation ratio so far as interference between stations is concerned. The paper concludes with a study of the allocation of stations in a system employing the new type of modulation.

27. POWER-TUBE PERFORMANCE AS INFLUENCED BY HARMONIC VOLTAGE

R. I. SARBACHER
(Harvard University, Cambridge, Mass.)

The effect of harmonic voltages on the operation of a power tube has been investigated. It was found that the second- or third-harmonic voltage introduced into the plate or grid circuit in the proper phase would aid in approaching "ideal" operation. Harmonics of higher order are found to be undesirable in general. An ideal path of operation for a power tube was determined and it was found that this ideal path may be obtained easily by the introduction of the third-harmonic voltage in the correct phase into the plate circuit. Various means for doing this have been devised and the power output and over-all efficiency of a tube, acting as a class C amplifier, have been increased. When the tube is used as a linear amplifier or plate- or grid-modulated amplifier the benefits derived from the interjection of the harmonic voltage are less pronounced and in some cases detrimental to proper operation. Dynamic characteristics have been obtained to show this effect.

A method has been developed by means of which it is possible to calculate the performance of a plate-modulated power amplifier with resistance bias. The results of this method show the locus of the quiescent point during the modulation cycle and explain theoretically the improved performance that is obtained.

9. AVAILABLE HIGH-MUTUAL-CONDUCTANCE TUBES

E. W. SCHAFER AND E. R. JERVIS
(National Union Radio Corporation, Newark, N. J.)

Television, frequency modulation, and untuned-radio-frequency-stage applications have placed new requirements on tube performance which have been met by the introduction of a number of new tube types.

The essential characteristics of the tube types now available for these applications (7A7, 6SK7GT, 6SK7, 7G7/1232, 6AC7/1852, 7H7, 6SD7GT, 6AB7/1853, 7L7, 6SE7GT, 6S6GT) are given under comparable operating conditions.

Factors in the choice of a tube for a particular application are pointed out.

28. HIGH-EFFICIENCY FREQUENCY DOUBLERS

J. E. SHEPHERD
(Harvard University, Cambridge, Mass.)

In the course of an investigation of the limitations on power output and efficiency of frequency doublers, the effects of altering the normal path of operation on the $e_p - e_g$ plane were studied. The results indicate that significant increases in power output and efficiency can be obtained by the introduction of small amounts of power of higher frequencies into the grid and plate circuits of the doubler stage.

15. A RADIO-FREQUENCY BRIDGE FOR MEASUREMENTS UP TO 30 MEGACYCLES

D. B. SINCLAIR
(General Radio Company, Cambridge, Mass.)

A radio-frequency bridge will be described that measures low impedances by a series-substitution method. Through the use of a new circuit, resistive components up to 1000 ohms can be measured directly in terms of a variable capacitance. An approximately logarithmic calibration on an 8-inch dial enables resistive components to be read to an accuracy of 1 per cent ± 0.1 ohm. The reading of this dial is independent of frequency. The reactance dial is calibrated directly in ohms at a frequency of 1 megacycle. At other frequencies the reactance scale must be divided by the frequency in megacycles. The design of a double-shielded transformer for use with the bridge will be described and the parameters causing residual errors will be discussed.

18. STABLE POWER SUPPLIES FOR THE ELECTRON MICROSCOPE

A. W. VANCE

(RCA Manufacturing Company, Inc., Camden, N. J.)

A description is given of the power supplies, developed in the Electronic Research Laboratory of the RCA Manufacturing Company, for the operation of electron microscopes. A high direct voltage (20 to 100 kilovolts) of exceptional constancy is obtained by applying an electronic regulator to a transformer and rectifier driven from the ordinary 60-cycle power line. Similar electronic regulators supply currents of great stability for operating the magnetic lenses of the microscope. Data are given showing the variation of voltage and current with time under ordinary power-line conditions. These supplies are so stable as to impose no limitations on the resolving power of the electron microscope.

24. PANORAMIC RECEPTION

MARCEL WALLACE

(Panoramic Radio Corporation, New York, N. Y.)

By panoramic reception is meant the simultaneous reception of all signals contained in a given band of the frequency spectrum in the form of individual visual deflections indicative of the frequency as well as the signal strength of each station.

Panoramic reception has several distinct advantages over ordinary, so-called "unisignal" reception, because it permits the observation and comparison of signals at different frequencies, originating from one or several stations and the observation of simultaneous variations of frequency and signal strength from one or several stations.

Important uses of panoramic reception are evident, not only in the navigational fields but also in innumerable applications in the laboratory for monitoring frequency bands, adjusting transmitters and receivers, especially television and frequency-modulated ones, and effecting various types of measurements.

The panoramic reception is obtained by periodically tuning a radio receiver through a band of frequencies of desired width at a rate which makes the individual signals appear on an oscillograph screen as flickerless, steady signals. A sweep voltage in synchronism with the frequency sweep is applied to one set of deflecting plates of the cathode-ray tube while the radio signals, preferably detected and amplified, are applied to the other set.

A tuning rate of at least 25 times per second is necessary but 60 cycles or more produce signals much more pleasant to observe, all trace of flicker being absent.

39. THE INFLUENCE OF FILTER SHAPE-FACTOR ON SINGLE-SIDEBAND DISTORTION

J. C. WILSON AND H. A. WHEELER

(Hazeltine Service Corporation, Little Neck, L. I., N. Y.)

The nature of the quadrature carrier distortion arising in radio transmission systems in which one sideband is totally or partially suppressed has been analyzed by Nyquist, Goldman, Urtel, and others. Quantitative relations between the shape of the attenuation characteristic for separating the sidebands in the region of the carrier and the shape of the resultant distortion envelope are given in the present paper; in particular, the effect of reducing the filter slope to zero at the carrier frequency is demonstrated. A simplified method of analysis of unsymmetrical-sideband problems, using a zero-frequency carrier, is utilized and the fundamental relations between distortion, band width, and filter slope are derived.

It is shown that the most favorable conditions in single-sideband transmission are approached when the filter slope in the region of the carrier frequency is zero. This, together with the fact that phase distortion is linked in real filters with a steep slope of attenuation, emphasizes the desirability of taking the 6-decibel attenuation not at the carrier frequency in the intermediate-frequency selectors but rather at zero frequency after the detector in television receivers.

8. A NEW ULTRA-HIGH-FREQUENCY TETRODE AND ITS USE IN A 1-KILOWATT TELEVISION SOUND TRANSMITTER

A. K. WING, JR., AND J. E. YOUNG

(RCA Manufacturing Company, Inc., Harrison, N. J., and Camden, N. J., respectively.)

A new tetrode suitable for use in the final stage of a 1-kilowatt ultra-high-frequency sound transmitter is described. Two of these tubes operated under plate-modulated conditions in such a transmitter will deliver 1 kilowatt of carrier output at 108 megacycles. Among the novel features of the design are the use of a metal header to provide a low-impedance screen-grid connection, beam-forming grids, and a forced-air-cooled anode. The new RCA type S-1 transmitter which uses these tubes is described and its performance reported.

Election Notice

Article VII, Section 1, of the Institute's Constitution is reprinted below as it contains all the information pertinent to the election of officers and directors. Following it will be found the names of the candidates nominated by the Board of Directors to be balloted on this year.

"On or before July first of each year, the Board of Directors shall submit to qualified voters a list of nominations containing at least one name each for the office of President and Vice President and at least six names for the office of elected Director and shall call for nominations by petition.

"Nominations by petition may be made by letter to the Board of Directors setting forth the name of the proposed candidate and the office for which it is desired he be nominated. For acceptance a letter of petition must reach the executive office before August fifteenth of any year and shall be signed by at least thirty-five voting members.

"Each proposed nominee shall be consulted and if he so requests his name shall be withdrawn. The names of proposed nominees who are not eligible under the Constitution shall be withdrawn by the Board.

"On or before September first, the Board of Directors shall submit to the voting members as of August fifteenth, a list of nominees for the offices of President, Vice President, and elected Director, the names of the nominees for each office being arranged in alphabetical order. The ballots shall carry a statement to the effect that the order of the names is alphabetical for convenience only and indicates no preference.

"Voting members shall vote for the candidates whose names appear on the list of nominees, by written ballots in plain sealed envelopes, enclosed within mailing envelopes marked "Ballot" and bearing the member's written signature. No ballots within unsigned outer envelopes shall be counted. No votes by proxy shall be counted. Only ballots arriving at the executive office prior to October twenty-fifth shall be counted. Ballots shall be checked, opened, and counted under the supervision of the Tellers Committee between October twenty-fifth and the first Wednesday in November. The result of the count shall be reported to the Board of Directors at its first meeting in November and the nominees for President and Vice President and the three nominees for Director receiving the greatest number of votes shall be declared elected. In the event of a tie vote the Board shall choose between the nominees involved."

For President—1941

W. R. G. Baker

For Vice President—1941

Adolfo T. Cosentino

For Directors—1941-1943

J. E. Brown	O. B. Hanson
E. T. Dickey	F. E. Terman
H. T. Friis	L. P. Wheeler

Membership

The following indicated admissions and transfers of memberships have been approved by the Admissions Committee. Objections to any of these should reach the Institute office by not later than June 29, 1940.

Transfer to Member

Arnaud, J. P., Guemes 827, Vte. Lopez, F.C.C.A., Argentina
 DeVore, H. B., RCA Manufacturing Company, Inc., Harrison, N. J.
 Haeff, A. V., RCA Manufacturing Company, Inc., Harrison, N. J.
 Kilgore, G. R., RCA Manufacturing Company, Inc., Harrison, N. J.
 Kimball, C. N., RCA License Laboratory, 711 Fifth Ave., New York, N. Y.
 Langmuir, D. B., RCA Manufacturing Company, Inc., Harrison, N. J.
 Law, R. R., RCA Manufacturing Company, Inc., Harrison, N. J.
 McIlwain, K., 200 S. 33rd St., Philadelphia, Pa.
 Rose, A., RCA Manufacturing Company, Inc., Harrison, N. J.
 Wagner, H. M., RCA Manufacturing Company, Inc., Harrison, N. J.

Admission to Member

Aceves, J. G., 529 W. 179th St., New York, N. Y.

Admission to Associate (A), Junior (J), and Student (S)

Bamford, H. S., (A) c/o Farnsworth Television & Radio Corp., Fort Wayne, Ind.
 Bauer, E. J., (S) 7814 S. Ada St., Chicago, Ill.
 Benzon, F. A., (A) Portage, Wash.
 Bhakat, B. P., (A) Colonelgola, Midnapore, Bengal, India
 Bonner, H. W., (A) 480 Harvard St., Palo Alto, Calif.
 Boyll, L. O., (A) 2807 Prairie Ave., Chicago, Ill.
 Breunich, C. B., (A) Box 272, Netcong, N. J.
 Britto, C. S., (A) 11 Paul St., Boston, Mass.
 Brown, R. K., (S) 405 Forest Ave., Ann Arbor, Mich.
 Capen, H. N., (A) Salem Y.M.C.A., Salem, Mass.
 Casian, W. R., (A) R.C.A. Victor Company, Ltd., 976 Lacasse St., Montreal, Que., Canada
 Chambers, G. W., (A) Ninth Bombardment Squadron, Hamilton Field, Calif.
 Clark, W. J., (S) 7117 Dobson Ave., Chicago, Ill.
 Cook, W. N., (A) Radio Station WCAR, Pontiac, Mich.
 Dalman, C., (S) 72 Barrow St., New York, N. Y.
 Daly, H. H., (A) 1121 Hebert St., St. Louis, Mo.
 Damle, G. S., (A) c/o M. N. Shintre, 4 Bhikoba Nivas, Gokhale Rd., Dadar, Bombay 14, India

D'Orio, P. A., (A) 1257 W. Fullerton Ave., Chicago, Ill.
 Edgerton, A. K., (A) 203 N. White, Compton, Calif.
 Foss, A. C., Jr., (S) 401 Wyckoff Ave., Ramsey, N. J.
 Fox, A. G., (A) Bell Telephone Laboratories, Box 107, Red Bank, N. J.
 Gamara, N. J., (A) 407 W. South St., Angola, Ind.
 Gammell, H. C., (A) c/o Department of Highways, Olympia, Wash.
 Gibbons, H. D., (A) Box 182, Horse Cave, Ky.
 Godfrey, B., (A) University of Portland, Portland, Ore.
 Godfrey, E., (A) 15 N. Iroquois Ave., Margate City, N. J.
 Gray, D. A., (A) Janefield 82 Renfrew Rd., Paisley, Renfrewshire, Scotland
 Gray, D. H., (J) Macdonald College, Quebec Province, Canada
 Haubrock, F. W., (S) 2633 Regent St., Berkeley, Calif.
 Heck, D., (S) 18 Avon Rd., Berkeley, Calif.
 Hierath, D. C., (A) 305 West St., Mamaroneck, N. Y.
 Hinton, W. R., (A) "Fidra" Huggetts Lane, Lower Willingdon, Sussex, England
 Housel, F. H., (S) 343 Washington Ter., Audubon, N. J.
 Hughes, E. J., (A) 14209 Prevost Ave., Detroit, Mich.
 Johnson, J. F., (A) 4316 Whitman Ave., Seattle, Wash.
 Johnson, L. R., (A) 32 Sixth Ave., Rm. 2712, New York, N. Y.
 Johnson, P. V., (J) 257 S. Locust St., Valparaiso, Ind.
 Kapileshwar, R., (A) c/o Irwin Hospital, Jamnagar, India
 Keith, E. G., (S) 130 E. Thach Ave., Auburn, Ala.
 Lacy, P. D., (S) c/o WRUF, Gainesville, Fla.
 Larinoff, M., (S) 15266 Walton Ave., Harvey, Ill.
 Longfellow, R. C., (A) 1802 Hamburg St., Schenectady, N. Y.
 Mahler, A. E., (A) Box 34 Woolsey Station, Astoria, L. I., N. Y.
 McCloud, W. W., (S) Rose Polytechnic Institute, Terre Haute, Ind.
 McKinley, R., Jr., (J) 214 Riverside Dr., New York, N. Y.
 McKnight, W., (S) WREN Broadcasting Company, Lawrence, Kan.
 Moran, W. M., (A) Second Signal Service Company, Corozal, Canal Zone
 Moulder, J. W., (S) 8811 Lumpkin St., Hamtramck, Mich.
 Mower, N. L., (A) 928 Avenel Ave., Roanoke, Va.
 Murphy, E. J., (A) 164 Argyle Rd., Brooklyn, N. Y.
 Nazareth, J. A., (A) c/o The Eastern Telegraph Company, Ltd., Aden, Arabia
 Newborg, D. S., (S) Box 1680, Georgia School of Technology, Atlanta, Ga.
 Nunan, C. S., (S) 2627 Ridge Rd., Berkeley, Calif.
 Nygren, A., (A) Radio Station WFIL, Philadelphia, Pa.
 Ogle, H. M., (S) 3012 St. Paul St., Baltimore, Md.

- Overmire, M. O., (A) 3020—28th, W., Seattle, Wash.
- Paradise, L. P., (S) 2444 DeVoc Ter., New York, N. Y.
- Paul, I., (S) 1649 53rd St., Brooklyn, N. Y.
- Quitter, J. P., (S) 3241 Jefferson Ave., Cincinnati, Ohio
- Rarer, E. B., (A) U.S.A.C.S., Box 624, Phoenix, Ariz.
- Ratcliffe, F. L., (A) Radio Station, Newfoundland Airport, Newfoundland
- Rayner, H. C., (A) Forrest, Manit., Canada
- Rousku, A. W., (S) 816 43rd St., Brooklyn, N. Y.
- Schelkunoff, S. A., (A) Bell Telephone Laboratories, 463 West St., New York, N. Y.
- Schneider, A. E., (S) 538 Rutherford Ave., Lyndhurst, N. J.
- Smith, D. P., (S) 272 Hoosick St., Troy, N. Y.
- Smith, D. R., (A) 31 W. Second St., Emporium, Pa.
- Stahl, B. H., (A) Box 44 Woolsey Station, Astoria, L. I., N. Y.
- Starr, E. W., (A) Cooper Union, New York, N. Y.
- Stephenson, G. E., (S) 59 Roosevelt Ave., Roosevelt, L. I., N. Y.
- Stevinson, H. T., (S) 11023 84th Ave., Edmonton, Alta., Canada
- Strain, M., (S) Colfax, Ind.
- Tiffany, W. D., (S) 2755 Franklin St., San Francisco, Calif.
- Ukai, S., (A) 1508 4-Chome, Nakameguro, Tokyo, Japan
- Ulrich, C. W., (A) 836 Exchange Ave., Chicago, Ill.
- Van Groos, J. C., (A) 837 Sanborn Ave., Los Angeles, Calif.
- Walford, F. R., (A) 15 Allison Rd., Elskrnwick S. 4, Victoria, Australia
- Whitaker, J., (A) 734 S. Storey, Dallas, Tex.
- Woodward, J. E., (S) Box 500, Clemson, S. C.

viding means to bring radiovision into the American home.

Donald G. Fink, author and editor, has again produced for the communication field a concise, clearly written volume of basic principles, brought together and arranged in a most satisfactory manner. His engineering education, television work, and position in the field of electronics, fit him to write with authority those things his readers *want* to know, and omit the obsolete, the irrelevant.

The reader comes face to face with a modern television system in the first chapter. The chapters cover Image Analysis, Camera Action, Scanning Beams and Their Control, The Video Signal and Its Amplification, Carrier Transmission of Video Signals, Image Reproduction, Television Broadcasting Practice, and Receiver Practice.

The method of presenting these subjects to the engineering reader is to explain the fundamentals and applications, using mathematics where helpful, showing actual circuits, giving design data in many cases, and listing references in footnotes. The sources of information the author draws upon are practical, up-to-the-minute, authoritative, and possess the advantage of not being limited to any one commercial laboratory or group.

While in future editions I should like to see more about such items as performance of receivers in the home, problems arising in antenna installations, actual field-strength-survey data, and the like, the book is unusually complete. It includes, for instance, the problem of side-band suppression at the transmitter, types and sizes of commercial picture tubes, and actual wiring diagrams of modern commercial receivers.

I heartily recommended "Principles of Television Engineering."

ALBERT F. MURRAY
Haddonfield, N.J.

Production and Direction of Radio Programs, by John S. Carlile.

Published by Prentice-Hall, Inc., 70 Fifth Ave., New York N. Y. 397 pages, 51 illustrations. Price, \$3.75. $6\frac{1}{4} \times 9\frac{1}{4}$ inches.

The author of this book is production manager of one of the large broadcast networks in the United States. He has brought together in this book a quantity of material relating to broadcast program production and the operation of broadcast studios which will be of real interest to radio engineers who have not had occasion personally to live in close contact with that part of the radio industry.

Nearly two thirds of the book is devoted to what may be called studio matters. Details of studio arrangement are discussed and different plans to meet various types of programs and groups of performers are presented in diagrammatic form. Both musical programs and dramatic productions are thus dealt with. Sound effects and a variety of methods for producing them are the subject of a chapter and a portion of the appendix. Another portion of the appendix consists of 25 pictures illustrating the sign language employed for communication between a studio and an adjoining control room.

One of the chapters is entitled "The Announcer." It seems somewhat inadequate, however, as a portrayal of the function which is of such great significance to the listener.

It is perhaps natural for very technical language to be used in a book of this kind. A glossary appearing in the appendix helps, however, to explain the meaning of words which to the layman sound like "studio slang." It would certainly be difficult without its help to know the sense in which such terms as "clam bake" and "west of Denver" are used in this field.

Almost every radio engineer, whether engaged directly in broadcasting or not, has been called on at one time or another by some one who wanted assistance in putting on a radio program. For example, the manager of a drive for funds for a hospital turns to a "radioman" for advice as to the use of broadcasting as a method of appeal. This book, particularly the chapter entitled "The Layman Speaks," gives many suggestions which are adaptable to such a situation. The book makes it clear that good technical performance is not in itself sufficient to make a program effective. In the last analysis the one who is responsible for accomplishing the program's objective must be a showman and one cannot read this book without having a fuller appreciation of the value of the service of an experienced radio production director.

The possible usefulness of this book to college students who are interested in radio problems is indicated by a section of the appendix which consists of questions and suggested study projects. The book contains also a bibliography and a list of about 40 schools and industrial organizations in the United States which carry on research in acoustics.

The book deals with audio, not video, broadcasting. Television is referred to in the last pages of the closing chapter.

L. E. WHITTEMORE
American Telephone and Telegraph Co.
New York, N.Y.

Books

Principles of Television Engineering, by Donald G. Fink.

McGraw-Hill Book Company Inc., 330 West 42nd St., New York, N. Y. First edition. 313 figures, 521 pages+19-page index. Price \$5.00. $6\frac{1}{4} \times 9\frac{1}{4}$ inches.

For radio and television engineers "Principles of Television Engineering" is one of the most worth-while books available. It is written for those radio engineers who, before very long, will find resting on their shoulders the responsibility of pro-

Contributors

Hans Erich Hollmann (A'39) was born on November 4, 1899, at Solingen, Germany. In 1917 he passed the examination at the Humanistic High School at Solingen. From 1918 to 1920 he served in the army. Dr. Hollmann began the study of electro-technics at the Technische Hochschule of Darmstadt in 1920 and received the degree of doctor in 1928. From 1924 to 1926 he was a laboratory engineer at the Darm-

trical engineering from the University of Kansas in 1921, the M.A. degree from Columbia University in 1924, and the Ph.D. degree in 1928 from Columbia. He has been a member of the Research Department of the Bell Telephone Laboratories since 1921. His work has been mainly with wave propagation networks, both electrical and mechanical, and with piezoelectric crystals. Dr. Mason is now

1937 he has been in charge of physical research work with Scophony, Limited, in London. Dr. Rosenthal is a Fellow of the Royal Astronomical Society.



Karl Spangenberg (A'34) was born at Cleveland, Ohio, on April 9, 1910. He received the B.S. degree in electrical engineering in 1932 and the M.S. degree in

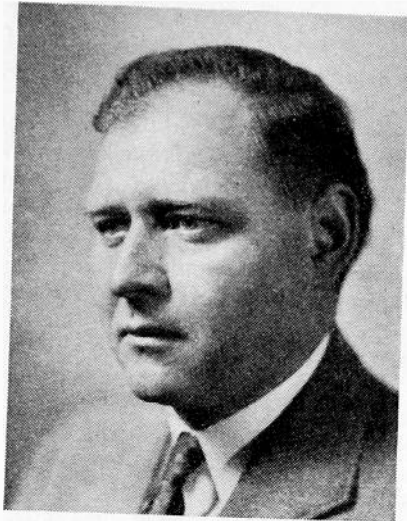

WARREN P. MASON

stadt Radio Works. He continued his investigations on microwaves at the Physikalischen Institut of the Technische Hochschule of Darmstadt as a scholar for the Notgemeinschaft der Deutschen Wissenschaft, transferring in 1930 to the Heinrich-Hertz Institut für Schwingungsforschung in Berlin. In 1932 Dr. Hollmann became assistant in the high-frequency department; since Easter of 1932 he has been scientific assistant at Telefunken Gesellschaft.



Warren P. Mason (A'36) was born in Colorado Springs, Colo., on September 28, 1900. He received the B.S. degree in elec-



A. H. ROSENTHAL

head of the department investigating piezoelectric crystals. He is a member of the Physical Society and a Fellow of the Acoustical Society.



A. H. Rosenthal (A'40) was born on March 10, 1906, at Frankfurt/Main, Germany. In 1929 he received the Ph.D. degree in physics from the University of Frankfurt/Main. Dr. Rosenthal did research work on various spectroscopic and heliophysical problems at scientific institutions in Frankfurt/Main, Potsdam, and Utrecht, Holland. He was chief optical designer of the Ilex Optical Company in Rochester from 1936 to 1937 and since



KARL SPANGENBERG

1933 from the Case School of Applied Science, and the Ph.D. degree in 1937 from Ohio State University. In 1934 he was a radio engineer at WHK, and during 1935 and 1936 he was an instructor in electrical engineering at Rose Polytechnic Institute. Since 1937 Dr. Spangenberg has been an instructor in electrical engineering at Stanford University. He is a member of Sigma Xi and the American Institute of Electrical Engineers.



For biographical sketches of T. R. Gilliland, S. S. Kirby, and N. Smith see the PROCEEDINGS for January, 1940; for Ronold King, February, 1940.

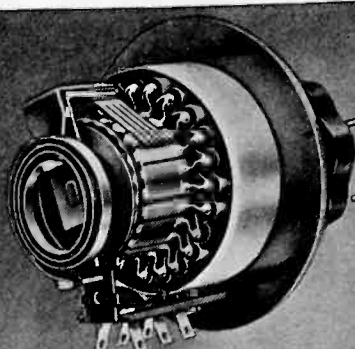

ATTENUATORS
2 sizes, 20- and 30-steps.



INSULATED METALLIZED
Also Type BW Wire Wound Insulated, 1/2-, 1- and 2-Watts.



HIGH VOLTAGE
Metallized type, 5 sizes.
TYPE MVQ
50000 VOLTS 50WATTS
3000 MEGS



PRECISION WIRE WOUND RESISTORS
12 sizes.

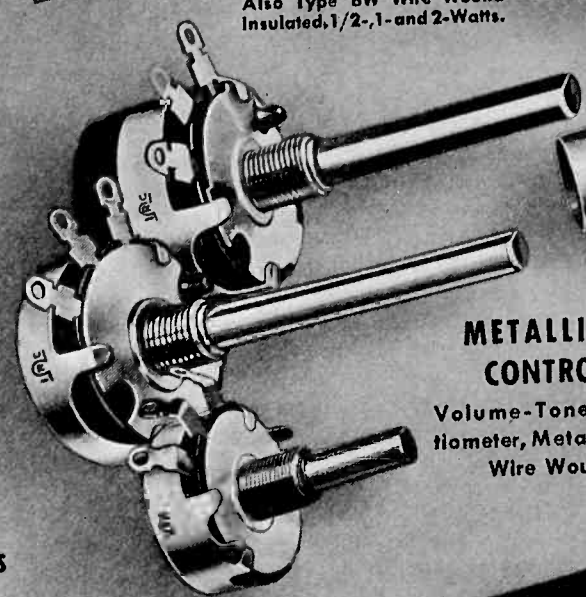

METALLIZED CONTROLS
Volume-Tone-Potentiometer, Metallized & Wire Wound.



HIGH FREQUENCY POWER RESISTORS
Metallized type, 10 sizes.
1/3 to 150 watts.
TYPE MFC
HIGH FREQUENCY 50 WATT
72 OHMS

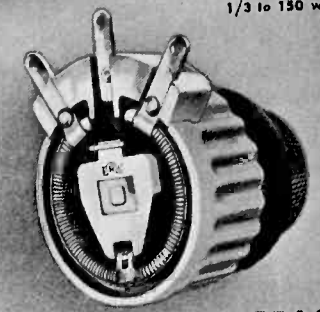

ALL-METAL RHEOSTATS
2 to 100 Watts.

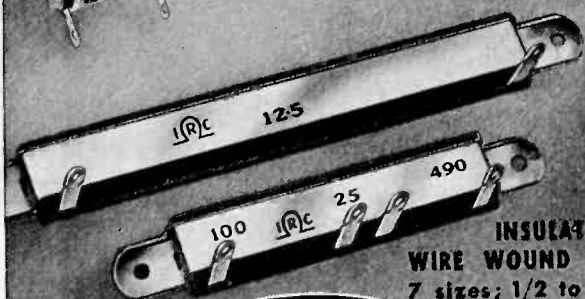

INSULATED WIRE WOUND RESISTORS
7 sizes; 1/2 to 20 Watts.



POWER WIRE WOUND RESISTORS
Cement Coated—53 sizes, fixed and variable types.



ULTRA HIGH FREQUENCY
Metallized type, 4 sizes.



One COMPANY THAT MEETS ALL RESISTANCE NEEDS

With so much depending upon the selection of the one right resistor for any job, the importance of having a single, specialized source of supply for all of the many fixed and variable resistance types becomes plainly evident. You gain full benefit of IRC's many years of experience in supplying the right resistors—in the right shapes—with the right terminals—protected by the right coatings—and selected with a full understanding of the specific problems involved. Above all, you are assured of dependability—the natural result of years of intense specialization on the development and production of quality resistance units only.



Makers of Resistance Units of More Types, in More Shapes, for More Applications Than Any Other Manufacturer in the World. Catalog of any type on request.

INTERNATIONAL RESISTANCE COMPANY

431 N. BROAD ST., PHILADELPHIA, PA.

Commercial Engineering Developments

These reports on engineering developments in the commercial field have been prepared solely on the basis of information received from the firms referred to in each item.

Sponsors of new developments are invited to submit descriptions on which future reports may be based. To be of greatest usefulness, these should summarize, with as much detail as is practical, the novel engineering features of the design. Address: Editor, Proceedings of the I.R.E., 330 West 42nd Street, New York, New York.

Wide Range Oscilloscope

To meet the need in television and other fields for an oscilloscope having independent deflection means in both the horizontal and vertical directions, and capable of handling the wide range of frequencies encountered, General Electric* engineers have designed a new cathode ray oscilloscope. Attention has been given to making operation convenient from either a standing or sitting position. A detachable light shield has been provided for use whenever the room illumination from side or top is too great.

* General Electric Company, Schenectady, New York

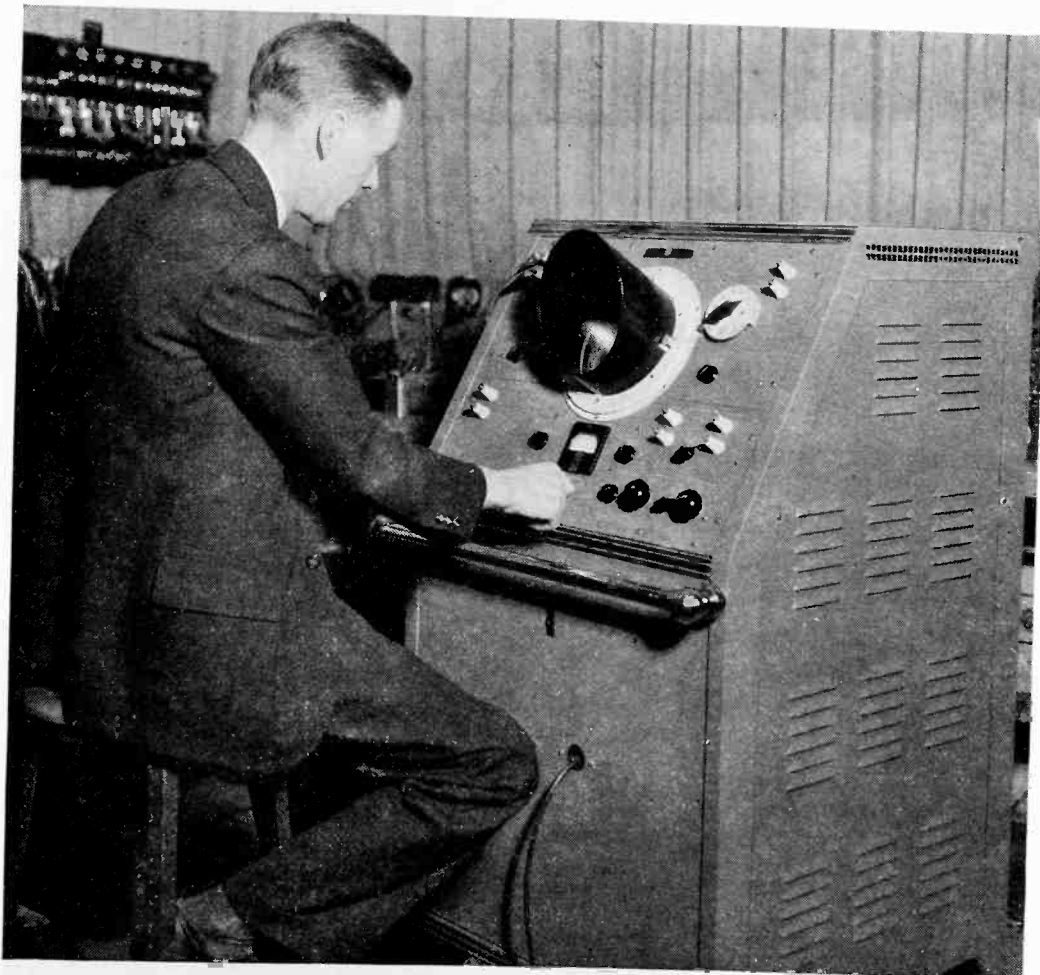

The new instrument is a means for showing complex wave shapes visually. Its deflection amplifiers will cover from 10 cycles to better than 5 megacycles with not more than 10 per cent amplitude deviation at the upper frequency limit and only five degrees of phase shift at the low-frequency end of the range. This wide range is obtained by the use of high transconductance tubes working into circuits designed to have low capacitance to ground. The low-frequency response of each amplifier stage is adjusted using square-wave input signals. This method has been found to be much more accurate than amplitude-response measurements since a better check on phase shift is obtained. Special coupling circuits are employed to permit the desired response at the low frequency limit stated above. Particular attention has been paid to the linearity of amplification. The horizontal and vertical deflection amplifiers are as nearly as possible duplicates of one another to facilitate phase measurement.

Means are provided to measure the signal potentials applied. This is done by comparing the picture size with that produced by a known voltage. The horizontal sweep frequency range is from 10 cycles to 100 kilocycles per second. The horizontal sweep generator employs a multivibrator to cover the unusually wide range of sweep frequencies provided in this instrument. Circuits of each component are adjusted to the necessary wave shapes. This in part

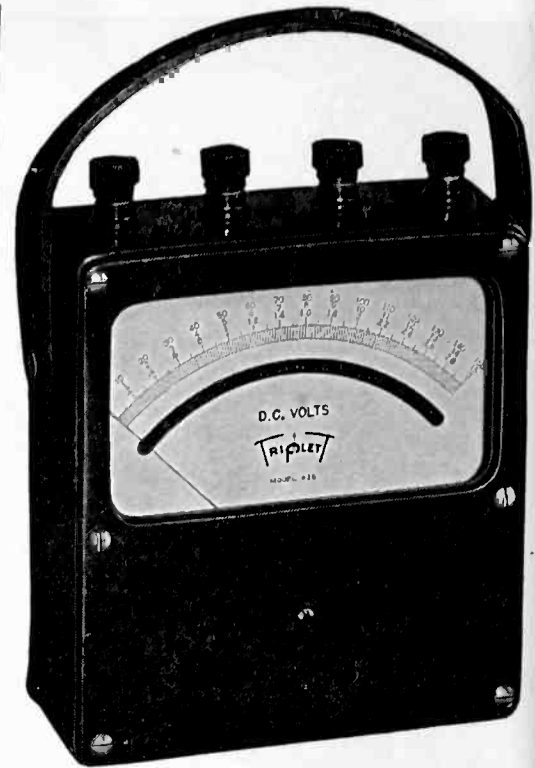

NEW PRECISION PORTABLES

Models 625 (DC—Moving Coil Type)—635 (AC—Movable Iron Vane Type) and 665 (Electrodynamometer Type) . . . new



molded case portables, may be obtained with extreme sensitivity for laboratory use—as well as those for general commercial and industrial testing purposes. Have mirror scale and knife-edge pointer to assure quick, accurate readings. Scale length is 4.58"—Accuracy within 1%. Attractive black molded case, 6" x 5 1/2" x 2 1/2". Attached leather strap handle.

Another popular line of portables includes Models 725 (DC)—735 (AC). This popular style has a precision instrument with long 6" mirror scale. Oak case is 11" x 9" x 4".

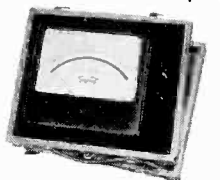

Model 325 . . . 2.37" Scales
Models 325 (DC)—335 (AC) for laboratory, shop bench and special purposes. Tilting feature permits adjustment to any angle for accurate reading.

To further meet the demand for portable instruments, Triplet has available handy instrument stands for 3" and 4" panel instruments; available with 2, 3, or 4 binding posts. Black wrinkle finish all metal case—sloping panel—4" x 4" x 3 1/2".



Model 525 . . . 3.50" Scale
Has mirror scale and knife edge pointer for extreme accuracy in reading.

Write for Catalog—Section 215 Harmon Drive

TRIPLET ELECTRICAL INSTRUMENT CO.
Bluffton, Ohio

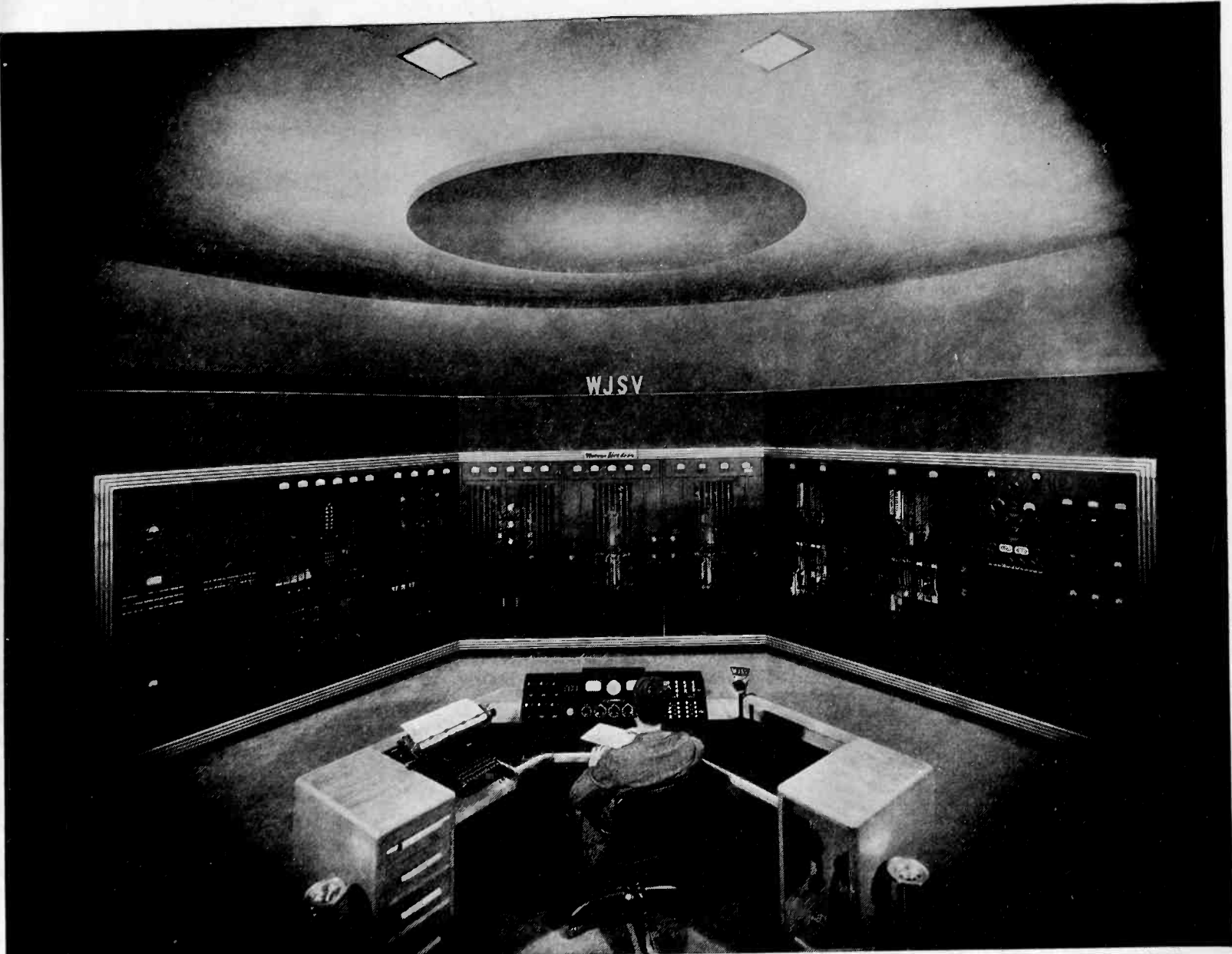

Another Western Electric 50 KW!

WJSV transmitter building at Wheaton, Md., showing three tower array.

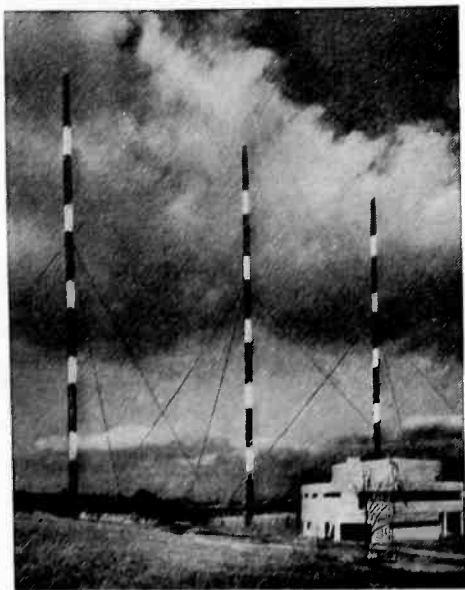

CBS Outlet for the Nation's Capital...

WJSV

WASHINGTON

The Doherty Circuit . . . improved stabilized feed-back . . . automatic line voltage regulators . . . emergency 5KW operation . . . are just a few of the reasons why Columbia selected Western Electric for WJSV. Whether you want a 100 watt or a 50KW, it will pay you to choose Western Electric — *for Better Broadcasting!*

Western Electric antenna coupling equipment for the 50 KW transmitter.

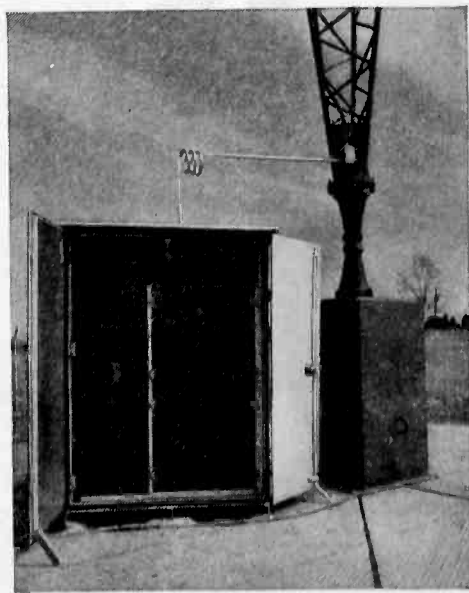

Western Electric



DISTRIBUTORS: In U.S.A.: Graybar Electric Co., New York. In Canada and Newfoundland: Northern Electric Co., Ltd. In other countries: International Standard Electric Corp.

DAVEN

Precision LEVEL INDICATOR



The Type 910 Volume Level Indicator is an audio level indicator designed for service in broadcasting, sound recording, and allied fields. The meter is sensitive, rugged and correctly damped for program monitoring. The meter multiplier is a heavy duty, step type "T" attenuator designed to offer a constant impedance both to the line, and to the meter at all steps of control. The zero adjustment provides corrections of ± 0.5 Db. in 0.1 Db. steps. The input impedance of the 910 is 7500 ohms. The reference level is 1 mw. into 600 ohms.

WRITE FOR TECHNICAL DESCRIPTIVE LITERATURE
THE DAVEN COMPANY
 158 SUMMIT STREET • NEWARK, NEW JERSEY

(Continued from page ii)

accounts for excellent linearity of the horizontal sweep.

Provision has been made for sectional wave expansion. The expansion is about six to one and choice of the section to be expanded is permitted on input signals synchronized with the 60 cycle supply or one of its low order harmonics. The expanded section of the wave is vertically displaced from the main wave on the cathode-ray screen. A switch on the operating panel permits the separate choice of the expander feature, blanking of the return trace on the screen, or neither, as desired. For test purposes, it is also possible to obtain voltages having rectangular wave shapes over a frequency range of 10 cycles to 100 kilocycles per second.

No visible effect of the supply frequency is found either in the deflection or brilliance of the screen trace because of the special magnetic and electrostatic shielding, the use of exceptionally low-flux-density transformers and reactors, and the placement of parts. The power components, switches, and wiring have been confined to shielded compartments to further reduce stray fields. Special attention has been given to attenuators to assure permanent accuracy of adjustment in the face of ambient temperature changes.

An input signal of less than $\frac{1}{4}$ volt, root-mean-square, will provide a specified picture measuring 4 by 4 inches for the sinusoidal input. However, in normal operation even a larger picture may be obtained. When required for special work, the operator may maintain a higher than normal potential for the cathode ray anode supply. It is also possible to double the deflection voltage from the amplifiers.

The face of the cathode ray tube is protected by means of a safety glass, and a co-ordinate system is incorporated in the bezel which holds the protective glass. This co-ordinate system may be rotated for phase measurement and is removable when desired. The voltage amplifiers, deflection unit, and cathode ray tube are

BLILEY

Precision Made



20 KC TO 30 MC
 WRITE FOR CATALOG G-11

CRYSTAL UNITS

BLILEY ELECTRIC CO., Erie, Pa.





New RCA Broadcast Frequency Monitor- Type 311-A

FCC APPROVAL No. 1462

**Designed for new frequency
deviation regulations of the FCC**

THE RCA 311-A is an entirely new instrument of unusual accuracy and reliability for measuring and checking carrier frequencies of broadcast transmitters. Employing advanced methods of precision frequency measurement, the 311-A makes it easy for the operator to know accurately his carrier frequency at all times and to maintain its value well within the 20 cycle deviation limits the FCC will require.

Designed for maximum stability and freedom from drift, the 311-A enables stations to avoid the expense of too frequent check measurements. An extra large Deviation Meter permits the operator to check deviation easily from across the average room. A unique audio discriminator circuit provides reactance balance rather than resonance equalization.

The oscillator employs a "V" cut

low temperature coefficient crystal mounted in a holder especially designed to eliminate frequency changes caused by sudden shock or vibration. The holder is contained in a heat chamber whose temperature is controlled to .05° C. The oscillator circuits are located in an outer temperature-regulated cham-

ber. Both thermostats are factory adjusted. Additional "watchman" thermostats furnish safety protection against accidental overheating.

A careful analysis of this instrument will reveal that the customary high standards of RCA Engineering have again created an instrument of real value to broadcasters.

TECHNICAL SPECIFICATIONS

POWER SUPPLY:	105-125 volts; 50-60 cycles; 165 watts total.
R. F. INPUT:	Less than one volt required.
FREQUENCY RANGE:	540 to 2000 KC by means of individual crystal.
ACCURACY:	Crystal oscillator stability, 2 parts per million. Effect of 25°C. temp. change, less than .6 cycle.
SIZE:	Rack mounting panel: width 19", height 15¾".
WEIGHT:	96 pounds (unpacked).



Measuring Equipment

RCA MANUFACTURING CO., INC., Camden, N. J. • A Service of the Radio Corporation of America

New York:
1270 Sixth Ave.

Chicago:
589 E. Illinois St.

Atlanta:
530 Citizens & Southern Bank Bldg.

Dallas:
Santa Fe Bldg.

San Francisco:
170 Ninth St.

Hollywood:
1016 N. Sycamore Ave.

AMERICAN AIRLINES USE EIMAC TUBES in their radio ground stations



New ground stations for American Airlines manufactured by COLLINS RADIO COMPANY. Another important endorsement of the superior quality and outstanding capabilities of

Eimac
TUBES

One after another, leaders in the field of radio communications are turning to Eimac for vacuum tubes. Practically every major Airline in the USA is now using these superior tubes for the important jobs in their vital radio communication systems.

This new multifrequency transmitter was designed and produced by one of the nation's leading radio equipment manufacturers for one of the world's leading air transportation companies. Eimac 450TL tubes are used in the power amplifier, operating at an anode potential of 4kv, drawing 1 amp. anode current. Another pair of Eimac 450TL's are the class B modulators. Driving power is extremely low considering the available output delivered by either stage. Complete details can be obtained by writing direct to the equipment manufacturers or to the makers of Eimac tubes.

EITEL-McCULLOUGH, INC., San Bruno, Calif.

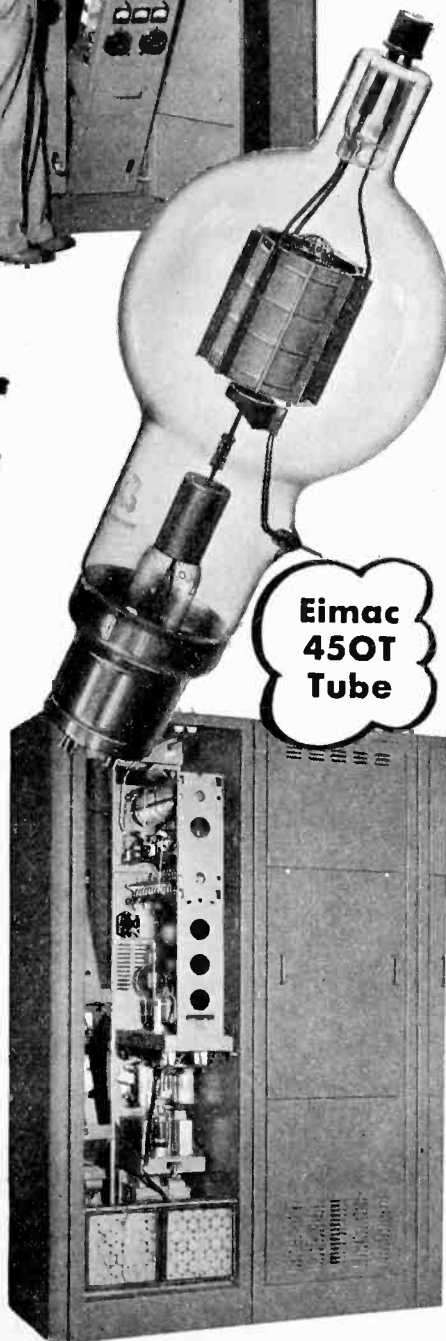

(Continued from page iv)

removable from the sloping control panel on which are located all essential controls. The controls have been simplified and are so located that it is unnecessary for an operator to remove his eyes from the screen to locate any desired control.

The cabinet has been provided with a safety interlock, a magnetic circuit-breaker switch, an indicating pilot lamp, and a special means to indicate supply line voltage. A tap-changing switch is provided to obtain normal operating potentials when the supply line voltage is low.

The d-c power for the voltage amplifiers and sweep generator is obtained from separate, electrically regulated supplies. Separate individual d-c power supplies are provided for the vertical and horizontal power amplifiers.

EXHIBITORS AT THE RADIO ENGINEERING SHOW

Preliminary list corrected to June 1

Alden Products Company, Brockton, Mass.

Amperex Electronic Products, Inc., Brooklyn, N. Y.

Boonton Radio Corporation, Boonton, N. J.

Bryan Davis Publishing Company, New York, N. Y.

Communication Products, Inc., Jersey City, N. J.

Cornell-Dubilier Electric Corporation, South Plainfield, N. J.

Tobe Deutschmann Corporation, Canton, Mass.

Eitel-McCullough, Inc., San Bruno, Calif.

Ferris Instrument Corporation, Boonton, N. J.

General Ceramics Company, New York, N. Y.

General Radio Company, Cambridge, Mass.

Hytron Corporation, and Hytronic Laboratories, Salem, Mass.

McGraw-Hill Publishing Company, New York, N. Y.

Measurements Corporation, Boonton, N. J.

Shakeproof Lock Washer Company, Chicago, Ill.

United Electronics Corporation, Newark, N. J.

United Transformer Corporation, New York, N. Y.

Something new and startling...

PLUG - IN ELECTROLYTICS

AEROVOX AP CONSTRUCTION

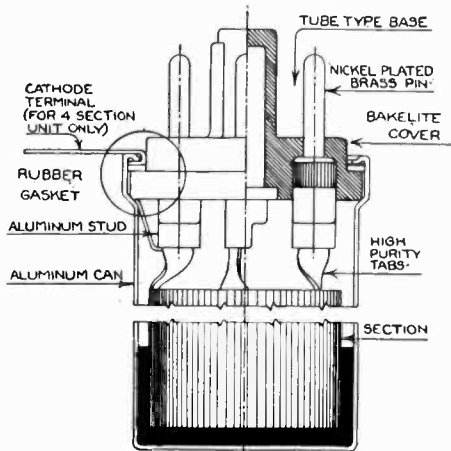

Octal base of special design and construction, made in AEROVOX molding department.

Nickel-plated brass prongs engage with standard octal socket contacts of similar metal. Prongs connect with aluminum section tabs through the aluminum studs, as shown, with junctions imbedded in protective bakelite seal to eliminate corrosive influences. Aluminum studs spun over prong ends. Section tab placed in cylindrical recess of aluminum stud, and portion of stud wall is partly sheared and collapsed firmly on imbedded tab for permanently tight, low-resistance, aluminum-to-aluminum bond.

Two cathode-tabs used wherever one pin is cathode terminal. One tab connected to number one pin, other tab to can, so that can may be at cathode potential and thus act as shield to eliminate radiation of interfering voltages. Whenever four sections must be placed in can, special ring with extended ground lug is placed under spun-over can rim. Can may be insulated in units of three sections or less.

Hermetic sealing achieved by can edge spun over soft rubber gasket and bakelite plug. Vented cover for full protection.

If standard octal socket is correctly wired, condenser simply cannot be incorrectly connected because of octal-base keying.

Units firmly gripped in octal sockets, just as with octal-base radio tubes. If desired, however, an extension ground lug or spring clips may be used for additional security.



● Developed primarily for the U. S. Signal Corps and for use in aircraft and police radio, the new AEROVOX Series AP plug-in electrolytic condensers are now available for other applications where, above all else, *continuity of service* is a prime requisite.

The far-reaching advantages of the plug-in electrolytic are at once obvious. Readily removed, tested, replaced, these octal-base condensers handle with the same ease as the conventional radio tube or vibrator. Assemblies can be equipped with fresh plug-in electrolytics immediately prior to shipment or to actual use, which feature is vitally important in overseas radio trade. Users of radio or electronic equipment subject to continuous service, can carry "spares" on hand for instant replacement.

Data and Samples:

Write on your business letterhead for engineering data on Series AP Plug-In Electrolytics. Samples, specifications, quotations, cheerfully submitted to responsible parties.

Auto-radio and home-radio servicing is vastly simplified.

Several serious problems confronted AEROVOX in developing this plug-in idea. Such a unit must be hermetically sealed. It must be positively leakproof to avoid external corrosion. There must be no unprotected dissimilar metal junctions to cause internal corrosion. Positive, low-resistance, "noiseless" conduction paths must be insured. These and other problems have been solved. Thus . . .

The Series AP plug-in electrolytics are now in regular production. Available in hi-purity plain foil and in etched foil sections. Two can sizes: $1\frac{1}{8}$ " and $1\frac{5}{32}$ " dia. $2\frac{1}{2}$ to $4\frac{1}{4}$ " high. Single, dual, triple and quadruple section units. 25 to 500 D.C.W. voltage.

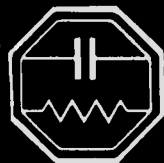

AEROVOX CORPORATION

New Bedford, Mass.



Sales Offices in All Principal Cities

WHERE *Quality* IS ESSENTIAL
Jensen

FULL RANGE
SPEAKER EQUIPMENT

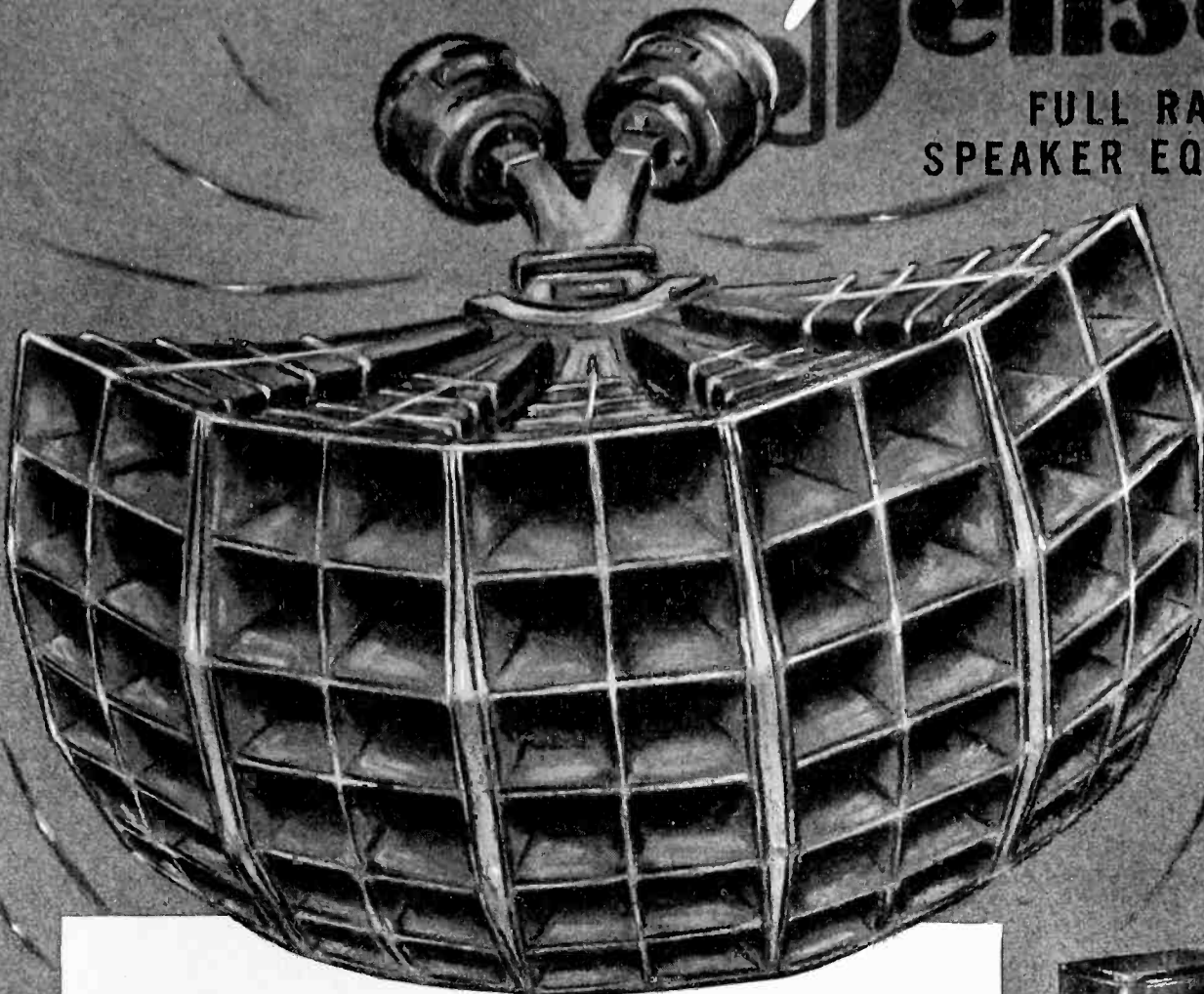

**A Complete New Line
of Jensen Products of Commanding
Character and Magnitude**

NEW • High Frequency Speakers • Low
Frequency Speakers • Multicellular Horns
Dividing Networks and accessories
Combined into 3 Basic Systems:

Type B . . . For **Type G and E . . . For**
largest audiences. smaller audiences.

NEW CATALOG

A Technical Catalog describing these new
developments is now available. Ask your
Jensen Distributor or write for your copy.

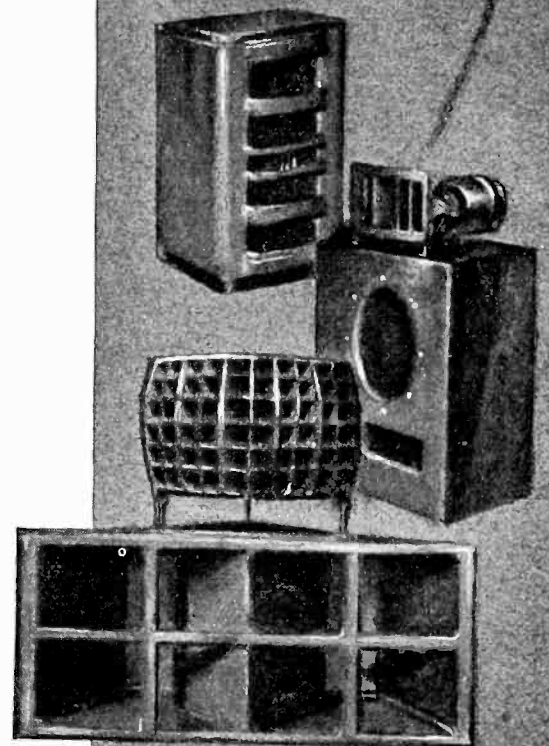
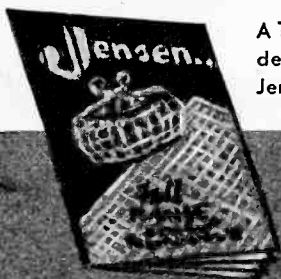

Jensen
6601 SOUTH LARAMIE AVE., CHICAGO

AMPEREX

presents

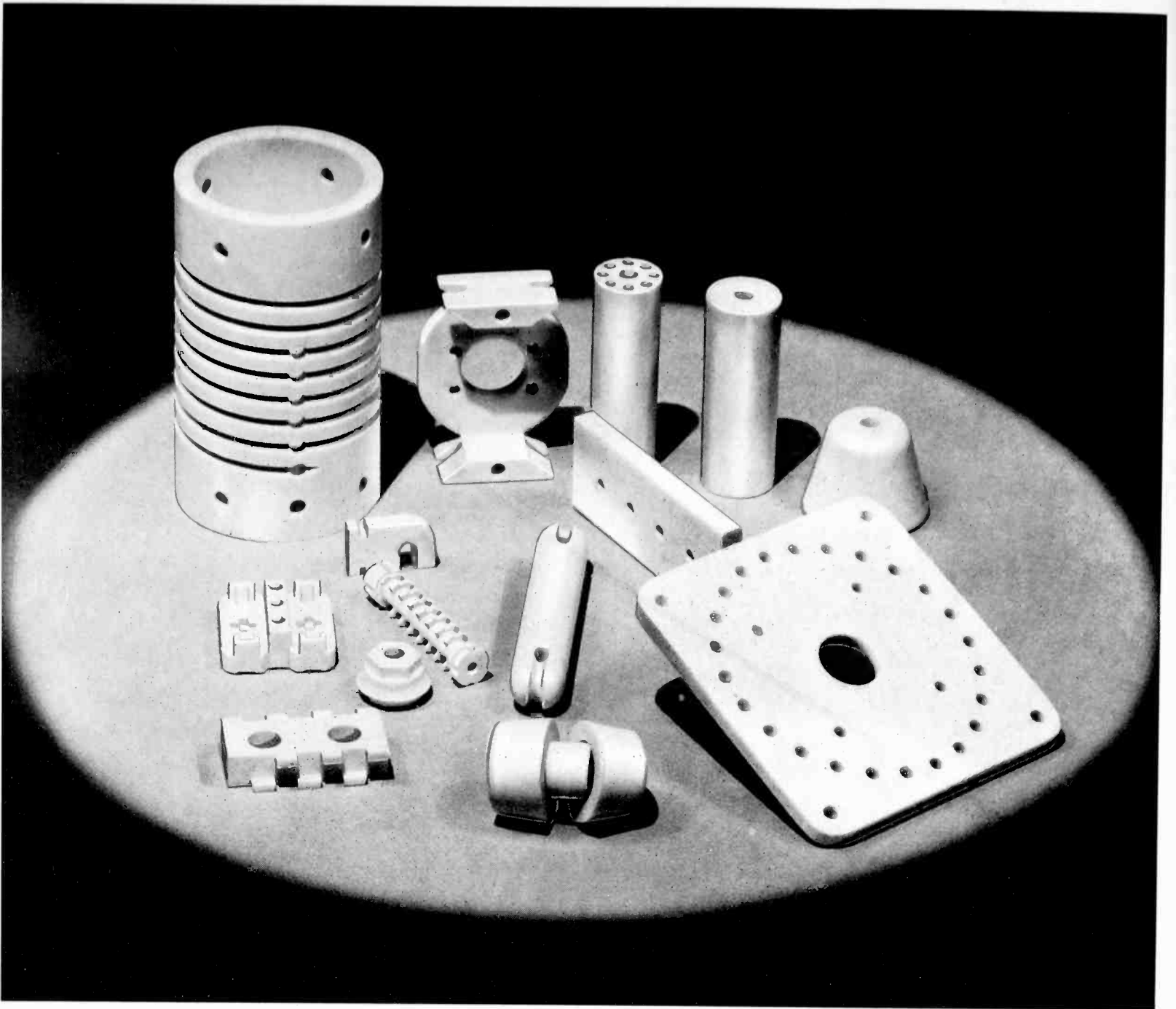

PIONEERING, developing and perfecting Steatite Ceramics has been American Lava Corporation's work for 38 years. More than 15,000 different custom-tailored products each year . . . production of millions of pieces a day . . . an engineering staff consulted by the nation's foremost research engineers . . . may indicate that you, too, can find the right answer to your insulation problems by consulting

ALSIMAG

Trade Mark Reg. U.S. Pat. Off.

FROM CERAMIC HEADQUARTERS

AMERICAN LAVA CORPORATION • CHATTANOOGA • TENNESSEE

CHICAGO • CLEVELAND • NEW YORK • ST. LOUIS • LOS ANGELES • SAN FRANCISCO • BOSTON • PHILADELPHIA • WASHINGTON, D. C.

IRE membership offers many services to the radio engineer

Proceedings—An outstanding publication in the radio engineering field. Over a quarter of a century of service to the world in publishing important radio engineering discoveries and developments, the PROCEEDINGS presents exhaustive engineering data of use to the specialist and general engineer. A list of its authors is a "Who's Who" of the leaders in radio science, research, and engineering.

Standards—Since 1914 our standards reports have stabilized and clarified engineering language, mathematics, graphical presentations, and the testing and rating of equipment. They are always in the process of revision and thus remain up to date.

Meetings—In twenty-two cities in the United States and Canada, meetings of the Institute and its sections are held regularly. Scores of papers on practically every branch of the field are presented and discussed. Several convention meetings are sponsored by the Institute and add materially to its effectiveness in distributing data of value to engineers.

The Institute of Radio Engineers

Incorporated

330 West 42nd Street, New York, N.Y.

To the Board of Directors

Gentlemen:

I hereby make application for ASSOCIATE membership in the Institute of Radio Engineers on the basis of my training and professional experience given herewith, and refer to the sponsors named below who are personally familiar with my work.

I certify that the statements made in the record of my training and professional experience are correct, and agree if elected, that I shall be governed by the Constitution of the Institute as long as I continue a member. Furthermore I agree to promote the objects of the Institute so far as shall be in my power.

.....
(Sign with pen)

.....
(Address for mail)

.....
(City and State)

.....
(Date)

SPONSORS

(Signatures not required here)

Mr.

Address

City and State

Mr.

Address

City and State

Mr.

Address

City and State

Associate membership affiliates you with the Institute and brings you the PROCEEDINGS each month as well as notices of meetings held near you.

(Typewriting preferred in filling in this form) No.....
RECORD OF TRAINING AND PROFESSIONAL EXPERIENCE

Name
 (Give full name, last name first)

Present Occupation
 (Title and name of concern)

Business Address

Home Address

Place of Birth Date of Birth Age

Education

Degree
 (College) (Date received)

TRAINING AND PROFESSIONAL EXPERIENCE
 (Give dates and type of work, including details of present activities)

Record may be continued on other sheets this size if space is insufficient.

Receipt Acknowledged Elected Notified

Requirements—For Associate membership, an applicant must be at least twenty-one years of age, of good character, and be interested in or connected with the study or application of radio science or the radio arts.

Sponsors—Three sponsors who are familiar with the work of the applicant must be named. Preferably these should be Associates, Members, or Fellows of the Institute. In cases where the applicant is so located as not to be known to the required number of member sponsors, the names of responsible nonmember sponsors may be given.

Dues—Dues for Associate membership are six dollars per year. The entrance fee for this grade is three dollars and should accompany the application.

Other Grades—Those who are between the ages of eighteen and twenty-one may apply for Junior grade. Student membership is available to full-time students in engineering or science courses in colleges granting degrees as a result of four-year courses. Member grade is open to older engineers with several years of experience. Information on these grades may be obtained from the Institute.



Did you say you're busy, Mr. Engineer?

Most of us radio engineers are busy these days with our own immediate problems. Yet, all around us, technical and commercial developments are breaking faster than at any time in 20 years.

How is one to keep up with his own specialty and in touch with the rest of the field? It's a difficult job, but it must be done if one is to maintain his usefulness to his employer and himself.

The I.R.E. Convention offers you a practical means of keeping up to date. There will be more than 40 technical papers to hear and discuss. Many of them are controversial; all of them deal with today's pressing engineering problems. In the show, the leading manufacturers of equipment, components, and materials, will exhibit their new products. Besides, there will be plenty of opportunity for informal, broadening discussion with other engineers.

You can do all of these things in one 3-day meeting. (You'll probably be away from the office only 2 days).

If you are engaged in engineering or scientific work in any branch of radio or allied fields, you are cordially invited to attend the convention. There will be no registration fee or other charge.



For additional information about the program or exhibition space in the Radio Engineering Show address

INSTITUTE OF RADIO ENGINEERS

330 West 42nd Street • New York, N. Y.

15th Annual Convention
and
Radio Engineering Show

Hotel Statler
BOSTON

June 27-29
(Thursday—Saturday)

At the Technical Sessions...

- ▶ Frequency Modulation
- ▶ Television
- ▶ Power Tubes
- ▶ Aviation Radio
- ▶ U-H F

See the complete program in
this issue of the Proceedings

All 3 Days...

the Radio Engineering Show

All engineers are cordially invited

ENGINEERING DIRECTORY

Consultants, Patent Attorneys,
Laboratory Services

**BRUNSON S. McCUTCHEN and
CHARLES B. AIKEN**
Consulting Engineers

Technical cooperation with Attorneys in connection with patent litigation—Design and Development work—Audio and radio frequency measurements—Equipment studies—Receiver and transmitter problems—A well equipped laboratory.

75 West Street Telephone
New York City WHitchall 4-7275

Use this directory . . .

when you need consulting services

when you are asked to suggest the name of a specialist on an engineering or patent problem

Consulting Engineers, Patent Attorneys, Laboratory Services . . . Applications for card space in the Engineering Directory are invited. Complete data will be sent on request to

PROCEEDINGS of the I.R.E.

330 West 42nd Street New York, N.Y.

INDEX

COMMERCIAL ENGINEERING DEVELOPMENTS	ii
ENGINEERING DIRECTORY	xvi

DISPLAY ADVERTISERS

A

Aerovox Corporation	vii
American Lava Corporation	xii
American Telephone & Telegraph Company	xvii
Amperex Electronic Products, Inc.	ix, x, xi

B

Bliley Electric Company	iv
-------------------------------	----

C

Cornell-Dubilier Electric Corporation	xviii
---	-------

D

The Daven Company	iv
-------------------------	----

E

Eitel-McCullough, Inc.	vi
-----------------------------	----

G

General Radio Company	Cover IV
-----------------------------	----------

I

International Resistance Company	i
--	---

J

Jensen	viii
--------------	------

R

RCA Manufacturing Company	v, Cover III
---------------------------------	--------------

T

Triplett Electrical Instrument Company	ii
--	----

W

Western Electric Company	iii
--------------------------------	-----

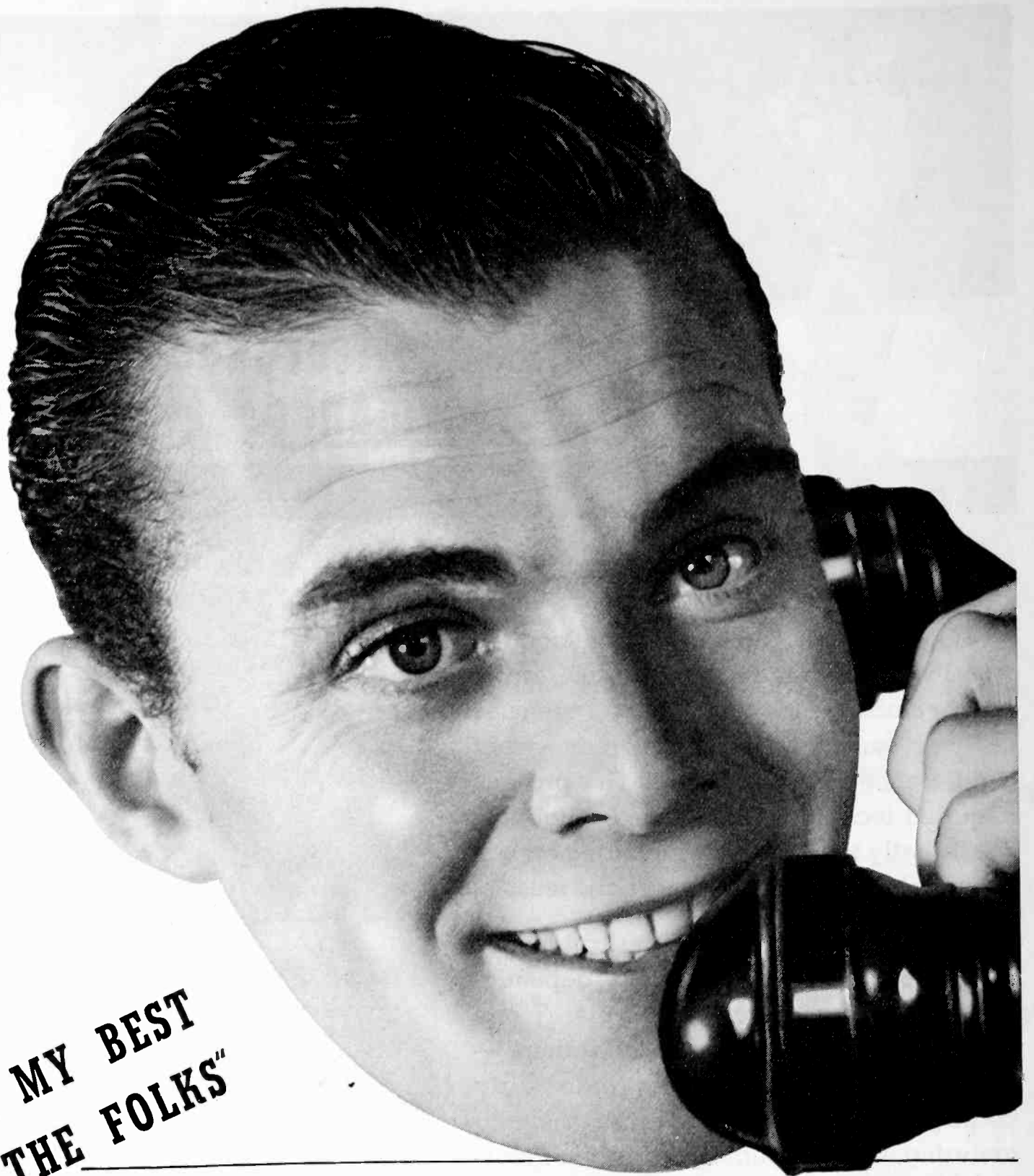

**"GIVE MY BEST
TO THE FOLKS"**

"Hope to be seeing you soon." . . . "Gee, it's swell to hear your voice." . . . "We're all well here."

No great words of business or state are these — just the homey, every-day conversations that are America. The thoughts and hopes and remembrances that bind families and friends together. The flow of understanding that helps to make this a united nation.

Always the Bell System stands ready to help — to do its part quickly, cheaply, courteously, in the manner of a friend.





**they may
look alike**

**but what a difference
in performance!**

Golfers or capacitors . . .

CONSIDER the "Sunday golfer" and the Pro. They may be dressed alike, swing similar clubs, tee identical balls . . . even use the exact same grip. But on the green—what a difference in performance! The pro has acquired technique, sure-footed reliability, consistently top form—through long experience. He has co-ordinated nerve and muscle.

There's a big difference, too, in capacitors. Not in looks, but in inbuilt quality, dependability, surviving economy. And there's one capacitor that outperforms all others—Cornell-Dubilier! With more than thirty years of specialization in capacitor manufacturing, Cornell-Dubilier holds the industry's experience record. And experience is the yardstick of value for knowing engineers. Witness the fact that there are more Cornell-Dubilier capacitors in use today than any other make!

CORNELL-DUBILIER ELECTRIC CORPORATION
1012 Hamilton Blvd., South Plainfield, N. J.

**ETCHED PLATE, NOT FABRICATED!*

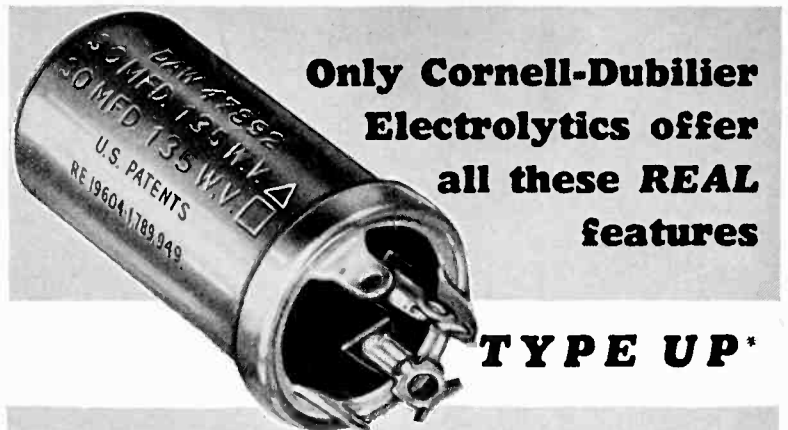

**Only Cornell-Dubilier
Electrolytics offer
all these REAL
features**

These Features:

- Special high-voltage paper separator
- C-D etched plate
- Special C-D electrolyte
- Special high formation process

Result in:

- Minimum capacity change over wide temperature range.
- Great reduction in physical size—up to 40% for some types.
- Increased useful life.
- Reduced direct current leakage.
- Reduced equivalent series resistance.
- Higher breakdown voltage.
- Improved audio and radio frequency impedance characteristics.

The Type UP is the smallest can type capacitor available, and can be supplied in single, dual, triple and quadruple capacity combinations. Complete physical and dimensional data on request.

Remember! All C-D capacitors are union made and competitively priced.

***specify* CORNELL-DUBILIER!**
THE WORLD'S LARGEST MANUFACTURER OF CAPACITORS

"Stromberg-Carlson SEES ADVANTAGES FOR ALL IN THE RCA PREFERRED TYPE TUBE PROGRAM"

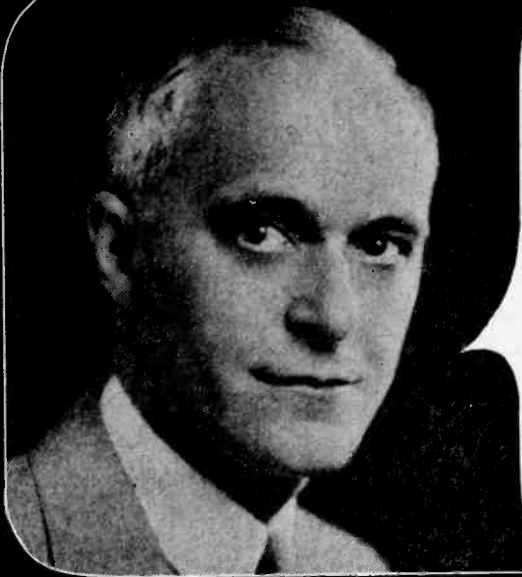

...says Fred N. Anibel,

Radio Sales Manager of the Stromberg-Carlson Telephone Manufacturing Co., Rochester, N. Y.

"As I see it, the purpose of this program is to solve a problem which has affected the entire industry. Manufacturers, distributors, dealers and service men will all benefit. Stromberg-Carlson is glad to cooperate to help the industry realize these benefits as quickly as possible."

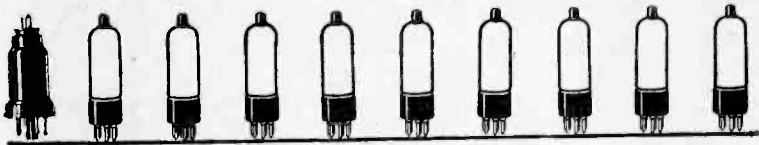

Less than one type in ten of the 470 types of radio receiver tubes now on the market is actually needed to design practically every type of radio receiver at the lowest ultimate cost. RCA has outlined a list of 36 RCA Preferred Type Tubes which adequately cover every function for any type of receiving set circuit.

Yes—and Stromberg-Carlson is cooperating where it counts the most—on the production line. Current Stromberg-Carlson radios and radio-phonographs are designed with RCA Preferred Type Tubes!

Thanks to this active participation in the program, distributors, dealers and service men will receive their benefits sooner.

RCA considers it a privilege to work with Stromberg-Carlson to this end. We are doing everything possible to see that our Preferred Types Tube Program brings relief from the chaotic tube situation of the past.



**New
Stromberg-Carlson
FM Triumph!
RCA Preferred Type
Tubes Exclusively!**

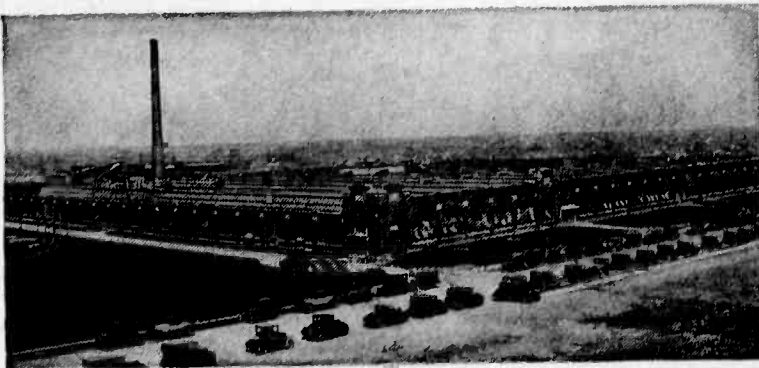

Radio Tubes

FREQUENCY DEVIATION — CYCLES

SPEAKING OF STABILITY

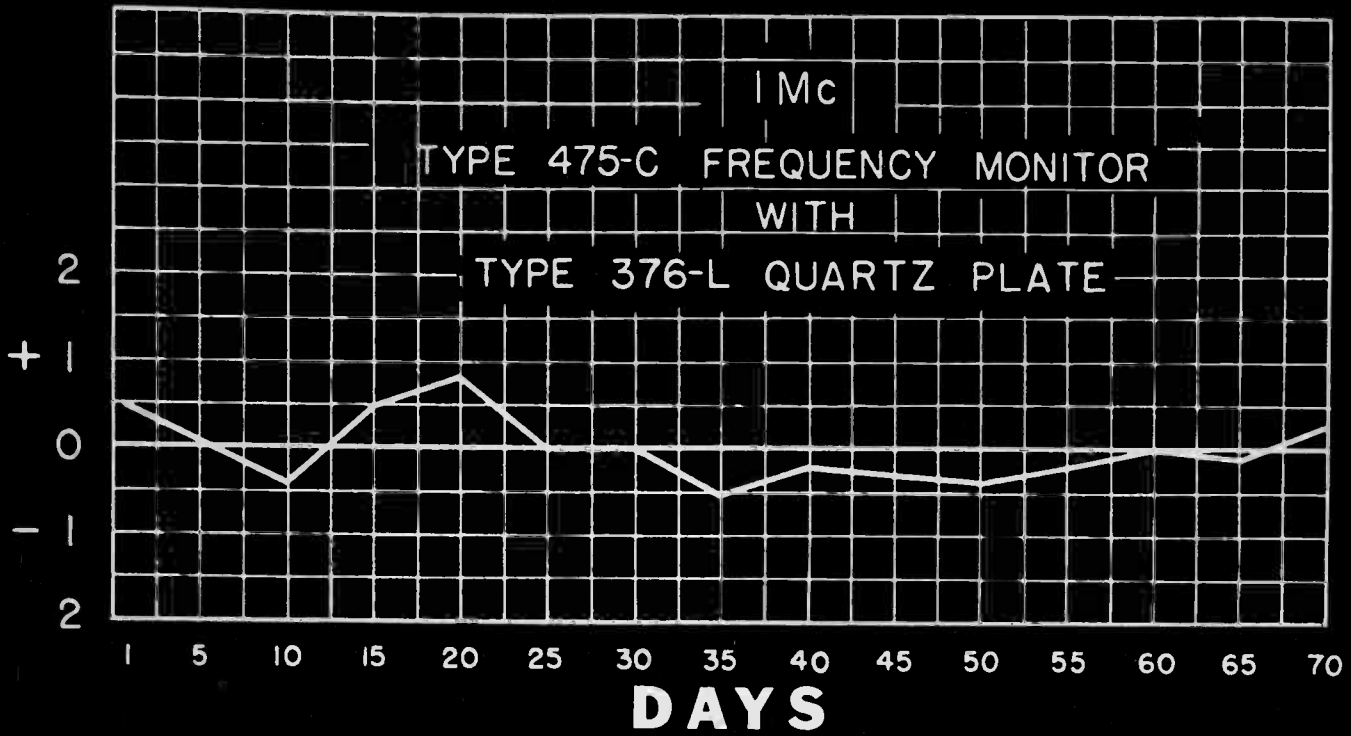

THE CURVE above shows the frequency deviation of a 1 megacycle G-R Broadcast Frequency Monitor, taken from stock and run continuously for seventy days from October 2, 1939 to December 12, 1939. The maximum deviation was less than one cycle! Remember, this was a STOCK model, not one especially tricked up, and is typical of the performance reported to us by many owners.

The G-R Broadcast Frequency Monitor assures your complying with Rule 3.59 of the F.C.C. at all times. The new deviation meter now reads to ± 30 cycles and is direct reading to one cycle.

Many new electrical and mechanical features are incorporated in the G-R Monitor, which bears F.C.C. Approval No. 1461.

ELECTRICAL FEATURES

- 1—High-stability crystal oscillator circuit as used in primary standards
- 2—Amplifier to isolate crystal oscillator
- 3—Input amplifier to isolate transmitter
- 4—Diode voltmeter to adjust input level
- 5—New foolproof temperature-control system
- 6—Improved highly stable frequency-deviation meter circuit
- 7—AVC circuit on deviation meter
- 8—Simplified operation
- 9—New inside layout for simplified replacements

G-R Monitors are now equipped with dress panels so that you can now secure a monitor to match any of five standard broadcast-equipment panel finishes from stock. Unfinished panels can be supplied for finishing by the user and subsequent assembly by us so that your monitor can have ANY panel finish desired.

You can't go wrong in selecting a G-R Monitor. G-R has pioneered in the broadcast frequency meas-

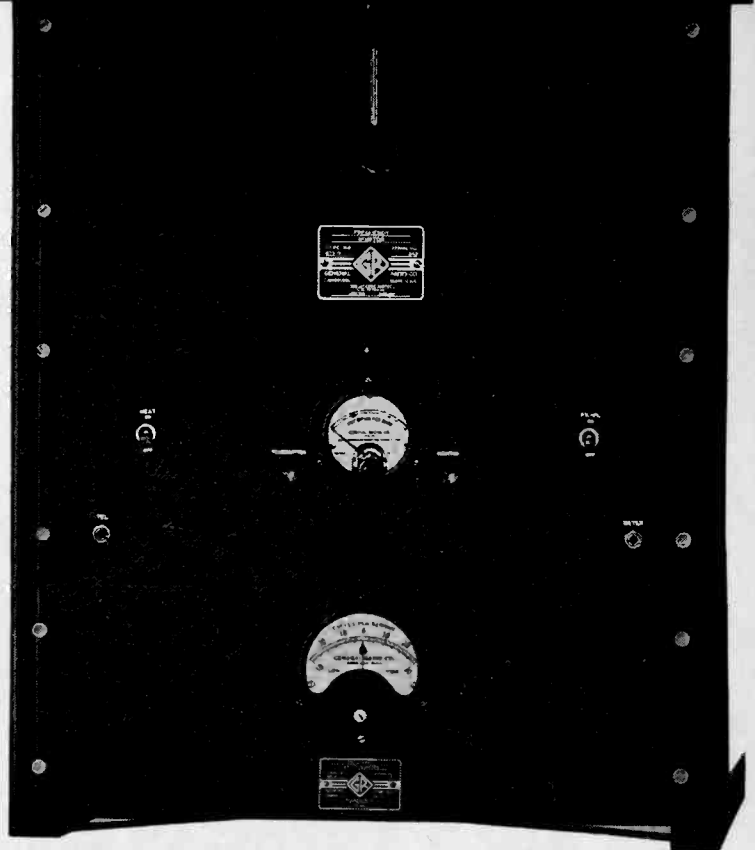

uring field since broadcasting started. G-R Monitors are used by hundreds of the leading stations.

TYPE 475-C FREQUENCY MONITOR ..	\$330.00
TYPE 681-B FREQUENCY DEVIATION METER	\$145.00
TYPE 376-L QUARTZ PLATE	\$ 85.00
<hr/>	
BROADCAST FREQUENCY MONITOR	\$560.00

WRITE FOR BULLETIN 575

GENERAL RADIO COMPANY CAMBRIDGE MASSACHUSETTS

