

Proceedings

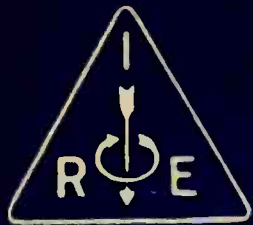

of the

I·R·E

JANUARY 1939

VOLUME 27 NUMBER 1

Car errors in field measurements
Aeronautical radio-station design
Transmission above 40 megacycles
Interference investigation
Line equalization by predistortion
Electron-beam magnetrons
Ultra-high-frequency propagation
56-megacycle propagation
Exponential transmission lines
Electromagnetic horn and theory
Ionosphere characteristics

Institute of Radio Engineers



FORTHCOMING MEETINGS AND INSTITUTE SECTIONS



NEW YORK MEETING—Engineering Societies Building—FEBRUARY 1
33 West 39th Street, New York, New York

- ATLANTA Chairman, C. F. Daugherty
Secretary, J. G. Preston, 230 Ansley Street, Decatur, Georgia
- BOSTON Chairman, H. W. Lamson
Secretary, E. B. Dallin, 64 Oakland Avenue, Arlington, Massachusetts
- BUFFALO-NIAGARA Chairman, G. C. Crom, Jr.
Secretary, E. C. Waud, 235 Huntington Avenue, Buffalo, New York
- CHICAGO Chairman, J. E. Brown
Secretary, E. Kohler, Jr., Ken-Rad Tube and Lamp Corporation, 2440 Sheffield Avenue,
Chicago, Illinois
- CINCINNATI Chairman, R. J. Rockwell
Secretary, M. M. Wells, Crosley Radio Corporation, 1329 Arlington Street, Cincinnati, Ohio.
- CLEVELAND Chairman, L. N. Chatterton January 26
Secretary, R. L. Kline, Winteradio, Inc., 3014 Lorain Avenue, Cleveland, Ohio
- CONNECTICUT VALLEY Chairman, E. R. Sanders
Secretary, W. R. G. Baker, General Electric Company, Bridgeport, Connecticut
- DETROIT Chairman, E. H. I. Lee January 20
Secretary, R. J. Schaefer, 9753 North Martindale, Detroit, Michigan
- EMPORIUM Chairman, A. W. Keen
Secretary, M. C. Hoffman, Hygrade Sylvania Corporation, Emporium, Pennsylvania
- INDIANAPOLIS Chairman, C. F. Wolcott
Secretary, B. V. K. French, P. R. Mallory and Company, Inc., East Washington Street,
Indianapolis, Indiana
- LOS ANGELES Chairman, R. O. Brooke January 17
Secretary, A. C. Packard, Columbia Broadcasting System, 5939 Sunset Boulevard,
Hollywood, California
- MONTREAL Chairman, Sydney Sillitoe
Secretary, R. E. Hammond, 1261 Shearer Street, Montreal, Quebec, Canada
- NEW ORLEANS Chairman, G. H. Peirce
Secretary, D. W. Bowman, 8327 Sycamore Street, New Orleans, Louisiana
- PHILADELPHIA Chairman, H. J. Schrader February 2
Secretary, R. L. Snyder, 103 Franklin Road, Glassboro, New Jersey
- PITTSBURGH Chairman, W. P. Place January 17
Secretary, R. E. Stark, 90 Pilgrim Road, Rosslyn Farms, Carnegie, Pennsylvania
- ROCHESTER Chairman, H. J. Klumb
Secretary, H. C. Sheve, Stromberg-Carlson Telephone Manufacturing Company,
Rochester, New York
- SAN FRANCISCO Chairman, Noel Eldred
Secretary, L. J. Black, 243—30th Street, Oakland, California
- SEATTLE Chairman, A. R. Taylor
Secretary, R. M. Walker, 2600—26th Avenue, S.W., Seattle, Washington
- TORONTO Chairman, R. C. Poulter
Secretary, N. Potter, Canadian National Carbon Company, Ltd., 805 Davenport Road,
Toronto, Ontario, Canada
- WASHINGTON Chairman, E. H. Rietzke January 9
Secretary, L. C. Young, Naval Research Laboratory, Bellevue, Anacostia, District of Columbia

BOARD OF DIRECTORS

- Haraden Pratt, *President*
- Ernest T. Fisk, *Vice President*
- Melville Eastham, *Treasurer*
- Harold P. Westman, *Secretary*
- Edwin H. Armstrong
- Harold H. Beverage
- Ralph Bown
- Jesse E. Brown
- Frederick W. Cunningham
- Alfred N. Goldsmith
- Virgil M. Graham
- Ralph A. Hackbusch
- Oscar B. Hanson
- Alan Hazeltine
- Lawrence C. F. Horle
- Cyril M. Jansky, Jr.
- Ewell K. Jett
- Albert F. Murray
- Browder J. Thompson
- Hubert M. Turner

BOARD OF EDITORS

- Alfred N. Goldsmith, *Chairman*
- Ralph R. Batcher
- Philip S. Carter
- Frederick W. Grover
- J. Warren Horton
- Greenleaf W. Pickard
- Benjamin E. Shackelford
- Karl S. Van Dyke
- Harold P. Westman, *ex officio*
- Lynde P. Wheeler
- Laurens E. Whittémore
- William Wilson

PAPERS COMMITTEE

- William Wilson, *Chairman*
- Herman A. Affel
- Edmond Bruce
- Howard A. Chinn
- James K. Clapp
- Tunis A. M. Craven
- Paul O. Farnham
- Enoch B. Ferrell
- Theodore R. Gilliland
- Elmer L. Hall
- Loren F. Jones
- Frederick B. Llewellyn
- De Loss K. Martin
- Albert F. Murray
- Harold O. Peterson
- Ralph K. Potter
- George G. Thomas
- Hubert M. Turner
- Paul T. Weeks
- Harold A. Wheeler
- William C. White
- Irving Wolff

- Helen M. Stote, *Assistant Editor*
- John D. Crawford,
Advertising Manager

Proceedings

of the I·R·E

Published Monthly by

The Institute of Radio Engineers, Inc.

VOLUME 27

January, 1939

NUMBER 1

The Relation of the Carrying Car to the Accuracy of Portable Field-Intensity-Measuring Equipment.....	John H. DeWitt, Jr., and Arthur C. Omberg	1
Some Principles in Aeronautical Ground-Station Design.....	P. C. Sandretto	5
Observations on Sky-Wave Transmission on Frequencies Above 40 Megacycles.....	D. R. Goddard	12
Radio Interference—Investigation, Suppression, and Control.....	H. O. Merriman and F. G. Nixon	16
Line Equalization by Predistortion.....	Walter J. Creamer	22
Electron-Beam Magnetrons and Type-B Magnetron Oscillations.....	Kinjiro Okabe	24
A Study of Ultra-High-Frequency Wide-Band Propagation Characteristics.....	R. W. George	28
56-Megacycle Reception via Sporadic-E-Layer Reflections...	E. H. Conklin	36
The Sectoral Electromagnetic Horn.....	W. L. Barrow and F. D. Lewis	41
Theory of the Electromagnetic Horn.....	W. L. Barrow and L. J. Chu	51
Transmission Lines with Exponential Taper.....	Harold A. Wheeler	65
Characteristics of the Ionosphere at Washington, D. C., November, 1938.....	T. R. Gilliland, S. S. Kirby, and N. Smith	72
Institute News and Radio Notes.....		74
Meeting of the Board of Directors.....		74
Broadcast Engineering Conference.....		74
Committees.....		74
Sections.....		75
Personal Mention.....		77
Membership.....		77
Books.....		78
"Radio Laboratory Handbook," by M. G. Scroggie.....	J. K. Clapp	
"Short-Wave Radio," by J. H. Reyner.....	E. L. Hall	
"Wireless Direction Finding," by R. Keen.....	Harry Diamond	
Contributors.....		80

Entered as second-class matter October 26, 1927, at the post office at Menasha, Wisconsin, under the Act of February 28, 1925, embodied in Paragraph 4, Section 412 of the Postal Laws and Regulations. Publication office, 450 Alnaip Street, Menasha, Wisconsin. Subscription, \$10.00 per year; foreign, \$11.00.

THE INSTITUTE

The Institute of Radio Engineers serves those interested in radio and allied electrical-communication fields through the presentation and publication of technical material. In 1913 the first issue of the PROCEEDINGS appeared; it has been published uninterruptedly since then. Over 1500 technical papers have been included in its pages and portray a currently written history of developments in both theory and practice.

STANDARDS

In addition to the publication of submitted papers, many thousands of man-hours have been devoted to the preparation of standards useful to engineers. These comprise the general fields of terminology, graphical and literal symbols, and methods of testing and rating apparatus. Members receive a copy of each report. A list of the current issues of these reports follows:

Standards on Electroacoustics, 1938
Standards on Electronics, 1938
Standards on Radio Receivers, 1938
Standards on Radio Transmitters and Antennas, 1938.

MEETINGS

Meetings at which technical papers are presented are held in the twenty-one cities in the United States and Canada listed on the inside front cover of this issue. A number of special meetings are held annually and include one in Washington, D. C., in co-operation with the American Section of the International Scientific Radio Union (U.R.S.I.) in April, which is devoted to the general problems of wave propagation and measurement technique, the Rochester Fall Meeting in co-operation with the Radio Manufacturers Association in November, which is devoted chiefly to the problems of broadcast-receiver design, and the Annual Convention, the location and date of which is not fixed.

MEMBERSHIP

Membership has grown from a few dozen in 1912 to more than five thousand. Practically every country in the world in which radio engineers may be found is represented in our membership roster. Approximately a quarter of the membership is located outside of the United States. There are several grades of membership, depending on the qualifications of the applicant. Dues range between \$3.00 per year for Students and \$10.00 per year for Members. PROCEEDINGS are sent to each member without further payment.

PROCEEDINGS

The contents of each paper published in the PROCEEDINGS are the responsibility of the author and are not binding on the Institute or its members. Material appearing in the PROCEEDINGS may be reprinted or abstracted in other publications on the express condition that specific reference shall be made to its original appearance in the PROCEEDINGS. Illustrations of any variety may not be reproduced, however, without specific permission from the Institute.

Papers submitted to the Institute for publication shall be regarded as no longer confidential. They will be examined by the Papers Committee and Board of Editors to determine their suitability for publication. Suggestions on the mechanical form in which manuscripts should be prepared may be obtained from the Secretary.

SUBSCRIPTIONS

Annual subscription rates for the United States of America, its possessions, and Canada, \$10.00; to college and public libraries when ordering direct, \$5.00. Other countries, \$1.00 additional.

The Institute of Radio Engineers, Inc.

Harold P. Westman, Secretary

330 West 42nd Street

New York, N.Y.



Copyright, 1939, by The Institute of Radio Engineers, Inc.



The Relation of the Carrying Car to the Accuracy of Portable Field-Intensity-Measuring Equipment*

JOHN H. DEWITT, JR.†, MEMBER, I.R.E., AND ARTHUR C. OMBERG‡, NONMEMBER, I.R.E.

Summary—The distortion of radio-frequency fields in the vicinity of automobiles is shown to be due to a secondary field resulting from eddy currents induced in the metal parts by the primary field. Theory and experiment demonstrate that the error of measurement caused by the presence of a metal-body car is independent of frequency within the broadcast band. It is shown that the distortion of the field changes with the position of the car, being greatest when the car is in line with the direction of the source and least when the length of the car is normal to the direction of the source. One method of equalizing this difference is pointed out. Measured field contours around three types of automobiles are illustrated.

FOR some time it has been known that metal objects such as automobiles may introduce errors in field-intensity measurements made in their vicinity; however, the magnitude and direction of these errors as well as their underlying cause, have been the subject of much controversy. Engineers have reported finding both increases and decreases from the correct values when field intensities were measured with a loop antenna mounted above an automobile with a metal body. The advent of the "turret" or all-metal automobile top has greatly increased both the interest in and the controversy over this subject.

In calibrating a mobile field-intensity-measuring apparatus constructed at station WSM, definite errors were found when readings were made with the equipment placed inside an all-metal truck and connected to a 17-inch loop antenna mounted with a lower corner about 6 inches above its top. The values obtained with the loop in this position would not agree with those found with the equipment in the same relative position with respect to the earth, but with the truck removed to some distance. An investigation of the phenomenon was undertaken with the following three aims in mind: First, to determine the magnitude of the error, its dependence upon the position of the truck relative to the source, its dependence upon the position of the loop antenna relative to the truck, and its dependence upon the frequency of the measured voltage. Second, to investigate the causes, with the ultimate hope of applying simple electrical circuit theory to predict the magnitude and direction of these errors in similar cases.

* Decimal classification: R270. Original manuscript received by the Institute, June 1, 1938.

† Chief Engineer, Station WSM, Nashville, Tennessee.

‡ Transmitter Engineer, Station WSM, Nashville, Tennessee.

Third, to develop some means of automatically compensating such errors.

A very simple but effective experimental technique was employed in securing data on the apparent distortion of the radio-frequency field: A small search coil was used as a pickup device in conjunction with an accurately calibrated radio receiver-voltmeter. The coil size was reduced to a small diameter in order to make it possible to sample areas of the field in close proximity to the automobile bodies under study. The exploring coil which was 4 inches in diameter and 2 inches long was electrostatically shielded and was connected to the radio receiver input through a 20-foot length of flexible concentric transmission line.

The coil and line were tested for "antenna" effect by measuring the strength of a known field with the plane of the coil first at an angle of zero and next at an angle of 180 degrees to the source. Any residual antenna effect is revealed in this manner as an inequality in the two readings. The receiver-voltmeter was checked for linearity of indication by introducing known voltages into its input from a General Radio type 605-A signal generator.

A large open field, free from power lines, wire fences, and other objects which might distort the field was selected as the site for all measurements. An area 20 by 20 feet was explored to a height of 15 feet in space in order to determine the degree of uniformity of the field from three near-by broadcast stations. The field produced by each of the three stations was found to be uniform within 2 per cent within the region explored. The three broadcast stations operate on frequencies of 650, 1210, and 1470 kilocycles, and have field strengths of 130, 12, and 40 millivolts per meter, respectively, at the point of measurement. Three types of automobile, an all-metal 1937 model Dodge truck, a 1936 model Ford Tudor sedan with a nonconducting top,¹ and a 1937 model Pontiac station wagon with a combination

¹ A radio antenna, made of wire netting, mounted in the top of the car and insulated from it, was standard equipment for the 1936 model Fords. No difference in the distribution of the field could be found when this antenna was connected to the body of the car at one point or left insulated from it.

wood and metal body, were each in turn driven into the previously tested area. The field was then re-measured and its distribution about each type of car found at each of the above-mentioned frequencies.

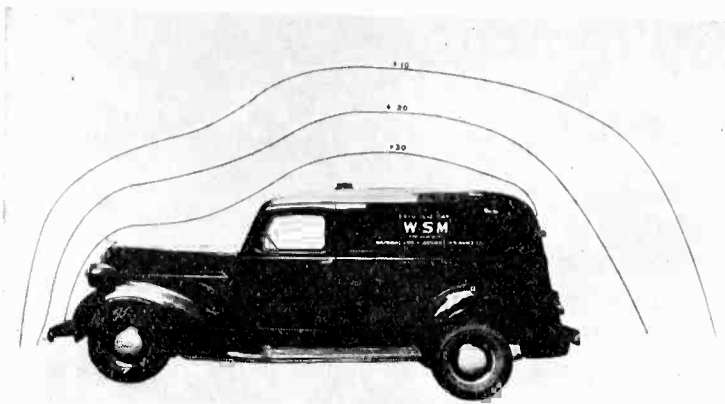

Fig. 1—All-metal truck. Direction of the car parallel to the direction of the source showing contours in the plane through the car center.

This was done by plotting radials (field strength versus distance) from each of the three automobiles and the isopotential points taken from these curves. From these points, field-strength contours were obtained and plotted about pictures of each car. These measurements were repeated with each car pointing toward, away, and at right angles to the sources. The data, which included nearly 1000 measurements, revealed three interesting and important facts.

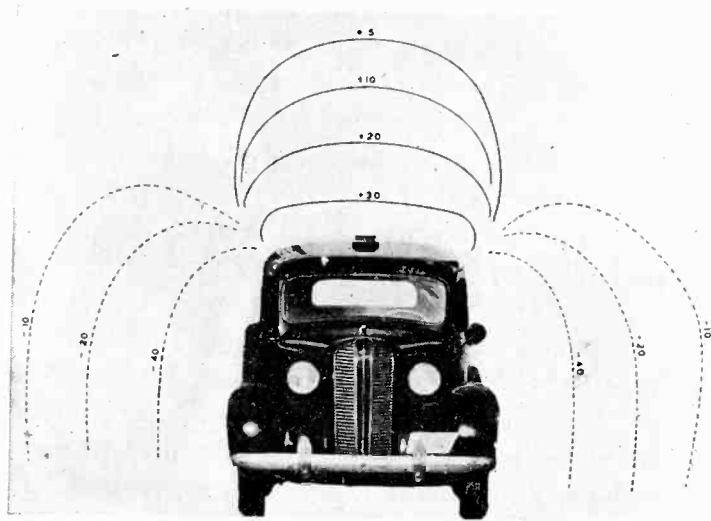

Fig. 2—All-metal truck. Direction of the car parallel to the direction of the source showing contours in the plane through the loop socket position.

1. The presence of the car may serve to increase or decrease the measured field strength, depending upon the location of the loop with respect to it.

2. The magnitude of the error varies with the angle of the car relative to the source. As might be expected, the error is the same whether the car is pointed toward or away from the source.

3. The error is independent of the frequency of the field within the frequency range from 650 to 1470 kilocycles.

Figs. 1 to 9 show the effect of three types of car on a uniform field at broadcast frequencies. In all illustrations the numbered contours represent the percentage change in field intensity due to the presence of the car. Although it is not shown in the

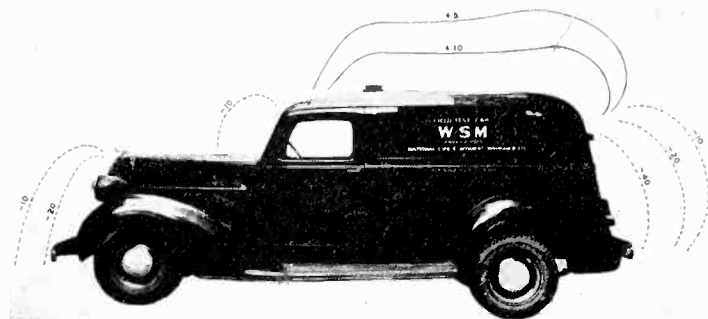

Fig. 3—All-metal truck. Direction of the car at right angles to the direction of the source showing contours in the plane through the car center.

figures, it was found that the direction as well as the magnitude of the field was changed. However, this change in direction was negligible at all points above the cars, and as loop antennas are generally placed in this position it was not thought worth while to investigate the effect further.

A study of the contours reveals that errors of the order of 25 per cent may be expected, and that a correction factor cannot be applied unless the angle of the car relative to the source is considered, which

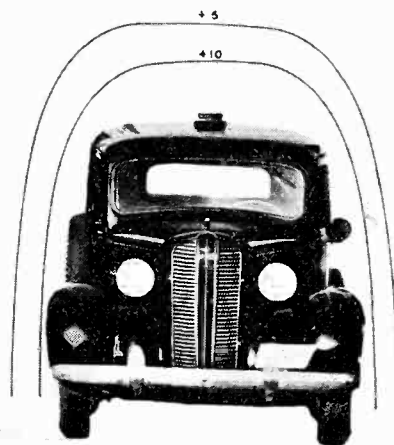

Fig. 4—All-metal truck. Direction of the car at right angles to the direction of the source showing contours in the plane through the loop socket position.

is, of course impracticable where a large number of measurements are to be made.

In order to gain an understanding of the mechanism causing the distortion of the field, a sheet of

metal, 4 feet by 8 feet, was set up, first parallel and then perpendicular to the surface of the earth. The field in its neighborhood was explored with the search coil used in the car measurements. Care was taken in all cases to see that the coil was not detuned by the proximity of the metal. It was found by this investigation that the distortion was maximum when the plane of the metal was perpendicular to the earth

sequently aid the primary field. Since the current induced in a closed loop depends primarily upon the inductance of the loop at radio frequencies so long as its Q is reasonably high,² the field of the induced cur-

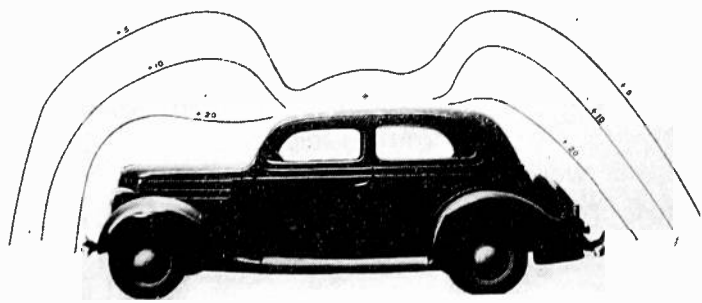

Fig. 5—Car with leatherette section in the top. Direction of the car parallel to the direction of the source showing contours in the plane through the car center.

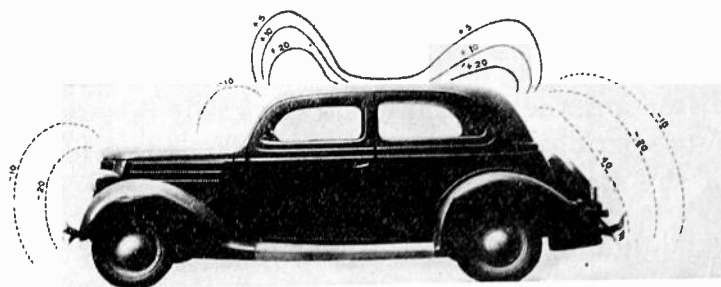

Fig. 7—Car with leatherette section in the top. Direction of the car at right angles to the direction of the source showing contours in the plane through the car center.

rent should be practically independent of the material of the conductor and of the frequency. Changes

and in line with the source, and was zero when the plate was at right angles to a line drawn through the source, or when the plate was parallel to the earth. There was no measurable difference between copper and iron sheets.

These findings made it apparent that the induced current in the closed loop formed by the distorting body when normal to the direction of the magnetic lines of force, was the primary cause of the changes in field distribution. By Lenz's law, the current induced in a conductor by a magnetic field has a field which opposes the original field. The field of the in-

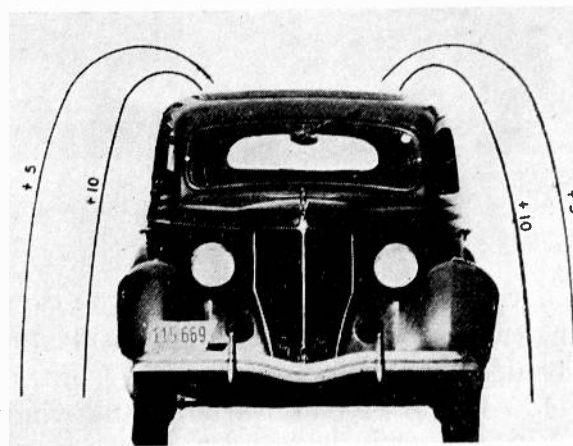

Fig. 8—Car with leatherette section in the top. Direction of the car at right angles to the direction of the source showing contours in the plane through the door handles.

in the resistance with frequency due to skin effect, and to large differences in resistivity of the metal

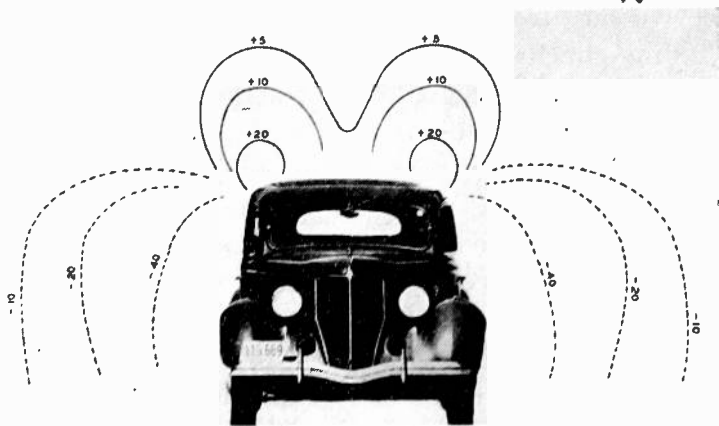

Fig. 6—Car with leatherette section in the top. Direction of the car parallel to the direction of the source showing contours in the plane through the door handles.

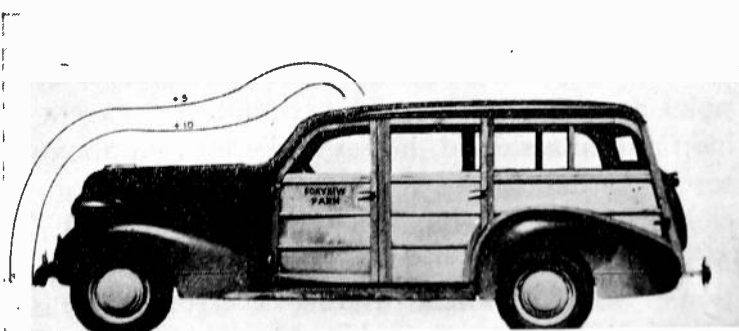

Fig. 9—Wood-body station wagon. Direction of the car parallel to the direction of the source showing contours in the plane through the car center.

duced current, therefore, opposes the primary field along all lines which intersect the metal, causing reduction in total field strength. The field is increased at all points lying within the return field since here the direction of the lines has reversed and they con-

would, of course, make the field vary with both frequency and resistivity, but for frequencies within the broadcast band no difference was found between the

² Q is used to denote the ratio of reactance to resistance.

distorting effect of iron and copper. The fact that the distortion is independent of frequency further strengthens the probability of induced current as being the underlying cause of the distortion, rather than changes in dielectric constant, permeability, hysteresis losses, resonance effects, etc., as have been suggested.

On the basis of the induced current causing the distortion, the resultant field can easily be predicted. A prediction of this type was made for the field inside of the station wagon, shown in Fig. 9. The theory

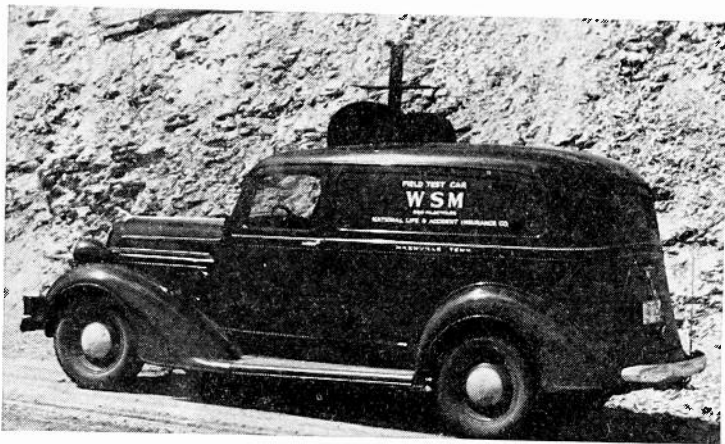

Fig. 10—All-metal truck with loop antenna and compensating fins in place.

indicated that when the direction of the car was at right angles to the source the field inside the body should be decreased at points near the front, because of the closed loop of metal around the windshield, and that it should be increased at points over the top of the seat because of the closed loop of metal in the seat springs. Both predictions were verified by measurement.

With the theory in mind it is quite easy to locate the current centers in the cars shown in Figs. 1 to 9 and to see why the contours take on the forms indicated. The wood-body station wagon (Fig. 9) is almost completely free of any field distortion at any point at which a measuring set might be placed. The loop antenna should, however, be located above the top, in order to get it as far as possible from the closed loop of the metal windshield frame.

The Ford Tudor with the leatherette top construction (Figs. 5 to 8) may produce an error of 5 per cent when pointed toward or away from the source even if the loop antenna is of small dimensions and is located

in the most favorable position. This happens to be near the center of the nonmetallic section of the top. The error will change about 5 per cent with car position. Location of the loop at any other point near the top of the car will produce large and uncontrollable errors.

The all-metal truck shown in Figs. 1 to 4 produces the greatest distorting effect as might be expected. With a square loop 17 inches on a side mounted in the loop socket shown in the photograph, the error is about plus 30 per cent when the truck is in line with the station direction and plus 10 per cent when normal to the station direction. In order to compensate this differential error two curved fins of copper were mounted on the top of the truck near the loop antenna so that the loop was partially inside the area of decreased field. With the truck pointed in the direction of the source, the metal fins were cut down until their field reduced the resultant field to the same magnitude as measured with the truck at right angles to the source. The fins were then shaped so as to compensate the error at intermediate positions. This resulted in a constant error of plus 10 per cent for all positions of the truck relative to the source. Complete compensation was perfectly possible but was decided against because of the increase in wind resistance caused by such an arrangement. The residual error of 10 per cent was included in the loop constant and thereafter appeared as a multiplier in field-intensity calculations. Fig. 10 shows the truck with the loop and compensating fins in place.

Close analysis of all data taken at the three frequencies (650, 1210, and 1470 kilocycles) did not reveal any trend of error with frequency. Since this finding checks with theory it is more than reasonable to assume that the error is constant over the band 550–1600 kilocycles. Just how high in frequency this theory will hold is a matter of conjecture but it certainly should be valid up to the point where the dimensions of the car begin to become an appreciable fraction of a wavelength in size.

ACKNOWLEDGMENT

The authors wish to acknowledge the valued assistance of Mr. J. S. Campbell who carried out much of the experimental work in connection with this paper.

Some Principles in Aeronautical Ground-Radio-Station Design*

P. C. SANDRETTO†, ASSOCIATE MEMBER, I.R.E.

Summary—This paper describes the problems of adjacent-channel interference that were encountered when the air-transport industry established numerous voice radio circuits. It describes the early solutions to this problem and the later investigations and equipment corrections necessary.

INTRODUCTION

WHEN the need for aeronautical ground radio stations arose in 1928, the greatest amount of radio voice-communication equipment in use was for broadcast purposes. There were some stations used for commercial telephony but, as far as can

is believed that the stage has now been reached where these problems may be reviewed and certain standards set down for the guidance of future builders or buyers of aeronautical ground-radio-station equipment. Other point-to-point communication problems may be found to have more in common with the aeronautical ground station than with the broadcast station; hence, designers of related equipment may be able to utilize certain portions of the solutions to be presented.

THE PROBLEM

Fig. 1 shows a map of the Chicago Municipal Airport. The problem here is typical of that encountered at all of the major airports in the United States. This map shows that 11 transmitters are located within an

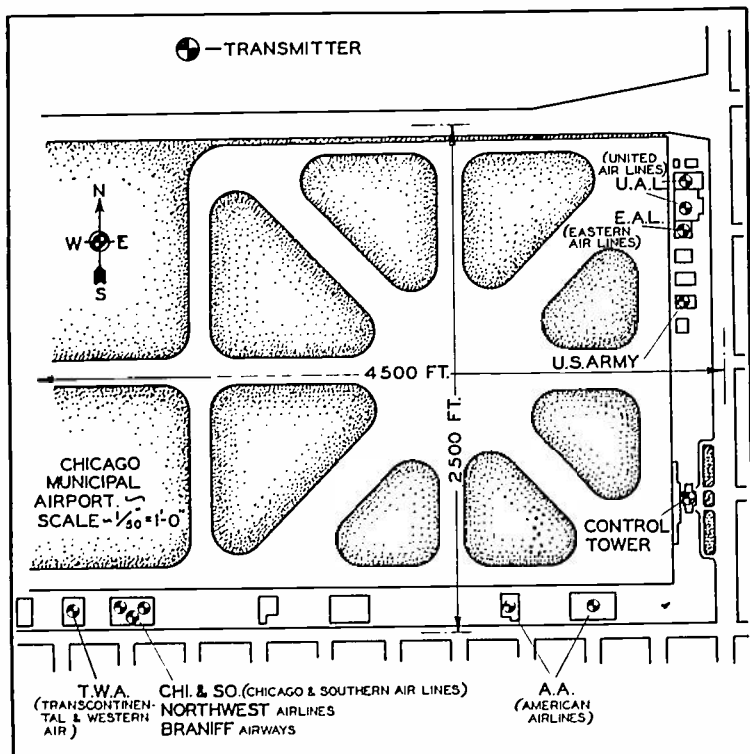

Fig. 1

be determined, there were no extensive radiotelephone circuits in use at that time. It was not surprising then, that the equipment designed for the aeronautical station was patterned after broadcast equipment and differed only from such equipment in its somewhat narrower audio-frequency response band. After this first equipment had been in operation for some time, various problems of aeronautical communications, which had not been foreseen at the time of design, presented themselves, and these were dealt with by a certain amount of minor redesign. It

* Decimal classification: R520. Original manuscript received by the Institute, November 5, 1937; revised manuscript received by the Institute, May 23, 1938. Presented before Chicago Section, October 15, 1937.

† Communications Engineer, United Air Lines Transport Corporation, Chicago, Illinois.

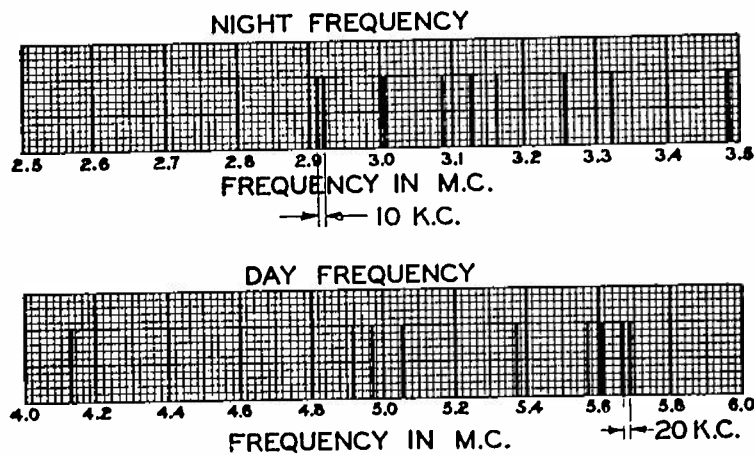

Fig. 2—Frequencies in use at the Chicago Municipal Airport.

area of less than one-half square mile. Omitting the airport transmitter which is on 278 kilocycles and the army transmitter which operates only at irregular intervals, Fig. 2 shows the positions of the remaining stations in their appropriate frequency band. It will be seen that there are stations near 5600 kilocycles which have frequency separations of only 20 kilocycles, or 0.36 per cent. The minimum frequency separation in the broadcast band is 10 kilocycles, or 0.67 per cent, and the separation for broadcast stations in a common area somewhat equivalent to the close association of the stations at the airport is several times greater than 10 kilocycles.

Another feature of this problem is that the maximum air-line distance between any two stations is only 3850 feet. Each station has a transmitter with an output of 400 watts and a receiver on which signals having a field strength of only 10 microvolts per

meter are being received.¹ When one remembers that early receivers consisted only of several tuned-radio-frequency stages, it can be seen that the conditions present make for very unsatisfactory radio operation.

PRESENT RECEIVING STATIONS

Qualitative and more detailed study of the problem just presented will be given later in this paper.

The method for obtaining aeronautical radio reception in common use today consists in finding an interference-free location in a suburb near the airport by a series of "listening" tests. The receiver (only) is moved to the garage or basement of some resident at this location. A line rented from the telephone company serves to bring the output of the receiver to the airport, where the radio operator and the transmitter are located. An audio-frequency tone put into the line at the airport and interrupted by means of a telephone dial serves to control the gain and frequency of the receiver. While these remotely located receivers are in general use, and will probably remain in use regardless of additional developments, there are factors which show that further developments are in order. Whenever a tube fails, a fuse blows, or the local power fails, it is necessary for a radio serviceman to leave the airport and travel several miles in order to examine the receiver and make the necessary repairs. During the time that the remote receiver is out of repair, radio watch is maintained by means of a local receiver, and, to be effective, the local receiver should be free of adjacent-channel interference. It often happens that the airport is an excellent receiving location were it not for the interference from the other air lines on the airport. These factors definitely call for effective local receivers.

THE PROBLEM AT THE RECEIVER

The interference was being experienced at the receiver, so it seemed only logical that the first attempt to clear up the problem was to improve the receiver. About the time it was decided that the selectivity of the radio receiver should be improved, superheterodyne receivers for 3 and 6 megacycles became commercially available. The selectivity curves of these receivers showed excellent characteristics. Over-all selectivities of from 50 to 80 decibels for frequencies 20 kilocycles from resonance seemed sufficient to prevent the adjacent-side-band interference. When these receivers were installed, however, it was found that except for some reduction in the intelligibility of the interference, there was no diminution in the amount of interference.

¹ R. L. Jones and F. M. Ryan, "Air transport communication," *Trans. A.I.E.E.*, vol. 49, p. 190; January, (1930).

If, for purposes of comparison, the field strength is computed 1000 feet from a 400-watt transmitter equipped with a quarter-wave antenna, the field strength will be given by

$$E_f = \frac{6140\sqrt{P}}{d}$$

where,

E_f = field strength in microvolts per meter,
 d = distance from transmitter in miles, and
 P = transmitter power in watts.

If the antenna efficiency is assumed to be 100 per cent, E_f will be 650,000 microvolts per meter. If, again for purposes of comparison, it is assumed that the signal from the above transmitter is received on a quarter-wave antenna, the voltage induced will be given by²

$$E_i = E_f\lambda/2\pi.$$

If the frequency is 6 megacycles, E_i will be 5,180,000 microvolts. If the receiver attached to the receiving antenna is coupled across a 50-micromicrofarad condenser which, together with a coil having a Q of 150, forms a series-resonant circuit, the voltage across the receiver input will be 63 volts. If there is an interfering station in the same relative position with the same power, but 20 kilocycles from the carrier of the station, the voltage of which was computed above, the series-resonant circuit will attenuate the interfering signal about 3 decibels. The interfering voltage across the receiver will be about 43 volts. This illustrates the fact that in most cases the high selectivity, shown by the selectivity curve for a receiver, means nothing in so far as local adjacent-frequency interference is concerned. High values of voltage reach the grid of the first tube and swing it from cutoff on negative peaks to overload values on positive peaks. A 10-microvolt-per-meter signal coming from the plane appears as modulation on the interfering frequency.

No amount of preselection, as long as it involves thermionic devices, would remedy the condition just described. This analysis shows why the multistage vacuum-tube wave traps used prior to the high-frequency superheterodyne receiver had failed to improve reception conditions. The above computations are not absolutely correct when applied to specific cases; however, they show that the satisfactory solution to the adjacent-channel interference must consist of a highly selective device which will have an essentially linear transmission characteristic for large values of input voltage. This device should be placed between the antenna and the first tube and would discriminate against undesired signals without gener-

² W. S. Everitt, "Communication Engineering," First Edition, p. 513, McGraw-Hill Book Company, (1932).

ating new interfering frequencies by cross modulation. Following this line of thought, complicated networks consisting of coils and condensers were constructed. These networks were not highly satisfactory because they were very difficult to adjust and the highest Q attainable did not give sufficient selectivity. The next step was the use of quartz-crystal resonators in a carefully balanced bridge circuit. All of the resonant characteristics of quartz crystals published in earlier articles and texts showed a single peak. These characteristics probably hold true for low-frequency crystals, but are not true for simple high-frequency crystals ground for oscillation at 3 and 6 megacycles. Fig. 3 shows the characteristics actually obtained for one of these resonators. Investigation disclosed the following factors affecting the multiple resonant peaks of a quartz resonator:

1. The thickness of the crystal for any given frequency.
2. The area of the crystal.
3. The perfection of the crystal surface.

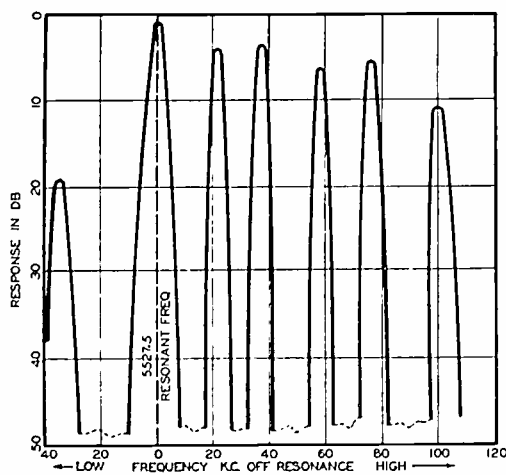

Fig. 3—Filter characteristics—commercial "AT"-cut quartz crystal.

Early work on quartz resonators was done with "AT"-cut types. This cut has a very low thickness-frequency coefficient, and it was found almost impossible to obtain a single-peak characteristic with this cut. The "BT" cut was used in order to obtain a zero temperature coefficient and a comparatively "thick" crystal. One-inch-square quartz plates of the type which had been used with oscillators were used in the first experimental preselectors. These plates were reduced to one fourth their previous area, with considerable improvement in performance. The last traces of spurious peaks were eliminated by carefully removing all unevenness from surfaces. The surfaces of the high-frequency resonator crystals must be ground to far greater accuracy than those of oscillator crystals.

The resultant preselector gave the characteristics

shown on Fig. 4. At 10 kilocycles from the resonant frequency, the response is down by 70 to 80 decibels. This curve was obtained with a power oscillator and a vacuum-tube voltmeter. When the preselector was

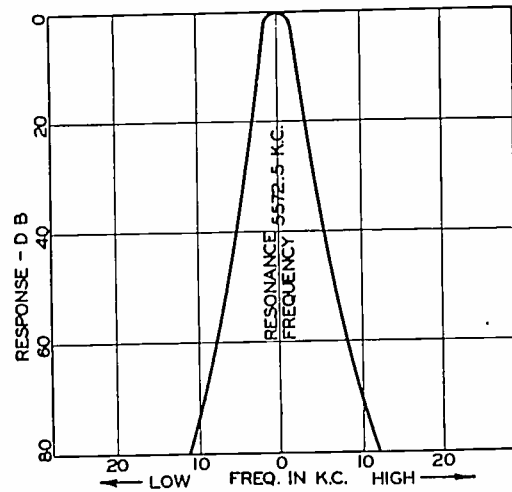

Fig. 4—Preselector characteristics.

connected to a receiver, leakage through the device reduced the selectivity to about 25 decibels at a frequency 10 kilocycles from resonance (see Fig. 5). This corresponds to the selectivity³ obtained from a circuit with a Q of about 5000. At 20 kilocycles from resonance, the selectivity should be about 40 decibels. Applying this to the calculation of voltage at the receiver, the interference is now 0.63 volt, and should not cause cross talk. With cross talk eliminated from the first tube, the selectivity of the remainder of the receiver can eliminate the interfering signal.

When the preselector was tested in the operating room, the interference came through until the radio

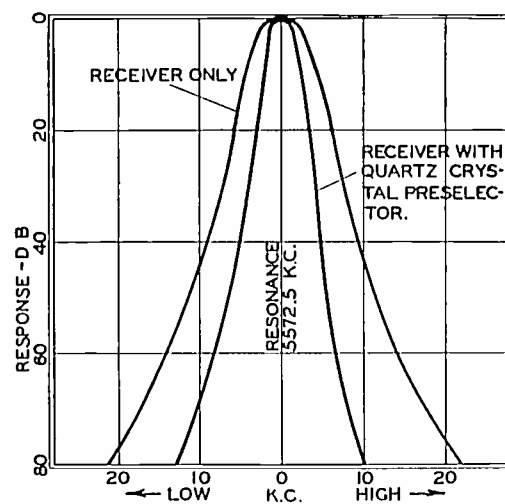

Fig. 5—Selectivity of United Air Lines model ES-192 ground-station receiver.

frequency picked up by control and power wires was reduced by filtering all receiver external leads. With this last step, the interference was greatly reduced but not eliminated. Interfering signals came through

³ B. delF. Bayly, "Selectivity, a simplified mathematical treatment," Proc. I.R.E., vol. 19, p. 880; May, (1931).

the receiver, no longer as the intelligible signals that earlier obliterated reception but as occasional "blurps." Receiver characteristics showed that the selectivity was such that reception was hardly possible unless the interfering station was directly on the frequency to which the receiver was tuned. It was concluded that the transmitter must be generating energy on this frequency. The next step was to investigate the transmitters in use at the aeronautical ground stations.

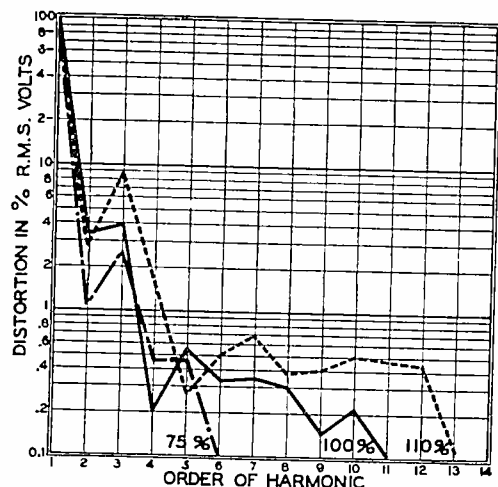

Fig. 6—Harmonic distortion of 9-type transmitter for various percentages of modulation.

TRANSMITTER INVESTIGATION

Probably the most common radiotelephone transmitter in use at aeronautical ground stations is the Western Electric 9 type. A number of changes have been made in the majority of these transmitters, but the changes are mechanical to a large extent, and the circuit is fundamentally the same as it was when the transmitters were originally designed. They employ a crystal-controlled oscillator using a 205-D tube, another 205-D tube as a doubler, a 261-A tube as a modulating amplifier, and a 251-A tube as a class B power amplifier. The 261-A tube is plate modulated with three 261-A class A audio-frequency tubes. All of these tubes are manufactured by the Western Electric Company.

A study was made on a 9-type transmitter, and it is believed that the principles learned through this study are general enough to apply to any transmitter intended for aeronautical ground-station use. This transmitter had been designed to work directly from a carbon microphone of sufficiently high level, and no audio-frequency preamplifier had been included. In order for the microphone to put out sufficient power, it was necessary that the operators talk loudly. Later preamplifiers were installed. In order to assure proper audio-frequency input to the transmitter, monitoring meters were installed in connection with gain controls. Each operator was

expected to monitor his own transmissions. Self-monitoring proved unsuccessful because operators were far too busy handling necessary message forms or reading information from weather printers to give proper attention to the audio-frequency input. Gain controls were operated only when the modulation was sufficiently great to cause arcing-over in the transmitter.

The fact that transmitters were being overmodulated was recognized at about the same time efforts were being made to add selectivity to the tuned-radio-frequency receiver. An input amplifier which would keep its output constant for input values over a range of 15 decibels was designed and installed. This constant-level amplifier was of great help in improving the operating problem, but little change was noticed as far as the adjacent side-band-interference problem was concerned. In order to study the effects of modulation on interference, the harmonic distortion curve shown on Fig. 6 was obtained for the transmitter with a 1000-cycle modulating frequency and no external speech amplifier. It can be seen that with modulation at 75 per cent, one tenth of one per cent of the 6th harmonic was measured, but if modulation had been 110 per cent, radio-frequency voltage with an amplitude of one tenth of one per cent of fundamental is still present at the 13th harmonic. It will be noted that radio-frequency voltage with an amplitude of four tenths of one per cent is present up to the 12th harmonic with the transmitter modulated 110 per cent. By 110 per cent

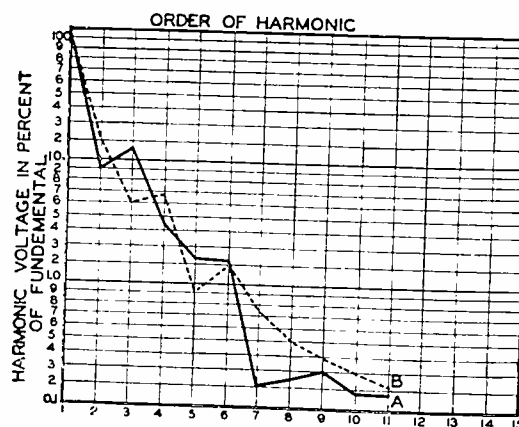

Fig. 7—Distortion with input amplifier.
A—audio-frequency input to produce 110 per cent modulation, no amplifier.
B---same audio-frequency input with amplifier.

modulation is meant that condition which produces on an oscilloscope, a modulated wave pattern reduced to zero for an interval of time corresponding to modulation of a carrier by an audio-frequency wave, the maximum amplitude of which is 10 per cent greater than the amplitude of the carrier wave. If the modulating frequency had been 2000 cycles, the 10th harmonic would have fallen directly on the

adjacent channel, where no amount of receiver selectivity could have removed the disturbance. A study of the constant-level-input amplifier gave the distortion curves of Fig. 7. Curve *A* was taken with an audio-frequency input such as to cause 110 per cent modulation. Curve *B* shows the resultant distortion when the same audio-frequency input is connected to the automatic amplifier. From a comparison of curves *A* and *B* (Fig. 7) it can be seen that the constant-level-input amplifier does not bring about a reduction in the amount of distortion. This happens to be true for the value of audio-frequency input chosen for obtaining the curves of Fig. 7, but with higher inputs, this amplifier reduces harmonic distortion. Investigation showed that in attempting to design this early constant-level amplifier so that it could reduce instantaneous high-peak input, the control-voltage time constant had been made so small that the resulting control caused distortion. In other words, this amplifier prevented distortion in the modulating amplifier and output stage but increased the harmonics in the transmitter input audio-frequency voltage.

The problem of designing a new automatic amplifier with a sufficiently long control-voltage time constant so that it would not distort the audio-frequency wave which it was amplifying, and yet act rapidly so as to prevent momentary high audio-frequency peaks from reaching the transmitter, was solved by an amplifier consisting of two parts. The first part is a true automatic monitoring amplifier with a long control-voltage time constant. The input audio-frequency voltage is amplified by the control

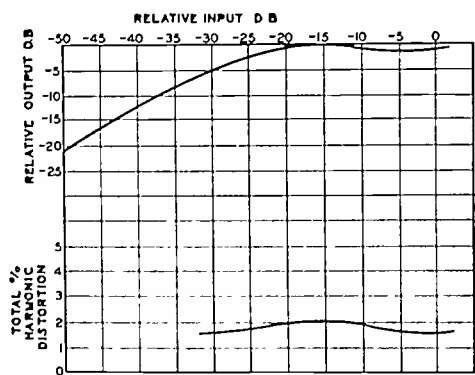

Fig. 8—Control-distortion curves for constant-level amplifier.

section of the amplifier, rectified, and applied to control the gain of the speech amplifier proper. The time constant was chosen as 3 milliseconds and gives control at a speed which will not cause audio-frequency distortion for a 400-cycle wave. The resultant amplifier has the steady-state characteristic shown on Fig. 8. Distortion over the entire range of microphone input does not exceed two per cent. The out-

put voltage is maintained constant to within 2 decibels for input voltage variations of 26 decibels. The second part of the amplifier can be called a peak-limiting device. It consists of a circuit across the output of the audio-frequency amplifier tube. This circuit was designed to have a zero time constant, but it does not act unless the input voltage is of such magnitude that it would cause overmodulation in the transmitter. This peak-control device operates on

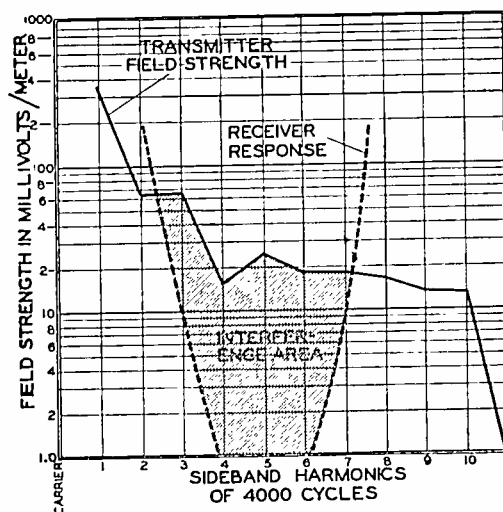

Fig. 9

suddenly applied peaks, and remains operating until the control of the monitoring amplifier has had sufficient time to come into play and reduce the amplifier gain. It is true that this peak-control device causes a certain amount of distortion, but, as will be shown later, it is best to cause distortion here rather than allow it to occur in the modulating amplifier and output stage.

Referring back to Fig. 6, it will be seen that the total harmonic distortion at 100 per cent modulation would not amount to more than 6 per cent. This figure is quite low even when compared with the distortion figures of broadcast transmitters. This low figure is true because there is only a single class A audio-frequency stage in the transmitter, and this stage need not be operated at capacity in order to secure 100 per cent modulation. The only other distortion is caused by nonlinearity in the modulating amplifier and output stage.

The per cent distortion may be computed in terms of watts of side-band power, which power may be used to compute the field strength produced at a given distance from the antenna. The side-band field strength 1000 feet from a 9-type transmitter working into a quarter-wave vertical antenna was computed for the case where the transmitter is modulated 100 per cent by a 4000-cycle audio-frequency wave. These computed data were plotted on Fig. 9. On the same figure is plotted the selectivity curve of the

ground-station receiver equipped with a crystal pre-selector as previously described. This receiver is tuned to respond to a frequency 20 kilocycles from the transmitter carrier. It is assumed that the receiver is adjusted to respond to a 10-microvolt-per-meter signal. The area enclosed between the two curves represents the interference that may be ex-

TABLE I

Modulating Frequency (Cycles per Second)	Order of Interfering Harmonic	Interference Field Strength in Microvolts per Meter
2000	10	14
2856.3	7	18
4000	5	21
5000	4	18
6666.7	3	65
10000	2	65

pected. Actually, no area exists if the audio frequency is a pure sine wave; however, since the human voice is not a constant-frequency tone, the input voltage will vary above and below 4000 cycles, and the area of Fig. 9 is a fairly accurate analysis of what actually takes place. The results are somewhat surprising. Despite the fact that receiver selectivities are very high and transmitter distortion is low, spurts of power originating from the harmonics of the voice frequencies appear at the receiver at high magnitudes compared with the field strength of the desired signal. These extraneous signals are present because of the distortion in the transmitter. The field strength of an individual signal is a function of the amount of distortion peculiar to the particular transmitter from

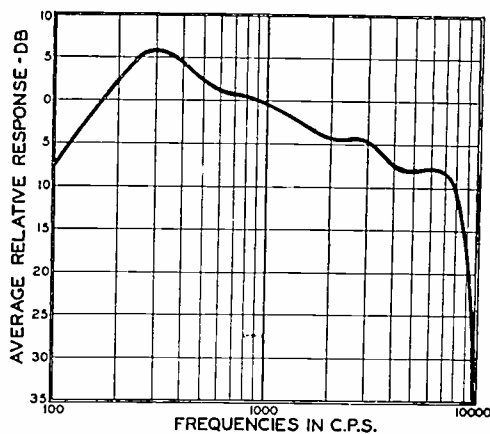

Fig. 10—Fundamental audio frequencies present in transmitter output when transmitter is modulated by a male voice.

which it is emitted and what harmonic it is of the fundamental frequency from which it had its derivation. Generally speaking, if the 5th harmonic of 4000 cycles falls on an adjacent frequency band, the 10th harmonic of 2000 cycles will interfere with much less power. Also it follows that if, for a particular transmitter, the 10th harmonic is the highest-order harmonic with sufficient power to cause interference to the nearest adjacent channel, all audio frequencies

above 2000 cycles put into the transmitter will cause interference. This principle may be demonstrated by assuming that the adjacent channel is 20 kilocycles from the carrier frequency of the interfering station and by arranging the data of Fig. 9 in Table I. From this table it is evident that if the receiver being interfered with can respond to a 14-microvolt-per-meter signal, all frequencies greater than 2000 cycles will produce interfering signals.

We ordinarily think of the male operator as having a voice made up largely of the lower frequencies. Fig. 10 was constructed by modifying the data given in *Speech Power and Its Measurements*⁴ in accordance with the audio-frequency characteristics of the 9-type radio transmitter. From this curve it can be seen that the audio-frequency voltage, which will

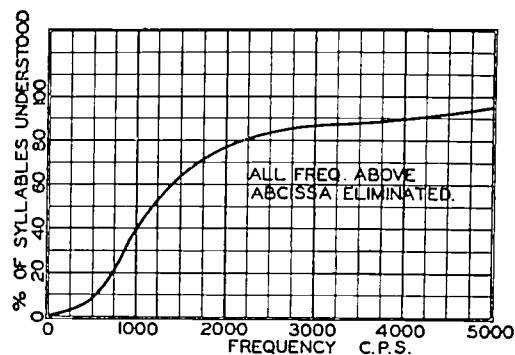

Fig. 11—H. Fletcher, "Interpretation of speech," *Jour. Frank. Inst.*, vol. 6, p. 193; June 6, (1922).

be present in the transmitter if a male operator were speaking into the microphone, would be composed of 1000- to 8000-cycle frequencies with less than 17 decibels difference in their relative amplitudes. If the line marked zero level on Fig. 10 represents the average input level, high frequencies to 7000 cycles will be down only 8 decibels from this average value. Fig. 9 suggests that adjacent-channel interference may be reduced if as many of the high frequencies of curve 10 as practicable are removed. This practice would remove all frequencies, the harmonics of which would have sufficient power to cause adjacent-channel interference and all distortion frequencies generated in the audio-frequency system where the fundamentals are below the cutoff frequency and the 1st harmonic falls at a frequency higher than the cutoff frequency. The only interference frequencies generated must be high-order harmonics originating in the radio-frequency sections of the transmitter. With linear radio-frequency stages of reasonably good design, these high-order harmonics will not have magnitude sufficient to cause interference if the input amplifier prevents overmodulation.

Fig. 11 gives the percentage of syllables understood

⁴ L. J. Sivian, "Speech power and its measurement," *Bell Sys. Tech. Jour.*, vol. 8, pp. 646-661; October, (1929).

when all frequencies higher than various abscissas⁵ are suppressed. The difference in the syllables understood when all frequencies above 5000 cycles are removed compared with those understood when all frequencies above 2500 cycles are removed is only 15 per cent. In his book *Speech and Hearing* Fletcher shows that any system having a syllabic intelligibility of 80 per cent will have an over-all intelligibility of 98 per cent or more if the over-all intelligibility is defined as the percentage of sentences received correctly. From the interference standpoint, the difference in choice of cutoff fre-

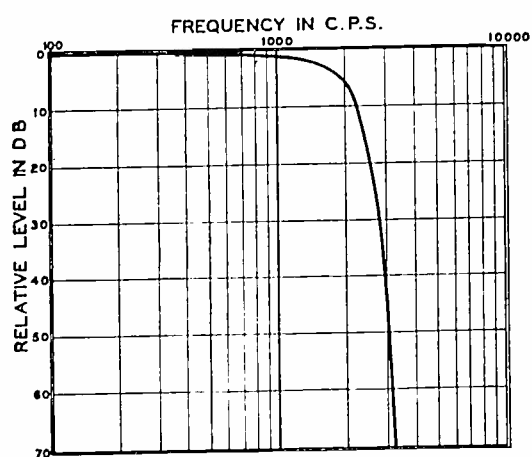

Fig. 12—2500-cycle low-pass filter characteristic.

quencies (2500 or 5000) would mean the difference between the 4th and 8th harmonic as the interference frequency. Filters with cutoff frequencies of 3500 and 2500 cycles were tested. The characteristic of the 2500-cycle low-pass filter is shown on Fig. 12. The 2500-cycle filter was somewhat more effective from the interference reduction standpoint, while the 3500-cycle filter gave better intelligibility. The

⁵ H. Fletcher, "Interpretation of speech," *Jour. Frank. Inst.*, vol. 193, p. 6; June, (1922).

proper cutoff frequency should be determined consistent with the conditions at the aeronautical ground station where interference reduction is to be effected. This filter should be placed in the circuit

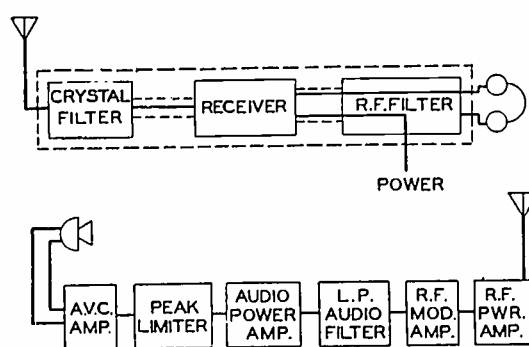

Fig. 13—Block diagram of interference-free, aeronautical ground station.

at the point where the audio frequency is introduced to modulate the radio frequency. By connecting this filter to the circuit in this manner, it follows all audio-frequency amplification; hence, it can remove all high-order harmonics caused by audio-frequency amplifier distortion (such as that caused by the action of the peak-control circuit).

CONCLUSIONS

Interference tests were made using a portable receiver on a frequency 35 kilocycles from that of the transmitter. Interference-free reception was possible when only 50 feet from the transmitting antenna. When the low-pass filter was removed, a distance of one and one-quarter miles was the separation necessary between the receiver and transmitter before interference-free reception could be had. The block diagram of Fig. 13 sums up the elements found necessary to complete the solution of the interference problem.

ground-station receiver equipped with a crystal pre-selector as previously described. This receiver is tuned to respond to a frequency 20 kilocycles from the transmitter carrier. It is assumed that the receiver is adjusted to respond to a 10-microvolt-per-meter signal. The area enclosed between the two curves represents the interference that may be ex-

TABLE I

Modulating Frequency (Cycles per Second)	Order of Interfering Harmonic	Interference Field Strength in Microvolts per Meter
2000	10	14
2856.3	7	18
4000	5	21
5000	4	18
6666.7	3	65
10000	2	65

pected. Actually, no area exists if the audio frequency is a pure sine wave; however, since the human voice is not a constant-frequency tone, the input voltage will vary above and below 4000 cycles, and the area of Fig. 9 is a fairly accurate analysis of what actually takes place. The results are somewhat surprising. Despite the fact that receiver selectivities are very high and transmitter distortion is low, spurts of power originating from the harmonics of the voice frequencies appear at the receiver at high magnitudes compared with the field strength of the desired signal. These extraneous signals are present because of the distortion in the transmitter. The field strength of an individual signal is a function of the amount of distortion peculiar to the particular transmitter from

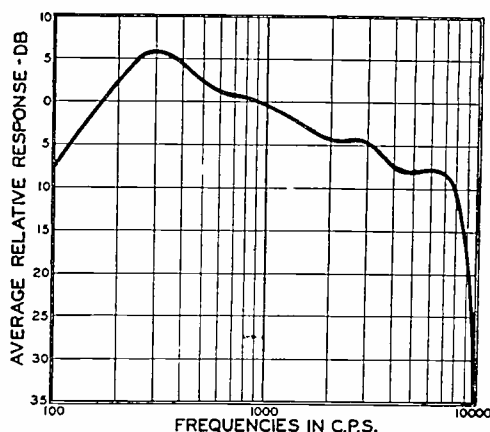

Fig. 10—Fundamental audio frequencies present in transmitter output when transmitter is modulated by a male voice.

which it is emitted and what harmonic it is of the fundamental frequency from which it had its derivation. Generally speaking, if the 5th harmonic of 4000 cycles falls on an adjacent frequency band, the 10th harmonic of 2000 cycles will interfere with much less power. Also it follows that if, for a particular transmitter, the 10th harmonic is the highest-order harmonic with sufficient power to cause interference to the nearest adjacent channel, all audio frequencies

above 2000 cycles put into the transmitter will cause interference. This principle may be demonstrated by assuming that the adjacent channel is 20 kilocycles from the carrier frequency of the interfering station and by arranging the data of Fig. 9 in Table I. From this table it is evident that if the receiver being interfered with can respond to a 14-microvolt-per-meter signal, all frequencies greater than 2000 cycles will produce interfering signals.

We ordinarily think of the male operator as having a voice made up largely of the lower frequencies. Fig. 10 was constructed by modifying the data given in *Speech Power and Its Measurements*⁴ in accordance with the audio-frequency characteristics of the 9-type radio transmitter. From this curve it can be seen that the audio-frequency voltage, which will

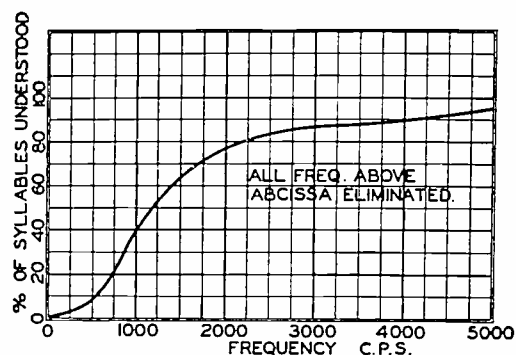

Fig. 11—H. Fletcher, "Interpretation of speech," *Jour. Frank. Inst.*, vol. 6, p. 193; June 6, (1922).

be present in the transmitter if a male operator were speaking into the microphone, would be composed of 1000- to 8000-cycle frequencies with less than 17 decibels difference in their relative amplitudes. If the line marked zero level on Fig. 10 represents the average input level, high frequencies to 7000 cycles will be down only 8 decibels from this average value. Fig. 9 suggests that adjacent-channel interference may be reduced if as many of the high frequencies of curve 10 as practicable are removed. This practice would remove all frequencies, the harmonics of which would have sufficient power to cause adjacent-channel interference and all distortion frequencies generated in the audio-frequency system where the fundamentals are below the cutoff frequency and the 1st harmonic falls at a frequency higher than the cutoff frequency. The only interference frequencies generated must be high-order harmonics originating in the radio-frequency sections of the transmitter. With linear radio-frequency stages of reasonably good design, these high-order harmonics will not have magnitude sufficient to cause interference if the input amplifier prevents overmodulation.

Fig. 11 gives the percentage of syllables understood

⁴ L. J. Sivian, "Speech power and its measurement," *Bell Sys. Tech. Jour.*, vol. 8, pp. 646-661; October, (1929).

when all frequencies higher than various abscissas⁶ are suppressed. The difference in the syllables understood when all frequencies above 5000 cycles are removed compared with those understood when all frequencies above 2500 cycles are removed is only 15 per cent. In his book *Speech and Hearing* Fletcher shows that any system having a syllabic intelligibility of 80 per cent will have an over-all intelligibility of 98 per cent or more if the over-all intelligibility is defined as the percentage of sentences received correctly. From the interference standpoint, the difference in choice of cutoff fre-

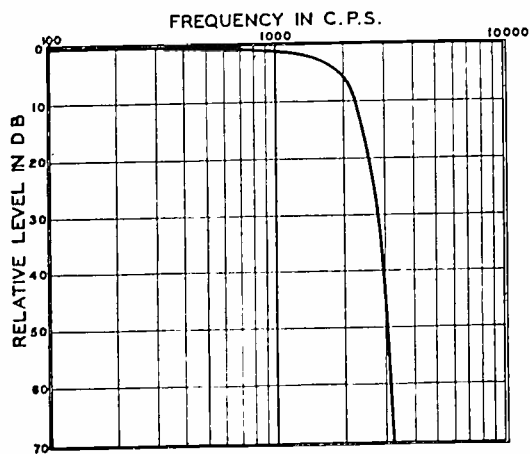

Fig. 12—2500-cycle low-pass filter characteristic.

quencies (2500 or 5000) would mean the difference between the 4th and 8th harmonic as the interference frequency. Filters with cutoff frequencies of 3500 and 2500 cycles were tested. The characteristic of the 2500-cycle low-pass filter is shown on Fig. 12. The 2500-cycle filter was somewhat more effective from the interference reduction standpoint, while the 3500-cycle filter gave better intelligibility. The

⁶ H. Fletcher, "Interpretation of speech," *Jour. Frank. Inst.*, vol. 193, p. 6; June, (1922).

proper cutoff frequency should be determined consistent with the conditions at the aeronautical ground station where interference reduction is to be effected. This filter should be placed in the circuit

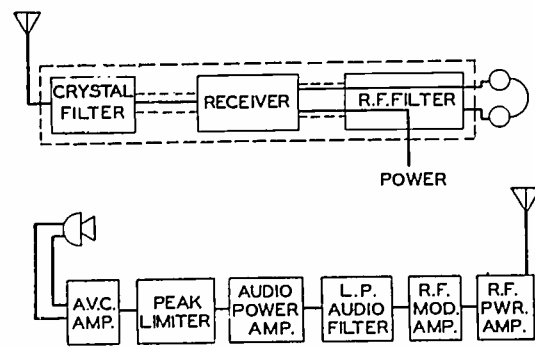

Fig. 13—Block diagram of interference-free, aeronautical ground station.

at the point where the audio frequency is introduced to modulate the radio frequency. By connecting this filter to the circuit in this manner, it follows all audio-frequency amplification; hence, it can remove all high-order harmonics caused by audio-frequency amplifier distortion (such as that caused by the action of the peak-control circuit).

CONCLUSIONS

Interference tests were made using a portable receiver on a frequency 35 kilocycles from that of the transmitter. Interference-free reception was possible when only 50 feet from the transmitting antenna. When the low-pass filter was removed, a distance of one and one-quarter miles was the separation necessary between the receiver and transmitter before interference-free reception could be had. The block diagram of Fig. 13 sums up the elements found necessary to complete the solution of the interference problem.

Observations on Sky-Wave Transmission on Frequencies Above 40 Megacycles*

D. R. GODDARD†, ASSOCIATE MEMBER, I.R.E.

Summary—The results of daily observations at Riverhead, L. I., N. Y., since September, 1937, of European 40-to 45-megacycle transmitters are reported. Measurements of field strength were made on English, French, and German television signals. Multipath propagation of the English video-frequency channel was observed optically and the difference in path length determined.

THIS paper deals briefly with the results obtained by systematically observing and measuring the field strength of television signals from England, France, and Germany.

The English transmitters located at Alexandra Palace, London, operated on 41.5 megacycles for the sound channel and 45 megacycles for the picture

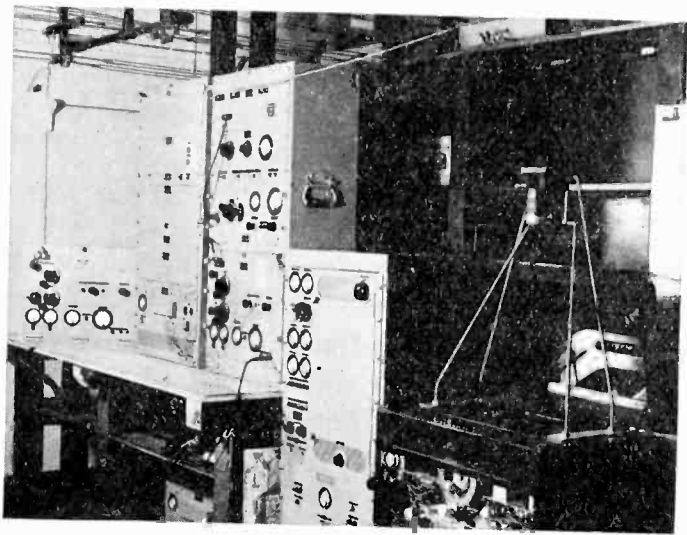

Fig. 1—Ultra-high-frequency receiving equipment used for field-strength determinations and path-delay measurements.

channel. The frequency of the French sound transmitter at the Eiffel Tower was 42 megacycles and the Berlin sound-transmitter frequency was 42.5 megacycles.

A rhombic antenna 45 feet above ground and directed towards London was used for these measurements. Its length was 400 feet per side and it was arranged so that the dimensions of the major and minor diagonals could be readily changed. This was done so as to facilitate matching the antenna to the vertical arrival angle of the signal. The effective height of the antenna system was about 20 meters.

Antenna adjustments were made by comparing various settings of the rhombic antenna to a reference dipole 45 feet above ground. As comparisons

* Decimal classification: R113.7. Original manuscript received by the Institute, May 25, 1938. Presented before joint U.R.S.I.-I.R.E. meeting, Washington, D. C., April 29, 1938; presented before New York meeting, November 2, 1938.

† R.C.A. Communications, Inc., Riverhead, L. I., New York.

were made on the London 41.5-megacycle signal the results gave the optimum setting for that signal. This setting corresponded to a vertical arrival angle of roughly 7 degrees.

Fig. 1 shows the receiving equipment used. In the foreground is a television receiver with a small camera mounted over the oscilloscope. Only the video-frequency amplifier and Kinescope controls were used as it was thought desirable for these experiments to have available greater flexibility than the radio circuits of this set provided. Therefore, the receiver standing to the left of the one just described was designed by Bertram Trevor of this department. This set provided automatic or manual volume control, a minimum noise equivalent of about 30 microvolts, with a band width somewhat less than 5 megacycles, and two diode outputs, one giving a "positive" and one a "negative" image. On the bench is the signal generator and receiving equipment used for signal-strength measurements.

Most of the observations took place between 9:45 A.M. and 11:30 A.M., E.S.T., as that appeared to correspond approximately to the afternoon schedules of all three countries. On several occasions, however, the transmitters continued on into the afternoon, usually on tone modulation. On November 19 and 20 the English audio-frequency transmitter was operated from 5 A.M. to 8 A.M., and 9 A.M. to 11 A.M., E.S.T. On both occasions the signal was first heard at Riverhead a few minutes before seven. On the latter date, however, the signal disappeared at 7 A.M. and did not reappear until 9:20 A.M. October 16 from 4:00 P.M. to 4:30 P.M. was the only occasion on which the 41.5-megacycle English signal was heard on the evening schedule corresponding to 3:45 to 5:00 P.M., E.S.T.

Fig. 2 shows the peak signal strength in decibels above or below one microvolt per meter of the English audio- (41.5 megacycles) and video-frequency (45 megacycles) signals for every day during the winter of 1937-1938 that either or both were heard. The small crosses indicate holidays on which no observations were made. The uppermost curve is a plot of F_2 -layer virtual height as broadcast by the National Bureau of Standards. These measurements are taken each Wednesday at noon, E.S.T. Directly below this curve is a plot of the critical frequency of

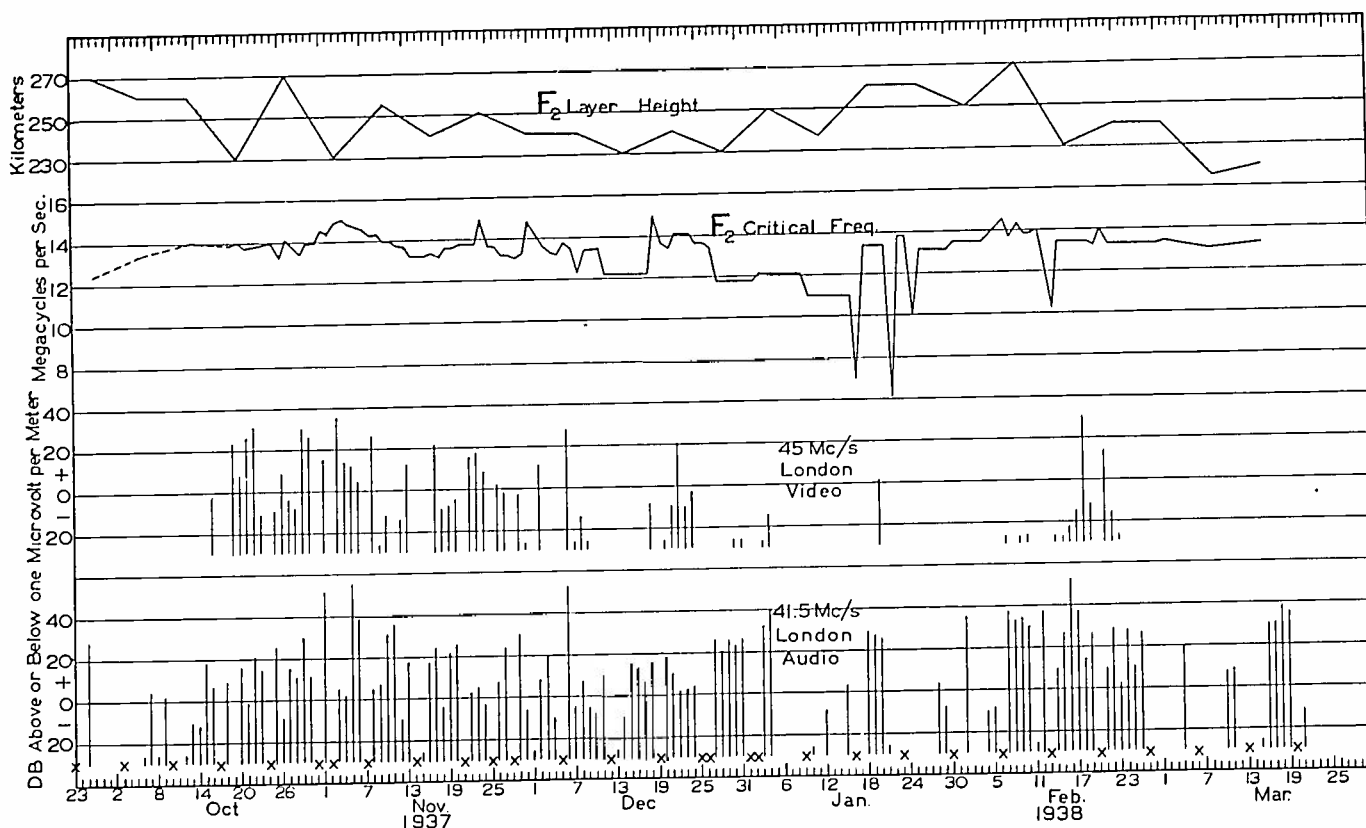

Fig. 2—Comparison of F_2 -layer height and critical frequency to observed maximum signal strengths from the London television audio- and video-frequency channels. The crosses indicate days on which no observations were made.

the F_2 extraordinary ray. The data for this curve were supplied by John Howard Dellinger of the National Bureau of Standards. Some of these values were not obtained by actual critical frequency measurements but are close approximations.

Inspection of Figs. 2 and 3 indicate that a strong signal is not necessarily accompanied by a high critical frequency or low layer height. However, the month of November produced the most consistently strong signals and was characterized by a uniformly

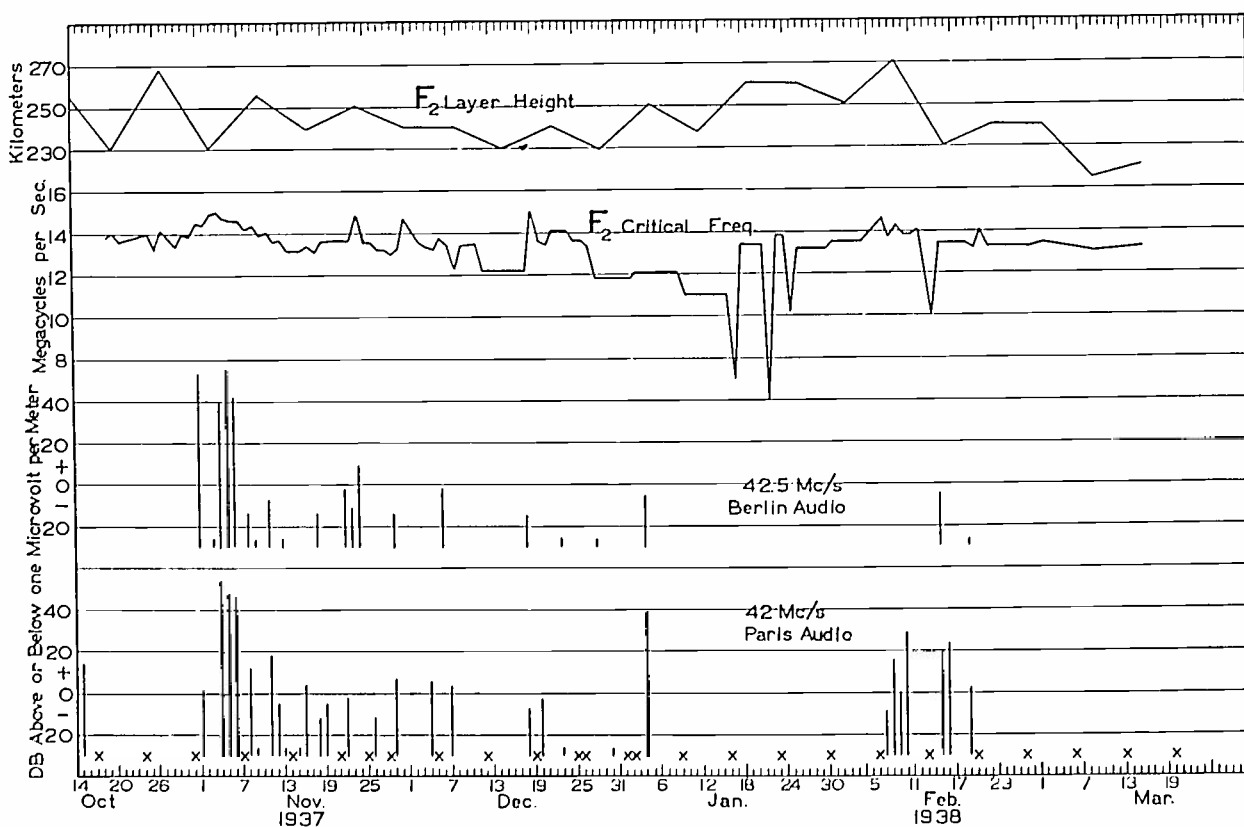

Fig. 3—Comparison of F_2 -layer height and critical frequency to observed maximum signal strengths from the Berlin and Paris television audio-frequency channels. The crosses indicate days on which no observations were made.

high critical frequency. One interesting case was that of February 14. On this day, probably due to a magnetic storm, the noontime critical frequency dropped to 10,150 kilocycles and yet the English 45-megacycle channel was heard faintly and the English 41.5-megacycle channel was quite strong. On December 1, however, the critical frequency rose to 14,700 kilocycles and only a weak signal was observed on 41.5 megacycles and the 45-megacycle channel went unheard.

Of course, it should be pointed out that the critical-frequency and layer-height measurements were made at Washington, D. C., at noon while most of

megacycle channel. The small circles indicate no signal heard for that day.

From these data it may be seen that at no time was 45 megacycles indicated as useful, the highest values being 43.4 and 43.7 megacycles on December 1 and 22, respectively. On December 1 the voice channel was heard faintly and the video-frequency channel not at all, while on December 22 both frequencies were quite strong. Another interesting case is that of October 27, a day having the relatively low maximum usable frequency of 35 megacycles. On that occasion both the 41.5- and the 45-megacycle signals were fairly strong. On March 23, there was a severe magnetic storm decreasing the usable frequency to 15.8 megacycles.

On November 5 the signal strength of the English voice channel rose to about 56 decibels above one microvolt per meter. Computation indicates that, neglecting the effect of the ground near the receiving and transmitting antennas, the field strength at Riverhead from the 3-kilowatt English transmitter should have been about 40 decibels above one microvolt per meter. At most, the effect of the ground at both antennas would have increased the field at Riverhead by 12 decibels making the expected field 52 decibels above one microvolt per meter or 4 decibels less than the peak values actually measured. Of course, the field-strength measurements probably include an error of a few decibels, but even so indications were that the attenuation over the path must have been at times nearly zero. Possibly there may have been a concentrating or focusing effect of some nature.

The fading on all four signals observed was usually very deep and rather rapid. During days of very strong signals, however, the fading was quite slow, occasionally remaining constant for nearly a minute at a time. Selective fading on the voice channels occurred rarely and was invariably accompanied by a deep dip in signal strength. Two-receiver diversity reception very effectively removed the distortion produced by this selective fading.

These European television signals have been reported heard on a number of occasions from as far west as Phoenix, Arizona. Clyde Criswell, located near Phoenix, has reported hearing all the aforementioned signals during the winters of 1936-1937 and 1937-1938. G. W. Kenrick at San Juan, Puerto Rico, reported hearing the French, German, and English voice channels several times during the past winter. On most of these occasions the signals were also heard at Riverhead.

On one occasion the rhombic antenna used for these observations gave a very much weaker signal

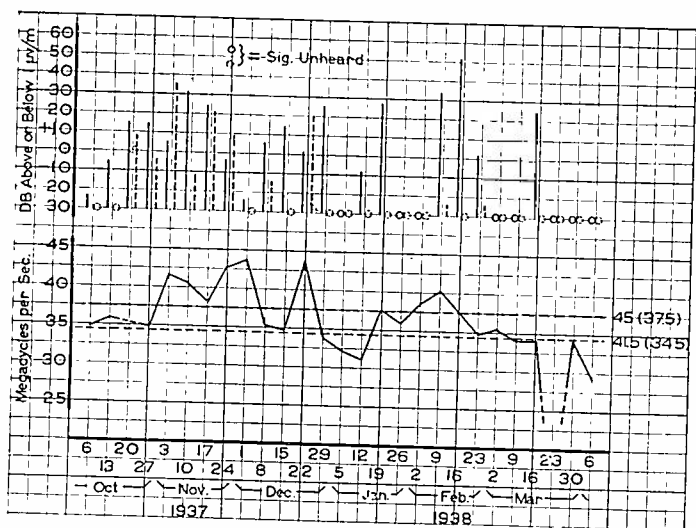

Fig. 4—Comparison of observed signal strengths to maximum usable frequencies interpolated for 2700 kilometers. Vertical solid lines of the upper plot represent maximum signal strengths observed from London on 41.5 megacycles. Broken lines represent the same for 45 megacycles.

the signal-strength measurements were made from one to two hours earlier in the day. Furthermore, as the signals coming from Europe probably traversed the Atlantic Ocean in two hops, the places in the ionosphere that caused the signals to return to the earth were something like 1800 and 4500 kilometers northeast of Washington.

An attempt to correlate the maximum usable frequencies taken from the weekly broadcast of ionosphere data from station WWV appears in Fig. 4. The lower half of this figure represents the maximum usable frequency interpolated for a distance of 2700 kilometers plotted for each Wednesday during the winter of 1937-1938. Twenty-seven hundred kilometers was used as it represents half the distance between Riverhead, L. I., N. Y., and London. The upper half of the figure is a plot of maximum signal strength observed on the two English channels for the same days that the ionosphere measurements were made. The broken lines represent the 45-megacycle signal and the solid lines represent the 41.5-

than a standard short-wave fishbone antenna directed towards London. Usually the rhombic antenna gave several times the signal strength observed on these fishbone antennas. This condition lasted from about 10:30 to 11:00 A.M. on February 15. This condition may have been due to the signal arriving over a path other than the great-circle path from London. A deviation of but a few degrees from this path would considerably reduce the voltage picked up by the rhombic antenna while it would have slight effect on the fishbone antennas as they were not designed for these frequencies. Criswell reported observing variations in horizontal arrival angle with his rotatable Reinartz beam antenna. He also reported usually obtaining a stronger signal from a southeasterly direction during times of weak signals from London. This same condition was observed at Riverhead during the winter of 1936-1937. In this connection it might be mentioned that an amateur at Peekskill, N. Y., operating on the 28-megacycle band was observed to have "around the world" echo. This occurred on December 12 at about 10:45 A.M., Eastern Standard Time. A few minutes later an amateur in Holland was heard calling the operator at Peekskill. At about the same time of the morning of February 17 "around the world" echo was heard on the second harmonic (37.8 megacycles) of a Rocky Point, L. I., N. Y., transmitter operating on 18.9 megacycles.

Before closing, mention should be made of the results obtained with the Kinescope shown in Fig. 1. On February 18 the English video-frequency channel became strong enough to synchronize the Kinescope sweep circuits and allow glimpses of the picture being transmitted. Usually these pictures consisted of numerous images superimposed one on another indicating two or more paths of propagation. The path conditions were continually changing and occasionally a single picture would appear quite plainly and with good detail. Fig. 5 shows an attempt to photograph this multipath phenomenon. It shows the front view of a man's head and shoulders. As can be

seen there are two images and computation shows that the horizontal displacement represents a time delay of about 3.5 microseconds which corresponds to a difference in total length of the two paths from London of something less than 3000 feet.



Fig. 5—Photograph of television image received at Riverhead from London showing displacement due to multipath propagation.

ACKNOWLEDGMENT

The helpful suggestions of Mr. Martin Katzin are gratefully acknowledged.

Added in Proof: Recent study indicates that the Lorentz¹ polarization term probably should be included in the computation of maximum usable frequencies. Application of the Lorentz term would in this case increase the predicted maximum usable frequencies by about 20 per cent. This may be shown graphically either by replotting the maximum usable frequency curve or, as is done in Fig. 4, by drawing the horizontal solid and dotted lines opposite 34.5 and 37.5 megacycles of the ordinate scale. These values represent 20 per cent less than the voice and video frequencies of the London transmitters.

Now the correspondence between predicted maximum usable frequencies and observed signal conditions is somewhat improved. Using these horizontal lines as references, prediction for the 45-megacycle channel rises from 38 per cent correct to 73 per cent correct, and for the 41.5-megacycle signal increases from 46 per cent correct to 77 per cent correct.

¹ H. G. Booker and L. V. Berkner, "Constitution of the ionosphere and the Lorentz polarization correction, *Nature*, vol. 141, pp. 562-563; March 26, (1938).

Radio Interference—Investigation, Suppression, and Control*

H. O. MERRIMAN†, ASSOCIATE MEMBER, I.R.E., AND F. G. NIXON‡, ASSOCIATE MEMBER, I.R.E.

Summary—The work of the Radio Division of the Department of Transport in investigating and controlling radio interference is described.

A detailed description is given of the equipment in the experimental car, which is used for special investigations and measurements of signal strength and interference in the field.

Thirty-three investigation cars are equipped with directional receivers and experimental surge traps. Two investigators on each car tour their respective districts, locating sources of interference and recommending cures. Means of suppressing interference, generally, are outlined, including the use of capacitors, choke coils, and shielding. The particular applications of these cures are described as relating to streetcars, electromedical apparatus, and domestic and commercial electrical equipment.

Reference is made to an Act of Parliament giving the Government control of the use of interfering apparatus.

A summary of means of measuring interference in foreign countries and in Canada is given with special reference to the work of the International Electrotechnical Commission.

INVESTIGATION OF INTERFERENCE

THE first step in the development work of the Radio Division of the Department of Transport of Canada in dealing with the interference problem was the organization in 1925, of the Interference Section. One experimental automobile, equipped for survey work, made tours in Quebec and Ontario. From the information thus obtained, equipment was improved and the work extended until today the Department has one large car fitted for measurements and experimental work and 33 cars for investigation purposes, having their headquarters at 22 principal cities throughout the Dominion.

In the beginning, the most serious interference was found to originate on power and distribution lines and it was in this direction that the principal efforts were directed, so that today the Department has, for work in this field, very satisfactory equipment and a staff of trained men who are leaders in this particular line of activity.

Experimental Car

The experimental car has a panel body with windows in the right side. Cabinets are built in the left side to contain the receivers and instruments, and a battery box on the right side below the windows also forms a seat for the operators.

The loop is of open-wire construction and is wound

* Decimal classification: R430. Original manuscript received by the Institute, April 27, 1938. Presented before Montreal Section, April 20, 1938.

† Engineer-in-Charge, Interference Section, Department of Transport, Dominion of Canada, Ottawa, Ont., Canada.

‡ Assistant Radio Engineer, Interference Section, Department of Transport, Dominion of Canada, Ottawa, Ont., Canada.

in two halves, each balanced to ground. The four leads are connected to the receiver by a low-capacitance line.

A plain antenna, consisting of copper mesh, is located in the roof of the car and a concentrated probe antenna, described later, is carried on a reel.

The input circuit of the receiver is designed to connect these antennas in several ways:

- (1) Plain vertical for nondirectional reception.
- (2) Loop for figure-of-eight response.
- (3) A combination of (1) and (2) for absolute direction or sense.
- (4) Probe antenna.

The receiver is designed for field-strength measurement and is an all-wave superheterodyne covering from 200–20,000 kilocycles. The radio-frequency indicator is a microammeter in the second-detector diode circuit. An audio-frequency voltmeter measures the audio-frequency output. A standard-signal generator may be connected to the input circuit of this receiver in the usual way. All of the above equipment is operated from self-contained batteries.

A second receiver consists of a modified 12-tube all-wave chassis, which may be operated from 25- or 60-cycle, 110-volt alternating current, or from 6-volt direct current. This receiver is used chiefly to make records of interference intensity over a wide frequency range.

To accomplish this the dial mechanism is driven by a spring motor and the output registered on a recording milliammeter. The drive for the latter mechanism may be either its own spring motor, or from the spring motor driving the receiver. Between the receiver output and the recording meter is a vacuum-tube voltmeter reading peak values and so arranged that excess input voltage cannot harm the meter.

Minor changes in the standard receiver have been made, including the removal of the automatic volume control, an extension of the sensitivity control to approximately 80 decibels, and an arrangement whereby the receiver sensitivity may be held constant over the entire frequency range. This is accomplished by manually varying the sensitivity control to conform to a curve on a rotating drum. The output of the standard-signal generator may be used to standardize the records of this receiver.

This method of obtaining graphic records of output at all frequencies has been extremely useful in many investigations such as the interference from the ignition systems of various types of automobiles. About 50 different cars were tested at all frequencies in a comparatively short time. A report of this test is available for all those interested.

Other equipment includes a cathode-ray oscillograph, an interference-measuring set of American manufacture, and various types of surge traps for determining the most satisfactory and economical method of suppressing the interference.

For special tests, where it is desirable to communicate between the observer in the car and the operator of the interfering apparatus, small 5-meter transceivers are used.

The probe antenna assembly consists of a 6-inch antenna, which may be extended for greater pickup, a matching transformer to couple this to a balanced transmission line, and a second matching transformer to couple the line to the receiver. The probe end is insulated to withstand high voltage and may be attached to a jointed pole for probing among pole-line hardware and overhead circuits to determine the point of maximum intensity and assist in locating sources of interference.

Investigation Cars

The 33 investigation cars are constructed from the standard coach-type car having the rear seat and back removed and cabinets built in for the instruments. An open-wire loop is mounted on the roof.

The receiver itself is a standard automobile type, modified to suit our requirements. The modification is along the same lines as described for the experimental car.

An indicating meter may be switched to indicate radio-frequency voltage at the second detector or audio-frequency voltage at the receiver output.

It is now proposed to equip the cars with receivers covering some of the high-frequency bands in addition to the standard band. These receivers will be specially constructed by using the domestic-type chassis converted as required.

The cars are equipped with a more powerful generator capable of delivering continually 25 amperes and an arrangement whereby the radio battery may be charged.

A separate battery is carried for the radio equipment in addition to the car battery. The charging circuit to this battery may be opened when the receiver is in use, if desired, to eliminate interference from the charging generator and ignition system.

The interference from the ignition system is suppressed to a large extent, the methods of suppression

varying with the different types of automobile engines.

SUPPRESSION OF INTERFERENCE

The principles of suppression of radio interference are now so well known that they will be discussed very briefly under three headings, namely, capacitors, inductances, and shielding.

(a) *Capacitors*. It has been found that the 1/10-microfarad capacitors are satisfactory in the majority of cases and that the exact capacitance is usually not critical. Smaller capacitors are frequently satisfactory but a peculiar case arose recently. Small capacitors were installed on a vacuum cleaner which, on the first demonstration, proved remarkably successful in eliminating interference when the receiver was tuned near the high-frequency end of the broadcast band. When, however, the receiver was tuned to the low-frequency end the interference was increased by the capacitors. It was found that the capacitor in combination with the inductance of the field coil of the vacuum-cleaner motor set up a resonant circuit which ruined reception on 550 kilocycles. When capacitors are used to by-pass a surge it is essential that the impedance of this by-pass at the frequency of the desired reception must be as low as possible and, therefore, the leads of the capacitors must be short. For suppressing interference from a large generator it is found necessary that capacitors be connected from each brush to the frame of the generator with leads as short as possible. Capacitors connected from the positive and negative terminals of the generator to the frame are not always satisfactory because of the high-frequency impedance from some of the brushes to the terminals of the machine. Large generators having 8 brush holders frequently require 10 capacitors, one from each brush to the frame and one from each terminal to the frame. The capacitor from the negative terminal to the frame is usually found very effective even though the negative lead of the generator may be grounded but the ground connection, if more than a few feet, introduces considerable high-frequency impedance.

(b) *Choke Coils*. Only in exceptional cases should choke coils be required. Frequently the field coils of a motor may be used effectively as a radio-frequency choke and thus provide a satisfactory and economic cure for the interference.

(c) *Shielding*. Shielding is only necessary in exceptional cases where the direct radiation is objectionable. Radio-frequency generators, both of the spark and tube type, used for electrotherapy, require very thorough shielding. Metal foil, such as aluminum foil 0.0003 inch thick, appears to be a better shield for high frequencies than wire mesh.

Impedance of Ground Lead

The effect of impedance of a ground lead was demonstrated when testing the interference from streetcar compressor motors. The radio inspector explained to the car company that there should be no interference from the compressor motors if the field coils were on the positive side of the armature but, to the surprise of the inspector, it was found that a compressor motor so connected caused considerable interference. On inspection, it was found that the negative brush of the compressor was connected to ground through a long lead. Therefore, he suggested the test of connecting a short jumper from the negative brush to ground. Instructions were given and a test carried out with no improvement. The radio inspector then found that the electrician considered 15 feet of No. 0 wire should be a good ground but it was not effective. When the test was repeated using a 6-inch ground connection from the negative brush the interference immediately dropped to such an extent that the inspector thought his receiver had failed. This test convinced the railway electricians regarding the importance of short ground leads for reducing interference.

Power and Distribution Systems

With the co-operation of the power companies, the background of radio interference from power and distribution systems has been greatly reduced.

These sources of interference may be considered under two headings, namely, normal high tension and interference from faults.

Normal high-tension interference due to the breakdown of overstressed air causes radiation from power lines, which affects near-by receivers where the coupling from the lines to the receivers is considerable. This is the case where lines of over 15,000 volts pass through the center of the town or where the distribution lines run on the same poles as the high-tension line and thus conduct the high-tension interference throughout the distribution system.

The latter case was satisfactorily and economically cured at St. Tite des Caps, Quebec, Canada. In this case, the 2000-volt distribution line was run along the 40,000-volt line a distance of three miles and then branched off to the town a distance of one-quarter mile. The interference in the town was so great that CKAC could scarcely be heard above the interference. Tests were conducted and the power company installed choke coils in the 2000-volt line, one span away from the high-tension line. These choke coils consisted of two hundred and fifty turns, in a single layer, on a three-inch fiber cylinder. They were so effective that with choke coils in circuit the radio

interference was barely audible when listening to CKAC. The drop in noise level appeared to be about 50 decibels at this particular frequency. The reduction in interference throughout the broadcast band was satisfactory, although probably not as great as 50 decibels throughout the entire band.

Radio-interference-free insulators for lines over 30,000 volts have a metallic coating near the line and tie-wire, and, also, in the pinhole, to provide a more uniform distribution of electrostatic stress and satisfactorily eliminate normal high-tension interference.

With regard to faults on high-tension lines, occasionally, cracked insulators are found as well as loose clamps and haywire lying on the line, and such faults cause very widespread interference. These sources are comparatively easy to locate with the direction-finding equipment in the interference cars, provided that the interference remains long enough to take a bearing; when the interference is very intermittent it is most difficult to locate. Some consideration was given to the use of a double radio receiver, so arranged that directional indication could be obtained from a single surge of interference. Preliminary tests showed that this was possible, but it was not considered practicable to increase the cost and weight of our equipment for the comparatively few occasions on which it would be required.

The more common sources of interference from power lines are classed as faults and include loose pole-line hardware in which various parts of the hardware, such as crossarm braces and ground wires located in different electrostatic fields, are not thoroughly bonded or sufficiently separated to prevent electrostatic spark. Loose hardware causes a continuous interference very similar to that caused by high-tension insulators where corona and brush discharge occur at overstressed areas on the surface of the porcelain. These two sources are similar, in that the interference usually disappears in wet weather, as the conducting wet surface of the insulators or poles prevents these points from becoming overstressed.

Electric-Railway Systems

Radio interference from electric-railway systems is such a large problem that it would require many hours to discuss. Reference will be made, therefore, only to a few interesting features. Radio interference from powerhouses has been practically eliminated by installing capacitors from the brushes of the generators to the frames.

The problem of interference from the traction motor could be simplified if the series field and interpole windings were placed on the line side of the

armature, in which position they would act as a choke to radio-frequency surges. Unfortunately for radio, however, some power engineers prefer to keep the field on the ground side of the armature in view of insulation considerations. One-tenth microfarad capacitors, connected with short leads from the positive and negative brushes to the frame, will reduce the noise 20 to 30 decibels. Motors of the interpole type are more satisfactory than others because of the improved commutation.

There is usually no objection to placing the field of the compressor motor on the line side of the armature, a change which will cure trouble from this source. A short lead from the negative brush to ground is essential.

No satisfactory and economic cure for the interference from the sparking at the trolley has been found.

Reports have appeared of tests in Germany where the carbon shoes are successfully used in connection with new trolley wire. These carbon shoes have a satisfactorily long life when exclusively used on smooth trolley wires and the trolley wires will remain smooth if no sparking occurs. If, however, a trolley wheel is run on the trolley wire the resulting spark will cause a roughness on the trolley wire, which will saw through any carbon shoes. Thus, it is not practicable to use both carbon shoes and wheels on the same trolley wire.

The trolley busses in Montreal are good examples of what may be accomplished by the use of choke coils in the line-feed and metal-shoe collectors. Interference from these vehicles has been reduced to a negligible minimum.

Automobile Ignition

Interference from this sources does not ordinarily affect reception on the standard broadcast band in the home, but may seriously affect short-wave reception. The Department has been working in co-operation with the Radio Manufacturers Association and the Society of Automotive Engineers, with the result that many automobile manufacturers have made changes in the design of their ignition systems, thus reducing the radiation from their latest types of automobile engines.

Electromedical Apparatus

Practitioners use apparatus similar to a radio transmitter for giving therapeutic treatments. They require to transmit this electrical energy only from the apparatus to the patient in the same room but, in so doing, this energy is transmitted many hundred miles. Recent tests indicated that apparatus operated

in an Ottawa hospital caused radio interference in many places three to five hundred miles distant.

The Department has developed means of suppressing this interference. Such suppressive means would cost the practitioner from two hundred to one thousand dollars for each installation.

CONTROL OF INTERFERENCE

The system of friendly co-operation has been remarkably successful in the great majority of cases and the Department proposes to continue this system wherever it can be successfully applied. There are, however, the few cases where individuals and companies have refused to give the necessary co-operation to reduce interference. One example is that of a manufacturer of household appliances who paid a few cents each for capacitors for the suppression of interference and installed these capacitors in apparatus made for export to New Zealand. In order to save this small additional cost he omitted to put the interference suppressors in the apparatus intended for the Canadian market and, thus, hundreds of household devices which will cause interference to radio reception are being installed in our own country.

Occasionally, a householder will tell the Department's inspectors, "I know my vacuum cleaner causes interference but I turn my radio off when the vacuum cleaner is in use." He refuses to purchase a suppressor and states that he is not interested in his neighbor's reception.

In order to deal with such cases Parliament, in 1936, passed the following legislation (Section 23 of the Canadian Broadcasting Act):

Regulations prohibiting interfering equipment.	23	(1) The Governor-in-Council may make regulations prohibiting or regulating the use of any machinery, apparatus or equipment causing or liable to cause interference with radio reception and to prescribe penalties recoverable on summary conviction for the violation or non-observance of any such regulation, provided, however, that such penalties shall not exceed fifty dollars per day for each day during which such violation or non-observance continues.
Publication and date effective.		(2) Such regulations shall be published in the <i>Canada Gazette</i> , and shall take effect from the date of such publication or from the date specified for such purpose in such regulations, and shall have the same force and effect as if enacted herein.

Regulations are now being drafted and will be put into effect in the near future.

Notice the wording of the Section "... may make regulations prohibiting THE USE ..." This Act does not give the Dominion Government control of the manufacture, advertising, sale, or installation. These are matters which the Provinces control. Most provinces, at present, control the manufacturing,

advertising, sale, and installation of electrical equipment and prohibit all electrical apparatus which does not bear an approval label issued in accordance with essential requirements and minimum standards, as laid down by the Canadian Electrical Code, covering hazards to life and property.

It is hoped to find some mutually acceptable means of co-ordinating the various services which control electrical apparatus and installation.

Great care is being exercised in the drafting of regulations to ensure that all sections of the radio and electrical industries may benefit and that no unnecessary hardships are imposed.

Obviously it would be unreasonable to prevent a doctor from using his X ray in case of emergency, in an endeavor to save life, simply because his apparatus might cause radio interference, and power should not be shut off from a large industrial plant immediately a slight defect in wiring causes a buzz in radio receivers. On the other hand, it would appear equally unreasonable for many broadcast listeners to have to endure reception marred by continual interference, caused by the operation of a single flashing sign or a solitary electric sewing machine, when the installation of a suitable suppressor could, in either case mentioned, be made at relatively small cost with beneficial results to all the broadcast listeners concerned.

It is more difficult to draw the line in the case of a doctor who occasionally uses electrical apparatus to give treatments, where the cost of suppression would amount to several hundred dollars. Very helpful co-operation has been received from the Canadian Medical Association and it is hoped to find a mutually acceptable solution to this particular phase of the problem.

There are many points yet to be determined regarding what surges causing noise in a receiver should be regarded as objectionable and be suppressed under the new regulations. It is intended first to remove the high spots of interference which can be economically dealt with and then endeavor to reduce the noise level progressively, giving due consideration to the economic side of the question and the strength of broadcast stations available to Canadian listeners. It appears probable that a signal strength of 250 microvolts per meter might be a reasonable minimum signal to be protected by regulations in urban districts.

Measurement of Radio Interference

In order that, eventually, electrical appliances may be given an approval rating with regard to radio interference, it is desirable that some standard method of measuring this interference be evolved.

In the United States, this matter is being studied by a Joint Committee of the Edison Electric Institute, National Electrical Manufacturers Association, and Radio Manufacturers Association. In Europe there has been formed an International Special Committee on Radio Interference, under the auspices of the International Electrotechnical Commission,¹ which has been active and has drawn up some very definite recommendations.

The first consideration was whether the interference should be measured in terms of the field strength surrounding the apparatus or in terms of the actual voltages at the terminals of the machine. The latter method has been adopted by both committees whenever feasible.

In an attempt to correlate the interference to stations of various field strengths with the voltage at the machine terminals the American committee found that 92 per cent of the listeners were satisfied when listening to a station at 5000 microvolts per meter if the noise voltage was limited to 5000 microvolts at the machine terminals. This assumed a modulation-to-noise voltage ratio of 30:1.

In England, the British Standards Institution has issued a standard specification which calls for the limitation of the noise voltage at the machine terminals to 500 microvolts. Where this measurement is not feasible the field strength of the interference, measured within 10 yards of the source, must not exceed 100 microvolts per meter.²

Since the permissible noise-to-modulation ratio is 40 decibels in England, this limitation would probably provide satisfactory reception for 90 per cent of the listeners when receiving stations of 1000 microvolts per meter or more.

In Canada, this value would have to be somewhat lower because we are attempting to protect signals of 250 microvolts per meter.

For measurement purposes the interference voltage at the terminals of the apparatus is divided into two components:

- (1) the voltage between lines, known as the symmetrical component, and
- (2) the voltage between line and ground, known as the asymmetrical component.

The standard measuring network recommended by the International Electrotechnical Commission and adopted by the British Standards Institution³ and the American Committee is shown in Fig. 1.

The receiver transmission line is connected between *A* and *B* for the symmetrical component and

¹ London Office: 28 Victoria St., Westminster, S.W.

² British Standards Specification No. 800.

³ British Standards Specification No. 727.

between *A* and *B* short-circuited, and ground for the asymmetrical component.

The receiver may be of standard design except for the indicator circuit. The nuisance value of a noise voltage tends to vary, not with the average or the root-mean-square value of the wave, but, with the peak value. The indicator should, therefore, be a vacuum-tube voltmeter designed to approximate peak values. For very sharp pulses, such as that produced by the ignition of an automobile, the "slide-back" type of meter is desirable.⁴

In order to standardize this measurement, American practice uses a standard-signal generator whose adjustable output is fed into the receiver's input circuit. The British receiver, on the other hand, employs a calibrated attenuator and makes use of thermal agitation voltage in the input circuit to standardize receiver gain.⁵

A difficult problem in Canada is to estimate the interference level at a complainant's location. As mentioned previously an effort is being made to protect all stations having field strengths greater than 250 microvolts per meter. By "protect" it is meant that the noise peaks must be 30 decibels below modulation peaks. The receiving installation also, must be satisfactory. The antenna must not have an unduly high coupling to the power wiring. In England, this coupling factor is defined as the ratio of the interference voltages at the terminals of the apparatus to the open-circuit voltage between the antenna terminal and ground. The receiver itself must not be abnormally susceptible to interference.

If the receiver is not carefully designed, the power cord may conduct noise into the receiver. One particular set employed two condensers across the line, the center tap of which was connected to the chassis in such a way that the ground currents from the line flowed through a portion of the first tuned circuit.

⁴ See Laurence C. F. Horle, "The development of the radio noise meter," Bulletin No. 16 of Radio Manufacturers Association.

⁵ British Standards Specification No. 727.

The ratio of signals required on the power cord to that required on the antenna for equal output was found to be 30. In a receiver of good design, using an electrostatically shielded transformer connected to the receiver ground post, this ratio was 7400.

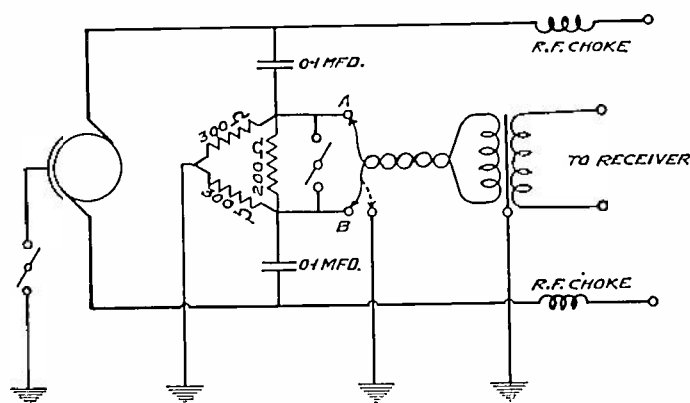

Fig. 1—Schematic diagram of circuit network for measurement of interference voltage.

Added in Proof: The whole problem of radio interference is now receiving consideration by the radio and electrical industries and by the governments of many countries in both Europe and America. The technical problems are being carefully considered and a great amount of data is being collected and exchanged through such organizations as the International Electrotechnical Commission, the British Post Office, the Canadian Engineering Standards Association, the Joint Co-ordination Committee of the Edison Electric Institute, National Electrical Manufacturers Association, and Radio Manufacturers Association, and the American Standards Association. The Department of Transport is particularly anxious at this time to co-operate with all those interested in this problem and would be pleased to supply copies of reports of specific investigations and receive data which might be useful in developing methods of measurement and standards. Such data will be very useful in drafting the regulations referred to in connection with the control of radio interference.

Line Equalization by Predistortion*

WALTER J. CREAMER†, ASSOCIATE MEMBER, I.R.E.

FOR some years the University of Maine, located in Orono, Maine, has supplied a small amount of program material to broadcast station WLBZ, located in Bangor, Maine, about ten miles distant. As the broadcast station did not feel justified in maintaining an expensive high-grade circuit, which at most would be used only a few hours a week, the New England Telephone and Telegraph Company was asked to supply a nonloaded cable

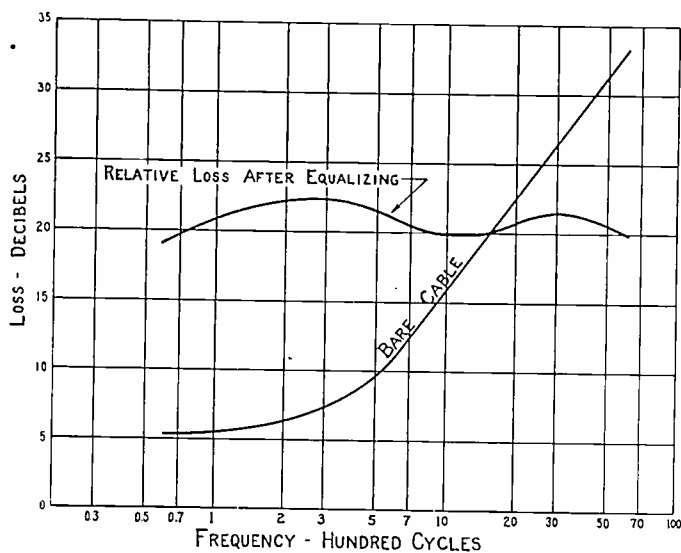

Fig. 1

loop. The circuit provided consists of approximately 7 miles of 19-gage cable, 2 miles of 24-gage cable, and 1.5 miles of 26-gage cable. Its loss characteristic is shown in Fig. 1. This circuit has been in operation for some time with a conventional two-terminal equalizer bridged across the line at the broadcast station.

Aside from the artistic and technical problems of the studio, two factors have operated against high-quality program supply of this circuit: (1) the lack of technically trained personnel to monitor and control the input to the line, keeping it uniformly high without overloading on signal peaks, and (2) the difficulty in equalizing the long nonloaded cable, with its line loss of about 32 decibels at 5000 cycles, without dropping the program level at the broadcast station below a reasonable value.

A satisfactory solution of both of these problems has been arrived at by the simple expedient of predistortion of the signal currents. An outline of the system with a brief discussion of its advantages may be of interest to those confronted with similar situations.

It may be well to point out first in somewhat

* Decimal classification: R550. Original manuscript received by the Institute, March 7, 1938.

† Department of Electrical Engineering, University of Maine, Orono, Maine.

greater detail the faults of the conventional system which was first employed on this channel. (See Fig. 2(A).) The studio microphones worked first into a three-stage preamplifier with manual gain control. The output of this amplifier was patched through a pad to a fixed-gain power amplifier of two push-pull stages, the power capability of which was about +25 decibels. On account of terminal requirements in Bangor it was necessary to operate this at an output level of about +5 decibels as read on a conventional copper-oxide level meter. Now it has been shown¹ that the peak power of the human voice in ordinary conversation frequently reaches a value 100 times as great as the average value, or a variation of 20 decibels above average. Since this reference power was obtained by integration over a considerable period, and therefore is spread over some silent intervals, it is not directly comparable to the average reading of the volume indicator. Nevertheless these two averages when used as references against peak power probably differ by only two or three decibels. Therefore we may conclude that for handling signal peaks there is little margin of safety for the power amplifier in spite of its 2-watt output rating. Furthermore, the use of the equipment on musical programs with their wider energy ranges resulted in frequent

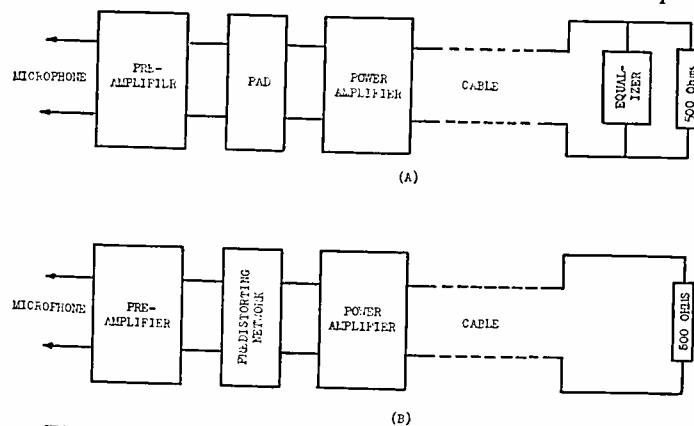

Fig. 2—Block diagram of audio-frequency channels.
(A)—Cable equalization at receiving terminal.
(B)—Cable equalization by predistortion at sending terminal.

overloading even when careful manual adjustment of the amplifier gain was attempted.

The use of a volume-limiting amplifier was considered for a time but the application of such a device would not have solved the second problem of frequency distortion in the cable.

The problem presented by the long nonloaded cable circuit was the customary one of widely vari-

¹ Harvey Fletcher, "Some physical characteristics of speech and music," *Bell. Sys. Tech. Jour.*, vol. 10, pp. 349-373; July, (1931).

able attenuation within the audio-frequency band, the equivalent being about 16 decibels at 1000 cycles and 32 decibels at 5000 cycles. For complete equalization of this circuit at the receiving end by a two-terminal shunt equalizer the equivalent was of course increased to about 32 decibels over the entire audio-frequency band below 5000 cycles. This reduced the indicated level at Bangor to nearly -27 decibels, which was far too low for the broadcast-station amplifiers to handle satisfactorily. The operating tendency, therefore, was to sacrifice equalization in order to procure sufficient power to drive the modulator equipment, the result being that low frequencies were given undue prominence.

A relatively simple solution for both the problem of power capability in the studio amplifier and that of cable equalization was suggested by the fact that most of the energy requirements in the amplifier were those imposed by the low-frequency components of the program material,² while at the same time these low-frequency energies were transmitted over the cable efficiently enough but only to be wasted in the terminal equalizer. The absurdity of taking pains to build up low-frequency energies to a high level for the sole purpose of wasting them in an equalizer became apparent. Accordingly, it was decided to introduce the equalization between the preamplifier and the power amplifier, or, in other words, predistort the signal currents, diminishing greatly the energy content of the low-frequency components. This would relieve the power amplifier of handling the large energies associated with the frequencies in the bass register and at the same time provide cable equalization at the sending end.

A four-terminal constant-resistance equalizer having a frequency characteristic the inverse of that of the cable was designed³ for insertion as a 500-ohm link between the preamplifier, now reduced to two stages, and the power amplifier, replacing the pad at that point. The line-up of equipment when working into 12 miles of artificial cable, as shown in Fig. 2(B), was tested and found to give a frequency characteristic reasonably flat up to 6000 cycles. A subsequent test from microphone input circuit to a 500-ohm termination in Bangor over the actual cable gave essentially the same results. The results of this test are shown in Fig. 1. The system was then placed in operation with a marked improvement in the over-all quality of transmission from the stand-points both of frequency and nonlinear distortion. While designed particularly for handling energy

ranges in ordinary speech, the equipment has also proved satisfactory for handling musical programs, in which the peak power frequently is of the order of 30 decibels above the average.

It has been found that an average predistorted input level of $+5$ decibels (largely high-frequency energy) to the line is ample to drive the equipment at the Bangor terminal, where the frequency components appear in approximately their true proportions, after transmission through the cable, at a level of about -10 decibels.

The equalizer used to effect the distortion is a simple network of resistance and reactance units. A more refined design would yield a still further improvement in the over-all frequency characteristic of the channel. It should be pointed out that the equalizer may be designed to correct also for diminishing gain which many amplifiers show at low frequencies. For such correction the equalizer would not introduce at the low frequencies as much loss as that demanded by the characteristic of the cable alone.

The chief advantages of this system of equalization are (1) that it permits the utilization of relatively long but inexpensive nonloaded cable circuits as a part of high-quality channels, (2) reduces the power-handling requirements of the studio amplifier, since the distortion of the preamplifier output by the equalizer reduces the energy content of the low frequencies far below the normal value, or, in other words, alters the relative energy levels of the high- and low-frequency components normally found in program material until they are more nearly alike, and (3) simplifies to a marked degree the monitoring and control functions at the speech-input equipment without resort to special volume-limiting devices, so that operators without technical training may usually find no difficulty in maintaining high-quality circuit performance.

The author wishes to suggest the possibility of applying the principle of predistortion to situations not involving cable equalization but for the purpose of reducing the number of control points in a given channel. If predistortion is applied after the first stage of amplification following the microphone, all succeeding stages will be driven more nearly alike on the various frequency components with far less likelihood of overloading. There will have to be provided ahead of the final stage, of course, a compensating equalizer to restore the frequency balance, but the control of energy levels should be critical only at this final stage.

ACKNOWLEDGMENT

The writer is indebted to Mr. B. K. Kellom, Chief Engineer at WLBZ, for assistance in making the measurements on this system.

² I. B. Crandall and D. MacKenzie, "Analysis of the energy distribution in speech," *Bell. Sys. Tech. Jour.*, vol. 1, pp. 116-128; July, (1922).

³ O. J. Zobel, "Distortion correction in electrical circuits with constant resistance recurrent networks," *Bell Sys. Tech. Jour.*, vol. 7, pp. 438-543; July, (1928).

Electron-Beam Magnetrons and Type-B Magnetron Oscillations*

KINJIRO OKABE†, NONMEMBER, I.R.E.

Summary—Various experimental results obtained with electron-beam magnetrons are given. The mechanism of type-B magnetron oscillations is described using a novel method which takes into consideration all the experimental results hitherto obtained in connection with magnetrons of various types.

INTRODUCTION

IT WAS pointed out in other communications^{1,2} that very high-frequency oscillations of two different types could be produced with a split-anode magnetron. These two types were the oscillation whose frequency is approximately independent of the ex-

ternal circuit (type A) and the one whose frequency depends principally on the external circuit (type B). Some investigators have attempted to explain type-B oscillations by a negative-resistance relation obtained statically, exactly in the same way as in the case of a dynatron, notwithstanding that the author³ has called attention to the fact that oscillations of type B differ fundamentally from those of the dynatron type, and from experimental evidence most of the ultra-high-frequency oscillations obtained with a split-anode magnetron are of the B type, not the dynatron type. Later, Posthumus⁴ theorized on the mechanism of the oscillation in question, showing that it differs fundamentally from the dynatron type. Kilgore⁵ also pointed out that the oscillations obtained with a four-split-anode magnetron may not be the dynatron type. Recently, Herriger and Hülster⁶ outlined a similar theory and called these oscillations "Laufzeitschwingung höherer Ordnung."

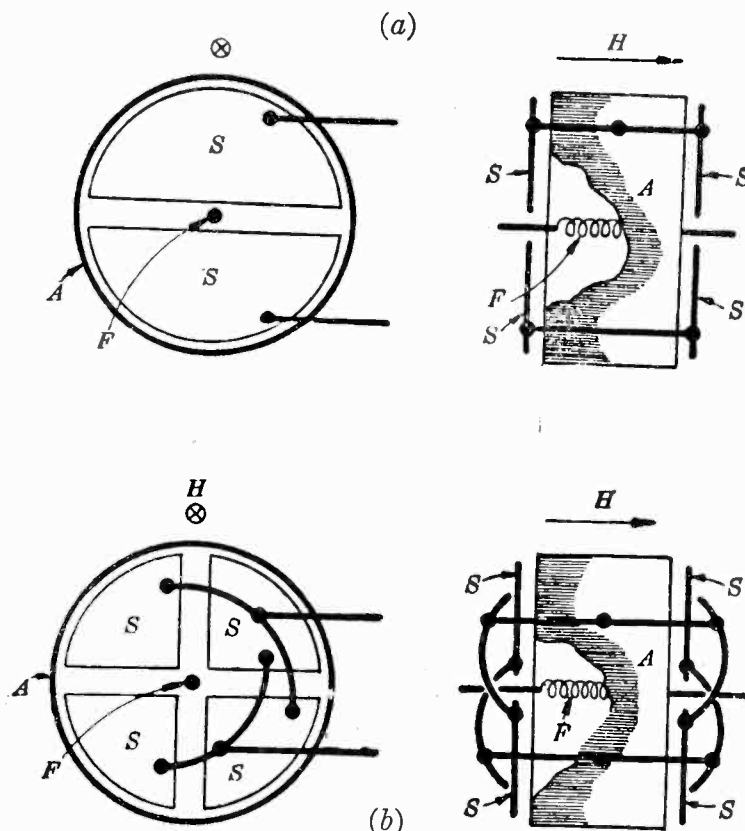

Fig. 1

ternal circuit (type A) and the one whose frequency depends principally on the external circuit (type B). Some investigators have attempted to explain type-B oscillations by a negative-resistance relation obtained statically, exactly in the same way as in the case of a dynatron, notwithstanding that the author³ has

* Decimal classification: R133. Original manuscript received by the Institute, June 14, 1937; revised manuscript received by the Institute, February 17, 1938.

† Department of Physics, Osaka Imperial University, Osaka, Japan.

¹ Kinjiro Okabe, "On the short-wave limit of magnetron oscillations," *Proc. I.R.E.*, vol. 17, pp. 652-659; April, (1929).

² Kinjiro Okabe, "On the magnetron oscillation of new type," *Proc. I.R.E.*, vol. 13, pp. 1748-1749; October, (1930).

³ Kinjiro Okabe, "On the production of ultra-short-wave oscillations with cold-cathode discharge tube," *Proc. I.R.E.*, vol. 21, pp. 1593-1598; November, (1933).

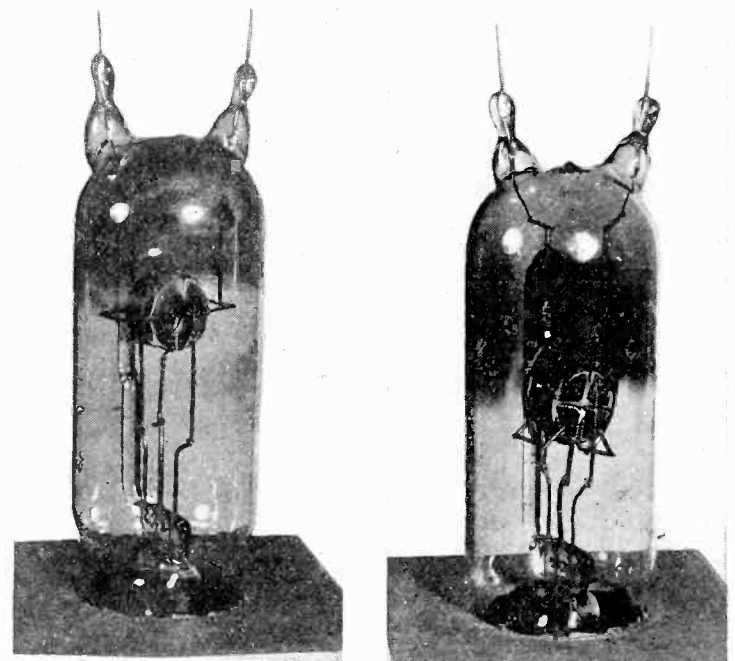

Fig. 2

Fig. 3

In this paper, the mechanism of the magnetron oscillation of type B will be described in detail, illustrating all the essential characteristics of the present oscillation. The operation of the electron-beam magnetron,⁷ a new type, will be given first. This tube produces type-B oscillations more successfully than does the split-anode magnetron and does not produce the

⁴ K. Posthumus, "Oscillations in a split-anode magnetron," *Wireless Eng.*, vol. 12, pp. 126-130; March, (1935).

⁵ G. R. Kilgore, "Magnetron oscillators for the generation of frequencies between 300 and 600 megacycles," *Proc. I.R.E.*, vol. 24, pp. 1140-1157; August, (1936).

⁶ F. Herriger and F. Hülster, "Die Schwingungen der Magnetfeldröhren," *Hochfrequenztech.*, vol. 49, pp. 123-132; April, (1937).

⁷ Kinjiro Okabe, "Electron-beam magnetron," *Jour. I.E.E. (Japan)*, vol. 57, p. 55; January, (1937).

ultra-high-frequency dynatron-type oscillations. Consequently, the pure characteristics of the type-B oscillation will be clearly understood from the experimental results obtained with the present tube.

ELECTRON-BEAM MAGNETRON

1. Construction and Connection

Figs. 1 (a) and (b) show the arrangement of the electrodes of typical electron-beam magnetrons, in which *A*, *S*, and *F* are, respectively, the anode, oscillation electrodes, and filament cathode. Figs. 2 and 3 are photographs of tubes constructed in our laboratory and with which the experimental results to be described were obtained. The anodes of these tubes are about 2 centimeters in diameter and about 1 centimeter in axial length.

Fig. 4 shows the construction of a water-cooled electron-beam magnetron. The anode can be water-cooled directly from the outside without the use of pipes within the tube—a great advantage when producing oscillations of very great power.

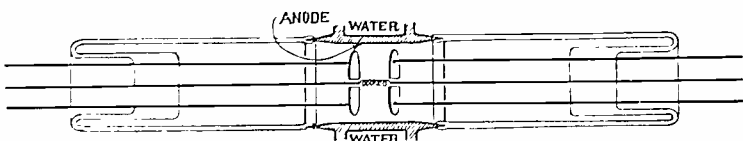

Fig. 4

A typical connection is shown in Fig. 5, from which it will be seen that a magnetic field of proper intensity must be applied to the tube in the direction of the axis of the anode, or in a direction near to it. The heavy lines show the circuit that determines the wavelength of the oscillation.

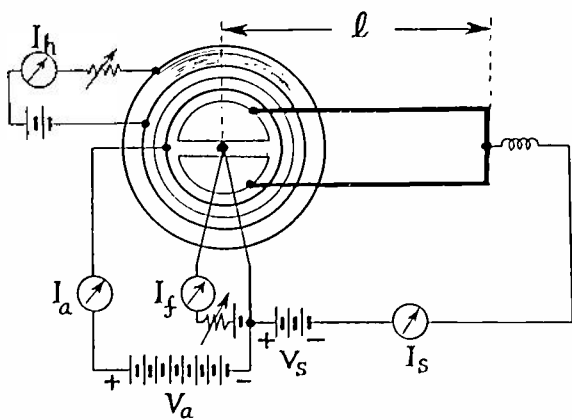

Fig. 5

The anode merely accelerates the electrons in traveling from the cathode. In the case of the split-anode magnetron, its anode performs the functions of both accelerating the electrons and maintaining the oscillation.

2. Experimental Results

In the figures that follow, η , λ , and I_d , respectively, represent the efficiency, the measured wavelength, and the detector current which becomes a measure of the oscillation intensity. The efficiency

is assumed to be the ratio of the power consumed by a lamp load to the anode input, expressed in percentage. The other symbols are diagrammatically shown in Fig. 5.

Fig. 6 shows the changes in the detector, anode, and oscillation-electrode currents when the intensity

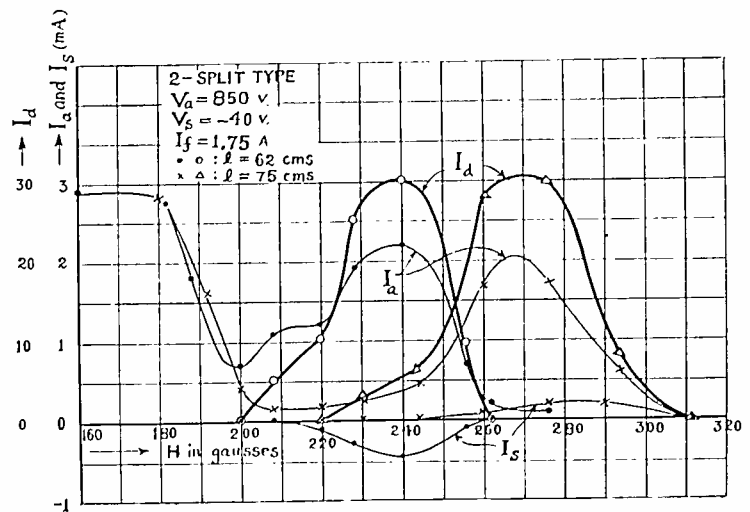

Fig. 6

of the applied magnetic field *H* was varied. These characteristics are very similar to those of the split-anode magnetron.

Fig. 7 shows the changes in the wavelength, the anode current, and the current of the oscillation electrodes as the length of the oscillation circuit was varied. Until oscillation starts, no appreciable current flows through the oscillation electrodes, showing that the value of negative resistance obtained statically is infinity. The anode current is also very

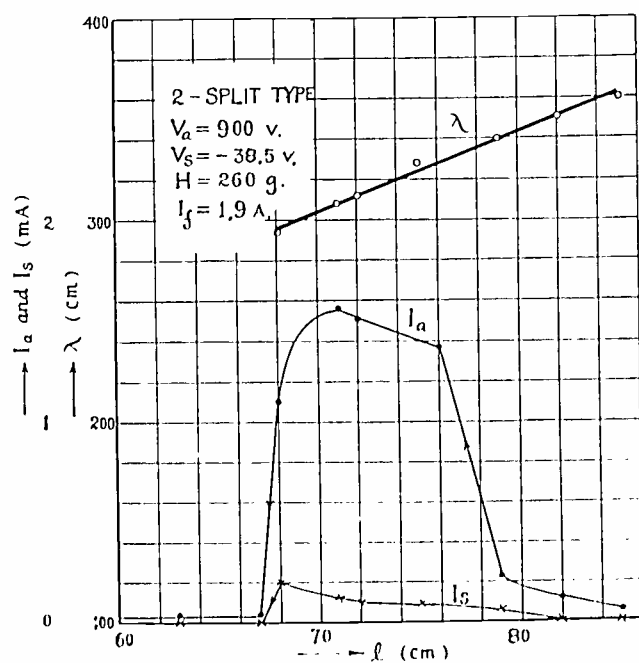

Fig. 7

small when oscillation does not occur. In its main points, the characteristics shown in the figure are about the same as those of the split-anode magnetron for type-B oscillations.

Fig. 8 shows the changes in the anode current, the oscillation-electrode currents, and the wavelength when the voltage applied to the oscillation electrodes was varied.

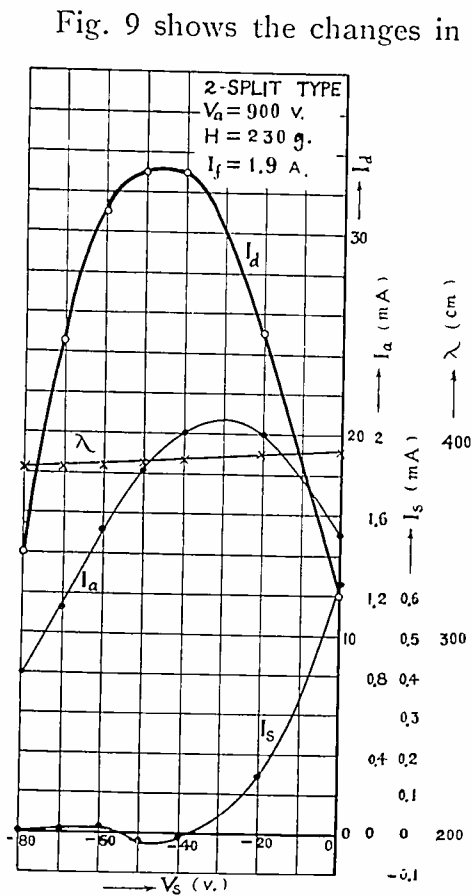

Fig. 8

produce longer-wavelength oscillations, the intensity of the applied magnetic field must be increased, exactly in the same way as in the case of type-B split-anode-magnetron oscillations.

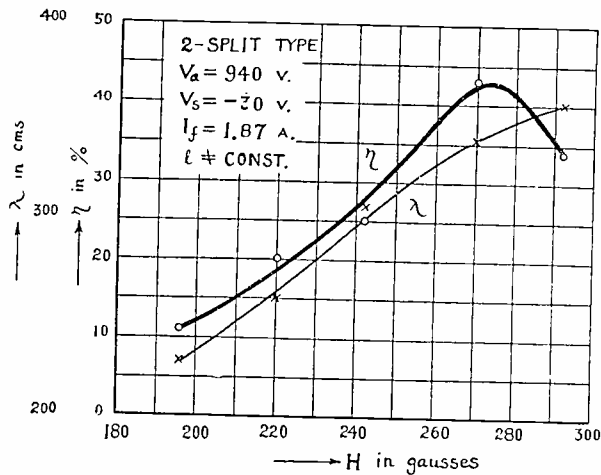

Fig. 9

The above results were obtained with the tube shown in Fig. 2. Results obtained with the tube shown in Fig. 3 are given in Fig. 11, which corresponds to Fig. 10. Assuming the dimensions of the electrodes and operating conditions to be the same, tubes shown in Figs. 1 (b) and 3 give oscillations of shorter wavelengths than those shown in Figs. 1 (a)

and 2. This relation is also exactly the same as that which holds in the case of the two- and four-split-anode magnetrons.

In short, these experimental results show that the oscillations obtained with electron-beam magnetrons, in their principal characteristics, are exactly the same as the type-B oscillations obtained with a split-anode magnetron, and also that a negative-resistance relation obtained statically is not necessary for producing oscillations of this type. This conclusion can also be supported by a number of experimental results obtained with magnetrons of other types.⁸

and 2. This relation is also exactly the same as that which holds in the case of the two- and four-split-anode magnetrons.

In short, these experimental results show that the oscillations obtained with electron-beam magnetrons, in their principal characteristics, are exactly the same as the type-B oscillations obtained with a split-anode magnetron, and also that a negative-resistance relation obtained statically is not necessary for producing oscillations of this type. This conclusion can also be supported by a number of experimental results obtained with magnetrons of other types.⁸

MECHANISM OF THE TYPE-B MAGNETRON OSCILLATION

We shall now deal with the mechanism of the magnetron oscillation of type B obtained with an electron-beam magnetron.

Fig. 12 (a) shows the path described by an electron, assuming that the alternating potential of the lower oscillation electrode is negative and the upper one is positive at the instant the electron arrives at point 1. The time required by this electron in traveling from 1 to 3 along the helical path 1, 2, 3 is approximately equal to half the period of the oscillation. Fig. 12 (b) shows the phase relation between the position of the electron in space and the alternating potentials of the oscillation electrodes. In this case, a certain amount of the kinetic energy of the electron must add itself to the energy of the oscillation every time the electron passes the split

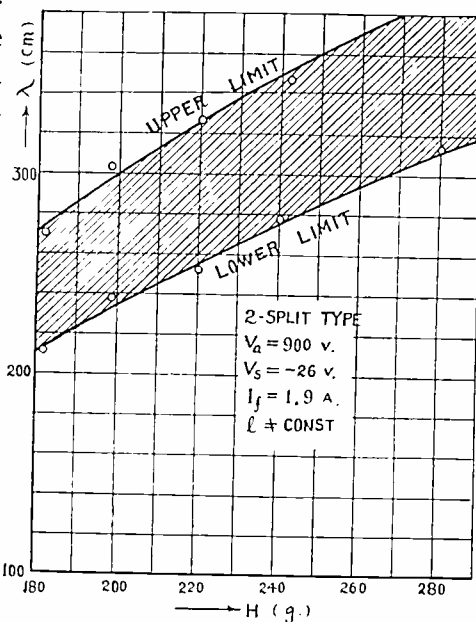

Fig. 10

oscillation electrodes. In this case, a certain amount of the kinetic energy of the electron must add itself to the energy of the oscillation every time the electron passes the split

⁸ Kinjiro Okabe, "Magnetron oscillations of ultra-short wavelengths," (in English), Shōkendō, Ogawacho, Kanda, Tokyo, 1937.

part, the velocity of the electron being reduced. Fig. 13 shows the path described by an electron, assuming that the phase of the alternating potential is opposite to the above at the instant the electron arrives at the gap on the right-hand side. In this case, the electron acts to diminish or stop the oscillation, the velocity of the electron itself being accelerated. The chances of the energy being withdrawn from the oscillating circuit must be less than those of the energy from the electrons being transferred to the oscillating circuit, since the accelerated electrons either will be captured readily by the anode, etc., or they may return to the neighborhood of the cathode in a satisfactory manner as will be shown later.

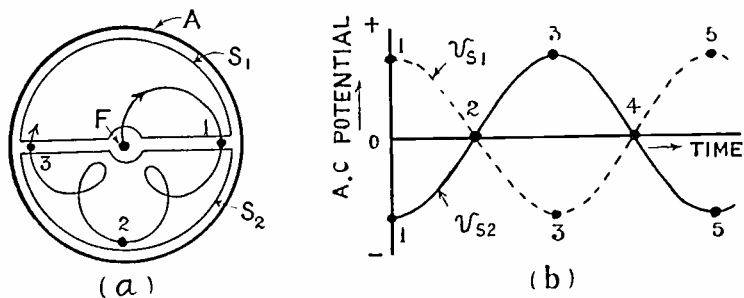

Fig. 12

The foregoing considerations could be extended to other cases in which the electrons emit from various parts of the cathode at any instant of alternating potential. The author, however, is confident that the mechanism of the oscillation in question will be clearly understood from the above, without describing these cases.

The path of an electron in an electron-beam magnetron of the four-split type, which corresponds to that of Fig. 12, is shown in Fig. 14. Figs. 12, 13, and 14 show diagrammatically, why, provided the dimensions of the tubes and their operating conditions are the same, a tube of the four-split type produces oscillations of shorter wavelength than one of the two-split type.

Fig. 15 shows the paths of electrons that are described under the same conditions as those assumed in the case of Figs. 12 and 13, except in the matter of the intensity of the applied magnetic field. In this case, it is reasonable to assume a large virtual cathode around the cathode from a theoretical point of view. The apparent diameter of this virtual cathode increases with the intensity of the applied magnetic field and may be very small at the critical value of the magnetic field. As shown by the dotted line in the figure, most of the electrons accelerated by the alternating electric field, instead of reaching the anode directly, may return to the virtual cathode. Consequently, the efficiency of the tube under this condition may become much higher than in the cases of Figs. 12 and 13.

In short, Figs. 12, 13, and 15 show diagrammatically why both the wavelength of the oscillation and the efficiency increases with an increase in the intensity of the applied magnetic field.

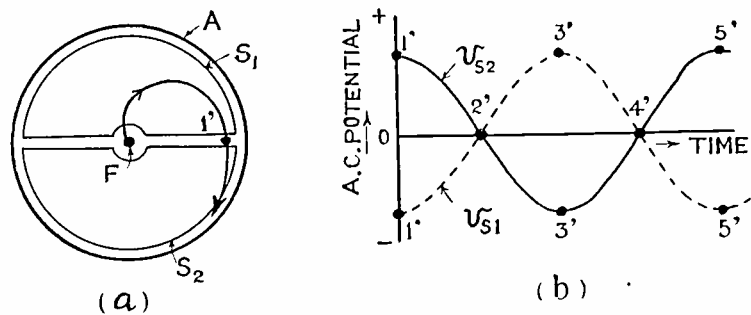

Fig. 13

The mechanism of type-B oscillations obtained with a split-anode magnetron can be explained in the same way as for the above case. No further illustration of this seems to be necessary.

Various calculations and a number of experiments were tried in order to check the above considerations.

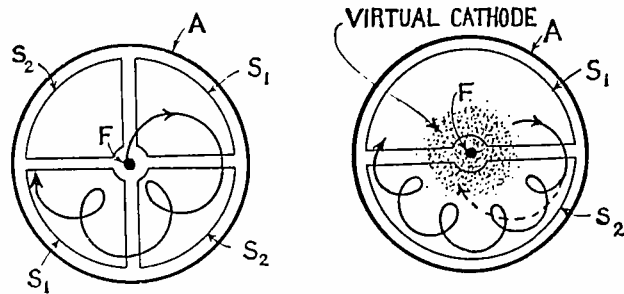

Fig. 14

Fig. 15

CONCLUSION

The experiments regarding the electron-beam magnetron are now being continued. However, it seems to be noteworthy that a small radiation-cooled sectionalized magnetron^{8,9} operating on the principles of the electron-beam magnetron, successfully produced a useful output of 100 to 200 watts at a wavelength between 50 and 80 centimeters. This indicates the probability of being able to produce very intense oscillations at ultra-short wavelengths with a water-cooled electron-beam magnetron.

The theory of the mechanism of type-B magnetron oscillations seems to have been completed qualitatively and follows from the assumption of a virtual cathode.

ACKNOWLEDGMENT

The author expresses his thanks to Professor Yagi for his valuable suggestions and also to Messrs. Hisida and Owaki for their valuable assistance.

⁹ Kinjiro Okabe, "Split-anode magnetron of special type," *Jour. I.E.E. (Japan)*, vol. 57, p. 485; June, (1937).

A Study of Ultra-High-Frequency Wide-Band Propagation Characteristics*

R. W. GEORGE†, ASSOCIATE MEMBER, I.R.E.

Summary—Signals reflected from buildings and other large objects introduce distortion in the received signal because of their relative time delay and phase relations. This distortion is especially evident in the form of blurred and multiple images in television reception. Data on the relative merits in this respect, of vertically and horizontally polarized waves transmitted from the Empire State Building in New York City, were obtained at the two frequency ranges of 81 to 86 megacycles and 140 to 145 megacycles. Some data using circular polarization at the lower frequency range were also obtained.

The effects of indirect-path signals were indicated on recorded curves showing field strength versus frequency. The methods and equipment used to record these data at a number of representative receiving locations are briefly described.

A minimum of indirect-path signal interference was found to be generally had with horizontal polarization at both signal-frequency ranges. In this respect, circular polarization was found to be slightly preferable to vertical polarization. Horizontal polarization also gave somewhat greater average field strength.

Miscellaneous data and observations are described, including sample propagation-characteristic curves. In conclusion, some relations between direct- and indirect-path signals and propagation paths are discussed.

ONE problem in television is to obtain received pictures free from secondary images caused by time-delayed signal components propagated from the transmitter along paths of different lengths. It is an object of this paper to show something of the nature of this problem, especially in and around such urban areas as New York City.

As an introduction to this subject,¹ P. S. Carter and G. S. Wickizer found that the use of some antenna directivity and horizontal polarization would be most effective for a 177-megacycle television circuit between the RCA Building and the Empire State Building. In the present paper the methods used and results of a similar but more extensive survey made to determine the relative differences in indirect-path propagation between horizontally and vertically polarized waves are described.

The field strength for a given frequency is the vector sum of all the signal components present. At another frequency, the signal components may be of the same intensity but will have different phase relations which result in a different value of field strength. A series of field-strength measurements plotted with corresponding frequencies will show a

* Decimal classification: R113.7. Original manuscript received by the Institute, May 5, 1938. Presented before Thirteenth Annual Convention, New York, N. Y., June 18, 1938.

† R.C.A. Communications, Inc., Riverhead, Long Island, New York.

¹ P. S. Carter and G. S. Wickizer, "Ultra-high-frequency transmission between the RCA Building and the Empire State Building in New York City," Proc. I.R.E., vol. 24, pp. 1082-1094; August, (1936).

sinusoidal variation of field strength with frequency in a simple case of the combination of two signal components propagated over paths of different lengths.

It can be shown that if f_1 and f_2 are frequencies between which one signal component has gone through 360 degrees phase shift with respect to the other, or in other words, between which frequencies a complete cycle of field-strength variation is had, the difference in path lengths d and the accompanying time delay t of the longer-path signal are

difference in path length,

$$d = \frac{3 \times 10^8}{f_2 - f_1} \text{ meters} \quad (1)$$

time delay,

$$t = \frac{1}{f_2 - f_1} \text{ seconds.} \quad (2)$$

Equations (1) and (2) may be derived as follows:

N is the number of wavelengths of path length d at the frequency f_1 .

$(N+1)$ is the number of wavelengths of path length d at the frequency f_2 .

λ_1 is the wavelength corresponding to f_1 .

λ_2 is the wavelength corresponding to f_2 .

$$d = N\lambda_1 = (N + 1)\lambda_2. \quad (3)$$

Eliminating N from (1)

$$d = \left(\frac{d}{\lambda_1} + 1 \right) \lambda_2$$

$$d \left(1 - \frac{\lambda_2}{\lambda_1} \right) = \lambda_2$$

$$d = \frac{\lambda_2 \lambda_1}{\lambda_1 - \lambda_2}$$

$$d = \frac{c^2}{f_2 f_1} \left(\frac{1}{f_1} - \frac{1}{f_2} \right)$$

where c , the velocity of light, = 3×10^8 meters per second

$$\lambda_1 = \frac{c}{f_1} \quad \text{and} \quad \lambda_2 = \frac{c}{f_2}$$

$$d = \frac{c}{f_2 - f_1} = \frac{3 \times 10^8}{f_2 - f_1} \text{ meters} \quad (1)$$

$$t = \frac{d}{c} = \frac{1}{f_2 - f_1} \text{ seconds.} \quad (2)$$

Thus, measurements over a frequency range of 5 megacycles ($f_2 - f_1$), are ample to indicate signal-arrival-time delays of 0.2 microsecond and upwards. Other indirect-propagation-path characteristics are indicated by such measurements and will be discussed later.

MEASURING EQUIPMENT AND METHODS

A frequency range of 81 to 86 megacycles was chosen to avoid interference with existing local radio circuits. Tests were also conducted at the higher-frequency range of 140 to 145 megacycles. The transmitting systems were built and operated by members of the engineering department of R.C.A. Communications, Inc., at Rocky Point, Long Island, New York.

Each transmitting system supplied substantially constant radiated power as a mechanical system varied the frequency at a constant rate of change from one extreme to the other in one-half minute and likewise back again in one-half minute. Frequency control was maintained by the use of resonant concentric circuits.² Variation was obtained in the 81- to 86-megacycle transmitter by changing the length of the frequency control element with a motor-driven cam. In the 140- to 145-megacycle transmitter, frequency variation was produced by means of a small motor-driven variable condenser. The radiated power was about 750 watts at the lower frequency and 68 watts at the higher frequency.

Both transmitters were installed about 1200 feet above the ground near the top of the cylindrical steel tower on the Empire State Building. Short transmission lines were connected to the respective special doublet antennas. These antennas were each mounted about one-fourth wave from the tower on a copper pipe containing the two-wire transmission line and were arranged to be turned manually to transmit either vertically or horizontally polarized waves. Both frequencies were in turn radiated from approximately the north and south sides of the tower.

The 81- to 86-megacycle antenna on the south side was made of two doublets crossed at their centers, each with a separate transmission line to the trans-

mitter. By this arrangement, in addition to horizontal or vertical polarization, it was possible to obtain circular polarization by establishing a 90-degree phase difference in the transmission lines before connecting them in parallel at the transmitter.

The object of the field-strength-measuring system was to make a series of recorded measurements as the transmitter frequency varied from one extreme to the other. The block diagram, Fig. 1, indicates the

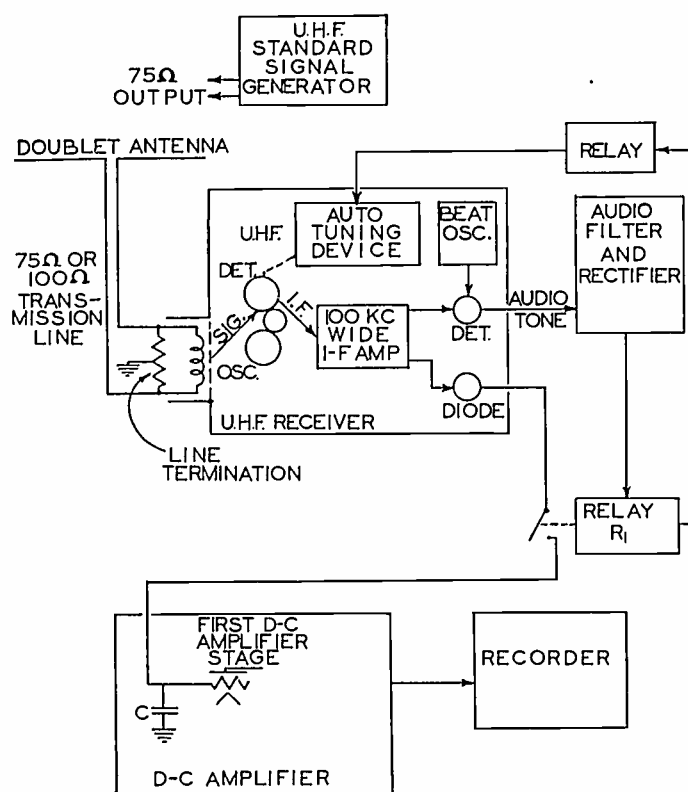

Fig. 1—Block diagram of the field-strength-measuring system.

functions which made this system somewhat unusual. A half-wave doublet antenna fed a low-impedance transmission line which was properly terminated at the receiver. The receiver, of conventional design, was suitably modified to meet the present requirements. The ultra-high-frequency detector input and heterodyne-oscillator circuits were ganged together by gears and adjusted to track over the desired signal-frequency range, 81 to 86 megacycles or 140 to 145 megacycles.

In operation, the signal frequency, changing at the rate of 166 kilocycles per second, was in the pass-band of the receiver about 0.3 second before reaching the mid-band of the intermediate-frequency amplifier, and produced, by means of the diode detector, an output voltage corresponding to the value of the input signal voltage. In order to record the signal level, at this instant, use was made of the audio-frequency beat note produced by combination of the intermediate frequency and a fixed heterodyne oscillator in a separate detector. This audio-fre-

² C. W. Hansell and P. S. Carter, "Frequency control by low power factor line circuits," Proc. I.R.E., vol. 24, pp. 597-619; April, (1936).

quency beat-note output, converted to direct current, caused the relay R_1 to connect the diode voltage to the grid of the first direct-current amplifier stage A , thus charging the condenser C to the value of the diode voltage, and operating the recorder through the subsequent direct-current power amplifier. After about 0.1 second, the audio-frequency output was removed as the signal frequency increased and passed out of the audio-frequency filter, causing the relay R_1 to disconnect the diode from the condenser

spreading the 5-megacycle range uniformly on the chart.

The method of calibrating the record was to substitute a standard-signal generator having a 75-ohm output, for the doublet antenna. This established the voltage in the antenna, and from the known effective height of the doublet, the field strength was determined. The necessarily frequent calibrations were obtained by connecting the signal generator directly to the receiver and taking into account the transmission-line loss. The standard-signal generator was also used to check the response of the measuring system. The over-all response was constant with fixed voltage input over the desired frequency range and the output was directly proportional to the input. The response of the doublet antennas over the 5-megacycle range was known to be substantially constant.

A final check of the flatness of response of the entire measuring system was obtained by recording field strength versus frequency at a receiving location where one would expect, from consideration of the terrain, that a constant field strength should be obtained. This location, about 13 miles from the transmitter, was well away from possible reflecting objects in a clear flat field with several miles of unobstructed ground in the direction of New York. One major indirect-path signal existed at this location due to reflection from the ground but its path was so little different in length from the direct-signal path that negligible changes in resultant field strength were had over the 5-megacycle range.

Duplicate measurements were often made, all of which showed good agreement when propagation conditions and the antenna position were unchanged.

The signal generator, receiver, direct-current amplifiers, and voltage-regulating power-supply units were mounted in two portable racks and installed in a 3/4-ton panel truck in which measurements were made wherever possible. Otherwise, the equipment was removed to the desired receiving locations. Power was usually obtained from near-by 110-volt alternating-current outlets.

Receiving antenna locations were generally chosen which might be considered suitable for a television antenna. In some cases, such as on the roof of the RCA Building, Fig. 2, measurements were made at several antenna positions.

In order to make comparisons, the antenna was always placed in the same position at each location. All locations were within 22 miles from the transmitter except one which was 42 miles away.

Circular polarization was received with an antenna arrangement similar to that used at the transmitter.

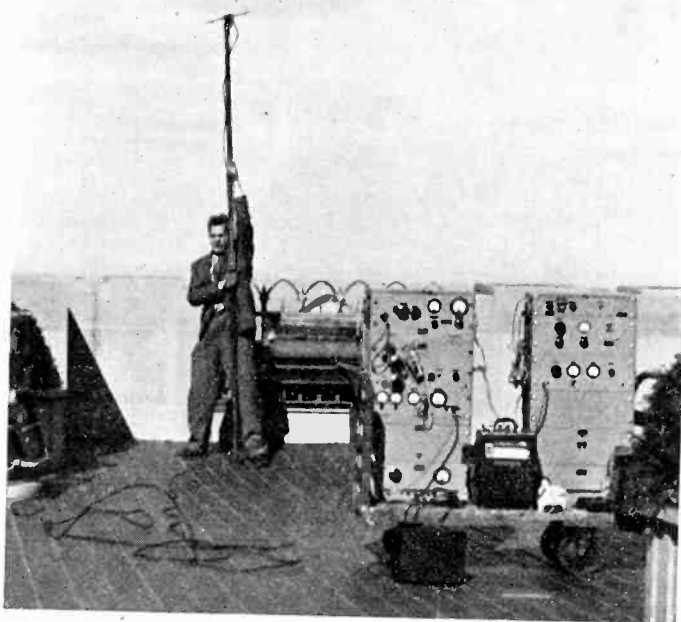

Fig. 2—Field-strength-measuring equipment on the roof of the RCA Building.

C . The condenser C maintained the voltage on the grid of the direct-current amplifier A , holding the recorder at its last reading until the next measurement was made. During subsequent measurements, the condenser C was charged or discharged according to the new signal level.

A series of measurements was started by tuning the receiver to the lowest frequency reached by the signal. When the signal swept into the receiver, a measurement was made, causing the recorder to show abruptly the starting signal level for the forthcoming curve. When the measurement was completed, the relay R_1 returning to normal operated an electromagnetic device which quickly set the receiver tuning up to a frequency just higher than the increasing signal frequency. As each measurement was completed, this operation was repeated until at the end of one-half minute, the highest frequency was reached. The result was that about 70 evenly spaced measurements were recorded showing a substantially complete field-strength-versus-frequency curve. The recorder chart was driven at a constant rate, thus

SUMMARY OF DATA: HORIZONTAL AND VERTICAL POLARIZATION

As expected, at a number of random receiving locations, the measurements showed a large variety of direct- and indirect-path-signal combinations. The relative strength of the indirect signals is an indication of the intensity of expected interference or secondary television images. Thus, to show the relative merits of horizontal and vertical polarization with respect to minimum indirect-signal interference, comparisons of the ratio of maximum field strength to minimum field strength, obtained from representative data for each location and polarization are shown in Fig. 3. From this figure it is seen that most of the points are above the value of 1.0, indicating that at most of the locations, indirect-path-propagation efficiency was better for vertical polarization than for horizontal polarization.

The geometric means of all of the maximum to minimum field-strength ratios for each polarization and frequency range are shown in Table I. These

TABLE I
GEOMETRIC MEANS OF THE RATIOS, MAXIMUM FIELD STRENGTH TO MINIMUM FIELD STRENGTH

	81 to 86 megacycles	140 to 145 megacycles
Horizontal polarization	1.86	2.12
Vertical polarization	2.97	3.38

data indicate that the indirect interfering signals were from 10 to 20 per cent stronger at the higher frequency and were strongest with vertical polarization at both frequencies.

Average field strengths were determined for each location from the recorded data. In Fig. 4 are shown

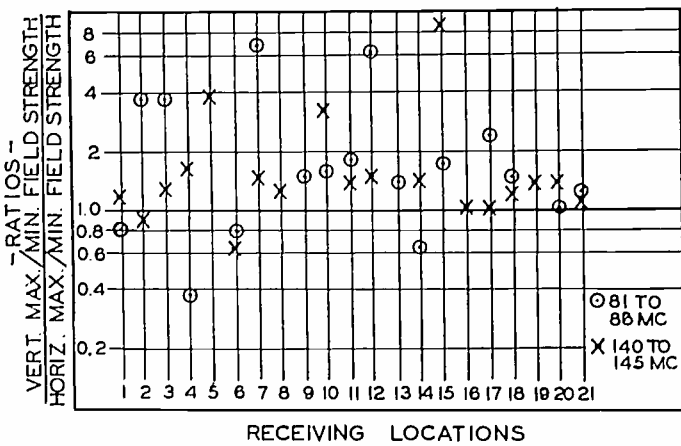

Fig. 3—Comparisons between vertical and horizontal polarization of maximum to minimum field-strength ratios obtained at each receiving location and signal-frequency range.

the ratios of average field strength for vertically polarized waves to average field strength for horizontally polarized waves. The geometric mean of all these ratios for the 81- to 86-megacycle range is 0.83,

and for the 140- to 145-megacycle range 0.82. This summary indicates that in general horizontally polarized waves were received about 20 per cent stronger than were vertically polarized waves.

The geometric mean of all the average field strengths using horizontal polarization was for the

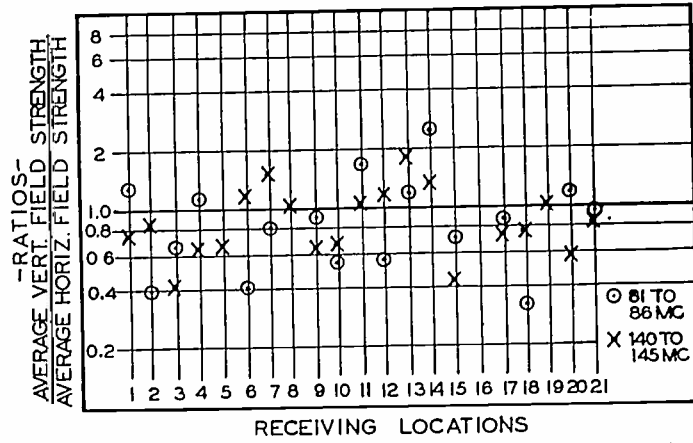

Fig. 4—Comparisons between vertical and horizontal polarization of average field strengths obtained at each receiving location and signal-frequency range.

81- to 86-megacycle range, 88.5 per cent of that obtained at the 140- to 145-megacycle range. This comparison is based on the same transmitted power at both frequency ranges.

CIRCULAR POLARIZATION

It was predicted that under certain propagation conditions involving a direct path and an indirect path, the rotation of a circularly polarized wave would be reversed upon reflection. Thus, the receiving antenna adjusted to receive the direct circularly polarized wave, would not respond to the indirect-path wave. For the circularly polarized wave to be reversed upon reflection, it would be necessary for the wave component polarized perpendicular to the plane of incidence to undergo a 180-degree phase shift with respect to the wave component polarized in the plane of incidence. In general, this phase relation may be established under the following conditions.³

For a wave polarized perpendicular to the plane of incidence, the reflected wave is always substantially 180 degrees out of phase with the incident wave. For a wave polarized in the plane of incidence, the phase of the wave reflected from a medium having negligible conductivity, is the same as that of the incident wave when the angle of incidence is less than the critical angle. This critical angle is known as Brewster's angle or the angle of polarization in connection with light, and is a function of the

³ Bertram Trevor and P. S. Carter, "Notes on propagation of waves below ten meters in length," Proc. I.R.E., vol. 21, pp. 387-426; March, (1933).

dielectric constant of the reflecting medium. If the stone walls of buildings may be regarded as having negligible conductivity at high frequencies, the desired phase relations may thus be established between vertically and horizontally polarized signal components. When the angle of incidence is greater than the critical angle, the phase of the reflected wave is 180 degrees different from that of the incident wave and thus is the same as the phase of a reflected wave polarized perpendicular to the plane of incidence.

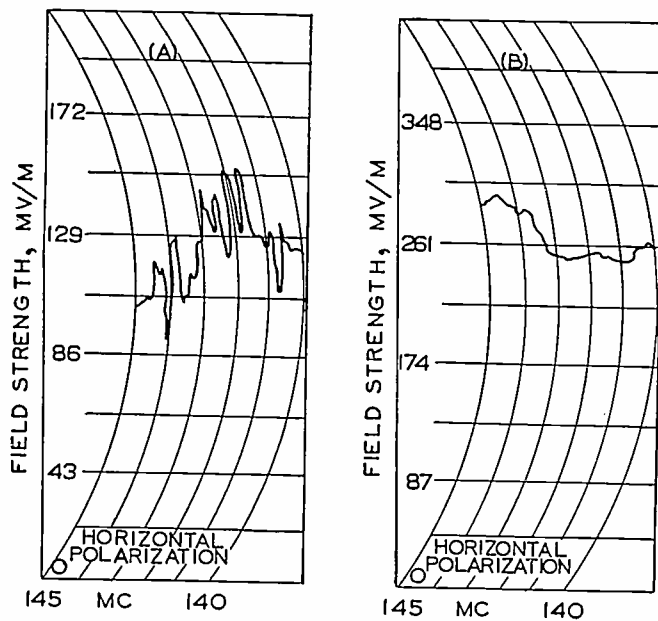

Fig. 5—Propagation-characteristic curves obtained on the roof of a 10-story building about three quarters of a mile south of the transmitter. For curve *B* the antenna had a relatively clear exposure to the transmitter, and for curve *A* its exposure was partially obstructed by a near-by ventilator.

In order for a receiving antenna to respond only to the direct-path signal, it would be necessary for the received indirect-path vertically and horizontally polarized wave components to be equal as well as 180 degrees out of phase. Practically, this condition could not occur in New York City because of the presence of several indirect paths, each involving different coefficients of reflection for vertically and horizontally polarized waves, and the angles of incidence usually being too large to give the necessary 180-degree phase difference between vertically and horizontally polarized waves after reflection.

Measurements using circular polarization were made at three types of locations using the 81- to 86-megacycle transmitter. These locations were: south of Newark Airport in the previously mentioned clear area, on the roof of 75 Varick Street Building, and from a north side window on the 26th floor of the Woolworth Building. In order to obtain relatively accurate information, measurements of both horizontal and vertical polarization were made consecutively for direct comparison.

The summary of these measurements in Table II shows circular polarization to be in general less desirable than horizontal and possibly somewhat more desirable than vertical polarization.

MISCELLANEOUS DATA AND OBSERVATIONS

Some data were obtained on the average field strengths of the horizontally polarized component received for vertically polarized wave transmission and conversely. These indicated that horizontally polarized wave transmission had an average vertical component of from 25 to 30 per cent of its horizontal field strength, and that for vertically polarized transmission, the horizontal component was somewhat less, on the order of 20 per cent of the corresponding vertical-field strength.

A change in receiving-antenna position by a small distance of one or two feet usually altered the shape of the recorded propagation-characteristic curve. Very large differences in field strength as well as shape of the curve were had at locations having near-by obstructions or reflecting objects.

The importance of obtaining the strongest possible direct signal was well illustrated under the following conditions. Two antenna positions, about 30 feet apart, were had on the roof of a ten-story building about three quarters of a mile from the transmitter. Both positions had exposure to the direct-path signal but one was almost obstructed by a large metal

TABLE II
CIRCULAR POLARIZATION DATA COMPARISONS
81 to 86 megacycles

Comparison	Location		
	Airport	Woolworth	Varick St.
Vert. Max/Min ratio			
Horiz. Max/Min ratio	1.16	1.24	1.37
Circ. Max/Min ratio			
Horiz. Max/Min ratio	1.02	0.94	1.11
Avg. Vert. mv/m			
Avg. Horiz. mv/m	0.8	0.97	1.48
Avg. Circ. mv/m			
Avg. Horiz. mv/m	1.0	0.91	1.16

ventilator. The reflected signal from this ventilator combined with the direct signal at the antenna to produce a weakened resultant signal. Other indirect signals not so much affected by the ventilator, if at all, were relatively strong with the result that they greatly modified the received signal. This was in contrast with the results obtained at the better exposed antenna where the direct-path signal was stronger. Propagation-characteristic curves obtained at each antenna position are shown in Fig. 5.

The additional sample propagation-characteristic curves shown in Figs. 6, 7, 9, 10, and 11 will give an idea of the nature and range of the field-strength variations encountered. The calibrations shown are

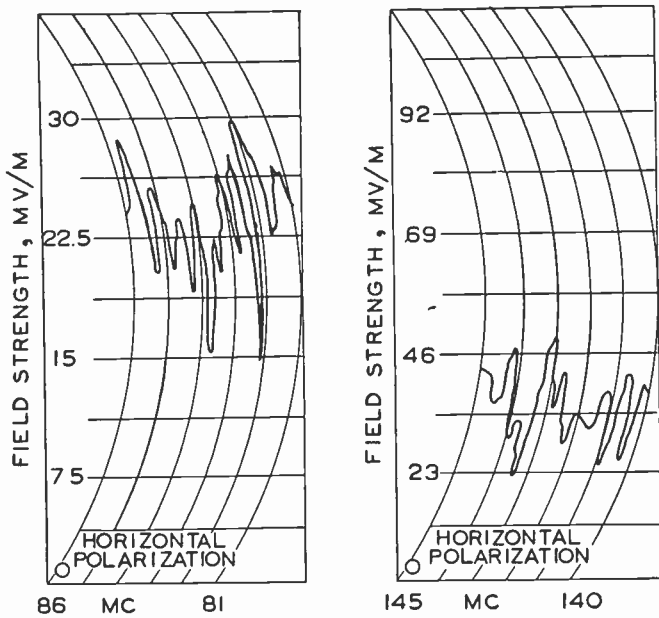

Fig. 6—Propagation-characteristic curves obtained on the roof of a 10-story apartment building about three miles north of the transmitter.

corrected for one kilowatt radiated. Usually there may be only one or two indirect paths of major importance and, if desired, their corresponding time delay t and difference in path length d can be roughly

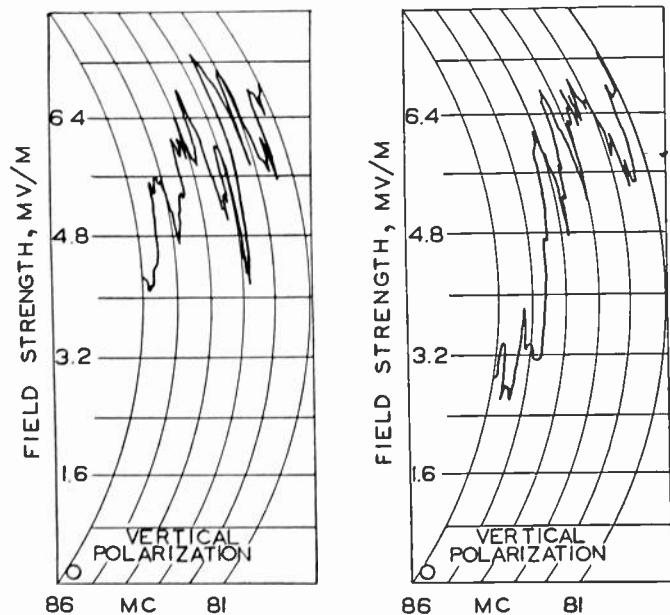

Fig. 7—Propagation characteristic curves obtained at a residence on Staten Island about 12 miles from the transmitter. The two curves are for antenna positions about seven feet apart.

determined. Apparently, a complete analysis of the indirect paths would be difficult and have little value because the problems presented at each proposed receiving location must, in practice, be solved individually.

The data in Fig. 6 were obtained with an antenna on the roof of a 10-story apartment building about three miles north of the Empire State Building.

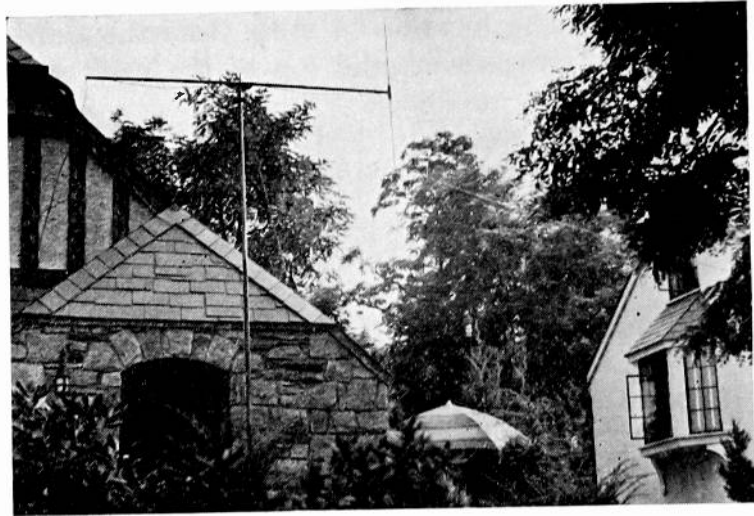

Fig. 8—Receiving antenna on a portable mast, with which data in Fig. 9 were obtained.

A television receiver having a 12-inch Kinescope was available here on which a fairly strong secondary image was observed. It was displaced about one fourth of an inch corresponding to a time delay of about 1.5 microseconds. The time delay of one

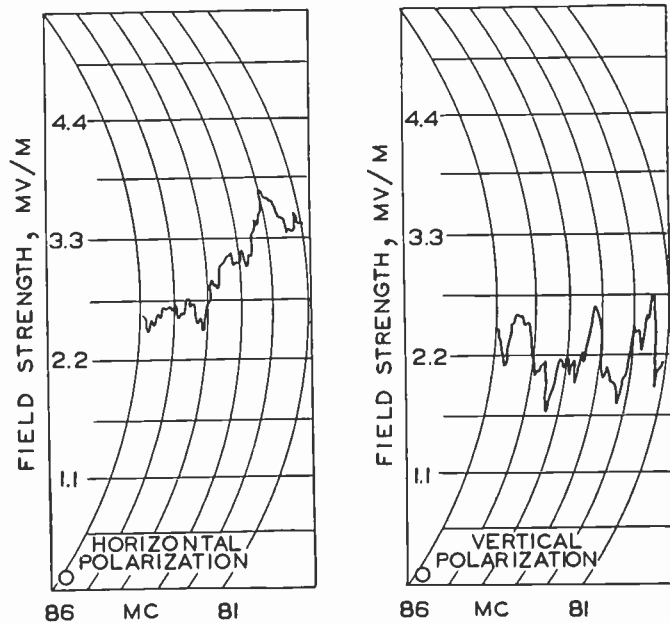

Fig. 9—Propagation-characteristic curves obtained at a residence about 14 miles north of the transmitter.

prominent indirect-path signal indicated on the data, is found by the use of (2), to be on the order of 1.5 to 1.8 microseconds which is in substantial agreement with the displacement of the observed image. The difference in path lengths would be, by (1), 450 meters for a time delay of 1.5 microseconds.

The curves in Fig. 7 were obtained on Staten Island about 12.5 miles from the transmitter. The antenna was mounted on the 22-foot portable mast in the back yard of a residence. These curves were

taken within a period of two and a half minutes but with a difference of about seven feet in antenna positions.

In Fig. 8 is shown one setup of the portable mast, 17 feet high, at a location 14 miles from the transmitter. The crossarm at the top of the mast sup-

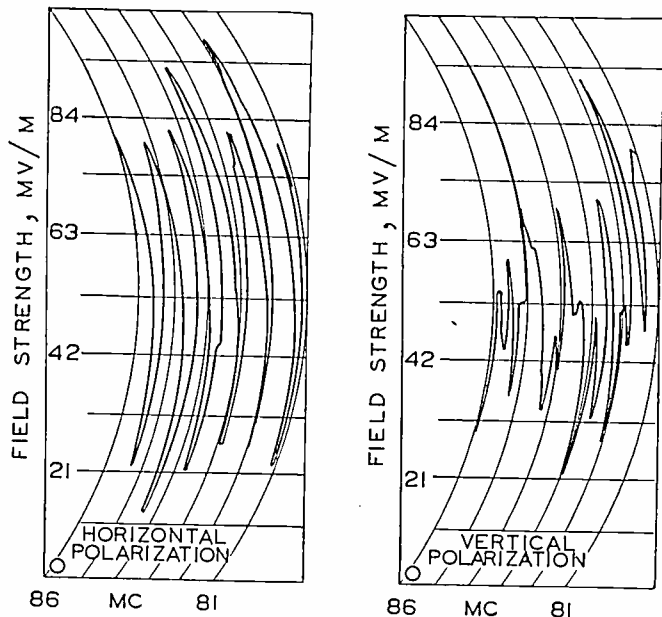

Fig. 10—Propagation-characteristic curves obtained about one mile north of the transmitter on Fifth Avenue.

ported the transmission line and the antenna. The crossarm could be rotated through 90 degrees by means of ropes, thus controlling the polarization of the antenna. The position of the antenna could be changed on a circle of 5-foot radius by simply rotating the mast. Representative data obtained at this location are shown in Fig. 9.

The unusually strong indirect-path signals indicated in Fig. 10, were recorded with the antenna on a parapet, 12 stories above and adjacent to Fifth Avenue. The tower of the Empire State Building was just visible between the intervening buildings and was about one mile south. The two curves show considerable differences between the indirect paths involved with horizontally and vertically polarized waves. The uniformity of the field-strength variation curve for horizontal polarization indicates that only one major interfering indirect wave was received, and this might be eliminated by the use of a simple directive-antenna system. The more complex combination of indirect waves obtained for vertical polarization would apparently not be so easily controlled.

The data in Fig. 11 were recorded in the clear area south of Newark Airport with the object of testing the flatness of response of the entire measuring system.

CONCLUSIONS

One conclusion substantiated by the data in this

paper is that vertically polarized waves are propagated more efficiently along indirect paths than are horizontally polarized waves. The relatively large differences observed between direct- and indirect-path lengths show that the reflecting objects involved must generally have been the vertical walls of buildings rather than their roofs or ground. Consideration of the general properties of such imperfect reflectors having small values of conductivity, will also lead to the above conclusion. It is known³ that for all but very large or small angles of incidence, waves polar-

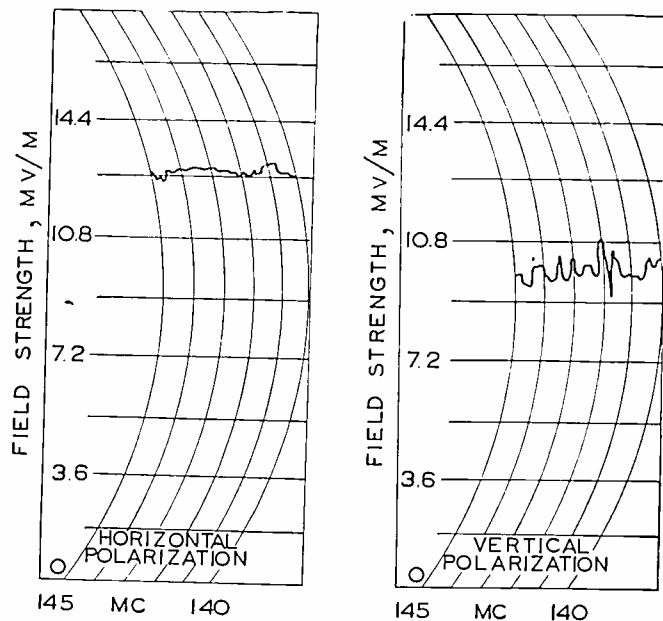

Fig. 11—Substantially constant field-strength-versus-frequency data obtained south of Newark Airport.

ized perpendicular to the plane of incidence (referred to as horizontal polarization with respect to the earth's surface) are reflected more efficiently than are waves polarized in the plane of incidence. Thus, vertically polarized waves are polarized perpendicular to the plane of incidence with reference to the vertical walls of buildings and consequently reflected therefrom most efficiently.

In some cases, indirect signals will arrive from a reflecting point at one side or behind the receiving antenna and can be reduced or eliminated by the use of relatively simple directive antenna systems.

If the indirect-path carrier is combined in phase with the direct-path carrier, the result will be an increase in carrier strength with no change in the values of the side bands of the respective carriers. Thus, the depth of modulation is reduced for both the direct- and indirect-path side bands. The time delay of the indirect-path side bands ordinarily will not be long enough to affect the synchronizing impulses but will produce a displaced image. This image will be of the same polarity as that produced by the direct-path side bands. Both images would be

complete except for the complex interference between each set of side bands.

If the indirect-path carrier is combined out of phase with the direct-path carrier, the result will be a reduced carrier with no change in the values of the side bands of the respective carriers. A secondary image produced by the indirect-path side bands in this case will be reversed in polarity with respect to the image produced by the direct-path side bands. It is highly probable that the resulting weakened carrier would be overmodulated at times by either or both sets of side bands.

It is not within the purpose of this paper to discuss further the complex interference conditions resulting from the combination of direct- and indirect-path, wide-band modulated waves. In closing it may be mentioned that some phase modulation is one product resulting from direct- and indirect-path modulated waves combined with the respective carriers having intermediate phase relations.

No conclusive data are available to show the stability of indirect-propagation-path characteristics under varying weather conditions. However, it is apparent that heavy rain may cause appreciable changes in the constants of certain reflectors.

The study of indirect-propagation-path characteristics at ultra-high frequencies is obviously a large and fruitful field for investigation. Propagation by reflection from the ionosphere may present some occasional problems in television broadcasting at the lower frequencies but this phenomenon was outside the scope of the investigations here reported. Future investigations with widely different types of transmitter locations or propagation areas may give somewhat different results; however, it is not expected that vertical polarization will generally be found preferable to horizontal polarization.

ACKNOWLEDGMENT

The author wishes to express his thanks and appreciation to members of the RCA organizations and others who kindly co-operated in conducting the survey with which this paper is concerned. Credit is due in particular to Messrs. P. S. Carter, N. E. Lindenblad, and G. L. Usselman who produced the transmitting facilities, and to Messrs. R. K. Gallup and L. L. Young who stood by at the Empire State Building during the tests. Messrs. H. H. Beverage and H. O. Peterson rendered valuable criticism in the preparation of this paper.

56-Megacycle Reception via Sporadic-E-Layer Reflections.*

E. H. CONKLIN†, ASSOCIATE MEMBER, I.R.E.

Summary—A theory that 56-megacycle transmission at a distance of 400 to 1200 miles takes place via sporadic-E-layer reflections has been investigated by comparing numerous reports of such reception with ionosphere data provided by the National Bureau of Standards. Simultaneous transmission conditions on lower frequencies are also considered. An indication is given of the necessary geographical separation of ultra-high-frequency transmitting stations, operating at the same frequency, to avoid occasional severe interference.

DURING the summers of 1934 through 1938, amateur 56-megacycle communication has taken place with increasing regularity over distances of roughly 400 to 1200 miles. All evidence pointed to a "skip," producing a large silent zone between the stations communicating with each other, and a silent zone beyond. The zone of reception was often rather narrow, apparently 50 to 200 miles. An explanation of this type of communication was advanced by the National Bureau of Standards—that it resulted from reflections from a sporadic-E ionosphere layer, at a virtual height of around 110 to 130 kilometers. On a few occasions when a large number of long-distance reports on 56 megacycles were received, the ionosphere records of the Bureau indicated sporadic-E reflections,¹ but the data were not considered to be sufficiently extensive to confirm the explanation.

Reports of about 280 cases of 56-megacycle reception or two-way communication over a similar distance on thirty-three days during May, June, July, and August, 1937, have been gathered.² This volume of observations gave promise of being sufficient to confirm or refute the suggested explanation. The Bureau provided hourly measurements of the incident critical frequency of the E layer over the four-month period, so that the correlation might be studied.

LIMITATIONS OF THE DATA

The Bureau makes automatic records of signals returning vertically from the ionosphere, indicating the height of the layers and the maximum frequency

* Decimal classification: R113.61. Original manuscript received by the Institute, March 18, 1938; revised manuscript received by the Institute, July 12, 1938. Presented before Chicago Section, December 16, 1938.

† Wheaton, Illinois.

¹ E. H. Conklin, "Five meters goes to town," *Radio*, no. 221, p. 24; July, (1937).

² Comments including the individual reports were contained in the author's article, "56 Mc., the new DX band," *Radio*, no. 222, p. 66, October, (1937), except for the August 16 and 18 reports which will be found in the November issue of the same journal.

which will be returned. The automatic data during the summer of 1937, however, extended only to 6200 kilocycles. The sporadic-E data obtained by these measurements were grouped and tabulated in the form of an index, the numeral 1 indicating sporadic reflections above 4.4 megacycles but not above 6.2 megacycles, and 2 indicating reflections at 6.2 megacycles and over. Once each week, extended runs were made manually at higher frequencies; when this was done, additional indexes are available—3 indicating reflections above 9 megacycles but not above 12 megacycles; and 4, reflections above 12 megacycles. When these manual observations were lacking, any index 2 may have been a 3 or 4.

On some days or hours, the data are missing. When observations are not available for the hours near the time of a case of 56-megacycle reception, the report cannot be used. Between midnight and at least 10 A.M., few amateurs are operating at this frequency, so the absence of reports may not indicate that 56-megacycle communication was impossible, inasmuch as all data may not have reached us, and stations are not always in operation at the correct distances and times.

DAILY RELATIONSHIP

The number of 56-megacycle reception reports in a single day have been assigned index numbers for convenience. The number 1 indicates a single report; 2, either two or three reports; 3, four or five reports; while 4 is used where more than five reports have been received.

TABLE I

Daily 56-Mc Reception Index	Daily Total of Hourly Sporadic-E Indexes					
	0	1-2	3-4	5-6	7-8	over 8
	Number of days					
0	32	24	13	7	2	3
1	1	1	1	—	1	4
2	1	—	2	3	—	—
3	—	1	—	—	—	1
4	—	1	1	4	1	3
Ratio of Days of Reception to Total Days (%)	5.9	11.1	23.5	50.0	50.0	72.8

Table I shows a tabulation of the number of days on which occurred both the daily 56-megacycle reception indexes indicated in the left-hand column and the sporadic-E indexes indicated by the top line of numbers. At the bottom is entered the rising percentage of days on which reception was reported with

days of increasing totals for the hourly sporadic-E index. This shows that 56-megacycle communication was more probable on days of higher sporadic-E index totals. No account has been taken of the fact that the high total might have resulted from a large number of hours of low indexes, or a few hours of high indexes.

HOURLY DATA

Unlike a comparison between sunspots and radio, the relationship between sporadic-E-layer reflections and 56-megacycle communication over a distance of 400-1200 miles becomes much more apparent as the data for a shorter period of time are compared.

In Fig. 1 are plotted the hourly indexes provided by the Bureau, for all days on which extended manual observations were made, during the four months, except the ten Wednesdays on which no signals were heard and almost no sporadic-E-layer reflections were recorded at Washington. The indexes 3 and 4, therefore, appear here. The dashed line indicates the

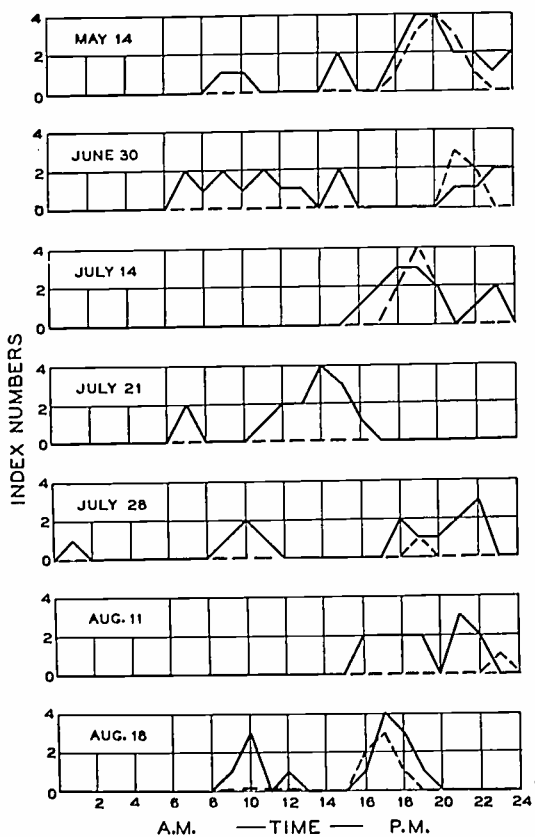

Fig. 1—Hourly comparisons of sporadic-E-layer reflections observed at Washington (solid lines) with long-distance 56-megacycle reception (dashed lines) for days on which extended manual observations were made, using index numbers explained in text.

hourly number of 56-megacycle reports, using hourly index numbers similar to the daily indexes mentioned above. The major peaks on the evening of May 14 show a remarkable similarity between the sporadic-E-layer reflections observed in Washington, and 56-

megacycle communication between the midwest and New England.

On July 14, there is another marked similarity. Although most of the reports were those of a Dallas station in communication with amateurs in the east-

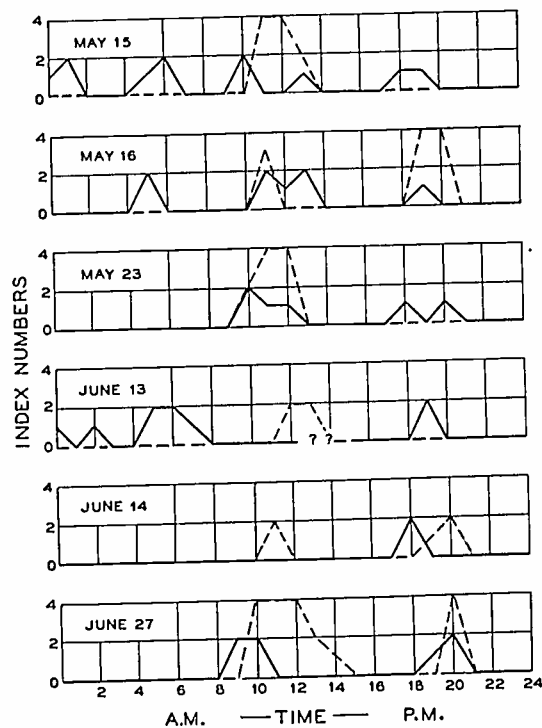

Fig. 2—Hourly comparisons of sporadic-E-layer reflections observed at Washington (solid lines) with long-distance 56-megacycle reception (dashed lines), May 15 through June 27, 1937, for days of automatic observations only.

north-central states, there was also transmission between the midwest and the east, and between Wyoming and Oregon, all plotted in terms of local standard time.

July 21 was one of the best days for sporadic-E-layer reflections, but no reports of long distance 56-megacycle transmission have been received. One explanation is that there may not have been amateur stations active on 56 megacycles at the proper distances on this Wednesday afternoon.

The data for July 28 and August 18 are similar to that for May 14 and July 14. August 11 includes a single report over a relatively short path of 320 miles—Fort Thomas, Kentucky, to Beloit, Wisconsin—and is so much shorter than the next nearest distance that it has not definitely been attributed to ionosphere transmission.

In Figs. 2 and 3, the data have also been plotted for the balance of the days on which two or more cases of 56-megacycle reception were reported. These also in most cases indicate some association between the series, which is particularly striking on the evening of July 19 when the lines are identical, and on May 16 and June 27 when reception was recorded twice during the day, each time being nearly

identical with high levels for the ionosphere index. On the morning of June 27, one station in Dallas, W5EHM, established two-way communication with 22 amateurs in New York, Pennsylvania, and the east-north-central states, reporting that 50 or 75 signals were audible.

The early peak on June 14, not accompanied by sporadic-E reflections observed at Washington, represents reports from Ohio and Pennsylvania of the signals of W5EHM in Dallas. This is the most severe

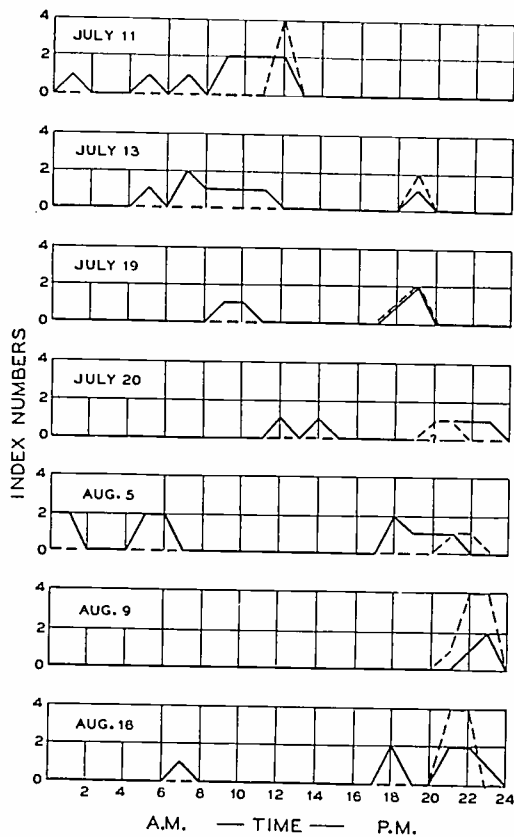

Fig. 3—Hourly comparisons of sporadic-E-layer reflections observed at Washington (solid lines) with long-distance 56-megacycle reception (dashed lines), July 11 through August 16, 1937, for days of automatic observations only.

case of a lack of correlation, but covers a path centered somewhat west of Washington.

In six out of the seven remaining days—those for which only one report was received—there were sporadic-E reflections at the same time or within one hour. On the seventh, the path was between Texas and Arizona, far west of Washington; there remains some confusion as to the exact date on which it took place.

This table summarizes the sporadic-E (E_s) and 56-megacycle reception data by months during the summer of 1937 and shows the increased probability of 56-megacycle reception at distances between 400 and 1200 miles when sporadic ionization occurs over when it does not occur.

The data by months are on an hourly basis, showing the percentage of hours on which sporadic-E

TABLE II

	May	June	July	August	Total
No. hours E_s observed	51	57	69	51	228
No. hours E_s not observed	260	334	216	362	1172
% E_s observed	16.4	14.6	24.2	12.3	16.3
No. hours reception coincided with E_s	12	6	9	8	35
No. hours reception within an hour of E_s	3	2	1	3	9
No. hours reception with no E_s within an hour	1	5	0	0	6
% reception coinciding with E_s	75.0	46.2	90.0	72.7	70.0
% reception coinciding with or within one hour of E_s	93.7	61.6	100.0	100.0	88.0

reflections were observed at Washington, and during which 56-megacycle reception coincided with the sporadic condition or took place within one hour of such sporadic ionization. The five hours in June when the 56-megacycle reception was not within an hour of observation of sporadic reflections include one hour when no ionosphere observations were made, and four hours when the mid-points of the transmission paths were considerably west of Washington. It is seen that reception was generally much more likely to coincide with sporadic ionization than it was to occur when such ionization was absent.

It has also been possible to study the effect of stronger ionization as indicated by E-layer reflections at higher frequencies by using only the days on which manual measurements were made. It happens that sporadic ionization was observed during every hour that 56-megacycle reception was reported on these days except for the 320-mile report on August 11 which has not definitely been attributed to ionosphere transmission. It was found that 56-megacycle communication was about 20 times more probable when the ionization indexes 3 or 4 appear, than when indexes 1 or 2 were reported. Also, 56-megacycle transmission was 48 times more probable when one of the two higher indexes was recorded within one hour. These high figures for the likelihood that long-distance transmission will coincide with strong sporadic ionization appear even though the two higher indexes were reported during only 4.6 per cent of the hours of manual observations.

Figs. 1, 2, and 3 serve to indicate the duration of periods of reception, which varied from a few minutes in some cases, to several hours in others. When the period is longer, a greater number of reception reports is almost invariably received.

DISTANCE VERSUS LAYER HEIGHT

The longest distance in the U.S. over which 56-megacycle signals were reported during these months was approximately 2200 miles between Jerome, Arizona, and Malden, Massachusetts, on May 14 when at the same time numerous Massachusetts and mid-western stations were able to establish two-way con-

tacts. The Arizona station was unable to identify six other signals due to severe fading. Because of the 600- to 900-mile communication taking place at the eastern end of the Arizona-Massachusetts path and the severe fading, these signals were considered to have arrived by two hops averaging 1100 miles each.

The second longest reception was on July 20 and 27 when W2XCH in New York on 53 megacycles was reported in Dallas. This distance is about 1365 miles as calculated for a great-circle path. However, the longest reasonably stable reception for an amateur transmission was 1214 miles between Dallas and North Tonawanda, New York. There were numerous reports of reception and two-way communication somewhat under 1200 miles, as shown in Fig. 4 which summarizes all the data by transmission range except for the 2200-mile reception discussed above.

It is possible to calculate maximum distances for transmission via a single reflection at the virtual height of the E layer. This has been done for several heights in Table III, assuming that signals within 3

TABLE III

Layer Height (kilometers)	Maximum Distance (statute miles)
100	1041
110	1105
120	1165
130	1225

degrees of being tangent to the earth are largely cancelled due to ground-reflection effects. It will be recognized that a normal value³ of 120 kilometers very nearly coincides with the maximum of about 1200 miles mentioned above. High power, or, unusual transmission conditions, can readily permit some variation in the assumed 3-degree limit,⁴ explaining all except the one 2200-mile case which is considered to have been two-hop.

The shortest distance represented is 320 miles from Fort Thomas, Kentucky, to Beloit, Wisconsin, on August 11. This is an unconfirmed report. The signal may not have traveled via an ionosphere reflection. It is an isolated case, the next nearest being 430 miles between Ambridge, Pennsylvania, and Elgin, Illinois. A number of signals have been heard at distances somewhat greater than this. The range of distances which we have attributed to this mode

³ This is the figure consistently reported for the virtual height of the E layer during the past winter. The range of virtual heights from April, 1934, through December, 1936, was given as about 110 to 130 kilometers in the following reference: Gilliland, Kirby, Smith and Reymer, "Characteristics of the ionosphere and their application to radio transmission," *Proc. I.R.E.*, vol. 25, pp. 823-840; July, (1937).

⁴ Potter and Friis, "Some effects of topography and ground on short-wave reception," *Proc. I.R.E.*, vol. 20, pp. 699-721; April, (1932).

of transmission, therefore, is approximately 400 to 1200 miles with occasional cases extending another 200 miles.

28-MEGACYCLE COMPARISONS

If a signal is received from a transmitting station 1200 miles away via one ionosphere reflection, the point of reflection is about midway between, or 600 miles from the receiver. If the same layer condition extends from the point of reflection toward the receiver, then lower frequencies such as 28 megacycles should be heard at shorter distances also. This connection between 56-megacycle reception and that on lower frequencies has been observed by several of

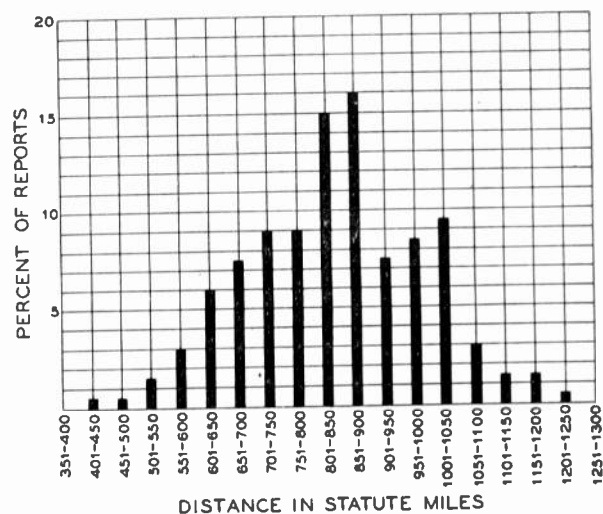

Fig. 4—The distribution of 56-megacycle reception reports during the summer of 1937 by transmission range.

the reporting amateurs, and was used considerably at W5EHM either to indicate that 56-megacycle communication might be possible, or to contact a station on 28 megacycles to request that the operating frequency be doubled.

It may not always be possible to notice this connection on lower frequencies with what has been considered to be sporadic-E-layer 56-megacycle transmission because, while communication is usually possible over the same distance on lower frequencies, sporadic ionization may be confined to a relatively small geographic area, thus not necessarily permitting shorter hops to be observed from the same receiving station.

CONCLUSIONS

The relationship between 56-megacycle communication and sporadic-E-layer reflections measured at Washington, together with the apparent identity of the maximum observed distances with those expected from a layer situated at the E-layer height, tend to confirm the theory that communication at this frequency over a distance of 400 to 1200 miles takes place via sporadic-E-layer reflections.

The data are not yet sufficient to indicate whether a given condition travels west with the sun or remains fixed geographically until it disappears, though the phenomenon may be more complex than either of these assumptions. The answer to this question may be found with 56-megacycle transmissions and ionosphere measurements at more locations.

The data do, however, give an indication of the amount of interference that may be encountered at similar frequencies between transmitters separated geographically. Reception at 320 miles without an ionosphere reflection⁵ has been relatively rare, with no signals reported at distances between 320 and 430 miles. Interference during the summer half of the year occasionally is severe at 400 to 1200 miles or slightly farther, especially at 600 to 1050 miles. No

⁵ Ross A. Hull, "Air-mass conditions and the bending of ultra-high-frequency waves," *QST*, vol. 19, no. 6, p. 13; June, (1935).

trouble is likely to be encountered from about 1200 miles out to where a G-layer or winter F₂-layer reflection may be heard. The nearest point of probable reception via F₂ or sporadic-E reflections can be calculated readily to extend these data to moderately different frequencies. Knowledge of the probable occurrence of interference at certain distances may be of value in selecting frequencies for television and other services where distant signals of substantial volume will cause difficulty.

ACKNOWLEDGMENT

The author is indebted to the National Bureau of Standards for providing detailed data and suggestions which made this study possible; and to the many amateur operators who have helped in the gathering of the reception reports.

The Sectoral Electromagnetic Horn*

W. L. BARROW†, ASSOCIATE MEMBER I.R.E., AND F. D. LEWIS†, ASSOCIATE MEMBER I.R.E.

Summary—An electromagnetic horn radiator two of whose opposite sides are flared, the other two being parallel, was studied experimentally at wavelengths between 40 and 100 centimeters. For comparison, measurements on parabolic reflectors and broadside arrays were also made. By virtue of its unusual freedom from secondary lobes and stray radiation, its ability to operate well over a broad band width, its simple construction, and its ease and stability of operation, the electromagnetic horn offers unique possibilities as a directive radiating system for microwave applications. These results and the application to a straight-line blind-landing system for airplanes are discussed.

INTRODUCTION

THIS paper deals with the radiation of electromagnetic waves at ultra-high frequencies from flared horns of metal, and particularly with the characteristics of a horn whose cross section is rectangular and whose sides flare in one direction only,

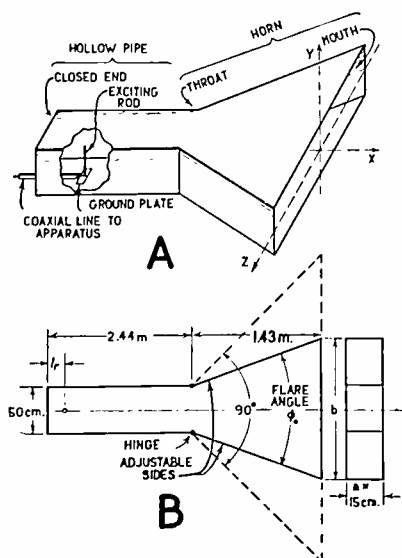

Fig. 1—Horn I. Schematic perspective view (A) and cross-sectional view with dimensions in the x, z plane (B).

and which therefore hereinafter will be termed a *sectoral horn*.

This research has to do with one aspect of a comprehensive program directed toward the realization of an improved system for the blind, or instrument, landing of airplanes. The program is being conducted by the Massachusetts Institute of Technology and is sponsored by the United States Bureau of Air Commerce of the Department of Commerce.

Although electromagnetic horn radiators were previously suggested^{1,2} and the related open-end

* Decimal classification: R111.2. Original manuscript received by the Institute, June 1, 1938. Presented before the joint meeting of the I.R.E. and the U.R.S.I., Washington, D.C., April 30, 1938.

† Massachusetts Institute of Technology, Cambridge, Massachusetts.

¹ W. L. Barrow, "Transmission of electromagnetic waves in hollow tubes of metal," Proc. I.R.E., vol. 24, pp. 1298-1328; October, (1936).

² G. C. Southworth, "Hyper-frequency wave guides—general considerations and experimental results," Bell Sys. Tech. Jour., vol. 15, pp. 284-309; April, (1936).

hollow-pipe radiator has been studied,³ no previous detailed investigation of the horn appears to have been published. However, electromagnetic horns possess such favorable features and are so ideally adapted to the frequencies above about 300 megacycles that they deserve serious consideration for applications to "microray" communication, to ultra-short-wave direction finding and obstacle location, to marine and airplane navigation, and to other developments employing ultra-short waves. It is hoped that this paper will serve to show some of the possibilities of this new type of radiator. It will deal with the experimental and practical aspects of the sectoral horn, particularly with reference to the straight-line landing-path application. A companion paper⁴ presents a theoretical analysis and general discussion.

THE EXPERIMENTAL SECTORAL HORNS

Several shapes of horns have already been described¹ and many others are obviously possible. The shape that will receive principal attention in this paper is simple, both for purposes of measurement and for theoretical analysis. In addition, it has a radiation characteristic that makes it especially adapted to applications like the straight-line landing system where a beam sharp in one plane but broad in another plane at right angles thereto is desired.

Fig. 1 shows a perspective view A and the dimensions B of an experimental horn of this type, which will be referred to hereinafter as Horn I. It was constructed of galvanized-iron sheeting supported by an external framework of wood. Two of its walls, the top and bottom surfaces in the figure, are parallel, but the other two walls, the sides, are flared to include a "flare angle" of ϕ_0 degrees. The shape of the horn proper resembles somewhat a slice of pie or a sector of a circular disk; as stated above, we have termed it the *sectoral horn*. The large end will be called the "mouth" and the small end the "throat."

A section of rectangular hollow pipe is joined tightly and conductively to the throat. The back end of the pipe is tightly closed by a piece of galvanized-iron sheet. The exciting rod or antenna is vertically disposed in the hollow pipe. As illustrated in the Fig. 1A, the antenna is fed from a coaxial line which also serves as its support. The distance between the re-

³ W. L. Barrow and F. M. Greene, "Rectangular hollow-pipe radiators," Proc. I.R.E., vol. 25, pp. 1498-1519; December, (1938).

⁴ W. L. Barrow and L. J. Chu, Proc. I.R.E., this issue, pp. 51-64.

flecting surface that closes the back end of the pipe and the antenna is adjustable by sliding the coaxial line and antenna back or forth in the pipe.

The top and bottom walls of this horn were fixed, but the side walls were hinged at the throat and could be swung on the hinge to provide different flare angles ϕ_0 . The side walls were securely fastened to the top and bottom by self-tapping screws after each new setting; this precaution was found necessary to reliable operation.⁵ The ends of the side walls were flush with the mouth for $\phi_0 = 90$ degrees, but they extended somewhat beyond for smaller angles. The width of the mouth b was not constant, but increased with increasing flare angle. The symbol $W_h = b/\lambda$ will denote the horizontal aperture measured in wavelengths, where λ is the wavelength.

A photograph of the horn of Fig. 1 is reproduced in Fig. 2. This is the smaller of two experimental horns and will be referred to as the small horn.

The larger horn, which will be referred to as Horn II, is shown in Fig. 3A. It had fixed sides and a flare angle of 40 degrees. It was constructed by attaching an extension to the front of the smaller Horn I. The section of hollow pipe was sometimes completely removed and excitation was effected by placing the antenna and closing reflector directly in the throat,¹ as shown in Fig. 3B for a plane reflector and in Fig. 3C for a parabolic reflector.

The cross sections of these horns at right angles to the x axis are rectangles. As normally excited with a vertical antenna, the lines of electric intensity are vertical, that is, they are parallel to the y axis

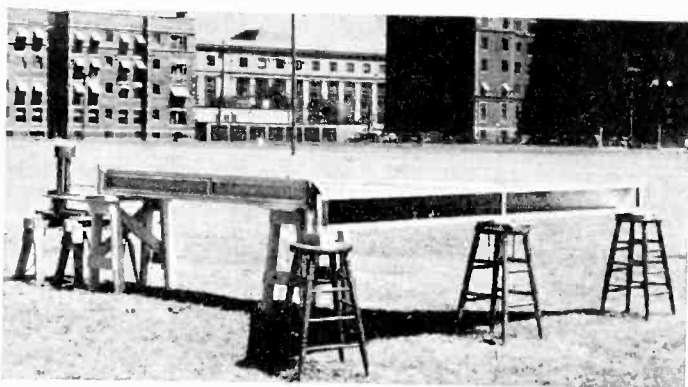

Fig. 2—Photograph of experimental sectoral Horn I.

throughout the interior of the horn. As a result, a simple vertically polarized wave is radiated. When fed from a hollow pipe, a pipe of rectangular cross section with a terminal device for the $H_{0,1}$ wave is preferred,⁶ although a circular pipe with the II_1 wave

⁵ Experience has demonstrated that nonadjustable horns may be advantageously constructed by welding the seams to provide mechanical strength and good electrical connection.

⁶ L. J. Chu and W. L. Barrow, "Electromagnetic waves in hollow metal tubes of rectangular cross section," *PROC. I.R.E.*, vol. 26, pp. 1520-1555; December, (1938).

might also be used. From the standpoint of radiating a wave of strictly linear polarization, horns of rectangular cross section are preferable to those of other cross sections.³

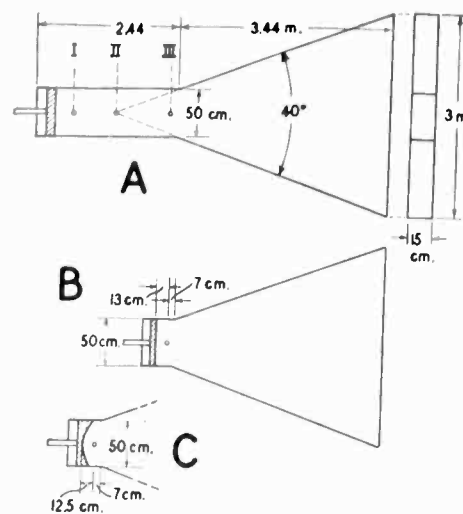

Fig. 3—Horn II. Cross sections of the x,z plane with hollow-pipe feed (A), directly excited with plane reflector (B), and directly excited with parabolic reflector (C).

APPARATUS AND TECHNIQUE OF MEASUREMENT

The same equipment and technique were employed as was used earlier in measuring the radiation from open-end hollow pipes.³ Since descriptions of most of this equipment have been published^{3,7} details will not be repeated here. The following remarks, however, will serve to indicate how the measurements were made.

Several watts were available in the antenna at wavelengths from about 40 to 125 centimeters. The receiver comprised an adjustable-length antenna in a cylindrical parabolic reflector, a grid-leak detector using a type 955 tube, and a calibrated audio-frequency amplifier and meter. Distances up to 700 feet could be reached when both horn and receiving antenna were several feet above the ground. Tests demonstrated that stray radiation and reflection effects were entirely negligible.

The radiation patterns to follow represent the electric field intensity measured on a path of constant radius about the mouth of the horn. The measured values are represented by the solid-line curves. Theoretical values are represented by dots, as will be explained later. With the one exception of Fig. 7, the radiation patterns are in the horizontal plane (vertical antenna), that is, in the x,z plane of Fig. 1A. The angular departure from the forward direction (x axis) in the horizontal plane will be designated by θ . In all instances, the curves are plotted to correspond to the horn aimed toward the top of the

⁷ W. L. Barrow, "Oscillator for ultra-high frequencies," *Rev. Sci. Inst.*, vol. 9, pp. 170-174; June, (1938).

page. The curves show relative magnitudes only; the maximum magnitude for $\theta=0$ degrees has been designated as unity for simplicity in representation.

The curves of distribution across the mouth were measured by a short probe antenna, a crystal detector, and a milliammeter, which were arranged to be

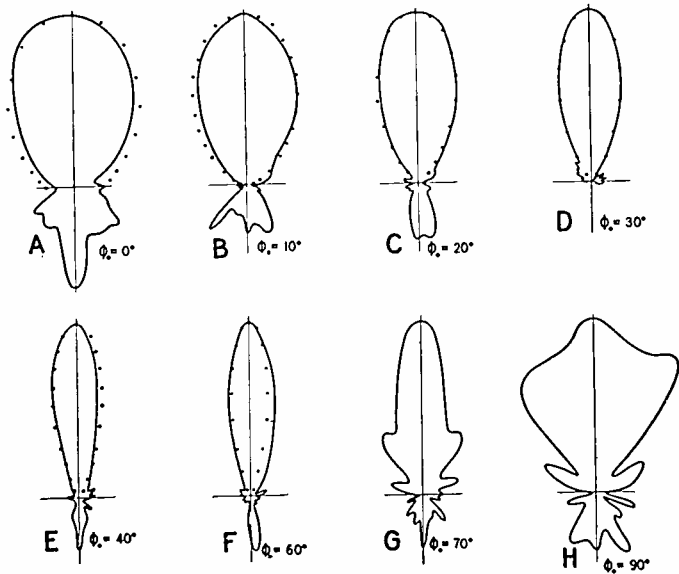

Fig. 4—Horn I. Measured patterns of electric field intensity versus space angle θ in the horizontal plane (x, z plane of Fig. 1) for different angles of flare ϕ_0 .

moved by means of strings across the mouth of the horn by the operator, who kept about 25 feet away while reading the meter (by means of binoculars when necessary).

RADIATION PATTERN VERSUS FLARE ANGLE—HORN I

The series of radiation patterns⁸ in Fig. 4, show the effect of progressively increasing the flare angle from zero, corresponding to an open-end hollow pipe, up to a maximum value of 90 degrees, which was the limit of angular adjustment of the experimental Horn I. The measurements were made at points on a circular path of a radius of 100 feet. The wavelength was 50 centimeters. The exciting rod or antenna was near the end of the hollow pipe remote from the horn, indicated in Fig. 1A. The distance l_r between the antenna and the reflector was adjusted for maximum radiation in each case by properly positioning the antenna and ground plate inside the hollow pipe. The distance l_r is usually not greatly different from $n\lambda_p/4$, where λ_p is the wavelength of $H_{0,1}$ waves inside the pipe and $n=1, 3, 5, \dots$

For $\phi_0=10$ degrees, the radiated energy is formed into a rather broad beam along the principal axis, and there is an irregular back-radiation curve. As ϕ_0 is made larger, the beam becomes sharper up to a value

⁸ The assistance of F. M. Greene in obtaining this series of patterns is gratefully acknowledged.

of ϕ_0 between 40 and 60 degrees. At both these angles the beam is quite sharp. As the flare angle is made even greater, the beam becomes distorted by the appearance of secondary lobes, which push out into the principal lobe, broadening the beam as shown in Fig. 4G. For $\phi_0=90$ degrees, the secondary lobes are nearly as large as the principal lobe and the beam has been spread into a fan-shaped pattern with almost uniform radiation over an 80-degree sector.

Particularly noteworthy is the shape of the pattern for flare angles of 40 to 60 degrees. There is only one lobe of small amplitude and the back radiation,⁹ which is of relatively small amplitude, is confined to a small angle. This unusually clean-cut pattern offers possibilities not easily obtained by other types of radiators. The practical absence of secondary lobes in the forward half plane contrasts markedly with the presence of two or more such lobes of objectionably large amplitude in the patterns of conventional arrays of half-wave antennas and of parabolic reflectors. We note also that the back radiation for these flare angles is very small compared to that forward.

In Fig. 5 is shown a curve of the relative power gain of this horn as a function of the flare angle. The curve has a broad maximum in the vicinity of 40 degrees $<\phi_0 < 60$ degrees and a maximum relative gain of approximately 15 is obtained. This power gain has been computed from the polar plots of electric intensity as follows:

$$\text{relative power gain} = \frac{\text{area of unit circle}}{\text{area of the pattern}}$$

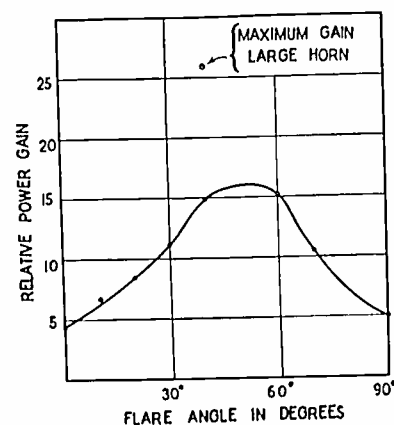

Fig. 5—Relative power gain versus flare angle for Horn I (curve), and power gain of Horn II.

The unit circle is a circle with a radius equal to the maximum amplitude of the pattern. This relative

⁹ The back radiation was proved to come from diffraction around the mouth of the horn. When the mouth was closed by a metal sheet, no radiation was observed. In some of the patterns the curve is shown only in the forward 180-degree sector and hence back radiation appears to have vanished altogether. In these cases no data were recorded for the back 180-degree sector.

gain gives the relative amounts of power required in a nondirective antenna fifteen centimeters high with a uniform current distribution and in the electromagnetic sectoral horn to produce the same field intensity at the same distance in the principal forward direction.

Since the radiation patterns can be calculated approximately from the distribution of electric intensity across the mouth of the horn,³ measurements of this distribution are helpful in explaining the shapes of the radiation patterns. Such measurements show that the electric intensity is directed vertically and is substantially constant in the vertical direction, that is, independent of y in Fig. 1A, but that it has variations in the horizontal direction, that is, along the x axis, such as those shown in Fig. 6.

For $\phi_0 = 20$ degrees, the distribution is smooth and substantially a half sinusoid in form, as it is also for 40 degrees. However, for wider flare angles the small irregularities, barely noticeable for 40 degrees, become quite pronounced, until, when $\phi_0 = 80$ degrees, the distribution assumes a jagged saw-tooth form. We see in these curves the transition from a sinusoidal distribution for small flare angles to a nonsinusoidal distribution that contains higher harmonic components of space variation for large angles. The factors influencing this distribution and the means for obtaining sinusoidal and other distributions are discussed in the companion paper.⁴

Comparing Figs. 4 and 6, we find that a sinusoidal variation of electric intensity across the mouth corresponds to a radiation pattern having a single principal lobe and secondary lobes of insignificant amplitudes. On the other hand, we find that nonsinusoidal distributions, occurring with flare angles

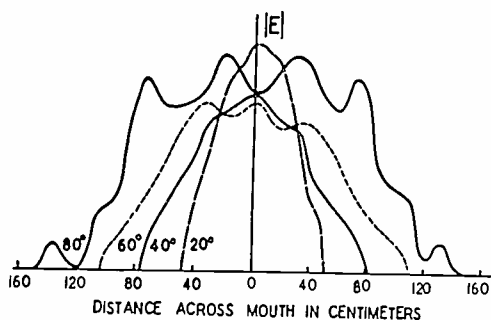

Fig. 6—Horn I. Electric-field-intensity distribution across the mouth for different flare angles.

greater than about 60 degrees, correspond to irregular beams found in Figs. 4G and 4H.

The irregular shape, that is, the strong secondary lobes, may be attributed to the harmonic components of the distribution across the mouth. However, even if the distribution remained sinusoidal, there would be a broadening of the main lobe for increasing flare

angles greater than about 50 degrees. This latter effect is explained by the fact that the waves travel outward in the *radial* direction in the horn, and consequently a horn of large flare angle cannot concentrate the waves mainly in *one* direction even inside the horn. For example, a flare angle of 180 degrees corresponds to a plane baffle, rather than a horn.

We note that if a rectangular hollow-pipe radiator with $H_{0,1}$ waves is increased in aperture, keeping the length sufficiently long for true hollow-pipe waves to exist, and if the terminal device is such that this type of wave alone is present, the beam will continue to increase in sharpness indefinitely. Although in this case, too, the distribution across the mouth is sinusoidal, the direction of propagation of the waves inside the guiding structure is forward, and not radial as it is inside the horn. This apparent advantage possessed by the hollow-pipe radiator over the electromagnetic horn is, however, partially negated by its greater length and by the difficulty of obtaining $H_{0,1}$ waves to the exclusion of other waves in relatively wide pipes. With proper design, a sinusoidal distribution can be maintained in very large horns without difficulty.

On the basis of the above discussion, the decrease in the width of the beam with increasing flare angle up to $\phi_0 \cong 50$ degrees may be attributed to the increase in the horizontal aperture W_h . Further increase in flare angle distorts the distribution across the mouth from the sinusoidal form and causes the actual widening of the beam and the appearance of secondary lobes as observed in the figure.

We conclude that for the production of a single sharp beam a flare angle of about 40 to 50 degrees represents optimum design. If length is no consideration, angles much smaller than this value may be used.

Vertical radiation patterns were not measured for the horns because of the difficulty of obtaining them. However, the vertical pattern for an open-end pipe, i.e., a horn of zero flare angle, was taken³ by placing it on its side with the antenna parallel to the earth. This pattern is reproduced in Fig. 7; the wavelength was fifty centimeters. We believe that the corresponding pattern for the horn will not differ materially from this shape. The radiation is widely spread out over the front 180-degree sector for the reason that the vertical aperture $W_v = a/\lambda = 0.3$ is small. This radiation may be concentrated into a smaller angle either by increasing the distance a between the top and the bottom walls or by flaring the horn in the y dimension as well as in the z dimension.

Table I summarizes the more important quantities obtained from the series of patterns shown in Fig. 4.

TABLE I

Fig.	Flare angle ϕ_0 in degrees	Horizontal aperture W_h	Beam angle in degrees		Relative power gain
			down 0.5 max	down 0.25 max	
4A	0	1.0	80	120	4.4
4B	10	1.4	66	90	6.6
4C	20	1.9	50	70	8.3
4D	30	2.4	40	63	11.1
4E	40	3.0	28	40	14.8
4F	60	4.1	30	45	15.2
4G	70	4.7	33	80	10.5
4H	90	6.5	80	82	5.0

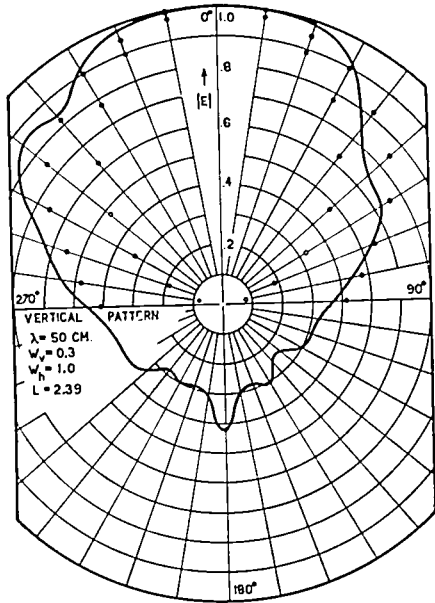

Fig. 7—Horn I. Measured pattern of electric field intensity versus space angle θ in the vertical plane (x, y plane of Fig. 1) for flare angle $\phi_0 = 0$ degrees.

CALCULATION OF THE RADIATION PATTERNS

In the companion paper,⁴ a rigorous analysis of the transmission of waves inside the horn and of the radiation patterns in space is given, but this rigorous method leads to rather involved expressions for the radiated field. We have found, however, that the relatively simple expressions obtained for the radiation from open-end hollow pipes of rectangular cross section³ may be used with surprisingly good effect for flare angles up to forty or fifty degrees.

The approximate expression for the horizontal characteristic for flare angles less than 40 or 50 degrees and apertures greater than two or three is, therefore,

$$|E| \cong \text{constant} \left| \cos \theta \frac{\cos(\pi W_h \sin \theta)}{(\pi W_h \sin \theta)^2 - \left(\frac{\pi}{2}\right)^2} \right|$$

where θ denotes the angle from the forward direction at which the field intensity is observed. Points have been calculated for the series of conditions represented in Fig. 4 and are plotted in the diagrams as small circles. The agreement with the measured curves is quite satisfactory for flare angles up to 60 degrees. For this value, however, the actual beam is

broader than that shown by the calculations, and this discrepancy becomes increasingly larger as the flare angle is increased further. Also, this simple theory cannot be used with accuracy for very long horns, say horns whose lengths are around a hundred wavelengths or more.

The derivation of this expression assumed a sinusoidal field distribution of equal phase across the mouth of the pipe. It also assumed that the waves were propagated in the x direction at all points in the plane of the mouth. Both assumptions represent the approximate conditions when the flare angle is not too large, but, as a little consideration will show, they are not even approximately true for large angles. From our experiments, the upper limit of validity appears to be about 50 degrees.

Having established that the above approximate expression is valid within limits, we may also assume as valid within the same limits the calculation of the beam angle, θ_h , that is, the angle between the zeros that define the principal lobe, given by Barrow and Greene.³ The curves of the beam angle θ_h versus the horizontal aperture W_h given in this reference and reproduced in Fig. 8 for convenience may be used in predetermining the performance of sectoral horns under the afore-mentioned limitations. The second curve in this figure is the calculated curve for the beam angle θ_v in the x, y plane versus the vertical aperture $W_v = a/\lambda$.

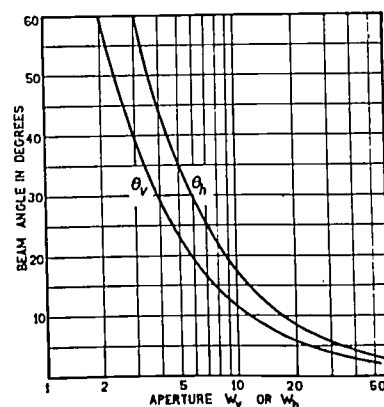

Fig. 8—Calculated curves for the beam angles (angle measured between zeros defining the principal lobe) versus the relative aperture for horizontal (θ_h vs. W_h) and vertical (θ_v vs. W_v) planes.

RADIATION PATTERNS VERSUS WAVELENGTH—HORN II

The larger experimental Horn II of Fig. 3 was constructed with a flare angle of 40 degrees. When operated at $\lambda = 50$ centimeters, one would expect a single beam, narrower than any shown in Fig. 4. Such a beam was obtained. An important question not yet answered is the effect of a change in the operating wavelength on the radiation.

Fig. 9 shows radiation patterns for Horn II at four different wavelengths. For $\lambda = 98$ centimeters (the critical frequency for the hollow pipe was 100 centimeters), the beam is broad and large secondary lobes are present. For the other three wavelengths the beam is narrow and the secondary lobes are very small. The back radiation decreases with decreasing wavelength. The pattern for $\lambda = 50$ centimeters is perhaps the best. Strikingly, there is little difference between the three patterns for $\lambda = 44, 50,$ and 67 centimeters. Thus, the directive characteristics of this horn remain substantially unaltered for a change in wavelength or in frequency of over 50 per cent or over a frequency band of 235 megacycles. Since the single-beam pattern would probably obtain also for wavelengths below 44 centimeters, this band does not represent the limit. This feature of the electromagnetic horn, which is perhaps not equalled in any other type of ultra-high-frequency radiator, fits it peculiarly to wide-band applications like television, to applications where the frequency must be shifted rapidly between several values as in long-distance microray communication, and to applications where difficult and precise phasing and amplitude adjustments cannot be made and maintained as in mobile, field, and amateur operation.

Fig. 10 shows the measured field distributions across the mouth for the wavelengths used in Fig. 9. We observe that the distribution for $\lambda = 50$ centimeters is not greatly different from the sinusoidal

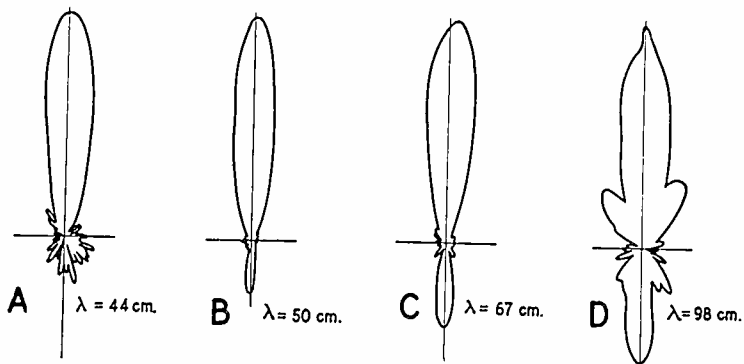

Fig. 9—Horn II. Measured patterns of electric field intensity versus space angle θ in horizontal plane for four different wavelengths.

form, as predicted from the experiments discussed in the preceding section. At $\lambda = 67$ centimeters some distortion occurs, and at $\lambda = 98$ centimeters a marked nonsinusoidal distribution is found. In the latter case, this irregular distribution is accompanied by the broadening of the pattern and the occurrence of strong secondary lobes. Although the distribution for $\lambda = 44$ centimeters is predominately sinusoidal, there is an irregular structure probably caused by higher spatial harmonics of small amplitude.

The beam angles and relative power gains for the large horn are given in Table II. A substantial reduc-

TABLE II

Fig.	Wavelength in cm	Horizontal aperture	Beam angle in degrees		Relative power gain
			down 0.5 max	down 0.25 max	
7A	44	6.82	23	35	17.5
7B	50	6.0	21	35	21.0
7C	67	4.48	23	34	18.3
7D	98	3.06	25	84	11.3

tion in the beam angle and a corresponding increase in the relative power gain ($\lambda = 50$ centimeters) is seen to have accompanied the increase in size from the smaller Horn I to the larger Horn II.

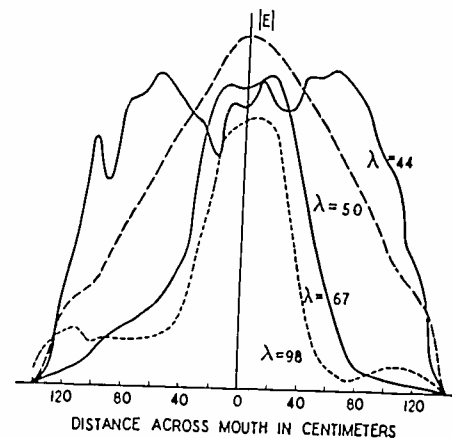

Fig. 10—Horn II. Measured electric-field-intensity distribution across the mouth for four different wavelengths.

Recalling that the larger Horn II was constructed with a flare angle of 40 degrees on the basis of the experiments on the smaller model I, and comparing the pattern E of Fig. 4 with B of Fig. 9, shows that the predictions of a narrower single beam for the large horn have been substantiated. There appears every reason to believe that a further increase in the length of the horn, keeping the flare angle constant, will effect a greater sharpening of the beam without changing the characteristics of the pattern as regards smoothness and freedom from secondary lobes. Therefore, by increasing the aperture in this way it should be possible to realize a beam of high degree of sharpness.

RADIATION PATTERNS VERSUS DISTANCE—HORN II

The radiation patterns of Figs. 4 and 9 as stated were measured on a circle of 100 feet radius. The comparative shapes of the patterns that obtain at shorter and at longer distances from the horn are also of interest. Four patterns taken on circles of radii 12.5, 25, 50, and 200 feet, respectively, for $\lambda = 50.5$ centimeters are shown in Fig. 11. The patterns taken near the mouth of the pipe are broader than those taken at greater distances. However, the difference

between those for 100 (Fig. 9B) and 200 (Fig. 11D) feet radii is inappreciable, and therefore most of the measurements were taken at 100 feet for the sake of convenience. The power gain computed from the 200-foot radius measurement is 26 and is plotted on the graph of Fig. 5 for comparison with the small horn.

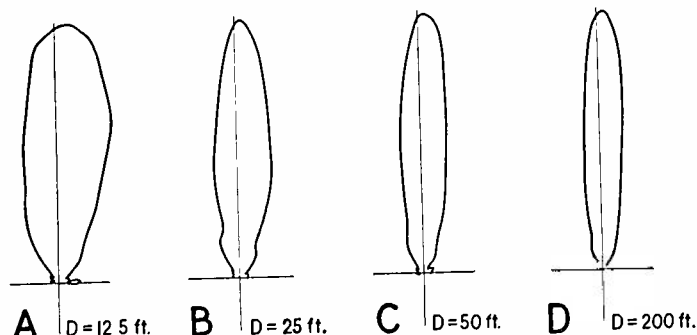

Fig. 11—Horn II. Measured patterns of electric field intensity versus space angle θ in horizontal plane at four different distances D from the center of the mouth.

This series of measurements is also interesting from the standpoint of a diffraction problem. Near the mouth of the pipe, the pattern may be considered to be the result of diffraction of the Fresnel type, and at the greater distances it is caused by diffraction of the Fraunhofer type. A general agreement with optical experiments is observed. However, the present instance differs from most optical cases in that here the distribution across the slit (mouth of the horn) is not uniform and the dimensions of the slit (horizontal and vertical apertures) are relatively small.

DIRECTLY EXCITED HORN—HORN II

In certain instances, particularly when the wavelength is below about 10 centimeters, the electromagnetic horn is most conveniently fed with a hollow-pipe transmission line, as indicated in Fig. 1. The preceding measurements apply specifically to the horn when fed in this way. In other cases, especially those of wavelengths greater than about 20 centimeters, it is more convenient to use a coaxial, parallel wire, or other conventional line to feed the horn and to position the exciting rod or antenna directly in the throat. A horn operated in this latter way will be called a "directly excited horn," to distinguish it from a "hollow-pipe-fed horn." The electromagnetic horn, accordingly, may be considered as a distinct type of radiating or absorbing means, apart from the particular type of transmission line that is used to connect it to the sending or receiving apparatus.

Viewed in this manner, the section of pipe in Fig. 3A appears as part of the horn itself and, for sake of economy of space, weight, and material, this section should either be shortened into a mere stub or done

away with altogether. As a matter of fact, experiment has shown that both of these modifications can be effected without materially influencing the radiation patterns and with considerable reduction in size, weight, and cost.

A series of radiation measurements were made in which the antenna and reflector were moved successively toward the throat, see Fig. 3A, I, II, and III. Substantially no change was observed in the patterns even when the antenna was definitely within the V formed by the sides of the horn, as at III. One such curve is reproduced as A in Fig. 12 for the disposition of antenna and reflector indicated as B in Fig. 3. As a comparison will show, this pattern is substantially identical with that obtained with hollow-pipe feed, the principal observable difference being a very slight accentuation of secondary lobes. A curve that is indistinguishable from Fig. 12A was obtained when the plunger was given a parabolic form, Fig. 3C, indicating that the shape of the radiation pattern is determined almost entirely by the shape and flare of the horn sides and very little if at all by the shape of the reflecting plunger.

COMPARISON OF HORN WITH PARABOLIC REFLECTOR

The question naturally arises as to how the directly excited horn differs in its behavior from a corresponding type of cylindrical parabolic reflector.

There is a fundamental difference in the mode of operation of the two devices. The parabolic reflector has a focus at which the antenna must be placed for proper functioning, and the concentrating action is

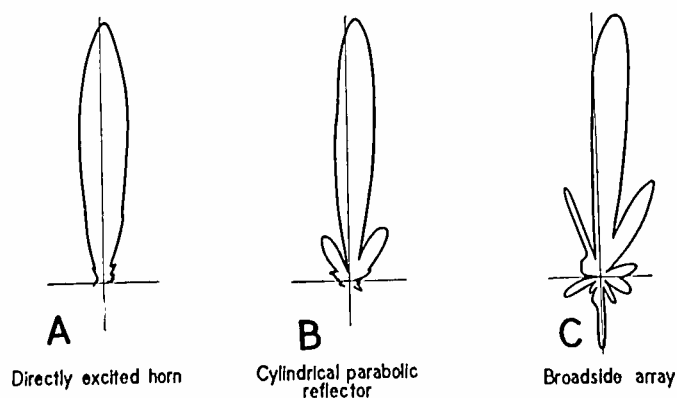

Fig. 12—Measured radiation patterns showing typical shapes obtained with the electromagnetic horn, cylindrical parabolic reflector, and broadside array.

based on a quasi-optical reflecting process. Departures from a parabolic or near-parabolic shape impair its beam-forming effectiveness. In striking contrast, *the horn has no focus* and the antenna may be located anywhere in the throat with equal effectiveness. The concentrating action is based on a guiding process, rather than on reflection. There is

a wide range of flare angles (and of flare shapes) for which substantially the same shaped single-beam radiation pattern will be produced.

The pattern reproduced as B in Fig. 12 was obtained with a cylindrical parabolic reflector made from the large horn by locating between the top and bottom surfaces a vertical conducting sheet having a parabolic contour with a focal distance of $3\lambda/4$, thus providing a cylindrical parabolic reflector closed at the top and bottom and with the same aperture as that of the large horn. The radiation pattern manifests the characteristics typical of parabolic reflectors viz., a relatively sharp principal lobe and large secondary lobes and agrees with calculated values. The large magnitude of the secondary lobes is explained by the substantially uniform electric intensity distribution across the aperture plane of the parabolic cylinder. We recall that the sectoral horn produced a sinusoidal distribution across this plane. Other parabolic-shaped sheets were tried in the experimental structure and parabolic reflectors with open top and bottom ends were measured, but always with results of the above general character.

The power gain for the horn, pattern A of Fig. 12, and for the parabolic cylindrical reflector, pattern B of Fig. 12, is 24 in magnitude.

Another striking practical difference in the behavior of parabolic reflectors and of horns is found for changes in wavelength. The parabolic reflectors are very critical with wavelength and require careful painstaking adjustment in this regard. The horn, on the other hand, is not at all critical and will operate satisfactorily over a much wider range of wavelengths. By simply adjusting the plunger, which can be done in several minutes, a horn can be brought to optimum adjustment at any wavelength within a range of over two-to-one, or even greater.

Where this wide-band feature is important, the plunger can be replaced by a nonreflecting medium; although the losses are increased thereby, the horn is made almost equally responsive over a wide range of frequencies.

COMPARISON OF HORN WITH ANTENNA ARRAYS

A theoretical investigation of a broadside array of half-wave antennas and the well-known success of this system at short wavelengths made it seem plausible that such an array might be a satisfactory radiator for producing the narrow beams at wavelengths of one meter and less. For a given over-all physical size, a broadside array appears to provide a narrower beam than does a horn, an end-fire array, or any other type of directive system. However, the relative magnitudes of its secondary lobes should

be considerably greater than those obtained with a horn.

To verify the predictions and to evaluate their worth for our application, a number of broadside arrays of the "pine-tree" type were constructed and thoroughly tested at wavelengths from 40 to 100 centimeters. Although very sharp principal lobes were obtained, the secondary lobes were relatively large and the operation of the arrays was very critical.

One of the best of the patterns obtained is reproduced as C of Fig. 12. It is for a 13-element array of the same relative aperture, $W_h = 6$, as those of the horn and parabolic reflector whose patterns are shown as A and B, respectively, of the same figure. It had a sheet-metal reflector disposed parallel to and one-quarter wavelength behind the half-wave antennas. It was fed at its center by a coaxial line inserted through the reflecting sheet. Comparison with A and B of the same figure shows it to have a slightly sharper principal lobe but much larger secondary lobes. Also, the beam is displaced from the forward direction by about six degrees. This unpredictable deviation of the direction of the beam is a serious fault of the broadside arrays we have tried. Some of the patterns had the principal lobe as much as ten degrees off of the direction in which the array was aimed.

Our results prompt certain general observations on the operation of multiple-antenna arrays at wavelengths below one meter. The arrays are very difficult to adjust and to maintain in adjustment. Since it is not practicable with present equipment to measure the phases and amplitudes of the currents in the several elements, the adjustment must be made by rule-of-thumb methods and the only check on the adjustment is the measurement of the radiation pattern itself. The arrays are highly resonant and not only does the radiated power depend critically on the wavelength but also the shape of the pattern changes rapidly with it. Spurious radiation from the oscillator the transmission line, and the supporting structure presents a serious problem where the detailed shape of the beam is important. No entirely satisfactory patterns were obtained until a sheet-metal reflector was placed behind the array.

APPLICATION OF THE SECTORAL HORN TO THE INSTRUMENT LANDING OF AIRPLANES

In the instrument landing problem the need of a radiation field pattern that is free from any effects of the "ground" is manifest, because a radio path that is to act as a reference to the airplane in the act of landing must not be affected by any ground condi-

tions. Also there is a strong argument at the present time in favor of a straight-line reference or glide path in preference to the prevailing curved one. Without going into the relative merits of the straight-line versus the curved path it may be said with assurance that the horn type of radiator described in this paper now offers a means for realizing both these features of the radio aspect of the landing problem.

In the proposed system, two similar beams of the same carrier frequency but of different signal frequencies overlap slightly in the vertical plane to establish an equisignal plane at the natural landing angle of the airplane. The sketch of Fig. 13 illustrates schematically the straight-line equisignal intersection of the two vertical beams. The method is similar in principle to that employed in the Department of Commerce radio range beacons and in certain runway localizers. Another set of overlapping beams defines a vertical plane through the runway, and the intersection of the two planes establishes a straight

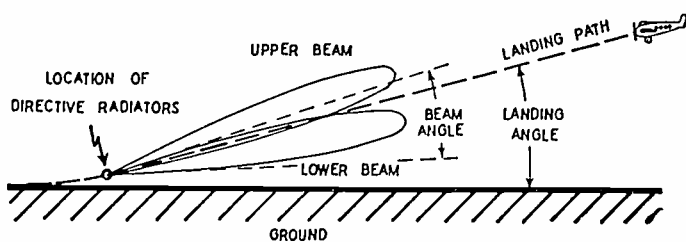

Fig. 13—Pictorial representation of overlapping beams in the vertical plane for blind or instrument landing of airplanes.

reference line in space to control the landing of the airplane. We considered that the realization of the straight-line lateral guidance could be taken for granted, since several systems have already demonstrated precise runway localizers. On the other hand, numerous obstacles lie before the successful production of the straight-line vertical guidance, and it is with this aspect of the system that this paper is principally concerned.

A prerequisite to the realization of this inclined straight line is a beam sufficiently smooth and sharp to be used in producing the inclined equisignal plane that establishes the straight-line landing path.

Based on such factors as the permissible landing-path angle, straightness of the landing path, safety from collision with the radiator, and reliability under all weather conditions, we assumed the following general specifications for the characteristics of the radiator: (1) a very sharp beam in the vertical plane (the beam angle must be 6 to 8 degrees or less); (2) substantially complete absence of secondary lobes in the vertical plane (preventing waviness and multiplicity of path); (3) a broad beam in the horizontal plane (allowing the radiator to be located at a safe

distance to the side of the runway); (4) the radiated beam must not be reflected from or connected with the ground (so that sleet, snow, etc., cannot influence the system); and (5) the dimensions of the radiator must be so small as not to constitute a hazard when located in the vicinity of the runway.

It appears probable that these general specifications can only be met by wavelengths below one meter in magnitude, preferably of the order of ten centimeters. However, for test purposes and because of the limited power and reliability of vacuum tubes for ten-centimeter waves at the present time, the original experiments were made at wavelengths of 40 to 100 centimeters.

These specifications for the radiation characteristics are unusually severe. In most highly directive antenna systems, the *power gain* compared to a non-directive antenna has been the dominating feature. For the production of a straight-line landing path free from waviness and from ground effects, however, the *shape* of the beam is of primary concern. Secondary lobes must be reduced to negligible proportions. Although not unwelcome, power gain is of minor importance.

The results given above indicate that the sectoral horn is better able to meet the requirements just given for the instrument-landing application than are other types of antennas in that this horn can be designed to radiate beams of sufficient smoothness and sharpness to produce the desired straight-line landing path.¹⁰

CONCLUDING REMARKS

The horn of sectoral shape investigated in this research represents but one of the many horns that may be used to accomplish specific results. Several modifications of this horn may be made with a slight increase in effectiveness; namely, the throat may be flared gradually so that the pipe stub and the horn sides are connected smoothly and without discontinuity, giving a substantially hyperbolic contour, and the mouth edge may be made to coincide with an arc of a circle with its center at the apex, making the front rounded instead of straight.

In certain instances, it may be desirable to dispose the vacuum tube or other energy-translating device within the horn in the throat or pipe stub, thereby obviating any radio-frequency transmission line. Parallel-wire grids in the throat or in the horn may be employed to increase the sharpness of response of the system, to filter undesired waves, to act as polarization filters, or to effect impedance matching.

¹⁰ In the application to instrument landing the horn will have its long sides vertical. Preliminary tests on a horn so disposed have indicated that the conclusions made here are justified.

When such bars are at right angles with the antenna, they may be used as mechanical supports for a non-conducting weatherproof covering for the mouth.

When power at sufficiently short wavelengths is available and the horn is relatively small in size, it may be located quite near a runway in an instrument landing system without presenting a hazard. In this case the beam can be made sharp in both the horizontal and vertical planes. This result is easily accomplished in either of two ways, First, the spacing between the parallel sides of the sectoral horn may be increased, or second, the horn may be flared in both of the transverse dimensions so that it assumes a pyramidal shape. Because of the configuration of the field within the horn, it need have a flare angle in the vertical plane (Fig. 1A) only two thirds as large as that in the horizontal plane for equal beam angles in the two planes, as may be seen from Fig. 8. The angle in these two planes of the beam can be nicely controlled by properly proportioning the flare angle and the aperture in the y and z directions. This pyramidal horn is an ideal one for producing a pencil-like beam for point-to-point communication and for other applications where a beam of this character is required.

As demonstrated in these experiments and as explained theoretically in the companion paper, the horn may be made longer with a resulting sharpening in beam angle. Physical size and cost appear to be the principal factors that limit the sharpness of the beam that may be produced.

The principle of models may be made full use of in the design of horn radiators. If all of the linear dimensions are altered by a numerical factor m and the wavelength is changed by the same factor, identical beam shapes will result. Thus, the results of experiments at one wavelength may be readily translated to other wavelengths.

Based on the results of our research, we draw the following conclusions:

- (1) The electromagnetic horn can produce beams substantially free from secondary lobes in one plane.
- (2) The optimum flare angle for the sectoral horn is about 40 to 50 degrees; this value should also hold for the hyperbolic and pyramidal horns.
- (3) The beam angle can be made smaller by increasing the length, and thus the aperture, of the horn.
- (4) Spurious radiation is substantially absent.
- (5) A given horn functions almost equally well, both as to power output and general shape of the beam, over a tremendous band width or over a frequency range of about two to one.
- (6) Compared to other highly directive ultra-short-wave radiators, the horns appear to be the simplest to construct and the easiest to operate.

Finally, when operated at sufficiently short wavelengths, the sectoral horn can meet all of the specifications that we proposed for the straight-line landing-path blind-landing system.

Theory of the Electromagnetic Horn*

W. L. BARROW†, ASSOCIATE MEMBER, I.R.E., AND L. J. CHU†, NONMEMBER, I.R.E.

Summary—A theoretical analysis of the operation of the electromagnetic horn "antenna" is derived from Maxwell's equations. The details apply to a horn of sectoral shape. The analysis also applies to a tapered hollow-pipe transmission line. Certain transmission quantities, like the phase constant, attenuation constant, velocity of propagation, etc., are calculated for horns of any angle of flare and the field configuration within the horn is plotted. One result is a clear understanding of the propagation of waves within the horn. Another result is that design specifications for horns may be established. Calculations of radiation patterns made in this analysis agree satisfactorily with experiments reported in a companion paper.

INTRODUCTION

IN A companion paper,¹ the radiation of electromagnetic waves from a horn of sectoral shape is discussed from experimental and practical viewpoints, particularly with respect to the realization of

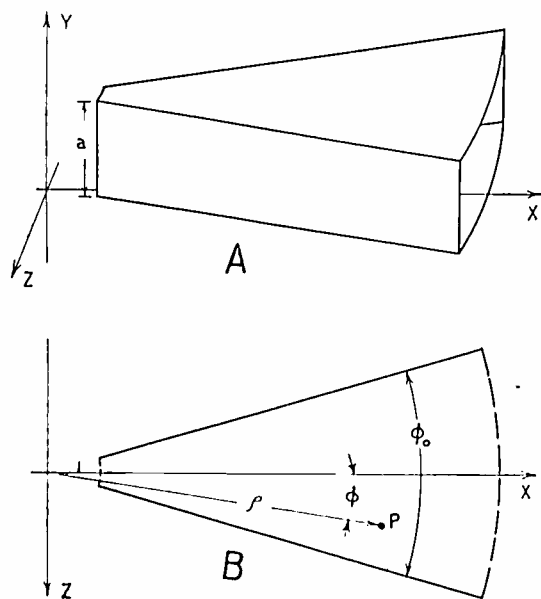

Fig. 1—View of sectoral horn A and the cylindrical co-ordinate system B.

a straight-line landing-path system for the blind landing of airplanes.

In this paper, we shall present the theory of the transmission of waves through the inside of the horn and into the outer free space. Although the analysis applies specifically to the sectoral horn, it provides a clear physical picture of the operation of electromagnetic horns of any shape. The method may be applied to a number of specific shapes, such as conical

* Decimal classification: R111.2. Original manuscript received by the Institute, June 10, 1938. Presented in part before the joint meeting of the I.R.E. and the U.R.S.I., Washington, D. C., April 30, 1938. Many of the calculations contained in this paper were made as a part of a Doctor's thesis in the Department of Electrical Engineering at Massachusetts Institute of Technology by L. J. Chu.

† Massachusetts Institute of Technology, Cambridge, Massachusetts.

¹ W. L. Barrow and F. D. Lewis, "The sectoral electromagnetic horn," *PROC. I.R.E.*, this issue, pp. 41-50.

and hyperbolic, for which the boundary-value problem can be solved.

Although in this paper the emphasis will be on the electromagnetic horn, the problem that we solve is of much broader import. For example, the analysis applies directly to the transmission of waves in a hollow-pipe line with constants that change uniformly along its length, that is, to a "tapered" hollow-pipe line. The similar problem has been solved for conventional transmission lines. The analysis also bears on the operation of a tapered section of hollow pipe used as a connection between two uniform hollow-pipe lines of unequal cross sections. Such tapered sections may be used to reduce the electrical discontinuity when joining two pipes of unequal dimensions, for an aid in matching their impedances, and for other purposes. The strong similarity between the internal aspects of the electromagnetic horn and the hollow-pipe line makes it helpful to carry over into the horn problem certain of the conceptions and terminology of hollow-pipe transmission theory.

The analysis falls naturally into two parts. In the first part, the boundary conditions for a horn of perfect conductivity and of infinite length will be imposed on the appropriate solutions of Maxwell's equations to obtain the expressions for the electric and magnetic fields within the horn and to derive the more important transmission properties of these internal waves. In the second part, Huygens' principle will be invoked to calculate the shape of the radiation field at a great distance from the mouth of the horn by assuming the distribution across the mouth to be the same as would exist there if the sides of the horn extended to infinity. General discussions of electromagnetic-horn radiators will be given throughout the paper.

PART I. WAVES INSIDE THE SECTORAL HORN

The Field Inside the Horn

The shape of the sectoral horn is shown in Fig. 1, which also shows the cylindrical co-ordinate system y , ρ , and ϕ . The horn is bounded by perfectly conducting surfaces at $\phi = \pm\phi_0/2$ and at $y=0,a$. The interior space is assumed to be nonconducting and of dielectric constant ϵ and permeability μ ; in the horn, this space will usually be air, but in the hollow-pipe applications of this analysis it might be another gas or a vacuum. In other cases, it might be a liquid or even a solid dielectric.

In this section, the sides of the horn are assumed to extend to infinity in the ρ direction, or at least so far in that direction that the field in the region under consideration is not disturbed by end effects. The origin will be left out of explicit formulation, as will the exact configuration of the exciting system. As discussed in the companion paper,¹ excitation may take place either by means of a section of hollow pipe opening into the horn near the apex, or origin of the co-ordinate system, by means of an exciting rod or antenna located within the horn near the apex, or by means of a suitable high-frequency energy-converting device disposed in the throat. In the latter cases, a suitable reflector is desirable, and the distance between the antenna and reflector should be adjusted or adjustable. In any case, waves of the same type may be excited inside the horn.

Maxwell's equations in a form suitable for our problem with an assumed time variation $e^{i\omega t}$, where $i = \sqrt{-1}$, $\omega = 2\pi \times$ frequency, and $t =$ time in seconds, are as follows:

$$\begin{aligned}
 i\omega\epsilon\rho E_y &= \frac{\partial}{\partial\rho}(\rho H_\phi) - \frac{\partial}{\partial\phi}H_\rho \\
 i\omega\epsilon\rho E_\rho &= \frac{\partial}{\partial\phi}H_y - \frac{\partial}{\partial y}(\rho H_\phi) \\
 i\omega\epsilon E_\phi &= \frac{\partial}{\partial y}H_\rho - \frac{\partial}{\partial\rho}H_y \\
 -i\omega\mu\rho H_y &= \frac{\partial}{\partial\rho}(\rho E_\phi) - \frac{\partial}{\partial\phi}E_\rho \\
 -i\omega\mu\rho H_\rho &= \frac{\partial}{\partial\phi}E_y - \frac{\partial}{\partial y}(\rho E_\phi) \\
 -i\omega\mu H_\phi &= \frac{\partial}{\partial y}E_\rho - \frac{\partial}{\partial\rho}E_y.
 \end{aligned} \tag{1}$$

The components E_y , E_ρ , E_ϕ , H_y , H_ρ , and H_ϕ of electric field E and magnetic field H , respectively, in these expressions are complex quantities independent of the time and depend on the space variables only. The actual field is the real part of $Ee^{i\omega t}$ and of $He^{i\omega t}$. A practical system of units is used in which

$E =$ electric intensity in volts per centimeter

$H =$ magnetic intensity in amperes per centimeter

$\mu =$ permeability in mhos per centimeter (for air $\mu_0 = 4\pi \cdot 10^{-9}$)

$\epsilon =$ dielectric constant in farads per centimeter (for air $\epsilon_0 = 10^{-11}/36\pi$)

$c = 1/\sqrt{\mu\epsilon} =$ velocity of light in a medium with constants μ , ϵ (for air, $c =$ velocity of light in vacuum $= 3 \times 10^{10}$ centimeters per second).

A great number of solutions may be obtained for (1) and the choice of any particular solution or group of solutions depends on the conditions of the problem. It is possible to choose solutions that lead to fields varying with all three of the co-ordinates y , ρ , ϕ or with any two of them. We may also classify all possible waves into two broad types, the E waves and the H waves, corresponding to similar types of waves in hollow metal pipes. The E wave has no *radial* component of magnetic intensity ($II_\rho = 0$) and the H wave has no *radial* component of electric intensity ($E_\rho = 0$). The several lowest-order waves of each type may be excited readily by an appropriate disposition of antennas near the throat or by means of a corresponding wave from a hollow pipe opening into the throat.

For the moment, we limit our attention to one type of wave, namely, that corresponding to the $H_{0,m}$ wave, m an odd integer, in a hollow pipe of rectangular cross section.² This wave is the one used in the sectoral horn of the companion paper to produce a single sharp beam of radiant energy and will be called the $H_{0,m}$ wave in a sectoral horn hereafter. In this wave, all components of field are independent of y , the electric intensity is everywhere parallel to the y axis, i.e., perpendicular to the top and bottom surfaces, and the magnetic field lies in planes perpendicular to the y axis. The problem, therefore, reduces to a two-dimensional one in which E_ρ , E_ϕ , and H_y are all zero. Under these conditions, (1) reduces to

$$\begin{aligned}
 i\omega\epsilon\rho E_y &= \frac{\partial}{\partial\rho}(\rho H_\phi) - \frac{\partial}{\partial\phi}H_\rho \\
 -i\omega\mu\rho H_\rho &= \frac{\partial}{\partial\phi}E_y \\
 i\omega\mu H_\phi &= \frac{\partial}{\partial\rho}E_y.
 \end{aligned} \tag{2}$$

By eliminating H_ϕ and H_ρ from (2), we obtain the following equation for E_y :

$$\left[\frac{\partial^2}{\partial\rho^2} + \frac{1}{\rho} \frac{\partial}{\partial\rho} + \frac{1}{\rho^2} \frac{\partial^2}{\partial\phi^2} + \left(\frac{\omega}{c} \right)^2 \right] E_y = 0. \tag{3}$$

The general solution of this equation is

$$\begin{aligned}
 E_y &= [A \sin(m\nu\phi) + B \cos(m\nu\phi)] \\
 &\quad \cdot \left[CJ_{m\nu} \left(\frac{\omega}{c} \rho \right) + DY_{m\nu} \left(\frac{\omega}{c} \rho \right) \right]
 \end{aligned} \tag{4}$$

where A , B , C , and D are complex constants, $J_{m\nu}$ and $Y_{m\nu}$ are Bessel functions of the first and second kinds,

² L. J. Chu and W. L. Barrow, "Electromagnetic waves in hollow metal tubes of rectangular cross section," PROC. I.R.E., vol. 26, pp. 1520-1555; December, (1938).

respectively, of the $m\nu$ th order, and the positive integer m and the real constant ν are both to be determined from the boundary conditions.

There is a correspondence between the expression for E_y from (4) for the horn and the corresponding expression for the $H_{0,m}$ wave in a hollow pipe of rectangular cross section. First, in the hollow pipe there is a sinusoidal space variation in the z direction transverse to the direction of propagation, but in the horn there is a sinusoidal space variation in the ϕ direction along an arc of a circle with its center at the apex of the horn, which is also at right angles to the propagation direction. Second, in the pipe the waves travel along the axis in the x direction with an exponential form of propagation, but in the horn they travel outward in the radial direction with a Bessel function form of propagation. Only those $H_{0,m}$ waves which have an electric field of even symmetry about the center of the pipe radiate beams with a central lobe. For this reason, only the cosine term in (4) will be retained. As a practical matter, the sine term cannot exist if the horn is excited by an antenna placed vertically in the $\phi=0$ plane, as it is in the normal operation of the horn. A wave propagated in the radial direction may be conveniently represented by the Bessel function of the third kind, or Hankel function,

$$K_{m\nu} = J_{m\nu} - iY_{m\nu}. \quad (5)$$

Hence, we put the constants C and D in (4) equal to 1 and $-i$, respectively. With these modifications, we obtain from (4) and (2) the following solutions for the field within the horn:

$$\left. \begin{aligned} E_y &= B \cos(m\nu\phi) K_{m\nu} \left(2\pi \frac{\rho}{\lambda} \right) \\ H_\rho &= B \frac{m\nu}{i\omega\mu\rho} \sin(m\nu\phi) K_{m\nu} \left(2\pi \frac{\rho}{\lambda} \right) \\ H_\phi &= -Bi \sqrt{\frac{\epsilon}{\mu}} \cos(m\nu\phi) K_{m\nu}' \left(2\pi \frac{\rho}{\lambda} \right) \end{aligned} \right\} \quad (6)$$

where $K_{m\nu}'$ is the derivative of $K_{m\nu}$ with respect to its argument $(2\pi\rho/\lambda)$ and λ is the wavelength of a plane wave in an unbounded medium of constants μ and ϵ . The remaining components of field are zero, i.e., $H_y = E_\rho = E_\phi = 0$.

The metal is assumed to have an infinitely high conductivity.³ The boundary conditions require that the tangential component of the electric field vanish at the boundary. There is no electric field in our wave tangential to the top and bottom surfaces of

the horn, hence, the boundary conditions are automatically satisfied for $y=0, a$. At the two sides, where $\phi = \pm\phi_0/2$, E_y must vanish, so we must have

$$\cos(m\nu\phi_0/2) = 0. \quad (7)$$

This equation can be satisfied by letting the integer m be odd (1, 3, 5, . . .) and

$$\nu = \frac{\pi}{\phi_0}. \quad (8)$$

The integer m specifies the order of the wave. Physically it indicates the number of half-period sinusoidal variations between the two sides of any component of the field along an arc $\rho = \text{constant}$. The constant ν depends only on the flare angle ϕ_0 , as specified by (8). Since m is always associated with ν as a product, the product

$$m\nu = \frac{m\pi}{\phi_0} \quad (9)$$

determines the behavior of the wave inside the horn. Thus, as will be made clear later, the $H_{0,3}$ wave ($m=3$), in a horn of $\phi_0=60$ degrees behaves in a way similar to the $H_{0,1}$ wave ($m=1$) in a horn of $\phi_0=20$ degrees. In the preferred mode of operating the sectoral horn, $m=1$ and $m\nu=\pi/\phi_0$; this mode corresponds to a single half-period distribution around an arc connecting the two flared sides and a uniform distribution along lines perpendicular to the arc and the radii.

The field distribution of the $H_{0,1}$ wave for $\phi_0 \cong 30$ degrees is sketched in an approximate way in Figs. 2 and 3, respectively. The field distributions of the third- and higher-order waves may be sketched in a similar manner. The rectangles shown at the right-hand end of the figures are developed views of the arctuate cross sections of the horn. Near the small end or "throat," the wavelength in the horn is very large and the crowding of the magnetic lines indicates the relatively large magnitudes of field intensities. As will be explained in a following paragraph, the waves are offered large opposition in passing through this part of the horn, hence we term it the "attenuation" region. Farther away from the throat the waves enter a part of the horn through which they pass with little or no opposition, which we term the "transmission" region. In the beginning of the transmission region, the magnetic lines form closed loops. It is observed from Figs. 2 and 3 that the wavelength in the horn, as well as the concentration of the lines of force, decreases gradually as the waves travel outward.

Near the throat the radial component of the magnetic field is still of considerable magnitude, but in

³ The attenuation caused by finitely conducting walls will not be given in this paper. Its effect will generally be small, because of the short length of the structures used for horns.

the more distant parts of the horn this component becomes negligible compared to the other two components of field. However, both the magnetic and the electric lines of force are normal to each other and to the direction of propagation, and the waves inside the horn behave very much as do transverse electromagnetic waves in free space. If the sides of the horn are terminated to form a "mouth" in this distant region, and if we assume that the termination does not materially effect the wave near the mouth, these substantially transverse cylindrical waves may continue their propagation outward into the surrounding free space. Because there is no appreciable longitudinal field, they easily form a beam in space, but because of the limited dimensions of the mouth this beam has a definite angular spread.

Viewed in this way, the operation of the horn consists in guiding electromagnetic energy from a source disposed in the throat outward in such a way that a substantially transverse wave is produced over the bounded but relatively large surface of the mouth. If certain conditions are satisfied as to the nature of the source, the shape of the wave radiated from the horn depends primarily on the configuration of the horn.

Transmission Constants

The transmission properties of the waves in the horn may be expressed by a number of physical quantities, such as the phase constant, the phase

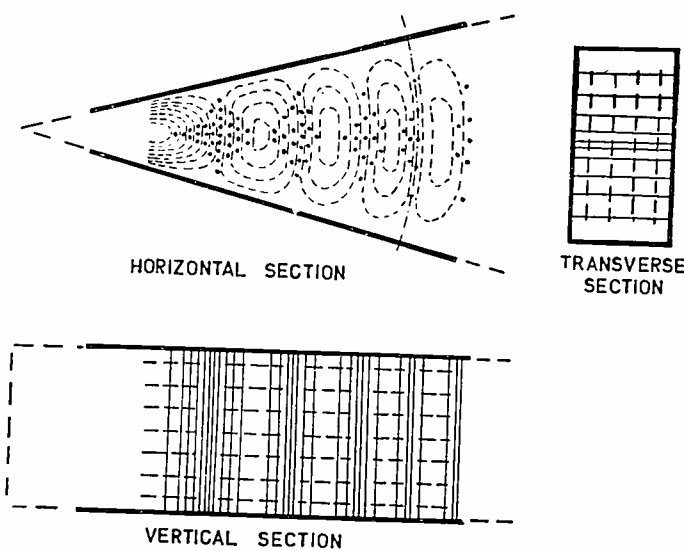

Fig. 2—Sketch of field distribution of the $H_{0,1}$ wave in a sectoral horn. Dotted lines represent magnetic field intensity and solid lines represent electric field intensity.

velocity, the wavelength, the attenuation, the density of flow of energy, the energy distribution, and the characteristic wave impedance.

For exponentially propagated waves, like waves on wires or in hollow pipes, the attenuation constant α and the phase constant β may be defined as the

logarithmic rate of decrease of magnitude and of change of phase, respectively, in the direction of propagation x , and the expression results

$$\alpha + i\beta = -\frac{\partial}{\partial x} \log E = -\frac{1}{E} \frac{\partial E}{\partial x} \quad (10)$$

where E represents any component of the field. In the conventional cases, all components of the field have the same exponential variation with x and therefore $\alpha + i\beta$ is simply the coefficient of x in the exponent.

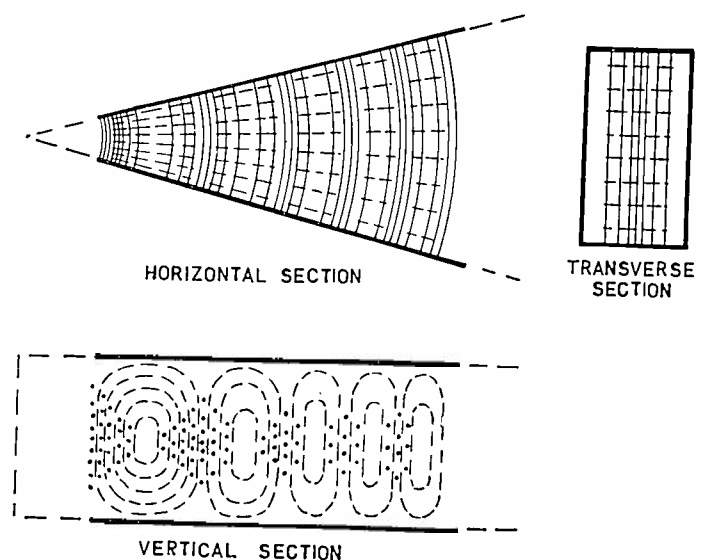

Fig. 3—Sketch of field distribution of the $H_{0,1}$ wave in a sectoral horn. Dotted lines represent magnetic field intensity and solid lines represent electric field intensity.

A more complicated situation exists in the horn. The waves are propagated in the radial direction ρ and the Hankel functions specify the variation with ρ . Furthermore, the three components E_y , H_ρ , and H_ϕ do not vary in the same functional way. Despite the above differences, we will use the definition (10) for the horn also, replacing x by ρ . Since our principal interest is in the electric field, which we can easily measure experimentally, we will deal with E_y alone. Using the value for E_y from (6), we get

$$\alpha + i\beta = -\frac{2\pi}{\lambda} \frac{K_{m\nu}'\left(2\pi \frac{\rho}{\lambda}\right)}{K_{m\nu}\left(2\pi \frac{\rho}{\lambda}\right)} \quad (11)$$

where the prime represents differentiation with respect to the argument.

The interpretation of these expressions for α and β will make definite the conceptions of the attenuation and the transmission regions described qualitatively in the last section. We define the attenuation region as that portion of the horn in which the phase constant β is very small compared to its value $2\pi/\lambda$ for a wave in free space. Similarly, we define the *trans-*

mission region as that portion of the horn in which the phase constant β is almost equal to $2\pi/\lambda$. The attenuation region involves small values of ρ and the

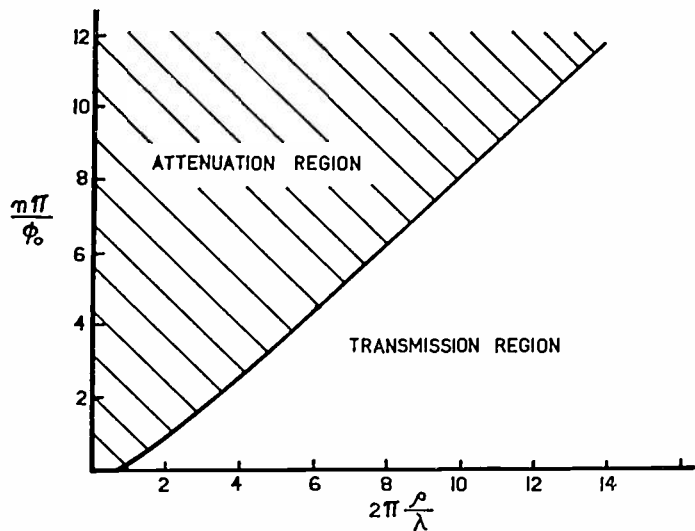

Fig. 4—Attenuation and transmission regions for a sectoral horn.

transmission region large values. By using the following asymptotic expressions for the Hankel function

$$K_{m\nu} \approx \begin{cases} \frac{1}{(m\nu)!} \left(\frac{2\pi\rho}{2\lambda}\right)^{m\nu} + i \frac{(m\nu-1)!}{\pi} \left(\frac{2\lambda}{2\pi\rho}\right)^{m\nu}, & \rho \text{ small} \\ \sqrt{\frac{2\lambda}{\pi 2\pi\rho}} e^{-i[2\pi(\rho/\lambda) - ((2m\nu-1)/4)\pi]}, & \rho \text{ large} \end{cases} \quad (12)$$

we obtain the approximate expressions for α and β in the two regions

$$\text{attenuation region} \left\{ \begin{aligned} \alpha &\approx \frac{m\pi}{\phi_0\rho} \\ \beta &\approx \frac{2\pi}{\lambda} \frac{\pi}{\left[\left(\frac{m\pi}{\phi_0} - 1\right)!\right]^2} \cdot \left(\frac{\pi\rho}{\lambda}\right)^{(2\pi m/\phi_0)-1} \end{aligned} \right. \quad (13)$$

$$\text{transmission region} \left\{ \begin{aligned} \alpha &\approx \frac{1}{2\rho} \\ \beta &\approx \frac{2\pi}{\lambda} \end{aligned} \right. \quad (14)$$

The boundary between these two regions is not definite, as should be evident from the way in which they were defined. For convenience alone we may say that the values of $2\pi\rho/\lambda$ for which $Y_{m\pi/\phi_0}(2\pi\rho/\lambda)$ passes through its lowest root represent the dividing line. With this reservation, the attenuation and transmission regions are shown in Fig. 4 (computed from values from Jahnke and Emde, *Tables of Functions*). For small flare angles ϕ_0 , the attenuation region extends over large distances from the apex.

As the flare angle is increased, the attenuation region shrinks and is confined substantially to the throat. This region occupies a progressively longer portion of the horn for the successively higher-order waves.

The phase constant β is small compared to $2\pi/\lambda$ in the attenuation region, but it increases as the wave progresses outward, i.e., with increasing ρ , and approaches the value $2\pi/\lambda$ for a free-space wave when the transmission region is reached. This behavior is illustrated by the curves of Fig. 5, which have been computed from the exact expression of (11). The dotted line marks the transition between attenuation and transmission regions. The similarity between these curves and the corresponding ones for a hollow pipe is worthy of note.

The phase velocity v_p and the wavelength of the waves within the horn λ_h (not to be confused with the free-space wavelength of the exciting current, which is denoted throughout the paper by λ) are given by $v_p = \omega/\beta$ and $\lambda_h = 2\pi/\beta$, respectively. Curves of these two quantities are reproduced in Fig. 6. The dotted line again separates the attenuation region (above the line) from the transmission region (below the line). For a horn of given flare angle, the phase velocity is substantially infinite for distances ρ/λ up to a certain range, which range is greater the smaller is the flare angle ϕ_0 . Within this range, the group velocity $v_g = d\omega/d\beta$ is almost zero and a signal will be propagated with very small velocity. The waves in this

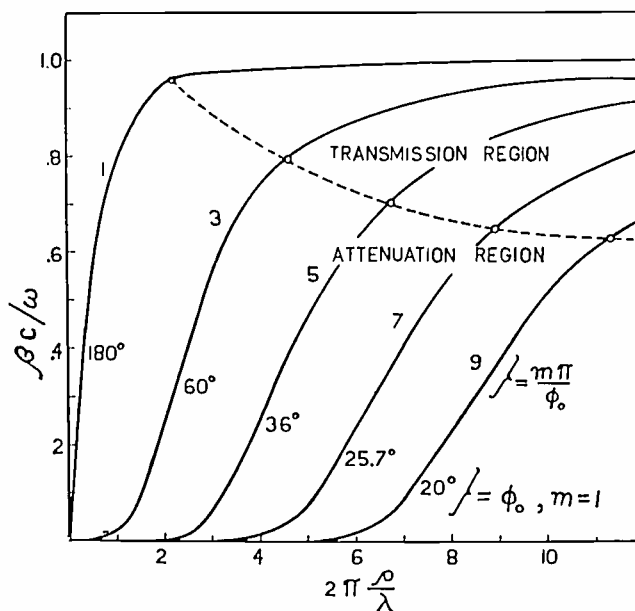

Fig. 5—Phase constant $\beta c/\omega$ versus the radial distance from the apex in wavelengths $2\pi\rho/\lambda$ for different values of flare angle ϕ_0 and for waves of different orders m .

part of the horn have a hybrid character halfway between standing waves and traveling waves. In the region of transition, the velocity of a signal increases as it propagates outward, rapidly approaching the

velocity of light as it enters the transmission region. In the transmission region, the waves are clearly of the traveling-wave type. The phase velocity becomes smaller during this course and also approaches the value for light.

The curves also show the way in which the several higher-order waves behave. For example, the curve for $m\pi/\phi_0 = 3$ applies to the $H_{0,1}$ -wave in a horn of 60-degree flare angle, but the $H_{0,3}$ wave in the same horn is governed by the curve for $m\pi/\phi_0 = 9$. For distances $2\pi\rho/\lambda$ above three in magnitude, the $H_{0,1}$ wave in this horn has emerged from its "frozen" or quasi-stationary condition, while the $H_{0,3}$ wave must travel to a distance $2\pi\rho/\lambda$ equal to about eleven before it is released to be freely transmitted.

We have assumed the horn to have a perfectly conducting boundary, and the dielectric inside it to be a perfect insulator. Since there can be no loss of energy as Joule heat in either medium, the same amount of total power must be transmitted through any cylindrical cross section of the horn. The density of the transmitted power, i.e., the real part of the Poynting vector in the radial direction, must be proportional to $1/\rho$ and consequently the field should be proportional to $1/\sqrt{\rho}$. We observe that in the transmission region the field does behave in this way. The expression for the attenuation constant, $\alpha = 1/2\rho$, is a natural consequence of the diverging shape of the horn. In the attenuation region, the attenuation constant is given approximately by $m\nu/\rho$, but only the small part $1/2\rho$ is caused by the divergence. This

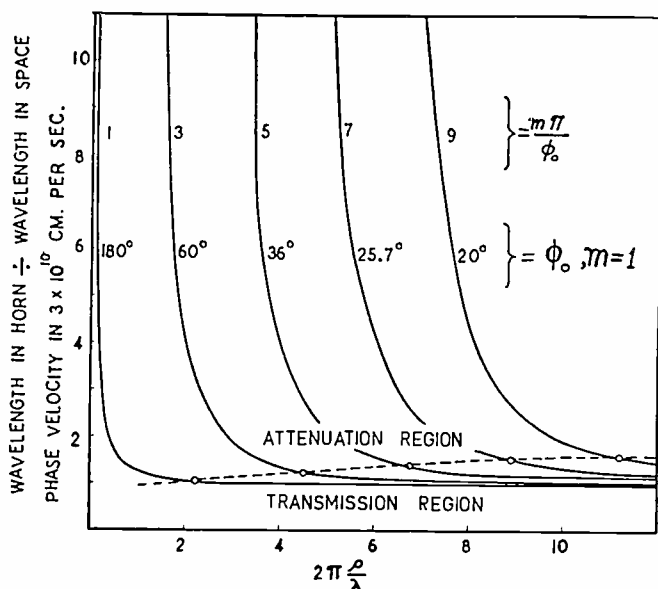

Fig. 6—Relative wavelength and the phase velocity versus $2\pi\rho/\lambda$ for different values of $m\pi/\phi_0$.

fact does not mean that there is dissipation of energy; it indicates simply that a small fraction only of the energy in this region is transmitted through the horn in the radial direction.

The attenuation curves of Fig. 7 are based upon the exact formula (11). The dotted line has the same significance as does the dotted line in Fig. 5. The

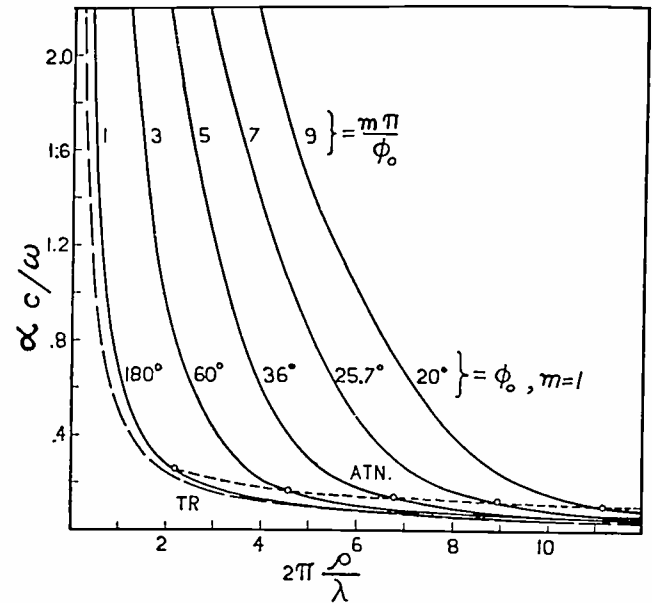

Fig. 7—Attenuation constant $\alpha c/\omega$ versus radial distance in wavelengths $2\pi\rho/\lambda$ for different values of $m\pi/\phi_0$.

dashed line represents the asymptotic value $1/2\rho$ which is caused by the spreading of energy over the cylindrical cross section, whose area increases constantly with the radius ρ . This figure again shows definitely the cutoff effect in the horns of different flare angles, and for waves of different orders in a horn of given flare angle.

As discussed above, these horn waves degenerate into the $H_{0,m}$ wave in a rectangular hollow pipe as the flare angle is reduced indefinitely. For this case, if we let $\rho = \rho_1 + x$ and $x \ll \rho_1$, $\phi_0\rho_1$ becomes the linear dimension b of the rectangular pipe. In the hollow pipe, the transmission characteristics α , β , etc., are no longer dependent upon the longitudinal co-ordinate x , and there is a definite ratio of b/λ which separates the transmission and attenuation regions. Since b is a constant, the two regions mentioned depend only on the frequency and lose the spatial meaning that they have in the horn. When $\lambda = \lambda_0 = 2b/m$, the critical wavelength of the $H_{0,m}$ wave, both α and β are zero. For $\lambda < \lambda_0$, the attenuation constant only is zero, and for $\lambda > \lambda_0$, the phase constant only is zero.

The effect of finite conductivity is greater in the attenuation region than in the transmission region, as may be seen from the following argument. The power dissipated in the walls is roughly proportional to the square of the magnitude of the tangential magnetic field at the boundary. Since, for the same amount of transmitted power, this field is relatively large in the attenuation region, the power loss in this region is also comparatively large. As a consequence, the curves of the attenuation constant will be steeper

for actual horns than are the curves for the ideal horns of perfect conductivity as shown in Fig. 7.

Energy Flow and Characteristic Impedance

Another useful physical quantity is the density of flow of energy, as given by the Poynting vector P . Its time-average value is as follows:

$$P = \frac{1}{2}(E \times H^*) \quad (15)$$

where P , E , and H^* are complex vector quantities, and H^* is the conjugate of H . By using (6), the three components of P are obtained as follows:

$$\left. \begin{aligned} P_y &= 0 \\ P_\rho &= -i |B|^2 \frac{1}{2} \sqrt{\frac{\epsilon}{\mu}} \\ &\quad \cos^2(m\nu\phi) K_{m\nu}(2\pi\rho/\lambda) K_{m\nu}'^*(2\pi\rho/\lambda) \\ P_\phi &= i |B|^2 \frac{m\nu}{2\omega\mu\rho} \\ &\quad \sin(m\nu\phi) \cos(m\nu\phi) |K_{m\nu}(2\pi\rho/\lambda)|^2 \end{aligned} \right\} \quad (16)$$

There is no flow of energy in the y direction. The Poynting vector in the ϕ direction is a pure imaginary quantity, hence there is no net energy transfer in that direction either. An imaginary flow of energy is equivalent to reactive power⁴ in electric-circuit analysis. Since P_ϕ is the product of E_y and the component of H_ρ that is out of time phase with E_y , it gives a direct measure of the amount of energy that oscillates with respect to time back and forth in the horn without getting out. In the attenuation region, P_ϕ is proportional to $(2\pi\rho/\lambda)\mu^{-2m\nu-1}$, and in the transmission region it is proportional to $(2\pi\rho/\lambda)^{-2}$.

The only direction in which energy is transmitted is the radial one. The integral of P_ρ over a cylindrical surface $\rho = \text{constant}$ from $-\phi_0/2$ to $+\phi_0/2$ and from 0 to a , is given by

$$S = -i |B|^2 \sqrt{\frac{\epsilon}{\mu}} \frac{\phi_0 a \rho}{4} K_{m\nu}(2\pi\rho/\lambda) K_{m\nu}'^*(2\pi\rho/\lambda). \quad (17)$$

The real part of S is

$$S_{\text{real}} = |B|^2 \sqrt{\frac{\epsilon}{\mu}} \frac{\phi_0 a \rho}{4} [J_{m\nu}(2\pi\rho/\lambda) Y_{m\nu}'(2\pi\rho/\lambda) - Y_{m\nu}(2\pi\rho/\lambda) J_{m\nu}'(2\pi\rho/\lambda)]. \quad (18a)$$

The factor in the square brackets is known as the Wronskian of $J_{m\nu}$ and $Y_{m\nu}$. It is equal to $\lambda/\rho\pi^2$ as given by Watson.⁵ Therefore the total power transmitted in the radial direction is

$$S_{\text{total}} = |B|^2 \sqrt{\frac{\epsilon}{\mu}} \frac{\phi_0 a \lambda}{4\pi^2}. \quad (18b)$$

It is independent of ρ . That is, the power transmitted through any one cylindrical section of the horn is the same as that transmitted through any other such section, as required by the law of conservation of energy.

The imaginary part of S is the reactive power in the radial direction,

$$S_i = - |B|^2 \sqrt{\frac{\epsilon}{\mu}} \frac{\phi_0 a \rho}{4} \frac{\partial}{\partial(2\pi\rho/\lambda)} |K_{m\nu}(2\pi\rho/\lambda)|^2. \quad (19)$$

In the attenuation region, the reactive power is large compared to the transmitted power. In the transmission region, the reactive power is inversely proportional to the radial distance from the apex. When ρ/λ is sufficiently large, it is negligibly small compared to the transmitted power.

The time average of the stored energy densities may be computed from the expressions

$$\begin{aligned} \text{electric energy density} &= \frac{1}{4}\epsilon |E_y|^2 \\ \text{magnetic energy density} &= \frac{1}{4}\mu [|H_\rho|^2 + |H_\phi|^2]. \end{aligned} \quad (20)$$

We wish to compute the energy stored in a small volume of the horn contained between the bounding walls and two cylindrical surfaces $\rho = \rho_1$ and $\rho = \rho_1 + \delta\rho$ where $\delta\rho$ is arbitrarily small. To this end, we integrate (20) over the volume just described, using the values from (19), and obtain the total electric and magnetic energies stored in this volume

$$\begin{aligned} U_E &= \frac{1}{8} |B|^2 \epsilon \phi_0 \rho_1 a |K_{m\nu}|^2 \cdot \delta\rho \\ U_H &= \frac{1}{8} |B|^2 \epsilon \phi_0 \rho_1 a \left[|K_{m\nu}'|^2 + \left(\frac{m\nu\lambda}{2\pi}\right)^2 |K_{m\nu}|^2 \right] \cdot \delta\rho. \end{aligned} \quad (21a)$$

With the aid of the approximations (12), we find that both U_E and U_H are relatively large in the attenuation region, decrease rapidly as ρ_1/λ increases, and approach the limiting value

$$\lim_{\rho_1/\lambda \rightarrow \infty} U_E = \lim_{\rho_1/\lambda \rightarrow \infty} U_H = \frac{1}{8\pi^2} |B|^2 \epsilon \phi_0 a \lambda \cdot \delta\rho. \quad (21b)$$

If we take twice the value from (21b) with $\delta\rho = 1$, we obtain the limiting value for the total stored energy per centimeter length in the horn. Comparing this quantity with (19), we find that the ratio of the power transmitted through a cross section to the total energy stored per centimeter is exactly $1/\sqrt{\epsilon\mu}$, i.e., this ratio is equal to the velocity of light in a medium like that within the horn. The same situation exists in a plane wave in free space.

In both the attenuation region and the transmission region, the magnetic energy is always greater than the electric energy; the two energies approach each other in value only when ρ/λ is very large. The

⁴ W. V. Lyon, "Reactive power and power factor," *Trans. A.I.E.E.*, vol. 52, pp. 763-770; September-December, (1933).

⁵ Watson "Treatise on the Theory of Bessel Functions," equation 1, p. 76, Cambridge University Press, (1922).

predominance of magnetic energy allows us to consider the field of this type of wave as inductive rather than capacitive. The large energy densities near the throat are caused by the proximity to the source. At greater distances from the source, the above-described inductive effect becomes less, and consequently the energy densities decrease. At large distances from the source, the only energy present is that coming from the source as radiation in the ρ direction and the wave then behaves almost like a plane wave.

The characteristic wave impedance⁶ in the radial direction is given by

$$Z_o = -\frac{E_y}{H_\phi} = -i\sqrt{\mu/\epsilon} \frac{K_{mv}}{K_{mv'}} \quad (22a)$$

By separating the real and imaginary parts, we obtain the characteristic resistance R_o and the characteristic reactance X_o ,

$$R_o = \frac{\omega}{c} \sqrt{\frac{\mu}{\epsilon}} \frac{\beta}{\alpha^2 + \beta^2};$$

$$X_o = \frac{\omega}{c} \sqrt{\frac{\mu}{\epsilon}} \frac{\alpha}{\alpha^2 + \beta^2} \quad (22b)$$

where α and β are the attenuation constant and the phase constant respectively, given by (11). The reactance is always positive; therefore in agreement

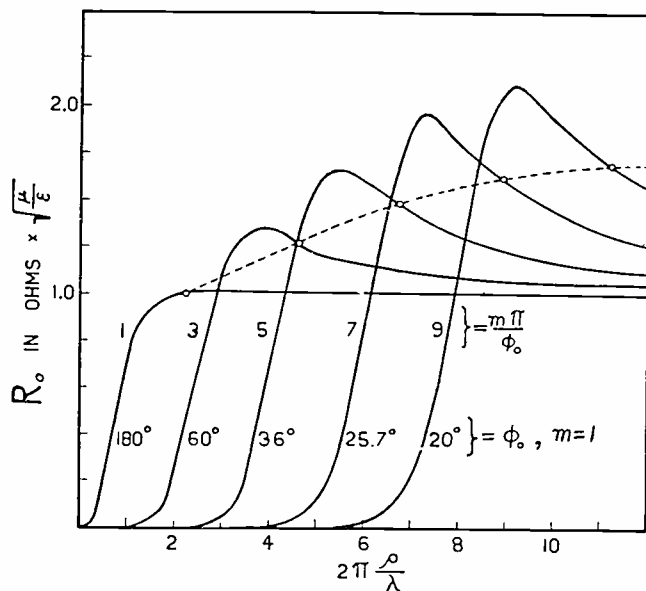

Fig. 8—Resistive component R_o of characteristic impedance versus radial distance in wavelengths ρ/λ for different values of $m\pi/\phi_o$.

with the preceding paragraph, it represents an inductive field. Figs. 8 and 9 show the curves of R_o and X_o as a function of $2\pi\rho/\lambda$ for several values of $m\pi/\phi_o$. The resistance approaches $\sqrt{\mu/\epsilon} = 377$ ohms for large

⁶ S. A. Schelkunoff, "The impedance concept and its application to problems of reflection, refraction, shielding and power absorption," *Bell Sys. Tech. Jour.*, vol. 17, pp. 17-49; January, (1938).

values of $2\pi\rho/\lambda$, and the reactance approaches zero. Thus, the characteristic impedance of the horn is the same as that of free space when the wave is well into the transmission region.

We have now formed a rather complete picture of the behavior of the energy inside the horn that may be summarized as follows: We may consider that the

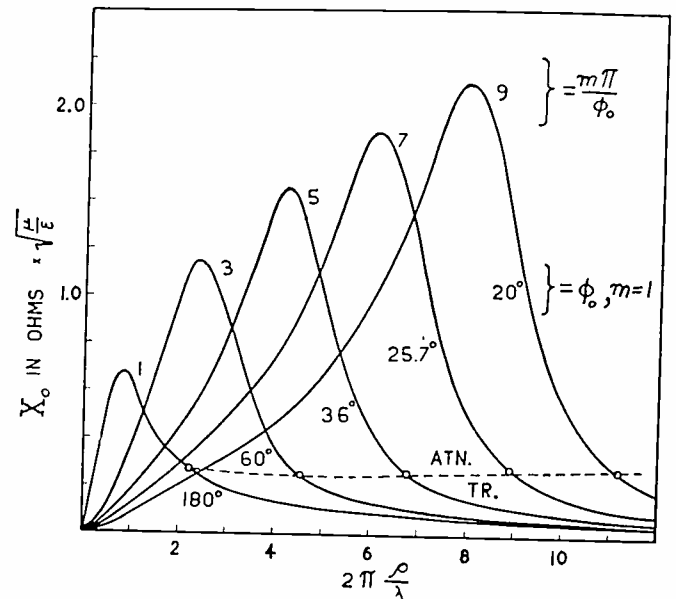

Fig. 9—Reactive component X_o of characteristic impedance versus radial distance in wavelengths ρ/λ for different values of $m\pi/\phi_o$.

field is composed of two parts, the "induction" field and the "radiation" field. The energy associated with the induction field is not propagated away but is stored in the field. Its amplitude decreases rapidly as the distance from the source is increased. The radiation field represents the actual traveling wave with which the transmitted energy is associated. In our particular case, the components of this field are transverse to the radial direction, and the Poynting vector is a pure real quantity. The magnitude of the radiation field is proportional to $1/\sqrt{\rho}$, hence, the total energy transmitted through any cylindrical cross section is constant. In the attenuation region, the induction field predominates. In the transmission region, the induction field is negligible and the radiation field predominates.

What is the significance of the two fields on the performance of the horn? Let us assume that a certain feeding system generating one only of the first- or higher-order waves is disposed in the throat of the horn. The field at the throat is fixed by the feeding system, and the sum of the induction and the radiation fields at the throat must be equal to the field at the feeding system. If the induction field at the throat is large compared to the radiation field, only a small amount of energy may be derived from the feeding system, as the voltage of the feeding system

is fixed, and the active power is small compared to the reactive power. On the other hand, if the conditions are such that the induction field is small compared to the radiation field at the exciter, the power derived from the feeding system will be relatively large. It is primarily the radiation field in the horn that is useful in most practical instances.

The attenuation property of the horn provides an effective means for eliminating higher-order waves. To make this point clear, let us assume that a horn is excited for the $II_{0,1}$ wave by a small antenna in its throat. As the current oscillates in the antenna, not only the $II_{0,1}$ wave but also the higher-order waves or spatial harmonics are produced, which tend to propagate in the radial direction of the horn. In the vicinity of the throat, the field distribution along an arc of the horn is nonsinusoidal because of the presence of these $II_{0,m}$ waves, and is so configured that the boundary conditions at the surface of the antenna are satisfied. The magnitude of the fields of the higher-order waves are less than that of the $II_{0,1}$ wave at the throat. We observe from Fig. 3 that, for a given value of flare angle ϕ_0 , the range of the attenuation region is approximately proportional to the order of the wave. If the throat is appropriately near the apex, it may be in the transmission region of the $II_{0,1}$ wave but deep in the attenuation region of the third- and higher-order ($m=3, \dots$) waves. The $II_{0,1}$ wave is transmitted freely in this case but the higher-order waves are "inductive" and very little of their fields can penetrate the attenuation region. That is, most of the energy associated with the $II_{0,1}$ wave is transmitted out through the horn, but only a small fraction of the energy associated with the higher-order waves is able to get out as far as the mouth. Consequently, the field distribution across the mouth will be substantially free from the third- and higher-order waves and will be a half-period sinusoid.

$II_{n,0}$ Waves in the Sectoral Horn

The discussion up to this point has concerned electromagnetic-horn waves whose electric field is vertically polarized, i.e., parallel to the y axis of Fig. 1. These waves correspond closely to the $II_{0,m}$ waves in a rectangular hollow pipe. Another simple type of horn wave of interest is that in which the electric field is polarized along the arc, or ϕ coordinate, of the same figure. This second type of wave corresponds to the $II_{n,0}$ wave in the rectangular pipe. In this section, we present without discussion the essentials of the analysis for this type of wave in the sectoral horn.

When $E_y=0$ and $E_\rho=0$ in (1), the Maxwell equa-

tions are reduced to the following groups of three equations, involving E_ϕ , H_ρ , and H_y :

$$\left. \begin{aligned} i\omega\epsilon E_\phi &= \frac{\partial}{\partial y} H_\rho - \frac{\partial}{\partial \rho} H_y \\ i\omega\mu\rho H_y &= -\frac{\partial}{\partial \rho} (\rho E_\phi) \\ i\omega\mu\rho H_\rho &= \frac{\partial}{\partial y} (\rho E_\phi) \end{aligned} \right\} \quad (23)$$

The wave equation for E_ϕ is as follows:

$$\frac{\partial^2 E_\phi}{\partial \rho^2} + \frac{1}{\rho} \frac{\partial E_\phi}{\partial \rho} + \left(\frac{\omega}{c}\right)^2 E_\phi + \frac{\partial^2 E_\phi}{\partial y^2} - \frac{1}{\rho^2} E_\phi = 0. \quad (24)$$

After separation of variables, the solution is found to be simply

$$E_\phi = B \left. \begin{aligned} \sin \\ \cos \end{aligned} \right\} (\gamma y) K_1 \left(\sqrt{\left(\frac{\omega}{c}\right)^2 - \gamma^2} \rho \right). \quad (25)$$

The boundary conditions require that E_ϕ vanish at the top and bottom surfaces of the horn, $y=0, a$. At $y=0$, the cosine term vanishes. At $y=a$, $\sin \gamma y=0$, which condition provides the values for γ ,

$$\gamma = n\pi/a, \quad n = 1, 2, 3, \dots \quad (26)$$

Therefore, the three components of fields are given by

$$\begin{aligned} E_\phi &= B \sin \left(\frac{n\pi}{a} y \right) K_1 \left(\sqrt{\left(\frac{\omega}{c}\right)^2 - \left(\frac{n\pi}{a}\right)^2} \rho \right) \\ H_y &= -B \frac{\sqrt{\left(\frac{\omega}{c}\right)^2 - \left(\frac{n\pi}{a}\right)^2}}{i\omega\mu} \\ &\quad \sin \left(\frac{n\pi}{a} y \right) K_0 \left(\sqrt{\left(\frac{\omega}{c}\right)^2 - \left(\frac{n\pi}{a}\right)^2} \rho \right) \\ H_\rho &= B \frac{n\pi/a}{i\omega\mu\rho} \cos \left(\frac{n\pi}{a} y \right) K_1 \left(\sqrt{\left(\frac{\omega}{c}\right)^2 - \left(\frac{n\pi}{a}\right)^2} \rho \right). \end{aligned} \quad (27)$$

This wave is independent of the flare angle of the horn, and has a sinusoidal variation in the y direction. The field distribution of the $II_{0,1}$ wave for $\phi_0 = 30$ degrees is sketched in Fig. 3.

The transmission properties of the $II_{n,0}$ waves in the sectoral horn depend mainly upon the distance between the top and bottom surfaces. The Hankel functions represent a traveling wave only when their argument is a real quantity. In our case, since ρ is always real, the condition is that

$$\frac{n\pi}{a} < \frac{\omega}{c}. \quad (28)$$

By setting the two terms equal to each other, we obtain a definite cutoff frequency f_o ,

$$f_o = \frac{nc}{2a}. \quad (29)$$

This cutoff frequency is exactly the same as that of the $H_{n,0}$ wave in a rectangular hollow pipe if the values of a in both cases are equal.

Using (9), the attenuation constant α and the phase constant β for $f > f_o$ are given by

$$\alpha + i\beta = -\frac{\sqrt{(2\pi/\lambda)^2 - (n\pi/a)^2} K_1'(\sqrt{(2\pi/\lambda)^2 - (n\pi/a)^2} \rho)}{K_1(\sqrt{(2\pi/\lambda)^2 - (n\pi/a)^2} \rho)}. \quad (30)$$

When $2\pi/\lambda$ is replaced by $\sqrt{(2\pi/\lambda)^2 - (n\pi/a)^2}$ in Figs. 5 and 7, the curves for $n\pi/\phi_o = 1$ illustrate the variations of α and β with the radial distance ρ . The attenuation is caused solely by the decreasing of energy density as the area of the cylindrical surface increases with ρ .

PART II. WAVES RADIATED INTO SPACE

Calculation of Radiation Patterns

The transmission theory of waves inside horns developed in the foregoing section apply, strictly, only to horns that extend to infinity in the radial direction. Although we are not able to treat rigorously a horn of finite length, we have obtained an approximate solution suitable for most cases of practical interest. In this solution, the assumption is made that the field distribution across the mouth is the same that would exist at this distance from the apex if the sides of the horn extended to infinity. Thus, the end effects are neglected. The radiation characteristic is then calculated from this distribution by means of Huygens' principle. It is feasible to carry out this process under the following conditions: (a) the mouth of the horn is several wavelengths beyond the attenuation region of the wave; (b) the flare angle is not too large, say less than 90 degrees; (c) the radial length of the horn is greater than several wavelengths; and (d) the radiation comes from the mouth of the horn only.

We shall now investigate the radiation characteristics of the $H_{0,m}$ wave in the sectoral horn. As has been shown in a previous paper,⁷ the radiation pattern in the x,y plane for the $H_{0,m}$ wave in a rectangular pipe depends roughly only upon the dimension a of the rectangular pipe. The field distribution of the $H_{0,m}$ wave in a sectoral horn in the x,y plane is similar to that of the $H_{0,m}$ wave in the rectangular pipe,

⁷ W. L. Barrow and F. M. Greene, "Rectangular hollow-pipe radiators," Proc. I.R.E., vol. 26, pp. 1498-1519; December, (1938).

and we may, therefore, expect the radiation pattern in the x,y plane to be approximately the same in form as the $H_{0,m}$ wave in the rectangular pipe. For this reason, our interest lies mainly in the radiation patterns in the x,z plane, and only these patterns will be calculated. A spherical co-ordinate system r, θ, ζ will be employed, but calculations are limited to the plane $\zeta = \pi/2$ in which our interest principally resides.

The radiation field is best obtained from the Hertzian vector Π for the field within the horn. Although such a representation gives no additional information inside the horn, it is more convenient to

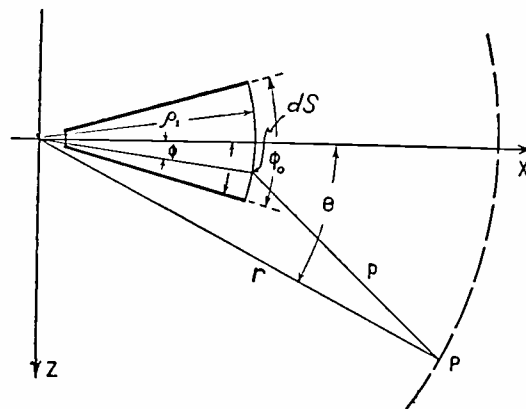

Fig. 10—Spherical co-ordinate system used in calculating radiation patterns.

use than is the electric or the magnetic intensity in securing the complex field of the radiation in the wave zone. The relations between H , E , and Π are as follows:

$$\begin{aligned} H &= i\omega\epsilon \text{ curl } \Pi \\ E &= \left(\frac{\omega}{c}\right)^2 \Pi + \text{grad div } \Pi. \end{aligned} \quad (31)$$

The values of H and E have been determined in Part I. The determination of Π from H and E is not unique. However, if we let $\text{div } \Pi$ be equal to zero, the Hertzian vector for the sectoral-horn waves discussed here may be written as

$$\Pi = i_y \Pi_y = i_y \left(\frac{c}{\omega}\right)^2 E_y \quad (32)$$

where i_y is a unit vector in the positive y direction and Π_y is the component of Π in the same direction. The value of E_y is that given in (6); consequently, Π_y also has this same form. Although the horn terminates along the cylindrical surface ρ , as shown in Fig. 10, we assume that (32) and (6) represent the field along this surface without appreciable distortion. We shall consider the case in which only one of the $H_{0,m}$ waves exists in the horn.

The Hertzian vector Π'_y in the outside space at a

point P at a distance large compared with the wavelength and the dimensions of the horn may be calculated by Huygens' principle, which may be written in the form⁸

$$\Pi_{\nu'} = \frac{1}{4\pi} \iint \frac{1}{p} \left[\frac{i\omega}{c} \Pi_{\nu} \cos(n', p) + \frac{\partial \Pi_{\nu}}{\partial p} \right] e^{-i(\omega/c)r} dS \quad (33)$$

The inner normal to the surface element dS is n' and p is the distance between this element and point of observation P . The integration is to be taken over the cylindrical surface of the mouth. It should also be extended over the outer metallic surface of the horn, but that is out of the question, since the field distribution is not known there.

Substituting the value for Π_{ν} into (33) gives

$$\begin{aligned} \Pi_{\nu'} = \frac{B}{4\pi} \left(\frac{c}{\omega} \right)^2 \int_0^a \int_{-\phi_0/2}^{\phi_0/2} \frac{i\omega}{pc} \left[K_{m\nu} \left(\frac{\omega}{c} \rho_1 \right) \cos(\phi - \theta) \right. \\ \left. + K_{m\nu'} \left(\frac{\omega}{c} \rho_1 \right) \right] \cos(m\nu\phi) e^{-i(\omega/c)r} \rho_1 d\phi dy. \end{aligned} \quad (34)$$

If the angle of flare is small, the factor in the bracket is slowly varying compared to the remaining factors. We shall use the mean value θ of $(\phi - \theta)$ over the surface and bring the bracketed factor outside the integral. Further, we shall approximate $K_{m\nu}$ and $K_{m\nu'}$ by their asymptotic forms. The point P lies in the x, y plane, hence p may be approximated, for large values of r , by

$$p = \sqrt{r^2 + \rho_1^2 - 2r\rho_1 \cos(\phi - \theta)} = r - \rho_1 \cos(\phi - \theta). \quad (35)$$

Making these modifications in (34), we obtain

$$\begin{aligned} \Pi_{\nu'} = \frac{iB}{4\pi} \frac{c}{\omega} \frac{a}{r} \frac{1}{\pi} \sqrt{\rho_1 \lambda} (1 + \cos \theta) e^{-i(\omega/c)(r + \rho_1)} \\ \cdot \int_{-\phi_0/2}^{\phi_0/2} \cos(m\nu\phi) e^{i(\omega/c)\rho_1 \cos(\phi - \theta)} d\phi. \end{aligned} \quad (36)$$

The evaluation of the integral in (36) is rather involved and will not be given here. The result, valid for the x, z plane at large distances from the mouth, is given by

$$\begin{aligned} \Pi_{\nu'} = \frac{iB}{4\pi} \frac{3\lambda^2}{16\pi} \frac{a}{R\sqrt{10}} (1 + \cos \theta) e^{i[-2\pi(r/\lambda) + 9\pi\lambda(m\nu)^2/320\rho_1]} \\ \cdot \left[e^{im\nu\theta} \int_{u_1}^{u_2} \frac{1}{2} \{ J_{-1/2}(u) - iJ_{1/2}(u) \} du \right. \\ \left. + e^{-im\nu\theta} \int_{u_3}^{u_4} \frac{1}{2} \{ J_{-1/2}(u) - iJ_{1/2}(u) \} du \right] \end{aligned} \quad (37)$$

where

⁸ Slater and Frank, "Introduction to Theoretical Physics," Chapters XXVI and XXVII. McGraw-Hill Book Company, New York, N.Y. (1933).

$$\begin{aligned} u_1 &= \left[-\frac{\phi_0}{2} - \theta - m\nu \frac{9\pi\lambda}{160\rho_1} \right]^2 \frac{80\rho_1}{9\pi\lambda} \\ u_2 &= \left[\frac{\phi_0}{2} - \theta - m\nu \frac{9\pi\lambda}{160\rho_1} \right]^2 \frac{80\rho_1}{9\pi\lambda} \\ u_3 &= \left[-\frac{\phi_0}{2} - \theta + m\nu \frac{9\pi\lambda}{160\rho_1} \right]^2 \frac{80\rho_1}{9\pi\lambda} \\ u_4 &= \left[\frac{\phi_0}{2} - \theta + m\nu \frac{9\pi\lambda}{160\rho_1} \right]^2 \frac{80\rho_1}{9\pi\lambda}. \end{aligned}$$

Each term of the integral is known as Fresnel's integral, for which numerical tables are available.

The component $\Pi_{\nu'}$ is the resultant Hertzian vector for the radiation field. It is convenient to resolve it into the spherical co-ordinate components, as follows:

$$\begin{aligned} \Pi_{r'} &= \Pi_{\nu'} \cos \zeta \sin \theta \\ \Pi_{\theta'} &= \Pi_{\nu'} \cos \zeta \cos \theta \\ \Pi_{\zeta'} &= \Pi_{\nu'} \sin \zeta \end{aligned} \quad (38)$$

where $\Pi_{r'}$, $\Pi_{\theta'}$, and $\Pi_{\zeta'}$ are the components of $\Pi_{\nu'}$ in the r , θ , and ζ directions, respectively. In the x, z plane ζ is equal to $\pi/2$, consequently, $\Pi_{r'}$ and $\Pi_{\theta'}$ vanish, and $\Pi_{\zeta'}$ is equal to $\Pi_{\nu'}$.

Applying (31) to (37) and neglecting terms involving powers of $1/r$ greater than the first, we find that the radial components of field vanish and a transverse electromagnetic wave propagated in the radial direction results with components

$$\begin{aligned} H_{\theta'} &= \left(\frac{\omega}{c} \right)^2 \sqrt{\frac{\epsilon}{\mu}} \Pi_{\nu'} \\ E_{\zeta'} &= - \left(\frac{\omega}{c} \right)^2 \Pi_{\nu'}. \end{aligned} \quad (39)$$

A plot in polar co-ordinates of the absolute magnitude of $E_{\zeta}(\theta)$ supplies the radiation characteristic or pattern of the horn. The numerical evaluation of these patterns, which involves the integral of (37), is quite lengthy, but evaluations have been made for a series of different conditions. These calculations are all for lengths ρ_1/λ equal to or greater than 8. In such horns, the $H_{0,1}$ wave has traveled a distance of five or six wavelengths beyond the attenuation region. Calculations are made for $u < 50$, corresponding to values of θ from -60 to $+60$ degrees. Because of the insufficiency of available numerical tables, the pattern beyond that angle is not readily calculated, but the amplitudes of the secondary lobes have been estimated at less than ten per cent of that of the principal lobe.

Since the $H_{0,1}$ wave is of greatest practical importance the following radiation patterns for this wave have been calculated: (1) the variation of radiation

pattern with the flare angle of the horn; (2) the variation of radiation pattern with the length of the horn; and (3) the effect of the simultaneous presence of an $H_{0,3}$ wave.

Discussion of Patterns

Fig. 11 illustrates the radiation patterns from horns having equal ratios of $\rho_1/\lambda=8$ but different flare angles ϕ_0 . The dotted, solid, and dashed lines are for horns having $\phi_0=30, 40,$ and 50 degrees, respectively. These curves show that on increasing the

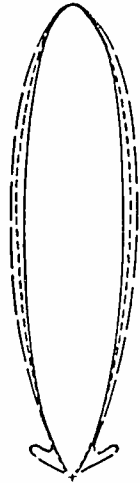

Fig. 11—Calculated radiation pattern of electric intensity in the x,z plane for a sectoral horn of length $\rho_1/\lambda=8$ for the following flare angles: 30 degrees (dotted curve); 40 degrees (solid curve); and 50 degrees (dashed curve).

flare angle from a small value, the beam is first sharpened and then broadened again. The flare angle giving a minimum beam angle is about 40 degrees, which is very close to the value for the experimental horn, as reported in the companion paper.¹

The broadening of the radiation patterns that accompanies either an increase or a decrease of the flare angle from the optimum value was discussed to some extent in the companion paper. In connection with the radiation from rectangular hollow pipes,⁷ it was shown that the sharpness of the beam depends only on the dimension b of the pipe. When the flare angle of the horn is small the sides are almost parallel to each other and the radial direction ρ along which the wave is propagated is not greatly different from the longitudinal direction x . Consequently, waves from horns of small flare angles behave very much like those from rectangular pipes. When the arc length $\phi_0\rho_1$ at the mouth of the horn, which is equivalent to the dimension b of the rectangular pipe, is decreased by decreasing the flare angle the beam is broadened. On the other hand, if the flare angle is made too large, it is evident that the wave will be propagated over a wide angle even inside the horn. It may be recalled that a sectoral horn of $\phi_0=180$ degrees is nothing other than a plane

surface, or baffle, which is obviously not very effective for directional radiation.

With the value of flare angle of 40 degrees, calculation shows that there is no detectable variation in the shapes of the patterns for variations of the radial length ρ_1/λ within the range from 8 to 12. This range of ρ_1/λ is practically important. Horns of this length are neither too short to hinder the formation of horn waves, nor too long to make the mechanical construction impracticable.

Let us see what happens if the radial length of the horn is made very large. In this case the arc at the mouth of the horn is a great number of wavelengths long, and we may perform the integration of Π'_y in an approximate way using Fresnel zones.⁹ The radiation field in the x,z plane of such a horn can thus be shown to have the form

$$|E| = \text{const.} \left| \frac{1}{r} \cos \left(\frac{\pi\theta}{\phi_0} \right) e^{i\omega r/c} \right|. \quad (40)$$

That is, the radiation pattern is the same as the field distribution along an arc inside the long horn and the beam angle is equal numerically to the flare angle.

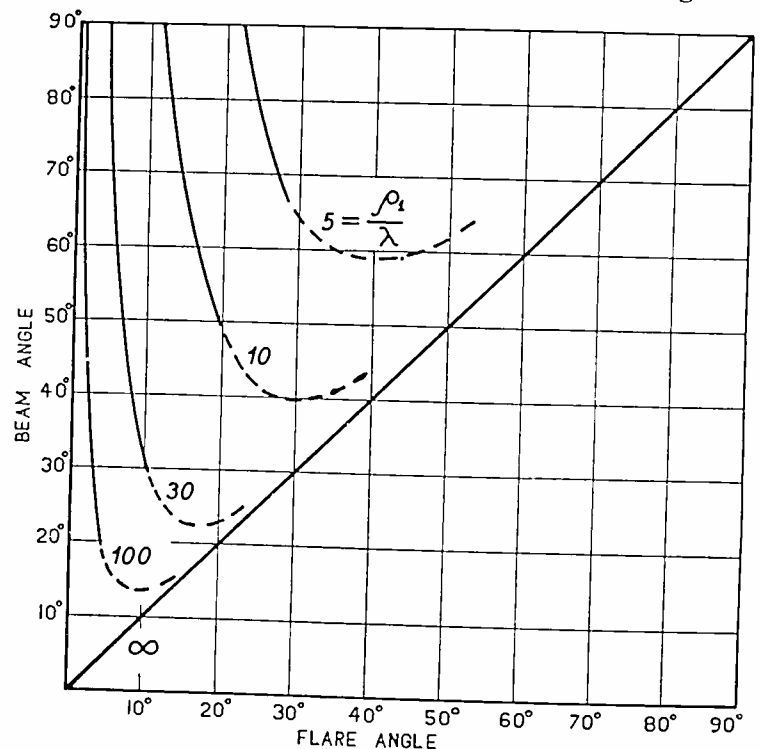

Fig. 12—Theoretical curves of beam angle versus flare angle for horns of several radial lengths ρ_1/λ . The dotted portions of the curves are estimated; the solid portions are calculated.

Naturally, the limiting expression (40) does not include the case of zero flare angle; because this case reverts to the hollow-pipe radiator. The beam angle, therefore, does not become zero for $\phi_0=0$ but assumes a value that depends on the width b of the pipe.

We see that there are two important factors which

⁹ See page 308 of footnote reference (8).

play vital but opposite rôles in determining the radiation pattern of a sectoral horn. These factors are the arc length at the mouth of the horn and the divergence of the waves inside the horn. Consider a short horn several wavelengths long. If the flare angle is small, the beam angle of the radiation pattern is essentially controlled by the arc length or aperture at the mouth of the horn and larger apertures produce sharper beams. If the flare angle is large, on the other hand, the beam angle is essentially controlled by the direction of propagation in the horn, i.e., by the angle of flare. The smaller the flare angle, the less divergent will be the directions of propagation in the horn, and the sharper is the radiated beam. If the flare angle is neither too large nor too small, the opposite effects of the two factors compensate each other and the beam angle has its sharpest value.

The more or less complicated way in which the beam angle is affected by the several factors may be

and are only intended to indicate general behavior. A study of these curves brings out the following general facts:

1. For a constant flare angle, the beam angle decreases with an increase of the length.
2. For a constant flare angle, there is a corresponding length beyond which the beam angle does not decrease appreciably with further increase in length.
3. For a constant length, there is always an optimum flare angle for which the beam angle is a minimum.

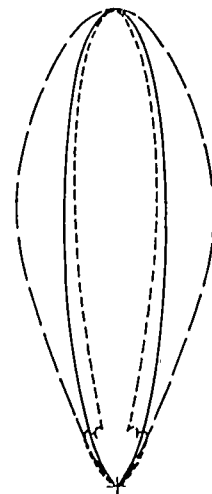

Fig. 14—Radiation patterns of electric intensity from sectoral horn in x,z plane with $\rho_1/\lambda=8$ and $\phi_0=40$ degrees when both $H_{0,1}$ and $H_{0,3}$ waves are present simultaneously. Dashed curve for a distribution across the mouth of $E_y=\text{const.} [\cos(\pi\phi/2\phi_0) - \frac{1}{3}\cos(3\pi\phi/2\phi_0)]$. Dotted curve for a distribution $E_y=\text{const.} [\cos(\pi\phi/2\phi_0) + \frac{1}{3}\cos(3\pi\phi/2\phi_0)]$. Solid curve for a distribution $E_y=\text{const.} [\cos(\pi\phi/2\phi_0)]$.

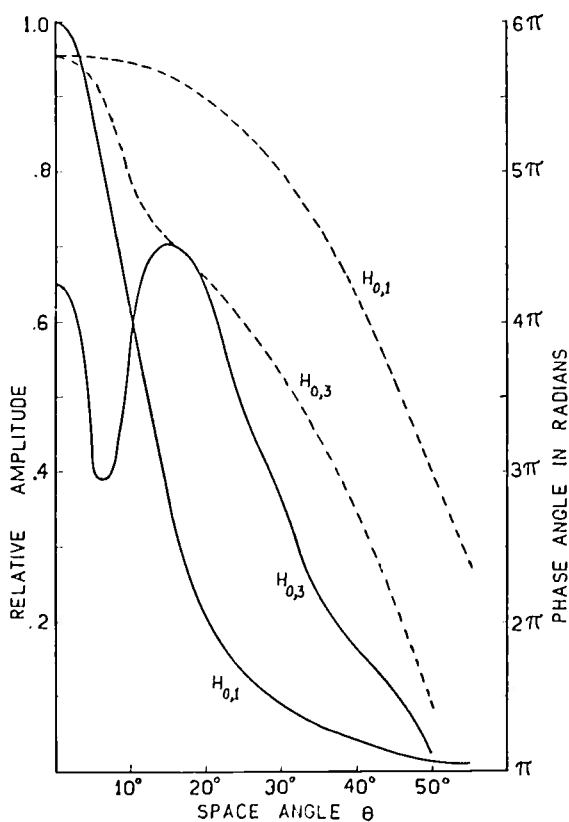

Fig. 13—Relative amplitudes and phases of the two separate components of radiated electric intensity from $H_{0,1}$ and $H_{0,3}$ waves, respectively, of equal amplitudes and phases at the mouth of a sectoral horn of length $\rho_1/\lambda=8$ and flare angle of 40 degrees. Solid curves show relative amplitudes and dotted curves show relative phases.

shown clearly by a set of curves of beam angle versus flare angle for horns of different radial lengths. Such a family of curves is reproduced in Fig. 12. In this figure, the asymptotic curve for infinite length and the steeply descending solid curves for finite lengths are accurate. The dotted portions are approximate

4. The optimum flare angle decreases with increasing length, as does also the corresponding minimum beam angle.
5. For a constant aperture, the beam angle decreases with decreasing flare angle and is a minimum for zero flare angle, (viz., for a hollow-pipe radiator).

In some cases, the $H_{0,1}$ wave will not exist alone inside the horn. For example, in a horn with $\phi_0=40$ degrees but a relatively wide throat, it is possible to have an appreciable amount of the $H_{0,3}$ wave at the mouth. Higher-order $H_{0,m}$ waves also may be present in certain cases.

To determine the effect of the presence of an $H_{0,3}$ wave, we just plot separately in Fig. 13 the relative amplitude and the phase angles of the radiated electric field intensity for the $H_{0,1}$ and the $H_{0,3}$ waves. The horn is 8 wavelengths long from apex to mouth and has $\phi_0=40$ degrees. The amplitudes and phases of the electric field intensities for the two waves are taken as equal; that is, $B_1K_v(2\pi\rho_1/\lambda) = B_3K_{3v}(2\pi\rho_1/\lambda)$. The figure shows that the amplitude of the central

lobe of the $H_{0,3}$ wave is only 64 per cent of that of the $H_{0,1}$ wave. There is a secondary lobe of larger amplitude than the central one. Furthermore, the phase difference between the radiated fields of the $H_{0,1}$ wave and the $H_{0,3}$ wave is almost zero within the central lobe of the $H_{0,3}$ pattern, and is approximately π radians apart within the second lobe of this wave.

Since the fields are linearly superposable, we are able to construct a composite pattern from Fig. 13 when the $H_{0,1}$ and the $H_{0,3}$ waves exist at the same time. The resultant radiation field in space is the complex sum of the fields radiated by the two waves independently. Let

$$w = \frac{B_3 K_{3v}(2\pi\rho_1/\lambda)}{B_1 K_v(2\pi\rho_1/\lambda)}$$

This quantity is complex and indicates the ratio of the amplitudes and the phase difference between the electric fields of the two mentioned waves. The three radiation patterns of Fig. 14 are for ratios of $w = -1/3$ (dashed curve) and $w = +1/3$ (dotted curve), respectively; while the solid curve is the radiation pattern of the $H_{0,1}$ wave alone, drawn for sake of comparison. Thus, when the two waves are simultaneously present at the mouth of the horn, the

radiation pattern may be broader or narrower than that for the $H_{0,1}$ wave alone, depending on the relative phase of the two component waves at the mouth of the horn. The larger the amplitude of the $H_{0,3}$ wave, the more prominent is this effect. In either case, however, the secondary-lobe size is increased. In terms of the resultant electric field distribution at the mouth of the horn, a peaked distribution produces a sharp beam with secondary lobes of appreciable amplitude, and a flattened distribution produces a broad beam. For a sharp, clean-cut beam without appreciable side lobes, an undistorted sinusoidal distribution at the mouth of the horn appears to be essential.

CONCLUSION

The analysis presented here provides an adequate explanation of the way in which the electromagnetic horn functions as a radio "antenna," and gives quantitative expressions and results from which the design of horns of sectoral shape can be carried out. The very satisfactory accord between the theory developed here and the experiments reported in the companion paper is convincing evidence that we are able to design horns for various applications in a thoroughly engineering manner.

Transmission Lines with Exponential Taper*

HAROLD A. WHEELER†, FELLOW, I.R.E.

Summary—Exponential lines, like exponential horns, are useful as impedance-matching devices. They are best inserted in a high-pass filter having the same cutoff frequency determined by the rate of taper. Unusual rules are derived for inserting the line in the filter with exact matching of iterative and image impedances. Design formulas are derived for the construction of exponential lines.

I. INTRODUCTION

A TRANSMISSION line whose impedance varies exponentially along its length, has electrical impedance-matching capabilities similar to those of an exponential horn in acoustical impedance matching. Likewise, it behaves as a high-pass filter whose cutoff frequency depends only on the rate of exponential taper. Such a tapered line has apparent utility in matching an antenna (such as a horizontal doublet) with a uniform (nontapered) line of much lower impedance.

This paper includes a collection of formulas which have been derived to express the electrical properties of the exponential line, and their relation to the mechanical dimensions. Increasing the rate of taper increases the cutoff frequency, reducing the useful range of frequencies.

The iterative impedance above the cutoff frequency has a constant magnitude, but its resistive component is equal to the corresponding image impedance (resistance) of a constant- k high-pass filter. Therefore the exponential line can be inserted in such a filter as a device for matching different impedances. Rules and circuits are given for this use of the exponential line.

Particular attention is given to the design of an exponential line comprising a pair of wires whose separation varies along their length. The method of design is described with reference to an example in which a straight-wire doublet is matched with a uniform transmission line.

II. THE EXPONENTIAL LINE

The exponentially tapered transmission line, like the exponential horn, behaves at once like a transformer and a high-pass filter. In practice, a transformer acts as a band-pass filter, and an exponential horn departs from the ideal in its behavior toward frequencies much higher than the cutoff frequency. An exponential line is susceptible of much greater refinement than either a transformer or a horn, because a line can be made which has small attenuation

over a wide range of frequencies, and which has nearly ideal properties in other respects.

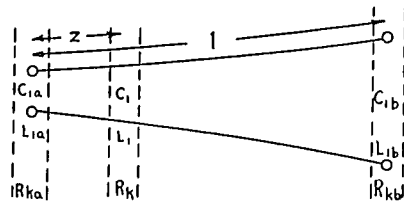

Fig. 1—Electrical dimensions of the exponential line.

The properties of the ideal exponential line will be derived with reference to Fig. 1. It is assumed that there is no dissipation and that the line is tapered in accordance with the formulas

$$\frac{L_1}{L_{1a}} = \frac{C_{1a}}{C_1} = \exp \frac{4\pi z}{\lambda_c} \quad (1)$$

in which L_1 and C_1 are the inductance and capacitance per unit of length, z is the distance along the wires from the narrow end (the end denoted by subscript a), and λ_c is the "cutoff wavelength" to be identified below. It is also assumed that the separation is much less than the wavelength in space, at all frequencies of interest.

The line equations are

$$\frac{dE}{dz} = -Ij\omega L_1; \quad \frac{dI}{dz} = -Ej\omega C_1 \quad (2)$$

in which E and I are vectors of alternating voltage and current along the line. There is assumed, subject to justification below, a progressive wave, free of terminal reflections starting at the narrow end (subscript a)

$$E = E_a \exp 2\pi z \left(\frac{1}{\lambda_c} - \frac{j}{\lambda} \right); \quad (3)$$

$$I = I_a \exp 2\pi z \left(-\frac{1}{\lambda_c} - \frac{j}{\lambda} \right)$$

in which z is the distance along the wires and λ is the wavelength along the wires at the operating frequency. From (3)

$$\frac{dE}{dz} = 2\pi \left(\frac{1}{\lambda_c} - \frac{j}{\lambda} \right) E; \quad \frac{dI}{dz} = 2\pi \left(-\frac{1}{\lambda_c} - \frac{j}{\lambda} \right) I \quad (4)$$

Substituting in (2), and expressing C_1 and L_1 in terms of C_{1a} and L_{1a} from (1), the exponential terms cancel out, thereby justifying the assumed progressive wave of (3). There remain the relations

* Decimal classification: R142. Original manuscript received by the Institute, April 28, 1938.

† Hazeltine Service Corporation, New York, N. Y.

$$\begin{aligned} 2\pi\left(\frac{1}{\lambda_c} - \frac{j}{\lambda}\right)E_a &= -I_a j\omega L_{1a}; \\ 2\pi\left(-\frac{1}{\lambda_c} - \frac{j}{\lambda}\right)I_a &= -E_a j\omega C_{1a}. \end{aligned} \quad (5)$$

Eliminating E_a and I_a ,

$$4\pi^2\left(\frac{1}{\lambda_c^2} + \frac{1}{\lambda^2}\right) = \omega^2 C_{1a} L_{1a}. \quad (6)$$

Let

$$\frac{2\pi}{\lambda_c} = \frac{\omega_c}{v_0}; \quad \frac{2\pi}{\lambda} = \frac{\omega}{v} \quad (7)$$

in which ω_c is the cutoff frequency of the line and v is the steady-state wave velocity along the wires, having a limiting value of v_0 at high frequencies. Therefore, from (6) and (7), the limiting velocity (at infinite frequency) is

$$v_0 = \frac{1}{\sqrt{C_{1a} L_{1a}}} \quad (8)$$

and the actual velocity is

$$v = \frac{v_0}{\sqrt{1 - \frac{\omega_c^2}{\omega^2}}} \quad (9)$$

If the wires have negligible dissipation and are located in air, v_0 is nearly the velocity of light. The steady-state wave velocity along the wires is greater, becoming infinite at the cutoff frequency ω_c . The "cutoff wavelength" λ_c is, in this case, approximately the wavelength in air at the cutoff frequency. This is a convenient parameter for design, whereas the actual wavelength in the line is infinite at the cutoff frequency. At lower frequencies, the velocity is imaginary, which denotes attenuation as distinguished from wave transmission.

In the case mentioned, the steady-state velocity is variable and is greater than the limiting velocity which is nearly the velocity of light. This is found also in optical filters; it is a form of distortion which is absent in the ideal uniform line but is found in some filters. The "group velocity" or "impulse velocity" does not really exceed that of light, although the "phase velocity" or "steady-state velocity" are greater, as affected by the taper.

The iterative impedance of the line at the narrow end is the driving-point impedance of the progressive wave assumed in (3); it is obtained by solving (5) and substituting from (7):

$$Z_a = \frac{E_a}{I_a} = \left(\frac{v_0}{v} - j\frac{\omega_c}{\omega}\right) \sqrt{\frac{L_{1a}}{C_{1a}}} \quad (10)$$

In further expressions, it is convenient to use the image resistance R_k of any small section of the line, so short that its taper can be neglected:

$$R_k = \sqrt{\frac{L_1}{C_1}} = R_{ka} \exp \frac{4\pi z}{\lambda_c} \quad (11)$$

The line is comparable with a transformer whose turns ratio is

$$q = \sqrt{\frac{R_{kb}}{R_{ka}}} = \exp \frac{2\pi l}{\lambda_c} \quad (12)$$

in which l is the length of the line. It appears that a nominal ratio can be secured with a length only a small fraction of λ_c .

In the transmission band, above the cutoff frequency ω_c , the exponential line has a complex iterative impedance of constant magnitude. The real (resistive) component of the latter is equal to the image impedance (resistance) of a constant- k high-pass filter having the same cutoff frequency. The imaginary (reactive) component of the complex iterative impedance is such that the exponential line can still be matched exactly with a constant- k high-pass filter. The imaginary component always can be represented by an actual inductance or capacitance. The real component varies with frequency, and therefore cannot be represented by an actual resistance.

The iterative impedance of the exponential line, looking respectively into the low-impedance (narrow) and high-impedance (wide) ends, is given by the following expressions, in which the subscripts a and b denote the respective ends:

$$R_k = \sqrt{\frac{L_{1a}}{C_{1a}}}; \quad R_{kb} = \sqrt{\frac{L_{1b}}{C_{1b}}} = R_{ka} \exp \frac{4\pi l}{\lambda_c} \quad (13)$$

$$\begin{aligned} \frac{Z_a}{R_{ka}} &= \sqrt{1 - \frac{\omega_c^2}{\omega^2}} - j\frac{\omega_c}{\omega} = \frac{1}{\sqrt{1 - \frac{\omega_c^2}{\omega^2} + j\frac{\omega_c}{\omega}}} \\ \frac{Z_b}{R_{kb}} &= \sqrt{1 - \frac{\omega_c^2}{\omega^2}} + j\frac{\omega_c}{\omega} = \frac{1}{\sqrt{1 - \frac{\omega_c^2}{\omega^2} - j\frac{\omega_c}{\omega}}} \end{aligned} \quad (14)$$

The latter is obtained in the same manner as the former, the opposite sign of ω_c resulting from the sign of z or l , denoting the opposite taper effective toward the backward wave. The square root in each of these expressions is equal to the relative mid-series image impedance or mid-shunt image admittance of the corresponding constant- k high-pass filter, having the same cutoff frequency. In the transmission band above the cutoff frequency, the square root is real

and positive. In the attenuation band below the cut-off frequency, the square root is imaginary and negative. The remaining term in the above expressions is imaginary and its sign depends on which end of the line is represented.

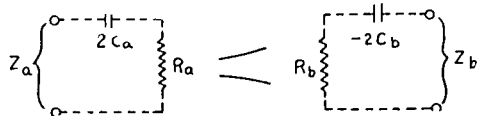

Fig. 2—The resolution of the iterative impedance into series components.

Fig. 2 shows the resolution of Z_a and Z_b into series components, as follows:

$$Z_a = R_a + jX_a = R_a + \frac{1}{j\omega(2C_a)} \quad (15)$$

$$R_a = R_{ka} \sqrt{1 - \frac{\omega_c^2}{\omega^2}}; \quad (16)$$

$$X_a = \frac{-1}{\omega(2C_a)}; \quad 2C_a = \frac{1}{\omega_c R_{ka}}$$

$$Z_b = R_b + jX_b = R_b + \frac{1}{j\omega(-2C_b)} \quad (17)$$

$$R_b = R_{kb} \sqrt{1 - \frac{\omega_c^2}{\omega^2}}; \quad (18)$$

$$X_b = \frac{1}{\omega(2C_b)}; \quad 2C_b = \frac{1}{\omega_c R_{kb}}$$

These relations are valid only in the transmission band, where R_a and R_b are equal to the mid-series image resistance of the corresponding filters.

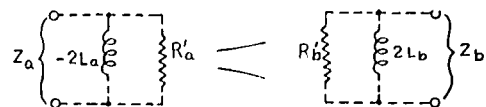

Fig. 3—The resolution of the iterative impedance into parallel components.

Fig. 3 shows the resolution of Z_a and Z_b into parallel components, as follows:

$$\frac{1}{Z_a} = \frac{1}{R'_a} + \frac{1}{jX'_a} = \frac{1}{R'_a} + \frac{1}{j\omega(-2L_a)} \quad (19)$$

$$R'_a = \frac{R_{ka}}{\sqrt{1 - \frac{\omega_c^2}{\omega^2}}}; \quad X'_a = \omega(-2L_a); \quad 2L_a = \frac{R_{ka}}{\omega_c} \quad (20)$$

$$\frac{1}{Z_b} = \frac{1}{R'_b} + \frac{1}{jX'_b} = \frac{1}{R'_b} + \frac{1}{j\omega(2L_b)} \quad (21)$$

$$R'_b = \frac{R_{kb}}{\sqrt{1 - \frac{\omega_c^2}{\omega^2}}}; \quad X'_b = \omega(2L_b); \quad 2L_b = \frac{R_{kb}}{\omega_c} \quad (22)$$

These relations are valid only in the transmission band, where R'_a and R'_b are equal to the mid-shunt image resistance of the corresponding filter.

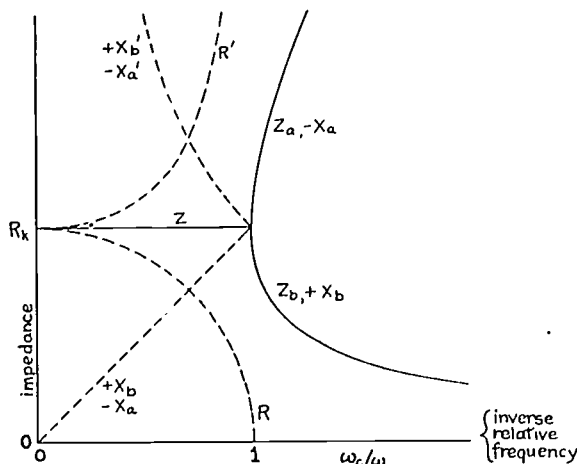

Fig. 4—The iterative impedance and its components.

Fig. 4 shows graphically the iterative impedance and its components in either end of the exponential line. The abscissas are inversely proportional to frequency, to show concisely the limiting conditions at high frequency.

In Figs. 2 and 3, the quantities C_a , L_a , and C_b , L_b are the full-series and full-shunt elements of the corresponding filter. These quantities doubled are the respective mid-series and mid-shunt elements. This relation forms the basis for matching the corresponding line and filter terminations.

III. IMPEDANCE MATCHING

Matching the exponential line with adjacent circuits is a problem involving the nature of the line impedance. The line impedance approximately matches a constant resistance (R_{ka} or R_{kb}) at frequencies much higher than the cutoff frequency. Closer matching is secured by "power-factor correction" which converts the line impedance to a pure resistance which varies with frequency. Either end of the line can be matched exactly with a high-pass constant- k filter. An m -derived termination of such a filter can be used to match closely a constant resistance.

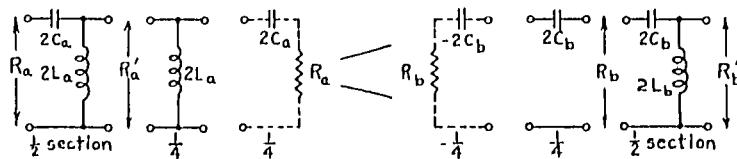

Fig. 5—Power-factor correction of the line impedance, and matching the line with a high-pass filter.

Fig. 5 shows the principle of power-factor correction of the line impedance. The narrow end of the line is represented as in Fig. 2, by R_a in series with $2C_a$. The reactance of $2C_a$ is canceled by connecting $2L_a$

in parallel, and the resistance is transformed to R_a' . (This is the effect of the half-section high-pass filter formed by $2C_a$ and $2L_a$.) The wide end is also represented as in Fig. 2, by R_b in series with $-2C_b$. The reactance is canceled by connecting $2C_b$ in series, leaving purely R_b . (It is noted that the elements

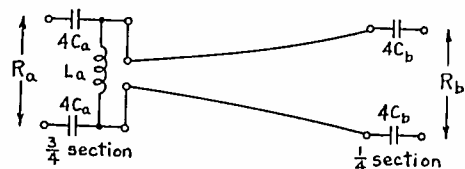

Fig. 6—The insertion of the line in a whole-section high-pass filter.

added for power-factor correction, $2L_a$ and $2C_b$, comprise together a half-section filter, divided by the line.)

Fig. 5 shows also the matching of the line with half-sections of a constant- k high-pass filter. At the narrow end, R_a' is the mid-shunt image impedance of the half-section shown on the left, whose mid-series image impedance is R_a . At the wide end, R_b is the mid-series image impedance of the half-section shown on the right, whose mid-shunt image impedance is R_b' . Any number of half sections may be added, according to the ordinary rules of filter design.

The two essential requirements are met by the matching of line and filters according to Fig. 5. First, each terminal circuit presents to the line a modified image impedance equal to the iterative impedance of a continuation of the line with the same exponential taper. For example, at the wide end, $2C_b$ and R_b in series represent the iterative impedance of the narrow end of a continuation of the line, as if the line were continued without interruption, but actually it is obtained by the filter elements. Second, each end of the line with its power-factor correction presents to the respective filter a modified iterative impedance equal to the image impedance of the adjoining filter termination.

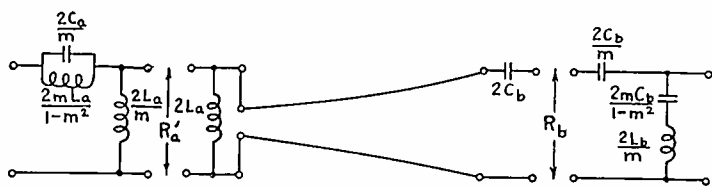

Fig. 7—Matching either end of the line with a constant resistance by means of an m -derived half section.

Fig. 6 shows an application of Fig. 5 to secure the same form of image impedance (mid-series) at both ends by the insertion of the line in a whole-section high-pass filter. The section is divided with three quarters at one end and one quarter at the other end of the line.

Since the "constant- k " image resistances R_a , R_a' , R_b , and R_b' vary with frequency, they are not very nearly matched with a constant-resistance circuit. The matching is greatly improved by the use of an m -type half section. The complete circuit at either end then becomes that of Fig. 7. The circuits of Fig. 8 are equivalent to those of Fig. 7, but are in a balanced arrangement. Figs. 7 and 8 provide nearly exact matching, at frequencies above the cutoff frequency, between the ends of the exponential line and the constant resistances R_{ka} and R_{kb} . The choice of m determines the residual variation of the image resistance at the termination in Figs. 7 and 8. A value $m=0.6$ is suggested, which causes this image resistance to be within about 5 per cent of the terminating resistance at all frequencies more than 15 per cent above the cutoff frequency. This value places the "frequency of infinite attenuation" 20 per cent below the cutoff frequency.

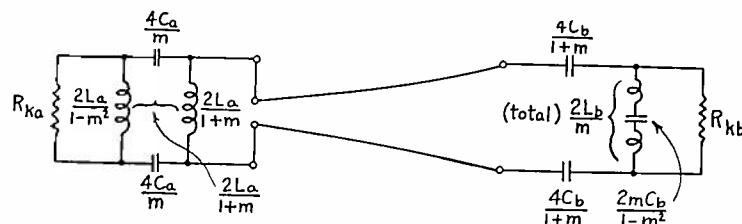

Fig. 8—Balanced networks for matching either end of the line with a constant resistance.

The circuits of Figs. 7 and 8 are about the simplest that can be used to match closely either end of an exponential line with a constant-resistance circuit (such as a uniform line). If such close matching is not required, either of two simpler connections may be used. The simplest is the direct connection of R_{ka} or R_{kb} to the corresponding end of the line. This expedient is not nearly ideal at frequencies less than 40 per cent above the cutoff frequency, because the power factor of the line impedance is there less than 70 per cent. The power-factor correction of Fig. 5 is nearly as simple, and greatly improves the matching. If the latter is used, the terminating resistance should have a value which is the geometric mean of the minimum and maximum values of the image resistance of the line, over the required frequency range. For example, if all frequencies more than 40 per cent above the cutoff frequency are to be used, the terminating resistance at the low-impedance end of the line should be about $0.84 R_{ka}$ to match R_a or about $1.19 R_{ka}$ to match R_a' .

If a definite cutoff frequency is not required, the rate of taper may be varied along the line. There is some advantage in approximate matching, if the rate of taper is least at the ends and greatest in the middle part of the line.

The usual problem in the design of an exponential line is to secure a given impedance ratio over a given frequency range, with a minimum length of line, in order to minimize the space requirement and the line attenuation. The matching at the terminals can be improved, in general, by using special terminal circuits, or by increasing the length of line and lowering its cutoff frequency without changing the impedance ratio, or both.

IV. WIRE SEPARATION

A two-wire transmission line has an exponential taper only when the separation of the wires varies correctly with distance along the wires. If the desired variation of R_k is given, in accordance with (1) and (11), the actual values of R_k determine the ratio of separation to wire diameter at all distances. An explicit formula for the separation in terms of the distance, is derived on the assumption of bare wires of zero resistance.

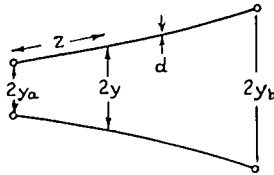

Fig. 9—Space dimensions of an exponential line made of a pair of wires.

Referring to Fig. 9 and equation (11),

$$\frac{R_k}{R_{ka}} = \frac{\log \frac{4y}{d}}{\log \frac{4y_a}{d}} = \exp \frac{4\pi z}{\lambda_c} \tag{23}$$

in which d is the wire diameter, y is half the separation, and z is the distance measured along the wire. This equation yields the solution,

$$\frac{4y}{d} = \left(\frac{4y_a}{d} \right)^{\exp 4\pi z / \lambda_c} \tag{24}$$

There is a maximum separation, beyond which this formula cannot be satisfied, because the half separation would have to increase more rapidly than the distance along each wire. The maximum separation is defined by the relation

$$\frac{dy}{dz} = 1. \tag{25}$$

From (24)

$$\frac{dy}{dz} = \frac{\pi d}{\lambda_c} \log \frac{4y_a}{d} \cdot \exp \frac{4\pi z}{\lambda_c} \left(\frac{4y_a}{d} \right)^{\exp 4\pi z / \lambda_c} \tag{26}$$

Since z is measured from an arbitrary datum point, it may be assumed without loss of generality that

$z=0$ at the point of maximum separation. This greatly simplifies (26) and its simultaneous solution with (25). This solution involves the wire diameter d , the cutoff wavelength λ_c , and the maximum half separation y_m . It is expressible in any of several forms, but an explicit solution for y_m is impossible.

$$\lambda_c = 4\pi y_m \log \frac{4y_m}{d} \tag{27}$$

$$\frac{\lambda_c}{\pi d} = \frac{4y_m}{d} \log \frac{4y_m}{d} \tag{28}$$

$$\frac{\lambda_c}{y_m} = 4\pi \log \frac{4y_m}{d} \tag{29}$$

$$\frac{4y_m}{d} = \exp \frac{\lambda_c}{4\pi y_m} \tag{30}$$

$$d = \frac{4y_m}{\exp \frac{\lambda_c}{4\pi y_m}} \tag{31}$$

The separation of the wires along the length of the exponential line is best expressed in terms of the ratio y/y_m , which is always less than unity. In order to make this expression as simple as possible, z is measured from the point of maximum separation. At all points of less separation, and therefore at all other possible points, z is negative. The following formula gives an explicit solution for y :

$$\frac{y}{y_m} = \left(\frac{d}{4y_m} \right)^{1 - \exp(-p)} \tag{32}$$

in which

$$p = \frac{-z}{\frac{y_m}{\log \frac{4y_m}{d}}} \tag{33}$$

Conversely, the relative distance for a given half separation y is

$$\frac{-z}{y_m} = \log \frac{4y_m}{d} \cdot \log \frac{4y_m}{\log \frac{4y}{d}} \tag{34}$$

The shape of an exponential line near the point of maximum separation ($z=0$), as computed by (32), is nearly independent of the wire diameter d in practical cases where the latter is very small as compared with the maximum half separation y_m . A convenient criterion for the shape is the ratio y_m/d . Fig. 10 shows the shape of the line for this ratio equal to 1000, which is a practical value. (The circles merely indi-

cate the plotted points, where $p = 0, 0.1, 0.2, 0.3, 0.4, 0.5$ from left to right.)

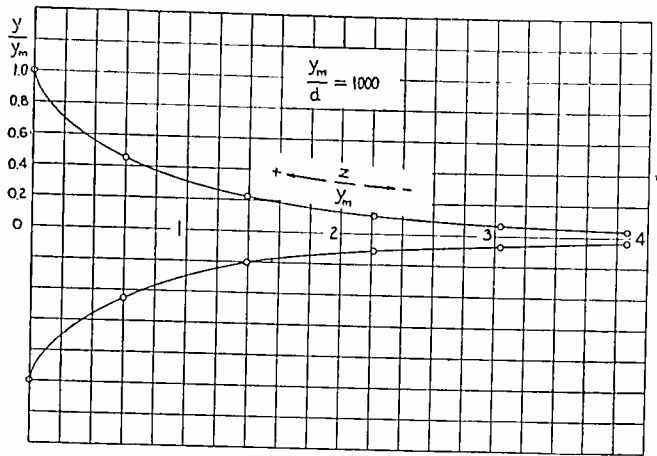

Fig. 10—The shape of an exponential line in which the maximum half separation is 1000 times the wire diameter.

Fig. 11 shows the variation of separation with distance along the wires from the point of maximum separation. The ratio y_m/d is used as a parameter. Interpolation is possible for values of this ratio between 100 and 10,000. These curves are most useful in the design of exponential lines.

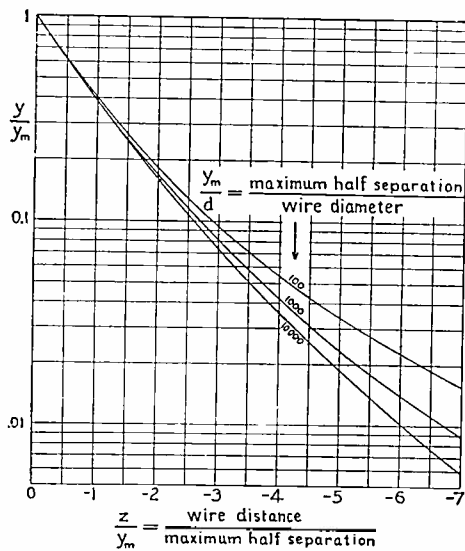

Fig. 11—The relative separation along the wires for several values of the ratio of maximum half separation to the wire diameter.

Fig. 12 shows the relation between cutoff wavelength and maximum half separation, computed by (28). Fig. 13 shows the slight variation of the ratio λ_c/y_m with the criterion y_m/d , computed by (29).

V. METHOD OF DESIGN

The following procedure is useful in designing an exponential line according to the above principles and relations. The example chosen is the problem of matching a uniform transmission line with a straight-wire doublet. The cutoff wavelength $\lambda_c = 100$ meters,

the wire diameter $d = 0.2$ centimeters, and the uniform-line separation $D = 10$ centimeters are assumed.

The ratio $\lambda_c/100d$ is 500. The curve of Fig. 12 gives the corresponding ratio $y_m/d = 520$. From these two ratios, it appears that $\lambda_c/y_m = 96$, which value is verified by Fig. 13. In view of the value of λ_c , the maximum half separation y_m is 104 centimeters.

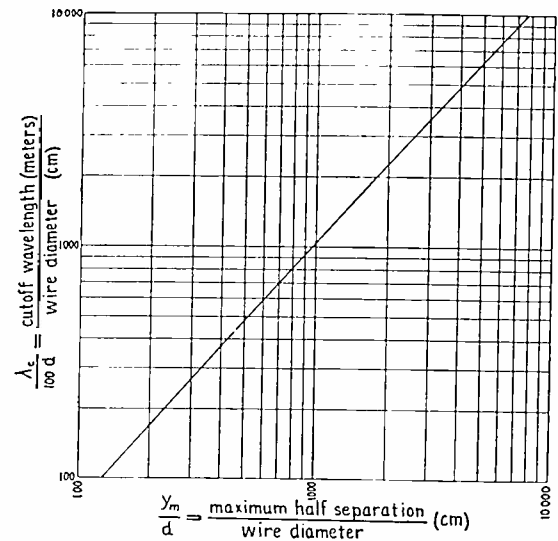

Fig. 12—The relation between the cutoff wavelength and the maximum half separation, involving the wire diameter.

The minimum half separation is $D/2 = 5$ centimeters $= 0.048 y_m$. Reading opposite $y/y_m = 0.048$ in Fig. 11, it is found that the exponential taper will require a length of wire equal to $3.9 y_m$, which is 4.0 meters. Also the variation of separation along the wires is determined by interpolation from the curves of Fig. 11. The shape is substantially like that shown in Fig. 10.

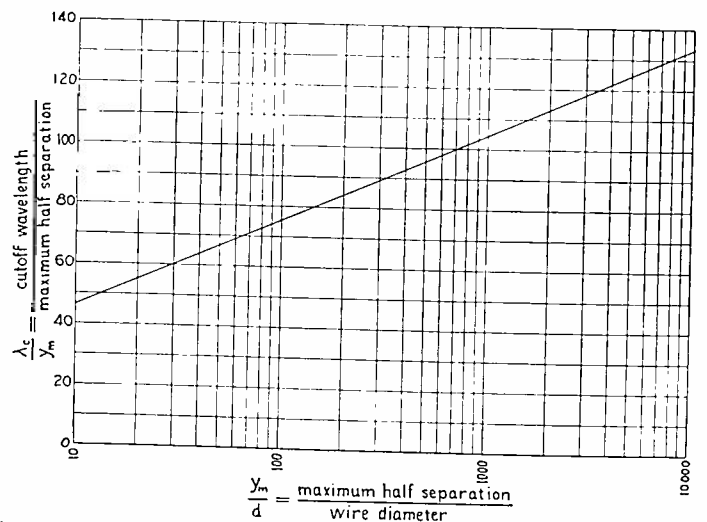

Fig. 13—The ratio of the cutoff wavelength to the maximum half separation, which is not critically dependent on the wire diameter.

Tension cords or separators are connected between the tapered wires, at intervals sufficiently close to maintain substantially the correct shape. The straight wire of the doublet is cut out in the center

for a space of about 2 meters, and the wide end of the tapered line is connected in this space.

If rough matching is sufficient, the narrow end of the tapered line may be connected directly to the uniform line. Otherwise a matching filter may be inserted, such as that on the left-hand side of Fig. 8.

No matching filter is required at the doublet end of the tapered line, in this example, because the rate of taper decreases gradually in the doublet itself. Likewise, improved matching at the junction of the two lines may be secured by gradually reducing the rate of taper and extending the length of the tapered wires.

The above design procedure easily may be modified to fit any given set of conditions.

Bibliography

- (1) Crandall, "Theory of Vibrating Systems and Sound," pp. 158-174. (1926). (Theory of the exponential horn, bibliography.)
- (2) E. Dietze, "Tapered filter for alternating currents of varying frequency," U. S. Patent 1,603,329; October, (1926.) (Filter with exponential taper for matching unequal impedances.)
- (3) S. Ballantine, "Non-uniform lumped electric lines," *Jour. Frank. Inst.*, vol. 203, pp. 561-582; April, (1927). (Theory of lumped and smooth lines with algebraic taper.)

(4) H. A. Wheeler and F. D. Murnaghan, "Theory of wave filters containing a finite number of sections," *Phil. Mag.*, vol. 6, pp. 146-174; July, (1928). (Lumped line with exponential taper, pp. 162-164.)

(5) "Coupling devices for use in high-frequency circuits," Australian Patent 18,994/29; March 19, 1929. (Lumped and smooth lines with exponential taper, applications to impedance matching.)

(6) "Coupling devices for use in high-frequency circuits," Australian Patent 18,994/29; March 19, 1929. (Exponentially tapered smooth lines, also low-pass and high-pass filters.)

(7) A. T. Starr, "The nonuniform transmission line," *Proc. I.R.E.*, vol. 20, pp. 1052-1063; June, (1932). (Theory of lines with algebraic taper.)

(8) J. W. Arnold and R. C. Taylor, "Linearly tapered loaded transmission lines," *Proc. I.R.E.*, vol. 20, pp. 1811-1817; November, (1932).

(9) N. E. Lindenblad, "Antenna for radio communication," U. S. Patent 1,927,522; September, 1933. (The exponential line, its use as an antenna, its application to matching unequal impedances.)

(10) W. van B. Roberts, "Radio frequency transmission line," U. S. Patent 2,018,320; October, 1935. (Theory of the exponential line, applications to matching unequal impedances.)

(11) R. B. Dome, "Antenna and coupler system," U. S. Patent 2,104,610; January 4, 1938. (Tapered junction between doublet antenna and transmission line.)

(12) C. R. Burrows, "The exponential transmission line," *Bell. Sys. Tech. Jour.*, vol. 17, pp. 555-573; October, (1938); also *Communications*, vol. 18, pp. 7-9, 26-28; October, (1938); and vol. 18, pp. 11-13, 17-18; November, (1938). (Theory of the exponential line, experimental results.)

Characteristics of the Ionosphere at Washington, D.C. November, 1938*

T. R. GILLILAND†, ASSOCIATE MEMBER, I.R.E., S. S. KIRBY†, ASSOCIATE MEMBER, I.R.E.,
and N. SMITH†, NONMEMBER, I.R.E.

DATA on the critical frequencies and virtual heights of the ionosphere layers during November are given in Fig. 1. Fig. 2 gives the monthly average values of the maximum frequencies which could be used for sky-wave radio communica-

value. The ionosphere storms and sudden ionosphere disturbances are listed in Tables I and II, respectively. One mild ionosphere storm was observed during November.

Strong sporadic E reflections were observed up to

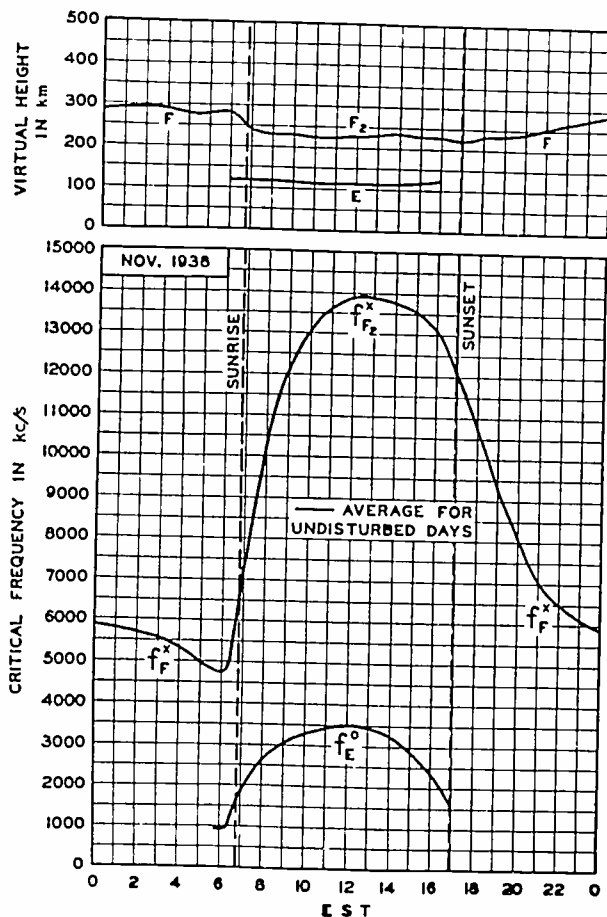

Fig. 1—Virtual heights and critical frequencies of the ionosphere layers, November, 1938.

tion by way of the regular layers. Fig. 3 gives the distribution of the hourly values of the F- and F₂-layer critical frequencies about the average for the month. This is done by obtaining for each hour of observation the ratio of f_F^x or $f_{F_2}^x$ to the undisturbed average shown in Fig. 1. Fig. 3 shows the percentage of time for which this ratio exceeds any specified

* Decimal classification: R113.61. Original manuscript received by the Institute, December 12, 1938. These reports have appeared monthly in the PROCEEDINGS starting in vol. 25, September, (1937). See also vol. 25, pp. 823-840, July, (1937). Publication approved by the Director of the National Bureau of Standards of the U. S. Department of Commerce.

† National Bureau of Standards, Washington, D. C.

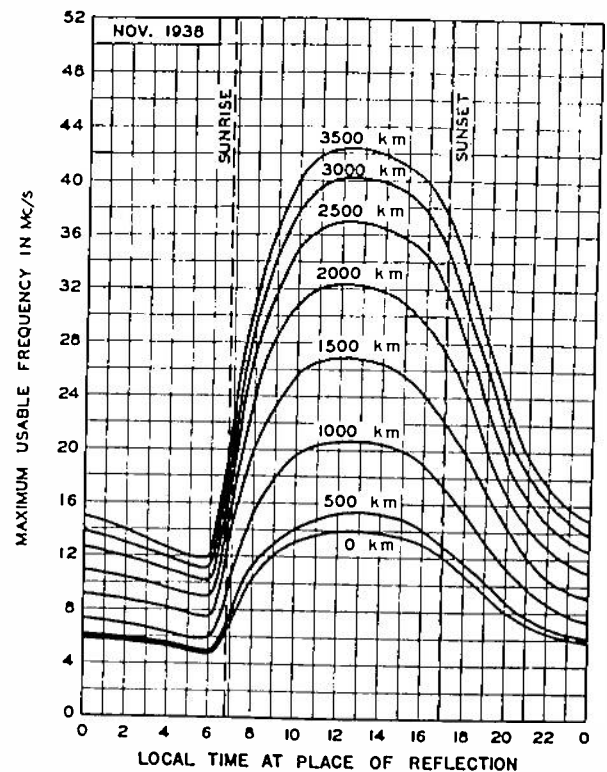

Fig. 2—Maximum usable frequencies for radio sky-wave transmission; averages for November, 1938, for undisturbed days, for dependable transmission by the regular F- and F₂-layers.

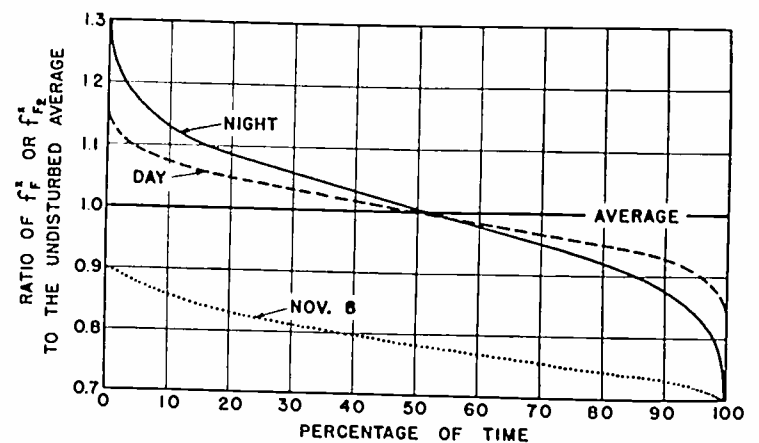

Fig. 3—Percentage of time for which the ratio of f_F^x or $f_{F_2}^x$ to the undisturbed average exceeded the value given by the ordinate. The graphs give data as follows: solid line, 471 hours of observations on undisturbed days between 1700 and 0800 E.S.T.; dashed line, 40 hours between 0900 and 1600 E.S.T. on Wednesdays all undisturbed; dotted line, 8 hours between 0900 and 1600 E.S.T. on the disturbed day of November 8.

TABLE I
IONOSPHERE STORM

Date and hour E.S.T.	h_f before sunrise (km)	Minimum f_{\min}^o before sunrise (kc)	Noon f_{\min}^o (kc)	Magnetic character ¹		Ionosphere character ²
				00-12 G.M.T.	12-24 G.M.T.	
November 8	322	5500	about 10500	0.5	0.9	1/2
9 (until 0600)	340	4800	—	1.0	0.9	1/2
For comparison: Average for undisturbed days	284	4750	13900	0.2	0.2	0

¹ American magnetic character figure, based on observations of seven observatories.

² An estimate of the severity of the ionosphere storm at Washington on an arbitrary scale of 0 to 2, the character 2 representing the most severe disturbance.

TABLE II
SUDDEN IONOSPHERE DISTURBANCES

Date	G.M.T.		Location of transmitter	Minimum relative intensity ¹
	Beginning of fade-out	Recovery complete		
November 26	1840	1923	Ohio, Mass., D.C.	0.0
27	1500	1540	Ohio, D.C.	0.1
28	1722	1800	Ohio, D.C.	0.1
28	1812	1923	Ohio, D.C.	0.0
29	1653	1700	Ohio, D.C.	0.1
29	1740	1840	Pa., Mass., D.C.	0.0

¹ Ratio of received field intensity during fade-out to average field intensity before and after; for station W8XAL, 6060 kilocycles, 650 kilometers distant.

8 megacycles during the morning hours of November 16 and 25.

Institute News and Radio Notes

Board of Directors

The Board of Directors met on December 7 in the Institute office and those present were Haraden Pratt, president; Melville Eastham, treasurer, H. H. Beverage, Ralph Bown, J. E. Brown, Alfred N. Goldsmith, Virgil M. Graham, O. B. Hanson, Alan Hazeltine, R. A. Heising (president-elect), L. C. F. Horle, C. M. Jansky, Jr., F. B. Llewellyn (director-elect), B. J. Thompson, H. M. Turner, and H. P. Westman, secretary.

Twenty-six applications for Associate membership, one for Junior, and four for Student grade were approved.

As a result of the report of the Investments Committee, it was agreed that \$10,000 be invested in United States Government savings bonds, and \$5,000 be used to purchase certain common stocks.

Approval was granted for holding the 1939 Rochester Fall Meeting on November 13, 14, and 15.

An invitation of the American Medical Association Council of Physical Therapy to the Institute to be represented at a meeting to discuss problems of interference to radio reception caused by medical electrical equipment was accepted.

Broadcast Engineering Conference

The Second Annual Conference on Broadcast Engineering sponsored by Ohio State University will be held from February sixth to seventeenth. Full details of the meeting may be obtained from Dr. W. L. Everitt, Ohio State University, Columbus, Ohio. The subjects to be discussed and those who will lecture on them follow.

Rectifiers, by E. M. Boone, Ohio State University.

Measurements on Broadcast Antennas, by D. B. Sinclair, General Radio Company.

Practical Aspects of Radiation Systems and Transmission Lines, by J. F. Morrison, Bell Telephone Laboratories.

Waves, Words, and Wires, by J. O. Perrine, American Telephone and Telegraph Company.

Standards of Good Engineering Practice, by A. D. Ring, Federal Communications Commission; J. H. De Witt, WSM; and S. L. Bailey, Jansky and Bailey.

Transmission Tubes, by E. E. Spitzer, RCA Manufacturing Company.

Electromagnetic Waves, by W. L. Everitt, Ohio State University.

Facsimile, by C. J. Young, RCA Manufacturing Company.

Development of the Proposed Standard Volume Indicator, by R. M. Morris, National Broadcasting Company.

Functional Design and the Measurement of Broadcast Studio Facilities, by H. A. Chinn, Columbia Broadcasting System.

Electron Optics, by V. K. Zworykin, RCA Manufacturing Company.

Television, by L. F. Jones, RCA Manufacturing Company.

The Receiver as Part of the Broadcast System, by A. F. Van Dyck, RCA License Laboratory.

Receiver Characteristics Having Special Broadcast System Significance, by D. E. Foster, RCA License Laboratory.

Committees

Admissions

The admissions Committee met on December 7 and those present were F. W. Cunningham, chairman; Melville Eastham, J. F. Farrington, R. A. Heising, L. C. F. Horle, C. M. Jansky, Jr., and H. P. Westman, secretary.

Four applications were acted on and approved. Two of these were for transfer to Fellow, one was for transfer to Member, and the fourth was for admission to Member.

Electroacoustics

H. S. Knowles, chairman; J. T. L. Brown, R. P. Glover, Knox McIlwain, G. M. Nixon, L. J. Sivian, and H. P. Westman, secretary; attended a meeting of the Technical Committee on Electroacoustics on November 21.

A program of work to be attempted to establish standards on microphones and on graphical symbols was outlined. A preliminary

discussion of the preparation of the annual-review material was held and a schedule of operations for this work prepared.

Electronics

The Technical Committee on Electronics met on November 14. Those present were P. T. Weeks, chairman; K. C. DeWalt, E. C. Honer, (representing H. P. Corwith), Ben Kievit, F. R. Lack, A. F. Murray, G. D. O'Neill, H. W. Parker, C. E. Scholz (representing George Lewis), B. J. Thompson, and H. P. Westman, secretary.

A schedule for the preparation of annual-review material was organized.

A report was presented on the activities of the Electronics Conference Committee in its preparation for the conference to be held during January.

A brief discussion on the most recently published standards report indicated certain features of it which might receive additional work in the near future.

Electronics Conference

The Electronics Conference Committee met on December 2. Those present were F. R. Lack, chairman; F. B. Llewellyn, G. A. Morton, B. J. Thompson, and H. P. Westman, secretary.

The committee reviewed the recommendations of the three subcommittees, reports of whose meetings immediately follow, in order that the entire plan of the conference may be properly co-ordinated.

The following three subcommittee meetings were devoted to the preparation of a program of technical subjects to be treated during the conference and of lists of active specialists in these particular fields who are to receive special invitations to be present.

Electron Optics. This subcommittee met on November 15 and was attended by R. M. Bowie, chairman; R. C. Hergenrother, Harley Iams, A. G. Jensen, G. A. Morton, and H. P. Westman, secretary.

High-Transconductance Devices. This subcommittee met on November 23 and those present were B. J. Thompson, chairman; J. O. McNally, R. L. Snyder, Jr., H.A. Wheeler, and H.P. Westman, secretary.

Ultra-High-Frequency Electronics. F. B. Llewellyn, chairman; L. S. Nergaard, D. O. North, A. L. Samuel, Irving Wolff, and H. P. Westman, secretary; attended a meeting of this subcommittee on November 29.

Investments

Melville Eastham, chairman; Ralph Bown, Alfred N. Goldsmith, and H. P. Westman, secretary; attended a meeting of the Investments Committee on December 7.

After reviewing the list of bonds now held by the Institute, it was the opinion of the committee that there was no assurance of improving our investments by any changes evident at this time. It was felt that the Institute's cash balance was larger than was needed to insure operations through any probable immediate future conditions and it was recommended that about \$15,000 be invested in interest-bearing securities. It was felt that two thirds of these funds should be put in United States Government savings bonds and the remainder in common stocks.

New York Program

On November 29, the New York Program Committee met and those present were Austin Bailey, chairman; A. B. Chamberlain, J. D. Crawford, assistant secretary, J. K. Henney, G. T. Royden, H. M. Saunders (representing I. S. Coggeshall), and H. P. Westman, secretary. Preparations were made for the next few New York meetings of the Institute.

Receivers

On November 30, a subcommittee of the Technical Committee on Radio Receivers met to prepare a preliminary annual-review report. Those present were D. E. Foster, chairman; L. F. Curtis, W. E. Reichle, (representing H. B. Fischer), and H. P. Westman, secretary.

Sections

Atlanta

"The Location of Tropical Disturbances by Means of Associated Static" was discussed by W. B. Bernard of the Federal Communications Commission Atlanta office. He presented first an historical background of the project which has been undertaken by the engineering experiment station at the University of Florida. This was followed by a description of the equipment used to determine the direction of static centers associated with tropical disturbances. It included loops, amplifiers, a cathode-ray oscilloscope, and equipment for photographically recording the oscillographic patterns which represent either single static crashes or a composite record of all disturbances received during various periods of time. Reception was at ten kilocycles which was considered the optimum frequency.

The importance of proper alignment of the recording system and the nature of errors introduced by misalignment and the

effects of magnetic fields from local sources were outlined. Bearings on the static center were obtained by two observing stations to locate its position. The stations synchronize their observations through a radio link.

A comparison of these observations and those of the Weather Bureau during the 1936 hurricane showed very close agreement in following the measurement of the storm while at sea.

The paper was illustrated with photographs of the equipment used and of the oscillographic patterns from which the bearings were computed.

October 20, 1938—C. F. Daugherty, chairman, presiding.

Buffalo-Niagara

"Television Receivers" was the subject of a paper by William M. Perkins of the National Union Radio Corporation. In it he compared and contrasted the major functions of sound and sight receivers. The problems met in obtaining amplification over the very wide frequency bands required by television transmission were particularly stressed. Chief design features of a specific television receiver were described and the reasons for procedures which differ notably from sound-receiver technique were outlined.

November 2, 1938—H. C. Tittle, chairman, presiding.

Chicago

Using a portable video-frequency signal generator and kinescope to illustrate various phenomena under discussion, S. W. Seeley of the RCA License Division Laboratories presented a paper on "Principles and Methods of Television Laboratory Technique." He dealt with the problems of circuit design and laboratory technique in television work. Comparisons were drawn between components having similar functions in sound and television receivers. The obtaining of proper frequency and phase characteristics in transmission systems was described. Synchronizing circuits and sweep oscillators were outlined together with their problems. Idiosyncrasies of the propagation of television waves were described and illustrated.

October 19, 1938—J. E. Brown, chairman, presiding.

Cincinnati

"The Manufacture and Use of Molded Plastics" was presented at a joint meeting with the American Institute of Electrical Engineers local section by Gordon Brown, sales manager of the Bakelite Corporation. Plastics were divided into two major divisions: Thermosetting which includes phenolic and urea types and thermoplastic which encompasses cellulose acetate, acrylate, and polystyrene varieties. The

advantages and disadvantages of these types were described and it was pointed out that as greater strength and better electrical characteristics were obtained, the cost invariably increased. The ability of the various types to withstand impact was demonstrated and the destroyed samples were kept in boiling water until the end of the paper to demonstrate their relative abilities to withstand moisture.

Products made from various materials were displayed and a sound motion picture, "The Fourth Kingdom," showing their manufacture was exhibited.

November 11, 1938—R. J. Rockwell, chairman, presiding.

Detroit

Andrew Friedenthal, technical supervisor of WJR, based his paper "Modern Speech Input Installation" on the new equipment installed at WJR. In it, all mixing and program switching in the master-control room is done at a +10-decibel level. A two-way talkback system using no keys permits instantaneous talking from the control booth to the studio without affecting the use of the studio. Loud speakers in the studio are automatically disconnected when on the air.

The entire assembly shows a response-frequency characteristic within one decibel from 20 to 10,000 cycles. Under normal operation the distortion at any single frequency is less than two per cent. Reverse feedback is used extensively. In spite of alternating-current operation, noise and hum are 61 decibels below program level.

At the end of the paper, the equipment was inspected and a demonstration of instantaneous recording on equipment loaned by the Metropolitan Sound Company showed advances made in this field. Small blanks were supplied to those present to make their own recordings.

October 21, 1938—E. H. I. Lee, chairman, presiding.

Emporium

J. R. Nelson, radio engineer for the Raytheon Production Corporation, presented a paper on "Converter Tubes and Circuits." He confined his paper to operation between 2 and 50 megacycles and divided converter tubes into two classes. The first included tubes employing separate elements acting on a single electron stream while the other class employed separate elements acting on different electron streams.

A further division of the first class required that the inner grid be used as the oscillator grid as is the case in the 6A7, 6K8, and the English 4-beam type. Tubes using the outer grid for the oscillator are not represented on the American market because such tubes would completely cut off plate current and thus preclude automatic-volume-control action.

The second class was similarly divided. The 6J8G, having the oscillator grid tied

to the outer grid, is the only one in use. An experimental tube was mentioned in which the oscillator grid was tied to the first grid.

A series of curves indicating the impedances of the various types as the signal frequency varies from below to above the oscillator frequency were presented. They were shown in the form of positive and negative contour lines. The negative impedance of the injector grid reinforces the converter in some cases and permits operation at higher frequencies than otherwise would be effective.

October 26, 1938—A. W. Keen, chairman, presiding.

"Loud-Speaker Consideration in Feedback Amplifiers" was discussed by H. S. Knowles, chief engineer of the Jensen Radio Manufacturing Company. He covered briefly the fundamentals of feedback and described three methods of achieving it at audio frequencies. The first method, which requires the placing of a microphone at an appreciable finite distance from the loud speaker, is unsatisfactory because of the slow speed of sound in air. The second method which is better requires a mechanical connection between the voice coil of the loud speaker and the microphone. The third system of diverting part of the voltage across the voice coil back to the amplifier is considered best. Both calculated and experimental results of such operation were presented.

It was pointed out that the experimental data were obtained in an acoustically treated room. The improvement under these listening conditions was not as marked as under more normal listening environment with attendant reverberation. The chief advantage of audio-frequency feedback was considered to be a reduction in distortion at both high and low frequencies. It was considered of little value in home receiving sets but should find application in high-fidelity systems similar to those used for theatrical purposes.

This was the annual meeting of the section and R. K. McClintock of Hygrade Sylvania Corporation was elected chairman; M. S. May, Speer Carbon Company, vice chairman; and D. R. Kiser, Hygrade Sylvania Corporation, secretary-treasurer.

November 17, 1938—A. W. Keene, chairman, presiding.

Los Angeles

"The Galcit Radiometeorograph" was discussed and demonstrated by Anthony Easton. The equipment is used for high-altitude observations and comprises balloons which carry aloft the observation instruments and a radio transmitter by means of which the collected data are reported to the ground station. The radio-transmission and meteorographic equipment must be light enough to be carried to high altitudes and sufficiently reliable to

transmit trustworthy data. A complete set of transmitting and recording apparatus was displayed and operated.

"Transmission Characteristics of the Mt. Palomar Radiotelephone Link" was described by B. M. Oliver. The ninety miles between Pasadena and the Mt. Palomar Observatory is spanned by a 41-megacycle radiotelephone system. The variation in field strength and other factors of importance in the regular operation of the system were described. It was pointed out that excellent service has been had even though there are intervening mountain ranges between the two stations.

Conrad Miller discussed "Electron Applications for Astrophysics." The applications discussed related particularly to those of obtaining extreme magnification by means of electronic devices.

M. H. Brown then discussed "The 200-Inch Telescope Mirror." The problems involved in the casting of such a gigantic piece of glass were described. The precision and skill required in grinding and maintaining the optical surface of the mirror were then outlined.

All of the speakers were connected with the California Institute of Technology and following the presentation of the papers, an inspection tour was made of the radio equipment and of the grinding laboratory where the grinding operations on the mirror were viewed.

October 18, 1938—R. O. Brooke, chairman, presiding.

Philadelphia

"Radiotelegraphy and the Mackay System" was the subject of a paper by Haraden Pratt, vice president and chief engineer of the Mackay Radio and Telegraph Company.

In reviewing the development of the radio art, he divided it into decades. From 1890 to 1900 was the inception and experimental period and the dropping of the wave theory for the electronic theory. Between 1900 and 1910 the spark method came into use. Marconi developed a ship-to-shore telegraphic system about 1906 and transatlantic operation in 1908.

Between 1910 and 1920 vacuum tubes came into extensive use. Previously the Poulsen arc was used by the Federal Telegraph Company for continuous-wave transmission. The Alexanderson generator appeared and both were rendered obsolete by vacuum tubes. In 1916, Fessenden designed the United States Navy Station at Arlington, Va.

From 1920 to 1930 witnessed the development of modern broadcasting and the application of directive antennas and higher frequencies for communication purposes toward the end of that period.

The work of co-ordinating radio broadcasting through various international conventions was described.

The paper was closed with descriptions of the world-wide circuit layout of the

Mackay system and the facilities employed.

November 3, 1938—H. J. Schrader, chairman, presiding.

Pittsburgh

A "Description of the New Westinghouse KYW Studio in Philadelphia" was given by A. C. Goodnow, engineer of the Westinghouse Electric and Manufacturing Company. He presented a detailed description of the construction of the studios and the operation of the various control panels which were equipped with interlocking devices to prevent two programs from being broadcast simultaneously.

October 18, 1938—W. P. Place, chairman, presiding.

San Francisco

"A Round-Table Discussion on Negative Feedback" was led by Robert Buss, F. C. Cahill, Edward Ginzton, and William Hewlett of Stanford University. It covered the application of negative feedback to audio-frequency amplifiers, vacuum-tube voltmeters, audio-frequency oscillators using no inductances, and neutralization of tube input capacitance to extend the high-frequency range of video-frequency amplifiers while maintaining the high gain of narrow-range amplifiers. The addition of three new circuit elements, namely, negative resistance, negative inductance, and negative capacitance have made possible the use of negative feedback. An audio-frequency oscillator, a wide-frequency-range amplifier, and a vacuum-tube voltmeter employing the principle of negative feedback were demonstrated.

November 2, 1938—Carl Penther, vice chairman, presiding.

R. V. Howard, chief engineer of KSFO, presented a paper on the "New KSFO Studios." There were presented first motion pictures of the construction of the KSFO transmitter and antenna. The paper covered a general discussion of studio design which included considerations of sound isolation, optimum reverberation time, acoustical material, lighting, control booths, and studio size. After the paper, an inspection of the studios was made.

November 16, 1938—Carl Penther, vice chairman, presiding.

Seattle

D. H. Loughridge, professor of physics at the University of Washington, presented a paper on "Cosmic Rays," in which he discussed the history of the discovery of these rays and of the various theories about them. Methods of identifying and making quantitative measurements were described. The effects of these rays in a Wilson cloud chamber were shown. Their distribution with altitude and latitude was outlined.

The research program now being carried on includes continuous recordings of ray intensity between Seattle and Alaska in order that additional data on their distribution with latitude may be obtained. At the conclusion of the paper, a device for audibly indicating the arrival of cosmic rays was demonstrated.

November 18, 1938—A. R. Taylor, chairman, presiding.

Toronto

S. T. Fisher of the Northern Electric Company presented a paper on "Electrical Production of Musical Tones." In discussing the electric organ, it was pointed out that the engineer can assist the musical world by producing new and hitherto impossible effects which may be useful to the musician. In describing the development of the musical scale, it was pointed out that two notes sound harmonious when the ratios of their frequencies can be expressed by small integral numbers. Various manners in which these scales have been tempered to produce uniform spacing between notes and yet have the harmonics or overtones of the notes not produce discord were described. He showed graphically that the harmonic which produces the greatest discord was the seventh.

In the electric organ each tone is a pure sine wave and overtones are added in a controlled manner by synthesis. The seventh harmonic is eliminated completely to avoid the discord, its absence not affecting noticeably the resulting tone.

It was pointed out that the necessity of temperament in the case of a piano occurred because of the necessity of changing key and the impossibility of retuning the piano to do this. The key of the electric organ may be changed simply by varying the speed of the motor driving the small alternators. This allows a rapid change in key while maintaining true temperament.

October 17, 1938—R. C. Poulter, chairman, presiding.

"Notes on Electroacoustic Feedback Systems" was presented by H. S. Knowles, chief engineer of the Jensen Radio Manufacturing Company. This paper contained predominantly the material presented by the same author in Emporium on November 17 and described in this issue.

November 11, 1938—R. C. Poulter, chairman, presiding.

Washington

President Pratt presented a brief informal talk on his recent visit to Australia in behalf of the Institute.

He was followed by S. S. Kirby of the National Bureau of Standards who described the meeting of the International Scientific Radio Union General Assembly in Venice, Italy, which was participated in by almost a dozen different countries.

The main paper of the evening on "Television" was presented by T. T. Goldsmith, director of research of the

Allen B. DuMont Laboratories. In it Dr. Goldsmith presented a brief history of television. Various systems were described and their characteristics outlined. A receiver using a 14-inch tube was displayed. A small demonstration unit was used to indicate the effects of scanning speed, frame speed, number of lines, and interlacing on the operation of a system.

November 14, 1938—G. C. Gross, vice chairman, presiding.

Personal Mention

The following members have recently informed us of changes in their company affiliations or titles to those given below.

Blanchard, D. E.; radio engineer, Hazeltine Service Corporation, Bayside, N. Y.



E. R. SHUTE

E. R. Shute, who has served on the Institute Board of Directors and several committees, was recently appointed Vice President in Charge of Traffic of the Western Union Telegraph Company.

Drake, R. L.; Lear Developments, Incorporated, Roosevelt Field, Mineola, N. Y.

Hintz, R. T.; Hazeltine Service Corporation, New York, N. Y.

Hromada, J. C.; Radio Development Section, Civil Aeronautics Authority, Municipal Airport, Indianapolis, Ind.

Hucke, H. M.; Safety Board, Civil Aeronautics Authority, Department of Commerce Building, Washington, D. C.

McKelvey, C. A.; U.S.S. *Wright*, basing at San Diego, Calif.

Senf, H. R.; Naval Research Laboratory, Anacostia, Washington, D. C.

Whitney, Alexander; radio engineer, Westinghouse Electric and Manufacturing Company, Baltimore, Md.

Membership

The following indicated admissions and transfers of memberships have been approved by the Admissions Committee. Objections to any of these should reach the Institute office by not later than January 31, 1939.

Transfer to Fellow

Farnsworth, P. T., 127 E. Mermaid La., Philadelphia, Pa.

Lindsay, W. W., Jr., 1539 Ensley Ave., Los Angeles, Calif.

Transfer to Member

Byrnes, I. F., 6171 Liebig Ave., Riverdale, N. Y.

Admission to Member

Content, E. J., 8642—57th Rd., Elmhurst, L. I., N. Y.

Admission to Associate (A), Junior (J), and Student (S)

Adams, S. E., (A) 6 Hedgeley, Woodford Ave., Ilford, Essex, England.

Aird, A. W., (A) Box 48, New Brunswick, N. J.

Anderson, A. G., (S) Pioneer Hall, Box 8, Minneapolis, Minn.

Anderson, F. O., (S) 1001 E. 19th St., Minneapolis, Minn.

Andrasko, J. P., (A) 2136 Harrison Ave., New York, N. Y.

Baracket, A. J., (S) 7 Lawn Pl., Atlantic City, N. J.

Beckham, G. R., (A) 3224—16th St., N. W., Washington, D. C.

Benson, J. E., (A) "Mascotte," Arthur St., Ryde, N. S. W., Australia.

Berger, W., (A) 3224-16th St., N. W., Washington, D. C.

Blickensderfer, J., (S) 11964 Montana Ave., Los Angeles, Calif.

Bliss, A., (S) M.I.T. Dormitories, Cambridge, Mass.

Bower, K. E., (S) 609 S. E. Delaware St., Minneapolis, Minn.

Braverman, M., (S) 2150 Bath Ave., Brooklyn, N. Y.

Brinda, J., (S) 415-20th Ave., N. E., Minneapolis, Minn.

Broding, R., (S) 531 Walnut St., S. E., Minneapolis, Minn.

Brown, W. C., (A) 307 Crest Ave., Haddon Heights, N. J.

Browne, C. W., (S) 12 Park St., Orono, Maine.

Brynes, K., (S) 4717 Carpenter Ave., New York, N. Y.

Burns, R. H., (A) 3224—16th St., N. W., Washington, D. C.

Caffery, E. C., (A) Box 134, Galveston, Texas.

Caldicott, E., (S) 1533 St. Nicholas Ave., New York, N. Y.

- Chandler, H. G., (A) 749 Campbell St., Swan Hill, Victoria, Australia.
- Clark, H. T., (A) 711 Brandywine Ave., Schenectady, N. Y.
- Clemens, W. A., (S) 1022 Van Buren St., South Bend, Ind.
- Cohen, B., (S) 336 Central Park West, New York, N. Y.
- Collins, A. B., (A) 326 Customhouse, New Orleans, La.
- Colman, L., (A) 42 Third Ave., New York, N. Y.
- Corbell, P., Jr., (J) R.F.D. 1, Box 34, Placerville, Calif.
- Culbertson, G. K., (S) 4928 Newton Ave., S., Minneapolis, Minn.
- Davies, T. J., (A) 3 Broad St., Welshpool, Mont., Wales.
- Dawson, J. W., (A) 1937 Commonwealth Ave., Auburndale, Mass.
- De Carvajal, C. A. R., (A) 102 W. 93rd St., New York, N. Y.
- Doig, W., (A) Trans Canada Airlines, Winnipeg, Manit., Canada.
- Ebrall, H. N., (A) Box 127, Geraldton, Western Australia.
- Edwards, G. E., (S) 407 W. South St., Angola, Ind.
- Elliott, L. W., (A) 3720 Queen Mary Rd., Cote des Neiges, Montreal, Que., Canada.
- Farrelle, P. S., (A) 2210 M St., Sacramento, Calif.
- Gange, L. A., (A) 1847 Stanford Ave., St. Paul, Minn.
- Goldberg, A., (A) 1636 S. Central Park, Chicago, Ill.
- Gordon, T. M., Jr., (S) 1551 El Camino Real, Palo Alto, Calif.
- Haave, C. R., (A) 1018 N. 28th St., Billings, Mont.
- Hansel, P. G., (S) 910 Ohio St., Lawrence, Kan.
- Havstad, H. H., (A) 171 W. 64th St., New York, N. Y.
- Hobday, S. W., (A) St. James' Vicarage, Maxwell Rd., Fulham, London, S.W.6., England.
- Hollan, D. C., (A) Y.M.C.A. Building, Pittsburg, Kan.
- Jenkinson, T. F., (A) Wireless Experimental Station, Box 48, Quetta, Baluchistan, India.
- Jones, B. F., Jr., (A) 24 Westbury Ave., Mineola, L. I., N. Y.
- Jones, E. F., Jr., (J) 3224—16th St., N. W., Washington, D. C.
- Kendrick, J. T., (A) Box 327, Leadville, Colo.
- Kinross, R. I., (A) Regentone Products, Ltd., Worton Rd., Isleworth, Middx., England.
- Klyce, B. H., Jr., (S) 2000—19th Ave., S., Nashville, Tenn.
- Kornetz, N. S., (A) 46 W. Girard Blvd., Kenmore, N. Y.
- Leppert, M. L., (A) 47 Pershing Dr., Scotia, N. Y.
- Lingo, J. E., (A) 28th St., and Buren Ave., Camden, N. J.
- Ludwig, M. R., (S) 1811 Second Ave., S., Minneapolis, Minn.
- Lyman, H. T., Jr., (A) Marshall St., Milford, Conn.
- Mabe, W. S., (A) 42 Collindale Ave., Sidcup, Kent, England.
- Mackay, F. S., (A) 163 Jackson St., W., Hamilton, Ont., Canada.
- Marsh, C. O., Jr., (S) 916 Ridgeway Ave., Morgantown, W. Va.
- Mehra, M. L., (A) c/o L. Bishan Dass Mehra, St. John Buildings, Lahore India.
- Moses, S., (J) 1554½ Sixth Ave., Los Angeles, Calif.
- Newman, R. J., (S) 520 N. 11th St., Corvallis, Ore.
- Oelrich, E. E., (A) 2840 Tieman Ave., New York, N. Y.
- Osahr, B. F., (J) 68 Berkeley Pl., Brooklyn, N. Y.
- Osdin, C., (A) Hotel Koehler, Grand Island, Neb.
- Peck, A. G., (S) 2645 Dupont Ave., S., Minneapolis, Minn.
- Poole, J. H., Jr., (A) RCA Institutes, 1154 Merchandise Mart, Chicago, Ill.
- Rahn, E., (A) Frohnerstr. 7, Berlin, Germany.
- Rajchman, J., (A) Electronic Research, RCA Manufacturing Company, Inc., Camden, N. J.
- Rhoads, E. B., (S) Red Hill Farms, R.F.D., Bridgeport, Pa.
- Ridge, C. G. W., (A) 239A Church St., Pietermaritzburg, Natal, South Africa.
- Rinker, S. R., (A) Eleventh Bombardment, Squadron, Hamilton Field, Calif.
- Rizk, K. S., (A) Eastern Air Lines, Inc., Miami, Fla.
- Ruze, J., (S) 1363 First Ave., New York, N. Y.
- Shulman, C. I., (S) 1680 N. Shore Rd., Revere, Mass.
- Siegel, O., (A) 1329 Belmont St., N. W., Washington, D. C.
- Sofsky, J. D., (S) 39 N. 10th St., Allentown, Pa.
- Steinbright, F. L., (A) 427 S. LaSalle St., Chicago, Ill.
- Stevenson, M. H., (A) c/o Radio 2UE Sydney Pty., Ltd., 29 Bligh St., Sydney, Australia.
- Stuhrman, E. L., (A) c/o American Export Airlines, 120 Wall St., New York, N. Y.
- Troxel, R. E., (A) 7504 S. Aberdeen St., Chicago, Ill.
- Usher, W. B., (A) 10 Rutgers Pl., Passaic, N. J.
- Wall, C. E., (S) 1514 Brook, S. E., Minneapolis, Minn.
- Washburn, H. W., (A) 168 N. Hill Ave., Pasadena, Calif.
- Williams, N., (A) 1144 Calumet Ave., Calumet, Mich.
- Wright, L. L., (A) 56 Council St., St. Kilda, Dunedin, New Zealand.
- Wright, R. B., (A) Grafton Hotel, 1139 Connecticut Ave., N. W., Washington, D. C.

Books

Radio Laboratory Handbook, by M. G. Scroggie.

Published by Iliffe and Sons, Ltd., Dorset House, Stamford Street, London, S.E. 1, England. 379 pages plus a 5-page index. Price 8/6, by post 9/-.

"You, lifting up this book to find out whether it is for dignified engineers, like yourself, and not just for amateurs (or, alternatively, for enthusiastic home-experimenters, like yourself, and not just for dull professionals) are to be informed without delay that it is humbly dedicated to the use of both," says the author in the preface. Further on, it is stated that a reasonable foundation in the principles of radio is assumed, so the text neither steps down to the very beginner nor soars to abstruse technicalities. While adhering admirably to this middle ground in exposition (making for easy reading), the true value of this choice is rather more apparent when it is noted that all the material of the book is based on practical experience.

The choices of methods and equipment for measurements are considered carefully. Particular reference is given to adapting methods to the equipment available and to the selection of equipment having the largest number of applications. Much useful emphasis is given to obtaining the best and most accurate results from the equipment on hand; for example, the use of capacitance differences (nullifying the effects of unknown or indeterminate strays) instead of total capacitance values. Emphasis is also placed on the cathode-ray oscillograph as a laboratory tool, not only in research but in checking performance either of new designs or in servicing existing equipment. "More can be learned in half an hour with a cathode-ray tube than in days of work with meters," says the author in reference to testing amplifiers, (a sentiment to which the reviewer heartily subscribes).

In particular, the reviewer commends the space given to precautions to be observed in obtaining desired results; not only are those covered which would be expected by the experienced investigator, but many of those more elusive pitfalls which even the experienced untangle only after expending considerable time and effort.

After the introductory material on the need for a laboratory and on the construction of suitable space, the author gives a brief but very pertinent review of fundamental principles of measurements. Four sections of the book are then devoted to equipment; sources, indicators, standards, and assemblies. In many cases constructional data are given so that certain items may be constructed by the experimenter.

The next section covers measurements

of components; resistors, condensers, coils, loud speakers, valves, aerials, and also the use of a dynatron oscillator in many measurements. This is followed by a section on testing "sets" (assemblies) such as amplifiers, detectors, frequency changers, power units, and receivers.

A section on ultra-high-frequency work emphasizes the new problems arising from effects of strays, transit times, low impedances, and so on.

The next section deals with analyzing the results of experiment, determination of what may be neglected and how, methods of tabulating and interpreting results, and filing.

The final section covers reference data, formulas, and tables. Some of the latter are not very useful to workers in the United States, since symbols, wire tables, etc., differ appreciably.

While there are some differences in terminology, the greater part of the book loses none of its effectiveness for U. S. readers. The book should be useful to the serious amateur who wishes to have means for testing parts or assemblies; it is also useful to the professional engineer for its concise summaries of methods and precautions.

J. K. CLAPP
General Radio Company
Cambridge, Massachusetts

Short-Wave Radio, by J. H. Reyner.

Published by Sir Isaac Pitman and Sons, Ltd., London. Obtainable through Pitman Publishing Corporation, 2 West 45th Street, New York, N. Y. 159 pages plus a 2-page index. Price \$2.75.

This book presents a very interesting nonmathematical explanation of short-wave radio transmission and reception and its advantages in radio communication. The reader is assumed to have a general knowledge of ordinary radio technique. A six-page glossary gives brief explanations of some fifty terms found in the text. The whole treatment is brief, but references to more extended explanations or proofs are given.

The text is divided into ten chapters under the following headings: What are Short Waves? The Propagation of Wireless

Waves; Aerials and Feeders; Aerial Arrays; Receiving Aerials; Short-Wave Transmitters; Modulation; Short-Wave Receivers; Ultra-Short Waves; Micro-Waves.

The text is illustrated with eighty-three diagrams and charts which are used to simplify further the clear explanations of the many details presented. The book should enable the student to obtain a very practical understanding of this interesting phase of radio engineering.

E. L. HALL
National Bureau of Standards
Washington, D. C.

Wireless Direction Finding, by R. Keen. (Third Edition)

Published by Iliffe and Sons, Ltd., Dorset House, Stamford Street, London, S.E.1, England. 797 pages plus a 15-page index and 550 illustrations. Price 25/-.

For many years Keen's book has been regarded as the standard work on radio direction finding. This new edition has been thoroughly revised and includes much new material. Any engineer interested in radio navigational systems will be pleased to see in one volume a description of nearly all direction-finding systems which have found or may find application on shipboard, in aircraft, and at fixed stations. The author has evidently made an exhaustive research into the technical literature in an attempt to include all of the more important arrangements. In the author's own words, he has endeavored "to make the book acceptable, not only to the engineering student, but also to the radiotelegraphist, the air pilot, and the installing technician. For this reason the text is mainly descriptive" and accordingly makes easy and interesting reading. For the more technical reader and for the investigator, a comprehensive bibliography at the end of the book, together with frequent references throughout the text to pertinent items in the bibliography, is of particular value.

The subject matter of the book includes a brief historical account of the development of direction finding, an excellent chapter on radio wave propagation, an analysis of the principles underlying the use of loop and other spaced antenna

arrangements in radio direction finding, a comprehensive presentation of the subject of polarization errors or "night effect," and a discussion of shore, ship, and aircraft direction-finder installations, together with the problems typical of each class. An interesting chapter presents a survey of direct-reading direction finders developed primarily for aircraft applications. Separate chapters deal with aircraft navigational systems employing directive radio transmission, such as the fixed-course beacons and aircraft approach and landing systems. Other chapters cover practical procedures evolved to make effective use of direction-finder bearings taken at shore, ship, and aircraft stations. Material covering the principles of map projections and of field and nautical astronomy, of importance in the application of direction finding to navigation, is also included.

As a whole, the book is excellent and should prove of value to any student or worker in this field. It has certain deficiencies, however, which appear important to the reviewer. The organization of the book to cover fundamental considerations in the earlier chapters and practical direction-finding circuits and installations in later chapters, coupled with the author's aim to follow simple presentation has resulted in inadequate treatment of essential details. For example, the reader goes from one chapter to another to determine the fundamentals underlying the shielded-loop antenna and modern methods for balancing out quadrature effect only to find the treatment quite perfunctory. A second deficiency lies in the lack of a clear explanation of the organization of certain of the systems of navigation treated. For example, the reader is left to wonder how the use of shore-station direction finders ties in with the radio-beacon service set up for the use of ship direction finders. A third criticism arises from the nature of much of the material covered and can hardly be laid at the author's door. Because of the rapid advances in the use of radio for aircraft navigational aids, the technical literature does not present an accurate picture of actual practice. As a result the author's discussions of the American setup leave much to be desired.

HARRY DIAMOND
National Bureau of Standards
Washington, D. C.

Contributors



W. L. BARROW

W. L. Barrow (A'28) was born in Baton Rouge, Louisiana, on October 25, 1903. In 1926 he received his B.S. degree in electrical engineering from Louisiana State University, and in 1929 an M.S.



L. J. CHU

degree from Massachusetts Institute of Technology. He was a Redfield Proctor Fellow in Physics at the Technische Hochschule in Munich, Germany, where, in 1931, he received his Sc.D. degree in physics. Serving from 1931 to 1936 as an instructor in the communications division of Massachusetts Institute of Technology and as a member of the Round Hill research group, Dr. Barrow was appointed professor of electrical communications in 1936. He is a member of the American Institute of Electrical Engineers.

Lan Jen Chu was born at Hwei-ying, Kiangsu, China, in 1913. He received his B.A. degree from Chiao-tung University in Shanghai, in 1934, and in 1935 his M.S. degree from Massachusetts Institute of

Technology where he is continuing as a graduate student. He is a member of Sigma Xi.

E. H. Conklin (A'37) was born September 22, 1907, at San Francisco, Cali-



E. H. CONKLIN

fornia. He received his B.S. degree from Northwestern University in 1930. From 1935 to 1937 he was assistant editor of *R/9* and *Radio*, becoming associate editor of the latter in 1937. He has been an



W. J. CREAMER

amateur radio operator from 1918 to date. Mr. Conklin is a member of Phi Beta Kappa.

W. J. Creamer (A'29) was born on March 3, 1896, at Penobscot, Maine. The University of Maine conferred on him the B.S. degree in electrical engineering in 1918, the E.E. degree in 1921, and the B.A. degree in 1923. He was an engineer in the transmission department of the Western Electric Company from 1918 to

1919. Since 1919, Professor Creamer has been engaged in teaching and administrative work at the University of Maine, becoming professor of Communication Engineering in 1938. He is a member of Tau Beta Pi, Phi Kappa Phi, and the Society for the Promotion of Engineering Education.

John H. DeWitt, Jr., (A'31, M'38) was born in Nashville, Tennessee, on February 20, 1906. He attended Vanderbilt University and from 1929 to 1932 was



© Harris & Ewing

J. H. DEWITT, JR.

a member of the technical staff of Bell Telephone Laboratories. In 1932 he became chief engineer of WSM at Nashville.

Ralph W. George (A'31) was born on July 19, 1905, at Jamestown, North



R. W. GEORGE

Dakota. He received the B.S. degree in electrical engineering at Kansas State College in 1928. Since that date he has been with the field laboratories of R.C.A. Communications.

T. R. Gilliland (A'28) was born in Danville, Illinois, on March 16, 1903. He received his B.S. degree in electrical engineering at the California Institute of Technology in 1927 and an M.S. degree in communication engineering at Harvard University in 1931. For two years between 1923 and 1927 he was a radio operator aboard ship. From 1928 to 1930 and from June, 1931, to date, Mr. Gilliland has been with the Radio Section of the National Bureau of Standards.



T. R. GILLILAND

DeWitt R. Goddard (A'31) was born in New York City on November 30, 1904. He received his B.S. degree in electrical engineering from Worcester Poly-Technic Institute in 1929. Since then he has been in the communication receiver research and development departments of R.C.A. Communications.



DEW. R. GODDARD

S. S. Kirby (A'27) was born on October 27, 1893, at Gandy, Nebraska. He received the A.B. degree from the College of Emporia in 1917 and the M.A. degree from the University of Kansas in 1921. From

1918 to 1919 he was with the Signal Corps of the American Expeditionary Force. He was a high school teacher from 1919 to 1921, and from 1921 to 1926 a professor of physics at Friends University in Wichita, Kansas. Mr. Kirby served as an assistant physicist at the National Bureau of Standards from 1926, as an associate physicist from 1930 to 1938, and physicist from 1938 to date.



S. S. KIRBY

Frank D. Lewis (S'36, A'38) was born at Liberty, Missouri, on July 2, 1911. He received his A.B. degree from Central College at Fayette, Missouri, in 1933, and his B.S. degree from Massachusetts In-



F. D. LEWIS

stitute of Technology in 1937. From 1933 to 1935 he was with the Federal Reserve Bank of Kansas City. Since 1937 he has been research assistant at Massachusetts Institute of Technology. Mr. Lewis is an associate member of Sigma Xi.



Horace Owen Merriman (A'36) was born November 21, 1888, at Hamilton, Ontario, Canada. In 1910 he was graduated with honors in electrical engineering

from the University of Toronto; in 1911 he received his B.A.Sc. degree and in 1932 his E.E. degree. From 1915 to 1919 he was a technical officer in the Royal Naval Air



H. O. MERRIMAN

Service and the Royal Air Force. With the late Honorable Lionel Guest he was co-inventor of a system of sound recording and worked in this field from 1919 to 1923. In 1924 Mr. Merriman became a member



A. C. OMBERG

of the Research Council of Canada, developing a method of dealing with radio inductive interference. Since 1925 he has been Engineer-in-Charge of the Interference Section of the Radio Division of the Department of Transport.



Arthur C. Omberg was born on November 4, 1909, at Memphis, Tennessee. In 1932 he received the B.S. degree, the M.A. in 1934, and in 1935 the E.E. from Vanderbilt University. From 1928 to 1929 he was employed as a ship operator with the Radiomarine Corporation. He has been a transmitter engineer at WSM from 1932 to date.

Kinjiro Okabe was born at Nagoya, Japan, on March 27, 1896. He received his B.S. degree in electrical engineering from the Tohoku Imperial University in 1922



KINJIRO OKABE

and his Kogakuhakusi (D.Eng.) degree in 1928. He was a member of the electrical engineering department of Tohoku Imperial University from 1922 to 1928 and the electrical engineering department of the Nagoya Higher Technical College from 1928 to 1934. Since 1934 he has been connected with the department of physics of the Osaka Imperial University.



P. C. SANDRETTO

Frederick Gordon Nixon (A'37) was born in 1912 at Summerland, British Columbia. He received the B.A.Sc. degree in electrical engineering from the University of British Columbia in 1933. From 1934 to 1937 he was engaged in radio research for the National Research Council, and in 1937 he became assistant radio engineer of the Department of Transport. In 1933 he joined the American Institute of Electrical Engineers as an associate member.



Harold Alden Wheeler (A'27, M'28, F'35) was born at St. Paul, Minnesota, on May 10, 1903. He received his B.S. degree in physics at George Washington University in 1925. From 1925 to 1928 he took postgraduate work in the physics department of Johns Hopkins University and was a lecturer there from 1926 to 1927. From 1921 to 1922 he was an assistant in the Radio Section of the National Bureau of Standards. In 1923 Mr. Wheeler became an assistant to Professor Hazeltine and in 1924 he entered the Hazeltine Corporation and the Hazeltine Service Corporation as an engineer. He is a member of Sigma Xi.



P. C. Sandretto (A'30) was born April 14, 1907, at Pont Canaese, Italy. He received the B.S. degree in electrical engineering from Purdue University in 1930 and the E.E. degree in 1938. From 1925 to 1930 he was a broadcast radio operator; from 1930 to 1932, a member of the technical staff of the aircraft radio group of the Bell Telephone Laboratories; and from 1932 to date, a communications engineer of the United Air Line Transport Corporation. Mr. Sandretto is a member of Eta Kappa Nu.

Newbern Smith was born on January 21, 1909, at Philadelphia, Pennsylvania. He received his B.S. degree in electrical engineering from the University of Penn-



NEWBERN SMITH

sylvania in 1930, his M.S. degree in 1931, and his Ph.D. degree in physics in 1935. Since 1935 he has been a member of the Radio Section of the National Bureau of Standards.



H. A. WHEELER

Yours for Good Service

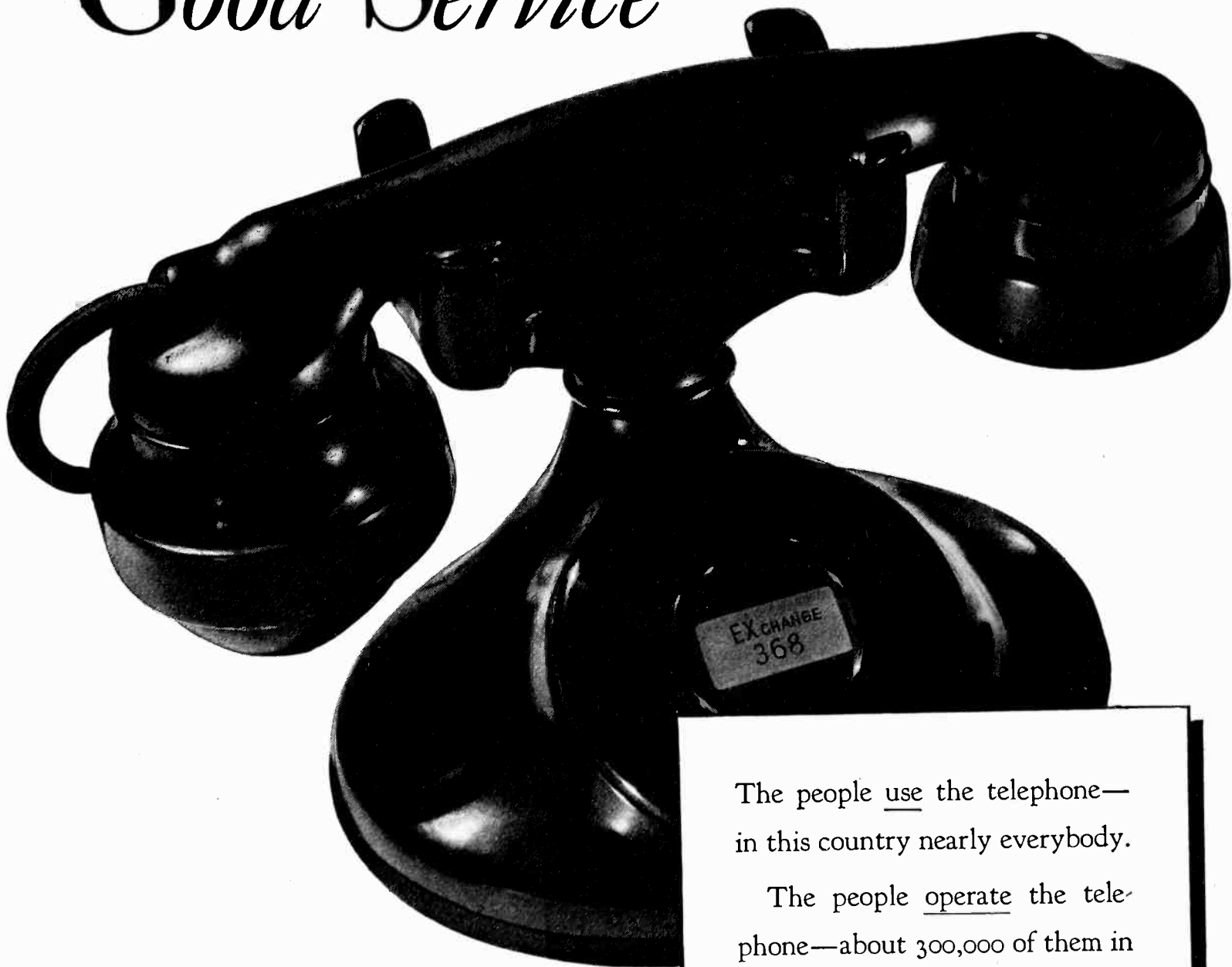

The people use the telephone—
in this country nearly everybody.

The people operate the tele-
phone—about 300,000 of them in
the Bell System.

The people own the telephone
business. There are about 750,000
owners of Bell System securities.

All of this works together to
give you the best telephone ser-
vice in the world at the lowest
possible cost.

BELL TELEPHONE SYSTEM



Commercial Engineering Developments

These reports on engineering developments in the commercial field have been prepared solely on the basis of information received from the firms referred to in each item.

Sponsors of new developments are invited to submit descriptions on which future reports may be based. To be of greatest usefulness, these should summarize, with as much detail as is practical, the novel engineering features of the design. Address: Editor, Proceedings of the I.R.E., 330 West 42nd Street, New York, New York.

Limiting Amplifiers

A limiting amplifier is a program amplifier equipped with automatic gain-adjusting circuits to compress the volume range of signals exceeding a given level. Installed in the speech-input circuit of a broadcast transmitter or other recording or program service, it can be adjusted to keep the signal from at any time exceeding the overload level of the circuit.

Besides, the limiting amplifier can ordinarily respond more quickly to unexpected program peaks than a monitoring operator, which makes it possible to maintain a higher average signal level than if the responsibility for preventing overloading fell on the operator alone. How much the average level can be increased by this means, depends, of course, on the nature of the program and the operating standards of the station. The possible gains are, however, considerable, since, if the 3- to 4-decibel increase in the average signal level mentioned by the equipment manufacturers be realized, there results an increase in signal at the receiver that would require doubling of the carrier power to equal.

Limiting amplifiers are being built by at least 4 American manufacturers. All exhibit similar operating characteristics: So long as the signal level remains below a predetermined level, the gain of the amplifier is constant. Let this level be exceeded and the automatic gain control system rapidly reduces the over-all gain, allowing it to return slowly to normal only after the signal peak has passed. The amount of gain reduction depends on the signal level

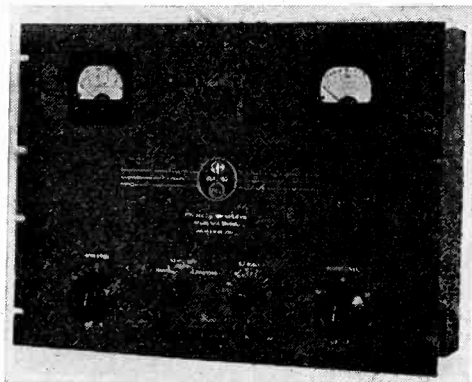

Collins limiting amplifier

so that a graded compression of the volume range is obtained.

One gain-regulating system employs a passive, bridge-type network. Each arm of the bridge is a nonlinear resistor whose resistance varies with the direct-current in it. By introducing the plate current of an

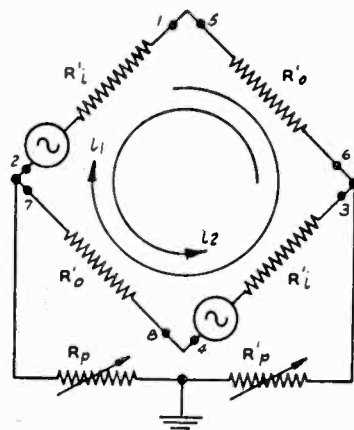
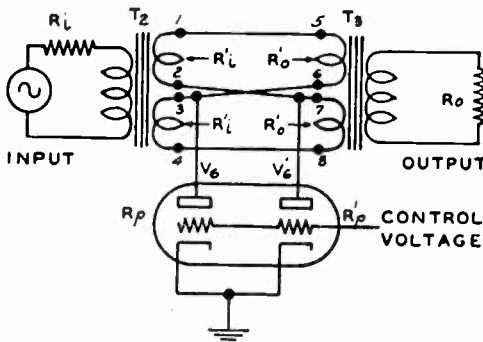

Schematic diagram and equivalent circuit of the gain adjusting circuit in the Collins limiting amplifier

auxiliary control amplifier into the network, the transmission of the network and the over-all gain of the limiting amplifier are made to vary in the desired manner.

Another system controls the gain by changing the bias voltage on the variable- μ tubes in one stage of the amplifier.

The Gates* limiting amplifier recently combines a bridge-type system and a vacuum tube-type system in one instrument. The first 3 decibels of gain reduction is taken care of by a bridge network containing non-linear resistors. If greater gain reduction is called for, a portion of the output voltage from the bridge is rectified and impressed on the suppressor grids of the variable- μ tubes in the first audiostage.

The gain-control circuit used in the Collins† limiting amplifier is shown, with its equivalent circuit, in the accompanying drawing.

When a high negative bias is applied to the grids of the control tube so that R_p is very large, the current i_1 in the bridge due to the voltage across winding 1-2 will be equal in magnitude and opposite in direction to i_2 , the current due to the voltage across winding 3-4. The net voltage drop across each R'_0 (and across the load R_0) is zero. Hence, the transmission through the circuit is zero.

Similarly, when the plate resistances of

* Gates Radio & Supply Company, Quincy, Illinois.

† Collins Radio Company, Cedar Rapids, Iowa.

the tube are low as the result of decreasing the control-grid bias, a low-resistance path is placed between points 2-7 and 3-6. The transmission through the circuit will then be practically unity. Thus, the transmission through the circuit and the over-all gain of the amplifier containing it is made to vary over a wide range by variations in the control-grid voltage.

Coaxial Antenna

By the use of what is, in effect, a high- Q anti-resonant circuit at the base of the radiator to "isolate" it from the supporting pole, a "coaxial antenna" developed for ultra-high-frequency service is reported to reduce wasteful high-angle radiation.

When a radiator is placed at the top of a high metal pole and fed by a coaxial transmission line, the pole and the outside surface of the line, acting together, behave much like a long antenna grounded at the base and excited at the top by the presence of the supported antenna. Appreciable energy is radiated at high angles—at the expense of useful signal along the ground—as it is with other radiating conductors whose length exceeds one-half a wavelength. The coaxial antenna is intended to minimize pole radiation by reducing the conductive coupling between the radiator and the pole.

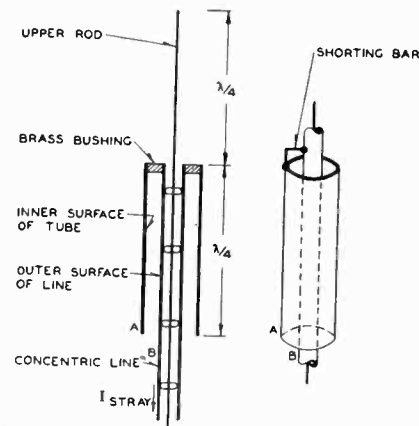

Schematic cross-section drawing of the coaxial antenna

As the accompanying simplified cross-sectional drawing shows, the coaxial antenna is, essentially, a length of coaxial transmission line which has had the outer shell peeled back for a quarter wavelength to expose an equal length of the inner conductor. The inner surface of the peeled-back section acts with the outer surface of the transmission line to form a short-circuited quarter-wave coaxial line. An extremely high impedance is developed between the points A and B, the equivalent of a high- Q anti-resonant circuit, which isolates the pole below B from the antenna.

Electrically, the resulting antenna, is a center-fed half-wave doublet consisting of the quarter-wave rod and the outer surface of the peeled-back section, which is also a quarter-wavelength long.

The development was announced by Western Electric.*

* Western Electric Company, 195 Broadway, New York, N. Y.

Announcing

the AEROVOX NEW BEDFORD plant...

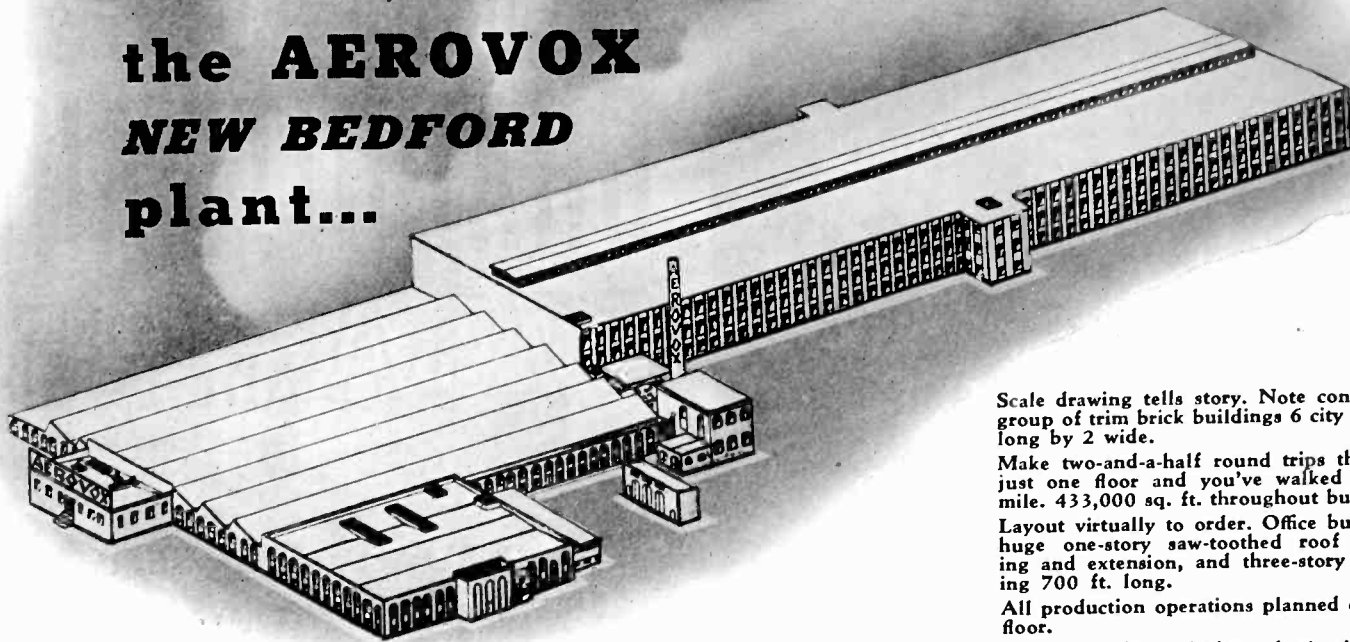

Scale drawing tells story. Note connected group of trim brick buildings 6 city blocks long by 2 wide.

Make two-and-a-half round trips through just one floor and you've walked a full mile. 433,000 sq. ft. throughout building.

Layout virtually to order. Office building, huge one-story saw-toothed roof building and extension, and three-story building 700 ft. long.

All production operations planned on one floor.

The most advanced ideas of scientific layout have been adopted in each department.

YES, we have moved to New Bedford, Mass. Simply outgrew our Brooklyn quarters which ranked among industry's largest. To provide for current and future requirements, we now have four times previous space. And to insure a permanent home for so much heavy equipment and intricate installation, we have bought these buildings outright.



Approximately 150 loads on 24-foot trailer trucks moved up our Brooklyn plant equipment. Much new equipment has been added. The work of installing the equipment and keying up production is being rapidly completed. Additional workers were carefully trained for a number of weeks under the supervision of AEROVOX key foremen and engineers who have moved up from Brooklyn.



Thus AEROVOX enters a new and still greater era of A.A.E.* Service to you. Our sincere thanks for your past patronage and our promise of the finest products and the greatest service ever offered in the Condenser Industry. And so, once again we welcome your requirements, fully confident of our ability to meet them to the last detail.

* Aerovox Application Engineering.



AEROVOX CORPORATION

New Bedford, Mass.

Sales Offices in All Principal Cities



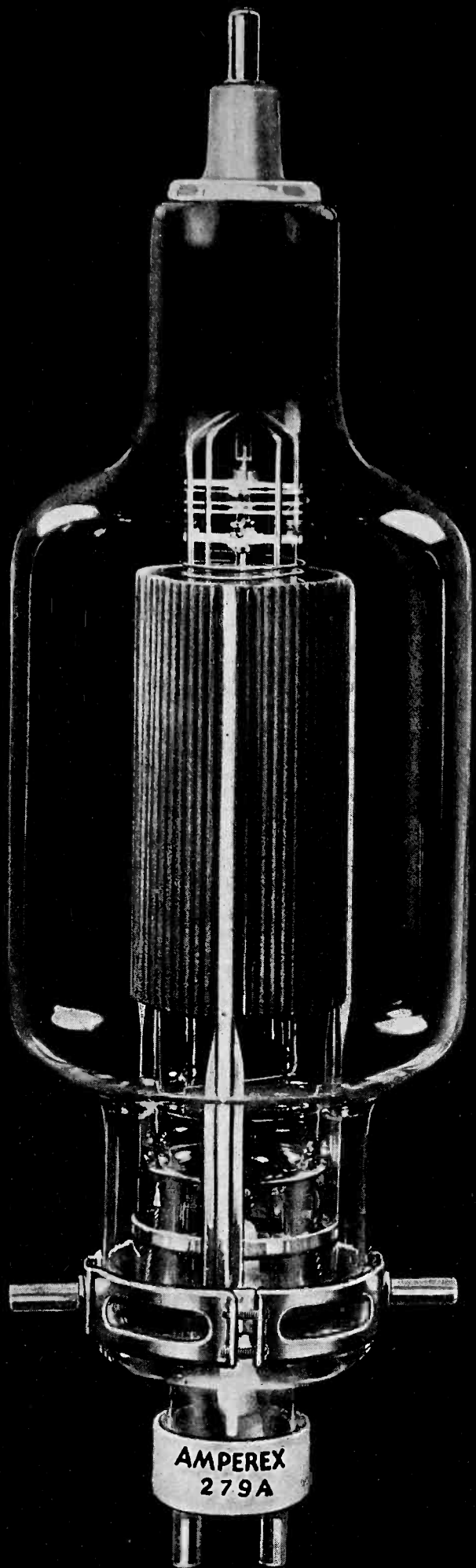

AMPEREX GRAPHITE ANODE 279-A and 251-A

AMPEREX has redesigned the 279-A and 251-A. Their structures have been simplified and their elements anchored with greater rigidity.

THE merit of these two excellent tubes is further enhanced by the incorporation in their design of graphite anodes.

THE following outstanding features of all AMPEREX tubes, by reason of their Graphite Anodes, are now properties of the redesigned AMPEREX 279-A and 251-A.

- ★ LONGER LIFE
- ★ COOLER OPERATION
- ★ GREATER EFFICIENCY
- ★ NO CHANGE OF INTERELEMENT SPACING DURING LIFE

279-A.....\$350

251-A.....\$300

AMPEREX ELECTRONIC PRODUCTS, Inc.

79 WASHINGTON STREET

BROOKLYN, NEW YORK

DIVISION DE EXPORTACION: 100 VARICK STREET, NEW YORK, E. U. A. CABLEGRAMAS: "ARLAB".

Best Results With DAVEN ATTENUATORS

The inherent quality and dependability of DAVEN resistance units for attenuation is not affected by their low prices. The DAVEN attenuators are designed for commercial applications, and are guaranteed to give utmost satisfaction.

DAVEN products are demanded by leading broadcast stations, newsreel companies, recording studios and public address sound specialists for best results at lowest cost.

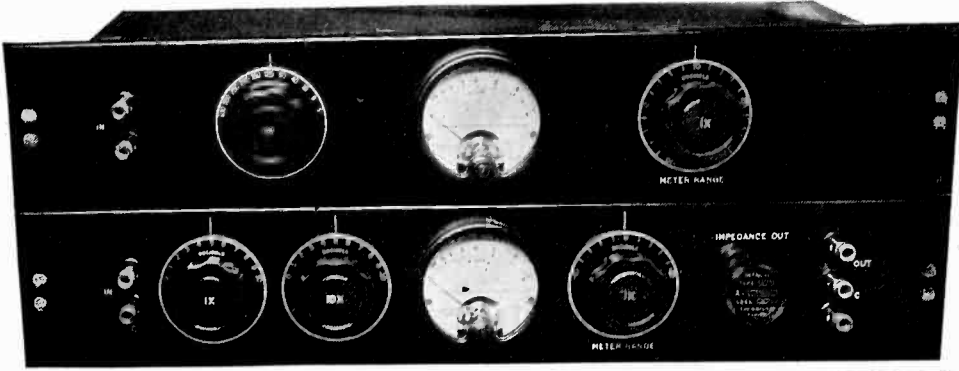

TYPE 685 DAVEN UNIVERSAL GAIN SET

A universal gain measuring instrument for rapid and accurate measurement of overall gain, frequency response and power output of audio amplifiers. All networks, meters and associated apparatus shielded and carefully balanced, matched for uniform accuracy over a wide frequency range.

★
● **ATTENUATION RANGE:** plus 10 db. to minus 120 db. in 1 db. steps ● **POWER MEASURING RANGE:** minus 20 db. to plus 36 db. ● **LOAD IMPEDANCE:** Eleven values, ranging from 5 to 600 ohms, are available ● **OUTPUT IMPEDANCES:** May be changed from "balanced" to "unbalanced" and to any loss and impedance required by means of plug-in type matching networks ● **FREQUENCY RANGE:** 20 to 17,000 cycles ● **ACCURACY OF ATTENUATION CONTROLS:** plus or minus 1% ● **PRICES ON REQUEST.**



TYPE LA-350

Circuit: Ladder network. Noise level: minus 137 db. Number of steps: 20. Minimum attenuation: 6 db. for 1:1 impedance, 2 db. for 1:2 impedance. Maximum attenuation: Infinity. Attenuation on next to last step: 52 db. Attenuation per step: 2 db., tapered on last three steps to complete cut-off. Frequency error: None over the range 0 to 20,000 cycles. 100% wire wound. Knob, Alumilite dial and Shield supplied. Dimensions: 1-3/4 in. diameter, 1-3/4 in. depth. Mounting: Single hole, 3-8/32 bushing. Terminal impedances: 30/30, 50/50, 200/200, 250/250, 500/500, 600/600, 30/60, 50/100, 250/500.

Net Price \$7.50

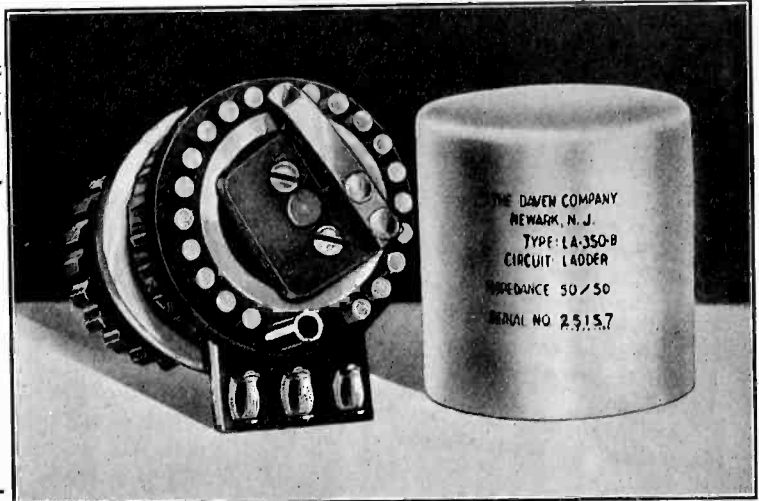

TYPE T-330

Circuit: "TEE" type. Noise level: minus 137 db. Minimum attenuation: Zero. Maximum attenuation: Infinity. Range of control: 30 steps of attenuation, tapered from 1-1/2 db. to a total loss of 60 db. on the next to last step and approximately 128 db. on the last contact. Frequency error: None over the range of 0 to 20,000 cycles. 100% wire wound. Knob, Alumilite dial and Shield Supplied. Dimensions: 2-3/4 in. diameter, 2-1/16 in. depth. Mounting: Two 8/32 screws, 1-1/2 in. apart on horizontal center line. Terminal impedances: 30/30, 50/50, 200/200, 250/250, 500/500, 600/600.

Net Price \$17.50

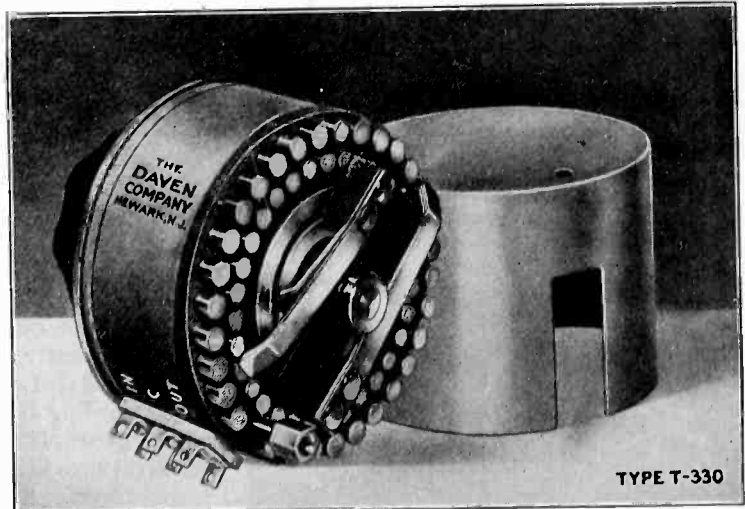

TYPE 154

Type 154 pads are fixed type attenuator networks for use where a definite and constant loss must be introduced without upsetting the impedance characteristics of the system. They are also used for changing from one impedance to another. Most popular terminal impedances and decibel loss available in stock for immediate delivery. Any terminal impedance or loss may be secured at no additional cost.

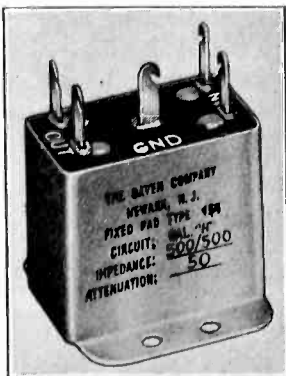

Balanced "H" network \$4.00

"TEE" network \$3.00

MANUFACTURERS OF

- | | | |
|------------------------------|-------------------|--------------------------------|
| Single & Dual Potentiometers | Faders | Laboratory Equipment |
| Special Rotary Switches | RF Switches | Speech Input Control Apparatus |
| Flament Rheostats | Volume Indicators | Decade Resistances |
| Mixer Panels | Output Meters | Resistances |
| Variable & Fixed Attenuators | Line Equalizers | Gain Sets |
| | Attenuation Boxes | Output Power Meters |
| | Multipliers | |
| | Super Davohms | |

THE DAVEN COMPANY

158-160 SUMMIT STREET • NEWARK, N. J.

ENGINEERS specify

WE deliver . . .

We've every reason to be proud of our record of service to radio engineers—

Because—

Radio engineers agree they find **TERMINAL** their most reliable source of radio equipment. You, too, can save time and money and headaches by buying at **Terminal!**

**You specify—
we'll deliver!**

If it's radio, we have it!

RECEIVERS • TRANSMITTERS • TUBES
• TRANSFORMERS • CHOKES • CONDENSERS • RESISTORS • METERS • TEST EQUIPMENT • RACKS AND PANELS • DIALS • PHONES • MICROPHONES • TRANSMITTING ACCESSORIES

Radio equipment headquarters for radio engineers and amateurs—these words sum up the Terminal Radio story. A complete stock of parts—the understanding service of the technically-trained staff accounts for the constant and tangible satisfaction realized by Terminal's clientele.

Mail orders are promptly shipped—usually within a few hours after your order is received. 'Phone VANDerbilt 6-5050, and a messenger will promptly deliver your order.

There is no charge for these extra services. On the contrary, our prices can't be beat!

VISIT THE
TERMINAL STORE
NEAREST YOU!

TERMINAL

Radio Corporation

2 STORES IN NEW YORK CITY

80 CORTLANDT ST. • 68 WEST 45th ST.

Cable Address: TERMRADIO

(Continued from page ii)

Video-Signal Generator Tube

A video-signal-generator tube of the monoscope type for checking the performance of television equipment has been made available commercially.*

The signal results from electron-beam scanning of a calibrated test pattern that is printed on a signal plate inside the tube.

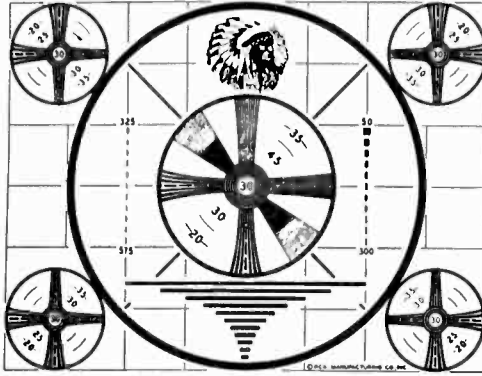

This reproduction of the test pattern is about 70 per cent of its actual size in the signal-generator tube

Tests for various factors affecting picture quality can be made; among them, for horizontal and vertical resolution, linearity of scanning, spot defocusing, and amplitude, phase and frequency response.

Operation of the tube is based on the fact that, under bombardment by an electron beam, more secondary-emission current is obtained from the unprinted (white) areas of the signal plate than from the printed (black) areas. When the pattern is scanned, therefore, a video-signal current representing the shading of the pattern flows in the load resistor connected to the signal plate. Operation is electrically similar to that of an iconoscope-type pickup tube, except that the collector electrode must be maintained positive with respect to the signal plate by from $22\frac{1}{2}$ to 200 volts.

The pattern, slightly smaller than the one actually printed on the signal plate, is shown on the accompanying figure. In its center are 6 concentric circles, the center of which is labelled 30. The radial spacing between the circles is the same spacing as would exist between 300 horizontal lines equally spaced in the vertical dimension of the pattern. Hence, if a television receiver can reproduce the pattern with the central circles separate and distinct, the receiver is said to be capable of resolving 300-line detail. The 4 resolution wedges radiating from the circles are calibrated in a similar manner, the number of equivalent lines varying linearly along a radius. Both horizontal and vertical resolution may thus be checked. The tube has the ability to resolve up to 500-line detail in its pattern and still provide an output having a high signal-to-noise ratio.

The wedges in the center at an angle of 45 degrees are tone scales to provide a test for amplitude distortion of the video signal.

The 2 circles surrounding the central wedges provide a test of linearity of scanning. Small departures from linearity cause noticeable distortion of these circles.

The resolution wedges in each of the 4 corners of the pattern provide a measurement of spot defocusing. When a receiver resolves less detail in a corner than in other

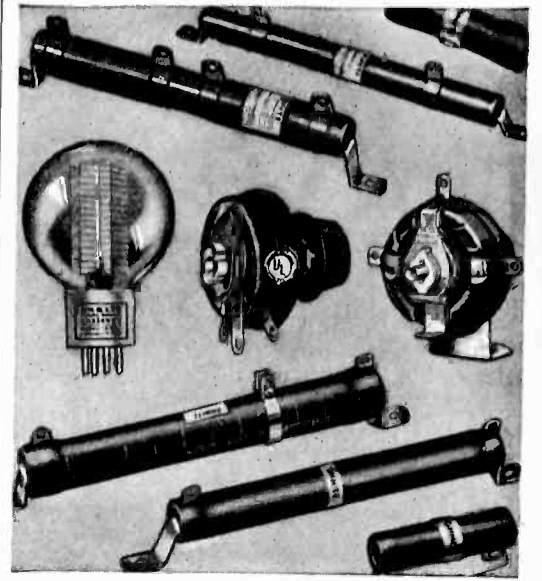

From Input to Output

OHMITE

Parts are Right!

DUMMY ANTENNA. New Ohmite Vacuum-Type! Offers more than 10 convenient, practical ways to improve transmitter efficiency. Used to measure actual output for tuning up to peak efficiency, and many other purposes. Send today for Bulletin 111.

RHEOSTATS. Time-proved Ohmite all-porcelain vitreous-enameled Rheostats (Underwriters' Laboratories Listed). Provide permanently smooth, closely graduated current control. Widest range of types, sizes and values.

DIVIDOHMS. Handy vitreous-enameled Adjustable Resistors for quick, accurate change of resistance value. Convenient Voltage Dividers. 10 to 200 watts.

FIXED RESISTORS. Vitreous-Enameled. Regular and non-inductive types—general-purpose and precision units, fixed or tapped. Hundreds of convenient stock sizes and values.

BROWN DEVILS Popular, economical, dependable resistors for voltage dropping, bias units, bleeders, etc. 10 to 20 watt sizes.

BAND SWITCH. Provides instant, easy change from one frequency to another with really low-loss efficiency.

R. F. PLATE CHOKES. High frequency solenoid chokes designed to avoid either fundamental or harmonic resonance.

POWER LINE CHOKES. Keep R.F. currents from going out over the power line—lessen interference with BCL receivers.

Send Today for Your Copy of Ohmite Catalog 17 listing extensive range of stock types, sizes and values designed to meet your needs quickly, economically.



OHMITE MANUFACTURING COMPANY
4860 West Flournoy Street, Chicago, U. S. A.

OHMITE

RHEOSTATS RESISTORS TAP SWITCHES

THE HANDIEST TESTER OF ALL....

MODEL 666 POCKET VOLT-OHM- MILLIAMMETER

A complete instrument for
all AC-DC voltage, current
and resistance
analyses

- Engineers and experimenters pronounce this instrument the most useful tester of all for laboratory, shop or field use.



ONLY
\$15.00
NET

Model 666 has 3" sq. Triplet improved rectifier type instrument. AC-DC Voltage Scales read: 0-10-50-250-500-1000 at 1000 ohms per volt. DC Milliampere Scale reads: 0-1-10-50-250. Ohms Scales read: Low 1/2-300; High 250,000. Resistance range can be increased by adding external batteries. Size, 3-1/16" x 5 7/8" x 2 1/8". Black Molded Case and Panel. Newly Improved Low Loss Selector Switch. Complete with Alligator Clips, Battery and Test Leads. Dealer Price\$15.00

EXCLUSIVE NEW TRIPLET LOW LOSS SWITCH
Incorporated in Model 666. Uses two silvered contacts instead of

one, insuring lower contact resistance. On actual breakdown test, on and off operation exceeded 10 million times without failure. Attractive, Black Leather Carrying Case, Model 669, is supplied extra. Dealer Price\$3.67

In designing testers of ultra compact size, many problems occur that do not have to be considered where more space is available. Triplet's Model 666 has stood the test of time and it is the biggest seller of its kind in this market.

TRIPLET
Precision
ELECTRICAL INSTRUMENTS

The Triplet Electrical Instrument Co.
211 Harmon Ave., Bluffton, Ohio

Please send me more information on

Model 666 Triplet Catalog

Name

Address

City State

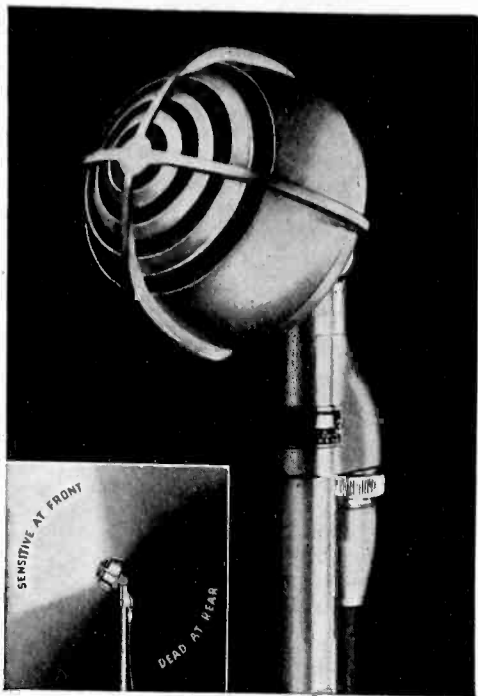

The NEW "UNIPLEX" UNI-DIRECTIONAL Crystal Microphone

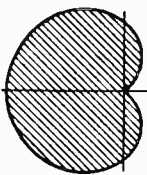

**True Uni-Directivity
by the New Shure
Uni-Phase Principle**

Development of the new "Uni-Phase" principle by Shure Engineers gives P.A. and Broadcast Engineers the advantages of true unidirectional pick-up for the first time at such astonishingly low cost. The 730A "Uniplex" provides excellent high quality response from 30 to 10,000 cycles at the front, yet is "dead" at the rear. (Rear response down 15 db. average, over a wide frequency range.) Easily solves tough pick-up problems—Eliminates feedback, audience and background noise, reduces reverberation energy 66%. Tilting head may be aimed at the source of sound. Functional speed-line design, finished in rich Satin Chrome. Equipped with built-in Cable Connector and 25 ft. of special noise-free Super Shielded cable.

The Model 730A "Uniplex"
lists at only **\$29.50**

Write today for Catalog 150H



SHURE TRI-POLAR
Controlled-Direction
Crystal Microphone

The first microphone to provide Uni-Directional, Bi-Directional, and Non-Directional pick-up control in one unit. Smooth "Ultra" Wide-Range response from 30 to 10,000 cycles. Built-in Cable Connector and 25 ft. Super Shielded cable.

Model 720B
lists at **\$45**

Shure Patents Pending. Licensed under patents of the Brush Development Co.

★ **SHURE** ★

SHURE BROTHERS

"Microphone Headquarters"

225 W. Huron St., Chicago, U. S. A.

(Continued from page vi)

parts of the pattern, the indication is that the spot on the reproduction is defocused in that corner.

Base connections of the tube are the same as those of the iconoscope so that it can be used for testing iconoscope equipment. Neither shading signals nor key-stoning are required. Since the signal voltage output for a highlight in the picture is negative from an iconoscope and positive from the monoscope, the pattern actually printed on the signal plate is a negative of the pattern shown here. Positive reproduction of the pattern will be obtained by using an odd number of video amplifier stages between the signal-generator tube and the reproduction tube.

The monoscope is an RCA* development.

* RCA Manufacturing Company, RCA Radiotron Division, Harrison, New Jersey.

Lock Washer and Screw Pre-assembled

A manufacturer of fastening devices* now assembles lock washers on machine screws for sale and use as single units.

The lock washer, slightly smaller in inside diameter than the screw, rides freely on a narrow unthreaded shoulder. The first thread of the screw acts as a burr to hold the lock washer in place against the head of the screw.

Among the advantages claimed are an increase in speed on production assembly operations and a guarantee that every screw has a lock washer—and the correct lock washer.

* Shakeproof Lock Washer Company 2501 North Keeler Avenue, Chicago, Illinois.

Electrolytic Condensers with Fabricated Plates

Conventional electrolytic condensers use aluminum foil, plain or etched, for the anodes on which the characteristic dielectric film is formed. A method of building up an anode material by spraying molten aluminum on gauze has been developed. Polarized dry electrolytic condensers embodying this construction are being manufactured by Mallory* and by Magnavox.†

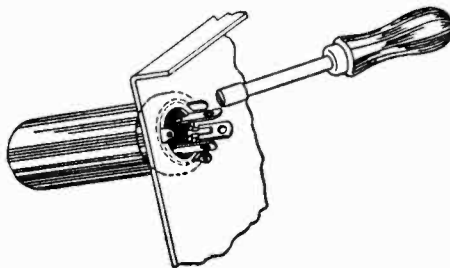

Electrolytic condensers of the fabricated-plate type are designed for mounting by the "twisted-lug" method. Drawing, courtesy of P. R. Mallory and Company, Inc.

Because the aluminum is deposited on the fabricated anode in a finely divided state, the active surface presented to the electrolyte and the resulting capacitance is some 10 times greater than in a plain-foil anode, from 2 to 3 times greater than an etched-foil anode of the same area.

* P. R. Mallory & Co., Inc., Indianapolis, Indiana.
† The Magnavox Company, Fort Wayne, Indiana.

**IT COSTS NO MORE
TO USE THE BEST!**

Specify
GENUINE



**PILOT
LIGHT
ASSEMBLIES!**

**They do the job better
and more economically**

Drake Pilot and Jewel Light Assemblies are built to highest standards... yet cost no more than ordinary types... Drake offers you a more complete selection of... Standard Types... Special Types... "Underwriters Approved" Types... Bayonet, Screw and Bracket Types... Jewel Types... and hundreds of others.

★ **ENGINEERS:** Drake Assemblies are designed with a safety factor adequate to meet varying conditions in the field. Materials are finest grade. Our engineers will cooperate with you on your Pilot Light problems... no obligation.

★ **MANUFACTURERS:** Drake will supply your Pilot Light needs faster, better, more economically, and usually at no extra die cost. Try "Drake," you'll be more than satisfied with our service, quality, prices.

★ **SERVICE MEN:** Ask your jobber to show you Drake Assemblies. Compare them with others... note their quality and low prices... we're confident you'll specify "DRAKE" thereafter.

Send for **FREE** catalog!

DRAKE MANUFACTURING CO.

1713 W. HUBBARD ST. • CHICAGO, U. S. A.



IRC Type CS Controls combine the twin noise eliminating features of (1) Silent Spiral Connector and (2) 5-Finger "Knee Action" Silent Element Contactor—each equally important—each pioneered and perfected by IRC. The combination of these two features plus the inherent dependability of the Metallized element insures better performance under all conditions than any other known construction.

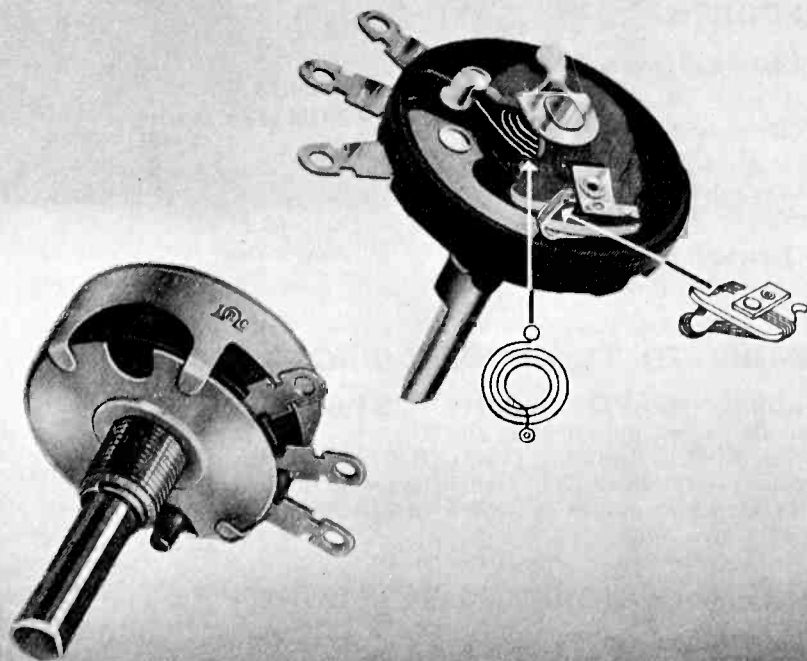

INTERNATIONAL RESISTANCE COMPANY, 401 N. BROAD STREET, PHILADELPHIA, PA.

BINDERS FOR THE PROCEEDINGS

Protect your file of copies
against damage and loss

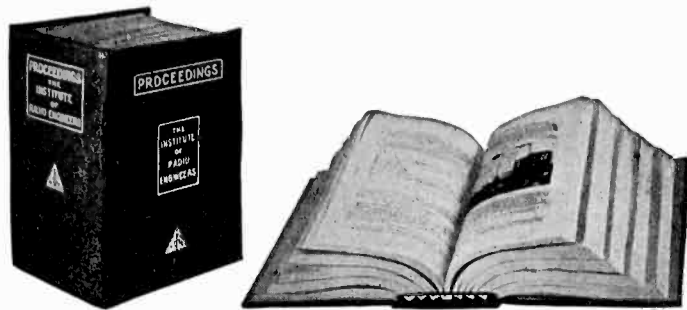

Binders are available for those who desire to protect their copies of the PROCEEDINGS with stiff covers. Each binder will accommodate the twelve monthly issues published during the year. These binders are of blue spanish grain fabricoid with gold lettering and will serve either as temporary transfers or as permanent binders. They are so constructed that each individual copy of the PROCEEDINGS will lie flat when the pages are turned. Copies can be removed from the binder in a few seconds and are not damaged by their insertion.

Available for both the old (small size) PROCEEDINGS or the new (large size).

Price: \$1.50, either size (specify which)

Postpaid to all countries

You may have a volume number or your name stamped in gold for 50 cents additional

OTHER PUBLICATIONS OF THE I. R. E.

STANDARDS REPORTS

Standards on Radio Receivers, 1938 (vi + 58 pages)

Standards on Electronics, 1938 (viii + 59 pages)

Standards on Transmitters & Antennas, 1938 (vi + 42 pages)

Standards on Electroacoustics, 1938 (vi + 37 pages)

**50 cents each,
\$2.00 per set**

*Postpaid to all
countries*

CUMULATIVE INDEX TO THE PROCEEDINGS

Index to *Proceedings*, 1909-1936 (ii + 113 pages). A list of all papers published in the *Proceedings* of the Wireless Institute (1909) and in the *Proceedings* of the Institute of Radio Engineers (1913-1936), with an index by author and an index by subject.

\$1.00 per copy

Postpaid to the U.S. & Canada. Elsewhere, postage 10 cents additional.

Remittance should accompany your order

THE INSTITUTE OF RADIO ENGINEERS, INC.
330 West 42nd Street, New York, N.Y.

(Continued from page viii)

Connecting leads or "tabs" are mounted on the gauze base before the aluminum is applied, so that they become an integral part of the anode plate.

Units in this series are assembled in metal containers for horizontal mounting in a clip or for vertical mounting as shown in the accompanying drawing. Lugs protruding from the beaded edge of the container can be slipped into slots punched in the chassis and twisted with a slotted tool to hold the condenser in place. Slotted metal or bakelite mounting plates, like wafer-type tube sockets, are available for riveting to the chassis.

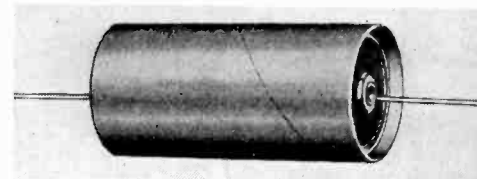

The Magnavox tubular fabricated-plate condenser

The Magnavox Company also manufactures a fabricated-plate condenser in a cardboard-insulated tubular case for mounting, either from its lead wires or in a strap-type clip.

Microphone Directivity by Combination of Ribbon and Dynamic Elements

In a directive microphone just developed, a "cardioid" unidirectional response characteristic is obtained by combining the equalized outputs of a dynamic and a ribbon unit, both mounted in the same housing. Besides, either unit may be used separately to give the non-directional response of a pressure (dynamic) microphone, or the bidirectional response of the velocity or pressure-gradient (ribbon) microphone. Western Electric* is sponsoring the device.

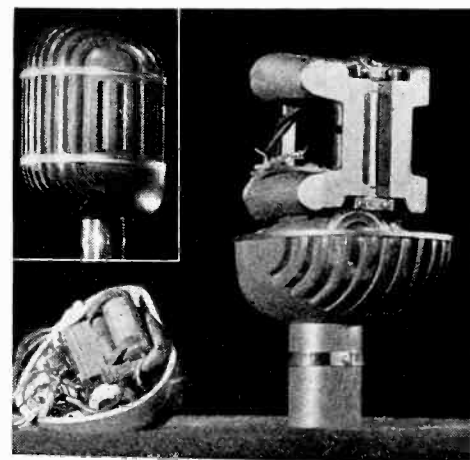

The dynamic microphone unit of the Western Electric unidirectional microphone can be seen below the ribbon unit. In the case at the left is mounted the ribbon transformer and equalizers

The polar sensitivity curve of the dynamic microphone is a circle, $r = a$, for example. That of the ribbon microphone is the 2-lobed figure, $r = a \cos \theta$. Then, roughly speaking, the response curve resulting from the equalized combination is the heart-shaped cardioid, $r = a(1 + \cos \theta)$.

* Western Electric Company, 195 Broadway, New York, New York.



RCA . . . the name symbolizing creation, progress, achievement in radio! RCA . . . Radio Corporation of America . . . a family of doers writing history with sound in the sky!

Makers of instruments for radio transmission and reception of sound, code messages and facsimile reproduction. Makers of instruments for the recording of sound on records and on motion picture film. Creators of countless radio devices vital to science, industry, medicine, telephony, and public safety.

RCA . . . creator of a nation-wide broadcasting service, The National Broadcasting Co.

RCA . . . creator of a world-wide radio communications system with direct circuits between the United States and 43 foreign countries, and with ships at sea . . . a message service with the speed of lightning.

RCA . . . pioneer in research in radio, sound and television.

RCA . . . truly American, owned by a quarter of a million stockholders in 48 states.

RCA . . . 19 years a name across the sky . . . 19 years of service to all the world.

Listen to the "MAGIC KEY" every Sunday, 2 to 3 P. M., E. S. T., on the NBC Blue Network.



Radio Corporation of America

RADIO CITY, N. Y.

RCA Manufacturing Co., Inc.

Radiomarine Corporation of America

RCA Institutes, Inc. National Broadcasting Company R.C.A. Communications, Inc.

MUELLER

UNIVERSAL

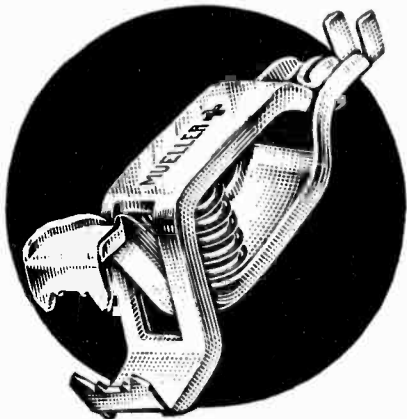

CLIPS

The complete Mueller Line offers a selection of test clips in all sizes for every purpose. Made in steel, solid copper, insulated, entirely non-ferrous etc. Stocked by jobbers everywhere. From 5 to 300 amperes.



The Wee-Pee-Wee



Insulated Alligator Clip



Solid Copper Test Clip

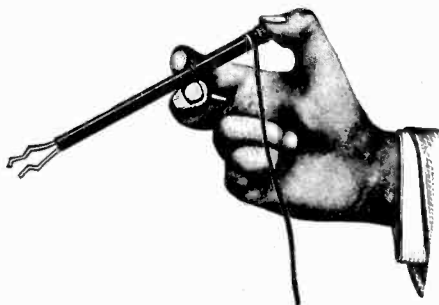

The Snapper
A long, insulated clip

SEND FOR CATALOG NO 805
AND FREE SAMPLES

Clip Makers for 30 Years

**MUELLER ELECTRIC
COMPANY**

1531 E. 31st St., Cleveland, Ohio.

(Continued from page x)

The dynamic unit was used in an earlier microphone, the so-called "eight ball," but the ribbon unit differs from conventional designs. The ribbon itself is made thicker and 10 to 15 times stiffer with the result that ruggedness is improved and wind noise reduced by some 10 decibels. It is given a cylindrical curvature over most of its length and is corrugated at each end so that the action is like a bar with a spring at each end.

Offhand, since sensitivity is proportional to the mass of the ribbon, it might seem that use of a thicker ribbon would result in too high a loss. But associated with the thicker ribbon is a reduction in electrical resistance. Practically, this permits a higher step-up in the ribbon transformer which tends to offset the loss.

In order to obtain a good directive discrimination in response between the "front" and "back" directions over a sufficiently wide frequency range, an equalizing network is employed in each output before combination. These correct for, among other factors, differences between the magnitude and phase of the voltage from each unit.

The output power level of the microphone (cardioid characteristic) is 84 decibels below 6 milliwatts, when terminated in its own impedance of 40 ohms. The minimum discrimination between "front" and "back" directions is 15 decibels in the range from 70 to 6000 cycles, and 10 decibels over the ranges from 40 to 70 cycles and from 6000 to 8000 cycles. The average discrimination is 10 decibels over the range from 40 to 10,000 cycles.

Microphone Directivity by Phase-Shifting Acoustical Network

A unidirectional microphone developed by Shure Brothers* employs a phase-shifting acoustical network associated with a diaphragm-type crystal unit, instead of a combination of pressure- and velocity-microphone elements, as has been conventional practice.

A simplified cross-sectional view of the mechanism illustrating the "uniphase" principle is shown in the accompanying drawing. The transducer itself consists of a curvilinear diaphragm driving a bimorph Rochelle Salt crystal by means of a connecting rod. The circular enclosure, instead of being



Schematic drawing to illustrate the uniphase principle

impermeable to sound as is the case with conventional pressure microphones, contains an acoustical network which allows the sound to enter the enclosure without change of magnitude but with an accompanying lag of phase angle ϕ equivalent to that undergone by the sound wave

* Shure Brothers, 225 West Huron Street, Chicago, Illinois.

travelling from the front to the back of the instrument.

The net effective pressure upon the crystal (and hence the voltage developed) is proportional to the vector difference of the pressures at the outer and inner sides of the diaphragm. Sound waves arriving from the front exert a pressure P upon the outer side of the diaphragm leading that exerted upon the inner side by an angle 2ϕ since the sound wave arriving inside of the enclosure undergoes the double phase shifting effect due to the distance travelled from front to rear plus that incurred in the network. The vector difference between these pressures is given by the expression $2P \sin \phi$.

Sound waves arriving from the back of the instrument arrive at the outer and inner sides of the diaphragm at substantially the same time since the phase lag undergone by the sound wave in reaching the inner side of the diaphragm through the network is equal to that undergone by the wave travelling around the case to the outer side of the diaphragm. The outer and inner pressures being equal and opposite have a cancelling effect upon each other and the output of the microphone approaches zero.

The voltage developed by the unidirectional crystal unit is proportional to frequency and an electrical network is employed to provide a high-quality frequency-response characteristic from 30 to 10,000 cycles. The polar characteristic is of a cardioid shape having a front-to-back discrimination of approximately 15 decibels.

Booklets, Catalogs and Pamphlets

The following commercial literature has been received by the Institute.

COAXIAL CABLES..... *Victor J. Andrew, 6429 S. Laverne Avenue, Chicago, Illinois, Bulletin 89 2 pages, 8½ × 11 inches.* Soft- and hard-copper coaxial cable and accessories for low- and high-power installations.

CRYSTAL TRANSDUCERS..... *Brush Development Company, 3311 Perkins Avenue, Cleveland, Ohio. Bulletin, 6 pages, 8½ × 11 inches.* Brief descriptions of Brush rochelle-salt crystal devices: microphones, headphones, pickups, etc.

FASTENING DEVICES..... *Parker-Kalon Corporation, 200 Varick Street, New York, New York. Catalog, 68 pages + cover, 8½ × 11 inches.* Description, specifications, and recommended uses for self-tapping screws, socket screws, etc.

TUBE DATA (RCA)..... *RCA Manufacturing Company, Harrison, New Jersey. Application Notes, 8½ × 10½ inches. No. 98, "On the Operation of Single-Ended Tubes," No. 99, "Revision of 6K8 Ratings," and No. 100, "On Operation of the 6SA7."*

TUBE DATA (SYLVANIA)..... *Hygrade Sylvania Corporation, Emporium, Pennsylvania. Bulletin 211, 8 pages, 8½ × 11 inches.* Tabular characteristics of receiving tubes, with base diagrams and dimensions.

IRE membership offers many services to the radio engineer

Proceedings—An outstanding publication in the radio engineering field. Over a quarter of a century of service to the world in publishing important radio engineering discoveries and developments, the PROCEEDINGS presents exhaustive engineering data of use to the specialist and general engineer. A list of its authors is a "Who's Who" of the leaders in radio science, research, and engineering.

Standards—Since 1914 our standards reports have stabilized and clarified engineering language, mathematics, graphical presentations, and the testing and rating of equipment. They are always in the process of revision and thus remain up to date

Meetings—In twenty-two cities in the United States and Canada, meetings of the Institute and its sections are held regularly. Scores of papers on practically every branch of the field are presented and discussed. Several convention meetings are sponsored by the Institute and add materially to its effectiveness in distributing data of value to engineers.

The Institute of Radio Engineers

Incorporated

330 West 42nd Street, New York, N.Y.

To the Board of Directors
Gentlemen:

I hereby make application for ASSOCIATE membership in the Institute of Radio Engineers on the basis of my training and professional experience given herewith, and refer to the members named below who are personally familiar with my work.

I certify that the statements made in the record of my training and professional experience are correct, and agree if elected, that I shall be governed by the Constitution of the Institute as long as I continue a member. Furthermore I agree to promote the objects of the Institute so far as shall be in my power, and if my membership shall be discontinued shall return my membership badge.

.....
(Sign with pen)

.....
(Address for mail)

.....
(City and State)

.....
(Date)

SPONSORS

(Signatures not required here)

Mr.

Address

City and State

Mr.

Address

City and State

Mr.

Address

City and State

ENTRANCE FEE SHOULD ACCOMPANY APPLICATION

A

ssociate membership affiliates you with the Institute and brings you the PROCEEDINGS each month as well as notices of meetings held near you.

(Typewriting preferred in filling in this form) No.....
RECORD OF TRAINING AND PROFESSIONAL EXPERIENCE

Name
(Give full name, last name first)

Present Occupation
(Title and name of concern)

Business Address

Home Address

Place of Birth Date of Birth Age

Education

Degree
(College) (Date received)

TRAINING AND PROFESSIONAL EXPERIENCE
(Give dates and type of work)

Record may be continued on other sheets of this size if space is insufficient.

Receipt Acknowledged Elected Notified

Requirements—For Associate membership, an applicant must be at least twenty-one years of age, of good character, and be interested in or connected with the study or application of radio science or the radio arts.

Sponsors—Three sponsors who are familiar with the work of the applicant must be named. Preferably these should be Associates, Members, or Fellows of the Institute. In cases where the applicant is so located as not to be known to the required number of member sponsors, the names of responsible nonmember sponsors may be given.

Dues—Dues for Associate membership are six dollars per year. The entrance fee for this grade is three dollars and should accompany the application.

Other Grades—Those who are between the ages of sixteen and twenty-one may apply for Junior grade. Student membership is available to full-time students in engineering or science courses in colleges granting degrees as a result of three-year courses. Member grade is open to older engineers with several years of experience. Information on these grades may be obtained from the Institute.

Aladdin

Permeability Tuning is Here!

Remarkable
NEW ALADDIN

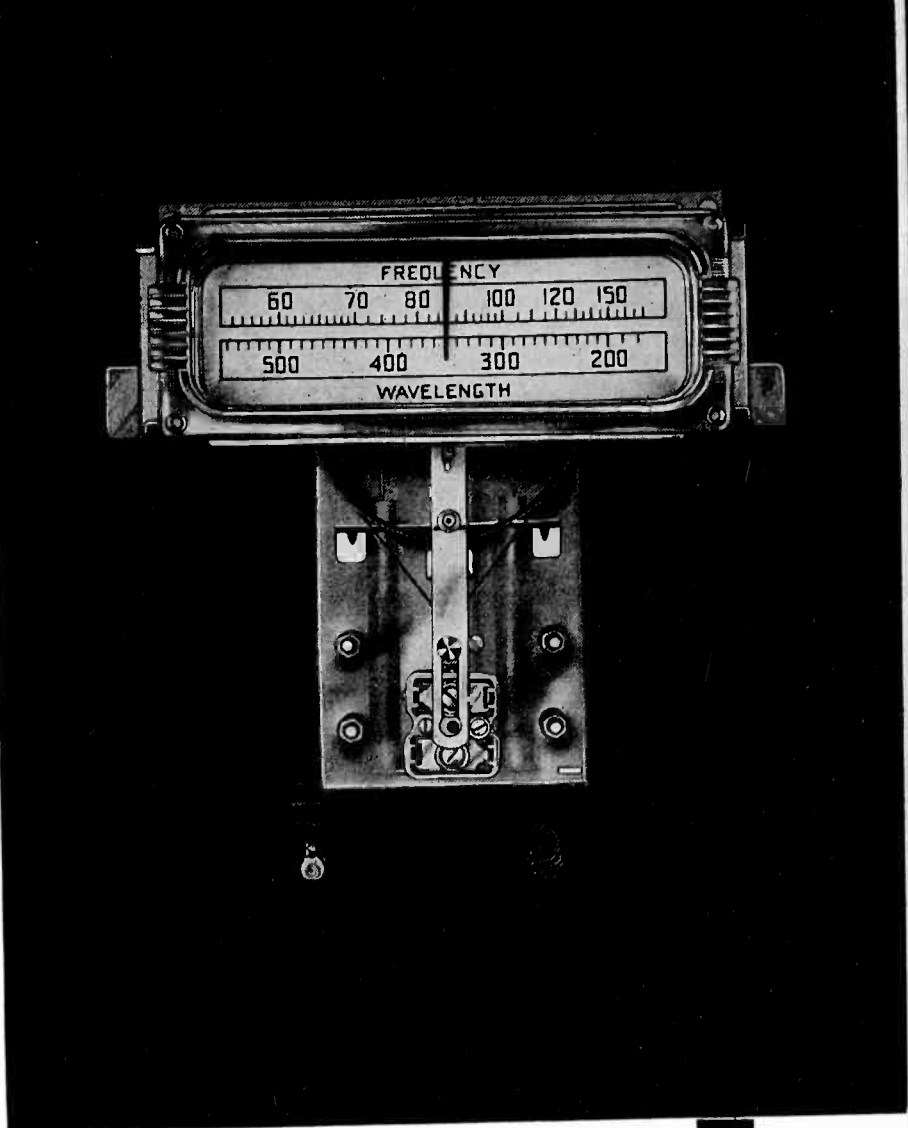

ELIMINATES GANG TUNING CONDENSERS!

PERFECT TRACKING WITH SINGLE POINT ALIGNMENT

Again, Aladdin Engineers contribute another important development to radio . . . the **NEW ALADDIN POLYIRON PERMEABILITY TUNER**. This remarkable assembly **ELIMINATES** gang tuning condensers! It takes the place of a 2-gang condenser, an antenna coil, and an oscillator coil, and combines the function of all three into one compact, simple movement. It assures perfect tracking with single point adjustment. Uniform antenna gain. Excellent image rejection. More freedom from microphonics. Simplifies assembly and wiring. Covers Broadcast band 1720 to 540 kc. Tuning ratio 6 to 1.

ALADDIN RADIO INDUSTRIES, INC.

466e W. Superior Street, Chicago, Ill.

Licensee of Johnson Laboratories, Inc.

These devices manufactured under one or more of the following U. S. Letters Patent:

1,887,380	1,978,600	2,002,500	2,032,580	2,051,012	2,082,590	2,104,792	2,111,490	2,131,976
1,940,228	1,982,689	2,005,203	2,035,439	2,059,393	2,082,595	2,106,226	2,111,373	2,135,841
1,978,568	1,982,690	2,018,626	2,037,883	2,082,587	2,094,189	2,106,229	2,113,603	Other pat-
1,978,599	1,997,453	2,028,534	2,038,281	2,082,589	2,095,420	2,106,253	2,122,874	ents pending



Reg. U. S. Pat. Off.

ENGINEERING DIRECTORY

Consultants, Patent Attorneys,
Laboratory Services

CONSULTANTS AND DESIGNERS

including
Amplifiers · Antennas · Transmitters
Receivers · Laboratory Equipment
Special equipment designed
and constructed
**RADIO DEVELOPMENT &
RESEARCH CORP.**
145 West 45th Street, New York, N.Y.
Tel. BRyant 9-6898

**BRUNSON S. McCUTCHEN and
CHARLES B. AIKEN**
Consulting Engineers

Technical cooperation with Attorneys in
connection with patent litigation—De-
sign and Development work—Audio and
radio frequency measurements—Equip-
ment studies—Receiver and transmitter
problems—A well equipped laboratory.
75 West Street Telephone
New York City Whitehall 4-7275

MADISON CAWEIN

Consultant in Television Problems

Design and Construction of
Television Receiver Test Equipment
Television Tube Test Equipment
Special Oscilloscopes
Television Receivers
Studio Transmitter Equipment

17 Beachwood Ave., Manhasset, N.Y.
Manhasset 1361M

ALFRED CROSSLEY Consulting Engineer

Radio-engineering problems involving
receiver design, iron-core investigations,
and A- and B-battery substitutes

549 West Randolph Street, Chicago,
Illinois; Telephone STAt 7444

Use this directory . . .

when you need consulting serv-
ices

when you are asked to suggest
the name of a specialist on an en-
gineering or patent problem

Consulting Engineers, Patent Attor-
neys, Laboratory Services . . . Applica-
tions for card space in the Engineering
Directory are invited. Complete data
will be sent on request to

PROCEEDINGS of the I.R.E.

330 West 42nd Street New York, N.Y.

INDEX

COMMERCIAL ENGINEERING DE- VELOPMENTS	ii
BOOKLETS, CATALOGS, & PAMPHLETS	xii
POSITIONS OPEN	xvi
ENGINEERING DIRECTORY	xvi

DISPLAY ADVERTISERS

A

Aerovox Corporation	iii
Aladdin Radio Industries, Inc.	xv
American Telephone & Telegraph Company	i
Amperex Electronic Products, Inc.	iv

C

Cornell-Dubilier Electric Corpora- tion	xviii
--	-------

D

Daven Company, The	v
Drake Manufacturing Company	viii

G

General Radio Company	Cover IV
---------------------------------	----------

I

Institute of Radio Engineers	x
International Resistance Company	ix

M

Mueller Electric Company	xii
------------------------------------	-----

O

Ohmite Manufacturing Company	vi
--	----

R

RCA Manufacturing Company, Inc.	Cover III
Radio Corporation of America	xi

S

Shure Brothers	viii
--------------------------	------

T

Terminal Radio Corporation	vi
Triplett Electrical Instruments Com- pany	vii

W

Western Electric Company	xvii
------------------------------------	------

POSITIONS OPEN

The following positions of interest
to I.R.E. members have been re-
ported as open on December 27.
Make your application in writing
and address it to

Box No.

PROCEEDINGS of the I.R.E.
330 West 42nd Street, New York, N.Y.

TELEVISION SERVICE

**INSTALLATION AND SERV-
ICE** department of a television-
receiver manufacturer wants engi-
neers for educational, contact, and
service work among dealers in
the New York area. Applicants
should be engineering graduates
familiar with radio equipment
through practical service or ama-
teur experience. Give full details
of education and experience. Pres-
ent staff knows of these openings.
Box No. 192.

RECEIVER ENGINEERS

RADIO BROADCAST receiver
engineer having formal technical
education and several years of
practical experience in all phases
of receiver design wanted by large
Chicago manufacturer. Our pres-
ent staff knows of this opening.
Box No. 190.

EXPERIENCED AUTO and
household radio engineers, and
mechanical designers wanted.
Technical training and actual de-
sign experience required. Colonial
Radio Corporation, 254 Rano
Street, Buffalo, N.Y.



Attention Employers . . .

Announcements for "Positions
Open" are accepted without charge
from employers offering salaried
employment of engineering grade
to I.R.E. members. Please supply
complete information and indicate
which details should be treated as
confidential. Address: "POSITIONS
OPEN," Institute of Radio Engi-
neers, 330 West 42nd Street, New
York, N.Y.

The Institute reserves the right to refuse any
announcement without giving a reason for
the refusal



Pick-up Control
 you never dreamed of
 ...with NEW microphone by
Western Electric

It's the answer to a sound-transmission engineer's prayer! — The new Western Electric Cardioid Directional—the microphone that gives you pick-up control never approached by even the best dynamic or ribbon mikes!

The key to this control is cardioid directivity—for all ranges from the lowest bass to the highest overtone. Bell Telephone Laboratories achieved this by combining dynamic and ribbon units in one mike and electrically equalizing and combining their outputs.

In addition to this realization of true cardioid pick-up, a 3-way switch enables you to use either unit independently. This makes the 639A either a dynamic or a ribbon

mike at your will. One way or another, it can handle *any* situation!

Small, sturdy, beautifully streamlined, the 639A is interchangeable with the 8-Ball and Salt-Shaker on stands using the 442A Jack. It greatly simplifies pick-up technique—assures balance, clarity and fidelity of pick-up that will give you a new conception of what broadcast quality can now be!

For booklet giving full details, write to Graybar. Better still, order one mike—put it “over the jumps”—and tell us how many more you want!

DISTRIBUTORS:

Graybar Electric Co., Graybar Building, New York.
 In Canada and Newfoundland: Northern Electric Co., Ltd. In other countries: International Standard Electric Corp.

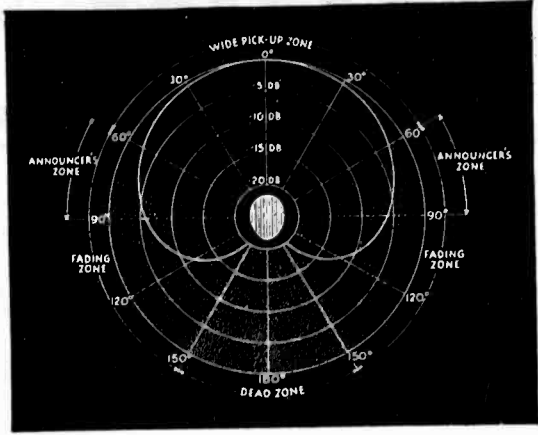

1. Cardioid directional response of 639A.

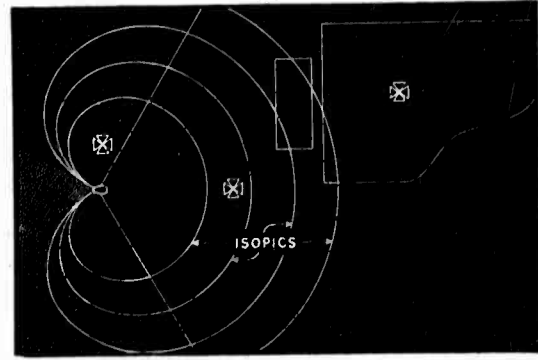

2. Showing isopics, or lines of equal pick-up.

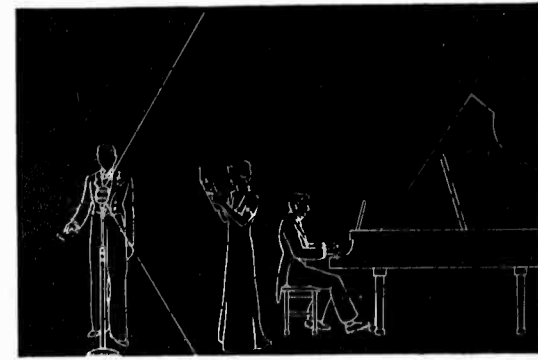

3. 120° pick-up angle lessens need for tilting.

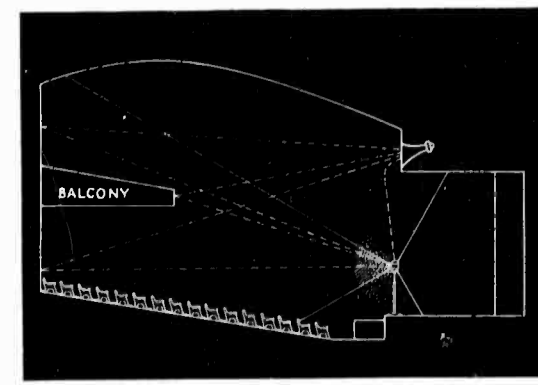

4. No feedback from rear of playhouse.

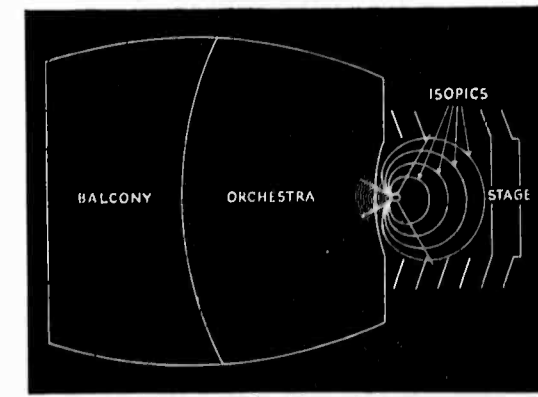

5. Ideal for dividing stage and audience.

**A MODERN PLANT DEVOTED TO THE
MANUFACTURE OF MODERN CAPACITORS**

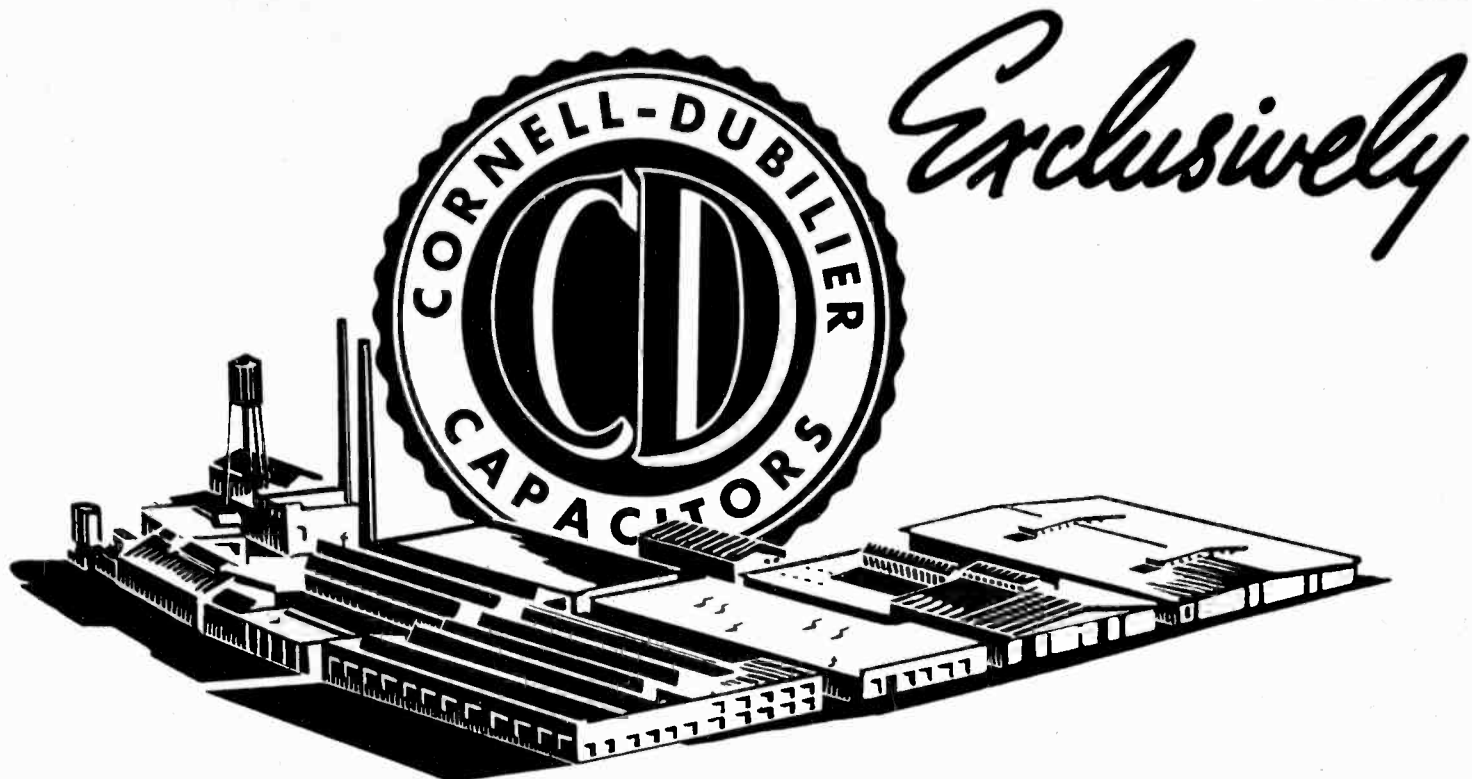

CORNELL-DUBILIER *{World's Largest & Oldest
Capacitor Manufacturers}*

Capacitors for every radio & electrical use

MICA • DYKANOL • PAPER • WET AND DRY ELECTROLYTIC

A few of the applications for which C-D capacitors are available:

- RADIO RECEIVING
 - TRANSMITTING
 - TELEPHONE
 - TELEVISION
 - TELEGRAPH
 - RECORDING INSTRUMENTS
 - PHOTO ELECTRIC CELL APPLICATIONS
 - AMPLIFIERS
 - CONTACT SPARK ELIMINATION
 - INTERFERENCE ELIMINATION
 - X-RAY APPLICATIONS
 - THERAPEUTIC AND DYATHERMY
 - MOTOR STARTING METERS
 - POWER-FACTOR IMPROVEMENT
 - HIGH TENSION LINES
 - EXPERIMENTAL AND RESEARCH WORK
 - LIGHTNING SURGE CAPACITORS
 - CARRIER CURRENT WORK, ETC.
- ELECTRONIC APPLICATIONS • ULTRA HIGH VOLTAGE • ULTRA HIGH FREQUENCY AND HEAVY CURRENT APPLICATIONS • WELDING

Our engineering department will be glad to cooperate with you in obtaining the most economical and efficient type unit for your requirements. Your inquiries are invited. Catalog No. 160 on request.



**CORNELL-DUBILIER
ELECTRIC CORPORATION**

1012 Hamilton Boulevard, South Plainfield, New Jersey

Cable Address: "CORDU"

Tomorrow's
Tube TODAY!

NEW RCA 813

**gives 260 watts output
with less than 1 watt
Driving Power!**



IT'S A FACT! This sensational new RCA Beam Power Transmitting Tube actually requires less than one watt driving power to give 260 watts output in Class "C" Telegraph service. Needing no neutralization, a pair of 813's makes a bang-up final for that quick-band-change, high-power transmitter.

The new 813, is among the finest transmitting tubes RCA has ever developed, employs a new stem structure which makes practical a compact tube—only 7½" long—having very short heavy leads and low lead inductance. Because of its design, this new high-power beam tube can be operated at full ratings up to 30 megacycles without neutralization.

Other noteworthy features of this new tube are: Heavy-duty thoriated-tungsten filament, oversized graphite plate, dome-top bulb with cushion mount supports, low screen current, and a new Giant 7-pin base having short shell and wide pin spacings.

Typical Operation (Class "C" Telegraphy)

Filament Voltage
10 volts (a. c. or d. c.)

Filament Current
5 amperes

D-C Plate Voltage
2000 volts

D-C Screen Voltage
400 volts

D-C Grid Voltage
-90 volts

D-C Plate Current
180 milliamperes

D-C Screen Current
15 milliamperes

Driving Power
0.5 watt

Power Output
260 watts

Price, \$28.50



View of moulded glass stem assembly showing individual lead seals.

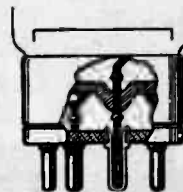

Cut-away view showing short, heavy leads to terminal pins.



Radio Tubes

RCA MANUFACTURING COMPANY, INC., CAMDEN, N. J.

A Service of the Radio Corporation of America

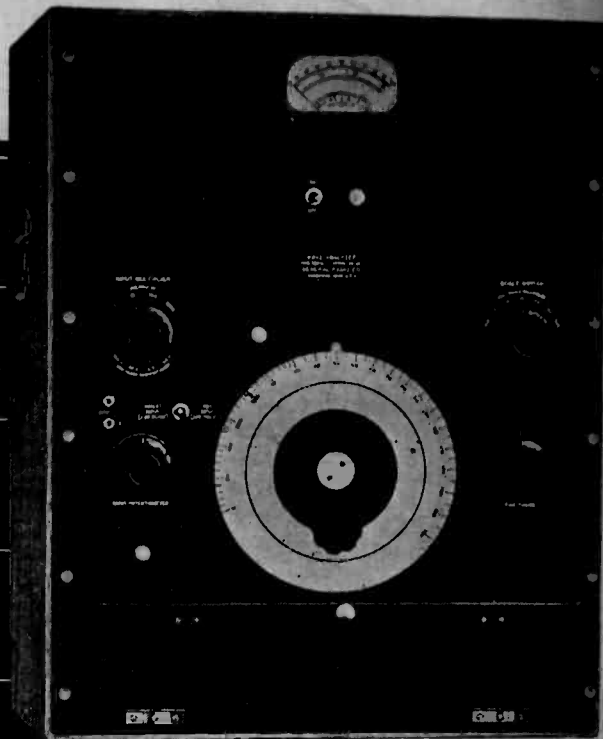
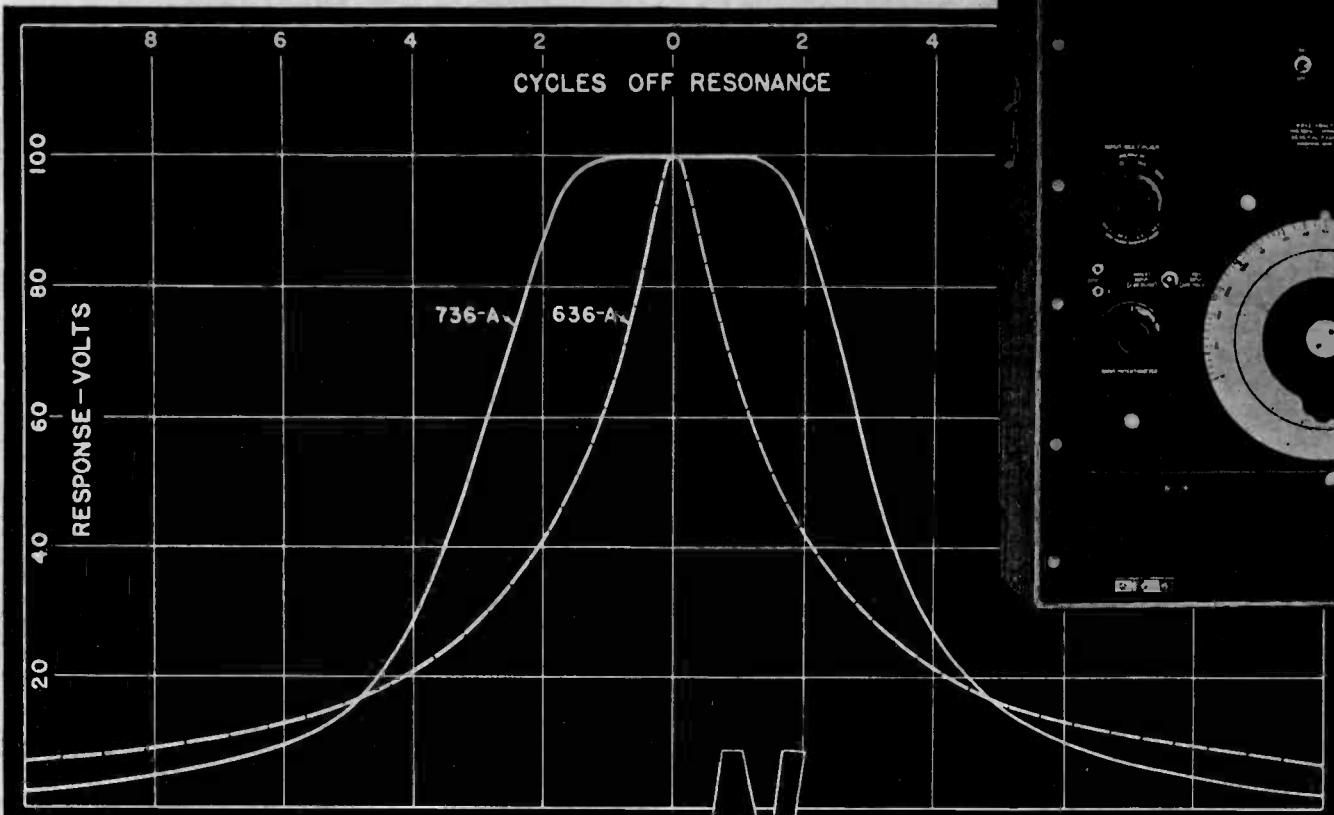

New Wave Analyzer

THE NEW Type 736-A Wave Analyzer provides the simplest and most accurate method for making analyses of harmonic distortion in audio-frequency equipment, broadcasting receivers and transmitters, telephones for public-address systems, oscillators and vacuum-tube circuits of all types; in electrical power systems and electrical machinery.

The new analyzer has the following mechanical and electrical improvements which contribute to its increased sensitivity, improved stability and more convenient operation:

- **CRITICAL TUNING UNNECESSARY:** flat-top tuning characteristic 4 cycles wide (see curve)
- **IMPROVED SELECTIVITY:** new 3-crystal filter increases discrimination against unwanted voltage. Attenuation at 60 cycles from resonance is 75 db (0.02%)
- **EASIER OPERATION:** improved calibration circuit makes precise balancing unnecessary and speeds up measurements
- **EXTENDED VOLTAGE RANGE:** 300 microvolts to 300 volts, full scale, with 1 megohm input impedance
- **INCREASED STABILITY:** all components protected from effects of humidity. Oscillator and amplifier stability improved greatly
- **A-C OPERATION:** with hum voltage less than 50 microvolts
- **NO EXTERNAL MAGNETIC PICK-UP:** balanced modulator is fed by a phase-inverter tube instead of a transformer

TYPE 736-A WAVE ANALYZER\$640.00

Write for Bulletin 347 for complete data

GENERAL RADIO COMPANY
 CAMBRIDGE, MASSACHUSETTS
 BRANCHES: New York and Los Angeles

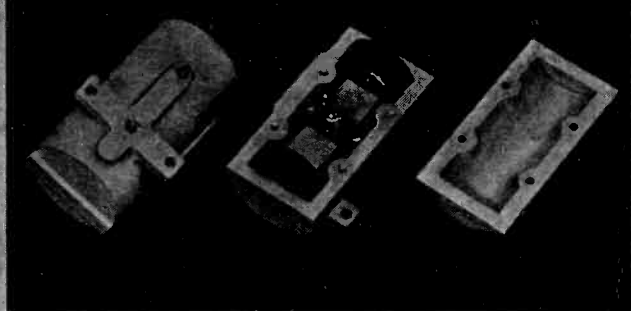

Hermetically sealed, 3-electrode quartz crystal in rubber-cushioned, cast mounting frame

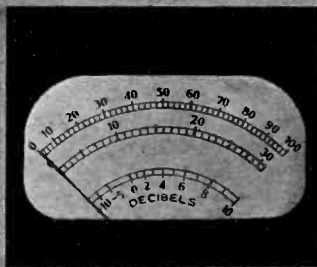

Illuminated linear meter with auxiliary db scale

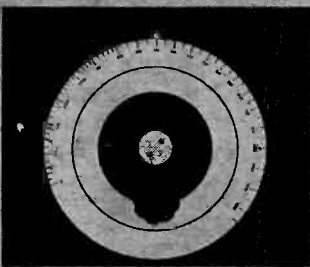

Direct reading from zero to 16,000 cycles

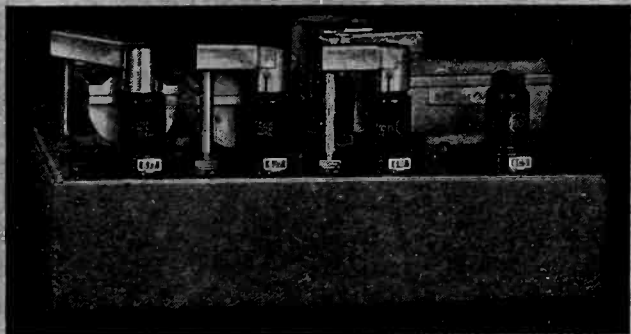

Low-impedance, stable, aperiodic amplifier of moisture-proof construction

PRECISION ELECTRICAL LABORATORY APPARATUS

