

TOTH ✓

VOLUME 25

MAY, 1937

NUMBER 5

PROCEEDINGS
of
**The Institute of Radio
Engineers**



Silver
Anniversary Convention
May 10, 11, and 12, 1937
New York, N. Y.

Application Blank for Associate Membership on Page XI

**INSTITUTE OF RADIO ENGINEERS
SILVER ANNIVERSARY CONVENTION
HOTEL PENNSYLVANIA, NEW YORK, N.Y.**

MAY 10, 11, and 12, 1937

Sunday—May 9

4:00 P.M.—6:00 P.M. Registration.

Monday—May 10

**9:00 A.M. Registration and opening of exhibition.
10:30 A.M.—12:30 P.M. Official Welcome and Technical Session.
10:30 A.M.—11:30 A.M. Ladies meet in Parlor
12:30 P.M.— 6:00 P.M. Trip No. 1. Ladies sightseeing trip.
2:30 P.M.— 5:00 P.M. Technical Session—Ballroom.
6:00 P.M. Close of registration and exhibition.**

Tuesday—May 11

**9:00 A.M. Registration and opening of exhibition.
10:00 A.M.—12 noon Technical Session—Ballroom.
10:30 A.M. Trip No. 2. Ladies trip to Macy's department store and luncheon.
1:45 P.M.— 6:00 P.M. Trip No. 3. Men's trip to American Telephone and
Telegraph Company, or RCA Radiotron plant, or WOR
transmitter, or sightseeing tour of Manhattan.
6:00 P.M. Close of registration and exhibition.**

Wednesday—May 12

**9:00 A.M. Registration and opening of exhibition.
10:00 A.M.—12:30 P.M. Technical Session—Ballroom.
10:00 A.M. Trip No. 4. Ladies sightseeing tour, luncheon, and Metropolitan
Museum of Art.
2:00 P.M.— 5:00 P.M. Technical Session—Ballroom.
3:00 P.M. Close of registration and exhibition.
7:00 P.M. Silver Anniversary Banquet—Ballroom.**

EASTERN DAYLIGHT SAVING TIME

PROCEEDINGS OF

The Institute of Radio Engineers

VOLUME 25

May, 1937

NUMBER 5

Board of Editors

ALFRED N. GOLDSMITH, *Chairman*

R. R. BATCHER	B. E. SHACKELFORD
P. S. CARTER	K. S. VAN DYKE
F. W. GROVER	H. P. WESTMAN, <i>ex officio</i>
J. W. HORTON	L. P. WHEELER
G. W. PICKARD	L. E. WHITTEMORE

WILLIAM WILSON

CONTENTS

PART I

Frontispiece, Statue of Liberty.....	522
Institute News and Radio Notes.....	523
Silver Anniversary Convention.....	523

PART II

Technical Papers

A Simplified Circuit for Frequency Substandards Employing a New Type of Low-Frequency Zero-Temperature-Coefficient Quartz Crystal.....	S. C. HIGHT AND G. W. WILLARD	549
The Harmonic Mode of Oscillation in Barkhausen-Kurz Tubes.....	W. D. HERSHBERGER	564
Grid Control of Radio Rectifiers.....	S. R. DURAND AND O. KELLER	570
The Fading Characteristics of the Top-Loaded WCAU Antenna.....	G. H. BROWN AND JOHN G. LEITCH	583
Application of the Autosynchronized Oscillator to Frequency Demodulation.....	J. R. WOODYARD	612
Lattice Attenuating Networks.....	GUY C. OMER, JR.	620
A Voltage Stabilized High-Frequency Crystal Oscillator Circuit.....	SAMUEL SABAROFF	623
Determination of the Radiating System which will Produce a Specified Directional Characteristic.....	IRVING WOLFF	630
Book Review: "Radio Beacons," by V. I. Bashenoff and N. A. Mjascoedoff.....	J. H. DELLINGER	644
Contributors to This Issue.....		645

The Institute of Radio Engineers

GENERAL INFORMATION

INSTITUTE. The Institute of Radio Engineers was formed in 1912 through the amalgamation of the Society of Wireless Telegraph Engineers and the Wireless Institute. Its headquarters were established in New York City and the membership has grown from less than fifty members at the start to several thousand.

AIMS AND OBJECTS. The Institute functions solely to advance the theory and practice of radio and allied branches of engineering and of the related arts and sciences, their application to human needs, and the maintenance of a high professional standing among its members. Among the methods of accomplishing this is the publication of papers, discussions, and communications of interest to the membership.

PROCEEDINGS. The PROCEEDINGS is the official publication of the Institute and in it are published all of the papers, discussions, and communications received from the membership which are accepted for publication by the Board of Editors. Copies are sent without additional charge to all members of the Institute. The subscription price to nonmembers is \$10.00 per year, with an additional charge for postage where such is necessary.

RESPONSIBILITY. It is understood that the statements and opinions given in the PROCEEDINGS are views of the individual members to whom they are credited, and are not binding on the membership of the Institute as a whole. Papers submitted to the Institute for publication shall be regarded as no longer confidential.

REPRINTING PROCEEDINGS MATERIAL. The right to reprint portions or abstracts of the papers, discussions, or editorial notes in the PROCEEDINGS is granted on the express condition that specific reference shall be made to the source of such material. Diagrams and photographs published in the PROCEEDINGS may not be reproduced without making specific arrangements with the Institute through the Secretary.

MANUSCRIPTS. All manuscripts should be addressed to the Institute of Radio Engineers, 330 West 42nd Street, New York City. They will be examined by the Papers Committee and the Board of Editors to determine their suitability for publication in the PROCEEDINGS. Authors are advised as promptly as possible of the action taken, usually within two or three months. Manuscripts and illustrations will be destroyed immediately after publication of the paper unless the author requests their return. Information on the mechanical form in which manuscripts should be prepared may be obtained by addressing the secretary.

MAILING. Entered as second-class matter at the post office at Menasha, Wisconsin. Acceptance for mailing at special rate of postage is provided for in the act of February 28, 1925, embodied in Paragraph 4, Section 412, P. L. and R., and authorization was granted on October 26, 1927.

Published monthly by

THE INSTITUTE OF RADIO ENGINEERS, INC.

Publication office, 450-454 Ahnaip St., Menasha, Wis.

BUSINESS, EDITORIAL, AND ADVERTISING OFFICES

Harold P. Westman, *Secretary*

330 West 42nd Street, New York, N. Y.

INSTITUTE SECTIONS

- ATLANTA—Chairman, N. B. Fowler; Secretary, G. S. Turner, Federal Communications Commission, 411 Federal Annex, Atlanta, Ga.
- BOSTON—Chairman, E. L. Bowles; Secretary, Roland G. Porter, Northeastern University, Boston, Mass.
- BUFFALO-NIAGARA—Chairman, George C. Crom; Secretary, E. C. Waud, 235 Huntington Ave., Buffalo, N. Y.
- CHICAGO—Chairman, J. K. Johnson; Secretary, V. J. Andrew, 7221 San Francisco Ave., Chicago, Ill.
- CINCINNATI—Chairman, G. F. Platts; Secretary, A. P. Richards, Crosley Radio Corporation, 1329 Arlington St., Cincinnati, Ohio.
- CLEVELAND—Chairman, R. A. Fox; Secretary, R. L. Kline, Winteradio, Inc., 3014 Lorain Ave., Cleveland, Ohio.
- CONNECTICUT VALLEY—Chairman, F. H. Scheer; Secretary, C. E. Keeler, 59 Fairfield St., Springfield, Mass.
- DETROIT—Chairman, R. L. Davis; Secretary, Howard S. Gould, 214 Tuxedo Ave., Detroit, Mich.
- EMPORIUM—Chairman, M. I. Kahl; Secretary, R. N. Palmer, Hygrade Sylvania Corporation, Emporium, Pa.
- INDIANAPOLIS—Temporary Secretary-Treasurer, I. M. Slater, P. R. Mallory and Company, 3029 E. Washington St., Indianapolis, Ind.
- LOS ANGELES—Chairman, Douglas Kennedy; Secretary, F. G. Albin, United Artists Studios, 1041 N. Formosa Ave., Los Angeles, Calif.
- MONTREAL—Chairman, A. M. Patience; Secretary, W. R. Wilson, Canadian Marconi Company, Mount Royal, Que., Canada.
- NEW ORLEANS—Chairman, L. J. N. Du Treil; Secretary, G. H. Peirce, Electrical Research Products, Inc., 1631 Canal Band Bldg., New Orleans, La.
- PHILADELPHIA—Chairman, Irving Wolff; Secretary, R. L. Snyder, 103 Franklin Rd., Glassboro, N. J.
- PITTSBURGH—Chairman, Branko Lazich; Secretary, W. P. Place, Curtis St., R.D. 1, Wilkinsburg, Pa.
- ROCHESTER—Chairman, Lee A. Du Bridge; Secretary, H. A. Brown, 89 East Ave., Rochester, N. Y.
- SAN FRANCISCO—Chairman, V. J. Freiermuth; Secretary, C. J. Penther, 1000 Aileen St., Oakland, Calif.
- SEATTLE—Chairman, J. W. Wallace; Secretary, R. O. Bach, Pacific Telephone and Telegraph Company, 820 Fairview Ave., N., Seattle, Wash.
- TORONTO—Chairman, B. de F. Bayly; Secretary, H. P. Knap, Stromberg-Carlson Tel. Mfg. Company, 211 Geary St., Toronto, Ont., Canada.
- WASHINGTON—Chairman, W. B. Burgess; Secretary, E. H. Rietzke, 3308 14th Ave., N. W., Washington, D. C.

GEOGRAPHICAL LOCATION OF MEMBERS ELECTED
APRIL 7, 1937

Elected to the Associate Grade

California	San Diego, U.S.S. Holland.....	Bolen, F.
Delaware	Wilmington, National Vulcanized Fibre Co.....	Otis, J. O.
District of Columbia	Bellevue, U. S. Naval Research Lab.....	Williams, C. L.
Illinois	Chicago, 309 S. Clark St.....	Gootee, T. E.
	Chicago, Northmere Hotel, 4943 Kenmore Ave.....	Haubrich, A. M.
Minnesota	Redwood Falls.....	Winter, H.
New Jersey	Arlington, 61 Clinton Ave.....	Richardson, H. M.
	East Orange, 96 N. Walnut St.....	Barnes, G. W.
	Fort Monmouth, 15th Signal Service Co.....	Lyon, A. C.
	Jersey City, 260 Jewett Ave.....	Dalton, J. L.
	Linden, 1200 Roselle St.....	Wilner, J. T.
	Newark, 27 Pomona Ave.....	Finklestein, S. B.
	Princeton, Palmer Physics Labs.....	Harnwell, G. P.
New York	Brooklyn, 55 Hanson Pl.....	Rettenmeyer, R. D.
	New York, 74 Trinity Pl.....	Ellis, F. C.
	New York, Sonotone Corp., 19 W. 44th St.....	Pearson, H. A.
	Stapleton, S. I., U.S.S. Champlain C.G., Pier 18.....	Little, W. A.
Ohio	Cincinnati, 1410 Yarmouth Ave.....	Etter, C. W.
	Cincinnati, 5630 Ridge Ave.....	Hackman, E.
Oklahoma	Enid, Box 298.....	Clopton, A. B.
Pennsylvania	Edgewood, 207 Elm St.....	Pickels, G. W.
	Emporium, 7 E. 4th St.....	Kiser, N. L.
	Emporium, 210 W. Allegheny Ave.....	Sassaman, F. H.
	Williamsport, 340 W. 4th St.....	Phipps, G. A.
Belgium	Liege, 3 Rue de Chaudfontaine.....	Bielefeldt, H.
Canada	Montreal, P. Q., 377 Fairmount Ave. W.....	Hammond, J. W.
	Montreal, P. Q., 3837 St. Denis St.....	Henry, M.
	Montreal, P. Q., Engineering Bldg., McGill Univ.....	Howes, F. S.
	Montreal, P. Q., 1261 Shearer St.....	Hunt, A. B.
	Nipigon, Ont.....	Slater, E. W.
	Prince George, B. C.....	McLean, L. D.
Canal Zone	Pedro Miguel, Box 236.....	Shaw, N. N.
Colombia	Bogota, Apartado 1266.....	Amore, I.
	Bogota, c/o Ministerio De Correos y Telegrafos.....	Zapata, E. S.
Cuba	Havana, 3a Avenida y Calle 34, Miramar.....	Mendoza, N. G.
England	London, N. 11, 42 Brookdale, New Southgate.....	Chiang, C. R.
	London, S.W. 1, c/o Egyptian Education Office, 4 Central Bldgs.....	Mahmoud, H. M.
	Portishead, Somerset, "Solheim," Down Rd.....	Shorten, G. J.
	South Kensington, S.W. 7, c/o Lloyds Bank Ltd.....	Puri, K. L.
Poland	Warszawa, Wepolna 35 m. 18.....	Gurtzman, J.
Venezuela	Caracas, Sur 6-157.....	Gil-Borges, J.
	Caracas, Oeste 7, No. 76.....	Jimenez, L. G.

Elected to the Junior Grade

California	Los Angeles, 927 Beacon Ave.....	Grumbein, P., Jr.
Canada	Toronto, Ont., 34 Broadway Ave.....	Simmonds, L. C.

Elected to the Student Grade

California	Berkeley, 2498 Piedmont Ave.....	Jones, D. E.
	Oakland, 5927 Chabolyln Ter.....	Organ, W. H.
	Pasadena, Blacker House, California Inst. of Tech.....	Miller, C. N.
	Stanford University, Box 1182.....	Barnes, F. P.
Illinois	Urbana, 1205 W. Clark St.....	Kempf, R. A.
Iowa	Iowa City, 521 E. College St.....	Safra, J.
Massachusetts	Cambridge, M.I.T. Dormitories.....	Gilman, M. A.
	Cambridge, M.I.T. Dormitories.....	Winans, R. C.
Michigan	Ann Arbor, 1142 E. Catherine St.....	Vadhana, S. T.
	Detroit, 5221 Crane Ave.....	Berg, C. N.
Minnesota	Minneapolis, 2852-44th Ave. S.....	Prestholdt, O.
New York	Forest Hills, L.I., 7727 Kew Forest Lane.....	Robinson, J. T.
	Syracuse, 809 Madison St.....	Peckham, M. A.
Pennsylvania	Philadelphia, 3300 Richmond St.....	Rubin, H.
Washington	Seattle, 6817-19th Ave. N.E.....	Cole, R. J., Jr.
West Virginia	Wheeling, 100 Maple Tree Lane.....	McLain, W. W.
Canada	Montreal, P. Q., 3483 Peel St.....	Dean, W. W. H.
	Toronto 6, Ont., 182 Fulton Ave.....	Anthes, R. G.

APPLICATIONS FOR MEMBERSHIP

Applications for transfer or election to the various grades of membership have been received from the persons listed below, and have been approved by the Admissions Committee. Members objecting to transfer or election of any of these applicants should communicate with the Secretary on or before May 31, 1937. Final action will be taken on these applications on June 2, 1937.

For Election to the Associate Grade

District of Columbia	Washington, 1828 Ingleside Ter. N.W.	Anspach, A. A.
	Washington, 4610 Eastern Ave. N.E.	Burns, D. G.
	Washington, 1803 Monroe St. N.W.	Dean, E. H.
	Washington, 2212 Que St. S.E.	Hagen, J. P.
	Washington, 1537 Monroe St. N.W.	Hunter, D. O.
	Washington, 1321 Irving St. N.W.	James, C. T.
	Washington, 5109-3rd St. N.W.	Newman, S. E.
	Washington, 3440-34th Pl. N.W.	Varela, A. A.
Florida	Jacksonville, 2521 Calvin St.	Goins, C. L.
Georgia	Atlanta, Box 2211	Hughes, J. S.
Illinois	Chicago, 6431 S. Harper	Moore, C.
	Chicago, 1546 Juneway Ter.	Schlesinger, W. A.
	LaGrange, 136 Dover St.	Hagey, W. C.
Kansas	Kansas City, 1524 S. 17th St.	Foster, C. L.
Kentucky	Anchorage, R.R. No. 2	Williams, L. A.
Massachusetts	Bondsville, 12 State St.	Chapman, T. P.
	Cambridge, 24 Fisk Pl.	Mitropoulos, T. N.
	Watertown, 114 Charles River Rd.	Overbeck, W. P.
Michigan	Ann Arbor, 818 W. Liberty St.	Sturgeon, S. S.
	Dearborn, 7039 Kendal Ave.	Weaver, R. D.
	Detroit, 1313 Seward Ave.	Webster, R. A.
	Dover, 47 W. Fairview Ave.	Cook, L. L.
New Jersey	Lyndhurst, 487-5th Ave.	Roemisch, J. L.
	Springfield, 9 Prospect Pl.	Knowlton, C. S.
	Summit, 38 Shadyside Ave.	Michon, A. E.
New York	Albany, 20 Austin Ave.	Decker, J. L.
	Brooklyn, 1588 E. 14th St.	Frankel, S.
	Brooklyn, 269 Prospect Pl.	Kensinger, J. C.
	Brooklyn, 339 E. 18th St.	Quick, H. L., 2nd.
	New York, U.S.S. Nokomis, c/o Postmaster	Bridges, H. O.
	New York, 35 Hillside Ave.	Campbell, J. B.
	New York, 463 West St.	Trucksess, D. E.
	Rochester, 195 Merwin Ave.	Quick, R. G.
	Schenectady, E. E. Bldg., Union College.	Haefner, S. J.
	West Hempstead, L. I., 52 Buckingham Rd.	Thiede, F. C. W.
North Carolina	Charlotte, c/o Western Union Tel. Co.	Stewart, A. E.
Ohio	Cincinnati, 3778 Drake Ave.	Brady, F. B.
	Cincinnati, Graybar Elec. Co., 310 Elm St.	Moore, R. E.
	Cincinnati, 4220-33rd St.	Siemer, H. R.
	St. Bernard, 115 Baker Ave.	Breitfelder, W. J.
Pennsylvania	Philadelphia, 4721 Sansom St.	McCoy, C. T.
	Pittsburgh, 36 St. Clair Dr., S.H.	Miller, W. M.
Rhode Island	Providence, 57 Waterman St.	Schmelzer, C. C.
Utah	Garland, Box 133	Burton, E. B.
Virginia	Alexandria, 119 Grove Ave.	Caulk, J. R.
West Virginia	Fairmont, 111 Virginia Ave.	Mills, H. A.
Alaska	Juneau, Station KINY, Box 2597	Heister, C. F.
Australia	Sydney, N.S.W., 34 Seymour St. S., Hurstville.	Hannam, H. W.
Canada	Montreal, P.Q., 7574 Stuart Ave.	Dewar, J. N.
	Montreal, P.Q., 1261 Shearer St.	Miller, J. J. H.
	Wadduwa, "Elettra"	Fernando, B. C.
Ceylon	Cairo, Wireless Section, E.A.A.F. Almaza.	Wassef, Y.
Egypt	Beckenham, Kent, 58a Foxgrove Rd.	Hale, J. A. B.
England	Croydon, Surrey, 17 South Park Hill Rd.	Hill, C. A. R.
	Derby, 18 Sadler Gate	Buckland, V.
	Dudley, Worcs., 27 New St.	Wilshere, S. A.
	Greenford, Middlesex, 6 Marden Gardens, Sudbury Heights.	Goddard, L. P.
	London N 5, Belmont, Highbury, New Park.	Drake, B.
	London N.W.10, 60 Donnington Rd., Willesden Green	Montague, D.
India	Bombay, Sethua Bldg., Sethua St., Thakurdwar	Mugaseth, P. P.
	Bombay, All India Radio, Irwin House	Sarin, D.
	Calcutta, c/o British Wireless Marine Service, 6 Old Post Office St.	Parkin, H.
Italy	Monza, c/o Philips Radio S.A.I.	del Vecchio, A.
New Zealand	Auckland, c/o Automatic Telephone Exchange, Wellesley St.	Sturges, C. H.
	Wellington, c/o 2YA, 124 Featherston St.	Huggins, W. P.

Applications for Membership

Philippine Islands	Bulacan, Muson Receiving Station, San Jose del Monte.	Stagner, G. H.
Roumania	Bucharest, 17 Dr. Capsa.	Popesco, A.
Sweden	Stockholm, Royal Technical Univ.	Palme, K. B.

For Election to the Junior Grade

District of Columbia	Washington, 3342-18th St. N.W.	Cheung, M. C.
	Washington, 3166-18th St. N.W.	Smith, W. A.
Maryland	Bethesda, 514 Maple Ridge Rd.	Pariseau, R. G.
New York	Brooklyn, 102 Ridgewood Ave.	Alter, B. E. K., Jr.
North Carolina	Hendersonville, R.F.D. No. 1.	Pike, W. N.

For Election to the Student Grade

California	Berkeley, 2552 Haste St.	Gilardi, A. J.
	Palo Alto, 510 Columbia St.	Buss, R. R.
Connecticut	New Haven, 22 Asylum St.	Altieri, V. J.
Indiana	West Lafayette, 300 Sylvia St.	Brewer, S. T.
	West Lafayette, 23 Waldron St.	Jensen, R. M.
	West Lafayette, 460 N. Grant St.	Shank, R. J.
Massachusetts	Cambridge, 71 Hammond St.	Chou, C. H.
Michigan	Detroit, 1970 Highland Ave.	Shiller, B.
Ohio	Dayton, 8 Bradford St.	Brelsford, H.
Pennsylvania	Nanticoke, 275 E. Main St.	Pensyl, D. S.
	Philadelphia, 45 Memorial Tower, Univ. of Pennsylvania.	Herr, D. L.



OFFICERS AND BOARD OF DIRECTORS

(Terms expire January 1, 1938, except as otherwise noted)

President

H. H. BEVERAGE

Vice President

P. P. ECKERSLEY

Treasurer

MELVILLE EASTHAM

Secretary

HAROLD P. WESTMAN

Editor

ALFRED N. GOLDSMITH

Directors

STUART BALLANTINE, *Past President*

T. A. M. CRAVEN

L. C. F. HORLE

C. M. JANSKY, JR.

C. B. JOLLIFFE

A. F. MURRAY

E. L. NELSON

HARADEN PRATT

B. J. THOMPSON

L. E. WHITEMORE

SERVING UNTIL JANUARY 1, 1939

E. H. ARMSTRONG

VIRGIL M. GRAHAM

ALAN HAZELTINE, *Past President*

SERVING UNTIL JANUARY 1, 1940

RALPH BOWN

H. M. TURNER

1713

1714

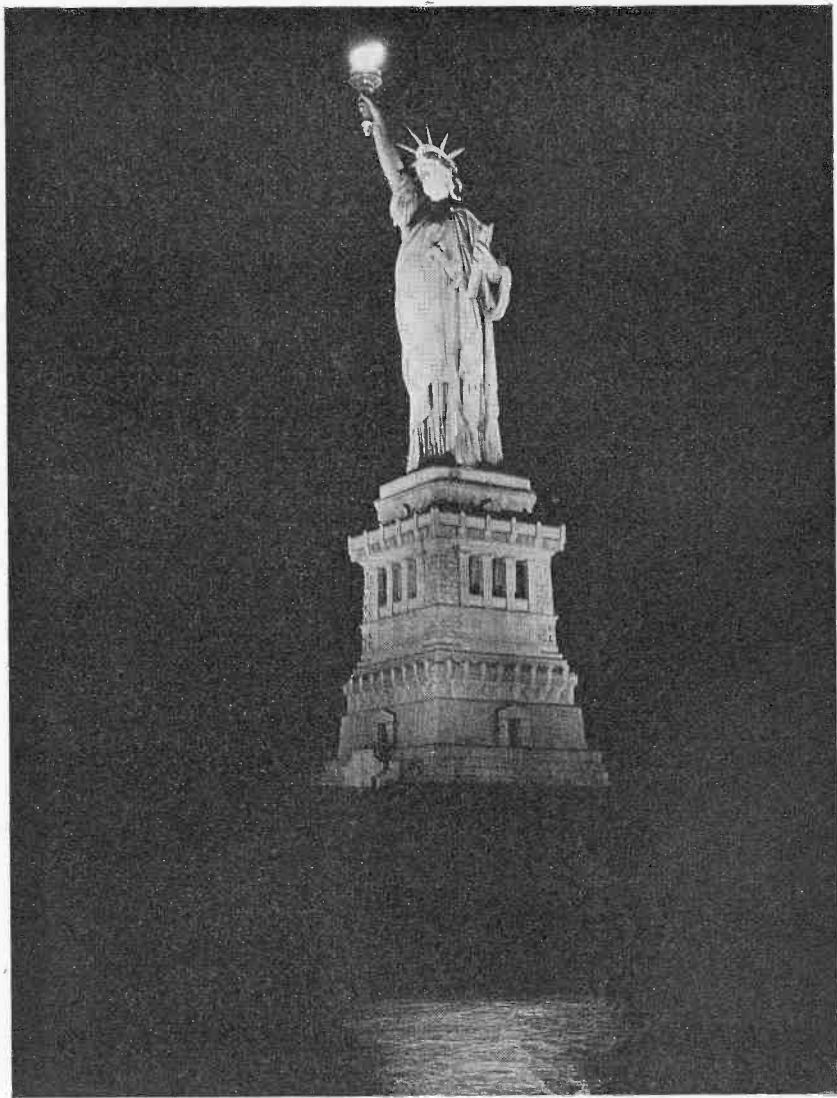

Underwood & Underwood

INSTITUTE NEWS AND RADIO NOTES

Silver Anniversary Convention

Our Silver Anniversary Convention commemorating the founding of the Institute on May 13, 1912, will be held in New York City on May 10, 11, and 12. Convention headquarters will be at the Hotel Pennsylvania.

Over two-dozen papers will be presented during the five technical sessions which occupy the major portion of the program. Although several inspection trips have been scheduled, they are to run simultaneously and will require but a single afternoon. This permits the presentation of all papers without the necessity of simultaneous meetings, thus avoiding confusion and making it possible for anyone in attendance to hear every paper in which he may be interested. It is anticipated that the following program will be changed only to a very minor degree if at all. All times shown are Eastern Daylight Saving Time.

It should be noted that registration facilities are available on the afternoon of Sunday, May 9, and those who are able to take advantage of this are urged to do so. This will assist greatly in the handling of registration just prior to the opening session on Monday morning.

SUNDAY, MAY 9

4:00 P.M.—6:00 P.M. Registration

MONDAY, MAY 10

9:00 A.M. Registration and opening of exhibition.

10:30 A.M.—12:30 P.M. Official welcome by H. H. Beverage, President of the Institute. The last paper in this technical session is sponsored by the Radio Club of America and the speaker will be introduced by J. H. Miller, President of that organization.

Technical Session—Ballroom

"The Origin and Development of Radiotelephony," by Lloyd Espenschied, Bell Telephone Laboratories, Inc., New York, N.Y.

"Transoceanic Radiotelephone Development," by Ralph Brown, Bell Telephone Laboratories, Inc., New York, N.Y.

"Ground Systems as a Factor in Antenna Efficiency," by G. H. Brown, R. F. Lewis, and J. Epstein, RCA Manufacturing Company, Inc., Camden, N.J.

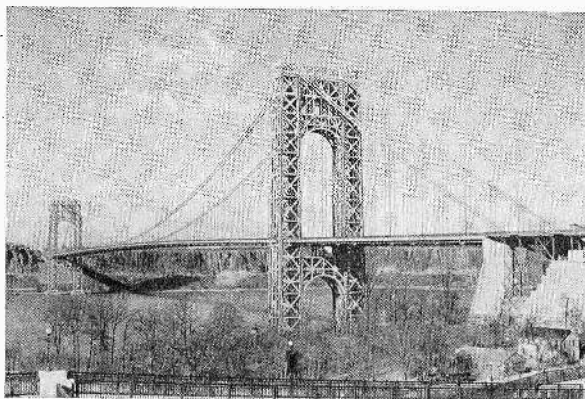

George Washington Bridge which spans the Hudson.



A view of Central Park and upper Manhattan.

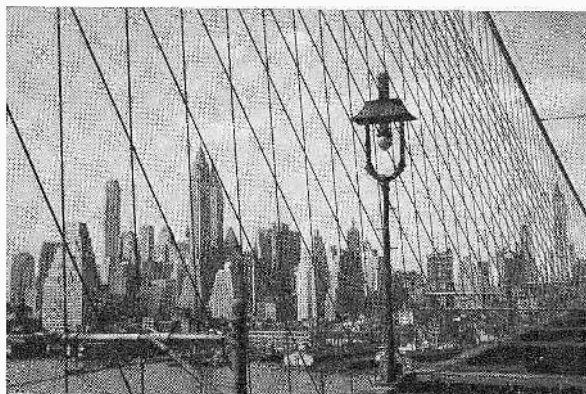

Keystone View Co.

Downtown Manhattan as seen from Brooklyn Bridge.

- “Simple Method for Observing Current Amplitude and Phase Relations in Antenna Arrays,” by J. F. Morrison, Bell Telephone Laboratories, Inc., New York, N.Y.
- “Ultra-High-Frequency Relay Broadcasting,” by W. A. R. Brown and G. O. Milne, National Broadcasting Company, New York, N.Y.
- 10:30 A.M.—11:30 A.M. Ladies will meet in the Ladies’ Parlor for a chalk talk on New York City by Mrs. H. S. Rhodes, Chairman, Ladies’ Committee.
- 12:30 P.M.—6:00 P.M. Trip No. 1. Ladies sightseeing trip around Manhattan by boat and by bus through lower Manhattan.
- 2:30 P.M.—5:00 P.M. **Technical Session—Ballroom**
- “The Ultra-Short-Wave Beacon and Its Field of Application,” by Walter Hahnemann, C. Lorenz, A. G. Berlin, Germany.
- “A Multiple Unit Steerable Antenna for Short-Wave Reception,” by H. T. Friis and C. B. Feldman, Bell Telephone Laboratories, Inc., New York, N.Y.
- “Time Division Multiplex in Radiotelegraphic Practice,” by J. L. Callahan, R. E. Mathes, and A. Kahn, RCA Communications, Inc., New York, N.Y.
- “Automobile Receiver Design,” by F. D. Schnoor and J. D. Smith, RCA Manufacturing Company, Inc., Camden, N.J.
- “Radio Methods for the Investigation of Upper-Air Phenomena with Unmanned Balloons,” by H. Diamond, W. S. Hinman, Jr., and F. W. Dunmore, National Bureau of Standards, Washington, D.C.
- “Characteristics of the Ionosphere and Their Application to Radio Transmission,” by T. R. Gilliland, S. S. Kirby, N. Smith, and S. E. Reymer, National Bureau of Standards, Washington, D.C.
- “An Automatic Sound Pressure Recorder,” by W. S. Bachman, General Electric Company, Bridgeport, Conn.
- 6:00 P.M. Close of registration and exhibition.

TUESDAY, MAY 11

- 9:00 A.M. Registration and opening of exhibition.
- 10:00 A.M.—12 noon **Technical Session—Ballroom**
- “A Basis for Vacuum Tube Design,” by M. A. Acheson, Hygrade Sylvania Corporation, Emporium, Pa.
- “The Development Problems and Operating Characteristics of a New Ultra-High-Frequency Triode,” by W. G. Wagener, RCA Manufacturing Company, Inc., Harrison, N.J.
- “Effects of Space Charge in the Grid-Anode Region of Vacuum Tubes,” by B. Salzberg and A. V. Haeff, RCA Manufacturing Company, Inc., Harrison, N.J.

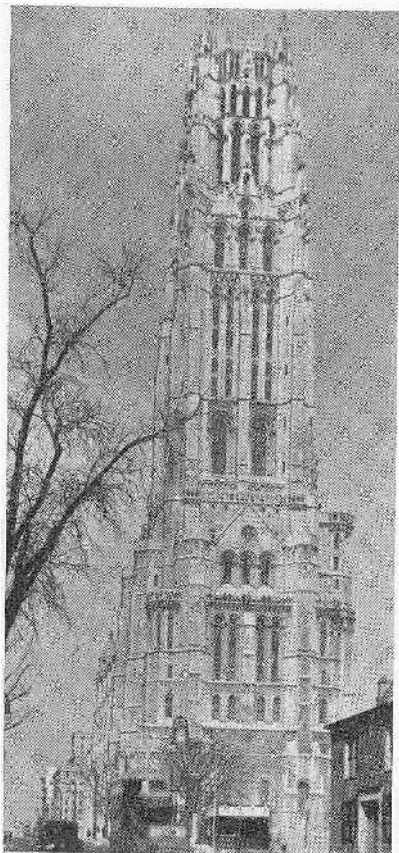

Riverside
Church.

Keystone View Co.

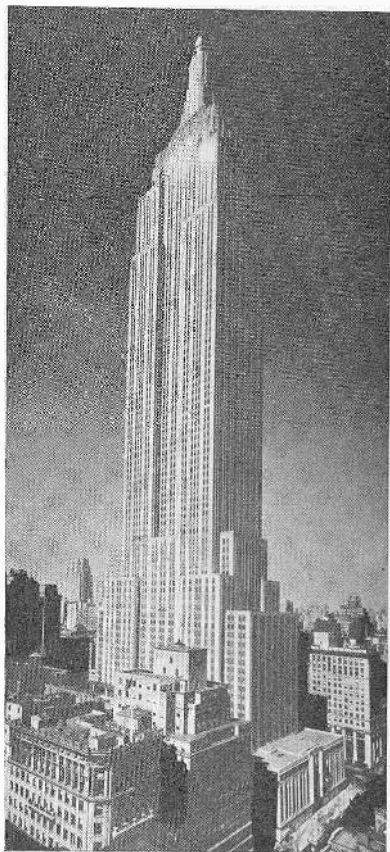

Empire State
Building.

- "Study of Changes in Contact Potential," by E. A. Lederer, D. H. Wamsley, and E. G. Widell, RCA Manufacturing Company, Inc., Harrison, N.J.
- "An Oscillograph for Television Development," by A. C. Stocker, RCA Manufacturing Company, Inc. Camden, N.J.
- 10:30 A.M. Trip No. 2. Ladies trip to the Macy Department Store and luncheon. The afternoon program will be planned by the ladies individually.
- 1:45 P.M.—6:00 P.M. Trip No. 3 Men's trip offering choice of any one of the following:
- (a) American Telephone and Telegraph Company, 32 Sixth Avenue Building and the Western Union Telegraph Company, 60 Hudson Street offices.
 - (b) RCA Radiotron plant, Harrison, N.J.
 - (c) WOR transmitter, Carteret, N.J.
 - (d) Sightseeing tour of Manhattan.
- 6:00 P.M. Close of registration and exhibition.
- WEDNESDAY, MAY 12
- 9:00 A.M. Registration and opening of exhibition.
- 10:00 A.M.—12:30 P.M. **Technical Session—Ballroom**
- "Relation Between Radio Transmission Path and Magnetic Storm Effects," by G. W. Kenrick, University of Puerto Rico, Rio Piedras, P.R.; A. M. Braaten, RCA Communications, Inc., Riverhead, N.Y. and J. General, RCA Communications, Inc., San Juan, P.R.
- "A New Antenna Kit Design," by W. L. Carlson and V. D. Landon, RCA Manufacturing Company, Inc., Camden, N.J.
- "Concentric Narrow Band Elimination Filter," by L. M. Leeds, General Electric Company, Schenectady, N.Y.
- "Higher Program Level Without Circuit Overloading," by O. M. Hovgaard and S. Doba, Bell Telephone Laboratories, Inc., New York, N.Y.
- "A Wide Range Beat Frequency Oscillator," by J. W. Brumbaugh, RCA Manufacturing Company, Inc., Camden, N.J.
- "Measurement of Condenser Characteristics at Low Frequencies," by W. D. Buckingham, Western Union Telegraph Company, Water Mill, N.Y.
- "A New Method of Measurement of Ultra-High-Frequency Impedance," by S. W. Seeley and W. S. Barden, RCA License Laboratory, New York, N.Y.
- 10:00 A.M. Trip No. 4. Ladies sightseeing tour of upper Manhattan, luncheon at Jaegers Restaurant and visit to the Metropolitan Museum of Art. Ladies will return to the hotel at their own pleasure.

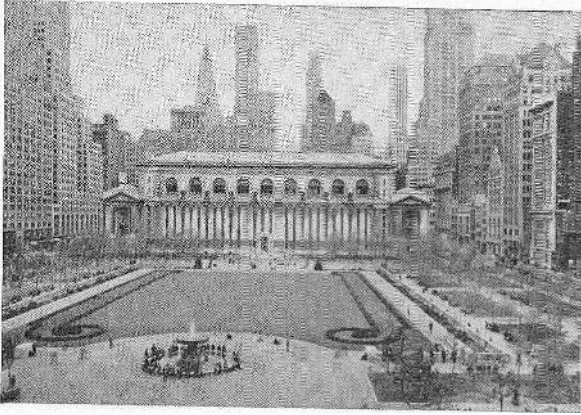

Bryant Park at the back of which stands the
Public Library.

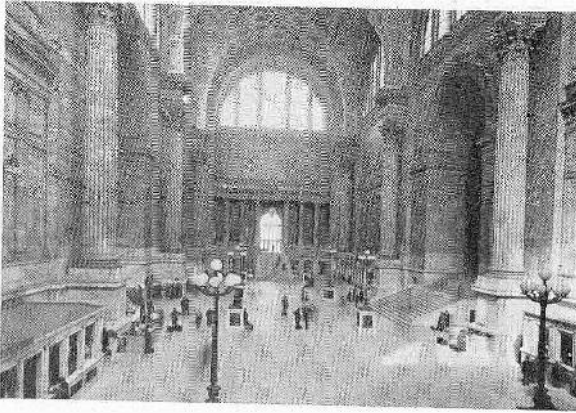

Pennsylvania Station, one of New York's
main terminals.



New York's famous art treasures are housed in the
Metropolitan Museum of Art.

2:00 P.M.—5:00 P.M.

Technical Session—Ballroom

The following papers on television problems are by members of the staff of RCA Manufacturing Company, Inc.

“Development of a Projection ‘Kinescope,’” by V. K. Zworykin and W. H. Painter.

“High Current Electron Gun for Projection ‘Kinescopes,’” by R. R. Law.

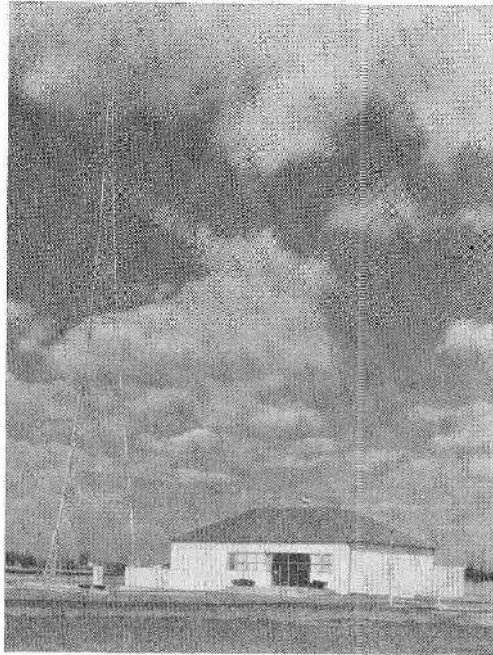

The WOR transmitter building and one of the antenna towers.

“A Circuit for Studying ‘Kinescope’ Resolution,” by C. E. Burnett.

“The Brightness of Outdoor Scenes and Its Relation to Television Transmitters,” by H. Iams, R. B. Janes, and W. H. Hickok.

“Television Pickup Tubes with Cathode-Ray Beam Scanning,” by H. Iams and A. Rose.

“Theory and Performance of the ‘Iconoscope,’” by V. K. Zworykin, G. A. Morton and L. E. Flory.

3:00 P.M.

Close of registration and exhibition.

7:00 P.M.

Silver Anniversary Banquet—Ballroom

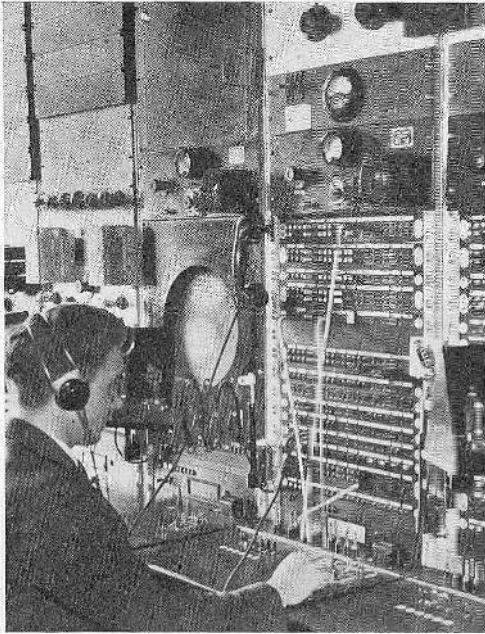

Broadcast network line switchboard
in "Long-Lines Building."

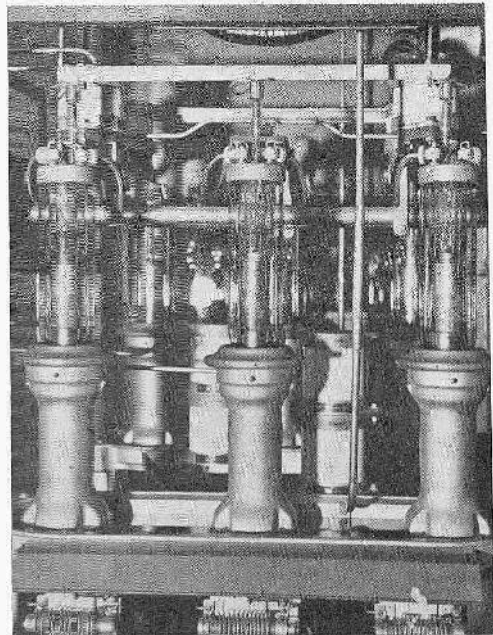

Power amplifier stage of WOR's fifty-kilowatt
transmitter at Cateret, N. J.

Technical Sessions

None of the papers which are scheduled for presentation will be available in preprint form. While attempts will be made to obtain all of them for publication in the PROCEEDINGS, it is highly probable that there will be several which will not appear therein. There will be no duplication of the technical sessions and the program is arranged to permit those in attendance to hear all papers in which they are interested. It has been necessary to restrict somewhat the time available for the presentation of papers. It is felt, however, that ample time has

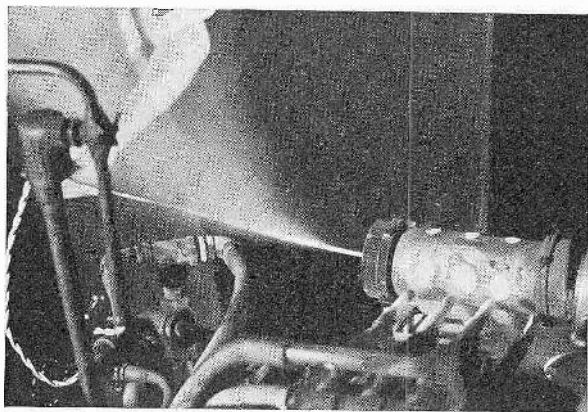

Drawing tungsten at the Radiotron plant.

been provided to permit each paper to be presented in sufficient detail to give the interested auditor enough knowledge of its contents to permit intelligent discussion. Such discussions are of substantial benefit to those in attendance and members are urged to participate in them. Summaries of all of the papers are given in this issue.

Inspection Trips

Monday, May 10—Trip No. 1

Ladies Sightseeing Trip

The ladies will leave the hotel in busses at 12:30 P.M. for the Battery which is at the southern tip of Manhattan Island. There they will embark on the observation steamer *Islander* for a trip around Manhattan Island. After a two and a half hour sail, the Aquarium will be visited and the return to the hotel will be in the form of a bus tour of lower Manhattan.

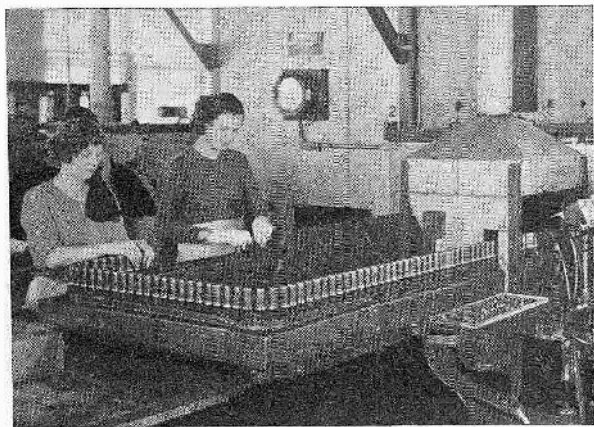

One of the first stages in the manufacture of metal radiotrons.

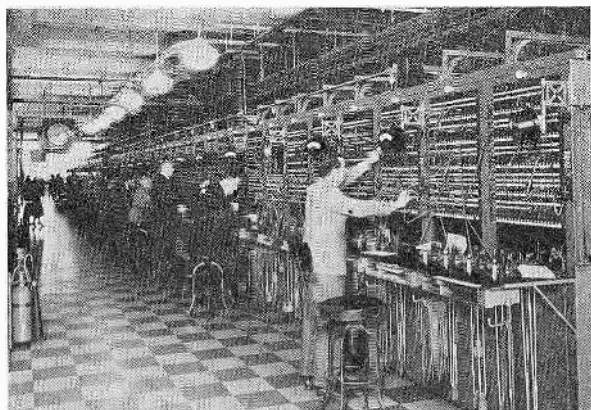

The main switchboard for land telegraph circuits at Western Union.

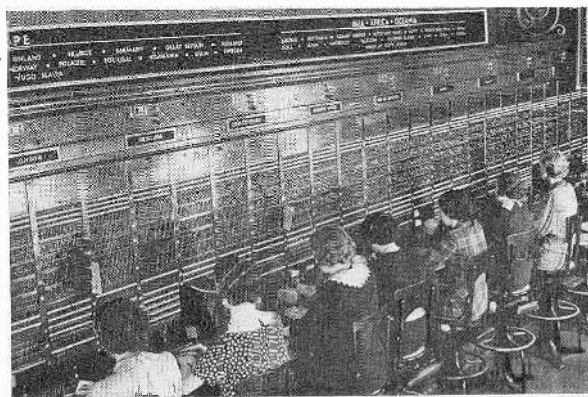

This switchboard handles all overseas and ship-shore telephone connections.

Tuesday, May 11—Trip No. 2

Ladies Visit to Macy's Department Store

The ladies will leave the hotel at 10:30 A.M. for the Macy Department Store which is a very short walk from the hotel. A tour of the store will include "a look behind the scenes" of a modern department store. Lunch will then be served and the afternoon will be entirely unscheduled. The ladies may visit the sales portion of the store or may visit other large stores in the immediate vicinity. Times Square, the theatrical district, is but a few blocks from Macy's.

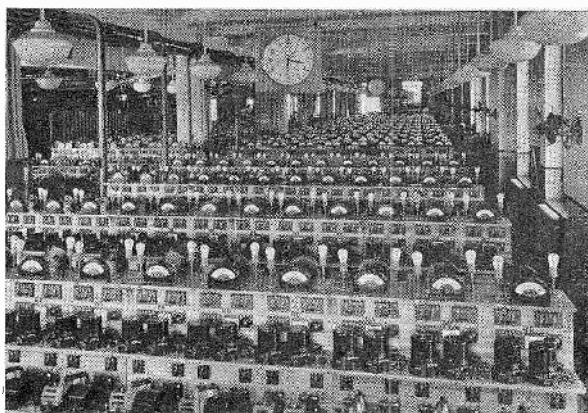

Just a few of the telegraph repeaters at Western Union.

Trip No. 3

Inspection Trip for Men

There are four trips which will be operated simultaneously. This has been made necessary because several of the trips are of such type as require a limit being placed on the maximum number participating. Information on the four trips is as follows:

(a). Visit to the American Telephone and Telegraph Company "Long-Distance Building." This building contains the transoceanic and ship-shore radiotelephone terminals, the long lines which are operated out of New York City, the teletypewriter exchange, radio program wire circuit terminations, and the telephotograph service equipment. After this visit, the party will go to the Western Union Telegraph Company building where the operation of an international telegraphic system may be studied.

(b). This trip will be by bus to the RCA Manufacturing Company's

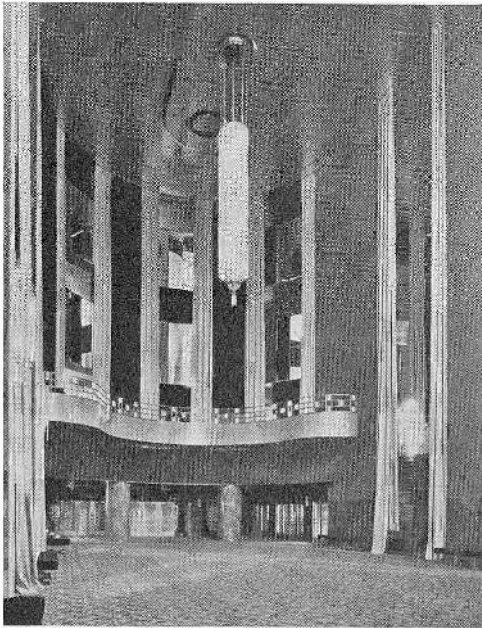

Lobby of the Music Hall, one of the theatres
at Radio City.



Grand Central Terminal, one of New York's
two large railroad stations.

vacuum tube manufacturing plant at Harrison, N.J. The inspection will include the manufacturing facilities for both glass and metal tubes.

(c). The fifty-kilowatt broadcast station of WOR located at Carteret, N.J., which was described in a paper given at the last annual convention and published in the August, 1936, issue of the PROCEEDINGS will be visited.



The lobby of the Hotel Pennsylvania, convention headquarters.

(d). This will be a sightseeing tour of Manhattan which will offer the visitor and the "native" an opportunity of learning something about that portion of New York City.

Wednesday, May 12—Trip No. 4

Ladies Sightseeing Tour and Metropolitan Museum of Art

The ladies will leave the hotel at 10:00 A.M. for a sightseeing tour of upper Manhattan thus completing their view of the Island by land and water. Luncheon will be at Hans Jaeger's Restaurant. After luncheon, they will visit the Metropolitan Museum of Art. No attempt will be made to organize a tour through the museum in view of its size and the wide range of arts exhibited.

Exhibition

An exhibition of measuring and test equipment, component parts, and manufacturing aids will permit those in attendance to become acquainted with the latest developments in those fields. A substantial number of manufacturing organizations will exhibit their products and several thousand square feet of space will be given over to these activities. Booths will be in charge of men who are competent to discuss the engineering aspects of the products displayed and there will be sufficient time available for everyone to make as complete an inspection of the Exhibition as his interest prompts.

Banquet

Our Silver Anniversary Banquet will be held in the Ballroom at seven o'clock on Wednesday evening. Souvenirs of historical interest not only in relation to the life of the Institute but picturing radio engineering of twenty-five years ago will be distributed.

The Institute Medal of Honor will be presented to Melville Eastman for his pioneering work in the field of radio measurements, his constructive influence on laboratory practice in communication engineering, and his unfailing support of the aims and ideals of the Institute. The Morris Liebrann Memorial Prize will be presented to W. H. Doherty for his improvement in the efficiency of radio-frequency power amplifiers.

Sections Committee

The annual meeting of the Sections Committee will be held at 5:30 P.M. on Monday, May 10 in Parlor A which is on the Convention floor. Each section should be represented at this meeting and if an officer cannot be in attendance, it is advisable to designate some member of the section who can attend to represent it. The operation of our sections will be reviewed at this meeting and proposals for modifications of existing methods will be discussed.

Railroad Rates

In the past, reduced railroad rates on the certificate plan have been granted for Institute conventions. The general reduction of railroad rates which took place several months ago resulted in a cancellation of all plans for reduced rates to conventions. There will, therefore, be no restriction on the purchasing of tickets and no reduction of fare below existing tariffs.

Acknowledgment

We are indebted to the New York Convention and Visitors Bureau, the Metropolitan Museum of Art, and the various commercial organizations visited for the use of photographs appearing in this issue.

SUMMARIES OF TECHNICAL PAPERS

A BASIS FOR VACUUM TUBE DESIGN

M. A. ACHESON

(Hygrade-Sylvania Corporation, Emporium, Pa.)

Invention of basic units for expression of vacuum tube dimensional relations, and proper synthesis of these units, allows rigorous calculation of vacuum tube design and performance. These calculations are of simpler form than those where solutions by present methods can be had and often allow solutions where no present solutions exist.

The units and their synthesis are of such a nature that logical trends in design can be followed in many cases entirely aside from the formulas into which they enter.

In the present paper these units are derived and defined and their synthesis for various tube characteristics is deduced. Three exemplary problems are solved, that of minimizing microphonics, that of designing tubes for least random variation from bogey characteristics, and that of finding optimum design for maximum output with limited input signal.

AN AUTOMATIC SOUND PRESSURE RECORDER

W. S. BACHMAN

(General Electric Company, Bridgeport, Conn.)

An automatic sound pressure recorder is described in which constant amplifier output level is maintained by means of a thyatron controlled motor-driven attenuator located at the input to the amplifier. A continuous record is traced of the attenuator settings. The entire audio range is covered in four minutes and records may be accurately duplicated. Electrical and mechanical design features are described and the operation of the instrument is discussed.

TRANSOCEANIC RADIOTELEPHONE DEVELOPMENT

RALPH BOWN

(Bell Telephone Laboratories, Inc., New York, N.Y.)

Marking the tenth anniversary of the beginning of commercial long-distance radiotelephone service, the paper reviews briefly (1) technical advances over the older telegraph and short-distance telephone arts which made the initiation of long-distance service possible, (2) engineering developments without which the growth of such services would have been severely restricted, (3) further improvements, and (4) the present outlook for future development.

GROUND SYSTEMS AS A FACTOR IN ANTENNA EFFICIENCY

G. H. BROWN, R. F. LEWIS, AND J. EPSTEIN

(RCA Manufacturing Company, Inc., Camden, N.J.)

Theoretical considerations concerning the losses in ground systems are advanced. These considerations indicate the feasibility of antennas much less than a quarter-wave length tall for low power broadcast use. The desirability of large ground systems is also indicated.

Experimental data are given which show that an eighth-wave antenna is practically as efficient as a quarter-wave antenna. It is also found that a ground system consisting of 120 buried radial wires, each one-half wave long, is desi-

table. Tests of ground screens show them to be of no importance when adequate ground systems are used.

The experimental data include antenna resistance and reactance, field intensity at one mile, current in the buried wires, and total earth currents, for many combinations of antenna height, number of radial wires, and length of radial wires.

ULTRA-HIGH-FREQUENCY RELAY BROADCASTING

W. A. R. BROWN AND G. O. MILNE

(National Broadcasting Company, New York, N.Y.)

Radio circuits as an extension of wire line facilities to permit the presentation of programs from points not otherwise accessible have now become an integral part of broadcasting.

Some of the more important problems involved in relay broadcasting are outlined and brief descriptions are given of the equipment developed for this service and its operation under field conditions.

Portable relay broadcast transmitters of various powers and frequencies and their associated receivers will be displayed and demonstrations given of their use.

A WIDE-RANGE BEAT-FREQUENCY OSCILLATOR

J. M. BRUMBAUGH

(RCA Manufacturing Company, Inc., Camden, N.J.)

A discussion is given of the development and operation of an instrument having output ranges of 20 to 3,000,000 cycles (logarithmic scale), and 0.0004 to 45 volts, with automatic output level control. A description is presented of the oscillator, radio-frequency amplifier, detector, video amplifier automatic volume control, and control circuits with remarks on the attainment of stability. Design of the incorporated wide-range tube voltmeter, semiautomatic curve recorder, and oscilloscope is discussed and notes on the application of the complete instrument to television and other test work are included.

MEASUREMENT OF CONDENSER CHARACTERISTICS AT LOW FREQUENCIES

W. D. BUCKINGHAM

(Western Union Telegraph Company, Water Mill, N.Y.)

Wherever condensers and resistors must be of very high quality there is justification for measuring their characteristics with a degree of accuracy which does not obtain for ordinary audio- and radio-frequency work. It is known that the capacitance of a condenser may change with temperature, time, air pressure, voltage, frequency, and polarity. Numerous investigators have shown that the stability of a condenser with changing conditions is related to the losses and absorption of the condenser.

A condenser with absorption is equivalent to a pure capacitance shunted by other pure capacitances in series with resistances. Through the use of circuits and apparatus associated with the oscilloscope, described in this paper, the equivalent values of a condenser in direct and retarded capacitance, may be determined by a process similar to that used in balancing an artificial line. A bridge system is set up and the known condenser is balanced by a pure capacitance

shunted by a number of branch circuits consisting of capacitance and resistance in series. At balance, these capacitances and resistances are the equivalent of the known condenser. By this means, for example, a condenser of one microfarad can be shown to be equivalent to one microfarad in pure capacitance shunted by three circuits, the first of which consists of 0.00493 microfarad in series with 100,000 ohms, the second of 0.00298 microfarad in series with one megohm, and the third of 0.00215 microfarad in series with eight megohms.

Oscillograms accompany the paper showing the balances obtained in a temperature controlled, variable ratio bridge with a synchronized sweep tube and amplifier used as the balance detector.

Among the dielectrics measured and discussed in the paper are air, mica, paper, gutta-percha, castor oil, pyranol, vegetal, mineral oil, and ceresine. The absorption characteristics of typical condensers are given by figures expressing in microamperes the absorption current flowing into one microfarad condenser at various times, in seconds, after the condenser has been connected to a 100-volt source.

The results of certain temperature runs and determination of temperature coefficients are discussed. There is also some material on the effects of clamping.

This development was undertaken primarily in connection with artificial lines for transatlantic cables, where the number of microfarads required run into several thousands, where the conditions of stability are very rigorous, and where the frequencies are of the order of zero to sixty cycles per second. The technique of measurement, however, is applicable to standardization and measurement in the radio laboratory and should be of interest to radio engineers engaged in that work.

A CIRCUIT FOR STUDYING "KINESCOPE" RESOLUTION

C. E. BURNETT

(RCA Manufacturing Company, Inc., Harrison, N.J.)

Several of the characteristics of a cathode-ray tube which determine its usefulness as a "Kinescope" for television reception are outlined. Various means for studying these characteristics are discussed.

A system is outlined for studying "Kinescope" resolution by breaking the picture into alternate black-and-white picture elements arranged in checker-board fashion. A practical application of this system is described for a television system using a picture of approximately 340 lines and repeating 30 times per second. The deflection and grid signal frequencies that are involved are discussed. The problem of synchronizing these frequencies is covered and circuits developed for this purpose are described. Some of the results obtained with these circuits are shown.

TIME DIVISION MULTIPLEX IN RADIOTELEGRAPHIC PRACTICE

J. L. CALLAHAN, R. E. MATHES, AND A. KAHN

(RCA Communications, Inc., New York, N.Y.)

This paper outlines certain methods of multiplexing telegraphic signals on a common communication channel and the factors governing the application of these methods to radio circuits. The recently developed trend toward the use of multiplex methods in radiotelegraphic service is discussed. Consideration is given to the advantages of using the time division method based on the Baud, at least at the present state of the radio art. General specifications for the

equipment are stated, based on practical operating requirements. Major changes from practices obtaining on wire line multiplex systems are mentioned and the reasons therefor are given.

A description of a practical system based on the above considerations, and its use and effectiveness in a large radiotelegraph organization are furnished.

A NEW ANTENNA KIT DESIGN

W. L. CARLSON AND V. D. LANDON
(RCA Manufacturing Company, Inc., Camden, N.J.)

A new antenna kit is described in which the improvement in noise ratio is exceptionally high. The improved noise ratio is obtained by maintaining a very high degree of symmetry in the balanced transmission line and by reducing the intertwining capacitance of the transformers. A further feature of the kit is the ease and flexibility of installation.

RADIO METHODS FOR THE INVESTIGATION OF UPPER-AIR PHENOMENA WITH UNMANNED BALLOONS

H. DIAMOND, W. S. HINMAN, JR., AND F. W. DUNMORE
(National Bureau of Standards, Washington, D. C.)

Experimental work conducted for the U. S. Navy Department on the development of a radio meteorograph for sending down from unmanned balloons information on upper-air pressures, temperatures, humidities, and wind conditions has led to radio methods applicable to the study of a large class of upper-air phenomena. The miniature transmitter sent aloft on the small balloon employs an ultra-high-frequency oscillator and a modulating oscillator; the frequency of the latter is controlled by resistors connected in its grid circuit. These may be ordinary resistors mechanically varied by instruments responding to the phenomena being investigated, or special devices the electrical resistances of which vary with the phenomena. The modulation frequency is thus a measure of the phenomenon studied. Several phenomena may be measured successively, the corresponding resistors being switched into circuit in sequence by an air-pressure-driven switching unit. This unit also serves for indicating the balloon altitude. At the ground receiving stations, a graphical frequency recorder, connected in the receiving set output, provides an automatic chart of the variation of the phenomena with altitude. Special direction finding methods are described for determining the azimuthal direction of the balloon and its distance from the ground station, data required in measuring upper-air wind conditions.

THE ORIGIN AND DEVELOPMENT OF RADIOTELEPHONY

Lloyd ESPENSCHIED
(Bell Telephone Laboratories, Inc., New York, N.Y.)

In recognition of the observance of the Twenty-Fifth Anniversary of the founding of the Institute there is reviewed briefly the origin and growth of the greatest development which has occurred in radio in this period, radiotelephony.

Practical radiotelephony was born out of the great advance which occurred along the whole forefront of electric communications, as the result of the development of the vacuum tube amplifier and what may be called the carrier current transmission technique which came from wire telephony and wireless telegraphy.

In the evolution of the art three periods may be distinguished. First is the formative one, in which there appeared the three-element tube as an amplifier, its conversion to a reliable high vacuum status, its adaptation to generation and modulation, and the preliminary trying out of the first all-vacuum tube radiotelephone system. The second period, that of the War, disarranged normal development, but brought a fillip on the practical side in the production of large numbers of tubes, amplifiers, and radiotelephone sets, and in the spreading of the knowledge of the new art among a large number of energetic young men. The third period, following the War, witnessed substantial further contributions in the direction of higher power transmitting tubes, acoustics, and high quality reproduction of telephony, the development of circuit theory and practice, as exemplified by the conception of side bands and the perfection of filter circuits, the study of the radio medium and the reduction of the whole art to a quantitative engineering basis. With these advances the art flowered into the two-way radiotelephone services we know today and the great one-way service of broadcasting.

The paper attempts to give a balanced picture of the development of radiotelephony in relation to the earlier arts of wire telephony and radiotelegraphy.

A MULTIPLE UNIT STEERABLE ANTENNA FOR SHORT-WAVE RECEPTION

H. T. FRIIS AND C. B. FELDMAN

(Bell Telephone Laboratories, Inc., New York, N.Y.)

This paper discusses a receiving system employing sharp vertical plane directivity, capable of being steered to meet the varying angles at which short radio waves arrive at a receiving location. The system is the culmination of some four years effort to determine the degree to which receiving antenna directivity may be carried to increase the reliability of short-wave transatlantic telephone circuits. The system consists of an end-on array of antennas, of fixed directivity, whose outputs are combined in phase for the desired angle. The antenna outputs are conducted over coaxial transmission lines to the receiving building where the phasing is accomplished by means of rotatable phase shifters operating at intermediate frequency. These phase shifters, one for each antenna, are geared together, and the favored direction in the vertical plane may be steered by rotating the assembly. Several sets of these phase shifters are paralleled, each set constituting a separately steerable branch. One of these branches serves as an exploring or monitoring circuit for determining the angles at which waves are arriving. The remaining branches may then be set to receive at these angles. The several receiving branches have common automatic gain control and thus provide a diversity on an angle basis. To obtain the full benefit of the angular resolution afforded by the sharp directivity, the different transmission times, corresponding to the different angles, are equalized by audio delay networks, before combining in the final output.

The experimental system, located at the Bell Telephone Laboratories' field laboratory near Holmdel, N.J., is described. This system comprises six rhombic antennas extending three fourths of a mile along the direction to England. Two receiving branches, in addition to a monitoring branch, are provided. Experience obtained with this system since the spring of 1935 is discussed. The benefits ascribable to it are (1), a signal-to-noise improvement of seven to eight decibels,

referred to one of the six antennas alone, and (2), a substantial quality improvement due jointly to the diversity action and the reduction of selective fading.

While a three-fourths-mile short-wave antenna system is an unusually long one, the steerability feature permits the employment of considerably more directivity than that yielded by this one. A system two miles long is believed to be practicable and desirable. It could be expected to perform more consistently better than the three-fourths-mile trial installation, and should yield a signal-to-noise improvement of 12 to 13 decibals referred to one rhombic antenna. With the object of predicting the performance of larger systems, the performance of the experimental system is examined in great detail and compared with theory.

CHARACTERISTICS OF THE IONOSPHERE AND THEIR APPLICATION TO RADIO TRANSMISSION

T. R. GILLILAND, S. S. Kirby, N. SMITH, and S. E. REYMER

(National Bureau of Standards, Washington, D.C.)

Results of ionosphere measurements near Washington made at normal incidence over the period May, 1934, to April, 1937, inclusive are presented in graphical form as monthly averages for each hour of the day. The general forms of the diurnal and seasonal variations of the critical frequencies and virtual heights have recurred from year to year. In addition to the seasonal variation there has been a continuous long-time increase of critical frequencies which is associated with the 11-year sunspot cycle. Data are given only for those layers which are fairly regular in behavior—the normal E, F, F₁ and F₂ layers.

The interpretation of properties of the ionosphere in terms of radio transmission over medium and long distances is discussed. The properties considered are absorption, virtual height, and critical frequency. It is pointed out that the long-time increase of critical frequencies indicates a corresponding rise in useful transmission frequencies. The paper also describes briefly two types of irregular disturbances of the ionosphere which affect radio transmission.

THE ULTRA-SHORT-WAVE BEACON AND ITS FIELD OF APPLICATION

WALTER HAHNEMANN

(C. Lorenz, A. G., Berlin, Germany.)

A report on the present state of the art of ultra-short-wave blind landing beacons is given on the basis of a brief historical survey. The favorable results obtained with this system have led to studying the possibility of using these ultra-short-wave beacons for other purposes of air navigation. The conditions of the propagation of ultra-short waves for these purposes are being discussed on the basis of the theory of combining reflection and diffraction on the earth. Finally a new example of applying ultra-short-wave beacons for the further development of commercial air navigation systems of a country is shown in order to give points for discussion in connection with the questions raised.

HIGHER PROGRAM LEVEL WITHOUT CIRCUIT OVERLOADING

O. M. HOVGAARD AND S. DOBA

(Bell Telephone Laboratories, Inc., New York, N.Y.)

Program volume control operators are constantly faced with the contra-

dictory objectives of maintaining the highest practicable program level and avoiding the distortion resulting from overloading. This dilemma is aggravated by the difficulties of varying the gain by the correct amount and at the right time to accomplish their purpose. The paper describes a device which, without introducing overloading, permits a higher general program level than is practicable with manual control. It accomplishes this automatically with minimum departure from the volume expression of the program at its input. In broadcasting, the benefits derived from its use will be a greater station coverage with freedom from distortion and extra band radiation due to overmodulation.

THE BRIGHTNESS OF OUTDOOR SCENES AND ITS RELATION TO TELEVISION TRANSMISSION

HARLEY IAMS, R. B. JANES, AND W. H. HICKOK

(RCA Manufacturing Company, Inc., Harrison, N.J.)

During the early stages of television, both the transmitting and receiving systems were crude, and experimenters were glad to obtain a recognizable picture. The last few years have witnessed great improvement in the quality of the picture. The adoption of cathode-ray tubes has permitted a large increase in the number of scanning lines, and use of interlaced scanning and a greater number of frames per second has practically eliminated flicker. As the system improved, larger and brighter pictures became possible.

A comparable change has also taken place in the sensitivity of devices for converting light into television picture signals. The earliest apparatus required so much light that transmission was largely limited to films. At best, direct pick-up could be obtained only when scenes were in direct sunlight or under blinding artificial light. With the advent of such electronic devices as the "Iconoscope,"¹ direct transmission of outdoor scenes became practical even on cloudy days.

Since the illumination requirements for television transmission now fall within practical limits, it is time to consider the relation between light available under average conditions and the sensitivity of the apparatus.

In the transmission of motion pictures or studio scenes, the amount of light used may be controlled; out-of-doors it is usually necessary to operate with whatever light the sun provides. In considering how much light is available for the illumination of a scene which is to be transmitted, we shall, therefore, largely limit ourselves to a discussion of outdoor scenes in daylight.

The subject is discussed from two angles: (1) the surface brightness and contrast of typical outdoor scenes; and (2) the brightness and contrast which are necessary for the transmission of a satisfactory television picture. This study permits the drawing of conclusions as to what outdoor scenes can, at present, be transmitted satisfactorily. Because of the complexity of the subject it is necessary to make some approximations, but these approximations are relatively unimportant in view of the wide range of brightness encountered and the latitude of the television apparatus. In conclusion, some of the recent advances which have been incorporated in the "Iconoscopes" used in these tests are described.

¹ V. K. Zworykid, "The Iconoscope—A modern version of the electric eye," Proc. I.R.E., vol. 22, pp. 16-32; January, (1934).

**TELEVISION PICKUP TUBES WITH CATHODE-RAY
BEAM SCANNING**

HARLEY IAMS AND ALBERT ROSE
(RCA Manufacturing Company, Inc., Harrison, N.J.)

Television pickup tubes which use cathode-ray beam scanning, although only one class of television pickup devices, may be made in a variety of ways, a number of which are described in this paper. In these tubes, the function of the electron beam is to release secondary electrons from the target, the number escaping being modulated by electrostatic fields, magnetic fields, orientation of electrodes or changes in the secondary emission ratio of the target. The "Iconoscope" is a well-known example of modulation by electrostatic fields produced by photoemission from the target. A conducting photocathode used as a target, however, operated as if its secondary emission ratio were decreased by light. A copper plate oxidized and treated with caesium transmitted a picture with some time lag. Photoconductive materials exposed to light and scanned by an electron beam were made to develop potential variations over their surface and thereby transmit a television picture. Aluminum oxide and zirconium oxide, treated with caesium were used in this manner. Selenium, used as a photoconductive material also transmitted a picture. Germanium used as a target sensitive to heat radiation was able to transmit a picture, probably as a result of some thermoelectric effect. The most sensitive tubes tested were those in which an electron picture was focused upon a scanned, secondary electron emissive target. The scanning and picture projection operations may be separated by using a two-sided target. Coupling between the two sides was obtained by conducting plugs through the target. Stray secondary electrons from the electron gun, which contributed a spurious signal, were eliminated by the use of apertures in the first anode. A demountable television pickup tube was used for the experiments with selenium.

**RELATION BETWEEN RADIO TRANSMISSION PATH
AND MAGNETIC STORM EFFECTS**

G. W. KENRICK
(University of Puerto Rico, Rio Piedros, P.R.),
A. M. BRAATON
(RCA Communications, Inc., Riverhead, L.I., N.Y.),
AND
J. GENERAL
(RCA Communications, Inc., San Juan, P.R.)

This paper presents a quantitative study of the relationship between the proximity to the magnetic pole of great-circle transmission paths and signal stability during magnetic disturbances. Reception from Europe as observed at Riverhead, Long Island, and San Juan, Puerto Rico, is compared during normal and disturbed periods. San Juan was chosen for comparison, because the distance of its great-circle path from the north magnetic pole is about 1000 miles greater than any path available in the continental United States. The apparatus used at the two points was made as nearly identical as possible to facilitate the comparisons. A brief description of the equipment and the antenna system employed are included.

The results of observations covering a period of years confirm the anticipated relationship between signal stability and proximity of the transmission path to the magnetic pole.

Evidence of higher ionospheric ionization over the more southerly path is noted in a number of cases by a comparison of nighttime cutoff effects and allied phenomena.

HIGH CURRENT ELECTRON GUN FOR PROJECTION "KINESCOPES"

R. R. LAW

(RCA Manufacturing Company, Inc., Harrison, N.J.)

One of the problems in the art of reproducing a scene by television is to secure an image of adequate size. Because of this, there has been considerable interest in projection systems where a small, high intensity image reproduced on the face of a projection "Kinescope" is thrown onto a viewing screen of the desired size by a suitable optical system. The light output and the definition of these systems has been limited by the inability of the electron gun to provide a sufficiently large beam current in a small spot.

This paper describes an electron gun giving large beam current in a small spot. The design of this electron gun is based on the results of the present investigation which shows that the ratio of the current in the first crossover inside the radius r to the total space current is

$$I/I_s = 1 - e^{-ar^2/E}$$

where E is the voltage applied to the first crossover forming system and a is a constant for any given cathode temperature, potential distribution, and geometry.

A description is given of an electron gun based on this theory. This electron gun gives useful beam currents of 1.5 to 2 milliamperes at an operating potential of 10 kilovolts. This beam current may be readily concentrated into a 300-micron spot on the screen when the electron gun is spaced at such a distance from the screen as to give a 2.4×1.8 -inch image. In conjunction with an f 1.4 lens having a focal length of 12 centimeters, this projection "Kinescope" has a light output sufficient to give an 18×24 -inch picture having high lights with an apparent brightness of about 2.5 foot-lamberts when viewed on a 480 per cent directional screen.

STUDY OF CHANGES OF CONTACT-POTENTIAL

E. A. LEDERER, D. H. WAMSLEY, AND E. G. WIDELL

(RCA Manufacturing Company, Inc., Harrison, N.J.)

One factor influencing the stability of the plate current is the contact potential difference between cathode and control grid. The contact potential is defined by the difference in the work function of two surfaces. Therefore, it is affected by a change in either surface. It is usually measured by applying retarding potentials. In measuring contact potential in this manner, one usually assumes that no change takes place in the emitting surface and the observed changes are attributed to the surface condition of the collector.

Measurements of contact potential difference between control grid and cathode during aging on type 6K7 tube are given, using a pure barium-strontium getter.

In order to check the correctness of the above assumption, a method was devised to determine the change of the control-grid surface independent of the cathode. This method permits measurements of contact potential against a metallic reference electrode after the collector has been subjected to contaminations from an oxide-coated cathode and other influences.

CONCENTRIC NARROW BAND ELIMINATION FILTER

L. M. LEEDS

(General Electric Company, Schenectady, N.Y.)

A novel wave filter is described which utilizes the phenomenon of standing waves on a concentric transmission line to obtain a desired elimination characteristic. A per section voltage ratio of 40 decibels may be realized in practical designs. Filters of this type are especially useful at the ultra-high frequencies where the customary lumped constant filters become impractical. They have been used in ultra-high-frequency police communication systems simultaneously to transmit and receive on the same antenna, without interference, on adjacent channels in the 30- to 42-megacycle band with transmitter powers up to 150 watts.

SIMPLE METHOD FOR OBSERVING CURRENT AMPLITUDE AND PHASE RELATIONS IN ANTENNA ARRAYS

JOHN F. MORRISON

(Bell Telephone Laboratories, Inc., New York, N.Y.)

This paper describes a simple apparatus arrangement for observing the relative amplitudes and phases of the currents in the elements of a multielement radiating system. The process of adjusting the array is greatly facilitated, much less time and skill being required than when each step in the process is checked by field intensity measurements. Using the method described, these measurements need only be used as a final verification of the adjustment. Field experience with a commercial application is described.

The arrangement is also suitable for use by operating personnel in making routine checks to verify the maintenance of the desired amplitude and phase relations or to indicate the direction and magnitude of changes if they have occurred.

EFFECTS OF SPACE CHARGE IN THE GRID-ANODE REGION OF VACUUM TUBES

BERNARD SALZBERG AND A. V. HAEFF

(RCA Manufacturing Company, Inc., Harrison, N.J.)

The effects of space charge in a region between parallel planes constituting the grid and anode of a vacuum tube are determined from the results of a simple analysis. The main effects of the space charge are (a) to introduce departures from the linear potential distribution of the electrostatic case; (b) to set an upper limit, under certain conditions, for the anode current; (c) to introduce instabilities and "hysteresis" phenomena in the behavior of the tube; and (d) to increase the electron transit time in this region.

Four modes of potential distribution which may exist in this region are treated: (1) Neither potential minimum nor virtual cathode exist, (2) potential minimum exists, (3) space-charge-limited virtual cathode exists, and (4) temperature-limited virtual cathode exists (negative anode potentials). For each of the various states of operation, expressions are derived for the distribution of potential and electric intensity throughout the region; the time of flight of electrons from grid to anode, and from grid to the point of zero potential; and the location and magnitude of the minimum potential. An expression is also derived for the dependence of the anode current on the space current, grid-anode distance, grid voltage, and anode voltage. Curves are plotted from these expressions and it is shown how the behavior of a large variety of practical tubes can be predicted and explained with their aid. The assumptions which underlie

the theory are stated and the effects of the neglected phenomena are discussed qualitatively.

Anode current versus anode voltage and anode current versus space current curves representing observations made on a specially constructed tetrode are presented by way of experimental verification of the theoretical results.

For purposes of illustration application is made of these results to elucidate the theory of the type of power amplifier tube which employs a minimum potential, formed in front of the anode as a result of the space charge of the electrons, to minimize the passage of secondary electrons from anode to grid.

AUTOMOBILE RECEIVER DESIGN

F. D. SCHNOOR AND J. C. SMITH
(RCA Manufacturing Company, Inc., Camden, N.J.)

This paper describes briefly the history of automobile radio. The various problems, mechanical and electrical, which have arisen during the evolution of the automobile radio from a simple portable receiver to the present specialized unit are outlined and their solutions are discussed.

Various current problems peculiar to automobile radio or influenced by the specialized requirements of automobile radio are considered. Layout and space requirements, fundamentals of design of power supply and vibrator, the elimination of vibrator interference, the voltage variation of the battery supply and its effect on design, ignition interference and its elimination, and the all-important antenna problem are briefly discussed. The interrelation of fluctuation noise interference with antenna and receiver input circuit design, and the lack of a simple and satisfactory rating means are pointed out. The acoustic problem is considered, as well as its relation to body, motor, and wind noises.

The performance characteristics of a typical modern receiver are described and the differences from home receiver performance characteristics are noted.

A NEW METHOD OF MEASUREMENT OF ULTRA-HIGH-FREQUENCY IMPEDANCE

S. W. SEELEY AND W. S. BARDEN
(RCA License Division Laboratory, New York, N.Y.)

This paper deals with a new and extremely simple method for measurement of resistance and reactance at frequencies in the neighborhood of 100 megacycles.

The method described is not only convenient and simple in use but provides a degree of accuracy much higher than that obtained by previous and more complicated systems. It uses the incremental capacitance of a very small condenser as a standard. The absolute capacitance of this element need not be known. The indicating device is a vacuum tube voltmeter whose deflection law (but not absolute calibration) must be known.

The system is described and results of typical measurements on circuit elements, transmission lines, etc., are given.

AN OSCILLOGRAPH FOR TELEVISION DEVELOPMENT

A. C. STOCKER
(RCA Manufacturing Company, Inc., Camden, N.J.)

Development of high fidelity television with its essentially transient signal wave shapes, demands an oscillograph with unusually good transient response. Frequency versus response characteristics have proved of small value in the development of such an instrument. An oscillograph having exceptionally accurate response to transient waves and sine wave response which is flat to 2000 kilocycles is described in detail. Test and development methods suitable for work on

equipment intended for transient operation will be given, and some comparative test results are shown.

THE DEVELOPMENTAL PROBLEMS AND OPERATING CHARACTERISTICS OF A NEW ULTRA-HIGH-FREQUENCY TRIODE

WINFIELD G. WAGENER
(RCA Manufacturing Company, Inc., Harrison, N.J.)

The general requirements are presented for the production and amplification of large power at very short wave lengths by conventional type vacuum tubes. The design of the vacuum tube must consider in addition to the usual structural and electrical features, the importance of the complete circuit design, the transit time of all electrons in flight, the large radio-frequency lead currents, the abnormal demands of the very high frequency on the insulation, and the practical construction of very compact tubes.

A new tube is presented in which the design has been developed in the light of these requirements. The tube is a small water- and air-cooled triode which will give an output as a power amplifier of above 700 watts at 100 megacycles. It is also capable of operation as a neutralized power amplifier with reasonably high efficiency up to higher frequencies of the order of 200 megacycles.

THEORY AND PERFORMANCE OF THE "ICONOSCOPE"

V. K. ZWORYKIN, G. A. MORTON, AND L. E. FLORY
(RCA Manufacturing Company, Inc., Harrison, N.J.)

Field tests have shown the present standard "Iconoscope" to be a very satisfactory television pickup device. However, from a theoretical point of view the efficiency of the "Iconoscope," as a storage system, is rather low. The principle factors responsible for the low efficiency are lack of collecting field for photoelectrons, and losses caused by the redistribution of secondary electrons produced by the beam.

Limits to the sensitivity of the standard "Iconoscope" are set by the ratio of picture signal to amplifier and coupling resistor "noise." Experimental and theoretical determinations indicate that an excellent picture can be transmitted with from $2\frac{1}{2}$ to 6 millilumens/cm² on the mosaic.

Two methods are considered by which the sensitivity may be increased. The first is by the use of secondary emission signal multipliers and a low capacitance mosaic, while the second makes use of secondary emission image intensification. The sensitivity limits for the two cases are calculated.

DEVELOPMENT OF THE PROJECTION "KINESCOPE"

V. K. ZWORYKIN AND W. H. PAINTER
(RCA Manufacturing Company, Inc., Harrison, N.J.)

The paper discusses the general requirements and design of "Kinescope" tubes for projecting television images. A picture 18×24 inches in size having a brightness in the highlights of 0.9 candle per square foot appears to be an acceptable minimum for home television reception. Several years of developmental work were required before the problems of designing a suitable projection system were clarified. This clarification led to a developmental "Kinescope" which closely approaches the minimum brightness requirements. The possibilities of further improvements in electron guns, fluorescent screen materials, and optical systems are discussed.

TECHNICAL PAPERS

A SIMPLIFIED CIRCUIT FOR FREQUENCY SUBSTANDARDS
EMPLOYING A NEW TYPE OF LOW-FREQUENCY
ZERO-TEMPERATURE-COEFFICIENT
QUARTZ CRYSTAL*

By

S. C. HIGHT AND G. W. WILLARD

(Bell Telephone Laboratories, Inc., New York City)

Summary—This paper presents a new type of stabilized quartz-controlled oscillator and a new type of low-temperature-coefficient piezoelectric quartz circuit element which, in their combination, are particularly suitable for portable substandards of frequency.

The oscillator circuit is simple and may be easily stabilized by two reactance adjustments so that the frequency is unaffected by change of tubes or by small changes in the circuit reactances, the plate voltage, and the ambient temperature. Measured stabilities are given for this circuit when constructed as a substandard of frequency, employing the new CT crystal, and generating one hundred kilocycles and its harmonics.

A previously unused type of vibration in quartz plates cut at an angle to the crystalline axes provides low-frequency circuit elements with a wide range of temperature coefficients. Two specified orientations, designated as CT and DT cuts, exhibit zero temperature coefficient at specific temperatures and are closely related to the recent, but now popular, AT and BT high-frequency plates. The new plates are especially useful in precision applications for by slight final adjustment their frequency may be either raised or lowered and their temperature coefficient made either more positive or more negative.

INTRODUCTION

THE recent development of the AT and BT high-frequency low-temperature-coefficient quartz plates has attracted increasing attention to the subject of low-coefficient quartz elements. Elimination of delicate temperature apparatus in several types of commercial radio apparatus has simplified transmitter circuits, improved their reliability, and widened the field of application. It is inevitable, therefore, that as new problems present themselves, the question arises of utilizing the new elements in new fields. It is also inevitable that, when such applications differ from those for which the elements were originally developed, difficulties are likely to be encountered. When the thickness of AT and BT plates is increased to secure

* Decimal classification: R214. Original manuscript received by the Institute, October 22, 1936. Presented before New York Meeting, March 3, 1937.

lower operating frequencies, such as those below the broadcast range, the thickness dimension becomes comparable with the other linear dimensions. Though the AT and BT plates exhibit only small elastic couplings between the desired mode of vibration and other undesired modes, the latter can still introduce extraneous and undesired effects with these unusual dimensional proportions. This trouble becomes of serious magnitude below five hundred kilocycles, if one does not wish to be restricted to unusually large plates of quartz. In order to secure plates operating below five hundred kilocycles and still utilize the characteristics for low temperature coefficient found in the AT and BT types, an investigation has been carried out which has resulted in the disclosure of two new types of quartz crystal elements which have been designated as CT and DT plates.

One of the principal uses appearing for the new low-temperature-coefficient plates in this lower frequency region is that of frequency substandards for measuring purposes. Such a substandard is expected to be better than the frequency control elements in radio transmitters, but not so elaborate, accurate, nor delicate as the precision standards used for the most precise scientific work. The circuit for this substandard may not be practical for all commercial radio installations and necessarily must not be as complicated as that for a precise standard. It becomes necessary in producing this kind of a substandard to use, in conjunction with the new crystals, a circuit employing such features of stabilized circuits as will provide a unit which is at once precise, rugged, and simple. Such a circuit, taking full advantage of the CT plate, has been devised.

THE NEW CT AND DT TYPE QUARTZ PLATES

The new low-frequency low-temperature-coefficient CT and DT plates are directly related to the high-frequency low-temperature-coefficient AT and BT plates described by Lack, Willard, and Fair.¹ This relation is most simply explained by comparing only the AT and DT plates in connection with Fig. 1. The direct relation between the two is through the similar elastic strains produced when in vibration. This strain, according to the axial notation adopted in Fig. 1, is the x_y' shear strain and is associated with the X' and Y' axes, the same for both crystal plates. In the AT plate the x_y' strain is produced by a shear² mode of vibration as shown by the arrows which represent instantaneous displacements. The mid-plane of the plate is a nodal

¹ F. R. Lack, G. W. Willard, and I. E. Fair, "Some improvements in quartz crystal circuit elements," *Bell Sys. Tech. Jour.*, vol. 13, pp. 453-463; July, (1934).

² In the theory of elastic vibrations in thin plates there are three possible fundamental thickness modes of vibration; namely, one longitudinal and two

plane. The relatively high frequency of the AT plate results from the relatively small frequency-determining dimension y' .

In the DT plate the x_y' strain is produced by a shear mode of vibration as shown again by the arrows. Two diagonally opposite corners move radially outward while the other two move radially inward. The nodal line joins the face centers. The relatively low frequency of the DT plate results from the relatively large frequency-determining dimensions x and y' . The frequency of both plates depends upon that shear elastic constant which relates the x_y' shear strain to the X_y' shear stress. The temperature coefficient of frequency of these plates

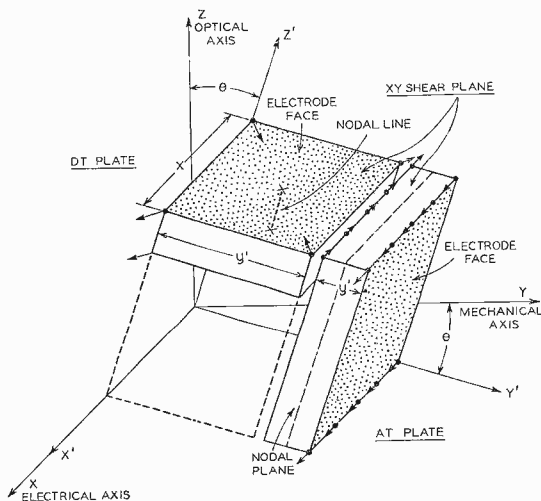

Fig. 1—The new low-frequency DT plate is related to the recently developed high-frequency AT by the similar x_y' shear strain produced when in vibration. Both plates vibrate in a shear mode; small dots and arrows in the figure indicate instantaneous displacements. Frequency-determining dimensions are labeled x and y' .

may be made zero, for the proper angle of cut, because of the fact that the temperature coefficient of the above shear elastic constant may be made to have the proper small value to balance the temperature coefficients of density and elongation. Actually the angle of cut of the DT plate is not exactly ninety degrees to that of the AT cut. This is due to several factors, one being that the frequency-determining dimensions are not in the same direction. However, the low-frequency

shear. The longitudinal mode results from the propagation of a longitudinal wave through the thickness of the plate as in the high-frequency X-cut plate. The shear modes result from the propagation of a transverse wave as in the high-frequency Y-cut quartz plate. The shear mode of the AT plate is of this latter type.

DT plate is basically analogous to the high-frequency AT plate because of the same elastic shear employed in each.

It might be thought that the AT plate could be made to operate at low frequencies by merely increasing the y' thickness dimension thereof. Actually it is found that such procedure introduces trouble from coupled modes of vibration. To be entirely free from such difficulties one must keep the frequency-determining dimension y' of the AT plates small compared to the other dimensions. Correspondingly, but to a lesser extent, the frequency-determining dimensions x and y' of the DT plate should be large compared to the other dimensions. It is to be observed that, when such favorable dimensional ratios are used, the frequencies of undesired fundamental modes of vibration in AT plates will be far below those of the desired mode, while in the DT plates the undesired modes will be high compared to the desired mode. Under these conditions the undesired modes have the least effect upon the desired mode. The effects of coupled modes of vibration are present in any type of crystal or elastic vibrator, and are most pronounced when the dimensional ratios have intermediate values. This is because the effects of coupling are greatest when the various frequencies approach the same value.

Though the coupling effects are unusually small in AT plates, due to the orientation being such as greatly to reduce the elastic coupling constants, they do cause trouble with the temperature coefficient when intermediate dimensional ratios are employed. The reason for this is that zero temperature coefficient of frequency of these plates is secured by balancing the temperature coefficients of the density and frequency-determining dimension against that of the x_y' shear elastic constant. Hence coupled modes with their separate temperature effects on frequency, if present, cause an interference with the normal balance and operation. When AT plates are made with low dimensional ratios to secure lower frequencies, the coupling effects must be adjusted by edging to be ineffective or balanced. This process becomes more and more difficult as the thickness dimension approaches the other dimensions. Fortunately, however, as one proceeds to lower frequencies the DT plate may be used and these difficulties eliminated.

Corresponding to the AT and DT plates shown in Fig. 1 the new CT plate is the low-frequency analogue of the high-frequency BT plate. They are related in the same manner as described above.

In Fig. 1 a manner of denoting orientations was used which simplified the above theoretical description of the relationship between the high-frequency AT and BT plates and the low-frequency CT and DT plates. However, that system is confusing in practice for by it two

plates cut at right angles to each other may have either the same or different angular designation, depending on whether the y' or z' dimension is smaller. Fig. 2 shows the system of denoting the orientation, or angle of cut, which will henceforth be used, and gives a clear description of the manner of cutting the various plates from the natural quartz crystal.

These types are cut in the form of thin plates of thickness y' , the major faces of which are parallel to the X electric axis of the crystalline material, and inclined at an acute angle θ to the Z optic axis, as

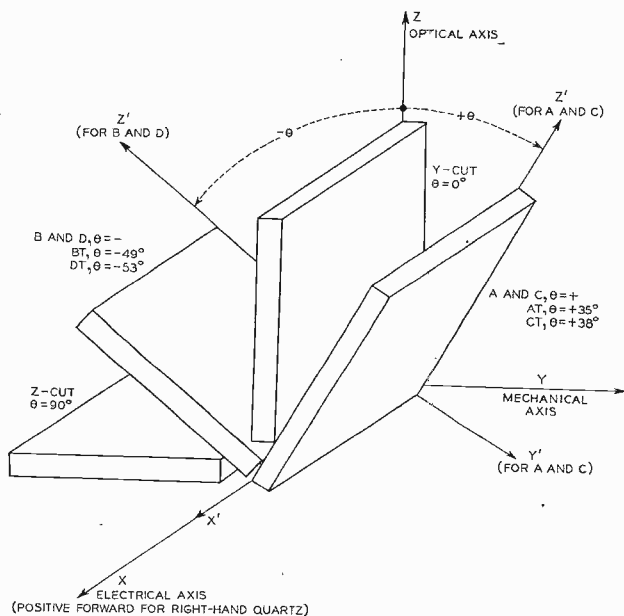

Fig. 2—The standard notation for describing the orientation of various cuts. A and B signify plates operated in the high-frequency shear mode, C and D signify low-frequency shear mode, T appended signifies zero-temperature coefficient of frequency.

shown in Fig. 2 for right-hand quartz. The larger edge dimensions of each plate, when cut with a rectangular periphery, are parallel to the new X' and Z' axes (X' and X are coincident) and are designated as x and z' , respectively. Thus one might think of these plates as Y cuts rotated about the X axis. Accordingly the familiar Y cut, by this notation, is unrotated, $\theta = 0$ degrees, while the Z cut is rotated, $\theta = \pm 90$ degrees.³

³ Low-frequency quartz plates whose angles of cut are included within the above orientation range have been presented in recent literature. These plates which are of a different peripheral shape than the CT and DT, and of unstated mode of vibration, exhibit some of the characteristics of the C and D plates here described. See R. Bechmann, *Hochfrequenz und Elektroakustik*, vol. 44, no. 5, p. 145; and I. Koga, Report of Radio Research in Japan, vol. 4, no. 2, (1934).

Quartz plates thus oriented, parallel to, and rotated about the X axis, are classified according to their orientation and mode of vibration as follows. Those which operate in the high-frequency shear mode are designated A and B for positive and negative angles of rotation, respectively. Those which operate in the low-frequency shear mode are designated C and D for positive and negative angles, respectively. Plates cut at the specific angles to give zero temperature coefficient are designated AT, BT, CT, and DT, respectively, as shown in the figure. It should be noted that, in general,⁴ any one of these plates may be used for either the high-frequency mode or the low-frequency mode. Thus an AT plate may be operated as a low-frequency C plate with small (though not zero) temperature coefficient.

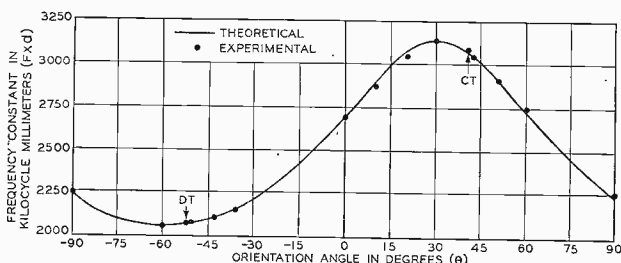

Fig. 3—The wide variation of frequency with orientation of C and D plates depends upon s_{55}' shear elastic-constant variations. CT and DT plates possess frequency constants near maximum and minimum, respectively.

As shown by Lack, Willard, and Fair¹ the frequency of type A and B plates depends upon the thickness of the plate y' , the density, and the x_y' shear elastic constant c_{66}' . It is due to the variation with orientation of c_{66}' and its temperature coefficient that one obtains in the A and B plates such a wide range of frequency constants and temperature coefficients of frequency. The latter range is from +80 to -80 parts in a million per centigrade degree. The AT and BT plates are cut at the special angles of +35 degrees and -49 degrees respectively to give zero temperature coefficient.

These same characteristics are found in the new low-frequency C and D plates. The frequency depends, now, upon the larger edge dimensions of the plate x' and z' , the density ρ , and the z_x' shear elastic constant s_{55}' , according to the formula⁵

$$f = 1.25/2d(s_{55}'\rho)^{1/2}, \quad (1)$$

⁴ For certain small ranges of orientation the activity is low or zero with electrodes applied to the large faces in the usual manner, though they may be excited by other arrangements.

⁵ It is only due to the manner of denoting the orientation that Z_x' and s_{55}' are used instead of X_y' and s_{66}' . If θ had been measured to the normal to the C and D plates as in Fig. 1, this difference would not have appeared.

where $d = x' = z'$ if the plate is square, and $d = (x' + z')/2$ if only nearly square. The elastic constant s_{55}' depends upon the orientation angle θ and the customary s_{ij} elastic constants of quartz according to

$$s_{55}' = s_{44} \cos^2 \theta + s_{66} \sin^2 \theta + 4s_{14} \sin \theta \cos \theta. \tag{2}$$

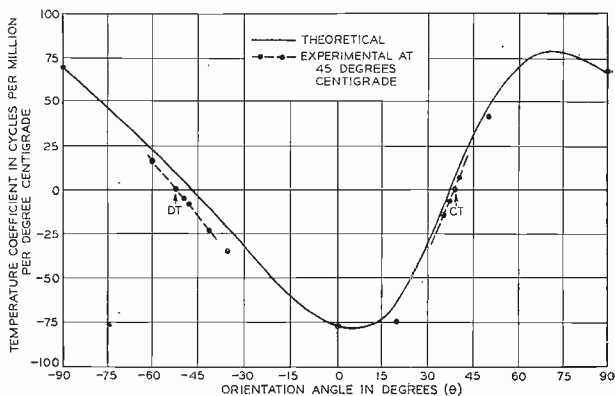

Fig. 4—The wide variations of the temperature coefficient of frequency obtainable in C and D plates depends mainly upon the variation of the temperature coefficient of s_{55}' . Orientations giving zero temperature coefficient are the CT and DT.

Fig. 3 shows the calculated variation of frequency constant (dimension times frequency, $d \cdot f$) with orientation θ . Measured values agree within two per cent. As seen in the figure a maximum and minimum of fre-

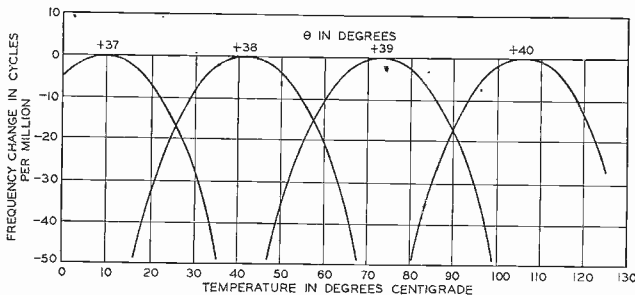

Fig. 5—A more detailed representation of the frequency-temperature variations with orientation in CT plates. Actual zero temperature coefficient is obtained only at a specific temperature which shifts with orientation. Slightly different orientations are used for different ambient-temperature ranges.

quency occur in the C and D ranges, respectively. This is just as was found in the high-frequency B and A types, respectively.

The temperature coefficient of frequency, calculated from (1) and (2) and the respective temperature coefficients of their constituents, goes through the wide variations characteristic of the temperature

coefficient of the shear constant s_{55}' . Fig. 4 shows the calculated and measured temperature coefficients of frequency of the C and D type plates. Though the agreement, here, is not perfect it is seen that from the theoretical curve excellent predictions could be made.

It is to be noted that there exist two orientations giving zero temperature coefficient of frequency; namely, that labeled CT at +38 degrees and that labeled DT at -53 degrees. Further it might be noted, parenthetically, that the plane of the frequency-determining shear elastic constant of the CT cut coincides within four angular degrees with that of the previous high-frequency BT cut, and likewise for the DT and AT cuts.

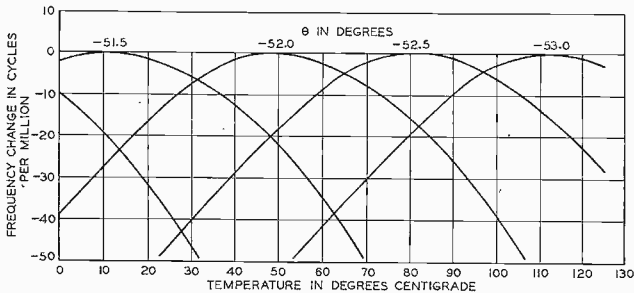

Fig. 6—The same representation for the DT plate as in Fig. 5. It is to be noted that, for the DT plate, the frequency varies less than one cycle in a million from its mean value over a range of twenty-five degrees centigrade.

The above temperature coefficient versus orientation curve of Fig. 4 shows the respective temperature coefficients for relatively narrow temperature ranges in the neighborhood of 45 degrees centigrade. A more detailed representation of the relations between frequency, temperature, and orientation are shown in Figs. 5 and 6. Fig. 5 shows, for CT plates, the variations of frequency with temperature for several orientations in the angular range of +37 to +40 degrees; and Fig. 6 shows, for DT plates, the orientation range -51 to -53 degrees. These curves, which are parabolic, show the shift of the zero coefficient region to higher temperatures with increasing positive or negative orientation angles. It is clear that for a crystal to be operated at a controlled oven temperature of 45 degrees centigrade, one should employ crystals oriented at either +38 or -52 degrees. For operation at average room temperatures of 25 degrees centigrade +37 degrees 30 minutes or -51 degrees 45 minutes orientations should be used, and for wide outdoor-temperature ranges of -40 to +60 degrees centigrade the +37 degrees or -51 degrees 30 minutes orientations are proper.

It is further to be noted that the DT-type plates exhibit a flatter characteristic than do the CT type. Whereas in the DT type the frequency varies less than twenty-five cycles in a million from its mean value (or twice this from the peak value) over a temperature range of 100 degrees centigrade the CT type varies the same amount over a temperature range of 50 degrees centigrade. For such wide temperature ranges these are very small frequency variations. When these crystals are operated in temperature controlled boxes or even in heated buildings the frequency variations with temperature are almost negligible.

The activity or electromechanical coupling of C and D type plates varies with orientation angle θ and is a function of the piezoelectric constant e_{25}' , which relates the Z_x' stress and the E_y' field producing that strain, according to the formula

$$e_{25}' = -e_{14} \cos^2 \theta - e_{11} \sin \theta \cos \theta. \quad (3)$$

The values of e_{25}' for the CT and DT cuts are, respectively, about 3.0 and -1.8×10^4 esu/cm.² This ratio of the relative activities checks with experimental observations of grid current measurements in an oscillator. Though the DT cut is an active or strong oscillator, the CT cut is still more active.

Either of these new types may be rigidly mounted by center clamping, with integral plated electrodes, or they may be mounted in various forms of spaced electrode holders with retainers. For filter elements the former method is preferable, whereas for oscillators under strong vibration, and consequent possibility of wearing through the coated electrodes, the latter method may be used.

FREQUENCY AND TEMPERATURE-COEFFICIENT ADJUSTMENT

The ease with which CT and DT plates may be finally adjusted to precise values of temperature coefficient and frequency exhibits an unusual and important advantage of these crystals for use in frequency standards. The frequency may not only be raised in the usual manner, but may also be lowered by a simple method of face grinding, without in either case affecting the temperature coefficient. This allows one to approach the required frequency as exactly as one wishes, necessitating only successive grindings to raise or lower the frequency, and eliminating the penalties of overadjustment which are inherent in the usual one-way adjustment method. Furthermore, the crystal may even be readjusted, at some later date, to some new circuit or slightly different frequency.

The temperature coefficient may be adjusted by small amounts,

either positively or negatively with small effect upon the frequency. This is of particular advantage for standards since it is difficult to obtain the desired angle of cut with the precision here required. The temperature coefficient may be adjusted by changing the effective orientation of the plate. This may be accomplished by slightly grinding any of the face regions *P* or *N* shown in Fig. 7. Grinding in region *P* makes the temperature coefficient more positive, in region *N* more negative. This adjustment may be carried out in such a manner as to leave the plate either plane parallel or tapered. As shown by the frequency versus orientation curve of Fig. 3, this adjustment of orientation changes the frequency only a small amount for CT and DT cuts. However, since the adjustment of frequency, as described below, is accompanied by negligible change of temperature coefficient it will, if carried out last, produce a plate finally adjusted.

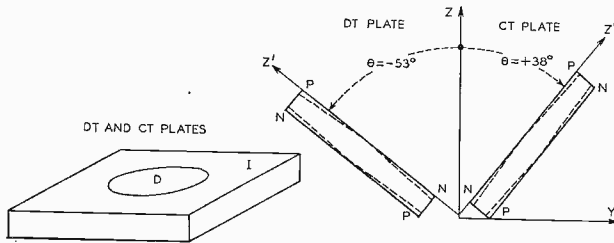

Fig. 7—An advantage of the CT and DT plates, for precision installations, is that the frequency may be finally adjusted in *either* direction—by grinding in regions *D* to decrease, and *I* to increase, the frequency. Further the temperature coefficient may be finally adjusted by grinding in regions *P* for a more positive value and *N* for a more negative value.

The ordinary method of raising the frequency, by reducing the frequency-determining dimensions, is of course, applicable here. In addition, the frequency may be increased relatively smaller amounts by reducing the thickness (i.e., by grinding the faces) only in the outer region *I*, shown in Fig. 7. Further, the frequency may be decreased a small amount by reducing the thickness only in the central region *D*, shown in the figure. Since the frequency may be either raised or lowered it is very simple to approach the desired value as exactly as required. There is no longer the usual hazard of overadjustment which ruins the plate, nor do plates need to be manufactured oversize to allow for circuit variations and final adjustment.

HOLDER

For substandards of frequency, the ordinary commercial holders have been found unsuited. Their greatest shortcomings lie in their

mechanical instabilities which affect spacings, friction, points of contact, etc. For our purposes, the holder shown in Fig. 10 has worked well. It is a spaced holder. The retainer is peripheral in shape and made of steel. The three spacers are isolantite beads, ground to dimension. The electrodes are of strain-free steel. They are clamped at three points in such a manner as to produce little or no warping strains. The base electrode is slightly convex to restrict the contact area with the quartz to a small section in the neighborhood of the node of the vibration. The holder is then mounted on springs, and damped, so that the frequency is negligibly affected by ordinary building vibration and jarring.

CIRCUIT

In general, the major frequency instabilities of oscillator circuits are associated with reactance, temperature, and voltage changes. Variations in temperature or applied voltage may be considered as equivalent reactance changes, for it is through reactance changes that they affect the frequency. Temperature changes act directly on the coils and condensers external to the vacuum tube to cause reactance changes, while variations in the applied voltage have the effect of changing the amplification factor and internal impedances of the tube. Hence, if a circuit may be so adjusted that the frequency is independent of small changes in any and all of the reactances, it is also independent of small temperature and voltage variations. Such an adjustment does not suggest itself as possible. Actually, it has been found attainable. It is possible to stabilize, in this manner, the relatively simple circuit of Fig. 8. The novelty of this circuit, therefore, lies in the particular adjustment employed, that is, the relative and absolute magnitudes of the reactances, and the manner in which this adjustment is brought about by successive approximations to produce stability.

It can be shown, by a theoretical treatment⁶ of the relations between the tube resistances R_g and R_p , and the external reactances X_g and X_p , that when

$$X_p = +jR_p \quad (4)$$

and

$$R_p = (\mu + 1)R_g \quad (5)$$

the frequency of oscillation is independent of either plate reactance X_p or plate resistance R_p . Since the plate resistance R_p , is affected mostly

⁶ After the method of F. B. Llewellyn, Proc. I.R.E., vol. 19, pp. 2063-2094; December, (1931), making certain approximations justified by a knowledge of the values of the circuit parameters employed experimentally.

by plate voltage, this condition should also make the frequency nearly independent of plate voltage. It can also be shown that if the product

$$R_o C_3 = \text{constant} \quad (6)$$

the first-order effects of C_3 vanish. The value of R_o is affected by C_3 through the amplitude of oscillation, and since experiment shows that the stabilization is obtained, it may be assumed that the above relation (6) is approximated. Actually the frequency of oscillation is made simultaneously independent of plate reactance, feed-back reactance, and applied voltage.

Experimentally it is found that as the plate reactance is varied by tuning the variable condenser C_p , the frequency reaches a definite

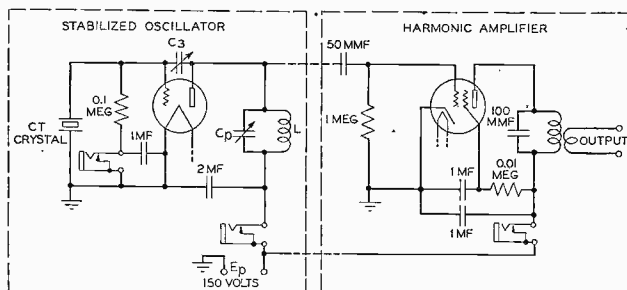

Fig. 8—A stabilized quartz-controlled oscillator circuit in which the frequency is not changed by small variations in either of the circuit reactances or the plate voltage. This oscillator with the CT quartz plate and harmonic amplifier shown results in a convenient portable substandard of frequency delivering one hundred kilocycles and its harmonics.

maximum.⁷ When so adjusted to its maximum, another maximum of frequency is found by varying the feed-back capacitance C_3 . This second adjustment affects the position of the first maximum only slightly. With both condensers simultaneously adjusted for maximum frequency, the frequency is not changed by small variations in either plate or feed-back capacitances, for the circuit is operating at the peaks of the frequency versus reactance curves, where the slopes are zero. Larger changes can only cause the frequency to decrease. Also, the plate voltage has practically no effect upon the frequency.

This adjustment to produce stability is not difficult to attain. A second oscillator and a detector are sufficient equipment. Greatest ease and accuracy of adjustments are obtained by comparison of the second oscillator with a high harmonic of the stable oscillator. Adjustment is complete when the two variable condensers in the circuit are set to produce maximum frequency, as indicated in the preceding paragraph.

⁷ Previously referred to by W. A. Marrison, *Proc. I.R.E.*, vol. 17, pp. 1103-1122; July, (1929).

RESULTS

According to the foregoing information a hundred-kilocycle substandard of frequency was constructed, employing a CT type plate of the following specification: $\theta_x = 37$ degrees 30 minutes, $x = 30.80$, $y' = 1.000$, $z' = 30.80$ millimeters. The CT type was chosen for several reasons: its convenient physical dimensions, low temperature coefficient, ease of adjustment to exact frequency, and its ability when used with the holder described above to withstand severe mechanical shocks without permanent change of frequency. Although the DT type offers

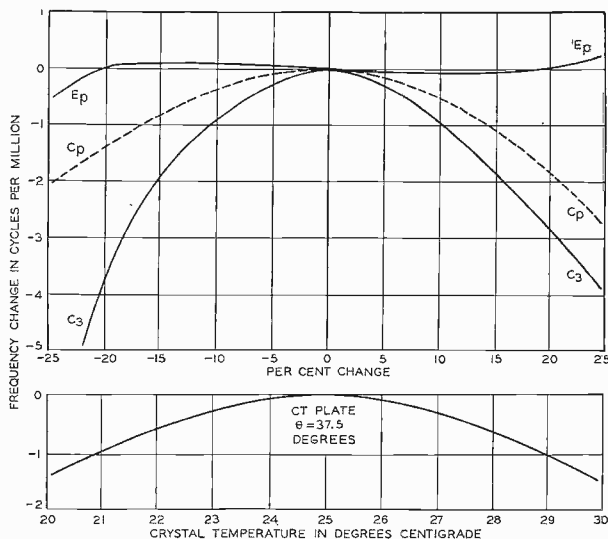

Fig. 9—Measured stabilities for the circuit of Fig. 8. The frequency is changed less than one-half cycle in a million for plus or minus five per cent changes in circuit reactances or plate voltage. Temperature variations over a range of ten degrees centigrade change the frequency less than one cycle in a million from its mean value.

a more desirable temperature-frequency relation, it is less active than the CT and not so well suited for use in this completely stabilized circuit.

The condition of stability was obtained with the following approximate values of circuit reactances: $C_3 = 15$ micromicrofarads, $C_p = 265$ micromicrofarads, $L = 5$ millihenrys. Actual frequency stabilities attained with this circuit may best be exhibited by referring to the experimental curves of Fig. 9. Percentage changes in the capacities connected in the plate and feed-back circuits are plotted against frequency changes in parts in a million. The largest capacity changes

(from temperature and aging effects) expected in long-time operation are less than five per cent, causing less than one part in a million frequency change. Changing vacuum tubes causes no appreciable change in frequency for the differences in tube capacities are only a small portion of the total capacities in the reactance branches. The same figure shows the effect of plate voltage changes and exhibits very good stability over a voltage range of plus or minus twenty per cent. A small voltmeter can be used to adjust the voltage to within plus or minus five per cent, assuring great accuracy of frequency adjustment.

Effects of temperature changes on the crystal frequency for a plate designed to operate at room temperature in a building which is heated

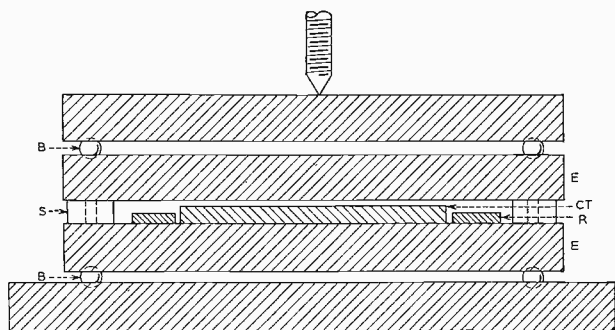

Fig. 10—The special holder for the CT plate as used in the frequency substandard. The plate is loosely retained between spaced electrodes *E* by a peripheral retainer *R*, the lower electrode being slightly convex to support the crystal nodally. The three isolantite spacers *S* and the steel clamping balls *B* are aligned to reduce warping strains in the electrodes.

in winter, are shown on the lower curve of Fig. 9. Over the practical temperature range shown, the frequency never departs as much as one part in a million from the mean.

The greatest frequency change caused by vigorous shaking and jarring of the entire circuit including the crystal was less than one part in ten million. Tipping the circuit so that one end was an inch higher than the other (about five degrees) caused the frequency to increase less than one cycle in a million. Restoring the circuit to a level position brought the frequency back to normal.

The effects of aging, atmospheric pressure, and humidity on all elements of the oscillator circuit except the quartz plate are well cared for by the circuit stabilization. The effects on the quartz plate itself may require special attention when great precision is required.

Effects of the load circuit upon the frequency are very small, but to decrease them further an output tube was added to act as a buffer-

amplifier. A tetrode was used in this stage because it also affords high harmonic content, providing harmonics, one hundred kilocycles apart, at frequencies as high as thirty megacycles, thus offering a great number of accurate frequencies for use in comparison measurements.

The entire unit containing oscillator and amplifier was constructed in a copper box measuring $7 \times 7 \times 12$ inches and weighing less than twenty pounds.



THE HARMONIC MODE OF OSCILLATION IN BARKHAUSEN-KURZ TUBES*

BY

W. D. HERSHBERGER

(Moore School of Electrical Engineering, University of Pennsylvania, Philadelphia, Pa.)

Summary—The phenomenon of harmonic operation of Barkhausen-Kurz tubes employing a resonating helical grid is investigated by the use of tubes with the plate cut transversely into three sections. It is shown that the fundamental or Barkhausen frequency may be elicited by exciting the grid at its central portion, but that if the grid is excited at its ends either symmetrically or unsymmetrically the oscillations occur at double the Barkhausen frequency. This doubled frequency is that usually generated by tubes of this type. It is also shown that it is essential to tune the filament circuit of the oscillator if maximum power output is desired.

THIS paper presents a study of the frequency doubling observed in Barkhausen-Kurz tubes of the helical grid type. The work is an extension of that previously reported¹ and again tubes employing a plate cut transversely into three sections were used. In the earlier work, it was found that maximum power was generated when the central plate was held five times as negative with respect to filament as the end plates. Also a relatively high degree of wave length stability was attained due to the selectivity of the half-wave transmission line used to link the two end plates. The present paper deals in particular with the phenomenon of frequency doubling found in these oscillators as well as with the part played by filament tuning in determining power output.

The frequency of the fundamental or Barkhausen oscillations generated by tubes which do not employ resonance in the grid structure may be calculated. A rational basis for such calculations is furnished by the theory presented by Benham² and extended by Llewellyn.³ The theory predicts oscillations in a positive grid tube and its associated circuit of a frequency such that a certain critical relationship between the period of oscillation and the electron transit time in the tube holds.

On the other hand, when resonance in the grid helix itself is employed, the frequency of oscillation is approximately twice as high as one would expect on the basis of the simple theory. Schaefer and

* Decimal classification: R133. Original manuscript received by the Institute, February 10, 1937.

¹ Hershberger, Proc. I.R.E., vol. 24, pp. 964-976; July, (1936).

² Benham, I, *Phil. Mag.*, p. 641; March, (1928). II, *Phil. Mag.*, vol. 11, p. 457; February, (1931); and III, *Wireless Engineer*, vol. 12, p. 3; January, (1935).

³ Llewellyn, Proc. I.R.E., vol. 21, pp. 1532-1573; November, (1933), and Proc. I.R.E., vol. 23, pp. 112-127; February, (1935).

Merzkirch⁴ made what were probably the first observations on higher modes of oscillation in Barkhausen-Kurz tubes. Various views have been advanced as to the electronic motions in a tube operating in this fashion. Thus Pierret⁵ held that the electrons oscillate from one part of the grid to another part. Hollmann⁶ in developing his theory of "inversion zones" deduced a formula $\lambda^2 E_g = K/n^2$ where $n = 1, 2, 3, \dots$, λ is wave length, E_g is the applied grid voltage, and K is a constant depending on tube geometry and the units used. When n is unity the usual Barkhausen law for the fundamental oscillations results, while integral values of n greater than unity are employed to account for the higher modes of oscillation. This theory can scarcely be considered adequate to account for the large variety of oscillations often observed.⁷ Collenbusch⁸ employed tubes with helical grids and found that when he divided such a grid into two sections, the wave obtained is approximately twice as long as that generated before the grid was divided. Müller⁹ held that a tube of this type oscillates in such a fashion that the current flow is from one end of the grid to the portion of the plate nearest it, then along the length of the plate, and finally from the far end of the plate to the far end of the grid. It is the purpose of this paper to present a further study of tubes of this same general type.

APPARATUS

The earlier work was carried on with a group of five experimental tubes. Five new tubes were constructed for the present investigation which differed from those used in the former work in that the filament was placed parallel to the axis of the glass envelope thus permitting the use of short straight leads to the electrodes. Fig. 1 is a photograph of one of the latter with its tuning circuits. The arrangement of leads was such as to permit filament tuning. In these tubes the grid leads came through the glass envelope in a plane at right angles both to the plane of the filament leads and the plane of the plate leads. Lecher wires were used in measuring wave length.

RESULTS

The results reported previously on the influence of plate and grid tuning on wave length and power were confirmed by the work with the new tubes, and the effectiveness of the tuned circuits in stabilizing frequency was checked.

⁴ Schaefer and Merzkirch, *Zeit. für Physik*, vol. 13, p. 173; January-February (1923).

⁵ Pierret, *Comptes Rendus*, vol. 187, p. 1132; December 10, (1928).

⁶ Hollmann, *Naturwiss.*, vol. 20, p. 181; March 11, (1932).

⁷ Consider for example the parasitic frequencies noted in reference 1.

⁸ Collenbusch, *Ann. der Phys.*, vol. 13, p. 191, (1929).

⁹ Müller, *Ann. der Phys.*, vol. 21, no. 6, p. 611; (1935).

The direct current for heating the filament was brought into the tube through parallel leads placed about one inch apart. Each of these leads was enclosed by but insulated from a straight piece of copper tubing. The filament was tuned by sliding a movable bridge across

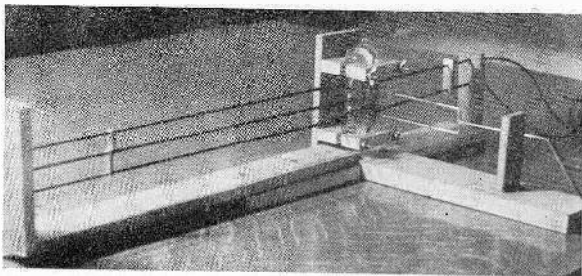

Fig. 1—Barkhausen tube and its circuit.

the two pieces of tubing. The plate and grid transmission lines were adjusted to such lengths and the operating voltages and currents were given such values as would give rise to oscillations of maximum amplitude at the resonance frequency of the grid, which corresponded to a wave length of between 24 and 25 centimeters. Table I gives the

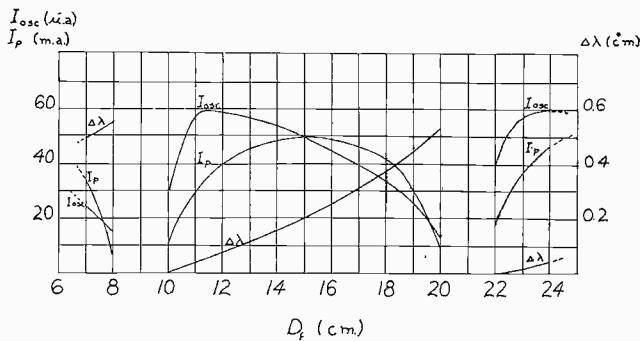

Fig. 2—Curves showing the effect of filament tuning on wave length, relative power, and plate current.

optimum operating conditions for two of the tubes. The outer plates were usually held at different potentials to compensate for the voltage drop in the filament itself. The distance from the axis of the tube to the bridge on the filament line was varied and the effects noted on wave length, on plate current, and on the rectified current through the crystal detector used with the wavemeter tuned to resonance. Fig. 2 shows some results obtained. It was found that the change in wave length which resulted from a change in the length of the filament

transmission line was only one tenth as large as the change in wave length noted on varying the length of the grid line by a corresponding amount. One would reasonably expect this result since the difference in potential at this frequency between the two ends of the grid is large compared to the potential difference between the ends of the filament which is short electrically. However, it is to be noted that oscillations do not occur at all when the bridge on the filament line is given any one of a series of positions corresponding to $D_f = (n\frac{\lambda}{2} - 3)$ centimeters while oscillations of maximum amplitude are generated when $D_f = (n\frac{\lambda}{2} - 0.5)$ centimeters. D_f is the distance from the axis of the tube to the bridge on the filament transmission line. The conclusion is that although filament tuning has a relatively small effect on frequency, yet it has a large effect on the amplitude of oscillation.

Kelley and Samuel¹⁰ reported results with eighteen tubes with helical grids, all of different sizes. The lengths of wire for their grids ranged from 16.3 to 80.0 centimeters and optimum wave lengths ranged from 13.5 to 65.0 centimeters. They reported the average ratio of the length of the grid wire to optimum wave length was 1.24 but this ratio itself went through the large range of values from 0.85 to 1.47. For the tubes whose performance is outlined in this paper the ratio was 1.05. No particular significance is to be attached to this ratio other than that it indicates that the grids used in tubes of this type are usually more or less similar as regards pitch of winding, and ratio of length to diameter.

That the tube operates as a frequency doubler is shown by experiments in which operating conditions were first selected to elicit the most powerful oscillations possible at the wave length corresponding to resonance in the grid. After these circuit adjustments were found, the grid voltage and current and the tuning of the circuit were left unchanged but the voltages on the inner and the outer plate sections were interchanged. Table I shows the operating conditions and the

TABLE I

Tube	E_g (volts)	I_g (m.a.)	E_p (outer) (volts)	E_p (inner) (volts)	I_p (m.a.)	λ (cm.)
A	200	90	-15	-160	0.90	25.0
A	200	90	-160	-15	0.16	52.0
B	200	90	-15	-200	0.55	24.2
B	200	90	-200	-15	0.10	48.7

wave lengths generated by two of the tubes under these circumstances. Similar results were obtained with other tubes.

Plate current flows only to the plate section or sections held

¹⁰ Kelly and Samuel, *Elect. Eng.*, vol. 53, p. 1504; November, (1934).

slightly negative with respect to filament, while no measurable current flows to the sections held highly negative. It is to be noted that the wave length generated on exciting the grid at its end portions is approximately 25 centimeters which is only one half the length of the waves generated on exciting the grid at its central portion. The fact that the wave lengths indicated in the last column of the table are not exactly in the ratio 2:1 is of no particular significance because the voltage adjustments for maximum power at 25 centimeters are not critical. This ratio may be made precisely 2:1 if desired by selecting slightly different operating voltages and circuit adjustments when the 25-centimeter wave is being generated. Tuning is effective in shifting the length of the 25-centimeter wave over but a limited range due the

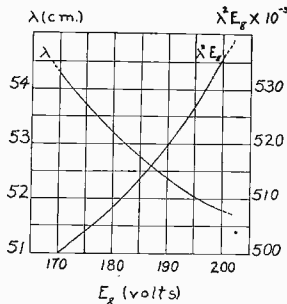

Fig. 3—Curves showing the dependence of the length of the 50-centimeter waves on grid voltage as well as the Barkhausen product $\lambda^2 E_g$.

marked control of frequency by the grid. On the other hand, the length of the 50-centimeter waves is dependent to a marked degree on grid voltage and circuit tuning, but this dependence is less than that demanded by the Barkhausen law. Fig. 3 shows the variation in wave length and in the product $\lambda^2 E_g$ as E_g is varied for the 50-centimeter waves. In short, with these tubes the length of the 50-centimeter waves is determined by the applied voltages and by the circuit tuning, these operating conditions having been chosen, however, to elicit 25-centimeter waves of maximum amplitude. The length of the latter is determined in part by the tuned circuits, in part by the grid structure, and to a slight degree by the operating voltages. The frequency doubling observed is attributed to the difference in the manner in which the grid is excited in the two cases.

The question arises as to whether it is possible to excite the grid in such a fashion as to elicit both oscillations simultaneously from a single tube. Unsymmetrical methods of applying voltages to the plates were employed but the only method found for generating the 50-centimeter waves was to hold both end plates highly negative and the

central plate slightly negative so it alone draws current. In no case were the two waves observed at once but it must be borne in mind that the 50-centimeter waves when observed were relatively feeble, hence this result is not surprising. Whenever 25-centimeter waves existed at all their amplitude was always considerable. The shorter waves were generated under a wide variety of operating conditions, but the tubes themselves differed somewhat in their ability to maintain oscillations when the grid was excited unsymmetrically. However, any tube capable of generating 25-centimeter waves at all would continue to oscillate in spite of the fact that one end plate was held twice as negative as the other and drew only one eighth of the total plate current. In the case of the most powerful oscillator, 25-centimeter waves were generated on holding one end plate and the central plate 200 volts negative with respect to filament and the remaining end plate only 13.5 volts negative so it drew a current of 0.10 milliamperes. The fact that one end plate was held highly negative and drew no direct current did not change in any appreciable manner the distribution of radio-frequency currents and voltages in the transmission lines used as tuned circuits. That is, the two ends of the grid operated in push-pull as before as well as the two end plates.

The results of the present study indicate that the path for radio-frequency currents is essentially like that described by Müller⁹ with such modifications as are needed because of the split plate construction. It also becomes evident that the two ends of the filament undergo potential variations in the same manner as do the two ends of the grid but due to its short electrical length these variations are relatively small. Further, the experiments show that oscillations may be maintained under conditions such that a displacement current flows from a plate section to the part of the grid nearest it in the absence of electronic current. This observation shows that the steady and the varying components of current in the tube are not subject to the same boundary conditions at an electrode. Finally, the experiments serve to emphasize the importance of the helical grid in determining the frequency of the oscillations. Only under special conditions of excitation could the fundamental oscillations be generated, while oscillations corresponding to the frequency for grid resonance were maintained whether the grid was excited symmetrically or unsymmetrically at both ends, or in the case of one tube at one end only.

ACKNOWLEDGMENT

I wish to thank Professor J. G. Brainerd for helpful discussions during the course of the investigation.

GRID CONTROL OF RADIO RECTIFIERS*

By

S. R. DURAND AND O. KELLER

(Allis-Chalmers Manufacturing Company, Milwaukee, Wisconsin)

Summary—This paper discusses grid control for voltage regulation and protection of mercury-vapor or arcing type rectifiers for radio transmitting service. The principles of two basic types of voltage control circuits are described, and illustrated by means of diagrams. Various advantages of grid control are brought out, such as automatic starting at reduced voltage, automatic voltage regulation, and high speed electronic protection of the rectifier and the transmitter. A number of oscillograms are reproduced, illustrating several factors coming into consideration when using the automatic grid protection circuit, and showing the comparative duration of the interrupting time with and without automatic inversion of the energy stored in the filter reactor.

IN AN earlier paper by one of the authors¹ the general features of steel-tank mercury-arc rectifiers for radio service were described, and the use of control grids for voltage regulation and high speed automatic protection was explained. The present paper discusses in greater detail the theory of electrically energized grids in a rectifier unit, and the practical grid control circuits used for voltage regulation and high speed automatic protection.

In a high vacuum type tube, grid elements inserted between the cathode and anode are capable of being used for complete control of the electron current. In gaseous, vapor, or arcing type tubes, on the contrary, the type of grid elements usually employed are capable of being used only to prevent the flow of electron current until a desired interval of time. Once current is established, the presence of ions in the region between the cathode and anode prevents the ordinary grid from being used to regulate or interrupt the current flow. This fact may appear to limit the value of grids in mercury-arc or -vapor type devices, but in polyphase rectifier circuits in which each anode carries current during only a portion of a cycle, each grid is able to regain control of its associated anode after such a relatively short interval of time that the use of grids is actually of very great value for controlling and protecting radio rectifier and transmitter equipment.

In addition to the ordinary type of grid, there has been developed in Europe a type of grid element which enables arc currents of con-

* Decimal classification: R356.3. Original manuscript received by the Institute, September 18, 1936.

¹ S. R. Durand, "Steel-cylinder grid-controlled mercury-arc rectifiers in radio service," Proc. I.R.E., vol. 23, pp. 372-379; April, (1935).

siderable magnitude to be interrupted in gaseous or vapor type power valves.² These grids have not, however, found application as yet in rectifiers for radio transmitting stations.

GRID CONTROL VOLTAGE REGULATION

There are two basic types of circuits that can be used for voltage control of a rectifier under load by means of electrically energized grids. These are generally known as phase shifting control and alternating-current-excitation—grid-bias control. Occasionally, both systems are combined.

Phase shifting control can be described in connection with a fundamental analysis of the principle of operation of grid control for voltage regulation. It is well known that with no control potential applied to the grids, each anode of a two-anode rectifier connected to a single phase alternating-current power system will fire and carry current during the half of the alternating-current cycle in which it is positive with respect to the cathode and will not carry current during the half of the cycle in which it is negative. If a positive direct-current potential is applied to both grids, firing of the anodes will not be changed, but if a negative direct-current potential of sufficient value is applied, the anodes will be prevented from igniting and carrying current. Voltage control can thus be accomplished simply by applying a negative blocking potential to each grid for a definite period of time after its associated anode becomes positive, and removing this blocking potential when it is desired to release the anode to permit it to fire at a delayed part of its positive voltage wave. To accomplish this periodic control, a small commutator or distributor can be driven by a synchronous motor, through which a negative direct potential is applied to the grids. By mechanically shifting the contacts on the distributor or by electrically shifting the axis of the rotor of the synchronous motor, adjustments can be made for releasing the anodes at any desired angle of delay in their firing periods.

This method of voltage control is illustrated by the fundamental diagram of Fig. 1. Part "a" shows normal operation without voltage control.³ Part "b" illustrates reduction of the average direct output voltage accomplished by delaying the firing point of each

² E. Kobel, "Unterbrechung eines brennenden Anodenstromes mittels Gitter in Quecksilberdampf-Gleichoder Wechselrichter," (Interruption of an arc in mercury-arc rectifiers or inverters by means of grids). *Schweizerischer Elektrotechnischer Verein Bulletin*, vol. 24, pp. 41-48; February, 1, (1933).

³ O. K. Marti, "Grid control of mercury arc rectifiers," *Elec. World*, vol. 102, pp. 507-509; October 14, (1933).

anode by an angle α_b . Part "c" illustrates a still further reduction of voltage equivalent to delaying the firing point by an angle α_c . Part "d" shows voltage reduction to zero caused by shifting the contacts through an angle, α_d , of 180 degrees. It is apparent that the direct output voltage of a rectifier can be regulated from full voltage to zero in this manner.

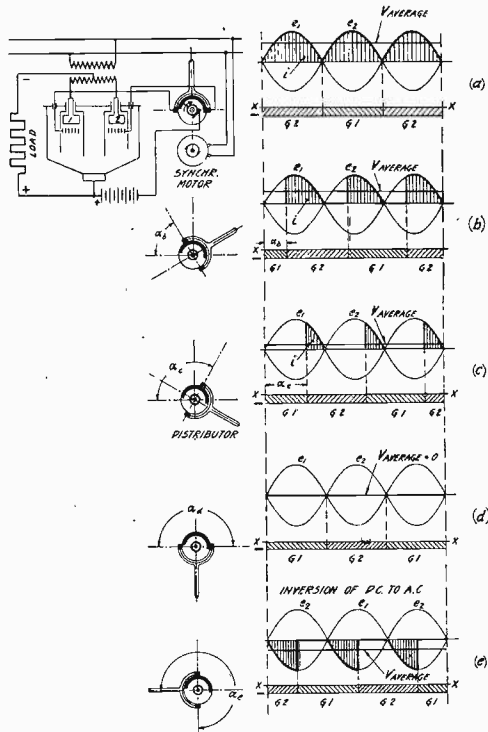

Fig. 1—Principle of operation of phase-shift control in a single-phase rectifier.

If the contacts of the distributor are shifted by an angle greater than 180 degrees, each anode will be released during the negative portion of its impressed voltage wave. For example, in part "e" of the diagram, the distributor contacts are shown shifted by an angle, α_e , of 270 degrees, so that the voltage across the rectifier unit is reversed, the cathode becoming negative and the neutral point of the transformer positive. In order for the anodes to fire under this condition, a voltage must be impressed across the direct-current terminals to cause power to flow back through the rectifier unit into the alternating-current system. Inverter operation of a rectifier unit in radio service is of

great value in connection with high speed automatic protection of rectifier and radio equipment by means of grid control. This will be explained and illustrated with an oscillogram in a later part of this article.

The second basic method of voltage control of a rectifier is generally preferred to the first method, since completely static type equipment can be used for regulation of the direct output voltage. A simplified circuit diagram illustrating alternating-current-excitation—grid-

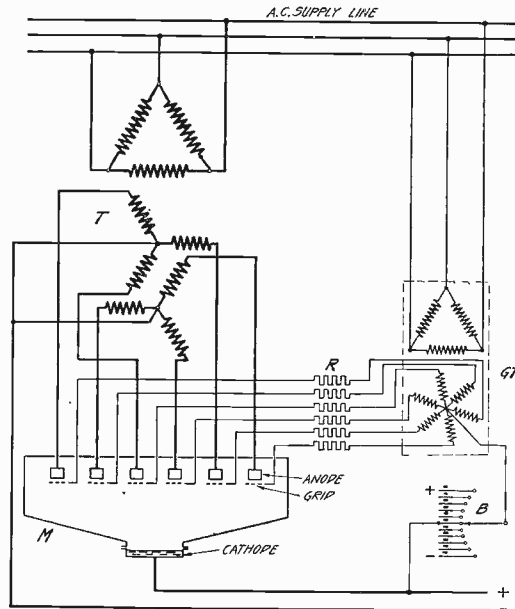

Fig. 2—Simplified diagram of connections of six-phase rectifier with static grid control.

bias control of a six-phase rectifier is shown in Fig. 2. The rectifier transformer *T* and grid transformer *GT* are connected to the same three-phase alternating-current power supply line. Each grid of the rectifier *M* is connected through a current limiting resistor *R* to a phase of the secondary winding of the grid transformer, and the neutral point of this winding is connected to the cathode through a battery *B* arranged to supply either positive or negative biasing voltage to the grids. In actual practice a small copper-oxide rectifier, tube type rectifier, or motor-generator set may be used in place of the battery, and a potentiometer may be connected across the direct-current bias supply to provide for regulation of the bias voltage (and thereby the output voltage of the rectifier) with very smooth control.

An understanding of the principle by which the direct output voltage of a six-phase rectifier is regulated in this manner can be obtained by reference to Fig. 3. Under normal operation at full voltage, as shown at the left in the upper part of the diagram, each anode fires in turn and carries current during the time it is at highest positive alternating potential in relation to the other anodes. The voltage on each grid is adjusted to reach zero or become positive in relation to the cathode at or before the normal firing period of the anode. In order to reduce the average direct voltage output of the rectifier, it is necessary only to adjust the grid bias voltage in relation to the grid excitation voltage so as to delay the point at which the resultant potential on each grid becomes zero, and thus to delay correspondingly the ignition point of the anodes. This is illustrated at the right of the

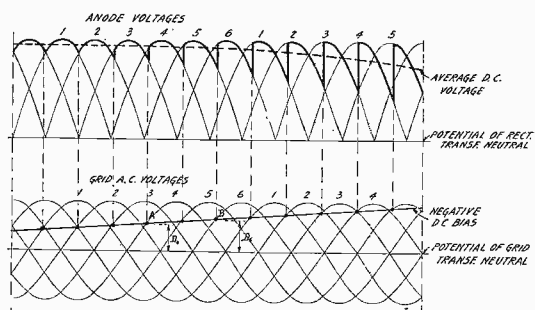

Fig. 3—Principle of voltage control with combined direct-current bias and alternating voltage on grids.

upper part of the diagram as shown in relation to the lower part of the diagram. It is evident that each anode is prevented from firing until the instant that the normally negative voltage on its associated grid becomes zero. For example, when the direct-current bias has a value D_4 , the positive half cycle of the alternating grid voltage does not offset it until point *A*, or, when the direct-current bias has a value D_6 , the positive alternating grid voltage does not offset it until point *B*, so that the ignition points of the anodes are delayed by a corresponding amount in each case.

It must be realized that the wave shapes shown in the voltage diagrams refer only to the theoretical voltage output of the rectifiers under consideration. In actual practice, the inductive reactance of the transformer windings exerts a smoothing effect on the wave shape, and, of course, the filter system of a radio rectifier plant can be designed to smooth out the ripple to any required degree. In designing the filter system, the operating conditions for the plant should be taken into

account, and the per cent ripple voltage tolerance after filtering should be specified only in accordance with the range of grid-control regulation that is required for normal continuous operation. During temporary operation at reduced voltage, such as in starting the plant at very low voltage and gradually increasing it to the normal operating value, a higher rippled voltage can be tolerated.

Fig. 4 is a curve showing the relation between the average direct voltage output of a six-phase rectifier as a function of the angle of delay of the firing period of the anodes under grid-control regulation. It is apparent from this curve that a very smooth control of the output voltage of a rectifier can be obtained from zero to full value.

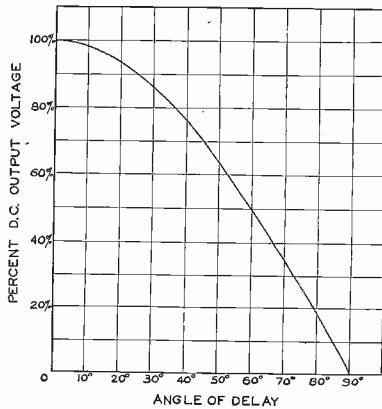

Fig. 4—Regulation of direct voltage output of a six-phase rectifier as a function of the angle of delay.

The great advantage of grid-control voltage regulation is that very sensitive and accurate adjustment of the output voltage of a rectifier plant can be made under load by means of only very inexpensive equipment. The amount of power required by the grids to control the mercury arc is only about one ten-thousandths (0.0001) of the amount of power passing through the rectifier unit, so it is evident that the grid circuit apparatus is of very low rating and small size compared to any equipment in the main power circuit. In rectifiers without grid control, voltage regulation is generally accomplished by means of taps on the rectifier transformer or by means of an induction regulator connected in the primary alternating-current circuit. Tap-changing equipment, particularly for operation under load, is expensive and provides at best only a few steps of comparatively coarse voltage adjustment. Induction regulators are more satisfactory in that they provide a fine degree of regulation, but they are very expensive if a wide range of voltage con-

control is required. Moreover, if induction regulators are used, it is often necessary to provide transformers for stepping the primary alternating line voltage down to 2300 volts, whereas with grid-control regulation, rectifier transformers can be designed for direct connection through circuit breakers to power lines of any voltage.

In starting radio rectifier plants, it is general practice to apply voltage first at a low value and then to increase it automatically in two or three steps to the normal operating value. This is done to decrease the surge charging current to the filter condensers and to apply at the beginning a low plate potential to the transmitter tubes. In rectifiers without grid control, starting at low voltage is usually accomplished by means of series resistors inserted in each phase of the primary alternating-current supply which are automatically shorted-out after definite time intervals by solenoid-operated contactors. In rectifiers with grid control, however, an improved method of starting is employed making use of a small automatic voltage regulator in the grid circuit to adjust the grid bias so that power is applied initially only at very low voltage and is then gradually and automatically increased to full value within any desired time interval.

A high speed automatic voltage regulator is also used to maintain the direct voltage output constant in spite of fluctuations in the alternating supply line voltage, and thus to maintain a more steady output of the transmitted radio-frequency signals. A small rocking-contact regulator connected in the grid circuit is capable of maintaining the output voltage of a rectifier constant to within one per cent. On the occurrence of fluctuations in the supply line voltage of the order of ten per cent, this regulator is capable of correcting the output voltage within a time of five cycles ($1/12$ th second in a 60-cycle power system). This is about 100 times faster than the speed of automatic induction regulators connected in the primary alternating-current power supply system to accomplish the same degree of regulation. High speed automatic voltage control is of great importance in radio broadcast service in keeping the signal distortion at a minimum on the occurrence of voltage fluctuations due to modulation or to other causes.

GRID CONTROL PROTECTION

In a high voltage rectifier without grids, power is interrupted for protection purposes by means of an alternating-current circuit breaker in the primary power supply line. In a grid-controlled rectifier, however, additional protection can be provided by means of electronic interruption of power obtained by the blocking action of the grids. This blocking action is dependent upon automatically placing a nega-

tive potential in relation to the cathode on all grids when an overload or short circuit occurs in the radio transmitter or rectifier equipment. By using a small high speed relay to apply the negative grid blocking bias, it is possible to interrupt power in the rectifier unit within one cycle. This is considerably faster than the interrupting time required by an alternating-current circuit breaker, and thus grid control provides much better protection than mechanically operated circuit breakers. Moreover, since an alternating-current circuit breaker is usually furnished in any event, double protection is provided in that the high speed grid-control protection apparatus is backed up by the slower speed circuit breaker equipment.

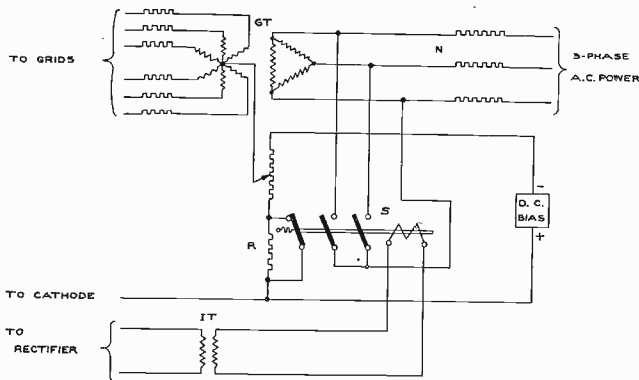

Fig. 5—Grid-control protection circuit.

Fig. 5 shows a diagram of a grid-control protection circuit. Upon the occurrence of a fault in the transmitting equipment, a surge current is induced through insulating current transformer IT on the coil of relay S . Opening of the back contact of this high speed relay instantly inserts resistance R into the bias potentiometer circuit and thereby causes the negative biasing voltage to be increased to a value of greater relative magnitude than the positive alternating-current potentials placed on the grids through resistors N and grid transformer GT . Closing of the other contacts of relay S an instant later short-circuits the grid excitation transformer, thus doubly assuring that only a negative blocking bias is maintained on the grids.

Since the greatest number of interruptions in radio service are caused by flashover arcs in the transmitter circuits or antenna system, or by gas-discharge arcs in the transmitting tubes, power can usually be restored immediately after a short-circuiting arc has been interrupted. Occasionally, however, mechanical breakdowns occur in a

transmitter, and it is necessary then to disconnect power completely and make repairs before service can be resumed. It is usual practice to include in the grid protection circuit two relays, one to control the automatic restoration of voltage after a definite interval of time (generally about five cycles), and the other to trip the main alternating-current circuit breaker of the rectifier plant in case power cannot be automatically restored after three successive attempts.

The action of the rectifier grids in causing power to be interrupted is explained as follows: the anode which is firing on the occurrence of a fault will start to carry the surge current. Perhaps one or two of the succeeding anodes in the firing period will also ignite and carry surge current before the grid relay operates to place a blocking negative bias on all grids and prevent the other anodes from firing. The last anode to carry current will continue to do so until its alternating voltage becomes negative and the current falls to zero value. At this point, the grid of this anode will gain control and prevent it from igniting again. It is thus evident that if a grid relay functions within a half cycle, power can be interrupted within the next half cycle so that the total time required to clear a fault with grid control is only about one cycle (1/60th second in a 60-cycle power supply system).

Fig. 6 shows an oscillographic record of a short circuit applied to a six-phase rectifier when operating at 24,000 volts, 37 amperes direct current.⁴ The record is marked with the following descriptive designations: E_p = direct voltage output, E_{PN} = neutral of transformer or zero line voltage, I_p = output direct current, I_{PN} = zero line of current, I_s = screen or grid current, I_{SN} = zero line of grid current. It is seen that when the short circuit was applied, the current rose rapidly to maximum surge value of about 400 amperes. It required only one cycle to apply a negative blocking bias to the grids and completely interrupt the short-circuit current. Power was automatically restored at full voltage after an interval of about eight cycles. Fig. 7 also shows an interruption of a short circuit and automatic restoration of power, but with voltage applied initially at a low value and then increased gradually to full value by grid control. These oscillograms were made with no filter reactor nor condenser connected in the direct-current output circuit.

In radio broadcast service, it is essential that the ripple voltage be smoothed out to a high degree by a filter system before the power is applied to the plates of the transmitting tubes. Moreover, it is neces-

⁴ A. Leuthold, "High-voltage a.c.-d.c. mutators with protective devices for wireless transmitting stations," *The Brown Boveri Rev.*, pp. 218-222, December, (1934).

sary that the natural period of the filter be less than the lowest modulating frequency of the transmitter, and it is therefore customary to design the filter for a resonant frequency of less than thirty cycles per second and sometimes even less than twenty cycles per second. The filter reactor is usually chosen with an inductance of the order of one henry and the filter condenser with a capacitance of the order of 100 microfarads, so that considerable energy is stored in the filter system when in service.

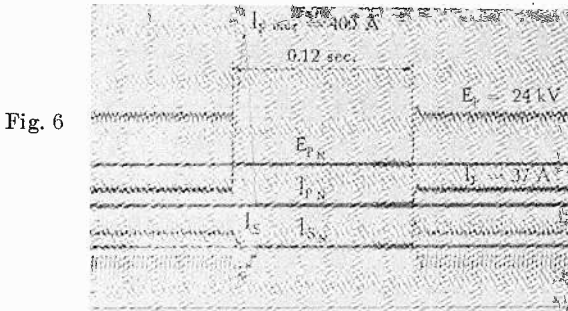

Fig. 6

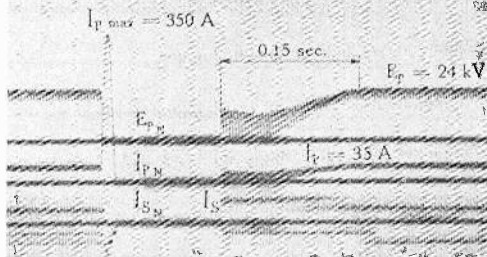

Fig. 7

Fig. 6—Oscillographic record of interruption of a short circuit by grid control.

Fig. 7—Oscillographic record of interruption of a short circuit by grid control and automatic gradual restoration of power.

If a flashover occurs in a transmitter, the energy in the filter system will discharge into the flashover arc and will prolong the arcing time for several cycles unless means are provided for dissipating the filter energy quickly in some other circuit. Fig. 8 is an oscillographic record showing the discharge of a filter reactor into a short-circuit arc. It is evident that the voltage E_D across the reactor prevented the direct current from reaching zero until after several cycles, so that during this time, the grid of the anode carrying current could not gain control and interrupt the short-circuit current. In a mercury-pool type rectifier⁵

⁵ S. R. Durand, "Metal-clad grid-controlled mercury rectifiers for radio stations," *Electronics*, vol. 7, pp. 4-6; January, (1934).

capable of carrying high surge currents, no damage would result to the rectifier unit on account of this delayed clearing of a fault, but in a hot-cathode tube type rectifier, a single tube carrying the surge current

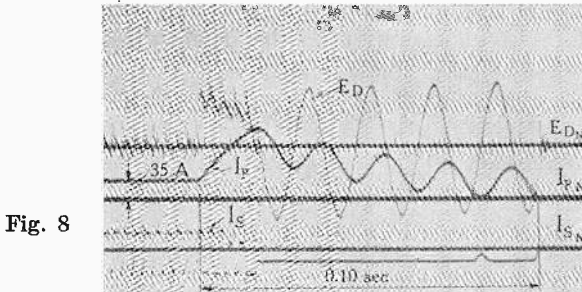

Fig. 8

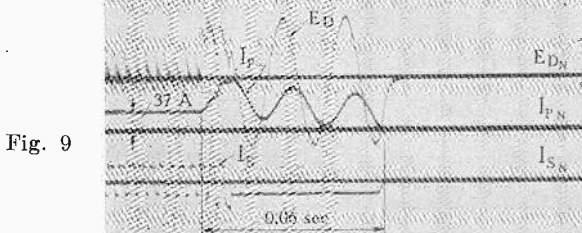

Fig. 9

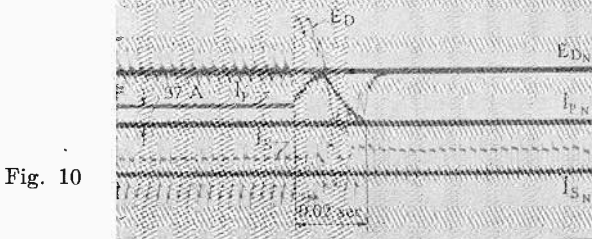

Fig. 10

Fig. 8—Oscillographic record showing discharge time of filter reactor energy into short-circuit arc.

Fig. 9—Oscillographic record showing discharge time of filter reactor energy shortened by protective gap across reactor.

Fig. 10—Oscillographic record showing discharge time of filter reactor energy reduced to a minimum by grid-controlled inverter operation of rectifier unit.

might be severely damaged. Moreover, the radio transmitting tubes might also be damaged in this time, so that it is important to provide

some means of diverting the filter energy and dissipating it as quickly as possible in a circuit other than the short-circuit arc.

Fig. 9 shows an oscillogram in which a protecting arc gap across the filter reactor was caused to break down on the occurrence of a fault. It is evident that this helped to dissipate the filter energy more quickly than before, but about three cycles' time was still required to interrupt a flashover arc completely. This method of attempting to dissipate reactor energy in a short-circuiting gap across the filter reactor is not fast enough to provide the best possible protection.

The most effective means of rapidly dissipating filter energy on the occurrence of a fault in a radio transmitter is automatically to switch the rectifier over to inverter operation and cause power to flow from

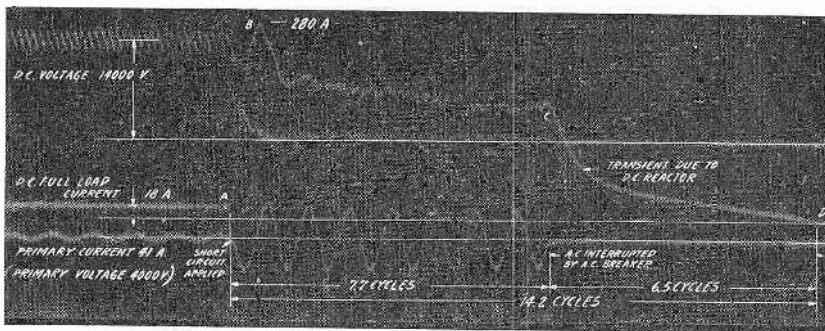

Fig. 11—Oscillographic record of interruption of a short circuit by an alternating-current circuit breaker.

the direct-current filter system back into the alternating-current network. This is accomplished simply by shifting the grid excitation potentials to release the anodes during the time that inverse alternating voltage waves are impressed on them, as described in connection with Fig. 1(e).

Fig. 10 shows an oscillographic record of the interruption of a short circuit in which the filter reactor energy was automatically inverted back into the alternating-current network. Power was completely interrupted and the filter system discharged within about one cycle, as shown in the oscillogram.

In contrast to this protection accomplished by grid control, Fig. 11 shows an oscillographic record in which a short circuit was interrupted by means of a circuit breaker in the primary alternating-current supply line. It is evident that it took 7.7 cycles before the breaker interrupted the alternating current from feeding into the short circuit, and that it

required an additional time of 6.5 cycles before the filter reactor energy was discharged in the short-circuit arc.

Grid-controlled rectifiers have made possible electronic control of power supply equipment, and electronic control has made possible very much better regulation and protection for both the rectifier and transmitter equipment of radio stations.

Additional References

- ¹ A. Gaudenzi, "An Explanatory Contribution to the Comprehension of Grid Control," *The Brown Boveri Review*, pp. 207-210, December, (1934).
- ² C. Brynhildsen, "50,000-volt Brown-Boveri mutator," *The Brown Boveri Review*, p. 234, December, (1934).
- ³ P. Egloff, "High-voltage mutators for wireless transmitting stations," *The Brown Boveri Review*, pp. 233-234; December, (1934).
- ⁴ Noel Ashbridge, H. Bishop, and B. N. MacLarty, "The Droitwich broadcasting station," *Engineering* (London), pp. 49-52, July 12, (1935); and pp. 82-84, July 26, (1935).
- ⁵ G. T. Royden, "Mercury rectifier for plate supply," *Electrical World*, vol. 105, p. 60 (2690); November 9, (1935).



THE FADING CHARACTERISTICS OF THE TOP-LOADED WCAU ANTENNA*

BY

G. H. BROWN

(RCA Manufacturing Company., Inc., Camden, N. J.)

AND

JOHN G. LEITCH

(Radio Station WCAU, Philadelphia, Pa.)

Summary—The electrical characteristics of the original "guyed cantilever" antenna in use at WCAU are reviewed. Fading characteristics taken at several points in the service area are shown and analyzed. Probability considerations are used to place the fading phenomena on a quantitative basis.

Model tests are described which led to the use of a capacitive area at the top of the tower. This capacitance consists of a set of outriggers insulated from the tower. The outriggers are then connected to the tower through an inductance.

The first hat so constructed was found to be too large for good suppression of fading. The hat was reduced in size until a desirable condition was reached.

Analysis of fading records, as well as listening tests, shows that the primary night service area is more than doubled and is now practically the same as the day service area. This has been accomplished with no increase in power and only a slight increase in ground signal.

I. INTRODUCTION

IT IS a well-known fact that the night service area of most high power transmitters is limited by fading rather than by signal deficiency. In some cases, "antifading" antennas are used to move the fading wall away from the transmitter. The ideal situation would be one in which the fading wall would be moved to a point beyond the day service area. The day service area is determined by signal deficiency, dependent on frequency, antenna efficiency, effective conductivity of the soil in the service area, and intensity of interfering noise. Most of the successful applications of antifading antennas have been in cases where the antennas have been of ideal shape to perform as predicted from theoretical considerations.

Since many stations are already using expensive antenna structures, with poor fading characteristics, it seemed desirable to attempt to correct the fading characteristics of these structures rather than to scrap them in favor of ideal antennas. In order to determine specific gains due to such corrections, it is necessary to make a great number of measurements and observations, involving the expenditure of large

* Decimal classification: R320. Original manuscript received by the Institute, March 12, 1937.

amounts of time and money. Such a test was arranged, to be carried on jointly by the engineering staff of radio station WCAU and the research division of the RCA Manufacturing Company. It is the purpose of this paper to report on the results of this test.

II. THE CHARACTERISTICS OF THE ORIGINAL ANTENNA

The original WCAU antenna, shown in Fig. 1, is of the "guyed cantilever" type. The tower proper is 400 feet high, with an additional

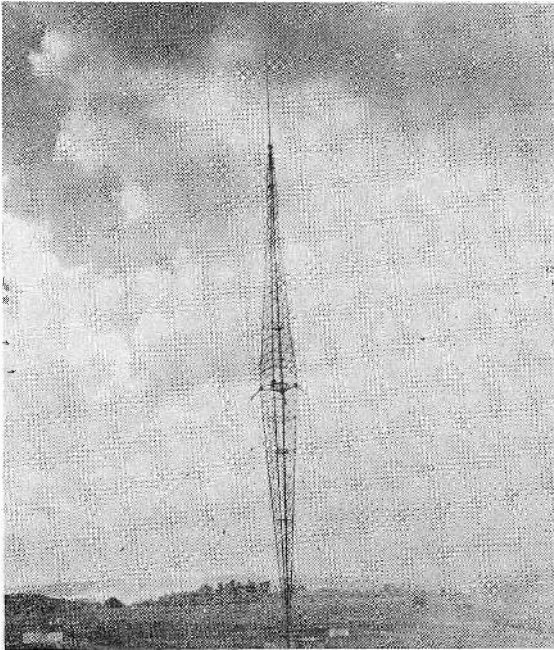

Fig. 1.—The original WCAU antenna.

shaft extending 100 feet above the structural steel, making a total height of 500 feet. The operating wave length is 256 meters (frequency = 1170 kilocycles). Thus the antenna was 215 degrees tall (0.595 wave length). Many of the electrical characteristics have been reported elsewhere,¹ but some of these details will be repeated here for completeness.

The particular height chosen was in accordance with theoretical considerations.² These theoretical considerations assumed a sinusoidal

¹ H. E. Gihring and G. H. Brown, "General considerations of tower antennas for broadcast use," *Proc. I.R.E.*, vol. 23, pp. 311-356; April, (1935).

² S. Ballantine, "On the optimum transmitting wave length for a vertical antenna over perfect earth," *Proc. I.R.E.*, vol. 12, pp. 833-840; December, (1924).

distribution of current on the antenna (Fig. 2a). The calculated vertical characteristic is then shown in Fig. 2c. Actual measurements on a model of the WCAU radiator showed the current distribution to

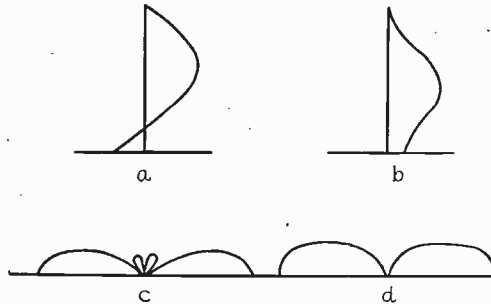

Fig. 2

be that shown in Fig. 2b. This distribution was found to be due to the nonuniform cross section of the tower. The vertical characteristic of the WCAU antenna was determined by calculation from Fig. 2b and from actual airplane observations, and found to be as shown in Fig. 2d.

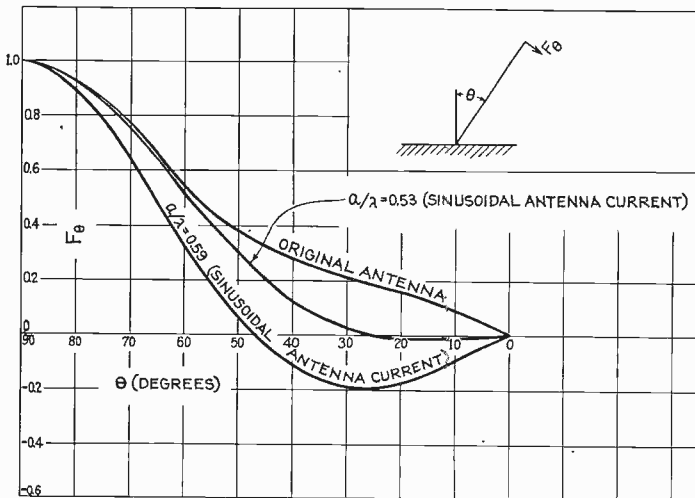

Fig. 3

The characteristics of Figs. 2c and 2d are replotted in Cartesian coordinates in Fig. 3. It should be noted that even a sinusoidal distribution of antenna current, with an antenna height of 0.595 wave length, would not relieve a fading condition since the high angle secondary lobe is large. For example, the electric field radiated at an angle of

25 degrees from the vertical by the original WCAU antenna is 19.0 per cent of the signal along the ground, and the field at the same angle for a perfect antenna of the same height is also 19.0 per cent of the ground signal. The energy leaving the antenna at this angle returns to earth, after reflection from the Heaviside layer, at a point on the earth's surface approximately 60 miles from the antenna. On Fig. 3, the vertical pattern of an antenna 0.53 wave length tall with a sinusoidal distribution of antenna current is also shown. This vertical characteristic is almost ideal.

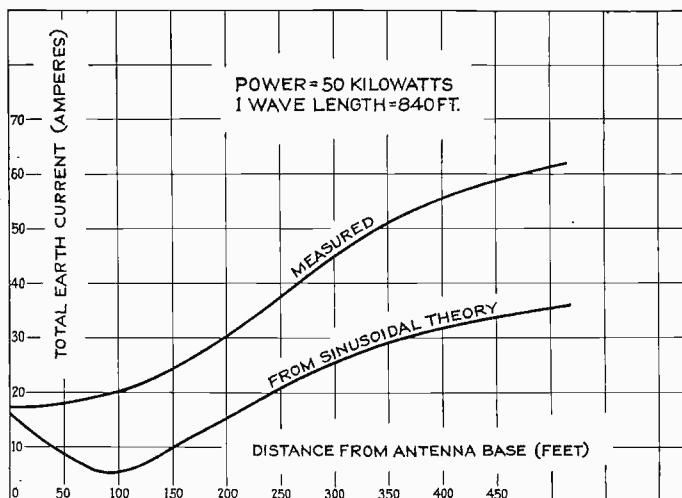

Fig. 4—Total earth currents near the original WCAU antenna.

The total earth currents flowing toward the antenna were measured in the vicinity of the antenna, and are shown on Fig. 4. The earth currents calculated for a sinusoidal distribution of antenna current are shown on this same figure. We see that the measured earth currents fail to show the pronounced dip near the antenna that is always present when a radiator is adjusted to the antifading condition.

Fig. 5 shows the measured antenna resistance as a function of antenna height measured in wave lengths. Here the antenna height is designated as a while the wave length is λ . The variation of a/λ was obtained by varying the frequency. The curve A was obtained when the tower stood entirely alone. Later an insulated lighting generator and static drain coils were attached to the tower, and curve B obtained.

III. OBSERVATIONS OF FADING WITH THE ORIGINAL ANTENNA

Previous to the tests under discussion, no definite observations of fading had been made. Listening tests and reports from listeners had

indicated that fading was noticeable at points where the daytime signal was very strong. Accordingly, before the antenna shown in Fig. 1 was modified, a careful check of the fading conditions was made. This was done in December, 1935.

The WCAU radiator is located at Newton Square, Pennsylvania, 12.8 miles west of the center of Philadelphia. Four observation points

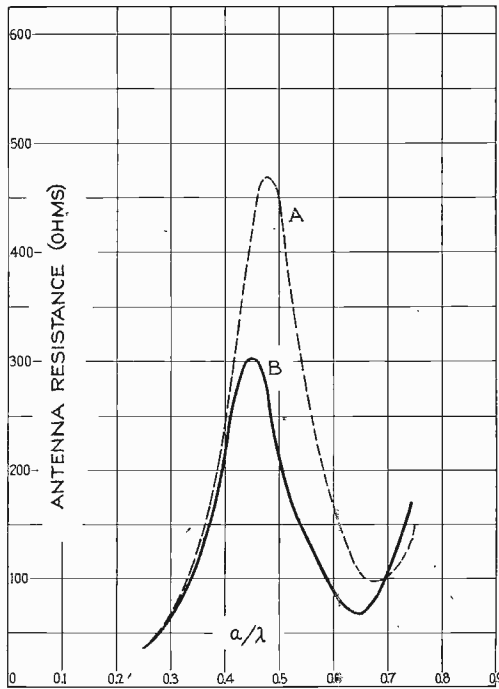

Fig. 5—Resistance of the original antenna.

were established on a line running approximately north from the antenna. The location and distance to these points were as follows:

1. Pennsburg, Pa.	30 miles
2. Cetrionia, Pa.	45 miles
3. Slatington, Pa.	60 miles
4. Rockport, Pa.	75 miles

At each of these observation points, a receiving antenna was erected. These antennas were representative of what might be expected in the average installation of an outside antenna. The antennas operated into a radio receiver which in turn operated an Esterline-Angus recorder with a full-scale deflection of five milliamperes.

When the receivers were first obtained, a conventional automatic

volume control circuit operated the recorders, so that the output varied logarithmically with the input voltage. For the type of fading under observation, it seemed desirable to have a linear output. A tube was added to each receiver, with a bridge arrangement in the output circuit, as shown by Fig. 6. A sensitivity control was also added in the intermediate amplifier, to take care of large ranges of average signal. The recorder calibration for two different sensitivity settings is also

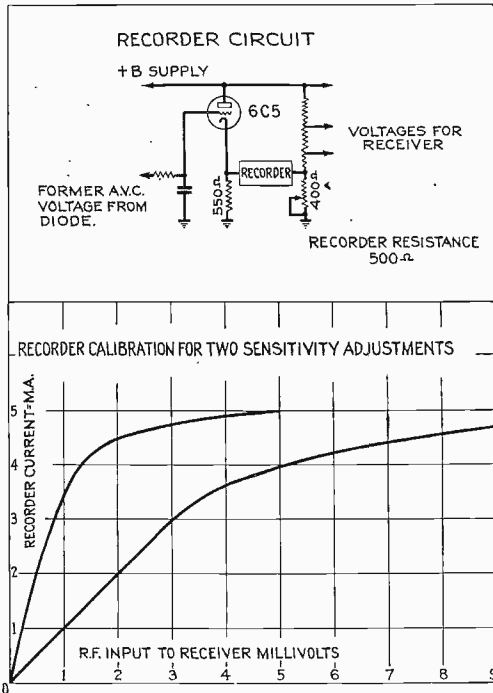

Fig. 6

shown on Fig. 6. We see that the device was practically linear for 80 per cent of full-scale deflection with the added advantage that excessive signals would not swing the recorder needle very far off scale.

The sensitivity of the receiver at each observation point was adjusted during the daytime to give a reasonable deflection for the daytime signal. The receiver-recorder combination was then calibrated with a signal generator. The daytime field intensity was measured with a conventional field intensity measuring set. The operator's duties throughout the night were then simply to maintain the tuning of the receiver, to check the zero of the recorder, and to listen to the program in order to comment on the distortion present with different types of

fading. Simultaneous records were taken at the four observation points from 7:00 P.M. to 1:00 A.M. for three consecutive nights. The recorders

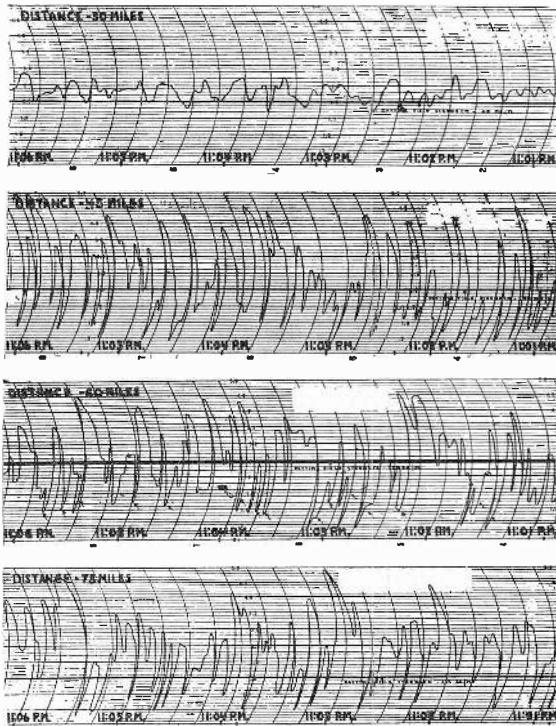

Fig. 7

were run at a paper speed of three inches per minute throughout the tests. Thus, for the total test, 1080 feet of records were obtained. Fairly representative samples are shown by Fig. 7. A slight amount of

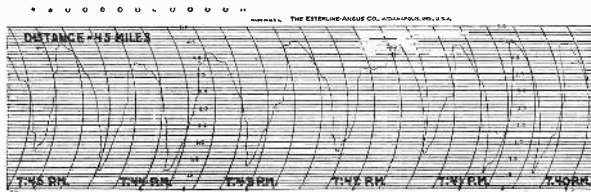

Fig. 8

amplitude fading, entirely free of distortion, was experienced at the thirty-mile point. However, at the forty-five-mile point, the distortion due to selective fading was very pronounced. The same was true at the

sixty-mile point. At the seventy-five-mile point, the nighttime signal tended to exceed the daytime signal due to the fact that the sky wave

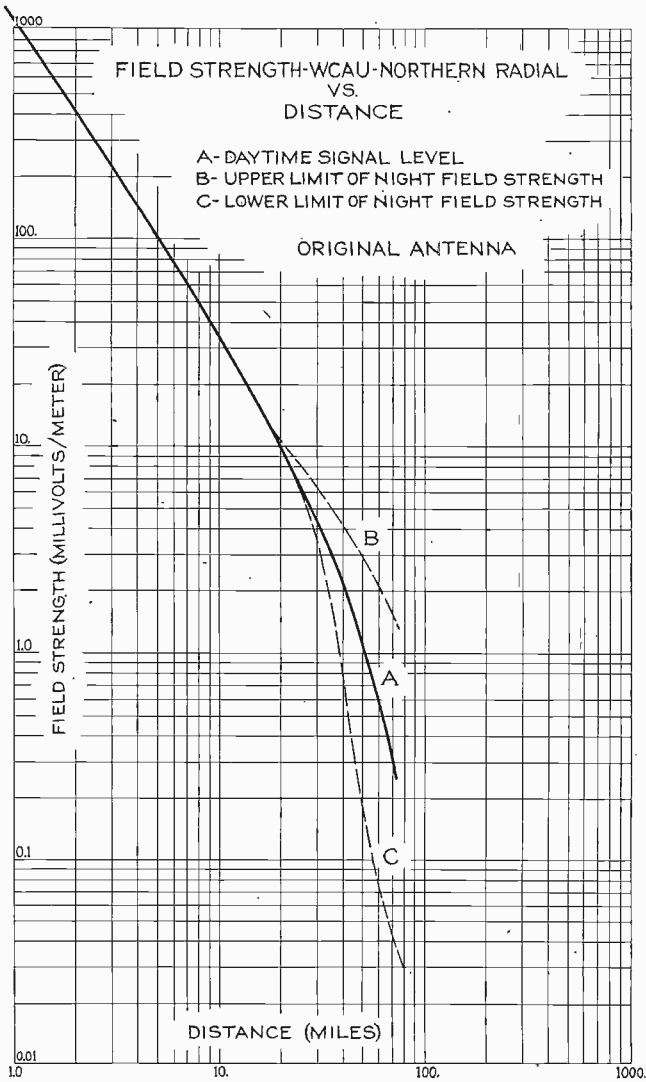

Fig. 9

was much larger than the ground wave. Here the distortion was not severe, but the noise level was high.

While the samples of Fig. 7 are fairly representative, it should be emphasized that they are far from the worst conditions obtained. Fig.

8 and the upper right-hand diagram of Fig. 7 illustrate the remarkable change in the character of the fading throughout a single night.³

The daytime field intensity measured at the observation points is given below:

TABLE I

Position	Distance	Field Intensity
1. Pennsburg	30 miles	4.8 mv/m
2. Cetronia	45 miles	1.98 mv/m
3. Slatington	60 miles	0.728 mv/m
4. Rockport	75 miles	0.259 mv/m

These measurements, together with the fading records, yielded the information shown in Fig. 9. Curve *A* shows the daytime signal as a function of distance from the transmitter. Curves *B* and *C* establish

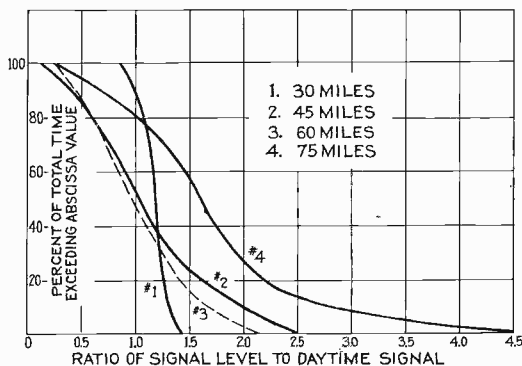

Fig. 10—Experimental "probability of fading" curves for the original antenna.

the upper and lower limits of fluctuation of the nighttime signal. It is important to note that the nighttime range is limited by fading rather than by signal deficiency. An examination of Fig. 9 reveals that the nighttime signal sank to one half of the daytime signal at the thirty-five-mile point, while it rose to twice the daytime signal at a distance of forty-four miles.

It seems interesting at this point to speculate a bit on the significance of the fading records. It is realized that the Heaviside layer is very unstable as to effective height and reflection coefficient. The fluctuations are extremely rapid and of random character, so that most calculations of fading character are meaningless. However, because of the random character, the problem lends itself to treatment by statistical or probability methods.

The records shown in Fig. 7, as well as many others, were broken down manually and the results shown in Fig. 10. Here the percentage

of the total time in which the signal exceeded a given value, x , is shown as a function of $x/(\text{daytime signal})$. Thus we see that at the 45- and 60-mile points the signal was above daytime level 50 per cent of the time.

From the curves of Fig. 9 and a knowledge of the vertical radiation characteristic of the transmitting antenna, it is possible to determine the maximum coefficient of reflection of the Heaviside layer as a function of angle of incidence at the layer. An effective layer height of 100 kilometers was assumed. The result of this calculation is shown by

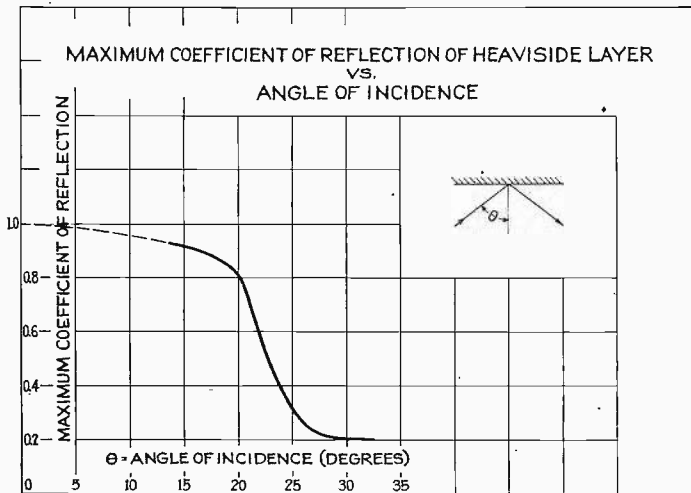

Fig. 11

Fig. 11. The coefficient of reflection at any given angle varies from zero to the value shown in the figure.

Mathematically, the question of fading may be approached by considering the effect of the addition of two fields, one of which is constant in magnitude and phase while the other has both random magnitude and random phase. This is essentially the condition we have in a fading region since the ground wave is constant in magnitude and time phase, while the sky wave, due to the variable properties of the Heaviside layer, is received with random magnitude and phase. This condition is shown by the vector diagram in Fig. 12. E_g is the constant ground wave. Added to this is the sky wave E_s which varies in magnitude between $0 < E_s < E_s'$ and in phase $0 < \phi < \pi$. For purposes of calculation it is convenient to change the variables, so that the ground wave is unity and the maximum value of the sky wave is given by the ratio of E_s'/E_g , which we shall designate by K . With these

changes, the vector diagram becomes as shown in Fig. 13 where the ground wave is unity, and the random sky wave is now given by k which varies between the limits of $0 < k < K$. The expression for the probability that the vector sum, S , will exceed a specified level, x , has been derived and is given by the following equation, under the assumption that all values of k between 0 and K and all values of ϕ between 0 and π are equally likely.

$$P_{s>x} = \frac{1}{K} \int_{k=0}^{k=K} \left[0.5 + \frac{1}{\pi} \sin^{-1} \left\{ \frac{1 + k^2 - x^2}{2k} \right\} \right] dk$$

where K is the magnitude of the maximum sky wave when the ground wave is unity and is equal to the ratio of E_s'/E_g , and x is the specified level for which the probability $P_{s>x}$ is desired. The value of this in-

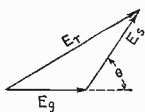

Fig. 12

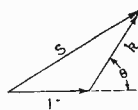

Fig. 13

tegral is found by plotting the integrand and determining the area under the curve with a planimeter. The maximum magnitude of the sky wave was determined from $E_s' = E_\theta R/r$ where E_θ is the value of the sky wave at one mile and angle θ with the vertical, r is the distance that the sky wave travels, and R is the reflection coefficient taken from Fig. 11. The ratio of E_s' to E_g then gives the value K , the maximum limit of the variable vector, k . The ground-wave intensities were all measured at the given points.

It will be noted that these calculated probability curves will, limited by the accuracy of the determination of the ground and sky wave and the reflection coefficient, correspond in meaning to the experimental curves of Fig. 10. The calculated probability curves are shown by Fig. 14 and show a marked resemblance to the experimental curves of Fig. 10. The value of curves of the type shown by Fig. 10 as a means of comparison of fading conditions will become apparent later in this paper, where similar experimental curves of the fading conditions of the modified antenna are given.

IV. MODEL TESTS OF TOP-LOADED ANTENNAS

Since it was known that the nonsinusoidal distribution of antenna current, which caused the fading, was due to the nonuniform cross section of the tower, the obvious solution was to attempt to improve the current distribution through the use of wires stretched along the

tower from outriggers at the top of the tower to a similar set of outriggers at the base. Structural limitations made few arrangements possible, none of which was near the ideal.

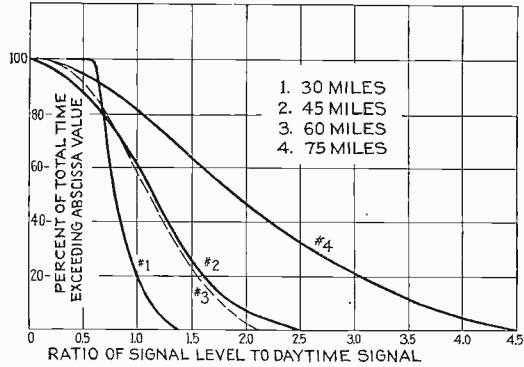

Fig. 14—Theoretical "probability of fading" curves for the original antenna.

A number of the most likely arrangements were tested by means of models operated at a wave length of four meters and promptly discarded. Further tests were made in which a system of outriggers

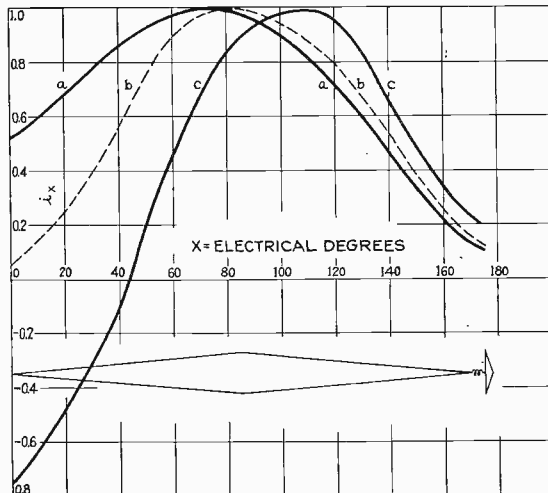

Fig. 15—Current distribution on a model of the top-loaded antenna.

(a "hat") was placed at the 400-foot level in place of the original 100-foot pole. The hat was insulated from the tower and was connected to the tower through an inductance. The results for a varying amount of coil are shown in Fig. 15. We see that it is possible to pull the current

distribution up the tower to yield a whole series of vertical radiation characteristics. Curve *a*, Fig. 15, was obtained when the coil was short-circuited. Curve *b* is the result of adding a small amount of coil, while the addition of still more coil yields curve *c*. Fig. 16 shows the computed vertical characteristics corresponding to distribution *b* and *c* of Fig. 15. The desired vertical radiation characteristic is shown by the broken line of Fig. 16. Thus the desired distribution of current lies between curves *b* and *c* of Fig. 15.

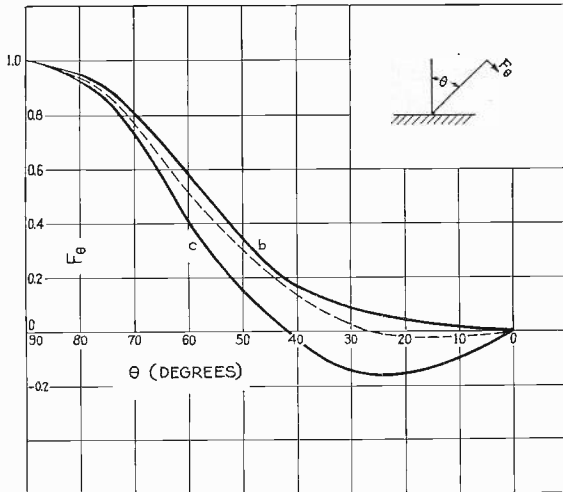

Fig. 16

From the model tests, it seemed apparent that the use of the insulated hat and loading coil was the most desirable arrangement. This allowed great flexibility of adjustment. It would then be possible to control the sky wave so that the best balance between extent of fading and direct ground signal would be obtained.

V. EXPERIMENTS WITH THE TOP-LOADED WCAU ANTENNA

The theory of the top-loaded antenna with sinusoidal distribution of antenna current is well known.³ When the tower is of variable shape, with current distributions departing greatly from the sinusoidal, the

³ Balsh. van der Pol, *Jahr. der drahtl. Tel. und Tel.*, Band 13, Heft 3, pp 217-238, (1918).

G. H. Brown and H. E. Gihring, "A brief survey of the characteristics of broadcast antennas," *Broadcast News*, No. 13, pp. 4-9; December, (1934).

C. A. Nickle, R. B. Dome, and W. W. Brown, "Control of radiating properties of antennas," *Proc. I.R.E.*, vol. 22, pp. 1362-1373; December, (1934).

G. H. Brown, "A critical study of the characteristics of broadcast antennas as affected by current distribution," *Proc. I.R.E.*, vol. 34, pp. 53-57; January, (1936).

theory serves as a general picture but cannot be used to determine specific values.



Fig. 17—The pole which was removed from the top of the original WCAU antenna. This pole was 100 feet long.

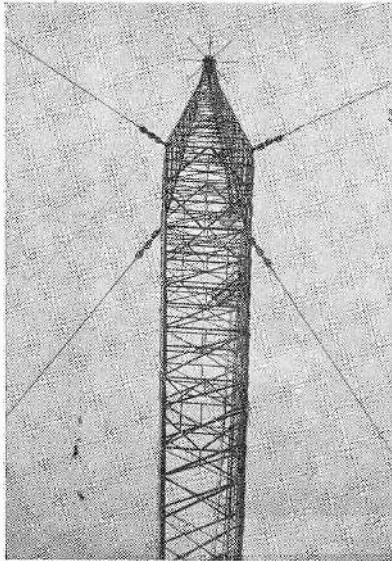

Fig. 18—The WCAU antenna with the large hat in place.

Thus in determining the size of the hat, we have only the model measurements to serve as a guide. The model results are influenced by such items as the size of insulators supporting the hat. However,

the model measurements were used to calculate the following values. For 50 kilowatts at 1170 kilocycles, it was determined that when the tower was adjusted for maximum suppression of sky wave, the coil would be not over 50 microhenrys, with 1000 root-mean-square volts across the insulators supporting the hat.

With this information, the pole was removed from the top of the tower and a system of outriggers erected. Fig. 17 shows the pole after removal from the tower.

The hat consisted of eight outriggers and bracing. The ends of the outriggers were connected together by a ring of two-inch pipe, with a ring diameter of 29 feet. Fig. 18 is a picture of the tower with the hat in place.

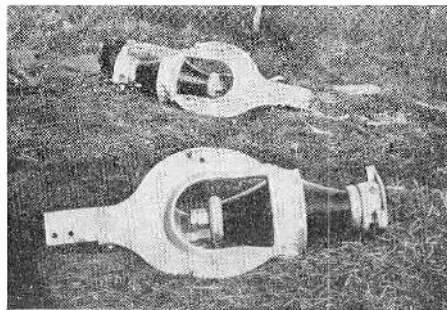

Fig. 19—The supporting insulators used at the top of the antenna.

The size of the supporting insulators is illustrated by Fig. 19.

The lack of space at the top of the tower made shielding of the coil somewhat of a problem, because of the danger of flashover. After a number of experiments, it was decided that the shield should be omitted. The coil that was installed was made of 3/4-inch copper tubing wound in solenoidal form. The diameter of the coil is 15 inches, with 1.25 inches between turns. This coil has been in operation and exposed to the weather for almost a year without a failure. The inductance and Q factor of the coil are given by Fig. 20.

From Fig. 20 we can compute coil reactance for a given number of coil turns. Resistance and reactance of the tower as a function of coil reactance was measured. At the same time, measurements were made with the coil removed and with varying amounts of capacitance between the hat and the tower proper. This was accomplished by means of a variable air condenser. The resulting measured values are shown in Fig. 21 as a function of the connecting reactance. It should be remembered that the reactance value shown as the abscissa of Fig. 21

is the actual lumped reactance inserted for the test. This reactance is shunted by the capacitance of the insulators and the capacitance of

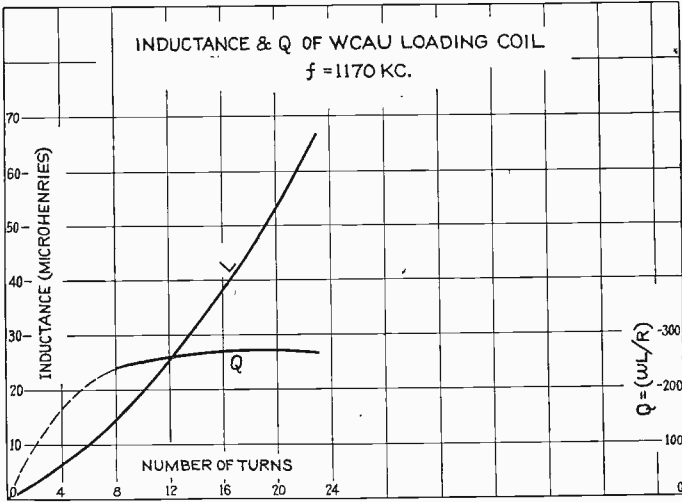

Fig. 20

the hat to the tower. The way the curve of Fig. 21 flattens off on the left indicates that this shunting capacitance is not over a few hundred

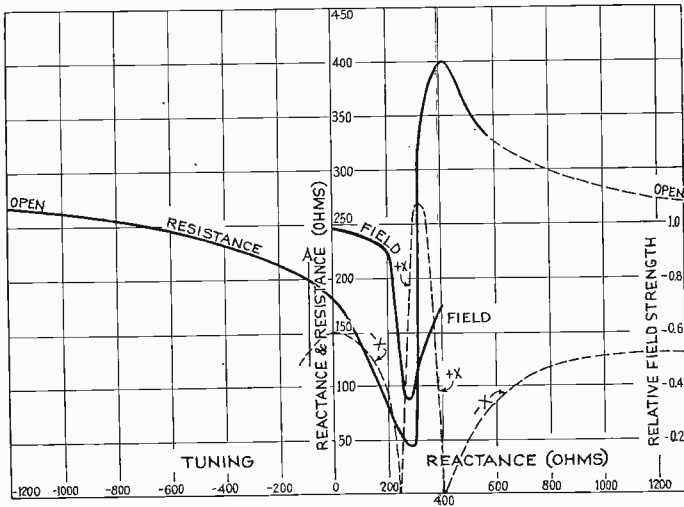

Fig. 21

ohms in magnitude. On this same sheet, the field strength along the ground as a function of coil reactance is given. The pronounced minimum of field strength comes with 15 turns in the coil. The shape of the

field strength curve is quite in accordance with theoretical considerations but came a good deal farther to the left than was anticipated.

Nighttime fading curves were taken for practically every possible coil setting. A rigger remained on the platform below the coil so that

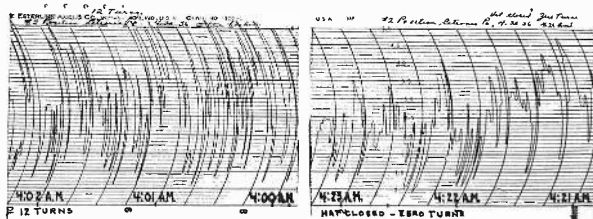

Fig. 22

a change in coil setting could be made in about one minute. Thus different tower conditions could be compared in quick succession. It was found that the improvement over the old antenna was very slight, if any. At all times, the fading was less violent with the hat open or

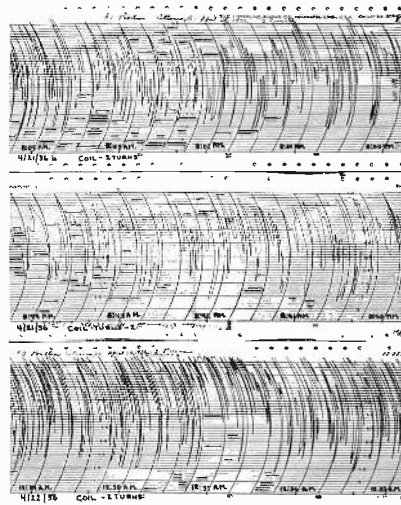

Fig. 23

shorted than it was with any number of coil turns. Fig. 22 shows a comparison between the fading with 12 turns and with zero turns, taken at Cetronia, Pa. There is some reduction in fading apparent. These samples are only short-time records. However, observations were made over a period of several months which agreed in general

although not in detail with these records. The character of the fading changed so greatly from time to time that it was necessary to make rapid coil changes in order to be useful. Fig. 23 shows fading records taken at Cetronia, Pa., at different times in a single night, with the same adjustment of the transmitting antenna.

The recordings in Fig. 24 were made at the WCAU studios in Philadelphia, twelve miles from the transmitter. They show a comparison with the hat closed with zero turns and with sixteen turns. It seems quite apparent from the attached recordings that there is less sky wave with the hat closed than with sixteen turns. In making the last recording on Fig. 24, power was reduced so that the recorder would



Fig. 24

show the same average deflection as with sixteen turns, in order that a direct comparison might be made. That any variation in signal at all occurs at this short distance is probably due to the fact that the receiving antenna at the studio is partially shielded from the ground wave by many tall buildings.

The results of Fig. 21, the numerous fading records, and resistance and field strength curves as a function of frequency taken at this time, led to the belief that the hat itself was so large that even with no coil at all and the hat shorted to the tower, the tower was loaded beyond the desirable point. Thus, instead of simulating a 190-degree antenna, the operation might be closer to the 230-degree point, in which case the large secondary lobe would send a great deal of energy at high angles.

A verification of this fact was attempted. The tower was grounded at its base, with a small millimeter in the ground lead. A variable frequency oscillator was placed near the base of the tower. The frequency of this oscillator was increased until the meter in the antenna

indicated that the first resonance point had been reached. This frequency is designated as f_1 . Then the frequency was still further increased until the second resonant frequency f_2 , was reached. Fig. 25 shows these two frequencies as a function of coil turns at the top of the antenna. A simple calculation from these data shows that even with zero turns in the coil the antenna was loaded to the 215-degree point. The discrepancy between model measurements and the actual

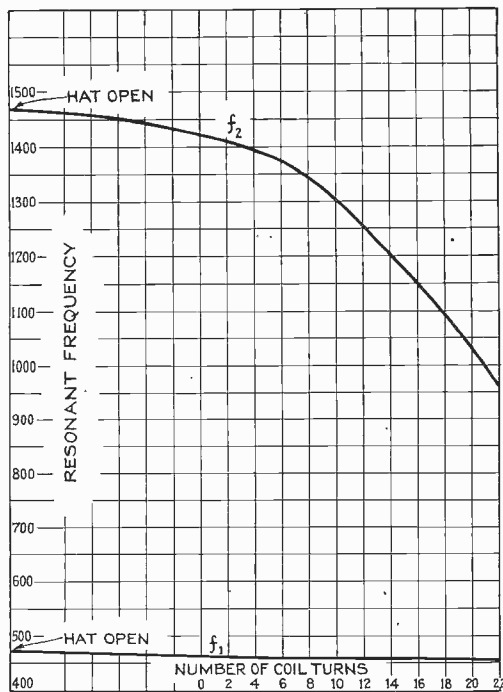

Fig. 25—The natural frequencies of the antenna with the large hat.

results may be attributed to the fact that the large capacitance of the hat insulators was not stimulated in the model (this capacitance is over 0.2 microfarad), that less material in the way of bracing was used in the model hat than in the full-scale job, and that the model hat actually scaled three feet less in diameter than the actual hat that was built on the WCAU tower.

Accordingly, it was decided that the hat should be reduced in size. In view of the variable nature of fading phenomena, a number of records were taken over a period of many nights before any change was attempted. Fig. 26 shows fading records taken on ten consecutive

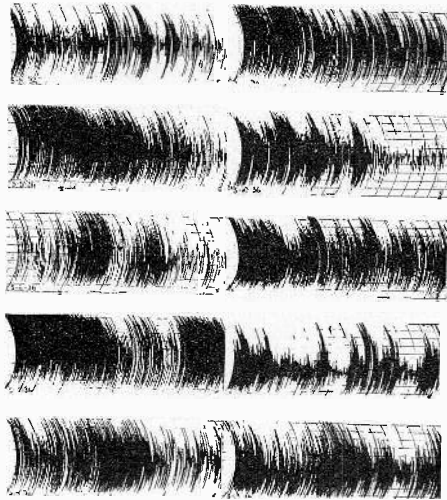

Fig. 26

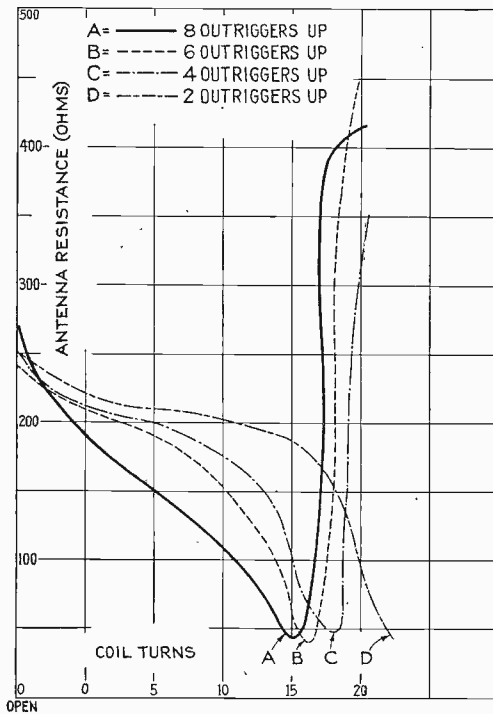

Fig. 27

nights at Cetronia, Pa. In this case, the recorders were run at slow speed, three inches per hour.

The procedure of modifying the hat was then begun. Each time that the hat was altered a complete run was made in which the resistance of the antenna and the field strength at an observation point 1.2 miles away were determined as a function of coil turns. The rim was first removed from the hat, with the eight outriggers still in place.

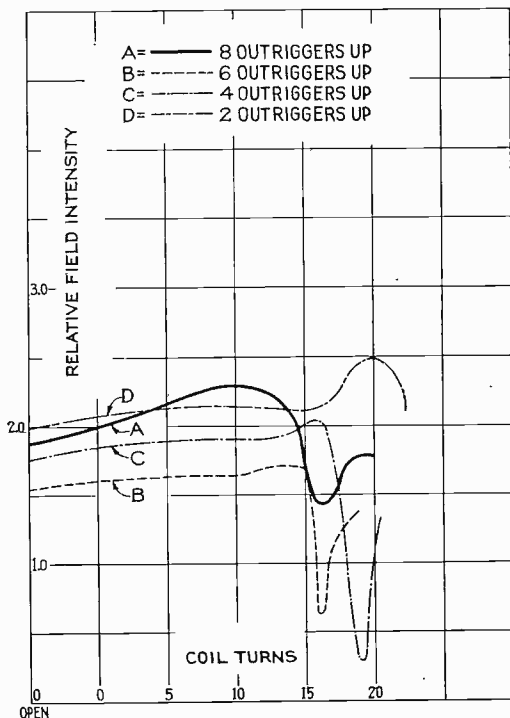

Fig. 28

No measurable effect was found. The outriggers were removed two at a time until only two remained. The data taken during this process are shown by Figs. 27 and 28. It was believed that two outriggers would be sufficient. The antenna with two outriggers is shown in Fig. 29.

Fading records taken over a long period of time showed that the desirable effect had been obtained. The coil position was not critical. However, from a number of observations, it was determined that eleven turns offered some advantage, while the twenty-turn condition produced a noticeable amount of sky wave. Fig. 30 shows fading records taken at slow speed at Cetronia, Pennsylvania, on nine con-

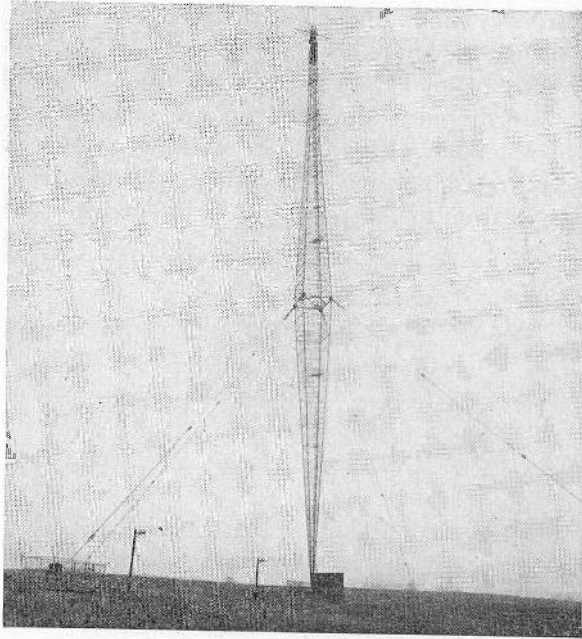

Fig. 29—The WCAU antenna with the small hat.

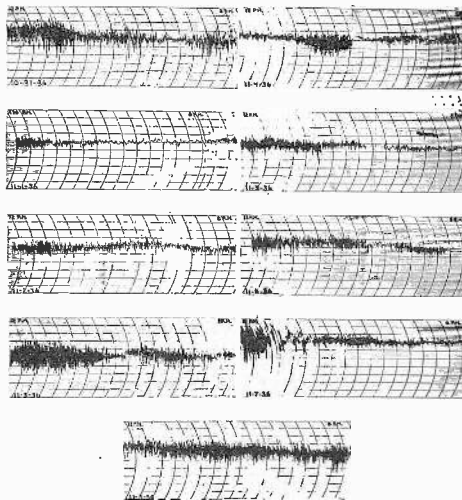

Fig. 30

secutive nights, with eleven turns in the coil. The marked improvement is evident from a comparison of Figs. 26 and 30. It is regrettable

that similar slow speed records were not taken on the original antenna.

Fig. 31 shows high speed records taken at the four recording points. A comparison of these records with those of Fig. 7 shows a great improvement over the old antenna.

As a check on the operation of the antenna, total earth currents were again measured, with eleven turns in the coil. Fig. 32 shows that

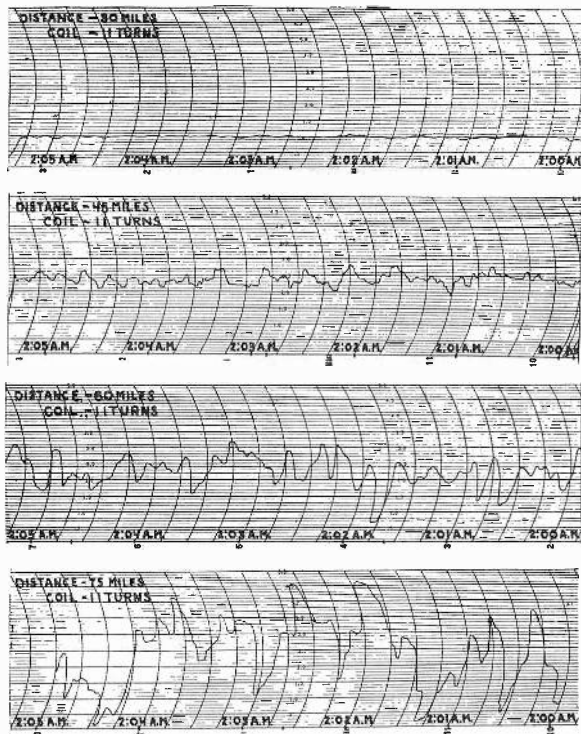

Fig. 31

the earth currents have now assumed the shape similar to that of the theoretical curve of Fig. 4.

The field intensity was again measured on the radial line going through the observation points, and found to be 8.5 per cent greater than the field intensity of the old antenna. The daytime field intensity is shown by the solid curve of Fig. 33. The broken lines show the upper and lower limits of the night field intensity, determined from Fig. 31 and similar records.

Fig. 31 and similar records were broken down to yield the experimental probability curves of Fig. 34. These correspond to the similar

curves of Fig. 10 for the old antenna and should be compared with Fig. 10.

From Figs. 9 and 33, Fig. 35 was constructed. Here the ratio maximum night signal to daytime signal is shown as a function of distance for both the old and new antennas. The ratio of minimum night signal to daytime signal is also shown. Fig. 36 shows a map of the service area of the station. Circle *A*, 35 miles in radius, shows the limit of the area within which the ratio of minimum night signal to daytime signal was greater than 0.5 for the old antenna. Circle *B* shows the similar limit at 54 miles for the new antenna. The area lying be-

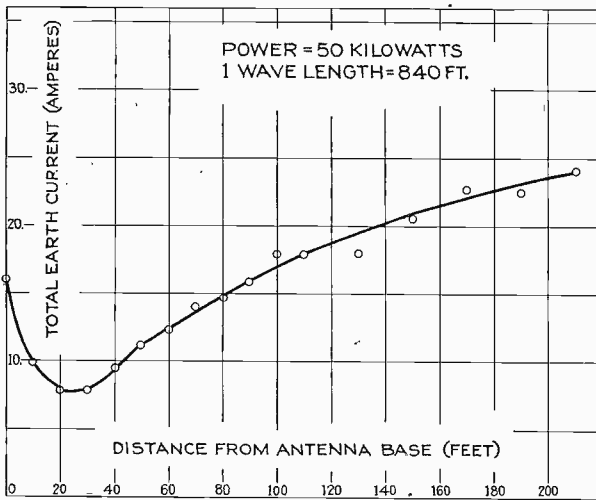

Fig. 32—Total earth currents near the modified WCAU antenna.

tween these two circles is 5330 square miles in extent. Circle *C* shows the limit to the area of the old antenna where the ratio of night signal to daytime signal does not exceed 2.0. This circle is 44 miles in radius. Circle *D* is a similar circle, 66 miles in radius, for the new antenna. The area included between these two circles is 7630 square miles.

Since it was decided that the antenna would be operated in the eleven-turn condition, it seemed desirable to determine the magnitude of some of the voltages existing on the tower.

The base resistance was found to be 196.0 ohms, while the reactance was -136.0 ohms. Then at a power of 50.0 kilowatts, the current at the base of the antenna is 16.0 amperes. The base impedance is $\sqrt{196^2 + 136^2} = 238.0$ ohms. The root-mean-square volts at the base insulator for an unmodulated carrier are $16.0 \times 238.0 = 3810.0$ volts. The peak voltage on 100 per cent modulation is 10,780.0 volts.

If the above values of reactance and resistance are applied to Fig. 21, it would appear that the point marked *A* on this figure corresponds to the condition of eleven turns of coil and the small hat. Thus if the

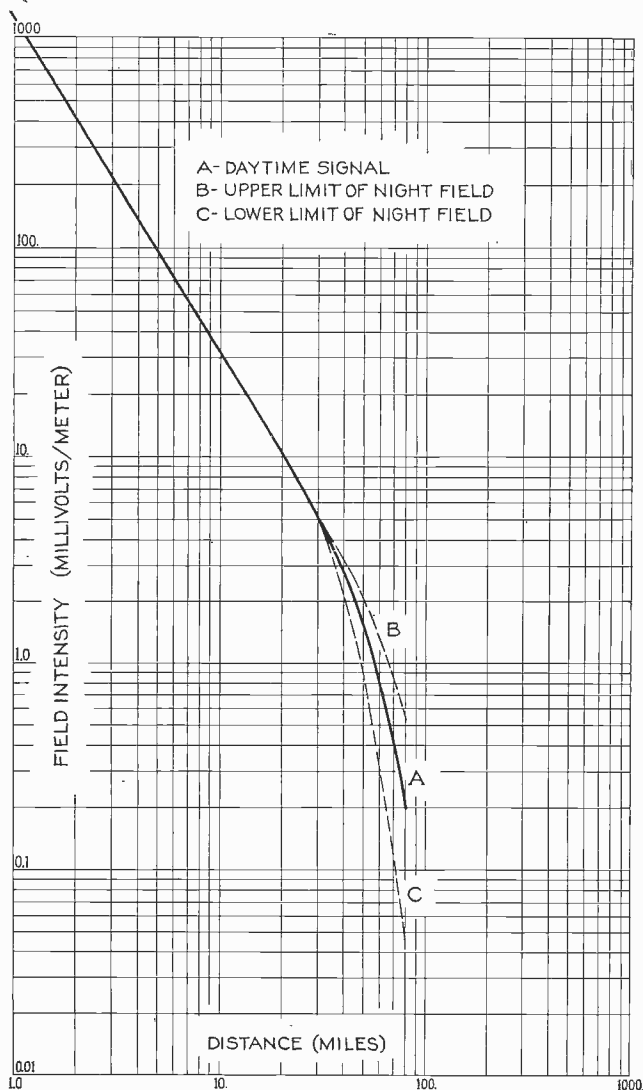

Fig. 33—Field strength along the northern radial, with the modified hat.

large hat had been connected to the tower through a capacitive reactance of 90 ohms, an antifading condition might have been achieved.

The eleven-turn coil had a reactance of 166.0 ohms. By measure-

ment at low power, the ratio of coil current (with eleven turns) to base current was found to be 0.405. Therefore, at full power, the coil carried

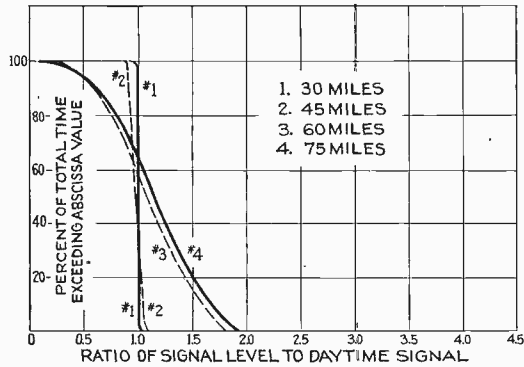

Fig. 34—Experimental “probability of fading” curves for the modified antenna.

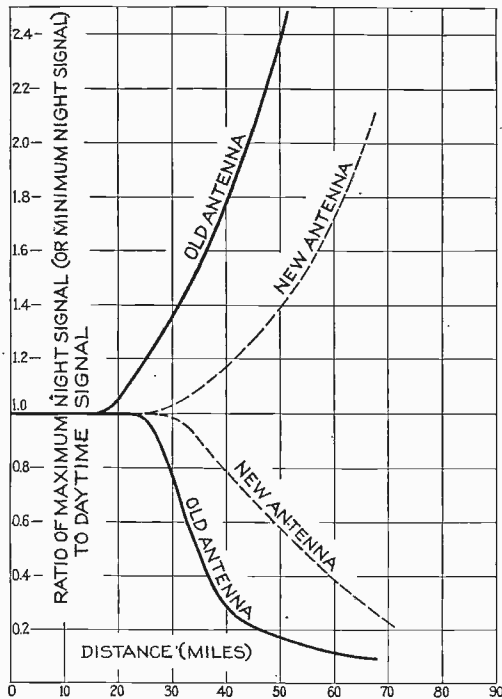

Fig. 35

$0.405 \times 16.0 = 6.48$ amperes. The coil voltage was then 1075.0 root-mean-square volts, rising to 3040.0 peak volts when the modulation is

100 per cent. From Fig. 20 we determine the Q of the coil and find that only 27.0 watts are dissipated in the coil proper.

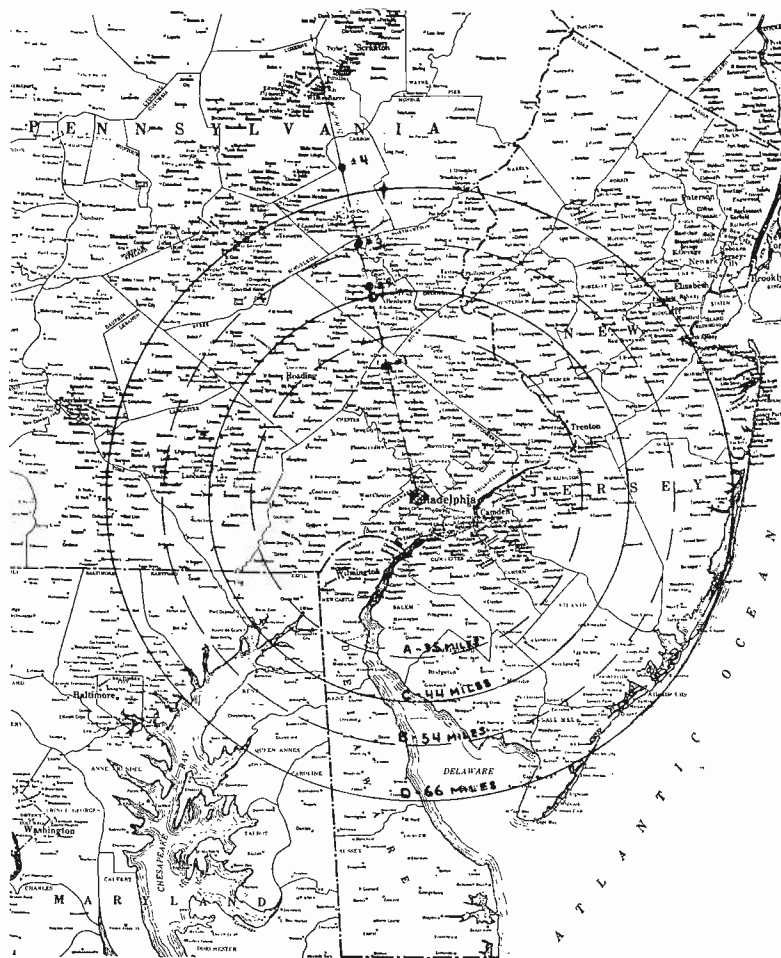

Fig. 36

VI. CONCLUSION

It has been found to be possible to modify the "guyed cantilever" tower by means of a tuned hat, with a marked reduction in fading throughout the service area. In the specific case of WCAU, the use of a tuned hat has more than doubled the effective night service area. The night service area is now practically the same as the day service area. This has been accomplished with no increase in power and only a

slight increase in ground signal. It should be emphasized that no increase in power, however great, would have extended the night service area since the night service area was definitely established by the position of the fading wall, and not by signal deficiency.

It is somewhat of a problem to decide on a satisfactory figure of merit for an antifading antenna. It is believed that the methods of presentation of Figs. 33, 34, and 35 offer a partial solution to this problem. The real criterion is, of course, the improvement in reception for the radio listener. Listening tests conducted before and after the experiments described left no doubt of the improvement in reception made available to the radio listener within the 66-mile circle.

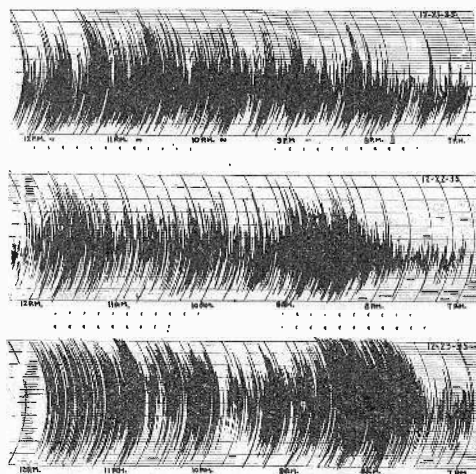

Fig. 37

In making fading records, it seems very important to make records at both high and low speeds. The former are valuable for purposes of breakdown and analysis, and for comparing the results of antenna adjustment, providing the antenna adjustments are made rapidly. The low speed records are of value in giving an average picture of the results of a particular adjustment over a period of several nights. At the time that the fading records of the original antenna were taken, the authors did not realize the importance of low speed records, so that no direct comparison with Fig. 30 was available. However, observations of the many recordings taken at both high and low speeds indicated that if the 45-mile records of Fig. 7 had been taken at low speed, the result would not be much different from the records of Fig. 26.

Slow speed records of the fading characteristics of the original antenna have since been obtained in the following manner. The high speed records taken on the original antenna were run through a recorder operating at high speed while fresh record paper was run through another recorder at one sixtieth the speed. The high speed recorder pen was dry while the low speed pen traced a record on the fresh paper. The electrical circuits of the two recorders were placed in a series circuit containing a battery and a rheostat. An operator then manually varied the rheostat so that the dry pen always followed the original trace on the high speed records. The slow speed recorder then reproduced the fading characteristics as slow speed records. Fig. 37 is a result of this procedure. Here the fading records of the original antenna are shown, with the receiver located at Cetronia, Pa. Then Figs. 26, 30, and 37 may be compared directly.*

Another point worthy of emphasis is that no fading test taken on a single night is conclusive, since the characteristics of the Heaviside layer are extremely variable in nature.

VII. ACKNOWLEDGMENT

The authors wish to express their appreciation to the RCA Manufacturing Company, Camden, New Jersey, for assistance in supplying apparatus and personnel, and in particular to two members of the engineering staff, Mr. J. Epstein and Mr. R. F. Lewis; to the engineering department of the Columbia Broadcasting System for advice and assistance; to the radio stations from the second zone, who have joint ownership in the equipment used in the recent clear channel survey, some of which was loaned for this work; and to WCAU engineers, Mr. Charles Miller and Mr. George Lewis, the former chief engineer of the transmitter plant, and the latter, in charge of field recording crews.

* This paragraph was added in proof.



APPLICATION OF THE AUTOSYNCHRONIZED OSCILLATOR TO FREQUENCY DEMODULATION*

BY

J. R. WOODYARD

(University of Washington, Seattle, Washington)

Summary—A new frequency-operated demodulator is described which does not respond to amplitude modulation. These results are achieved by making use of a controlled oscillator at the receiver which automatically synchronizes with the transmitter frequency. If desired, this method can be made to give a large response with extremely small amounts of frequency shift. On the other hand, it can also be used when the maximum frequency shift is many times as great as the signal band width. Other advantages are its linear response and its simplicity which requires the addition of only one tube to existing receivers. Tests show that a frequency-modulated signal and an amplitude-modulated signal may be applied simultaneously to the same carrier without noticeable interference at the receiver. Other applications of the synchronized oscillator are also described.

THE recent growth of interest in frequency modulation as a means of radio transmission has brought out the need of a more satisfactory demodulator. It is believed that the development of this method of modulation would be greatly accelerated by the introduction of a demodulator analogous to the ordinary rectifier as a demodulator of amplitude modulation. The desired device should give an output proportional to the instantaneous frequency of the carrier wave but independent of its amplitude, just as the rectifier gives an output proportional to the instantaneous amplitude of the envelope of the carrier but independent of its frequency.

Frequency demodulators making use of selective circuits tuned slightly off resonance have been in use for some time, but these require a comparatively large amount of frequency variation, even with the most sharply tuned circuit that it is practical to use, which may be a disadvantage. Furthermore, they respond to amplitude modulation. By using two circuits, tuned so that one is slightly above resonance and the other below resonance, with their rectifier outputs connected differentially, the response to pure amplitude modulation may be eliminated, but this method will still respond to amplitude modulation if frequency modulation is also present. It can be shown by a simple mathematical analysis that this response appears as strong cross modulation or distortion components between the amplitude and frequency modulated signals. Another disadvantage of off-resonance de-

* Decimal classification: R362.2. Original manuscript received by the Institute, May 26, 1936; revised manuscript received by the Institute, December 28, 1936. Presented before Seattle section, October 4, 1935.

vices, consisting of series or parallel combinations of inductance and capacitance, is the difficulty of obtaining a resonance curve with perfectly straight sides. This lack of linearity results in nonlinear distortion.

Frequency modulation may also be received by filtering out the carrier from the side bands, rotating its phase through ninety degrees, and recombining it with the side bands. Since a frequency-modulated wave consists of discrete frequencies, that is a carrier and side-band frequencies, separation may be accomplished in the conventional manner by highly selective filters, such as quartz crystals; but it should be remembered that the conditions of modulation must be such that higher order side bands are unimportant if this method of demodulation is to be successful. Aside from its obvious complexity, this system has the disadvantage that its low-frequency response is limited by the difficulty of constructing a sufficiently selective carrier filter. Also, as can easily be shown, its response is proportional to phase variation, rather than frequency variation, which may or may not be a disadvantage, depending upon how it is intended to be used.

A demodulator which overcomes some of these objections, by making use of an externally controlled oscillator, has been used at the University of Washington for some time as a receiver in connection with frequency-modulation research. It is a well-known fact that if a source of variable-frequency current is coupled to an ordinary vacuum tube oscillator, the beat frequency does not pass continuously through zero as the applied frequency is slowly changed. If an audible indicator is used, the pitch of the beat note decreases gradually at first, then drops suddenly to zero before the natural frequency of the oscillator is reached, and finally reappears suddenly at an equal distance on the other side of the natural frequency. This, of course, means that the oscillator is being drawn into exact synchronism when the applied frequency is nearly the same as the natural frequency of the oscillator.

Appleton¹ has shown that this synchronization is caused by the presence of a third-power term in the grid-voltage—plate-current characteristic of the oscillator tube, also that when the synchronizing voltage is applied to a triode oscillator in series with the inductance of a tuned plate circuit, the phase angle between the control current and the oscillator current is ninety degrees when the control frequency is equal to the natural frequency of the oscillator. This is precisely the phase relation desired, as will be shown later. Furthermore, this phase difference varies continuously from zero to 180 degrees as the control

¹ E. V. Appleton, "The automatic synchronization of triode oscillators." *Proc. Camb. Phil. Soc.*, vol. 21, p. 231, (1922).

frequency passes from one end of the zero-beat region to the other end.

Use may be made of this principle to demodulate frequency-modulated waves by using the current received from the distant transmitter as the control frequency. Fig. 1 shows a circuit diagram of such a receiver in its simplest form, where *B*, *C*, and *D* represent couplings between the three coils as indicated by the arrows. The antenna supplies a current through *B* to the oscillator, and the oscillator in turn supplies a current through *C* to the detector circuit which differs in phase from the original current by an amount depending on the instantaneous frequency of the transmitter. If this current is combined in the detector with some of the original current, supplied through *D*,

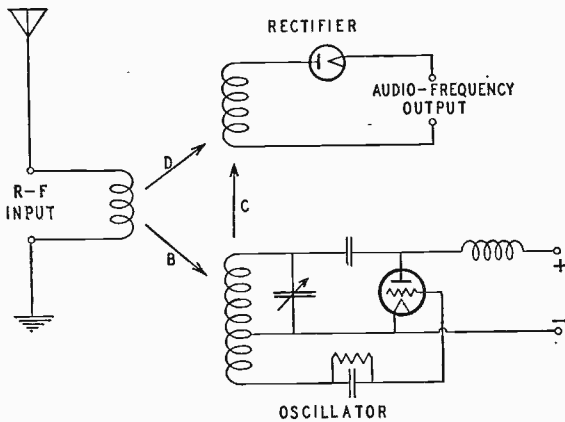

Fig. 1—Elementary diagram of receiver.

the resultant will be the vector sum of the two, and its magnitude will depend on the instantaneous frequency of the transmitter. By making the energy supplied to the rectifier from the oscillator somewhat larger than that supplied direct from the antenna, the rectifier output may be caused to be a good reproduction of the original modulation.

In order to test the linearity of this type of demodulator, rectified current was measured for a series of slightly different transmitter frequencies, using the circuit shown in Fig. 1, with another oscillator to take the place of the transmitter. A grid-leak type detector was used as the rectifier for linearity, with a tuned input circuit for sensitivity, and its tuning was made sufficiently broad by means of parallel resistance so that resonance would have no effect. Fig. 2 is a typical curve of rectifier plate current plotted against transmitter frequency in the vicinity of one million cycles, when the radio-frequency current in the rectifier circuit from the local oscillator is three times that from the transmitter direct. This curve indicates that the central part of the

characteristic is a straight line within the limit of experimental error which was less than one per cent. A constant value of rectifier plate current of 1.2 milliamperes has been balanced out for clarity, so that the ordinates represent a direct current that is proportional to the amplitude of the radio-frequency input to the rectifier over the operating range, this linearity having been checked separately by experimental determination of the amplitude characteristic of the rectifier. The straight part extends from one end of the zero-beat region to the other, the breaks in the curve occurring at the points where the beat note suddenly begins. An absence of nonlinear distortion is indicated

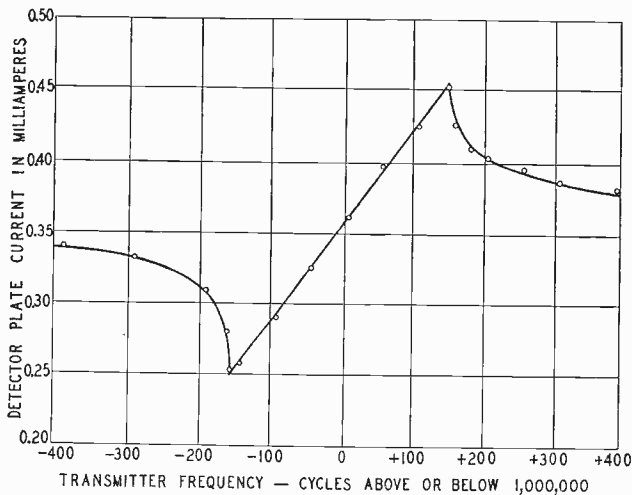

Fig. 2.—Demodulator characteristic, showing linearity with respect to frequency modulation.

by the straightness of the characteristic over the central portion to which operation must be limited.

The complete range of frequency may easily be made as small as two or three hundred cycles in the broadcast band as shown in Fig. 2, indicating the extreme sensitiveness to small amounts of frequency modulation which it is possible to obtain. This zero-beat range may be made as wide or as narrow as desired by adjusting the plate voltage of the local oscillator and the three coupling coefficients. Of course it should not be inferred that a smaller frequency swing at the transmitter necessarily means narrower side bands. Van der Pol² and others have shown that, because of higher order side bands, the total side-band width in frequency modulation is approximately $2\Delta f$ or $2F$, whichever is the larger, where F is the audio frequency, f is the radio frequency, and Δf is the maximum amount of its variation above or

² B. van der Pol, "Frequency modulation," *Proc. I.R.E.*, vol. 18, pp. 1194-1205; July, (1930).

below the average value during an audio-frequency cycle. It should be noticed that these higher order side bands are not the cause of distortion, but that, on the contrary, they are necessary to prevent distortion. At the lower audio frequencies, the static characteristic of Fig. 2 gives a complete and exact picture of the operation of the receiver when a pure frequency-modulated wave is applied, and no further analysis is necessary. At the higher audio frequencies, the situation may, under some conditions, be slightly different as will be seen later.

To show the effect of amplitude modulation, including simultaneous amplitude and frequency modulation, the curve of Fig. 2 was ex-

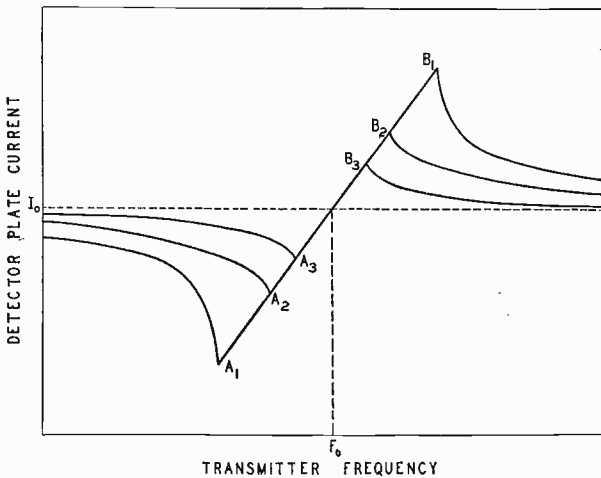

Fig. 3—Family of characteristics for three different amplitudes, showing freedom from response to amplitude modulation when frequency modulation is present.

perimentally redetermined for several different values of antenna current at the transmitter, which gave the family of curves in Fig. 3 for relative values of transmitter current of 100, 50, and 25 per cent. The purpose of Fig. 3 is to show that all the curves coincide in the zero-beat region. This means that, if the frequency shift is not too large, there should be no response to amplitude modulation even when frequency modulation is also present, and there should be no cross modulation between the two. The extent to which this is borne out by measurements is shown later.

The operation of the receiver may also be explained in terms of an approximation by means of vector diagrams. Let the vector OA in Fig. 4 represent the radio-frequency current received from the transmitter. In amplitude modulation, the length of this vector will be varying, but OA may be its length at some particular time when it is passing through its average or unmodulated value. Then let OB represent the

current supplied by the local oscillator with its phase such that the angle between their resultant, OC , and OA is ninety degrees. When modulation is applied and the length of OA varies between zero and twice its average value along the line OD , the resultant moves back and forth along the line BE . It is thus seen that the length of the re-

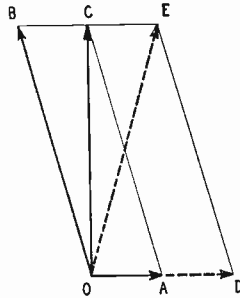

Fig. 4—Vector diagram of radio-frequency currents with amplitude modulation.

sultant is approximately constant if the strength of the local oscillator is made much greater than the incoming signal. In other words, amplitude modulation gives no appreciable response.

Consider next what happens in the case of frequency modulation, Fig. 5. The co-ordinate axes must now be considered as revolving at a

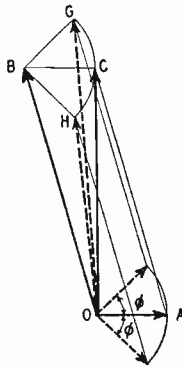

Fig. 5—Vector diagram of radio-frequency currents with frequency modulation.

varying velocity, rather than at a fixed velocity as in an ordinary vector diagram, since we now have no fixed frequency as a reference vector. For simplicity, let this varying frequency of rotation be the frequency of the local oscillator vector OB . We then have the same vector diagram as before, except that the incoming vector OA , instead of stretching and shrinking, now swings slowly back and forth through some angle ϕ , each side of its unmodulated position. The origin of this angle is evident if we remember that the phase angle between the

transmitter and local oscillator, when synchronized, varies with the instantaneous frequency of the transmitter. This action causes the end of the resultant to swing back and forth along the arc HCG . It is the resultant which is applied to the rectifier, and, since the length of OC changes, frequency modulation gives a large response.

It may be seen that the vector diagrams, as given, are only approximations since they disagree with the experimental results, shown in the static characteristics of Figs. 2 and 3, by an amount which is too large to attribute to experimental error. However, they should be useful as a qualitative explanation of the operation of the demodulator. As an example of the extent of this approximation, consider Fig. 4 when OC is three times OA . A table of trigonometric functions shows that, according to the vector diagram, the magnitude of the radio-frequency current applied to the rectifier should change by about five per cent during amplitude modulation, but Figs. 2 and 3 show that this effect, if it exists, is less than one per cent.

Consideration of the vector diagram shows that at high audio frequencies, with small amounts of frequency shift so that the total phase shift becomes less than ninety degrees, the transmitter should be phase modulated rather than frequency modulated. When necessary, this was accomplished in the experimental transmitter by a resistance-capacitance filter ahead of the speech amplifier. Integration of the expression for instantaneous angular velocity of a frequency-modulated wave shows that the maximum phase shift becomes less than ninety degrees when the audio frequency is greater than $2/\pi$ times the maximum frequency shift. For wide-band frequency modulation, such as might be used on ultra-short waves, no filter is needed because the output remains strictly proportional to instantaneous carrier frequency at all times, since the local oscillator then has time to take up its natural phase position with respect to the transmitter.

One application that immediately suggests itself is the simultaneous broadcasting of two programs from the same station on the same carrier frequency, and their separation at the receiver. If Δf is properly chosen the side-band width is not increased, over that required for amplitude modulation alone, by the addition of frequency modulation. This method of duplexing was demonstrated by modulating one oscillator with two phonographs, one by amplitude modulation and the other by frequency modulation. By merely opening a switch in the plate supply to the local oscillator at the receiver, it could be changed to an ordinary amplitude-modulation receiver, and either phonograph picked up at will. The separation was very satisfactory. Even with amplitude modulation approaching one hundred per cent on peaks, it was impossible by listening tests to detect any cross

talk from the undesired transmission in the presence of the other.

In an actual receiver, some refinements would be made in the interests of simplicity and ease of operation. The controlled local oscillator would, of course, operate at the intermediate frequency in a super-heterodyne circuit so that no additional tuning control would be required. Also, it has been proved by experiment that the oscillator itself may be used as the detector if an audio-frequency load is placed in its plate circuit.

It is advantageous, though by no means necessary, to allow one of the radio-frequency or intermediate-frequency tubes ahead of the demodulator to saturate somewhat while receiving frequency modulation if it is desired to separate simultaneous frequency and amplitude modulation. If this is done, points A_1 , A_2 , and A_3 in Fig. 3 are moved closer together, likewise B_1 , B_2 , and B_3 , and practically the entire straight part of the characteristic may be used for the reception of frequency modulation, even in the presence of high percentage amplitude modulation.

Measurements made on the experimental receiver, with simultaneous amplitude and frequency modulation at the transmitter, showed that cross talk from the undesired transmission was at least forty decibels below the desired transmission. By cross talk is meant fundamental frequency components from the undesired signal. Distortion components, of sum and difference frequencies from cross modulation, if any existed, were less than two per cent of the desired signal. It was not possible to make measurements below these limits, because of the difficulty of completely eliminating undesired frequency modulation at the transmitter with the apparatus available.

This receiver is really nothing more than a very sensitive frequency meter, and might be used for any purpose where it is desired to have a rapid indication of slight changes in frequency, since it is capable of indicating frequency variations of less than one part in a million. Because the synchronized oscillator type of demodulator is extremely sensitive to frequency modulation and is not affected by amplitude modulation, it may be used as an indicator of undesired frequency modulation on amplitude-modulated transmitters. Listening tests on various broadcast stations showed the presence of comparatively large amounts of frequency modulation on some of them, with a vast difference between stations. It was found that some broadcast stations could be received just as well by frequency modulation as by amplitude modulation. With minor changes, this device is useful in automatic tuning control on ordinary broadcast receivers, to convert frequency deviations into the direct voltage changes used to vary the reactance of a tuned circuit, thereby overcoming inaccuracies in manual tuning.

LATTICE ATTENUATING NETWORKS*

BY

GUY C. OMER, JR.

(University of Kansas, Lawrence, Kansas)

Summary—The recent compilation by P. K. McElroy of resistive attenuating network sections is extended to include the lattice or bridge type section. Design formulas are developed for the general case where the terminal impedances are unequal as well as for the special case where they are equal. The minimum attenuation limitation is shown to be identical to that of the T and the π section.

ANY TYPE of network section may be used as a resistive attenuating network, perhaps more commonly known as a "pad." P. K. McElroy¹ has recently described and developed design formulas for the T, π , bridged-T, and L sections. The only remaining form of network is the lattice or bridge type section shown in Fig. 1.

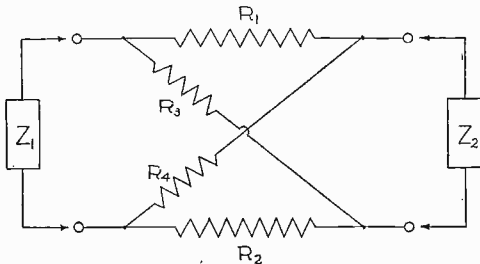

Fig. 1—Lattice network section.

This will be recognized as a standard bridge which has been skewed around so that the terminals appear in parallel lines. This type of section has the unique ability of producing high attenuations without requiring extremely high or low values of resistance in its arms. Infinite attenuation is possible, for instance, by merely balancing the bridge.

In developing the design formulas for this type of section symbols similar to those of McElroy's will be used.

Z_1 = smaller terminal impedance

Z_2 = larger terminal impedance

$k^2 = 10^n$ where n is the desired attenuation in *bel*s

$$\bar{Z} = \sqrt{Z_1 Z_2}$$

$$s = \sqrt{Z_2 / Z_1}$$

In the lattice network there are four unknowns to be determined, but as an attenuating network must satisfy only three natural condi-

* Decimal classification: R383. Original manuscript received by the Institute, September 9, 1936.

¹ P. K. McElroy, "Designing resistive attenuating networks," Proc. I.R.E., vol. 23, pp. 213-233; March, (1935).

tions, a fourth arbitrary condition must be imposed. A condition which seems to simplify the mathematics considerably is that

$$R_1R_3 = R_2R_4. \quad (1)$$

Two conditions that must be satisfied by an attenuating network are that the image impedances of the network must equal their associated terminal impedances. These image impedances are equal to the square root of the product of the open- and the short-circuited network impedances,² but when the equations are used in this form they are long and complicated. These equations may be reduced by expressing them in the form of a product and of a quotient:

$$Z_1Z_2 = R_1R_3 = R_2R_4 \quad (2)$$

$$Z_1Z_2 = \frac{(R_1 + R_4)(R_2 + R_3)}{(R_1 + R_3)(R_2 + R_4)}. \quad (3)$$

A fourth condition is that the network must have the desired attenuation. This attenuation is dependent on the ratio of the input and output currents of the network which may be found by the use of Thevenin's theorem:²

$$i_1/i_2 = ks = \frac{Z_1(R_1 + R_2 + R_3 + R_4) + (R_1 + R_4)(R_2 + R_3)}{(R_3R_4 - R_1R_2)} s^2. \quad (4)$$

These four simultaneous equations may be solved explicitly for the four unknowns.

$$R_1 = \frac{(k^2 - 1)s + (k^2 + 1)\sqrt{s^2 - 1}}{(k^2 + 1) + 2ks} \bar{Z}$$

$$R_2 = \frac{(k^2 - 1)s - (k^2 + 1)\sqrt{s^2 - 1}}{(k^2 + 1) + 2ks} \bar{Z}$$

$$R_3 = \frac{(k^2 - 1)s - (k^2 + 1)\sqrt{s^2 - 1}}{(k^2 + 1) - 2ks} \bar{Z}$$

$$R_4 = \frac{(k^2 - 1)s + (k^2 + 1)\sqrt{s^2 - 1}}{(k^2 + 1) - 2ks} \bar{Z}.$$

These four equations show a pleasing symmetry. Numerical solutions may be obtained by taking the values of k and k^2 from McElroy's table.³

² W. L. Everitt, "Communication Engineering," first edition, pp. 215 ff.

² *Loc. cit.*, pp. 36 ff.

³ P. K. McElroy, *loc. cit.*, Table IX, p. 233.

It may be readily seen when $k = s + \sqrt{s^2 - 1}$ that the lattice section degenerates into an L section. For a lower attenuation some of the arms become negative and the network can no longer be called a "pad." Only for an attenuation greater than this critical value will all arms of the network be positive and finite. Therefore $k = s + \sqrt{s^2 - 1}$ determines the lowest possible attenuation for a lattice section. This is exactly the condition derived by McElroy for the T and π sections. Hence in designing a lattice network, McElroy's curve⁴ of minimum attenuation should be used.

The design formulas are highly simplified for the special case where the two terminal impedances are equal ($Z_1 = Z_2 = Z$).

$$R_3 = R_4 = \left(\frac{k - 1}{k + 1} \right) Z.$$

$$R_1 = R_2 = \left(\frac{k + 1}{k - 1} \right) Z.$$

The terms within the parentheses are already tabulated in McElroy's table.³ It is interesting to note that when the two terminal impedances are equal the equations for R_1 and R_2 are identical to the equation for the series element of the T section and likewise that the equations for R_3 and R_4 are identical to that of the shunt element of the π section.

ACKNOWLEDGMENT

The author wishes to thank Dr. H. E. Jordan for solving the simultaneous equations.

⁴ P. K. McElroy, *loc. cit.*, Fig. 6, p. 230.



A VOLTAGE STABILIZED HIGH-FREQUENCY CRYSTAL OSCILLATOR CIRCUIT*

BY

SAMUEL SABAROFF

(WCAU Broadcasting Company, Philadelphia, Pennsylvania)

Summary—The theory and line of reasoning used in developing this circuit are described. The circuit elements aside from the crystal are resistors and capacitances. The type 57 tube was found to fulfill to a large measure the requirements of a sufficiently high mutual conductance and a fairly high internal plate resistance in the oscillating state. A method of varying the frequency of oscillation is described. The stability using a seven-megacycle crystal was found to be within about one in twenty million for a ten per cent variation in either or both the filament and plate voltages.

DURING the development of a high-frequency standard assembly it became evident that the usual crystal oscillator circuits were not satisfactory with frequencies in the vicinity of five megacycles or above. The frequency stability with respect to filament and plate voltage variation was relatively poor and since the usual circuit requires an impedance tuned to the vicinity of the crystal frequency, the output and frequency are quite critical with respect to the tuning of this impedance.

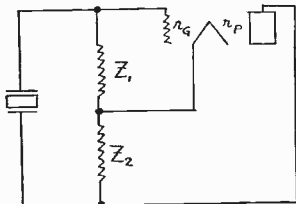

Fig. 1—Generalized diagram of circuit considered.

A search of the literature did not reveal anything definitely applicable to high-frequency crystal oscillators though several excellent articles were found pertaining to highly stable low-frequency oscillators and to crystal oscillators in general.

In one of these articles¹ a circuit was described that seemed to have some possibilities and it was decided to investigate this circuit further from the point of view of high-frequency operation. The circuit as drawn in Fig. 1 is essentially that described in the article. The mathematical approach will, however, be somewhat different. The crystal is

* Decimal classification: R214. Original manuscript received by the Institute, January 7, 1937.

¹ Issac Koga, "Characteristics of piezo-electric quartz oscillators," Proc. I.R.E., vol. 18, p. 1956, par. 8; November, (1930).

connected from grid to plate, Z_1 and Z_2 are generalized impedances, and r_G and r_p are the effective grid-to-cathode and plate-to-cathode resistances, respectively. The grid-to-cathode and plate-to-cathode capacitances are incorporated in Z_1 and Z_2 and the grid-to-plate capacitance can be considered to be a property of the crystal.

Let us derive the expression for the effective impedance facing the crystal. In deriving this expression it will be assumed that the ordinary amplifier theory is valid. Some qualitative corrections will be indicated later. The equivalent circuit is shown in Fig. 2. Z_G is the combined impedance of Z_1 and r_G in parallel, e is the grid-to-cathode voltage, μe is the equivalent plate generator voltage, E is the voltage across the crystal, and i_0 and i_1 are the crystal and internal plate currents, respectively.

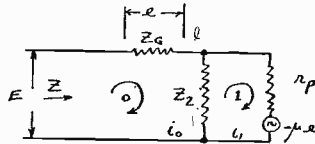

Fig. 2—Equivalent network of impedance seen from crystal.

Ordinary circuit analysis shows that

$$\frac{E}{i_0} = Z = Z_G + \frac{Z_2 r_p}{Z_2 + r_p} + \mu \frac{Z_2 Z_G}{Z_2 + r_p}. \quad (1)$$

If we let

$$Z_p = \frac{Z_2 r_p}{Z_2 + r_p} \quad (2)$$

and

$$\frac{\mu}{r_p} = g. \quad (3)$$

where g is the mutual conductance, we have finally

$$Z = Z_G + Z_p + g Z_G Z_p. \quad (4)$$

Equation (4) is the general expression for the impedance looking into the grid and plate of a vacuum tube. It is interesting to note that by a proper choice of Z_G and Z_p this impedance can be varied over a range of complex values by merely varying the mutual conductance of the tube.

If we let Z_c equal the effective electrical impedance of the crystal then the sum of Z_c and Z must equal zero when the steady state of oscillation is reached.² For oscillations to start the real part of Z must

² F. B. Llewellyn, "Constant frequency oscillators," *Proc. I.R.E.*, vol. 19, Appendix, pp. 2092-2094; December, (1931).

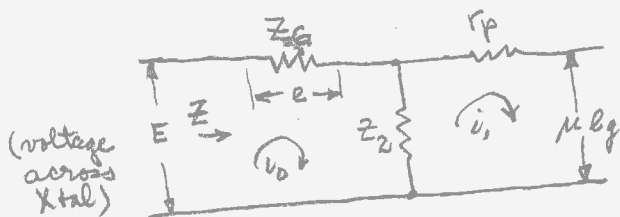
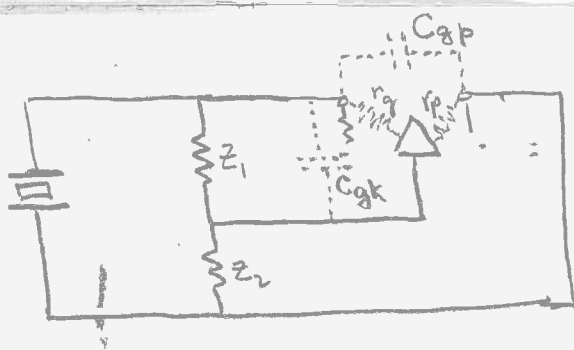

$e = g-k$ voltage

$i_0 = \text{Xtal cur.}$
 $i_1 = \text{plate "}$

$$Z_G = \frac{Z_1 r_g}{Z_1 + r_g}$$

$$E = v_0 Z$$

$$Z = \frac{E}{v_0} = Z_G + \frac{Z_2 r_p}{Z_2 + r_p} +$$



$$Z_2(j\omega) + R_p C_1 = R_e \quad e - e Z_G$$

$$\dot{e} = (Z_G - Z_2(j\omega))$$

be negative and have a numerical value equal to or greater than the real part of Z_c which is, of course, positive.

If the sum of the real parts is negative then the amplitude of oscillation will vary until the effective tube parameters; i.e., r_g , r_p , and g have changed sufficiently to make this sum equal zero. The variation in harmonic content³ with oscillation amplitude will qualify the above statement to some extent but this effect will be neglected in this paper. These parameters will also change as the applied voltages are varied and as the tube ages. Our problem is to choose circuit constants or devise correction methods that will nullify or minimize the effect of these changing parameters on the stability of the oscillator.

It was felt that inductances as circuit constants should be avoided so as to minimize any possible resonance effects. It was decided then to investigate Z when Z_p and Z_G are composed only of resistances and capacitances.

Let Z_G be made up of a resistance R_1 shunted by a capacitance C_1 and Z_p be made up of a resistance R_2 shunted by a capacitance C_2 . Incorporated in C_1 and C_2 are the grid-to-cathode and plate-to-cathode capacitances, respectively, and incorporated in R_1 and R_2 are the grid-to-cathode and plate-to-cathode resistances, respectively.

Substituting these values in (4) we find that

$$Z = K_1 + K_2 + gK_1K_2(1 - \omega^2C_1C_2R_1R_2) - j\omega[K_1R_1C_1 + K_2R_2C_2 + gK_1K_2(R_1C_1 + R_2C_2)] \quad (5)$$

where,

$$K_1 = \frac{R_1}{1 + \omega^2C_1^2R_1^2}$$

$$K_2 = \frac{R_2}{1 + \omega^2C_2^2R_2^2}$$

It is evident from (5) that it is possible, by correctly choosing the tube and circuit constants to make the real part of Z negative. We see also that the imaginary part of (5) is a function of all the tube parameters, so that as the real part of this equation is adjusting itself, in the oscillatory state, to any varying applied voltages and tube aging, these varying parameters will also change the value of the imaginary part. If we equate the sum of the imaginary parts of Z_c and Z to zero and solve for the frequency we would find that the frequency is a function of the circuit constants and the tube parameters.

³ Janusz Groszkowski, "Constant frequency oscillators," Proc. I.R.E., vol. 21, pp. 958-981; July, (1933).

The real parts of Z_c and Z are also functions of the frequency so that as the tube parameters vary, the real and imaginary parts vary in a quite complicated manner together until the steady state is reached. It is possible to set up the general expressions¹ for both the real and imaginary parts using the equivalent impedance of the crystal, which we have called Z_c but the resulting expressions become very complicated when an attempt is made to solve for the frequency and so determine the exact effect of the changing tube parameters on frequency. For the purpose of this paper it will be assumed that the real part of Z is independent of any changes in frequency and that the frequency is influenced only by changes in the imaginary part of Z .

Our problem now therefore resolves itself into determining in what manner the imaginary part of Z can be made as nearly independent of the tube parameters as possible. The lines of attack that suggested themselves were (1) to make the imaginary part of Z zero, (2) to make the imaginary part of Z constant, (3) or to devise a simple means of compensation.

Let us consider the above in order of presentation. The only manner in which the imaginary part of Z can be made zero is to make either the circuit resistors or capacitors zero or a capacitance and a resistor zero. This can be ruled out immediately as it is easily seen that the negative portion of the real part of (5) is also made zero and oscillations will therefore not be maintained.

The imaginary part of Z cannot be made absolutely constant since the tube parameters appear directly, but it appeared that it might be possible to so choose the circuit constants that any effect of changing tube parameters would be small. Let us investigate several extreme cases. Suppose that the circuit resistances and the internal tube resistance were very high. The value of Z would approach

$$Z \cong -\frac{g}{\omega^2 C_1 C_2} - \frac{j}{\omega} \left(\frac{1}{C_1} + \frac{1}{C_2} \right). \quad (6)$$

Equation (6) is indeed free from any of the tube parameters but it is easy to see that it is a practical impossibility to realize its advantages. It is possible to make R_1 high by keeping the grid current small and using a high circuit resistance, but R_2 has incorporated in it the shunting effect of r_p which is not very high when the tube is oscillating.

Another extreme case is when the circuit shunt resistors are very small. The effect of varying r_G and r_p will then be small. The value of Z for very small circuit resistors approaches

¹ *Loc. cit.*, p. 1937.

$$Z \cong R_1 + R_2 + gR_1R_2 - j\omega [R_1^2C_1 + R_2^2C_2 + gR_1R_2(R_1C_1 + R_2C_2)]. \quad (7)$$

In this case it is evident that the negative portion of the real part of (5) becomes zero and it will be impossible to maintain oscillation. This case can therefore be ruled out as an approach to the solution of the problem.

Still another extreme case utilizes a portion of the two cases just discussed. Suppose that R_1 be very large and that R_2 be small, and that R_2 be so small that the effect of r_p would be negligible. The expression for Z approaches

$$Z \cong R_2 - gR_2^2 \frac{C_2}{C_1} - \frac{j}{\omega C_1} (1 + gR_2). \quad (8)$$

It is seen in (8) that the negative portion of the real part is dependent on the square of a small quantity multiplied by the product of the mutual conductance and the ratio of C_2 to C_1 . It is necessary then to use a tube of high mutual conductance and a fairly high plate resistance, and that the quantity C_2/C_1 should be as large as possible.

We have already seen that the real part of Z is practically constant in an oscillatory circuit. This would mean that in the steady state the value of g would always be the same, and since g is the only tube parameter appearing in the imaginary part of (12), then this imaginary part will always remain constant and thus the frequency stability would be optimum.

It was decided as a result of these investigations that it would be advantageous to set up an experimental arrangement which would adhere as closely as possible to the conditions of (8).

The type 57 tube was selected as fulfilling to a large measure the requirements of a large mutual conductance and a fairly high plate resistance.

Several crystals ranging from 3.6 to 7.0 megacycles were available and were used in the experimental work. The circuit arrangement is shown in Fig. 3. r_1 and r_2 are the circuit resistances and C_1 and C_2 are the circuit capacitances. It was finally determined that stable oscillations could be secured, over this frequency range, with r_2 equal to 2000 ohms and r_1 equal to six megohms. The maximum values of C_1 and C_2 were 50 micromicrofarads.

It was noticed that for every value of C_1 there was a definite value of C_2 that would give the maximum intensity of oscillation, as indicated by the degree of dip in the plate current. A sample set of values were inserted in the real part of (5) and the result plotted against C_2 as shown in Fig. 4. It is evident that the negative resistance varies with

C_2 and does pass through a maximum. The capacitance range which makes the real part of (5) negative was found by experiment to contain the capacitance range over which the circuit oscillates. The point of

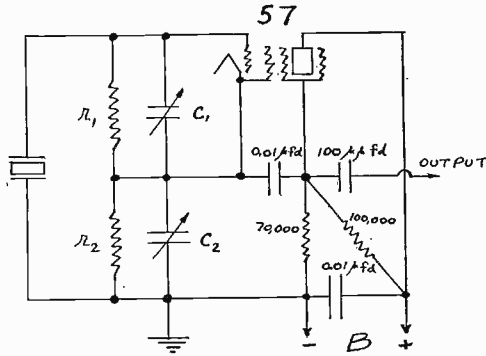

Fig. 3—Circuit of oscillator tested.

maximum intensity of oscillation corresponds approximately to the value of capacitance that gives the maximum negative resistance in (5).

It was found that with one of the condensers fixed, the position of the dip in plate current as found by varying the other condenser did

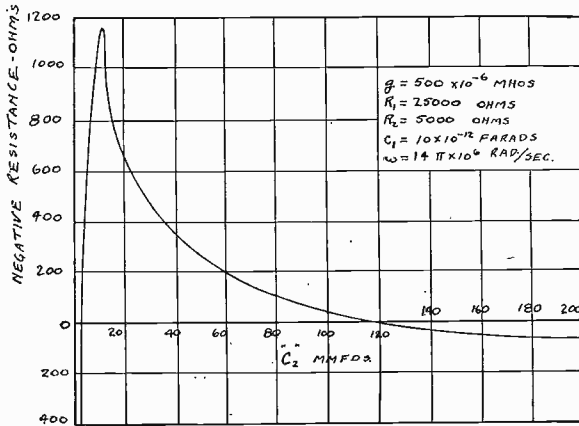

Fig. 4—Variation of negative resistance with cathode-plate capacitance.

not vary more than one in 500,000 as the plate and filament voltages were varied ten per cent either separately or together. There is quite a variation of frequency as the condensers are varied, as much as 100 cycles being observed over the range of oscillation of the seven-megacycle crystal.

These two facts taken together offer a simple means of frequency adjustment. It is simply necessary to vary the condensers together in such a manner that the dip in plate current occurs when the frequency is that desired. The frequency can be varied over a small range by varying one of the condensers around this point of maximum oscillation intensity. If it becomes necessary to return to the former setting, to within an accuracy of about one in 500,000, it is merely necessary to return the condenser which was moved to the point of maximum dip in plate current. This cannot be carried on over a large frequency range since there is an optimum ratio of C_1 to C_2 which gives the greatest intensity of oscillation. As the ratio is moved from this point the intensity of oscillation will decrease and finally cease altogether. This optimum condenser ratio must not be confused with the point of maximum oscillation intensity as found by fixing one of the condensers and varying the other.

It must be brought out here that some crystals made for high-frequency operation are so ground that they operate on some other mode than the fundamental. Such a crystal, when used in the circuit described will oscillate on the fundamental and not on the higher frequency for which operation they were sold.

The frequency stability was very good. It was found that, using the seven-megacycle crystal, with a standard B supply of 200 volts and a filament supply of 2.5 volts a ten per cent variation in either or both voltages did not vary the frequency more than about one in twenty million.

A variation in the B supply of 50 volts did not vary the frequency more than about one in a million. Disconnecting the filament voltage entirely did not cause the frequency to vary more than about one in a million by the time oscillation stopped. When the filament voltage was reconnected oscillation started at a frequency deviation of about one in three million and at the end of two minutes was within one in ten million. The deviation measuring equipment was not reliable for a longer period than several minutes so that no exact figures for long-time stability are available. It is reasonable to believe however, that the measurements made of the deviation with change in filament voltage are an indication of the kind of stability to be expected since the only change with age is a loss in cathode emission.



DETERMINATION OF THE RADIATING SYSTEM WHICH WILL PRODUCE A SPECIFIED DIRECTIONAL CHARACTERISTIC*

BY

IRVING WOLFF

(RCA Manufacturing Company, RCA Victor Division, Camden, N. J.)

Summary—Starting with the similarity of the radiation pattern from a pair of points to a harmonic function, it is shown that with a change in variable, the directional function can be put in a form which permits it to be analyzed into a Fourier series, each of whose terms represents a pair of sources. The same method is applied to other types of sources and arrays. The relationship is developed between source spacing and the range over which the function can be represented by the series. A number of examples are given to illustrate the application of this method.

INTRODUCTION

AS THE generation of higher radio frequencies becomes practical with consequent shortening of the radiated wave length, increased control of the radiated pattern becomes possible because of the greater number of wave lengths which can be included in the radiating system.

In a number of acoustical applications it has also been found that close control of the radiation pattern is desirable.

It is well known that the directional radiation pattern from two small sources, when the point of observation is at a distance from the sources, is of the form

$$R_{\beta} \sim \cos \left(\frac{\pi d}{\lambda} \sin \beta + \frac{\phi}{2} \right)$$

where R_{β} is the amplitude of the radiation in a direction β , β is the angle between the perpendicular to the line joining the points and the line from them to the point of observation, d is the distance between the points, λ is the length of the radiated wave, and ϕ is the phase difference of vibration between the two points.

The harmonic nature of the directional pattern from a pair of radiating points suggests that combinations of such points may be used to obtain any desired directional characteristic by a procedure similar to that of the Fourier method, which is used to synthesize a function in terms of a harmonic series.

As a consequence, we should be able to apply a direct mathematical procedure to the determination of the array, which will give a specified

* Decimal classification: R120. Original manuscript received by the Institute, January 21, 1937. Presented before joint meeting I.R.E.-U.R.S.I., Washington, D. C., May 1, 1936.

directional characteristic. Even though the solution which is obtained may, in certain cases, be too extended to be of practical use (because of slow convergence of the series) it will very often give a lead to other arrangements which are not too involved.

A rather limited application of some similar ideas has recently been made by Berndt¹ to the calculation of beam sharpness and other characteristics of a few special antenna arrangements.

The procedure which is used will be clearer if we start by building up the directional characteristics from some simple distributions along a line, generalizing this later to more complicated arrays in space. The character of the directional function will then indicate the procedure to be followed in the reverse process; i.e., finding the distribution which will give a specified directional characteristic. Finally, a few examples will be given to show how the method can be applied.

RADIATION FROM ANY ARRANGEMENT OF POINT SOURCES ON A STRAIGHT LINE

Any number of radiating points on a straight line can be replaced by a number of pairs of points along the same line and their directional patterns represented by a pair of harmonic series.

1 2 3 4

Suppose we have the points 1, 2, 3, 4 with intensities $a_1 + jb_1$, $a_2 + jb_2$, $a_3 + jb_3$, $a_4 + jb_4$, respectively, each being of arbitrary intensity and phase. Taking the points 1 and 4, we can substitute for them the pairs

$$\frac{a_1 + a_4}{2}, \quad \frac{a_1 + a_4}{2}; \quad \frac{a_1 - a_4}{2}, \quad \frac{a_4 - a_1}{2}; \quad \text{and}$$

$$j\left(\frac{b_1 + b_4}{2}\right), \quad j\left(\frac{b_1 + b_4}{2}\right); \quad j\left(\frac{b_1 - b_4}{2}\right), \quad j\left(\frac{b_4 - b_1}{2}\right)$$

at the same two positions. In considering the radiation from a series of pairs of points, the relative phases of the separate pairs must be taken into account, as well as the difference in phase between the points. In doing this we must distinguish clearly between the phase of the vibration of the points and the relative phase of the radiation from separate pairs of points. When we specified the different sources in terms of complex quantities, we set up the same zero of phase to be applied to each source. This can be entirely arbitrary. In order to specify the phase of the radiation from any pair, it is necessary to take some radia-

¹ W. Berndt, *Hochfrequenz. und Elektroakustik*, vol. 44, p. 23, (1934.)

tion as zero phase. In dividing the source into pairs of points, we shall find it convenient to locate each pair about the same center point. In the example which is being worked out, the point halfway between 1 and 4 has arbitrarily been chosen as this center. Any other point could have been taken. Having chosen this center point, we take the radiation which would come from it, if it were vibrating at zero phase, as the zero of radiation phase. A short consideration will show that the radiation

from the pair $\frac{a_1+a_4}{2}$, $\frac{a_1+a_4}{2}$ will, for all directions, be either in

phase or 180 degrees out of phase with our standard of phase, while the

radiation from the pair $\frac{a_1-a_4}{2}$, $\frac{a_4-a_1}{2}$ will be in quadrature; similarly, $j\frac{b_1+b_4}{2}$, $j\frac{b_1+b_4}{2}$ will be in quadrature and $j\frac{b_1-b_4}{2}$, $j\frac{b_4-b_1}{2}$ will be in

phase. When radiation from the point 2 is considered, where there is no corresponding source on the other side of the center point, two sources whose intensity adds to zero are substituted.

The substitute pairs which deliver in-phase radiations are then

$\frac{a_2}{2}$, $\frac{a_2}{2}$ and $j\frac{b_2}{2}$, $-j\frac{b_2}{2}$ and the quadrature components come from

$j\frac{b_2}{2}$, $j\frac{b_2}{2}$ and $\frac{a_2}{2}$, $-\frac{a_2}{2}$. The point 3 being at the chosen center of the

radiating system is taken as a single source a_3 , $j b_3$.

We can now substitute for the original points the pairs $\frac{a_1+a_4}{2}$

+ $j\frac{b_1-b_4}{2}$, $\frac{a_1+a_4}{2} - j\frac{b_1-b_4}{2}$; $\frac{a_2}{2} + j\frac{b_2}{2}$, $\frac{a_2}{2} - j\frac{b_2}{2}$; and the point a_3

which send out in phase radiation, and the pairs $j\frac{b_1+b_4}{2} + \frac{a_1-a_4}{2}$,

$j\frac{b_1+b_4}{2} - \frac{a_1-a_4}{2}$; $j\frac{b_2}{2} + \frac{a_2}{2}$, $j\frac{b_2}{2} - \frac{a_2}{2}$ and the point $j b_3$ which send out

quadrature radiations. This leads to the directional pattern,

$$R_\beta \sim A_0 + A_1 \cos\left(\frac{\pi d_1}{\lambda} \sin \beta + \frac{\phi_1}{2}\right) + A_2 \cos\left(\frac{\pi d_2}{\lambda} \sin \beta + \frac{\phi_2}{2}\right)$$

$$\begin{aligned}
 &+ j \left[B_0 + B_1 \cos \left(\frac{\pi d_1}{\lambda} \sin \beta + \frac{\psi_1}{2} \right) \right. \\
 &\left. + B_2 \cos \left(\frac{\pi d_2}{\lambda} \sin \beta + \frac{\psi_2}{2} \right) \right] \tag{1}
 \end{aligned}$$

where,

$$\begin{aligned}
 A_0 &= a_3, & B_0 &= b_3, & A_1 &= B_1 = \frac{1}{2} \sqrt{a_2^2 + b_2^2} \\
 A_2 &= \frac{1}{2} \sqrt{(a_1 + a_4)^2 + (b_1 - b_4)^2} \\
 B_2 &= \frac{1}{2} \sqrt{(a_1 - a_4)^2 + (b_1 + b_4)^2}
 \end{aligned}$$

$\frac{d_1}{2}$ distance from point 2 to center point, $\frac{d_2}{2}$ distance from 1 or 4 to center point.

$$\phi_1 = \tan^{-1} \frac{b_2}{a_2} \quad \psi_1 = \tan^{-1} \frac{a_2}{b_2} \quad \phi_2 = \tan^{-1} \frac{b_4 - b_1}{a_1 + a_4} \quad \psi_2 = \tan^{-1} \frac{a_4 - a_1}{b_1 + b_4}$$

Although this has been worked out for a special case, it is evident that the method is quite general and that the radiation pattern from any set of point sources along a line is of the form

$$\begin{aligned}
 R_\beta &\sim A_0 + A_1 \cos \left(\frac{\pi d_1}{\lambda} \sin \beta + \frac{\phi_1}{2} \right) \cdots A_n \cos \left(\frac{\pi d_n}{\lambda} \sin \beta + \frac{\phi_n}{2} \right) \\
 &+ j \left[B_0 + B_1 \cos \left(\frac{\pi d_1}{\lambda} \sin \beta + \frac{\psi_1}{2} \right) \cdots \right. \\
 &\quad \left. B_n \cos \left(\frac{\pi d_n}{\lambda} \sin \beta + \frac{\psi_n}{2} \right) \right] \tag{2}
 \end{aligned}$$

RADIATION FROM LINEAR SYSTEMS OF SIMILAR ELEMENTS

It is only under special circumstances that the radiating elements can be represented as point sources. However, in a large number of cases, a series of similar elements are used. These similar elements might be half-wave radiators, loud-speaker cones, sections of an array, or any other system having a directional pattern $f(\beta)$. It has been shown^{2,3} that the directional pattern $F(\beta)$ of such an arrangement is

$$f(\beta)R(\beta) \tag{2a}$$

where $R(\beta)$ is the pattern of the points obtained by choosing a similar reference point on each one of the elements. The phase and amplitude

² Wolff and Malter, *Jour. Acous. Soc. Amer.*, vol. 2, p. 215, (1930).

³ Southworth, *Proc. I.R.E.*, vol. 18, p. 1531; September, (1930).

of the point sources should correspond to the relative phases and amplitudes of the radiating elements.

THREE-DIMENSIONAL RADIATION PATTERNS

The radiation pattern from a series of point sources on a straight line has circular symmetry about that line. The directional pattern in any plane through the line is, therefore, sufficient to specify the complete pattern in space. Plane and cubical arrays in which each source has an arbitrary strength and phase will not be considered here and are not of much practical significance. The type of spatial array which is the most practical also leads to a simple expression for the directional pattern. Choosing three mutually perpendicular axes x , y , and z and assuming that the distribution of source intensity is of the form $g(\nu) = [g_1(x)] [g_2(y)] [g_3(z)]$ where the g 's on the right-hand side are functions only of the specified variable, and may be complex, the relative intensity in any direction $R(\alpha, \gamma, \delta)$ is

$$R_{(\alpha)} \cdot R_{(\gamma)} \cdot R_{(\delta)} \quad (3)$$

where α is the angle between the line joining the origin and the point of observation and the yz plane, γ the angle between the same line and the xz plane, and δ the angle between the line and the xy plane. $R(\alpha)$ is the directional pattern of $g_1(x)$, $R(\gamma)$ and $R(\delta)$ the patterns of $g_2(y)$ and $g_3(z)$, respectively.

APPLICATION OF FOURIER'S THEOREM TO DETERMINATION OF RADIATING SYSTEMS

Up to this point we have been building up directional patterns from known distributions. We are, however, interested in the reverse process of determining the distribution which will supply a specified directional pattern. It has been necessary to show how the directional patterns are built up in order to understand better the manner in which the reversed process can be carried out.

Suppose that we desire a directional pattern $F(\beta)$ of axial symmetry in a certain plane; that the radiating element which is to be used in our linear array has a directional pattern $f(\beta)$ in the same plane. Reversing the procedure of (2a), we form the new function

$$R(\beta) = \frac{F(\beta)}{f(\beta)} \quad (2b)$$

This must be satisfied between and including $\beta = \frac{-\pi}{2}$ and $\beta = \frac{+\pi}{2}$.

The function $R(\beta)$ might be complex; that is, $F(\beta)$ and $f(\beta)$ can have

both magnitude and phase specified. If $R(\beta)$ is complex, it is broken up into two functions in quadrature, each of which can be treated separately. The physical interpretation can be seen by reference to the section on radiation from a system of point sources in a line. Since the only complication introduced by complex functions is the necessity of having to satisfy two functions instead of one, the treatment from this point on will be carried out assuming that $F(\beta)$ is specified only in magnitude. Although in the illustrations which are to be given, we do not intend to use this fact, it is possible that when the magnitude only is specified there might be some advantage in forming the function $R(\beta)$ of two functions in quadrature whose magnitude satisfies $R(\beta)$, and obtaining the source arrangement which will fit them instead of trying to satisfy $R(\beta)$ directly.

We have seen that the radiation from a number of pairs of points on a straight line is of the form

$$R(\beta) \sim A_0 + \sum A_s \cos \left(\frac{\pi d_s}{\lambda} \sin \beta + \frac{\phi_s}{2} \right). \quad (4)$$

If a new variable $w = (\pi d_1)/\lambda \sin \beta$ is substituted, we obtain

$$M(w) = R \left(\sin^{-1} \frac{w\lambda}{\pi d_1} \right) \sim A_0 + \sum A_s \cos \left(\frac{d_s}{d_1} w + \frac{\phi_s}{2} \right) \quad (5)$$

where d_1 refers to the pair with least spacing. In order to solve the inverse problem of obtaining the distribution of points which will satisfy the desired $R(\beta)$, we proceed to substitute as above and obtain a new function $M(w)$. This must be satisfied between and including

$$\beta = -\frac{\pi}{2} \text{ and } +\frac{\pi}{2} \text{ or } w = -\frac{\pi d_1}{\lambda} \text{ and } +\frac{\pi d_1}{\lambda}.$$

If $M(w)$ satisfies certain conditions with regard to discontinuities⁴ it can be analyzed by means of Fourier's theorem into a series of harmonic terms of the form

$$M(w) = a_0 + \sum_1^{\infty} a_m \cos (mw + \psi_m) \quad (6)$$

between $w = -\pi$ and $+\pi$ but not including these values, where it takes the value $\frac{M(-\pi) + M(+\pi)}{2}$. Comparing with the radiation from a

number of pairs of points, as given in (5), we see that this represents the radiation from a number of pairs of points of relative amplitudes

$a_1 \cdots a_n$, phase differences $2\psi_1 \cdots 2\psi_n$, and spacings $d_1 \cdots nd_1$, respectively, plus that from a central point of relative amplitude a_0 . The spacing for the closest spaced pair can be chosen to suit the circumstances of the problem. There is no lower limit, but the upper limit is fixed by the range over which $M(w)$ can be satisfied by a harmonic series. In the last paragraph we saw that $M(w)$ had to be satisfied be-

tween and including $w = -\frac{\pi d_1}{\lambda}$ and $+\frac{\pi d_1}{\lambda}$. The Fourier method can

be applied between, but not including $-\pi$ and $+\pi$. We can, therefore, always find a distribution of pairs of points to satisfy the direc-

tional characteristic for $d_1 < \lambda$. If $R\left(-\frac{\pi}{2}\right) = R\left(+\frac{\pi}{2}\right)$ making

$M\left(-\pi \frac{d_1}{\lambda}\right) = M\left(+\pi \frac{d_1}{\lambda}\right)$ spacings as great as $d_1 = \lambda$ can be used

since under this condition the Fourier series can be made to fit the desired function between and including $w = -\pi$ and $+\pi$. In special cases, it will be found that the series can satisfy $M(w)$ over a greater range than $-\pi$ to $+\pi$ and under such conditions d_1 can be greater than λ . An example of this kind will be given later.

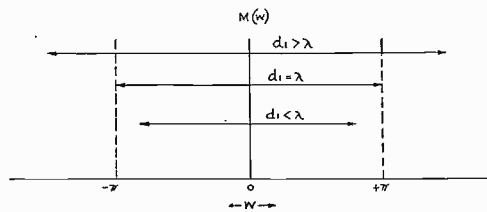

Fig. 1—Range over which $M(w)$ must be satisfied as a function of d_1/λ .

The relation between d_1 and the range over which $M(w)$ must be satisfied to correspond to a range of β from $-\pi/2$ to $+\pi/2$ is shown in Fig. 1. In order to use the Fourier method, the function should be specified from $-\pi$ to $+\pi$. When $d_1 < \lambda$ no values of $M(w)$ are determined by $R(\beta)$ between $w = -\pi$ and $-\pi(d_1/\lambda)$ or between $+\pi(d_1/\lambda)$ and π . We therefore are at liberty to supply any arbitrary function which satisfies Dirichlet's conditions in these regions.⁴ In general, the function should be supplied which will either simplify the series as much as possible or make it converge most rapidly. Under any conditions there are an infinite number of solutions when $d_1 < \lambda$.

⁴ Byerly, "Fourier's Series and Spherical Harmonics," p. 60.

By making d_1 smaller we can approach as closely as desired to a continuous distribution. In the limit this solution approaches the Fourier integral.

ILLUSTRATIONS OF THE METHOD

1. Uniform Intensity on One Side of a Plane, 0 Intensity on the Other Side.

In view of the axial symmetry of a series of point sources along a line, it is evident that this requirement is met if the intensity is 0 from $\beta = 0$ to $\beta = +\pi/2$ and constant from $\beta = 0$ to $\beta = -\pi/2$. Substituting the variable $w = \pi d_1/\lambda \sin \beta$, $M(w)$, the function to be satisfied by the Fourier series is 0 from $w = 0$ to $w = +\pi d_1/\lambda$ and equals a constant taken to be 1 from $w = 0$ to $w = -(\pi d_1/\lambda)$. Now $(d_1)/\lambda$ must be chosen so that the limits of the range for $M(w)$ will be those that can be satisfied by a Fourier series. Since $M\left(\frac{\pi d_1}{\lambda}\right) \neq M\left(-\frac{\pi d_1}{\lambda}\right)$, w can range

from 0 to $+\pi$ and $-\pi$ but not including $+\pi$ and $-\pi$. Therefore $d_1/\lambda < 1$. An arbitrary function must be added to complete the range to $-\pi$ and $+\pi$. We will find the function which is 0 from $+\pi$ to $+\pi d_1/\lambda$ and 1 from $-(\pi d_1/\lambda)$ to $-\pi$ convenient, since it leads to a series in which alternate terms drop out. A function which decreased uniformly from 1/2 to 0 between $+\pi d_1/\lambda$ and $+\pi$ and decreased in a similar manner from 1 to 1/2 between $w = -(\pi d_1/\lambda)$ and $-\pi$ would lead to a series which converged more rapidly as a function of d but would have more terms for the same convergence.

The Fourier series for $M(w) = 0$ from $+\pi$ to 0 and 1 from 0 to $-\pi$ is

$$\frac{1}{2} + \frac{2}{\pi} \sum_{s=0}^{s=\infty} \frac{\cos \left[(2s+1)w + \frac{\pi}{2} \right]}{2s+1}. \quad (7)$$

This is shown in Fig. 2 for the series carried to $s=2$. The value at $w = -0.9\pi$ is practically 1 and at $+0.9\pi$ is almost zero. By choosing $d_1/\lambda = 0.9$ the range over which the function must be satisfied to correspond to a range of β from $-\pi/2$ to $+\pi/2$ extends from -0.9π to 0.9π . This is shown dashed in Fig. 2, while the arbitrary added function is dotted. Comparison of (7) with (5) gives the source strengths which are shown in Table I. The directional pattern is shown in Fig. 3. By increasing the number of radiating pairs, this pattern could be made to approach more nearly to the desired one.

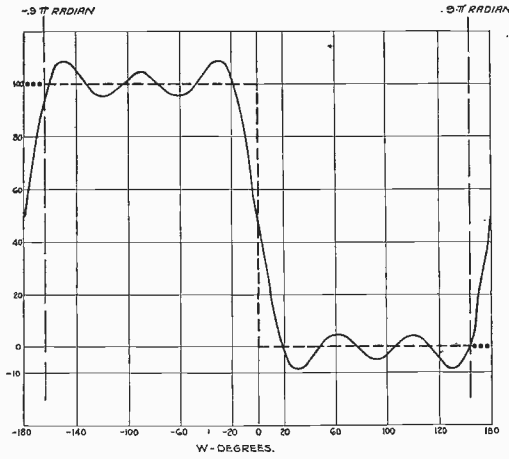

Fig. 2— $M(w)$ for illustration 1.

TABLE I
Distribution of source intensity,
illustration 1.

Spacing	Relative Amplitude
Central Element	$\pi/4$
0.9λ	$j, -j$
2.7λ	$j/3, -j/3$
4.5λ	$j/5, -j/5$

TABLE II
Distribution of source intensity,
illustration 2.

Spacing	Relative Amplitude
Central Element	0.83
λ	1.00, 1.00
2λ	-0.07, -0.07
3λ	-0.38, -0.38
4λ	0.02, 0.02
5λ	0.24, 0.24

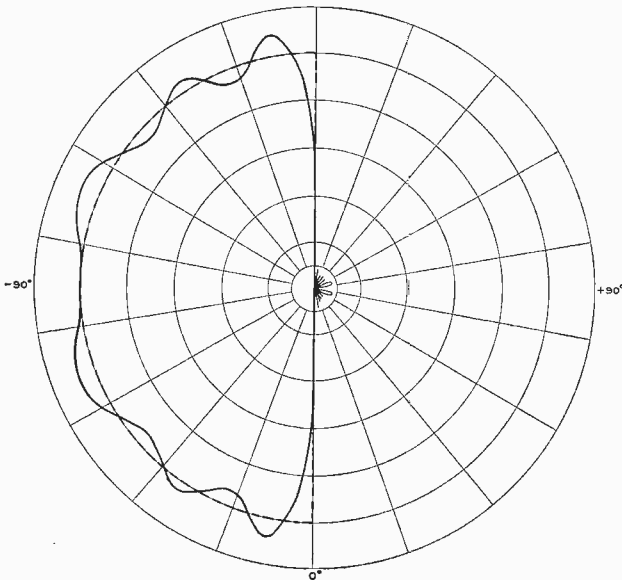

Fig. 3—Directional pattern, illustration 1.

2. Compensation for the Radiation Pattern of an Extended Radiator.

The radiation pattern of a linear half-wave element in a plane through the element is a maximum at right angles to the radiator and drops to zero along the line. If, therefore, a specified directional pattern in the plane of an array of half-wave radiators is desired, compensation must be made for the directivity of the half-wave elements.

As a concrete example, let us solve the problem of obtaining a characteristic of uniform intensity from $\beta = -\pi/6$ to $+\pi/6$ and 0 elsewhere, using half-wave elements placed end to end in linear array. $\beta = 0$ degrees lies in the plane perpendicular to and through the center of the central half-wave element.

The directional characteristic of a half-wave radiator is

$$f(\beta) \sim \frac{\cos\left(\frac{\pi}{2} \sin \beta\right)}{\cos \beta}$$

In accordance with (2b) $R(\beta) = \frac{F(\beta)}{f(\beta)}$ we must develop a directional

pattern equal to $\frac{\text{const.} \cos \beta}{\cos(\pi/2 \sin \beta)}$ from $\beta = -\pi/6$ to $+\pi/6$, and 0 from

$-\pi/2$ to $-\pi/6$ and from $+\pi/6$ to $+\pi/2$. Substituting the new variable $w = (\pi d_1/\lambda) \sin \beta$, we may choose $d_1 = \lambda$ since $w(-\pi)$ equals $w(\pi)$. The substitution then becomes $w = \pi \sin \beta$, and the function to be satisfied by the Fourier series is

$$\frac{\text{const.} \cos \sin^{-1} w/\pi}{\cos w/2} = \frac{\text{const.} \sqrt{\pi^2 - w^2}}{\pi \cos w/2}$$

from $w = -\pi/2$ to $+\pi/2$, and 0 from $-\pi$ to $-\pi/2$ and $+\pi/2$ to $+\pi$. The Fourier series for this function carried out to six terms is $0.83 + \cos w - 0.07 \cos 2w - 0.38 \cos 3w + 0.02 \cos 4w + 0.24 \cos 5w$, arbitrarily making the coefficient of the $\cos w$ term = 1. The spacing of the center points of the half-wave radiators and the amplitudes are given in Table II. The directional pattern of this arrangement is shown in Fig. 4 as well as the desired characteristic and the pattern of a half-wave radiator. Because of symmetry, these patterns are shown only on one side of the line.

3. Case Where d_1 Can Be Chosen $> \lambda$.

Let us suppose we desire bidirectional radiation, uniform over an angle of 10 degrees, and zero elsewhere. Choose the center of the beam

perpendicular to the line of radiators. The directional characteristic to be satisfied is proportional to constant from $\beta = -5$ to $+5$ degrees and 0 from -90 to -5 degrees and $+5$ to $+90$ degrees. Substituting as usual $w = (\pi d_1/\lambda) \sin \beta$, we choose a value of d_1 . Since the function to be

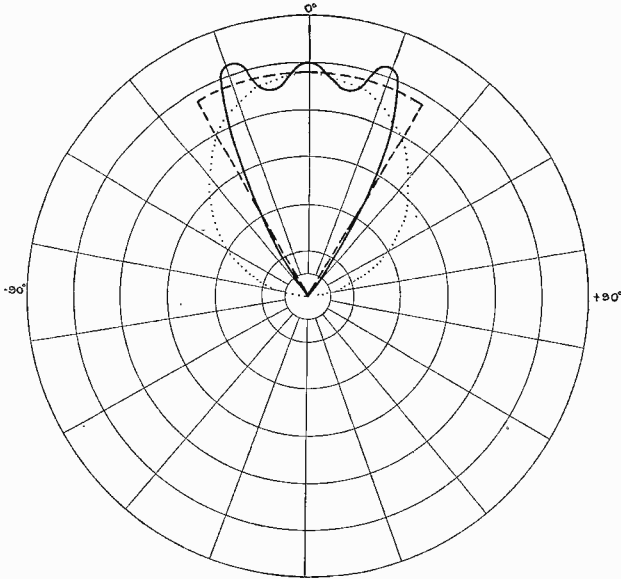

Fig. 4—Directional pattern, illustration 2.

satisfied has the same value at the positive and negative ends of the scale, d_1 could be chosen as great as λ . However, owing to the nature of the function, we find that the Fourier series can be made to satisfy it over a range greater than $-\pi$ to $+\pi$ giving the possibility of choosing greater d_1 with consequent reduction in the number of elements in the

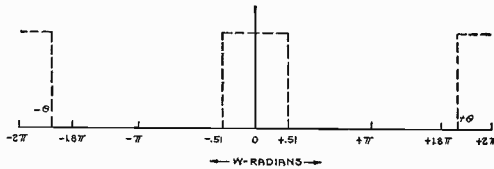

Fig. 5—Range over which $M(w)$ can be satisfied, illustration 3.

array. In Fig. 5 the type of function which will result from the Fourier series is shown from -2π to $+2\pi$. It is evident that the function we desire can be satisfied between $-\theta$ and $+\theta$. A few trials show that $d_1/\lambda = 1.8$ can be chosen, while still allowing leeway for approximation to the desired characteristic. For $d_1/\lambda = 1.8$ the function to be satisfied

is constant from $w = -0.51$ to $+0.51$ and zero from -1.8π to -0.51 and $+0.51$ to $+1.8\pi$. For the mechanics of solving the Fourier series, the function to be satisfied is constant from -0.51 to $+0.51$ and 0 from $-\pi$ to -0.51 and $+0.51$ to π . The relative amplitudes to be applied to the pairs are given in Table III for 11 pairs and a central element.

TABLE III
Distribution of source intensity, illustration 3.

Spacing	Relative Amplitude
Central Element	0.52
1.8λ	1.00, 1.00
3.6λ	0.87, 0.87
5.4λ	0.67, 0.67
7.2λ	0.45, 0.45
9.0λ	0.22, 0.22
10.8λ	0.08, 0.08
12.6λ	-0.12, -0.12
14.4λ	-0.20, -0.20
16.2λ	-0.22, -0.22
18.0λ	-0.18, -0.18
19.8λ	-0.07, -0.07

All are in phase. The directional patterns for total length of 9λ and 19.8λ are shown in Fig. 6 as well as the desired pattern. These curves illustrate the effect of the number of elements we choose to use in the system, on the spacing that must be used. Although the secondary maxima for the 19.8λ array are negligible, there is considerable output

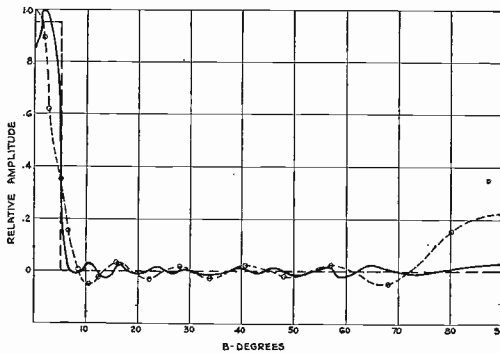

Fig. 6—Directional pattern, illustration 3.

between 75 and 90 degrees when using the 9λ array. This secondary maximum could be avoided by choosing a spacing somewhat less than 1.8λ . A trial shows that 1.7λ would be adequate.

4. Radiation Pattern Specified for All Directions in a Plane.

Using sources along a line the pattern is symmetrical on the two sides of the line. With this means we are therefore limited to obtaining

any pattern which is symmetrical with respect to a line. In order to include unsymmetrical patterns a distribution in a plane must be used. The array can be determined as follows:

Divide the pattern into two, from 0 to 180 degrees and 180 to 360 degrees. Call these patterns $R_{(\beta_1)}$ and $R_{(\beta_2)}$, respectively. Determine the linear distribution which will produce $R_{(\beta_1)}$ on one side of a line. If each radiating point is replaced by a radiator or array of same phase and relative amplitude which has uniform radiation on one side of the line and no radiation on the other side, unidirectional radiation of pattern $R_{(\beta_1)}$ will be obtained (equation (2a)). In example (1) we saw how to obtain such radiation. A similar method can be used to obtain $R_{(\beta_2)}$ on the other side of the line. Superposition gives the specified directional pattern $R(\beta)$.

5. Three-Dimensional Patterns—A Beam.

In the synthesis of spatial distributions the principles which are well known in building up arrays may also be used in the inverse process (equations (2a) and (3a)).

We desire a unidirectional beam of radiation 10 degrees high and 60 degrees wide, using half-wave elements. For simplicity, ground reflections will be neglected.

Using the notation of (3) and taking the Z axis vertical, the Y axis straight front, and X axis perpendicular to both these, the requirements are that the characteristic equals constant from $\alpha = -30$ degrees to $+30$ degrees, and $\delta = -5$ degrees to $+5$ degrees and zero elsewhere, also that there be no radiation from $\gamma = 90$ degrees to 0 degrees (unidirectional). Referring to (3), this result is attained if we can develop three directional patterns $R_{(\alpha)}$, $R_{(\gamma)}$, and $R_{(\delta)}$ equal to a constant from $\alpha = -30$ degrees to $+30$ degrees, zero elsewhere; 0 from $\gamma = 0$ degrees to $+90$ degrees, constant elsewhere; and constant from $\delta = -5$ degrees to $+5$ degrees, 0 elsewhere, respectively. We have seen how linear arrangements can be produced to give these patterns. Calling these arrangements $G_1(x)$, $G_2(y)$, and $G_3(z)$ the relative intensities in the cubical array are given by

$$G(v) \sim [G_1(x)][G_2(y)][G_3(z)].$$

The requirement as regards γ is not entirely determinate in the example which is given. Although it was stated that $R(\gamma) = 0$ from $\gamma = 90$ degrees to 0 degrees and constant from 0 degrees to -90 degrees, this was merely the general condition for unidirectional radiation and in view of the requirements on α and δ need not be as severe for this particular case. More specifically, $R(\gamma) = 0$ from 90 degrees to 59 degrees

and constant from -59 degrees to -90 degrees with any reasonable value between -59 degrees and $+59$ degrees.

As a matter of fact, in view of the narrowness of the beam in the δ direction, the desired directional pattern could also be obtained using a plane instead of a cubical array. Considering only radiation in a forward direction, we see that the region bounded by $\delta = +5$ degrees and -5 degrees in the vertical plane and α equals $+30$ degrees and -30 degrees in the horizontal plane is almost the same as that bounded by $\delta = +5$ degrees and -5 degrees and $\gamma = -60$ degrees. The desired directional pattern could, therefore, be attained (very nearly) by a plane array which would make $R(\delta)$ constant from $\delta = -5$ degrees to $+5$ degrees, 0 from -90 degrees to -5 degrees and $+5$ degrees to $+90$ degrees while $R(\gamma) =$ constant from -90 degrees to -60 degrees and zero from -60 degrees to $+90$ degrees.

6. Radiation Pattern Specified in All Directions in Space.

The array which is required to meet this condition would of necessity generally be quite complex, but a theoretical solution which might point to a practical approximation is possible. One method of procedure is to divide the pattern up into a number of circular sectors about the vertical axis over each one of which the change of amplitude of pattern in the γ direction is comparatively small. By the methods outlined previously distributions of sources along the Z axis can be obtained which will make the intensity constant in any one of the sectors and zero elsewhere. Combining a vertical distribution of this type with horizontal distributions as indicated in example 4 the specified directional pattern is obtained in the segment. The solutions for the separate segments are then superposed. In order to limit the number of elements it may be advantageous to take a fundamental spacing somewhat less than λ so that it will be applicable to all the arrays which are superposed.



BOOK REVIEW

"Radio Beacons," by V. I. Bashenoff and N. A. Mjasoedoff. In Russian. Published in Moscow, 1936. 671 pages, 507 illustrations. Available through Bookniga Corporation, 255 Fifth Avenue, New York, N.Y. Price, \$3.20.

This book, in the Russian language, deserves to be known among the radio engineers of the world, as it is the only comprehensive treatment of a subject of urgent and increasing interest in marine and aerial navigation. The book presents the results of more than ten years of work by the authors in the field of radio guidance; it also synthesizes the results of work done by others all over the world. Some of its material was published in preliminary form in *Proc. I.R.E.*, vol. 15, p. 1013; December, (1927); vol. 16, p. 1553; November, (1928); vol. 19, p. 984; June, (1931); and vol. 24, p. 778; May, (1936).

While the reviewer is unable to read the Russian text, he has had the advantage of an English translation of the preface and table of contents. A survey of the profuse illustrations and the mathematical formulas also reveals much of the character of the book. The treatment is in two parts: Part I, Directive transmission and radio beacon antennas; Part II, Theory and application of radio beacons. The practical information given is thus based on a broad foundation of fundamental theory. The chapters are:

1. Principles of directive radiation.
2. Current distribution and directive effect of closed antennas.
3. Inductance and capacitance of closed antennas.
4. Effective height of closed antennas.
5. Effective resistance of closed antennas.
6. General review and classification of radio beacons.
Radio beacons (undirected).
7. Rotating radio beacons.
8. Equisignal radio beacons.
9. Calculation of the angle of the equisignal zone.
10. Utilization of power in equisignal radio.
11. Utilization of an equisignal beacon for several courses.
12. Steadiness of the equisignal radio beacon direction.
13. On the peculiarities of calculation of the accuracy of the equisignal radio beacon.
14. Radio beacons with double and triple modulation.
15. Apparatus for the visual reception of radio beacons with double and triple modulation.
16. Methods for the visual reception of radio beacons with interlocking signals.
17. Night effects.
18. Radio beacons with TL antennas.
19. On some special errors in the reception of radio beacon signals and on the types of aircraft antennas for such reception.
20. Radio beacons for blind landing.

*J. H. DELLINGER

* National Bureau of Standards, Washington, D. C.

CONTRIBUTORS TO THIS ISSUE

Brown, George H.: See PROCEEDINGS for January, 1937.

Durand, Samuel R.: Born March 12, 1904, at Milwaukee, Wisconsin. Received A.B. degree, University of Wisconsin, 1926; assistant in physics, 1926-1927. Engineer, apparatus development department, Bell Telephone Laboratories, Inc., 1927-1929; radio engineer, International Telephone and Telegraph Company, 1929-1931; electrical engineer, rectifier division, Allis-Chalmers Manufacturing Company, 1932 to date. Nonmember, Institute of Radio Engineers.

Hershberger, W. D.: Born May 10, 1903, at Wellman, Iowa. Received A.B. degree in mathematics, Goshen College, 1927; A.M. degree in physics, George Washington University, 1930. Junior physicist, sound division, Naval Research Laboratory, 1927-1931; associate physicist, Signal Corps Laboratories, 1931-1936. Harrison Fellow in electrical engineering, University of Pennsylvania, 1936-1937. Member, Sigma Xi and American Physical Society. Nonmember, Institute of Radio Engineers.

Hight, S. C.: Born July 28, 1906, at Berkeley, California. Received B.S. degree in electrical engineering, University of California, 1930; A.M. degree in physics, Columbia University, 1934. Member of technical staff, Bell Telephone Laboratories, Inc., 1930 to date. Associate member, Institute of Radio Engineers, 1931.

Keller, Otto: Born March 3, 1902, at Winterthur, Switzerland. Wheaton College, 1919-1923; University of Pennsylvania, 1928. Engineering department, American Brown Boveri Electric Corporation, 1928-1931; rectifier division, Allis-Chalmers Manufacturing Company, 1931 to date. Associate member, Institute of Radio Engineers, 1936.

Leitch, John G.: Born May 5, 1898, at Harwood, Michigan. U. S. Army radio, 1918; marine radio operator, 1919; installation engineer, Radiomarine Corporation of America, 1922; U. S. radio inspector, 1924; chief engineer, Universal Broadcasting Company, 1929; technical director, WCAU Broadcasting Company, 1932 to date. Member, Institute of Radio Engineers, 1936.

Omer, Guy C., Jr.: Born March 20, 1912, at Mankato, Kansas. Received B.S. degree in electrical engineering, University of Kansas, 1936. Assistant in physics, University of Kansas, 1935 to date. Nonmember, Institute of Radio Engineers.

Sabaroff, Samuel: Born November 10, 1908, at Philadelphia, Pennsylvania. Received B.S. degree in electrical engineering, Drexel Institute, 1931; special graduate student, Moore School of Electrical Engineering, University of Pennsylvania, 1932 to date. Reject control and factory laboratory, Philco Radio and Television Corporation, 1931-1932; radio operator, WCAU Broadcasting Company, 1932-1933; plant supervisor, 1933 to date. Nonmember, Institute of Radio Engineers.

Willard, G. W.: Born June 19, 1901, at Mankato, Minnesota. Received B.A. degree, University of Minnesota, 1924, M.A. degree in physics, 1928. Instructor in physics, University of Kansas, 1927-1928; teaching Fellow, University of Chicago, 1928-1930. Member of technical staff, Bell Telephone Laboratories, Inc., 1930 to date. Member, American Physical Society. Associate member, Institute of Radio Engineers, 1931.

Wolff, Irving: Received B.S. degree, Dartmouth College, 1916. Nontechnical work, 1916-1919; instructor, Iowa State College, 1919-1920; instructor, Cornell University, 1920-1923; received Ph.D. degree, Cornell University, 1923. Research on polarization capacity, Heckscher Research Council, 1923-1924; research on electroacoustics, Radio Corporation of America, 1924-1929; RCA Victor Corporation, Inc., 1930-1935; RCA Manufacturing Company, RCA Victor Division, 1935 to date. Chairman, Philadelphia Section, Institute of Radio Engineers, 1936-1937. Fellow American Association for the Advancement of Science and Acoustical Society of America; Member, American Physical Society. Associate member, Institute of Radio Engineers, 1927.

Woodyard, John R.: Born 1904, at Parkersburg, West Virginia. Received B.S. degree in electrical engineering, University of Washington, 1933; graduate student, University of Washington, 1933-1934. Instructor in electrical engineering, University of Washington, 1935-1936. Graduate student, Stanford University, 1936 to date. Member, Sigma Xi. Student member, Institute of Radio Engineers, 1933; Associate, 1935.



1927

1937

TEN YEARS AGO THIS OCTOBER

It is interesting to turn back the pages of the years and read the record of a business. For time has a way of testing purposes and policies. Good years and lean reveal the character of men and organizations. The fundamental policy of the Bell System is not of recent birth—it has been the corner-stone of the institution for many years. On October 20, 1927, it was reaffirmed in these words by Walter S. Gifford, Pres., American Telephone and Telegraph Co.

“The business of the American Telephone and Telegraph Company and its Associated Bell Telephone Companies is to furnish telephone service to the nation. This business from its very nature is carried on without competition in the usual sense.

“The fact that ownership is so widespread and diffused imposes an unusual obligation on the management to see to it that the savings of these hundreds of thousands of people are secure and remain so.

“The fact that the responsibility for such a large part of the telephone service of the country rests solely upon this Company and its Associated Companies also imposes on the management an unusual obligation to the public to see that the service shall at all times be adequate, dependable and satisfactory to the user.

“Obviously, the only sound policy that will meet these obligations is to continue to



furnish the best possible telephone service at the lowest cost consistent with financial safety.

“Earnings must be sufficient to assure the best possible telephone service at all times and to assure the continued financial integrity of the business. Earnings that are less than adequate must result in telephone service that is something less than the best possible.

“Earnings in excess of these requirements must either be spent for the enlargement and improvement of the service furnished or the rates charged for the service must be reduced. This is fundamental in the policy of the management.

“With your sympathetic understanding we shall continue to go forward, providing a telephone service for the nation more and more free from imperfections, errors or delays, and always at a cost as low as is consistent with financial safety.”



**BELL
TELEPHONE
SYSTEM**

When writing to advertisers mention of the PROCEEDINGS will be mutually helpful.

8 YEARS AGO . . .

RCA was a newcomer in the highly technical field of transmitting and broadcast equipment manufacture.



and TODAY . . .

RCA is the outstanding leader in this field!



THE REASON FOR RCA'S AMAZING SUCCESS

... Right Quality at Right Prices!

The reason for RCA's thrilling progress is this: No other manufacturer has the vast experience enjoyed by RCA. Only RCA does and makes *everything* in radio. And its background of research and experience—plus its large staff of highly skilled engineers, is reflected in RCA transmitters, power tubes, microphones, speech input and other broadcast equipments. RCA provides you with

quality products—at prices that are right! That's why so many radio stations, both here and abroad, use RCA equipment.

Just remember, when considering broadcast apparatus, that RCA makes all types of equipment, for every purpose. A letter to us will bring you, without obligation, full details about the complete RCA Broadcast Equipments Service.

New York: 1270 Sixth Ave. Chicago: 589 E. Illinois St. Atlanta: 490 Peachtree St., N. E.
Dallas: 2211 Commerce St. San Francisco: 170 Ninth St.



Broadcast Equipment

RCA Mfg. Co., Inc., Camden, N. J. • A Service of the Radio Corporation of America

When writing to advertisers mention of the PROCEEDINGS will be mutually helpful.

The Institute of Radio Engineers

Incorporated

330 West 42nd Street, New York, N.Y.

APPLICATION FOR ASSOCIATE MEMBERSHIP

(Application forms for other grades of membership are obtainable from the Institute)

To the Board of Directors
Gentlemen:

I hereby make application for Associate membership in the Institute of Radio Engineers on the basis of my training and professional experience given herewith, and refer to the members named below who are personally familiar with my work.

I certify that the statements made in the record of my training and professional experience are correct, and agree if elected, that I will be governed by the constitution of the Institute as long as I continue a member. Furthermore I agree to promote the objects of the Institute so far as shall be in my power, and if my membership shall be discontinued will return my membership badge.

.....
(Sign with pen)

.....
(Address for mail)

.....
(Date)

.....
(City and State)

Sponsors:

(Signature of references not required here)

Mr. Mr.

Address Address

City and State City and State

Mr.

Address

City and State

The following extracts from the Constitution govern applications for admission to the Institute in the Associate grade:

ARTICLE II—MEMBERSHIP

Sec. 1: The membership of the Institute shall consist of: * * * (c) Associates, who shall be entitled to all the rights and privileges of the Institute except the right to hold any elective office specified in Article V. * * *

Sec. 4: An Associate shall be not less than twenty-one years of age and shall be a person who is interested in and connected with the study or application of radio science or the radio arts.

ARTICLE III—ADMISSION AND EXPULSIONS

Sec. 2: * * * Applicants shall give references to members of the Institute as follows: * * * for the grade of Associate, to three Fellows, Members, or Associates; * * * Each application for admission * * * shall embody a full record of the general technical education of the applicant and of his professional career.

ARTICLE IV—ENTRANCE FEE AND DUES

Sec. 1: * * * Entrance fee for the Associate grade of membership is \$3.00 and annual dues are \$6.00.

ENTRANCE FEE SHOULD ACCOMPANY APPLICATION

(Typewriting preferred in filling in this form) No.

RECORD OF TRAINING AND PROFESSIONAL EXPERIENCE

Name
(Give full name, last name first)

Present Occupation
(Title and name of concern)

Business Address

Permanent Home Address

Place of BirthDate of BirthAge

Education

Degree
(College) (Date received)

TRAINING AND PROFESSIONAL EXPERIENCE

DATES

Record may be continued on other sheets of this size if space is insufficient.

Receipt AcknowledgedElectedDeferred.....
GradeAdvised of ElectionThis Record Filed.....

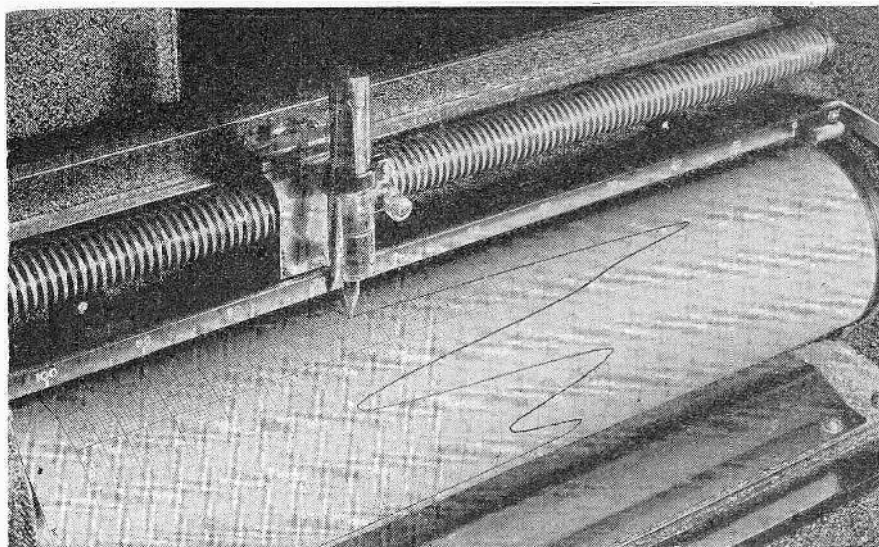

To Measure—COLOR ELECTRICALLY

MAUVE, orchid, vermilion, the infinite varieties of gray and white—all these yield their secrets to a measuring instrument invented by Prof. A. C. Hardy of M.I.T. and developed for commercial application by General Electric measurement engineers. Manufacturers of colored inks, of paper, of paints, and textiles can trust the colors if the color values are checked by the recording photoelectric spectrophotometer—the instrument that analyzes color and writes an exact color *analysis*.

Color is but one of the many fields to which General Electric engineers have brought the science of accurate measurement. General Electric instruments measure sound, light, vibration, even the power of lightning. If you have a problem that involves the measurement of any quantity, remember that General Electric is HEADQUARTERS FOR ELECTRICAL MEASUREMENT. General Electric Company, Schenectady, New York.

430-80D

GENERAL  **ELECTRIC**

When writing to advertisers mention of the PROCEEDINGS will be mutually helpful.

INTERNATIONAL ACCEPTANCE



The broadcast engineer in far off China—the radio serviceman in Rangoon—the "Ham" in Iceland—the "Sparks" of a tramp steamer plying tropic seas—the Manufacturer of radio receivers in America—all know, approve, and use Cornell-Dubilier Condensers.

Because C-D Condensers are engineered and constructed to withstand the rigors of every conceivable degree of abuse—because they provide dependable service consistently—they are the internationally accepted standard by which condensers are judged. Look for the C-D trademark. It is truly a symbol of quality.

WORLD'S LARGEST EXCLUSIVE MANUFACTURERS OF CAPACITORS
MICA • PAPER • WET & DRY ELECTROLYTICS • DYKANOL

CORNELL-DUBILIER

C O R P O R A T I O N

SOUTH PLAINFIELD • NEW JERSEY



CORNELL-DUBILIER



Honolulu must be ahead!



Out of the storm-swept skies that erased all visibility, a dozen sea-planes alighted on the land-locked waters of Pearl Harbor... and Man once again defeated the

elements. These twelve Navy planes had spanned the 2553 miles of open sea from San Diego to Honolulu, thus completing the longest over-water mass flight in aviation history. ★With the weather as thick as pea soup and visibility nil, these fliers flew with confidence toward a mile square spot in a vast ocean. They knew their goal **MUST** be ahead! Adverse weather conditions were forgotten, for these PBY-1 Consolidated long-range patrol boats were kept on a sure course with the unfailing precision and dependability of Bendix Radio Direction Finders. ★When efficient performance is

needed, over land or sea, Bendix equipment will not fail. Bendix Radio Corporation offers the finest engineering facilities for the development and manufacture of aircraft radio products of every type for use in commercial, naval and military aviation.

PARTIAL LIST OF BENDIX AVIATION PRODUCTS

Transmitters	Intercommunicating Telephones
Receivers	Ground Station Equipment
Direction Finders	Traffic Control Transmitters
Radio Compasses	Receivers
'Approach' and 'Glide Path' Land- ing Systems	Radio Ranges
Radio-Instruments	Field Localizers
Radio-Mechanical Devices	Marker Beacons
	Quartz Crystals and Holders

Direct All Correspondence to BENDIX RADIO CORPORATION 9th and Kearny Sts., N. E., Washington, D. C.

BENDIX
RADIO CORPORATION
NEW YORK WASHINGTON DAYTON CHICAGO OAKLAND

A New Achievement for a Famous Name



A great drama of life and death was enacted when the raging waters of the Ohio and Mississippi spread terror and disaster during the recent flood. Out of this great drama emerged the nation's cast of heroes whose efforts saved thousands of lives from watery graves and controlled the inevitable aftermath of disease. ★ Bendix is proud to have been able to play a part in the timely rescue efforts of the many governmental and independent agencies. The Coast Guard rushed men, boats, planes and communication trucks, some equipped with Bendix transmitters, receivers and other equipment to the flooded area.



PHOTOS COURTESY U. S. COAST GUARD

In cooperation with the Naval Reserve, Army and Amateurs, they established a joint emergency radio network to facilitate rescue work and relieve human suffering. ★ Such occasions as this bear testimony to the reliability and efficiency of Bendix Radio products under all conditions. Bendix Radio Corporation provides complete research, engineering and manufacturing facilities for every type of radio equipment.

Partial List of Bendix Radio Products

- Hurricane-proof Spike Antennas
- Antenna Arrays
- Low Temperature Coefficient Quartz Crystal and Holders
- Variable Condensers
- Fixed Condensers
- Inductances
- Frequency Standards
- Frequency Monitors
- Frequency Meters
- Precision Gear Drives
- Synchronizers
- Audio Analyzers
- Modulation Monitors
- Tube Testers
- Set Testers
- Remote Control Devices
- Capacity Standards
- Field Intensity Meters

Direct All Correspondence to BENDIX RADIO CORPORATION 9th and Kearny Sts., N. E., Washington, D. C.

BENDIX

RADIO CORPORATION

NEW YORK

WASHINGTON

DAYTON

CHICAGO

OAKLAND

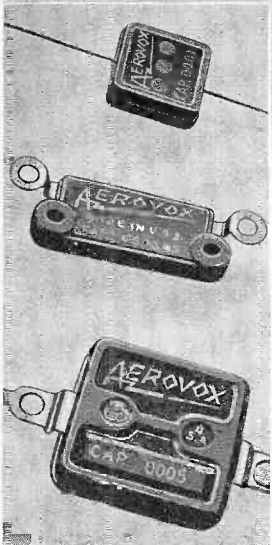
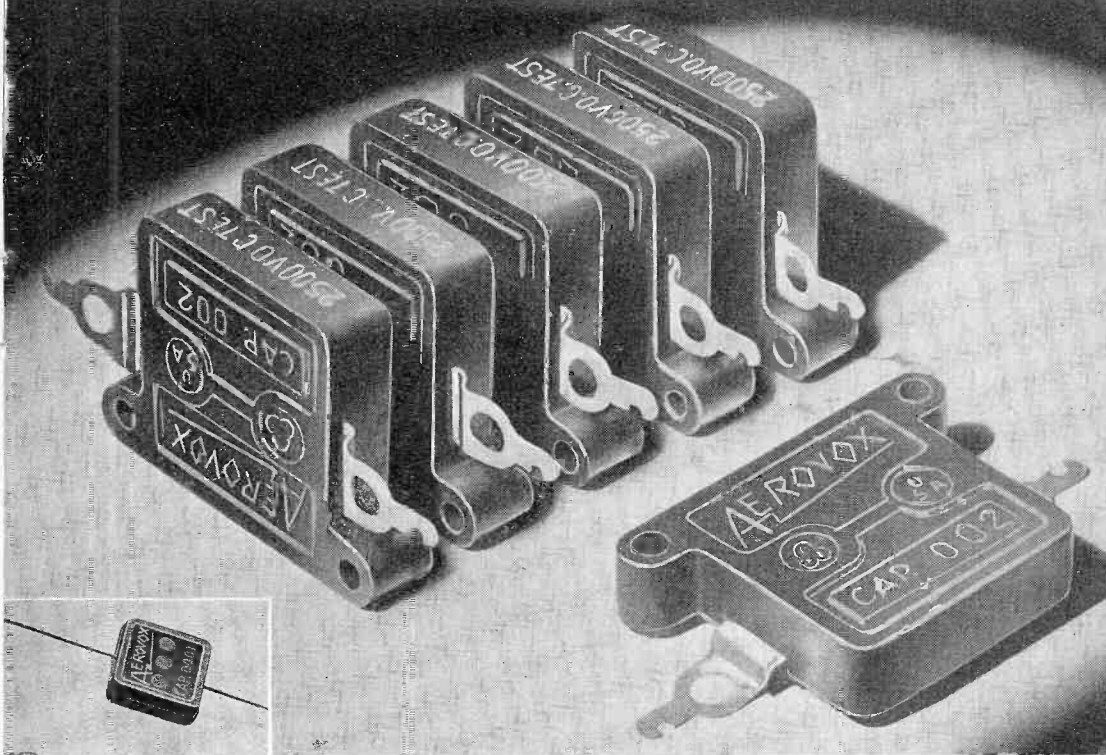

Mica HIGH-VOLTAGE CAPACITORS

TINY, inexpensive, inconspicuous, of course. Yet frequently called upon for a critical function in receiver or transmitter. That's why AEROVOX expends the same degree of engineering effort and production care on these mica capacitors as on larger and costlier capacitors of other types.



And again, the AEROVOX Mica Department—the plant within the plant—devotes that specialized attention so essential for a thoroughly satisfactory product.



Consult Us

No matter what your capacitance problem may be, submit it to us for engineering collaboration and quotations. Meanwhile, be sure to include our catalog in your working literature.

Thirteen different types to choose from.

From tiny "postage-stamp" bakelite unit to large metal-case unit.

500 to 7000 v. ratings. Capacities from .00004 to .1 mfd.

Each unit plainly stamped with capacity and voltage. Conservatively rated. Longest trouble-proof life.

FOR THE LABORATORY—

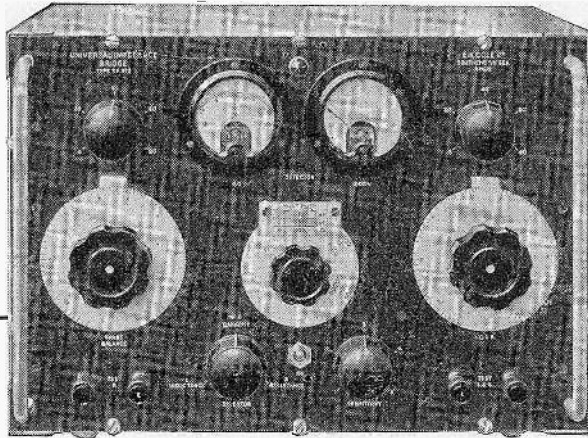

Universal Impedance Bridge. Type TF373.

An exceedingly useful general purpose instrument incorporating 1,000 cycle valve oscillator with a visual detector giving high discrimination for the measurement of:

CAPACITANCE

5 micro micro-farads to 100 micro-farads.
Condenser loss 0-1 ($R\omega C$).

INDUCTANCE

5 micro-henries to 100 henries.
Coil magnification 0-100 $\frac{\omega L}{R}$.

RESISTANCE

to 1 megohm using D.C.

Mains operated—no batteries or headphones required.

May we send prices and further details?

MARCONI-EKCO INSTRUMENTS LIMITED

Electra House, Victoria Embankment, London, W.C. 2, Eng.

When writing to advertisers mention of the PROCEEDINGS will be mutually helpful.

Here It Is!

THE *Instrument* OF 1000 Uses

HANDY SIZE
COMPLETE
A.C.-D.C.

POCKET VOLT-OHM- MILLIAMMETER

Engineers are very enthusiastic about this pocket size instrument, sturdy and precision built. Handy for laboratory, shop or field use.

MODEL
666

DEALER \$15.00
NET . .



MOLDED CASE AND PANEL

Model 666

Has 3" Sq. Triplett Rectifier Type Instrument.

A.C.-D.C. Voltage Scales Read: 10-50-250-500-1000 at 1000 ohms per volt.

D.C. Milliampere Scale Reads: 1-10-50-250.

Ohms Scale Reads: Low 1/2-300; High, 250,000.

Size—3 1/16" x 5 7/8" x 2 1/8".

Black Molded Case and Panel.

Low Loss Selector Switch.

Complete with Alligator Clips, Battery and Test Leads.

DEALER PRICE \$15.00

A complete instrument for all servicing and other needs. Can be used for all A.C.-D.C. voltage, current and resistance analyses.

Attractive Heavy Black Leather Carrying Case with finished Edges and Strap, Model 669, supplied extra.

Dealer Price . . \$3.00

WRITE FOR CATALOG



The Triplet Electrical Instrument Co.
215 Harmon Ave., Bluffton, Ohio

Without obligation please send me

_____ More information on Model 666.

_____ I am also interested in _____

Name

Address

City State

When writing to advertisers mention of the PROCEEDINGS will be mutually helpful.

ENGINEERING DIRECTORY

QUARTZ CRYSTALS

for Standard or Special
Radio Frequency Applications

Write for Catalog

BLILEY ELECTRIC CO.
230 Union Station Bldg.
ERIE, PENNA.

Cathode Ray Tubes
and Associated
Equipment For All
Purposes

*Write for Complete
Technical Data*

**ALLEN B. DUMONT
LABORATORIES**
UPPER MONTCLAIR, N.J.

COIL APPLICATIONS

Our coil specialists will engineer and design to your specific requirements coils for original installation or replacement purposes. Write for catalog or send specifications for quotations.

**EDWIN I. GUTHMAN and
CO., INC.**

400 S. Peoria St.
Chicago, Ill.

DON C. WALLACE

*Representing Eastern Radio
Manufacturers*

Manufacturers' Representative,
Phone 434-59

Pacific Coast Office: 4214 Country
Club Dr.
Long Beach, California

PRACTICAL RADIO ENGINEERING

One year Residence Course
Advanced Home Study Course
Combined Home Study-Residence
Course

Write for details

**Capitol Radio Engineering
Institute**
Washington, D.C.

MICROPHONE APPLICATIONS

Our engineering department will cooperate, without obligation, in the selection of suitable microphones for standard or special applications.

SHURE BROTHERS

"Microphone Headquarters"
225 WEST HURON ST. CHICAGO, U.S.A.

"Q" - Measurements

We specialize in equipment for the radio frequency measurement of "Q" (X/R) of coils, condensers and other radio components.

Write for Circular

BOONTON RADIO CORPORATION
BOONTON, NEW JERSEY

To Consultants and Designers of Special Equipment

A card on this page is an effective business-builder. Write for information and rates to

**THE INSTITUTE OF RADIO
ENGINEERS, INC.**

330 West 42nd Street, New York, N.Y.

When writing to advertisers mention of the PROCEEDINGS will be mutually helpful.

Change in Mailing Address or Business Title

Members of the Institute should use this form to notify the Institute office of a change in their mailing address or the listing of their company affiliation or title.

The Secretary
THE INSTITUTE OF RADIO ENGINEERS
330 West 42nd Street
New York City

New Affiliation or Title

Name _____
(Print or type)

Title _____

Company Name _____

Company Address _____

Home Address

Street _____
(Print or type)

City and State _____

Old Mailing Address

Street _____
(Print or type)

City and State _____

Please indicate whether you wish your mail to be sent to your home
or business address.

Signature _____

Date _____

Alphabetical Index to Advertisements

A	
Aerovox Corporation	XVII
American Telephone & Telegraph Company	IX
B	
Bendix Radio Corporation	XV, XVI
C	
Central Radio Laboratories	XXIV
Cornell-Dubilier Corporation	XIV
E	
Employment Page	Cover III
Engineering Directory	XX
Erie Resistor Corporation	XXIII
G	
General Electric Company	XIII
General Radio Company	Cover IV
I	
Institute of Radio Engineers	XI, XII, XXI, Cover III
M	
Markoni-Ekco Instruments Ltd.	XVIII
R	
RCA Manufacturing Company	X
T	
Triplett Electrical Instrument Company	XIX

PROCEEDINGS BOUND VOLUMES

VOLUME 23 (1935) of the Proceedings is now available in bound form to members of the Institute. It may be obtained in Buckram or Morocco leather for \$9.50 and \$12.00 respectively. Foreign postage is \$1.00 additional per volume.

Buckram bound copies of Volumes 18 and 19 (1930 and 1931) are also available for \$9.50. Foreign postage is \$1.00 additional per volume.

When writing to advertisers mention of the PROCEEDINGS will be mutually helpful.

3 FACTS TO CONSIDER IN TERMS OF YOUR PRODUCTION



DEPENDABLE INSULATION



EASY-TO-READ COLOR BANDS



CAPACITY FOR GREATEST DEMANDS

ERIE *insulated* RESISTORS

1. You may locate Erie Insulated Resistors in the chassis with complete safety wherever it is most convenient for easy installation. Their ceramic insulating shells give positive insulation even at 3,000 volts.

2. Your assemblers and inspectors can pick out the correct resistance values of Erie Insulated Resistors quickly and without eye-strain under all types of illumination. Color bands are clean, sharp, true to hue because they are applied on a pure white surface.

3. Regardless of your production requirements,

your orders for Erie Insulated Resistors can be filled promptly. Modern automatic manufacturing and testing equipment makes possible quantity production without sacrificing quality.

Put these aides to more efficient production to work in our assembly line and see for yourself what they can accomplish.

CARBON RESISTORS
AND SUPPRESSORS

**ERIE RESISTOR
CORPORATION**

AUTOMATIC INJECTION
MOLDING

TORONTO

ERIE, PENNSYLVANIA

LONDON

check-



*these Reasons
for CENTRALAB popularity*

Because of their universal use the resistor is still an important factor in the production of modern Electronic equipment . . . Centralab's popularity is maintained through constant vigilance in engineering details . . . Millions are yearly built into equipment contributing materially to the dependability of that equipment . . . Therefore insure performance of your equipment with Centralab.

CENTRALAB Division of Globe-Union Inc.
MILWAUKEE, WISCONSIN

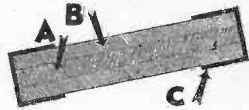

- A.** Center core of resistance material is surrounded by a dense shock-proof ceramic, providing strength and protection against humidity.
- B.** Core and jacket are fired together at 2500 degrees F. into a single, solid unit, hard and durable as stone.
- C.** Pure copper covers the resistor end for wire lead contact. Contact to the resistance material is at the extreme ends only, providing uniform resistance and load distribution over *entire* length. End contacts do not short circuit part of resistance as in other types.

Centralab

Canterbury Road, Kilbourn, London, N. W. 6, England
118 Ave Ledru-Rollin, Paris, France

RESISTORS

When writing to advertisers mention of the PROCEEDINGS will be mutually helpful.

INSTITUTE SUPPLIES

EMBLEMS



Three styles of emblems are available to members of the Institute only. They are all of 14K gold with gold lettering on an enameled background, the color of which indicates the grade of membership. The approximate size of each emblem is as illustrated.

The lapel button is supplied with a screw back having jaws which fasten it securely to the coat. The price is \$2.75, postpaid, for any grade.

The pin which is provided with a safety catch may be obtained for any grade for \$3.00, postpaid.

The watch charm is handsomely finished on both sides and is equipped with a suspension ring for attaching to a watch chain or fob. Price for any grade, \$5.00, postpaid.

BINDERS



Binders are available for those who desire to protect their copies of the PROCEEDINGS with stiff covers. Each binder will accommodate the twelve monthly issues published during the year. These binders are of blue Spanish Grain Fabricoid with gold

lettering, and will serve either as temporary transfers or as permanent binders. They are so constructed that each individual copy of the

PROCEEDINGS will lie flat when the pages are turned. Copies can be removed from the binder in a few seconds and are not damaged by their insertion. They are priced at \$1.50 each, and the member's name or PROCEEDINGS Volume Number will be stamped upon the binder in gold for \$0.50 additional.

BACK ISSUES OF THE PROCEEDINGS

Complete volumes of back issues of the PROCEEDINGS are available in unbound form for the years 1918, 1921, 1922, 1923, and 1926 at \$6.75 per year (six issues) to members. Also complete unbound for 1931, 1932, 1933, 1934, and 1935 at \$7.50 per year to members. A list of the available miscellaneous copies published from 1913 on may be obtained from the Secretary. Single copies published prior to 1927 are sold to members at \$1.13 each, and those issued during and after 1927 are \$0.75 each. Foreign postage on single copies is \$0.10 per copy, making \$0.60 on unbound volumes before 1927.

Issues bound in blue buckram for 1922 (six numbers) are available at \$8.75 to members. For 1930 and 1931 they are priced at \$9.50 each to members. Foreign postage is \$1.00 additional per volume. Volumes for 1922 and 1926 bound in Morocco leather are available at \$10.25 each to members.

TWENTY-EIGHT-YEAR INDEX

An Index of the PROCEEDINGS for the years 1909-1936, inclusive, is available at \$1.00 per copy. It is extensively cross indexed. The earlier references are to the PROCEEDINGS of the Wireless Institute; the PROCEEDINGS of the Institute of Radio Engineers has been published since 1913.

When ordering any of the above, send remittance with order to the Secretary, Institute of Radio Engineers, 330 West 42nd Street, New York City.

SILVER ANNIVERSARY

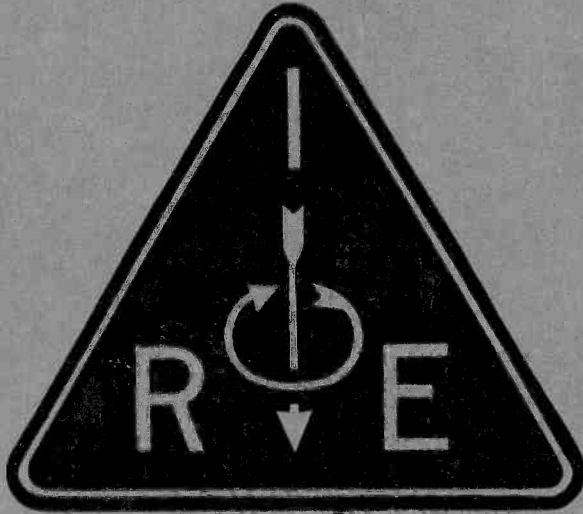

THE INSTITUTE OF RADIO ENGINEERS

ORGANIZED 1912

General Radio Company congratulates the Institute of Radio Engineers on its twenty-five years of service to the radio engineering profession . . . Cambridge, Mass. May 1937