

TOTE ✓

VOLUME 25

APRIL, 1937

NUMBER 4

PROCEEDINGS
of
**The Institute of Radio
Engineers**



**Silver
Anniversary Convention**
May 10, 11, and 12, 1937
New York, N. Y.

Application Blank for Associate Membership on Page XIII

Institute of Radio Engineers Forthcoming Meetings

SILVER ANNIVERSARY CONVENTION

May 10, 11, and 12, 1937

New York, N. Y.

JOINT MEETING

American Section, International Scientific Radio Union
and Institute of Radio Engineers

Washington, D. C.

April 30, 1937

BUFFALO-NIAGARA SECTION

April 21, 1937

CLEVELAND SECTION

April 22, 1937

DETROIT SECTION

April 16, 1937

LOS ANGELES SECTION

April 20, 1937

TORONTO SECTION

April 12, 1937

April 26, 1937

WASHINGTON SECTION

April 12, 1937

PROCEEDINGS OF
The Institute of Radio Engineers

VOLUME 25

April, 1937

NUMBER 4

Board of Editors

ALFRED N. GOLDSMITH, *Chairman*

R. R. BATCHER	B. E. SHACKELFORD
P. S. CARTER	K. S. VAN DYKE
F. W. GROVER	H. P. WESTMAN, <i>ex officio</i>
J. W. HORTON	L. P. WHEELER
G. W. PICKARD	L. E. WHITTEMORE

WILLIAM WILSON

CONTENTS

PART I

Institute News and Radio Notes.....	371
March Meeting of the Board of Directors.....	371
A New Award.....	371
Joint Meeting of the U.R.S.I. and I.R.E.....	371
Committee Work.....	373
Institute Meetings.....	374

PART II

Technical Papers

Characteristics of American Broadcast Receivers as Related to the Power and Frequency of Transmitters.....	387
.....ARTHUR VAN DYCK AND D. E. FOSTER	
Multiple Amplifier.....	421
.....L. A. KUBETSKY	
Alternating-Current Resistance of Rectangular Conductors.....	434
.....S. J. HAEFNER	
The Temperature Coefficient of Inductance.....	448
.....JANUSZ GROSZKOWSKI	
The Production of Rochelle Salt Piezoelectric Resonators Having a Pure Longitudinal Mode of Vibration.....	465
.....NORMAN C. STAMFORD	
Frequency Modulation Noise Characteristics.....	472
.....MURRAY G. CROSBY	
Discussion on "A Proposed Wattmeter Using Multielectrode Tubes," by J. R. Pierce.....	515
.....N. H. ROBERTS	
Book Reviews: "Short Wave Wireless Communication," by A. W. Ladner and C. R. Stoner.....	517
.....J. K. CLAPP	
"Radio Field Service Data" by Alfred A. Ghirardi.....	518
.....ALFRED W. BARKER	
Contributors to This Issue.....	519

The Institute of Radio Engineers

GENERAL INFORMATION

INSTITUTE. The Institute of Radio Engineers was formed in 1912 through the amalgamation of the Society of Wireless Telegraph Engineers and the Wireless Institute. Its headquarters were established in New York City and the membership has grown from less than fifty members at the start to several thousand.

AIMS AND OBJECTS. The Institute functions solely to advance the theory and practice of radio and allied branches of engineering and of the related arts and sciences, their application to human needs, and the maintenance of a high professional standing among its members. Among the methods of accomplishing this is the publication of papers, discussions, and communications of interest to the membership.

PROCEEDINGS. The PROCEEDINGS is the official publication of the Institute and in it are published all of the papers, discussions, and communications received from the membership which are accepted for publication by the Board of Editors. Copies are sent without additional charge to all members of the Institute. The subscription price to nonmembers is \$10.00 per year, with an additional charge for postage where such is necessary.

RESPONSIBILITY. It is understood that the statements and opinions given in the PROCEEDINGS are views of the individual members to whom they are credited, and are not binding on the membership of the Institute as a whole. Papers submitted to the Institute for publication shall be regarded as no longer confidential.

REPRINTING PROCEEDINGS MATERIAL. The right to reprint portions or abstracts of the papers, discussions, or editorial notes in the PROCEEDINGS is granted on the express condition that specific reference shall be made to the source of such material. Diagrams and photographs published in the PROCEEDINGS may not be reproduced without making specific arrangements with the Institute through the Secretary.

MANUSCRIPTS. All manuscripts should be addressed to the Institute of Radio Engineers, 330 West 42nd Street, New York City. They will be examined by the Papers Committee and the Board of Editors to determine their suitability for publication in the PROCEEDINGS. Authors are advised as promptly as possible of the action taken, usually within two or three months. Manuscripts and illustrations will be destroyed immediately after publication of the paper unless the author requests their return. Information on the mechanical form in which manuscripts should be prepared may be obtained by addressing the secretary.

MAILING. Entered as second-class matter at the post office at Menasha, Wisconsin. Acceptance for mailing at special rate of postage is provided for in the act of February 28, 1925, embodied in Paragraph 4, Section 412, P. L. and R., and authorization was granted on October 26, 1927.

Published monthly by

THE INSTITUTE OF RADIO ENGINEERS, INC.

Publication office, 450-454 Ahnaip St., Menasha, Wis.

BUSINESS, EDITORIAL, AND ADVERTISING OFFICES

Harold P. Westman, *Secretary*

330 West 42nd Street. New York, N. Y.

INSTITUTE SECTIONS

- ATLANTA—Chairman, N. B. Fowler; Secretary, G. S. Turner, Federal Communications Commission, 411 Federal Annex, Atlanta, Ga.
- BOSTON—Chairman, E. L. Bowles; Secretary, Roland G. Porter, Northeastern University, Boston, Mass.
- BUFFALO-NIAGARA—Chairman, George C. Crom; Secretary, E. C. Waud, 235 Huntington Ave., Buffalo, N. Y.
- CHICAGO—Chairman, J. K. Johnson; Secretary, V. J. Andrew, 7221 San Francisco Ave., Chicago, Ill.
- CINCINNATI—Chairman, G. F. Platts; Secretary, A. P. Richards, Crosley Radio Corporation, 1329 Arlington St., Cincinnati, Ohio.
- CLEVELAND—Chairman, R. A. Fox; Secretary, R. L. Kline, Winteradio, Inc., 3014 Lorain Ave., Cleveland, Ohio.
- CONNECTICUT VALLEY—Chairman, F. H. Scheer; Secretary, C. E. Keeler, 59 Fairfield St., Springfield, Mass.
- DETROIT—Chairman, R. L. Davis; Secretary, Howard S. Gould, 214 Tuxedo Ave., Detroit, Mich.
- EMPORIUM—Chairman, M. I. Kahl; Secretary, R. N. Palmer, Hygrade Sylvania Corporation, Emporium, Pa.
- INDIANAPOLIS—Temporary Secretary-Treasurer, I. M. Slater, P. R. Mallory and Company, 3029 E. Washington St., Indianapolis, Ind.
- LOS ANGELES—Chairman, Douglas Kennedy; Secretary, F. G. Albin, United Artists Studios, 1041 N. Formosa Ave., Los Angeles, Calif.
- MONTREAL—Chairman, A. M. Patience; Secretary, W. R. Wilson, Canadian Marconi Company, Mount Royal, Que., Canada.
- NEW ORLEANS—Chairman, L. J. N. Du Treil; Secretary, G. H. Peirce, Electrical Research Products, Inc., 1631 Canal Band Bldg., New Orleans, La.
- PHILADELPHIA—Chairman, Irving Wolff; Secretary, R. L. Snyder, 103 Franklin Rd., Glassboro, N. J.
- PITTSBURGH—Chairman, Branko Lazich; Secretary, W. P. Place, Curtis St., R.D. 1, Wilksburg, Pa.
- ROCHESTER—Chairman, Lee A. Du Bridge; Secretary, H. A. Brown, 89 East Ave., Rochester, N. Y.
- SAN FRANCISCO—Chairman, V. J. Freiermuth; Secretary, C. J. Penther, 1000 Aileen St., Oakland, Calif.
- SEATTLE—Chairman, J. W. Wallace; Secretary, R. O. Bach, Pacific Telephone and Telegraph Company, 820 Fairview Ave., N., Seattle, Wash.
- TORONTO—Chairman, B. de F. Bayly; Secretary, H. P. Knap, Stromberg-Carlson Tel. Mfg. Company, 211 Geary St., Toronto, Ont., Canada.
- WASHINGTON—Chairman, W. B. Burgess; Secretary, E. H. Rietzke, 3308 14th Ave., N. W., Washington, D. C.

**GEOGRAPHICAL LOCATION OF MEMBERS ELECTED
MARCH 3, 1937**

Elected to the Associate Grade

California	Santa Ana, 113 N. Lyon	Levering, C. A.
Connecticut	Devon, 559 Baker St.	Schwartz, R. D.
	New Haven, 356 Elm St.	Berg, R.
District of Columbia	Washington, 1434 Harvard St., N.W.	Murty, E. H.
	Washington, 914 National Press Bldg.	Rothrock, H. B.
Idaho	Twin Falls, Box 521, Radio Station KTFI	Soule, S. M.
Illinois	Chicago, 1863 S. Sawyer Ave.	Broude, M.
	Chicago, 1042 Rosemont Ave.	Korf, M. B.
	Chicago, 2749 W. 64th St.	Martin, C. F.
	Ontarioville, Sweet Briar Farm.	Post, E. A.
Indiana	Gary, 705 W. 35th Ave.	Schroeder, W. R.
	Indianapolis, 21st and Northwestern.	Decker, A. L.
	Notre Dame, Box 85.	Vitter, G. L.
Kentucky	Covington, Y.M.C.A., 620 Madison Ave.	Sussin, D.
Maryland	Annapolis, PG School, USNA.	Gleim, F.
Massachusetts	Springfield, 126 Westford Circle.	Briggs, M. R.
	Springfield, 117 Northampton Ave.	Weeks, E. W.
New Jersey	Belleville, 75 Little St.	Demark, P. J.
	Cranford, 49 John St.	O'Neill, R. A., Jr.
	Oceanport, Fort Monmouth.	Urhane, F. F.
New Mexico	Albuquerque, 209 S. Tulane.	Johnson, G. S.
New York	Astoria, L. I., 31-38-29th St.	Kane, H. E.
	New York, Electrical Research Products, 250 W. 57th St.	Keith, C. R.
	New York, SS Dean Emery, c/o Standard Oil Co. of New Jersey	
	Marine Dept., 30 Rockefeller Plaza.	Petty, J. M.
	New York, R.C.A. Communications, Inc., 66 Broad St.	Sholkin, A. N.
Ohio	North Canton, The Hoover Co.	Stahl, M. D.
Pennsylvania	Philadelphia, 1207 Race St.	Neuber, H. K.
	Philadelphia, 1013 W. Lehigh Ave.	Ohler, A. E.
	Philadelphia, 519 W. King St.	Salinger, H. W.
	Philadelphia, 412 W. Mt. Airy Ave.	Wild, R. F.
Virginia	Alexandria, 103 W. Luray Ave.	Bond, C. H.
	Norfolk, U. S. Semmes.	Gray, T.R.
Wisconsin	Milwaukee, c/o Pennsylvania Central Airlines Corp., County Airport.	Ferguson, R. G.
Alaska	Cape Hinchinbrook, Via Cardova.	Kerrell, R. W.
Canada	Montreal, P.Q., c/o Northern Elec. Co. Ltd., 1261 Shearer St.	Mason, G. A. R.
	Montreal West, P.Q., 241 Ballantyne Ave. N.	Woodhead, R. C.
England	Blackpool, 33 Primrose Ave.	Sealey, N. W.
	Esher, Surrey, "Esgair"	Robinson, D. B. H.
	Farnborough, Hants, Firocroft, Farnborough Rd.	Fry, D. W.
	Heston, Middlesex, 9 Westway.	Rowe, C. H.
	St. George, Bristol, 332 Church Rd.	Malpas, H. A.
Japan	Tokyo, c/o Laboratory, Broadcasting Corp. of Japan, Kamata- Cho, Setagaya-Ku.	Fujita, T.
	Tokyo, c/o Laboratory, Broadcasting Corp. of Japan, Kamata- Cho, Setagaya-Ku.	Mizokami, K.
New Zealand	Auckland, Druleigh College.	Mack, H. D.
South Africa	Capetown, 61 High Level Rd., Green Point.	DeJong, A. C.
South India	Salem, "Hemadri," Cherry Rd.	Ramachandran, M. S.
Straits Settlements	Singapore, "Tudor House," Institution Hill.	Anderson, J.
	Singapore, 7 Institution Hill.	Barracrough, J. F.

Elected to the Junior Grade

District of Columbia	Washington, c/o Capitol Radio Eng. Inst., 14th and Park Rd.	Fuqua, J. B.
-------------------------	---	--------------

Elected to the Student Grade

California	Oakland, 1560 Madison St.	Bigelow, G.
	Pasadena, 1301 E. California St.	Eddy, B. T.
	Pasadena, Electrical Eng. Dept., California Institute of Tech- nology.	Ward, D. J.
Indiana	West Lafayette, 146 N. Grant St.	Morgenege, A. W.
Massachusetts	West Roxbury, 3 Prentiss Rd.	Fernekes, J. E.
Mississippi	State College, Box 494.	Ferrill, F. M., Jr.
New York	Bronxville, 30 McIntyre St.	McCoy, R. D.
	Brooklyn, 564 E. 2nd St.	Okrent, J.
	Troy, 207 Hoosick St.	Halker, H. F.
Oklahoma	Oklahoma City, 1220 N. Francis.	Nicholson, T.
Pennsylvania	Overbrook, 1352 Garden Rd.	Ayres, J. J.
	Pittsburgh, Box 373, Carnegie Inst. of Technology.	Copp, J. H.
	Pittsburgh, 5535 Forbes St.	Latta, W. L., Jr.
	Pittsburgh, Box 373, Carnegie Inst. of Technology.	Stine, S. L.
Washington	Tacoma, Route 5, Box 405.	Whaley, J. C.
Japan	Osaka, Dept. of Physics, Osaka Imperial Univ.	Tamura, Y.

APPLICATIONS FOR MEMBERSHIP

Applications for transfer or election to the various grades of membership have been received from the persons listed below, and have been approved by the Admissions Committee. Members objecting to transfer or election of any of these applicants should communicate with the Secretary on or before April 30, 1937. Final action will be taken on these applications on May 5, 1937.

For Transfer to the Fellow Grade

New Jersey	Millburn, 18 Main St.	Miessner, B. F.
Canada	Toronto, Ont., 211 Geary Ave.	Hackbusch, R. A.

For Transfer to the Member Grade

District of Columbia	Washington, 1808 Connecticut Ave.	Baker, T. S.
Indiana	Indianapolis, 6433 E. Shelley Ave.	Slater, I. M.
Utah	Salt Lake City, Intermountain Broadcasting Corp.	Baldwin, J. M.

For Election to the Member Grade

California	Berkeley, 1740 University Ave.	Lucas, P. S.
Florida	Gainesville, University of Florida.	Weil, J.
Illinois	Glenview, Box 375.	Paulsen, L. A.
Michigan	Grosse Pointe, 600 Neff Rd.	Powers, R. A.
England	Thornton Heath, Surrey, 1031a London Rd.	Ringham, G. B.
India	Benares, Engineering Hostels, Hindu University.	Mukerjee, G. C.

For Election to the Associate Grade

California	Berkeley, 2527 Hearst Ave.	Thal-Larsen, H.
	Los Angeles, 3054 E. 5th St.	Cade, S. E.
	Redlands, 522—4th St.	Jones, L. W.
	San Pedro, USS California, c/o Postmaster.	Shepard, S. A.
District of Columbia	Washington, 1742 Lamont St. N.W.	Robinson, W. A., Jr.
Georgia	Atlanta, 510 Peters Building.	McGehee, J. S.
Illinois	Chicago, 619 Wellington Ave.	Ferris, W. T.
	Chicago, 5536 Higgins Ave.	Olsen, T. E.
	Chicago, 1103 Bryn Mawr Ave.	Rowe, H. C. Jr.
	Chicago, 4723 Kenwood Ave.	Wray, W. C.
	Elgin, 714 May St.	Lang, G. W.
	Maywood, 1832 S. 4th Ave.	Aldred, A. D.
	Oak Park, 515 N. Elmwood Ave.	Bryan, R. H.
Indiana	Gary, 366 Hanerck St.	Gustofson, C. L.
	Sheridan, 228 E. 8th St.	Pulliam, E. H.
	Valparaiso, Dodge's Radio Institute.	Gall, J. E.
	Valparaiso, Dodge's Radio Institute.	Goldberg, J.
Louisiana	Ringgold, Box 273.	Bryan, J. R.
Maryland	Chevy Chase, 202 Spring St.	Ryssy, J. W.
Minnesota	Duluth, 2914 Exeter St.	Bernard, E. O.
Missouri	Kansas City, 2811 Campbell St.	Curtis, C. V.
	Kansas City, Bellerive Hotel.	Taylor, G. L.
New Jersey	Deal, c/o Bell Telephone Labs.	McRae, J. W.
	Elizabeth, Elizabeth Carteret Hotel.	Rodgers, R. W., Jr.
	Harrison, RCA Radiotron Division, RCA Mfg. Co.	Mager, I.
	Pensauken, 4322 N. 41st St.	Seitz, F. R.
	Rutherford, 14 Elizabeth St.	Buchanan, L. C.
New Mexico	Albuquerque, Box 152, University of New Mexico.	Jones, H. L.
New York	Brooklyn, 2 Grace Court.	Kaunitz, F. M.
	Buffalo, 216 E. Genesee St.	Dybowski, A. J.
	Jamaica, L. I., 148—24—86th Ave.	Schaefer, J. B.
	Merrick, L. I., 33 Sherman St.	Bedell, T. A.
	Newburgh, 39 Johnston St.	Ruben, H.
	New York, Bell Telephone Labs., 463 West St.	Braga, F. J.
	New York, Bell Telephone Labs., 180 Varick St.	Brown, J. T. L.
	New York, Bell Telephone Labs., 463 West St.	Dennis, F. R.
	New York, RCA Communications, Inc., Rm. 519, 66 Broad St.	Smith, J. E.
Ohio	Lakewood, 2025 Atkins Ave.	Quinn, C. E.
Pennsylvania	Emporium.	McClintock, R. K.
	Philadelphia, 3058 N. 15th St.	Hottenstein, J. M.
Texas	Abilene, Radio Station KRBC, Box 263.	Robertson, W. W., Jr.
	Dallas, c/o United Motors Service, Inc., 515—523 N. Pearl St.	Chenault, H. P.
	Dallas, 501 Oak Cliff Blvd.	Ridgway, H. F.
	Wichita Falls, 102 Radio Building.	Adams, J.
Virginia	Newport News, c/o Radio Station WGH, 2813 Washington Ave.	Aylor, R. P., Jr.
	Richmond, 1106 W. Franklin St.	Armstrong, F. M.

Applications for Membership

Washington	Vashon, Radio Station KVI.....	North, W. L.
Wisconsin	Evansville, 39 N. 1st St.....	Roderick, H. E., Jr.
Canada	Coleman Alta., Airways Radio Station.....	Ramsay, W. R.
	Montreal, P. Q., 925 Lenoir St.....	Clarke, G. W. R.
	Montreal, P. Q., 3440 Des Erables.....	Del Motte, L. I.
	Montreal, P. Q., RCA Victor Co., Ltd.....	Guthmann, E. W.
	Montreal, P. Q., 994 Addington Ave. N.D.G.....	Hills, R. S.
	Montreal, P. Q., 925 Lenoir St.....	Hines, S.
	Montreal, P. Q., 1060 Van Horne, Outremont.....	Klein, J.
	Montreal, P. Q., 8420 St. Denis St.....	Neovit, H. J. B.
	Montreal, P. Q., 183 St. Catherine's St., E.....	Panesar, W. S.
	Montreal, P. Q., Northern Electric Co., Dept. 892, 1261 Shearer St.....	Winters, R. H.
	Toronto, Ont., 469 Spadina Rd.....	Wamboldt, G. L. B.
China	Tientsin, Eastern Sales and Engineering Co., 108-110 Rue du Baron Gros.....	Yeh, W. S. Y.
England	Dulwich London S.E. 21, 68 Thurlow Park Rd.....	Cooper, L. H. H.
	Iford, Essex, c/o The Plessey Co., Ltd., 54 Vicarage Lane.....	Bazin, R. E.
	London, S.W. 4, 16 Old Town.....	Hayes, G.
	Oxshott, Surrey, "Daisymead".....	Waldock, D. A. G.
	Woodbridge, Suffolk, Bawdsey Ferry.....	Carter, R. H. A.
India	Delhi, Radio and Television Bureau, Bar Shahbula, Chaori Bazar.....	Bansal, T. D.
Japan	Tokyo, Nippon Electric Co., Mitashikokumachi Shibaku.....	Nakai, S.
Manchoukuo	Dairen, Gisho Wireless and Electric Co., 2 Wakasa-cho.....	Namba, E.
Scotland	Strathyre, "Balvaig".....	MacLachlan, L. A.
Wales	Tregaron, Cards., Dinam Shop, Station Rd.....	Seaden, D. H.
Western Australia	Cottesloe, 271 Marmion St.....	Urquhart, M. S.

For Election to the Junior Grade

Illinois	Chicago, 2647 W. Cullerton St.....	Kowalewski, A. W.
New Jersey	Newark, 54 Willoughby St.....	Dubin, P.

For Election to the Student Grade

Georgia	Atlanta, Box 48, Georgia School of Technology.....	Aldridge, R. F.
Illinois	Glencoe, 181 Beach Rd.....	Brion, B. W.
Indiana	Fort Wayne, 331 W. Wayne St.....	Clark, H. L.
	Fort Wayne, 222 E. Wayne St.....	Jimenez, M. A.
	West Lafayette, 516 Northwestern Ave.....	Caldwell, J. Jr.
	West Lafayette, 422 N. Salisbury St.....	Loh, H. S.
Kansas	Manhattan, 603 N. 11th St.....	Meisenheimer, R. L.
Maine	South Portland, 36 Cottage St.....	Jenney, W. A.
Massachusetts	Andover, 46 Whittier St.....	Bliss, F.
	Fall River, 82 Madison St.....	Davenport, H. R.
	Newton Highlands, 48 Circuit Ave.....	McCann, D. J.
Michigan	Detroit, 740 Beard Ave.....	Valmassy, L.
Ohio	Columbus, 21 W. Frambes Ave.....	Bloomer, T. M.
Pennsylvania	Allentown, 116 N. 13th St.....	Waidelich, D. L.
	Bryn Athyn.....	Simons, K. A.
South Carolina	Charleston, 207 Spring St.....	Cheek, R. C.
Vermont	Northfield, Theta Chi Fraternity.....	Campbell C. M., Jr.
	Northfield, Norwich University.....	Wallstrom, J. D.
Washington	Seattle, 4317 Brooklyn Ave.....	Linkleiter, R. L.



OFFICERS AND BOARD OF DIRECTORS

(Terms expire January 1, 1938, except as otherwise noted)

President

H. H. BEVERAGE

Vice President

P. P. ECKERSLEY

Treasurer

MELVILLE EASTHAM

Secretary

HAROLD P. WESTMAN

Editor

ALFRED N. GOLDSMITH

Directors

STUART BALLANTINE, *Past President*

T. A. M. CRAVEN

L. C. F. HORLE

C. M. JANSKY, JR.,

C. B. JOLLIFFE

A. F. MURRAY

E. L. NELSON

HARADEN PRATT

B. J. THOMPSON

L. E. WHITTEMORE

SERVING UNTIL JANUARY 1, 1939

E. H. ARMSTRONG

VIRGIL M. GRAHAM

ALAN HAZELTINE, *Past President*

SERVING UNTIL JANUARY 1, 1940

RALPH BOWN

H. M. TURNER

COMMITTEES OF THE INSTITUTE OF RADIO ENGINEERS
1937

ADMISSIONS COMMITTEE

C. M. JANSKY, JR., *Chairman*

F. W. CUNNINGHAM	C. W. HORN
MELVILLE EASTHAM	HARADEN PRATT
R. A. HEISING	E. R. SHUTE
L. C. F. HORLE	J. S. SMITH

A. F. VAN DYCK

ANNUAL REVIEW

A. F. VAN DYCK, *Chairman*

KEITH HENNEY	J. C. SCHELLENG
J. V. L. HOGAN	B. J. THOMPSON
H. F. OLSON	H. M. TURNER
HARADEN PRATT	H. A. WHEELER

L. E. WHITEMORE

AWARDS COMMITTEE

ALAN HAZELTINE, *Chairman*

R. R. BEAL	HARADEN PRATT
L. M. HULL	L. E. WHITEMORE

BOARD OF EDITORS

ALFRED N. GOLDSMITH, *Chairman*

R. R. BATCHER	B. E. SHACKELFORD
P. S. CARTER	K. S. VAN DYKE
F. W. GROVER	H. P. WESTMAN, <i>ex officio</i>
J. W. HORTON	L. P. WHEELER
G. W. PICKARD	L. E. WHITEMORE

WILLIAM WILSON

CONSTITUTION AND LAWS COMMITTEE

H. M. TURNER, *Chairman*

AUSTIN BAILEY	ALFRED N. GOLDSMITH
RALPH BOWN	B. J. THOMPSON

H. A. ZEAMANS

MEMBERSHIP COMMITTEE

F. W. CUNNINGHAM, *Chairman*

NATHANIEL BISHOP	H. C. HUMPHREY
E. L. BOWLES	J. J. LONG, JR.
C. J. BURNSIDE	A. F. MURRAY
H. A. CHINN	L. G. PACENT
T. H. CLARK	M. E. PACKMAN
J. M. CLAYTON	J. C. RANDALL
I. S. COGGESHALL	C. R. ROWE
E. D. COOK	W. A. SCHNEIDER
ALFRED CROSSLEY	C. E. SCHOLZ
COKE FLANNAGAN	J. E. SMITH
H. C. GAWLER	H. J. VENNES
P. F. GODLEY	W. H. WEST
K. E. HASSELL	LESLIE WOODS

(*Chairmen of Membership Committees of Sections, ex officio*)

NEW YORK PROGRAM COMMITTEE

R. R. BEAL, *Chairman*

AUSTIN BAILEY	R. A. HEISING
G. C. CONNOR	KEITH HENNEY
D. E. FOSTER	L. G. PACENT

HARADEN PRATT

NOMINATIONS COMMITTEE

C. M. JANSKY, Jr., *Chairman*

STUART BALLANTINE
RALPH BOWN

J. V. L. HOGAN
C. B. JOLLIFFE

PAPERS COMMITTEE

WILLIAM WILSON, *Chairman*

M. A. ACHESON
H. A. AFFEL
EDMOND BRUCE
H. A. CHINN
J. K. CLAPP
T. A. M. CRAVEN
P. O. FARNHAM
E. B. FERRELL
T. R. GILLILAND
E. L. HALL
L. F. JONES

F. B. LEWELLYN
DEL. K. MARTIN
R. M. MORRIS
A. F. MURRAY
H. O. PETERSON
R. K. POTTER
G. G. THOMAS
H. M. TURNER
H. A. WHEELER
W. C. WHITE
IRVING WOLFF

PUBLICITY COMMITTEE

O. E. DUNLAP, *Chairman*

C. E. BUTTERFIELD
O. H. CALDWELL
L. M. COCKADAY

KEITH HENNEY
R. C. POULTER
K. B. WARNER

SECTIONS COMMITTEE

VIRGIL M. GRAHAM, *Chairman*

J. E. BROWN
E. D. COOK
F. W. CUNNINGHAM

R. A. HACKBUSCH
L. C. F. HORLE
H. J. KLUMB

IRVING WOLFF

(*Chairmen of Sections, ex officio*)

STANDARDS COMMITTEE

L. C. F. HORLE, *Chairman*

J. H. DELLINGER
MELVILLE EASTHAM
VIRGIL M. GRAHAM
J. V. L. HOGAN
H. F. OLSON
HARADEN PRATT
J. C. SCHELLENG

F. E. TERMAN
B. J. THOMPSON
H. M. TURNER
H. J. VENNES
H. A. WHEELER
L. P. WHEELER
WILLIAM WILSON

TELLERS COMMITTEE

E. H. ARMSTRONG, *Chairman*

ARTHUR BATCHELLER

J. D. CRAWFORD

H. P. WESTMAN, *ex officio*

TECHNICAL COMMITTEES

BROADCAST COMMITTEE

C. M. JANSKY, Jr., *Chairman*

E. K. COHAN
G. D. GILLETT
R. N. HARMON
J. V. L. HOGAN
C. W. HORN

C. B. JOLLIFFE
J. C. McNARY
R. E. POOLE
V. E. TROUANT
H. A. WHEELER

ELECTROACOUSTICS COMMITTEE

H. F. OLSON, *Chairman*

SIDNEY BLOOMENTHAL
J. T. L. BROWN
A. M. GRANUM
H. S. KNOWLES

KNOX McILWAIN
BENJAMIN OLNEY
HANS RODER
V. E. WHITMAN

HAROLD ZAHL

ELECTRONICS COMMITTEE

B. J. THOMPSON, *Chairman*

R. S. BURNAP
E. L. CHAFFEE
A. M. GRANUM
F. R. LACK
R. W. LARSON
GEORGE LEWIS
BEN KIEVIT, JR.
KNOX MCLLWAIN

G. F. METCALF
J. W. MILNOR
A. F. MURRAY
G. D. O'NEILL
H. W. PARKER
O. W. PIKE
DAYTON ULREY
B. VAN DER POL

P. T. WEEKS

RADIO RECEIVERS COMMITTEE

H. A. WHEELER, *Chairman*

E. H. ARMSTRONG
C. R. BARYDT
R. I. COLE
W. F. COTTER
L. F. CURTIS
HARRY DIAMOND
E. T. DICKEY
J. F. DREYER, JR.
MALCOLM FERRIS
H. B. FISCHER

D. E. FOSTER
A. M. GRANUM
VIRGIL M. GRAHAM
DAVID GRIMES
D. E. HARNETT
J. K. JOHNSON
P. D. MCKEEL
H. O. PETERSON
F. X. RETTENMEYER
A. E. THIESSEN

LINCOLN WALSH

TELEVISION AND FACSIMILE COMMITTEE

J. V. L. HOGAN, *Chairman*

H. S. BAIRD
STUART BALLANTINE
R. R. BATCHER
J. L. CALLAHAN
E. K. COHAN
E. W. ENGSTROM
P. T. FARNSWORTH
ALFRED N. GOLDSMITH
C. W. HORN

D. D. ISRAEL
C. B. JOLLIFFE
E. F. KINGSBURY
E. H. LEE
H. M. LEWIS
R. H. MANSON
J. W. MILNOR
A. F. MURRAY
C. J. YOUNG

TRANSMITTERS AND ANTENNAS COMMITTEE

J. C. SCHELLENG, *Chairman*

RAYMOND ASSERSON
W. W. BROWN
HARRY DIAMOND
A. M. GRANUM
RAYMOND GUY

D. G. LITTLE
R. E. POOLE
E. G. PORTS
D. S. RAU
P. E. WATSON

J. E. YOUNG

WAVE PROPAGATION COMMITTEE

J. H. DELLINGER, *Chairman*

E. V. APPLETON
S. L. BAILEY
L. V. BERKNER
C. R. BURROWS
G. D. GILLETT

F. A. KOLSTER
H. R. MIMNO
K. A. NORTON
H. O. PETERSON
G. W. PICKARD

BALTH. VAN DER POL

INSTITUTE NEWS AND RADIO NOTES

March Meeting of the Board of Directors

The regular monthly meeting of the Board of Directors was held on March 3 in the Institute office and attended by H. H. Beverage, president; Melville Eastham, treasurer; Ralph Bown, Virgil M. Graham, L. C. F. Horle, C. M. Jansky, Jr., B. J. Thompson, H. M. Turner, L. E. Whittemore, and H. P. Westman, secretary.

Forty-nine applications for Associate membership, one for Junior, and sixteen for Student membership were approved.

An Annual Review Committee was appointed to take charge of the preparation of a report on the developments in radio and allied fields which have been published during the past few years. A. F. Van Dyck was named chairman.

A Technical Committee on Wave Propagation was established with J. H. Dellinger as chairman. This committee will prepare a review of this subject each year for submission to the Annual Review Committee as part of its report.

An invitation for the Institute to hold its 1938 Convention at Murray Bay, Quebec, Canada, was considered and tabled pending the obtaining of further information.

An award to the author of the best prepared paper published in the PROCEEDINGS each year was approved.

A New Award

At the March 3 meeting of the Board of Directors it was agreed that a new award would be made as an incentive for the careful preparation of papers submitted for publication in the PROCEEDINGS. A prize of \$100 will be awarded at the annual convention of the Institute for 1938 to the author or authors for that paper of sound technical merit published in the PROCEEDINGS for 1937 which, in the opinion of the Awards Committee, constitutes the best presentation of the subject.

Joint Meeting of the Institute and the American Section of the International Scientific Radio Union

The annual joint meeting of the Institute of Radio Engineers and the American Section of the International Scientific Radio Union will be held in Washington, D. C., on April 30, 1937. This all-day meeting

is an important feature of the week which attracts to Washington every year an increasingly large number of scientists and scientific societies. Papers on the more fundamental and scientific aspects of radio will be presented. There will be two sessions at the building of the National Academy of Sciences, 2101 Constitution Avenue, Washington, D. C., beginning at 10 A.M. and 2 P.M. Papers will be limited to fifteen minutes each to allow time for discussion. The tentative program given below had been arranged at the time of going to press.

TENTATIVE PROGRAM, APRIL 30

Ursigrams Distributing Cosmic Data. A Progress Report, W. Davis, Science Service.

The American Character-Figure as a Measure of Magnetic Activity of the Earth, A. K. Ludy, U. S. Coast and Geodetic Survey, and A. G. McNish, Carnegie Institution of Washington.

The Behavior of the Ionosphere During Terrestrial Magnetic Disturbances, S. S. Kirby, T. R. Gilliland, N. Smith, and S. E. Reymer, National Bureau of Standards.

Asymmetry in Radio Transmission Conditions Between Northern and Southern Hemispheres, L. V. Berkner and H. W. Wells, Carnegie Institution of Washington.

Anomaly of Broadcast Transmission over the North Atlantic, J. H. Dellinger, S. S. Kirby, and N. Smith, National Bureau of Standards.

Further Observations of Ultra-High-Frequency Signals over Long Indirect Paths, R. A. Hull, American Radio Relay League.

Radio Methods for the Investigation of Upper-Air Phenomena with Unmanned Balloons, H. Diamond, W. S. Hinman, Jr., and F. W. Dunmore.

A Method of Measuring the Static Characteristics of a Power Tube and Calculations of its Operating Characteristics, E. L. Chaffee, Harvard University.

Measurement of Vacuum Tube Admittances at Ultra-High Frequencies, B. Salzberg, J. M. Miller, and D. G. Burnside, RCA Manufacturing Company, Inc.

The Frequency Stability of Ultra-High-Frequency Oscillators, Arnold Peterson, Massachusetts Institute of Technology. (In co-operation with General Radio Company.)

An Analysis of the Operation of Voltage-Controlled Electron Multipliers at Ultra-High Frequencies, W. R. Ferris, RCA Manufacturing Company, Inc.

Parasitic Reflectors for Two-Frequency Antenna Arrays, A. A. Alford, Mackay Radio and Telegraph Company.

Radiation from a Circular Antenna with Uniform Current, D. Foster, Westinghouse Electric and Manufacturing Company.

New Services from Station WWV of the National Bureau of Standards, J. H. Dellinger, National Bureau of Standards.

Negative-Grid-Triode Oscillator and Amplifier for Ultra-High Frequencies, A. L. Samuel, Bell Telephone Laboratories, Inc.

Committee Work

ADMISSIONS COMMITTEE

A meeting of the Admissions Committee was held in the Institute office on March 3 and attended by C. M. Jansky, Jr., chairman; F. W. Cunningham, Melville Eastham, R. A. Heising, L. C. F. Horle, C. W. Horn, E. R. Shute, A. F. Van Dyck, and H. P. Westman, secretary. Two applications for transfer to the grade of Fellow were approved. Three applications for transfer to Member were approved and one tabled pending the collection of additional data. Six applications for admission to the grade of Member were approved.

CONSTITUTION AND LAWS COMMITTEE

The Constitution and Laws Committee met in the Institute office on February 26. Those present were H. M. Turner, chairman; Austin Bailey, Ralph Bown, B. J. Thompson, and J. D. Crawford, assistant secretary. The committee continued its scrutiny of the Institute Constitution and proposed a number of modifications.

CONVENTION COMMITTEE

A meeting of the Silver Anniversary Convention Committee was held on February 18 in the Institute office. Those present were H. P. Westman, chairman; Austin Bailey, J. D. Crawford, Alfred N. Goldsmith, J. D. Parker (representing E. K. Cohan), Haraden Pratt, H. S. Rhodes, and B. J. Thompson. Preliminary plans were made for our forthcoming convention.

MEMBERSHIP COMMITTEE

The Membership Committee met in the Institute office on March 3. Those present were F. W. Cunningham, chairman; H. A. Chinn, T. H. Clark, I. S. Coggshall, E. D. Cook, Coke Flannagan, H. C. Gawler, C. R. Rowe, W. A. Schneider, C. E. Scholz, and H. P. Westman, secretary.

Arrangements were made for preparing lists of existing members who are eligible for transfer to higher grades than those held by them. All sections will be asked to co-operate in this project as it is felt that a substantial number of present members are amply qualified for advancement in grade.

NEW YORK PROGRAM COMMITTEE

The New York Program Committee met in the Institute office on March 2. Those present were R. R. Beal, chairman; Austin Bailey, G. C. Connor, J. D. Crawford, assistant secretary; R. A. Heising, Keith Henney, and H. P. Westman, secretary. Arrangements for an April

meeting were prepared and consideration given to the desirability of circulating a questionnaire at a future New York meeting to obtain information on the interests and desires of those who attend.

Institute Meetings

ATLANTA SECTION

The annual meeting of the Atlanta Section was held on January 21 at the Atlanta Athletic Club and attended by seventeen. I. H. Gerks, chairman, presided. In the election of officers for the forthcoming year, N. B. Fowler of the American Telephone and Telegraph Company was elected chairman; P. C. Bangs of the Acoustic Equipment Company, vice chairman; and G. S. Turner of the Federal Communications Commission, secretary-treasurer.

Members learned with regret of the passing of H. L. Wills who served as chairman of the section during 1932 and 1933.

A paper on "Automatic Frequency Control for Broadcast Receivers" was presented by Tracy Barnes, service engineer of the Brown Distributing Company. An analysis was given of the latest circuits used in Philco receivers. The operation of the discriminator and phasing oscillator to secure "magnetic tuning" was developed and its performance in the various frequency bands outlined. The advantage of balanced circuits was stressed. The paper was discussed by Messrs. Gerks, Owen, and Reid.

The meeting was closed with a brief description by Ben Ackerman of WGST of the items of major interest in the new transmitter and antenna system at that station.

The February meeting of the section was held on the 18th with N. B. Fowler, chairman, presiding. The meeting was held at the monitoring station of the Van Nostrand Radio Engineering Service. Major Van Nostrand presented a paper on "Radio-Frequency Measurements" and it was possible not only to describe the system of measurement used but to demonstrate it. The importance of extreme accuracy as well as positive identification of the station undergoing measurement was stressed. Graphs showing the results of measurements over a considerable period of time were presented. Seventeen members and guests attended this meeting and a general discussion followed the presentation of the paper.

At this meeting favorable action was taken on consideration of pending legislation regarding the registration of engineers in Georgia. In addition, new standing committees were appointed.

BUFFALO-NIAGARA SECTION

G. C. Crom, chairman, presided at the February 17 meeting of the Buffalo-Niagara Section which was held at the University of Buffalo and attended by thirty-eight.

L. A. DuBridge, professor of physics at the University of Rochester presented a paper on "The Cyclotron and What It Can Do." In introducing his subject, Dr. DuBridge pointed out that the transmutation of elements has occupied the minds of scientists and others for many years. He described the construction of equipment designed or used for this purpose in comparatively recent years. A brief outline of current concepts associated with efforts to break up the atom was given. He then described the cyclotron and its method of operation. Its limitations and the results so far obtained were given. Over one hundred transmutations have so far been obtained but have involved extremely small quantities of the elements. Many transmutations proved unstable or were radioactive substances.

CHICAGO SECTION

On February 19 a meeting of the Chicago Section was held at the La Salle Hotel and attended by ninety-five. J. K. Johnson, chairman, presided.

The first paper was on "Electroacoustic Devices" by R. P. Glover, chief engineer, Shure Brothers. He described the basic principles in the early work of the Rochelle salt crystal devices. The bimorph composite crystal has been applied successfully to sound-cell and diaphragm type microphones. The design features, performance, and applications of these microphones were discussed together with resulting practical advancements in the technique of microphone calibration. The paper was discussed by Messrs. Andrew, Conta, Crossley, Hershman, Johnson, Smith, and Starrett.

The second paper was on "Electromechanical Devices" and was presented by Benjamin Baumzweiger of Shure Brothers. The treatment of mechanical elements from the standpoint of electrical circuit theory was discussed with particular reference to crystal vibration pickups, actuators, and calibrating devices. The design and performance characteristics of a new phonograph record reproducer were described. Corrective networks for crystal devices were treated briefly. The paper was discussed by Mr. Wray.

CINCINNATI SECTION

G. F. Platts, chairman, presided at the February 23 meeting of the Cincinnati Section which was held at the University of Cincinnati. There were sixty-seven members present.

"Impedance Matching in Vacuum Tube Amplifiers" was the subject of a paper by W. L. Everitt, professor of electrical engineering at Ohio State University. In introducing the subject, Dr. Everitt presented a general discussion of the problems of impedance matching as adapted to vacuum tube operation. It was pointed out that in each case matching does not necessarily mean that the best condition is to make the external impedance equal to the internal impedance of the generator. He then discussed the conditions to be considered in adjusting impedance to obtain maximum power output and to reduce distortion. The use of impedance transformer networks was explained. By using Thevenin's theorem some points not clearly brought out otherwise were clearly emphasized. He also discussed the use of non-linear impedances such as in the case of class C amplifiers. The paper was discussed by Messrs. Goldstein, Silver, and Yoller.

CLEVELAND SECTION

The February 25 meeting of the Cleveland Section was held at Case School of Applied Science and attended by nineteen. R. A. Fox, chairman, presided.

L. A. Chatterton, superintendent of radio communication of the Cleveland Police Department, presented a paper on "Police Radio Communication." The subject was introduced with a brief history of police radio work, credit being given to Detroit for having furnished initial impetus to this development. The Cleveland police radio service opened in December, 1929, with six cars equipped. At the present time the service is extended to thirty-six municipalities and actively serves an immediate area of seventy-seven square miles and a total area of approximately four hundred and seventy-seven square miles. In 1936 approximately 85,000 local messages were handled and in addition, about 3000 interdepartment, intrastate, and interstate messages. Police radio is valuable for its importance as a means of constant contact between headquarters and men in the field which increases tremendously the amount of work which can successfully be handled, its psychological effect as a means of crime prevention, its ability to permit the catching of criminals before they have had time to dispose of the evidence of their crimes, and its breaking down of boundary lines between local and suburban departments and its fostering of generally wider co-operation.

A construction permit has been issued for a five-hundred watt ultra-high-frequency transmitter in Cleveland. Nolan Walker of Canton, Ohio, in discussing the subject, described the new ultra-high-frequency two-way police radio system in use in that city. R. A. Fox and

R. M. Pierce also discussed the paper. An inspection was made of one of the Canton police squad cars equipped for two-way service.

CONNECTICUT VALLEY SECTION

The Hotel Charles in Springfield, Massachusetts, was the location of the February 18 meeting of the Connecticut Valley Section which was presided over by F. H. Scheer, chairman. Twenty-five were present.

A paper on "How To Protect Inventions" was presented by Walker C. Ross, patent attorney. It was pointed out that patents are of two types, basic and improvement. They are granted for objects, processes, and machines. A patent conveys protection for a period of seventeen years. When a new object or improvement is conceived it should be sketched and described and immediately filed in the patent office. Filing should not be delayed because having sketches witnessed does not protect the inventor. In case of conflict, the patent will be granted to the person showing the most diligence in filing and producing a working model. For protection in foreign countries, the patent must be filed within one year of the date the invention is filed in the United States. The United States office handles about one thousand patents each week and with the present system it takes from two to three months to procure action. The filing fee is thirty dollars and an additional similar sum is charged for issuing the patent. In case a search must be conducted to prevent infringement, this investigation cost is additional and runs from fifteen dollars up.

DETROIT SECTION

The February 19 meeting of the Detroit Section was held in the Detroit News Conference Room and presided over by Emory Lee, vice chairman. There were eighty-five present.

H. J. Schrader, engineer for RCA Victor, presented a paper on "Nine-Inch Cathode-Ray Oscilloscope and Engine Pressure Measuring Equipment." He described first a new nine-inch cathode-ray oscillograph tube and its application in a device for measuring pressure in the cylinders of gasoline engines. The apparatus consists of a quartz crystal pickup inserted in the cylinder of the engine, an amplifier, the oscilloscope, and a synchronous timer. The pickup comprises a pair of quartz crystals, used in a steel tube which is inserted in the cylinder of the engine. Pressure in the cylinder causes the crystal to generate a proportional electromotive force. This is passed through an amplifier which is compensated to be linear from four-tenths cycle to eleven thousand cycles. The output is impressed on the oscillograph tube.

Timing is effected by small inductor type alternators mounted on the shaft of the engine being tested. Pressure curves are obtained on engines operating from twelve hundred revolutions per minute up. Pressures are measured in the range from one hundred to above five thousand pounds per square inch.

EMPORIUM SECTION

"Properties and Production of Nickel" was the subject of a paper by E. M. Wise of the International Nickel Company which was presented at the February 19 meeting of the Emporium Section. M. I. Kahl, chairman, presided. The meeting was held in the Emporium American Legion Club Rooms and attended by forth-nine.

The subject was introduced with a review of the history of nickel and how it has gradually come to be one of the most used metals in vacuum tubes. A motion picture was then shown illustrating how nickel was produced from the ore to the finished electrolytic product which is better than 99.5 per cent pure. Methods of treating nickel to gain various characteristics such as degrees of hardness, softness, etc., were described. The characteristics of nickel and nickel alloys were then given in detail. The paper was discussed by Messrs. Abbott, Bair, Bowie, Kahl, Kievit, Krahl, Ratchford, and Rischell.

LOS ANGELES SECTION

Douglas Kennedy, chairman, presided at the January 19 meeting of the Los Angeles Section which was attended by twenty-seven and held in the Los Angeles Junior College.

H. L. Olesen, engineer, Weston Electrical Instrument Company, presented a paper on "Radio Instruments." It was pointed out that the recent extension in sensitivity of small portable instruments was made possible by the use of new small wire having an outside diameter of a thousandth of an inch together with the development of machines capable of winding this wire. Several meters were described in which the pole pieces were especially shaped to produce the desired relation between input and response. Some new high voltage multipliers were described. An assortment of new types of meters and devices using meters was exhibited and the component parts of some popular types of meters displayed.

MONTREAL SECTION

The inaugural meeting of the Montreal Section was held on January 20 in the auditorium of the Engineering Institute of Canada. There were seventy present. The first election of officers resulted in the nomination of A. M. Patience of the RCA Victor Company as chairman, C.

B. Fisher of the Northern Electric Company as vice chairman, and W. R. Wilson of the Canadian Marconi Company, secretary-treasurer.

A paper on "Recent Developments in Measurements in Radio and Audio Frequencies" was presented by R. F. Field of the General Radio Company. After a brief outline of the history of various bridge circuits, the advantages and applications of the Schering bridge were discussed and its superiority over other circuits explained. The mathematical theory of the bridge was developed and the frequency limitations in its application for measuring capacitance, inductance, impedance, etc., were described. It was shown that care must be exercised in the construction of the components of the bridge with special reference to electric screening.

The February 17 meeting of the Montreal Section was held at McGill University with A. M. Patience, chairman, presiding. There were eighty members and guests present.

"Low-Loss Dielectrics at High Frequencies" was the subject of a paper by G. E. Landt, technical director of the Continental Diamond Company. Dr. Landt first classified the various uses of dielectrics in receiver construction as well as their application to other fields. Vector diagrams were used to describe the effects of the dielectric when it became a part of an equivalent series capacitance or resistance. Methods of measuring power factor were outlined and total power losses of various dielectrics compared. The probable mechanism of power loss was reviewed and reasons given for certain lack of correlation between measurements and theories. The desirability of measuring power loss in laminated materials in a plane parallel to the laminations was stressed and standard methods described. An interesting physical fact is that higher Q factors and better power factors are realized when exposed edges are very smooth and especially if they are treated with waterproofing compound to reduce conductance leakage caused by moisture absorption. Tables were shown of power factor changes of laminated phenolic materials of various thicknesses after twenty-four hours immersion in water and indicated increased loss for the thinner materials. Power factor changes with temperature were also described. High-frequency characteristics and types of measurements were discussed. In concluding his paper, Dr. Landt discussed mechanical considerations pointing out that in general the better the power loss characteristics of a dielectric, the poorer are its mechanical properties. The advantages of using a shaving die in punching operations were pointed out. Mr. Ballard, director of the Diamond State Fibre Company, described the construction of such dies. The paper was discussed by Messrs. Moore and Oxley.

NEW YORK MEETING

The regular New York meeting of the Institute was held in the Engineering Societies Building on March 3 and presided over by President Beverage. There were 300 present.

A paper on "A Simplified Circuit for Frequency Substandards Employing a New Type of Low-Frequency Zero-Temperature-Coefficient Quartz Crystal" was presented by S. C. Hight and G. W. Willard of the Bell Telephone Laboratories. The paper presented a new type of stabilized quartz-controlled oscillator and a new type of low-temperature-coefficient piezoelectric quartz circuit element which, in their combination, are particularly suitable for portable substandards of frequency.

The oscillator circuit is simple and may be easily stabilized by two reactance adjustments so that the frequency is unaffected by change of tubes or by small changes in the circuit reactances, the plate voltage, and the ambient temperature. Measured stabilities were given for this circuit when constructed as a substandard of frequency, employing the new CT crystal, and generating a one-hundred kilocycle current and its harmonics.

A previously unused type of vibration in quartz plates cut at an angle to the crystalline axes provides low-frequency circuit elements with a wide range of temperature coefficients. Two specified orientations, designated as CT and DT cuts, exhibit zero-temperature-coefficient at specific temperatures and are closely related to the recent, but now popular, AT and BT high-frequency plates. The new plates are especially useful in precision applications, for by slight final adjustment their frequency may be either raised or lowered and their temperature-coefficient made either more positive or negative.

Another paper on "Characteristics of Amplitude Modulated Waves" was presented by E. A. Laport of the RCA Manufacturing Company. A vector method of calculating envelopes of amplitude-modulated waves with random variations of phases and amplitudes of the carrier and its side bands was presented.

PHILADELPHIA SECTION

The Philadelphia Section met at the Engineers Club on February 4 with Irving Wolff, chairman, presiding. There were 260 present.

"The New York-Philadelphia Ultra-High-Frequency Relay System" was the subject of a paper by H. H. Beverage, chief research engineer of RCA Communications. He presented first some information concerning ultra-high-frequency propagation which bears on the choice of frequencies for radio relaying purposes. The ultra-high-frequency

two-way relaying system between New York and Philadelphia was then described. The system normally handles two facsimile channels, two printer channels, and several additional channels for telegraphic and control purposes. Two unattended relay points are located at New Brunswick, N. J., and Arney's Mount, N. J.

In the optical path, it was shown that the received signal was the resultant of a direct ray and a ray reflected from the ground substantially 180 degrees out of phase with the direct ray for the case of glancing incidence. An approximate equation was derived for calculating the signal strength from the geometry of the path between the transmitting and receiving antennas. It was shown that the resultant signal falls off as the inverse square of the distance in the optical path.

Beyond the optical distance, other factors contribute to the resultant signal. These were described as diffraction and refraction fields. Below about sixty megacycles, sky-wave transmission occurs occasionally but is believed to be of little consequence above about forty to forty-five megacycles.

The frequency assignments on the New York-Philadelphia circuit are worked out on a systematic basis such that the northbound and southbound transmitting frequencies at a given relay point are always separated by 9.5 megacycles, while the two received frequencies are approximately halfway between the transmitting frequencies. This arrangement makes it possible to mount the transmitting and receiving antennas in close proximity on a single tower, where desired, without cross modulation between the transmitters or interference between the transmitters and receivers. All of the radio equipment at the relay points is housed in a single small building.

Directive arrays of horizontal dipoles were used for the transmitting antennas, and rhombic antennas were used for reception.

The New Brunswick relay is about thirty miles from the terminal at 30 Broad Street, New York City. The Arney's Mount relay is thirty-six miles from New Brunswick, and the distance from Arney's Mount to the Philadelphia terminal at the Philadelphia Trust Building is twenty-five miles. The relatively shorter distances at the terminal points were required in order to produce signals of sufficient intensity to be well above the comparatively high noise levels experienced at the city terminals.

The arrangement used for remotely starting and stopping the relay transmitters from the terminal points was described, as well as the method for intercommunicating over the system from any point in the circuit.

The paper was discussed by Messrs. Barrows, Hershberger, Kellogg, Packard, West and others.

The March meeting of the Philadelphia Section was held on the 4th and attended by 275. Chairman Wolff presided and the meeting was at the Engineers Club.

A paper on "Automatic Tuning—Simplified Circuits and Design Practice" by D. E. Foster and S. W. Seeley of the RCA License Laboratory was presented by Mr. Seeley. This paper appeared in the March, 1937, issue of the PROCEEDINGS.

ROCHESTER SECTION

The Rochester Section met on February 11 at the University of Rochester. L. A. DuBridge, chairman, presided and there were 300 present.

A paper on "Transmutation of Atomic Nuclei" was presented by Niels Bohr, director of theoretical physics at Copenhagen, Denmark. Dr. Bohr, a Nobel Prize winner in physics, developed the Bohr theory of atomic structure. Since 1914 he had been a leader in the development of atomic theory. His paper concerned the probable structure of the atomic nucleus and the problems involved in attempting to break up the nucleus so that its nature may be studied. The mass is so small and so tightly bound together that it is rather difficult to bombard it or break it up in comparison to the relative ease with which the atom may be smashed. It will probably require energies of the order of one to twenty million volts to enter the nucleus successfully by some outside particle. It is easier to bombard the nucleus with an uncharged electron particle than with a charged alpha particle.

SAN FRANCISCO SECTION

The San Francisco Section held two meetings during February. The first on the 10th of the month was attended by twenty-four and held in the Pacific Telephone and Telegraph Company auditorium. V. C. Freiermuth, chairman, presided.

"Ultra Sensitive Measuring Instruments Using the New High Retentivity Magnetic Alloys" was the subject of a paper by H. L. Olesen of the Weston Electrical Instrument Corporation. He pointed out the three main divisions of instruments and explained the uses and capabilities of each. Some very interesting facts in connection with the very small parts required in the manufacture of meters were given. The Weston Electrical Instrument Corporation makes the smallest screw machine parts as well as the smallest bakelite mouldings in the world. The jewels and pivots are drilled and polished in Puerto Rico. In addition to the material presented, many fine instruments and parts were displayed.

The second meeting of the month was held on the 24th in the same auditorium and presided over by Noel Eldred, vice chairman. There were twenty present. The meeting was devoted to discussions of two papers which have appeared in the PROCEEDINGS. The first of these was on "Directional Antennas" by G. H. Brown which appeared in the January, 1937, issue and was reviewed by Robert Barnes of the Mackay Radio and Telegraph Company. The second paper was on "A Critical Study of Two Broadcast Antennas" by C. E. Smith which appeared in the October, 1936, issue. W. C. Hilgedich of the U. S. National Park Service led the discussion on this paper.

SEATTLE SECTION

J. W. Wallace, chairman, presided at the February 26 meeting of the Seattle Section which was held at the University of Washington and attended by thirty-three.

A. R. Taylor, Lieutenant, U.S.N., presented a paper on "The Naval Communications System" which described its general setup and functioning. Outbound traffic from shore to ships is broadcast mainly through a group of high powered stations which constitute the super-primary system. Supplementing these stations is the primary system consisting of low power stations covering very restricted areas, such as a naval district. The shore stations with a few exceptions are administered by the director of naval communications in Washington, D.C. The ship radio systems are under the complete jurisdiction of the ship commanders, the Director of Naval Communications having control only over the allotment of the group of frequencies available for ship use. The ship radio has two distinct functions, the first is a means of carrying on a tactical operation of the fleet and the second as a means of communication with the bases. All communications from ship to shore follow the normal lines of naval organization. The system utilizes telegraphic code almost exclusively.

TORONTO SECTION

On January 11 a meeting of the Toronto Section which was attended by 101 was held at the University of Toronto and presided over by D. Hepburn, chairman of the Papers Committee.

A paper on "Electrotherapeutic Oscillation Generators" was presented by H. W. Parker assisted by H. D. Short of the Rogers Radio Tube plant. Mr. Parker pointed out that the simple laws of nature were followed in the use of an oscillator for therapeutic work. Nature effects a cure by setting up local heat for the affected area of the body and the oscillator is used to produce this same result artificially. A short

history of the work done by early experimenters was given and tribute paid to Lee deForest. In 1910 Dr. deForest procured patents on the radio knife which makes use of the high-frequency generator.

Experiments have shown that a power output as high as four hundred watts is required to raise the body from ninety-six degrees to one hundred and six degrees. Approximate design requirements for a suitable oscillator are a total power output of four hundred watts, ability to vary continuously the power output from maximum to zero, stability of operation at all power outputs, a constant frequency of fifty megacycles, and simplicity of operation.

It has been found that fifty megacycles is an optimum frequency for greatest penetration. Higher frequencies are reflected by the body. Vacuum tubes for such oscillators were described and the development of tubes for this purpose was outlined by a family of tubes exhibited to show the various steps and improvements made in their design. The use of heavy duty thoriated tungsten filaments was discussed as this type is particularly suitable where large emissions are required.

Mr. Short demonstrated the oscillator. Several types of insulators were connected to the electrodes and some of these developed considerable heat while a special ceramic seemed not to be greatly affected. The variable output was demonstrated by connecting some one-hundred-and-fifty-watt lamps which were lighted to full brilliancy. The radio knife was demonstrated on a piece of steak. Stability of the oscillator was shown by connecting various impedance loads in the output circuit, the short-circuiting of which did not stop oscillation. The paper was discussed by Messrs. Choat, Hackbusch, Hepburn, Humphries, Weir, and others.

The February meeting of the Toronto Section was presided over by B. deF. Bayly, chairman and was held in the University of Toronto and attendance was sixty.

"The Military Uses of Radio" was the subject of a paper by W. J. McGill, Captain, Signal Officer, Military District No. 2 of the Royal Canadian Corps of Signals. He presented first the comparison of the requirements of commercial and military operations. Commercial services are based on public demand and installations are made to meet this demand. In the army the object is to provide communication between various positions and divisions and this is accomplished by many methods of which radio is one of the most important. The type of service available in any war zone varies with the distance from the front line. At main headquarters all the services represented are available. While at the front line extremely mobile services are required and radio is the chief method of communication.

The first radio sets used in the Canadian army were built by the Sappers of the Canadian Division who used them to receive press news. In 1917 several sets were built using spark transmission and used in France. During the last one hundred days of the Great War, radio signal systems were fairly well organized and used extensively.

Transmitters and receivers used in the army must be capable of quick transportation. Mobile equipment must have its own power supply and be constructed to permit rapid dismantling and erection. Present sets can be put into service in from five to fifteen minutes. Low power consumption is essential and as the service is severe the equipment must be extremely rugged in construction. Simplicity of operation permits emergency service by persons of limited experience. Interchangeability of parts is necessary to permit damaged equipment to be placed back in service promptly. Power output must be limited to avoid interference with other stations and to reduce the possibility of the enemy picking up the signals. All army communications are transmitted in code and decoded at the destination.

An elaborate display of army signal equipment was set up, described, and demonstrated at the end of the paper. Progressing from the older and obsolete sets to those of the present time, Captain Megill pointed out the various improvements made and the reason for them.



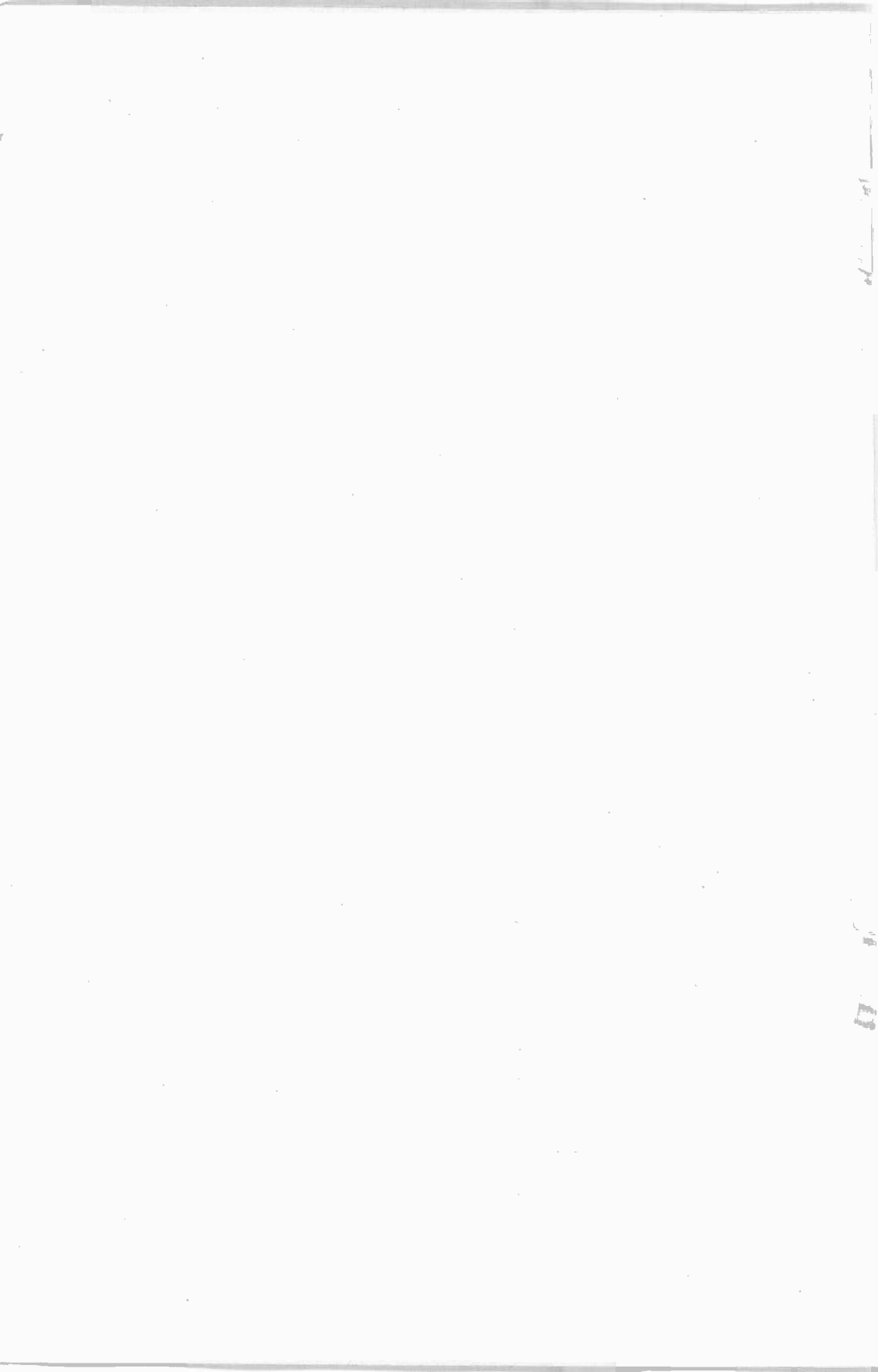

TECHNICAL PAPERS

CHARACTERISTICS OF AMERICAN BROADCAST RECEIVERS
AS RELATED TO THE POWER AND FREQUENCY
OF TRANSMITTERS*

BY

ARTHUR VAN DYCK AND DUDLEY E. FOSTER

(Radio Corporation of America, License Division, New York City)

Summary—In a system of broadcasting the conditions under which there is freedom from interference depend upon the characteristics of receivers in use and upon the frequency allocation and power of transmitters. The characteristics of American broadcast receivers now in use have been investigated to determine the permissible input and frequency separation for freedom from cross talk, heterodyne beats, and flutter effects. Seven types of interference are described separately in the data on the susceptibility of present receivers to each type. Finally there are given quantitative conclusions and specifications covering the relations between signal input, frequency separation, and receiver performance.

IN A broadcast system, the prime factors determining the field intensities which will exist at any receiving location are the power, geographical situation, and frequency allocation of transmitters. The characteristics of receivers determine whether or not interference will exist at that location. This paper deals with the performance of American broadcast receivers in use today in regard to those characteristics influencing their ability to select a desired signal in the presence of interfering signals of various types.

In any broadcast system, development of transmitter allocation and receivers must proceed in co-ordination in order to give the best possible service to listeners. To date the best means of providing the listener with signals free from static and man-made interference is to furnish high signal levels. The listener should also be provided with a variety of programs from which he may choose. Technical advances in receivers may permit changes in transmitter allocation to produce a wider variety of programs and higher field intensities without interference, and at other times changes in the transmitter situation may require changes in receiver design to maintain freedom from interference. Much consideration has been given in the technical literature to certain aspects of receivers which have to do with their ability to

* Decimal classification: R361. Original manuscript received by the Institute, December 24, 1936. Presented before Rochester Fall Meeting, November 17, 1936.

select desired programs, but little attention has been given to the general problem as to how well receivers now in use can discriminate against all of the types of undesired signals to which they are subjected. This paper attempts to describe the many types of possible interference, and to examine the available data on receivers to determine their freedom from interference.

It is interesting to observe that the complexity of today is merely a normal development of the art from a simple beginning to greater and greater refinement, improvement, and utilization of this resource of nature. Broadcasting began with 50-watt transmitters and one-circuit receivers. Then came 500-watt and 5000-watt transmitters with two- and three-circuit receivers. Now we have 50,000- and 500,000-watt transmitters with eight-circuit receivers. In another five or ten years we may reasonably expect to have 5,000,000-watt transmitters and corresponding receivers, as a part of the continuing march of progress in this field. Therefore the problem of operation is one of adjusting parts and relations more precisely and with more refinement, as the system becomes larger and more intricate.

RECEIVERS NOW IN USE

Perhaps the first question of interest in the subject of general receiver conditions, is the number of receivers in use today, and their age distribution. Age is a factor because the performance will depend upon date of manufacture, and perhaps very critically, in an art where technical advance is rapid.

Table I is presented as showing this situation. Some of the figures are necessarily estimates, but are believed to be fairly accurate.

TABLE I
BROADCAST RECEIVERS IN USE IN THE UNITED STATES AS OF JANUARY 1, 1937

	No. Manufactured	No. Now in Use (estimated)
Before 1930	15,000,000	3,500,000
In 1930	3,838,000	2,500,000
1931	3,594,000	2,500,000
1932	2,444,000	2,000,000
1933	4,157,000	3,500,000
1934	4,556,000	4,000,000
1935	6,026,000	6,000,000
1936 (estimated)	6,000,000	6,000,000
Total	45,615,000	30,000,000

The salient points of Table I are:

1. Figures check closely with those determined by the Federal Communications Commission Allocation Survey, reported September 1, 1936.

2. The total number of receivers in homes estimated for January, 1937, is 30,000,000.
3. Of this total over 50 per cent will have been manufactured during the past three years, and about 75 per cent during the past five years.
4. To determine the average performance characteristics of receivers in homes today with fair accuracy, we will have to examine the product of the past three to five years only.

GENERAL CONSIDERATIONS OF BROADCAST RECEIVERS

From the viewpoint of performance, there are two kinds of receiving circuits now known and usable, one the tuned radio frequency, and the other the superheterodyne. These two have very different qualities of performance.

Prior to 1930 the tuned radio-frequency circuit was predominant, but in 1930 the superheterodyne began a very rapid increase in extent of use. By 1933, sales were 96 per cent of superheterodyne type (in the United States). Since 1933, sales of the superheterodyne type have become practically 100 per cent in all price classes except that below fifteen dollars, which class is relatively small.

These figures, together with those of Table I, make possible a fair estimate that at least 80 per cent of all receivers in homes today are of the superheterodyne type, and that by the end of 1937 the figure will be over 90 per cent. Therefore we will have to consider only one type of circuit, the superheterodyne.

During the past few years, price has become a significant factor in performance, and we should examine the performance in all price classes, and the relative quantities sold in each price class, to determine either an "average performance characteristic" for the American home, or the percentage of homes which will have satisfactory service under any specified transmitting station setup.

For purposes of analysis the receivers were divided into four arbitrary price classes.

Class	List Price
A	\$15 to \$35
B	\$35 to \$65
C	\$65 to \$100
D	Over \$100

EFFECT OF AGE

The measurements were all made on new receivers in the condition in which they left the manufacturer. In considering actual performance in homes, the decrease in efficiency of the receivers with age should be

taken into account. No specific data are available on the manner in which receivers are affected by age, but it is expected that the range of performance for old receivers will be considerably wider than for new receivers, although the degree of change will be less in some receivers than in others. The degree of change depends, of course, upon the quality of the design and upon the kind of treatment the receiver experiences. We are, in general, concerned with selectivity and there are fewer factors which would affect selectivity than sensitivity. In drawing conclusions from data, the effect of age can be allowed for, in a general manner, by considering receivers to be somewhat worse than the data taken on new receivers would indicate them to be.

CLASSES OF INTERFERENCE

There are many different kinds of interference, each arising from different causes or circumstances. It is this fact which makes the study of reception conditions so exceedingly complex, and a general understanding of the several different kinds is essential to a clear picture of any broadcast system. These must be treated separately because each kind has, or does not have, effect, depending upon conditions existing in particular receiving locations.

The several kinds of interference between stations, which excludes the other class of interference from atmospherics and inductive interference, may be listed as follows:

1. Cross talk from undesired signal ten kilocycles or more away from desired signal frequency.
2. Adjacent channel heterodyne beat note between carriers of desired and undesired signals.
3. Side-band beat interference.
4. Overmodulation of undesired station transmitters on adjacent channels.
5. Heterodyne beating of desired and undesired signals having the same assigned frequency.
6. Cross talk or beats from particular relations of frequencies of desired and undesired stations, in connection with receiver design characteristics, occurring when frequency separation is large (greater than 50 kilocycles).
7. Cross modulation from effects set up by the radio signals in neighboring nonradio electrical systems, or in the antenna system.

Any one or more of these several kinds of interference may be present or absent at any receiving location, depending upon relations of the receiver characteristics to the frequency separation and intensities of the desired and undesired signals.

DISCUSSION OF INTERFERENCE

Cross Talk

Two methods of selectivity measurement are in general use. The older and simpler method consists in determining the input required

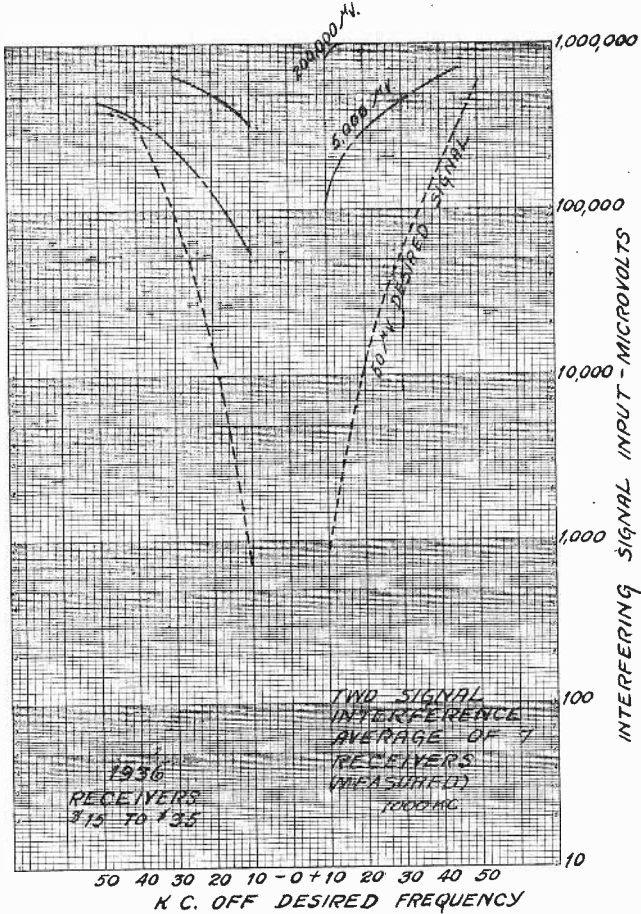

Fig. 1

to produce a specified output at various frequencies above, below, and on the frequency to which the receiver is resonated. Only one signal generator is required in this method, hence its designation as the single signal method.

The other method, the two-signal method, requires the use of two signal generators, but gives results which are more nearly representative of those in the existing broadcast system. In this method, one

generator, to which the receiver is tuned, represents the desired signal and the other the interfering signal.

The method of the two-signal cross talk interference test was that standardized by the Institute.¹ The measurements were made at 1000

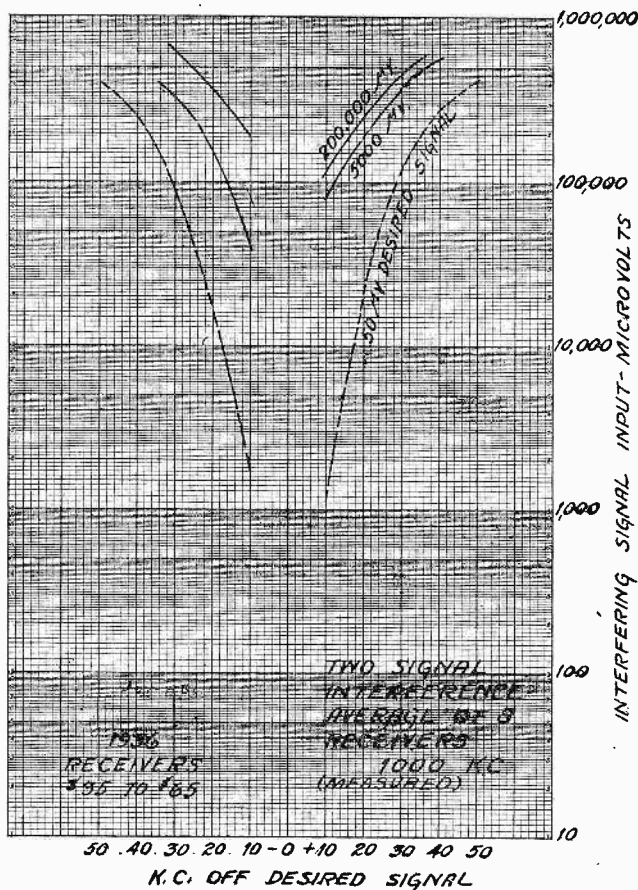

Fig. 2

kilocycles as that frequency, being near the center of the broadcast band, will give most representative data. The three standard input values of 50, 5000, and 200,000 microvolts were used for the desired signal. The desired signal output was made 500 milliwatts instead of the value of 50 milliwatts given in the 1933 Standards Report. The interfering signal output was 30 decibels below the desired signal output, or 0.5 milliwatts. Listening tests confirmed the fact that cross talk

¹ Report of Standards Committee of I.R.E., 1933.

interference 30 decibels below the desired signal gives satisfactory freedom from interference.

Through the co-operation of several receiver manufacturers, two-signal cross talk data on their products were obtained for receivers

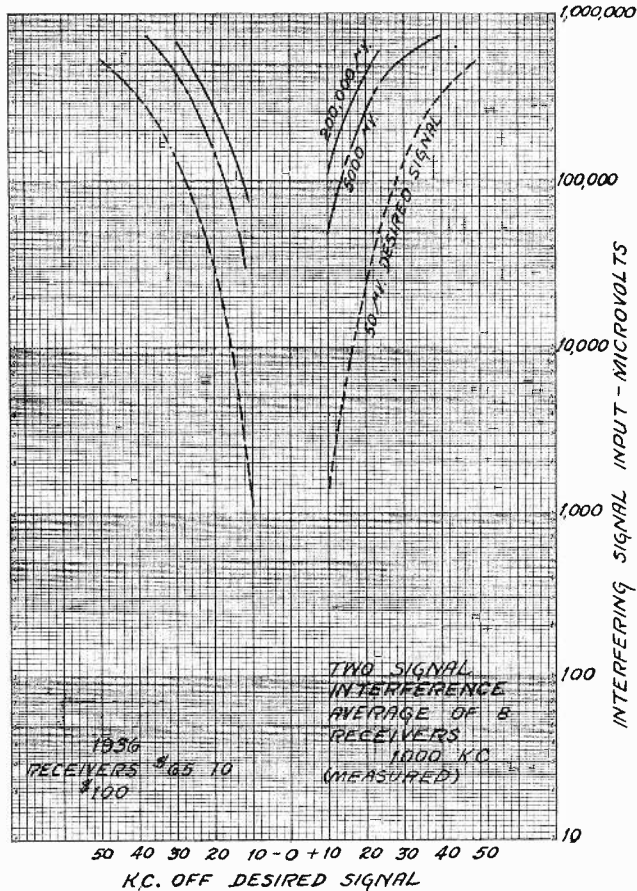

Fig. 3

manufactured in the years 1934, 1935, and 1936. These data have been separated according to price class, and then averaged. They are presented in Figs. 1 to 9. For 1934 there were not sufficient data to permit division into price classes, so the curves for that year cover all price classes. The graphs are all for 1000 kilocycles and show the number of receivers measured in each case.

The data extend to 50 kilocycles on either side of resonance, or to one volt interfering signal input, whichever requires least input. The

curves were not taken closer to resonance than ten kilocycles because in that region the heterodyne beat between carriers is the predominant factor, and because in the American broadcast system the transmitter frequencies are integral multiples of ten kilocycles.

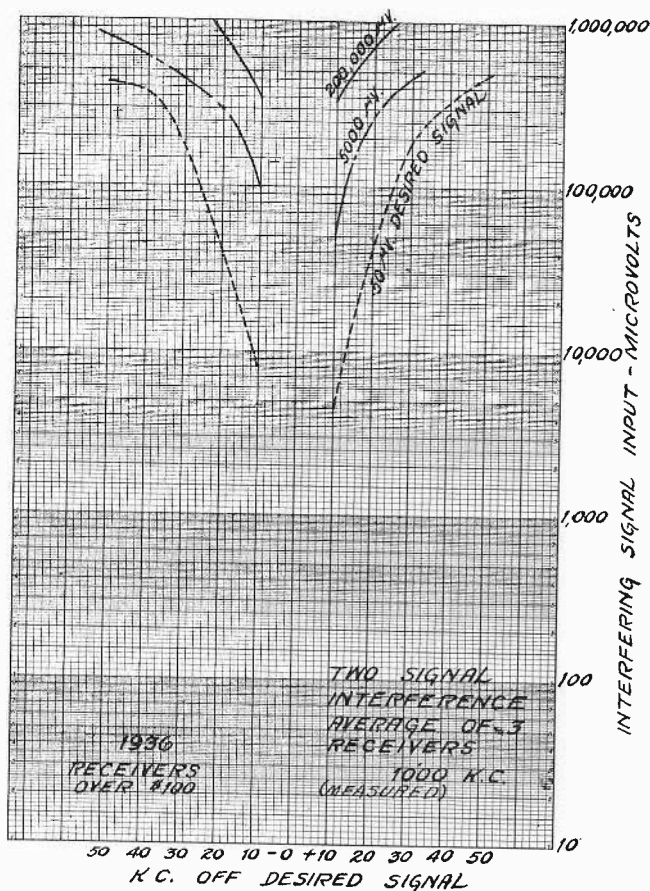

Fig. 4

Two-signal measurements were not made in earlier years, so that resort was had to single signal measurements for receivers manufactured in the years 1930 to 1933. One half of the selectivity curve, averaged for each category for those years, is shown in Fig. 10. These curves are averages of the following number of types of receivers.

1930 Tuned radio-frequency	46 Receivers
1930 Superheterodyne	11 Receivers
1931 Tuned radio-frequency	44 Receivers
1931 Superheterodyne	51 Receivers
1932 All classes	55 Receivers
1933 Class A	16 Receivers
1933 Class B	11 Receivers
1933 Class C	7 Receivers

Cross Modulation and Masking Effects

There are two effects in receivers which the two-signal method of measurement takes into account, but which are not accounted for in the single signal method. These are cross modulation and masking.

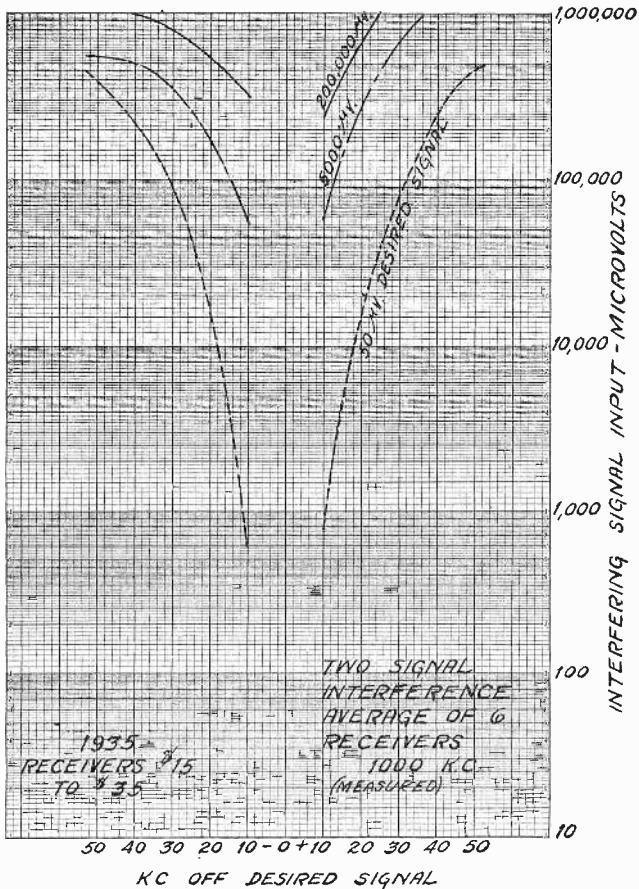

Fig. 5

Both of these effects have a decided influence on receivers in actual use and since the two-signal test, by virtue of the method of conducting it, includes these effects, it is the more exact representation of the effective selectivity of the receiver.

The cross modulation phenomenon has been known for a number of years and has been treated in technical literature, but it is sometimes overlooked that it has a large effect on receiver selectivity, even with the remote cutoff tubes of today. The type of cross modulation we are dealing with here is that due to curvature of the characteristic

of vacuum tubes, whereby in the presence of two signals the modulation of one is imposed on the other.

The cross modulation is given by the expression,²

$$M = \frac{mE^2S_m''}{2S_m}$$

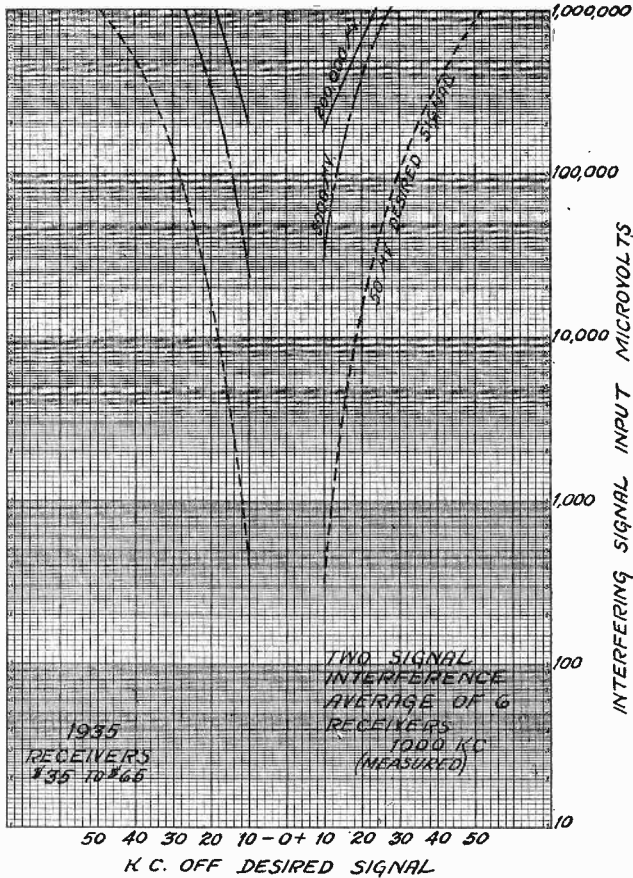

Fig. 6

where,

M is cross modulation

m is modulation of interfering signal

E is peak carrier value of interfering signals

S_m is transconductance of the tube under the grid bias conditions existing

² Stuart Ballantine and H. A. Snow, "Reduction of distortion and cross-talk in radio receivers by means of variable- μ tetrodes," Proc. I.R.E., vol. 18, pp. 2102-2127; December, (1930).

S_m'' is second derivative of transconductance with respect to grid voltage at the same operating point.

The cross modulation occurs in the first or second tube of the receiver and, as the expression above shows, depends upon tube characteristic, input voltage, magnitude of automatic volume control de-

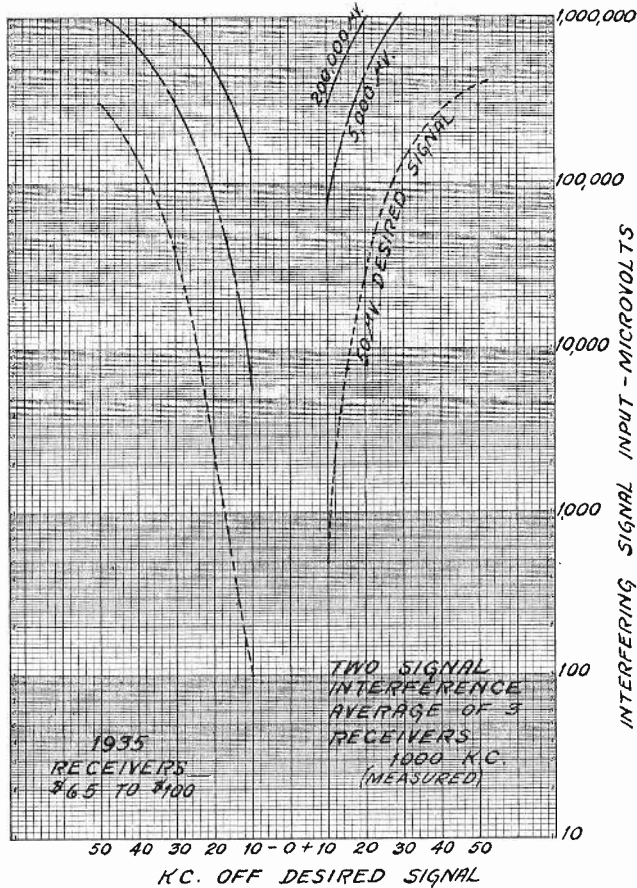

Fig. 7

veloped, and thus indirectly also upon gain and selectivity in the early stages of the receiver.

The masking, or so-called "demodulation" effect, acts to decrease the cross talk interference when two signals of differing radio frequency are impressed on a linear detector. Detectors are practically all linear today with inputs of 50 microvolts, so that this phenomenon has an important influence on the results of two-signal measure-

ments.^{3,4,5} If we assume two carriers, differing by 20 kilocycles, applied to a linear detector, the smaller one modulated by 400 cycles, the first order output will be frequency terms of 19.6, 20, and 20.4 kilocycles, which are inaudible. It is only by virtue of a second order effect (due to the fact that the input ratio of two signals on the detector is not a

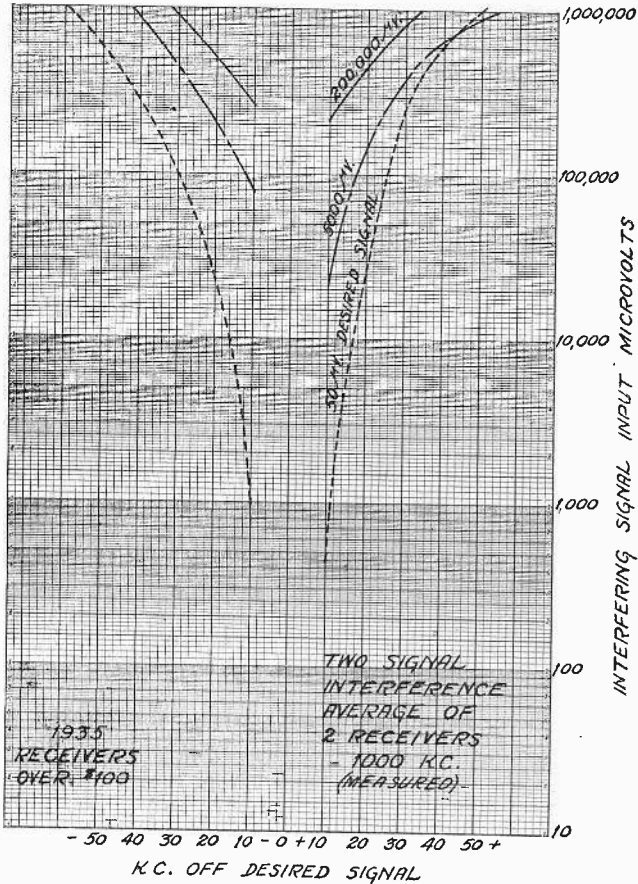

Fig. 8

constant but varies at the 400-cycle rate) that cross talk interference occurs.

³ C. B. Aiken, "Theory of the detection of two modulated waves by a linear rectifier," *Proc. I.R.E.*, vol. 21, pp. 601-629; April, (1933).

⁴ C. B. Aiken, "The detection of two modulated waves which differ slightly in carrier frequency," *Proc. I.R.E.*, vol. 19, pp. 120-137; January, (1931).

⁵ C. B. Aiken, "Further notes on the detection of two modulated waves which differ slightly in carrier frequency," *Proc. I.R.E.*, vol. 20, pp. 569-578 March, (1932).

The output of audio frequency due to the smaller signal in the presence of the larger is given by⁶

$$V = \frac{k m x^2}{2} E \left(1 + \frac{x^2}{8} \right) \cos q t$$

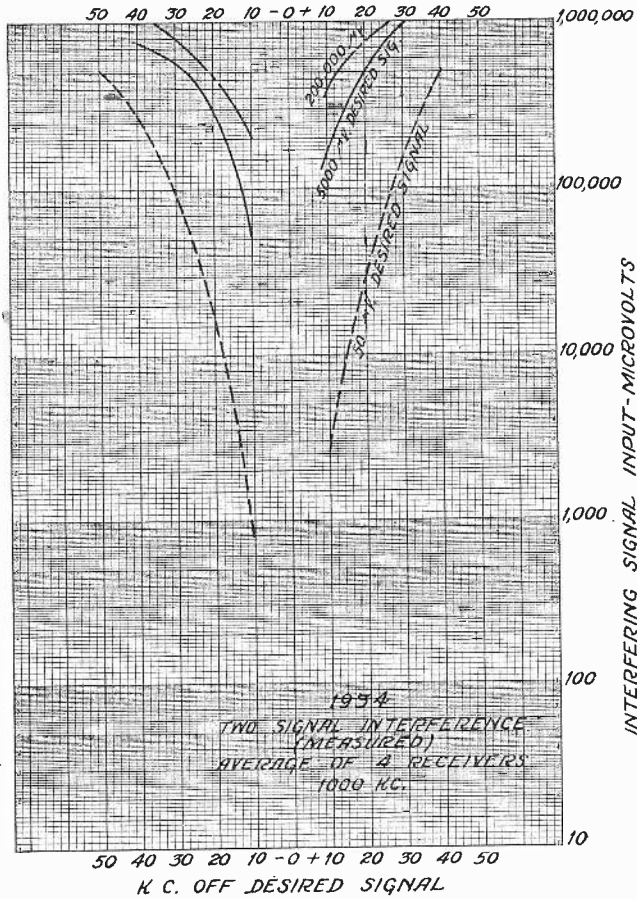

Fig. 9

where,

- V is audio-frequency output
- k is detection coefficient
- m is modulation of smaller signal
- E is magnitude of larger carrier
- e is magnitude of smaller carrier

⁶ E. B. Moullin, "Detection by a straight line rectifier of modulated and heterodyne signal," *Wireless Engineer and Experimental Wireless*, pp. 378-383; July, (1932).

q is 2π times modulation frequency
 x is e/E .

This expression can be used for calculating the two-signal interference curves from single signal selectivity measurements for inputs

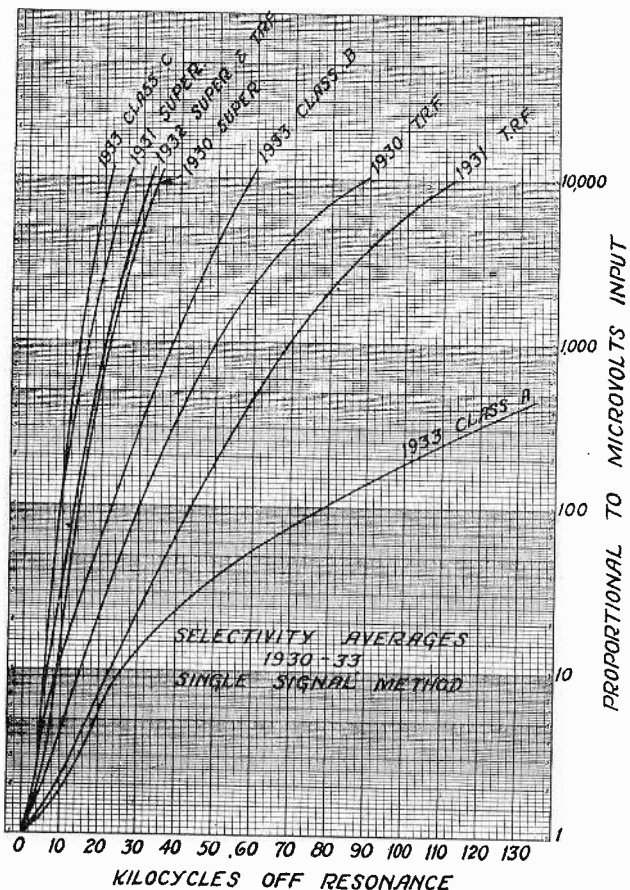

Fig. 10

where cross modulation does not exist. If the desired and undesired signals have the same modulation and the smaller is 0.256 times the larger, at the detector input, the output of the smaller (undesired) signal will be 30 decibels below the desired signal output. An example of the results of this method of calculation is shown in Fig. 12, where the circles show two-signal values calculated from single-signal measurements of Fig. 11. The main discrepancy between the measured two-

signal values and those calculated from single-signal selectivity is a shift of 0.25 kilocycle in tuning which occurred between the two series of measurements.

Composite Curves

From the measured two-generator curves for the years 1934 to 1936, and from the calculated results for earlier years, composite curves can be plotted showing the percentage of receivers which will experience interference under varying conditions of frequency separa-

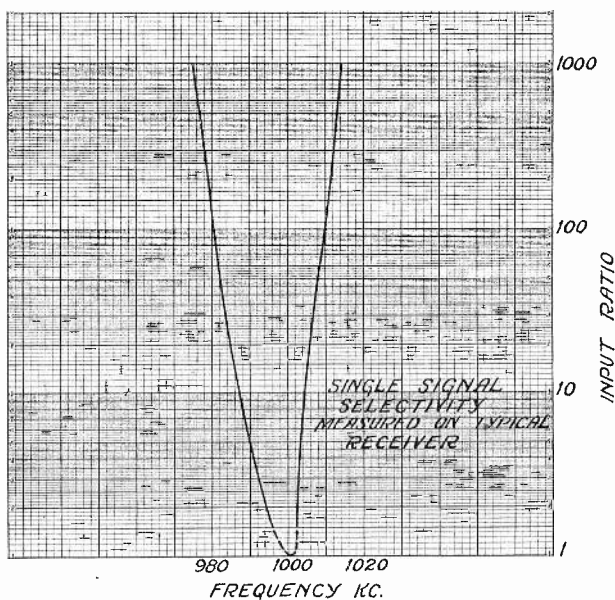

Fig. 11

tion and interfering signal input. For the years 1930–1936 such curves can be prepared for a desired signal of 50 microvolts only, since the calculated results for the early years do not take into account cross modulation and must therefore be limited to small inputs. Such a curve is shown in Fig. 13.

An explanation of this type of curve is probably in order. It attempts to show the performance of receivers manufactured in the United States during the past seven years, with regard to susceptibility to cross talk interference. Obviously, the problem is one of many indefinite factors, involving millions of receivers, in unknown condition, in unknown circumstances of installation and location. Nevertheless, considered in the aggregate, a reasonably useful average should

be obtainable, even though we are forced to use measurements made on receivers in original factory condition. Inasmuch as the production of the last seven years constitutes between 80 and 90 per cent of all receivers now in use, these curves may fairly be said to be adequately representative of the receivers in American homes today. Therefore,

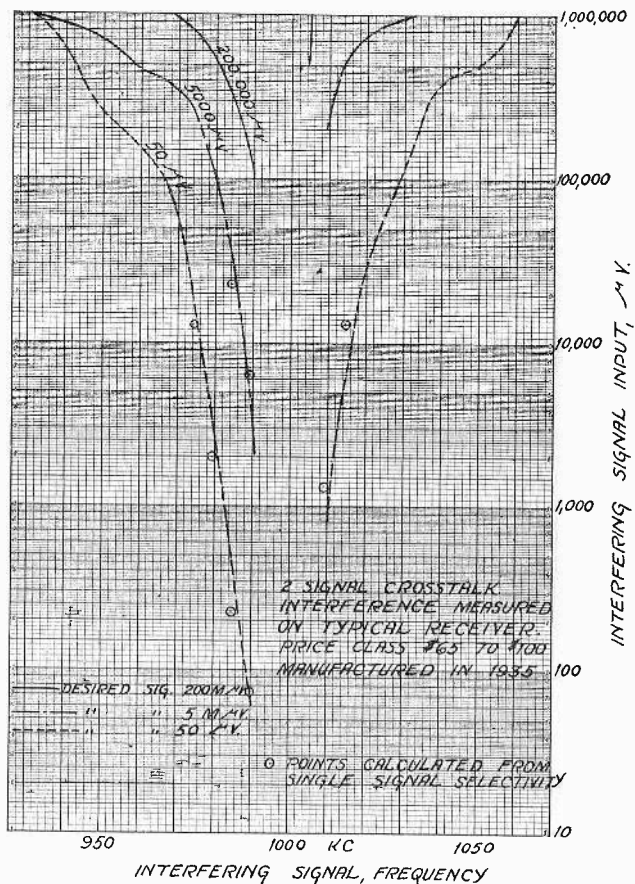

Fig. 12

conclusions can be drawn from these curves, on which to base transmitter allocations, with reasonably safe prediction for conditions which will avoid cross talk interference in any desired, predetermined percentage of receivers.

For allocation study purposes, a proper percentage figure of receivers which may be permitted to have interference must be selected arbitrarily, but a reasonable figure can be selected readily. Obviously

an interference level which would affect 100 per cent of all receivers is too high. Similarly, an interference level which would affect less than ten per cent of all receivers is impracticably low. It is reasonable that more than 50 per cent of all receivers should be protected, so that

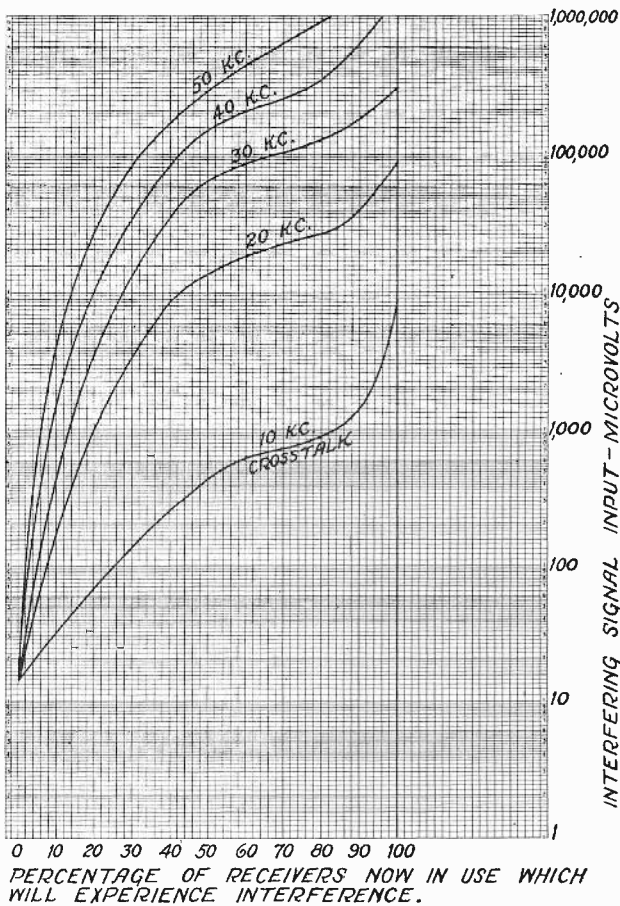

Fig. 13

convergence indicates that a figure of 20 per cent would be a reasonable one. It should be noted that the percentage value selected has large effect on permissible interfering signal inputs. For example, in Fig. 13, if 30 per cent were used instead of 20 per cent, on the 20-kilocycle separation curve, the interfering signal input would be 3500 microvolts, instead of 1000 microvolts.

Curves of the same type can be prepared for all three values of

desired signal input for the years 1935 and 1936 from the two-signal measurements for those years. These curves appear in Figs. 14, 15, and 16.

In order to show the effect of signal input on interference the data

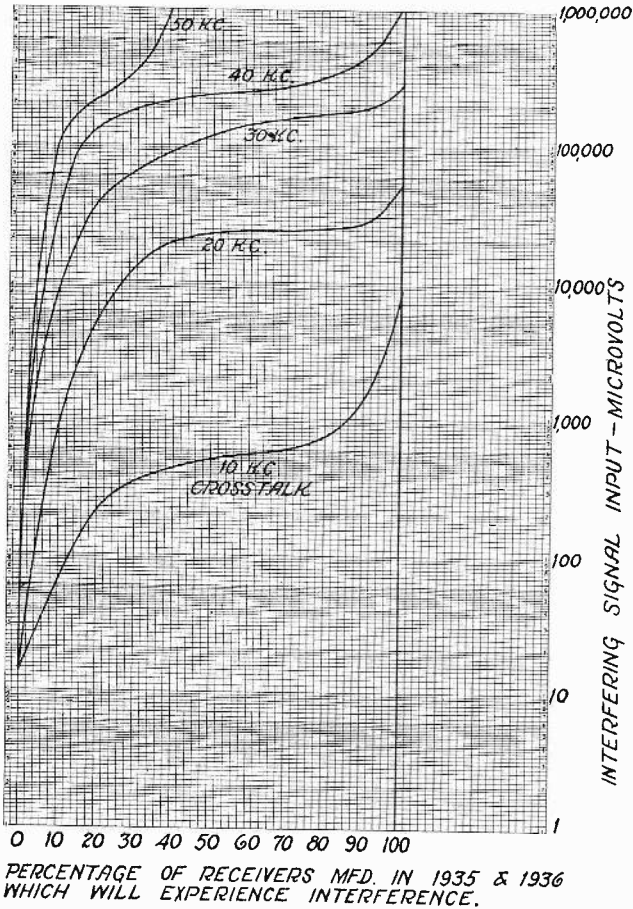

Fig. 14

may be plotted as in Fig. 17. This figure shows the conditions under which 20 per cent of the receivers manufactured in 1935 and 1936 will experience cross talk interference. The logarithm of the desired signal is used because of the wide range of signal to be covered. If cross modulation did not exist, the ratio between desired and undesired signal would be a constant for a given frequency separation, and would be the value calculated by the single-signal measurement to allow for the masking effect.

Fig. 17 shows that for small signals, the ratio of desired to interfering signal is a constant, as shown by the straight-line portion of the curves for each frequency separation. As the signal input (desired and interfering) increases, the curve departs from a straight line, indicating

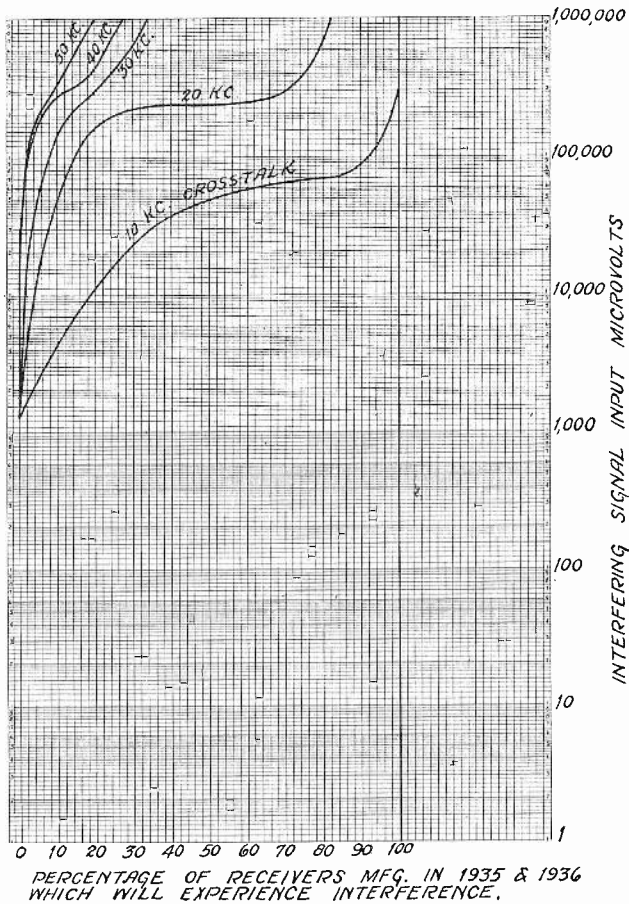

Fig. 15

the start of cross modulation. This figure also shows that for each frequency separation there is a maximum permissible interfering signal. An increase in the desired signal beyond that point requires a smaller value of undesired signal to avoid interference. These curves would seem to indicate that the expression for cross modulation which shows that this factor is dependent only on the magnitude of the interfering signal, does not hold in practice. However, it must be borne in mind that the masking phenomenon has a large effect when cross modula-

tion does not exist, but this phenomenon is of no benefit in reducing the interference resulting from cross modulation.

This figure illustrates plainly why the single signal method of selectivity measurement is inadequate for presenting the effective selectivity under actual usage conditions. This figure also shows that

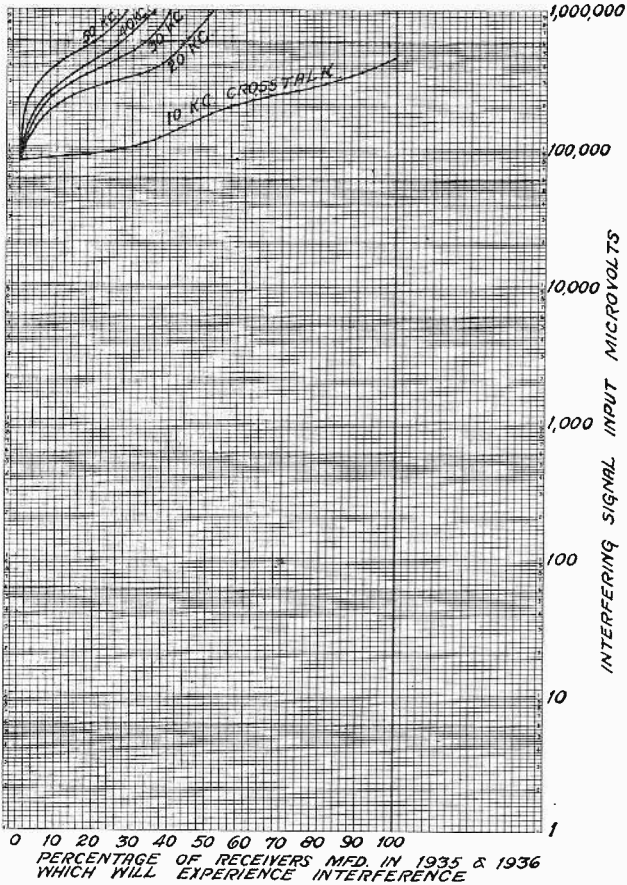

Fig. 16

cross modulation is still very much a factor in present-day receivers, and that reduction of cross modulation would materially improve the effective selectivity for large signal inputs.

We may conclude from these curves that for receivers manufactured in 1935 and 1936, with a desired signal of 5000 microvolts, if no more than 20 per cent of such receivers are to experience cross talk interference (interference 30 decibels below desired signal) the interfering signal inputs given below are the maximum permissible.

Frequency Separation	Permissible Interfering Signal Input
10 kc	11 mv
20 kc	142 mv
30 kc	300 mv
40 kc	446 mv
50 kc	1000 mv

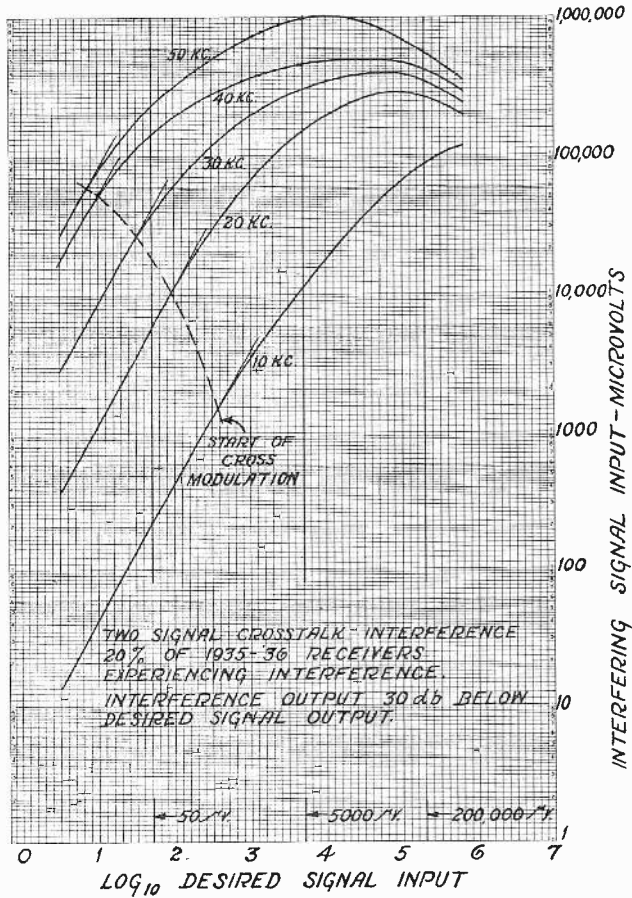

Fig. 17

Adjacent Channel Heterodyne

As is well known, simultaneous application to a detector of two carriers differing in frequency by ten kilocycles will give a resultant ten-kilocycle beat frequency output. Since this phenomenon is due to the carriers only, which need not be modulated, the masking effect noted above does not occur. The ten-kilocycle frequency output then is a function only of the strength of the two carriers and the fidelity of the receiver. Most receivers attenuate ten kilocycles greatly and the

heterodyne interference would be very serious indeed if this were not the case. Furthermore, the reproducer (loud-speaker) of most receivers has small output at ten kilocycles, and because of the ear characteristic, audibility of frequencies of the order of ten kilocycles is much less than that of one- to two-kilocycle frequencies.

In order to arrive at a conclusion as to the relative output of desired program and heterodyne beat note which could be tolerated, a test was made using two signal generators, either or both of which could be modulated as desired. The output of the signal generators was

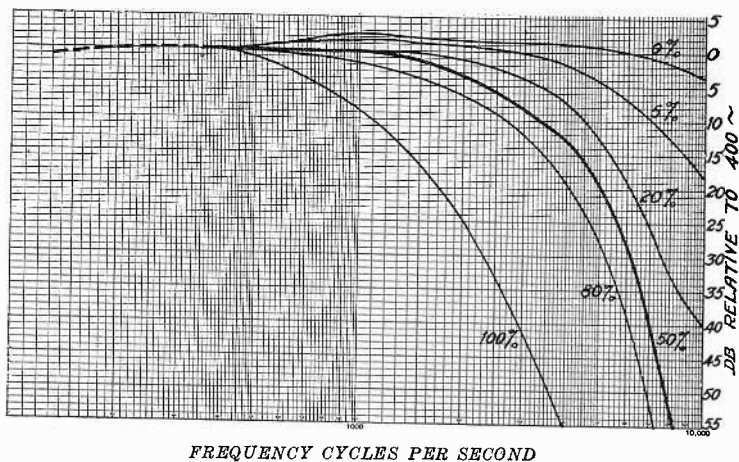

Fig. 18

applied to a radio receiver whose fidelity had been measured. It was determined from observations made by numerous observers that the heterodyne beat should be 37 decibels below the desired program output for freedom from interference.

From Figs. 18 and 19 we see that the average receiver was down 60 to 65 decibels at ten kilocycles, but the average variable selectivity receiver when operated in the wide band condition was down only 15 to 30 decibels at the same frequency, as is shown by Fig. 20. The question arises as to whether the wide band receivers should be protected from heterodyne interference. Certain of the variable selectivity receivers incorporated a special filter for eliminating the ten-kilocycle beat note. This type of receiver is found usually in the higher price classes, but all wide band receivers could incorporate such filters if found necessary.

The curves of Figs. 18 and 19 were made with the tone control adjusted for maximum high-frequency response. The average curve

with tone control adjusted for minimum high-frequency response indicates the ten-kilocycle output under this condition is ten decibels

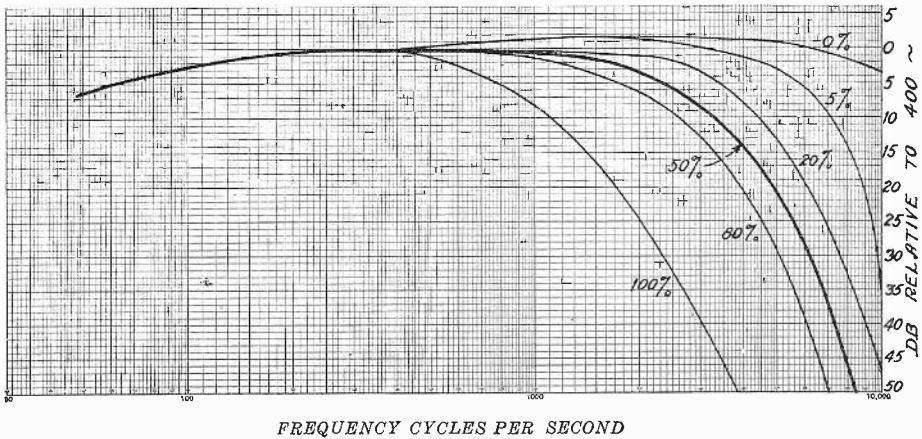

Fig. 19

less than those shown in Figs. 18 and 19. While the selectivity of receivers prior to 1935 was in many cases less than that of 1935 and 1936 receivers, yet the response at ten kilocycles was little higher, as the

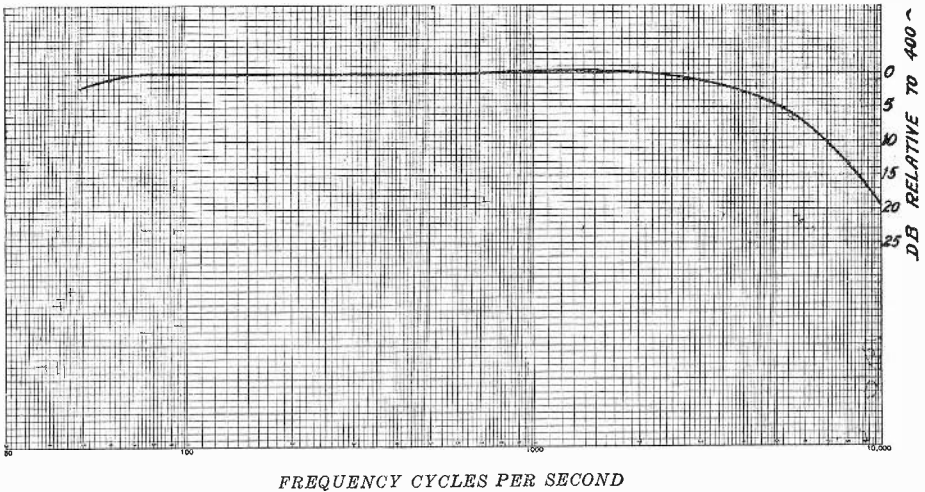

Fig. 20

progress of the art has tended toward a selectivity curve having less attenuation near resonance but more attenuation at frequencies remote from resonance.

The curves of Fig. 19 would indicate that for not more than 20 per cent of receivers manufactured in 1930 to 1936 to experience heterodyne interference 37 decibels below a desired program having 30 per cent modulation, the interfering carrier should not exceed 0.425 times the desired carrier. This is explained below.

The requirement that the heterodyne note be 37 decibels below the desired program was arrived at by observation as described above. This interference level is not as definite as that for cross talk interference because of variation in characteristics of the ear of individuals at ten kilocycles. To some of the observers the ten-kilocycle beat was virtually inaudible, while to others even the level 37 decibels below desired program gave very objectionable interference. The 37-decibel figure was that chosen by the majority of the observers.

The fidelity curves of Fig. 19 for 1930-1936 show that only 20 per cent of receivers have ten-kilocycle response less than 40 decibels down, but this curve was for a 30 per cent modulated signal. The heterodyne beat is between carriers only, so that the heterodyning carrier must be reduced to 0.3 times or 10.5 decibels below the desired carrier to allow for the 30 per cent modulation used in the fidelity measurements. With the heterodyning carrier 10.5 decibels below the desired carrier, the beat note will be 40 decibels below the desired program, but only 37 decibels is required, so that the interfering carrier can be three decibels greater or 7.5 decibels below the desired carrier, which gives the ratio of 0.425 to 1 between interfering and desired signal levels.

Beating Side-Band Effects

Another condition arises in receivers where the side bands of one station beat with the carrier of another station, which causes sum and difference tones. This effect has been aptly called "monkey-chatter," from its characteristic sound when heard on a receiver.⁷ Consider two carriers separated by ten kilocycles, with one of them modulated by a 3000-cycle tone. If any appreciable amount of this three-kilocycle side band is present at the detector along with the other carrier, sum and difference frequencies, namely, seven and thirteen kilocycles, will result. Because of the fidelity characteristic of receivers only the difference term need be considered. Thus a low-frequency side band, when it beats with an adjacent carrier, produces a high audio frequency, and vice versa.

Evaluation of the input ratio of field intensities for protection against monkey-chatter is extremely complex because of the large

⁷ Stuart Ballantine, "High quality radio broadcast transmission and reception," *Proc. I.R.E.*, vol. 22, pp. 564-629; May, (1934).

number of factors involved. Receiver selectivity discriminates against low modulation frequency side bands more than against higher ones, but generally high frequencies modulate a carrier to lesser depth than low ones. Also the higher audio frequencies become attenuated in the audio system of the receiver more than the low ones, etc. It would be necessary to have data on receiver selectivity excluding the audio-frequency system, and receiver fidelity excluding selectivity ahead of the detector, to arrive at conclusions, since the audio frequency suffers an inversion in this type of interference. It might be expected, and experience indicates, that this interference will be somewhat worse than adjacent channel cross talk interference, but not as severe as heterodyne carrier beats.

A direct measurement would be the best means of determining the susceptibility of a given receiver to beating side-band interference, and it is hoped that such measurement data will be available in the future.

The method would be that of the two-signal interference test with ten-kilocycle separation between the desired and interfering signals, and with the interfering carrier modulated by audio frequencies of perhaps two to seven kilocycles. The interference output measured would be that of the difference frequency between ten kilocycles and the modulating frequency of the interfering carrier. The modulation level should be decreased for the higher audio frequencies in order to duplicate service conditions.

Transmitter Overmodulation

It can be appreciated that overmodulation of a transmitter makes the monkey-chatter worse on a given receiver because of the higher frequency side bands generated by the overmodulation. A transmitter which emits normal and correct side-band frequencies to eight kilocycles can contribute to program fidelity on receivers capable of reproducing such frequencies (so-called "high fidelity" receivers), but when high-frequency side bands arise from overmodulation or any other transmitter nonlinearity, the result is distortion and monkey-chatter without any attendant benefit to fidelity, the effect becoming worse the better the receiver is from the standpoint of reproduction of high frequencies.^{7,8}

Flutter Effect

When two transmitters operate on the same assigned frequency that is, their carriers differ in frequency by less than 50 cycles, effects

⁸ I. J. Kaar, "Some notes on adjacent channel interference," Proc. I.R.E., vol. 22, pp. 295-313; March, (1934).

occur which have commonly been called "flutter." The beat frequency between carriers may be heard if it is above the lower limit of audibility, and in addition the interference of the undesired program if different than the desired program, or program distortion may occur if the two transmitters are modulated by the same program.

These effects have been studied both mathematically and experimentally by several observers, in particular the case where the two programs are the same.⁹ Since the mathematical analysis has been covered by several writers, and since experimental observation is necessary to evaluate the results as to effect on the listener, the experimental method was employed. The results have been compared with those of other observers, where results for the same conditions are available in the literature.^{10,11,12}

The only receiver characteristics which have any effect on these phenomena are the type of detector and the automatic volume control system. Since the vast majority of receivers now have linear detectors, and automatic volume control systems nearly enough alike that results will be the same, conclusions drawn from observations on any one typical receiver will apply generally, and the required ratio of field intensities may be determined directly.

However, the characteristics of the two simultaneously applied signals affect results greatly, so consideration must be given to a number of cases.¹⁰ The factors which are of importance are:

1. Relative intensity of the two carriers.
2. Whether the two signals have the same or different programs.
3. The frequency difference between the carriers.
4. The modulation depth of the respective signals.
5. The phase difference between the modulation of the two carriers when the program is the same.
6. The phase difference between the carriers when the frequency of the carriers is the same and there is no audio phase displacement.

In the observations made for this test, the modulation depth averaged 30 per cent but varied about that level in accordance with the program or programs. It is not believed practical to impose the con-

⁹ Hans Roder, "Superposition of two modulated radio frequencies," *Proc. I.R.E.*, vol. 20, pp. 1962-1970; December, (1932).

¹⁰ G. D. Gillett, "Some developments in common frequency broadcasting," *Proc. I.R.E.*, vol. 19, pp. 1347-1369; August, (1931).

¹¹ C. B. Aiken, "A study of reception from synchronized broadcast stations," *Proc. I.R.E.*, vol. 21, pp. 1265-1301; September, (1933).

¹² P. P. Eckersley, "On the simultaneous operation of different broadcast stations on the same channel," *Proc. I.R.E.*, vol. 19, pp. 175-194; February, (1931).

dition of zero phase angle between either the respective audio or carrier frequencies, so the condition causing most severe interference, namely 180 degrees phase difference between the audio components applied to the two carriers, was chosen. An observation was made for the condition of zero-degree audio phase displacement, and it was found that any relative signal intensity ratio of the two carriers could be used without interference. However, it is felt that this observation is not of practical importance, in most cases, because of the difficulty of maintaining zero-degree phase displacement for all frequencies, over wire lines connecting transmitters separated appreciable distances.

When the signals had modulations from different programs, the permissible relative carrier intensities did not change appreciably with differences between carrier frequencies of one to 25 cycles. There was a difference in intensity ratio required, depending upon whether the desired program consisted of speech or music modulation, as the continuous tones of music modulation obscured the interfering program more than when the desired signal had speech modulation. With music on the desired signal, an input voltage from the desired signal ten times that of the undesired signal gave freedom from interference, whereas when the desired program was speech, it was required to be 20 to 30 times that of the interfering signal. Since this case is that of two stations entirely independent in operation, the programs may be of any type and protection from interference should be had for the worst conditions. Accordingly, a field intensity ratio of not less than 20 to 1 appears desirable for satisfactory degree of freedom from interference.

The table below gives the results of our observations when two stations have the same program modulation, the phase displacement of modulation being 180 degrees. The receiver had automatic volume control and a linear detector. The symbol Δf designates the difference in frequency of the two carriers, and the several columns are conclusions by different observers as identified. The figure in each column for a given Δf is the number of times the field intensity of the desired signal must exceed that of the undesired signal for practical freedom from interference.

RELATIVE FIELD INTENSITIES—SAME PROGRAM MODULATION

Δf	A	B	C	D
0 cycles	5	4	3.16	5
1	10		10	
10	9		10	10
25	12		14	

A. RCA observations, September, 1936.

B. C. B. Aiken, Proc. I.R.E., September, 1933.

C. G. D. Gillett, Proc. I.R.E., August, 1931.

D. P. P. Eckersley, Proc. I.R.E., February, 1931.

The agreement among the several observers is sufficiently good that conclusions may be drawn therefrom with confidence.

Particular Effects for Frequency Separation Greater than 50 Kilocycles

Certain types of interference exist when the desired and interfering signals are widely separated in frequency. These effects occur only for certain discrete frequency separations and are noticed principally on superheterodyne receivers. The major of these effects are the following:

(a) *Two stations separated by the intermediate frequency.*

When two stations in the same community differ in frequency by an amount equal to the intermediate frequency of a given superheterodyne receiver, and are of sufficient strength to be present simultaneously at the translator tube (first detector), an output at intermediate frequency will occur, although the receiver be tuned to neither of them. Discrimination against this type of interference is had only by the selectivity of the portion of the receiver preceding the translator.

(b) *Image response.*

With a superheterodyne receiver tuned to a given signal and a second signal present, differing from the first by twice the intermediate frequency, the second signal will combine with the local oscillator to produce output at intermediate frequency.

(c) *Direct intermediate-frequency response.*

When there is a signal present whose frequency is the same as that of the intermediate frequency of a given receiver, and the circuits preceding the translator do not sufficiently attenuate it, it will be amplified by the intermediate-frequency amplifier and appear as interference.

(d) *Second harmonic of the intermediate frequency.*

When a signal is applied whose frequency is twice that of the intermediate frequency, or differs therefrom by a small amount, there appears in the output of the translator in addition to the desired intermediate-frequency output, corresponding to the difference between signal and oscillator frequencies, a second order effect of the difference of twice the signal frequency and the oscillator frequency.¹³ It will be seen that when the signal frequency is twice the intermediate frequency, each of these effects will produce an intermediate-frequency

¹³ M. J. O. Strutt, "On conversion detectors," Proc. I.R.E., vol. 22, pp. 981-1005; August, (1934).

output, and since they vary at different rates as the receiver is tuned, a whistle will be heard at that point. Selectivity cannot discriminate against this whistle as only a single signal is involved. At frequencies differing slightly from twice the intermediate frequency, a spurious response may also occur from the same cause, which will give interference but not a whistle.

All of the foregoing effects as well as some minor ones due to various combinations of harmonics of the oscillator with harmonics of the signal, are seen to depend in any individual case on the value of intermediate frequency used. Therefore a frequency separation condition which will cause interference in one receiver, will not cause interference in a receiver with a different intermediate frequency. There have been many different intermediate frequencies used, mainly in an attempt to avoid one or more of the types of interference noted above.

Survey of the industry, by models introduced in 1935, discloses use of the following intermediate frequencies:

Intermediate Frequency	Per Cent of Models in Which Used
115 kilocycles	0.14 per cent
132	0.40
172.5	0.40
175	4.60
177.5	0.40
181.5	0.14
250	0.14
252.5	0.60
260	0.40
262	0.50
264	0.70
345	0.40
360	0.40
450	7.70
456	48.40
458	2.90
460	12.00
463	0.40
465	15.40
470	0.40
472.5	1.30
480	1.00
485	0.14
490	0.14

It is to be noted that 86.8 per cent of models had intermediate frequencies between 450 and 465 kilocycles.

Average Image and Intermediate-Frequency Response Ratios for Receivers Manufactured in 1935

A survey of the industry for receivers manufactured in 1935 gave the following data for average image and intermediate-frequency response ratios. These data indicate the order of interference to be expected from these sources.

The image and intermediate-frequency response ratios are both affected by the amount of preselection and the intermediate frequency

used, so that the following data have been divided into two- and three-gang condenser models. The two-gang condenser models have been further divided into two intermediate-frequency ranges, those receivers having 175 to 350 kilocycles intermediate frequency being put into one category. The three-gang condenser receivers had a wider range of intermediate frequencies and were divided into three categories, 175 to 200 kilocycles, 200 to 350 kilocycles, and 350 to 480 kilocycles.

The presence or absence of a wave trap also affects the intermediate-frequency response ratio, but no account is taken of that factor in the data below. Likewise, those receivers having image frequency rejection systems have not been separated from the others.

The image response ratio at a given frequency is the ratio of the sensitivity measured, with the receiver tuned to that frequency, when the applied frequency differs from the tune frequency by twice the intermediate frequency, to the sensitivity measured when the applied frequency is the same as the frequency to which the receiver is tuned.

The intermediate-frequency response ratio with receiver tuned to a given frequency is the ratio of the input of intermediate frequency applied to the antenna required to produce standard output, to the input required to produce the same output when the applied frequency is the same as that to which the receiver is tuned.

Image Ratio, Averages

Data are given under each intermediate-frequency category from measurements with the receiver tuned to each of three test frequencies, 600, 1000, and 1400 kilocycles.

TWO GANG

Inter. Freq.	175-350			350-480		
	600	1,000	1,400	600	1,000	1,400
No. of Cases	2	2	2	11	10	11
Max. Ratio	21,300	2,600	955	845	490	228
Min. Ratio	6,460	1,100	188	57	40	20
Ave. Ratio	13,880	1,850	571	365	228	111

THREE GANG

Inter. Freq.	175-200			200-350			350-480		
	600	1,000	1,400	600	1,000	1,400	600	1,000	1,400
No. of Cases	13	13	13	9	9	9	18	18	18
Max. Ratio	62,000	11,000	2,200	61,600	18,700	8,500	150,000	47,200	24,800
Min. Ratio	2,420	730	115	6,400	2,100	1,540	1,630	445	278
Ave. Ratio	11,018	3,299	722	21,555	7,121	2,261	49,423	14,961	6,273

Average image ratio for two-gang condensers all frequencies = 1056.

Average image ratio for three-gang condensers all frequencies = 14,550.

Intermediate-Frequency Response Ratio, Averages

Data are given under each intermediate-frequency category from measurements with the receiver tuned to each of three test frequencies, 600, 1000, and 1400 kilocycles.

TWO GANG

Inter. Freq.	350-480		
Test Freq.	600	1,000	1,400
No. of Cases	4	7	2
Max. Ratio	92.1	750	81
Min. Ratio	10	17	47
Ave. Ratio	34.8	143	64

THREE GANG

Inter. Freq.	175-200			200-350			350-480		
	600	1,000	1,400	600	1,000	1,400	600	1,000	1,400
No. of Cases	3	9	2	2	5	—	11	15	7
Max. Ratio	17,200	90,000	31,000	11,100	75,500	—	13,300	23,000	15,800
Min. Ratio	4,600	15,000	30,000	960	875	—	69	840	805
Ave. Ratio	11,267	52,944	30,500	6,030	27,361	—	2,502	6,076	6,259

Average intermediate-frequency response ratio two-gang condenser all frequencies = 98.
 Average intermediate-frequency response ratio three-gang condenser all frequencies = 16,345.

(e) Direct pickup.

When a receiver is subjected to a strong field intensity, some of the energy may reach the receiver via other than the antenna, due to exposed wiring, etc. Energy picked up by later amplifying stages of the receiver will of course be amplified less than signals from the antenna, but the selectivity may be nil for the signal directly picked up, and interference result if the signal is sufficiently intense.

This type of interference is a function of type of wiring and shielding of a receiver, but can occur in any receiver not sufficiently well protected by design and construction. From data available it is believed that field intensities greater than 1.0 volt per meter are required to produce direct pickup interference, on well-designed receivers.

Cross Modulation from Extraneous Systems

Especially interesting, and observed and understood only within the past year, is the effect of cross modulation from exterior radio systems. This cross modulation exists outside the radio receiver, and may cause serious difficulty with reception on any receiver. Such difficulty has been found in certain receiver locations where field intensities of 0.1 volt per meter or greater are encountered. In addition to high field intensity, a nonlinear element or rectifier must be present. The

môst common source is in power wiring, and is much more prevalent where the power mains are of the exposed, overhead type. The rectifier may be a poor ground connection, giving a copper-, zinc-, or aluminum-oxide rectifier, for example. In some instances a poor connection in the antenna circuit itself may be the source of trouble. In view of the widespread use in homes of poorly installed antennas, leadins, and ground connections, the authors believe that cases of interference from this cause are numerous, in districts having high field strengths, although unsuspected until recently.

When two or more signals of sufficient intensity are present, together with the requisite rectifying condition, spurious frequencies result. These spurious frequencies are integral multiples of each frequency, sum and difference frequencies, the difference between twice one frequency and the second, etc. In general, it is only the difference between twice one frequency and the second frequency which causes responses falling in the broadcast band.

It is possible that this cause of cross modulation is responsible for those cases of interference which have been observed in Europe, ascribed to nonlinear action in the propagation path and called the "Luxembourg Effect." Calculations from frequencies of all signals present at the receiving location with field intensity of about 0.1 volt per meter or more, will answer the question.

CONCLUSIONS

The various causes of interference with radio reception by undesired signals have been described, and the ability of present-day receivers to discriminate against interfering signals has been investigated. Quantitative conclusions were obtained for some types of interference and not for others.

Cross Talk

The following table is a résumé of these results and illustrates the permissible strength of interfering signal when the desired signal has a strength of 5000 microvolts, and not over 20 per cent of the receivers in use are to experience this type of interference.

PERMISSIBLE INTERFERING SIGNAL INPUT FOR 20 PER CENT OF RECEIVERS MANUFACTURED 1930-1936 TO EXPERIENCE INTERFERENCE.

Frequency Separation	Permissible Interfering Signal Strength (Desired Signal 5 mv)
50 kc	1000 mv
40 kc	450
30 kc	225
20 kc	100
10 kc	6.75

Adjacent Channel Heterodyne

From the data given, an interfering signal separated ten kilocycles from the desired signal may not exceed a strength of 212 microvolts, if not more than 20 per cent of receivers in use are to experience heterodyne beat interference.

The adjacent channel heterodyne beat is the most limiting condition for receiver selectivity, and receivers would be improved by the adoption of suitable filters to limit this heterodyne beat. The heterodyne beat limitation has been calculated from measurements of receiver fidelity, but direct measurement by simultaneously impressing on the receiver two carriers separated by ten kilocycles is recommended, since it arrives at the desired data directly and in many cases receiver fidelity measurement is not extended to ten kilocycles, so that fidelity data for calculating beat interference may not always be available. Additional data on the reaction of individual observers to a ten-kilocycle interfering tone is needed because of differences of auditory perception of this frequency by different individuals.

Side-Band Beat Interference

The need for measurement data on susceptibility of receivers to side-band beats was disclosed by this investigation, and here also a direct measurement method is suggested as the best means of obtaining the necessary data.

Transmitter Overmodulation

Interference and distortion resulting from overmodulation of transmitters is not primarily a receiver effect. Moreover this type of interference may be expected to diminish in severity because of improved transmitter operation and the probable eventual adoption of automatic overmodulation control.

Flutter Effect

Interference between stations operating on the same assigned frequency is not a function of receiver selectivity, and the following conclusions result directly from experimental observations and are valid for all receivers in use today.

Frequency Deviation	Permissible Interfering Signal (Desired Signal 5 mv)
0-50 cycles, different programs	0.25 mv
25 cycles, same program	0.42
10 cycles, same program	0.55
1 cycle, same program	0.50
0 cycles, same program	1.0

Particular Effects for Frequency Separation Greater than 50 Kilocycles

Insufficient quantitative data exist for many of the types of spurious responses and beat interferences which fall in this category. General field experience indicates that interfering signal inputs of 0.5 volt are permissible on the basis that not more than 20 per cent of receivers in use will experience interference of this type.

Spurious responses are largely influenced by receiver design. They are aggravated by higher field intensities. In view of the trend toward higher field intensities, it appears that more attention to this characteristic by receiver designers is desirable.

External Cross Modulation

If two signals are present with 100 mv/m or higher field intensity, this factor may give interference, provided a rectifying condition exists in or near the antenna. In locations where the rectifying condition is absent, field intensities of over 1.0 v/m will not cause interference from this source.

It is seen from the data presented that the single-signal method of selectivity measurement does not give useful results under many conditions encountered in actual usage, and that the two-signal interference test should always be used to obtain a representative measure of effective receiver selectivity. When starting this investigation it was found that there existed very little data on receivers which had been taken by the two-signal method. It is to be hoped that more general use will be made of this method in the future.

The results obtained by the two-signal method show that data for interference inputs of greater than one volt would be desirable, especially in view of possible increase in power of broadcast transmitters in the future.

From the two-signal data obtained it is seen that cross modulation plays a large part in receiver selectivity for even moderate signal inputs, and that the selective circuits of receivers could be made more useful in discriminating against interfering signals by improvements in tube and circuit characteristics to minimize cross modulation.



MULTIPLE AMPLIFIER*

By

L. A. KUBETSKY

(People's Commissariat of Communications, Moscow, U.S.S.R.)

Summary—The development, by the author, of amplifying tubes utilizing secondary emission is discussed. Various designs are shown, including the latest type which is described as possessing the quality of small dimensions, high sensitivity (10–100 amperes per lumen), high over-all amplification (10^6), high voltage output, minimization of noise, absence of microphonics.

The characteristics of these tubes are mentioned and their application for such use as television and talking pictures are included.

THE amplification of electronic currents by means of secondary emission presents one of the most important problems of today and introduces into electron technique an entirely new principle promising developments in many fields.

Some information bearing on the question can be found in technical literature dealing with the recent experimental work of Farnsworth and Zworykin.¹

In the present paper a brief description is given of similar research carried out at the All-Union Institute for Television, Department of Electronic Devices.

The investigations are based on the definition principle of multiple amplification of the secondary emission, given by the author in 1930,² which consists of the repeated conversion of the energy of a stream of secondary electrons into another more powerful secondary electron emission. It had previously been suggested³ that use might be made of the emission of secondary electrons from a set of electrodes, each of which, when struck by the electrons from the preceding one, becomes the source of a new, more powerful emission. An arrangement of the kind is shown⁴ in Fig. 1.

It consists of several electrodes with highly efficient emitting surfaces arranged in such a way that the secondary electrons produced at the first electrode under the influence of the primary beam are drawn towards the next electrode causing a considerably increased emission

* Decimal classification: R330×R583. Original manuscript received by the Institute, July 16, 1936.

¹ *Jour. Frank. Inst.*, October, (1934); *Electronics*, November, (1935); *Wireless World*, November, (1935).

² Certificates No. 24040 and No. 45765. Application for Patent 74242, 1930.

³ Joseph Slepian, U. S. Patent No. 1450265, 1919; U. S. Patent No. 1748386, 1926; English Patent No. 364006, 1930.

⁴ Given in the description to certificate No. 24040 (1930).

of secondary electrons at its surface; these again are drawn towards the next electrode, and so on, producing an avalanche-like increase of the electronic current in the evacuated space.

Thus, if the coefficient of secondary emission be denoted by σ , i.e., the ratio of the secondary to the primary current $\sigma = i_2/i_1$ for a given potential difference between two adjacent electrodes, then the growth of the electronic current can be expressed as follows

$$I_n = i_1 \sigma^m \quad (1)$$

where i_1 is the primary current striking the first electrode, I_n , the current collected at the last electrode and m , the number of stages.

The above formula clearly expresses a geometrical progression.

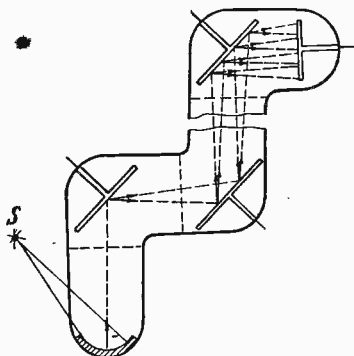

Fig. 1—Early type of elementary secondary emission amplifier.

The same expression is obtained for the amplification in a multistage electron tube amplifier with equal stages. With regard to amplification, the above system is seen to be equivalent to a multistage amplifier, but possesses the further advantage that the amplification is purely electronic in character and takes place in a single evacuated space.

It is this latter circumstance which determines the superiority of cumulative secondary emission over the usual multistage electronic tube amplifier, the process being entirely free from the disturbing influence of extraneous factors, such as the variation of resistance owing to frequency and phase distortions, or the Schrott-effect due to the direct-current component of the electronic current in the tube.

These advantages are very important and the cumulative principle might be expected to produce a complete change in electronic technique, especially since the present state of development allows the use of electronic tubes of much simpler design and smaller size than the tubes hitherto used. At the same time, with the new device, a million-fold amplification can be obtained.

The first practical devices, constructed and tested in 1934, were of the type shown in Fig. 2. As the design⁵ is still of interest from the con-

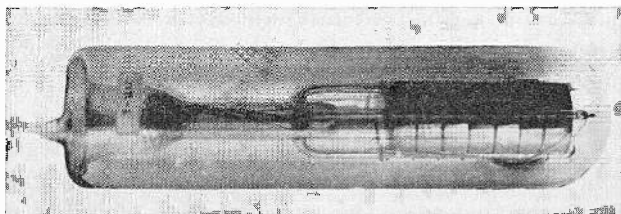

Fig. 2—Secondary emission amplifier with ring electrodes.

structional point of view, a brief description follows. The general principle of the design is illustrated in Fig. 3. The electrodes of thin silver are in the shape of cylindrical rings and a special electrode is

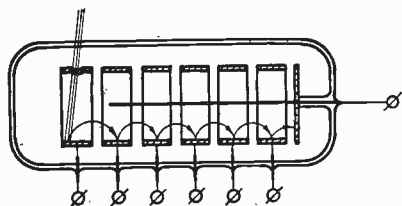

Fig. 3—Schematic section of Fig. 2.

placed along the axis. Holes provided in the rings facilitate the mounting and handling of the device. The inner surface of the cylindrical electrodes are treated with oxygen and cesium in a way similar to that

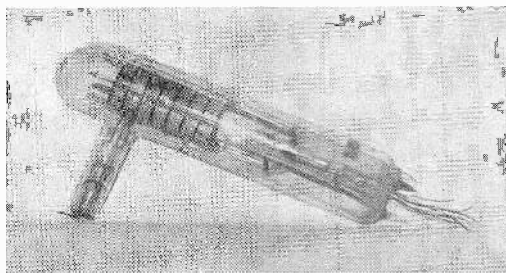

Fig. 4—Secondary emission amplifier with ring electrodes.

used in the construction of photocells to obtain photosensitiveness and high emissivity simultaneously. By means of a high resistance potenti-

⁵ Application for Patent No. 146218, April, 1934. Certificate of November 19, 1935.

ometer a potential step-up of some 200 or 300 volts is applied to each successive electrode.

The source of primary electronic emission consisted either of a thermionic cathode of small intensity the weak electronic emission of which was passed on through a slit to the first electrode, or of an illuminated photoactive surface. A tube of this kind using a thermionic cathode and a grid is shown in Fig. 4.

On the basis of certain theoretical considerations regarding the movement of electron streams in complex electric and magnetic fields, it is to be expected that when the arrangement is placed in a magnetic field of the required intensity and direction, the tracks of the moving electrons emitted from the inner surfaces of the ring electrodes will be

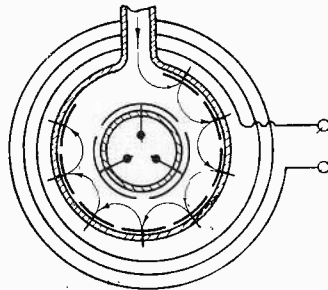

Fig. 5—Schematic section of Fig. 6.

as shown in the diagram. Since experimental tests completed in June, 1934, confirmed this view, devices containing six ring electrodes were constructed, the amplification being of the order of 1000.

Somewhat later, in September, 1934, the operation of the device was demonstrated to a number of highly qualified visitors, including both Soviet and foreign scientists.⁶ About the same time satisfactory results were obtained with the design shown in Fig. 5, a modification of the one previously described.⁷ A photograph of the tube is shown in Fig. 6. Tubes with twelve ring electrodes, i.e., twelve cascades, were also used and are shown in Fig. 7.

The above device, however, was lacking in simplicity, and other methods were developed to afford better facilities for mass production.⁸ With this end in view the inner surface of the glass was coated with a metallic film obtained by precipitation, and the film was afterwards subdivided into a number of separate parts by a special chemical method, Fig. 8.

⁶ Academicians Joffe, Chernysheff, Zworykin, etc.

⁷ Application for Patent No. 146218, April, 1934.

⁸ Application for Patent No. 166537, April, 1935.

Mounted electrodes are entirely absent, the process of splitting the film into separate electrodes occupies on the whole only a few minutes, no matter how primitive the method used.

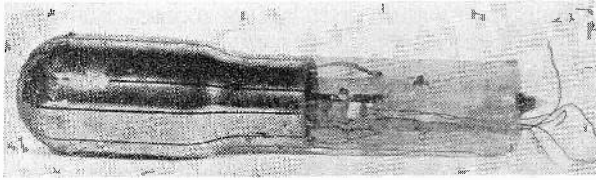

Fig. 6—Secondary emission amplifier with cylindrical array of electrodes.

The results obtained with these devices were summarized and presented on February 2, 1935, at a special meeting held in Leningrad⁹ at which a number of eminent Soviet specialists were present. Tubes with

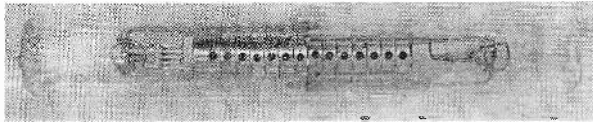

Fig. 7—Twelve-stage secondary emission amplifier with ring electrodes.

ten electrodes were demonstrated giving an amplification of the order of a 1,000,000, with a photosensitivity of one ampere per lumen.

MODERN TYPES OF CASCADE TUBES

A comparison of tubes containing mounted electrodes (Figs. 2, 6, and 7) with those with chemically separated metallic films on the glass

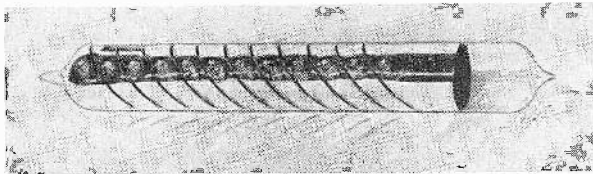

Fig. 8—Secondary emission amplifier with inclined electrodes deposited on glass wall of glass envelope.

walls (Figs. 8 and 9) showed that the latter presented many constructional and operative advantages, and all subsequent work was therefore confined in this direction. Designs of this kind are shown in Figs.

⁹ A stenographic report has been published in the *Jour. for Automatics and Telemechanics*, no. 1, (1936).

10 and 11. Fig. 12 represents a vertical section of the tube; on the inner surface of the glass a number of circular films are seen at an angle to the axis. Usually the films consist of colloidal silver precipitated from a special solution used for silvering and submitted to a special treatment in vacuum with active oxygen first and then with

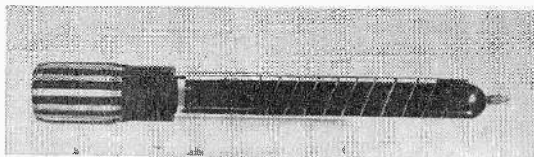

Fig. 9—Secondary emission amplifier with metallized glass electrodes.

cesium. No other metallic electrodes are employed. The use of inclined electrodes is a characteristic feature of this system. Part of a still more positive electrode is situated near any part of the preceding active electrode, so that a positive gradient is set up at the surfaces which emit secondary electrons, and the influence of space charge, as

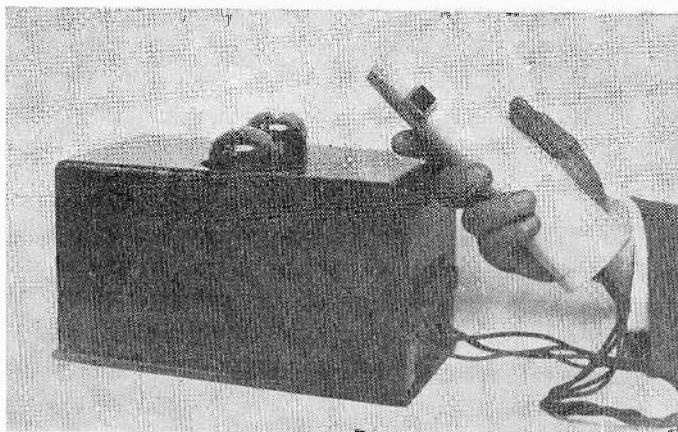

Fig. 10—Secondary emission amplifier (in housing) and voltage supply.

well as that of the negative electric field from those electrodes having lower potentials, is compensated.

The proposed construction presents many advantages and possibilities; in addition to extreme compactness and simplicity, it has the further merit of being free from microphonic disturbances.

Cooling conditions are also very favorable; the evolved heat is easily carried away across the thin glass walls by conductivity and

diffused over large surfaces by direct contact with thermal conductors. A simple calculation, supported by experimental evidence, shows that when the temperature of the inner electrode attains 100 to 150 degrees (which may be considered the maximum temperature in the case of an activated silver film) from five to ten watts will be carried off from

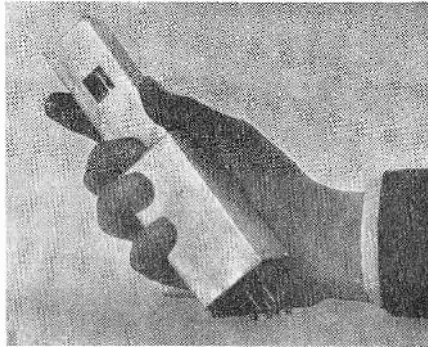

Fig. 11—Secondary emission amplifier in housing.

every square centimeter of surface, whereas an electrode mounted in vacuum would give off only 0.2 watt per cm^2 .

In the system described a millionfold amplification can be obtained, while its photoelectrical sensitivity attains some 100 amperes per lumen.

Since no complicated mounted electrodes are used, the dimensions of the tube can be considerably diminished; thus, tubes only 100

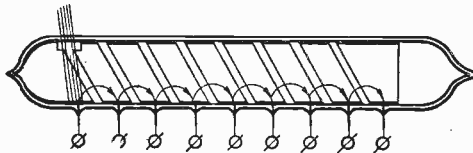

Fig. 12—Schematic section illustrating construction of amplifier with inclined electrodes deposited on interior wall of glass envelope.

millimeters long and 12 millimeters in diameter have been constructed in the laboratory; a photograph is given in Fig. 13. The general features of these tubes will be described below.

In some cases, it may be desirable to avoid the use of magnetic fields; for this reason, a tube is now being designed where magnetic fields are eliminated. The design is based on the use of a central elec-

trode a description of which was given by the author in 1934.¹⁰ At that time it was intended to use several truncated cones or other electrodes together with a central electrode (Fig. 14). Later on, a metallic wire

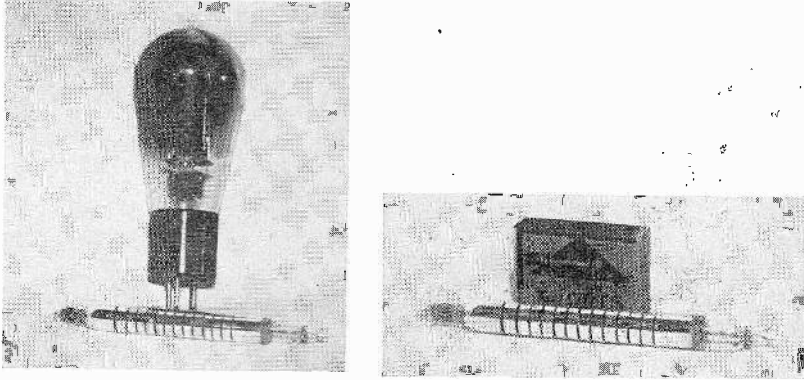

Fig. 13—Illustration of dimensions of modern secondary emission amplifiers.

was substituted and the truncated cones were replaced by rings (Fig. 15).

This type can be easily constructed by using the previous method of depositing the electrodes on the inner glass surface. The operation

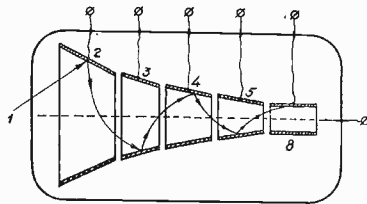

Fig. 14—Schematic section of secondary emission amplifier not requiring magnetic field for operation.

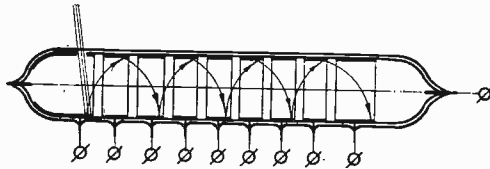

Fig. 15

of the tube requires a special distribution of the potential applied at the separate rings.

The characteristics of the tube and the amplification afforded do

¹⁰ Application for patent No. 146216. Certificate awarded February 12, 1935.

not differ much from those obtained in the devices previously described.

We also might mention some other systems suggested by the author in 1934 incorporating a series of activated grids or ribbed electrodes resembling a Venetian blind. The idea has been made use of in some later systems.

THE CHARACTERISTICS AND APPLICATIONS OF TUBES WITH SECONDARY ELECTRONIC EMISSION

The tubes, after manufacture, were submitted to a detailed study. Some of the experimental data obtained are given below.

The relation between the output current and the intensity of the incident light beam striking the photocathode was examined; the

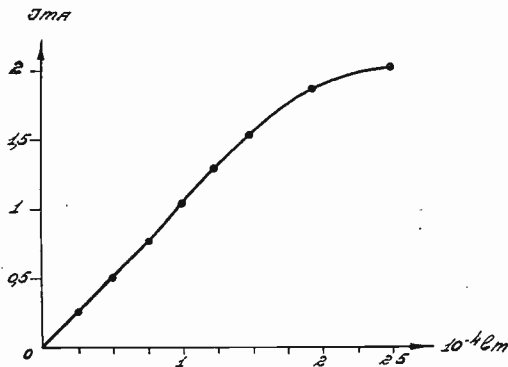

Fig. 16—Variation of output current with illumination.

results are plotted in Fig. 16, and show a linear relationship over a wide range of intensity in accordance with theoretical expectations.

In order to elucidate the nature of the process going on in the tube, the amplification was measured at each cascade. On the diagram of Fig. 17 the logarithms of the current in a given cascade are plotted against the number of the latter. It is easy to see that the amplification is almost uniform from one cascade to another, the emission ratio being nearly the same for all the rings. Equation (1) may therefore be used without considerable error.

Current potential characteristics were also obtained for the last cascade, and the maximum potential variations at the output which do not lead to notable distortion determined. These were found to depend to a large extent on the size and the shape of the anode. A curve of this kind (Fig. 18) refers to a tube with a large anode occupying considerable space and shows that large potential variations on the anode

(within the limits of some 200 to 300 volts) do not result in notable distortion.

The above fact shows that variations of the anode potential due to the output do not depend on those factors which determine the value of the initial current. In this respect, the tubes differ essentially from the conventional vacuum tubes, especially when grids are applied for the control of the primary electronic currents.

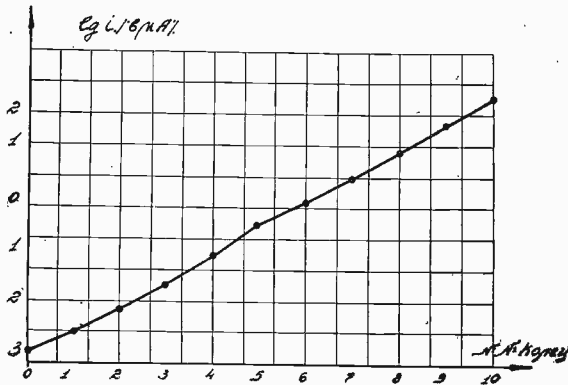

Fig. 17—Logarithm of the current value per stage plotted against the number of stages which illustrates the uniform amplification obtained in each stage.

The use of grids for the control of electronic currents in tubes with single secondary electron amplification had been suggested before by more than one author. However, these tubes have not been found to be of practical use, for direct amplification, owing to the impossibility of obtaining sufficiently high amplification. The latter fact is due to

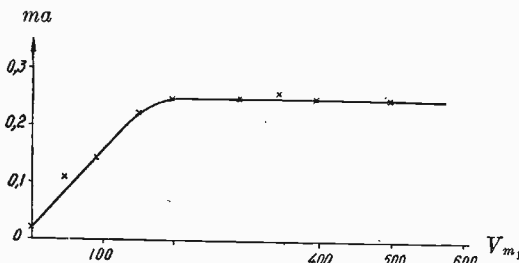

Fig. 18—Variation of output current with stage voltage.

the lack of materials with a high ratio of secondary emission. The maximum value which has been hitherto obtained does not exceed ten.

Given the development of multistage secondary emission electron tubes, we are in a position to reconsider the problem of amplifiers, generators, etc., which would differ essentially from the existing vacuum tubes.

Even in its present state of development, it is possible to visualize "filamentless" vacuum tubes with parameters similar to those of ordinary vacuum tubes.

Some attempts in this direction have already been made in our laboratory showing the possibility of controlling the electronic current in secondary emission electron tubes by means of special grids.

In this case, the characteristics are much like the grid characteristics of ordinary vacuum tubes. A tube of this type has been used as a detector and amplifier in several of the simplest radio receiving sets. The radio transmission, for which a good loud-speaker was used, ceased when the tube was shielded by the hand. The tube acted as an amplifier and detector simultaneously.

In this case, back coupling and complicated systems with several grids can be applied, just as in schemes with vacuum tubes, and even more successfully.

It must be acknowledged however that the design of secondary emission electron tubes used for potential amplification is not yet sufficiently developed and values as high as those in current amplification cannot be obtained. Secondary emission electron tubes have been operated directly on alternating current (fifty cycles) without any rectifier. The present designs have been successfully applied in the construction of sensitive photorelays, the latter being directly connected to the transformer without rectifiers. A relay of this kind can be operated from the alternating-current line and can be widely applied in various automatic devices.

The sensitivity of a tube, operating on alternating current, has been found to be ten amperes per lumen and even higher. We also tried to determine the maximum sensitivity of the tubes.

Experimental data, as well as theoretical considerations, show that the principle of electronic amplification outlined above secures a new method for amplifying the smallest electronic currents, far below those which can be amplified by means of the existing methods using vacuum tubes.

The usual factors by which the application of vacuum tubes is limited, such as fluctuations of the resistance, the Schrott-effect due to the direct-current component of the electronic current, phase and frequency distortion in the external circuit, are here absent, since the whole process of amplification is a purely electronic one and practically free from inertia.

All this is a point of the utmost importance in television problems, which were formerly handicapped in their development by the impossibility of amplifying very low currents.

The use of electronic tubes with secondary emission together with

some mechanical device, as for instance the Nipkow disk, will considerably increase the value of such systems.

M. Lurie of our Institute, by using a mechanical device intended for a sixty-line picture, succeeded in reducing the illumination of the object to one tenth of the usual while simultaneously diminishing the number of cascades.

Transmission could be obtained at an illumination of only 200 to 400 lux, which already approaches the usual lighting conditions. A

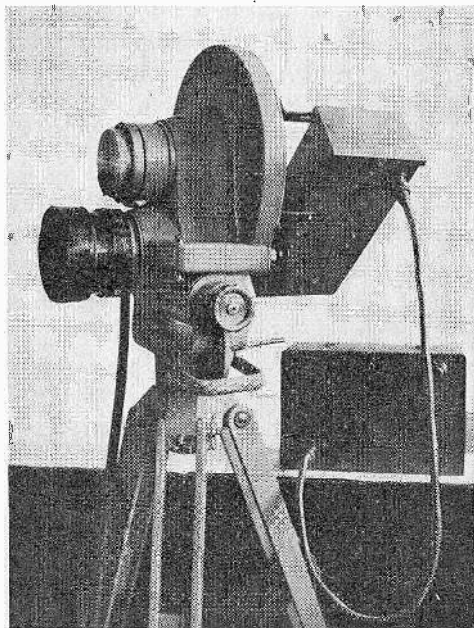

Fig. 19—Nipkow disk scanner with secondary emission amplifier.

photograph of the disk transmitter employed, with its tube and amplifier, is shown in Fig. 19.

The principle of electronic conversion, whether applied to transmitters using an electronic image or to a system collecting the charge, means an important advance in the development of this extremely complicated problem.

On the theory of cathode transmitters with collected charge proposed by Zworykin, we have devised a system¹¹ with the simultaneous use of collected charges and secondary electronic conversion. Second-

¹¹ "Television," Russian. Published by the Radio State Commission, (1935).

ary electronic conversion can be applied in such systems, due to a new method of converting the collected charge into component impulses which are not transmitted by capacitance coupling, as in Zworykin's system, but in the form of electronic emission accompanying the commutation process.

Further details on this subject may be found in the above-mentioned article.

Work now being conducted shows the possibility of a practical solution of the problem.

The use of secondary electronic emission for the detection and measurement of extremely low currents (those arising in high velocity processes, for instance) which it would be impossible to determine by the existing methods, opens new fields in various domains of physics, biology, medicine, etc., and will enable many scientists to attack problems hitherto considered hopeless because of the lack of technical means for the measurement of low emission currents.

In conclusion, we may mention the applicability of the above tubes for sound motion pictures and other acoustical problems. The tube presents a supersensitive photocell, with a sensitivity many hundred thousand times exceeding that of the most perfect vacuum cell, and its use promises to simplify considerably the whole of the sound equipment and to result in a reduction of noise and distortion. Tests have already shown that with a sensitive loud-speaker, the sound may be reproduced with sufficient loudness without even the use of a multi-stage vacuum tube amplifier. In this case, the loud-speaker must be connected directly to the tube. By using a one-stage amplifier, an output of five to ten watts can be obtained, which is quite sufficient for large lecture rooms.

Space does not allow us to consider even a small fraction of the many applications involved in the further development of the given principle. There is however no doubt that we are dealing with an entirely new principle of electronic technics which opens up new paths of development.

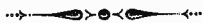

ALTERNATING-CURRENT RESISTANCE OF RECTANGULAR CONDUCTORS*

BY

S. J. HAEFNER

(Union College, Schenectady, New York)

Summary—New experimental data are presented for conductors having ratios of width to thickness of 1 to 1 to 2400 to 1 for frequencies up to eight kilocycles. These data are co-ordinated with existing data furnishing an experimental proof of the "principle of similitude." "Skin effect" formulas are also checked with the experimental data over the range of frequencies for which these relations apply.

INTRODUCTION

KNOWLEDGE of the alternating-current resistance of conductors is of importance both in the design of bus bars to carry high currents of low frequency and in the case of smaller conductors carrying high-frequency currents.

For isolated conductors of circular section the resistance ratio, i.e., the ratio of the alternating-current resistance to the resistance with direct current, may be calculated from the equation¹ developed by Maxwell, Heaviside, and Rayleigh.

The theory of the effect of neighboring current-carrying conductors in changing the resistance ratio on account of proximity effect leads to greater mathematical difficulties. The formulas² of Curtis, Carson and others enable it to be evaluated and show that for parallel cylindrical conductors the proximity effect is insensible if the axial spacing is fairly large, compared with the diameter of the cross section.

Dwight³ and Russell have given formulas for the resistance ratio of isolated tubular conductors and for the approximate evaluation of the proximity effect.

A complete treatment of the important case of conductors of rectangular cross section, however, leads to formidable mathematical difficulties. Dwight,⁴ it is true, has obtained a series formula for an iso-

* Decimal classification: R241.5 × R282.1. Original manuscript received by the Institute, November 23, 1936.

¹ A. E. Kennelly, F. A. Laws, and P. H. Pierce, "Experimental researches on skin effect in conductors," *Trans. A.I.E.E.*, vol. 34, part II, p. 1953; September, (1915).

² Harvey L. Curtis, "An integration method of deriving the alternating-current resistance and inductance of conductors," *Bur. Stand. Bull.*, no. 374, April, (1920).

³ H. B. Dwight, "Proximity effect in wires and thin tubes," *Trans. A.I.E.E.*, vol. 42, p. 850; June, (1923).

⁴ H. B. Dwight, "Skin effect in tubular and flat conductors," *Trans. A.I.E.E.*, vol. 37, part II, p. 1379; June, (1918).

lated thin strap but this converges only for cases where the resistance ratio is small. Cockroft⁵ has used the Schwarz-Christoffel⁶ transformation to derive an expression which gives the resistance ratio in terms of elliptic integrals, but this applies only to cases where the skin effect is very pronounced, the penetration being less than both of the cross-sectional dimensions.

Experimental determinations of the resistance ratio are therefore of importance to give quantitative results for the middle region and to supply observational data on which to base future theoretical work.

An important principle which is of great usefulness in co-ordinating the measured resistance ratios of different experimenters was pointed out by Dwight.⁷

The theory for isolated cylindrical conductors shows that the resistance ratio is a function of the single parameter $p = \sqrt{8\pi f A / \sigma}$ in which f = frequency, A = area of cross section in square centimeters, and σ = specific resistance in abohms per centimeter cubed. This may be written also as $p = \sqrt{8\pi f / R_{D.C.}}$ in which $R_{D.C.}$ = the direct-current resistance of one centimeter of the conductor (in abohms).

Noticing that the same parameter entered in his expressions for the resistance ratios of isolated tubular and thin rectangular conductors Dwight⁷ enunciated what he designated as the "principle of similitude;" viz., "A conductor, or a combination of conductors, of a certain proportionate shape and a certain value of $f/R_{D.C.}$ will have a definite value of $R_{A.C.}/R_{D.C.}$. This is true of isolated conductors and single phase and polyphase circuits. If this principle of similitude is adopted by those making skin effect tests, they will plot their test results on a base of $f/R_{D.C.}$ or $\sqrt{f/R_{D.C.}}$ instead of on a base of f as usually has been done. If the principle is adopted by designers who require to know skin effect values, they will make use of tests made on any size of conductors and at any frequency, and will correct them mathematically according to the principle of similitude."

An interesting theoretical proof of this principle applied to conductors of any cross-sectional shape has been contributed by J. Slepian.⁴

Admitting the generality of this principle, measurements made with large conductors at lower frequencies may be extended to the case of smaller conductors at higher frequencies and vice versa.

⁵ J. D. Cockroft, "Skin effect in rectangular conductors at high frequency," *Proc. Royal Soc.*, vol. 122, no. A790, pp. 533-542; February 4, (1929); also *Jour. I.E.E.*, (London), p. 400, July, (1928), for electrostatic analytical method.

⁶ W. M. Page, "Conformal transformation for isolated rectangular conductors," *Proc. Lond. Math. Soc.*, vol. 2, p. 321, (1912-1913).

⁷ H. B. Dwight, "Skin effect and proximity effect in tubular conductors," *Trans. A.I.E.E.*, vol. 41, p. 190; February, (1922).

Experimental proof of the truth of this principle is much to be desired. It will be furnished if measurements on the resistance ratio of conductors of very different sizes but of the same cross-sectional shape and measured by different methods and at different frequencies are found to yield the same resistance ratio if the parameter (p) is the same.

Several papers giving the results of experimental measurements have appeared in the early literature on the subject, notably that by Kennelly, Laws, and Pierce,¹ giving data for frequencies up to 5000 cycles and parameter (p) up to about 3.9. The measuring apparatus was a Heaviside mutual inductance bridge, using as a source one of several alternators of various ranges of frequency, and as a detector a pair of head telephones. This paper gives observations upon three copper strips of different widths and the same thickness as indicated in Table I. Another paper³ by Kennelly and Affel covered a frequency band of zero to 100 kilocycles furnished by an Alexanderson radio-frequency alternator. A null method employing a differential transformer was used to obtain the measurements, together with a pair of head telephones as the detector. Much smaller strips were measured in these experiments giving an average parameter range from zero to about 3.5. Three sets of strips were tested and are listed in Table I. A recent paper⁹ by H. C. Forbes and L. J. Gorman gives data for small conductors found at frequencies ranging from 22 to 287 kilocycles, the parameter (p) varying from zero to about 10. A "substitution method" was used, in which a vacuum tube oscillator as the source together with a vacuum tube voltmeter and a current indicating vacuum tube amplifier provided a means of comparing resistance ratios of rectangular shaped conductors with those of round copper conductors used as standards. The comparison was carried out by adjusting the circuit to resonance in each case by slightly altering the dimensions of the test loop thus avoiding detrimental proximity effects.

The object of the present paper is (a) to describe measurements of the resistance ratios of rectangular conductors with a considerable range of different cross-sectional shapes at frequencies up to 8000 cycles. The cross-sectional dimensions are such as to yield a range of parameter up to about seven; (b) to compare these measurements with those of the experimenters previously mentioned in the light of the similitude principle; and (c) to compare the theoretical formulas of Dwight and Cockroft with the existing experimental data.

¹ Kennelly and Affel, "Skin-effect resistance measurements of conductors to 100 kilocycles," *Proc. I.R.E.*, vol. 4, pp. 523-574; December, (1916).

⁹ H. C. Forbes and L. J. Gorman, "Skin effect in rectangular conductors," *Trans. A.I.E.E.*, vol. 52, no. 2, p. 516; June, (1933).

EXPERIMENTAL ARRANGEMENT

A conventional bridge network of the Wheatstone type was used, special precautions being taken to eliminate the residual errors inherent in this type of impedance network when the source potential is alternating. Referring to Fig. 1, the network is shown in which two adjacent branches were one-ohm noninductive resistors and two were impedances. The alternating potential source was a vacuum tube oscillator-amplifier with an output of approximately 300 milliwatts calibrated for frequency settings from 0 to 10 kilocycles within one per cent. Its

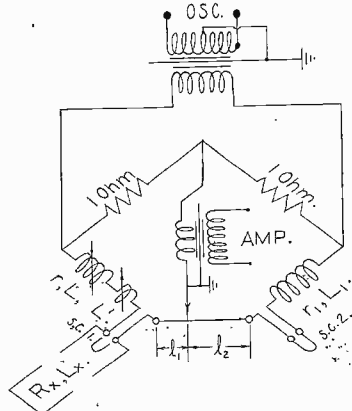

Fig. 1—Arrangement of bridge.

- R_e —Effective resistance of test sample.
- L_2 —Effective inductance of test sample.
- L —Brook's variable inductance.
- L' —Variable inductance of single turn of variable diameter.
- r —Resistance of inductometer plus turn plus twisted leads.
- L_1 —Inductance of fixed coil.
- r_1 —Resistance of fixed coil plus twisted leads.
- l_1, l_2 —Lengths of slide wire.

output was coupled to the bridge through an electrostatically shielded transformer giving the proper impedance ratio which was of the order of 600 to 5 ohms. For the detector two step-up transformers were used in conjunction with a three-stage resistance coupled amplifier and sensitive headphones making it possible to reach an exceedingly sharp balance.

It may be of interest to refer to several refinements in the design of the variable Brook's¹⁰ type inductometer, (L , Fig. 1) and Fig. 3. The coils of this instrument were wound with a conductor consisting of ninety strands of No. 30 B. & S. gage enamel-insulated wire thereby reducing to a minimum the change in its high-frequency resistance

¹⁰ Brooks and Turner, *Bur. Stand. Bull.*, no. 290, October, (1916).

brought about by a change of rotor setting. As discussed later this change of resistance may be a serious source of error in the bridge measurements. Special attention was given to contact points, as the resistance to be measured was quite small, generally in the neighborhood of

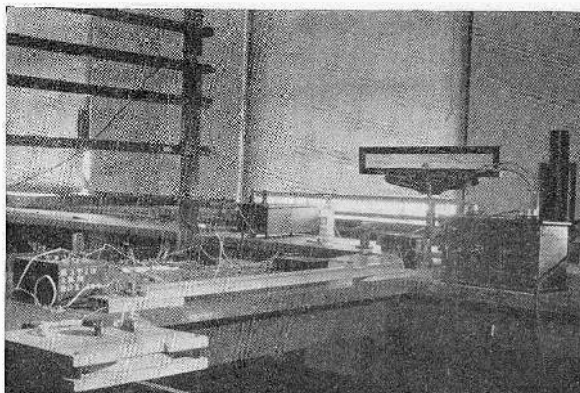

Fig. 2—Arrangement of apparatus.

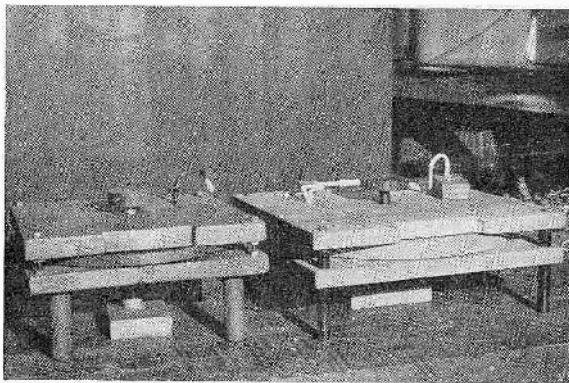

Fig. 3—Brook's inductometer.

0.01 ohm. For instance, in the inductometer, the leads from the rotor coils were led through the hollowed shaft of the instrument and joined electrically to the stationary coils by the use of mercury cups, (Fig. 4).

A "fixed" coil of convenient inductance was also wound of the same type of conductor (used here because of the ease of winding a stranded conductor of large cross section) and is L_1 , (Fig. 1).

Measurements were taken by the method of differences. To carry out this method two mercury cups were arranged in each impedance

arm with similar short-circuiting U-shaped copper bars thus making it possible to reach a balance with the test sample in the arm, and with the test sample short-circuited. The test sample was then transferred to the opposite impedance arm and the method of differences repeated.

Since the sample had a small inductance it was necessary to balance for equality of the inductance of the arms as well as their resistances. By the method of differences the resistance of the sample was obtained in terms of a length of slide-wire which consisted of about a meter of No. 9 B. & S. gage "Advance" alloy, having a negligible temper-

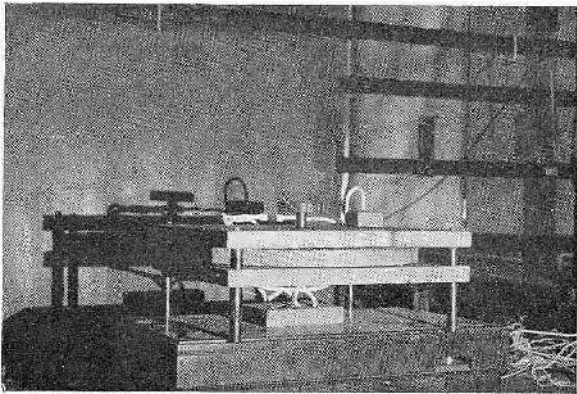

Fig. 4—Rotor and stator connection.

ature coefficient and negligible skin effect for the temperatures and frequencies encountered. At the maximum frequency, 8500 cycles, the parameter (p) had a value of about 0.5, giving $R_{A.C.}/R_{D.C.}$ a calculated value of 1.0003. This makes possible the evaluation of the resistance ratio as a ratio of lengths of the slide-wire, provided there is no change of resistance of other parts of the bridge arms when the sample is shorted. The change in inductance necessary to rebalance the bridge when the sample is removed was obtained from a change in the setting of the variable Brook's inductance which also included compensation for the small inductances of the portions of the slide-wire transferred from one side of the bridge to the other. The direct-current resistance of the variable was independent of the setting. The only change in the alternating-current resistance of the variable which can occur is that brought about by change in the proximity effect of the coils of the variable inductance (and capacity between them) due to the change of the relative positions of the coils.

This effect was proved to be negligible by the agreement of the

measured values of the resistance ratio of the round conductors with those calculated from the theoretical formula when the Brook's variable of larger range was used. Preliminary measurements, using the variable L of smaller value, indicated an appreciable change in the alternating-current resistance of the arm at frequencies above 3000 cycles because the relative movement of the coils necessary for balancing was

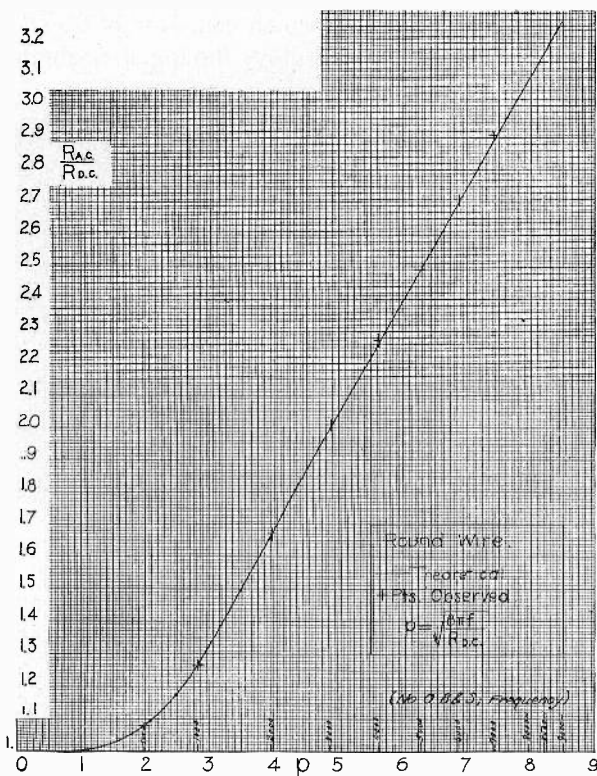

Fig. 5—Test and theoretical values, round wire.

much greater than with the larger variable. The use of the larger variable for an approximate inductance balance with a fine adjustment brought about by changing the shape of a single turn of wire was adopted as the procedure in the case of all the measurements here reported.

Four sets of readings were taken, two with the sample in the variable inductance arm, the second set being obtained by reversing the ratio arms, and two similar sets with the sample in the fixed inductance arm.

Referring to Fig. 1 the equations at balance are (primes denoting alternating-current readings)

$$\begin{aligned} \text{(a)} \quad & \text{loop shorted} \quad r' + \rho_1' = r_1' + \rho_2' \\ \text{(b)} \quad & \text{short removed} \quad r' + \rho_1'' + R' = r_1' + \rho_2'' \\ \text{(b)-(a)} \quad & R' = (\rho_2'' - \rho_2') - (\rho_1'' - \rho_1'). \end{aligned}$$

If α = resistance per centimeter of the slide-wire and D its length, then,

$$\begin{aligned} \rho_1' &= \alpha l' & \rho_1'' &= \alpha l'' \\ \rho_2' &= \alpha(D - l') & \rho_2'' &= \alpha(D - l''). \end{aligned}$$

Substituting these relations in (b) - (a)

$$R' = 2\alpha(l' - l'').$$

By a switching arrangement dry cells and a galvanometer were substituted for oscillator and headphones and the direct-current balance was obtained. The direct-current resistance

$$R = 2\alpha(l_1 - l_2)$$

and,

$$\therefore \frac{R'}{R} = \frac{l' - l''}{l_1 - l_2}.$$

An inspection of the last equation indicates that it is not necessary to calibrate the slide-wire to measure the resistance of the test samples. For purposes of comparison, however, it is highly desirable. Using a Leeds and Northrup potentiometer and a resistance standard the resistance of the slide wire was measured as 0.0008015 ohm per centimeter.

The loop of wire to be tested was supported on two wooden racks spaced about fifteen feet apart, and some distance from the bridge network. The total length of wire under test was generally about 65 feet. The loop was indoors and was arranged with parallel sides about two feet apart in a vertical plane. This distance was great enough to render proximity effect negligible as indicated by the experimental work already cited. Instead of a loop 30 feet long, it was convenient to fold the loop back upon itself.

Table I gives the physical dimensions of the specimens which were provided through the courtesy of E. S. Lee and J. J. Kehoe of the General Electric Company. These specimens consisted of soft-drawn copper with the edges slightly rounded as is the case in the commercial production of such strip conductors. The cross sections are shown one-third size in column 1, Table I. The rectangular samples have cross-sectional areas lying approximately between those of the round wires

TABLE I
AVERAGE DIMENSIONS OF TEST SPECIMENS

Specimen No.	Actual (mils) Dimensions		Nom. (mils) Dimensions		Average Area Square Inches	RATIO a/c		Wire Length Feet	Total $R_{p.c.}$ (ohms)	
	$2a$	$2c$	$2a$	$2c$		Actual	Nom.			
No. 4, B.S. 	1	diam. 182	204	diam. 180	0.0328			48.33	0.01186	
	2	374	180	375	180	0.0331	1.00	1	65.0	0.0162
	3	402	81.1	400	80	0.0650	2.07	2	65.0	0.00840
	4	751	75.0	750	75	0.0326	4.95	5	60.0	0.0152
	5	1200	5.0	1200	5	0.0560	10.0	10	61.0	0.00876
No. 0, B.S.	diam. 325		diam. 325		0.0600	2400	2400	60.0	0.00850	
					0.0829			64.2	0.00622	
K_1	496	62.3	Kennelly, Laws, and Pierce		0.0309	7.96	8	200	0.0545	
K_2	992	62.3			0.0618	15.9	16	200	0.0259	
K_3	1500	62.6			0.0940	23.95	24	200	0.0173	
			Kennelly and Affel*							
A	1000	3.0			333	330	25?			
B	756	3.0			278	280				
C	526	2.7			194	195				
D	240	3.0			80	80				
E	140	2.7			52	52	3?			

* Only a very rough check is possible with these data since the length of wire under test and its total direct-current resistance were not given.

included in the table. Also included in the table are the three strips tested by Kennelly, Laws, and Pierce and the three sets of strips tested by Kennelly and Affel.

TABLE II
COMPARISON OF TEST AND THEORETICAL VALUES FOR ROUND WIRES

Freq.	300	500	1000	2000	3000	4000	5000	6000	7000	8500	
No. 4, B.S.	R' $\frac{p}{\text{Calc.}}$	0.9642	1.245	1.761	2.490	3.049	3.522	3.937			
	R' $\frac{p}{\text{Obs.}}$	1.004	1.013	1.048	1.173	1.334	1.500	1.654			
	% Diff.	-0.10	+0.49	+0.57	0.00	-0.15	0.00	+0.24			
No. 0, B.S.	R' $\frac{p}{\text{Calc.}}$		1.989	2.812	3.978	4.871	5.627	6.291	6.889	7.441	8.201
	R' $\frac{p}{\text{Obs.}}$		1.076	1.260	1.669	1.997	2.264	2.496	2.704	2.898	3.164
	% Diff.		0.00	-0.16	0.00	+0.15	+0.49	-0.04	+0.26	+0.35	-0.76

Table II tabulates the measured and calculated¹¹ resistance ratios of the round wires. Fig. 5 is a graph of test and theoretical values using the parameter (p) as a base. The deviation of the observed points show the agreement of the values measured by the bridge with the theoretical values, and indicate the absence of appreciable errors in the bridge.

CONCLUSIONS

(a) The test results for the resistance ratios of rectangular conductors having shape factors of 1:1 to 2400:1 are presented graphically in Figs. 6, 7, and 8.

¹¹ F. W. Grover and E. B. Rosa, *Bur. Stand. Bull.*, vol. 8, no. 1, January, (1911).

(b) Fig. 6 compares test data measured at relatively high frequency on small conductors by Forbes and Gorman with that measured by the author at low frequency on large conductors. The curves are in good agreement and represent rather completely experimental values on round, square, and rectangular conductors for parameter values up to about seven. The good agreement gives experimental evidence of the truth of the "similitude principle" and speaks well for the reliability of the data.

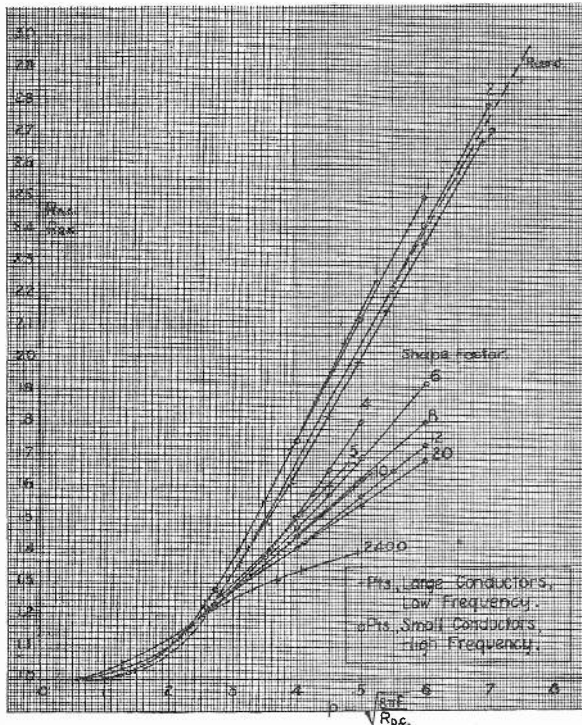

Fig. 6—Experimental evidence of truth of similitude principle.

The values of resistance ratios as graphed on Figs. 6, 7, and 8 may therefore be used with confidence for frequencies beyond those actually employed in the tests if the cross-sectional area of the conductor and the frequency gives a value of the parameter (p) within the range plotted. It should be kept in mind, however, that these ratios are for true "skin effect" and "edge effect" only, or in other words, the ratio of the effective resistance of unequal current distribution within the conductor to its direct-current value. The order of frequencies where

satisfactory results can be obtained by such extension is limited, as in the case of the isolated round wire, by radiation and capacitive effects. It is only necessary when making such extension for conductors of rectangular section to have the shape factor the same. At extremely high frequencies there are additional resistances caused by radiation

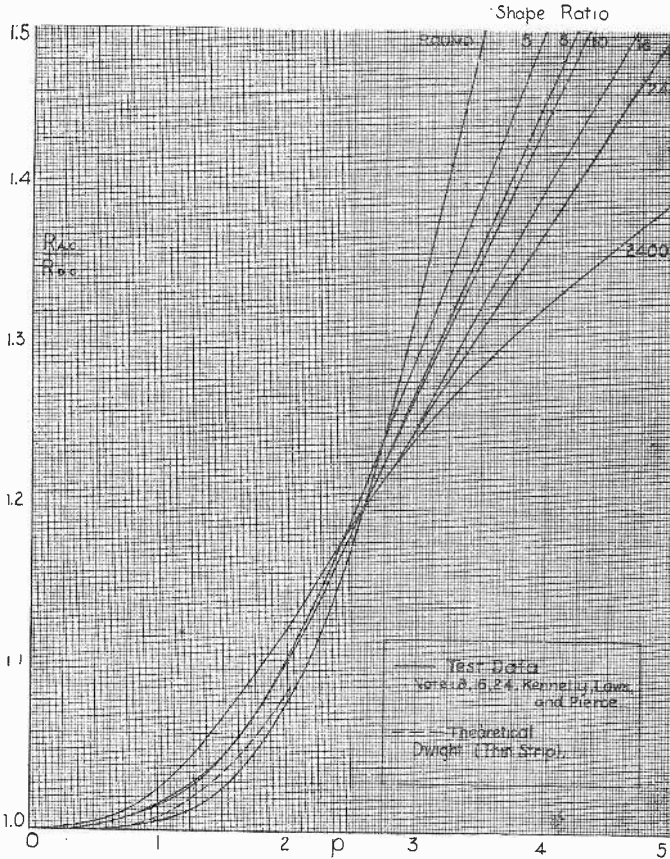

Fig. 7—Test and theoretical values compared, small resistance ratio.

and capacitive effects for both the round wire and the rectangular conductor which should be calculated separately.¹²

The use of the similitude principle for finding the resistance ratio caused by unequal current distribution within the conductor might well be illustrated by a numerical example. For instance a copper strip

¹² C. P. Steinmetz, "Theory and Calculation of Transient Electric Phenomena and Oscillations," Chap. 9, McGraw-Hill Publishing Company.

having a shape factor of 5 to 1 and a cross-sectional area of 0.0021 square centimeter, which is roughly equal to that of No. 24 B. & S. gage wire, is to be used at 500 kilocycles. Its resistivity is 1724 absohms.

$$p = \sqrt{\frac{8\pi f A}{\sigma}} = \sqrt{\frac{8 \times \pi \times 5 \times 10^5 \times 2.1}{1724 \times 10^3}} = 3.92.$$

From Fig. 6, using the curve for shape factor 5 to 1,

$$\frac{R_{A.C.}}{R_{D.C.}} = 1.48.$$

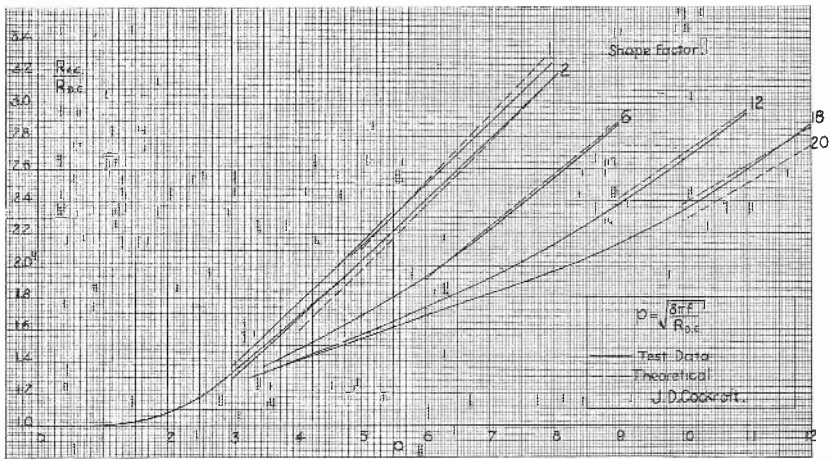

Fig. 8—Test and theoretical values compared, large resistance ratio.

(c) Fig. 7 compares test data with Dwights' series formula which gives values about two per cent less than the observed ratios for strips having shape factors 5:1 and 24:1. At $p=2$, beyond which it is impracticable to use the formula for computation, the calculated value is 1.81 per cent less than the measured value, this being the largest deviation. For the very wide thin strip (2400:1) the deviation is much greater even though a better agreement might be expected since Dwights' formula was derived on the assumption of a negligibly thin conductor.

The skin effect formula of Rayleigh¹³ for an indefinitely wide strip gives values which fall far below those measured on the widest ribbon and are not included on the graph.

¹³ Lord Rayleigh, *Phil. Mag.*, pp. 382, 469, 1886; *Sci. Papers*, vol. 11, pp. 486, 495.

Test data for the three strips K_1, K_2, K_3 are also graphed in Fig. 7, which should prove useful together with the new data, for estimating graphically fairly accurate resistance ratios when the parameter (p) is small.

Fig. 8 compares theoretical values of the formula of J. D. Cockroft¹⁴ with existing test data and indicates that the formula may be used at the higher frequencies. An inspection of the curves shows that for parameter values greater than about seven the resistance ratio in-

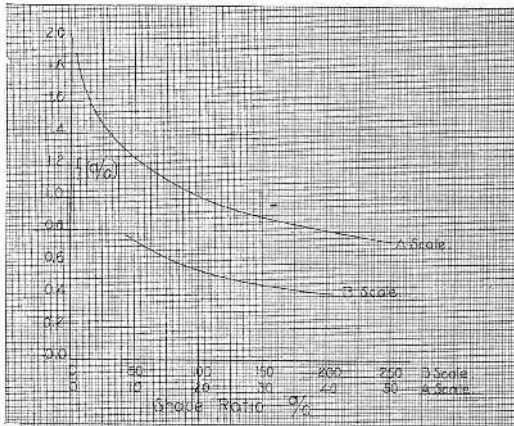

Fig. 9—Elliptic function solution, J. D. Cockroft.

$\frac{R_{A.C.}}{R_{D.C.}}$ of rectangular conductors for large values of the parameter (p).

$$\frac{R_{A.C.}}{R_{D.C.}} = \frac{f(a/c)}{\pi\sqrt{2}} \cdot p \quad p > \sqrt{\frac{32}{\pi}} \sqrt{\frac{a}{c}}$$

Example: Square cross section: $a/c = 1$
 From curve, a scale: $f(a/c) = 1.86$

$$\frac{R_{A.C.}}{R_{D.C.}} = \frac{1.86}{\pi\sqrt{2}} \cdot p = 0.418 p$$

$p > 3.2$

creases considerably faster with frequency increase than it does below this value. It is interesting to note that resistance ratios calculated from Cockroft's approximation corroborate this rather unexpected bend¹⁵ in the experimental curves. It should be emphasized that the dashed lines as calculated from Cockroft's formula give only the slopes

¹⁴ A solution for rectangular conductors in terms of complete elliptic integrals of the first and second kinds but with the limitation that the penetration of the current into the wire must be less than either of the conductor dimensions. The elliptic functions are graphed in Fig. 7 with accompanying formulas.

¹⁵ An interesting discussion of this change of slope is given in *Elect. Eng.*, pp. 724-725, October, (1933).

of the resistance ratio curves at infinite frequency and should thus be considered as asymptotes of the exact curves. The experimental curves contribute the very useful information that the slope at finite frequencies is not sensibly different from that at infinite frequency. A further important contribution given by the test values is the location of the asymptote which was not calculated in the theoretical treatment mentioned above. It will be noted on Fig. 8 that the test curves show the intercepts of the asymptotes on the vertical axis to be very nearly equal to zero.

On account of the inadequacy of the existing formulas in the middle region the experimental work done should be of value not only for furnishing additional evidence for judging the value of theoretical formulas, but for providing a further experimental basis for future theoretical work.

ACKNOWLEDGMENT

The author wishes to thank Dr. F. W. Grover for valuable suggestions in the preparation of the paper, and Dr. E. S. Lee and Mr. J. J. Kehoe of the General Electric Company for their kind assistance in procuring the test samples.



THE TEMPERATURE COEFFICIENT OF INDUCTANCE*

By

JANUSZ GROSZKOWSKI

(State Institute of Telecommunications, Warsaw, Poland)

Summary—The author tries to explain the discrepancy between theory and experiment with regard to the temperature coefficient of inductance of coils. Experiments show that the temperature coefficient of inductance is not equal to the coefficient of linear expansion of the material of the coil, but exceeds it many times. Such a considerable discrepancy cannot be explained by means of the factors pointed out by certain authors. There must still exist an unknown factor which is responsible for it, probably eddy currents in the mass of the winding as distinguished from skin effect. The author's experiments confirm this. Other experiments show the influence of various factors in the construction of a coil on its temperature coefficient of inductance.

I. GENERAL CONSIDERATIONS

IN A letter to the editor of *The Wireless Engineer*,¹ I gave the results of preliminary investigations on the temperature coefficient of inductance of coils (see Appendix I). On the basis of these results I have proposed a hypothesis to explain the divergences between theory and experiment; namely, that in spite of the theory the temperature coefficient of inductance, instead of being equal to the coefficient of linear expansion of the winding, ordinarily exceeds it. Thus, in a copper coil made in such a way that all its dimensions can change freely with temperature, the values exceed 100 parts in a million per degree centigrade, as compared with seventeen parts in a million, respectively.

The investigations of the causes of the discrepancy between the theory and experiment have so far had little success.

E. B. Moullin² has examined some factors influencing the temperature coefficient of inductance; that is, the inner inductance at high frequencies, the self-capacitance of the coil, the difference of radial and axial expansion, deforming of turns, etc.

Taking these factors into consideration and making necessary corrections by means of available formulas, it was, however, possible to account for a discrepancy between theory and experiment up to about fifty per cent, but in no case to 200 or 300 per cent.

* Decimal classification: R382×R230. Original manuscript received by the Institute, September 15, (1936). Résumé from the paper in Polish, *Wiadomości i Prace Państwowego Instytutu Telekomunikacyjnego*, vol. 7, January, (1936).

¹ J. Groszkowski, "The temperature coefficient of inductance," (Correspondence, *Wireless Engineer and Engineering Wireless*, vol. 12, pp. 650-651; December, (1935).

² E. B. Moullin, "The temperature coefficient of inductance, with special reference to the valve generator," *Proc. I.R.E.*, vol. 23, pp. 65-84; January, (1935).

H. A. Thomas³ of The National Physical Laboratory recently called attention to the influence of the mechanical deformations of the winding as well as that of the self-capacitance of the coil. Although his paper was primarily concerned with the design of special coils of the compensated type, nevertheless it helps to explain the cause of the above-mentioned discrepancy. However, the experimental results are again greater than the theoretical.

This discrepancy cannot be attributed to the method of measurement. As may be seen from Appendix III, the influence of the resistance variation of the coil under test on the frequency of the oscillator is negligible, not exceeding, even in the most unfavorable cases, a few per cent. There is still some other factor which exerts a considerable influence on the temperature coefficient of inductance, and according to my previous correspondence,¹ it is the effect of eddy currents in the winding of the coil itself.

Of course, we can consider the mass of metal of the winding as the secondary of a transformer which diminishes the primary inductance. When the coil expands with an increase of temperature, there is also an increase in the resistivity of the material of the winding, which reduces the reaction of the secondary on the primary, thus resulting in an increase of inductance. Consequently the temperature coefficient of inductance of the coil λ' , determined experimentally, becomes greater than the calculated value λ , (see Appendix IV).

Howe,⁴ in connection with the problem suggested in my letter, considers in an editorial the effect of eddy currents as the skin effect in its wider sense. However, the question arises: Is there any difference between the skin effect and the effect of eddy currents in a coil? It would be useful to distinguish between them.

In a straight conductor or in an ideal solenoid (infinitely long, formed not of the turns but of a uniform sheet of current, having no self-capacitance) each element of the length of coil is in the same conditions with regard to the alternating magnetic field; the current lines, in spite of their displacement, remain therefore always parallel to the conductor axis and there are no currents flowing in the planes perpendicular to the axis of conductor. Such an effect of displacement of the current lines in the conductor section we can attribute to skin effect.

This matter is slightly different in the case of a real coil of finite length, wound with a conductor of circular cross section, of given pitch,

³ H. A. Thomas, "The stability of inductance coils for radio frequencies," *Jour. I.E.E.* (London), vol. 77, pp. 702-722; November, (1935).

⁴ G. W. O. Howe, "The temperature coefficient of inductance," (Editorial). *Wireless Engineer and Engineering Wireless*, vol. 12, pp. 637-638; December, (1935).

and having self-capacitance. For instance, in a mass-wound coil,⁵ owing to the leakage of the flux, the extreme turns do not link the same flux as the middle ones; also the flux passing through the individual elements of the conductor may be not equal in different points of the turns.

Generally, the individual elements of a turn may not be symmetrically located with respect to the alternating magnetic field; in consequence, currents may flow in a direction perpendicular to the conductor axis and turn back over a longer or shorter length of the conductor. This effect, in order to distinguish it from the preceding one, we consider as the eddy current effect.

As an explicit example of eddy currents in the winding of a coil consider a part of one turn which is considerably deformed, located in the main magnetic field of coil. This part of the conductor will be a seat of currents which flow and turn back over its length; these currents cannot be considered as the result of the skin effect.

Evidently, in a normal coil, the deformation of turns is small; nevertheless the irregularity of the winding as well as the deformation of the magnetic field at the borders of the coil, particularly in multilayer coils, can be the cause of eddy currents in the winding. With regard to the skin effect, it is manifested independently as the parallel displacement of the current lines on the total length of the conductor of the coil.

Usually, the distribution of the high-frequency current in the cross section of the conductor of the coil is considered in connection with the calculation of the inductance or resistance of the coil and ordinarily concerns simple and idealized systems (for instance the straight conductor,² the infinitely long solenoid, the turns of the square cross section closely wound)⁶ where the occurring phenomena reduce themselves, of course, only to the parallel displacement of the current lines in the section, that is, to the pure skin effect.

It is clear that the formulas obtained under these suppositions are not sufficient when dealing with the effect of eddy currents, that is, in the majority of cases of the real coils used in practice.

As regards the pure skin effect, it can be shown (see Appendix V) that, in some cases, it plays an important rôle in increasing the temperature coefficient of inductance of the coil, which becomes a function of the frequency and passes through a maximum. Thus, in a coil of one turn of diameter $D=10$ centimeters, made of copper of circular

⁵ S. Butterworth, "Effective resistance of inductance coils at radio frequency," *Wireless Engineer and Engineering Wireless*, vol. 3, pp. 203-210; April, (1926).

⁶ J. G. Coffin, "The influence of frequency upon the self-inductance of coils," *Bull. Bur. Stand.*, vol. 2, pp. 275-296, (1906).

cross section of diameter $d = 0.1$ centimeter, the maximum value occurs at a frequency $F = 250$ kilocycles, and is 87 parts in a million per degree centigrade, while the coefficient of linear expansion of copper is only 17. For higher frequencies, the temperature coefficient of inductance decreases, and at $F = 1$ megacycle is 46 parts in a million, per degree centigrade.

II. EXPERIMENTS

In order to prove these considerations experimentally, a one-turn copper coil was made (which could spread freely, according to its coefficient of linear expansion) of dimensions: $D = 200$ centimeters, $d = 1.0$ centimeter. However, in order to facilitate the heating of the coil by a current of hot water, a copper tube was used having an external and internal diameter of $d_1 = 1.0$ centimeter and $d_2 = 0.8$ centimeter respectively, instead of a conductor of full cross section.

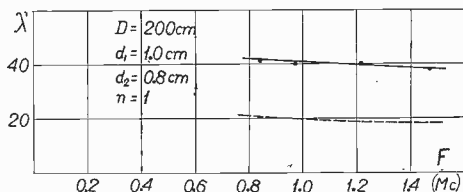

Fig. 1

For a coil of full cross section the temperature coefficient of inductance, λ' , as a function of the frequency F is given by the formula (see Appendix V)

$$\lambda' = 17 + \frac{2.5}{\sqrt{F_{Mc}}};$$

the corresponding curve is shown in Fig. 1 by an interrupted line. The experimental results for the coil of tubular conductor in the range of frequency from 0.8 megacycle to 1.5 megacycles are given in the same figure by a full line. Though we observe there a considerable numerical difference between the results, the character of both curves is similar.

Now let us examine the influence of the self-capacitance of coil on its temperature coefficient of inductance. It follows from the calculations (see Appendix VI) that, at frequencies much lower than the proper frequency of the coil, this influence is negligible, not exceeding a few per cent. In our experiments, in the case of the largest coil at the highest frequency ($F = 1.6$ megacycles) the increase due to the self-capacitance was only about fifteen per cent. As proof that the self-capacitance does not increase considerably the temperature coefficient of induct-

ance, experimental results were obtained with the constantan coils, to which turns of copper and of constantan wire were added. If the increase is caused by the effect of capacitance due to the added turns it should be the same in both cases; the experiments however, show the opposite.

In order to prove that the effect of eddy currents influences the temperature coefficient of inductance, because of the change of the "transformer effect" of the mass of winding with the change of its resistivity with the temperature, an experiment was carried out which may be regarded as the "*experimentum crucis*."

The reasoning was as follows: If the increase of the temperature coefficient of inductance beyond the theoretical value λ is caused by the variation of the resistance of the winding which occurs with temperature changes, then, (1) in a coil having zero temperature coefficient of resistivity, the experimental value should be λ , calculated, (2) adding to this coil turns having a positive resistivity coefficient should increase the temperature coefficient of inductance, (3) the adding of turns of zero temperature coefficient of resistivity should produce no increase. Copper has a temperature coefficient of resistivity $\beta = 4200$ parts in a million per degree centigrade, as compared to $\beta = 8$ for constantan.

The coils used for the experiment were so made that their dimensions could change freely with the temperature. The simplest and most suitable coils were "self-supporting," either owing to the stiffness of the winding or mass-wound coils which kept their shape because their turns were tied together at points on the periphery. Such a coil being free of all other materials, except the enamel insulation, one can be sure that its dimensions change freely with temperature; moreover, the comparatively small thermal capacity of the coil allowed its temperature to change quickly thus facilitating thermal measurements.

Moreover, such a coil should be free of the tensions, mentioned by Thomas,³ which might cause the radial expansion to exceed the axial. As a precaution against this possibility, each coil under test was preliminarily heated to a temperature higher than that at which measurements were made. Changes in frequency were not observed and the measurements were always repeatable.

The temperature coefficient of inductance and its dependence upon frequency were determined by the method of the frequency variations of an oscillating circuit consisting of the coil under test which was heated and of a condenser at constant temperature; the circuit was excited by a dynatron, Fig. 2, adjusted by means of the inner grid potential, to operate at the threshold of oscillation generation. The

precision of adjustment was sufficient being some cycles as compared to some hundred cycles caused by the heating of the coil. Other experiments have shown that the same precision could be obtained by means of the automatic control of the threshold of regeneration by using a suitable connection.⁷

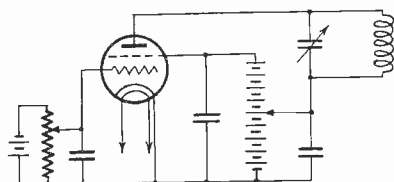

Fig. 2

The frequency variations were measured by the method of beating with respect to the constant reference frequency by means of an audio-frequency meter.

The coil under test was placed in an air thermostat of large dimensions (in order to avoid the influence of its walls); the condenser and the dynatron were outside.

The temperature coefficient of inductance was determined from the slope of the curve "frequency variation versus temperature" as

$$\lambda' = \frac{1}{2} \frac{1}{F} \frac{\Delta F}{\Delta t}$$

in the range of temperatures 25 to 60 degrees centigrade.

The shape of the curves $\lambda' = f(t)$ was always regular and repeatable; an example of two such curves with the measurement points is shown in Fig. 3.

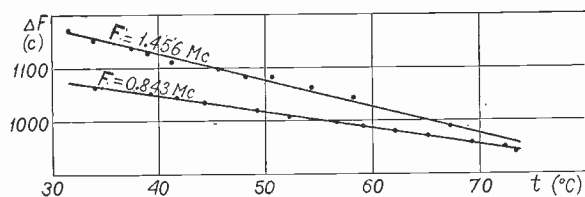

Fig. 3

Preliminary measurements were made at a frequency of $F = 1.4$ megacycles for two coils: of copper and of constantan; coil diameter was $D = 7$ centimeters, number of turns $n = 16$, wire diameter $d = 0.1$ centimeter, the construction as described above.

⁷ J. Groszkowski, "Oscillators with automatic control of the threshold of regeneration," *Proc. I.R.E.*, vol. 22, pp. 145-151; February, (1934).

The added turns had the form of the open circles of the same diameter and thickness as the main winding. The results obtained are represented in Table I and Fig. 4, which shows the temperature coefficient

TABLE I

Added turns n	16-turn coil of:	
	copper	constantan
$n=0$ $\lambda' =$	($\lambda \cong 17$)	($\lambda \cong 16$)
$n=16$ copper $\lambda' =$	45	17
$n=16$ constantan $\lambda' =$	67	28
	47	18

of inductance versus the added turns and the influence of small amounts of metal affixed to the coil. Table I shows that the value $\lambda' = 45$ for the copper coil alone exceeds considerably that corresponding to the temperature coefficient of expansion of copper $\lambda = 17$, while that for constantan is $\lambda' = 17$, close to $\lambda = 16$, owing to the fact that the temperature coefficient of resistance of constantan is very small.

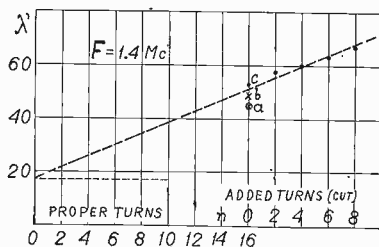

Fig. 4

The addition of the copper turns to the constantan coil increases λ' from 17 to 28, while the addition of constantan turns increases λ' only from 17 to 18. The addition of copper turns to the copper coil increases λ' from 45 to 67, while the addition of constantan turns increases λ' only from 45 to 47. Fig. 4 shows the increase in the temperature coefficient of inductance, λ' , is almost proportional to the number of added copper turns n ; by extrapolating to $n=0$ we obtain $\lambda = \lambda'$.

In the same experiment was observed the influence of small metal masses added to the coil on λ' : a , in Fig. 4, being a reference point for a 16-turn coil; b , after adding two pieces 0.3-millimeter copper wire some centimeters long (this wire served for joining the added turns in two points of the coil circumference); c , after adding four such pieces. The further points correspond to the added turns (in presence of these four pieces).

The second series of measurements concerned the influence of fre-

quency on the temperature coefficient of inductance of different coils with added turns. The coils were wound closely with enameled wire of diameter $d=0.1$ centimeter; coil diameter was $D \cong 8$ centimeters. The results of measurements in the range of frequency 0.8 to 1.6 megacycles are shown in Fig. 5. Curve No. 1 corresponds to the multilayer copper coil of 16 turns having an inductance of approximately 35 microhenrys, and a resistance of three ohms at 1.4 megacycles. λ' varies from 50 to 85.

Curve No. 2 is for a similar coil of constantan ($R \cong 11$). λ' lies between 20 and 25. Curve No. 3 is obtained by adding to No. 2 16 turns of copper wire of the same diameter ($R \cong 19$) which increases λ' of the constantan coil from 20–25 to 45–65. Such a coil behaves nearly as the copper one. Curve No. 4 is obtained by adding to No. 2 16 turns of

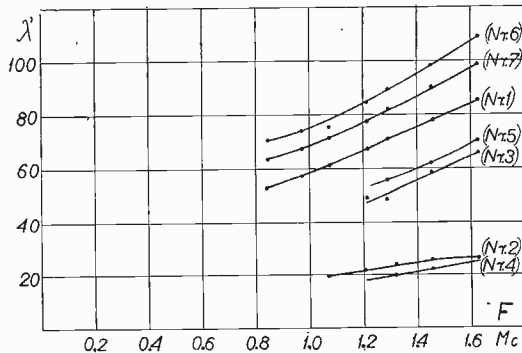

Fig. 5

constantan wire of the same diameter. This made practically no change. Curve No. 5 was obtained by adding to No. 2 16 turns of brass wire. This increases λ' to 50–70. Curve No. 6 is obtained from No. 1 by adding 16 turns of the copper wire. The temperature coefficient of inductance increased here from 50–85 to 70–110.

The added turns, which were in all cases of the same form and dimensions as the reference coil, were not electrically connected to it but touched it close at the circumference, being tied with pieces of wire; the ends of the added coil were free.

Curve No. 7 is obtained by adding to No. 1 16 turns of the copper wire cut asunder in one-turn pieces. Here the increase of λ' is slightly smaller than in the previous case (uncut turns).

Subsequently the influence of the number of turns of the coil on the temperature coefficient of inductance was examined and its dependence on the frequency. Three series of measurements were made with the mass coils having $D=8$ centimeters, $c=0.1$ centimeter, and

the number of turns $n=32, 23,$ and $16,$ respectively. The diminishing of number of turns was obtained by cutting off. The results are given in Fig. 6. We see there that λ' increases with the frequency; this

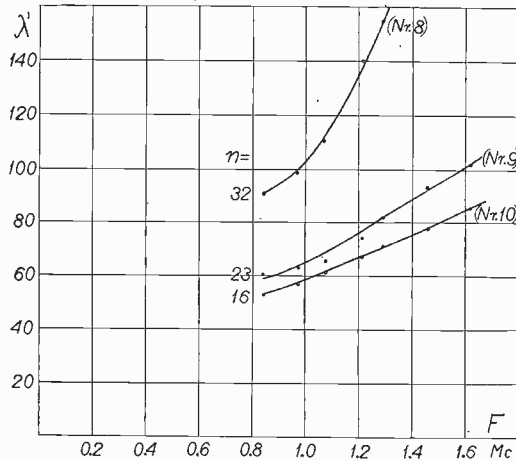

Fig. 6

increase being the more considerable the greater is the number of turns. The influence of the conductor thickness d on the temperature coefficient of inductance is shown in Fig. 7 for copper coils Nos. 11, 12, 13, and 14 ($D=8$ centimeters, $n=16$ turns) of wire diameter $d=0.05, 0.10, 0.15,$ and 0.30 centimeters, respectively. The effect decreases with the increase of the thickness of conductor.

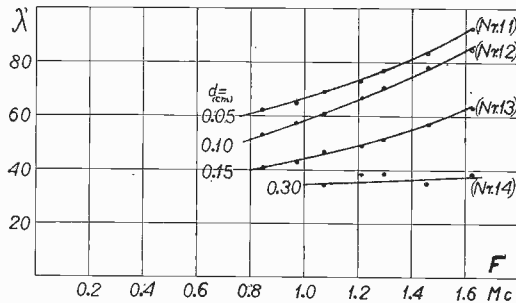

Fig. 7

Finally in order to prove the influence of the spacing of turns on the temperature coefficient of inductance the relation $\lambda=f(F)$ was measured for two cylindrical copper coils ($D=8$ centimeters, $d=0.3$ centimeter, $n=15$) of turns spacing $g=0.3$ and 0.5 centimeter, respectively. The coils were "formerless"; they kept their shape owing

to the tying of turns by the help of small pieces of thin enameled copper wire. Practically, the temperature coefficient of inductance in the frequency range from 0.8 to 1.5 megacycles did not depend on the frequency. For the coil having $g=0.3$ centimeter, $\lambda' \cong 24$, and for one having $g=0.5$ centimeter, $\lambda' \cong 19$.

III. CONCLUSION

Recapitulating the above considerations we can point out the following factors influencing the temperature coefficient of inductance of a coil which changes its dimensions with temperature in a manner conforming to the coefficient of linear expansion of the material of coil: First, the thermal expansion of the material of winding given by its coefficient of linear expansion is independent of the frequency. Second, the skin effect, causing the increase of the temperature coefficient of inductance of coil by the value proportional to

$$\chi\phi'(\chi)\cdot\beta$$

(χ being the function of frequency F). For F beyond a certain value the increase of the temperature coefficient of inductance due to the skin effect is proportional to

$$\beta\cdot F^{-1/2}.$$

Third, the eddy currents, causing the increase of the temperature coefficient of inductance by a value proportional to the square of frequency. Fourth, the self-capacitance of coil which causes the increase of the temperature coefficient of inductance by a value proportional to the square of frequency.

Thus, the temperature coefficient of inductance as a function of frequency is given, for a certain frequency range, by the formula

$$\lambda' = \lambda + aF^{-1/2} + bF^{1+2} + cF^2.$$

Relative to the value of a , b , and c we obtain a different shape of the curve. Usually, for multilayer coils, where the eddy currents and the distributed capacitance effects prevail over the skin effect, the curve $\lambda'=f(F)$ is rising with frequency. For a one-turn coil λ' can be, in a certain range of frequency, independent of F or even can decrease with the increase of F .

APPENDIX I

The temperature coefficient of inductance.

The temperature coefficient of inductance of a coil of inductance L is determined by the relative variation of L which corresponds to the temperature variation of one degree centigrade

$$\lambda' = \frac{1}{L} \left(\frac{\Delta L}{\Delta t} \right). \quad (1)$$

λ' can be expressed in parts in a million per degree centigrade.

APPENDIX II

The theoretical relation between the temperature coefficient of inductance and the coefficient of linear expansion.

For an isotropic coil, that is, for a coil all dimensions of which change with temperature according to thermal expansion of its material, the temperature coefficient of inductance should be equal to the coefficient of linear expansion of the material.

Of course, if we denote the coefficient of linear expansion by λ , the change of the scale of geometrical dimensions of coil with the temperature will be according to the relation

$$l = l_0(1 + \lambda t). \quad (1)$$

The inductance of coil in cgs electromagnetic system of units is expressed in units of length. We have the proportionality

$$L \doteq l = l_0(1 + \lambda t)$$

and therefore

$$\lambda' = \frac{1}{L} \left(\frac{\Delta L}{\Delta t} \right) = \frac{1}{l} \left(\frac{\Delta l}{\Delta t} \right) = \lambda. \quad (3)$$

The temperature coefficient of coils made anisotropically or being subjected to deformations is examined in the papers of Moullin,² Thomas,³ Piddington,⁸ Griffith⁹ and others.

APPENDIX III

The influence of the tube.

We assume that the coil under test and the condenser of a constant capacitance form an oscillating circuit excited by a dynatron tube (Fig. 2). The resistance of the capacitive branch we put equal zero, the coil resistance is R . If the oscillating system is always adjusted at the threshold of the regeneration, the frequency is given¹⁰ by the formula

⁸ J. H. Piddington, "A temperature compensated dynatron oscillator of high frequency stability," Paper No. 516. The Sydney Division of the Institution, or *Proc. Inst. Eng. Australia*, vol. 7, pp. 53-61; February, (1935).

⁹ W. H. F. Griffith, "Inductances of high permanence," *Wireless Engineer and Engineering Wireless*, vol. 6, pp. 543-549; October, (1929).

¹⁰ J. Groszkowski, "The interdependence of frequency variation and harmonic content and the problem of constant frequency oscillators," *Proc. I.R.E.*, vol. 21, pp. 958-981; July, (1933).

$$\omega^2 = \frac{1}{LC} \left(1 - \frac{R^2 C}{L} \right) = \frac{1}{LC} - \frac{R^2}{L^2}. \quad (1)$$

L and R change with temperature; if the system is always kept at the threshold, the frequency drift due to these temperature variations is

$$\frac{d\omega}{\omega} = -\frac{1}{2} \frac{dL}{L} - \frac{CR^2}{L} \frac{dR}{R} + \frac{CR^2}{L} \frac{dL}{L}. \quad (2)$$

Equation (2) is obtained by differentiating (1).

The dependence of R and L on the temperature we can express by the formulas

$$R = R_0(1 + \beta t) \quad (3)$$

$$L = L_0(1 + \lambda t) \quad (4)$$

where β is the thermal coefficient of resistivity of the coil winding; λ , the coefficient of the linear expansion of the winding material.

From (3) and (4) we have

$$\frac{dR}{dt} = R_0\beta \cong R\beta \quad (5)$$

$$\frac{dL}{dt} = L_0\lambda \cong L\lambda. \quad (6)$$

The frequency variation due to the temperature variation, therefore, will be

$$\frac{1}{\omega} \frac{d\omega}{dt} = -\frac{1}{2} \left(1 - \frac{2R}{r} \right) \lambda - \frac{R}{r} \beta. \quad (7)$$

r denotes here the dynamic resistance of the oscillating circuit

$$r = \frac{L}{RC} = \frac{\omega^2 L^2}{R}. \quad (8)$$

Usually for the oscillating systems met in practice $2R \ll r$; therefore (7) can be written as

$$\frac{1}{\omega} \frac{d\omega}{dt} = -\frac{1}{2} \lambda - \frac{R}{r} \beta. \quad (9)$$

Denoting the power factor of the circuit

$$p = \frac{R}{\omega L}$$

we transform (9) to the form

$$\frac{1}{\omega} \frac{d\omega}{dt} = -\frac{1}{2} (\lambda + 2p^2\beta) = -\frac{1}{2} \lambda \left(1 + 2p^2 \frac{\beta}{\lambda} \right). \quad (10)$$

For copper $\lambda = 17$, $\beta = 4200$ parts in a million per degree centigrade, $\beta/\lambda = 250$. With regard to p , it changes within large limits, according to the frequency range. For instance, for a frequency of one megacycle, p is of the order from several thousandths to several hundredths. Thus, the expression $2p^2\beta/\lambda$ is of the order from several hundredths to several tenths.

APPENDIX IV

The temperature coefficient of inductance of a transformer with short-circuited secondary.

The inductance L of the primary of an air-core transformer, in consequence of the reaction of the secondary (of inductance N and resistance S) which is coupled to the primary by the mutual inductance M , diminishes by the value

$$\frac{\omega^2 M^2}{S^2 + \omega^2 N^2} N \quad (1)$$

and is given by the formula

$$L' = L - \frac{\omega^2 M^2}{S^2 + \omega^2 N^2} N. \quad (2)$$

In the case $\omega^2 N^2 \ll S^2$ (2) becomes

$$L' = L - \frac{\omega^2 M^2}{S^2} N. \quad (3)$$

Assuming that the changes of L , M , N , and S with temperature occur according to the formulas

$$\begin{aligned} L &= L_0 (1 + \lambda t) \\ M &= M_0 (1 + \lambda t) \\ N &= N_0 (1 + \lambda t) \\ S &= S_0 (1 + \beta t) \end{aligned} \quad (4)$$

(λ = the coefficient of linear expansion, β = the temperature coefficient of resistivity) we obtain the temperature coefficient of inductance

$$\lambda' = \frac{1}{L'} \frac{dL}{dt} \cong \lambda - \frac{\omega^2 M^2}{S^2} \frac{N}{L} (3\lambda - 2\beta). \quad (5)$$

As

$$\frac{\omega^2 M^2}{S^2} \frac{N}{L} \ll 1,$$

and for copper $\beta \gg \lambda$, (5) can be written

$$\lambda' = \lambda + \left(2 \frac{\omega^2 M^2}{S^2} \frac{N}{L} \right) \beta. \quad (6)$$

Assuming M , N , and L as independent of the frequency, and S varying proportionally to the square root of frequency

$$S \doteq \sqrt{\omega} \quad (7)$$

(6) can be represented as

$$\lambda' \cong \lambda + k\omega\beta. \quad (8)$$

The more probable form of (8) is

$$\lambda' \cong \lambda + k\omega\beta^m$$

where m lies between 1 and 2.

APPENDIX V

The temperature coefficient of inductance of a single turn coil.

The inductance (in cgs electromagnetic units) of a circular ring of the diameter D centimeter, of the circular cross section d centimeter, made of nonmagnetic material of resistivity ρ at the frequency F is given by the formula¹¹

$$L = 2\pi D \left[\log_e \frac{8D}{d} - 2 + \delta \right] \quad (1)$$

where,

$$\delta = \phi(\chi), \quad \chi = 0.14d \sqrt{\frac{F}{\rho}} \quad \left(\frac{d}{D} < 0.2 \right). \quad (2)$$

The curve $\delta = \phi(\chi)$ shown in Fig. 8 is obtained from the table on p. 282 of reference (11).

The formula (1) can be written in the form

$$L = 2\pi D \log_e \frac{1.1D}{d} \left[1 + \frac{\phi(\chi)}{\log_e \frac{1.1D}{d}} \right]. \quad (3)$$

¹¹ Bureau of Standards, Radio Instruments and Measurements, Circular no. 74, p. 250, (1924).

We find the temperature coefficient of inductance by differentiating (3) as

$$\lambda' = \frac{1}{L} \frac{dL}{dt} = \lambda + \frac{\chi \phi'(\chi)}{\log_e \frac{1.1D}{d}} \left(\lambda - \frac{1}{2} \beta \right) \quad (4)$$

and assuming the following relations concerning the temperature

$$\begin{aligned} D &= D_0(1 + \lambda t) \\ d &= d_0(1 + \lambda t) \\ \rho &= \rho_0(1 + \beta t). \end{aligned} \quad (5)$$

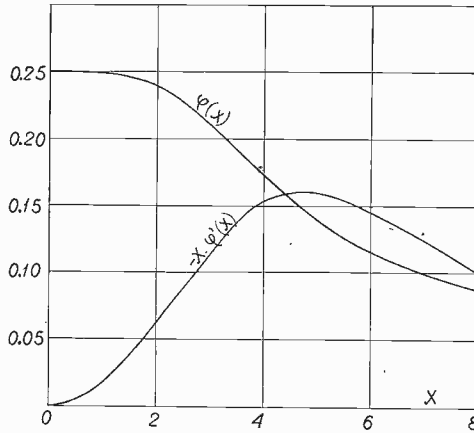

Fig. 8

The form of the function $\chi \phi'(\chi)$ is given in Fig. 8. It is seen that this function has the maximum

$$[\chi \phi'(\chi)]_{\max} \cong -0.16 \quad (6)$$

for

$$\chi \cong 5.$$

For $\chi > 3$ we can admit, with sufficient approximation,

$$\delta = \frac{0.7}{\chi} \quad (7)$$

or

$$\phi'(\chi) = -\frac{0.7}{\chi^2}. \quad (8)$$

For a conductor of circular cross section in the range $\chi > 3$ becomes

$$\lambda' = \lambda + \frac{5}{d\sqrt{\frac{F}{\rho}} \log_e \frac{1.1D}{d}} \left(\frac{1}{2}\beta - \lambda\right). \quad (9)$$

For copper $\lambda = 17$, $\beta = 4300$, ($\lambda \ll \beta$), $\rho = 1.7$ microhms per centimeter, therefore (9) will be

$$\lambda' = 17 + \frac{5.9}{d\sqrt{F_{Mc}} \log_{10} \frac{1.1D}{d}}. \quad (10)$$

The temperature coefficient of inductance, according to (6), becomes a maximum

$$\lambda' = 17 + \frac{145}{\log_{10} \frac{1.1D}{d}}. \quad (11)$$

for the frequency $F = 2500/d^2$. For example for a single turn coil of $D = 10$ centimeters, $d = 0.1$ centimeter ($\log_{10} (1.1D/10d) = 2.04$) this maximum is $\lambda' = 17 + 70 = 87$, at the frequency $F = 250$ kilocycles. At $F = 1$ megacycle, $\lambda' = 17 + 29 = 46$. For a coil of $D = 200$ centimeters, $d = 1$ centimeter (at $F > 2500$ cycles) we have

$$\lambda' = 17 + \frac{2.5}{\sqrt{F_{Mc}}}. \quad (12)$$

APPENDIX VI

The influence of the self-capacitance on the temperature coefficient of inductance.

The natural frequency of a circuit consisting of a coil L with the self-capacitance K and of a condenser C is given by

$$\omega = \frac{1}{\sqrt{CL(1 + K/C)}}. \quad (1)$$

We can assume that the self-capacitance K changes the inductance of coil to the value

$$L' = L \left(1 + \frac{K}{C}\right). \quad (2)$$

The temperature coefficient of inductance will be, therefore,

$$\frac{1}{L'} \frac{dL'}{dt} = \frac{1}{L} \frac{dL}{dt} + \frac{1}{C \left(1 + \frac{K}{C}\right)} \frac{dK}{dt}. \quad (3)$$

If we assume that in the case of an isotropic coil K changes with temperature according to the formula

$$K = K_0(1 + \lambda t) \quad (4)$$

we obtain (2) as

$$\lambda' = \lambda \left(1 + \frac{K}{K + C}\right) \quad (5)$$

or, replacing $(K + C)$ by $1/\omega^2 L$

$$\lambda' = \lambda(1 + KL\omega^2). \quad (6)$$

When $K = 0$, we have $\lambda' = \lambda$. When $K > 0$ at $\omega = 0$, $\lambda' = \lambda$; when ω increases, λ' increases also to the value 2λ (for $C = 0$). For instance, for a formerless mass-wound coil ($D = 8$ centimeters, $n = 32$ turns, $L \cong 160$ microhenrys) putting $K = 10$ micromicrofarads, we obtain at $F = 1.5$ megacycles, ($C \cong 60$ micromicrofarads), $\lambda' = \lambda(1 + 0.14)$; thus, the influence of K is fourteen per cent here.



THE PRODUCTION OF ROCHELLE SALT PIEZOELECTRIC RESONATORS HAVING A PURE LONGITUDINAL MODE OF VIBRATION*

By

NORMAN C. STAMFORD

(College of Technology, Victoria University of Manchester, England)

Summary—The correct orientation of specimens cut from Rochelle salt crystals for use as piezoelectric resonators having a pure longitudinal mode of vibration is developed from Voigt's theory of piezoelectricity, and the frequency of resonance of these specimens is derived from the constants of the material. Some practical details are given regarding the growing of the crystals and grinding of the specimens.

THE FACT that Rochelle salt specimens are comparatively easy to prepare, and have a high piezoelectric constant, renders them more convenient than quartz for certain work, in spite of their very inferior mechanical properties. For this reason a paper dealing with the production of such specimens may be considered justified.

The theoretical determination of the correct orientation of the specimens for pure longitudinal vibration is based on the general theory of piezoelectricity developed by Voigt and dealt with fully in his textbook on crystal physics.¹

The requirements for the type of resonator specimen to be considered are, that the application of an electric field to the specimen shall produce longitudinal extension or contraction along its length, and a corresponding contraction or extension along one of the other rectangular axes of the specimen, there being freedom from any shear strains.

If a set of rectangular axes coincident with the crystallographic axes are designated by the letters OX , OY , and OZ , and an electric field having components E_1 , E_2 , E_3 parallel to these axes is applied to the crystal, then the resulting strains can be represented by the following set of equations:

$$\begin{aligned} X_x &= d_{11}E_1 + d_{21}E_2 + d_{31}E_3 \\ Y_y &= d_{12}E_1 + d_{22}E_2 + d_{32}E_3 \\ Z_z &= d_{13}E_1 + d_{23}E_2 + d_{33}E_3 \\ Y_x &= d_{14}E_1 + d_{24}E_2 + d_{34}E_3 \\ Z_y &= d_{15}E_1 + d_{25}E_2 + d_{35}E_3 \\ X_y &= d_{16}E_1 + d_{26}E_2 + d_{36}E_3. \end{aligned} \tag{1}$$

* Decimal classification: 537.65. Original manuscript received by the Institute, November 20, 1936.

¹ W. Voigt, "Lehrbuch der Kristallphysik."

Having obtained these values, it is possible to write down equations corresponding to (2) in terms of d_{14} , d_{25} , and d_{36} , but these equations are too cumbersome to derive any information regarding the orientation of the axes to make the shear strain terms equal to zero. A further simplification is therefore made by taking one of the arbitrary axes coincident with one of the original axes, and considering this special case.

The scheme for the direction cosines corresponding to the general case given in (3), for the special case where the arbitrary axis OX' is made coincident with the original axis OX , and the OY' and OZ' axes make an angle ϕ with OY and OZ respectively, can be written in the following form, where $c = \cos\phi$ and $s = \sin\phi$:

	X'	Y'	Z'
X	1	0	0
Y	0	c	$-s$
Z	0	s	c

Inserting the values of $d_{11}' \dots d_{36}'$ in terms of d_{14} , d_{25} , d_{36} in the general equations given in (2) we get

$$\begin{aligned}
 X_x' &= \quad \quad \quad + \quad \quad \quad - \quad \quad \quad + \quad \quad \quad - \\
 Y_y' &= \quad csd_{14}E_1' \quad + \quad \quad \quad - \quad \quad \quad + \quad \quad \quad - \\
 Z_z' &= \quad -csd_{14}E_1' \quad + \quad \quad \quad - \quad \quad \quad + \quad \quad \quad - \\
 Y_z' &= (c^2 - s^2)d_{14}E_1' + \quad \quad \quad - \quad \quad \quad + \quad \quad \quad - \\
 Z_x' &= \quad \quad \quad - \quad \quad \quad + (c^2d_{25} - s^2d_{36})E_2' + [-cs(d_{25} - d_{36})E_3'] \\
 X_y' &= \quad \quad \quad - \quad \quad \quad + cs(d_{25} - d_{36})E_2' + [(c^2d_{36} - s^2d_{25})E_3'].
 \end{aligned} \tag{5}$$

Considering these equations, the shear strains represented by Z_x' and X_y' can be made zero by the application of the field parallel to the OX' axis; the remaining shear strain Y_z' can be made zero by making $\phi = 45$ degrees.

This leaves the longitudinal strain Y_y' along the OY' axis and the corresponding negative strain Z_z' along the OZ' axis; both of these strains representing transverse effect. Since the strain X_x' is zero, it is seen that there is no longitudinal effect in specimens having this orientation. Similar sets of equations could be obtained for the other two cases in which the other arbitrary axes are in turn coincident with the corresponding crystallographic axis.

In general then it may be stated that pure longitudinal vibration can be obtained with specimens having one axis coincident with the

crystallographic axis and the other two at forty five degrees to the crystallographic axes, the field being applied parallel to the coincident axis.

Considering the three types of specimen having the OX' , OY' , and OZ' axes respectively coincident with the corresponding crystallographic axis, and calling the types I, II, and III; values for the theoretical resonant frequency for each of these types can be determined. In the case of type I, the specimen should be in the form of a thin rod having its length in a plane normal to the OX' axis, and along a line at forty-five degrees to the OY and OZ axes, being along the direction of the arbitrary OY' axis.

Then the fundamental mode of vibration along its length l will correspond to a stationary wave system where $l = \lambda/2$ when the specimen responds to an applied voltage of its natural frequency; the velocity of propagation will be given by

$$v = \sqrt{E/D} \quad (6)$$

where,

v = velocity of propagation

E = Young's modulus in the direction of propagation

D = density of the crystal (1.790).

Then from the relationship $\lambda f = v$, the resonant frequency of the specimen can be obtained from

$$f = \frac{1}{2l} \sqrt{\frac{E}{D}} \quad (7)$$

Since the crystal is not isotropic, it is necessary to calculate the value of Young's modulus E in the appropriate direction for each specimen. These values have been obtained from the values of the elastic constants of Rochelle salt given by Mandell,² giving the following results for the three types of specimen:

$$\text{Type I } E = 25.87 \times 10^{10} \text{ dynes/cm}^2.$$

$$\text{Type II } E = 11.85 \times 10^{10} \text{ dynes/cm}^2.$$

$$\text{Type III } E = 27.93 \times 10^{10} \text{ dynes/cm}^2.$$

Inserting these values in (7) we obtain the following values for the resonant frequencies:

$$\text{Type I } f = \frac{1900}{l} \text{ kc.}$$

² W. Mandell, "The determination of the elastic moduli of the piezo crystal Rochelle salt by statical method," *Proc. Roy. Soc.*, vol. 116, p. 623, (1927).

$$\text{Type II} \quad f = \frac{1286}{l} \text{ kc.}$$

$$\text{Type III} \quad f = \frac{1975}{l} \text{ kc.}$$

In each case the length of the specimen is measured in millimeters.

These results are only applicable strictly when the length of the specimen is large compared with its other dimensions; there will however be a second resonant frequency due to stationary waves across the breadth of the specimen at right angles to the direction of application of the field, and this may be calculated approximately by inserting the value of this dimension instead of the length in the resonant frequency expression for the type considered, using the same value of constant as for the case of mechanical resonance along the length of the specimen.

A point of importance arises from the fact that there is no longitudinal effect in the types of specimen considered. Since there is no dilatation along the direction of the applied field, contact with the holder does not increase the damping of the crystal as much as in the case of quartz specimens having longitudinal effect; furthermore the use of an air gap does not introduce the possibility of increased damping due to resonance of the supersonic air waves set up in the gap of the type described by Dye for the case of quartz specimens.

SOME PRACTICAL DETAILS

A method of growing Rochelle salt crystals has been given in some detail by Nicolson,³ but crystals of this type having a composite structure are not suitable for the production of resonator specimens.

The method adopted was to grow small seed crystals as described by Nicolson, and to use them for growing large specimens in the following manner.

One of these small crystals was used to seed a saturated solution of the salt, which was evaporated at constant temperature in a vacuum desiccator under reduced pressure until the crystal had grown to the required size. By this method crystals were grown slowly and developed without flaws or stress lines to a length of about forty millimeters, which was found to be a convenient size. A point of very great importance was found to be that the solution must be very carefully filtered before seeding; for this purpose a sintered glass crucible was

³ A. McL. Nicolson, "The piezo electric effect in the composite Rochelle Salt crystal," *Trans. A.I.E.E.*, vol. 38, p. 1467, (1919).

used, with the result that the very fine cracks, which had been noticed with ordinary paper filtering, were no longer produced.

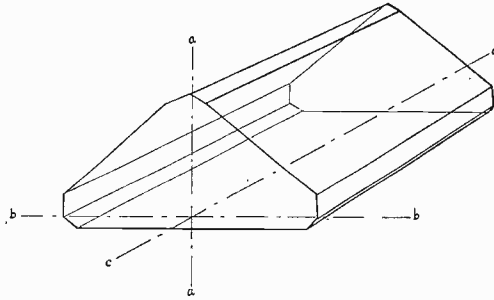

Fig. 1.

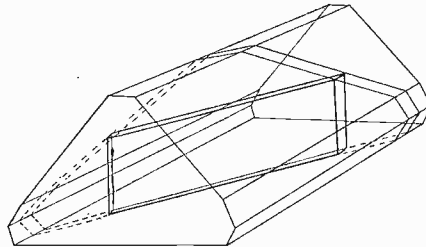

Fig. 2.

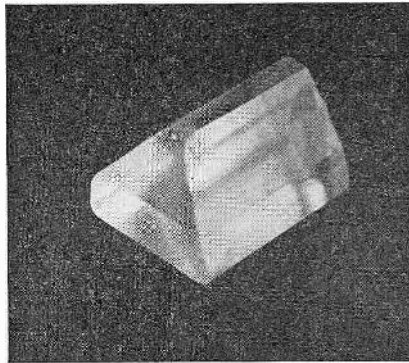

Fig. 3—Crystal specimen grown with suppressed b axis.

It is not necessary to have crystals equally developed along all three axes, and it was found that the best results were obtained by using seeds having either the a or b axis suppressed. These types are

shown in Figs. 1 and 2, the latter, in which the b axis is vertical, indicating how a specimen of type II is obtained from a crystal of this habit.

The specimen was cut to a size somewhat larger than was finally required by means of a specially prepared miter block, using a moistened string as the saw. The specimen was then roughly ground to size on a ground-glass lap, using fine pumice powder and turpentine, the final grinding being carried out on a ground-glass lap with methylated spirit as a lubricant and no abrasive powder. The specimens were finally washed in methylated spirit to remove the powdered material produced by grinding. In this connection it should be mentioned that a specimen should not be washed in cold spirit immediately after grinding, as it will be very liable to crack due to the change of temperature.



FREQUENCY MODULATION NOISE CHARACTERISTICS*

By

MURRAY G. CROSBY

(RCA Communications, Inc., Riverhead, L. I., New York)

Summary.—Theory and experimental data are given which show the improvements in signal-noise ratio effected by frequency modulation over amplitude modulation. It is shown that above a certain carrier-noise ratio in the frequency modulation receiver which is called the "improvement threshold," the frequency modulation signal-noise ratio is greater than the amplitude modulation signal-noise ratio by a factor equal to the product of a constant and the deviation ratio (the deviation ratio is equal to the ratio between the maximum frequency deviation and the audio modulation band width). The constant depends upon the type of noise, being slightly greater for impulse than for fluctuation noise. In frequency modulation systems with high deviation ratios, a higher carrier level is required to reach the improvement threshold than is required in systems with low deviation ratios; this carrier level is higher for impulse than for fluctuation noise. At carrier-noise ratios below the improvement threshold, the peak signal-noise ratio characteristics of the frequency modulation receiver are approximately the same as those of the amplitude modulation receiver, but the energy content of the frequency modulation noise is reduced.

An effect which is called "frequency limiting" is pointed out in which the peak value of the noise is limited to a value not greater than the peak value of the signal. With impulse noise this phenomenon effects a noise suppression in a manner similar to that in the recent circuits for reducing impulse noise which is stronger than the carrier in amplitude modulation reception.

When the power gain obtainable in certain types of transmitters by the use of frequency modulation is taken into account, the frequency modulation improvement factors are increased and the improvement threshold is lowered with respect to the carrier-noise ratio existing in a reference amplitude modulation system.

INTRODUCTION

IN A previously published paper,¹ the propagation characteristics of frequency modulation were considered. Prior to, and during these propagation tests, signal-noise ratio improvements effected by frequency modulation were observed. These observations were made at an early stage of the development work and were investigated by experimental and theoretical methods.

It is the purpose of this paper to consider that phase of the frequency modulation development work by RCA Communications,

* Decimal classification: R148×R270. Original manuscript received by the Institute, November 23, 1936. Presented as part of a paper on "Propagation and characteristics of frequency modulated waves," before New York meeting, January 8, 1936. Revised and presented in full before Chicago Section, September 11, 1936.

¹ Murray G. Crosby, "Frequency modulation propagation characteristics," Proc. I.R.E., vol. 24, pp. 898-913; June, (1936).

Inc., in which the signal-noise characteristics of frequency modulation are studied. The theory and experimental work consider the known systems of frequency modulation including that independently developed by E. H. Armstrong.²

TABLE OF SYMBOLS

- C = carrier peak voltage.
- C/N = theory: Ratio between peak voltage of carrier and instantaneous peak voltage of the noise in the frequency modulation receiver. Experiment: Ratio between peak voltage of carrier and *maximum* instantaneous peak voltage of the noise.
- C/n = ratio between the peak voltage of the carrier and the peak voltage of the noise component.
- C_a/N_a = carrier-noise ratio in the amplitude modulation receiver.
- F_a = maximum audio frequency of modulation band.
- F_c = carrier frequency.
- F_d = peak frequency deviation due to applied modulation.
- F_{dn} = peak frequency deviation of the noise.
- F_1 = intermediate-frequency channel width.
- F_m = modulation frequency.
- F_n = frequency of noise resultant or component.
- F_d/F_a = deviation ratio.
- K = slope filter conversion efficiency.
- M = modulation factor of the amplitude modulated carrier.
- M_f = modulation factor at the output of the sloping filter.
- M_{fn} = modulation factor at the output of the sloping filter when noise modulates the carrier.
- N = instantaneous peak voltage of the noise.
- n = peak voltage of the noise component.
- N_a = noise peak or root-mean-square voltage at amplitude modulation receiver output.
- N_f = noise peak or root-mean-square voltage at frequency modulation receiver output.
- $p = 2\pi F_m$.
- S_a = signal peak or root-mean-square voltage at amplitude modulation receiver output.
- S_f = signal peak or root-mean-square voltage at frequency modulation receiver output.
- $\omega = 2\pi F_c$.

² Edwin H. Armstrong, "A method of reducing disturbances in radio signaling by a system of frequency modulation," Proc. I.R.E., vol. 24, pp. 689-740; May, (1936).

$$\omega_n = 2\pi F_n.$$

$$\omega_{na} = (\omega - \omega_n) = 2\pi(F_c - F_n) = 2\pi F_{na}.$$

$$Z = C/n + n/C.$$

$\phi(t)$ = phase variation of noise resultant as a function of time.

THEORY

In the following analysis, frequency modulation is studied by comparing it with the familiar system of amplitude modulation. In order to do this, the characteristics of frequency modulation reception are analyzed so as to make possible the calculation of the signal-noise ratio improvement effected by frequency modulation over amplitude modulation at various carrier-noise ratios.³ The amplitude modulation standard of comparison consists of a double side-band system having the same audio modulation band as the frequency modulation system and producing the same carrier at the receiver. Differences in transmitter power gain due to frequency modulation are then considered separately. The frequency modulation reception process is analyzed by first considering the components of the receiver and the manner in which they convert the frequency modulated signal and noise spectrum into an output signal-noise ratio.

The Frequency Modulation Receiver

The customary circuit arrangement used for the reception of frequency modulation is shown in the block diagram of Fig. 1. The intermediate-frequency output of a superheterodyne receiver is fed through a limiter to a slope filter or conversion circuit which converts

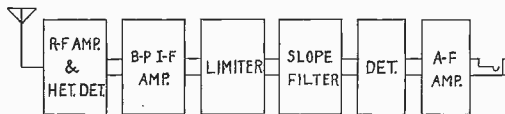

Fig. 1—Block diagram of a frequency modulation receiver.

the frequency modulation into amplitude modulation. This amplitude modulation is then detected in the conventional amplitude modulation manner. The audio-frequency amplifier is designed to amplify only the modulation frequencies; hence it acts as a low-pass filter which rejects noise frequencies higher than the maximum modulation frequency.

³ Throughout this paper, carrier-noise ratio will refer to the ratio measured at the output of the intermediate-frequency channel. Signal-noise ratio will refer to that measured at the output of the receiver and will depend upon the depth of modulation as well as upon the carrier strength.

The purpose of the limiter is to remove unwanted amplitude modulation so that only the frequency modulation component of the signal will be received. It may take the form of an overloaded amplifier tube whose output cannot rise above a certain level regardless of the input. Care must also be exercised to insure that the output of the overloaded amplifier does not fall off as the input is increased since this would introduce amplitude modulation of reverse phase, but of equally undesirable character.

The main requirement of the conversion circuit for converting the frequency modulation into amplitude modulation is that it slope linearly from a low value of output at one side of the intermediate-frequency channel to a high value at the other side of the channel. To do this, an off-tuned resonant circuit or a portion of the characteristic of

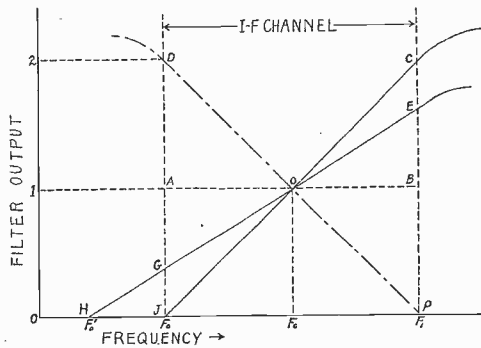

Fig. 2—Ideal sloping filter characteristics.

one of the many forms of wave filters may be utilized. The ideal slope filter would be one which gave zero output at one side of the channel, an output of one voltage unit at carrier frequency, and an output of two units at the other side of the channel. Such a characteristic is given by the curve *JOC* of Fig. 2. From this curve it is easily seen that if the frequency is swung between the limits F_0 and F_1 , about the mean frequency F_c , the output of the filter will have an amplitude modulation factor of unity. The modulation factor for a frequency deviation, F_a , will be given by

$$M_f = \frac{F_a}{(F_1 - F_c)} = \frac{F_a}{(F_c - F_0)} = \frac{2F_a}{F_i} \quad (1)$$

where F_i = intermediate-frequency channel width.

When the converting filter departs from the ideal characteristic in the manner of the filter of curve *HGOE* of Fig. 2, the modulation factor produced by a given frequency deviation is reduced by a factor equal

to the ratio between the distances AG and AJ or BE and BC . A convenient term for this reduction factor of the filter is "conversion efficiency" of the filter. Taking into account this conversion efficiency, the modulation factor for a frequency deviation F_d becomes

$$M_f = \frac{2KF_d}{F_i} \quad (2)$$

where $K = AG/AJ = BE/BC =$ conversion efficiency of the filter.

A low conversion efficiency may be used as long as the degree of limiting is high enough to reduce the amplitude modulation well below the level of the converted frequency modulation. This is true since lowering the conversion efficiency reduces the output of the noise in the same proportion as the signal as long as no amplitude modulation is present. Hence the signal-noise *ratio* is unimpaired and the only effect is a reduction of the audio gain by the factor K . If insufficient limiting is applied so that the output of the limiter contains appreciable amplitude modulation, a filter with a high conversion efficiency is desirable so that the amplitude modulation noise will not become comparable to the frequency modulation noise and thereby increase the resultant noise.

A push-pull, or "back-to-back" receiver may be arranged by providing two filters of opposite slope and separately detecting and combining the detected outputs in push-pull so as to combine the audio outputs in phase. Another slope filter having a characteristic as shown by the dot-dash line DOP in Fig. 2 would then be required.

A further type of receiver in which amplitude modulation is also balanced out may be arranged by making one of the slope filter circuits of the above-mentioned back-to-back type of receiver a flat-top circuit for the detection of amplitude modulation only. The sloping filter channel then detects both frequency and amplitude modulation; the flat-top channel detects only amplitude modulation. When these two detected outputs are combined in push-pull, the amplitude modulation is balanced out and the frequency modulation is received. This type of detection, as well as that in which opposite slope filters are used, has the limitation that the balance is partially destroyed as modulation is applied. However, if a limiter is used, the amplitude modulation is sufficiently reduced before the energy reaches the slope filters; consequently, for purposes of removing amplitude modulation, the balancing feature is not a necessity.

Noise Spectrum Analysis

The first step in the procedure to be followed here in determining the noise characteristics of the frequency modulation receiver will be

to determine mathematically the fidelity with which the noise is transmitted from the radio-frequency branch, in which it originates, to the measuring instrument as a function of frequency. To do this, the waves present at the receiver input will be assumed to be the frequency modulated carrier and the spectrum of noise voltages. This wave and spectrum will be combined into a single resultant whose amplitude and phase are functions of the constants of the component waves. The resultant will then be "mathematically" passed through the limiter to remove the amplitude modulation. From a determination of the instantaneous frequency of the resultant, the peak frequency deviation effected by the noise will be found. A single noise component of arbitrary frequency will then be substituted for the resultant of the noise spectrum, and the modulation factor at the output of the converting filter will be obtained. This noise component will then be varied in frequency to determine the over-all transmission of the receiver in terms of the modulation factor at the sloping filter output. The area under the curve representing the square of this over-all transmission will then be determined. By comparing this area with the corresponding area for an amplitude modulation receiver under equivalent conditions, and taking into consideration the pass band of the intermediate- and audio-frequency channels, a comparison will be obtained between the average noise powers, or the average root-mean-square noise voltages from the two receivers.⁴

The peak voltage characteristics of the two receivers will be compared for fluctuation noise by a correlation of known crest factors with the root-mean-square characteristics. (Crest factor = ratio between the peak and root-mean-square voltages.) The peak voltage characteristics of impulse noise will be determined by a separate consideration of the effect of the frequency modulation over-all transmissions upon the peak voltage of this type of noise.

After a comparison between the noise output voltages from the frequency and amplitude modulation receivers has been obtained, the respective signal output voltages will be taken into consideration so that the improvement in signal-noise ratio may be determined.

In the process of determining the over-all transmission of the noise, the frequency modulated wave may be expressed by

$$e_s = C \sin \{ \omega t + (F_d/F_m) \cos pt \} \quad (3)$$

⁴ Stuart Ballantine, "Fluctuation noise in radio receivers," *Proc. I.R.E.*, vol. 18, pp. 1377-1387; August, (1930). In this paper, Ballantine shows that the average value of the square of the noise voltage "... is proportional to the area under the curve representing the square of the over-all transimpedance (or of the transmission) from the radio-frequency branch in which the disturbance originates to the measuring instrument as a function of frequency"

where C = carrier peak voltage, $\omega = 2\pi F_c$, F_c = carrier frequency, F_a = applied frequency deviation, $p = 2\pi F_m$, and F_m = modulation frequency. The noise spectrum may be expressed by its resultant,⁵

$$e_n = N \sin(\omega_n t + \phi(t)) \quad (4)$$

where N = instantaneous peak voltage of the noise (a function of time). $\phi(t)$ takes into account the fact that the noise resultant is phase modulated, as would be the case with the resultant of a spectrum of many noise voltages. $\omega_n = 2\pi F_n$, F_n = frequency of the noise resultant.

The signal voltage given by (3) and the noise voltage given by (4) may be combined by vector addition to give

$$e = \sqrt{C^2 + N^2 + 2CN \cos \left\{ (\omega - \omega_n)t - \phi(t) + \frac{F_a}{F_m} \cos pt \right\}}$$

$$\sin \left[\omega t + \frac{F_a}{F_m} \cos pt + \tan^{-1} \frac{\sin \left\{ (\omega - \omega_n)t - \phi(t) + \frac{F_a}{F_m} \cos pt \right\}}{\frac{C}{N} + \cos \left\{ (\omega - \omega_n)t - \phi(t) + \frac{F_a}{F_m} \cos pt \right\}} \right] \quad (5)$$

When the resultant wave given by (5) is passed through the limiter in the frequency modulation receiver, the amplitude modulation is removed. Hence the amplitude term is reduced to a constant and the only part of consequence is the phase angle of the wave. The rate of change of this phase angle, or its first derivative, is the instantaneous frequency of the wave. Taking the first derivative and dividing by 2π to change from radians per second to cycles per second gives

$$d \left[\omega t + \frac{F_a}{F_m} \cos pt + \tan^{-1} \frac{\sin \left\{ \omega_{nat} - \phi(t) + \frac{F_a}{F_m} \cos pt \right\}}{\frac{C}{N} + \cos \left\{ \omega_{nat} - \phi(t) + \frac{F_a}{F_m} \cos pt \right\}} \right] \times \frac{1}{2\pi}$$

$$= f = F_c - F_a \sin pt - \frac{\left(F_{na} - \frac{1}{2\pi} \frac{d\phi(t)}{dt} - F_a \sin pt \right)}{\frac{C}{N} + \cos \left\{ \omega_{nat} - \phi(t) + \frac{F_a}{F_m} \cos pt \right\}} + 1$$

$$\frac{N}{C} + \cos \left\{ \omega_{nat} - \phi(t) + \frac{F_a}{F_n} \cos pt \right\}$$

$$(6)$$

⁵ John R. Carson, "The reduction of atmospheric disturbances," Proc. I.R.E., vol. 16, pp. 967-975; July, (1928).

in which $\omega_{na} = (\omega - \omega_n) = 2\pi(F_c - F_n) = 2\pi F_{na}$.

Equation (6) gives the instantaneous frequency of the resultant wave consisting of the signal and the noise resultant voltage. From this equation the signal and noise frequency deviations may be obtained. In order to determine the over-all transmission with respect to the various components in the noise spectrum, a single component of noise, with constant amplitude and variable frequency, will be substituted for the resultant noise voltage given by (4). This makes N equal to n , which is not a function of time, and $\phi(t)$ equal to zero. Making these changes in (6) gives

$$f = F_c - F_d \sin pt - \frac{(F_{na} - F_d \sin pt)}{\frac{C}{n} + \cos \left\{ \omega_{nat} + \frac{F_d}{F_m} \cos pt \right\}} + 1 \quad (7)$$

$$\frac{n}{C} + \cos \left\{ \omega_{nat} + \frac{F_d}{F_m} \cos pt \right\}$$

The equations for the instantaneous frequency, given by (6) and (7), show the manner in which the noise combines with the incoming carrier to produce a frequency modulation of the carrier. From these equations the frequency deviations of the noise may be determined, and from the frequency deviations the modulation factor at the output of the sloping filter may be found. Hence the over-all transmission may be obtained in terms of the modulation factor at the output of the sloping filter for a given carrier-noise ratio. When the carrier-noise ratio is high, (6) and (7) simplify so that calculations are fairly easy. When the carrier-noise ratio is low, the equations become involved to a degree which discourages quantitative calculations.

High Carrier-Noise Ratios

When C/n is large compared to unity, and the applied modulation on the frequency modulated wave is reduced to zero ($F_d = 0$), (7) reduces to

$$f = F_c - \frac{n^2}{C^2} F_{na} - \frac{n}{C} F_{na} \cos \omega_{nat}. \quad (8)$$

From (8) the effective peak frequency deviation of a single noise component of the spectrum is

$$F_{dn} = \frac{nF_{na}}{C} \left(\frac{n}{C} + 1 \right). \quad (9)$$

But, since n/C is negligible compared to unity,

$$F_{dn} = \frac{nF_{na}}{C}. \quad (10)$$

When this value of frequency deviation is substituted in (1) to find the modulation factor⁶ of the energy at the output of the sloping filter, the following results:

$$M_{fn} = \frac{n}{C} \times \frac{2F_{na}}{F_i}. \quad (11)$$

Equation (11) shows that the modulation factor of the noise is inversely proportional to the carrier-noise ratio and directly proportional to the ratio between the noise audio frequency and one half the intermediate-frequency channel width. When this equation is plotted with the noise audio frequency, F_{na} , as a variable and the modulation factor as the ordinate, the audio spectrum obtained for the detector output is like that of the triangular spectrum *OBA* in Fig. 3. Such a spectrum would be produced by varying F_n through the range between the upper and lower cutoff frequencies of the intermediate-frequency channel. The noise amplitude would be greatest at a noise audio frequency equal to one half the intermediate-frequency channel width. At this noise audio frequency, the ratio $2F_{na}/F_i$ is equal to unity and the modulation factor becomes equal to n/C . If the detector output is passed through an audio system having a cutoff frequency F_a , the maximum frequency of the audio channel governs the maximum amplitude of the spectrum. The maximum amplitude of the detector output is therefore reduced by the ratio $F_i/2:F_a$. This can be seen by a comparison of the spectrum *OBA* for the detector output and the spectrum *ODH* for the audio channel output.

When the amplitude modulation reception process is analyzed with a carrier and noise spectrum present at the receiver input, the modulation factor of the energy fed to the detector is found to be equal to the reciprocal of the carrier-noise ratio for all of the noise frequencies in the spectrum. That is to say, the receiver transmission for amplitude modulation will be constant for all of the frequencies in the spectrum. Normally the upper cutoff frequency of the audio amplifier is equal to one half the intermediate-frequency channel width ($F_a = F_i/2$). Consequently the audio spectrum of the amplitude modulated noise fed to

⁶ The ideal filter is used in this case since the use of a filter with a low conversion efficiency would merely require the addition of audio gain to put the frequency modulation receiver on an equivalent basis with the amplitude modulation receiver. The audio gain necessary would be equal to the reciprocal of the conversion efficiency of the sloping filter.

the detector will be the same as that at the receiver output and will be as portrayed by the rectangle $OCEH$.

The spectra of Fig. 3 show the manner in which the frequency modulation receiver produces a greater signal-noise ratio than the amplitude modulation receiver. The noise at the output of the detector of the frequency modulation receiver consists of frequencies which extend out to an audio frequency equal to one half the intermediate-frequency channel width, and the amplitudes of these components are proportional to their audio frequency. Hence in passing through the audio channel the noise is reduced not only in range of frequencies, but also in amplitude. On the other hand, the components of the signal wave are properly disposed to produce detected signal frequencies which fit into the audio channel. In the case of the amplitude modulation receiver, the amplitude of the components at the output of the audio

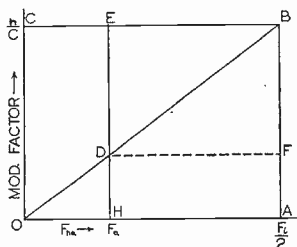

Fig. 3—Amplitude and frequency modulation receiver noise spectra. OBA = frequency modulation detector output. ODH = frequency modulation receiver output. $OCEH$ = amplitude modulation receiver output.

channel is the same as that at the output of the detector since the spectrum is rectangular. Thus the frequency modulation signal-noise ratio is greater than the amplitude modulation signal-noise ratio by a factor which depends upon the relative magnitudes of the spectra $OCEH$ and ODH . The magnitudes which are of concern are the root-mean-square and peak values of the voltage due to the spectra.

Root-Mean-Square Noise Considerations

The average noise power or average root-mean-square voltage ratio between the rectangular amplitude modulation spectrum $OCEH$ and the triangular frequency modulation spectrum ODH , of Fig. 3, may be found by a comparison of the squared-ordinate areas of the two spectra. Thus,

$$\frac{W_a}{W_f} = \frac{\text{area } OCEH \text{ (ordinates)}^2}{\text{area } ODH \text{ (ordinates)}^2}$$

$$= \frac{\left(\frac{n}{C}\right)^2 F_a}{\int_0^{F_a} \left(\frac{n}{C} \times \frac{2F_{na}}{F_i}\right)^2 dF_{na}} = 3 \left(\frac{F_i}{2F_a}\right)^2 \quad (12)$$

where W_a/W_f is the ratio between the amplitude modulation average noise power and the frequency modulation average noise power at the receiver outputs. The root-mean-square noise voltage ratio will be

$$\frac{N_a}{N_f} \text{ (r-m-s fluctuation)} = \sqrt{\frac{W_a}{W_f}} = \sqrt{3} \frac{F_i}{2F_a}. \quad (13)$$

Equation (13) gives the root-mean-square noise voltage ratio for equal carriers applied to the two receivers. The modulation factor of the frequency modulated signal due to the applied frequency deviation, F_d , is, from (3), equal to $2F_d/F_i$. The modulation factor of the amplitude modulated signal may be designated by M and has a maximum value of 1.0. Thus the ratio between the two signals will be given by

$$\frac{S_a}{S_f} \text{ (peak or r-m-s values)} = \frac{F_i M}{2F_a} = \frac{F_i}{2F_a} \text{ (for } M = 1.0). \quad (14)$$

Dividing (13) by (14), to find the ratio between the signal-noise ratios at the outputs of the two receivers, gives

$$\frac{S_f/N_f}{S_a/N_a} \text{ (r-m-s values)} = \sqrt{3} \frac{F_d}{F_a}. \quad (15)$$

It is apparent that the ratio between the frequency deviation and the audio channel, F_d/F_a , is an important factor in determining the signal-noise ratio gain effected by frequency modulation. A convenient term for this ratio is the "deviation ratio" and it will be designated as such hereinafter.

Equation (15) gives the factor by which the amplitude modulation root-mean-square signal-noise ratio is multiplied in order to find the equivalent frequency modulation signal-noise ratio. Since this factor is used so frequently hereinafter, it will be designated by the word "improvement." The improvement given by (15) has been developed under the assumption of zero applied frequency deviation (no modulation) and a carrier which is strong compared to the noise. However, as will be shown later, as long as the carrier is strong compared to the

noise, this equation also holds true for the case where modulation is present.

Peak Noise Considerations

In the ultimate application of signal-noise ratios, peak voltages are of prime importance since it is the peak of the noise voltage which seems to produce the annoyance. This is especially true in the case of impulse noise such as ignition where the crest factor of the noise may be very high. Thus the energy content of a short duration impulse might be very small in comparison with the energy content of the signal, but the peak voltage of the impulse might exceed the signal peak voltage and become very annoying. The degree of this annoyance would of course depend upon the type of service and will not be gone into here. In view of this importance of peak noise considerations, the final judgment in the comparison between the systems of frequency and amplitude modulation treated here will be based upon peak signal-noise ratios.

When the peak voltage or current ratio of the frequency and amplitude modulation spectra is to be determined, the characteristics of the different types of noise must be taken into consideration. There seem to be two general types of noise which require consideration. The first of these is fluctuation noise, such as thermal agitation and shot effect, which is characterized by a random relation between the various frequencies in the spectrum. The second is impulse noise, such as ignition or any other type of noise having a spectrum produced by a sudden rise of voltage, which is characterized by an orderly phase and amplitude relation between the individual frequencies in the spectrum.

Experimental data taken by the author have shown that the fluctuation noise crest factor is constant, independent of band width, when the carrier is strong compared to the noise. Thus the peak voltage of fluctuation noise varies with band width in the same manner that root-mean-square voltage does, namely, as the square-root of the band width ratio. Consequently, for the strong-carrier condition, the peak voltage characteristics of fluctuation noise may be determined by applying the experimentally determined crest factor to the root-mean-square characteristics. Hence, in the case of fluctuation noise, (15) applies for peak noise improvement as well as for average root-mean-square noise improvement.

Impulse Noise Characteristics

A simple way of visualizing the manner in which impulse noise produces its peak radio-frequency voltage is to consider the case of a

recurrent impulse. It is well known that a recurrent impulse, such as square-wave-form dots, may be expressed by a Fourier series which consists of a fundamental and an infinite array of harmonics. The amplitudes of these harmonics are inversely proportional to their frequencies. The components of the single impulse will be similar to those of the recurrent impulse since the single impulse may be considered as a recurrent impulse with a very low rate of recurrence. The part of this impulse spectrum that is received on a radio receiver is a small band of the very high order harmonics. Since the frequency difference between the highest and lowest frequencies of this band is small compared to the mid-frequency of the band, all of the frequencies received are of practically equal amplitude. These harmonics are so related to each other by virtue of their relation to a common fundamental that they are all in phase at the instant the impulse starts or stops. Hence, for the interval at the start or stop of the impulse, all of the voltages in the band add up arithmetically and the peak voltage of the combination is directly proportional to the number of individual voltages. Since the individual voltages of the spectrum are equally spaced throughout the band, the number of voltages included in a given band is proportional to the band width. Consequently, the peak voltage of the resultant of the components in the spectrum is directly proportional to the band width. Thus impulse noise varies, not as the square root of the band width, as fluctuation noise does, but directly as the band width.⁷ Since the voltages in the spectrum add arithmetically, their peak amplitude is proportional to their average ordinate as well as proportional to the band width. This makes the peak voltage of impulse noise, not proportional to the square root of the ratio between the *squared-ordinates areas*, as is the case with root-mean-square noise, but proportional to the ratio between the *areas* of the two spectra. Hence, (referring to Fig. 3)

$$\begin{aligned} \frac{N_a}{N_f} \text{ (peak values, impulse)} &= \frac{\text{area } OCEH}{\text{area } ODH} \\ &= \frac{(n/C) \times F_a}{F_a \times \frac{1}{2} \times \frac{2F_a}{F_i} \times \frac{n}{C}} = \frac{F_i}{F_a}. \quad (16) \end{aligned}$$

⁷ The fact that the peak voltage of impulse noise varies directly with the band width was first pointed out to the author by V. D. Landon of the RCA Manufacturing Company. The results of his work were later presented by him as a paper entitled "A study of noise characteristics," before the Eleventh Annual Convention, Cleveland, Ohio, May 13, 1936; published in the Proc. I.R.E., vol. 24, pp. 1514-1521; November, (1936).

Dividing (16) by (14) to obtain the ratio between the frequency and amplitude modulation output signal-noise ratios gives

$$\frac{S_f/N_f}{S_a/N_a} (\text{peak values, impulse}) = 2 \frac{F_d}{F_a}. \quad (17)$$

Equation (17) shows that the frequency modulation peak voltage improvement with respect to impulse noise is equal to twice the deviation ratio or about 1.16 times more improvement than is produced on fluctuation noise. The peak power gain would be equal to the square of the peak voltage gain or four times the square of the deviation ratio.

Low Carrier-Noise Ratios

When the expression for the instantaneous frequency of the wave modulated by the noise component and signal, given by (7), is resolved into its components by the use of the binomial theorem, the following is the result:

$$f = F_c - F_d \sin pt - \frac{(F_{na} - F_d \sin pt)}{Z} \left[\frac{n}{C} - \left(1 - \frac{2n}{ZC} \right) \left\{ \frac{K_0}{Z} - K_1 \cos(\omega_{na}t - F_d \sin pt) + K_2 \cos 2(\omega_{na}t - F_d \sin pt) + K_3 \cos 3(\omega_{na}t - F_d \sin pt) \dots \right\} \right] \quad (18)$$

in which $Z = \frac{C}{n} + \frac{n}{C}$ and

$$K_0 = K_1 = \left(1 + \frac{3}{Z^2} + \frac{10}{Z^4} + \frac{35}{Z^6} + \frac{126}{Z^8} + \frac{462}{Z^{10}} + \frac{1716}{Z^{12}} + \dots \right) \quad (19)$$

$$K_2 = \left(\frac{1}{Z} - \frac{4}{Z^3} - \frac{15}{Z^5} - \frac{56}{Z^7} - \frac{210}{Z^9} - \frac{792}{Z^{11}} - \frac{3003}{Z^{13}} - \dots \right) \quad (20)$$

$$K_3 = \left(\frac{1}{Z^2} + \frac{5}{Z^4} + \frac{21}{Z^6} + \frac{84}{Z^8} + \frac{330}{Z^{10}} + \frac{1287}{Z^{12}} + \frac{5005}{Z^{14}} + \dots \right). \quad (21)$$

Additional terms of the series of (19), (20), and (21), as well as higher order series, may be found with the aid of a table of binomial coefficients.

Equation (18) shows that, as the carrier-noise ratio approaches unity, the effective signal-noise ratio at the receiver output is no longer directly proportional to the carrier-noise ratio. The effective frequency deviation produced by the noise has harmonics introduced and a constant frequency shift added. The effect of the harmonics and

constant shift is to make the wave form of a single noise component very peaked and of the nature of an impulse. Because of the selectivity of the audio channel, none of the harmonics are present for the noise frequencies in the upper half of the audio spectrum. As the frequency of the noise voltage is lowered, more and more harmonics are passed by the audio channel and as a consequence, the peak frequency deviation due to the noise is increased. This can be more easily understood from the following calculation of the wave form produced by the instantaneous frequency deviation of the single noise component.

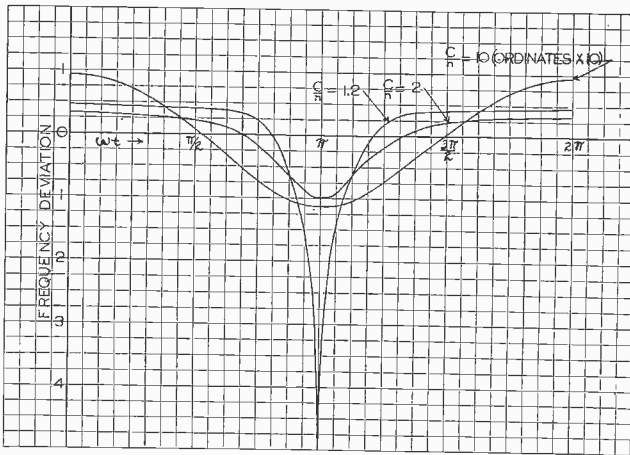

Fig. 4—Calculated wave forms showing the distortion produced on the instantaneous frequency deviation of the wave composed of the combination of the carrier and a single noise component. C/n = ratio between the peak voltage of the carrier and the peak voltage of the noise component.

The curves of Fig. 4 have been calculated from (7) and show how the instantaneous frequency deviation varies with time or the phase angle of the wave. A wave with the instantaneous frequency given by these curves would produce voltages in the output of the detector of the frequency modulation receiver which are proportional to the frequency deviations. It can be seen from these curves that, as the carrier-noise ratio approaches unity, the wave form becomes more and more peaked. The harmonics which enter in to make up this peaked wave form are given by (18) and are completely present for all noise frequencies only in the absence of audio selectivity.

In the presence of audio selectivity, the condition portrayed by (18) is approached as the audio frequency of the noise approaches zero. Thus the wave form of the noise is sinusoidal at a noise frequency high

enough to have its harmonics eliminated by the audio selectivity, but becomes more peaked as the frequency is made lower so that more harmonics are included. This effect tends to increase the peak voltage of the low-frequency noise voltages which have a large number of harmonics present. Thus, as the carrier-noise ratio approaches unity, the triangular audio spectrum is distorted by an increase in the amplitude of the lower noise frequencies.

The above gives a qualitative and partially quantitative description of the noise spectrum which results at the lower carrier-noise ratios. Further development would undoubtedly make possible the exact calculation of the peak and root-mean-square signal-noise ratio at the receiver output when the carrier-noise ratio at the receiver input is close to unity, but, because of the laborious nature of the calculations involved in evaluating the terms of (18), and pressure of other work, the author is relying upon experimental determinations for these data.

Noise Crest Factor Characteristics

The crest factor characteristics of the noise can be studied to an approximate extent by a study of (6). This equation portrays the resultant peak frequency deviation of the wave at the output of the limiter. From it, the crest factor characteristics of the output of the detector may be determined since in the frequency modulation receiver frequency deviations are linearly converted into detector output voltages. However, the crest factor characteristics of the receiver output are different from those at the detector output due to the effect of the selectivity of the audio channel. This is especially true in the case of the frequency modulation receiver with a deviation ratio greater than unity, that is, where the audio channel is less than one half the intermediate-frequency channel. Consequently, in order to obtain the final results, the effect of the application of the audio selectivity must be applied to the results determined from a study of (6).

From the curves of Fig. 4, it can be seen that the peak frequency deviation of the wave given by (7) occurs at a phase angle equal to 180 degrees. From the similarity of (6) and (7), it can be seen that the peak frequency deviation of (6) would also occur at a phase angle of 180 degrees. At this phase angle the noise peak frequency deviation from (6) is

$$f_{dn}(\text{peak}) = \frac{\left(F_{na} - \frac{1}{2\pi} \frac{d\phi(t)}{dt} - F_d \sin pt \right)}{\frac{(C/N) - 1}{(N/C) - 1} + 1}$$

$$= \frac{\left(F_{na} - \frac{1}{2\pi} \frac{d\phi(t)}{dt} - F_a \sin pt \right)}{(C/N) - 1} \quad (22)$$

Equation (22) shows that the peak frequency deviation of the noise, for any value of carrier-noise ratio, C/N , is proportional to the noise instantaneous audio frequency given by the quantity

$$\left(F_{na} - \frac{1}{2\pi} \frac{d\phi(t)}{dt} - F_a \sin pt \right), \text{ and to the quantity } 1/\{(C/N) - 1\}.$$

C/N is the resultant instantaneous peak carrier-noise ratio which is present in the output of the frequency modulation intermediate-frequency channel. It is apparent that when this carrier-noise ratio is high, the peak frequency deviation of the noise is proportional to N/C . When the carrier-noise ratio is equal to unity, the peak frequency deviation becomes infinite and it is evident that the frequency modulation improvement, which is based on a high carrier-noise ratio, would be lost at this point. The term "improvement threshold" will be employed hereinafter to designate this point below which the frequency modulation improvement is lost and above which the improvement is realized. Theoretically this term would refer to the condition where the instantaneous peak voltage of the noise is equal to the peak voltage of the carrier. However, in the practical case, where only *maximum* peak values of the noise are measured, the improvement threshold will refer to the condition of equality of the *maximum* instantaneous peak voltage of the noise and the peak voltage of the carrier.

As the experimental characteristics will show, this increase in peak frequency deviation of the noise is manifested in an increase in crest factor of the noise. The crest factor cannot rise to infinity, however, due to the limitations imposed by the upper and lower cutoff frequencies of the intermediate-frequency channel. This selectivity limits the peak frequency deviation of the resultant of the noise and applied modulation to a value not greater than one half the intermediate-frequency channel width. Hence, in the absence of applied frequency modulation, the peak voltage of the noise at the detector output may rise to a value equal to the peak voltage due to the applied frequency modulation with maximum frequency deviation. In the presence of the applied frequency modulation, the total peak frequency deviation is limited so that the noise peaks depress the signal, that is, they punch holes in the signal, but do not rise above it. Thus a phenomenon which might be termed "frequency limiting" takes place. This frequency

limiting limits frequency deviations in the same manner that amplitude limiting limits amplitude deviations. The resulting effect is the same as though an amplitude limiter were placed at the detector output to limit the output so that the peak voltage of the noise or signal, or their resultant, cannot rise above a voltage corresponding to that produced by the signal alone at full modulation.

Since the frequency limiting limits the noise so that its maximum amplitude cannot rise above the maximum amplitude of the applied modulation, a noise suppression effect is present which is similar to that effected by the recent noise suppression circuits^{8,9} used for reducing impulse noise which is stronger than the amplitude modulated carrier being received. The result of such limiting is a considerable reduction of the annoyance produced by an intermittent noise, such as ignition, where the duration of the impulses is short and the rate of recurrence is low. With such noise, the depression of the signal for the duration of the impulse reduces the presence of the signal for only a small percentage of the time; the resultant effect is a considerable improvement over the condition where the peaks of the noise are stronger than the signal. On the other hand, for steady noise such as fluctuation noise, as the carrier-noise ratio is made less than unity, the signal is depressed more and more of the time so that it is gradually smothered in the noise.

When the effect of the audio selectivity is considered in conjunction with the frequency limiting, it is found that the noise suppression effect is somewhat improved for the case of a deviation ratio greater than unity. The reason for this is as follows: The frequency limiting holds the peak voltage of the noise at the output of the detector so that it cannot rise above the maximum value of the signal. However, in passing through the audio channel, the noise is still further reduced by elimination of higher frequency components whereas the signal passes through without reduction. Consequently the over-all limiting effect is such that the noise is limited to a value which is *less* than the maximum value of the signal. The amount that it is less depends upon the difference between the noise spectra existing at the output of the detector and the output of the audio selectivity.

Experimental determinations, which will be shown later, point out that as unity carrier-noise ratio is approached, the frequency

⁸ Leland E. Thompson, "A detector circuit for reducing noise interference in C.W. reception," *QST*, vol. 19, p. 38; April, (1935). A similar circuit for telephony reception is described by the same author in *QST*, vol. 20, pp. 44-45; February, (1936).

⁹ James J. Lamb, "A noise-silencing I.F. circuit for superhet receivers," *QST*, vol. 20, pp. 11-14; February, (1936).

modulation audio noise spectrum changes from its triangular shape to a somewhat rectangular shape. Hence the noise spectrum at the output of the detector when frequency limiting is taking place would be approximately as given by *OCBA* of Fig. 3. When the audio selectivity is applied, the spectrum would be reduced to *OCEH* and the band width of the noise would be reduced by a ratio equal to the deviation ratio. This would reduce the peak voltage of fluctuation noise by a ratio equal to the square root of the deviation ratio and that of impulse noise by a ratio equal to the deviation ratio. Thus, the resultant effect of the frequency limiting is that the fluctuation noise output is limited to a value equal to the maximum peak voltage of the signal divided by the square root of the deviation ratio. The corresponding value of impulse noise is limited to a value equal to the maximum peak voltage of the signal divided by the deviation ratio. Consequently, with fluctuation noise, when the noise and signal are measured in the absence of each other, the signal-noise ratio cannot go below a value equal to the square root of the deviation ratio; the corresponding signal-noise ratio impulse noise cannot go below a value equal to the deviation ratio. However, these minimum signal-noise ratios are only those which exist when the noise is measured in the absence of the applied frequency modulation. When the applied modulation and the noise are simultaneously present, the noise causes the signal to be depressed. When this depressed signal, with its depression caused by noise composed of a wide band of frequencies, is passed through the audio selectivity, the degree of depression is reduced. The amount of the reduction will be different for the two kinds of noise. The determination of the actual magnitude of this reduction of the signal depression, as effected by the audio selectivity, will be left for experimental evaluation.

In comparing frequency modulation systems with different deviation ratios at the *low carrier-noise ratios*, the wider intermediate-frequency channel necessary for the high deviation ratio receiver gives that receiver a disadvantage with respect to the low deviation ratio receiver. Since this wider channel accepts more noise than the narrower intermediate-frequency channel of the low deviation ratio receiver, when equal carriers are fed to both such receivers equality of carrier and noise occurs at a higher carrier level in the high deviation ratio receiver. As a result, a higher carrier voltage is required to reach the improvement threshold in the case of the high deviation ratio system. Thus at certain low carrier levels, the carrier-noise ratio could be above the improvement threshold in the low deviation ratio system, but below in the high deviation ratio system; at this carrier level the

low deviation ratio system would be capable of producing a better output signal-noise ratio than the high deviation ratio system.

The difference between the improvement thresholds of receivers with different deviation ratios may be investigated by a determination of the carrier-noise ratio which exists in the reference amplitude modulation receiver when the improvement threshold exists in the frequency modulation receiver. This carrier-noise ratio may be found by a consideration of the relative band widths of the intermediate-frequency channels of the receivers. Thus, when the deviation ratio is unity, and the intermediate-frequency channel of the frequency modulation receiver is of the same width as that of the amplitude modulation receiver,¹⁰ the two receivers would have the same carrier-noise ratio in the intermediate-frequency channels. When the deviation ratio is greater than unity, and the intermediate-frequency channel of the frequency modulation receiver is broader than that of the amplitude modulation receiver, the carrier-noise ratio in the frequency modulation receiver is less than that in the amplitude modulation receiver. For the case of fluctuation noise, where the peak values vary as the square root of the ratio between the two band widths concerned, the carrier-noise ratio in the frequency modulation intermediate-frequency channel would be less than that in the amplitude modulation intermediate-frequency channel by a ratio equal to the square root of the deviation ratio. Thus, when equal carrier voltage is fed to both receivers,

$$C_a/N_a = (C/N)\sqrt{F_d/F_a} \text{ (fluctuation noise, peak or r-m-s values)} \quad (23)$$

in which C_a/N_a = carrier-noise ratio in the amplitude modulation intermediate-frequency channel and C/N = corresponding ratio in the frequency modulation intermediate-frequency channel.

In the case of impulse noise, where the peak values of the noise

¹⁰ In order to assume that the frequency modulation receiver with a deviation ratio of unity has the same intermediate-frequency channel width as the corresponding amplitude modulation receiver, the assumption would also have to be made that the peak frequency deviation due to the applied frequency modulation is equal to one half the intermediate-frequency channel width. In the ideal receiver with a square-topped selectivity characteristic, this amount of frequency deviation would produce considerable out-of-channel interference and would introduce distortion in the form of a reduction of the amplitudes of the higher modulation of frequencies during the intervals of high peak frequency deviation. However, under actual conditions, where the corners of the selectivity characteristic are rounded, it has been found that the frequency deviation may be made practically equal to one half the normal selectivity used in amplitude modulation practice without serious distortion. Receivers with high deviation ratios are less susceptible to this distortion due to the natural distribution of the side bands for the high values of F_d/F_m which are encountered with such receivers.

vary directly with the band-width ratio, the carrier-noise ratios in the two receivers are related by

$$C_a/N_a = \frac{C}{N} \frac{F_d}{F_a} \text{ (impulse noise, peak values).} \quad (24)$$

From (23), it can be seen that, with fluctuation noise, a carrier-noise ratio equal to the square root of the deviation ratio would exist in the amplitude modulation intermediate-frequency channel when the carrier-noise ratio is at the improvement threshold ($C/N=1$) in the frequency modulation intermediate-frequency channel. Likewise, from (24), with impulse noise, the frequency modulation improvement threshold occurs at a peak carrier-noise ratio in the amplitude modulation intermediate-frequency channel which is equal to the deviation ratio.

Effect of Application of the Modulation

For the condition of a carrier which is strong compared to the noise, the equation for the instantaneous frequency of the wave modulated by the noise and signal, given by (7), may be reduced to the following:

$$f = F_c - F_d \sin pt - \frac{n^2}{C^2} (F_{na} - F_d \sin pt) - \frac{n}{C} (F_{na} - F_d \sin pt) \cos \left\{ \omega_{nat} + \frac{F_d}{F_m} \cos pt \right\}. \quad (25)$$

By neglecting the inconsequential term proportional to n^2/C^2 , applying the sine and cosine addition formulas, the Bessel function expansions, and the Bessel function recurrence formulas, (25) may be resolved into

$$\begin{aligned} f = F_c - (n/C) & \left[J_0 \left(\frac{F_d}{F_m} \right) F_{na} \cos \omega_{nat} \right. \\ & - J_1 \left(\frac{F_d}{F_m} \right) \{ (F_{na} + F_m) \sin (\omega_{nat} + pt) + (F_{na} - F_m) \sin (\omega_{nat} - pt) \} \\ & - J_2 \left(\frac{F_d}{F_m} \right) \{ (F_{na} + 2F_m) \cos (\omega_{nat} + 2pt) + (F_{na} - 2F_m) \cos (\omega_{nat} - 2pt) \} \\ & + J_3 \left(\frac{F_d}{F_m} \right) \{ (F_{na} + 3F_m) \sin (\omega_{nat} + 3pt) + (F_{na} - 3F_m) \sin (\omega_{nat} - 3pt) \} \\ & \left. + J_4 \dots \right]. \quad (26) \end{aligned}$$

This resolution shows that the application of frequency modulation

to the carrier divides the over-all transmission of the receiver into components due to the carrier and each side frequency. The amplitudes of these components are proportional to the frequency difference between the noise voltage and the side frequency producing the component. The frequency of the audio noise voltage in each one of these component spectra is equal to the difference between the side frequency and the noise radio frequency. Thus the application of the modulation changes the noise from a single triangular spectrum due to the carrier, into a summation of triangular spectra due to the carrier and side frequencies. In the absence of selectivity, the total root-mean-square noise would be unchanged by the application of the modulation since the root-mean-square summation of the frequency modulation carrier and side frequencies is constant; hence the root-mean-square summation of noise spectra whose amplitudes are proportional to the strength of the carrier and side frequencies would be constant. However, since selectivity is present, the noise is reduced somewhat. This can be seen by considering the noise spectrum associated with one of the higher side frequencies. The noise spectrum associated with this side frequency, which acts as a "carrier" for its noise spectrum, is curtailed at the high-frequency end by the upper cutoff of the intermediate-frequency channel. The region of noise below the side frequency is correspondingly increased in range, but yields high-frequency noise voltages which are eliminated by the audio-frequency selectivity. Consequently when modulation is applied, the noise is slightly reduced. The amount of this reduction may be calculated by a root-mean-square summation of the individual noise spectra due to the carrier and side frequencies. For the case of a deviation ratio of unity, an actual summation of the various spectra for full applied modulation has shown the root-mean-square reduction to be between two and three decibels depending upon the audio frequency of the noise. The same sort of summations also shows that the reduction becomes less as the deviation ratio is increased.

The weak-carrier root-mean-square noise characteristics in the presence of applied frequency modulation do not lend themselves to such straightforward calculation as the corresponding strong-carrier characteristics and will not be gone into here. The same can be said for the peak-noise characteristics in the presence of applied frequency modulation.

Transmitter Frequency Modulation Power Gain

The above considerations, which are based upon the equivalent conditions of equal carrier amplitude at the input of the amplitude

and frequency modulation receivers, do not take into account the power gain effected by the use of frequency modulation at the transmitter. Since the power in a frequency modulated wave is constant, the radio-frequency amplifier tubes in the transmitter may be operated in the class C condition instead of the class B condition as is required for a low level modulated amplitude modulation system. In changing from the class B to the class C condition, the output voltage of the amplifier may be doubled. Consequently a four-to-one power gain may be realized by the use of frequency modulation when the amplitude modulation transmitter uses low-level modulation. On the other hand, when the amplitude modulation transmitter uses high level modulation—that is, when the final amplifier stage is modulated, the power gain is not so great. However, for the purpose of showing the effect of a transmitter power gain, the amplitude modulation transmitter will be assumed to be modulated at low levels.

As this paper is in the final stages of preparation, systems of amplifying amplitude modulation have been announced wherein plate efficiencies of linear amplifiers have been increased practically to equal the class C efficiencies.^{11,12} Since these systems are not in general use as yet, it will suffice to say that such improvements in amplitude modulation transmission will tend to remove the frequency modulation transmitter gain in accordance with these improvements. Hence the overall frequency modulation gain will more nearly approach that due to the receiver¹³ alone.

With a four-to-one power gain at the transmitter, a frequency modulation system would deliver twice the carrier voltage to its receiver that an amplitude modulation system would with the same transmitter output stage. Hence (15) and (17), and (23) and (24) become, respectively,

$$\frac{S_f/N_f}{S_a/N_a} \text{ (peak values, fluctuation noise)} = 2\sqrt{3}F_d/F_a \quad (27)$$

$$\frac{S_f/N_f}{S_a/N_a} \text{ (peak values, impulse noise)} = 4F_d/F_a \quad (28)$$

¹¹ W. H. Doherty, "A new high efficiency power amplifier for modulated waves," presented before Eleventh Annual Convention, Cleveland, Ohio, May 13, (1936); published in Proc. I.R.E., vol. 24, pp. 1163-1182; September, (1936).

¹² J. N. A. Hawkins, "A new, high-efficiency linear amplifier," *Radio*, no. 209, pp. 8-14, 74-76; May, (1936).

¹³ The receiver and transmitter gain are mentioned rather loosely when they are separated in this way. However, it will be understood that the receiver gain could not be realized without providing a transmitter to match the requirements of the receiver.

$$C_a/N = (C/2N)\sqrt{F_d/F_a} \text{ (fluctuation noise, r-m-s or peak values)} \quad (29)$$

$$C_a/N = (C/2N)F_d/F_a \text{ (impulse noise, peak values)}. \quad (30)$$

These equations show that this increase in carrier fed to the frequency modulation receiver not only increases the frequency modulation improvement, but also lowers the carrier-noise ratio received on the amplitude modulation receiver when the improvement threshold exists in the frequency modulation receiver.

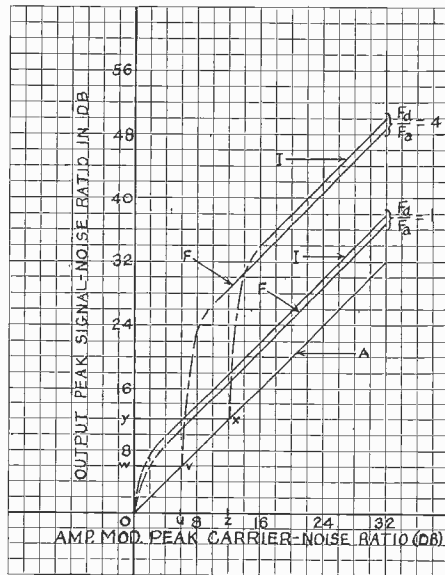

Fig. 5—Theoretical signal-noise ratio characteristics of frequency and amplitude modulation without the transmitter gain taken into account. Curve A = amplitude modulation receiver. The curves marked with I and F show the characteristics of the frequency modulation receivers for impulse and fluctuation noise, respectively. F_d/F_a = deviation ratio.

Theoretical Conclusions

The curves of Fig. 5 and 6 summarize the theoretical conclusions by means of an example in which receivers with deviation ratios of four and one are compared with each other and with an amplitude modulation receiver at various carrier-noise ratios. Fig. 5 shows the receiver gain only, whereas Fig. 6 takes into consideration a transmitter power gain of four to one. The curves are plotted with peak carrier-noise ratio in the amplitude modulation selectivity channel as a standard of comparison. Thus the curve for the amplitude modulation receiver is a straight line with a slope of forty-five degrees. The

curves for the frequency modulation receivers show output signal-noise ratios which are greater or less than those obtained from the amplitude modulation receiver depending upon the carrier-noise ratio.

For Fig. 5, (15) and (17) were used to obtain the strong-carrier frequency modulation improvement factors. Hence the frequency modulation output signal-noise ratios were obtained by multiplying the amplitude modulation signal-noise ratios by the frequency modulation improvement factors. The carrier-noise ratios which exist in the amplitude modulation receiver when the improvement threshold exists

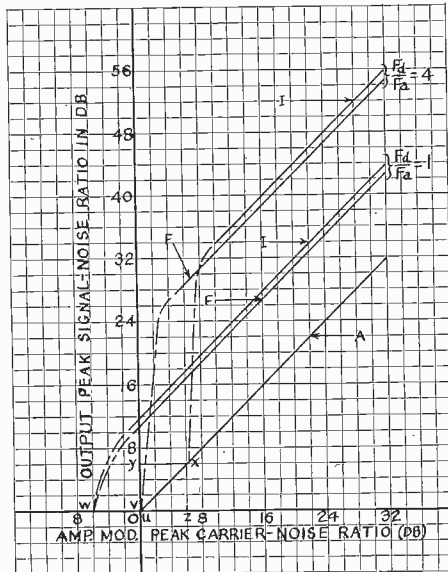

Fig. 6—Theoretical signal-noise ratio characteristics of frequency and amplitude modulation receivers with the transmitter gain taken into account.

in the frequency modulation receiver were determined by substituting a value of unity carrier-noise ratio in (23) and (24). The improvement thresholds are designated in both Figs. 5 and 6 by the points u and z for fluctuation and impulse noise, respectively. Since the theory does not permit actual calculation of signal-noise ratios in the region between high ratios and the improvement threshold, that part of the curves has been sketched in with a dashed line.

The part of the impulse-noise curve, for the deviation ratio of four represented by the line $x-y$ shows the characteristic which would be obtained if the noise and signal were measured in the absence of each other. Because of frequency limiting, the noise is limited to equality

with the signal at the output of the detector and is then reduced in peak voltage by the audio selectivity. The amount of this reduction for impulse noise would be a ratio equal to the deviation ratio or, in this case, twelve decibels. In the case of fluctuation noise, the reduction of the noise, which is present in the absence of modulation, would be equal to the square root of the deviation ratio, or six decibels, and the corresponding curve is shown by the line $v-w$. However, these lines do not portray the actual signal-noise ratio characteristics since the noise depresses the signal when the carrier-noise ratios go below the improvement threshold. In the case of fluctuation noise this signal depression causes the signal to become smothered in the noise as the carrier-noise ratio is lowered below the improvement threshold. On the other hand, with impulse noise such as ignition, where the pulses are short and relatively infrequent, carrier-noise ratios below the improvement threshold will present an output signal which is depressed by the noise impulses, but which is quite usable due to the small percentage of time that the impulse exists.

The curves of Fig. 6, which take into account the frequency modulation transmitter gain, utilize (27) and (28) to obtain the frequency modulation improvements at the high carrier-noise ratios. These curves assume a carrier at the frequency modulation receiver inputs which is twice the strength of that present at the amplitude modulation receiver input. The frequency modulation improvements are therefore increased by six decibels and the improvement thresholds occur at signal-noise ratios in the amplitude receiver which are six decibels below the corresponding ratios for the case where the transmitter gain is not taken into account.

Further conclusions of the theory are as follows: For the high carrier-noise ratios, the application of modulation does not increase the root-mean-square value of the noise above its unmodulated value. Also, in the case of the low deviation ratio receivers, the root-mean-square value of the noise will be slightly reduced as the modulation is applied.

EXPERIMENT

In the experimental work it was desired to obtain a set of data from which curves could be plotted showing the frequency modulation characteristics in the same manner as the theoretical curves of Fig. 5. To do this it was necessary to have an amplitude modulation reference system and frequency modulation receivers with deviation ratios of unity and greater than unity. Equal carrier voltages and noise spectra could then be fed to these receivers and the output signal-noise ratios measured while the carrier-noise ratio was varied. Since it was

not convenient to measure the carrier-noise ratio at intermediate frequency, the output signal-noise ratios of the amplitude modulation receiver were measured instead and were plotted as abscissas in place of the carrier-noise ratios. This gives an abscissa scale which is practically the same as that which would be obtained by plotting carrier-noise ratios. The validity of this last statement was checked by measuring the linearity with which the output signal-noise ratio of the amplitude modulation receiver varied from high to low values as the carrier-noise ratio was varied by attenuating the carrier in known amounts in the presence of a constant noise. At the very low root-mean-square ratios the inclusion of the beats between the individual noise frequencies in the spectrum increases the apparent value of the

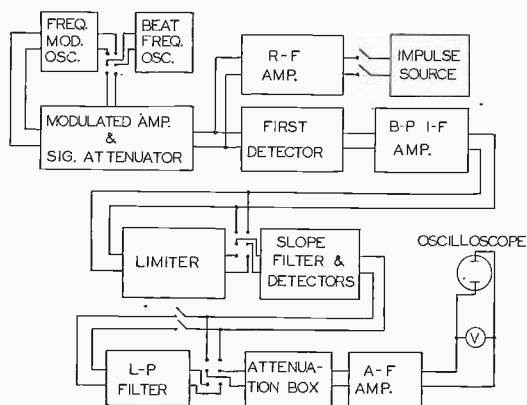

Fig. 7—Block diagram of experimental setup.

root-mean-square resultant of the noise voltages about two or three decibels. Thus, except for this small error at the low root-mean-square carrier-noise ratios, the amplitude modulation signal-noise ratio can be assumed equal to the carrier-noise ratio.

The block diagram of Fig. 7 shows the arrangement of apparatus used in obtaining the experimental data: The frequency modulated oscillator employed a circuit which was similar to that used in the previously mentioned propagation tests.¹ The modulated amplifier consisted of a signal generator which was capable of being amplitude modulated, but whose master oscillator energy was supplied from the frequency modulated oscillator. Thus a signal generator was available which was capable of being either frequency or amplitude modulated. A two-stage radio-frequency amplifier, tuned to the carrier frequency, but with no signal at its input, was used as the source of fluctuation noise. For the impulse noise measurements, the radio-frequency output

of a square-wave multivibrator was fed to the input of this radio-frequency amplifier.

In order to make available frequency modulation receivers with different deviation ratios, a method was devised which made possible the use of a single intermediate-frequency channel and detection system for all receivers. The method consisted in the insertion of a low-pass filter in the audio output of the receiver so as to reduce the width of the audio channel and thereby increase the deviation ratio of the receiver. This procedure is not that which might be normally followed since to increase the deviation ratio, the audio channel would normally be left constant and the intermediate-frequency channel increased.

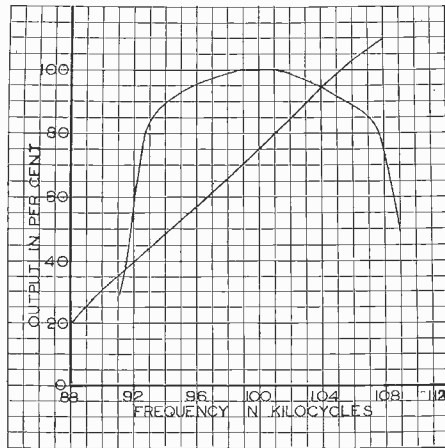

Fig. 8—Band-pass characteristic of receiver intermediate-frequency amplifier, and characteristic of sloping filter.

However, since it is only the *ratio* between the intermediate- and audio-frequency channels which governs the frequency modulation improvement, such an expedient is permissible for the purpose of the experiments.

The band-pass filter of the receiver intermediate-frequency amplifier was adapted from broadcast components and gave an output which was about one decibel down at 6500 cycles off from mid-band frequency. (See Fig. 8.) Hence maximum frequency deviation was limited to 6500 cycles. The audio channel of the receiver cut off at 6500 cycles and the low-pass filter cut off at 1600 cycles. Thus the following four different types of receivers were available: Number one, a frequency modulation receiver with a deviation ratio of unity which would receive a 6500-cycle modulation band. Number two, an amplitude modu-

lation receiver which would receive a 6500-cycle modulation band. Number three, a frequency modulation receiver with a deviation ratio of about four ($6500 \div 1600$) which would receive a 1600-cycle modulation band. Number four, an amplitude modulation receiver which would receive a 1600-cycle modulation band.

With these four receivers, a comparison between number two and number one would produce a comparison between amplitude modulation reception and frequency modulation reception with a deviation ratio of unity. A comparison between receivers number four and number three would produce a comparison between amplitude modulation reception and frequency modulation reception with a deviation ratio of four. Thus both frequency modulation receivers had as a standard of comparison an amplitude modulation receiver with an audio channel equal to that of the frequency modulation receiver.

The limiter of the frequency modulation receiver consisted of four stages of intermediate-frequency amplification arranged alternately to amplify and limit. The sloping filter detectors utilized the same circuit as used in the propagation tests¹ except that only one sloping filter was used in conjunction with a flat-top circuit as described in the theoretical section of this paper. Thus a balanced detector type of receiver was available which would also receive amplitude modulation by switching off the frequency modulation detector and receiving the detected output of the flat-top circuit. The characteristic of the sloping filter is shown in Fig. 8.

The output of the detectors was fed to a switching system which connected either to a low-pass filter and attenuator or directly to the attenuator. The output of the attenuator passed to an audio-frequency amplifier having an upper cut-off frequency of 6500 cycles. The indicating instruments were connected to the amplifier output terminals. For the root-mean-square fluctuation noise measurements, a copper-oxide-rectifier type meter was used.¹⁴ A cathode-ray oscilloscope was used for all peak voltage measurements.

In the procedure used to obtain the data, the carrier-noise ratio was varied over a wide range of values and the receiver output signal-noise ratios were measured at each value of carrier-noise ratio. To do this, the output of the noise source was held constant while the carrier was

¹⁴ In the preliminary measurements, a thermocouple meter was connected in parallel with the copper-oxide-rectifier meter in order to be sure that no particular condition of the fluctuation noise wave form would cause the rectifier meter to deviate from its property of reading root-mean-square values on this type of noise. It was found that the rectifier type of instrument could be relied upon to indicate correctly so that the remainder of the measurements of root-mean-square fluctuation noise were made using the more convenient rectifier type of instrument.

varied by means of the signal generator attenuator. The output peak signal-noise ratios were obtained by first measuring the peak voltage of the tone output with the noise source shut off and then measuring the peak voltage of the noise with the tone shut off. The *maximum* peak voltage of the noise was read for its peak voltage. The root-mean-square signal-noise ratios were measured by reading the root-mean-square voltage of the tone in the presence of the noise and then reading the voltage of the noise alone. The signal was then separated from the noise by equating the measured signal-plus-noise voltage to $\sqrt{S^2 + N^2}$, substituting the measured noise voltage for N , and solving for the signal, S . In these measurements, a 1000-cycle tone was used to modulate

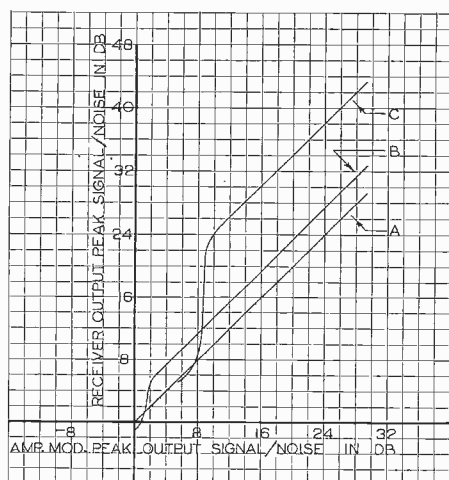

Fig. 9—Measured peak signal-noise ratio characteristics for fluctuation noise. Curve A = amplitude modulation receiver. Curve B = frequency modulation receiver with deviation ratio equal to unity. Curve C = frequency modulation receiver with deviation ratio equal to four.

at fifty per cent the amplitude modulator or to produce one-half frequency deviation (3250 cycles) on the frequency modulator. The output signal-noise ratios were corrected to a 100 per cent, or full modulation, basis by multiplying them by two. The radio frequency used was ten megacycles.

Fluctuation Noise Characteristics

The curves of Fig. 9 show the fluctuation noise characteristics, in which peak signal-noise ratios were measured. These curves check the theoretical curves of Fig. 5 as nearly as such measurements can be expected to check. With the deviation ratio of four (low-pass filter in), the

theoretical strong-carrier improvement should be $4 \times 1.73 = 6.9$ or 16.8 decibels; the measured improvement from Fig. 9 is about 14 decibels. With the deviation ratio of unity (low-pass filter out), the measured improvement was about 3.5 decibels as compared to the 4.76-decibel theoretical figure. The full frequency modulation improvement is seen to be obtained down to carrier-noise ratios about two or three decibels above the improvement threshold (equality of peak carrier and noise). The fact that the frequency modulation improvement threshold occurs at a higher carrier-noise ratio in the case of the receiver with a deviation ratio of four than in the case of the receiver with a deviation ratio of unity, also checks the theoretical predictions. In this case of fluctuation noise, the improvement threshold for the receiver with the deviation ratio of four should occur at a carrier-noise ratio in the amplitude modulation intermediate-frequency channel which was twice the corresponding ratio for the receiver with a deviation ratio of unity. The curves show these two points to be about seven decibels apart or within one decibel of the theoretical figure of six decibels.

The data for the curves of Fig. 9 were obtained by measuring the peak value of the noise alone and signal alone and taking the ratio of these two values as the signal-noise ratio. Hence the signal depressing effect, occurring for carrier-noise ratios below the improvement threshold, does not show up on the curves. In order to obtain an approximate idea as to the order of magnitude of this effect, observations were made in which the carrier-noise ratio was lowered below the improvement threshold while the tone modulation output (100 per cent modulation in the case of the amplitude modulation observation and full frequency deviation in the case of the frequency modulation observation) was being monitored by ear and oscilloscope observation. It was found that the fluctuating nature of the instantaneous peak voltage of the fluctuation noise had considerable bearing upon the effects observed. Due to the fact that the instantaneous value of the peak voltage is sometimes far below the maximum instantaneous value, frequency modulation improvement is obtained to reduce still further the peak voltage of these intervals of noise having instantaneous peak voltages lower than the maximum value. This effect seems to produce a signal at the output of the frequency modulation receiver which sounds "cleaner," but which has the same maximum peak voltage characteristics as the corresponding amplitude modulation receiver. Thus, as far as maximum peak voltage of the noise is concerned, the frequency modulation receiver produces about the same output as the amplitude modulation receiver for carrier-noise ratios below the improvement threshold. The reduction of the peak voltage of the noise during the

intervals of lower instantaneous peak value reduces the energy content of the noise in the output; hence some idea of the magnitude of this effect can be obtained from the root-mean-square characteristics of the noise.

The curves of Fig. 10 are similar to those of Fig. 9 except that the root-mean-square signal-noise ratios are plotted as ordinates. Since the crest factor of the signal is three decibels and that of fluctuation noise is about thirteen decibels (as later curves will show), the root-mean-square signal-noise ratios are ten decibels higher than the corresponding peak ratios. It can be seen that the root-mean-square characteris-

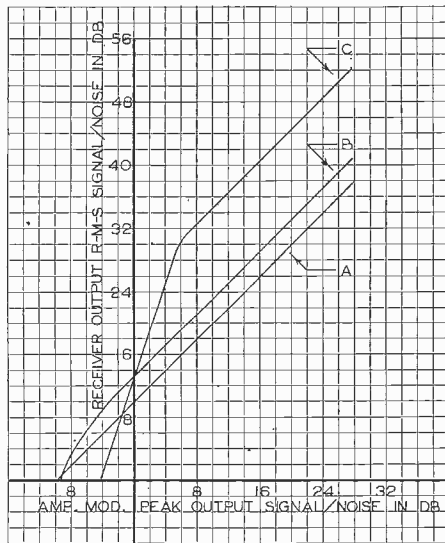

Fig. 10—Measured root-mean-square signal-noise ratio characteristics for fluctuation noise. Curve A = amplitude modulation receiver. Curve B = frequency modulation receiver with deviation ratio equal to unity. Curve C = frequency modulation receiver with deviation ratio equal to four.

tics differ from the peak characteristics in the range of carrier-noise ratios below the improvement threshold; above the improvement threshold, the characteristics are similar.

Since the root-mean-square and peak signal-noise ratios display different characteristics below the improvement threshold, it is quite evident that the crest factor of the noise changes as the carrier-noise ratio is lowered below this point. The crest factor can be obtained from the curves of Fig. 9 and 10 as follows: By adding three decibels to the ordinates of Fig. 10 they will be converted to peak signal to root-mean-square noise ratios. Hence by subtracting from these ratios the corre-

sponding ordinates of Fig. 9, the crest factor of the noise is obtained. The results of such a procedure are shown in Fig. 11.

In the case of the frequency modulation receiver with a deviation ratio of four, Fig. 11 shows that the crest factor increases by about 14.5 decibels at the improvement threshold. Hence the frequency modulation improvement, which is about fourteen decibels by measurement and sixteen by calculation, is counteracted by an increase in crest factor. This same situation exists in the case of the receiver with a deviation ratio of unity. Here the increase in crest factor is about four decibels; the measured frequency modulation improvement is about 3.5 decibels and the calculated value 4.76 decibels.

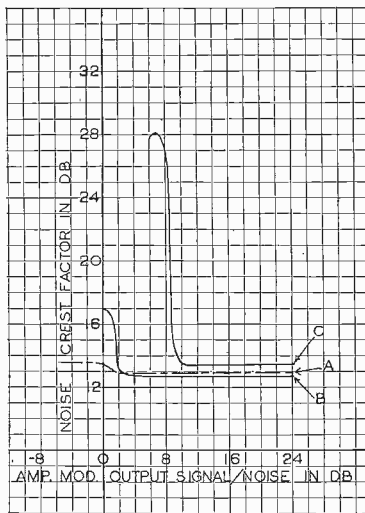

Fig. 11—Crest factor characteristics of frequency and amplitude modulation receivers. Curve *A* = amplitude modulation receiver with 6500-cycle audio channel. Curve *B* = frequency modulation receiver with deviation ratio equal to unity. Curve *C* = frequency modulation receiver with deviation ratio equal to four.

Curve *A* of Fig. 11 shows the crest factor characteristics of the amplitude modulation receiver. It is seen that this crest factor is about equal to that for frequency modulation above the improvement threshold. The average value of the crest factor for both amplitude and frequency modulation in this region is thirteen decibels or about 4.5 to one. This value checks previous measurements of crest factor where a slide-back vacuum tube voltmeter was used in place of an oscilloscope to measure the peak voltage and a thermocouple was used to measure the root-mean-square values.

The point where the crest factor of the noise increases, which occurs at the frequency modulation improvement threshold, has a rather distinctive sound to the ear. When fluctuation noise is being observed, as this point is approached the quality of the hiss takes on a more intermittent character, somewhat like that of ignition. This point has been termed by the author the "sputter point," and since it coincides with the improvement threshold it is a good indicator for locating the improvement threshold. It is caused by the fact that the fluctuation noise voltage has a highly variable instantaneous peak voltage so that there are certain intervals during which the instantaneous peak voltage of the noise is higher than it is during other intervals. Consequently, as the maximum peak value of the noise approaches the peak value of the signal, the higher instantaneous peaks will have their crest factor increased to a greater degree than the lower instantaneous peaks. Fig. 12 shows oscillograms taken on the fluctuation noise output of the

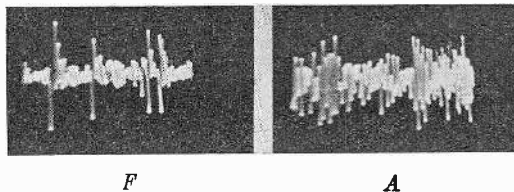

Fig. 12—Wave form of the fluctuation noise output at unity carrier-noise ratio in the frequency modulation receiver. *F* = frequency modulation receiver. *A* = amplitude modulation receiver.

frequency and amplitude modulation receivers with the 1600-cycle low-pass filter in the audio circuit and with the signal-noise ratio adjusted to the sputter point. These oscillograms also tend to show how the frequency modulation signal would sound "cleaner" than the amplitude modulation signal when the carrier-noise ratio is below the improvement threshold.

Data were also taken to show the fluctuation noise characteristics as frequency modulation is applied. These data were taken by inserting low-pass or high-pass filters in the audio system and then applying a modulation frequency to the frequency modulated oscillator which would fall outside the pass band of the filters. The low-pass filter cut off at 1600 cycles so that modulating frequencies higher than 1600 cycles were applied. The output of the filter contained only noise in the range from zero to 1600 cycles and the change of noise versus frequency deviation of the applied modulation could be measured. The high-pass filter also cut off at 1600 cycles so that measurements of the noise in the range from 1600 to 6500 cycles were made while applying

modulation frequencies below 1600 cycles. In the case of the high-pass filter, the harmonics of the modulating frequencies appeared at the filter output in addition to the noise. Consequently, a separate measurement of the harmonics in the absence of the noise was made so that the noise could be separated from the harmonics by the quadrature relations. The results with the low-pass filter are shown in Fig. 13. The results with the high-pass filter are shown in Fig. 14.

The curves of Fig. 13 are representative of a system with a deviation ratio of four. They point out the fact that when the peak carrier-noise ratio in the frequency modulation intermediate-frequency channel

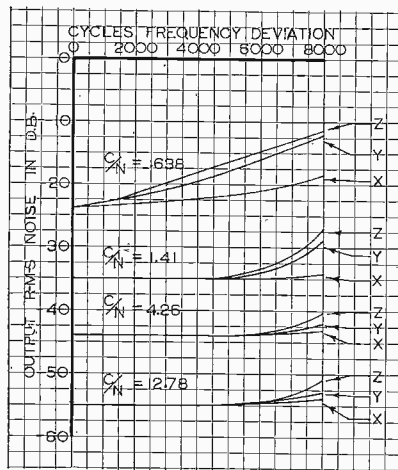

Fig. 13—Variation of frequency modulation receiver output noise as frequency modulation is applied. 1600-cycle low-pass filter in audio output. Modulation frequency: for curve X = 6000 cycles, Y = 3000 cycles, and Z = 2000 cycles. C/N = peak carrier-noise ratio in the output of intermediate-frequency channel.

is greater than unity, the root-mean-square noise is substantially unchanged due to the application of modulation. The one curve for a carrier-noise ratio less than unity shows a gradual increase of the noise, which would effect a decrease of the signal-noise ratio as the modulation is applied; this increase in the noise is displayed to a greater extent on the lower modulation frequency of 2000 cycles than on the higher modulation frequencies of 3000 and 6000 cycles.

Fig. 14 is approximately representative of a receiver with a deviation ratio of unity. This is because the range of noise frequencies from zero to 1600 cycles, which were eliminated by the high-pass filter, were a small part of the total range extending out to 6500 cycles. At the

highest carrier-noise ratio, the noise is decreased as the modulation is applied. This is in accordance with the deductions of the theory in the section *Effect of Application of Modulation*. As the carrier-noise ratio is lowered this tendency is eliminated.

Data similar to that for Fig. 13, with the low-pass filter in the audio circuit, were taken measuring the output *peak* voltage of the noise. The characteristics obtained were identical to those obtained with root-mean-square measurements.

Since the harmonics of the tone present in the output of the high-pass filter could not readily be separated from the noise for the peak

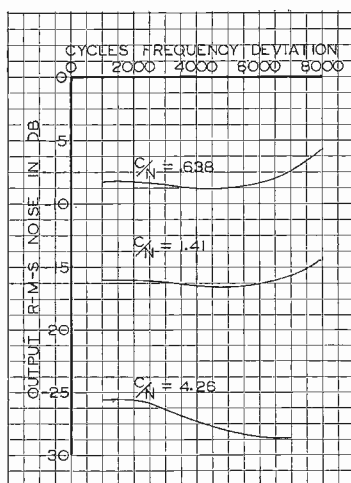

Fig. 14—Variation of frequency modulation receiver output noise as frequency modulation is applied. 1600-cycle high-pass filter in audio output. Modulation frequency = 1000 cycles.

voltage measurements, the high-pass filter data were taken by root-mean-square measurements only.

Measurements were also made to determine how much the audio selectivity reduced the degree of signal depression present at the output of the detector of the frequency modulation receiver. The carrier-noise ratio was set so that the maximum peak voltage of the fluctuation noise was equal to the peak voltage of the carrier. At this carrier-noise ratio the maximum noise peaks depressed the signal down to zero at the output of the detector. At the output of the 1600-cycle low-pass filter, the maximum noise peaks depressed the signal five decibels. Thus, without the audio selectivity, the signal was depressed by an amount equal to its total amplitude; with the audio selectivity, the

signal was depressed to five decibels below full amplitude or down to an amplitude of 56 per cent. Hence the reduction of the depth of the signal depression was from a 100 per cent depression to a depression of $(100 - 56) = 44$ per cent or a reduction of about seven decibels. The theoretical reduction of the fluctuation noise in the absence of the modulation would be equal to the square root of the ratio of band widths or six decibels. Thus the reduction of the signal depression is, for all practical purposes, the same as the reduction in the peak voltage of the noise alone.

Impulse Noise Measurements

The first measurements on impulse noise were made using an automobile ignition system driven by an electric motor. However the output from this generator proved to be unsteady and did not allow a reasonable measurement accuracy. Consequently a square-wave multi-vibrator was set up. This type of impulse noise generator proved to be even more stable than the fluctuation noise source and allowed accurate data to be obtained. On the other hand, the output of the receiver being fed by this noise generator was not as steady as would be expected. In the absence of the carrier the output was steady, but as the carrier was introduced the output peak voltage started to fluctuate. Apparently the phase relation between the components of the noise spectrum and the carrier varies in such a manner as to form a resultant wave which varies between amplitude modulation and phase or frequency modulation. Hence the output of a receiver which is adjusted to receive either type of modulation alone will fluctuate depending upon the probability considerations of the phase of combination of the carrier and noise voltages.

The preliminary impulse noise measurements were made on an amplitude modulation receiver by comparing the peak voltage ratio between the two available band widths of 6500 and 1600 cycles. The 6500-cycle channel was fed to one set of oscilloscope plates and the 1600-cycle channel to the other. Thus, when the peak voltages at the outputs of the two channels were equal the oscilloscope diagram took a symmetrical shape somewhat like a plus sign. The two channel levels were equalized by means of a tone. Hence, when the noise voltage was substituted for the tone, the amount of attenuation that had to be inserted in the wider band to produce a symmetrical diagram on the oscilloscope was taken as the ratio of the peak voltages of the two band widths. In this manner a series of readings was taken which definitely proved that the peak voltage ratio of the two band widths was proportional to the band width ratio. These readings were taken on both the

ignition system noise generator and the multivibrator generator. As a check, readings on fluctuation noise were also taken which showed that the peak voltage of fluctuation noise varies as the square root of the band width.

The final measurements on impulse noise were made using the same procedure followed for the fluctuation noise measurements of Fig. 9. Only peak voltage measurements were made on this type of noise. The curves are shown in Fig. 15. It can be seen that the peak voltage characteristics of impulse noise are similar to those of fluctuation noise except for the location of the improvement threshold. For the receiver



Fig. 15—Measured peak signal-noise ratio characteristics of impulse noise. Curve *A* = amplitude modulation receiver. Curve *B* = frequency modulation receiver with deviation ratio of unity. Curve *C* = frequency modulation receiver with deviation ratio of four.

with a deviation ratio of four, the improvement threshold occurs at a carrier-noise ratio slightly above sixteen decibels as compared with slightly above eight decibels for fluctuation noise. The difference between the improvement thresholds for the two frequency modulation receivers is about fourteen decibels; the corresponding theoretical figure, which is equal to the ratio of the two deviation ratios, is twelve decibels. The theoretical difference between the strong-carrier frequency modulation improvements for impulse and fluctuation noises, as indicated by the difference between the factors two and the square root of three respectively, is too small to be measurable with such variable quantities as these noise voltages.

Since the signal-noise ratios for the curves of Fig. 15 were obtained by measuring the noise and signal in the absence of each other, the signal-depressing effect of the noise does not show up. However, in the case of impulse noise, these curves are more representative of the actual situation existing, because the noise depresses the signal for only a small percentage of the time. In the listening and oscilloscope observations conducted with carrier-noise ratios below the improvement threshold, it was observed that at unity carrier-noise ratio the noise peaks depressed the amplitude of the signal to zero at the output of the detector. When the low-pass filter was inserted in the audio circuit, the impulse noise peaks depressed the signal about 2.5 decibels or reduced the amplitude from 100 per cent to 75 per cent. The effective signal-noise ratio is then increased from unity to $100/(100-75) = 4$ or 12

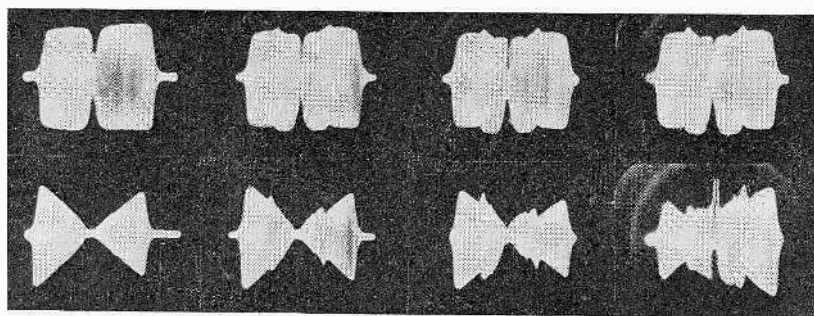

Fig. 16—Over-all transmission oscillograms of the frequency and amplitude modulation receivers. 1600-cycle low-pass filter in audio output. Top row = amplitude modulation, bottom row = frequency modulation. C/n = ratio between the carrier and the variable-frequency heterodyning voltages.

decibels. This is equal to the theoretical reduction in peak voltage of impulse noise which would be effected by this four-to-one band width ratio. It is then evident that the reduction of the depth of the signal depression caused by the impulse noise is of the same magnitude as the reduction of the peak voltage of the noise alone.

Over-all Transmissions

The oscillograms of Fig. 16 show the over-all transmissions of the amplitude and frequency modulation receivers at various carrier-noise ratios. These oscillograms were taken by tuning the receiver to a carrier, and then, to simulate the noise, manually tuning a heterodyning signal across the intermediate-frequency channel. The audio beat output of the receiver was applied through the low-pass filter to the verti-

cal plates of the oscilloscope. A bias proportional to the frequency change of the heterodyning voltage was applied to the other set of oscilloscope plates. Consequently the spectra obtained are those which would be produced by the combination of a single noise component of variable frequency and the carrier. At the higher carrier-noise ratios, the spectrum is rectangular for amplitude modulation and triangular for frequency modulation. The dip in the middle of the amplitude modulation spectrum is where the audio output is near zero beat. As the carrier-noise ratio is decreased, the frequency modulation spectrum deviates from its triangular shape and the wave form of the receiver output has increased harmonic content at the lower audio frequencies where the audio selectivity does not eliminate the harmonics.

The amplitude modulation spectra of Fig. 16 also show the presence of added harmonic distortion on the lower modulation frequencies and lower carrier-noise ratios. However, the effect is so small that it is of little consequence.

The spectra of Fig. 16 allow a better understanding of the situation which is theoretically portrayed by (7) of the theory.

Experimental Conclusions

It can be concluded that the experimental data in general confirm the theory and point out the following additional information:

The improvement threshold starts at a carrier-noise ratio about three or four decibels above equality of peak carrier and noise in the frequency modulation intermediate-frequency channel. Hence the full frequency modulation improvement may be obtained down to a peak carrier-noise ratio in the frequency modulation receiver of three or four decibels.

The root-mean-square fluctuation noise characteristics differ from the peak fluctuation noise characteristics for carrier-noise ratios below the improvement threshold. The improvement threshold starts at about the same peak carrier-noise ratio, but the improvement does not fall off as sharply as it does for peak signal-noise ratios. Thus, for carrier-noise ratios below the improvement threshold the energy content of the frequency modulation noise is reduced, but the peak characteristics are approximately the same as those of the amplitude modulation receiver. The characteristics are not exactly the same due to the frequency limiting which allows the noise peaks to depress the signal, but does not allow them to rise above the signal.

The crest factor of the fluctuation noise at the outputs of the frequency and amplitude modulation receivers is about thirteen decibels or 4.5 to one for the strong-carrier condition. The crest factor of ampli-

tude modulation fluctuation noise remains fairly constant regardless of the carrier-noise ratio. At equality of peak carrier and peak noise in the frequency modulation intermediate-frequency channel, the crest factor of the noise in the output of the frequency modulation receiver rises to a value which counteracts the peak signal-noise ratio improvement over amplitude modulation; the improvement threshold manifests itself in this manner.

At the improvement threshold, the application of the audio selectivity reduces the signal depression due to a noise peak by the same ratio that it reduces the noise in the absence of the signal. Thus the depth of a noise depression in the signal is reduced by a ratio equal to the square root of the deviation ratio in the case of fluctuation noise, and equal to the deviation ratio in the case of impulse noise.

GENERAL CONCLUSIONS

The theory and experimental data point out the following conclusions:

A frequency modulation system offers a signal-noise ratio improvement over an equivalent amplitude modulation system when the carrier-noise ratio is high enough. For fluctuation noise this improvement is equal to the square root of three times the deviation ratio for both peak and root-mean-square values. For impulse noise the corresponding peak signal-noise ratio improvement is equal to twice the deviation ratio. When the carrier-noise ratio is about three or four decibels above equality of peak carrier and peak noise in the frequency modulation intermediate-frequency channel, the peak improvement for either type of noise starts to decrease and becomes zero at a carrier-noise ratio about equal to unity. Below this "improvement threshold," the peak characteristics of the frequency modulation receiver are approximately the same as those of the equivalent amplitude modulation receiver. The root-mean-square characteristics of the frequency modulation noise show a reduction of the energy content of the noise for carrier-noise ratios below the improvement threshold; this is evidenced by the fact that the improvement threshold is not as sharp for root-mean-square values as for peak values.

At the lower carrier-noise ratios, frequency modulation systems with lower deviation ratios have an advantage over systems with higher deviation ratios. Since the high deviation ratio system has a wider intermediate-frequency channel, more noise is accepted by that channel so that the improvement threshold occurs at a higher carrier level in the high deviation ratio system than in the low. Hence the

low deviation ratio systems retain their frequency modulation improvement down to lower carrier levels.

The peak voltage of fluctuation noise varies with band width in the same manner as the root-mean-square voltage, namely, as the square root of the band width. The peak voltage of impulse noise varies directly as the band width. In frequency modulation systems with a deviation ratio greater than unity, this difference in the variation with band width makes the improvement threshold occur at a higher carrier level with impulse noise than with fluctuation noise. Hence frequency modulation systems with higher deviation ratios are more susceptible to impulse noise interference.

Because of a phenomenon called "frequency limiting" the peak frequency deviations of the noise or the noise-plus-signal are limited so that the peak value cannot rise above the maximum peak value of the signal at the output of the detector. The application of audio selectivity reduces this maximum value of the noise so that fluctuation noise cannot rise to a value higher than the maximum value of the signal divided by the square root of the deviation ratio; the corresponding value of impulse noise cannot rise to a value higher than the maximum peak voltage of the signal divided by the deviation ratio. Inherent with this limiting effect is a signal-depressing effect which causes the fluctuation noise gradually to smother the signal as the carrier-noise ratio is lowered below the improvement threshold. However in the case of impulse noise, the signal depression is not as troublesome, and a noise-suppression effect is created which is similar to that effected in the recent circuits for suppressing impulse noise which is stronger than the carrier in an amplitude modulation system. When the deviation ratio is greater than unity, this frequency limiting is more effective than the corresponding amplitude modulation noise-suppression circuits; this is caused by the audio selectivity reducing the maximum peak value of the noise so that it is less than the peak value of the signal.

For carrier-noise ratios greater than unity, the application of frequency modulation to the carrier does not increase the noise above its value in the absence of applied frequency modulation.

At the transmitter, a four-to-one power gain is obtained by the use of class C radio-frequency amplification for frequency modulation instead of the customary class B amplification as is used for low level amplitude modulation. Therefore, for the same transmitter power input, a frequency modulation system will produce at its receiver a carrier which is twice as strong as that produced at the receiver of an amplitude modulation system. This results in two effects: first, the

frequency modulation improvement is doubled for carrier-noise ratios above the improvement threshold; second, when the improvement threshold occurs in the frequency modulation receiver, the carrier-noise ratio existing in the amplitude modulation receiver is one half of what it would have been without the transmitter power gain.

ACKNOWLEDGMENT

The author thanks Mr. H. H. Beverage and Mr. H. O. Peterson for the careful guidance and helpful suggestions received from them during the course of this work. The assistance of Mr. R. E. Schock in the experimental work is also appreciated.



DISCUSSION ON "A PROPOSED WATTMETER USING MULTIELECTRODE TUBES"

JOHN R. PIERCE*

N. H. Roberts¹: John R. Pierce's article on the use of multielectrode tubes for measuring power at low levels is of interest to me, for I have independently developed such a vacuum tube wattmeter.

The actual make-up of my instrument differs in some respects from that described by Mr. Pierce, and a short note on the differences and on some operating difficulties should be of interest.

One difficulty lay in obtaining sufficiently well-matched tubes in South Africa. The voltage supply was originally obtained from the alternating-current mains but the variation in the voltage was sufficient to give rise to an intolerable unsteadiness of the zero when tubes of differing characteristics were used. For precise work, it was necessary to change over to battery operation, and, in order to reduce the size of the battery required, the direct-coupled amplifier was replaced by an arrangement employing neon tubes as coupling devices.² This arrangement was found to work satisfactorily.

An investigation was carried out on the effect of varying the potential of the anode grid G_2 . Reducing this to the potential of the cathode somewhat surprisingly increased the sensitivity of the device, with no further effect other than a reduction of the total cathode current. This electrode was therefore permanently strapped to the cathode. I have not tested sufficient tubes to be certain whether this effect is common to all tubes or not, but all of four tubes behaved in this way.

Inaccurate matching leads to an incomplete cancellation of the "rectification" which is caused by nonlinearity of the characteristics. Different tubes differ widely in this respect. With one particular tube, the deflection due to the application of a certain alternating voltage to G_4 alone was less than one-half per cent of the deflection produced by applying the same voltage to both G_1 and G_4 . In the case of another tube from the same shipment, the unwanted deflection due to rectification amounted to more than 30 per cent! With the tubes available, it was not possible to obtain complete cancellation of this rectification component. This difficulty was however completely overcome by using a central zero instrument as indicator and reversing the potential applied to the parallel fed grids G_1 . The change in deflection on reversal gives the wanted reading; as the rectification effect is independent of the reversal.

The instrument in this form gives full deflection with 0.1 volt root-mean-square applied to the primaries of two 1:3.5 push-pull input transformers which feed the grids G_1 and G_4 . As a wattmeter, it is being used at present in an investigation into the iron losses of small portions of transformer sheet, where it is particularly useful on account of its sensitiveness. Whenever possible, the transformers are omitted to eliminate the effects of phase shift and of meter load. The accuracy is of the same order as that of the indicating meter used, but check calibrations are necessary every few minutes. No more than two points need be

* Proc. I.R.E., vol. 24, pp. 577-583: April, (1936).

¹ Department of electrical engineering, University of Cape Town, South Africa.

² Smith and Hill, "Gas discharge tube as intervalve coupling," *Wireless Engineer and Experimental Wireless*, vol. 11, p. 359.

checked up once the original calibration has been carried out. The apparatus was devised primarily for this work which is still being carried on and therefore a description has not as yet been published.

I should be interested to know whether Mr. Pierce has experienced similar troubles and I hope that these details will be of interest to him. I make no claim to priority, as my work on this instrument was commenced towards the end of 1935 after other types of tube had been tried out.

John R. Pierce³: I am pleased to find that a wattmeter such as I described has proved useful in research work.

The difficulties that Mr. Roberts experienced due to variation among individual tubes of a given type I had noticed also, and a process of selection from a large quantity of tubes is certainly necessary.

While the unsteadiness of zero due to alternating-current supply fluctuations may be made reasonably small by proper filtering, battery operation is no doubt preferable if not absolutely necessary in precision work.

Mr. Roberts has evidently made a much more thorough investigation of the characteristics of tubes under various operating conditions than I found the opportunity of making. This is an important contribution, and I feel that an even more extended investigation of the characteristics of various existing tubes of the converter and mixer types might prove valuable.

I believe that all Mr. Roberts says will prove of value to those who wish to make an application of this means of power measurement, and I wish to thank him for the interesting discussion he has contributed.

³ California Institute of Technology, Pasadena, California.



BOOK REVIEWS

"Short-Wave Wireless Communication," by A. W. Ladner and C. R. Stoner. John Wiley and Sons, Inc., 440 Fourth Ave., New York, N. Y. Price, \$4.50.

In the preface, the authors state that it is their aim "to fill an obvious gap in the current literature and supply a textbook which shall satisfy the needs not only of engineers and telegraphists engaged in wireless, but cater for the scientific amateur and those who already have an outline knowledge of long-wave working."

Viewing the book as a whole, differences in style and terminology considerably reduce the effectiveness for American readers. The nationalistic emphasis developed throughout the book is misplaced in a work intended to serve as a general text. The commercial aspects, while of a prominence not usual in a reference or textbook, are understandable in the light of the authors' affiliations and the source of much of the material on commercial equipment.

After outlining in the introduction the requirements of a communication system and the compromises which must be made in the practical realization of such a system, a brief historical outline of developments in short-wave communication is given. Two chapters on electromagnetic waves and the propagation of waves present, clearly and briefly, a summary of wave relationships and the behavior of waves, with emphasis on factors affecting the choice of wave length for a desired communication circuit. In the reviewer's opinion these are the best chapters of the book, as such a commendable presentation of difficult material is of particular interest and benefit to those whom the authors desire particularly to reach.

An unusual approach is made in presenting the material on modulation of waves before means for producing waves have been considered. The intent is to indicate the nature of modulation in general, including wire as well as radio circuits. General discussions of noncarrier, carrier, and suppressed-carrier systems are given.

Circuit material begins with a discussion of push-pull amplifiers, covers self-oscillator circuits, intermediate and power amplifiers, keying circuits, constant frequency oscillators and modulation circuits. In these five chapters the discussions are mainly theoretical with reference to schematic diagrams.

A chapter is devoted to feeders (transmission lines), with reference to impedance matching and proper terminations. Two chapters on aerials, beginning with the conception of an antenna as a nonterminated feeder and covering the various phases of antenna design, including arrays and tiered arrays, give a general view of this important part of a communication system.

A chapter, which covers simple types of regenerative, superregenerative and superheterodyne receivers with short discussions of the theory of operation, is followed by another dealing with the requirements of commercial receivers, illustrated by detailed reference to a commercial short-wave receiver. The problems of frequency range, selectivity, gain, noise and automatic volume control are discussed.

A chapter on commercial radiotelephone circuits begins with an outline of requirements, passes to land-line terminating circuits, with discussion of echo and singing suppression, and goes on to discussions of suppressed-carrier, single side-band, spread side-band, and quiescent-carrier systems. Mention is made of compandor circuits and some discussion of secrecy systems is given. This is followed by a chapter on commercial transmitters, some detail of constructional and circuit design being included.

The book closes with a chapter on ultra-high-frequency communication, presenting material on propagation, antennas, receivers, and transmitters.

In general, the material dealing with principles is clearly treated, but much of the material dealing with practice is presented with a curious turn of abbreviation (by omission) and "shop lingo"; for example, "feed" for direct plate current; "flick" for impulse; "backed off to any desired negative" for any desired negative grid bias, and "cut off by negative on grid" for negative bias cutoff.

*J. K. CLAPP

* General Radio Company, Cambridge A, Massachusetts.

Radio Field Service Data, by Alfred A. Ghirardi, 1936. Loose-leaf binder, pages $5\frac{1}{2} \times 8$ ", 428 pages, published by Radio and Technical Publishing Co., 45 Astor Place, New York, N. Y. Price \$2.50.

The present book is a second and revised edition of that published in 1935 and bears the date of October, 1936. Obviously a book giving specific information on radio receivers as this one does must be kept up to date if its value is to be maintained. While some entirely new types of information are contained in the present edition it has been changed over the old mainly by bringing the various departments up to date.

While the present book is divided into thirty-two sections, four of these sections occupy about four fifths of the total number of pages. These four main sections are headed, "Intermediate Peak Frequencies of Receivers," "Case Histories of Receivers," "Remedies for Stubborn Automobile Ignition Interference," and "Electrical Wiring Diagrams of Automobiles." The remaining twenty-eight sections contain a wide variety of useful information such as tube base designations, tube operating conditions, and wire tables. Practically all of the information in the book except that in main sections two and three is purely factual.

The "Case Histories" and "Ignition Interference Remedies" cover 1500 receivers and 29 cars. The information is based on the actual radio service experience in locating and remedying radio troubles. The "Case Histories" consist of various trouble symptoms and one or more of the most frequent remedies. The author in his preface clearly indicates that the remedies are not to be taken as the only ones in a given case but that they are valuable as "first tries," and as such should save a serviceman a great deal of time in his work.

There can be no doubt of the large scope of the book and it is apparent that the author has been entirely rational in his treatment of the subject. This book is recommended to any serviceman doing a reasonable amount of repair work.

†ALFRED W. BARBER

† Hazeltine Corporation, Jersey City, N. J.



CONTRIBUTORS TO THIS ISSUE

Crosby, Murray G.: Born September 17, 1903, at Elroy, Wisconsin. University of Wisconsin, 1921-1925. Radio Corporation of America, 1925-1927. Received B.S. degree in electrical engineering, University of Wisconsin, 1927. RCA Communications, Inc., 1927 to date. Associate member, Institute of Radio Engineers, 1925.

Foster, Dudley E.: See PROCEEDINGS for March, 1937.

Groszkowski Janusz: Born March 1898, at Warsaw, Poland. Received electrical engineering degree, 1921; Doctor of Technical Science degree, 1927, Warsaw Polytechnical High School. Professor, Warsaw Polytechnic High School, 1928 to date. Director, State Institute of Telecommunications, Poland 1929 to date. President, 1936, Association of Electrical Engineers of Poland, 1936. Member, Academy of Technical Sciences, Poland, 1934. Member, Institute of Radio Engineers, 1931.

Haefner, Sylvester J.: Born August 1, 1903, at Brooklyn, New York. Received B.S. degree in electrical engineering, Union College, 1925; M.S. degree in electrical engineering, Union College, 1926. General Electric Company, 1925-1927. Graduate work, Union College, 1925-1932; received Ph.D. degree in electrical engineering, 1932. Instructor in electrical engineering, Union College, 1932 to date. Member, Sigma XI; associate member, American Institute of Electrical Engineers. Nonmember, Institute of Radio Engineers.

Kubetsky, Leonid Alexandrovich: Born July 12, 1906, at Tsarskoje Selo (Pushkin), Russia. Received electrical engineering degree, Polytechnical Institute, Leningrad, 1931; received degree, Master of Technical Sciences, 1935. Began research work on electronics and electronic applications, Electrophysical Institute, 1928; head of corresponding laboratories, 1932; Television Institute, 1933 to date; head of laboratory for secondary emission, 1936 to date. Nonmember, Institute of Radio Engineers.

Stamford, Norman C.: Born November 23, 1907, at London, England. Studied electrical engineering, City and Guilds Engineering College, London, 1925-1929. Assistant engineer, Marconi's Wireless Telegraph Company, Chelmsford, 1929-1933. Assistant lecturer, College of Technology, Victoria University, Manchester, 1933 to date. Received M.Sc. technical degree, Victoria University, 1936. Associate member, Institution of Electrical Engineers. Associate member, Institute of Radio Engineers, 1930, Member, 1934.

Van Dyck, A. F.: Born May 20, 1891, at Stuyvesant Falls, New York. Received Ph.B. degree, Sheffield Scientific School, Yale University, 1911. Amateur experimenter and commercial operator at sea, 1907-1910. National Electric Signalling Company, Brant Rock, Massachusetts, 1911-1912; research department, Westinghouse Electric and Manufacturing Company, 1912-1914; instructor in electrical engineering, Carnegie Institute of Technology, 1914-1917; expert radio aide, U. S. Navy, 1917-1919; Marconi Company, Aldene, New Jersey, 1919-1920; in charge, radio receiver design, General Electric Company, 1920-1922; Radio Corporation of America, 1922 to date. Charter Associate member, Institute of Radio Engineers, 1913; Member, 1919; Fellow, 1925.





Her **FIRST** Telephone Call

A BRAND-NEW CUSTOMER used the telephone this morning. Betty Sue called up that nice little girl around the corner.

Every day, hundreds of Betty Sues speak their first sentences into the telephone. Just little folks, with casual, friendly greetings to each other. Yet their calls are handled as quickly as if they concerned the most important affairs of Mother and Daddy.

For there is no distinction in telephone service. Its benefits are

available to all—old and young, rich and poor alike.

To Betty Sue, the telephone may some day become commonplace. But it is never that to the workers in the Bell System.

There is constant, never-ending search for ways to improve the speed, clarity and efficiency of your telephone calls . . . to provide the most telephone service, and the best, at the lowest possible cost.



BELL TELEPHONE SYSTEM

When writing to advertisers mention of the PROCEEDINGS will be mutually helpful.

CIRCUIT MAGNIFICATION METER

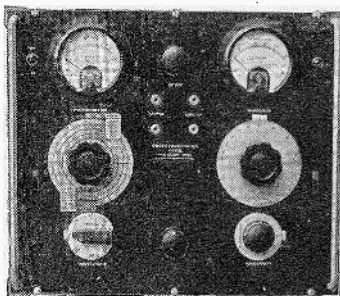

Type T.F. 329

A mains operated instrument for measuring directly the magnification (Q values) of inductance coils at any frequency between 50 kc/s and 50 Mc/s.

Magnification, directly indicated, range 10—500.

Accuracy $\pm 5\%$. ± 5 on frequencies up to 10 Mc/s.

This instrument can also be used for the measurement of effective resistance, capacity and dielectric loss.

We shall be pleased to send further details and prices of
this and other instruments

MARCONI-EKCO INSTRUMENTS

LIMITED

Electra House, Victoria Embankment,



London, W.C.2 England

When writing to advertisers mention of the PROCEEDINGS will be mutually helpful.

The Institute of Radio Engineers

Incorporated

330 West 42nd Street, New York, N.Y.

APPLICATION FOR ASSOCIATE MEMBERSHIP

(Application forms for other grades of membership are obtainable from the Institute)

To the Board of Directors
Gentlemen:

I hereby make application for Associate membership in the Institute of Radio Engineers on the basis of my training and professional experience given herewith, and refer to the members named below who are personally familiar with my work.

I certify that the statements made in the record of my training and professional experience are correct, and agree if elected, that I will be governed by the constitution of the Institute as long as I continue a member. Furthermore I agree to promote the objects of the Institute so far as shall be in my power, and if my membership shall be discontinued will return my membership badge.

(Sign with pen)

(Address for mail)

(Date)

(City and State)

Sponsors:

(Signature of references not required here)

Mr. Mr.

Address Address

City and State City and State

Mr.

Address

City and State

The following extracts from the Constitution govern applications for admission to the Institute in the Associate grade:

ARTICLE II—MEMBERSHIP

Sec. 1: The membership of the Institute shall consist of: * * * (c) Associates, who shall be entitled to all the rights and privileges of the Institute except the right to hold any elective office specified in Article V. * * *

Sec. 4: An Associate shall be not less than twenty-one years of age and shall be a person who is interested in and connected with the study or application of radio science or the radio arts.

ARTICLE III—ADMISSION AND EXPULSIONS

Sec. 2: * * * Applicants shall give references to members of the Institute as follows: * * * for the grade of Associate, to three Fellows, Members, or Associates; * * * Each application for admission * * * shall embody a full record of the general technical education of the applicant and of his professional career.

ARTICLE IV—ENTRANCE FEE AND DUES

Sec. 1: * * * Entrance fee for the Associate grade of membership is \$3.00 and annual dues are \$6.00.

ENTRANCE FEE SHOULD ACCOMPANY APPLICATION



RESISTANCE SPECIALISTS

Since 1921 MAKERS OF
RESISTANCE UNITS *ONLY*

INTERNATIONAL RESISTANCE COMPANY

401 NORTH BROAD STREET, PHILADELPHIA, PA.

Factories or Licensees in Canada, England, France, Germany, Italy, Denmark and Australia

MAKERS OF RESISTANCE UNITS OF MORE TYPES, IN MORE SHAPES, FOR
MORE APPLICATIONS THAN ANY OTHER MANUFACTURER IN THE WORLD

When writing to advertisers mention of the PROCEEDINGS will be mutually helpful.

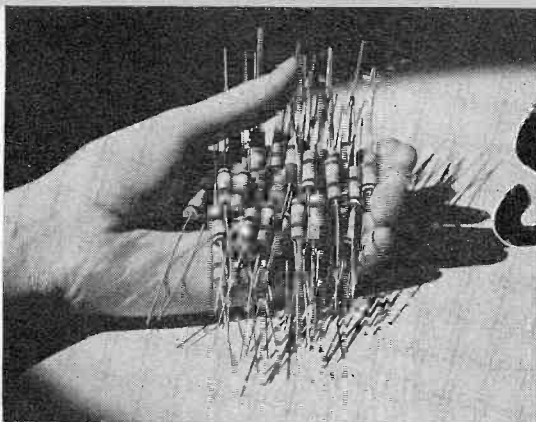

See them

Erie Insulated Resistors are protected by a pre-formed, uniform ceramic wall that will withstand 3,000 volts A. C. Because ceramic case is white, color code paint retains its true hue on application; is easy to read, cannot flake off.

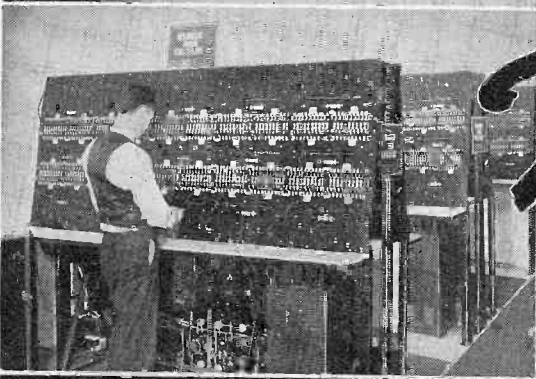

Test them

Erie Insulated Resistors give uniformly superior results in all standard tests for load, temperature, voltage, humidity and noise. We will be glad to send you a generous supply of samples to test in your own laboratories.



Use them

Erie Insulated Resistors are made in 1/4 and 1/2 watt sizes in all resistance values from a few ohms to several megohms. You can depend on them to maintain their actual ratings under all ordinary operating conditions.

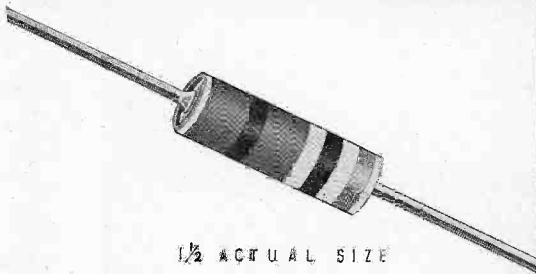

1/2 ACTUAL SIZE

ERIE *Insulated* RESISTORS

CARBON RESISTORS
AND SUPPRESSORS

**ERIE RESISTOR
CORPORATION**

AUTOMATIC INJECTION
MOLDING

TORONTO

ERIE, PENNSYLVANIA

LONDON



Inductance Forms by ISOLANTITE are

1. **EFFICIENT**—Low dielectric losses increase power output.
2. **ECONOMICAL**—Large or small quantities can be produced without expensive tools.
3. **PRECISE**—Uniformly close tolerances ensure accurate fit.
4. **STURDY**—Winding and mounting are accomplished without breakage.
5. **CLEAN-CUT**—Appearance of equipment is improved.

● Leading manufacturers of military, naval and commercial short wave radio equipment specify ISOLANTITE inductance forms.

● Why adapt your equipment to a coil? ISOLANTITE builds the coil to fit the equipment. Special forms, costing but little more, ensure the ultimate in performance.

ISOLANTITE
INC.
CERAMIC INSULATORS

233 Broadway, New York, N. Y.

**BROADCASTERS
WILL FIND MANY
USES FOR THIS
NEW 2-IN-1 MIKE**

**It's the "Salt-Shaker"
... Western Electric's
latest sensation!**

Like its older brother—the famous "8-ball"—the new "Salt-Shaker" mike is finding immediate acceptance in stations everywhere.

And no wonder! It's a 2-in-1 mike—non-directional or directional (when you put on the acoustic baffle)—gives regular Western Electric broadcast quality—and

**Its cost is amazingly
LOW!**

Western Electric

Distributed by GRAYBAR Electric Co. In Canada: Northern Electric Co., Ltd.

RADIO TELEPHONE BROADCASTING EQUIPMENT

When writing to advertisers mention of the PROCEEDINGS will be mutually helpful.



Popular-priced round can oil-filled capacitors. Ring mounted.

★

Compact rectangular can oil-filled capacitors for handy banking.

★

Uncased paper sections for high-voltage filtering and by-passing functions.

★

Electrolytics in every type, size, rating, capacity and terminal arrangement.

★

Wet electrolytics including voltage regulators.

★

Widest variety of mica capacitors for every transmitting and receiving need.

★

Wire-wound resistors ranging from tiny 5-watt units to giant 200-watt transmitting grid leaks, both fixed and adjustable.

Dependability

A COINED word—only recently included in the dictionary. But everyone knows its tremendous implication. And so we borrow it from the makers of reliable automobiles, in order best to express the full meaning of AEROVOX Transmitting Capacitors to those who simply *must* stay on the air. Performance, in the final analysis, is the sole gauge of value in radio communication.

Consult Us regarding your capacitor and resistor problems and requirements. Specifications, quotations and samples cheerfully submitted to large users. Latest general catalog covering the largest line of standard units, sent on request.

AEROVOX CORPORATION

71 WASHINGTON STREET, BROOKLYN, N. Y.



Sales Offices in All Principal Cities

Instruments by



A GUARANTEE OF PRECISION AND RELIABILITY

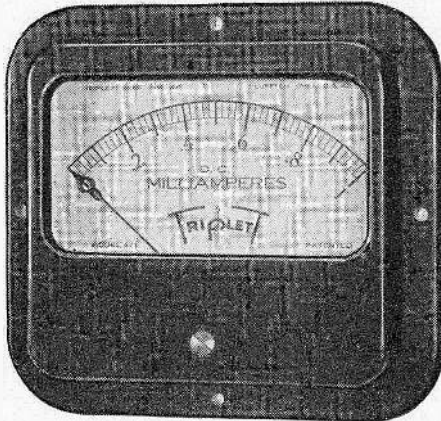

The 4" Square . . . One of Triplet's large line of electrical measuring instruments. Others available in two, three and five inch sizes and in all standard ranges. Economically priced.

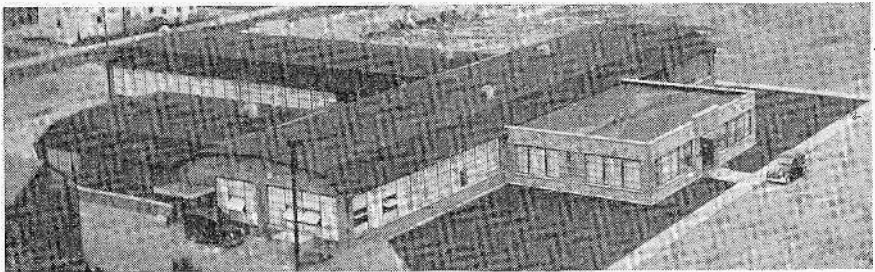

Triplet Factory, Bluffton, Ohio

The new Triplet factory was designed to manufacture precision instruments. Every modern facility and the very latest of equipment make it outstanding.

The factory has daylight construction, it is air-conditioned throughout with temperature and humidity controlled. Especial measures have been taken to keep out dust, lint and microscopic particles . . . the enemies of precision accuracy.

The latest equipment makes possible

the most modern processes for ageing, relieving strains and stresses of materials and making the fine adjustments in assembly necessary for producing precision instruments. With this background it is easy to understand that "instruments by Triplet" . . . is a guarantee of precision and reliability.

WRITE FOR CATALOG

The Triplet Electrical Instrument Co.
214 Harmon Ave., Bluffton, Ohio

Please send me more complete information on
.....Triplet 4" Square Instruments
.....I am also interested in

Name

Address

City State



When writing to advertisers mention of the PROCEEDINGS will be mutually helpful.

ENGINEERING DIRECTORY

QUARTZ CRYSTALS

for Standard or Special
Radio Frequency Applications

Write for Catalog

BLILEY ELECTRIC CO.
230 Union Station Bldg.
ERIE, PENNA.

Cathode Ray Tubes
and Associated
Equipment For All
Purposes

*Write for Complete
Technical Data*

**ALLEN B. DUMONT
LABORATORIES**
UPPER MONTCLAIR, N.J.

COIL APPLICATIONS

Our coil specialists will engineer and design to your specific requirements coils for original installation or replacement purposes. Write for catalog or send specifications for quotations.

**EDWIN I. GUTHMAN and
CO., INC.**
400 S. Peoria St.
Chicago, Ill.

PRACTICAL RADIO ENGINEERING

One year Residence Course
Advanced Home Study Course
Combined Home Study-Residence
Course

Write for details

**Capitol Radio Engineering
Institute**
Washington, D.C.

MICROPHONE APPLICATIONS

Our engineering department will cooperate, without obligation, in the selection of suitable microphones for standard or special applications.

SHURE BROTHERS
"Microphone Headquarters"
225 WEST HURON ST. CHICAGO, U.S.A.

"Q"—Measurements

We specialize in equipment for the radio frequency measurement of "Q" (X/R) of coils, condensers and other radio components.

Write for Circular

BOONTON RADIO CORPORATION
BOONTON, NEW JERSEY

For the Engineering Consultant

who can handle a little extra business this year

For the Designer

who can manage some additional work

we suggest the Engineering Directory of the I.R.E. PROCEEDINGS. Manufacturers who need services such as yours and organizations with special problems come to our Engineering Directory for information. Your name and special service announced here will put you in line for their business. For further information and special rates for I.R.E. members write to the Institute of Radio Engineers.

When writing to advertisers mention of the PROCEEDINGS will be mutually helpful.

Change in Mailing Address or Business Title

Members of the Institute should use this form to notify the Institute office of a change in their mailing address or the listing of their company affiliation or title.

The Secretary
THE INSTITUTE OF RADIO ENGINEERS
330 West 42nd Street
New York City

New Affiliation or Title

Name _____
(Print or type)

Title _____

Company Name _____

Company Address _____

Home Address

Street _____
(Print or type)

City and State _____

Old Mailing Address

Street _____
(Print or type)

City and State _____

Please indicate whether you wish your mail to be sent to your home
or business address.

Signature _____

Date _____

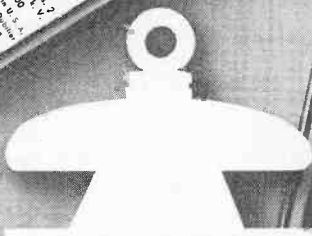
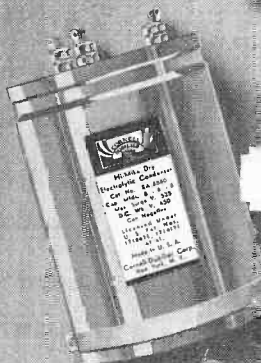
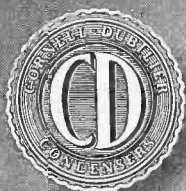

CAPACITORS

for every

ENGINEERING REQUIREMENT

SPECIALIZATION . . . specialization in the manufacture of quality condensers, exclusively . . . which has inspired the CORNELL-DUBILIER organization throughout its twenty-seven years of achievement—has made the dream of yesterday the accomplished fact of today.

Broadcasting stations; United States Navy, Army, Signal Corps, and other governmental divisions; telephone companies; manufacturers of receivers, transmitters, transceivers and transmitters; engineers, amateurs and servicemen—the CORNELL-DUBILIER organization supplies the condenser needs of all and does so with performance plus!

No more expensive shopping . . . no more testing . . . and no more experimentation. C-D engineers have a design for every requirement.

PAPER · MICA · DYKANOL
WET AND DRY ELECTROLYTICS

FOR DEPENDABLE PERFORMANCE
Standardize on C-D CAPACITORS

WORLD'S LARGEST EXCLUSIVE MANUFACTURER
OF CAPACITORS FOR MORE THAN 27 YEARS.

*Complete descriptive literature free
on request.*

CORNELL-DUBILIER CORPORATION
SOUTH PLAINFIELD, NEW JERSEY

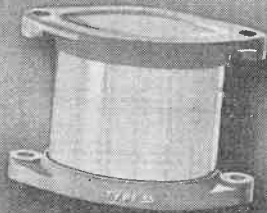
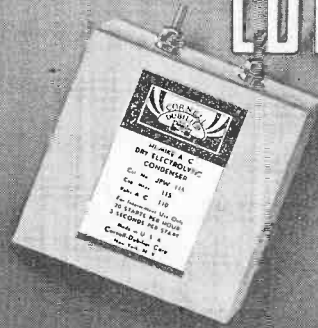
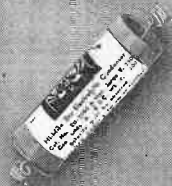

CORNELL-DUBILIER

Alphabetical Index to Advertisements

A	
Aerovox Corporation	XIX
American Telephone & Telegraph Company	XI
C	
Central Radio Laboratories	XXVI
Cornell-Dubilier Corporation	XXIII
E	
Employment Page	Cover III
Engineering Directory	XXI
Erie Resistor Corporation	XVI
G	
General Radio Company	Cover IV
I	
Institute of Radio Engineers	XIII, XIV, XXII
International Resistance Company	XV
Isolantite, Inc.	XVII
M	
Markoni-Ekco Instruments Ltd.	XII
R	
RCA Manufacturing Company	XXV
T	
Triplett Electrical Instrument Company	XX
W	
Western Electric Company	XVIII

PROCEEDINGS BOUND VOLUMES



VOLUME 23 (1935) of the Proceedings is now available in bound form to members of the Institute. It may be obtained in Buckram or Morocco leather for \$9.50 and \$12.00 respectively. Foreign postage is \$1.00 additional per volume.

Buckram bound copies of Volumes 18 and 19 (1930 and 1931) are also available for \$9.50. Foreign postage is \$1.00 additional per volume.

When writing to advertisers mention of the PROCEEDINGS will be mutually helpful.

THIS NEW RCA HIGH FIDELITY SPEAKER OFFERS MANY ADVANTAGES!

A new RCA High Fidelity Speaker which offers many advantages which can be found only in this type of combined Horn and Direct Radiator speaker construction.

Besides offering many technical refinements, this speaker is housed in an unusually attractive, high quality cabinet. It is rugged, extremely compact and will blend perfectly with almost any room.

The superior performance of this speaker makes it particularly well suited to a variety of uses. These include: special wide range radio receivers, broadcast monitoring, sound motion picture recording monitoring, centralized radio and office and study use. Your request will bring complete information without obligation.

NOTE THESE MANY ADVANTAGES!

- 1 Combined Horn and Direct Radiator construction gives superior wide-range, high fidelity performance.
- 2 New Double Voice Coil unit with small cone, gives wide angle distribution of high frequencies.
- 3 Substantially uniform frequency response 60-10,000 cycles.
- 4 Completely enclosed, making frequency response independent of location in room.
- 5 Employs an acoustic baffle.
- 6 Cabinet wood reinforced to prevent vibration.
- 7 Cabinet is rugged, light in weight, extremely compact.

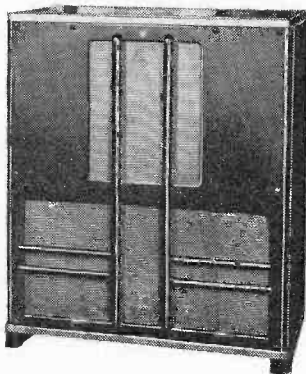

Broadcast Equipment

RCA Mfg. Co., Inc., Camden, N. J. • A Service of the Radio Corporation of America

When writing to advertisers mention of the PROCEEDINGS will be mutually helpful.



● Here are but a few of the infinite variations possible with Centralab Switches. ● Whatever your requirements there is a positive, bull-dog contact switch which can be designed and produced to meet your particular circuit requirements. ● They are engineered to meet Centralab's exacting standards of quality. » » » » »

CENTRALAB Division of Globe-Union Inc.
MILWAUKEE, WISCONSIN

BRITISH CENTRALAB LTD.
Canterbury Rd., Kilburn
London N. W. 6 England

FRENCH CENTRALAB CO.
118 Avenue Ledru-Rollin
Paris XI, France

Centralab Selector Switches

for

- TONE SWITCHES
- WAVE BAND SWITCHES
- LOCAL DISTANCE SWITCHES
- HIGH FIDELITY SWITCHES
- INPUT OUTPUT REVERSAL SWITCHES
- SHORT WAVE LOW LOSS
- ISOLANTITE SWITCHES

When writing to advertisers mention of the PROCEEDINGS will be mutually helpful.

EMPLOYMENT PAGE

A nationally known manufacturer of radio receivers in the middle West has two openings on his staff:

Experienced Radio Development Engineer—Reply Box No. 175, c/o I.R.E.

Experienced Radio Draftsman, capable of taking charge of drafting department—Reply Box No. 174, c/o I.R.E.

His own employees know of this advertisement.

ENGINEERING POSITIONS

Advertisements on this page are accepted from organizations interested in employing Institute members. Information on rates, preparation of material, and closing dates will be mailed on request.

THE INSTITUTE OF RADIO ENGINEERS
330 WEST 42ND STREET, NEW YORK, N.Y.



INSTITUTE EMBLEMS

Three styles of emblems are available to members of the Institute only. They are all of 14k gold with gold lettering on an enameled background, the color of which indicates the grade of membership. The approximate size of each emblem is as illustrated.

LAPEL BUTTON

The lapel button is supplied with a screw back having jaws which fasten it securely to the coat. The price is \$2.75, postpaid, for any grade.



PIN

The pin which is provided with a safety catch may be obtained for any grade for \$3.00, postpaid.



WATCH CHARM

The watch charm is handsomely finished on both sides and is equipped with a suspension ring for attaching to a watch chain or fob. Price for any grade, \$5.00, postpaid.



THE INSTITUTE OF RADIO ENGINEERS, INC.
330 WEST 42ND STREET, NEW YORK, N.Y.

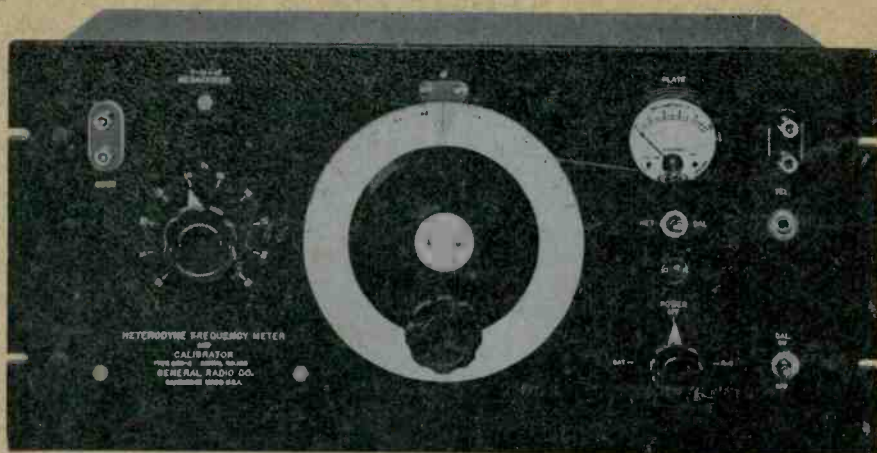

Everything you want in a Frequency Meter

The G-R Type 620-A Frequency Meter-Monitor and Calibrator has everything you want in a frequency monitor for checking frequencies over an extremely wide frequency band. Check these features:

- 1 **DIRECT READING** No plug-in coils . . . no calibration charts or curves . . . positive-action band-selector switch.
- 2 **EXCEPTIONALLY WIDE FREQUENCY RANGE** Continuous from 300 kc to 300 Mc.
- 3 **HIGH ACCURACY** Over-all accuracy of 0.01% or better . . . suitable for use as a monitor for practically all classes of service throughout its entire range.
- 4 **SELF-CALIBRATING** Calibration can be checked quickly and simply against built-in low-temperature-coefficient quartz plate.
- 5 **SIMPLE TO OPERATE** Operating personnel can use this instrument with entire success . . . positive identification of harmonics assured.
- 6 **PORTABLE** Two models supplied; a relay rack and a portable model . . . portable model weighs only 45 pounds . . . both models can be used on either a-c or d-c. Built-in a-c supply in each.
- 7 **RUGGED CONSTRUCTION** Unique electrical and mechanical design insures trouble-free operation.
- 8 **INEXPENSIVE** Type 620-AR (Relay-Rack Mounting), \$490 Type 620-AM (Portable Model), \$555.

Investigate this frequency meter, monitor and calibrator. It may be the answer to your frequency monitoring problem.

Write for Bulletin 123-F for complete data

GENERAL RADIO COMPANY

30 STATE STREET, CAMBRIDGE, MASSACHUSETTS

New York

Los Angeles

San Francisco

General Radio employs two-hundred and seven persons in its factory, laboratory and commercial departments at Cambridge. Its factory occupies over seventy-five thousand square feet of floor space.

GEORGE BANTA PUBLISHING COMPANY, MENASHA, WISCONSIN