

VOLUME 24

NOVEMBER, 1936

NUMBER 11

PROCEEDINGS
of
The Institute of Radio
Engineers



Application Blank for Associate Membership on Page XI

Institute of Radio Engineers Forthcoming Meetings

ROCHESTER FALL MEETING
November 16, 17, and 18, 1936

CINCINNATI SECTION
November 24, 1936

CLEVELAND SECTION
November 26, 1936

DETROIT SECTION
November 16, 1936

LOS ANGELES SECTION
November 17, 1936

NEW YORK MEETING
November 12, 1936
December 2, 1936

PHILADELPHIA SECTION
November 5, 1936
December 3, 1936

PITTSBURGH SECTION
November 20, 1936

WASHINGTON SECTION
November 9, 1936

The Institute of Radio Engineers

Board of Editors

ALFRED N. GOLDSMITH, *Chairman*

R. R. BATCHER

K. S. VAN DYKE

H. H. BEVERAGE

H. P. WESTMAN, *ex officio*

F. W. GROVER

L. P. WHEELER

J. W. HORTON

L. E. WHITTEMORE

G. W. PICKARD

WILLIAM WILSON

CONTENTS

PART I

Frontispiece, Samuel Montgomery Kintner.....	1404
Institute News and Radio Notes.....	1405
September Meeting of the Board of Directors.....	1405
Rochester Fall Meeting.....	1405
Federal Communications Commission Hearing.....	1407
Committee Work.....	1414
Institute Meetings.....	1415
Personal Mention.....	1426

PART II

Technical Papers

Electronic Music and Instruments.....	BENJAMIN F. MIESSNER	1427
A Power Amplifier for Ultra-High Frequencies.....	A. L. SAMUEL AND N. E. SOWERS	1464
Oscillations of Hollow Quartz Cylinders Cut Along the Optic Axis.....	TSI-ZÉ NY, LING-CHAO TSIEN, AND SUN-HUNG FANG	1484
A Harmonic Method of Intercomparing the Oscillators of the National Standard of Radio Frequency.....	E. G. LAPHAM	1495
This Matter of Contact Potential.....	R. M. BOWIE	1501
A Study of the Characteristics of Noise.....	V. D. LANDON	1514
Quasi Transients in Class B Audio-Frequency Push-Pull Amplifiers.....	A. PEN-TUNG SAI	1522
Booklets, Catalogs, and Pamphlets Received.....		1542
Contributors to This Issue.....		1543

The Institute of Radio Engineers

GENERAL INFORMATION

INSTITUTE. The Institute of Radio Engineers was formed in 1912 through the amalgamation of the Society of Wireless Telegraph Engineers and the Wireless Institute. Its headquarters were established in New York City and the membership has grown from less than fifty members at the start to several thousand.

AIMS AND OBJECTS. The Institute functions solely to advance the theory and practice of radio and allied branches of engineering and of the related arts and sciences, their application to human needs, and the maintenance of a high professional standing among its members. Among the methods of accomplishing this is the publication of papers, discussions, and communications of interest to the membership.

PROCEEDINGS. The PROCEEDINGS is the official publication of the Institute and in it are published all of the papers, discussions, and communications received from the membership which are accepted for publication by the Board of Editors. Copies are sent without additional charge to all members of the Institute. The subscription price to nonmembers is \$10.00 per year, with an additional charge for postage where such is necessary.

RESPONSIBILITY. It is understood that the statements and opinions given in the PROCEEDINGS are views of the individual members to whom they are credited, and are not binding on the membership of the Institute as a whole. Papers submitted to the Institute for publication shall be regarded as no longer confidential.

REPRINTING PROCEEDINGS MATERIAL. The right to reprint portions or abstracts of the papers, discussions, or editorial notes in the PROCEEDINGS is granted on the express condition that specific reference shall be made to the source of such material. Diagrams and photographs published in the PROCEEDINGS may not be reproduced without making specific arrangements with the Institute through the Secretary.

MANUSCRIPTS. All manuscripts should be addressed to the Institute of Radio Engineers, 330 West 42nd Street, New York City. They will be examined by the Papers Committee and the Board of Editors to determine their suitability for publication in the PROCEEDINGS. Authors are advised as promptly as possible of the action taken, usually within two or three months. Manuscripts and illustrations will be destroyed immediately after publication of the paper unless the author requests their return. Information on the mechanical form in which manuscripts should be prepared may be obtained by addressing the secretary.

MAILING. Entered as second-class matter at the post office at Menasha, Wisconsin. Acceptance for mailing at special rate of postage is provided for in the act of February 28, 1925, embodied in Paragraph 4, Section 412, P. L. and R., and authorization was granted on October 26, 1927.

Published monthly by

THE INSTITUTE OF RADIO ENGINEERS, INC.

Publication office, 450-454 Ahnaip St., Menasha, Wis.

BUSINESS, EDITORIAL, AND ADVERTISING OFFICES

Harold P. Westman, *Secretary*

330 West 42nd Street, New York, N. Y.

INSTITUTE SECTIONS

- ATLANTA—Chairman, I. H. Gerks; Secretary, N. B. Fowler, 1479 Lanier Pl., Atlanta, Ga.
- BOSTON—Chairman, E. L. Bowles; Secretary, Roland G. Porter, Northeastern University, Boston, Mass.
- BUFFALO-NIAGARA—Chairman, George C. Crom; Secretary, E. C. Waud, 235 Huntington Ave., Buffalo, N. Y.
- CHICAGO—Chairman, H. C. Vance; Secretary, J. E. Brown, 2022 Engineering Building, Chicago, Ill.
- CINCINNATI—Chairman, C. D. Barbulesco; Secretary, R. L. Freeman, Crosley Radio Corporation, Cincinnati, Ohio.
- CLEVELAND—Chairman, R. Morris Pierce; Secretary, J. S. Hill, 3325 Beechwood Ave., Cleveland Heights, Ohio.
- CONNECTICUT VALLEY—Chairman, M. E. Bond; Secretary, B. E. Atwood, 243 Grove St., Chicopee Falls, Mass.
- DETROIT—Chairman, E. C. Denstaedt; Secretary, Howard S. Gould, 214 Tuxedo Ave., Detroit, Mich.
- EMPORIUM—Chairman, Raymond R. Hoffman; Secretary, L. E. West, Hygrade Sylvania Corporation, Emporium, Pa.
- LOS ANGELES—Chairman, C. R. Daily; Secretary, L. W. Howard, 525 West Central St., Anaheim, Calif.
- NEW ORLEANS—Chairman, L. J. N. Du Treil; Secretary, G. H. Peirce, Electrical Research Products, Inc., 1631 Canal Band Bldg., New Orleans, La.
- PHILADELPHIA—Chairman, Irving Wolff; Secretary, R. L. Snyder, 103 Franklin Rd., Glassboro, N. J.
- PITTSBURGH—Chairman, Branko Lazich; Secretary, W. P. Place, Curtis St., R.D. 1, Wilkinsburg, Pa.
- ROCHESTER—Chairman, Lee A. Du Bridge; Secretary, H. A. Brown, 89 East Ave., Rochester, N. Y.
- SAN FRANCISCO—Chairman, Robert Kirkland; Secretary, Henry Tanck, RCA Communications, Inc., Bolinas, Calif.
- SEATTLE—Chairman, Earl D. Scott; Secretary, Harold C. Hurlbut, 2633-11th Ave. N., Seattle, Wash.
- TORONTO—Chairman, B. de F. Bayly; Secretary, H. P. Knap, Stromberg-Carlson Tel. Mfg. Company, 211 Geary St., Toronto, Ont., Canada.
- WASHINGTON—Chairman, Chester L. Davis; Secretary, Gerald C. Gross, Federal Communications Commission, Washington, D. C.

GEOGRAPHICAL LOCATION OF MEMBERS
ELECTED OCTOBER 7, 1936

Elected to the Associate Grade

California	Hollywood, 5128 Raleigh St.	Farnsworth, H. D.
	Los Angeles, 824 Wooster St.	Brockway, W. W.
Colorado	Colorado Springs, 1512 N. Corona	Hathaway, C. E.
Florida	Coral Gables, Coral Gables Radio, Inc., 2305 Ponce de Leon Blvd.	Larson, L. W.
	Gainesville, Box 2404 University Station	Duncan, F. B.
Illinois	Chicago, International House	Kadri, S. S.
Kentucky	Louisville, 1525 Brown Hotel	Hudson, W. E.
Louisiana	New Orleans, 8327 Sycamore St.	Bowman, D. W.
Massachusetts	Cambridge, 58 Hammond St.	Mohan, A. R.
	Cambridge, 9 Ellery St.	Shepherd, J. E.
	Salem, 9 Cambridge St.	Hartwell, H. G.
Michigan	Dearborn, 10459 Bertram Ave.	Jinks, C. C.
	Detroit, 1285 Rademacher Ave.	Werner, G. A.
Minnesota	Minneapolis, 902-16th Ave. N.	Jacobsen, G. K.
New Jersey	Harrison, RCA Radiotron Company	Rose, A.
New York	Brooklyn, 920 St. Marks Ave.	Kaplowitz, M.
	New York, Rm. 854, 1775 Broadway	Fottati, L. R.
	New York, Bell Telephone Labs., Inc., 463 West St.	Gutshall, R. W.
	Rochester, 115 Allendale St.	Biggar, R. A.
Ohio	Akron, 156 W. Miller Ave.	Harpley, D.
	Dayton, c/o Aircraft Radio Lab., Wright Field	Beugen, A. A.
	Woodsfield, West Court St.	Flieman, G. E.
Oregon	Salem, 1547 Court St.	Patton, W. R.
Pennsylvania	Emporium, 210 E. 4th St.	Kaplawka, G. A.
	Emporium, 229 W. 5th St.	Keim, D. Y.
	Emporium, P.O. Box 83	Myers, H. W.
	Emporium, 324 W. 4th St.	Smith, C. R.
	Emporium, 220 W. 4th St.	Stasz, C. E.
	Emporium, 517 1/2 Vine St.	Toner, W. C.
	Erie, 2618 Pennsylvania Ave.	Raub, L. A.
	Lansdowne, 65 Ardmore Ave.	Goodnow, A. C.
	Philadelphia, 5915 Chestnut St.	LaKatos, L. L.
	Philadelphia, 4103 N. 5th St.	West, H. L.
	Spring City	Wynn, J. C.
Virginia	Newport News, 125-33rd St.	Wilson, C. C.
Argentina	Buenos Aires, San Juan 2958	Guaragna, L. F.
Canada	Guelph, Ont., 65 Oxford St.	Walker, R. B.
	Toronto, Ont., 224 Jarvis St.	Daugharty, G. B.
England	Blandford, Dorset, Charlton Marshall	Musselwhite, W. E.
	Chelmsford, Marconi's Wireless Tel. Co.	Forster, H. J.
	Esher, Surrey, "Esgair," Portsmouth Rd.	Robinson, D. D.
	London, W.C. 1, 11 Upper Woburn Pl.	Hickson, P.
	Rugby, Post Office Radio Station	Hollinghurst, F.
Japan	Tokyo, 15 Banchi, Iearago-cho, Shiba-ku.	Yoshioka, H.
Mexico	Mexico, Apartado 1403	Bruce, J. H.
New Zealand	Rangiora, North Canterbury, 114 High St	Hunter, B. F.
	Wanganui, 40 Ingestre St.	Turner, W. G.
Paraguay	Asuncion, Casilla de Correo 516	Schoemaker, J. P.
South Africa	Johannesburg, Radio Dept., Rand University	Bozzoli, G. R.
	Pretoria, P. O. Box 1185	Wild, W. H.
Switzerland	Ste. Croix, Le Tourelle	Nicole, A.

Elected to the Junior Grade

New Jersey	Bogota, 229 Summit Ave.	Montllor, J. A.
------------	-------------------------	-----------------

Elected to the Student Grade

Massachusetts	Brookline, 225 St. Paul St.	MacAdam, W. K.
Michigan	Dearborn, 4710 Greenfield Ave.	Wiesner, J. B.
Minnesota	St. Paul, 180 State St.	Abramovich, M. N.
New York	Brooklyn, 156 Smith St.	Marcovitz, N.
	Middle Village, L. I., 7501-68th Ave. Ridgewood Station	Kushner, M. H.
	Troy, 4 Park Pl.	Hayward, J. W.
Wisconsin	Madison, 215 S. Bassett St.	Knopow, J.
Canada	Vancouver, B.C., 3929 W. 13th Ave.	McLeish, C. W.

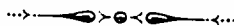

APPLICATIONS FOR MEMBERSHIP

Applications for transfer or election to the various grades of membership have been received from the persons listed below, and have been approved by the Admissions Committee. Members objecting to transfer or election of any of these applicants should communicate with the Secretary on or before November 30, 1936. These applications will be considered by the Board of Directors at its meeting on December 2, 1936.

For Election to the Associate Grade

Georgia	Atlanta, 1292 Gordon St., S.W.	Underwood, T. C.
Illinois	Chicago, 6301 N. Claremont Ave.	Fasulo, J. C.
	Chicago, 1515 W. Monroe St.	Seales, L. B.
	Chicago, 4705 N. Artesian Ave.	Wallace, J. T.
	Ottawa, Box 13	Wirkler, W. H.
Indiana	Columbus, c/o Noblitt-Sparks Industries, Inc.	Booth, E. C.
	Columbus, 932 Pearl St.	Dougherty, R.
	Columbus, 2224 Pearl St.	Irwin, B. H.
	Columbus, c/o Noblitt-Sparks Industries, Inc.	Mason, H. J.
	Columbus, 803-4th St.	Patterson, W. M.
	Columbus, 704 Werner Ave.	Perry, W. R.
	Columbus, 1109 Lafayette St.	Smith, B. J.
	Hope, Route 2	Miller, F.
	Indianapolis, 202 N. Gray St.	Arvin, M. J.
	Indianapolis, 4240 Guilford Ave.	Audritsh, Z. E.
	Indianapolis, 3321 E. 10th St.	Aust, R. J.
	Indianapolis, Police Headquarters, 33-37 S. Alabama St.	Batts, R. L.
	Indianapolis, 47 N. Keating Ave.	Bull, W. T.
	Indianapolis, 3834 E. 13th St.	Ealy, J. W.
	Indianapolis, 21 N. Kenyon St.	Earl, E. O.
	Indianapolis, R.R. 9, Box 702G	Goetz, L. R.
	Indianapolis, 350 Whittier Pl.	Lewis, R. O.
	Indianapolis, 4310 N. Meridian St.	Mallory, H. R.
	Indianapolis, 1822 New St.	Musser, C. W.
	Indianapolis, 5961 University Ave.	Nichols, J. L.
	Indianapolis, 1920 Park Ave.	Rinehart, B. H.
	Indianapolis, P. R. Mallory & Co., Inc., 3029 E. Washington St.	Rosser, F. N.
	Indianapolis, 2422 Kenwood Ave.	Vaughan, B. W.
	Indianapolis, 4414 E. New York St.	Wiley, J. L. G.
	La Porte, 120 Fox St.	Marshall, E. L.
Maine	Orono, 46 Main St.	Crabtree, K. G.
Massachusetts	Bethesda, 4815 Battery Lane	Stanton, H. E.
	Cambridge, Suite 208, 10 Dana St.	Robinson, E. B.
	Lowell, 486 Fletcher St.	Landry, L. H.
Michigan	Highland Park, 154 Massachusetts Ave.	Stinson, R. C.
Missouri	Boonville, 207 Mc Roberts St.	Shaw, C. E.
New Jersey	Newark, 200 Mt. Pleasant Ave.	Crosby, R.
	Newark, c/o Weston Elec. Inst. Corp., 614 Frelinghuysen Ave.	Lamb, F. N.
	Westmont, 425 Maple Ave.	Fredendall, G. L.
New York	Larchmont, 172 Myrtle Blvd.	Blasi, E. A.
	New York, Rm. 1110B, 463 West St.	Hefele, J. R.
	Schenectady, 8 State St.	Carlock, H. A.
	Schenectady, 1660 Helderberg Ave.	Lattemann, W.
	Schenectady, 1191 Stratford Rd.	Summerhayes, H. R., Jr.
	Schenectady, 2804 Campbell Ave.	Wilcox, J. F.
	Yonkers, 33 Hudson St.	Rudovsky, L.
Oklahoma	Tulsa, 3103 E. Admiral Pl.	Sheaffer, C. F.
Pennsylvania	Emporium, 229 W. 5th St.	Ishler, H. K.
	Emporium, 128 E. 5th St.	Miller, J. A.
	Emporium, 116 W. 6th St.	Orr, M. J.
	Emporium, 301 E. Allegany Ave.	Schneider, E. J.
	Emporium, 505 Broad St.	Smithgall, H. E., Jr.
	Emporium, 32 W. 6th St.	Wellendorf, J. J.
	Philadelphia, Y.M.C.A., 5722 Greene St., Germantown	Applegarth, A. R., Jr.
	Philadelphia, 1632 Spruce St.	Hagerty, G. E.
	Philadelphia, 522 Arbutus St., Mt. Airy	West, W. P.
Vermont	Burlington, 500 S. Willard St.	Dick, R. T.
Argentina	Buenos Aires, 25 de Mayo 489	Grant, I. C.
Australia	Ballarat, Victoria, 1214 Sturt St.	Kerr, A. D.
Canada	Montreal, P.Q., 6780 Chambord St.	Marcotte, J.
	Winnipeg, Manit., 112 Lipton St.	Smith, O.
China	Hangchow, Central Aviation Academy, Shien-Chiao	Bocharoff, G. M.

Applications for Membership

England	Barking, Essex, 52 A Wakering Rd.....	Sturdy, G. H.
	Chelmsford, Essex, c/o Marconi's College.....	Ong, H. Y.
	Coventry, 451 Walsgrave Rd.....	Panton, R.
	London N.W.3, 15 Belsize Park.....	Schaffer, P.
	London W.13, 66 Elers Rd., Ealing.....	Way, R. J.
India	Suffolk, Bawdsey Manor, Nr. Woodbridge.....	Squires, M.
	Bombay, Bombay Broadcasting Station, Irwin House, Bal- lard Estate.....	Garudachar, T. K.
Italy	Mylapore, Madras, 42 Mowbray's Rd.....	Ramanathan, K. N.
	Torino, Via Pietro Micca N.12.....	Fubini-Ghiron, E.
Malaya	Kuala Lumpur, Posts and Telegraphs Dept.....	Stubbs, W.
Rumania	Bucharest, Stirbey-Voda 152.....	Petrasco, E.
South Africa	Johannesburg, 107 Smit St.....	Sackson, H.
	Johannesburg, P.O. Box 1566.....	Toeplitz, W.

For Election to the Junior Grade

Illinois	Chicago, 5230 Drexel Ave.....	Weinstein, D. D.
Canada	Preston, Ont., 246 King St.....	Yaroslawski, A. B.

For Election to the Student Grade

California	Berkeley, 1219 Dwight Way.....	Wainola, A.
	Kingsburg, Route 2, Box 169.....	Anderson, S. C.
	Oakland, 2818 Modesto St.....	McLeod, G. R.
	Oakland, 566 Montclair Ave.....	Nourse, M. S.
	Vallejo, 907 Alabama St.....	Miller, J. R.
Iowa	Ames, Oak Lodge.....	Harder, R. B.
Maine	Orono, 26 Peters St.....	Matchett, W. E.
Massachusetts	Cambridge, 49 Wendell St.....	Chang, H.
New Jersey	Palisade, Buckingham Rd.....	Doersam, P. D.
New York	New York, 1678 Appleton Ave.....	Zima, L. C.



OFFICERS AND BOARD OF DIRECTORS

(Terms expire January 1, 1937, except as otherwise noted)

President

ALAN HAZELTINE

Vice President

VALDEMAR POULSEN

Treasurer

MELVILLE EASTHAM

Secretary

HAROLD P. WESTMAN

Editor

ALFRED N. GOLDSMITH

Directors

ARTHUR BATCHELLER

J. V. L. HOGAN

L. C. F. HORLE

C. M. JANSKY, JR., *Junior Past President*

C. B. JOLLIFFE

A. F. MURRAY

H. M. TURNER

WILLIAM WILSON

SERVING UNTIL JANUARY 1, 1938

STUART BALLANTINE, *Senior Past President*

E. L. NELSON

HARADEN PRATT

L. E. WHITTEMORE

SERVING UNTIL JANUARY 1, 1939

E. H. ARMSTRONG

VIRGIL M. GRAHAM

H. H. BEVERAGE

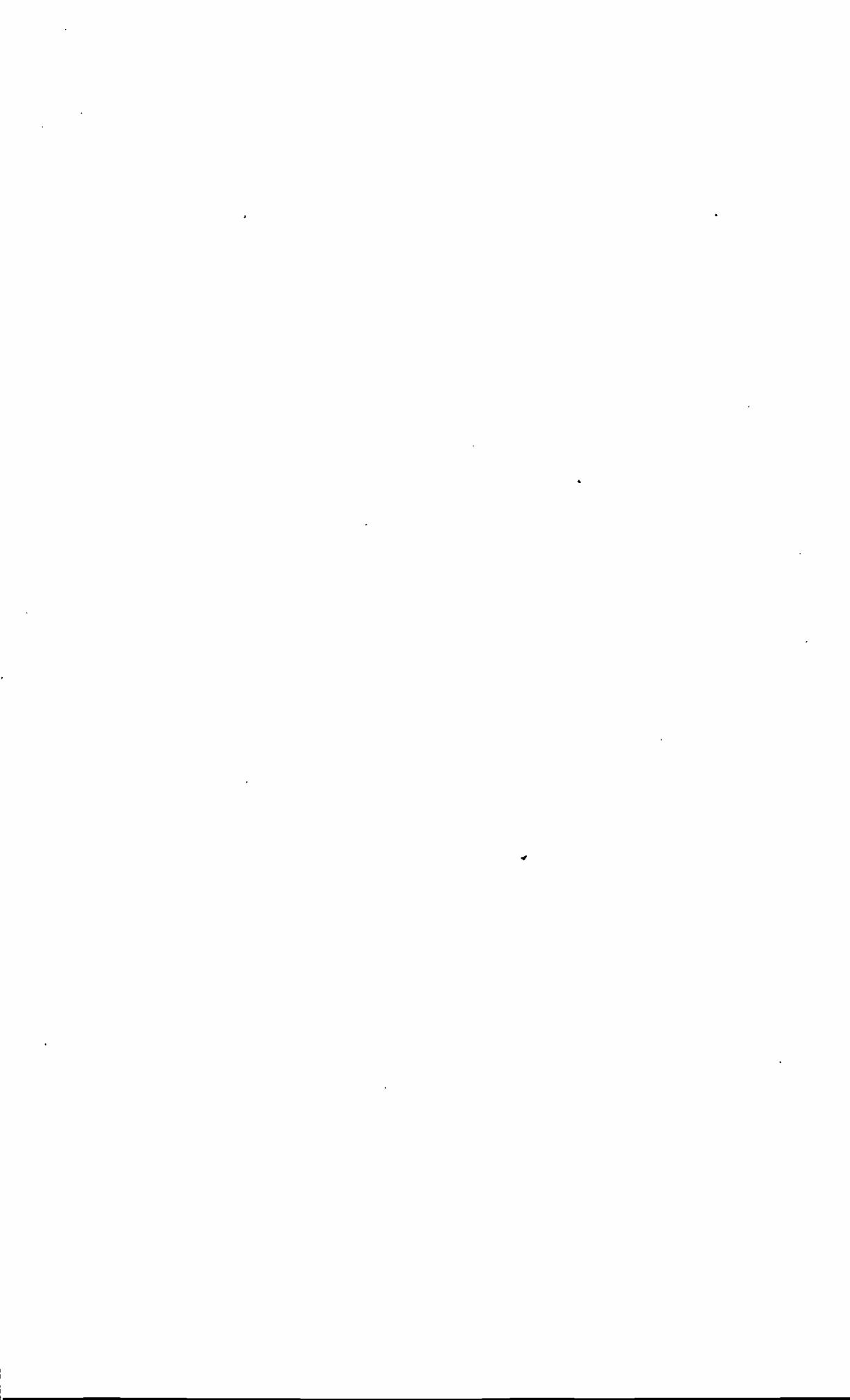



With deep regret we record the death of

Samuel Montgomery Kintner

Samuel Montgomery Kintner was born in New Albany, Indiana, on December 11, 1871. His early education was received in that city and in 1894 he completed a course in electrical engineering at Purdue University. In 1896 he became an assistant to Professor Fessenden at the University of Pennsylvania and two and a half years later was made Assistant Professor of mathematics. Later he succeeded Professor Fessenden as Professor of Engineering. During this time, he participated in investigations on Hertzian waves, X rays, and like phenomena.

In 1903 he joined the Westinghouse Electric and Manufacturing Company Research Department. Eight years later he resigned to become general manager of the National Signalling Company and subsequently became president of the organization. During this period the heterodyne system of reception was developed to practical importance, the Arlington Radio Station of the Navy Department was installed and numerous installations were made for the United Fruit Company and others.

In 1922 he rejoined the Westinghouse organization which had purchased the patent rights of the National Signalling Company. Two years later he was made manager of the Research Department and in 1930 he became assistant vice president in charge of engineering activities.

The University of Pittsburgh conferred on him the honorary degree of Doctor of Science and Purdue University bestowed an honorary degree of Doctor of Engineering.

Dr. Kintner died at his home in Pittsburgh on September 28, 1936.

September Meeting of the Board of Directors

The regular October meeting of the Board of Directors was advanced to September 29 to permit consideration of the report being prepared by the Broadcast Committee. Those present were Alan Hazeltine, president; E. H. Armstrong, Arthur Batcheller, H. H. Beverage, Alfred N. Goldsmith, Virgil M. Graham, L. C. F. Horle, C. M. Jansky, Jr., C. B. Jolliffe, E. L. Nelson, L. E. Whittemore, William Wilson, and H. P. Westman, secretary.

Fifty-one applications for Associate membership, one for Junior grade, and eight for Student grade were approved.

The Secretary reported receipt of a petition naming W. G. H. Finch as candidate for director of the Institute. The petition was in good order and the name was added to the list of those on the ballots distributed to the membership on September 4, 1936.

L. E. Whittemore was designated the Institute's representative on a newly formed Sectional Committee on Graphical Symbols and Abbreviations for Use on Drawings which has been established under American Standards Association procedure.

The five technical committees of the Institute were instructed to prepare material for the annual review of radio which for the past few years has been presented at the December meeting of the Institute in New York City. These reports previously had been prepared by individuals designated by the New York Program Committee. Henceforth, reports will be made at the annual meetings of the Institute which are held in New York City in January of each year.

E. T. Dickey and Virgil M. Graham were designated representative and alternate on a newly formed committee in charge of the revision of the material on radio broadcast reception equipment of the National Electrical Code.

The Secretary was designated as the chairman for the 1937 Convention Committee.

A report prepared by the Broadcast Committee for presentation before the hearings of the Broadcast Division of the Federal Communications Commission starting on October 5, 1936 was considered and approved. The full report is included in this issue.

Rochester Fall Meeting

The Rochester Fall Meeting of the Institute will be held at the Sagamore Hotel in Rochester, New York, on November 16, 17, and

18, 1936. A detailed program is given below. As in the past, there is no assurance that any of these papers will appear in the PROCEEDINGS as many of them have been prepared for informal presentation only and not for publication.

MONDAY, NOVEMBER 16

- 9:00 A.M. Registration
 Inspection of Exhibits
- 10:00 A.M. **Technical Session**
 "Equipment and Methods Used in Routine Measurements of Loud-Speaker Response," by S. V. Perry, RCA Manufacturing Company, Victor Division.
 "Current Measurements at Ultra-High Frequencies," by J. H. Miller, Weston Electrical Instrument Corporation.
 "Acoustic Networks in Radio Receiver Cabinets," by H. S. Knowles, Jensen Radio Manufacturing Company.
- 12:30 P.M. Group Luncheon
- 2:00 P.M. **Technical Session**
 "Shot Effect in Space-Charge-Limited Vacuum Tubes," by B. J. Thompson and D. O. North, RCA Manufacturing Company, Radiotron Division.
 "Automatic Control of Selectivity by Feedback," by H. F. Mayer, General Electric Company.
- 4:00 P.M. Inspection of Exhibits
 RMA Committee on Broadcast Receivers
- 6:30 P.M. Group Dinner
- 7:30 P.M. Inspection of Cyclotron at University of Rochester.
- 9:00 P.M. "Open House" at Rochester Club, Courtesy of Delco Appliance Corporation.

TUESDAY, NOVEMBER 17

- 9:00 A.M. Exhibits Open
- 9:30 A.M. **Technical Session**
 "The Federal Communications Commission and the Engineering Division of RMA," by T. A. M. Craven, Federal Communications Commission.
 "Radio Tubes Today," by R. M. Wise, Hygrade Sylvania Corporation.
 "Survey of Receiver Characteristics," by A. F. Van Dyck and D. E. Foster, RCA License Laboratory.
- 12:30 P.M. Group Luncheon
- 1:00 P.M. **Technical Session**
 "Commercial Television—and Its Needs," by Alfred N. Goldsmith, consulting engineer.
 "Latest Television Standards as Proposed by the Engineering Division by RMA," by A. F. Murray, Philco Radio and Television Corporation.
- 4:00 P.M. Inspection of Exhibits
 RMA Committee on Sound Equipment

6:30 P.M. Stag Banquet
Toastmaster—J. S. Wellwood
Speaker—H. W. Parker
Subject—Radio Observations

WEDNESDAY, NOVEMBER 18

9:00 A.M. Exhibits Open
9:30 A.M. Technical Session
“Applications of Nickel to Radio,” by E. M. Wise, International Nickel Company.
“Partial Suppression of One Side Band in Television Reception,” by W. J. Poch and D. W. Epstein, RCA Manufacturing Company, Victor Division.
“Improvements in the Performance of Cabinet Type Loud-Speakers at Low Frequencies,” by Benjamin Olney, Stromberg Carlson Telephone Manufacturing Company.
12:30 P.M. Group Luncheon
2:00 P.M. Technical Session
“Notes on Feed-Back Amplifiers,” by R. B. Dome, General Electric Company.
“Improvements in High-Frequency Receivers,” by J. J. Lamb, American Radio Relay League.
4:00 P.M. Exhibits Close
RMA Committee on Vacuum Tubes

Federal Communications Commission Hearing

The following statement was presented by Alan Hazeltine, President of the Institute, at an informal hearing before the Broadcast Division of the Federal Communications Commission on October 6, 1936.

In the announcement of this hearing the Commission has outlined in considerable detail the topics on which discussion is desired. Many of these items are essentially technical and quite fundamental in their nature. It has been felt, therefore, that comment by a purely engineering group, such as the Institute of Radio Engineers, should be helpful and would be welcomed. Accordingly, the statement which follows has been prepared by the Institute's Broadcast Committee and is presented to you with the approval of its Board of Directors.

At the outset, the Institute of Radio Engineers recognizes that the engineering problems involved in broadcast allocation are intimately interwoven with problems of social, legal, and economic character. Such latter problems are inherently less capable of precise formulation than engineering problems, and their tentative solutions are best described under the term “general policy.”

Among the matters of general policy lies that of maintaining both

reasonable stability in the broadcast structure and its healthy growth. On the one hand, no sudden and drastic change, regardless of its technical merits, would be possible from a practical standpoint. For we have a great body of listeners who collectively have an investment in over 25,000,000 radio receivers and behind them a well-established industry employing tens of thousands of people and representing a large capital outlay. Thus for the time being at least the country will look to the 550- to 1600-kilocycle band for the bulk of its broadcast service. On the other hand, provision is needed for the application in service of technical advances, both in improving conditions in the 550- to 1600-kilocycle band and in making use of other portions of the spectrum that may be found suitable and available for broadcasting. Thus the present policy of granting experimental licenses to qualified applicants for exploratory work is sound and should be continued. The questions that must be answered before a decision can be reached on the establishment of a broadcast service at frequencies remote from the present broadcast band are so wide in scope and so involved that, in general, only actual operation over a reasonable period of time will afford adequate information. The pioneering work that is now being done in the high-frequency and very high frequency bands is thought to be particularly worthy of encouragement. It is firmly believed to be in the public interest that such changes as are found desirable in methods of operation or in the bands allocated to broadcasting should be made on an evolutionary basis after experimental trial.

An important matter of policy is the establishment of *clear channels* and the determination of their number and their geographical and frequency distributions. The engineering conception of the clear channel has always been the absolute absence of duplication of assignments in the North American region during night hours. If more than one station is assigned for night operation on a given channel, that channel automatically becomes *shared*; and it is believed that it should be so classified by the Commission.

Some three years ago, the Institute's Broadcast Committee prepared a statement dealing with the question of the relative number of clear and shared channels. This statement was transmitted to the Radio Commission and subsequently published in the IRE PROCEEDINGS (vol. 21, p. 331; March, 1933) under the title "The Clear Channel in American Broadcasting." Subsequent developments have not affected the validity of the conclusions; and the following quotations from it may serve to indicate more clearly the existing situation with regard to such matters and to point out the direction in which remedial measures should be applied.

The statement first points out that:

1. "The field of the shared channel is to afford broadcast service to important detached centers of population, such as our cities and larger towns.

2. "The field of the clear channel is to afford service to those vast intervening areas in which the density of population is so low that a broadcast service could not otherwise be supported, and in addition to a single large center."

From these definitions it is concluded that:

1. "Decreasing the number of clear channels by assigning additional stations (for nighttime operation) to channels now used by only one station at a time would have the effect of affording additional services to certain localized urban groups but at the expense of decreasing the service to rural listeners and to those at remote points.

2. "Increasing the number of clear channels at the expense of the shared channels would have the opposite effect, assuming that assignments for the stations thus displaced could not be provided for on the remaining shared channels."

And finally the situation is summarized in the final paragraph as follows:

"Assuming that service to distant listeners is to be maintained, it is evident that continued provision must be made for an adequate number of clear channels. Whether the number should be forty, or more, or less, however, is a matter that can be determined only by careful study. The balance of service between the rural listener and the urban listener is determined in considerable measure by the relative number of allocated clear and shared channels. Decision as to the correct balance point is a matter of general policy."

From the engineering standpoint, it is believed that the continuance of an adequate number of clear channels is the only economic way of extending broadcast service worthy of the name to the scattered populations of the nation's farms and country towns and thus to comply with the provision of the law that "the Commission shall make such distribution of licenses, frequencies, hours of operation and of power among the several States and communities as to provide a fair, efficient, and equitable distribution of radio service to each of the same" (recent revision of the Communications Act. Section 307 (b)).

If there were ever any doubt concerning the extent to which rural listeners depend upon clear channel stations for their service, the results of the Allocation Survey recently published by the Commission should serve to remove it.

It is believed that, to avoid confusion of thought and action, it would be helpful to include in the Commission's regulations a definition of a clear channel station as one adapted to serve a substantial portion of the whole country. Essential elements in achieving this purpose are recognized in the "empirical standards" employed by the Engineering Department of the Commission. The incorporation of standards of this character into the regulations is also recommended.

The exclusive nature of the clear channel assignment can only be justified by the nighttime service to remote points which is made possible thereby. Such an exclusive assignment, therefore, carries with it a responsibility for extended rural service that should be fully recognized by all concerned. Of prime importance in this connection is the matter of power. After sixteen years of experience there is certainly ample technical evidence with regard to the dependence of satisfactory service on adequate power. Under the circumstances, it seems only logical and consistent to require of channels that are set aside at some sacrifice to serve the more distant rural sections of the country the use of the highest power that is technically and economically feasible. In view of the great success of the experiments with high power at WLW, which is strikingly confirmatory by the results of the Allocation Survey, it is evident that a desirable power for at least some clear channel stations is 500 kilowatts or more. Many of the reputed limitations of clear channel coverage which have come up for discussion in recent years are undoubtedly merely the inevitable consequences of inadequate power for this type of assignment.

Turning now to the *shared channel allocations*, we are fortunate in having available for guidance the principle embodied in the distance tables of the Commission of affording protection against interference to the good service area of a station. Here the Institute recognizes the policies necessitated by other than engineering consideration of classifying stations in accordance with the different degrees of protection afforded and of modifying the degree of protection in specific instances when this appears to be in the public interest. However, it is felt that distance tables, revised from time to time as the radio art advances and as more transmission data become available, constitute a valuable general guide, and it is recommended that they be given formal recognition in the Commission's regulations. In applying and in revising these distance tables, the Institute invites attention to the engineering factors outlined in the following paragraphs.

In applying the distance tables, the data which should determine whether or not a particular assignment is satisfactory from the interference standpoint should preferably not be average values computed to be reasonably representative of conditions throughout the whole country, but actual measurements made within the area under consideration, whenever these are available. The wide variations in earth conductivity known to exist in the country, and the recognized change of attenuation with frequency, combine to produce wide departures from the national average in particular cases. Under the circumstances, it is believed that better balance within the allocations structure and increased capacity for service within the broadcast band will be promoted by allowing the distance tables to be superseded in specific instances by an adequate showing of fact.

In revising the distance tables, it is recommended that the most recent transmission data be employed. In particular, the transmission data resulting from the Allocation Survey is evidently based upon a much greater number of observations and should be much more complete and reliable than those previously available.

The good service area of a station is bounded by a contour at which its field intensity has fallen to some specific value, as one millivolt per meter, and within which the listeners to that station are protected against interference from other stations. The proper value or values to be selected for the limiting intensities are associated with the general power level of the stations. Engineering considerations call for adequate power as the primary means for minimizing natural and man-made noise. The noise background is an extremely important factor in determining the entertainment value of a reproduced program. This has been very clearly demonstrated in the experience of the radio industry during the past few years with high fidelity receivers. It has been shown that in urban areas under many conditions even the local stations do not establish sufficiently strong fields to bring out the inherent qualities of the apparatus and the artistic excellence of the programs. On the shared channels, for obvious reasons, higher nighttime power cannot be regarded as a measure for reaching a larger group of listeners, but rather as a desirable step to improve the service being received by the audience which already exists. It is believed that in many cases one kilowatt is wholly inadequate for affording the grade of service which the local communities served by regional stations have a right to expect at the present stage of the art. Doubling the limiting field intensity, as from one to two millivolts per meter, would permit quadrupling the powers of a group of stations without altering their mutual interference.

The assumed limiting ratio of 20:1 between wanted and unwanted

signals is thought to be a fairly representative figure and it is recommended that it be retained as a minimum. A 20:1 ratio represents a fair grade of service when the relatively low fields to which it is applied and the correspondingly high noise levels due to natural and man-made disturbances are kept in mind. To attempt to apply a much higher ratio generally under existing conditions is undoubtedly impractical. It is also recommended that the 20:1 ratio be understood to apply for ninety per cent of the time, or in other words, intermittent interference that does not exceed the specified value more than ten per cent of the time should be taken to indicate compliance. This procedure is consistent, it is believed, with the practice now being followed by the Commission's engineers.

There is considerable evidence to the effect that the receiver selectivity curve assumed for the present distance tables is appreciably below the capabilities of modern receivers. It is understood that the Radio Manufacturers Association will present data on this point. In undertaking to establish a new average curve for regulatory purposes, it is felt that the Commission is justified in setting a reasonably high standard, in fairness to the owners of the better classes of modern receivers. It seems neither logical nor equitable to base the service for the entire country on the poorest receivers now being bought, nor on receivers that were bought so long ago that they are effectively obsolete. Since good selectivity must necessarily be reflected in the purchase price, it is practically certain that receivers below any reasonable standard adopted by the Commission will continue to be sold for some time to come. There are undoubtedly locations in which such receivers will give very acceptable service and, in any event, the listener should be permitted to choose his own price and obtain a curtailed service if he so desires. In so far as obsolescence is concerned, the receiver data resulting from the Allocation Survey are most interesting and seem to indicate that consideration for early types of receivers is not as important as has sometimes been assumed.

In recomputing the distance tables, it is believed that special consideration should be given to the "allocation factor." This factor was evidently employed in the original calculations because the data then available were relatively meager and empirical methods were necessary. Since the factor employed in evaluating adjacent channel interference varies over a range of several hundred per cent, however, it is thought to play an unjustifiably prominent part in fixing the minimum geographical spacings. With more adequate information on transmission and on receiver characteristics, it should now be possible to employ more accurate methods and unless its use can be shown

to be essential, the avoidance of any arbitrary factor of this character is recommended.

In the course of its work, the Commission is undoubtedly confronted at relatively frequent intervals with the necessity of deciding upon an appropriate course of action in the absence of adequate information with regard to actual service conditions. There is evidently need for a much more detailed and accurate engineering survey of radio service throughout the entire country than is now available. Such a survey should not only chart the service areas of individual stations but should also endeavor to integrate the service available to listeners in various sections so that some picture may be obtained of the structure as a whole. This is obviously an undertaking of large magnitude which will require the slow and painstaking assembly and analysis of a mass of engineering data relating to conditions at numerous points in the country. It will undoubtedly take years for its completion and will have to be started as a skeleton structure, to be supplemented, clarified, and developed in greater detail as further information becomes available. It is firmly believed, however, that this is the course that the Commission and its engineers must follow to make fully effective the provisions of Section 307(b). Radio transmission over a large heterogeneous area such as the North American continent is too complex a phenomenon and is subject to too many exceptions and variations to be fully represented by so rudimentary a concept as the distance tables, useful as these are for obtaining a first approximation to the minimum geographical spacing between stations. No amount of measuring and averaging of conditions throughout the entire country, however, will give a simple formula which can hope to express in the same terms the results achieved by a low-frequency station on the plains of Texas and a high-frequency station in New England. In our efforts to make intensive use of the broadcast band, we have passed the point where nation-wide averages will afford adequate guidance and it is only by recognizing the fact that the phenomena with which we have to deal are subject to wide variations in various sections of the country that we can hope to rectify the service deficiencies which now exist and to effect further improvements.

In conclusion, the Institute of Radio Engineers wishes to express its appreciation for this opportunity of appearing before the Commission and its desire to aid the Commission, whenever possible, in clarifying the technical and engineering principles underlying frequency allocation.

Committee Work

ADMISSIONS COMMITTEE

The Admissions Committee met on Wednesday, September 16, in the Institute office and those present were C. M. Jansky, Jr., chairman; F. W. Cunningham, H. M. Turner, and H. P. Westman, secretary. Five applications for transfer to Member grade were approved. Of eleven applications for admission to the grade of Member, six were approved, four were tabled and one was rejected.

BROADCAST COMMITTEE

Two meetings of the Broadcast Committee were held during September to complete the report prepared for presentation before the Federal Communications Commission in October. At the first meeting which was held on the 15th, there were present E. L. Nelson, chairman; R. N. Harmon, Alan Hazeltine (representing H. A. Wheeler), J. V. L. Hogan, L. C. F. Horle (visitor), C. W. Horn, C. M. Jansky, Jr., C. B. Jolliffe, J. C. McNary, V. E. Trouant, and H. P. Westman, secretary.

At the second meeting held on the 29th, there were present, E. L. Nelson, chairman; R. N. Harmon, Alan Hazeltine (representing H. A. Wheeler), J. V. L. Hogan, G. D. Gillette, C. W. Horn, C. M. Jansky, Jr., C. B. Jolliffe, W. B. Lodge (representing E. K. Cohan), J. E. Young (representing V. E. Trouant), and H. P. Westman, secretary.

CONSTITUTION AND LAWS COMMITTEE

A meeting of the Constitution and Laws Committee which was held on September 30 in the Institute office was attended by H. M. Turner, chairman; Austin Bailey, Arthur Batcheller, and H. P. Westman, secretary. Further consideration was given to the revision of the Institute Constitution.

TECHNICAL COMMITTEE ON ELECTROACOUSTIC DEVICES

A meeting of the Technical Committee on Electroacoustic Devices was held on September 25 in the Institute office and those present were H. F. Olson, Sydney Bloomenthal, J. T. L. Brown (representing C. H. G. Gray), Benjamin Olney, Hans Roder, Julius Weinberger (visitor), V. E. Whitman, H. A. Zahl, and H. P. Westman, secretary. Material on the testing of loud-speakers was given final consideration and that report is now to be presented to the Standards Committee for action.

MEMBERSHIP COMMITTEE

The Membership Committee met in the Governors Room of the Midston House in New York City on October 7 and those present

were F. W. Cunningham, chairman; C. J. Burnside, J. M. Clayton, H. C. Gawler, E. W. Schafer, W. A. Schneider, C. E. Scholz, Leslie Woods, and H. P. Westman, secretary. A letter to those who have been delinquent in the payment of dues was drafted. A discussion of existing grades of membership and their significance took place.

NEW YORK PROGRAM COMMITTEE

Haraden Pratt, chairman; R. R. Beal, G. C. Connors, R. A. Heising, George Lewis, and H. P. Westman, secretary, attended a meeting of the New York Program Committee held on September 9 in the Institute office. At this meeting plans were discussed for the New York meetings during November and December of 1936 and January of 1937.

TECHNICAL COMMITTEE ON RADIO RECEIVERS

A meeting of the Technical Committee on Radio Receivers was held in the Institute office on October 8. Those present were H. A. Wheeler, chairman; C. R. Barhydt, R. I. Cole, L. F. Curtis, Harry Diamond, E. T. Dickey, J. F. Dreyer, Jr., D. E. Harnett, W. A. Harris (visitor), H. A. Peterson, A. E. Thiessen, M. L. Thompson (representing David Grimes), Lincoln Walsh, E. W. Wilby (representing D. E. Foster), and H. P. Westman, secretary. The committee reviewed the report of its Subcommittee on Test Procedures in part and will endeavor to complete this review by correspondence.

STANDARDS COMMITTEE

The Standards Committee met on September 18 in the Institute office. Those present were L. C. F. Horle, chairman; J. H. Dellinger, Melville Eastham, Virgil M. Graham, Alan Hazeltine (visitor), J. C. Schelleng, B. J. Thompson, H. M. Turner, H. J. Vennes, William Wilson, and H. P. Westman, secretary. The committee reviewed in part the report of the Technical Committee on Electronics and will hold an additional meeting to complete that work.

Institute Meetings

ATLANTA SECTION

A meeting of the Atlanta Section was held at the Atlanta Athletic Club on May 21. I. H. Gerks, chairman, presided and there were seven members present.

A paper on "Amateur Projection Equipment Arranged for Sound" was presented by R. G. Markillie, a student at Georgia Institute of

Technology. The film used substitutes a sound track for one set of sprocket holes and employs variable area recording. The equipment is designed for voice recording only and was described in detail. The paper was closed with a demonstration of it.

Professor Gerks then presented a discussion of the paper by Professor Armstrong on "A Method of Reducing the Disturbances in Radio Signaling By a System of Frequency Modulation" which appeared in the May, 1936, PROCEEDINGS. He derived several of the formulas involved in the theory of this type of modulation and described the advantages of the system in reducing the effects of disturbances.

The June meeting of the section was held on the 18th with P. C. Bangs, vice chairman, presiding. There were nine present.

W. J. Holey, consulting engineer, presented a paper on "Field Intensity Measurements, Methods, and Equipment." In it, the history of field intensity measurements and equipment was outlined and trends in design and operation discussed. The theory of the methods involved was given and its application in field surveys discussed. Factors influencing field strength measurements were mentioned. The usefulness of these measurements in the design, construction, and operation of antennas was outlined. The paper was discussed by Messrs. Ackerman, Bangs, and Fowler.

BUFFALO-NIAGARA SECTION

The annual meeting of the Buffalo-Niagara Section was held on September 30 at the University of Buffalo. E. C. Waud, secretary, presided and there were fifty-seven present.

A paper on "1936 Tube and Circuit Developments" was presented by W. R. Jones of the Hygrade Sylvania Corporation. He described first the design and construction of multipactor tubes and outlined the theory associated with secondary electron emission on which they are based. He stressed the fact that in these tubes there is utilized electron tube characteristics which had heretofore been considered undesirable. A form of tube which avoided the "short-cut" effect due to electrons skipping stages in the tube was described. Television was suggested as a possible application for the device.

The electron telescope and its analogy to a light telescope was touched on. He then discussed the progress in the use of metal tubes and pointed out that many difficulties with them were due to improper circuit arrangements. The 6L6 power output tube was discussed in detail. The paper was closed with a consideration of automatic frequency control.

In the election of officers, G. C. Crom of the Engineering Department of Rudolph Wurlitzer Manufacturing Company was named chairman; K. B. Hoffman, Chief Engineer of the Buffalo Broadcasting Company, was designated vice chairman; and E. C. Waud was re-elected secretary-treasurer.

CHICAGO SECTION

Two meetings of the Chicago Section were held during September. The first was on the 11th at the Hotel LaSalle and was attended by seventy. J. K. Johnson, vice chairman, presided.

A paper on "Frequency Modulation Noise Characteristics" was presented by M. G. Crosby of RCA Communications and discussed by Messrs. Andrews, Johnson, Robinson, and White.

Theory and experimental data were given which show the improvements in signal-noise ratio effected by frequency modulation over amplitude modulation. Above a certain carrier-noise ratio in the frequency modulation receiver which is called the "improvement threshold," the frequency modulation signal-noise ratio is greater than the amplitude modulation signal-noise ratio by a factor equal to the product of a constant and the deviation ratio. The deviation ratio is the ratio between the maximum frequency deviation and the audio modulation band width. The constant depends upon the type of noise, being slightly greater for impulse than for fluctuation noise. In frequency modulation systems with high deviation ratios, a higher carrier level is required to reach the improvement threshold than is required in systems with low deviation ratios; this carrier level is higher for impulse than for fluctuation noise. At carrier-noise ratios below the improvement threshold, the peak signal-noise ratio characteristics of the frequency modulation receiver are approximately the same as those of the amplitude modulation receiver, but the energy content of the frequency modulation noise is reduced.

An effect which is called "frequency limiting" was pointed out in which the peak value of the noise is limited to a value not greater than the peak value of the signal. With impulse noise this phenomenon effects a noise suppression in a manner similar to that in the recent circuits for reducing impulse noise which is stronger than the carrier in amplitude modulation reception. When the power gain obtainable in certain types of transmitters by the use of frequency modulation is taken into account, the frequency modulation improvement factors are increased and the improvement threshold is lowered with respect to the carrier-noise ratio existing in a reference amplitude modulation system.

The second meeting was held on the 25th at the Hotel LaSalle with Vice-Chairman Johnson presiding. One hundred were present. A paper on "High Q Tuned Coupled Circuits" was presented by C. B. Aiken, Professor of Electrical Engineering at Purdue University. Dr. Aiken pointed out that the type of filter consisting of two tuned coupled circuits of reasonably high Q is widely used in radio work. Many analyses of such a filter have been developed but usually under restrictions that materially limit the usefulness of the results. Often limitations have been placed on the character of the circuits, such as that they are identical, or that they are coupled by a pure reactance, etc. These restrictions make the resulting theory inapplicable to the study of such important matters as detuning, unequal circuit resistances, resistance in the coupling impedance, etc. On the other hand, when no restrictions have been placed on the analysis, the results have been either incompletely developed or so complex as to make their application very tedious.

It was shown how various circuits met with in practice may be reduced to a simple equivalent coupled pair. The solution of this pair leads to the construction of families of universal resonance curves. In any one family the coupling index is the parameter, while different families are constructed for different ratios of the resistances of the two circuits.

Formulas are developed for the calculation of band width, not only at the peaks of the curve but at any given number of decibels down. Other points considered included the ratio of the height of peak to the height of valley, shift of peaks with changes in coupling impedance, effect of unequal L/C ratios in the two circuits, effect of series and shunt resistance, form of primary current curves, and impedance across the primary circuit. It is shown that when $R_1 \neq R_2$, the concept of critical coupling, while still useful, is not sufficient, and a new quantity, transitional coupling, was defined.

Circuits not tuned exactly alike were next considered, and it was shown that if $R_1 = R_2$, the universal resonance curves developed for isochronous circuits can by means of a simple artifice be applied to the study of detuned circuits. It was also shown that, when $R_1 \neq R_2$ and the circuits are detuned, serious assymetry of the resonance curves results. Formulas for the calculation of such curves were developed and typical curves given.

The effect of resistance in the coupling impedance was next studied, and typical lopsided resonance curves shown. Reasonably simple formulas for the calculation of these curves were developed, although they are necessarily more complex than those for the case of a pure

coupling reactance. Finally, application of the results was made to some of the circuits met with in radio receiver design.

The paper was discussed by Messrs. Andrews, Crossley, Johnson, Robinson, and White.

CINCINNATI SECTION

The Cincinnati Section met on September 22 at the University of Cincinnati with C. D. Barbulesco, chairman, presiding. There were sixty present.

W. S. Brian of the Ken-Rad Corporation presented a paper on "Beam Amplifier Tubes." He pointed out that in the usual type of power pentode the suppressor grid is too effective at the grid wires with low plate voltages. As a result a great number of cathode electrons are driven back to the screen, and the plate current falls off considerably as the plate voltage approaches zero. This causes high percentages of odd harmonics in push-pull operation. It was shown by means of potential distribution curves for the distance from cathode to plate, that a retarding field could be created by proper electrode spacings and by alignment of screen and control grid wires. This field decelerates secondary electrons from the plate, and thus serves the same purpose as a suppressor grid. The hiding of the screen wires from the cathode by the control grid wires also reduces the current intercepted by the screen.

The total result as revealed by the characteristic curves of beam tubes is the maintenance of high plate current and low screen current at low plate voltages. The paper was discussed by Messrs. Barbulesco, Greig, Osterbrock, and Tyzzer.

CLEVELAND SECTION

R. M. Pierce, chairman, presided at the September 24 meeting of the Cleveland Section which was held at the Case School of Applied Science. There were thirty-two present.

R. F. Guy, radio facilities engineer of the National Broadcasting Company presented a paper on "NBC Directional and Nondirectional Antenna Developments and Notes on Factors Affecting Broadcast Station Coverage."

The paper covered two outstanding experiments conducted at WPTF, Raleigh, N. C., and at KOA in Denver, Colo. The WPTF system comprised directive twin towers of uniform cross section with lumped capacitance and tuning systems at the tops. Numerous measurements made as far away as in the Rocky Mountains showed definite advantages in favor of this system as regards fading. The KOA

antenna is a 440-foot tower operated against a good ground screen and fed by a transmission line. Some notes were then given on new installations at WHIO and WMAQ. One conclusion from these experiments was that radiation greater than seven degrees above the earth was responsible for fading and other undesirable conditions.

A second paper on "A Method of Calculating Directional Antennas" was presented by W. S. Duttera, assistant radio facilities engineer of the National Broadcasting Company. In it he presented a graphical method of calculating radiation from directive systems employing radiators having any vertical characteristic.

CONNECTICUT VALLEY SECTION

The Connecticut Valley Section met on June 25 in the Hotel Garde at Hartford. The meeting was preceded by a banquet which was attended by forty-one of the forty-five who were present at the meeting. M. E. Bond, chairman, presided.

The meeting was devoted to descriptions of and visits to broadcast stations WDRC and WTIC. Mr. Martino, chief engineer of WDRC, described the equipment at that station. He pointed out that the studios are arranged so that a reflecting surface is opposite an absorbing surface. By employing two interlocked amplifier keys, control of material fed to the transmitters is simplified and the possibility of error in operation is reduced.

The equipment at WTIC was described by Mr. Sanders of that station. Some of their studios employ movable panels for acoustic control. A central control room contains the main amplifiers and individual control panels are located in each studio or an adjoining room. After these descriptions, two groups were formed and the stations visited.

The September 24 meeting of the Connecticut Valley Section was held in the auditorium of the Hartford Electric Light Company and there were fifty present. Chairman Bond presided.

R. B. Dome of the General Electric Company of Bridgeport, Connecticut, presented a paper on "Notes on Feed-Back Amplifiers." The Black feed-back amplifier was described and it was shown by theoretical and experimental data that this system reduced the harmonic content of the amplifier output, and improved output regulation. By changing the amount and phase of the feed-back voltage, the amplifier can be made degenerative, passive, regenerative, or oscillatory. Vector diagrams and circuits showing effects of different combinations of resistance, capacitance, and inductance on the frequency characteristics of the amplifier were presented. The paper was dis-

cussed by Messrs. Curtis and Lamb, Mr. Curtis describing the application of feedback to intermediate-frequency amplifiers and its effect on their selectivity.

DETROIT SECTION

E. C. Denstaedt, chairman, presided at the September 18 meeting of the Detroit Section which was held in the Detroit News Conference Room and attended by thirty.

A paper on "The Rôle of Rags in Industry" was presented by H. C. Steadman, special factory consultant for the Spaulding Fibre Company. In it he described the manufacture and uses of fibre and spauldite, a laminated phenolic product. The base consists of rags largely imported from European countries. Pieces of wool and silk are removed before the cloth is cut into small pieces in the initial stages of manufacture. The material is then treated in a manner very similar to the manufacture of paper, the finished rag-base paper being wound up into large rolls.

In the next stage several sheets of this highly absorbent paper are treated with a zinc-chloride solution which gelatinizes the cotton molecules, causing the built-up layers to lose their identity to a great extent, producing by subsequent shrinking a nonhomogeneous sheet. The excess of zinc chloride is squeezed out between rollers. By continuing this process any thickness of material can be built up.

Curing of the completed product requires much time and space, since large tanks of water are used to hold the fibre sheets, and the time may be from six months to two years, depending on the thickness of the material. At the end of that time the sheets are removed and the final stage consists in pressing them flat with huge hydraulic presses.

In the manufacture of spauldite the binding material consists of phenol and formaldehyde, used in the presence of high temperature and high pressure. By varying the binding material the power factor can be controlled over a wide range. At present the lowest power factor for spauldite is of the order of two per cent at 1000 kilocycles. Spauldite is available for many different uses, with no one type performing at its highest efficiency for all purposes.

The paper was discussed by Messrs. Buchanan and Denstaedt.

EMPORIUM SECTION

The Emporium Section met on September 24 in the American Legion Club Rooms. R. R. Hoffman, chairman, presided and there were seventy present.

A paper by A. A. Armer, engineer for The Magnavox Company, was on "Photoradio Analogs." He spoke briefly of the general phenomena of cause and effect giving numerous illustrations from the fields of radio and photography. Some of these were mathematically rigorous while others were not. Some of the outstanding similarities described included the likeness of certain tube characteristics and film properties. Others dealing with circuit properties had as their counterparts the characteristics of various photographic filters. The paper was concluded with slides showing the technique of colored photography for both still and motion pictures. It was pointed out that the presence of hiss resulting from the size of the silver grains was analogous to the noise due to shot effect and thermal agitation in radio. A lengthy discussion of the subject followed which was participated in by Messrs. Bachman, Baldwin, Bowie, Eccleston, Fink, Seeley, and Stringfellow.

LOS ANGELES SECTION

The Los Angeles Section met on September 1 in a joint meeting with the American Institute of Electrical Engineers for a series of papers on television by members of the staff of the Don Lee Broadcasting System. Three hundred and fifty persons attended, twenty of whom were present at an informal dinner which preceded the meeting. Chairman C. R. Daily presided.

The first paper on "Television Today" was presented by H. R. Lubeke, director of television. He gave a résumé of the recent Federal Communications hearings of June 8 and June 15, particularly as relating to television; a résumé of Eastern developments as noted during a six-week visit to Washington, New York, Philadelphia, Camden, Chicago and other cities; and general mention of the Don Lee Broadcasting System activities in Los Angeles from 1930 to the present time.

The second paper on "Television Transmitter Operation" was presented by Wilbur E. Thorp, assistant director of television. He described the construction and operation of their transmitting equipment and the ultra-high-frequency television transmitter, W6XAO. He pointed out how television equipment construction and operation differ from sound radio construction and operation, and the behavior of the equipment during recently inaugurated four-hour daily transmissions.

The third paper on "Television Receiver Operation" was presented by F. Alton Everest, television engineer. He described the construction of a cathode-ray television receiver and his experiences in demonstrating it to the public.

This was followed by adjournment of the meeting to a residence

three and one-half miles from the transmitter, where sight-and-sound television was demonstrated to groups of twenty persons at a time. The visual images were broadcast by W6XAO on forty-five megacycles and the aural accompaniment by KHJ on 900 kilocycles. Two hills intervened between W6XAO and the receiving location, making the demonstration equivalent to one conducted at two or three times the distance, with respect to the field strength of the visual transmitter.

The television transmitting station, W6XAO, was open for inspection.

NEW ORLEANS SECTION

The annual meeting of the New Orleans Section was held on October 7 at Loyola University and presided over by L. J. N. du Treil. There were twenty present.

A paper on "Audio-Frequency Amplifiers" was presented by J. D. Bloom, Jr., an engineer at WWL and an instructor at Loyola University. The subject of audio-frequency amplifiers was covered broadly. Various methods of coupling the amplifying vacuum tubes were discussed and their characteristics outlined. The paper was closed with a demonstration of the effect of changing the values of the plate and grid resistors in a resistance coupled amplifier while leaving the coupling capacitance fixed.

In the election of officers, L. J. N. du Treil on the field staff of the Federal Communications Commission was named chairman, H. G. Nebe of WSMB was elected vice chairman, and G. H. Peirce of Electrical Research Products was designated secretary-treasurer.

NEW YORK MEETING

The regular New York meeting of the Institute was held in the Engineering Societies Building on October 7 and presided over by President Hazeltine. There were 400 present.

A paper on "A Power Amplifier for Ultra-High Frequencies," by A. L. Samuel and N. E. Sowers of Bell Telephone Laboratories was presented by both authors. Mr. Samuel gave the first half on the tubes developed and Mr. Sowers discussed the circuits for their testing and use. The paper appears elsewhere in this issue.

SAN FRANCISCO SECTION

R. D. Kirkland, chairman, presided at the September 16 meeting of the San Francisco Section which was held at the Bellevue Hotel. There were thirty-five present.

A paper on "The June Conference at Washington on Radio-Frequency Allocations" was presented by V. Ford Greaves, inspector-in-charge of the Twelfth District of the Federal Communications Commission. He presented a picture of the manner and skill with which the conference was conducted. Careful attention was given to the papers presented by each speaker. Although no action was taken at the conference, the information presented will be useful in forming a good foundation for the allocation of the ultra-high frequencies. A list of speakers and the organizations represented were given and short abstracts from some of the papers were read and commented on. He presented also colored motion pictures taken on his 10,000-mile trip to the East coast by automobile.

TORONTO SECTION

A meeting of the Toronto Section was held jointly with the Toronto Section of the American Institute of Electrical Engineers at the University of Toronto on March 13. There were 155 present and M. J. McHenry, chairman of the American Institute of Electrical Engineers section, presided.

A paper on "Short-Wave Radio Communication" was presented by J. H. Thompson who is chief engineer of the Canadian Marconi Company. Mr. Thompson described numerous types of multiple antenna arrays of various wave lengths, spacings, and numbers of individual radiators and reflectors from which have been developed the effective directional arrays now used in long-distance high-frequency beam transmission. It was pointed out that a vertical angle of propagation of from twelve to fifteen degrees above the horizon is most satisfactory. Methods of confining a large proportion of the radiated energy to this arc were described. Skip distance, reflections, and the necessity in long-distance communication of having several transmission frequencies to permit continuous operation throughout each twenty-four-hour day were discussed. The paper was closed with a demonstration of two-meter beam transmissions using a parabolic reflector and a plane reflector.

A meeting of the Toronto Section was held on April 13 at the University of Toronto and attended by thirty. B. deF. Bayly, vice chairman, presided.

A paper on "The Psychology of Invention" was presented by H. F. Fruth, research engineer of P. R. Mallory and Company. Dr. Fruth opened his paper by expressing the opinion that the inventor was the foundation of our cultural progress. Man has risen not because of

physical endurance but more because of his capacity for invention. It was pointed out that in early times inventors were persecuted and that even today some indication of persecution of the whole principle of invention exists.

The development and progress of man power from 4000 B.C. to the present were traced. It was pointed out that a unit of man power had been set up and termed the "slave power" and that every person in the United States and Canada now has the equivalent of 177 "slave power" at his or her command.

The tremendous efforts and amount of time devoted by inventors to their inventions and overcoming prejudices were discussed. People, in general, do not appreciate the substantial handicaps facing the inventor.

Inventions are produced by the individual or free-lance inventors as one class and by the group or corporation inventor as the other. In spite of greater handicaps, the first group seems to have excelled in the number and value of inventions. In closing, the speaker advised inventors to learn to observe, have confidence, strive hard in the direction desired, try anything once, after a hard trial practice mental relaxation, and note any sort of "flash" or inspiration and record it. The paper was discussed by Messrs. Kohl, Sutherland, Waite, and others.

The annual meeting of the Toronto Section was held on May 4 at the University of Toronto. B. deF. Bayly presided and there were forty-two present.

Malcolm Ferris, president of the Ferris Instrument Corporation, presented a paper on "Extending the High-Frequency Limit for Receiver Sensitivity Measurements." It was pointed out that the coupling of the ultra-high-frequency generator to the receiver under test is one of the most important problems to be solved in the use of the instrument. He outlined the difficulties arising from employing leads of various lengths and of resonance introduced by the leads which greatly distort measurements. By matching the leads to the generator by means of a proper terminating resistor having satisfactory high-frequency characteristics, a cable three feet long may be used without affecting to an important degree the accuracy of the measurement. A general discussion followed the paper.

In the election of officers, B. deF. Bayly, assistant professor, department of electrical engineering, University of Toronto, was elected chairman. R. H. Klingelhoefter, of the International Resistance Company of Toronto, was named vice chairman, S. R. Paisley, of the Con-

tinental Carbon Company of Toronto, was designated recording secretary, and H. P. Knap, of the Stromberg Carlson telephone Manufacturing Company of Canada, was selected as secretary-treasurer.

WASHINGTON SECTION

A meeting of the Washington Section was held in the Auditorium of the Potomac Electric Power Company on September 14. There were sixty-four present.

A paper on "The Effect of Lateral Dimensions on the Output of Piezoelectric Oscillating Plates" was presented by J. G. Beard of the engineering department of the Westinghouse Electric and Manufacturing Company. In the investigation which he described, the author started with a very large quartz plate and reduced its lateral dimensions while retaining the thickness constant for the purpose of determining the proper dimensions for an oscillating plate to obtain highest power output. The presence of a most active portion of the plate was described as well as the operation of the plate at harmonics of its fundamental frequency. A series of illustrations showed graphically the results of the experiment. The discussion which followed was participated in by a number of those present.

Personal Mention

William De Mello of the General Electric Company has been transferred from Mexico to Saõ Paulo, Brazil.

P. F. Dugan, Lieutenant, U.S.N., has been transferred from Norfolk Navy Yard to the U.S.S. *Brant*, basing at San Diego, Calif.

Previously with Hygrade Sylvania Corporation, V. H. Fraenkel has become a physicist for the Electronic Tube Corporation of Philadelphia, Pa.

O. T. Francis, Captain U.S.M.C., has been transferred from Quantico, Va., to Fort Mifflin, Philadelphia, Pa.

W. C. Marlow, Jr., of the General Motors Corporation has been transferred to the Delco Radio Division at Kokomo, Ind.

D. P. Tucker, Lieutenant U.S.N., has been transferred from the U.S.S. *Pennsylvania* to the U.S.S. *Arizona*, basing at San Pedro, Calif.

C. B. Upp of the Westinghouse Electric and Manufacturing Company has been transferred from East Pittsburgh to the Westinghouse Lamp Company, engineering department, Bloomfield, N. J.

TECHNICAL PAPERS

ELECTRONIC MUSIC AND INSTRUMENTS*

By

BENJAMIN F. MIESSNER

(Miessner Inventions, Inc., Millburn, New Jersey)

Summary—*Electronic music and instruments, with an incubation period of about forty years since their early beginnings, are now rapidly growing into a final commercial stage. During 1935 retail sales of these new musical instruments exceeded two million dollars in the United States alone.*

This paper presents for the first time in this country a review of traditional musical instruments, their advantages and limitations, additional principles which must be considered in creating, and controlling sounds to make music. The various principles for generating musical tones and for varying their musical character are described. The historical development of electronic music instruments are traced, and the most important modern instruments are described in some detail.

WHEN we compare music with the other arts, and particularly with other fields of human endeavor, we find tradition enthroned instead of progress. The graphic arts have evolved photography and moving pictures, even in color, and television. The drama has availed itself of every conceivable device to intensify the arts of make-believe. Communication has made tremendously great strides, by telegraph, telephone, and radio. Transportation, likewise, has tremendously accelerated the pace of human movement, with steamships, railroads, automobiles, and airplanes. Illumination today is very far ahead of the oil lamp of the dark ages. Agriculture and industry leave no stone unturned to press improved machinery into service.

But what of music? In this age of progress in every conceivable field, music and musicians still use the traditional implements and machines of hundreds of years ago.

One musician scrapes a horsehair bow across strings of gut, and the older his instrument is, the more he prizes it. Another blows vividly through a brass tube or a wooden pipe; another hammers on the drum of the aborigines. Another, sometimes with terrific physical exertion, pounds on a keyboard to rouse his audience through the physical vibrations of struck strings and huge soundboards through an elaborate system of levers. Another with aggregations exceeding 10,000 pipes,

* Decimal classification: 621.385.97. Original manuscript received by the Institute, May 21, 1936. Presented before New York Meeting, May 6, 1936.

some as long and large as a forest log, and with hundreds of other complicated and bulky appurtenances, produces the sounds of the organ.

That most of these have reached the limit of their development is amply supported by their almost fixed design for hundreds of years. The principles upon which they are based, that is mechanicoacoustic, or pneumaticoacoustic, have been carried through these hundreds of years of development, to the end of their capabilities. In what great range of variation these principles have been applied, and for the most part discarded, can be realized by an inspection of the musical instrument departments of such museums as the Metropolitan in New York and the Deutsches in Munich. No radical or important improvements are to be expected from an extension of these old principles.

It is all the less understandable when we consider that other methods of producing musical sounds are available, electrical methods of far greater flexibility and efficiency, implements and machines of infinitely greater capabilities, of lesser complexity, weight, bulk, and cost. Surely the reason does not lie in the few remaining defects of electroacoustic translating devices, as some musicians believe. Violins can and do, even in the hands of the greatest artists, produce the same raucous sounds as overloaded amplifiers or speakers; the mechanical crack of a hammer on a string is surely no sacred part of a piano tone; the truly insuperable problem of keeping 10,000 pipes in tune through the vagaries of temperature and humidity is hardly to be treasured; the ability to vibrate one's lips and blow through a mouthpiece continuously for a whole minute is really not to be cherished as a means of expressing the esthetic art of music.

In this paper we take neither the broadest nor the narrowest definition within which to confine our discussion. To include all music, and apparatus useful in producing it, utilizing the technique of electricity generally, or only the electronic technique involved in vacuum tube apparatus, we must perforce include such arts as electrophonography with disk and films, and even radio broadcasting. We must however narrow our definition to exclude them, for we are here concerned only with music made by and with instruments for *making* music directly, rather than with those for reproducing or transmitting music already made by conventional instruments.

We cannot include instruments involving some use of electricity for then obviously we must discuss such well-known instruments as pipe organs with electromagnetic valve actions and electric blowers, and such other conventional instruments, involving mechanical vibrators, like bells, bars, drums, strings with coupled soundboards, and such as percussion apparatus of organs with electric action, carillons

with electromagnetic hammers, electric player pianos, for these are only conventional acoustic instruments electrically manipulated. We must even pass over, with but brief mention, such electromechanical instruments as the Choralcello,¹ wherein various types of vibrators, such as strings, bars, and diaphragms, tuned to definite frequencies, produce the final musical sounds, through the action of synchronized electromagnetic impulses, set up by interrupted currents, under the control of key switches. These are acoustic instruments electrically manipulated *and electrically energized*.

The Choralcello reached commercial exploitation and production, in some quantities, about twenty years ago. Its chief difficulty appears to have resided in inability to maintain accurate resonance between thousands of tuned mechanicoacoustic vibrators and their periodic, magnetic driving forces, provided by rotational current interrupters and electromagnets. As a result these instruments were very difficult to keep in tune, not because of frequency variations sufficient to impair temperament, but because of serious upsets in dynamic and timbre voicing through inexact resonance.

We cannot make our definition so narrow as to include only instruments wholly electrical in their operation, for there are many with mechanical-electrical tone generating systems.

We may therefore define an electronic music instrument as a device for creating music, wherein periodic electric currents are either selectively generated, or selectively controlled by a player, and translated into sound. Within these definitive boundaries we will attempt to confine our discussion.

We are concerned chiefly with methods for generating and controlling electric currents for use in producing musical sounds. It is not so important to the player or to the listener how these currents are generated, but of great importance are the methods provided for their control, and the nature of the sounds produced. While of no immediate concern to the listener, the control means must be satisfactory to those who create music by playing on the instruments; with a playing technique common to other instruments, such as a keyboard. But the output sounds must be satisfactory to musician and to listener alike.

There are in existence many types of musical instruments. In our large orchestras we find those which have proved most useful, and most of them have serious musical limitations. They may be limited to certain small ranges of tone frequency, or power, or timbre, or by

¹ Choralcello, U. S. Patents, 973,391; 1,137,544; 1,190,332; 1,218,324; 1,893,250; 1,899,884; 1,914,173; 1,935,215; 1,941,870; 1,958,866, and others.

their inability to sound more than one tone at a time, or their inability to change their tonal characteristics at the will of the player.

The cymbals, for example, while an important part of every large orchestra, can only emit sounds of a certain noisy character at stronger or weaker power at a constant pitch. The triangle produces a more musical sound but is otherwise just as limited as the cymbals. These, like the kettle drums, can hardly be considered as musical instruments, for one cannot truly make music on them. They are to music what exclamation points or other punctuation devices are to the written word—tremendously effective but seriously limited. The flute can make music alone, but has great limitations as to frequency, and power, and timbre. While its importance in an orchestral assemblage is undisputed, one would hardly care to listen to an entire concert played on a flute, or, worse still, a concert of flutes, as Helmholtz long ago observed!

Proceeding to the brass, wood wind, and string instruments, there is a progressive increase in musical utility. In the piano and organ, however, we find the greatest usefulness, because of their large range of pitch and power and timbre, and particularly their ability to produce many tones simultaneously. Where other instruments produce only simple melody, these can, in addition, produce very complicated harmonies. Large organs, especially, provide the maximum range and complexity of musical expression for a single performer.

The organ has a tremendous advantage over the piano in its timbre-variable performance; the piano, in which tone timbre cannot be dissociated from tone power, has, however, the ability to control the power of individual tones by the force of the fingers on individual keys. Also its tones change constantly in timbre from beginning to end. It has therefore a tremendous incisiveness and vitality due to dynamic nuances. The important point here is that the usefulness of a musical instrument resides in its *versatility*. The wider its range of performance, in pitch, in power, in timbre, and in other characteristics, the more useful does it become. The closer an individual performer can come to the effects of an orchestra the more impressive and satisfying will his performance become.

We, as scientific workers, may here well inquire as to what constitutes the musician's basis for a satisfactory musical instrument. One of our foremost musicians, Leopold Stokowski, has given us one such basis.^{2,3} He emphasized the need for providing "any desired

² Leopold Stokowski, "New horizons in music," *Jour. Acous. Soc. Amer.*, vol. 4, part 1, p. 11; July, (1932).

³ Leopold Stokowski, "New vistas in music," *Atlantic Monthly*, January, (1935).

timbres and for new timbres; for creating any frequency, any duration, any intensity, any combination of counterpoint, of harmony, of rhythm." We must, if we are completely to satisfy the musician, provide an instrument which will permit him to produce all the known and useful musical effects, and preferably also unknown but useful effects. If this requirement be too comprehensive then we must provide as many effects as possible, the limiting factors being cost, bulk, weight, and even the human limitations for controlling its performance.

In the language of electroacoustics, we must provide wide ranges of frequency, of amplitude, of harmonic composition; these are the conventional parameters of musical sounds. Here it seems necessary to define partial, harmonic, inharmonic partial, component, and overtone, as there is much confusion among musicians on the one hand and physicists on the other relative to their meaning. By partial I mean any single frequency part of a complex tone; by harmonic, any partial falling in a Fourier series of integrally related partials; by inharmonic partial, any single frequency partial which does not fall in such a Fourier series; by overtone, any partial above the fundamental in frequency; usually the first overtone is the second partial of a Fourier series, but it may, as in bell tones, be inharmonic also; by component, any part of a complex tone; it may be a harmonic or inharmonic partial of discrete frequency, or it may also be a transient or a noise comprising a band of frequencies, such as that set up by the crack of a felt hammer on a piano string, or the noise of escaping air made when a flute is blown, or the scrape of a bow on a string.

There is another important but generally unrecognized characteristic of musical sound, determined by the shape of the dynamic envelope of the tone. A tone of given amplitude, pitch, and harmonic composition may produce very different auditory effects due alone to the manner in which it starts and stops, even without transients. It will vary also with the *rate* of rise or decay.

The tones of a stretched string will vary markedly with the manner of excitation, as for example, by plucking, striking, and bowing, and this leads us to the tonal differences caused by transients, which are set up by such exciting devices. With continuous tones these may occur only at the moments of starting or stopping. With damped vibrations, produced by such generators as struck or plucked strings, the harmonic composition changes constantly during the progress of the tone from beginning to end, and its average character changes markedly with its initial amplitude. Obviously such a tone cannot be completely described by giving its fundamental pitch, its amplitude, and its harmonic composition.

We must specify the envelope of every component, harmonic or inharmonic, and include incidental noises as well.

There exists again a great deal of confusion among musicians and physicists on this point. We are accustomed to see spectral analyses of tones and sound. These may specify the exact frequencies of all harmonic components and their relative amplitudes; sometimes they include also inharmonic, definite-frequency components, and, only very seldom, also the continuous-frequency components of transients and noises. Obviously these spectral analyses can only hold good for a tone that has reached and continues in a steady state; during the starting and stopping periods practically all tones have a variable composition. A great many tones of the damped type vary constantly from beginning to end, so that it is quite impossible to describe them by a single analysis. A series of analyses, at different points along their time course, like a series of pictures of moving objects, must be used, or better still, we must provide a time-amplitude graph for each separate component of the complex sound. This is the only way of giving a comprehensive, objective description of a complex tone. A subjective description would involve also other factors determined by the limitations of the ear.

Again a tone of some constant and complex harmonic composition, will sound differently to the ear at differing fundamental pitch. If this be one thousand cycles, we may hear harmonics say up to the twentieth, but if it be 5000 cycles, we may hear them only up to the third or fourth. Variation of tone amplitude may also cause variations of harmonic composition as heard; harmonics below the audible threshold at low amplitudes may rise above it at high amplitudes. Again at high amplitudes the subjective pitch may be higher or lower than at low amplitudes.

These are some of the more important parameters of musical tones which we must consider in our electronic apparatus.

The mechanism or methods for the control of these parameters by a musician is also very important. While it may be that new methods of control might eventually prove to be better than the traditional methods, it is likely that faster progress will be made in electronic music with instruments utilizing playing techniques already mastered by most musicians.

In the keyboard instruments we find the easiest and, while not the most complete, perhaps the best control. Individual tones can be started and also stopped at will. The desired pitches are all predetermined and set; the timbres are also predetermined; off-pitch playing is not possible, unless the wrong key is struck, nor are unmusical single tone qualities possible. In these instruments, and particularly in the

large organs, the physical limitations of the player are fully or almost fully reached. Both hands and both feet are worked to their utmost for manipulation of the various controls; such instruments can produce tremendously intricate patterns involving very complicated melodies, harmonies, rhythms, timbres, and other characteristics of music.

ELECTRIC TONE GENERATING METHODS

The generation of tone representing currents for electronic music may be accomplished by a great variety of methods and apparatus. Any device for producing modulated or interrupted direct current, or any device for producing alternating currents may be more or less useful. These may be produced by rotary, vibratory, or other types of mechanically moving devices, by purely electrical devices, or by acoustic devices. In fact any device for producing any type of audio-frequency periodic motion may be so utilized if appropriate means are provided for translating the motion into periodic voltages or currents.

The writer has prepared a rather extended list of tone generator types and useful principles. These have been classified into five groups as follows: 1. Pure electrical; 2. rotary scanning devices; 3. vibratory mechanicoelectric; 4. acoustic electric; and 5. hybrid combinations of 1, 2, 3, and 4. These four classified groups are shown in Tables I, II, III, and IV. These groups are quite comprehensive but make no pretense of completeness.

TIMBRE CONTROL METHODS

In addition to means for generating currents for use in electronic instruments, we must provide methods and apparatus for their satisfactory control, not only for switching them on and off of amplifying and reproducing apparatus, but, more particularly, for timbre or tone quality control.

TABLE I

PURE ELECTRICAL

- (a) Oscillating arcs or any device with negative resistance characteristics such as dynatrons, crystal contacts, etc.
- (b) Relaxation oscillators
- (c) Vacuum tube with feedback
- (d) Thyatron oscillator
- (e) Condenser-inductance discharge
- (f) Magnetostriction oscillators
- (g) Radio-frequency beat systems
- (h) Electrolytic

TABLE II

ROTARY (SCANNING DEVICES)

- A Variable area, distance, impedance, or intensity
- (a) Magnetolectric: generators, modulators, etc.
- (b) Electrostatic: generators, modulators, etc.
- (c) Photoelectric
- (d) Acoustic siren
- (e) Phonographic: mechanicoacoustic electric, mechanicomagnetoelectric, mechanicoelectrostatic photoelectric, magnetoelectric, mechanicopiezoelectric, etc.
- (f) Impedance contact interrupters and modulators

TABLE III

VIBRATORY MECHANICOELECTRIC		
(a) Self-interrupter		
(b) Telephone howler (acoustic or mechanical feedback)		
(c) Microphone hummer (electromagnetic feedback)		
(d) Vibrators with any type of pickup and any type of feedback		
(e) Any type of vibrator with any type of excitation and with any type of pickup with electrical output such as:		
	GENERAL CHART ON VIBRATORY GENERATORS	
<i>Vibrator</i>	<i>Excitation Methods</i>	<i>Pickup Methods</i>
(1) Strings	(1) Striking	(1) Magnetic
(2) Reeds	(2) Plucking	(2) Electrostatic
(3) Rods:	(3) Bowing	(3) Electrodynamic
(a) Transverse	(4) Blowing	(4) Interrupted contact
(b) Longitudinal	(5) Resonance	(5) Modulated resistance
(c) Torsional	(6) Attraction	(a) By pressure
(4) Forks	(7) Repulsion	(b) By temperature
(5) Bells		(c) By area
(6) Tubes		(d) By length
(7) Clock chimes		(e) By materials in ion streams
(8) Membranes		(6) Piezoelectric (vibrator and translator may be combined as one device)
(9) Sounding boards		(7) Photoelectric
		(8) Magnetostrictive
		(9) Microphonic (air waves or mechanical)
		(10) Thermoelectric
		(11) Magneto-electronic
		(12) Magnetoresistive (Hall effect)
		(13) Magneto-optic
		(14) Magneto-galvanic
		(15) Electro-optic

TABLE IV

ANY TYPE OF ACOUSTIC VIBRATOR AND ANY TYPE OF ACOUSTIC ELECTRIC (MICROPHONIC) DEVICE
(a) Pipes or horns
(b) Reed pipes
(c) Sounding boards variously driven
(d) Membranes
(e) Bells, bars, strings, tubes, reeds, forks, chimes, and other sounding bodies

For control of harmonic composition of the output sounds there are available in general several distinct methods. These are listed in Table V.

TABLE V

TIMBRE CONTROL METHODS
(1) <i>Synthesis</i> ; adding together pure or relatively pure desired partials
(2) <i>Separation</i> ; subtracting undesired partials from a source very rich in partials
(3) <i>Multiple quality generation</i> ; using a separate complex-wave generator for each desired timbre, and mixtures of these.
(4) <i>Formants</i>
(5) <i>Frequency-amplification control</i>
(6) <i>Envelope control</i>

Let us examine these various methods.

(1) *The Synthesis Method*

In the synthesis method we generate separately the various current frequencies required for fundamentals and overtones (ordinarily harmonic) of all the tones of the musical scale in whatever range is desired, both as to fundamental pitch and number of partials for each separate pitch. Over each of these partial tone currents we provide amplitude control, so that we may introduce any partial generated, in

any desired amplitude, into the output tone; if inharmonic, definite-frequency partials or bands of continuous-frequency noises are desired, these may also be generated and controlled in amplitude. The controls preferably should be so unified that one device mechanically, somewhat as in unicontrol radio receivers, controls particular numbered partials for the whole range of fundamental pitches on a given keyboard or other playing pitch control arrangement. This is necessary to preserve constant timbre throughout a given fundamental pitch range. If several different keyboards are used, separate sets of partial controls for each keyboard are necessary in order that they may play with different output tone qualities.

(2) *The Separation Method*

This is the reverse of the synthesis method, since with it, we generate, for each desired fundamental frequency, a complex wave having in it all the partials that may be desired. Then, by a process of subtraction, we take out of this complex wave all of those partials not desired in the output tone, and leave those which are desired in the correct amplitudes.

For example, with a beat system, we may generate by radio-frequency vacuum tube oscillators (one for each desired fundamental output pitch) complex oscillations of different fundamental frequencies; the outputs of these oscillators are controlled by keyboard switches (one for each oscillator) and thereafter combined in a beat circuit, with the output of a fixed, complex-wave oscillator operating at a neighboring fundamental radio frequency. This oscillator is provided with a separate amplitude control, such as a tuned band-pass filter, for each of its partials. The carrier and summation frequencies are filtered out, and the difference frequencies, after rectification, are preserved for reproduction. The essential feature here is that but one control device for each partial of the fixed frequency oscillator determines the amplitude of each corresponding partial of the audio-frequency output current throughout its whole fundamental pitch range.

a. *Audio-Frequency Filters*

Very frequently it is suggested that audio-frequency filters be used for timbre control, but this is extremely impracticable and complicated. Suppose, for example, we have an instrument, like the piano, of 88 separate pitches, and suppose we wish to provide control only up to the tenth partials of those pitches. Theoretically we must then provide ten times 88 or 880 filters, starting at about twenty-seven cycles. If we provide no filters above say 15,000 cycles, we will still require

several hundred of them. Furthermore, all filters for like-numbered partials of all 88 fundamental frequencies must be ganged mechanically together to provide a workable control, and thus ten gangs of filters would be required, one for each of the ten partials. Realizing the amount of material required for such a scheme, we can readily understand its impracticability. The radio-frequency beat system, however, is practical because it involves only one radio-frequency filter for each controlled partial, and with ten partials only ten filters in all are required. However there are serious problems involved in providing 88 sources of stable radio-frequency oscillations without undue cost and complexity.

(3) *Multiple Quality Generation*

In this system a separate series of generators of fixed complex-wave forms is provided for each desired timbre. Thus, if we have say 88 distinct pitches, we provide one generator for each pitch, and all in this series have the same harmonic composition. If we wish ten different harmonic compositions we must provide ten such sets of generators, or a total of 880 generators. This is the plan utilized in pipe organs where the individual generators consist of wind-blown organ pipes of differing output tone quality. Obviously mixtures of two or more of the generator outputs may be used, either at the same fundamental frequencies or of harmonically related fundamental frequencies, to extend greatly the timbre range.

In the pipe organ no attempt is made to control the amplitude of individual generator outputs so combined, as this involves great difficulties, especially in voicing; it is necessary therefore to use large numbers of pipes, sometimes aggregating 50,000 to provide a very large range of timbres. With electrical generators such control is simple, and the ability to regulate the contributions of the various definite timbre generators to a mixture is very important as a means of greatly extending the timbre range with relatively few generators.

If the various complex-wave generators of the same fundamental frequency, or of exactly harmonically related frequencies, are so rigidly coupled together as to provide continuously fixed phase relationships between their like frequency partials, it is possible to extend further the timbre variation by phase reversal control, in addition to amplitude control, of their outputs. By this means the components of one generator may be made to add to, or *subtract* from, like frequency components of another or others and, by amplitude control, in desired degrees. For example, one generator with strong lower and weak higher partials may be combined with another of reverse type. With extreme

aiding phase adjustment a new harmonic composition, with strong low and also strong high components, is produced; with extreme opposing phase adjustment another new harmonic composition results, perhaps with no higher partials at all. With intermediate amplitude adjustments many other harmonic compositions result.

(4) *Formants*

An interesting type of timbre control has been developed in Germany, based on the theory of Hermann relating to the timbre of vocal sounds. According to Hermann⁴ the vocal timbres are formed in the throat, mouth, and nasal cavities, by steep wave-front transients caused by the opening and shutting of the vocal cords at the frequency of the fundamental vocal pitch. These explosivelike interruptions of the air stream from the lungs shock the several coupled acoustic resonators of the vocal system into damped oscillations, which may be inharmonic to the frequency of the vocal cords. Hermann introduced the term "formants" to designate these effects.

Obviously the timbre of the vocal sounds, as in vowels, changes with the shape and volume of these coupled, impulse excited, and rapidly damped resonators, as controlled by the tongue, the soft palate, the mouth, and so forth. Similarly, any externally coupled air cavity, such as cupped hands held before the mouth, or a coupled tubular or conical air column such as a megaphone, very materially alter the vocal timbre. The timbre modifying effects of diaphragms, horns, and other coupled, strong damped vibrators, particularly when of high frequency, on the performance of loud speakers is well known, and these effects are many times due to formants. If these coupled vibrators are not strongly damped, they have, in addition, another effect, caused by resonance with, or forced vibration by, some component of the driving force.

The formants always decline in amplitude during a fundamental oscillation period, and may even stop before the end of this period due to their rapid damping, or they are extinguished with the start of the next cycle. They usually comprise a band of frequencies, high compared to the fundamental, but this band does not move up and down with the fundamental frequency. If the fundamental frequency rises above the lower frequency border of the formant frequency band, the lowest of the formant frequencies disappears, since the damped resonator which supplied it is no longer excited by the fundamental.

The principles of formants are not actually inconsistent with con-

⁴ Literaturnachweis vgl. Geiger-Scheel, *Handbuch der Physik* (1927), Bd 8, Akustik, pp. 452 and 454. Published by Julius Springer, Berlin.

ventional theory. The changes they introduce are always within the fundamental frequency cycle, and they recur regularly with every such cycle. Therefore they constitute true Fourier components, the harmonics introduced by them always having integral frequency relationships with the fundamental.

With particular types of electrical tone generators,⁵ such as relaxation oscillators, and with amplifying circuits, provided with oscillatory portions of regulable frequencies and rates of damping, formants may be introduced and controlled so that they provide a very simple and important means of governing tone quality. They are most useful with instruments having a restricted pitch range, of the order of two or three octaves, where the formant frequency range is not too far removed in frequency from the fundamental pitch. The use of formants in instruments of wide pitch range such as pianos and organs, or in instruments designed for chordal performance is of questionable value.

(5) *Frequency-Amplification Control*

Another important timbre control method is one, based, not on particular partials, but on absolute frequencies, like tone controls of radio receivers. Such a control, while affecting the voicing, or sound power output between low and high frequencies in instruments of wide frequency range, is nevertheless a very useful one for timbre variation applicable very simply in the electroacoustic translating system.

(6) *Envelope Control*

We have previously discussed in some detail the effect of varying the shape of the envelope of a tone.^{6,7} While this type of control is not truly a timbre control, as that has to do with variations of the wave form of recurring fundamental frequency cycles, and as envelope control has to do with the envelope shape of a train of such waves, nevertheless we include it since broadly it does affect the character of the tone. Further, the writer has pointed out the desirability of means and controls therefor, which would enable us to give the desired envelope shape to each and every partial of a complex tone, whether definite frequency harmonics or definite frequency inharmonics, or continuous bands of noises. Only by such envelope control, added to generators

⁵ Friederich Trautwein, "Electrische Musik," Veröffentlichungen der Rundfunkversuchsstelle der Hochschule für Musik, Bd. 1, (1930). Weidmannsche Buchhandlung, Berlin.

⁶ B. F. Miessner, "Application of electronics to the piano," *Proc. Radio Club Amer.*, vol. 11, January, (1934).

⁷ B. F. Miessner, "Design considerations for a simple and versatile electronic music instrument," *Jour. Acous. Soc. Amer.*, vol. 6, p. 181; January, (1935)

for producing all desired components, can we ever produce every known or conceivable sound.

THE CHOIR EFFECT

In addition to the previously discussed arrangements for control of tone timbre or, more broadly, of tone character, there is another type of control important especially to those desiring duplication of pipe organ performance. This is the so-called "choir" effect; i.e., the sound effects of several independent sources tuned, as well as possible, to the same frequency, and having the same or different qualities. It is never obtainable where absolutely fixed phase relationships are found. In the pipe organ, when mixture stops are used, a new, single tone quality does not result, but rather a mixture of qualities definitely discernible, is the result. This is due to the fact that the tuning can never be so perfect that fixed phase relationships exist between all like numbered partials, and these random and continuously changing phase relationships, with resulting irregular beats, serve to keep each of the individual systems of partials, having fixed phase relationships among them, separate and apart from other systems (of the other tones in the mixture) and identifiable by the ear as individual systems. The result is that the ear hears several separate tones of different quality mixed together; i.e., sounding at the same time, as, for example, a violin, an oboe, and a trumpet, all sounding the same fundamental frequency. If, however, all the frequencies involved in these three sounds were produced by one generator, they would sound like one new sound instead of the three sounds mixed together.

Another example is as follows: If ten violins sound one note together, as in an orchestra, the ear hears something quite different from one violin amplified to the same loudness, or say from ten synthetic violin tone generators all producing exactly the same pitch, and with some fixed phase relationship between them. In the first case the combination tone (of all ten) is continuously varying, due to inexact or changing partial frequencies; in the latter the tone spectrum would be monotonously constant, having none of those rapid variations. I think the effect of several instruments in choir or chorus could never be produced by mechanical sources such as generators running at constant speed, certainly not with generators rigidly coupled together to prevent any possible phase shift.

With separate generators, or with generators (like rotors) having considerable inertia and running at constant, though slightly different speeds, so as to produce slight differences in like partial frequencies in the several tones, no true choir effect could be produced either, as the

beats between like partials, slightly different in frequency, would be of steady fixed periodicity, and the tone would still sound mechanical and monotonous.

Another important point here is that in the organ, orchestra, and other groups of tone sources, the tuning of these separate sources to the tempered scale frequencies is never exact, and the variations from exact tuning are random. The result of this is that, in changing from one pitch to another, the beats between the generators have different frequencies for every pitch.

With pipe organs, orchestras, etc., the separate sounds proceed to the listener from different sources in different positions in space, so that their sounds traverse different distances, and produce different interference patterns in places where reflections can occur.

Therefore if several like generators of fixed phase relationship or with some constant and small difference in fundamental frequency be sounded through separate loud-speakers spacially separated from one another, this might aid in producing the illusion of several wholly independent instruments of different timbre sounding together.

Much of this discussion on the choir effect is speculative and without conclusive experimental evidence. It is included as an important subject wanting a good deal more illumination by facts.

HISTORICAL DEVELOPMENT OF ELECTRONIC INSTRUMENTS

While it would be desirable to present a complete review of all the various developments in this art, as shown in its literature, this is utterly impossible in view of its already great extent.

My collection of published literature on this subject numbers thousands of items. There are in it, for example, over 350 United States Patents relating specifically to, or bordering on, electronic musical instruments; also foreign patents numbering about 200; published applications for foreign patents numbering several hundreds more; there are about 150 technical and semitechnical papers and descriptive articles, while popular articles, advertisements, etc., number in the thousands. There are also three books; a very comprehensive and technical one of 200 pages in German, "Electrische Musik," by P. Lertes, published in 1933, which includes a bibliography of 376 items, and two others, published in 1930, and of lesser scope, "Electrische Musik," by Dr.-Eng. Friederich Trautwein, and "Das Trautonium" by Joachim Winckelmann.

To digest and present a review of this great mass of information is completely beyond the scope and space allowable for this paper. A selected bibliography, is appended to this paper, for the use of those who may be especially interested in it.

The growth of the art as represented by patents, technical literature, popular articles, and commercial projects is presented in Fig. 1.

I shall attempt to make a selection of significant developments and instruments to act as guideposts for those seeking the course of progress of this art, and to point out what seem to be its most representative examples. Obviously a great many equally important developments cannot be here included. Of those treated here, only the important features can be described.

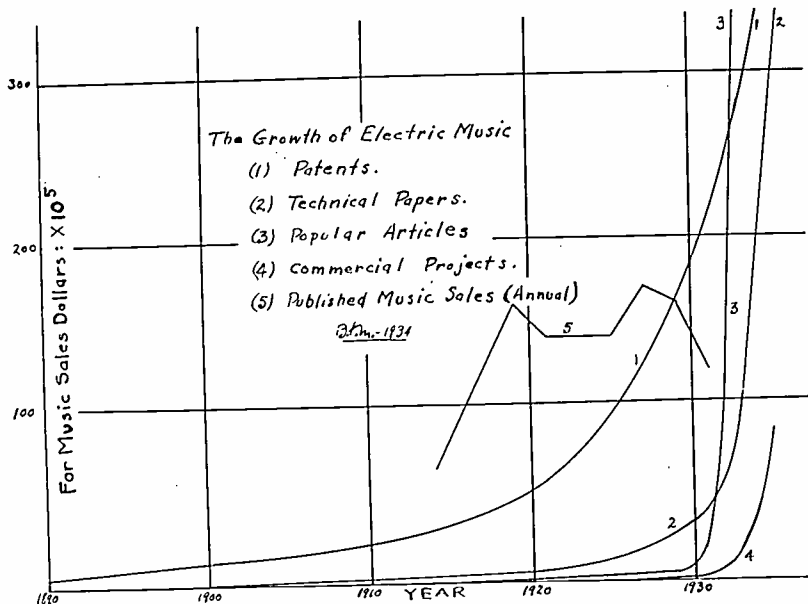

Fig. 1

In tracing this history, I find at the outset, that instruments have developed chiefly along three lines, namely rotating electric, pure electric, and mechanicoelectric.

ROTATING ELECTRIC INSTRUMENTS

Probably the earliest and most important of all the early schemes for making music electrically were those proposed and used by the American, Thaddeus Cahill, in his Telharmonium.⁸ His five voluminous patents⁹ comprise 322 pages altogether.

In Cahill's patents lie the broad foundation stones of all the rotating generator, synthetic timbre control instruments. He had a truly amazing and profound knowledge of the principles of this art that he was founding over thirty-five years ago. Nearly all that is funda-

⁸ "New Music for an Old World," *McClures Magazine*, July, (1906).

⁹ Thaddeus Cahill, Patents 580,035; 1,107,261, 1,213,803; 1,213,804; and 1,295,691.

mentally important today in instruments of this type, Cahill understood and utilized.

His Telharmonium consisted of a series of alternators of relatively pure wave form, and with definite frequencies of the musical scale. Timbre mixing switches permitted combining, for any one complex tone, harmonic components obtained from his generator sources. Keyboard master switches connected and disconnected the alternators so combined to and from telephone reproducers. His generators were of goodly power, as he proposed to distribute the music by wire to sub-

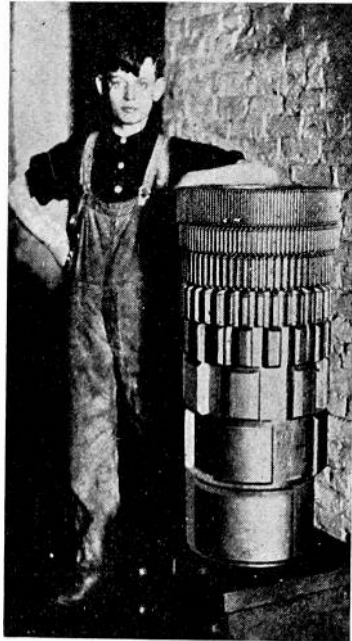

Fig. 2—Cahill magnetolectric tone generator unit comprising fundamental and seven overtones.

scribers. He lacked the amplifiers we now may use with alternators of minute size and power, and this is the chief difference between his apparatus and present-day instruments employing rotating magneto-electric generators. In his patents he shows, by hundreds of drawings, the various details of his inventions, such as interrupters and generators, with belt and gear-driving arrangements, frequency-stabilizing devices, timbre mixing systems, volume control, etc. His apparatus was actually built in Holyoke, Massachusetts, and transported to New York City where it was set up and operated. It comprised over thirty carloads of equipment. Cahill showed arrangements for producing all exactly harmonic components of complex tones up to the sixteenth, using separate alternators for each, and with the amplitude of each

regulable by timbre mixing stop switches. He showed also simplified arrangements whereby these partials could be obtained from fewer generators. Additionally he showed still simpler means for obtaining

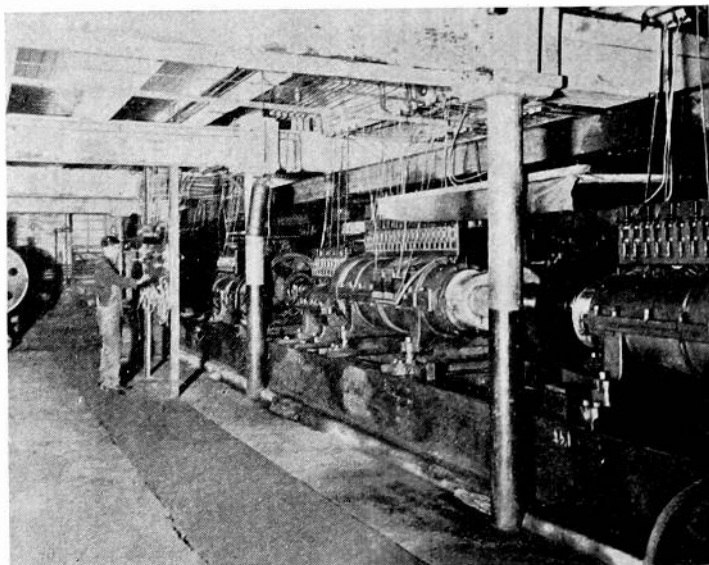

Fig. 3—Section of a generator room of the Telharmonium.

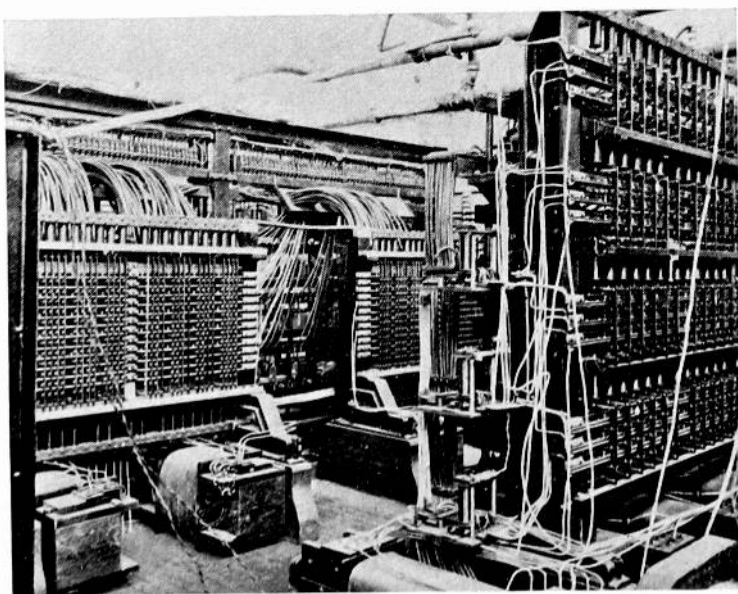

Fig. 4—Telharmonium. Close-up view of wiring.

his partials, with some sacrifices in exact harmony between them, by taking all of them from one series of alternators driven by one motor, with frequencies closely approximating those of the tempered scale. In

his patent No. 1,213,804, he says of this arrangement: "The approximate third, sixth, and twelfth harmonics, although varying by only a little more than one tenth of one per cent from true third, sixth, and twelfth harmonics I find to be much inferior to the corresponding true harmonics—so much inferior, that they ought not, in general, to be substituted for them." He had full appreciation of such difficulties as resonance in reproducing devices, which he overcame by proper voicing of the individual generator outputs. He even shows and explains means for securing a touch-responsive expression control, and for varying the output tone amplitudes of individual tones by variable pressure on individual keys of his playing keyboard. He points out the disadvantages of rectangular tone envelopes which this arrangement avoids.

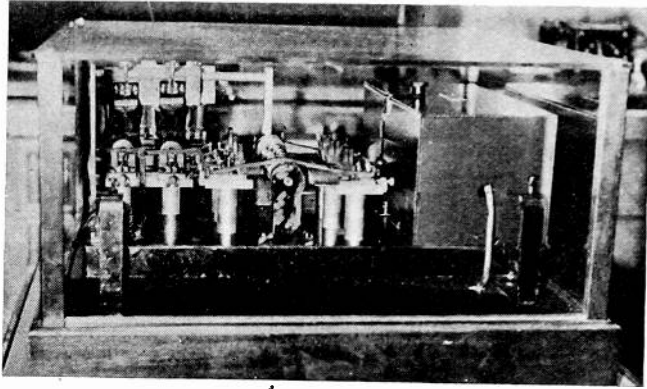

Fig. 5—Ranger organ.

In Figs. 2, 3, and 4, are presented some views of his apparatus. This electric music distribution system failed commercially because it was found to interfere seriously with telephone service due to induction.

THE RANGER ELECTRONIC ORGAN

In June, 1931, Captain Richard H. Ranger made the first public demonstration of his pipeless organ¹⁰ at Newark, New Jersey.

Ranger's apparatus consisted essentially of twelve separate sets of motor-driven alternators precisely maintained at given rotational speeds, by tuning-fork control apparatus. One of these sets of alternators, as shown in Fig. 5, generated all the required C's; another all the C sharps; another the D's, and so forth. From these alternators he obtained all the desired fundamentals and their true harmonic frequencies for the tempered scale. Timbre control switches selected the partials and their amplitudes for any desired tone quality. Amplifiers were, of

¹⁰ Richard H. Ranger, Patents 1,901,985; 1,901,986; 1,947,020; 1,991,522; 2,018,924; and 2,035,836.

course, used with reproducers to translate the feeble audio currents into sound.

Ranger's improvements over the basic work of Cahill were made possible by the advent of the vacuum tube. For example, he provides means for automatic selection of different amplifiers, for different simultaneously produced tones, to prevent cross modulation in a single amplifier; means for avoiding keying transients, for accentuating high or low frequencies, for restricting tremolo to specific components of a complex tone, and at different tremolo rates, means to provide glis-

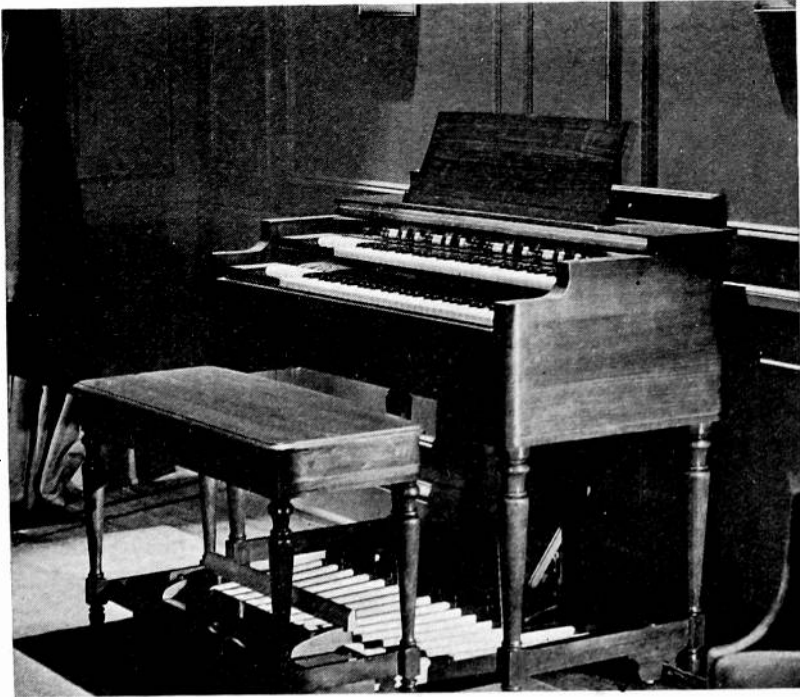

Underwood & Underwood

Fig. 6—Hammond organ, complete except for power amplifier reproducer cabinet.

sando effects, for regulating the temperament, for providing damped wave trains in simulation of percussive tones, and numerous other details.

THE HAMMOND ORGAN

Again following the basic principle of the Telharmonium, Laurens Hammond has developed an electronic organ. In Figs. 6 and 7 are shown some of the details of this instrument.

In this instrument¹¹ a synchronous motor drives a series of 91 tone generators of diminutive size through gears and pinions. These genera-

¹¹ Laurens Hammond, Patent 1,956,350.

tors have frequencies exactly at or near those of the tempered scale. The amount of agreement and departure from this tempered scale of frequencies found in the Hammond organ have been listed in his

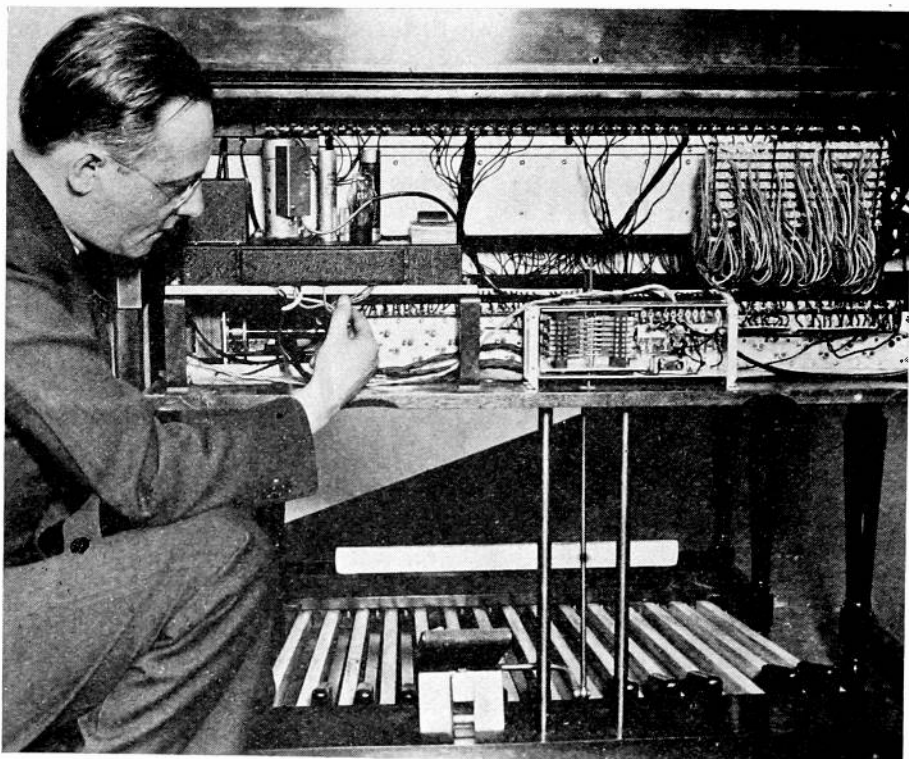

Underwood & Underwood

Fig. 7—Hammond organ. Internal view with back of console removed.

patent No. 1,956,350. For the sake of simplification the partials for complex tones are all obtained from this series of alternators. There is some sacrifice in the precision or exactness of harmony between some

TABLE VI
TABLE FOR ONE SYNTHESIZED, COMPLEX TONE E_4 OF HAMMOND ORGAN, SHOWING DEPARTURES FROM INTEGRALLY RELATED FREQUENCIES OF ITS PARTIAL TONES

Partial No.	Correct Fourier Frequency	Actual Frequency	Difference in Cycles	Per Cent Off
1	659.200	659.200	0.000	0.00
2	1318.400	1318.400	0.000	0.00
3	1977.600	1974.856	-2.744	0.14
4	2636.800	2636.800	0.000	0.00
5	3296.000	3321.080	+25.080	0.76
6	3955.200	3949.713	-5.487	0.14
7 not used	4614.400	4699.177	+84.777	1.84
8	5273.600	5273.600	0.000	0.00

of the partials due to this simplification, but this is hardly noticeable. In Table VI there are shown a series of eight partials based on a fundamental of 659.2 cycles per second; that is, E_4 in the musical scale, taken

from the table in the above-mentioned patent. It is seen that the first, second, fourth, and eighth partials are exactly in tune with each other, as they are all exactly integral multiples of the fundamental. However the third, fifth, and sixth partials are somewhat out of tune. The instrument provides no means for introducing any seventh partials. All the individual alternators except the twelve highest ones, give sine wave outputs as nearly as possible. Condensers are used in parallel to suppress their low amplitude harmonics. The twelve highest frequency alternators produce rather complex wave forms so that considerably higher frequencies than those indicated in the table are produced, when these are in the circuit.

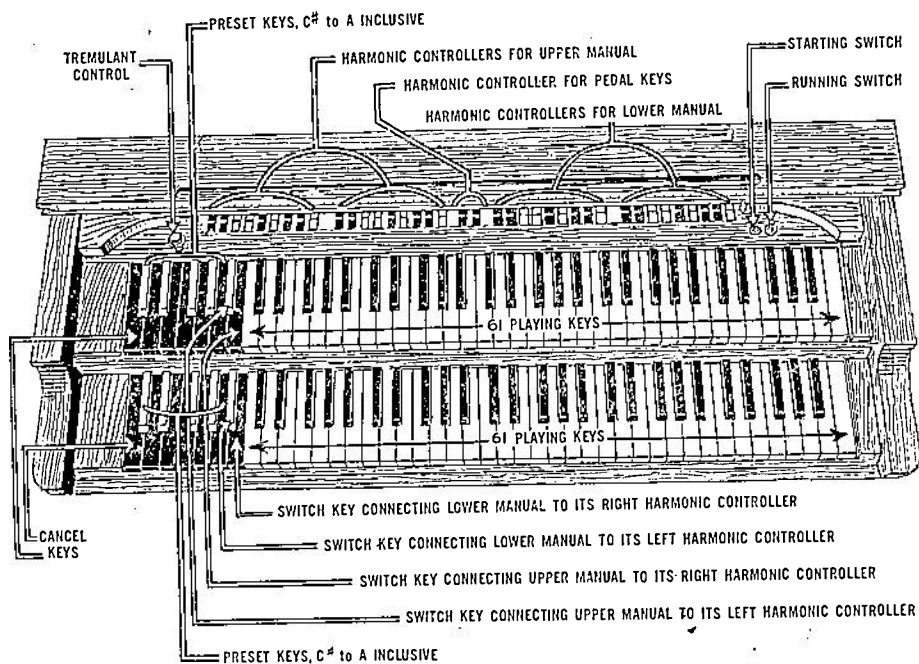

Fig. 8—Plan view of the Hammond organ console.

The harmonic controls for each manual provide amplitude regulation for a series including the first, second, third, fourth, fifth, sixth, and eighth partials. In addition to these, subfundamental and sub-third harmonic controls are provided, making nine components altogether, which can be mixed together in any desired amplitude ratios, as shown in Fig. 8.

Nine preselected timbre keys or "stops" are provided for each manual, or eighteen in all. In addition, five groups of harmonic controls are provided, two for each manual and one for the pedal keyboard. Each manual group has nine drawbars (Fig. 9), while the pedal has four, controlling the voltage of each partial tone of any mixture,

and each drawbar has nine different positions in logarithmic amplitude steps. The partials controlled by the manual drawbars are, subfundamental, subthird, harmonic, fundamental, second harmonic, third, fourth, fifth, sixth, and eighth harmonics.

There are thus twenty-three timbre mixtures instantly available, eighteen of which are set by internal adjustments, and five of which may be changed at will. The eighteen internally adjusted mixtures may also be altered, if desired, by changing internal connections.

The keyboard keys operate nine-pole switches, one for each component selected by the timbre mixing system. These switches produce output tone envelopes of rectangular shape. Since the tone thus starts instantly, this provides for a very rapid and responsive action. How-

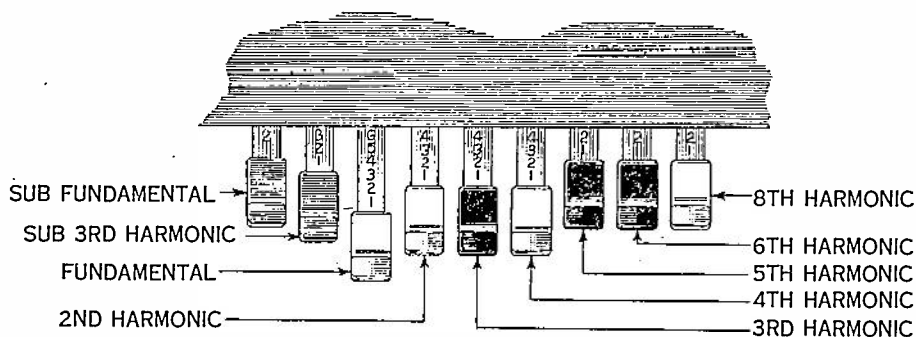

Fig. 9—Arrangement of harmonic controls for the Hammond organ.

ever, since organ pipe tones do not come up to amplitude instantly, there is a disadvantage in this rectangular envelope, where closely simulated pipe organ effects are desired. This rectangular wave shape objection is not noticeable where a reverberant room is used, especially if the auditor be at some distance from the reproducer, due to the time required for the building up and decay of sound in the room. In a reverberant room this may compensate for the abruptness of starting and stopping of the tone at the source. But, if the room is strongly absorptive, the rectangular envelope may give a disagreeable character to the tone.

The instrument is also provided with swell-pedal volume control, and an adjustable tremulant device usable at will. The regular amplifier is rated at thirty watts, with 0.5 per cent harmonic distortion, and feeds two Jensen reproducers. For increased tone power, additional standard power amplifiers with reproducers are added in parallel.

In spite of the theoretical objections discussed, the Hammond organ is of very fine design and construction in every respect, and it is a truly

remarkable commercial instrument of moderate cost and widely accepted musical capabilities.

PHOTOELECTRIC ROTATING GENERATORS

Photoelectric organs, depending in general on an optical counterpart of the acoustic siren, developed in 1799, have been known since 1888, when Mercadier used a rotating light interrupter and light sensitive cell as a source of alternating current for multiplex telegraphy.¹² Since 1916 H. J. van der Bijl,¹³ Hugoniot,¹⁴ Potter,¹⁵ Toulon,¹⁶ Spielmann,¹⁷ Goldthwaite and Hardy,¹⁸ Lesti,¹⁹ and Eremeeff,²⁰ among others, have produced instruments of the photoelectric type. As early as 1922 the writer designed photoelectric scanning systems and generators for pure and complex waves, actual or synthetic, involving variable intensity, variable area, and line wave records, and disclosed in 1926 in a patent application, a musical instrument involving these principles.

In the Hardy-Goldthwaite organ, photographic disks bearing variable area or variable density waves translated from recorded waves of original instrumental sound, rotate between a light, an optical slit, and a photocell, thus producing output currents of various definite timbres. Interesting here, in obtaining the tempered scale frequencies on a single disk, is the manner of avoiding rotational-frequency clicks due to sudden phase shifts at the joining point between beginning and end of a given circular tone wave track, (possibly 360 degrees). However only half of the total phase shift, or 180 degrees, need be so adjusted for since the adjustment may be either a shortening or a lengthening of the cyclic period. Instead of allowing all of this shift to occur at one point, it is divided between, say, ten points equispaced around the circular track, so that only one tenth of the total required shift occurs suddenly at any one point.

On each tone wave disk are recorded photographically the frequencies of the tempered scale for a pitch range of 71 notes, all for a given tone quality. Separate disks are used for each separate tone quality; also, of course, mixtures of two or more of these tones can be

¹² E. J. P. Mercadier, British Patent 10,363, filed July 17, 1888.

¹³ H. J. van der Bijl, Patent 1,369,764.

¹⁴ E. Hugoniot, French Patent 550,370.

¹⁵ R. H. Potter, Patent 1,678,872.

¹⁶ P. Toulon, French Patent 659,864.

¹⁷ E. Spielman, Austrian Patent 109,233.

¹⁸ Goldthwaite-Hardy, Patents 1,967,238 and 1,967,239.

¹⁹ A. Lesti, Patent 2,014,741.

²⁰ I. Eremeeff, Patents 1,924,713; 1,948,169; 1,990,023; 1,990,024; 2,030,248; 2,031,764; and 2,033,232.

used. The keyboard keys operate shutters, either by direct lever action or through a torque amplifier.

Mercadier, Goldthwaite-Hardy, Eremeeff, and others have also utilized sine wave records for synthesizing desired timbres according to the principle of Cahill.

Another interesting arrangement is that used by Lesti and Sammis in the Polytone. Here, instead of using a series of similar wave-form cycles on a continuous track, with a single scanning device, only one complete such cycle is used with periodic scanning by a series of similar scanning slits, equispaced on a continuous track. The slit spacing is precisely equal to the wave-form lengths, so that this wave form is repeated at the scanning frequency; i.e., the number of slits passing it per second. The same method was disclosed as early as 1921 by the French inventor Hugoniot, who described an electrical musical instrument of this type in his patent.

With this scheme the various types of wave forms for different timbres may be placed in radial sectors on a disk; another disk carrying the scanning slits in circular tracks rotates before this wave-form disk. A source of light and photocell complete the translating arrangements. Each slit track scans its corresponding wave cycle at a speed corresponding to one pitch of an approximate tempered scale. Thus, one wave and one slit track serve for each tone frequency of the tempered scale. Naturally the lowest pitch tracks are nearest the center and the highest are nearest the circumference of the scanning disk.

The wave-form cycles of different timbres are placed in different sectors on the wave-form disk. Any one of these timbres may be reproduced by rotating the wave-form disk to the fixed operating position between lights and photocell. A radial row of lights or shutters under keyboard control, one for each scanning track, enables one to reproduce a given wave form or timbre at any one of the scanning frequencies of its musical scale. If several rows of lights are used it is possible to reproduce several recorded wave timbres simultaneously as mixtures, or by different keyboards.

One difficulty with photoelectric generators is noted. When, as in most cases, numerous electric lamps are used, and operated from an alternating-current outlet, there is a very real problem in getting a steady light without modulations twice the exciting frequency or 120 cycles. Batteries are objectionable, and a rectifier-filter outfit providing sufficient steady current for dozens of lamps becomes cumbersome and expensive. The light itself must have no modulations, as these produce fixed tones, mixed with the recorded tones. Also the required high intensity lamps frequently burn out.

It is of interest here to note that, with these rotational generators, only frequencies at integral multiples of the rotational speed can be produced unless there is some special provision like, in effect, that of Hardy and Goldthwaite.

The tempered musical scale of frequencies progresses from one note to the next by a ratio of the twelfth root of two. Obviously a series of rotational generators driven by one motor cannot produce such frequency ratios. These ratios can be more and more closely approximated as the rotational speed is reduced, and as the number of cycles per revolution is increased. But, for the exact tempered scale of frequencies desired by musicians, particularly when playing with other instruments, some means, in addition, is necessary. Hardy's method is one solution; Eremeeff has shown another method, utilizing, instead of a rotary scanning device, a very long film strip scanner capable, like a motion picture film, of running an hour or so.

Cahill and Ranger avoid this difficulty by using twelve separately driven groups of generators, one for each of the pitches of the tempered scale of one octave; since all the other desired frequencies are merely integral multiples, that is, octaves, of these frequencies, their tempered scales are complete and exact. Hammond, however, has all his generators geared together and driven by one motor. This simplifies matters greatly but leaves the disadvantages of a scale of frequencies not strictly in accord with that used universally in other musical instruments.

ROTATING VARIABLE CAPACITY INSTRUMENTS

A number of inventors have suggested the use of rotating condenser types of generators for use in electrical organs, but, so far as is known to me, these schemes have not been developed very far; however they hold considerable promise.

PURE ELECTRONIC INSTRUMENTS

Probably the first to produce musical tones by pure electrical means was Duddell who, in 1899, utilized a direct-current arc, shunted by an inductance and condenser.^{21,22} Since that time numerous arrangements have been proposed for pure electrical musical instruments. These, like Duddell's arc, are based on generator devices with negative resistance characteristics, such as gaseous-conduction tubes of various types; or they use vacuum tube oscillators of audio- or beating radio-frequency types. Several use a damped oscillation produced merely

²¹ "Rapid variations of the current through the direct current arc," *Jour. I.E.E.* (London), vol. 30, (1900).

²² W. Duddell, British Patent 21,629.

by the discharge of a condenser through an inductance, such as those of F. E. Miller²³ and Bethenod.²⁴ DeForest²⁵ in 1915, suggested feed-back audions adjusted for the frequencies of the musical scale.

Jorg Mager²⁶ has made a great many contributions since 1918 and he has built a number of instruments with audio-frequency vacuum tube oscillators. Mager, in one of his arrangements, uses only one generator for each keyboard so that only one frequency at a time can be thus produced per keyboard. But with several parallel keyboards arranged staircase fashion and close together, he produces harmony, by using one key on each. This can be done with the fingers of one hand alone or with both. The keyboard keys switch in differing capacities for frequency changes. In other instruments he used radio-frequency oscillators in a beat system for audio-frequency tone generation.

Coupleaux and Givelet, since about 1918 have made numerous instruments.²⁷ Their most important type, like deForest's plan, utilizes one audio-frequency oscillator tube for each note of the musical scale. For each different timbre they use a complete series of such oscillators followed by an amplifier and speaker. Thus, for ten different timbres through a pitch range of 70 notes, they use 700 oscillator tubes, and ten amplifier and reproducer outfits. A number of these have been installed in French churches.

About 1924 Leon Theremin produced the instrument,²⁸ named after him, which used two beating radio-frequency oscillators, with space control of the frequency of one of these by hand capacity for pitch control. Space control for volume was also provided. One of the very serious disadvantages of this instrument was that it required a totally unfamiliar playing technique; also, only glissando playing was possible. This latter defect was remedied by Mager who provided, for volume control, a compressible resistance held in the hand and connected to the instrument by a cable. With this even staccato playing became possible. The Theremin was, of course, only a single toned instrument incapable of chordal performance. Theremin has also produced other types with keyboard and other more conventional playing techniques.

The International Telephone and Telegraph Company has developed, at its Paris laboratory, an organ also using a radio-frequency beat system of tone generation. One crystal-stabilized radio-frequency

²³ F. E. Miller, Patent 1,376,288.

²⁴ J. Bethenod, Patent 1,865,428.

²⁵ Lee deForest, Patent 1,543,990.

²⁶ P. Lertes, "Electrische Musik," (1933), Theodor Steinkopf Press, Berlin.

²⁷ Coupleaux-Givelet, U. S. Patents 1,905,996; 1,911,309; 1,957,392; 1,980,911; and 1,980,912. Givelet, French Patent 605,373.

²⁸ Leon Theremin, U. S. Patent 1,661,058 and French Patent 612,433.

oscillator is used for each note of the scale. The fixed frequency oscillator has one amplitude control for each of its partials for timbre regulation. In simultaneous playing in several timbres, several fixed frequency oscillators are used, each with such timbre regulating controls.

Using a gaseous conduction device, Langer had, in the "Emicon,"²⁹ one neon tube oscillator circuit with different resistances under keyboard control for different pitch production.



Fig. 10—Vierling-Kock organ using inductive neon tube circuits for tone current generation.

Vierling and Kock have recently built an organ³⁰ at the Heinrich Hertz Institute in Berlin, using many neon tubes in an improved inductive discharge circuit capable of large timbre variation. With this circuit even sine wave currents can be produced. A photograph of their instrument is shown in Fig. 10.

In the Trautonium,³¹ commercially produced by the German

²⁹ N. Langer, Patents 1,832,402; 1,937,389; 1,993,890; 2,017,542; and 2,035,238.

³⁰ Oskar Vierling, "Die Electroakustische Orgel," *Heinrich Institute Publication* (Berlin), October 20, (1934). Also see Winston E. Kock "Generating sine waves with a gas discharge tube," *Electronics*, p. 92, March, (1935).

³¹ Joachim Wincklemann, "Das Trautonium", Deutsches Literarisches Institut, J. Schneider, Berlin. F. Trautwein, German Patent 469,775; Lertes, "Electrische Musik."

Telefunken Company, a neon tube with formant circuits is used. A grid-glow tube is used as the variable-frequency generator. Control of the grid potential of this tube is obtained by a long, resistance wire, stretched over a metal plate, and the audio-frequency pitch generated is thus determined by the position along this wire where it is depressed against the plate by a player's finger. By suitable circuit arrangements, the pitch changes of the musical scale may be made linearly related to the frequency changes. Another and separate compressible resistance or other device, under the stiff, spring-mounted plate, varies with the finger pressure on the pitch control wire or tape, and this, in addition to a pedal control, is used to regulate output sound volume. This in-



Fig. 11—The Trautonium, made commercially by the Telefunken Company of Germany.

strument is most interesting in that it has, like the violin, a very responsive playing technique. Staccato, legato, glissando, crescendo, decrescendo, tremolo, vibrato, and other effects are easily obtained merely by the method of fingering the pitch wire. Formant circuits are provided which, like the vocal cavities, produce variations in the output timbre. For chordal performance, several of these control wires, each with its associated generator and timbre-control apparatus may be used, as in the Mager arrangement. A photograph of the Trautonium is shown in Fig. 11.

Helberger and Lertes produced another instrument³² with similar playing technique for pitch and amplitude control, that is, a hori-

³² B. Helberger and P. Lertes, German Patents 549,481; 552,040; and 557,926; U. S. Patent 1,847,119.

zontal motion of the finger is used for pitch variation and a vertical motion for amplitude variation. However they use, instead of a grid-glow tube, a feed-back audio-frequency oscillator, pitch-controlled by grid bias, as the generator. The timbre can be varied by filters, formant circuits, and so forth. With several such generator systems having their playing control bands mounted stepwise and close together, as in the Mager multikeyboard plan, harmony may easily be produced. However only one tone at a time can be produced with each band manual.

MECHANICOELECTRIC INSTRUMENTS

The earliest records I have been able to find on mechanicoelectric musical instruments show E. Lorenz³³ of Germany as the first to suggest them. In 1884 he constructed a crude instrument using the familiar electric-buzzer principle of self-maintained vibrator. These he tuned to the various frequencies of the musical scale. In circuit with the interrupted current he included an electromagnetic telephone for making these interrupted currents audible. The vibrators themselves were placed in an evacuated chamber to eliminate their own air-borne sounds. In 1913 R. Eisemann used a contact type of microphone on a string instrument soundboard³⁴ to feed back currents to driver electromagnets for maintaining string vibration in a mechanicoacoustic instrument.

In 1921, while engaged in electrophonographic research, I used vibration pickup devices on piano and other soundboards, followed by amplifiers and reproducers or recording devices. Later numerous other workers suggested similar arrangements, among them F. C. Hammond,³⁵ H. Gernsback,³⁶ E. Hoffman,³⁷ F. W. Dierdorf,³⁸ and others.

During the past five years a number of instruments have been produced wherein the pickup device, instead of being applied to a resonator coupled to a number of vibrators, is applied directly to the vibrators themselves. In the Neo-Bechstein piano,³⁹ made commercially in Germany, a single set of magnetic pickups, each serving for several strings, is used. A keyboard, hammer, and damper action serve to control the string vibration, while the amplifier and speaker apparatus reproduce the pickup voltages. A volume control, connected to a piano pedal, regulates volume of sound output. A set of very soft dampers

³³ E. Lorenz, German Patent 33,507.

³⁴ E. Eisemann, German Patent 259,896.

³⁵ F. C. Hammond, Patent 1,510,476.

³⁶ *Radio News*, November, (1926).

³⁷ E. Hoffmann, German Patent 357,466.

³⁸ F. W. Dierdorf, Patent 1,707,115.

³⁹ F. Noack, *Funkschau* (Munich), April 17, (1932).

permits regulation of the damping rate of the string vibrations. Control of timbre, or additional tone envelope control, is not provided.

In the Vierling-Forster Electrochord⁴⁰ (Fig. 12) also manufactured commercially in Germany, a generally similar arrangement is used, except that timbre and tone envelope control with electrostatic pickup is provided by the Miessner-Jacobs arrangements.

In the Miessner-Jacobs electronic piano⁴¹ all of the effects obtained with the Electrochord are secured as well as many others. Since this instrument has been rather completely described elsewhere a discussion of it is omitted. A view of it is shown in Fig. 13.

In the Loar Vivitone,⁴² tuned steel reeds clamped at one end are plucked by a keyboard action, and thus set into rather rapidly damped vibration with practically no harmonics. Magnetic pickups, with am-

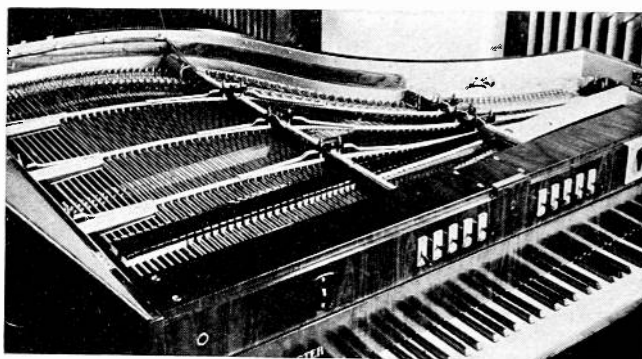

Fig. 12—Internal view of the Vierling-Forster piano.

plifier and reproducer, translate the reed vibrations into sound. A pedal volume control governs loudness.

In the RCA electric carillon,⁴³ tuned coiled vibrators, somewhat like clock chimes, are set into vibration, and their vibrations, after magnetolectric translation, are fed to very high power amplifiers and reproducers for outdoor carillons.

A broadcast studio chimes has also been developed by Ranger along these same lines. Its output is fed into the broadcast system for time or other periodic announcements.

⁴⁰ O. Vierling, *Zeit. Ver. Deutsche Ing.*, June 25, (1932).

⁴¹ Patents of B. F. Miessner, C. T. Jacobs, O. Vierling, and Evan P. Bone, 1,886,687; 1,906,607; 1,912,293; 1,915,858; 1,915,859; 1,915,860; 1,915,861; 1,929,027; 1,929,028; 1,929,029; 1,929,030; 1,929,031; 1,929,032; 1,933,294; 1,933,295; 1,933,296; 1,933,297; 1,933,298; 1,933,299; 1,961,159; 1,963,668; 1,977,832; 1,979,633; 1,992,438; 2,001,391; 2,001,392; 2,007,302; 2,027,073; 2,027,074; 2,027,075; 2,033,440; and 1,580,112.

⁴² Loyd Loar, Patents 1,992,317; 1,995,316; 1,995,317; and 2,020,557.

⁴³ A. N. Curtiss, Patent 2,026,342.

Various types of simple string instruments like violins, guitars, banjos, etc., with string vibration pickup, amplification, and reproduction, have appeared on the market in the past year or two, and are being sold in considerable numbers.

The most recent developments in this country are the electronic organs using wind-blown harmonium reeds. One such, the work of Hoschke,⁴⁴ has been placed on the commercial market by the Everett Piano Company. It follows the usual reed and pipe organ design with



Fig. 13—The Miessner-Jacobs electronic piano.

one bank of reeds for each timbre, and with pneumatic coupling devices for blowing more than one reed with a given key; that is, for introducing octaves, mixtures, and so forth. Electrostatic pickup is used for translating the reed vibrations into alternating voltages which are amplified and reproduced. A larger model, having two manuals and pedal board, has just been announced. This is shown in Fig. 14.

Ranger has developed an instrument⁴⁵ utilizing photoelectric translation of wind-blown reed vibration. These reeds operate continuously

⁴⁴ F. A. Hoschke, Patent 2,015,014.

⁴⁵ R. H. Ranger, Patent 2,039,659.

from an air blower. Small auto lights operated by keyboard furnish light reflected by reeds to the photocell. There are two sets of reeds.

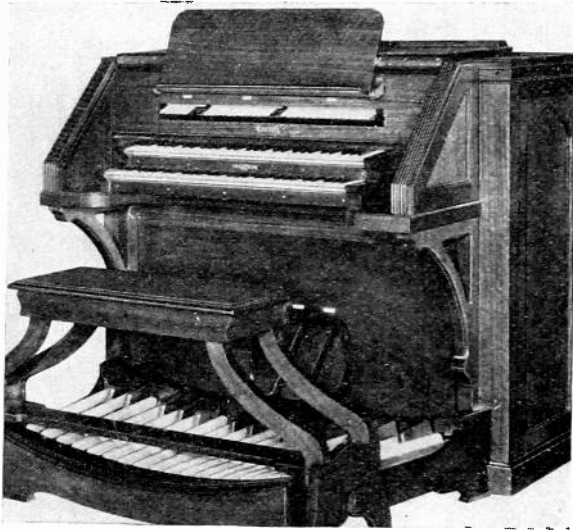

Fig. 14—Everett Orgatron Model MD-1, using wind-blown Harmonium reeds with electrostatic pickup.

The writer has developed several instruments with electrostatic translation of wind-blown reeds. Two of these are pictured in Figs. 15



Fig. 15—Miessner electronic organ with single bank of reeds and single electrostatic pickup.

and 16. Of chief interest in these is a new method of timbre control which permits production of numerous timbres from one vibrator. Two

or more electrostatic pickup electrodes are mounted near each vibratory reed tongue, particularly on its opposite sides in the direction of its vibration. Control of the polarities and magnitudes of the charging voltages on these electrodes produces distortions of the translated wave form of the reed motion, so that various electrical wave forms may be produced from a given, fixed, reed-vibration wave form, and thus a considerable range of output harmonic composition is obtained. The effect of wave-form distortion here is not an undesired or disagreeable one, as in sound reproducing equipment, where fidelity to an original is important. Rather its effect, as with formants, is to control the harmonic composition of a given periodically recurring wave form, and its use results in a very effective timbre control.

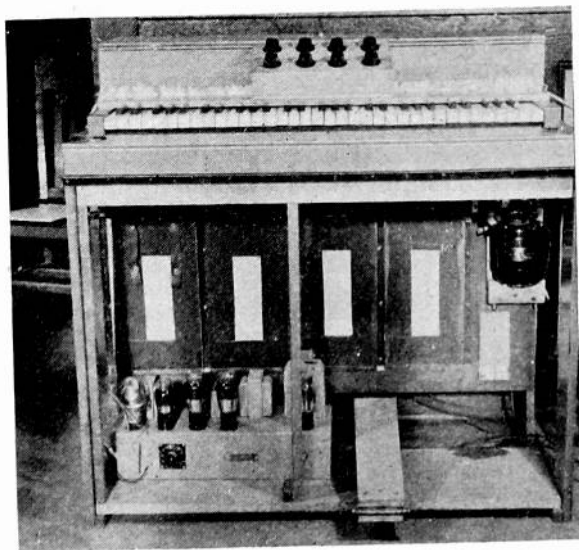

Fig. 16—Miessner electronic organ with four banks of reeds and dual electrostatic pickup.

In one of these instruments several reeds tuned in harmonic ratios such as first, third, fourth, and fifth are provided for each key of a manual, and these are blown together by the air stream permitted to flow through them when the key is depressed. An internal view of this organ is shown in Fig. 17.

All of these reeds are provided with electrostatic translation pickup electrodes, at least two per reed, front and back. The front electrodes of all fundamental, or first partial, reeds are connected together, and the charging voltage impressed on them is controlled as to sign and magnitude by a potentiometer. The back electrodes are similarly connected, and their voltage simultaneously controlled. Each of the other sets of reeds tuned to harmonic frequencies is similarly arranged. Thus,

for one manual, with four reeds per note and two pickups per reed, eight timbre controls are provided, in the form of these voltage adjusting potentiometers, unified for given partials of the whole pitch range.

These may be so set as to permit one or all reeds in a note group to be translated or not as desired. Further the translation from each reed may be linear or nonlinear in many variations, and they act in unicontrol fashion for given partials throughout the keyboard range, so as to maintain uniform timbre throughout that range.

Since, with linear translation adjustment, the output voltage from any reed is concentrated mostly on a few low partials, and with

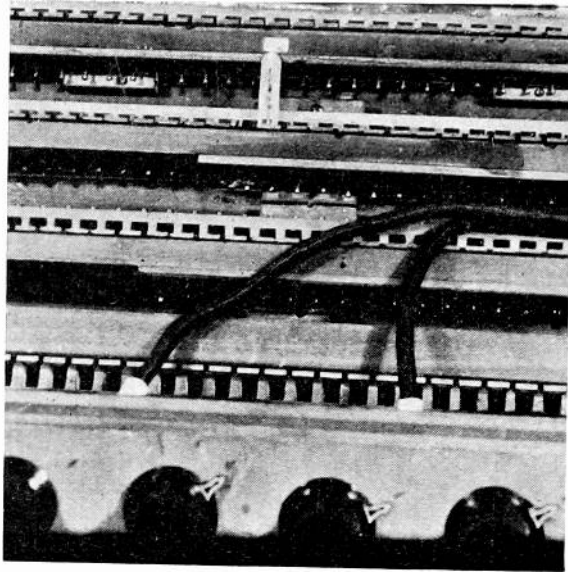

Fig. 17—Interior view of Miessner four-bank reed organ.

nonlinear translation, many harmonics may be introduced, this plan provides a very large timbre range with very simple apparatus. The choice of harmonic frequencies, to which the several reeds in each note group are tuned, is determined by the ability of the opposed pickups for each reed, to eliminate easily the fundamental and introduce double frequencies, or to leave as much fundamental and add as much second as is desired. Thus, with our reeds tuned to first, third, fourth, and fifth, we can easily get, by doubling, second, sixth, eighth, and tenth, giving us a series including first, second, third, fourth, fifth, sixth, eighth, and tenth. Other partials above the fundamental are present to some extent in the reed motions, and these appear in the translated output voltage wave to extend and enrich its harmonic composition. Harmonics up to the tenth or fifteenth, having amplitudes greater than

one per cent of the fundamental amplitude, are easily obtained from a reed by forcing upon it large amplitudes of motion, with increased air pressure.

If three pickups are provided for each reed, one at the top, another at the bottom, and a third at the side or end, and all have separately controllable charging voltage of variable amplitude and reversible polarity, the range of harmonic spectra is further extended. In Fig. 18 some of these are shown, all representing different tone qualities, and obtained by a General Radio wave analyzer, from a single reed, always vibrating with the same wave form and amplitude. As shown in No. 17

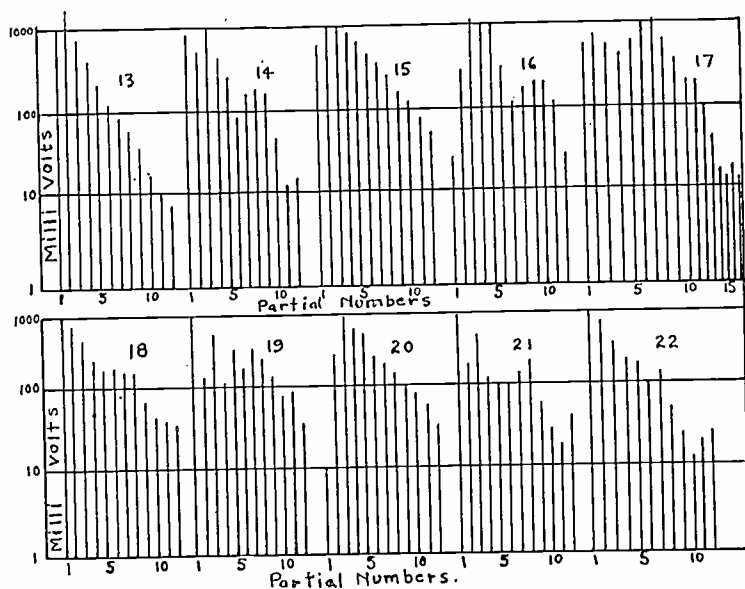

Fig. 18—Some harmonic spectra obtained from a single reed (237.5 cycles), always vibrating the same, using three electrostatic pickups. 13 is for top pickup alone; 14 is for side pickup alone; 15 is for bottom pickup alone. The others are for mixtures in aiding or opposing phases and random amplitudes of all three pickups.

of these spectra, it is possible to obtain harmonics as high as the twentieth, having amplitudes greater than a tenth of one per cent of the strongest partial present, while those up to the twelfth usually are within the one per cent amplitude ratio.

The reeds are very simple, cheap, and stable vibrators, easily maintained in vibration by an air stream of very low pressure and volume; the electrostatic translation devices need only be screws, adjustable in distance, for voicing; the timbre control devices are merely voltage regulating potentiometers, for preselected, or for stop manipulated timbre controls. No complicated timbre circuit wiring, or complicated key switches are required; the keys merely open air valves,

one for each group of reeds. There are no problems of exact speed control as in rotational generator devices, to avoid frequency drift, or of highly accurate machine work to avoid other undesired rotor or gear effects; the true tempered scale of frequencies, and partials tuned precisely to true harmonic frequencies, present no difficulties. Furthermore, the musically ideal tone envelope is automatically provided by the inability of the reeds to start and stop their vibration abruptly. Last, but very important, is the ability to provide true choir effect timbre mixtures, characteristic of pipe organs, orchestras, or voice groups.

There are, to be sure, some disadvantages with reeds. There is some difficulty in adjusting them for rapid speaking, especially at low pitches, while frequencies above five or six thousand are not very practical. There is also some difficulty, where several reeds are always blown together for each note, in tuning them to exact harmonic frequencies, although the same problem exists to an even greater degree in pipe organs with mixture stops. Again, where complete control of each harmonic is desired, there is a little difficulty in obtaining sine wave outputs from the reeds; for building up tones of numerous separately controllable components, one reed for each component must be used for each fundamental pitch of the organ, so that the number of reeds grows large. For example, in a single manual instrument of 61 notes, providing separate control of ten components, and none higher than 6000 cycles, several hundred reeds are necessary.

My discussion of a few of the significant instruments of the past and of today is now finished. What now of the future?

The ideal instrument is one which can make any sound, known, unknown, or conceivable; to do this we must provide a generator for periodic vibrations embracing the whole audio spectrum of frequencies. We must be able to select from this generator at will any desired single frequency, or many single frequencies simultaneously, whether harmonically or inharmonically related, or whether in narrow or wide continuous bands. We must further be able to emit these frequencies in any desired sound amplitudes and envelope shapes, even though, in a given sound, all the components require different shapes of envelope. We must be able to control the emission of these sounds by some suitable playing technique and apparatus.

With such an apparatus we shall be able to synthesize any possible sound, continuous, damped, transient, musical or nonmusical, for we have all the elements of sound, and means for putting together any desired combination of these elements in any desired time-amplitude re-

lationship. Looking ahead ten or twenty years we are now at work on such an instrument.

Additional Selected Bibliography

- (1) Thaddeus Cahill, "The Cahill Telharmonium," *Elec. World*, (1906).
- (2) Clyde J. Fitch, "The piano rad," *Radio News*, November, (1926).
- (3) G. B. Ashton, "Building the Tromborad," *Radio News*, April, (1927).
- (4) A. Givélet, "Les instruments de musique a oscillations electriques," *Le Genie Civil*, September 22, (1928).
- (5) C. T. Hourst, "Les instruments musicaux electriques," *L'Ingenieur Constructeur*, September and October, (1929).
- (6) Th. V. Muller, "Radioclavier," *Radio Welt*, May 10, (1929).
- (7) M. le Lieutenant-Colonel Jullien, "Applications du courant electrique, des oscillations radioelectriques et des phenomenes photoelectriques a la realisation d'instruments de musique," *Conservatoire National des Arts et Metiers*, (1929).
- (8) E. Weiss, "Le piano photoelectrique 'Spielman,'" *La Nature*, July 1, (1930).
- (9) E. Weiss, "Un appareil de musique radioelectrique," *La Nature*, July 15, (1930).
- (10) E. Weiss, "Nouveaux instruments de musique radioelectriques," *La Nature*, September, 15, (1930).
- (11) A. N. Goldsmith, "The music of the electron," *Electronics*, vol. 1, pp. 270-273; September, (1930).
- (12) "Das Hellertion, ein neues electrisches Musikinstrument," *Funkbastler*, July 3, (1931).
- (13) E. E. Free, "The electrical future of music," *Radio News*, July, (1931).
- (14) "Electroakustisches Musikinstrumente und ihre Bauart," *Rundfunk Jahrbuch*, (1932).
- (15) Oskar Vierling, "Electrische Musik," *Electrotech. Zeit.*, February 18, (1932).
- (16) Charles A. Culver, "An electrostatic alternator," *Physics*, vol. 2, p. 448; June, (1932).
- (17) Oskar Vierling, "Das Electrische Musikinstrumente," *Zeit. des Vereines Deutsches Ingenieure*, June 25, (1932).
- (18) W. Janovsky, "Electrische Musikinstrumente, ihre Wirkungweise und Aufgaben," *Electrotech. Zeit.*, July 13, (1933).
- (19) F. M. Sammis, "The Polytone," *Radio-Craft*, May, (1934).
- (20) R. G. Silbar, "Electronic music from vibrating reeds," *Electronics*, vol. 7, p. 226; July, (1934).
- (21) "WCAU's Photona organ," *Electronics*, vol. 8, p. 123; April, (1935).
- (22) "Hammond electric organ makes debut," *The Diapason* (Chicago), vol. 8, May 1, (1935).
- (23) "New electronic organ based on alternator principle," *Electronics*, vol. 8, p. 156; May, (1935).
- (24) Samuel Kaufman, "Music from whirling discs," *Radio News*, July, (1935).
- (25) "The Orgatron," *Music Trades Rev.* (New York), August, (1935).
- (26) E. B. Kurtz, and M. J. Larsen, "An electrostatic audio generator," *Elec. Eng.*, September, (1935).



A POWER AMPLIFIER FOR ULTRA-HIGH FREQUENCIES*

By

A. L. SAMUEL AND N. E. SOWERS

(Bell Telephone Laboratories, Inc., New York City)

Summary.—A consideration of the special problems encountered at ultra-high frequencies has led to the design of a push-pull power pentode, useful as an amplifier, frequency multiplier, and modulator at frequencies of 300 megacycles per second and below. Unusual construction features include the mounting of two pentodes in the same envelope with interconnected screen and suppressor grids, complete shielding between the input and output circuits with no common leads, and provision for cooling all grids while maintaining extremely small interelectrode spacings. The electrical characteristics depart from the conventional mainly in the low value of lead inductances and the high value of the grid input resistance at ultra-high frequencies.

The second part of the paper describes a single stage amplifier unit built for testing the tube at frequencies between eighty and 300 megacycles, and the associated apparatus for measuring input impedance, gain, and harmonic distortion. The results given indicate that by using this new tube it is possible to construct stable amplifiers at ultra-high frequencies up to 300 megacycles, having gains of twelve to twenty-five decibels per stage and delivering several watts of useful power. Stability and distortion compare favorably with those obtained from conventional tubes at much lower frequencies.

PART I—THE VACUUM TUBE

By

A. L. SAMUEL

WE ARE witnessing a rapid expansion and extension in the use of radio communication. A corresponding extension in the usable portion of the radio-frequency spectrum is highly desirable. With this in mind, special forms of vacuum tubes have already been developed for use as oscillators at frequencies above 100 megacycles.^{1,2} Except at low power levels,³ amplifier tubes have not been available. It is the purpose of this paper to discuss the problem of amplification at ultra-high frequencies and to describe one form of amplifier tube designed for moderate power in that frequency range.

* Decimal classification: R330 × R255. Original manuscript received by the Institute, June 23, 1936. Presented before New York Meeting, October 7, 1936.

¹ M. J. Kelly and A. L. Samuel, "Vacuum tubes as high-frequency oscillators," *Elec. Eng.*, vol. 53, pp. 1504-1517; November, (1934); *Bell Sys. Tech. Jour.*, vol. 14, pp. 97-134; January, (1935).

² C. E. Fay and A. L. Samuel, "Vacuum tubes for generating frequencies above one hundred megacycles," *Proc., I.R.E.*, vol. 23, pp. 199-212; March, (1935).

³ B. J. Thompson and G. M. Rose, "Vacuum tubes of small dimensions for use at extremely high frequencies," *Proc. I.R.E.*, vol. 21, pp. 1707-1721; December, (1933).

THE TRIODE AS AN AMPLIFIER AT ULTRA-HIGH FREQUENCIES

A simple triode amplifier as used at low frequencies becomes unstable as the operating frequency is increased, exhibiting a tendency to oscillate or "sing" because of the interaction between the input and output circuits. This interaction or "feedback" is, in the main, produced by the grid-plate capacitance of the tube. It may be overcome either by the introduction of a compensating capacitance somewhere in the circuit or by the introduction of an electrostatic shield or screen within the tube envelope. The first expedient, known as neutralization, is employed in the case of a triode. The second expedient results in the screen-grid tetrode. At moderately high frequencies either arrangement may be used.

The conventional triode is unsatisfactory at very high frequencies. The usual capacitance neutralization scheme fails, partly because of the inductance of the tube leads which makes difficult the correct location of the neutralizing capacitance. The appreciable time required for the electrons to traverse the interelectrode spaces within the tube structure makes neutralization more difficult by introducing a shift in the phase of the necessary compensation.

A more serious effect of electron transit time is the marked increase at high frequencies in the input conductance of a tube over the value observed at low frequencies. This effect has been the subject of considerable study.^{4,5,6,7} Theory and experiment both agree in relating the input conductance loss to the tube geometry and the applied electrode potentials. The conductance depends upon the electron transit time and increases rapidly with increasing frequency. The transit time may be reduced either by decreasing the electron paths or by increasing the electron velocities. Decreasing the path calls for smaller interelectrode spacings, and increasing the velocity calls for higher electrode potentials. On the other hand, practical considerations limit both the dimensions and the potentials. An optimum design may utilize special mechanical arrangements to combine both expedients.

The electron transit time limitation becomes of particular importance at frequencies above one hundred megacycles and sets an upper frequency limit on the useful operation of the usual triode as an amplifier just as it sets the limit at which the tube will operate as an oscilla-

⁴ J. G. Chaffee, "The determination of dielectric properties at very high frequencies," *Proc. I.R.E.*, vol. 22, pp. 1009-1020; August, (1934).

⁵ F. B. Llewellyn, "Operation of ultra-high-frequency vacuum tubes, *Bell Sys. Tech. Jour.*, vol. 14, pp. 632-665; October, (1935).

⁶ W. R. Ferris, "Input resistance of vacuum tubes as ultra-high-frequency amplifiers," *Proc. I.R.E.*, vol. 24, pp. 82-104; January, (1936).

⁷ D. O. North, "Analysis of the effects of space charge on grid impedance," *Proc. I.R.E.*, vol. 24, pp. 108-136; January, (1936).

tor. Because of the similarity in the special high-frequency requirements, negative grid tubes designed for use primarily as ultra-high-frequency oscillators are good amplifiers at somewhat lower frequencies. The necessity for very careful circuit design and for critical adjustment of the neutralization becomes particularly pronounced when triodes are used as ultra-high-frequency amplifiers.

THE MULTIELEMENT TUBE AS AN AMPLIFIER AT ULTRA-HIGH FREQUENCIES

Conventional screen-grid tetrodes and pentodes are also unsatisfactory at very high frequencies. Two factors are again primarily responsible, the one set by the circuit requirements, the other set by the electron transit time. These limitations will be considered in detail.

In the usual radio-frequency amplifiers using tetrodes or pentodes the input and output circuits are tuned to the desired frequency. For most practical purposes the upper limit to the frequency for which these circuits may be tuned is set by the natural period of the circuits formed by the corresponding lead inductances and interelectrode capacitances. Even before this limit is reached the major portions of the tuned circuits are within the tube envelope. Their inaccessibility makes it difficult to obtain effective coupling between amplifier stages.

Interaction between the input and output circuits if excessive may cause "singing." Such interaction is usually due to the residual value of the grid-plate capacitance. Not only must this capacitance be made very low by the proper design of the screen and suppressor grids, but its effective value must remain low at the operating frequency. This latter is realizable only if the screen and suppressor grids can be coupled to the cathode by leads having extremely small inductances. A further desirable feature is that there be no appreciable circuit impedance in the form of lead inductance common to both input and output circuits. The use of short leads is thus seen to be just as important in the design and use of the multielement tube as it is in the design of the triode.

As in the case of the triode, the electron transit time is effective in limiting the useful frequency range of the multielement tube. The increase in the input conductance which it introduces is again primarily responsible.

In considering the design of an amplifier tube for ultra-high frequencies, it appeared desirable to select frequency and power levels such that a break from conventional design was inevitable, leaving for future work the satisfactory coverage of the transition region. Since triodes had already been studied as oscillators it was decided to design and construct a pentode. A tentative rating of fifteen watts anode dis-

sipation (per tube) with an operating range up to 300 megacycles was chosen. It was further thought desirable to limit the sum of the grid-to-ground and plate-to-ground capacitances to a value less than eight micromicrofarads in order to facilitate the design of the accompanying circuits.

Preliminary considerations led to the conclusion that the desired results could be best obtained by push-pull operation. In view of the required shortness of leads it seemed logical, if not essential, to inclose both sets of tube elements within one envelope and to provide an internal by-pass condenser between the screen and suppressor grids. It also appeared desirable to design the structure so that a simple extension of the screen-grid element would form a partition separating the input portion of the tube from the output portion. By mounting the

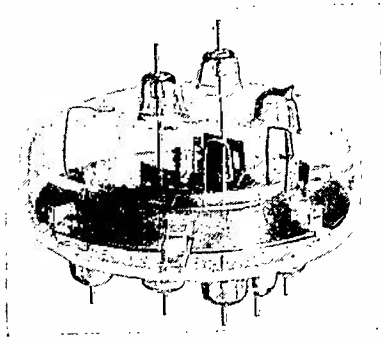

Fig. 1—An early experimental type tube.

tube so that the internal partition forms a continuation of the external partition separating the input and output circuits, quite adequate shielding should be possible. From previous experience, it was concluded that the special frequency requirements for a 300-megacycle amplifying tube would be satisfied by a design patterned after a 600-megacycle oscillator tube.²

To summarize, the following construction features were considered desirable:

- (1) The mounting of two sets of elements in the same envelope.
- (2) A method of interconnecting the two screen grids by a low impedance conductor.
- (3) A method of grounding the screen and suppressor grids inside the tube envelope.
- (4) Complete shielding between input and output sides of the tube.
- (5) The use of extremely short leads.
- (6) Means for maintaining very small spacings between the elements.

- (7) Provision for adequate cooling of all grids.
- (8) Adequate insulation paths to permit a high anode potential.
- (9) The absence of any leads common to both input and output circuits.

The first of the experimental tubes designed to have a fifteen-watt dissipation per anode is shown in Fig. 1. It will be noted that a parti-

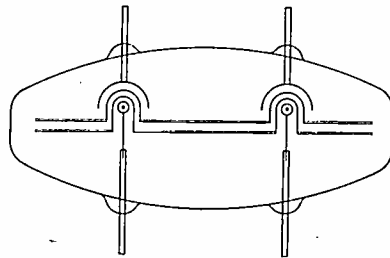

Fig. 2—Sectional view of the tube shown in Fig. 1.

tion divides the envelope into two parts. This partition is in reality double being made up of two sheets, one being connected to the suppressor grids and the mid-point of the filament circuit and the other being connected to the screen grids. Slots in these sheets provide space to mount the tube elements. The capacitance between the two closely spaced sheets forms an effective radio-frequency by-pass condenser

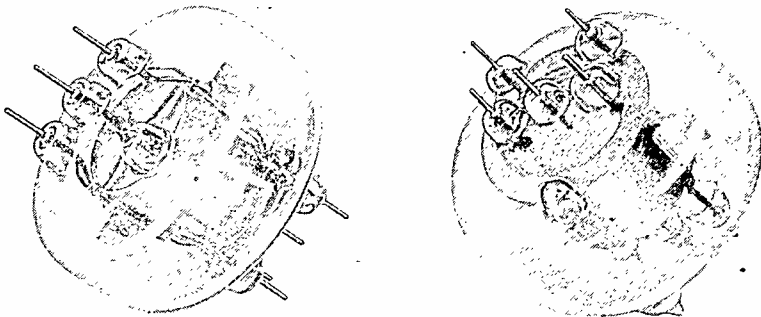

Fig. 3—The ultra-high-frequency double pentode vacuum tube.

between the screen grids and the filaments. Fig. 2 is a sectional view through the middle of the tube showing the disposition of the elements. While entirely satisfactory from an operating viewpoint, this design proved to be rather difficult to fabricate.

THE ULTRA-HIGH-FREQUENCY DOUBLE-PENTODE TUBE

The successful operation of the experimental models described above indicated the desirability of continuing this line of attack. A

complete mechanical redesign to facilitate the fabrication and pumping was undertaken. Fig. 3 is a photograph of this design. Sectional views are shown in Fig. 4. The large capacitance between the screen and suppressor which characterized previous models was retained in the form of concentric cylinders instead of parallel plates. These cylinders and

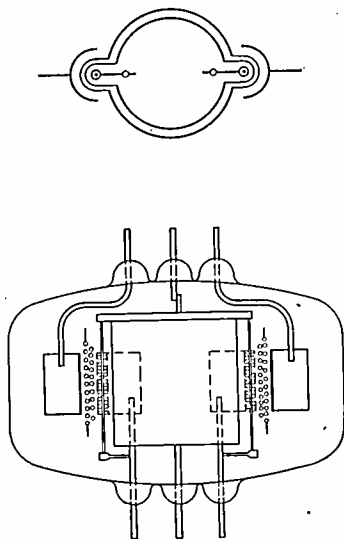

Fig. 4—Sectional view of the double pentode tube.

the flange at one end effectively shield the input and output sides of the tube. The low impedance connection between the two screens provided by these cylinders is an important feature of the design. Adequate cooling of the screen grid is provided by mounting it directly in a slot in one of the cylinders. The control grids are of the so-called

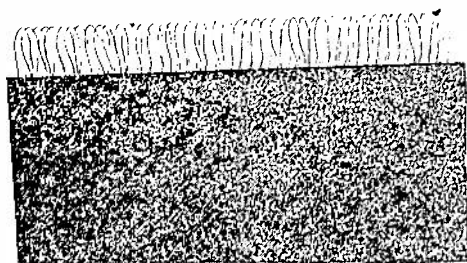

Fig. 5—One of the control grids used in the double pentode tube.

fin type of construction already employed with considerable success in triode oscillators. They consist of a series of tungsten loops attached to a common cooling fin. This construction makes feasible the use of extremely small dimensions, so that the grid-filament spacing is comparable with the filament diameter. One of these grids is illustrated in Fig.

5. The length of leads has been kept as small as is consistent with mechanical requirements. The longest lead, measured from the mid-point of its attached element to the outside of the envelope, is about three centimeters. Other details of the design are evident from the photograph and the diagram.

Operating characteristics and constants are listed in Table I.

TABLE I
OPERATING CHARACTERISTICS AND CONSTANTS OF THE DOUBLE PENTODE TUBE

Filament current (each side).....	5.0 amperes
Filament potential (each side).....	1.5 volts
Rated anode dissipation (each anode).....	15 watts
Rated screen dissipation (each side).....	5 watts
<i>At anode and screen potentials of 500 volts and anode current of 0.030 ampere—characteristics of each side</i>	
Transconductance.....	1250 micromhos
Anode resistance.....	200,000 ohms
Normal control grid potential.....	-45 volts
<i>Interelectrode capacitances (when properly mounted)</i>	
Direct control grid to control grid.....	0.02 micromicrofarad
Direct plate to plate.....	0.06 micromicrofarad
Total control grid to ground (each side).....	3.8 micromicrofarads
Total plate to ground (each side).....	3.0 micromicrofarads
Control grid to plate (each side).....	0.01 micromicrofarad
<i>Lead inductances</i>	
Total grid to grid.....	0.07 microhenry
Total plate to plate.....	0.08 microhenry
<i>Rating as class A amplifier</i>	
Maximum direct plate potential.....	500 volts
Maximum direct screen potential.....	500 volts
Maximum continuous plate dissipation (each).....	15 watts
Maximum continuous screen dissipation (total).....	10 watts
Maximum output at 150 megacycles with distortion down 40 decibels.....	1 watt
Nominal stage gain at 150 megacycles.....	20 decibels
Nominal control grid potential.....	-45 volts
<i>Rating as class B amplifier</i>	
Maximum direct plate potential.....	500 volts
Maximum direct screen potential.....	500 volts
Maximum space current (total).....	150 milliamperes
Maximum continuous plate dissipation (each).....	15 watts
Maximum continuous screen dissipation (total).....	10 watts
Maximum output at 150 megacycles.....	10 watts

Special attention is directed to the values of interelectrode capacitances and lead inductances. It will be observed that while the interelectrode capacitances are low they have not been reduced in proportion to the reduction in operating wave length. The more important feature is the reduction of the lead inductances. Tabulation of the value of these inductances represents a departure from the conventional practice and is made desirable by their relative importance.

A feature of the design not directly measurable under actual operating conditions but nevertheless responsible for some of the improvement over the more conventional designs is the reduction of an auxiliary dielectric material and the attending dielectric losses that occur at ultra-high frequencies.

The usual static characteristics given in Figs. 6 and 7 are seen to resemble those of the conventional pentode. For a tube which is to be used at ultra-high frequencies, certain other characteristics have a much greater significance. One of the most important of these is the

active grid loss which as already mentioned comes about because of the appreciable electron transit time. Fig. 8 gives a plot of the push-pull input shunting resistance of this tube as a function of frequency. The value of 30,000 ohms at 150 megacycles is to be compared with 2000 ohms, a typical value for two conventional tubes in push-pull. At 300 megacycles the input resistance of the twin pentode is still above 5000 ohms while for conventional tubes it is so low as to make them com-

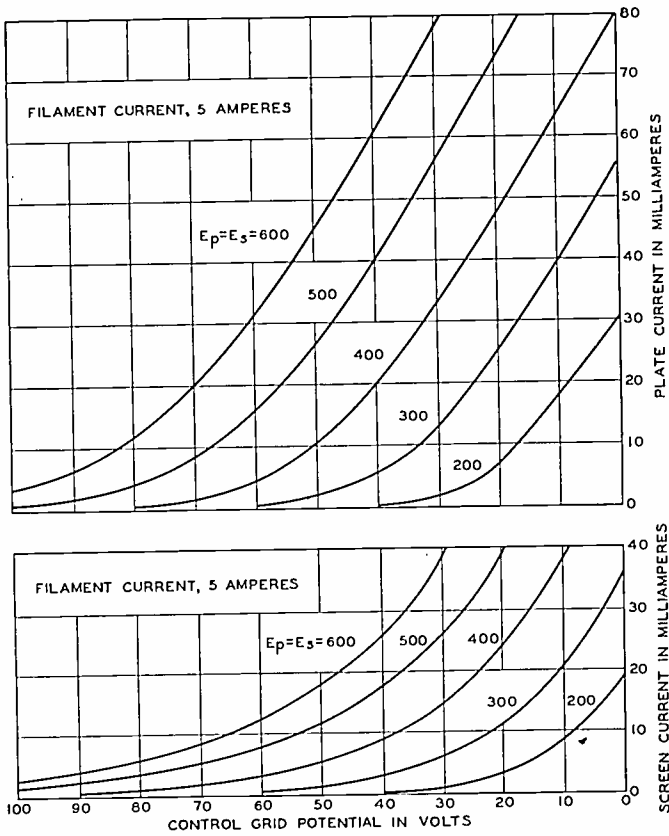

Fig. 6—Mutual characteristics of the double pentode tube.

pletely inoperative. The variation in the input resistance with the operating conditions of the tube for a constant frequency of 150 megacycles is shown in Fig. 9. It is evident that if a high value of input resistance is to be realized, high anode potentials with low space currents must be used. The reduction in the filament grid spacing made possible by the unusual construction is in a large measure responsible for the improvement in the input resistance just noted.

A characteristic measurable only at the operating frequency is the interaction between the input and output circuits which results from the residual value of the grid-plate capacitance. This reaction differs

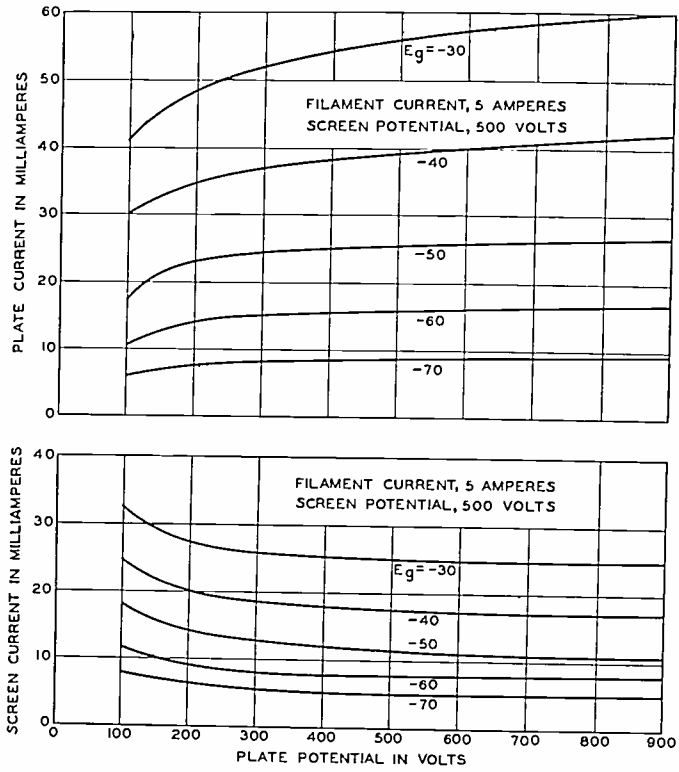

Fig. 7—Anode characteristics of the double pentode tube.

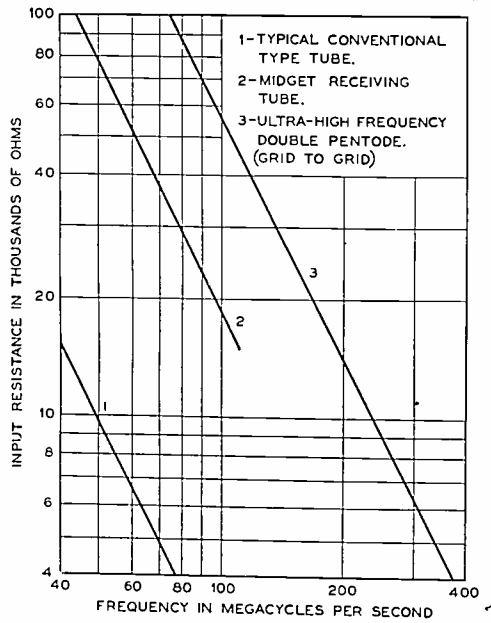

Fig. 8—The input resistance as a function of frequency.

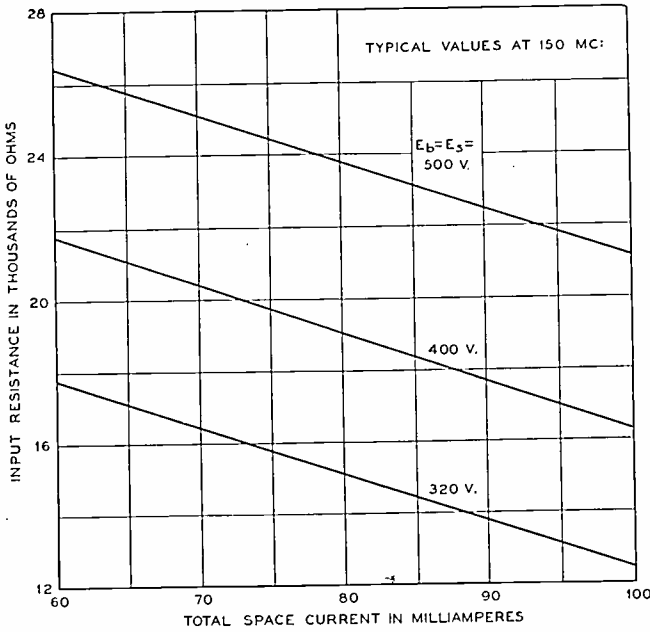

Fig. 9—The variation in input resistance with operating conditions at 150 megacycles.

from that predicted from the low-frequency capacitance measured on a cold tube because of the inductance of the screen-grid lead and because of the electron space charge. The reaction can be measured by observing the variation in the input impedance resulting from a varia-

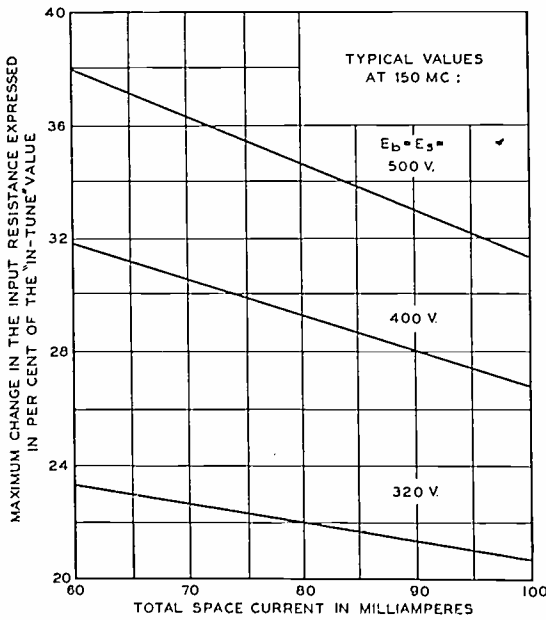

Fig. 10—The input-output reaction at 150 megacycles.

tion in the tuning and loading of the output circuit. Experimentally determined values are given in Fig. 10.

The double pentode tube has been found useful as a high quality class A amplifier, a class B amplifier, a frequency multiplier, and as a modulator at frequencies of 300 megacycles per second and below. Its performance in these various modes of operation is quite comparable to the performance of conventional pentodes of similar ratings at much lower frequencies. Stable operation with some gain has been obtained at frequencies as high as 500 megacycles. Because of the increased importance at ultra-high frequencies of circuit design in the over-all performance of an amplifier or modulator, such tests cannot be considered as a definite measure of the capabilities and limitations of the tube but they indicate what has already been accomplished.

When operating as a class A amplifier at 150 megacycles an output of one watt is obtained with the distortion forty decibels below the fundamental. Under these conditions the stage gain is twenty decibels. Outputs of ten watts with a plate efficiency of sixty to seventy per cent and a gain of ten decibels are secured with class B operation. Experimental results confirming these statements together with a discussion of the principles of circuit design and the technique of measurements are given in the accompanying paper by N. E. Sowers.

CONCLUSION

The development of this ultra-high-frequency pentode demonstrates that amplifier tubes of the negative grid type are usable at higher power levels and frequencies than have been reported previously. The extension of the principles underlying the design of this tube to the design of a tube with approximately ten times the output is now being considered. This type of development removes a practical barrier which has, up to the present, prevented the successful utilization of this frequency range.

PART II—THE CIRCUIT

By

N. E. SOWERS

INTRODUCTION

In the first section of this paper A. L. Samuel has described the development of a push-pull pentode designed to function as a stable amplifier at frequencies up to at least 300 megacycles. It is the purpose of the present section to describe the methods and apparatus used in testing this tube and to set forth the results of some of the tests.

An attempt to study the operating characteristics of an amplifier tube at ultra-high frequencies brings up many new problems. Such fundamental properties of the tube as amplification factor, transconductance, and plate impedance do not convey as much information about the behavior of the tube at these frequencies as they do at lower frequencies. The presence of unavoidable stray inductances and capacitances makes it much more difficult to separate tube problems from circuit problems. Consequently, at ultra-high frequencies we are virtually forced to consider the tube and its associated circuits as comprising a single piece of apparatus. If the circuit design is carefully made the stray inductances and capacitances can be greatly reduced in magnitude and so localized that their effects upon the over-all performance of such a piece of apparatus can, to a certain extent, be computed.

CIRCUIT DESIGN

Some idea of the extreme attention to detail required in designing amplifier circuits for use at ultra-high frequencies may be gained from the following considerations. Computations indicate that even with the tuned plate and grid circuits placed as close as physically possible to one of these push-pull pentodes, at 300 megacycles, the radio-frequency voltage actually applied to the grids of the tube may be as much as twenty-five per cent greater than the voltage developed across the tuned grid circuit. At the same time the load presented to the tube plates may be as much as twice the load actually present across the tuned plate circuit. These discrepancies are a direct result of the inductance of grid and plate leads which, in the case of this new tube, have already been reduced well nigh to the minimum possible.

In studying the performance of these tubes it was desired to be able to check experimental results against theory at every possible point. Consequently the simplest auxiliary circuits were chosen, namely, shunt-tuned antiresonant circuits from grid to grid and from plate to plate, with screens and filaments by-passed as directly as possible to ground. In their mechanical design these circuits embody a number of features intended to reduce and localize stray inductances and capacities, into the details of which it is not possible to go at present. A simple arrangement was evolved to provide a maximum of convenience and flexibility for experimental work. The single stage amplifier unit consists of three sections, an input circuit section, a tube housing section, and an output circuit section. This arrangement permits tubes to be changed with a minimum of disturbance to the circuits. During experimental work it is almost inevitable that circum-

stances will arise calling for major changes in the nature of the circuits, or the size, shape, and lead arrangement of the tubes. This sectional construction provides the necessary flexibility to take care of such needs, as the construction and substitution of appropriate new sections would permit the experimental work to proceed with a minimum of delay. To facilitate the operation of several units in tandem for tests on a multistage amplifier, each section is provided with its own power supply jacks so that the only longitudinal connections required within the sections are those between tube leads and the circuits. These connections are so arranged as to be very easily broken when sections are to be separated. Each circuit section has built into it a

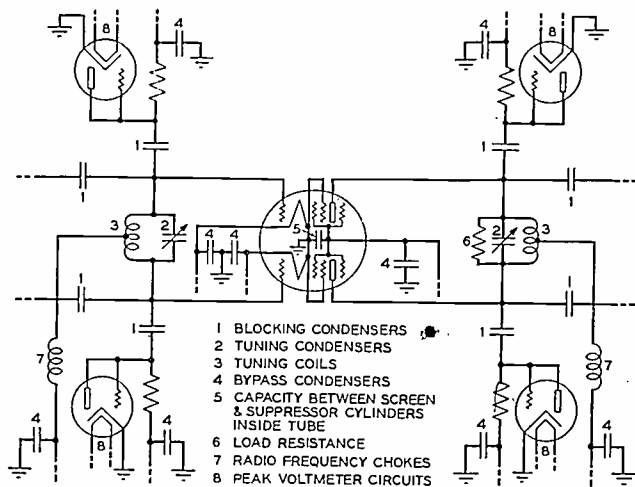

Fig. 11—Circuit diagram of single stage test amplifier.

pair of peak voltmeters for indicating the radio-frequency voltage developed across the tuned circuit. These voltmeters consist of RCA type 955 tubes used as diode rectifiers in the familiar self-biased peak voltmeter circuit. Fig. 11 shows the circuit in schematic form. Fig. 12 shows an experimental two-stage amplifier constructed in substantially the same fashion as the test circuit, but without the sectionalizing feature.

The desire to reduce the length of all leads to a minimum has naturally resulted in bringing the tuned circuits rather close to the sides of the circuit housings. Nevertheless care and attention to detail in the circuit design have enabled the stray capacitances to be kept down to satisfactory values. Fig. 13 shows in schematic form one of these circuits employed as the interstage circuit between two of these push-pull pentodes, all of the important inductances and capacitances being included.

INPUT IMPEDANCE MEASUREMENT

One of the factors which effectually limits the performance of a vacuum tube at ultra-high frequencies is the internal grid resistance or active grid loss. Consequently, this factor is of extreme interest in

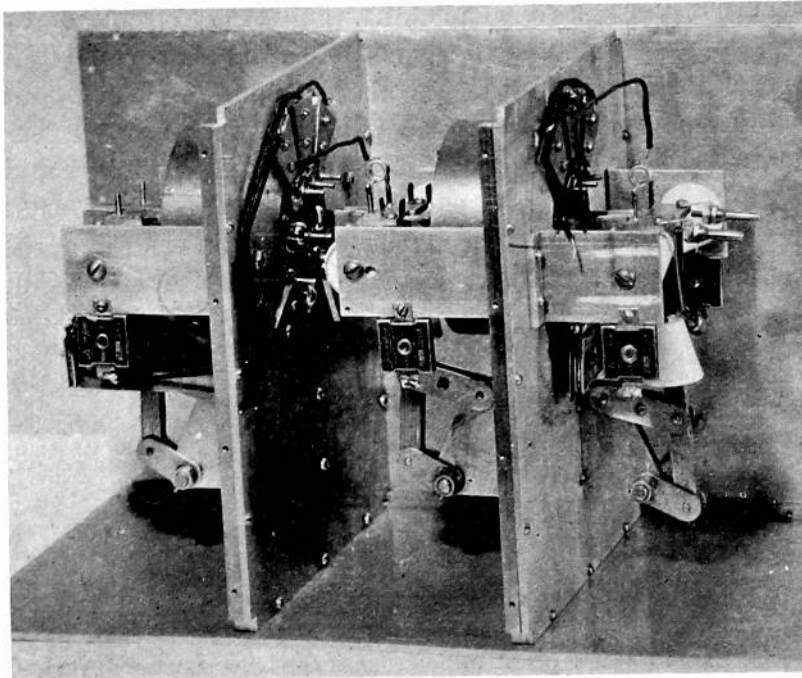

Fig. 12—An experimental two-stage one-meter amplifier using two of the earlier type push-pull pentode tubes.

the development of amplifier tubes for use in the ultra-high-frequency range and much of this work has centered around the development of apparatus and technique for rapidly and accurately measuring these

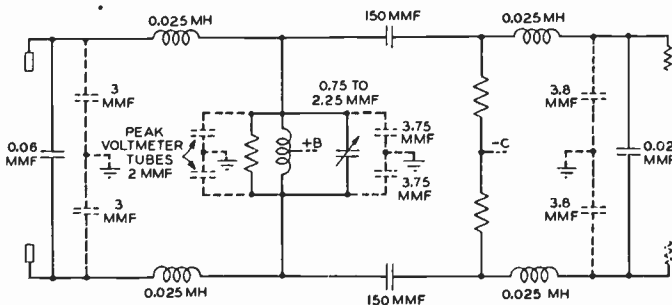

Fig. 13—Diagram of interstage circuit.

input resistances. The method employed has been the simple resistance substitution method used by Crawford.⁸

⁸ A. B. Crawford, "Input impedance of vacuum tube detectors at ultra-short waves," (Abstract), Proc. I.R.E., vol. 22, pp. 684-685; June, (1934).

An adjustable quarter-wave Lecher frame is provided with suitable means for inducing a radio-frequency voltage across it and a suitable detector for indicating the current flowing at the short-circuited end. A calibration is made by noting the detector indication corresponding to various known resistances connected across the open end of the frame, with the input voltage held constant. The input circuit of the tube under test is then connected to the end of the Lecher frame in place of the calibrating resistors and the detector indications corresponding to various voltages and loads applied to the tube are noted. Since the Lecher frame is initially tuned to the operating frequency and when the tube input circuit is attached, the circuit itself is retuned for resonance, it follows that the quantity actually measured is the effective resistance across the tuned circuit, including both the circuit losses

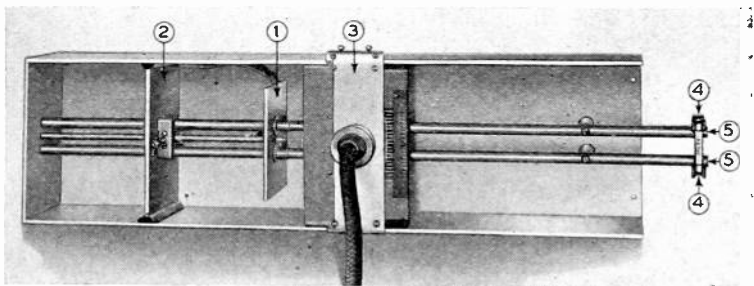

Fig. 14—Photograph of impedance measuring Lecher frame.

1. Short-circuiting bridge carrying detector tube and detector coupling coil.
2. Auxiliary bridge for breaking up unbalance currents flowing on the frame.
3. Input circuit. Note electrostatic screen between frame and input coil mounted on end of flexible transmission line leading to driving oscillator.
4. Clips carrying calibrating resistors.
5. Jacks into which plugs on amplifier input circuit fit.

and the active grid loss of the tube. It is of course possible to determine the circuit losses separately and to compute the contribution to the total resistance offered by the tube losses, and also to compute the active grid loss existing directly at the grids of the tube, taking into account the impedance transformation existing between the tube grids and the tuned circuit, brought about by the lead inductances. Practically, however, the total effective shunt resistance across the tuned circuit as actually measured is a more significant quantity, as this quantity determines more or less directly the gain which can be obtained from a multistage amplifier. It frequently happens that changes in the voltages applied to the tube produce small changes in the reactive component of the input impedance. These may be taken into account by noting the changes in grid circuit tuning required to maintain resonance. These changes are usually so small as to be of only minor interest.

The Lecher frame used in these measurements is shown in Fig. 14.

The plate bridging the frame nearest the open end carries the detector, an RCA type 955 tube set into the plate. The grid of this tube is coupled to the frame by means of a small rectangular single turn loop mounted just beneath and quite close to the bars at the short-circuited end. The second plate bridging the bars, in conjunction with the electrostatic screen between the bars and the input coupling coil, aids in eliminating any unbalance of the currents flowing in the two sides of the frame. The aluminum trough surrounding the frame provides sufficient shielding to render the apparatus virtually immune to the operator's body capacitance effects. The whole resistance measuring setup is remarkably stable and satisfactory to operate. Resistance measurements on a given tube at specified operating points can be repeated with a precision of two or three per cent even when weeks elapse between measurements.

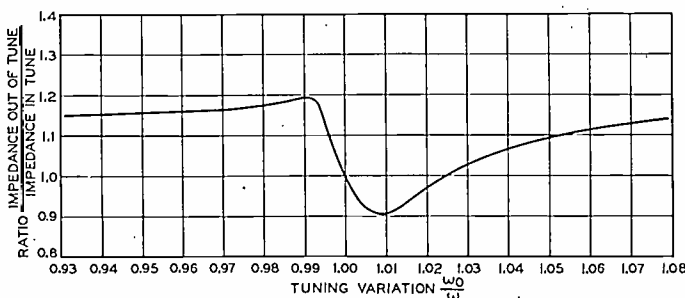

Fig. 15—Reaction Curve.

In addition to being a function of frequency, the input resistance of one of these tubes is also a function of all of the operating conditions, that is, applied voltages, plate circuit tuning, and load. In Table II are shown values of this input resistance for a typical tube at several frequencies and over a considerable range of operating conditions. Because of the large number of variables which affect this input resistance it is difficult to devise any way of plotting these data so as to give a comprehensive picture of tube performance.

The variation of input resistance with plate circuit tuning has, for this design, consistently been of the form illustrated in Fig. 15. However, the relations between maximum, minimum, and "in-tune" values vary somewhat with frequency, operating conditions, and plate load. Also, as may be expected, they vary somewhat in different tubes which have been made up with various grid and screen spacing, etc. A convenient numerical measure of the magnitude of this reaction is obtained by taking the difference between the maximum and minimum value at any specified operating point and dividing this difference by the "in-tune" value. This reaction ratio will also be found listed in Table II for various operating conditions.

TABLE II
INPUT RESISTANCE AND REACTION RATIO AS A FUNCTION OF FREQUENCY AND APPLIED VOLTAGES AND CURRENTS
PLATE CIRCUIT LOAD 15,000 OHMS

	f = 150 megacycles			f = 200 megacycles			f = 250 megacycles			f = 300 megacycles		
	64	80	100	64	80	100	64	80	100	64	80	100
$I_p + I_s$ mls	17200	15050	13500	9900	8650	7750	6600	5800	5200	4900	4300	3850
$E_p = E_s$ { resistance = 320 volts { reaction ratio	0.230	0.220	0.207	0.197	0.185	0.174	0.159	0.147	0.144	0.133	0.123	0.177
$E_p = E_s$ { resistance 400 volts { reaction ratio	21100	19050	16250	12150	10950	9350	8150	7350	6250	6000	5450	4600
$E_p = E_s$ { resistance = 500 volts { reaction ratio	0.311	0.289	0.271	0.267	0.251	0.241	0.227	0.211	0.192	0.175	0.174	0.163
	26000	23700	21300	14950	13600	12250	10000	9150	8250	7400	6750	6050
	0.373	0.346	0.314	0.324	0.298	0.273	0.270	0.257	0.232	0.216	0.207	0.190

Reaction Ratio = (maximum resistance - minimum resistance) as plate circuit is tuned
resistance with plate circuit in tune

TABLE III
STAGE GAIN IN DECIBELS AS A FUNCTION OF CURRENT, VOLTAGE, PLATE CIRCUIT LOAD, AND FREQUENCY

	f = 150 megacycles			f = 200 megacycles			f = 250 megacycles			f = 300 megacycles		
	64	80	100	64	80	100	64	80	100	64	80	100
$I_p + I_s$ mls Plate Cct. Lead, Ohms	25.2	26.1	26.5	23.6	24.5	24.9	23.0	23.9	24.3	23.1	24.0	24.3
$E_p = E_s$ { unloaded* = 320 volts { 15000† 5000†	18.2	19.1	19.5	17.7	18.6	19.0	18.0	18.9	19.3	18.7	19.6	20.0
	11.8	12.7	13.1	11.6	12.5	12.9	12.5	13.4	13.8	13.6	14.5	14.9
$E_p = E_s$ { unloaded* = 400 volts { 15000† 5000†	24.6	25.5	25.6	23.0	23.9	24.0	22.4	23.3	23.4	22.5	23.4	23.5
	17.6	18.5	18.6	17.1	18.0	18.1	17.4	18.3	18.4	18.1	19.0	19.1
	11.2	12.1	12.2	11.0	11.9	12.0	11.9	12.8	12.9	13.0	13.9	14.0
$E_p = E_s$ { unloaded* = 500 volts { 15000† 5000†	23.9	24.7	25.2	22.3	23.1	23.6	21.7	22.5	23.0	21.8	22.6	23.1
	16.9	17.7	18.2	16.4	17.2	17.7	16.7	17.5	18.0	17.4	18.2	18.7
	10.5	11.2	11.8	10.3	11.0	11.6	11.2	11.9	12.5	12.3	13.0	13.6

* Except for peak voltmeters
† In addition to peak voltmeters

GAIN MEASUREMENTS

The measurement of the voltage gain of an amplifier stage containing one of these tubes is a relatively simple matter. As stated in the description of the circuit, provision is made for connecting a peak voltmeter directly to each tuning condenser plate in both plate and grid circuits so that the applied grid drive and developed plate voltages may be read directly. Of course, the gain figure arrived at in this manner is an over-all factor, a function both of tube conditions and circuit construction and loading. Nevertheless, it is a satisfactory figure of merit for the stage. In Table III are shown these gain figures for a typical tube under various conditions.

DISTORTION MEASUREMENTS

One of the quantities of fundamental interest in studying class A amplifiers is the amount of distortion to the applied signal generated in the tube. The technique of making distortion measurements at audio and carrier frequencies is well understood and presents no outstanding problems. However we would not expect distortion measurements made at low frequencies to have any significant application to ultra-high-frequency operation. Since the input resistance of a tube at these frequencies is obviously a function of the various voltages and currents we should expect this input resistance to vary throughout the radio-frequency cycle, that is, to be essentially nonlinear. The question of whether or not this nonlinearity is of sufficient magnitude to cause trouble can best be answered by making direct distortion measurements at the ultra-high frequencies. After some consideration of the various methods of measuring distortion we have chosen the two-tone method as being the most promising. In this method two independent frequencies suitably chosen in the transmission band of the amplifier are fed into the amplifier and the amplitudes of these two tones and such of their modulation products as are of interest are measured in the output of the amplifier by means of a suitable voltage analyzer. In the present case the "tones" are actually a pair of ultra-high-frequency signals. The principal precaution which must be taken in this method is to prevent the oscillators which supply the driving frequencies from reacting on each other and producing distortion products ahead of the amplifier under test. In the present case we have taken care of this requirement by using relatively high powered driving oscillators, very well shielded, from which only very small amounts of power are taken by means of very loosely coupled and electrostatically screened coupling coils. The outputs of the two oscillators are still further isolated from each other by connecting each across opposite

diagonals of a balanced capacity bridge and taking off the voltage to drive the circuit under test across one arm of the bridge. A small amount of the voltage developed in the output circuit of the amplifier under test is picked up by a small coupling coil and fed into a voltage analyzer by means of which the relative amplitudes of the testing frequencies and their modulation products may be measured. This voltage analyzer consists of a high gain superheterodyne receiver having a rather sharply tuned, intermediate-frequency amplifier and an extremely precise tuning arrangement on the beating oscillator. The intermediate-frequency amplifier contains an attenuator which, in conjunction with the second detector current meter, permits the relative amplitude of signals to be measured.

The oscillators are push-pull tuned-plate—tuned-grid oscillators employing Western Electric type 304-A tubes with about 900 volts on their plates. These oscillators each deliver about twenty-five watts of radio-frequency power, nearly all of which is dissipated in a resistance load inside the shielding compartments. The receiver (voltage analyzer) has approximately one hundred decibels gain and a ninety-three-decibel attenuator adjustable in one-decibel steps so that measurements over a very wide range of amplitudes are possible. It was found desirable to interpose an additional amplifier (also using these push-pull pentodes) between the output of the bridge and the tube and circuits under test. Of course this amplifier introduces a possible source of distortion ahead of the circuit under test and care must be taken to operate it under such conditions that an adequate margin exists between distortion level measured at its output and distortion level existing at the output of the tube under test.

TABLE IV

RATIO OF AMPLITUDE OF THIRD ORDER MODULATION PRODUCTS TO AMPLITUDE OF ONE OF TWO EQUAL TEST FREQUENCIES

Frequency = 80 megacycles

E_P, E_S Volts	E_G Volts	I_P Mils	I_S Mils	Dist. ratio, decibels at 0.33 watt* output	Dist. ratio, decibels at 0.75 watt* output
320	-27.4	43.5	19.5	-52	-44
320	-23.8	54.0	26.0	-54	-46
320	-19.0	66.5	33.5	-56	-48
400	-38.3	44.0	22.0	-53	-44
400	-34.5	55.0	25.0	-54	-45
400	-29.5	68.5	31.5	-57	-49
500	-53.5	45.5	19.5	-57	-50
500	-49.0	56.0	24.0	-58	-50
500	-44.2	70.0	30.0	-56	-48

* For single frequency whose amplitude is the sum of the amplitudes of the two test frequencies

In Table IV are shown the results of distortion measurements made under several typical sets of operating conditions.

OTHER APPLICATIONS

A study of the performance of these tubes as class B amplifiers, as harmonic generators, and as modulators apparently presents no serious additional problems and requires very little in the way of additional new technique. Tests indicate that in the neighborhood of 150 megacycles the performance of these tubes in such modes of operation is comparable to that of conventional pentodes in the ordinary short-wave range. In a two-stage amplifier using these tubes, with the first tube working as a class A amplifier and the second tube under class B conditions an output of over ten watts has been obtained with a second stage plate efficiency of around seventy per cent and with an over-all voltage gain for the two stages of twenty-four decibels. Using the first tube as a harmonic generator, driven at fifty megacycles, and the second tube as a class B amplifier, over six watts of 150-megacycle power have been obtained with an over-all voltage gain from fifty-megacycle input to 150-megacycle output of about four decibels.

CONCLUSIONS

It is often little realized how completely our present highly developed technique of making communications measurements depends upon our ability to set up stable and reliable amplifiers at the frequencies we wish to use. We are now in a position to set up such amplifiers in the ultra-short-wave range; amplifiers of sufficient gain, stability, and most important, of sufficient power handling capacity to enable us to make many of the measurements we may wish, at low enough impedance levels to minimize some of the effects of unavoidable stray inductances and capacitances in our circuits and at high enough power levels to make practicable the use of simple and reliable, and almost necessarily rather insensitive measuring apparatus. Furthermore, our experience in this work indicates that it is not necessary to modify drastically our experimental procedures when we move into the ultra-short-wave field. Much more care in circuit design is required, but with more attention to details formerly unimportant, much of the background of electrical measuring technique becomes, with the advent of this new tool, available in the ultra-short-wave range.



OSCILLATIONS OF HOLLOW QUARTZ CYLINDERS CUT ALONG THE OPTIC AXIS*

By

TSI-ZÉ NY, LING-CHAO TSIEN, AND SUN-HUNG FANG
(Institute of Physics, National Academy of Peiping, Peiping, China)

Summary—Hollow quartz cylinders cut along the optic axis have been excited to vibrate at five fundamental frequencies, corresponding to radial, circumferential, longitudinal, torsional, and transverse vibrations. Empirical relations connecting the dimensions of the cylinders and the frequencies of the different modes of vibrations are formulated. All of these modes of vibrations have been confirmed by examination under polarized light and with lycopodium powder.

INTRODUCTION

A PIEZOELECTRIC quartz plate, when coated with electrodes at opposite ends of the electric axis, can vibrate in three directions; namely, along the electric axis, along the optic axis, and in the direction perpendicular to electric and optic axes. All of these vibrations are longitudinal. J. R. Harrison¹ first pointed out the possibility of producing transverse vibrations, in which the motion takes place in directions perpendicular to the line of propagation. Torsional vibrations about the electric axis and about the third axis have also been excited by Giebe and Scheibe.² A nonuniform exciting alternating electric field is necessary for the excitation of transverse and torsional vibrations; for the production of such a field four electrodes disposed in a suitable manner are, in general, required.

Interested in the experiments of Röntgen³ and Tawil⁴ on the electrification of quartz by torsion, Hund and Wright⁵ tried to set into self-oscillation a quartz cylinder cut along the optic axis, and succeeded only by resorting to circuits which were so regenerative that they were on the verge of self-oscillation.

A careful study of the phenomenon of electrification of quartz crystals by torsion⁶ has led us to work with a coaxial cylindrical shell of

* Decimal classification: 537.65. Original manuscript received by the Institute. September 17, 1935; revised manuscript received by the Institute, July 14, 1936.

¹ J. R. Harrison, *Proc. I.R.E.*, vol. 15, pp. 1040-1064; December, (1927).

² E. Giebe and A. Schiebe, *Zeit. für Phys.*, vol. 46, p. 607, (1928); *Elek. Nach. Tech.*, vol. 5, p. 65, (1928).

³ W. C. Röntgen, *Wied. Ann. der Phys.*, vol. 39, p. 16, (1890).

⁴ E. P. Tawil, *Comptes Rendus*, vol. 187, p. 1042, (1928).

⁵ A. Hund and R. Wright, *Bur. Stand. Jour. Res.*, vol. 4, p. 383, (1930); *Proc. I.R.E.*, vol. 18, pp. 741-761; May, 1930.

⁶ Ny Tsi-Zé and Tsién Ling-Chao, *Comptes Rendus*, vol. 198, p. 1395, (1934), vol. 199, p. 1101, (1934); vol. 200, p. 732 (1935), and *Chinese Jour. Phys.*, vol. 1, no. 3, p. 41, (1935).

quartz, the axis of the cylinder being cut along the optic axis of the crystal. With two electrodes applied to its inner and outer surfaces such a hollow quartz cylinder constitutes a veritable cylindrical condenser, and oscillates in a Pierce circuit as easily as an ordinary piezoelectric quartz plate.⁷

CIRCUITS USED IN THE EXPERIMENTS

The hollow cylinders which we used were carefully cut from optically perfect quartz in such a manner that the inner and outer lateral surfaces are coaxial and the axis of the cylinder is parallel to the optic axis of the crystal. Tin foils coated on the inner and outer surfaces of the cylinder may serve as electrodes and work well for experimental

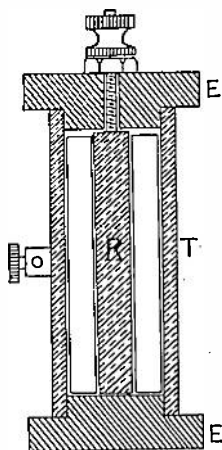

Fig. 1.—The holder for cylindrical quartz oscillator.

purposes, but a simple holder for these quartz cylindrical oscillators serves as a neater arrangement and is schematically shown in Fig. 1.

The holder consists essentially of a brass tube T which serves as the outer electrode and a brass rod R which serves as the inner electrode. The diameter of the rod R is nearly the same as the internal diameter of the quartz cylinder, while the internal diameter of the tube T is about half a millimeter larger than the external diameter of the quartz cylinder. Two ebonite plugs E and E' hold the electrodes in place and at the same time serve as the cover and base of the holder.

The oscillating circuits which we used in the experiments are given in Fig. 2. The arrangement (a) is the ordinary Pierce circuit. The quartz cylinder is connected between the grid and the filament, but it vibrates equally well when connected between the grid and the plate. A hollow quartz cylinder in this circuit vibrates at two fundamental frequencies,

⁷ Ny Tsi-Zé and Tsien Ling-Chao, *Nature*, vol. 134, p. 214, (1934); *Comptes Rendus*, vol. 200, p. 565, (1935).

designated in Table I by f_1 and f_2 , which depend only on the internal and external diameters of the cylinder and are independent of its

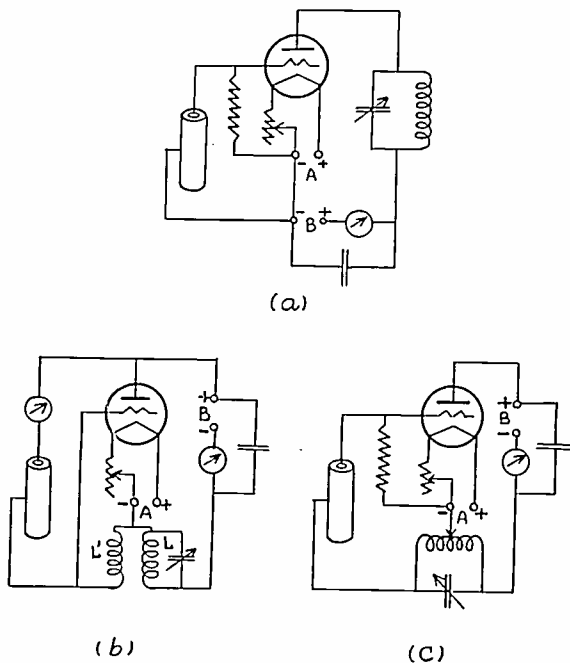

Fig. 2—Driving circuits for oscillations.

TABLE I

No.	I	II	III	IV	V	VI	VII	VIII
l	6.45 cm	5.25 cm	6.30 cm	3.05 cm	0.74 cm	0.49 cm	3.0 cm	2.71 cm
R	0.43 cm	1.35 cm	1.0 cm	0.99 cm	0.99 cm	0.88 cm	0.85 cm	0.87 cm
r	0.1 cm	0.33 cm	0.25 cm	0.25 cm	0.25 cm	0.25 cm	0.25 cm	0.27 cm
r/R	0.23	0.24	0.25	0.25	0.25	0.28	0.29	0.31
f_1	470 kc	242 kc	324 kc	332 kc	347 kc	370 kc	398 kc	410 kc
$f_1(R-r)$	261	248	243	245	256	231	239	246
f_2		151.5 kc	204 kc	204.7 kc	189.6 kc	222 kc	222.8 kc	212 kc
$f_2 \times \pi/3(R+r)$		265	267	266	247	262	257	253
f_3				70.9 kc			73 kc	81 kc
$f_3 \times l$				216			219	220
f_4				102.1 kc				112.5 kc
$f_4 \times l$				311				305

IX	X	XI	XII	XIII	XIV	XV	XVI	Mean
7.3 cm	2.32 cm	3.25 cm	3.2 cm	1.67 cm	3.2 cm	2.98 cm	2.74 cm	
1.18 cm	0.63 cm	0.78 cm	0.78 cm	0.78 cm	0.95 cm	1.18 cm	1.16 cm	
0.55 cm	0.33 cm	0.52 cm	0.52 cm	0.52 cm	0.73 cm	0.96 cm	0.96 cm	
0.47	0.52	0.67	0.67	0.67	0.76	0.81	0.83	
	910 kc	1057 kc	1052 kc	1050 kc		1380 kc	1380 kc	
	273	275	274	273		303	275	
281 kc	512 kc	407 kc	411 kc	408 kc	324.5 kc	260 kc	260.3 kc	260
253	257.5	277.5	280	278	286	292	290.5	260
	96 kc	67.5 kc	68.8 kc	132.5 kc	68.6 kc	73 kc	80 kc	277
	222	219	220	221	219	217	219	220
			97.1 kc	195 kc		104.2 kc	114 kc	
			310	326		311	312	
							233.7 kc	312

length. These frequencies will be shown to correspond respectively to radial and circumferential vibrations.

Other frequencies besides f_1 and f_2 have also been excited in circuits which were somewhat regenerative, such as (b) and (c) in Fig. 2. In circuit (b) the quartz cylinder in series with a high-frequency milliammeter is connected between the grid and the plate and a sensitizing coil⁸ L' is added between the grid and the filament. When the frequency of the circuit is tuned to that of the quartz cylinder, the latter will be set into vigorous oscillation, as shown by a sudden rise in the indication of the milliammeter. In circuit (c), a single coil is used and the grid excitation is obtained by a tap on this coil; this is, in principle, analogous to the ordinary self-controlled Hartley circuit. The quartz cylinder in this circuit is inserted in series with the grid. As the capacitance is increased from a small value, a point is reached at which the system starts oscillating. The oscillations are weak at first, but they become stronger and stronger as the capacitance is increased, and reach a maximum amplitude at a value of C just below that which makes the natural frequency of the LC circuit equal to the natural frequency of the quartz. Past this point the amplitude of the oscillations decreases, and a further increase of C will cause the oscillations to stop suddenly. The frequency in both arrangements (b) and (c) is nearly equal to the natural frequency of vibration of the quartz and varies very little with the condenser setting.

We obtained two additional fundamental frequencies of a hollow quartz cylinder with the arrangement (c), designated by f_3 and f_5 in Table I and three additional fundamental frequencies with the arrangement (b), designated by f_3 , f_4 , and f_5 , besides the frequencies f_1 and f_2 obtained with the Pierce circuit. Two of these frequencies f_3 and f_4 depend only upon the length of the cylinder, and are independent of its cross section. They will be shown to correspond respectively to torsional and longitudinal vibrations. The other frequency f_5 is probably of transverse vibration.

The coupling between L and L' in the arrangement (b) should be as loose as possible and the grid excitation in the arrangement (c) as low as possible, so as to avoid cracking the crystal with excessive power and also to avoid setting up circuit oscillations of other than crystal frequency. An ordinary receiving valve with plate supply of about one hundred volts will work well in all these circuits.

RESULTS

Experimental data for sixteen cylinders of different dimensions are summarized in Table I. A hollow quartz cylinder has been found to

⁸ A. Hinderlich, *Exp. Wireless*, vol. 4, p. 29, (1927).

possess five fundamental frequencies $f_1, f_2, f_3, f_4,$ and f_5 , corresponding respectively to radial, circumferential, torsional, longitudinal, and transverse vibrations.

(1) *Radial Vibration.* The frequency f_1 , as shown in the table, is a function only of the difference between the external and internal radii (i.e., the thickness of the wall) of the cylinder and is independent of its length. It can be expressed by the empirical formula

$$f_1 = \frac{260}{R - r} \text{ kc,}$$

where R and r are the external and internal radii of the hollow cylinder expressed in centimeters.

The constant 260 is the mean of the values obtained with fourteen cylinders. It may vary by more than ten per cent from one cylinder to another, probably as a function of the ratio r/R . When the ratio r/R is greater than 0.6, it approaches the value 273 of a "Curie-cut" quartz plate vibrating along its thickness. This frequency may be therefore considered as corresponding to vibration along the radius of the cylinder.

(2) *Circumferential Vibration.* The frequency f_2 is a function of the mean radius of the hollow cylinder, and is independent of its length. Among the cylinders listed in Table I, there are seven cylinders, namely, Nos. II–VIII, the ratio r/R of which is less than 0.31, and eight cylinders, namely, Nos. IX–XVI, the ratio r/R of which is greater than 0.47. The frequency for the cylinders Nos. II–VIII can be expressed by the empirical formula

$$f_2 = \frac{260}{\frac{\pi}{3} (R + r)} \text{ kc,}$$

while that for the cylinders Nos. IX–XVI can be expressed by the empirical formula

$$f_2 = \frac{277}{\frac{\pi}{6} (R + r)} \text{ kc.}$$

The constants 260, and especially 277, are quite close to the constant 273 of a Curie-cut quartz plate vibrating along the third axis. This frequency may be therefore considered as corresponding to vibration along the circumference of the cylinder. Cylinders II–VIII vibrate in three segments, and cylinders IX–XVI vibrate in six segments.

The circumferential vibration is the most easily excited of all the vibrations of a hollow quartz cylinder.

(3) *Torsional Vibration.* The frequency f_3 can be excited in both circuits (b) and (c) of Fig. 2. It is a function only of the length of the cylinder, and is independent of its cross section. It can be expressed by the empirical formula

$$f_3 = \frac{220}{l} \text{ kc,}$$

where l is the length of the cylinder. The constant 220 is fairly constant for all the cylinders, as shown in the table. From this constant, we deduce the value of torsional modulus of quartz $\mu = 5.13 \times 10^{11}$ by the equation

$$f_{\text{tor}} = \frac{1}{2l} \sqrt{\frac{\mu}{d}},$$

where d is the density of quartz and equal to 2.65 grams per cubic centimeter. This value is in excellent agreement with the torsional modulus of quartz about the optic axis determined by Voigt, Ricke, and Pockels.⁹ This frequency may be therefore taken as corresponding to torsional vibration about the optic axis.

(4) *Longitudinal Vibration.* The frequency f_4 can be excited in circuit (b) of Fig. 2. Like f_3 , it is a function only of the length of the cylinder. It can be expressed by the empirical formula

$$f_4 = \frac{312}{l} \text{ kc.}$$

From the constant 312, which agrees with that of a quartz plate vibrating along the optic axis, we deduce the modulus of elasticity of quartz in the direction of the optic axis $E_0 = 10.3 \times 10^{11}$ from the equation

$$f_{\text{long}} = \frac{1}{2l} \sqrt{\frac{E_0}{d}},$$

in good agreement with Voigt's direct determination.¹⁰ This frequency therefore corresponds to longitudinal vibration of the cylinder along its axis.

(5) *Transverse Vibration.* Cylinder No. XVI in Table I has a fifth fundamental frequency, namely 233.7 kc, obtained with both circuits (b) and (c) of Fig. 2. This frequency coincides approximately with that

⁹ A. Hund and R. Wright, Proc. I.R.E., vol. 18, p. 759; May, (1930).

¹⁰ P. Vigoureux, "Quartz Resonators and Oscillators," p. 15.

calculated from the following theoretical formula of transverse vibration of a hollow cylinder:¹¹

$$f_{\text{tran}} = \frac{\zeta^2}{4\pi} \sqrt{\frac{E_0}{d} \frac{\sqrt{R^2 + r^2}}{l^2}}$$

where the value of ζ for the fundamental mode is 4.71 and d is the density of quartz. However since the coincidence is only approximate and the evidence is as yet meagre, this identification requires further verification.

A hollow quartz cylinder thus possesses five fundamental frequencies, all of which agree fairly well with the empirical formulas which have been assigned to the various modes of vibrations. Some cylinders give one or two other frequencies which are not included in the table because their nature remains somewhat obscure and requires further study.

A circuit which is somewhat regenerative is necessary for the production of torsional, longitudinal, and transverse vibrations of a quartz cylinder. This is due, no doubt, partially to the fact that the modulus δ_{14} , which has the value of $+1.93 \times 10^{-8}$ c. g. s. electrostatic units, is operative¹² in the case of torsional oscillations, whereas the modulus responsible for the radial and circumferential vibrations of a hollow cylinder is the same as that responsible for the more usual "Curie-cut" plate oscillations and has the value $\delta_{11} = -6.45 \times 10^{-8}$ c. g. s. electrostatic units. In the cases of the longitudinal and the transverse vibrations, there is no corresponding direct piezoelectric effect in quartz.

DIRECT OBSERVATIONS OF THE DIFFERENT MODES OF VIBRATIONS

The optical properties of a quartz cylinder are altered when it is in resonance vibration. We have used this phenomenon for the study of the nature of the vibrations. For this purpose, the quartz was generally driven with a type 210 tube with 400 volts on the plate, in order to make the optical effect more marked.

The quartz cylinder under examination had its two bases carefully polished and was so placed in a Norremberg's polariscope that the polarized monochromatic green light from a mercury arc passed through it along its axis. The analyzing Nicol was set in such a position as to have a completely dark field of view. When the quartz cylinder entered into vibration, six bright spots would in general appear. Fig. 3 is the photograph of the pattern observed in polarized light of cylinder No. IV vibrating at its radial mode. The six bright spots ap-

¹¹ See, for example, H. Bouasse, "Verges et Plaques," p. 74 *et seq.*

¹² P. Langevin and J. Solomon, *Comptes Rendus*, vol. 200, p. 1257, (1935).

pear uniformly distributed around the external circumference of the cylinder, with their centers lying on the electric axes AA' , BB' , and CC' of the crystal. Fig. 4 is the photograph of the pattern of the same cylinder vibrating at its circumferential mode. The six bright spots now appear uniformly distributed around the internal circumference

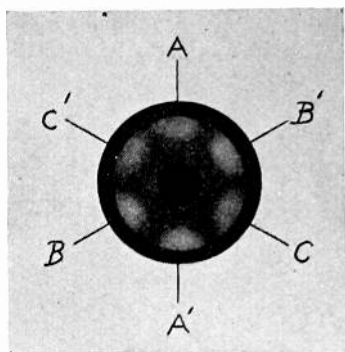
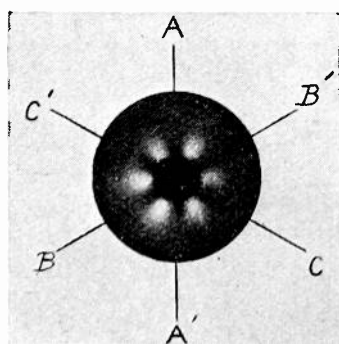
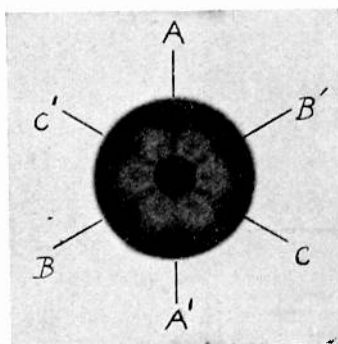

Fig. 3—Radial vibration, examined under polarized light.

of the cylinder, with their centers lying between the electric axes of the crystal. When the vibration attains its maximum amplitude, the spots become larger, and their centers turn dark again (Fig. 4, (b)). This shows that the change of optical properties of quartz in the circumfer-



(a)



(b)

Fig. 4—Circumferential vibration, examined under polarized light.

(a) Moderate vibration.

(b) Strong vibration.

ential vibration is considerable. Six bright spots similarly appear in the longitudinal vibration of the cylinder with their centers between the electric axes as in the case of the circumferential vibration, but these spots then lie in the middle between the internal and external circumferences.

To get some additional information, we sprinkled lycopodium powder over the top face of the cylinder. When the cylinder vibrates, different figures are formed according to the various modes of vibrations. Figs. 5 and 6 are the photographs of the lycopodium figures of cylinder No. IV vibrating at its radial and circumferential modes re-

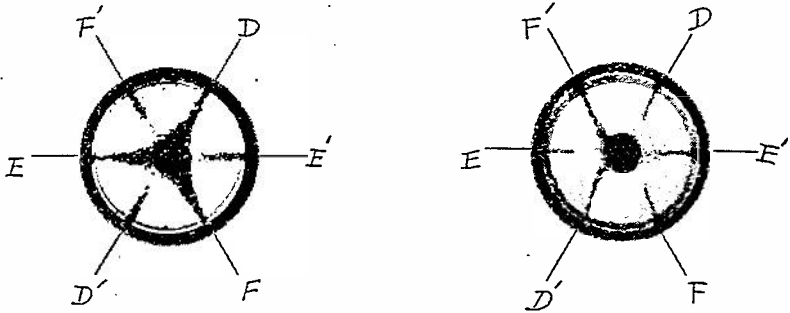

Fig. 5—Lycopodium figure of radial vibration.

Fig. 6—Lycopodium figure of circumferential vibration of a thick hollow cylinder.

spectively. In both cases, the lycopodium particles gather themselves along the bisectors DD' , EE' , and FF' of the angles between the electric axes AA' , BB' , and CC' , forming six alternatively long and short lines. But the long lines formed in radial vibration take the place of the

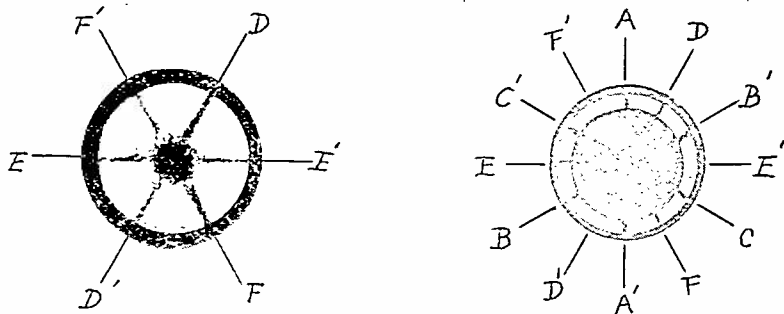

Fig. 7—Lycopodium figure of longitudinal vibration.

Fig. 8—Lycopodium figure of circumferential vibration of a thin hollow cylinder.

short lines in circumferential vibration, and vice versa. The lycopodium figure of the longitudinal vibration of the same cylinder is shown in Fig. 7. The lycopodium particles gather themselves into six lines along the bisectors DD' , EE' , and FF' of the angles between the electric axes. These lines are all of equal length, extending from the inter-

nal to the external circumference. But a careful examination of the figure will reveal that they are not of equal density, but alternatively heavy and light.

Fig. 8 is the lycopodium figure of cylinder No. XVI vibrating at its circumferential mode, the ratio r/R of this cylinder being equal to 0.83. There are nine lines: six along the electric axes AA' , BB' , and CC' , and three on the extremities D , E , and F of the bisectors of the angles between the electric axes. The lycopodium figure of transverse vibration of the same cylinder is shown in Fig. 9. The three lines formed are found lying on the extremities D' , E' , and F' of the bisectors of the angles between the electric axes. In torsional vibration, the lycopodium particles tend to collect themselves into a small sector.

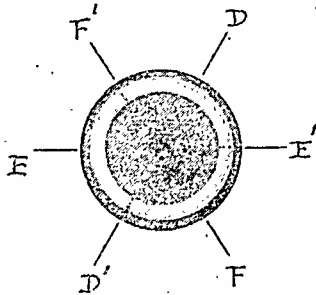

Fig. 9—Lycopodium figure of transverse vibration.

The positions of the electric axes in the cylinder were marked out before it was cut from the crystal, and the positions relative to these axes of the lycopodium lines and the bright spots observed in polarized light in the different modes of vibrations have been carefully noted during the experiments. The six bright spots in radial vibration mark clearly six regions of alternating dilatation and contraction, and the lycopodium lines which in this case lie intermediately between the adjacent bright spots evidently represent the lines of zero elongation. The planes of maximum amplitude of vibration therefore coincide with the diametral planes containing the electric axes of quartz crystal.

In circumferential vibration, the lycopodium lines and the centers of the bright spots both lie on the bisectors of the angles between the electric axes. The six bright spots show six regions of alternating condensation and rarefaction, and the lycopodium lines mark out the six nodal lines. The loops of vibration are therefore in the diametral planes containing the electric axes of the crystal. The lycopodium figures of the transverse and longitudinal vibrations show that the

cylinder is divided into three or six parts in these vibrations. This is to be expected from the anisotropic property of quartz.

Most of the cylinders, the fundamental frequencies of which we have determined, have been examined under polarized light and with lycopodium powder. Those frequencies listed as belonging to the same mode of vibration give identical polarized light patterns and lycopodium figures of the same general nature, thus confirming our assignment of modes to the various oscillation frequencies.

The vibrating cylinders have also been examined with glow discharges under a gas pressure of several millimeters of mercury. Patterns of various forms have been observed and will be described shortly.



A HARMONIC METHOD OF INTERCOMPARING THE OSCILLATORS OF THE NATIONAL STANDARD OF RADIO FREQUENCY*

By

E. G. LAPHAM

(National Bureau of Standards, Washington, D.C.)

Summary—A method of precisely measuring the frequency difference between two frequency standards which have nominally the same fundamental frequency is outlined. The application of this method to the continuous intercomparison of the piezo oscillators in the primary frequency standard maintained by the National Bureau of Standards is described.

The customary method of measuring the frequency difference between two piezo oscillators utilizes the beat frequency between the two standards at the fundamental frequency or one of the harmonics. The method described utilizes the frequency produced by heterodyning two consecutive harmonics to obtain any desired precision of frequency comparison without necessitating the operation of any circuits at exceedingly high frequencies.

I. INTRODUCTION

THE primary frequency standard which is maintained by the National Bureau of Standards is described in the paper "The national primary standard of radio frequency."¹ As described in that paper the output frequencies of the individual piezo oscillators which together constitute the primary frequency standard are continuously measured in terms of the frequency of one of the oscillators as a reference. This measurement has hitherto been made by heterodyning the output of each of the standards with the output of the reference standard, and recording graphically the frequency difference. The range of the recorder was from 0 to 0.4 cycle per second. Since the measurement was made at the fundamental frequency, 100 kilocycles per second, this range corresponded to a change in the frequency of the standard of four parts per million. There are 100 divisions on the recorder paper so that, other conditions being constant, the changes of the frequency difference could be read to ± 2 parts per hundred million.

The precision of this method of intercomparison was adequate at the time the standard was originally installed. The frequency variations were of such a magnitude that better precision was unnecessary.

* Decimal classification: R213.1. Original manuscript received by the Institute August 11, 1936. Publication approved by the Director of the National Bureau of Standards of the U. S. Department of Commerce.

¹Hall, Heaton, and Lapham, *Nat. Bur. Stand. Jour. Res.*, vol. 14, p. 85, (1935). RP759.

In the course of time, however, the variations of frequency were reduced considerably, with the result that the record obtained with this arrangement was practically a straight line. It showed the gradual changes in the frequency differences over a period of a few days but did not resolve the random variations of small magnitude which take place during shorter time intervals such as an hour or a few hours.

The simplest method of increasing the precision of the recorder was to measure the beat frequency at a harmonic of the fundamental frequency. If the reference standard has a frequency F and a standard to be compared with it has a frequency $F \pm f$, the frequency difference is f cycles per second. Multiplying both standards by a factor n , the frequency difference is given by

$$n(F \pm f) - nF = nf.$$

The precision of the measurement is multiplied by a factor equal to the harmonic number if the accuracy of the recording equipment remains the same. This condition can be realized if the frequencies of the different standards are sufficiently close to one another so that the range of beat frequency to be recorded is unchanged.

A consideration in the choice of methods was the desirability of making maximum use of the existing equipment. This included 100-kilocycle mixing circuits which produced the beat frequency to operate the recorder. In order not to discard those circuits it was necessary to use a method which produces the beat-frequency difference for the harmonic frequencies by mixing appropriate 100-kilocycle outputs.

II. METHOD

The method utilizes the frequency difference between two successive harmonics of the fundamental frequency. If the frequency of any standard is multiplied by a factor n , and the frequency of the reference standard is multiplied by a factor $(n-1)$, the frequency difference is given by

$$n(F \pm f) - (n-1)F = nF \pm nf - nF + F = F \pm nf.$$

This intermediate frequency differs from the fundamental frequency of the reference oscillator by an amount equal to n times the frequency difference between the two standards at their fundamental frequency or nf . If this process is repeated, multiplying the above intermediate frequency by the factor n , and subtracting from it the fundamental frequency of the reference standard multiplied by the factor $(n-1)$, a new intermediate frequency is obtained which is equal to

$$n(F \pm nf) - (n-1)F = nF \pm n^2f - nF + F = F \pm n^2f.$$

The intermediate frequency now differs from the fundamental frequency of the reference standard by a factor n^2f . This process of multiplication can be repeated until the frequency difference is of any desired magnitude.

The above arrangement as applied to the intercomparison of the oscillators of the primary standard is shown schematically for a single unit in Fig. 1. The frequency of the reference standard is multiplied by nine by means of a harmonic amplifier. If the fundamental frequency of the reference standard is 99,999.98 cycles, the output of the frequency multiplier will have a frequency of 899,999.82 ($9 \times 99,999.98$) cycles. In a similar manner the frequency of the standard to be compared

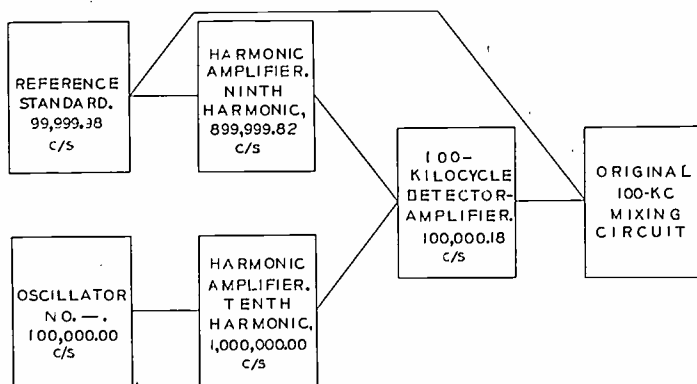

Fig. 1—Schematic diagram of method of comparing a standard with reference standard.

with the reference standard is multiplied by ten, which gives an output of 1,000,000.00 ($10 \times 100,000.00$) cycles if this standard has a fundamental frequency of exactly 100,000.00 cycles. Combining these two outputs in a detector-circuit arrangement a difference frequency is produced which is nominally 100,000 cycles and in the illustrative example is exactly 100,000.18 cycles. This 100-kilocycle output is amplified and coupled, along with the output of the reference standard, into the mixing circuits provided in the old arrangement. The difference frequency so produced is recorded just as in the old method. The beat frequency would be 0.20 cycle ($100,000.18 - 99,999.98$) which is exactly ten times the beat frequency at the fundamental. The result is that the recorder indicates the frequency changes on the tenth harmonic, 1000 kilocycles. If a higher order of precision is desired, this process can be repeated, using the 100-kilocycle output of the detector amplifier as the input to the succeeding multiplier.

The equipment for the intercomparison of the entire group of standards consists of a frequency multiplier for the reference standard, to change its frequency from 100 to 900 kilocycles, a frequency multi-

plier for each of the standards to be recorded, to change their frequency from 100 to 1000 kilocycles, a detector amplifier for each standard, and the present intercomparison equipment.

III. CIRCUIT ARRANGEMENT

The harmonic amplifier circuit arrangement is shown in Fig. 2. Two harmonic amplifiers are used as frequency multipliers, one pro-

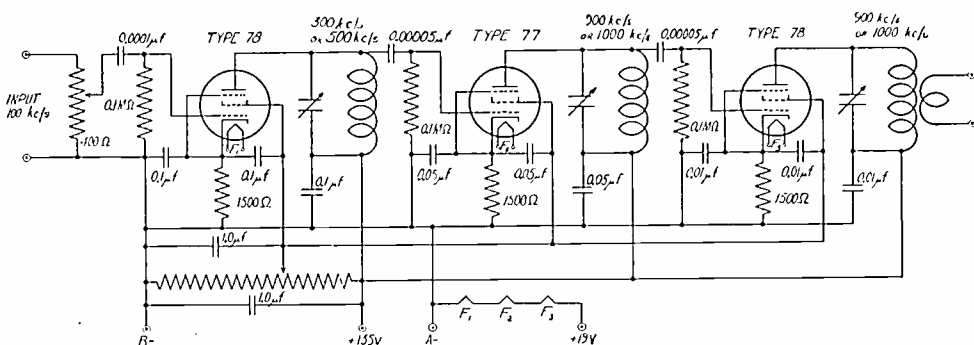

Fig. 2—Circuit arrangement of harmonic amplifiers.

viding a nine-to-one and the other a ten-to-one multiplication. In the frequency multipliers the plate circuits of the multiplier stages are tuned to the desired harmonic. The tuned circuits must be low-loss circuits in order to reduce the troublesome effect of amplitude modulation at the input frequency. The multiplier stages are followed by an output amplifier which provides the necessary power output and also

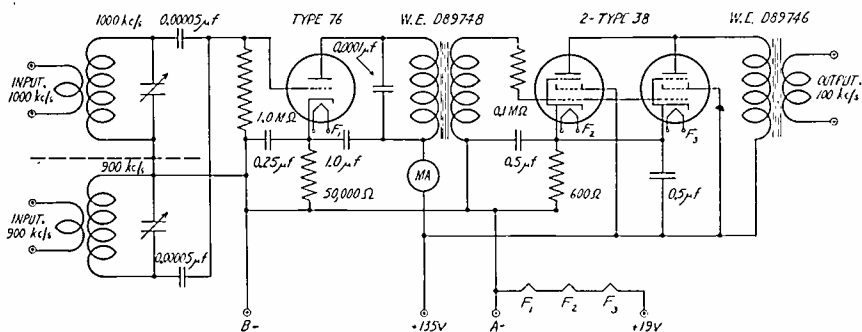

Fig. 3—Circuit arrangement of 100-kilocycle detector-amplifier.

serves to reduce further the amplitude of undesired components of the input voltage. A low impedance link circuit, consisting of a single turn closely coupled to the amplifier plate coil is used to couple the output of the harmonic amplifier to the 100-kilocycle detector and amplifier.

The circuit diagram of the 100-kilocycle detector and amplifier is shown in Fig. 3. The outputs of the 900- and 1000-kilocycle harmonic

amplifiers are link-coupled to 900- and 1000-kilocycle tuned circuits. These tuned circuits are capacitively coupled to a detector biased for

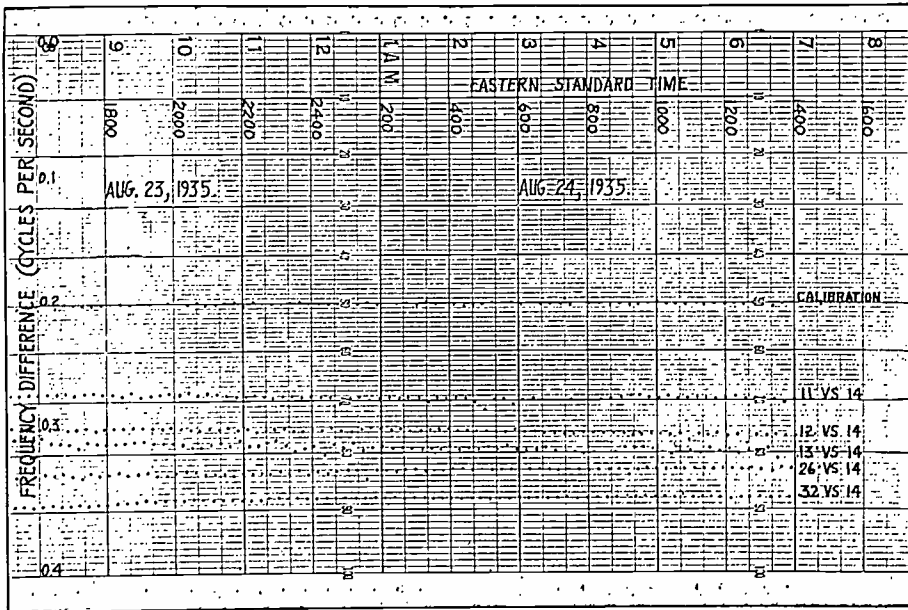

Fig. 4—Sample record of beat frequency at fundamental frequency.

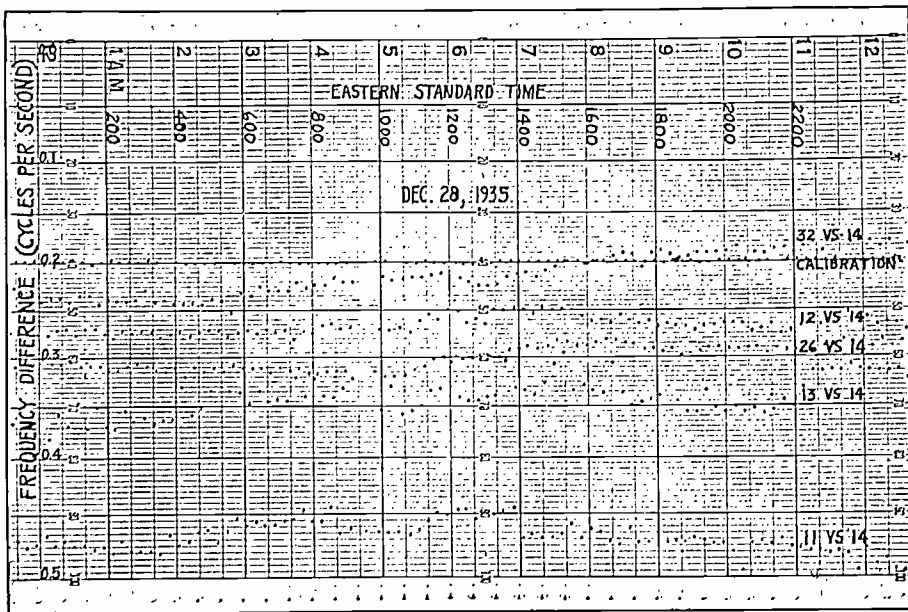

Fig. 5—Sample record of beat frequency at 10th harmonic.

plate detection. A meter which reads detector plate current is provided as an aid in adjusting the circuits. The detector is followed by a 100-kilocycle amplifier using two type 38 tubes in parallel. At a little

sacrifice in voltage two separate outputs can be obtained by connecting these tubes separately. Space is provided for the additional transformer if the need arises.

IV. RESULTS

The records of the frequencies of the different standards show the effectiveness of this arrangement in increasing the accuracy of the frequency intercomparisons. A sample record obtained with the recorder operating on the fundamental frequency is shown in Fig. 4. A similar record when the frequency difference is measured on the tenth harmonic is shown in Fig. 5. In Fig. 4, one small division on the record corresponds to a frequency change of four parts per hundred million, while in Fig. 5 it corresponds to a change of 0.5 part per hundred million.

V. ACKNOWLEDGMENT

A method of increasing the precision of intercomparison of two frequency standards, which is identical in principle to the one described, was suggested by my colleague, Mr. W. D. George, prior to the development of this equipment.



THIS MATTER OF CONTACT POTENTIAL*

By

R. M. BOWIE

(Hygrade Sylvania Corporation, Emporium, Pennsylvania)

Summary—The term "contact potential," when used in connection with thermionic vacuum tubes, has come to include certain combinations of spurious voltages which affect the operation of the tube. The combination which is effective depends upon the method of measurement used or upon the application to which the tube is put. The combinations which are effective are grouped under four heads: (1) floating element potential, (2) floating, shunted element potential, (3) effective current cutoff, and (4) calculated correction potential. The first three are points upon the current-voltage characteristic of the element while the fourth is the correction term appearing in the equation giving plate current as a function of the applied voltages. The true nature of contact potential is also pointed out.

THE term "contact potential," in connection with thermionic vacuum tubes, has come to include a combination of several spurious voltages which affect the operation of the tube. The so-called contact potential between the cathode and grid in a triode, for instance, may be made up of effects due to velocity of emission of electrons from the cathode, grid emission, grid leakage current, gas ions and true contact potential. A similar combination of spurious voltages show themselves in the case of diodes.

The reasons for grouping several such voltages together are the difficulty of measuring each separately and the fact that their total is usually less than a volt. Although some combination of spurious voltages exists between every element and its cathode, only the combinations which apply to elements at low potential with respect to their cathode and which exert a large control upon the electron stream need be considered. Thus, in multielement tubes or polyodes, the control grid or a diode plate is usually the only critical element. In what follows, the word element will be used to mean any critical element other than the cathode.

The combination effective is not only a constant of the element's position and material but is a function also of the applied voltages and the method of measurement. The quantities commonly measured may be divided into four groups: (1) floating element potential, (2) floating, shunted element potential, (3) effective element current cutoff, and (4) calculated correction potential.

* Decimal classification: R262.9. Original manuscript received by the Institute, June 12, 1934; revised manuscript received by the Institute, December 22, 1935. Presented before Ninth Annual Convention, Philadelphia, Pennsylvania, May, 28, 1934.

FLOATING ELEMENT POTENTIAL

The floating element potential is the potential which the element assumes when disconnected, all other elements having normal applied voltages.

This potential may be ascertained from data taken with the element connected to certain circuits.

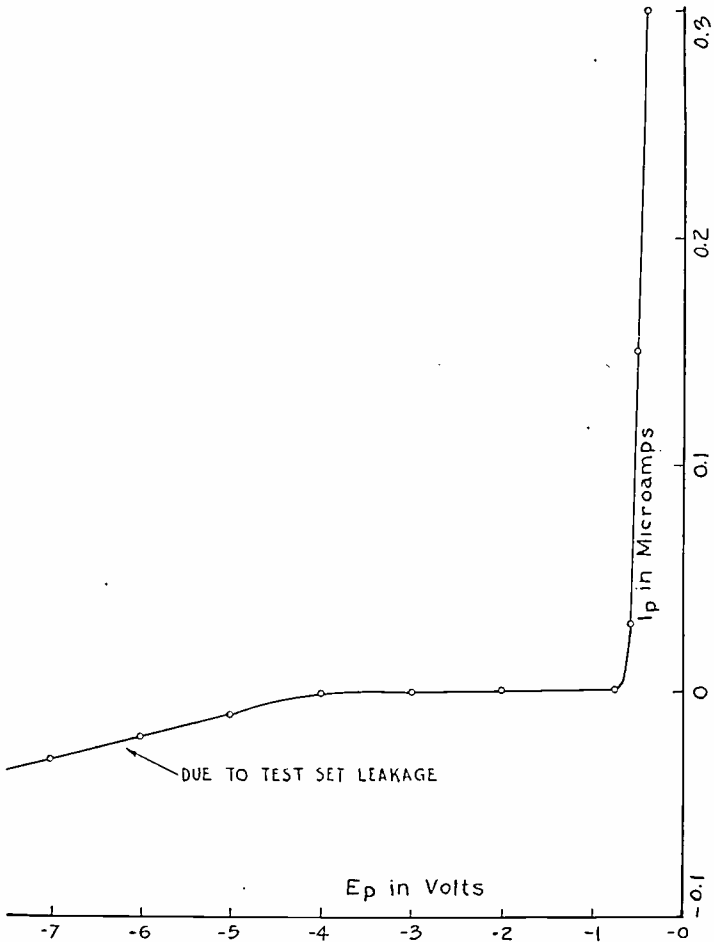

Fig. 1—Diode plate current vs. plate voltage for type 75.
 $E_a = 6.3$ volts

The first method of measurement which suggests itself is the use of a vacuum tube voltmeter. With this instrument a correct reading will be obtained only when the direct-current input resistance of the measuring tube is extremely high so as to be at least several times the direct-current resistance of the element being measured.

Determination of the potential at which the element current reverses also yields the floating element potential. In the case of the diode whose plate current vs. voltage curve appears in Fig. 1, it is evident

that a sensitive galvanometer is required to detect the point of reversal. The current drops nearly to zero at -0.75 volt and remains so near the zero current axis out to -3 volts that a microammeter will not detect the point of crossing. Unless gas or leakage currents are appreciable, the same is also true of control grids. (Fig. 2.)

In actual operation it is seldom that the floating plate potential of a diode is of importance. However, the floating grid potential of a tri-

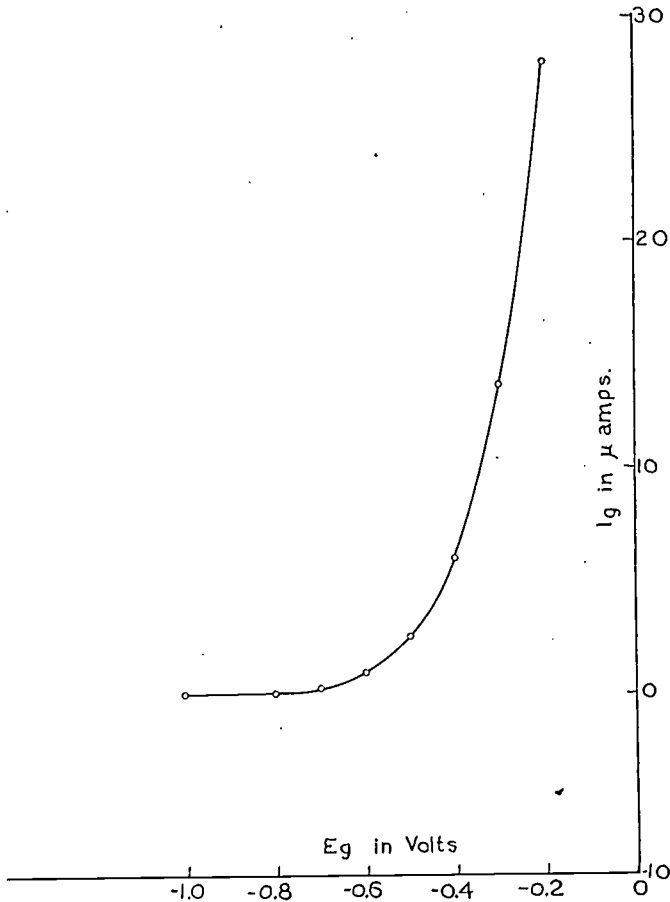

Fig. 2—Grid current vs. grid voltage curve for type 75.

$$E_h = 6.3 \text{ volts}$$

$$E_p = 250 \text{ volts}$$

ode or polyode is of interest in some scientific investigations in which the ions produced by neutrons, gamma rays, or X rays slightly shift the potential of the floating grid of the first stage of a high gain amplifier. Here the floating grid potential is the operating point of the tube.

FLOATING, SHUNTED ELEMENT POTENTIAL

The potential which the element assumes when connected externally to the cathode through a high resistance is the floating, shunted

element potential. All other elements are assumed to have normal applied voltages. In reporting this potential it is necessary, therefore, to state the size of the shunt. The same methods of measurement can be used as for the floating element potential. However, the direct-current input resistance of the vacuum tube voltmeter need only be large compared to the shunt. A microammeter will also suffice to determine the point of reversal of element current when a shunt of a megohm or less is used. By the use of Ohm's law the current through the shunt may also be used to determine this potential.

In the case of the skeleton automatic volume control circuit (Fig. 3) in which the diode current through a shunt furnishes part of the biasing voltage for certain of the preceding stages of amplification, the shunted, floating diode plate potential is important. As shown in Fig. 3, the potentials developed across the resistors R_3 and R_4 bias the grids of

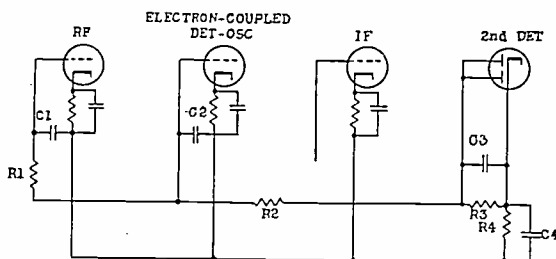

Fig. 3—Skeleton automatic volume control circuit.

two preceding stages. No grid current is assumed to flow to or from the controlled tubes. Therefore, the zero signal bias upon the controlled grids is determined by the voltage developed across R_4 due to the zero signal current of the second detector plus the shunted, floating plate potential of the diode.

In the same circuit the shunted, floating grid potentials of the controlled tubes are also of interest. The constants of the circuit must be so chosen that the potential of each grid with respect to its cathode always remains more negative than the shunted, floating grid potential of the tube. Otherwise, current will flow in the grid circuit which will increase the bias on all tubes which operate to produce automatic volume control and thereby limit the amplification in addition to producing distortion.

EFFECTIVE ELEMENT CUTOFF

True cutoff is the negative potential at which the element current vanishes and beyond which it remains at zero. In actual tubes the current drops to zero, but reverses with increasing bias. In a perfect tube having no leakage, gas ions, or secondary emission, the true cutoff is

at some very negative voltage or at minus infinity. An explanation of this appears later in connection with equation (2). For these reasons effective cutoff is defined as the potential at which the element current becomes less than some predetermined small value, such as one tenth microampere. In the case of the diode plate current vs. voltage curve of Fig. 1, the effective cutoff at 10^{-7} amperes is -0.53 volt and for 10^{-6} amperes it is -0.37 volt. It is interesting to note how these differ from the value of floating plate potential which lies somewhere between 2 and 2.5 volts.

As tubes other than diodes usually have from 0.1 to 5 microamperes of gas current depending upon their type and age, most sets are made to tolerate grid currents of this order. Therefore, for all practical purposes, the grid current has reached cutoff when it becomes less than the limit set for gas current.

Inasmuch as the first three potentials just discussed are points on the voltage-current curves of the element, it is of interest to investigate the various components of the element current. The total element current is made up of electrons from the cathode, $-I_c$, electron leakage current to the element, $-I_1$, primary or secondary emission from the element, I_e , primary or secondary emission to the element from other elements exclusive of the cathode, $-I_s$, and gas current, I_g , as follows:

$$\begin{aligned} I_c + I_1 + I_e + I_s + I_g &= I_{\text{element}} & (1) \\ &= 0 \text{ case (1)} \\ &= E/r \text{ case (2)} \\ &= K \text{ case (3)} \end{aligned}$$

E is the floating, shunted element potential and r is the shunt resistance. K is the effective element current cutoff.

It is very interesting to note the manner in which each component of (1) may be expected to vary with voltages near zero. In case the polyode is a diode, the plate of which is quite negative, the hot cathode constantly emits electrons most of which return. Only the fast ones oppose the retarding field and reach the plate. The works of Schottky¹ and Jones² have shown that the thermal electrons are emitted from the cathode with a Maxwellian distribution of velocities and are in thermal equilibrium with the cathode. The plate current, when not space-charge-limited, obeys the following equation in which E' is the retarding potential corrected for true contact potential, e is the charge on the electron, k is the gas constant per electron, T is the absolute temperature of the cathode, and I_0 is the current at $E' = 0$:

¹ Schottky, *Ann. der Phys.*, vol. 44, p. 1011, (1914).
² Jones, *Proc. Royal Soc., A*, vol. 102, p. 734, (1923).

$$I_c = I_0 \exp - E'e/kT. \quad (2)$$

As the negative plate bias becomes small, space charge begins to limit the current and the form of (2) changes continuously to the familiar three-halves power law. Although (2) indicates that the plate current is zero only when $E' = -\infty$, this is probably not the case. Its derivation from the Maxwellian distribution law assumes an infinite number of electrons in equilibrium with the cathode temperature. The quantity of energy in the system would therefore be infinite, while in

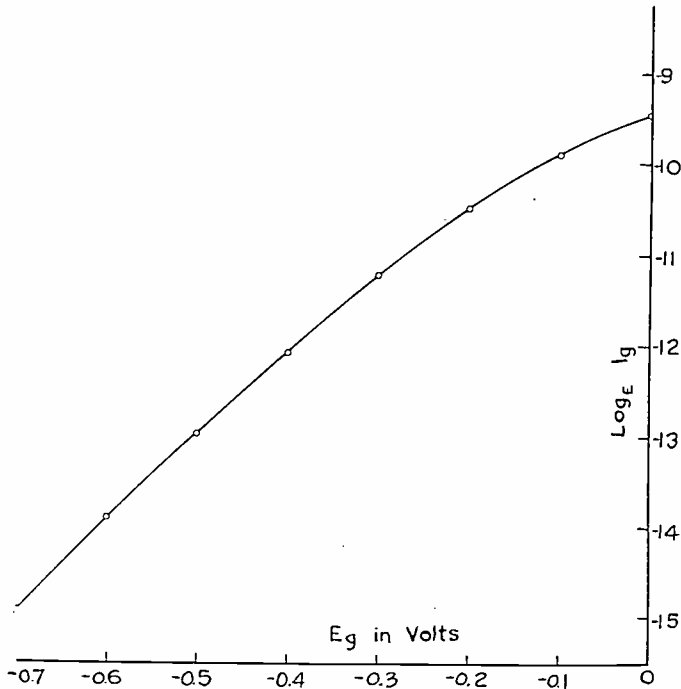

Fig. 4— Log_{10} grid current vs. grid voltage curve for type 75.
 $E_h = 6.3$ volts
 $E_p = 250$ volts

an actual tube there is a finite, but large, number of electrons between the cathode and plate and their total energy is finite. The fastest electron which could exist in this space is one having all the energy while the rest are temporarily stationary. This condition is extremely improbable. The highest probable energy which any electron would have is much lower than the extreme but is still of a high order.

For a polyode of more than two elements in which the critical one is a grid, (2) is not followed exactly because of the space-charge effect of the plate current. However, the form of the curve is usually nearly exponential as can be seen from Fig. 4. As in the case of the diode, therefore, there is a finite but remote negative potential at which the grid current of a perfect polyode vanishes.

I_1 is made up of electron-leakage current through the insulating supports and across their surfaces. This current frequently does not obey Ohm's law, but rises as some power of the voltage greater than one. Inasmuch as a critical element is usually at low potential with respect to the cathode the element emission must be either thermionic or photoelectric since impinging electrons have insufficient velocity to excite secondaries. The low potential of the element also prevents electrons from other parts of the tube from reaching it. Hence $I_s = 0$. The ion current, I_o , is due to ionization of the gas in the tube by the space current. In case the critical element is a grid, this ion current usually decreases with increasing element bias because of the decrease in ionizing space current passing it.

All of these components except I_c may be considered as spurious and seldom assume large proportions in the vicinity of the element current reversal. In cases (2) and (3) above, the effect of these spurious currents is negligible, while in case (1) their sum is balanced against I_c , giving erratic values of floating element potential.

CALCULATED CORRECTION POTENTIAL

The calculated correction potential, unlike the preceding three potentials, is not a point on the tube's voltage-current curve. It is defined here as the small quantity which is added to the voltage term of the polyode current equations. In van der Bijl,³ it is denoted by ϵ while here the letter v will be used. The method of evaluation will be illustrated for the triode grid.

It will be assumed that the triode plate current is given by the following equation, in which C is not a function of the applied voltages, E_g is the voltage on the grid, E_p is the plate voltage, $\mu = (-dE_p/dE_g)_I$, and n is a constant.

$$I = C(E_g + E_p/\mu + v)^n \quad (3)$$

$$I^{1/n} = C^{1/n}(E_g + E_p/\mu + v). \quad (4)$$

If the full line in Fig. 5 is the plate-current vs. grid-voltage curve of the triode, the dashed line is the $I^{1/n}$ vs. E_g curve. The value of n is so chosen that the dashed curve is straight in the vicinity for which the correction potential is wanted. Usually it is 3/2. The dotted line is then drawn through the straight portion of the dashed curve and intersects the voltage axis at E_{g0} . If (4) is set equal to zero and solved for v , (5) results:

$$v = -E_{g0} - E_p/\mu. \quad (5)$$

³ Van der Bijl, "Thermionic Vacuum Tubes," McGraw-Hill, (1920). Page 42, section 22.

Thus the value of v may be determined graphically.

In the case of a diode $I^{1/n}$ is plotted against E_p . If E_{p0} is the intercept on the $I_p^{1/n}$ axis then

$$v = - E_{p0}. \tag{6}$$

It is also possible to derive values for v from certain of the static and dynamic characteristics taken at the point for which the correction

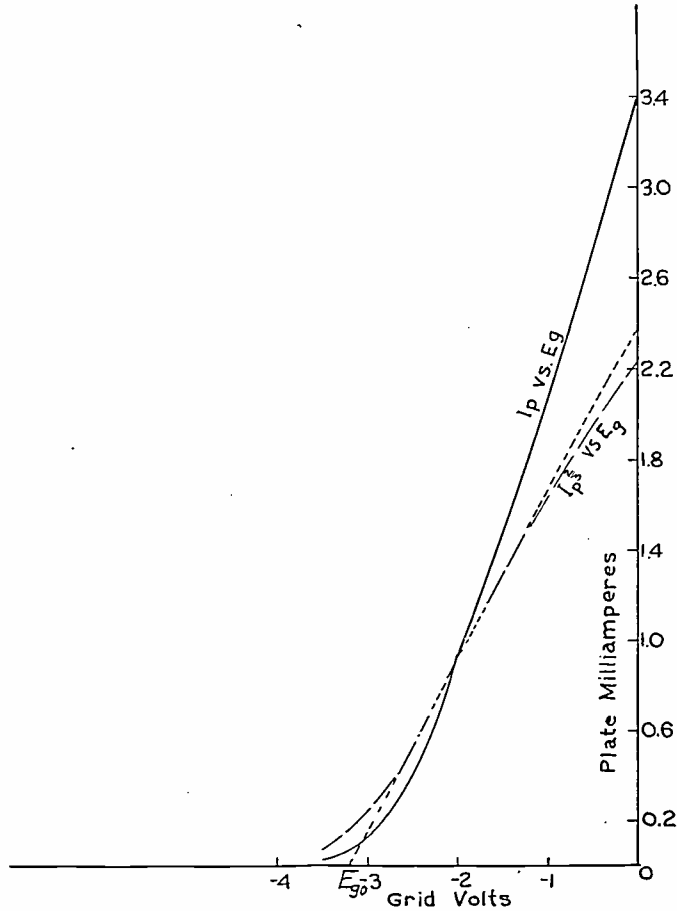

Fig. 5—Correction potential for type 75 grid by graphical method.

$$\begin{aligned} E_h &= 6.3 \text{ volts} \\ E_p &= 250 \text{ volts} \end{aligned}$$

potential is desired. The slope of the dotted line in Fig. 5 is given as follows:

$$S = (I^{1/n} - 0)/(E_g - E_{g0}) \tag{7}$$

or,

$$= \left(\frac{dI^{1/n}}{dE_g} \right) E_p, \mu, n. \tag{8}$$

Equation (9) follows from (8) when g_m , the mutual conductance, is substituted for dI/dE_g .

$$S = (1/n)g_m I^{(1/n)-1}. \tag{9}$$

Substitution of (9) and (7) in (5) yields the equation,

$$v = E_p/\mu - E_g + nI/g_m. \tag{10}$$

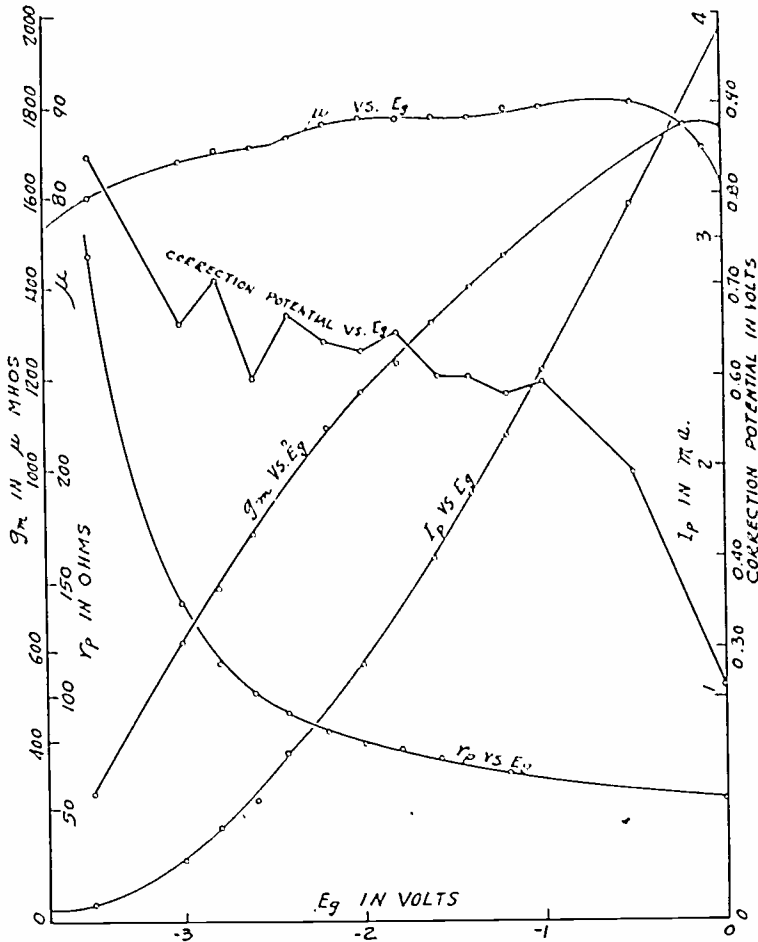

Fig. 6—Triode grid correction potential vs. grid voltage.
 Triode amplification factor vs. grid voltage.
 Triode mutual conductors vs. grid voltage.
 Triode plate current vs. grid voltage.
 Triode plate resistance vs. grid voltage.
 Type 75 $E_h = 6.3$ volts
 $E_p = 250$ volts

The corresponding equation for the diode can be similarly derived and is

$$v = -E_p + nI r_p \tag{11}$$

where r_p is the alternating-current plate resistance. Usually n can be taken to be $3/2$ in either (10) or (11).

The calculated correction potential is a function of nearly all of the structural variables of a tube as well as of the applied voltages. Its variation with grid voltage in the triode section of a type 75 tube⁴ is shown in Fig. 6. Fig. 7 gives the manner in which v for one diode section of the same tube varied with the plate voltage. The average variation

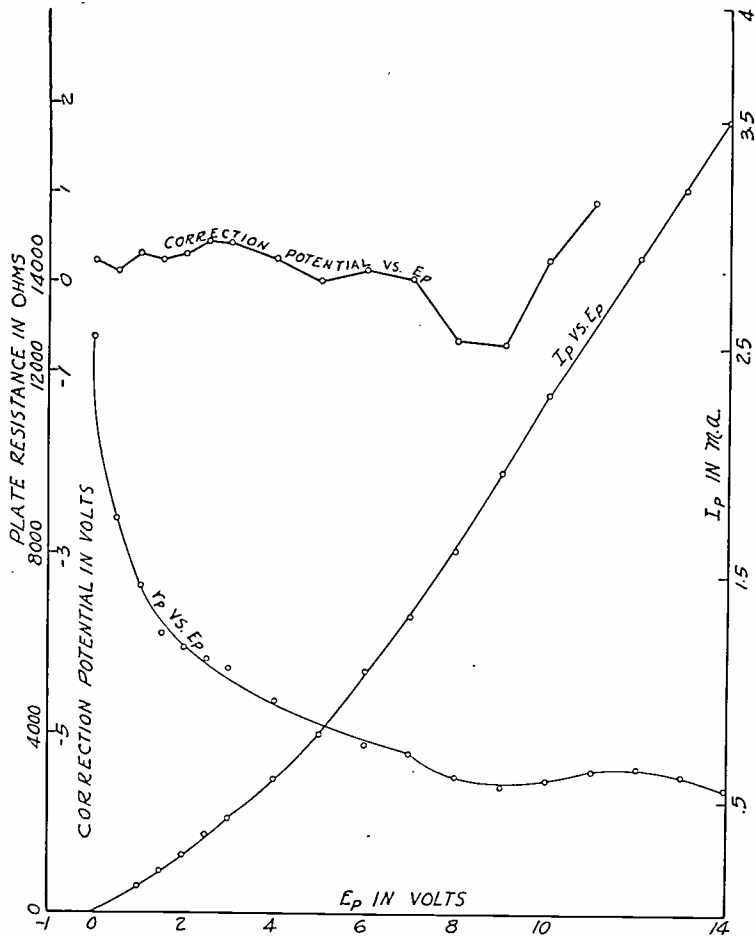

Fig. 7—Diode plate correction potential vs. plate voltage.
Diode plate current vs. plate voltage.
Diode plate resistance vs. plate voltage.
Type 75 $E_h=6.3$ volts

during life of the triode grid correction potential for four tubes is shown in Fig. 8.

It is because of its dependence upon structural variables that this quantity is of particular interest to the tube manufacturer. For in-

⁴ A type 75 tube consists of a high- μ triode and two small diodes located about different sections of the same cathode. This tube was chosen here because slight variations in any of the spurious voltages markedly affect its characteristics. This is to be expected as $E_g + E_p/\mu$ in (3) is only $-2 + 250/100 = 0.5$ volt for the triode section.

stance, one structure of type 75 tube has an average triode grid correction potential of 0.5 volt, while another with slightly larger grid and plate, but with practically the same operating characteristics, has a correction potential of 0.75 volt. A change of grid material also has a marked effect upon this potential.

TRUE CONTACT POTENTIAL

True contact potential is a function only of the nature of the two surfaces and does not depend upon sizes, shapes, or the distance of

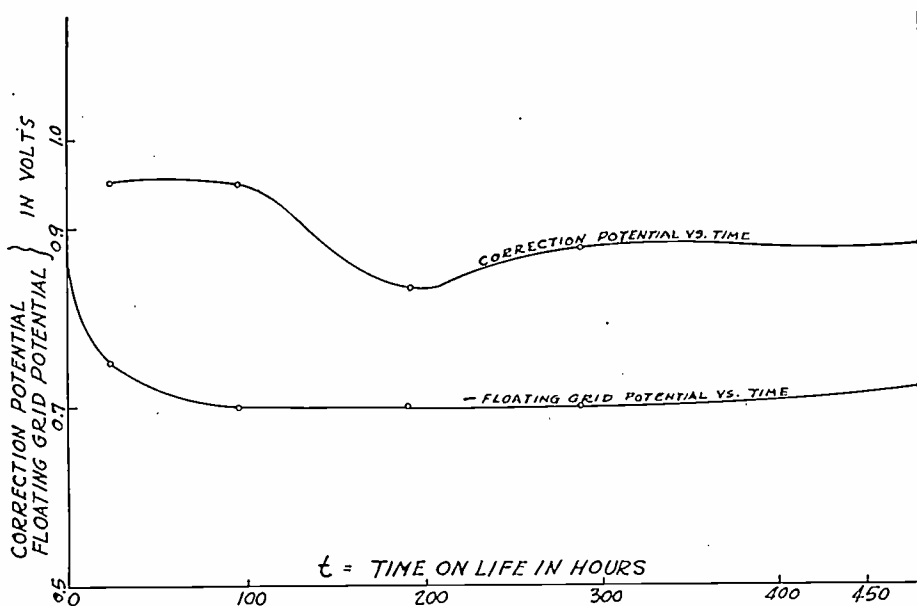

Fig. 8—Triode grid correction potential vs. time of life.
 Negative floating grid potential vs. time of life.
 Type 75 $E_h = 6.3$ volts
 $E_p = 250$ volts

separation. This has been pointed out in numerous works^{3,5} and will be presented here in a slightly different form for the purpose of clearness only.

An electron located just outside of b in Fig. 9 has, on the average, the energy given by the first member of (15). T is the absolute temperature and k is the gas constant per electron. Upon passing into b the electron gains the energy given by the second member where e is the electronic charge and ϕ_b is the work function of b . The energy given by the third term is gained on passing from T_b to T_a . The heat capacity

³ Van der Bijl, *loc. cit.* page 26, section 17.

⁵ "Theory of Thermionic Vacuum Tubes," E. L. Chaffee, McGraw-Hill (1933). Page 63, section 34.

of electrons within metal b is denoted by c . At the junction between a and b there is a Peltier potential P which contributes the energy in the fourth term to the passing electron. Terms five and six are the same as the first two with the subscripts changed. Their signs are different because the direction of passage of the electron is opposite. V denotes the true contact potential between a and b , and W is the energy gained by the electron in making the complete cycle.

$$\int_0^{T_b} \frac{3}{2} k dT - \phi_b e + \int_{T_b}^{T_a} c dT - P e - \int_0^{T_a} \frac{3}{2} k dT + \phi_a e + V e = W. \quad (15)$$

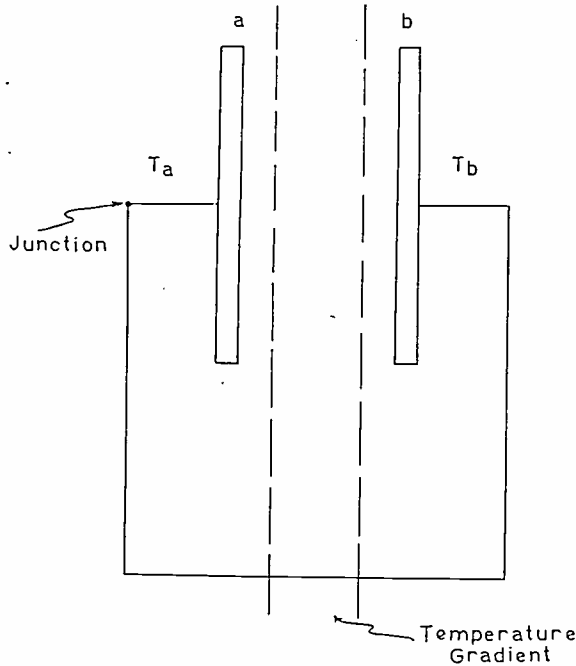

Fig. 9

When both plates are at the same temperature W must vanish. Terms 1, 3, and 5 also vanish leaving the following relationship for V . This is really the definition for V :

$$V = \phi_b - \phi_a + P. \quad (16)$$

Usually the work functions of metals are of the order of a few volts while the Peltier potential between them is of the order of a few millivolts. For all practical purposes, therefore, the last term in (16) may be neglected.

Return now to (15), in which $T_a \neq T_b$. Because of the form of energy distribution between electrons within a metal, their heat capacity is practically zero. This assumption is also used in the derivation of the

T^2 form of Richardson's equation from the Clausius-Clapeyron equation.⁶ The third term in (15) may, therefore, be neglected. If Pe is also neglected, (15) then takes the form given below:

$$W = \frac{3}{2} k(T_b - T_a). \quad (17)$$

In case a is hotter than b , electrons passing completely around the cycle in the direction from b to a through the wire will, on the average, lose energy. According to the principle of Le Chaterlier, any reaction which decreases the energy of a system will tend to go spontaneously. Therefore, electrons may be expected to move through the wire from b to a when a is hotter. Such we know to be the case.

CONCLUSION

The foregoing discussion indicates that the various quantities called "contact potential" differ widely in nature and in values. Further, they bear no direct relationship to the true quantity. Because of misunderstandings which have arisen in the past and to prevent possible ones in the future, the term "contact potential" should be reserved for the quantity defined by (16). When reporting the other quantities, names should be used which adequately describe them.

⁶ S. Dushman, *Rev. Mod. Phys.*, vol. 2, p. 381, (1930).



A STUDY OF THE CHARACTERISTICS OF NOISE*

By

V. D. LANDON

(RCA Victor Division, RCA Manufacturing Company, Inc., Camden, New Jersey)

Summary—It is well known that when smooth noise such as hiss is passed through or generated in a radio-frequency amplifier, the root-mean-square output is proportional to the square root of the frequency band width. Experiments are described which show that the peak value of the hiss is also proportional to the square root of band width. The crest factor (defined as the ratio of the amplitudes of the highest peaks to the root-mean-square value) was found to be equal to 3.4 and independent of band width.

When the noise is caused by impulse excitation with decay trains not overlapping, the result is quite different. The root-mean-square amplitude is still proportional to the square root of frequency band passed; however the peak amplitudes are directly proportional to the first power of the frequency band. This result is verified mathematically and experimentally.

INTEREST in noise reducing methods is on the increase. This is because of the partial success obtained by the use of limiters with or without wide band amplifiers, and by the use of frequency modulation. As a preliminary to understanding the operation of these systems, the characteristics of noise itself must be studied. A great deal has already been learned about the characteristics of noise. It is the purpose of this paper to clear up certain disputed or unknown points.

For the purposes of analysis, noise may be divided into two classes. The first type is smooth noise such as that due to thermal agitation or tube hiss. The second type is noise due to impulse excitation from widely separated impulses. There are also noises which cannot be placed in either classification having characteristics midway between the two types. This kind of noise is the most difficult to deal with both analytically and practically.

SMOOTH NOISE OR HISS

It is well known that with smooth noise of the thermal agitation or tube hiss type, the energy is uniformly distributed throughout the radio-frequency spectrum. Hence, the hiss power output of a radio-frequency amplifier is proportional to the frequency band width (at a given amplification). It follows that the root-mean-square voltage output is proportional to the square root of the band width. The variation of peak amplitude with band width is not so easy to predict.

* Decimal classification: R270. Original manuscript received by the Institute, May 26, 1936. Presented before Eleventh Annual Convention, Cleveland, Ohio, May 12, 1936.

No method of calculating these peak values has been developed, so the facts had to be found by experiment. To do this, a two-channel, high gain, radio-frequency amplifier was built. Photographs of the chassis are shown in Figs. 1 and 2. Each channel has five stages of

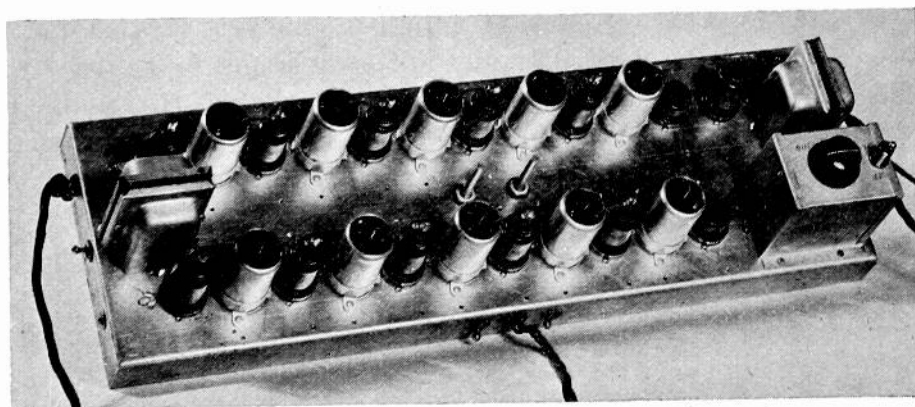

Fig. 1

amplification, with two tuned circuits per stage. One channel had a band width of 4.1, and the other a band width of 61.9 kilocycles at 90 per cent of the amplitude of the central frequency which was 150 kilocycles in each case. The shape of the two selectivity curves is the same.

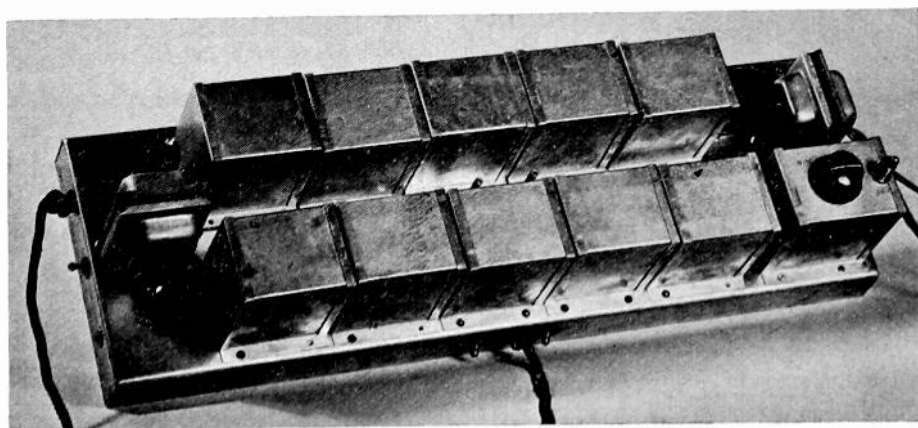

Fig. 2

The two channels are placed in operation alternately, by switching the B supply from one to the other. To minimize the chance of regeneration, a cascade resistance capacity filter is used on the B supply. With this circuit the filtering of the first tube is improved by the filter for the second, etc. Each stage was separately shielded by a can over

the transformer windings and a separate can over the tube and transformer constituting one stage. A bottom was made to shield against plate lead to plate lead feedback, but was found unnecessary. The available gain was about fifty per stage on the sharp amplifier and twenty-five per stage on the broad. This was more than enough to overload the final radio-frequency amplifier tube with hiss, so that full gain could never be used. For most measurements four stages were found to be sufficient, and the first was disconnected. No trouble was experienced with regeneration, except when unduly long input and output leads were used, producing over-all feedback.

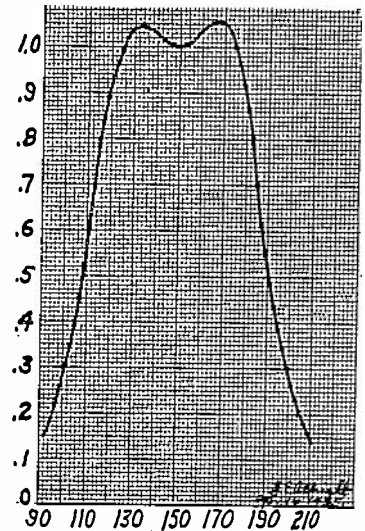
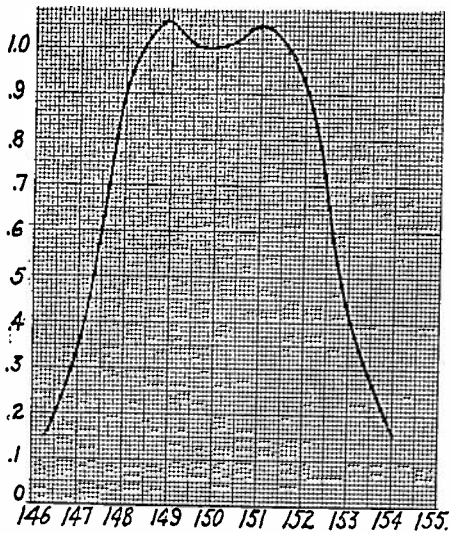

Fig. 3—Selectivity of sharp amplifier.

Fig. 4—Selectivity of broad amplifier.

The selectivity curves of the two amplifiers are given in Figs. 3 and 4. The ratio of band widths is approximately fifteen to one. Both of the channels were relined several times as various changes were made. The band width of each varied slightly from time to time under different conditions. In each experiment, calculations were based on band widths as measured during that experiment. At all times the first tube of the amplifiers was the source of the noise being measured. This tube was moved from one channel to the other to insure the same effective noise input.

The output of the two channels fed separate diode detectors which had a common audio amplifier connection. The bias on the diodes could be varied so that only those peaks which exceeded the bias produced any sound.

The amplification of each channel was adjusted so that the highest peaks of hiss were barely audible with twenty-two volts bias on the

diodes. The amplification of each channel was then measured and the ratio of gains compared to the ratio of band widths, and to the square root of the ratio of band widths.

The ratio of gains was 4.4, the ratio of band widths 15.1, and the square root of the band width ratio was 3.89. On a recheck at a lower gain, the square root of the ratio of gains was 3.85. This indicates that the peaks of hiss vary as the square root of the band width, just as the root-mean-square value does. If the term "crest factor" is defined as the ratio of the amplitudes of the highest peaks to the root-mean-square voltage, the indication is that this factor is a constant. However, the accuracy of this experiment is not very great, because of the difficulty of measuring such high gains accurately. Hence it was decided to measure the crest factor directly.

A tube voltmeter was connected across the diode circuit and moved from one side to the other with changing channels. This tube voltmeter was of the plate curvature type, with a bucking battery, and was believed to read root-mean-square voltage fairly accurately.

The gain of each channel was adjusted until the tube voltmeter read 2 volts of hiss. The diode bias was then increased until the noise barely disappeared. The bias required was exactly the same for the two channels, being 7.7 volts for silence, 7.3 volts for a few clicks per second, and 5 volts for the dividing line between a smooth and a rough hiss. The current in these diodes started at -0.9 volts, hence this figure must be subtracted from the biases given above to indicate peak values. This gives a crest factor of 6.8 divided by 2, which is 3.4.

Thus we are led to the somewhat surprising result that the highest peak voltages in hiss are not more than 3.4 times the root-mean-square value, and that this ratio is independent of band width. It is of some interest to note that an independent investigation by M. G. Crosby at Riverhead gave similar results except that a somewhat larger value was obtained for the crest factor. Crosby's factor was 4.47 instead of 3.4

NOISE FROM IMPULSE EXCITATION

With irregular noise the original source is almost always equivalent to Heaviside functions repeated at irregular intervals. The voltage applied to the antenna may consist of pulses of varying shape and duration, but this is usually because the circuits at the source of noise apply a certain amount of frequency discrimination to the original Heaviside function pulses. Usually the circuits in the receiver are considerably sharper than any that may be present in the noise source. Hence, the shape of the envelope of the wave train in the output of the

amplifier is usually almost independent of the wave form of the exciting voltages, provided the pulses are separated in time sufficiently to avoid overlapping decay trains.

The shape of the envelope of the wave train in the output of a radio-frequency amplifier is then a function of the circuits of the receiver, and is subject to calculation on the basis of Heaviside's operational calculus.

Operational methods, which are too involved to be included in a short paper, have led to the following equations. The equations are not exact, but the error is negligible if a/ω is negligible compared to unity.

When a single tuned circuit is used per stage, the output of the n^{th} stage divided by the gain is

$$E_n \doteq \frac{2a}{\omega} \frac{a^{n-1}t^{n-1}}{n-1} e^{-at} \sin \omega t$$

where,

$$\frac{2a}{\omega} = \text{the "power factor" of each circuit}$$

$$a = \frac{R}{2L}$$

$$\omega = \text{the frequency of the wave train times } 2\pi.$$

If two coupled circuits are used in each stage of the amplifier, the output of the n^{th} stage divided by the gain is

$$E_n \doteq \frac{2a}{\omega} \frac{a}{b} \frac{a^{n-1}t^{n-1}}{n-1} e^{-at} \sin bt \sin \omega t$$

where,

b = one half the frequency difference between the two resonant frequencies of each stage multiplied by 2π .

In either equation, the peak value of

$$\frac{a^{n-1}t^{n-1}}{n-1} e^{-at} \text{ occurs at } t \text{ equals } \frac{n-1}{a}.$$

At this instant

$$\frac{a^{n-1}t^{n-1}}{n-1} e^{-at} = \frac{(n-1)^{n-1}}{n-1} e^{1-n}$$

and does not vary with band width.

If the selectivity curve of two amplifiers has the same shape, then a/b is the same for the two cases.

Hence the factor a/ω determines the ratio of peak amplitudes in two amplifiers having different band widths. This factor is proportional to the band width. Thus the amplitude is proportional to the band width.

Thus a mathematical analysis leads to the conclusion that the amplitude of a wave train, caused by impulse excitation, is proportional to the first power of the band width and not to the square root of the band width, as with smooth hiss. This predicted difference made experimental confirmation desirable.

A preliminary experiment was made using the buzzer rectifier of an automobile receiver to generate impulses. This gave results which are fairly consistent with what follows, but the buzzer contact was too irregular to make accurate measurements possible. Hence, a vacuum tube impulse generator was thought desirable.

A square-wave generator was made, using a one-tube relaxation oscillator and a limiter to cut off the peaks. The frequency could be varied over wide limits by changing the setting of the gang condenser used in the resistance-capacity feed-back network. The wave shape of the output voltage of this unit is shown in Fig. 5, which is a photograph of the wave as shown by the RCA portable oscillograph.

It is evident that the sides of this "square wave" are not sufficiently steep to simulate a Heaviside function with any great degree of accuracy. It is, however, a source of impulses which repeats with much greater regularity than any mechanical device.

It was found possible to synchronize the oscillograph scanning with the impulses so that the decay train appears to be stationary on the screen. Fig. 6 is a photograph of the wave train from the sharp channel. The large diamond-shaped figure followed by two "beads" of decreasing size is the wave train from the up stroke of Fig. 5. The similar sequence of lesser amplitude is that caused by the down stroke, which is less effective in exciting the amplifier, because of its lesser slope.

Fig. 7 is a photograph of the corresponding wave train from the broad amplifier, with reduced gain. This illustrates the shorter time duration of the wave train from the broad amplifier.

Fig. 8 is another photograph of the output of the broad amplifier, but was taken with a higher frequency square wave applied to the input. The individual radio-frequency cycles can be discerned easily.

With the same input frequency used in obtaining Figs. 6 and 7, the gain required to give a certain amplitude of wave train on the oscillograph was next measured for each channel and the ratio of gains was

calculated. One measurement gave 15.8 and a re-check 16.7; the ratio of band widths at this time was 16.1.

In view of the experimental difficulties involved, this is considered a good check of the mathematical prediction that the amplitude of the wave train from an impulse is proportional to the band width of the amplifier.

It is important to note the difference in the results for the two types of noise. For both types, the root-mean-square amplitude is necessarily proportional to the square root of the band width. With smooth noise, the peak amplitude is also proportional to the square root of the

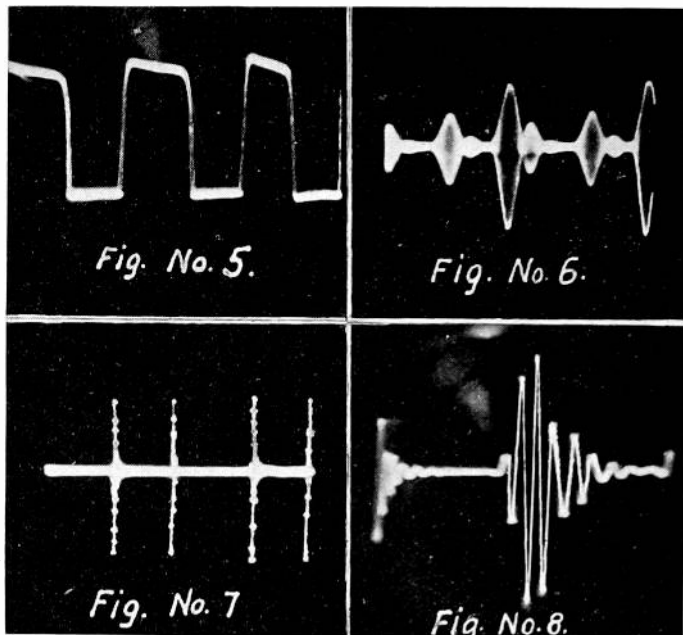

band width giving a constant crest factor. However, with noise consisting of isolated impulses (with decay trains not overlapping) the peak amplitudes are proportional to the first power of the band width. This difference results from the fact that the decay trains do not overlap for the second class of noise.

Another interesting factor brought out by the analysis is that the decay train from a single impulse has a time duration which is inversely proportional to the frequency band width. This fact is of the greatest importance in the design of noise reducers of the limiter type.

In this type of noise reducer the signal after amplification is applied to a tube which, by saturation or other means, limits the amplitude of all signal components to a certain predetermined value. The amplitude of the signal at the limiter should be just less than the value required

to saturate the limiter so that no distortion occurs. High amplitude pulses are then cut down to nearly the same amplitude as the signal. By the use of a wide band amplifier ahead of the limiter, the time duration of the pulses is reduced in direct proportion to the increase in band width. After limitation the amplitude of the noise pulses may be reduced far below signal level by passing the signal through a relatively sharp band-pass amplifier. Unfortunately, this process cannot be carried beyond a certain point. A certain amount of selectivity ahead of the limiter is essential and of course the greatest selectivity allowable in the amplifier following the limiter is determined by the fidelity requirements. Nevertheless, the best results will be obtained when the amplifier ahead of the limiter is kept as broad as practicable and the amplifier after the limiter, as sharp as practicable.

The foregoing analysis of impulsive noise brings out an important point in regard to noise reduction by wide band frequency modulation also. It is generally agreed that the frequency modulation system is inoperative if the noise peaks exceed the signal in amplitude. Widening the band improves the performance on smooth low amplitude noise, but may make it worse if the noise peaks are of about signal amplitude.



QUASI TRANSIENTS IN CLASS B AUDIO-FREQUENCY PUSH-PULL AMPLIFIERS*

BY

A. PEN-TUNG SAH

(National Tsing Hua University, Peiping, China; Visiting Professor, The Ohio State University, Columbus, Ohio)

Summary—Although class B audio-frequency amplifiers have been analyzed by many previous investigators, the effect of the leakage inductance of the output transformer or choke in producing quasi transients, i.e., exponential terms which recur periodically, has passed unnoticed. This paper gives equations for determining these quasi transients in the wave forms of the plate voltage, the plate current, and the output current, when the amplifier has reached a permanent state. The theoretical relations are derived from fundamental relations involving the tube characteristic, which is assumed to be linear, and the circuit external to the tubes. An equivalent circuit based on three-circuit transformer theory is also given to show the physical significance of the different terms in the equations. Cathode-ray oscillograms are presented in support of the theoretically calculated curves.

INTRODUCTION

THE performance of push-pull class B audio-frequency amplifiers has been studied by several writers^{1,2,3} recently either graphically or analytically. The graphical method has the advantage of being able to take into account the curvature of the tube characteristics while in the analytic method one has to assume linear tube characteristics in order to simplify algebraic relations. However, in both methods of study so far, no attempt has been made to consider the effect of the leakage inductances in the output transformer or coupling choke on the performance. True it is that in high quality output transformers⁴ the leakage inductances between windings have been kept low, and that any trouble due to them has been more or less eliminated at the root by proper design, still it is not without practical value, aside from the theoretical interest of the problem, to be able to precalculate such effects, because when one has to make an economic choice of transformers in his equipment, it is quite important to know the limit one has to go to eliminate the leakage inductances.

Broadly speaking, the effects of leakage inductances in variable

* Decimal classification: R363.2. Original manuscript received by the Institute, March 16, 1936. Presented before joint meeting U.R.S.I.-I.R.E. Washington, D. C., May 1, 1936.

¹ L. E. Barton, Proc. I. R. E., vol. 19, pp. 1131-1149; July, (1931); vol. 20, pp. 1085-1100; July, (1932).

² J. R. Nelson, Proc. I.R.E., vol. 20, p. 1763; November, (1932); vol. 21, pp. 858-874; June, (1933).

³ A. P-T. Sah, *Sci. Rep.*, Tsing Hua University, Peiping, China, series A, vol. 2, pp. 49-73, (1933).

⁴ J. F. Peters, *Elect. Eng.*, vol. 55, pp. 34-35, (1936).

frequency applications, such as the output stage of an audio-frequency amplifier, are twofold. First, they cause the impedance of the circuit to vary with frequency, thus producing, on a constant potential input, a decreased output as frequency increases, and second, they introduce finite time constants into the circuit thus bringing into play transients which distort the wave as one of the tubes changes from a conducting condition to a blocking condition and vice versa. The first of these effects, viz., variable impedance, is common to all classes of audio-frequency amplifiers, whether class A or class B, and has been very amply treated by Terman⁵ and his students. The second of these effects, viz., transient phenomena, is of importance, however, only in amplifiers, such as the class B, in which there is a periodic stoppage of current in the tubes. This second effect has probably been recognized by many to be one of the main troubles in the performance of class B audio-frequency amplifiers at high frequencies but, as stated before, it has not been studied analytically. In this paper, mathematical expressions for the plate voltage, the plate current, and the load current will be derived for class B push-pull audio-frequency amplifiers in terms of the tube constants, the load resistance, and the leakage reactances to take account of the latter's effects, and oscillograms will be presented to substantiate the theoretical relations.

ASSUMPTIONS AND STEPS IN THE SOLUTION OF THE PROBLEM

In order to avoid complicated analytic expressions, two assumptions will be made. The first is that the tube characteristic is linear. In other words, the plate resistance, ρ , and the amplification factor, μ , are taken to be constant, and when the tube is conducting, the following linear relation is assumed to hold:

$$i_p = \frac{e_p + \mu e_g}{\rho} \quad (1)$$

in which i_p , e_p , and e_g are instantaneous values of the plate current, the plate voltage, and the grid voltage, respectively. From (1) and the definition of a class B amplifier, the negative C bias voltage, E_c , will have a magnitude given by

$$E_c = \frac{E_b}{\mu} \quad (2)$$

where E_b is the voltage of the B source. As the purpose of this paper is to consider the quasi transients in the output stage of the amplifier, a second assumption made is that the peak input voltage E is equal to

⁵ F. E. Terman, "Radio Engineering," McGraw-Hill Book Company.

the C bias so that the grid is not allowed to draw any current and produce additional transient effects.

Although the definition of an ideal class B amplifier requires that the current flow in one tube lasts exactly half of a cycle, the transients in the circuit will prolong this conducting period to more than a half cycle. It is thus obvious that even after a permanent state is reached, there will be periods at which both tubes in a class B push-pull amplifier are conducting. To facilitate the analysis, a complete cycle will therefore be divided into the following four periods (Fig. 1):

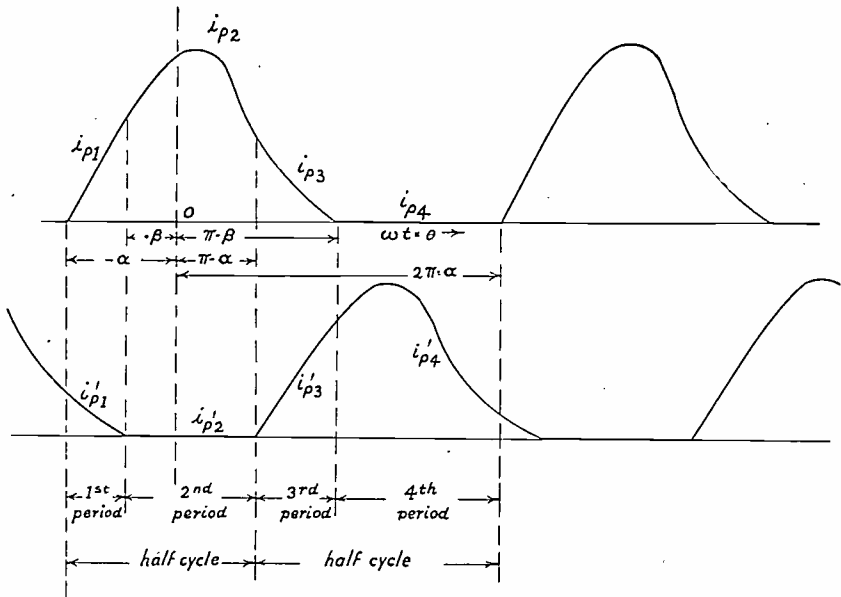

Fig. 1

- (1) Both tubes are conducting with plate current in first tube increasing and that in second tube decreasing;
- (2) First tube is conducting, but second tube is nonconducting;
- (3) The two tubes are again both conducting with plate current in the first tube decreasing and that in the second increasing;
- (4) First tube is nonconducting, but second tube is conducting.

To obtain general mathematical expressions for the different quantities in the different periods we need, in addition to the tube characteristic, viz., equation (1), the equations derivable from Kirchhoff's laws relating to the circuits external to the tube. With these written out they can be solved in the usual way.

The solution contains, of course, a steady-state term and one or two transients for each period. The constants of integration in the transient terms can be evaluated from the condition that at the transitional point from one period to the next the plate current is continuous. This condition of continuity of the plate current of one tube means also the continuity of all other quantities at the transitional points. In order to facilitate the algebraic work, it should be noted that the relations in the third and fourth periods will be exactly identical in value to those in the first and second periods, respectively, by changing all quantities referred to the first tube into those referring to the second tube, and vice versa. Also due to symmetry of the circuits, the first and second periods together will last one half cycle and the third and fourth periods the other half cycle, so that to specify the transitional points, only two auxiliary angles (say α and β) are necessary. Thus the first period will be taken to start at $\omega t = \theta = -\alpha$ and end at $\theta = -\beta$; the second period will last from $\theta = -\beta$ to $\theta = \pi - \alpha$; the third from $\theta = \pi - \alpha$ to $\theta = \pi - \beta$; and the fourth from $\theta = \pi - \beta$ to $\theta = 2\pi - \alpha$ (Fig. 1). In terms of these auxiliary variables α and β which can be found from two simultaneous equations involving the constants of the tube and the attached circuit, the constants of integration can be expressed; and when α and β are found, all the different parts of the complete wave form can be calculated and plotted.

Summarizing the above, one method of solving the problem will proceed as follows:

- (1) Assume linear tube characteristics;
- (2) Assume no grid current;
- (3) From Kirchhoff's laws write down current and voltage relations for
 - case (a) when both tubes are conducting, and
 - case (b) when only one tube is conducting;
- (4) Assume the open-circuit primary inductance of the transformer (i.e., with secondary open-circuited) to be very large; or in other words, neglect its effect and simplify the equations;
- (5) Solve these equations simultaneously in the usual manner to obtain the general solution containing both "steady-state" and "transient" terms;
- (6) Introduce two auxiliary angles α and β to specify the transition points from one period to the next;

- (7) Impose the condition of continuity at the transition points and obtain two simultaneous equations involving α and β and express constants of integration in terms of α and β ;
- (8) Find α and β by trial and error;
- (9) Evaluate the constants of integration from the values of α and β ;
- (10) Calculate the wave forms point by point from the equations obtained in step (5).

THE GENERAL SOLUTION

When the general circuit as shown in Fig. 2 is considered, it will be shown in the Appendix that after the effect of the primary induct-

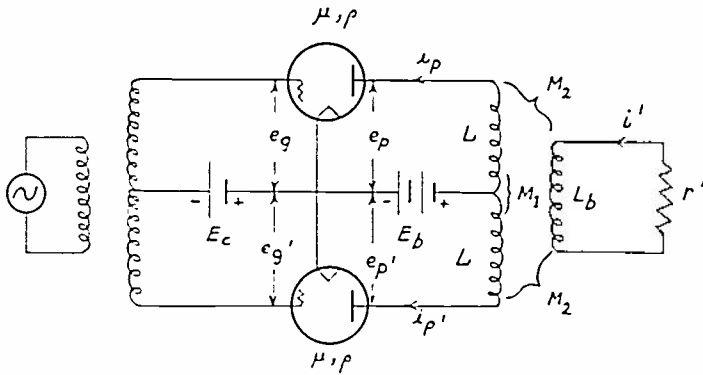

Fig. 2.— $r = (L/L_b)r'$; $i = \sqrt{L_b/L} i'$; $c_g = -E_c + E \cos \theta$; $c_g' = -E_c - E \cos \theta$;
 $L_2 = L - M_2^2/L_b$; $L_1 = L - M_1$.

ance L is neglected, the general solutions for the various quantities are: (a) When both tubes are conducting,

$$\left. \begin{aligned}
 i_p &= C\epsilon^{-s\theta} + B\epsilon^{-r\theta} + \frac{\mu E \cos(\theta - \cot^{-1} s)}{Z_s} \\
 i_p' &= -C\epsilon^{-s\theta} + B\epsilon^{-r\theta} - \frac{\mu E \cos(\theta - \cot^{-1} s)}{Z_s} \\
 c_p &= E_b + \rho C\epsilon^{-s\theta} + \rho B\epsilon^{-r\theta} - \frac{Z_1 \mu E \cos(\theta - \cot^{-1} s + \phi_1)}{Z_s} \\
 c_p' &= E_b - \rho C\epsilon^{-s\theta} + \rho B\epsilon^{-r\theta} + \frac{Z_1 \mu E \cos(\theta - \cot^{-1} s + \phi_1)}{Z_s} \\
 i &= 2C\epsilon^{-s\theta} + \frac{2\mu E \cos(\theta - \cot^{-1} s)}{Z_s}
 \end{aligned} \right\} (3)$$

wherein,

$$s = \frac{2r + \rho}{\omega(2L_2 - L_1)}; \quad m = \frac{\rho}{\omega L_1};$$

$$Z_s^2 = (2r + \rho)^2 + \omega^2(2L_2 - L_1)^2; \quad Z_1^2 = 4r^2 + \omega^2(2L_2 - L_1)^2;$$

$$\cos \phi_1 = \frac{2r}{Z_1}; \text{ and } B \text{ and } C \text{ are constants of integration};$$

and (b) when one tube is conducting while the other is not, then

$$\left. \begin{aligned} i_p &= A\epsilon^{-n\theta} + \frac{\mu E \cos(\theta - \cot^{-1} n)}{Z_n}, \\ i_{p'} &= 0, \\ e_p &= E_b + \rho A\epsilon^{-n\theta} - \frac{Z_2 \mu E \cos(\theta - \cot^{-1} n + \phi_2)}{Z_n}, \\ e_{p'} &= E_b + \frac{(r + \rho)L_1 - \rho L_2}{L_2} A\epsilon^{-n\theta} + \frac{Z_3 \mu E \cos(\theta - \cot^{-1} n + \phi_3)}{Z_n}, \\ i &= A\epsilon^{-n\theta} + \frac{\mu E \cos(\theta - \cot^{-1} n)}{Z_n}, \end{aligned} \right\} (4)$$

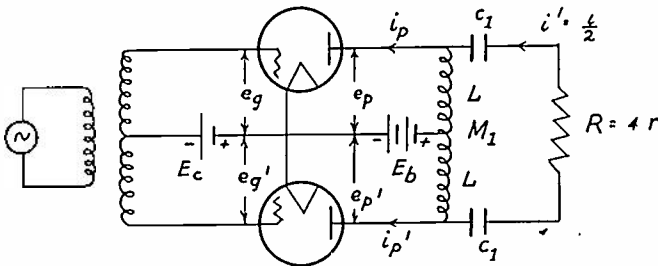

Fig. 3

wherein,

$$n = \frac{r + \rho}{\omega L_2};$$

$$Z_n^2 = (r + \rho)^2 + \omega^2 L_2^2; \quad Z_2^2 = r^2 + \omega^2 L_2^2; \quad Z_3^2 = r^2 + \omega^2(L_2 - L_1)^2;$$

$$\cos \phi_2 = \frac{r}{Z_2}; \quad \cos \phi_3 = \frac{r}{Z_3}; \quad \text{and}$$

A is a third constant of integration. In case the secondary is completely coupled to the primaries without leakage, which is realized in practice by connecting the load resistance $r' = R = 4r$ across the plates

through large insulating condensers C_1 as shown in Fig. 3 then $2L_2 = L_1$ and $C = 0$, and the equations (3) simplify to

$$\left. \begin{aligned} i_p &= B\epsilon^{-m\theta} + \frac{\mu E \cos \theta}{2r + \rho}, \\ i_p' &= B\epsilon^{-m\theta} - \frac{\mu E \cos \theta}{2r + \rho} \\ e_p &= E_b + \rho B\epsilon^{-m\theta} - \frac{2r\mu E \cos \theta}{2r + \rho}, \\ e_p' &= E_b + \rho B\epsilon^{-m\theta} + \frac{2r\mu E \cos \theta}{2r + \rho}, \\ i &= \frac{2\mu E \cos \theta}{2r + \rho}; \end{aligned} \right\} \quad (5)$$

while, e_p' of (4) becomes

$$e_p' = E_b + (2r + \rho)A\epsilon^{-n\theta} + \frac{Z_2\mu E \cos (\theta - \cot^{-1} n - \phi_2)}{Z_n} \quad (4a)$$

If subscripts 1, 2, 3, and 4 are used to distinguish the four periods as shown in Fig. 1 and unprimed and primed symbols to refer to the two tubes, then due to symmetry of arrangement

$$\left. \begin{aligned} i_{p3}(\theta) &= i_{p1}'(\theta - \pi) \\ i_{p3}'(\theta) &= i_{p1}(\theta - \pi) \\ e_{p3}(\theta) &= e_{p1}'(\theta - \pi) \\ e_{p3}'(\theta) &= e_{p1}(\theta - \pi) \\ i_3(\theta) &= -i_1(\theta - \pi) \end{aligned} \right\} \quad (6)$$

$$\left. \begin{aligned} i_{p4}(\theta) &= i_{p2}'(\theta - \pi) \\ i_{p4}'(\theta) &= i_{p2}(\theta - \pi) \\ e_{p4}(\theta) &= e_{p2}'(\theta - \pi) \\ e_{p4}'(\theta) &= e_{p2}(\theta - \pi) \\ i_4(\theta) &= -i_2(\theta - \pi). \end{aligned} \right\} \quad (7)$$

It is thus seen that only the two sets of general solutions as given in (3) and (4) are needed. Each one of the left-hand symbols in the set of (3) or (5) may then be given a subscript 1 to denote their respective values in the first period and those in set (4) a subscript 2 to

denote values in the second period. The values in the third and fourth periods are obtained from these two sets through the relations (6) and (7).

EQUIVALENT CIRCUIT

The solution given in detail in the Appendix is built up from fundamental relations. It is a little bit laborious and for practical analysis, perhaps, one would like to know whether it is possible to devise an equivalent circuit from which the above solutions may be obtained. Recognizing the fact that the output transformer in a push-pull circuit is nothing but a three-circuit transformer, the equivalent circuit for the latter properly combined with the equivalent circuit for the tubes should, from our physical intuition, give us the correct solution. Indeed the following equivalent circuit, Fig. 4, will be found to describe the push-pull amplifier exactly. Two points about the circuit may be mentioned. The first is that due to the differential effect of the currents i_p and i_p' in the push-pull arrangement, their positive directions are as shown while the equivalent voltage e' acting on the primed tube will have a positive direction opposite to that of i_p' to be in conformity with the actual push-pull arrangement. The fact that in the actual circuit diagram the positive directions of i_p and i_p' have been drawn away from their junction and that the grid voltages are 180 degrees out of phase must not misguide one to infer that in the equivalent circuit diagram the positive directions of i_p' and e' would be opposite to what are shown in Fig. 4. The second point to note is that all the resistances and inductances are referred to one tube only; in other words, all values connected across the tubes from plate to plate should be divided by four. Thus $2L_1$ is the total leakage inductance measured across one half of the primary windings when the other half is short-circuited and the secondary open-circuited, while L_2 is the total leakage inductance measured also across one half of the primary winding (i.e., from outer terminal to center tap) with secondary short-circuited and the other half of the primary open-circuited. It should be noted again that when the secondary is completely coupled to the whole primary without leakage, $L_2 = L_1/2$ and there is, in fact, a negative value of inductance (i.e., $-L_1/2$) existing in series with the load resistance r under such a condition.

TIME CONSTANTS AND IMPEDANCES BASED ON EQUIVALENT CIRCUIT

The theory of a three-circuit transformer is now quite well known and is already available in many textbooks.⁶ We shall, there-

⁶ O. G. C. Dahl, "Electric Circuits," vol. 1, McGraw-Hill Book Company.

fore, not deduce the equivalent circuit but rather show that the results calculated from the equivalent circuit give the correct time constants and steady-state impedance in the two cases of (a) both tubes conducting and (b) only one tube conducting. We shall assume the exciting admittance of the transformer, i.e., the parallel branch denoted by L and G to be nonexistent. Thus when both tubes are conducting, there are three meshes to consider, Fig. 4(b); viz., (1) $abcb'a'g$; (2) $gabcg$, and (3) $ga'b'cg$. Since the circuit is symmetrical the last two meshes have identical constants, so that there are only two time constants. From the mesh $abcb'a'g$, the total resistance in series is 2ρ and the total inductance $2L_1$, giving a time constant L_1/ρ , or an equivalent Q , if that term may be used, of $\omega L_1/\rho$. The transient current with

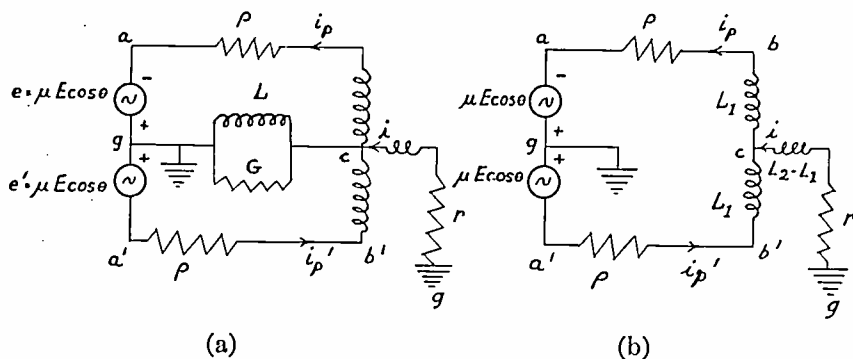

Fig. 4

this time constant appears, however, only in the plate currents i_p and i_p' . It gives rise to the term

$$B\epsilon^{-m\theta} = B\epsilon^{-(\rho/L_1)t} \quad (8)$$

of (3) or (5). The second time constant is found from the mesh $gabcg$ with the branch $gabc$ in parallel with $ga'b'c$. This contains a total resistance $r + \rho/2$ and a total inductance $L_2 - L_1/2$. Hence the time constant is $(2L_2 - L_1)/(2r + \rho)$. The transient term having this time constant is associated with all three currents, i , i_p , and i_p' . If it is to be taken as positive in case of i and i_p , it should be negative in case of i_p' due to the assumed positive direction of currents. This is then responsible for the term (equation (3)),

$$C\epsilon^{-s\theta} = C\epsilon^{-(2r+\rho)t/(2L_2-L_1)} \quad (9)$$

in i and i_p and its negative in i_p' .

Except for the transient term $B\epsilon^{-m\theta}$ there is no steady-state current in the mesh $abcb'a'ga$. The steady-state current in the load r is divided equally between i_p and i_p' . The impedance to the flow of this current i in the load r is, in complex notation,

$$\dot{Z} = r + \frac{\rho}{2} + \frac{j\omega(2L_2 - L_1)}{2} \tag{10}$$

which accounts for the steady-state terms given at the end of each one of the equations (3) or (5), the negative sign of this term in i_p' being again due to the fact that the positive direction of i_p is what is shown. All the currents i_p , i_p' , and i are thus seen correctly obtained from the equivalent circuit.

It is of interest here to note that when all constants are referred not to one half of the primary but to plate to plate, then the above impedance becomes:

$$\dot{Z}_{pp} = 4\dot{Z} = 4r + 2\rho + 2j\omega(2L_2 - L_1) = R + 2\rho + 2j\omega(2L_2 - L_1) \tag{11}$$

by setting $R=4r$, and the voltage to produce the current is $2\mu E \cos \theta$, giving a steady-state current

$$\dot{I}_{pp} = \frac{2\mu \dot{E}}{R + 2\rho + 2j\omega(2L_2 - L_1)} \tag{12}$$

showing that the circuit may also be assumed to be a series circuit as shown in Fig. 5, where the tubes are considered truly in series, for the applied electromotive forces are adding and the total internal plate

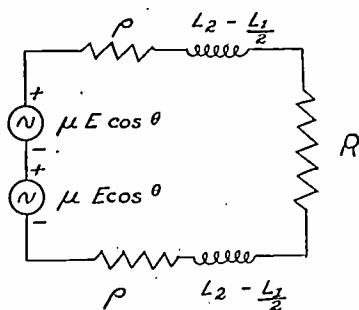

Fig. 5

resistance is 2ρ . This equivalent circuit is just as good as the one given in Fig. 4, provided one is not interested in the transient terms, for instance in case of class A amplifiers. However, if the transient terms are to be evaluated, the "series equivalent circuit" given in Fig. 5 has to be replaced by the "parallel" arrangement of Fig. 4 in order to get correct results.

Coming next to the second period of operation in which one tube is conducting alone, the mesh $gab'c$ is simply considered open-circuited in finding the impedance; i.e.,

$$\dot{Z}_n = \rho + r + j\omega L_2 \tag{13}$$

and the time constant is $L_2/(\rho+r)$ or equivalent Q is $\omega L_2/(\rho+r)$. The transient and the steady-state terms in i and i_p found in (4) exactly correspond with these considerations.

The equivalent circuit is not very well adapted to the evaluation of the plate voltages on the tubes. To find these, simply note that in case

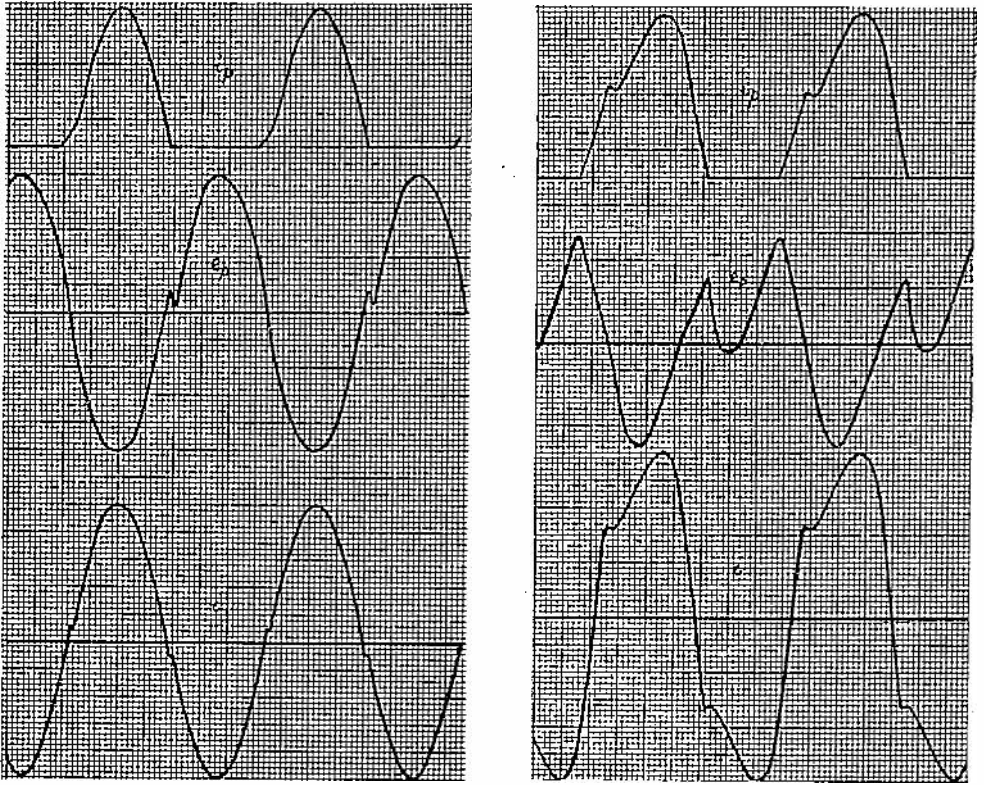

Fig. 6— $r = \rho = 4\omega L_1$; $2L_2 = L_1$; $m = 4$; $n = 16$.

Fig. 7— $r = \rho/2 = \omega L_1/4$; $2L_2 = L_1$; $m = 1/2$; $n = 3/2$.

i_p and i_p' are both positive, the linear characteristic of the tube requires

$$e_p = \rho i_p - \mu e_g = E_b - \mu E \cos \theta + \rho i_p$$

and,

$$e_p' = \rho i_p' - \mu e_g' = E_b + \mu E \cos \theta + \rho i_p' \tag{14}$$

and that in case $i_p = 0$, due to the blocking of the tube,

$$e_p' = E_b + [r + p(L_2 - L_1)]i_p. \tag{15}$$

SOME CALCULATED THEORETICAL CURVES

To show how the transient terms affect the wave shapes of the different quantities, two cases showing extreme conditions are given here,

assuming the output coupling to be a choke; i.e., $2L_2 = L_1$. The circuit parameters for these two cases are as follows:

$$(A) \quad r = \rho = 4\omega L_1$$

and,

$$(B) \quad 2r = \rho = 1/2\omega L_1.$$

They are plotted in Figs. 6 and 7. The following points in the curves may be noted:

(1) Plate currents flowing more than 180 degrees, the angle of current flow in case B is as much as 230 degrees;

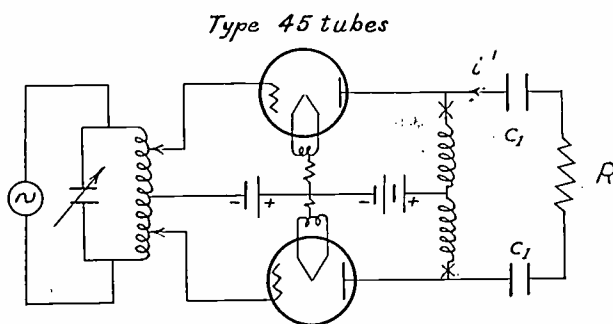

Fig. 8

(2) Characteristic kink in the plate voltage wave which not only causes the maximum plate voltage to be less than what would be expected from simple sine wave considerations but also distorts it very considerably in case the leakage reactance is too high; and

(3) Third harmonic distortion introduced into the load-current wave form.

DESCRIPTION OF EXPERIMENTAL SETUP AND OSCILLOGRAMS OBTAINED

To see in how far these theoretical curves are checked by actual experimental setups, the circuit shown in Fig. 8 was used. The input was derived from a class A amplifier of approximately two-watt capacity and the tuned circuit in the grid insures the input wave to be sinusoidal. The output choke was what one would use in the filter system of a sixty-cycle B battery eliminator. An RCA portable cathode-ray oscillograph, type TMV-122-B, was used and internally synchronized to obtain a stationary wave form on the fluorescent screen which was then photographed to nearly actual size by a camera with f 4.5 lens on timed exposure. In order to get the current wave through one tube, a small resistance (37.5 ohms) was introduced into each tube circuit

at the ground end and two separate transformers were used to heat the filaments. This was necessary because one deflecting plate of the cath-

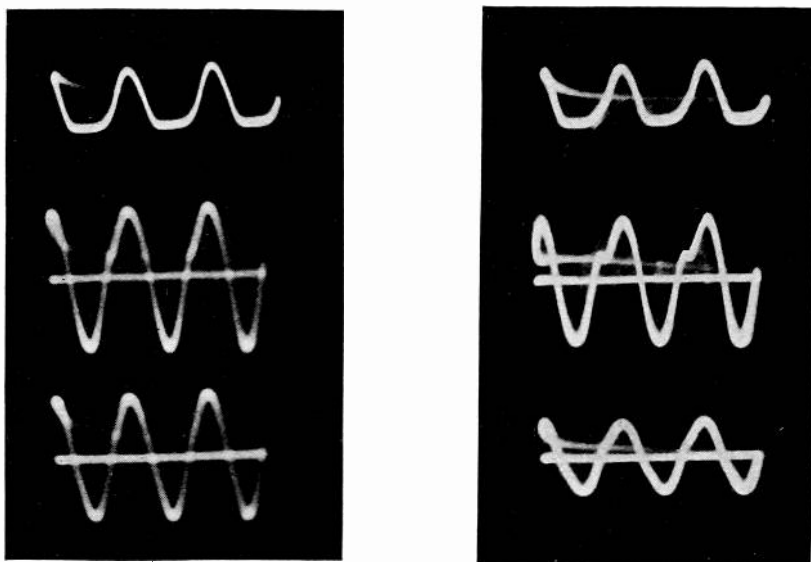

Fig. 9— $f=800$; $\omega L_1=250$; $r=1500$; $\rho=1500$; $m=6$; $n=24$.

Fig. 10— $f=800$; $\omega L_1=900$; $r=1500$; $\rho=1500$; $m=1.67$; $n=6.7$.

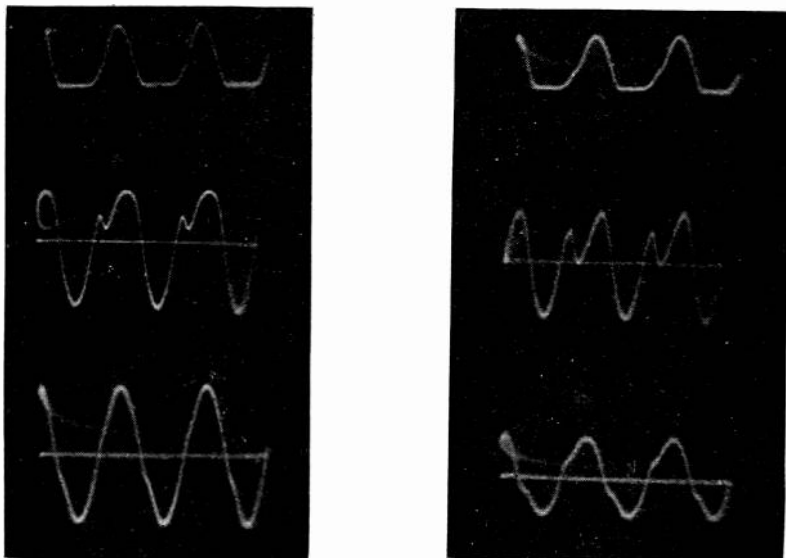

Fig. 11— $f=800$; $\omega L_1=250$; $r=750$; $\rho=1500$; $m=6$; $n=18$.

Fig. 12— $f=800$; $\omega L_1=900$; $r=750$; $\rho=1500$; $m=1.67$; $n=5$.

ode-ray tube had to be permanently grounded and could not be connected to any ungrounded resistance in the plate circuit. A positive crest voltmeter was connected into the grid circuit for the purpose of

adjusting the input exciting peak E to equal the C bias E_c . A positive trough voltmeter⁷ was connected in the plate circuit to measure the minimum plate voltage, $e_{p \text{ min}}$. Because of the distorted plate voltage wave, it may be noted that $2(E_b - e_{p \text{ min}})$ does not equal $\sqrt{2} RI_{\text{off}}$, which holds only when the waves are sinusoidal.

The oscillograms shown in Figs. 9, 10, 11, and 12 indicated that the three main points noted on the theoretically calculated curves were checked quite satisfactorily. Of course, an exact quantitative agreement would not be expected because the tube characteristic could not be considered as linear and the cutoff was not as sharp as assumed in the linear characteristic. In order to show that the wave forms depend only on the ratio of the resistance to leakage reactance for frequencies not low enough to call into play the effect of the primary inductance, artificial leakage was introduced into the circuit by connecting two separate identical telephone repeater coils each in series with the choke at points shown by X in the diagram. Oscillograms substantiated the theory in showing that with $\omega L_1/\rho$ and ρ/r constant the wave shapes were nearly the same in spite of the fact that the frequency ratios were quite large.

CONCLUSION

From the above experimental results, it is evident that on the basis of the two simple assumptions, the wave shape in a class B audio amplifier can be calculated quite satisfactorily. Also the equivalent circuit may be depended upon to give correct results. In order not to draw the present paper to too lengthy a study, only the theoretical aspect of the solution of the problem has been touched. Such practical problems as what limiting values of leakage inductances may be tolerated without impairing the operating characteristics of the amplifier have not been analyzed. Another interesting problem would be to consider the effect of the primary inductance on the wave shape as the frequency becomes lower. A third practical problem would be to study the effect of dissymmetry in the transformer on the performance by making use of an equivalent circuit similar to Fig. 4. The other more difficult problems are to take into account the effects of grid current transients or to solve the problems without being restricted by the linear characteristic for the tubes.

ACKNOWLEDGMENT

The writer is greatly indebted to Dr. F. E. Terman and Mr. James Sharp of Stanford University for laboratory facilities and suggestions in carrying out the experiments.

⁷ F. E. Terman, "Measurements in Radio Engineering," McGraw-Hill Book Company.

MATHEMATICAL APPENDIX

Fig. 2 shows the circuit. Let the symbols have the following significance:

- μ = amplification factor of the tubes
 ρ = plate resistance of one tube
 E_b = direct voltage supplied by B source
 E_c = magnitude of C bias voltage; $\mu E_c = E_b$
 E = peak value of alternating voltage impressed on the grid
 $= E_c$
 i_p, i_p' = plate currents through the upper and the lower tubes, respectively, at any time
 e_p, e_p' = plate voltages on upper and lower tubes, respectively, at any time
 e_g, e_g' = grid voltages on upper and lower tubes, respectively, at any time; $e_g = -E_c + E \cos \omega t$; $e_g' = -E_c - E \cos \omega t$
 L = self-inductance of one leg of the primary of transformer with the secondary and the other leg both open-circuited
 M_1 = mutual inductance between the two legs of the primary
 $L_1 = L - M_1$ = leakage inductance of one leg of primary with respect to the other leg
 L_b = self-inductance of the secondary with both legs of the primary open-circuited
 M_2 = mutual inductance between each leg of primary and the secondary
 $L_2 = L - M_2^2/L_b$ = total leakage inductance between one leg of primary and the secondary referred to the former
 $N = \sqrt{L/L_b}$ = ratio of number of turns in one leg of primary to that in the secondary
 r' = actual load resistance connected across the secondary
 $r = N^2 r'$ = load resistance referred to one leg of the primary
 $R = 4r$ = load resistance referred to the whole of primary; i.e., plate to plate
 i' = actual current in the secondary or load resistance
 i = load current referred to one leg of the primary = i'/N
 $p = d/dt$ = differentiating operator
 $\theta = \omega t$; $p\theta = \omega$

From Kirchhoff's laws, the plate voltages are:

$$e_p = E_b - Lpi_p + M_1pi_p' + M_2pi' \quad (16)$$

$$e_p' = E_b - Lpi_p' + M_1pi_p - M_2pi' \quad (17)$$

and for the secondary circuit we have

$$L_b p i' + r' i' - M_2 p (i_p - i_p') = 0 \quad (18)$$

or,

$$i' = \frac{M_2 p (i_p - i_p')}{L_b p + r'} \quad (18a)$$

These three equations relate to the circuits external to the tubes. The linear characteristic of the tubes give:

$$\rho i_p = e_p + \mu e_g \quad \text{and} \quad \rho i_p' = e_p' + \mu e_g' \quad (19)$$

Consider first the case when both tubes are conducting. Substituting i' from (18a) into (16) and (17) and then use e_p and e_p' in the characteristic (19), it will be found after simplification that

$$\rho i_p = \mu E \cos \theta - \frac{(L_2 p + r) L p}{L p + r} i_p + \frac{L(L_2 - L_1) p^2 + r M_1 p}{L p + r} i_p' \quad (20)$$

and,

$$\rho i_p' = -\mu E \cos \theta - \frac{(L_2 p + r) L p}{L p + r} i_p' + \frac{L(L_2 - L_1) p^2 + r M_1 p}{L p + r} i_p \quad (21)$$

Adding (20) and (21) we get

$$\rho (i_p + i_p') + L_1 p (i_p + i_p') = 0 \quad (22)$$

giving therefore

$$i_p + i_p' = 2B\epsilon^{-m\theta} \quad (23)$$

where,

$$m = \rho / \omega L_1; \quad (24)$$

and $2B$ is a constant of integration. Subtracting (21) from (20) gives:

$$\rho (i_p - i_p') = 2\mu E \cos \theta - \frac{L(2L_2 - L_1) p^2 + r(L + M_1) p}{L p + r} (i_p - i_p') \quad (25)$$

Assuming L and M_1 to be large and $L + M_1$ to be approximately $2L$, (25) becomes

$$[(\rho + 2r) + (2L_2 - L_1)p](i_p - i_p') = 2\mu E \cos \theta \quad (26)$$

from which the general solution is

$$i_p - i_p' = 2C\epsilon^{-s\theta} + \frac{2\mu E \cos(\theta - \cot^{-1} s)}{Z_s} \quad (27)$$

where,

$$s = (\rho + 2r)/\omega(2L_2 - L_1) \quad (28)$$

and,

$$Z_s^2 = (\rho + 2r)^2 + \omega^2(2L_2 - L_1)^2. \quad (29)$$

It may also be noted from (18a) that if L is large, then

$$i = \frac{i'}{N} = (i_p - i_p'). \quad (30)$$

In case the secondary is completely coupled to the primary, (the two legs of the primary are, however, not completely coupled), then

$$L_b = 2L + 2M_1 \quad \text{and} \quad M_2 = L + M_1 \quad (31)$$

so that

$$L_2 = L - M_2^2/L_b = (L - M_1)/2 = L_1/2. \quad (32)$$

The physical meaning of L_2 in this case is quite interesting. It represents the inductance measured between the center tap and the two outer terminals of the primary connected together, this inductance being the same as the parallel value of two identical uncoupled coils each having an inductance L_1 . Thus when the load resistance is connected directly across the output circuit from plate to plate as shown in Fig. 8, $s = \infty$ and $\cot^{-1} s = 0$, the transient term having time constant s does not exist and $Z_s = \rho + 2r$, a nonreactive resistance. Combining the results, the complete expressions for i_p , i_p' , e_p , e_p' , and i for the period in which both i_p and i_p' are positive are

$$i_p = C\epsilon^{-s\theta} + B\epsilon^{-m\theta} + \frac{\mu E \cos(\theta - \cot^{-1} s)}{Z_s}$$

$$i_p' = -C\epsilon^{-s\theta} + B\epsilon^{-m\theta} - \frac{\mu E \cos(\theta - \cot^{-1} s)}{Z_s}$$

$$e_p = E_b + \rho C\epsilon^{-s\theta} + \rho B\epsilon^{-m\theta} - \frac{Z_1 \mu E \cos(\theta - \cot^{-1} s + \phi_1)}{Z_s}$$

where,

$$Z_1^2 = 4r^2 + \omega^2(2L_2 - L_1)^2$$

and,

$$\cos \phi_1 = 2r/Z_1$$

$$e_p' = E_b - \rho C\epsilon^{-s\theta} + \rho B\epsilon^{-m\theta} + \frac{Z_1 \mu E \cos(\theta - \cot^{-1} s + \phi_1)}{Z_s}$$

and,

$$i = 2C\epsilon^{-s\theta} + \frac{2\mu E \cos(\theta - \cot^{-1} s)}{Z_s}$$

which are the equations (3) given in the body of the paper.

Coming to the case when one tube is not conducting, e.g., $i_p' = 0$, we find

$$\rho i_p = \mu E \cos \theta - \frac{(L_2 p + r)L p}{L p + r} i_p. \quad (33)$$

Assuming L to be large, this simplifies to

$$(\rho + r + L_2 p)i_p = \mu E \cos \theta \quad (34)$$

giving the complete solution

$$i_p = A\epsilon^{-n\theta} + \frac{\mu E \cos(\theta - \cot^{-1} n)}{Z_n} = i \quad (35a)$$

where,

$$n = (r + \rho)/\omega L_2$$

and,

$$Z_n^2 = (r + \rho)^2 + \omega^2 L_2^2$$

and A is another constant of integration. The values of e_p and e_p' are then

$$e_p = E_b + \rho A\epsilon^{-n\theta} - \frac{Z_2 \mu E \cos(\theta - \cot^{-1} n + \phi_2)}{Z_n} \quad (35b)$$

where,

$$Z_2^2 = r^2 + \omega^2 L_2^2; \quad \cos \phi_2 = r/Z_2;$$

and,

$$\begin{aligned} e_p' &= E_b + [r + (L_2 - L_1)p]i_p \\ &= E_b + \frac{(r + \rho)L_1 - \rho L_2}{L_2} A\epsilon^{-n\theta} \\ &\quad + \frac{Z_3 \mu E \cos(\theta - \cot^{-1} n + \phi_3)}{Z_n} \end{aligned} \quad (35c)$$

with $Z_3^2 = r^2 + \omega^2(L_2 - L_1)^2$, and $\cos \phi_3 = r/Z_3$. These are the equations (4) given in the body of the paper. As already explained, only two auxiliary angles α and β are needed to define the transitional points between the four periods. Denoting these periods by subscripts 1, 2, 3, 4, the set of equations (3) may be given a subscript 1, those in set (4) subscript 2, and then relations (6) and (7) are valid. Thus the continuity of the different quantities requires

$$i_{p1}(-\alpha) = 0 \quad (\text{defining equation for } \alpha) \quad (36a)$$

$$i_{p1}'(-\beta) = 0 \quad (\text{defining equation for } \beta) \quad (36b)$$

$$i_{p2}(\pi - \alpha) = i_{p3}(\pi - \alpha) = i_{p1}'(-\alpha) \quad (36c)$$

$$i_{p1}(-\beta) = i_{p2}(-\beta) \quad (36d)$$

and,

$$e_{p4}(2\pi - \alpha) + \mu e_{g4}(2\pi - \alpha) = 0. \quad (36e)$$

The above five equations are sufficient to determine the five quantities A, B, C, α , and β . Solving them simultaneously it is found that the three constants of integration may be expressed in terms of the two angles α and β as follows:

$$A = - \frac{L_2 \epsilon^{m(\pi-\alpha)}}{(r+\rho)L_1 - \rho L_2} \frac{Z_m}{Z_n} \mu E \cos(\alpha - \cot^{-1} m + \cot^{-1} n) \quad (37a)$$

with,

$$Z_m^2 = \rho^2 + \omega^2 L_1^2$$

$$B = - \frac{L_1 \epsilon^{-m\alpha}}{2[(r+\rho)L_1 - \rho L_2]} \mu E \cos \alpha \quad (37b)$$

$$C = - \frac{\mu E [\epsilon^{m\alpha} \cos(\beta + \cot^{-1} s) + \epsilon^{m\beta} \cos(\alpha + \cot^{-1} s)]}{Z_n [\epsilon^{\alpha+m\beta} + \epsilon^{\beta+ma}]} \quad (37c)$$

As for the values of α and β , they can be found from the following two additional equations after eliminating A and B :

$$2B\epsilon^{m\beta} = A\epsilon^{n\beta} + \frac{\mu E \cos(\beta + \cot^{-1} n)}{Z_n} \quad (37d)$$

and,

$$B = \frac{\mu E [\epsilon^{\alpha} \cos(\beta + \cot^{-1} s) - \epsilon^{s\beta} \cos(\alpha + \cot^{-1} s)]}{Z_n [\epsilon^{\alpha+m\beta} + \epsilon^{\beta+ma}]} \quad (37e)$$

When the secondary is completely coupled to the primary, then $2L_2 = L_1, s = \infty, \cot^{-1} s = 0, C = 0$, and B of (37e) simplifies to:

$$B = \frac{\mu E}{\rho + 2r} \left[\frac{\cos \beta - \cos \alpha}{\epsilon^{m\beta} + \epsilon^{m\alpha}} \right] \quad (38a)$$

and the value of A in (37a) becomes

$$A = - \frac{\epsilon^{m(\pi-\alpha)}}{r+\rho} \left[\frac{Z_m}{Z_n} \mu E \cos(\alpha - \cot^{-1} m + \cot^{-1} n) \right]. \quad (38b)$$

Combining (38a) and (37b) we get one relation which α and β must satisfy as follows:

$$\epsilon^{-m\alpha} \cos \alpha = -\epsilon^{-m\beta} \cos \beta. \quad (39)$$

Substituting the values of A and B from (38b) and (38a) into (37d) and simplifying, the second relation that α and β must satisfy is

$$\epsilon^{-n(\pi+\beta-\alpha)} = -\frac{(1+mn) \cos \alpha + (n-m) \sin \alpha}{(1+mn) \cos \beta + (n-m) \sin \beta}. \quad (40)$$

To evaluate α and β from the two transcendental equations (39) and (40) is not as difficult as it might appear at first sight, because α and β under ordinary circuit arrangements are both nearly equal to $\pi/2$ and n is fairly large, so that the value of α is approximately obtained by setting the numerator of (40) to zero; i.e.,

$$\tan \alpha \cong -\frac{1+mn}{n-m} \quad (41)$$

or,

$$\alpha \cong \tan^{-1} \frac{1+mn}{m-n}. \quad (42)$$

With the value of α so found, the corresponding value of β can be easily obtained from (39) with the help of logarithmic and trigonometric tables. A second and closer approximation can be obtained by checking up the relation of continuity

$$e_{p2}'(-\beta) = e_{p1}'(-\beta). \quad (43)$$

This relation is chosen for this purpose in preference to the others because a slight error in α and β shows up most prominently in the inequality of both sides of (43). If this relation does not check to within a small fraction of a per cent, a slightly different value for α should be used and the corresponding β found, and the same equality checked again. Usually two or three trials are sufficient to yield results that are accurate enough for curve plotting.

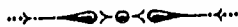

BOOKLETS, CATALOGS, AND PAMPHLETS RECEIVED

Copies of the publications listed on this page are not available from the Institute but may be obtained without charge by addressing the publishers.

Catalog J of the General Radio Company of 30 State St., Cambridge, Mass., covers measuring devices, power supplies, parts, and accessories.

Operadio Manufacturing Company of St. Charles, Ill., has issued a leaflet on two sound systems produced by them.

Rectox copper-oxide rectifiers are described in a booklet issued by the Westinghouse Electric and Manufacturing Company, East Pittsburgh, Pa.

A complete 1937 catalog of microphones and accessories has been issued by Shure Brothers of 215 W. Huron St., Chicago, Ill.

Bud Radio, Incorporated, of Cleveland, Ohio, has issued Catalog No. 137 describing radio parts and accessories.

General purpose power supplies for vacuum tube plate excitation are described in Bulletin DL-48-144 issued by the Raytheon Manufacturing Company of 190 Willow St., Waltham, Mass.

Bulletin PA-12 issued by the Jefferson Electric Company of Bellwood, Ill., describes a sixty-watt audio-frequency amplifier.

The Brush Development Company of 1899 E. 40th St., Cleveland, Ohio, has issued a leaflet on their B-1 sound cell microphone.

Information Bulletin 6 on electronic tubes, available from the Westinghouse Lamp Company, Bloomfield, N. J., describes a series of tubes ranging from low grid amplifiers to water-cooled power tubes.

Application Note No. 65 on tuning indicator circuits for the 6E5 and 6G5 and Note No. 66 on equal plate and screen voltage operation of the 6L6 have been issued by the RCA Manufacturing Company, RCA Radiotron Division, Harrison, N. J.

Engineering News Letter No. 30, issued by Hygrade Sylvania Corporation of Emporium, Pa., is on the input capacitance of tubes at audio frequencies. Technical data sheets have been issued on the 6D8G, pentagrid converter; 6L5G, supertriode amplifier and detector; 6S7G, supercontrol amplifier; and 6T7G, duodiode high-mu triode. A 1936-1937 edition of "Auto-Radio Installation and Servicing" is now available. A leaflet giving average characteristics of a large number of standard receiving type tubes has been issued as has a tube base chart.

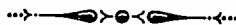

CONTRIBUTORS TO THIS ISSUE

Bowie, Robert M.: Born August 24, 1906, at Table Rock, Nebraska. Received B.S. degree in chemistry, 1929; M.S. degree in physics, 1931; Ph.D. degree in physics, 1933, Iowa State College. Physicist, Hygrade Sylvania Corporation, 1933 to date. Member, American Physical Society. Associate member, Institute of Radio Engineers, 1934.

Fang, Sun-Hang: Born Mar. 1, 1911, at Shanghai, China. Radio engineer, Ministry of Communication, Shanghai, 1928-1933; Received B.S. degree, La Universitato Utopia, Shanghai, 1933; assistant, Research Institute of Physics, Nanyang University, Shanghai, 1933; National Sheh Chi Technical Laboratory, Nanking, 1934; assistant, Institute of Physics, National Academy of Peiping, 1934 to date. Nonmember, Institute of Radio Engineers.

Landon, Vernon D.: Born May 2, 1901. Attended Detroit Junior college. In charge of radio-frequency laboratory, Westinghouse Electric and Manufacturing Company, Inc., 1922-1929; assistant chief engineer, Radio Frequency Laboratories, 1930; assistant chief engineer, Grigsby Grunow Company, 1931-1932; engineer in advance development section, RCA Manufacturing Company, Victor Division, 1932 to date. Associate member. Institute of Radio Engineers, 1927; Member, 1929.

Lapham, E. G.: Born September 26, 1902, at Gladstone, Michigan. Received A.B. degree in physics, University of Oregon, 1926. Graduate assistant, University of Oregon, 1927. Highway research, U.S. Bureau of Public Roads, 1928-1929; Bureau of Standards, 1929 to date. Associate member, Institute of Radio Engineers, 1931.

Miessner, Benjamin F.: Born July 27, 1890. Educated high school, U. S. Navy electrical school, and Purdue University. Radio operator, U. S. Navy, 1908-1911; torpedo control research, 1911-1912; Purdue University, 1913-1916; expert radio aide for aviation, U. S. Navy, 1916-1917; aircraft transmitter and long range receiver research and design, 1917-1920; electrophonographic research, 1920-1922; loud-speaker research, 1923; alternating-current receiver research, and design; 1923-1930; electrical musical instrument research, 1930 to date. President, Miessner Inventions, Inc. Member, American Physical Society and Acoustical Society of America; Fellow, Radio Club of America. Nonmember, Institute of Radio Engineers.

Ny, Tsi-Zé: Born December 4, 1900, at Tungyang, Chekiang, China. Received B.S. degree, National Southeastern University, Naking, 1923; Licencié ès-Sciences Mathématiques, University of Paris, 1925; Docteur ès Sciences Physiques, Paris, 1927. Professor of physics, La Universitato Utopia, Shanghai, 1927-1928; Research Fellow of the Institute of Physics, Academia Sinica, 1928-1929; research laboratories, University of Paris, 1929-1931; Director, Institute of Physics, National Academy of Peiping, 1931 to date. Member, Council of French Physical Society, 1934 to date; Secretary, Chinese Physical Society 1933 to date. Nonmember, Institute of Radio Engineers.

Sah, A. Pen-Tung: Born July 24, 1902, Foochow, China. Graduated, Tsing Hua College, Peiping, China, 1921; received A.B. degree, Stanford University, 1924; E.E. degree, Worcester Polytechnic Institute, 1925; D.Sc. degree, 1927. Engineer, Westinghouse Electric and Manufacturing Company, 1927-1928; assistant professor of physics and electrical engineering, National Tsing Hua University, 1928-1929; professor of physics, 1929 to date. Visiting professor of electrical engineering, Ohio State University, 1936. Nonmember, Institute of Radio Engineers.

Samuel, Arthur L.: Born December 5, 1901, at Emporia, Kansas. Received B.A. degree, College of Emporia, 1923; S.B. and S.M. degrees, Massachusetts Institute of Technology, 1926. General Electric Company (intermittently), 1923-1927; instructor, electrical engineering department, Massachusetts Institute of Technology, 1926-1928; technical staff, Bell Telephone Laboratories, Inc., 1928 to date. Member, American Physical Society and American Institute of Electrical Engineers. Associate member, Institute of Radio Engineers, 1924.

Sowers, Nelson E.: Born February 5, 1901 at Cypress, Illinois. Received B.S. degree in engineering physics, University of Illinois, 1924; M.A. degree, Columbia University, 1927; degree of engineer-physicist, University of Illinois, 1936. Engineering department, Western Electric Company, 1924-1925; Bell Telephone Laboratories, Inc., 1925 to date. Member, Sigma Xi and American Physical Society. Associate member, Institute of Radio Engineers, 1930.

Tsien, Ling-Chao: Born October 10, 1906, at Wusih, Kiangsu, China. Received B.S. degree, La Universitato Utopia, Shanghai, 1929, instructor of physics, Sin-Yue Middle School, Kwangsi, 1929-1930; assistant in physics, National Northeastern University, Mukden, 1930-1931; assistant, Institute of Physics, National Academy of Peiping, 1931-1934; research laboratory of Professor Andrade, London University, England, 1934 to date. Nonmember, Institute of Radio Engineers.



How long should a Man's legs be?

Lincoln had a good answer.
"Long enough," he drawled, "to
reach from his body to the
ground."

THAT seems like a good rule
to apply to a business. It
ought to be big enough to do
the job it is intended to do.

Have you ever thought
about the size of a company
—what makes it big or small?

It isn't the directors and it
isn't the stockholders — but
the public. No business grows,
and keeps on growing, unless
it meets the people's needs
and renders a worth-while ser-
vice at a fair price.

The Bell System has de-
veloped along those lines for
over fifty years. It has grown
as the nation has grown. It
has to be big to provide effi-
cient, adequate telephone
service to 127,000,000 people.

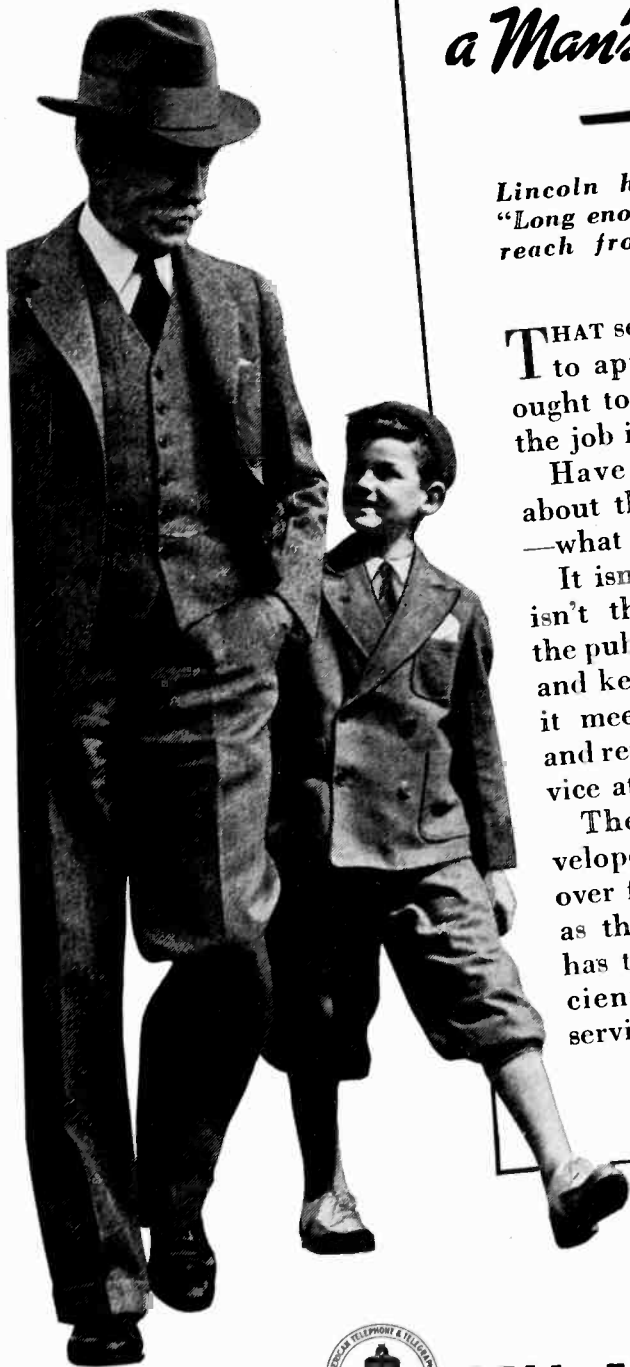

BELL TELEPHONE SYSTEM

When writing to advertisers mention of the PROCEEDINGS will be mutually helpful.

New TRANSMITTING CONDENSERS



Features...

Genuine oil-filled units in rectangular drawn-metal cans.

★

High-tension pillar insulator terminals. Sturdy mounting lugs.

★

Positively seepage-proof. Hermetically sealed to exclude moisture.

★

In 600, 1000, 1500, 2000 and 2500 volt ratings. And conservatively rated, too!

★

Capacities of 1, 2 and 4 mfd., except the 2500 v. units of 1 and 2 mfd.

ANOTHER example of the AEROVOX policy of providing quality products at popular prices. These new oil-impregnated oil-filled condensers have been carefully engineered for dependable operation and long life. They are now standard items. That means mass production and low cost, fully reflected in irresistible prices. It pays to use AEROVOX standard units wherever possible.

New CATALOG: Just out. More pages. More items. Lower prices. Send for your copy. And submit those special problems for engineering aid and quotations.



AEROVOX CORPORATION

71 WASHINGTON STREET, BROOKLYN, N. Y.

Sales Offices in All Principal Cities



When writing to advertisers mention of the PROCEEDINGS will be mutually helpful.

The Institute of Radio Engineers

Incorporated

330 West 42nd Street, New York, N.Y.

APPLICATION FOR ASSOCIATE MEMBERSHIP

(Application forms for other grades of membership are obtainable from the Institute)

To the Board of Directors
Gentlemen:

I hereby make application for Associate membership in the Institute of Radio Engineers on the basis of my training and professional experience given herewith, and refer to the members named below who are personally familiar with my work.

I certify that the statements made in the record of my training and professional experience are correct, and agree if elected, that I will be governed by the constitution of the Institute as long as I continue a member. Furthermore I agree to promote the objects of the Institute so far as shall be in my power, and if my membership shall be discontinued will return my membership badge.

(Sign with pen)

(Address for mail)

(Date)

(City and State)

Sponsors:

(Signature of references not required here)

Mr. _____ Mr. _____
Address _____ Address _____
City and State _____ City and State _____

Mr. _____
Address _____
City and State _____

The following extracts from the Constitution govern applications for admission to the Institute in the Associate grade:

ARTICLE II—MEMBERSHIP

Sec. 1: The membership of the Institute shall consist of: . . . (c) Associates, who shall be entitled to all the rights and privileges of the Institute except the right to hold any elective office specified in Article V.

Sec. 4: An Associate shall be not less than twenty-one years of age and shall be a person who is interested in and connected with the study or application of radio science or the radio arts.

ARTICLE III—ADMISSION AND EXPULSIONS

Sec. 2: . . . Applicants shall give references to members of the Institute as follows: . . . for the grade of Associate, to three Fellows, Members, or Associates; . . . Each application for admission . . . shall embody a full record of the general technical education of the applicant and of his professional career.

ARTICLE IV—ENTRANCE FEE AND DUES

Sec. 1: . . . Entrance fee for the Associate grade of membership is \$3.00 and annual dues are \$6.00.

ENTRANCE FEE SHOULD ACCOMPANY APPLICATION

To
THE RADIO ENGINEER



**YOU, TOO, CAN MAKE SPLENDID USE OF THIS
 ALL-EMBRACING BLUE RIBBON
 RADIO CATALOG**

HAVEN'T there been occasions when it was vital that you know immediately, **WHERE** to get a badly needed part—**HOW** much it would cost—**HOW** **QUICKLY** IT COULD BE OBTAINED? Every day, in hundreds of broadcasting stations, similar situations arise—and we suggest that it is well to have a centralized, **RELIABLE** source of supply for those parts, tubes, tools, meters and other radio equipment.

The engineer who has the 156 page Blue Ribbon Radio Catalog at his elbow has a valuable, thrifty ally, for there are more than 50,000 radio items listed in its pages—at prices which are possible only because of the overwhelming purchasing power of the world's largest distributor of radio apparatus.

Swift delivery, too—it is a "WHOLESALE rule" that orders must be shipped within twenty-four hours of their receipt. When you consider the ease of buying—the completeness of selection—the swiftness of delivery—the money saving possibilities—you will agree that the **WHOLESALE** way is the **BEST** way. Send for Catalog No. 65-L13 **TODAY**.

**GET THE BLUE
 RIBBON RADIO
 CATALOG . . .**

**IT'S
 FREE**

Send for it!



WHOLESALE RADIO SERVICE CO., Inc.

CHICAGO, ILL.
 901 W. JACKSON BLVD.

NEW YORK, N. Y.
 100 SIXTH AVENUE

ATLANTA, GA.
 430 W. PEACHTREE ST. N. W.

BRONX, N. Y.
 542 E. FORDHAM ROAD

NEWARK, N. J.
 219 CENTRAL AVENUE

When writing to advertisers mention of the PROCEEDINGS will be mutually helpful.

Change in Mailing Address or Business Title

Members of the Institute should use this form to notify the Institute office of a change in their mailing address or the listing of their company affiliation or title.

The Secretary
THE INSTITUTE OF RADIO ENGINEERS
330 West 42nd Street
New York City

New Affiliation or Title

Name _____
(Print or type)

Title _____

Company Name _____

Company Address _____

Home Address

Street _____
(Print or type)

City and State _____

Old Mailing Address

Street _____
(Print or type)

City and State _____

Please indicate whether you wish your mail to be sent to your home or business address.

Signature _____

Date _____

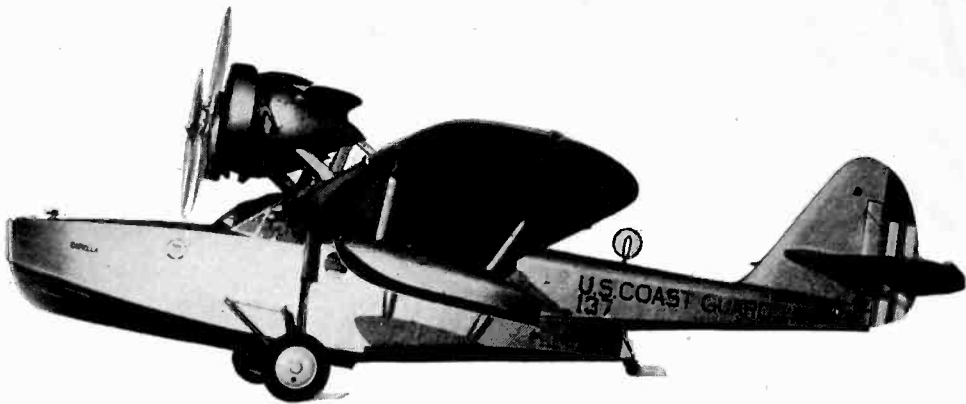

WHERE THERE CAN BE NO COMPROMISE...

THE U. S. Coast Guard is ever ready for unforeseen emergencies, to extend protection for shipping and commerce over the thousands of miles of our coast line . . . to serve as vigilant pilots of hazardous ocean lanes. Covering the waterfront in every season, in all weathers, is a duty which requires unflinching performance on the part of equipment.

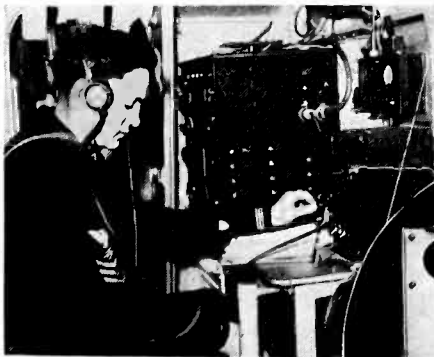

Only the finest materials go into these condensers, and every phase of their performance is tested by the most accurate instruments at the command of science.

Complete descriptive catalog Number 127 furnished on request.

Through its products, the Cornell-Dubilier Corporation . . . the world's largest manufacturer of capacitors has aided the Coast Guard in doing a faithful job. Cornell-Dubilier condensers are extensively utilized by U. S. Air Craft Signal Corps, Army, Navy, Air Force, Coast Guard, etc.

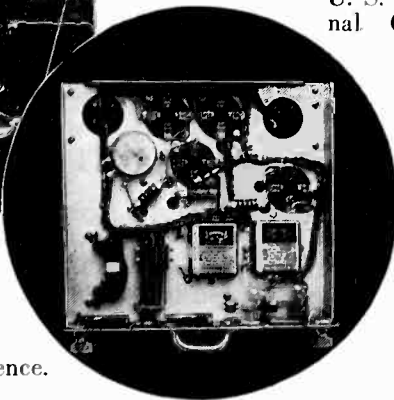

MICA
DYKANOL
WET AND
DRY
ELECTROLYTIC
PAPER

Photographs courtesy of the United States Coast Guard

CORNELL DUBILIER

CORNELL-DUBILIER CORP.

SO. PLAINFIELD, N.J.

When writing to advertisers mention of the PROCEEDINGS will be mutually helpful.

The Ultimate In Super-Sensitivity

1. * NO CURRENT DRAW
2. ** SELF-CALIBRATION
3. *** NO SKIN EFFECT

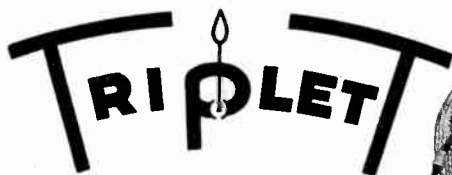

VACUUM TUBE VOLTMETER

MODEL 1250



**DEALER
PRICE
\$3334**

* Means accuracy cannot be affected by the current draw of the instrument itself. No current draw and permanent accuracy of Triplett Vacuum Tube Voltmeter is assured by the self-calibrating bridge circuit used.

** The most important advancement in circuit design for precision electrical instruments in recent years.

*** No skin effect assured because of infinity impedance at all frequencies.

Laboratories and engineers will use and immediately appreciate the significance of this remarkable instrument. Indispensable also in the servicing field for measuring electrical impulses either A.C. or D.C. of low magnitude such as the carrier wave of signal circuits, and particularly for television work.

The self-calibrating feature is automatic with the tube bridge circuit developed by Triplett engineers (Pat. Pend.). The initial operation of adjusting the bridge at the zero

level insures exact calibration independent of tube emission values or when replacing tubes.

Model 1250 is furnished with Triplett tilting type twin instrument. One instrument indicates when bridge is in balance. The other is a three range voltmeter with scales reading in peak A.C. and D.C. voltages. Ranges are 2.5, 10 and 50 volts. Other ranges to order.

Model 1250 is complete with all necessary accessories including 1-84, 1-6C6, 1-76. Case is metal with black wrinkle finish, panels are silver and black.

Dealer Price \$33.34

THIS IS A TRIPLETT MASTER UNIT

See Triplett Display I.R.E. Rochester Show, Booth 28.

See your jobber Write for more information

The Triplett Electrical Instrument Co. 2111 Harmon Drive, Bluffton, Ohio	
Without obligation please send me complete information on TRIPLETT VACUUM TUBE VOLTMETER.	
I am also interested in	
Name	
St. Address	
City	State



When writing to advertisers mention of the PROCEEDINGS will be mutually helpful.

ENGINEERING DIRECTORY

QUARTZ CRYSTALS

for Standard or Special
Radio Frequency Applications

Write for Catalog

BLILEY ELECTRIC CO.
230 Union Station Bldg.
ERIE, PENNA.

Cathode Ray Tubes
and Associated
Equipment For All
Purposes

*Write for Complete
Technical Data*

**ALLEN B. DUMONT
LABORATORIES**
UPPER MONTCLAIR, N.J.

COIL APPLICATIONS

Our coil specialists will engineer and design to your specific requirements coils for original installation or replacement purposes. Write for catalog or send specifications for quotations.

**EDWIN I. GUTHMAN and
CO., INC.**
400 S. Peoria St.
Chicago, Ill.

PRACTICAL RADIO ENGINEERING

One year Residence Course
Advanced Home Study Course
Combined Home Study-Residence
Course

Write for details

**Capitol Radio Engineering
Institute**
Washington, D.C.

MICROPHONE APPLICATIONS

Our engineering department will cooperate, without obligation, in the selection of suitable microphones for standard or special applications.

SHURE BROTHERS
"Microphone Headquarters"
225 WEST HURON ST. CHICAGO, U.S.A.

"Q"—Measurements

We specialize in equipment for the radio frequency measurement of "Q" (X/R) of coils, condensers and other radio components.

Write for Circular
BOONTON RADIO CORPORATION
BOONTON, NEW JERSEY

*For the Engineering Consultant
who can handle a little extra business this year*

*For the Designer
who can manage some additional work*

we suggest the Engineering Directory of the I.R.E. PROCEEDINGS. Manufacturers who need services such as yours and organizations with special problems come to our Engineering Directory for information. Your name and special service announced here will put you in line for their business. For further information and special rates for I.R.E. members write to the Institute of Radio Engineers.

When writing to advertisers mention of the PROCEEDINGS will be mutually helpful.

Alphabetical Index to Advertisements

A	
Aerovox Corporation	X
American Tel. & Tel. Company	IX
C	
Central Radio Laboratories	XX
Cornell-Dubilier Corporation	XV
E	
Employment Page	Cover III
Engineering Directory	XVII
Erie Resistor Corporation	XIX
G	
General Radio Company	Cover IV
I	
Institute of Radio Engineers	XI, XII, XIV
T	
Triplett Elec. Inst. Co.	XVI
W	
Wholesale Radio Service	XIII

PROCEEDINGS BOUND VOLUMES

VOLUME 23 (1935) of the Proceedings is now available in bound form to members of the Institute. It may be obtained in Buckram or Morocco leather for \$9.50 and \$12.00 respectively. Foreign postage is \$1.00 additional per volume.

Buckram bound copies of Volumes 18 and 19 (1930 and 1931) are also available for \$9.50. Foreign postage is \$1.00 additional per volume.

When writing to advertisers mention of the PROCEEDINGS will be mutually helpful.

Eric Resistor

MAKES **3** TYPES OF
RESISTORS

Insulated



TWICE SIZE

Body is insulated by a pre-formed, uniform ceramic wall that will withstand 3,000 volts A.C. without insulation breakdown. Entire unit is sealed with moisture-proof wax for humidity protection.

Non insulated

WITH LEADS IN LINE
WITH AXIS OF BODY



TWICE SIZE

Same as the insulated type but with ceramic sleeve omitted. The only non-insulated resistor with leads parallel to the resistance body that is as mechanically strong as the insulated type of corresponding design and rating.

Non insulated

WITH LEADS PERPENDICULAR
TO AXIS OF BODY

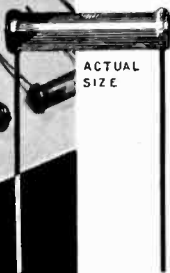

ACTUAL
SIZE

These resistors are recognized for their all-round excellent operating characteristics. Their resistance units are made from the identical composition of raw materials and operate with the same high efficiency as the other two types of Eric Resistors illustrated above.

CARBON RESISTORS
AND SUPPRESSORS

**ERIE RESISTOR
CORPORATION**

AUTOMATIC INJECTION
MOLDING

TORONTO ERIE, PENNSYLVANIA LONDON

When writing to advertisers mention of the PROCEEDINGS will be mutually helpful.

WHERE THE LONGEST WAY 'ROUND IS THE BEST WAY AFTER ALL

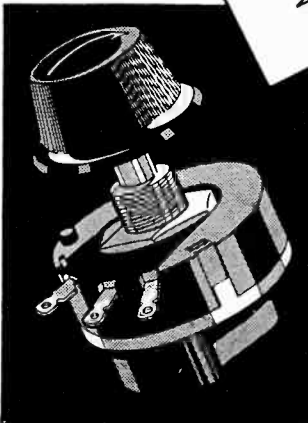

The useful length of old style volume control resistors is the smallest circumference because current takes the shortest path.

The useful length of the Centralab Radiohm resistor is its maximum circumference. This length is twice that of an old style control of equal outside diameter and represents the relative volume control efficiency.

Specify Centralab for original equipment and for replacements.

CENTRALAB Division of Globe-Union Mfg. Co., Milwaukee, Wis.

Centralab

CRL

RADIOHM

When writing to advertisers mention of the PROCEEDINGS will be mutually helpful.

EMPLOYMENT PAGE

RADIO ENGINEERS

In the rapidly growing field of radio transmission and reception, a large engineering and manufacturing company in England is augmenting its staff. The following positions require to be filled:—

1. **RADIO TRANSMITTING EXPERT**, familiar with present-day practice and design. The applicant must have laboratory experience together with proved ability to give practical manufacturing expression to his work.
 2. **RADIO RECEIVER ENGINEERS**, with up-to-date knowledge of radio application. First-class theoretical and practical experience. A knowledge of modern ultra-short-wave practice and cathode-ray technique would be advantageous. Write stating age, past experience in detail, and salary required. Box No. 164, care of The Institute of Radio Engineers.
-

HIGH SCHOOL and radio school graduate holding radiotelephone license and having servicing experience wants job with broadcast station or radio manufacturing concern. 20 years old. Will travel. Box No. 165, care of The Institute of Radio Engineers.

REGISTERED PROFESSIONAL ENGINEER desires responsible engineering position in broadcast, communications, or allied field. B.S. and M.S. degrees. Thorough knowledge of electrical engineering, communications, physics. Eleven years experience radio operation, maintenance, construction, design and field strength work. Age 26, married. Will travel or locate. Employed but desires change. Box No. 166, care of The Institute of Radio Engineers.

WANTED: Advertising solicitor for radio publication. Man must have sales ability, write good letter, and have general technical knowledge of radio. Give experience record and salary expected. Box No. 167, care of The Institute of Radio Engineers.

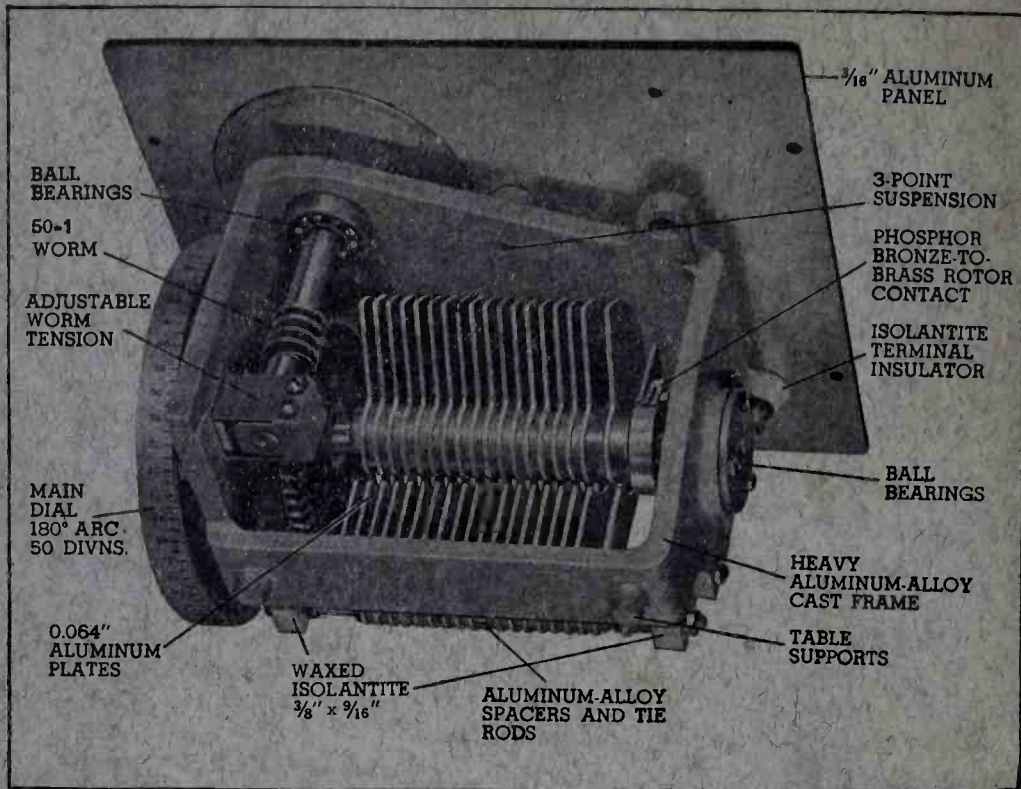

GENERAL RADIO COMPANY has always endeavored to anticipate the needs of the scientist and the engineer by making available laboratory standards which are considerably ahead of the immediate requirements of the measurements art.

This is illustrated particularly well in the case of precision variable capacitance standards. For many years the General Radio Type 222 Precision Condenser has been manufactured in large quantities for commercial, educational and governmental laboratory uses. After considerable development, General Radio announces an improved precision variable condenser which again anticipates the requirements of discriminating users.

The new Type 722 Condensers have many improvements over the Type 222 which they now supersede. Most of the mechanical improvements are suggested in the illustration. The resulting electrical characteristics include:

Low Temperature Coefficient of Capacitance: 22 parts per million (+0.0022% per deg. C)

Improved Figure of Merit: 0.04×10^{-12} (constant over audio range from 500 cycles)

Four models of the Type 722 Condenser are stocked. These are:

Type 722-F, 45 to 500 μf : \$85.00

Type 722-FU, unmounted model of Type 722-F: \$55.00

Type 722-D, double section of 25 to 100 μf and 100 to 1100 μf , direct reading: \$110.00

Type 722-M, 0 to 1000 μf , direct reading

Low Inductance: 0.06 μh

Accurate Setting: Vernier can be read to 1 part in 25,000

Figure of Merit unchanged up to 75% relative humidity

in capacitance removed from circuit; \$100.00

Worm correction calibration data for above (except Type 722-FU); \$35.00

Any of the Type 722 Condensers can be supplied with quartz insulators for \$55.00 additional.

Write for Bulletin 73-R for complete Data

GENERAL RADIO COMPANY
30 STATE STREET, CAMBRIDGE, MASSACHUSETTS