

VOLUME 24

MARCH, 1936

NUMBER 3

JW Ashmore

PROCEEDINGS
of
The Institute of Radio
Engineers



Eleventh
Annual Convention
Cleveland, Ohio
May 11, 12, and 13, 1936

Application Blank for Associate Membership on Page XI

Institute of Radio Engineers Forthcoming Meetings

ELEVENTH ANNUAL CONVENTION

May 11, 12, and 13, 1936
Cleveland, Ohio

JOINT MEETING

American Section, International Scientific
Radio Union and Institute of Radio Engineers
WASHINGTON, D. C.
May 1, 1936

CINCINNATI SECTION

March 17, 1936

CLEVELAND SECTION

March 26, 1936

DETROIT SECTION

March 20, 1936

EMPORIUM SECTION

March 20, 1936

LOS ANGELES SECTION

March 17, 1936

NEW YORK MEETING

March 4, 1936
April 1, 1936

PHILADELPHIA SECTION

March 5, 1936
April 2, 1936

ROCHESTER SECTION

March 12, 1936

The Institute of Radio Engineers

Board of Editors

ALFRED N. GOLDSMITH, *Chairman*

R. R. BATCHER
 H. H. BEVERAGE
 F. W. GROVER
 J. W. HORTON
 G. W. PICKARD

K. S. VAN DYKE
 H. P. WESTMAN, *ex officio*
 L. P. WHEELER
 L. E. WHITTEMORE
 WILLIAM WILSON

CONTENTS

PART I

Institute News and Radio Notes.....	335
February Meeting of the Board of Directors.....	335
Papers for 1936 Convention.....	335
Emergency Employment Service.....	336
Committee Work.....	337
Institute Meetings.....	337
Personal Mention.....	346
Report of Secretary for 1935.....	348

PART II

Technical Papers

The Secondary Emission Multiplier—A New Electronic Device.....	351
..... V. K. ZWORYKIN, G. A. MORTON, AND L. MALTER	
Review of Broadcast Reception in 1935.....	376
..... R. H. LANGLEY	
Radio Developments During 1935.....	385
..... C. M. JANSKY, JR.	
A Review of Radio Communication in the Fixed Services for the Year 1935.....	390
..... C. H. TAYLOR	
A Review of Radio Communication in the Mobile Services.....	396
..... C. N. ANDERSON	
Progress in Allied Fields to Radio (Abstract).....	408
..... O. H. CALDWELL	
An Experimental Television Receiver Using a Cathode-Ray Tube.....	409
..... MANFRED VON ARDENNE	
Losses in Twisted Pair Transmission Lines at Radio Frequencies.....	425
..... C. C. HARRIS	
Present Practice in the Synchronous Operation of Broadcast Stations as Exemplified by WBBM and KFAB.....	433
..... L. McC. YOUNG	
Grid Temperature as a Limiting Factor in Vacuum Tube Operation.....	447
..... I. E. MOUROMTSEFF AND H. N. KOZANOWSKI	
Terrestrial Magnetism and Its Relation to World-Wide Short-Wave Com- munications.....	455
..... H. E. HALLBORG	
Low-Frequency Transmission over Transatlantic Paths.....	472
..... H. H. BEVERAGE AND G. W. KENDRICK	
A Study of Ground-Wave Radio Transmission.....	483
..... R. C. HIGGY AND E. D. SHIPLEY	
An Analysis of Distortion in Class B Audio Amplifiers... TRUE McLEAN	487
Notes on Piezoelectric Quartz Crystals..... ISSAC KOGA	510
Young's Modulus of a Crystal in Any Direction..... ISSAC KOGA	532
Discussion on "The Grid-Coupled Dynatron," by F. Malcolm Gager....	534
..... TATUO HAYASI AND F. MALCOLM GAGER	
Book Reviews: "Communication Networks—Vol. II," by Ernst A. Guille- min.....	536
..... E. B. FERRELL	
"Handbook of Chemistry and Physics—Twentieth Edition," by Charles D. Hodgman.....	537
..... B. E. SHACKELFORD	
Contributors to This Issue.....	538

The Institute of Radio Engineers

GENERAL INFORMATION

INSTITUTE. The Institute of Radio Engineers was formed in 1912 through the amalgamation of the Society of Wireless Telegraph Engineers and the Wireless Institute. Its headquarters were established in New York City and the membership has grown from less than fifty members at the start to several thousand.

AIMS AND OBJECTS. The Institute functions solely to advance the theory and practice of radio and allied branches of engineering and of the related arts and sciences, their application to human needs, and the maintenance of a high professional standing among its members. Among the methods of accomplishing this is the publication of papers, discussions, and communications of interest to the membership.

PROCEEDINGS. The PROCEEDINGS is the official publication of the Institute and in it are published all of the papers, discussions, and communications received from the membership which are accepted for publication by the Board of Editors. Copies are sent without additional charge to all members of the Institute. The subscription price to nonmembers is \$10.00 per year, with an additional charge for postage where such is necessary.

RESPONSIBILITY. It is understood that the statements and opinions given in the PROCEEDINGS are views of the individual members to whom they are credited, and are not binding on the membership of the Institute as a whole. Papers submitted to the Institute for publication shall be regarded as no longer confidential.

REPRINTING PROCEEDINGS MATERIAL. The right to reprint portions or abstracts of the papers, discussions, or editorial notes in the PROCEEDINGS is granted on the express condition that specific reference shall be made to the source of such material. Diagrams and photographs published in the PROCEEDINGS may not be reproduced without making specific arrangements with the Institute through the Secretary.

MANUSCRIPTS. All manuscripts should be addressed to the Institute of Radio Engineers, 330 West 42nd Street, New York City. They will be examined by the Papers Committee and the Board of Editors to determine their suitability for publication in the PROCEEDINGS. Authors are advised as promptly as possible of the action taken, usually within two or three months. Manuscripts and illustrations will be destroyed immediately after publication of the paper unless the author requests their return. Information on the mechanical form in which manuscripts should be prepared may be obtained by addressing the secretary.

MAILING. Entered as second-class matter at the post office at Menasha, Wisconsin. Acceptance for mailing at special rate of postage is provided for in the act of February 28, 1925, embodied in Paragraph 4, Section 412, P. L. and R., and authorization was granted on October 26, 1927.

Published monthly by

THE INSTITUTE OF RADIO ENGINEERS, INC.

Publication office, 450-454 Ahnaip St., Menasha, Wis.

BUSINESS, EDITORIAL, AND ADVERTISING OFFICES

Harold P. Westman, *Secretary*

330 West 42nd Street, New York, N. Y.

INSTITUTE SECTIONS

- ATLANTA—Chairman, I. H. Gerks; Secretary, Philip C. Bangs, 218 Red Rock Building, Atlanta, Ga.
- BOSTON—Chairman, E. L. Bowles; Secretary, Roland G. Porter, Northeastern University, Boston, Mass.
- BUFFALO-NIAGARA—Chairman, L. E. Hayslett; Secretary, E. C. Waud, 235 Huntington Ave., Buffalo, N. Y.
- CHICAGO—Chairman, H. C. Vance; Secretary, J. E. Brown, 2022 Engineering Building, Chicago, Ill.
- CINCINNATI—Chairman, C. D. Barbulesco; Secretary, R. L. Freeman, Crosley Radio Corporation, Cincinnati, Ohio.
- CLEVELAND—Chairman, R. Morris Pierce; Secretary, J. S. Hill, 3325 Beechwood Ave., Cleveland Heights, Ohio.
- CONNECTICUT VALLEY—Chairman, J. A. Hutcheson; Secretary, E. E. Schwarzenbach, 42 Northwood, Chicopee Falls, Mass.
- DETROIT—Chairman, E. C. Denstaedt; Secretary, Howard S. Gould, 214 Tuxedo Ave., Detroit, Mich.
- EMPORIUM—Chairman, Raymond R. Hoffman; Secretary, L. E. West, Hygrade Sylvania Corporation, Emporium, Pa.
- LOS ANGELES—Chairman, C. R. Daily; Secretary, L. W. Howard, 525 West Central St., Anaheim, Calif.
- NEW ORLEANS—Chairman, L. J. M. DuTreil; Secretary, C. B. Reynolds, Radiomarine Corporation of America, 512 St. Peter St., New Orleans, La.
- PHILADELPHIA—Chairman, Knox McIlwain; Secretary, R. L. Snyder, 103 Franklin Rd., Glassboro, N. J.
- PITTSBURGH—Chairman, Lee Sutherlin; Secretary, Branko Lazich, Union Switch and Signal Company, Swissvale, Pa.
- ROCHESTER—Chairman, E. C. Karker; Secretary, H. A. Brown, 89 East Ave., Rochester, N. Y.
- SAN FRANCISCO—Chairman, Robert Kirkland; Secretary, Henry Tanck, RCA Communications, Inc., Bolinas, Calif.
- SEATTLE—Chairman, Earl D. Scott; Secretary, Harold C. Hurlbut, 2633-11th Ave. N., Seattle, Wash.
- TORONTO—Chairman, L. M. Price; Secretary, R. Klingelhoeffer, International Resistance Company, 187 Duchess St., Toronto, Ont., Canada.
- WASHINGTON—Chairman, Chester L. Davis; Secretary, Gerald C. Gross, Mt. Vernon Ave. and Carter's Lane, Oakcrest, Alexandria, Va.

GEOGRAPHICAL LOCATION OF MEMBERS ELECTED
FEBRUARY 5, 1936

Elected to the Associate Grade

California	Oakland, 646-63rd St.....	Combs, E. E., Jr.
Georgia	Columbus, Radio Station WRBL.....	Hull, M. I.
Illinois	Morrison, 304 Lincoln Way, E.....	Van Osdol, R. L.
Indiana	Indianapolis, 6433 Shellevy Ave.....	Slater, I. M.
Kansas	Kansas City, 901 N. 8th St.....	Hollister, H.
Minnesota	Duluth, 145 W. Anoka St.....	Scott, H. M.
New Jersey	Harrison, RCA Radiotron Division, RCA Manufacturing Co.	Perkins, T. B.
	Merchantville, 606 W. Maple Ave.....	Trafton, D. C.
	Orange, 449 Mountainview Ave.....	Casabus, H. R.
New York	Buffalo, 56 "C" St.....	Bennett, P. A.
	Greenport, L. I., 218-4th Ave.....	Wood, R. H.
	Kenmore, 297 W. Girard Blvd.....	Smith, G. G.
	New York, 463 West St.....	Glass, M. S.
	New York, Rm. 1211, 180 Varick St.....	Mason, W. P.
	Niagara Falls, 1634-10th St.....	Rogers, K. E.
	North Tonawanda, 1531 Kingston Ave.....	Manning, F. W.
	Tonawanda, 70 Elmwood Park, E.....	Christensen, A. B.
	Yonkers, 710 Warburton Ave.....	Kidd, G. B.
Ohio	Cleveland, National Broadcasting Co., 1367 E. 6th St.....	Caskey, H. B.
	Lakewood, 1641 Waterbury Rd.....	Weber, L. J.
	Sandusky, 1910 Barker St.....	Brindle, T. A.
Oklahoma	Tulsa, 247 E. 27th St.....	Floyd, F. M.
Oregon	Oakridge.....	Wolf, B. A.
Texas	Brenham, 604 S. Market.....	Lenert, R. H., Jr.
	Laredo, 809 Zaragoza St.....	Curtis, P. E.
	Lufkin, 124 Fred Ave.....	Saxon, M.
Wisconsin	Milwaukee, 2045 N. 57th St.....	Eckert, F. A., Jr.
Burma	Rangoon, Post Box 200.....	Dunkley, E. J.
Canada	London, Ont., Highland Rd.....	McIntosh, J. A.
	Toronto, Ont., 374 Brunswick Ave.....	Knap, H. B.
	Vancouver, B. C., 1955 Wiley St.....	Tupper, B. R.
England	Brentwood, Essex, "Greywalls," Shenfield Common.....	Ewen, M. E.
	London S. W. 5, 49 Eardley Crescent.....	Bharucha, J. H.
	London S. W. 13, 55 Lowther Rd., Barnes.....	Jones, I. C. A.
France	Ermont, (S. et O.), 5 rue des Faillettes.....	Grossin, H.
South India	Trivandrum, College of Science.....	Chacko, M. V.

Elected to the Junior Grade

Canada	Cochrane, Ont., P.O. 92.....	Tremblay, E. C.
--------	------------------------------	-----------------

Elected to the Student Grade

California	Berkeley, Bowles Hall, University of California.....	Cornes, R. W.
	Santa Paula, R.F.D. 2, Box 222.....	Teague, D. S. Jr.
Georgia	Atlanta, Box 44, Georgia School of Technology.....	Jones, W. L., Jr.
	Atlanta, 191 Poplar Circle, N. E.....	Winfree, R. W.
Massachusetts	Cambridge A, M.I.T. Dormitories.....	Lewis, F. D.
Michigan	Detroit, 258 S. Algonquin Ave.....	Eisen, C. G.
New Jersey	Hoboken, 907 Castle Point Ter.....	McAdie, C. H.
New York	Ithaca, 514 Wyckoff Rd.....	Harry, W. R.
Ohio	Minerva, 307 E. Lincoln Way.....	Rue, H. E.
England	London W. C. 1, 17 Brunswick Sq.....	Beck, A. H. W.

APPLICATIONS FOR MEMBERSHIP

Applications for transfer or election to the various grades of membership have been received from the persons listed below, and have been approved by the Admissions Committee. Members objecting to transfer or election of any of these applicants should communicate with the Secretary on or before March 31, 1936. These applications will be considered by the Board of Directors at its meeting on April 1, 1936.

For Election to the Associate Grade

California	Alhambra, 3132 Poplar Blvd.	Jeffords, R. D.	
	El Monte, 1001 N. Tyler St., Route 2	Clark, J. H.	
	Inverness, Box 111	Yokela, H. E.	
	Los Angeles, 2511-11th Ave.	Bertram, S.	
	Los Angeles, 906 S. Shenandoah Ave.	Birlenbach, S.	
	Los Angeles, 1607 S. Cresecent Heights Blvd.	Brace, F. R.	
	Okland, 5715 Onk Grove Ave.	Aiello, J.	
Connecticut	Stanford University, P.O. Box 945	Kulikowski, E. F.	
	Bridgeport, Rm. 316, YMCA	Worcester, J. A., Jr.	
District of Columbia	Washington, General Electric Co., 806-15th St.	Jacocks, T. B.	
	Chicago, 2309 W. 50th St.	Hanik, P., Jr.	
Illinois	Chicago, 1847 Berenice Ave.	Hayes, J. R.	
	Manhattan, 1641 Anderson Ave.	Paslay, L. C.	
Kansas	Manhattan, 1641 Anderson Ave.	Roberts, E. L.	
Maine	Orono, Lord Hall, University of Maine	Fletcher, R. H.	
	Cambridge, Dept. of Physics, Mass. Inst. of Technology	Heins, H.	
Massachusetts	Salem, Radio Eng. Dept., Hygrade-Sylvania Corp.	Bassett, E. D.	
	Springfield, 61 Mountainview St.	Curtis, K. V.	
Michigan	Swampscott, 44 Puritan Ave.	Workman, W. B.	
	Wyandotte, Radio Station WJR, Route 1	Butterfield, H. G., Jr.	
Missouri	Joplin, 612 Islington Pl.	Emmerich, C. M.	
	St. Louis, 4805 Leduc	Sims, W. H., Jr.	
New Jersey	Merchantville, 4779 West End Ave.	Ritchie, A. V.	
New York	Beacon, Drawer F.	Day, G.	
	Brooklyn, 701 Franklin Ave.	Mazyek, E. H.	
	Brooklyn, 875 E. 21st St.	O'Brien, J. C.	
	Coldwater, 245 Crestwood Blvd.	Hana, T. C.	
	Flushing, 34-19 Murray St.	De Friesse, F.	
	New York, 50 E. Kingsbridge Rd.	Greengard, J. E., Jr.	
	New York, 106-7th Ave.	Kalv, P. D.	
	New York, 60 W. 66th St.	Ostrolenk, S.	
	New York, 10 E. 40th St.	Porter, B. H.	
	New York, 444 Madison Ave.	Joss, E. T.	
	Queens Village, 9269-216th St.	Peebles, N. A.	
	North Carolina	Wilmington, 20 N. 8th St.	Bosomworth, G. P.
		Akron, Firestone Tire and Rubber Co.	Jerome, W. R.
	Ohio	Bedford, 32 Waulde Ave.	Luhn, C. W.
		Cincinnati, 4904 Arnold St.	Chatterton, L. N.
Pennsylvania	Cleveland, 479 E. 112th St.	Snedeker, M. L.	
	Cleveland, 1311 Terminal Tower	Heisner, D. A.	
Tennessee	Lorain, 1305-14th St.	Moore, W. R.	
	Emporium, 417½ Chestnut St.	Bean, N. S.	
Texas	Narberth, 300 Essex Ave.	Keachie, J. H.	
	Philadelphia, E. Cayuga and M Sts.	Thurnauer, H.	
Virginia	Chattanooga, American Lava Corp.	Daniels, T. E.	
	Sourlake	Kozakewicz, B. J.	
Canada	Quantico, 1st Signal Co., Marine Barracks	Scott, C. A.	
	Burlington, Ont., 24 Ontario St.	Richardson, W. G.	
England	Glencoe, Ont., Monitoring Station, R.R. No. 3	Christie, J. B.	
	Toronto, Ont., 269 Salem Ave.	Dean, H. B.	
	Toronto 9, Ont., 82 Glendonwynne Rd.	Mayne, L. F.	
	Vancouver, B. C., 2306 Kitchener St.	Gautby, H. R.	
	Brough, East Yorks, Melton Grange	Jones, A. R.	
	Cosham, Portsmouth, 122 Highbury Grove	Vigurs, R. F.	
	Gidea Park, Essex, 131 Pettits Lane	Parsons, D. R.	
	Lichfield, Staffs, "Cartref," Shenstone Ct. Dr.	Robinson, D. M.	
	London W. 8, Scopphony Ltd., Thomwood Lodge, Campden Hill	Weale, D. A.	
	London S.W. 6, 6 Chesilton Rd., Fulham	Woods, C. H.	
Holland	North Farnborough, Hants., "Quetta," Ship Lane	Bloemsmma, J.	
	The Hague, Mient 551	Monachesi, L.	
Italy	Genova, Via Giordana Bruno 18	Ausenda, C.	
	Milano, 4 Via S. Margherita	General, J.	
Puerto Rico	San Juan, RCA Communications, Inc., Edificio Ochoa	Thomson, W. B.	
Scotland	Paisley, 9 Barclay St.	Gibson, M.	
South Africa	Beaufort West, C. P., c/o Barclay's Bank Ltd.		

Applications for Membership

For Election to the Junior Grade

Illinois	Chicago, 1725 Wilson Ave.	Manatt, J.
Pennsylvania	Emporium, c/o C. A. Gasperson, 5 E. 4th St.	Somers, O. M.
	Pittsburgh, 7137 McPherson Blvd.	Bensley, J. T.

For Election to the Student Grade

California	Pasadena, 400 N. Holiston Ave.	Nestler, W. W.
Indiana	West Lafayette, Purdue Memorial Union	Lane, R. F.
Kansas	Lawrence, 1011 Indiana St.	Gemmill, F. Q.
Massachusetts	Cambridge, M.I.T. Dormitories	Kerr, D. E.
	West Somerville, 9 Lovell St.	Howard, S. B.
	Worcester, 25 Schussler Rd.	Libby, L. L.
Michigan	Ann Arbor, 630 Packard St.	Chapman, F. W.
	Houghton, 273 College Ave.	Bacon, C. W.
New Jersey	Newark, 288 Ridge St.	Brettell, G. A., Jr.
New York	Brooklyn, 77 Linden Blvd.	White, R. L.
	Ithaca, 207 Williams St.	Condren, J. M., Jr.
Ohio	Cincinnati, 1248 Rutledge St., Price Hill	Brauer, H. H.
Oklahoma	Tulsa, 1227 S. Frisco Ave.	Griffith, B. W., III
Pennsylvania	Bethlehem, 612 Montclair Ave.	Bomberger, D. C.
	Philadelphia, 6814 McCallum St.	Weil, W. S., Jr.
England	London, S.W. 7, City and Guilds College, Exhibition Rd., South Kensington	Foot, G. H.
	London N.W. 10, 17 Park Ave., West Twyford	Mole, J. H.

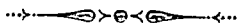

OFFICERS AND BOARD OF DIRECTORS

(Terms expire January 1, 1937, except as otherwise noted)

President

L. A. HAZELTINE

Vice President

VALDEMAR POULSEN

Treasurer

MELVILLE EASTHAM

Secretary

HAROLD P. WESTMAN

Editor

ALFRED N. GOLDSMITH

Directors

ARTHUR BATCHELLER

J. V. L. HOGAN

L. C. F. HORLE

C. M. JANSKY, JR., *Junior Past President*

C. B. JOLIFFE

A. F. MURRAY

H. M. TURNER

WILLIAM WILSON

SERVING UNTIL JANUARY 1, 1938

STUART BALLANTINE, *Senior Past President*

E. L. NELSON

HARADEN PRATT

L. E. WHITTEMORE

SERVING UNTIL JANUARY 1, 1939

E. H. ARMSTRONG

VIRGIL M. GRAHAM

H. H. BEVERAGE

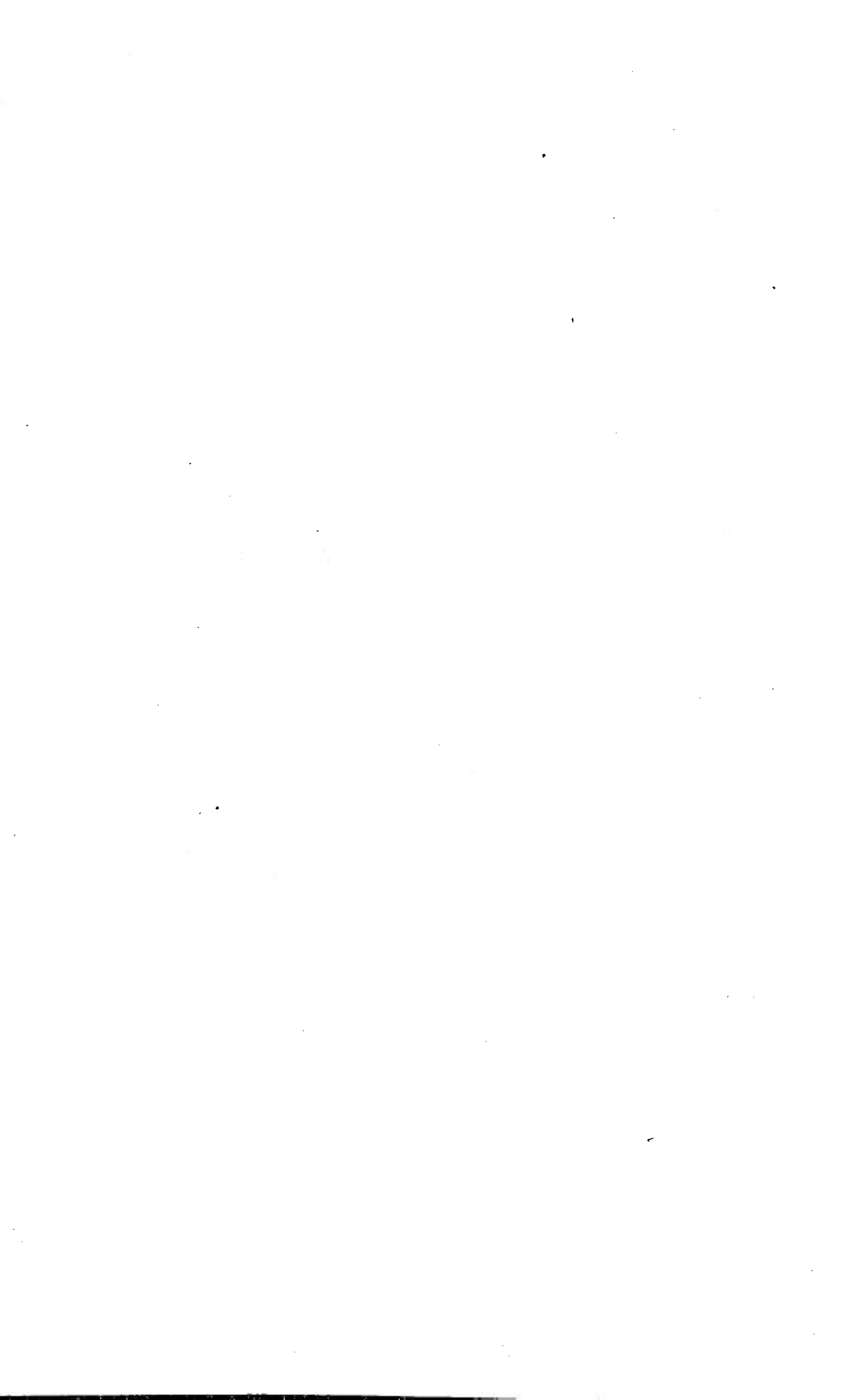

INSTITUTE NEWS AND RADIO NOTES

Board of Directors

The Board of Directors held its regular monthly meeting on February 5 in the Institute office. Those present were Alan Halzeltine, president; Melville Eastham, treasurer; Arthur Batcheller, H. H. Beverage, Alfred N. Goldsmith, Virgil M. Graham, L. C. F. Horle, C. B. Jolliffe, A. F. Murray, E. L. Nelson, Haraden Pratt, H. M. Turner, L. E. White-more, William Wilson, and H. P. Westman, secretary.

Thirty-six applications for Associate membership, one for Junior grade, and ten for Student membership were approved.

The accountant's report covering an audit of the Institute's books for the calendar year 1935 was accepted.

The Secretary's report on Institute operation during 1935 was approved and the Secretary was instructed to publish an abstract of it in this issue of the PROCEEDINGS.

Additional committee appointments were made and the final list will be given in the April issue of the PROCEEDINGS.

Section 37 of the By-Laws to the Institute's Constitution was amended to read as follows:

Section 37. The period of Student enrollment shall not extend more than one and one-half years beyond the date of award of the baccalaureate or leaving the university or technical school except that the period of Student enrollment may continue as long as at least half of the Student's time is devoted to a regular course of study in science or engineering in a school of recognized standing.

The Eleventh Annual Convention of the Institute will be held on May 11, 12, and 13, 1936, in Cleveland, Ohio, with headquarters at the Hotel Statler.

The Twelfth Annual Convention which will commemorate the twenty-fifth anniversary of the founding of the Institute will be held in New York City on May 10, 11, and 12, 1937.

Assistance to Institute members in obtaining employment will not be continued in the same manner as in the past and the Emergency Employment Service as such was discontinued. A more complete report on this appears elsewhere in these notes.

Papers for 1936 Convention

The program of technical papers to be presented at our Eleventh Annual Convention, to be held in Cleveland, on May 11, 12, and 13, is now being prepared. While invitations have already been extended

to organizations active in radio engineering work, it is not possible to invite individually each independent worker in the field. Those interested in presenting papers at the Convention should forward them to the secretary by not later than April first so the committee may have an opportunity of reviewing them to determine their suitability for presentation.

Emergency Employment Service

At the February meeting of the Board of Directors it was agreed that the Emergency Employment Service would be discontinued. This service was established in January, 1932, because of the keen emergency existing at the time. Some commercial employment agencies were collecting what appeared to be substantial fees for their services in placing men and it was the opinion of the Board of Directors that considerable stimulation might be given to employment through contact between the Institute and its members who were in a position to offer employment to others. In the four years of its existence, its registration reached a total of 811 of whom 579 were members of the Institute. There were 634 jobs handled in that period and 471 filled. A large proportion of the jobs filled were of a temporary nature.

At the present time there appears to be much less need for this service than when it was originally established. As time went on, it received fewer requests for men which had not also been placed with a number of commercial employment agencies and thus merely added one more organization to those active in the placement of men.

The effectiveness of this service was believed to diminish rapidly with distance from New York of the member and potential employer. The preponderant proportion of our placements have naturally been in and around the location of our headquarters office. While contributions from the membership supported the service to a large degree, this was not a serious limitation but during the past year the cost of the service has been met chiefly from the regular Institute funds. It was felt that expenditures of Institute funds should be along such lines as would so far as practicable benefit the membership as a whole and not any particular portion of it.

As a future program to assist unemployed members, the headquarters staff will continue to supply records of men to potential employers who request such information. The records of those who have already registered will be maintained and used.

An employment page open both to potential employers and Institute members will be available in the PROCEEDINGS. Advertisements of either type will be acceptable if they are of a suitable nature for publi-

ation at a nominal charge of \$2.00 each. It is hoped that this charge will pay the expense of publication. Instructions and information concerning the placement of these advertisements will be supplied on request.

Committee Work

MEMBERSHIP COMMITTEE

A meeting of the Membership Committee was held in the Institute office on February 5 and attended by F. W. Cunningham, chairman; H. A. Chinn, E. D. Cook, I. S. Coggeshall, H. C. Gawler, H. C. Humphrey, J. C. Randall, W. A. Schneider, C. E. Scholz, R. M. Morris, and H. P. Westman, secretary.

The committee reviewed some statistical data prepared by the secretary concerning membership in the Institute and prepared some material for use in circularizing delinquent members who might be interested in resuming their affiliations with the Institute.

TECHNICAL COMMITTEE ON RADIO RECEIVERS

The Subcommittee on Test Procedures of the Technical Committee on Radio Receivers of the Institute met on February 6 in the Institute office. Those present were D. E. Foster, chairman; L. F. Curtis, E. T. Dickey, Sarkes Tarzian, H. A. Wheeler, and H. P. Westman, secretary.

The committee continued its consideration of the existing report and prepared a number of modifications and additions to it.

SECTIONAL COMMITTEE ON RADIO-ASA

Technical Committee on Radio Receivers

The Technical Committee on Radio Receivers of the Sectional Committee on Radio met on January 31 in the Institute office. Those present were G. L. Beers, chairman; C. J. Franks, J. W. Fulmer, C. E. Kilgour (representing F. E. Johnston), George Rodwin (representing F. A. Polkinghorn), Gordon Thompson, E. B. Wilby (representing D. E. Foster), and H. P. Westman, secretary.

The committee gave final consideration to a number of items which are pending action by the Sectional Committee on Radio. It reviewed a portion of a document submitted by the International Electrotechnical Commission as a basis for international standardization.

Institute Meetings

ATLANTA SECTION

A meeting of the Atlanta Section was held on November 21 at the Georgia School of Technology. I. H. Gerks, chairman, presided and the

attendance was fifty-five. There were twenty-one present at the informal dinner which preceded the meeting.

A paper on "High Fidelity Transmission" was presented by J. H. DeWitt, Jr., chief engineer of WSM in Nashville, Tennessee. In it he outlined the results of his investigations of high fidelity transmission. The improvements in transmission during the past several years were outlined. Some of the points stressed were the relation between the volume range and level of the original production with the reproduction at the loud speaker of the receiver and the need of keeping the hum level at least sixty decibels below the normal signal level. The opinion was expressed that magnetic and crystal microphones are more suitable for high fidelity transmission than condenser and carbon types. The paper was discussed by Messrs. Bayne, Daugherty, Donovan, Eiselein, Fowler, Gerks, Middlebrooks, Reid, Shropshire, Turner, and Wills.

The December meeting of the section was held on the 19th at the Toll Office of the Southern Bell Telephone and Telegraph Company in Atlanta. Professor Gerks presided, and there were thirteen present.

The evening was devoted to an informal inspection trip through the Toll Office conducted by N. B. Fowler, technical employee, American Telephone and Telegraph Company. The equipment examined and described included that for wire photo, radio program, telegraphy, carrier telephony and teletype uses.

BOSTON SECTION

The Boston Section met on November 22 at Massachusetts Institute of Technology with E. L. Bowles, chairman, presiding. The meeting was attended by seventy-five and twenty were present at the informal dinner which preceded it.

The subject, "The Variable Air Condenser as an Impedance Standard at Radio Frequencies," was treated by two speakers. R. F. Field of the General Radio Company discussed "The Effect of Residual Impedances in an Air Condenser" and D. B. Sinclair, a research associate at Massachusetts Institute of Technology, discussed "Methods of Measurement."

All impedance standards for use at radio frequencies must be calibrated at direct or low-frequency current and assumed to remain unchanged or to follow a definite law as the frequency is increased. Of all possible standards, the variable air condenser has the smallest residual impedances. It consists of a residual inductance and a resistance highly localized in the leads and the stack support. Both are independent of the setting of the condenser and change only slowly with frequency.

The effect of the inductance is to cause the effective capacitance to increase both with frequency and with capacitance setting. This error may be ten per cent at six megacycles for one thousand micromicrofarads. The effect of the extra resistance is sufficient to total the series resistance at one megacycle for one thousand micromicrofarads.

The magnitude of these residual impedances may be determined by observing the change in the calculated values of capacitance and resistance by both series and parallel substitution methods for different initial settings of the variable air condenser. Straight-line plots of these data not only yield values of the residual impedances but prove by their linearity the correctness of the initial assumptions. For a representative precision condenser the inductance is 0.07 microhenry and the resistance is 0.02 ohm.

CHICAGO SECTION

The Chicago Section held its annual meeting on January 24 in the R.C.A. Institutes Auditorium. H. C. Vance, chairman, presided and there were sixty present. Fourteen attended the dinner which preceded the meeting.

A paper on "Features of Broadcast Studio Design" was presented by T. H. Phelan, Audio Facilities Engineering Division of the National Broadcasting Company. He outlined the construction of studios from the time the building is finished by the builders to the placement of the studio in service. Details were given of the construction of floors, walls, ceilings, doors, windows, and heating and ventilating systems. The problems connected with a floating floor so as to isolate it from the main building structure were covered. The isolation of walls from both the floor and building were described, and a sample section of both wall and floor structures displayed. The ceiling, supported from above rather than below, presents a different problem in which, however, the same general principles are used. Doors and windows of double and triple panels floated on special isolating gaskets were described. Methods of soundproofing ventilating ducts and floors were given and samples of acoustically lined ducts were shown.

In the election of officers, H. C. Vance of the R.C.A. Victor Company was elected chairman; J. K. Johnson of Wells Gardner and Company, vice chairman; and J. E. Brown, Engineering Department, Federal Communications Commission, was named secretary-treasurer.

CINCINNATI SECTION

The Cincinnati Section met in the Union Gas and Electric Company Auditorium on January 9 with C. D. Barbulesco, chairman, presiding.

The attendance totaled 250 and seventy were at the informal dinner which preceded the meeting.

The first paper of the evening on "Mechanical Methods in the Treatment of Respiratory Diseases" was by Louis Herrmann, Director of Vascular Clinic, Cincinnati General Hospital. Dr. Herrmann described his invention, which is called the "Paevex" machine, as a motor-driven device supplying alternating increments of a few pounds pressure fluctuating above and below atmospheric to a chamber which encloses a limb of the human body. The application of pressure and rarefaction in a cycle of five to ten seconds duration accomplished a dilation of arterials and capillaries in order that blood circulation rendered insufficient by conditions or disease in the limb treated is restored to normal. Specific cases of gangrene, blood clots, and frostbite, which had progressed to a degree necessitating amputation, were cited as examples which had been cured by the use of passive vascular exercise.

The second paper by C. E. Lane of the Bell Telephone Laboratories was on "Electric Wave Filters." He first treated the subject historically and classified filters as constant K, M derived, and latticed types. Their merits and the effects of combining the latter two types to obtain phase shift linear with frequency and the theory of terminal half sections to transform the filter impedance to match that of the connected circuits were treated. The design of radio-frequency filters usually makes necessary the transforming of the characteristic impedance within the filter to obtain practical circuit constants. Crystal and mechanical filters are present developments prompted by the search for circuit elements having higher Q values than obtainable in coils and condensers. A mechanical filter was demonstrated at the close of the paper.

The papers were discussed by Messrs. Barbulesco, Freeman, Platts, Rockwell and others.

CLEVELAND SECTION

On December 19 the annual meeting of the Cleveland Section was held in the Hotel Statler with K. J. Banfer, chairman, presiding. Fifty-five members and guests were present and forty-two attended the dinner which preceded the meeting.

R. M. Pierce, chief engineer of WGAR, presented a paper on "The New WGAR Antenna." The new radiator was described as a tower of uniform triangular cross section 374 feet high and weighing twenty-two tons. Its use increased the field strength by eighty to one hundred per cent. It is fed, by a coaxial transmission line filled with nitrogen under pressure.

The second paper by John Byrne, Professor of Communication

Engineering at Ohio State University, was on "The Construction and Operation of Field Strength Measuring Equipment." In it Professor Byrne described the antenna necessary for such equipment and developed the equation for the voltage generated in the loop. Several methods of measurement employed by workers in the field were then described.

In the election of officers, R. M. Pierce, chief engineer of WGAR, was named chairman; John Aitkenhead, of WADC, vice chairman; and J. S. Hill of the Case School of Applied Science, secretary-treasurer.

DETROIT SECTION

The January 21 meeting of the Detroit Section was held jointly with the American Institute of Electrical Engineers' local section in the Michigan Bell Telephone building. E. C. Denstaedt, chairman of the section, presided and the attendance was 350. About 100 were at the informal dinner which preceded the meeting.

K. K. Darrow, research physicist of Bell Telephone Laboratories presented a paper on "The newly Discovered Elementary Particles." Dr. Darrow opened his paper with a review of the atomic structure of the first eight elements. He described earlier concepts of the structure of matter. A table showing the relationship of the particles as to charge and mass was drawn and during the paper the particles were fitted into their respective places in the table. In order of their importance, they are electron and positron, neutron, proton, deuteron, and the positive alpha particle. It was shown that the atom of heavy hydrogen has but one electron but that the nucleus (deuteron) was apparently twice as heavy as that of normal hydrogen even though it has the same charge. The speaker then spoke briefly of transmutation describing how the nuclei must come in contact with each other and noted the great energy that must be imparted to them to accomplish this. Methods of disrupting the charge barrier were discussed and the construction of the Cyclotron and the Van der Graf generator described. Some of the results obtained with these machines were presented and the "fog chamber" method of making these results visible described. A discussion of the positron produced by transmutation and cosmic rays was then presented. It has the same mass and charge as the electron but is of opposite sign. The collision of a positron and an electron results in a corpuscle of light; an indication that probably all of the elementary particles can be converted one to the other.

EMPORIUM SECTION

The Emporium Section met on January 15 in the American Legion Club Room with R. R. Hoffman, chairman, presiding.

A paper on "Automatic Frequency Control for Superheterodynes" was presented by S. W. Seeley of R.C.A. License Laboratory. This development which is applied to superheterodyne circuits holds the oscillator system exactly in tune. It makes possible refinements in receiver construction not heretofore obtainable and eliminates unpleasant noises when tuning the receiver. There are additional possibilities for the application of the circuit and they were mentioned briefly. Messrs. Bachman, Baldwin, Bowie, Carter, Case, Fraenkel, Kievit, West, Wise, and Woods of the sixty-five members and guests participated in the discussion.

Another meeting of the Emporium Section was held on January 31 at the American Legion Club Room. Chairman Hoffman presided and there were seventy-four in attendance.

A paper on "Some Possibilities in New Vacuum Tubes and Radio Fundamentals" was presented by Alan Hazeltine, President of the Institute and Professor of Mathematics of Stevens Institute of Technology. Several different types of symmetrical and asymmetrical tube constructions whereby electron stream control is obtained by both deflection and emission control were described. Some of these constructions approximate a linearity in anode current control rather than following the approximate three-halves power relationship found in usual tubes. Inherent or natural neutralization of interelectrode capacitances is a noteworthy feature of certain of the symmetrical constructions discussed. Stability of oscillation at very small amplitude is another inherent feature in certain types while automatic frequency control and automatic phase control are additional important possibilities.

In the second part of his paper, Dr. Hazeltine touched on other than the usual mode of increasing the signal-to-noise ratio. Possibilities of compression-expansion and predistorting-restoring systems were pointed out. Amplitude modulation, frequency modulation, and amplitude and frequency modulation were discussed. The paper was discussed by Messrs. Bachman, Bowie, Salinger and others.

Distinguished guests from other sections were L. M. Price, chairman of the Toronto Section, W. E. Davison of the Radio Valve Company of Canada, and Dr. Salinger recently with the Heinrich Hertz Institute of Berlin.

Announcement was made of an annual award to be donated by the Hygrade Sylvania Corporation to the individual of the Institute exclusive of the local Executive Committee who has done most to promote activities in the section during the year.

LOS ANGELES SECTION

A meeting of the Los Angeles Section held on January 21 was attended by sixty-five members and guests.

C. R. Daily, chairman, presided and introduced J. R. Balsley of Balsley and Phillips, Ltd., who presented a paper on "Magnetic Materials and High-Q Coil Design." The speaker traced the development of various alloys of nickel, iron, and cobalt and indicated methods of treatment, the effect of impurities, and the magnetic properties of these alloys. A mathematical development of methods for producing high-Q coils indicated that with a specified coil material, Q values between 130 and 200 could be developed in coils having constant inductance over wide ranges of current flow.

NEW YORK MEETING

The New York Meeting of the Institute was held on February 5 in the Engineering Societies Building. Alan Hazeltine, president, presided and the attendance was about 400.

A paper on "Recent Developments of Class B Audio- and Radio-Frequency Amplifiers" was presented by L. E. Barton of the RCA Manufacturing Company. This paper was presented at the Tenth Annual Convention and is summarized in the June 1935, PROCEEDINGS.

PHILADELPHIA SECTION

On January 2 a meeting of the Philadelphia Section was held at the Engineers Club with Knox McIlwain, chairman, presiding. The attendance totaled 210 and fifteen were at the dinner which preceded the meeting.

A paper on "Vacuum Tubes in Biological and Medical Research" was presented by D. W. Bronk, Director of Eldridge Reeves Johnson Foundation for Medical Physics of the University of Pennsylvania Medical School. Dr. Bronk's presentation included an experimental demonstration of the electrical potentials generated by nerves and muscles of animals and humans. The impulses which travel over the nerve fibers giving rise to conscious sensation or muscular movement and the construction of the muscles are associated with the electrical charges. These potentials are often only a few microvolts and of brief duration but vacuum tube amplifiers make their detection and study possible.

Oscillograph records illustrate the regular sequence of electrochemical waves traveling along a nerve fiber from a single sense organ and the variation in frequency of those muscles with a variation in intensity of the stimulus. Such a train of impulses traveling along a sensory nerve

from a bit of frog skin was shown by means of a cathode-ray oscillograph and projected from a loud speaker so the audience could hear the regular sequence of events which constitute a sensory nerve message. Similar trains of impulses come from the central nerve system to the muscles of the body whose contractions are varied by changes in the frequency of the impulses. Illustrating this fact, Dr. Bronk inserted a very fine insulated wire encased in a hypodermic needle into a muscle of his arm so that the activity of a single muscle fiber was recorded by the loud speaker and oscillograph. An increase in the tension of the muscular contraction was shown to be due to a rise in the frequency of the contraction of the muscle fiber, and an increase in the number of fibers in action. Electric waves from the muscles of the heart were also illustrated to the audience. Dr. J. P. Hervey assisted Dr. Bronk and explained the electrical equipment used in the demonstration.

SAN FRANCISCO SECTION

On January 7 the San Francisco Section met jointly with the San Francisco Signal Post of the American Signal Corps Association at the Bellevue Hotel. Ralph Gray, chairman of the San Francisco Signal Post, presided.

"The Communication System of Spain" was the subject of a paper by W. H. Warren, division engineer of Mackay Radio and Telegraph Company. In it he described the installation problems of a complete new national wire telephone system with foreign radiotelephone connections. The meeting was attended by fifty-eight and twenty-three were present at the informal dinner which preceded it.

SEATTLE SECTION

R. F. Fisher, chairman, presided at the annual meeting of the Seattle Section which was held on December 27 at the University of Washington and attended by forty-eight.

"The Production, Transmission, and Perception of Sound" was the title of a paper presented by T. M. Libby, transmission engineer for the Pacific Telephone and Telegraph Company. He discussed the problems arising in the transmission and reproduction of sound and their solution. Various types of distortion were demonstrated and the technique of program distribution was shown by three sound motion picture films prepared by the Bell Telephone Laboratories. The paper was discussed by Messrs. Bouson, Eastman, Renfro, Scott, and Woodyard.

In the annual election of officers, E. D. Scott of the Puget Sound Power and Light Company was elected chairman; James W. Wallace,

Jr., Puget Sound Broadcasting Company, vice chairman; and Harold C. Hurlbut, Theatre Engineering Company, secretary-treasurer.

TORONTO SECTION

A meeting of the Toronto Section was held on January 13 at the University of Toronto. There were seventy-seven members and guests present and twelve at the dinner which preceded the meeting. L. M. Price, chairman, presided.

"Some Features of Short-Wave Antenna Operation and Design" was the subject of a paper by A. S. Blatterman, chief engineer of Rogers-Majestic Radio Corporation. Discussing first a simple circuit containing resistance, inductance, and capacitance, the speaker proceeded by analogy and comparison to the characteristics of transmission lines for wire communication and power and then to an antenna considered as a special type of transmission line. The impedance variation with frequency of various antenna structures indicated the maximum and minimum values obtained when excited at harmonic frequencies. Specifications were given for a short-wave doublet loaded and matched to a receiver, and graphs indicated its impedance characteristic and power factor to be definitely more uniform than for an unloaded antenna. With several short-wave channels spaced approximately three megacycles apart, an antenna having a fundamental frequency of 1500 kilocycles will exhibit resonance points or points of maximum response after the second harmonic at frequencies closely corresponding to the bands. Special loading methods such as inserting coils at intervals along the antenna, or a helical antenna of small diameter and pitch were also mentioned. Some practical difficulties in domestic installations were outlined. The paper was discussed by Messrs. Bayley, Price, Dawson, Hackbusch, Shane and others.

WASHINGTON SECTION

The Washington Section met on January 13 in the Potomac Electric Power Company Auditorium. Chester Davis, chairman, presided and there were seventy-three members and guests present. Twenty-six attended the dinner which preceded the meeting.

A paper on "Radio Propagation of Ultra-High-Frequency Waves, Including Work with Stratospheric and other Balloons" was presented by Harry Diamond of the National Bureau of Standards.

The forthcoming joint meeting of the Institute and the American Section of the International Scientific Radio Union on May 1 was discussed by Dr. Wheeler, chairman of the Committee on Arrangements.

Personal Mention

J. W. Greig has joined the radio laboratory staff of the U. S. Army at Wright Field, Dayton, Ohio, having formerly been with Northern Radio Company of Seattle Wash.

Formerly with Hygrade Sylvania Corporation, R. J. Davis has become an engineer in the transmitter department of the RCA Manufacturing Company at Camden, N. J.

W. G. H. Finch has left the Federal Communications Commission staff to reopen the Finch Telecommunications Laboratories in New York City.

Previously with Rudolph Wurlitzer Company, W. A. Hayes has joined the radio engineering staff of Colonial Radio Corporation at Buffalo, N. Y.

W. E. Holland formerly vice president in charge of engineering at Philadelphia Storage Battery Company has resigned and is retiring from active business because of poor health.

Formerly with the Engineering Research Department at the University of Michigan, J. D. Kraus has joined the Physicist Research Company of Ann Arbor, Mich.

G. C. Misener previously with United Research Corporation is now a member of the Research Laboratory of the Eastman Kodak Company.

Formerly with General Household Utilities Company, L. P. Morris has joined the Engineering Department of Case Electric Corporation at Marion, Ind.

D. A. Murray is now on the engineering staff of Heinz and Kaufman at South San Francisco, Calif., having previously been affiliated with Mackay Radio and Telegraph Company.

W. A. Murray has been appointed head of the Electrical Engineering Department of the Virginia Polytechnic Institute having formerly been at Michigan State College.

N. J. Oman has joined the staff of the broadcast transmitter division of the RCA Manufacturing Company at Camden, N. J., having formerly been with the Kenyon Transformer Company.

G. T. Royden of the Mackay Radio and Telegraph Company has been transferred from New York City to the Federal Telegraph Company, Newark, N. J.

G. E. West, formerly in the Electrical Engineering Department of Purdue University is now chief engineer of the Illinois State Police Radio System.

H. C. Behner, Lieutenant, U.S.N., has been transferred from Coco Solo, Canal Zone, to the *U.S.S. Wright*, basing at San Diego, Calif.

H. U. Graham formerly with RCA Victor Company is now an inspector at the Monitoring Station of the Federal Communications Commission, Grand Island, Nebr.

Orville Hill of Stewart Warner Alemite Corporation has been transferred from Belleville, Ontario, to Chicago, Ill.

E. A. Hayes has been transferred from Bridgeport, Conn., to Dallas, Texas, as a radio field engineer for the General Electric Company.

H. A. Gates has left Colonial Radio Corporation to become vice president in charge of engineering of Detrola Radio Corporation, Detroit, Mich.

Alex Corbunoff previously with Pilot Radio Corporation is now a radio engineer for General Household Utilities Company, Chicago, Ill.

Formerly with Stewart Warner Corporation, H. G. Lindner, is now affiliated with the aircraft television research group of RCA Manufacturing Company, Camden, N. J.

V. C. MacNabb has left Atwater Kent Manufacturing Company to become chief engineer for Fairbanks Morse and Company of Chicago, Ill.

H. V. Noble has joined the Transmitter Engineering Department of RCA Manufacturing Company at Camden, N. J., having previously been connected with the Gulf Research and Development Corporation of Pittsburgh.

J. L. Peters has left National Union Radio Corporation to become chief engineer for Electrode Specialty Company of Newark, N. J.

J. W. Sanborn is now in Canton, China, with the China Electric Company installing a broadcast station for the Kwangtung government.

E. R. Stoekle is now vice president of the Globe Union Manufacturing Company having formerly been with Central Radio Laboratories.

Formerly with Erie Resistor, Ltd., R. Weese has established Quadrant Metal Products, Ltd., of Stanmore, Middlesex, England.

I. A. Mitchell was erroneously listed as president of the Kenyon Transformer Company in the February issue. He is president of the United Transformer Company of New York City.



REPORT OF SECRETARY

1935

EACH year the Secretary submits a report on the more important phases of Institute activities for the information of the membership and this report covers 1935.

The Board of Directors is the governing body of the Institute. All problems are presented to it for decisions unless they are covered by the Constitution or by previously established policies. Standing committees and special committees are assigned problems which require more time than can be given them by the Board of Directors. The opinions of these committees are submitted to the Board for its guidance.

The secretarial staff is responsible for putting these policies and decisions into practice. It handles the routine business of the Institute.

Because of the size and geographical distribution of the membership, relatively few members actively participate in Institute operation. Those who do give of their time and efforts deserve the sincere appreciation of the entire membership.

Membership

The paid membership at the end of the year was 4419 compared with an active membership at the end of 1934 of 4854, a reduction of 9 per cent. The proportion of members residing outside of the United States and its possessions has increased to 24.2 per cent. Six hundred and sixty-four applications for membership were received during the year compared with 573 for 1934.

Proceedings

There were 1571 pages in the editorial portion of the PROCEEDINGS compared with 1413 published during 1934. Unfortunately, insufficient funds prevented the publication of all accepted papers but some improvement has been made in the situation.

The Papers Committee reviewed 114 manuscripts and the Board of Editors considered 146 papers during the year. Seventeen papers were rejected as being unsuitable for publication and twenty were returned to the authors for revision. Ninety-seven papers and discussions were published and eleven book reviews prepared and published.

Sections

The number of sections in operation is now eighteen; a new section with headquarters at Emporium, Pa., having been established during the year. There were 127 section meetings held during the year.

Meetings

The Tenth Annual Convention was held in Detroit on July 1, 2, and 3, and 586 members and guests attended it. Twenty-one technical papers were presented and thirty-four exhibition booths were occupied.

At the Rochester Fall Meeting, which was held on November 18, 19, and 20, there were 336 members and guests in attendance and ten papers were presented. Thirty-four booths comprised the exhibition which was a part of this meeting.

Committees

The Institute committees held seventy-one meetings during the year with somewhat over half of these being devoted to standardization work.

Emergency Employment Service

There were 127 new registrations filed with our Emergency Employment Service during the year. Of these, sixty-six were members of the Institute. The total registration is 802 of whom 575 are members. There were 154 jobs handled and seventy-seven of these were filled by us. In all placements, Institute members are given preference but if a job cannot be filled by a member, a nonmember is recommended. No charges are made for placement.

Finances

The financial position of the Institute is indicated by the comparative balance sheet which is given at the end of this report. The operating loss for 1935 is practically insignificant and indicates that the Institute has been quite successful in balancing its financial affairs for the year.

Deaths

We record here with deep regret the names of those whose deaths occurred during 1935.

Docherty, Curtis G.
Fung, Huo-Siu
Fussell, Lewis
Grebe, Alfred H.
Kent, James M.

McCanne, W. Roy
Pupin, M. I.
Sterns, Morton W.
Sveen, Erwing A.
Tuel, A. Y.

Respectfully submitted,



Secretary

EXHIBIT "A"

The Institute of Radio Engineers, Inc.

COMPARATIVE BALANCE SHEET

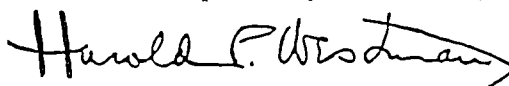
December 31, 1935 and 1934

	ASSETS	December 31, 1935	December 31, 1934	INCREASE DECREASE
<i>CURRENT ASSETS</i>				
Cash.....		\$11,932.87	\$7,479.81	\$ 4,453.06
<i>ACCOUNTS RECEIVABLE—CURRENT</i>				
Dues.....		440.00	1,133.90	693.90
Advertising.....		403.38	1,149.29	745.91
Reprints.....		156.19	20.14	136.05
<i>INVENTORY</i>		8,133.07	8,672.94	539.87
<i>ACCRUED INTEREST ON INVESTMENTS</i>		408.33	408.33	
<i>TOTAL CURRENT ASSETS</i>		<u>21,473.84</u>	<u>18,864.41</u>	2,609.43
<i>INVESTMENTS—AT COST (EXHIBIT "D")</i>		41,606.62	41,606.62	
<i>ACCOUNTS RECEIVABLE DUES—COLLECTIONS DEFERRED</i>				
			3,569.77	3,569.77
<i>FURNITURE AND FIXTURES AFTER RESERVE FOR DEPRECIATION</i>				
		2,408.91	2,833.44	424.53
<i>PREPAID EXPENSES</i>				
Unexpired Insurance Premiums.....		45.99	58.43	12.44
Stationery Inventory—Estimated.....		200.00	200.00	
Convention Expense.....		73.77		73.77
Salaries.....		220.68	68.40	152.28
<i>TOTAL ASSETS</i>		<u>\$66,029.81</u>	<u>\$67,201.07</u>	<u>\$ 1,171.26</u>
<i>LIABILITIES AND SURPLUS</i>				
<i>ACCOUNTS PAYABLE</i>		\$ 204.61	\$ 1,304.52	\$ 1,099.91
<i>SUSPENSE</i>		13.77		13.77
<i>ADVANCE PAYMENTS</i>				
Dues.....		1,397.30	1,267.95	129.35
Subscriptions.....		3,233.20	3,297.96	64.76
Advertising.....		53.28		53.28
<i>TOTAL LIABILITIES</i>		<u>4,902.16</u>	<u>5,870.43</u>	<u>968.27</u>
<i>FUNDS</i>				
Morris Liebman Memorial Fund Principal and Unexpended Income.....		10,077.87	10,077.87	
Associated Radio Manufacturers Fund.....		1,997.80	1,997.80	
<i>TOTAL FUNDS</i>		<u>12,075.67</u>	<u>12,075.67</u>	
<i>SURPLUS</i>				
Balance, January 1.....		49,254.97	51,700.36	2,445.39
Deduct—Operating Loss for Year (Exhibit "B").....		202.99	2,445.39	2,242.40
<i>SURPLUS—DECEMBER 31</i>		<u>49,051.98</u>	<u>49,254.97</u>	202.99
<i>TOTAL LIABILITIES AND SURPLUS</i>		<u>\$66,029.81</u>	<u>\$67,201.07</u>	<u>\$ 1,171.26</u>

Patterson and Ridgeway, Certified Public Accountants
74 Trinity Place, New York City

TECHNICAL PAPERS

THE SECONDARY EMISSION MULTIPLIER—A NEW
ELECTRONIC DEVICE*

By

V. K. ZWORYKIN, G. A. MORTON, AND L. MALTER

(RCA Manufacturing Company, RCA Victor Division, Camden, New Jersey)

Summary—This paper describes the construction, theory, and performance of various types of fixed field secondary emission multipliers. Detailed consideration is given of multiplier phototubes employing crossed electrostatic and magnetic fields and of electron multipliers using electrostatic focusing alone, to serve as coupling and amplifying units for cathode-ray tubes such as the "Iconoscope."

It is shown that while the power required for the operation of the secondary emission multiplier is about the same as that for the conventional amplifier, it is superior to the latter from the standpoint of noise. In the case of the multiplier phototube the signal-to-noise ratio is essentially determined by the shot noise of the photoemission, and is therefore sixty to one hundred times greater than that for a thermionic amplifier and phototube under conditions of low light intensity.

Multiplier phototubes have been built with an amplification factor of several millions and serve to replace the conventional phototube and accompanying amplifier system.

Their low "noise" level, together with their excellent frequency response and extreme simplicity, make these electron multipliers a very satisfactory form of amplifier.

INTRODUCTION

FOR MORE than thirty years it has been known that when certain surfaces are bombarded with cathode rays they emit electrons. This effect, known as secondary emission, has, from an early date, been extensively studied by a large number of workers such as Lenard, Hull, Von Bayer, etc.

The study of this phenomenon revealed that the number of electrons emitted is proportional to the bombarding current, the factor of proportionality ranging from a mere fraction to ten times as many secondary as primary electrons. The value of this ratio depends upon the surface used and on the velocity of the bombarding electrons. Although these facts have been known for a long time, the effect was not put to any useful work, except in the case of the dynatron invented by A. W. Hull. In fact, secondary emission had chiefly been looked upon as a serious obstacle in the design of thermionic vacuum

* Decimal classification: R535.38. Original manuscript received by the Institute, October 18, 1935; revised manuscript received by the Institute, November 21, 1935. Presented before New York meeting, October 23, 1935.

tubes, and much research was carried on with an aim towards suppressing and reducing it.

During the past fifteen years it became recognized that secondary emission could be used as a means of amplifying a small initial electron current and a number of workers began investigating this field. Patents on methods of carrying out this idea were filed as early as 1919 by Slepian¹ and later by such workers as Jarvis and Blair,² Iams,³ Farnsworth and others.

The general method involved is to allow the initial electron stream to impinge upon a target which has been sensitized for secondary emission. The secondary electrons from this target are directed on to a second target, producing still further electrons, the multiplication being repeated as many times as is desired. Reference to Fig. 1 will make this process clear. In this figure, electrodes *A*, *B*, *C*, etc., represent a number of plane targets having a high secondary emission ratio. These electrodes are connected to successively higher positive potentials. The stream of electrons to be multiplied is directed against *A*. This target gives rise to secondaries which go to target *B*, in turn giving rise to secondary electrons which are directed against *C*. After this process has been repeated a sufficient number of times to give the desired over-all multiplication, the electrons from the final target are collected on collector *O*. If *R* be the number of secondary electrons per primary for each stage and *n* the total number of stages, then the initial current *I*₀ will be multiplied up to an output current

$$I = I_0 R^n. \quad (1)$$

Clearly, the over-all gain will be *R*^{*n*} times. It will be seen that the over-all gain becomes very large indeed as the number of stages is increased if the secondary emission ratio of the targets is large (e.g., between five and nine).

A second class of multipliers has been described by P. T. Farnsworth,⁴ in which the electrons are made to go back and forth between a single pair of targets receiving their energy from a high-frequency electric field. Of these two classes of multipliers, only the type using successive targets, wherein the number of impacts can be rigorously controlled and the stability, consequently, is very great, will be discussed in this paper.

¹ Slepian, Patent No. 1,450,265, April 3, 1923 (1919).

² Jarvis and Blair, Patent No. 1,903,569, April 11, 1933 (1926).

³ Iams and Salzberg, "The secondary emission phototube," *Proc. I.R.E.*, vol. 23, pp. 55-64; January, (1935).

⁴ P. T. Farnsworth, "Television by electron image scanning." *Jour. Frank. Inst.*, vol. 218, pp. 411-444; October, (1934); also see *Electronics*, vol. 7, pp. 242-243; August, (1934).

The problem of making a multiplier which gives high gain is not, however, so simple as it might seem at first sight. A simplified multiplier constructed in accordance with the diagram (Fig. 1) would be almost completely inoperative, for the reason that practically all the electrons leaving any target would not go to the following one, but would merely go down the length of the tube and be collected at the final collector with almost no multiplication. In order to construct a successful multiplier, not only must the targets have a high secondary emission ratio, but also means must be provided to focus the electrons on to each target, and to draw away secondary electrons from one target preparatory to focusing them on to the next succeeding target.

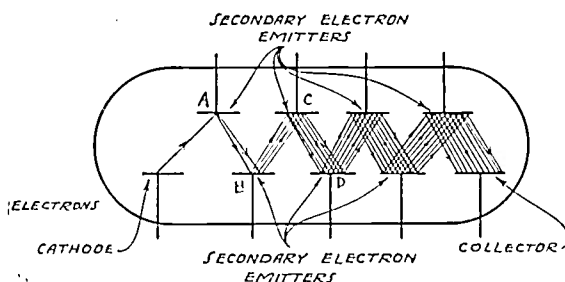

Fig. 1—Simplified secondary emission multiplier.

Before methods of electron focusing employed in specific multipliers are considered, there are certain general aspects of fixed field multipliers that should be discussed.

I. GENERAL CONSIDERATIONS

1. Secondary Emission

Since the successful operation of these multipliers depends upon a high secondary emission from the targets, it is of prime importance to discover the most suitable surfaces to use. In our search for good emitters, very little aid can be obtained from the theoretical physicist.

The most complete treatment of the theoretical aspect of secondary emission in the light of quantum mechanics was done by H. Fröhlich⁵ in 1932. In this discussion he calculates the probability of the transfer of energy between an incoming primary electron and a conduction electron moving in the periodic potential field of the metal, where the exchange is such as to give the conduction electron sufficient momentum to escape from the metal. On this basis, he concludes that metals with a crystal structure having a large lattice spacing and with a low work function should be the best secondary emitters. However, this treatment applies only to simple metal surfaces.

⁵ H. Fröhlich, *Ann. der Phys.*, Band 13, no. 2, pp. 229-248, (1932).

Experimentally, it has been found that the emission ratio from simple metal surfaces is invariably below that obtained from composite surfaces just as is the case with photoelectric emission. Since the theoretical knowledge of secondary emission does not extend to these composite surfaces, it is necessary to go ahead more or less empirically on the basis that, other things being equal, a surface of low work function is the most likely to be a good emitter. A large number of low work function surfaces were, therefore, studied having as a base metal, Ag, Be, Ta, Ni, Al, Zr, Ca, W, Cr, etc., and Na, K, Rb, and Cs as a surface layer. Of these, the most satisfactory to date have been oxidized Ag, Be, or Zr with a surface layer of cesium. These surfaces have a maximum secondary emission ratio of from eight to ten, occurring at a bombarding velocity of from 400 to 600 volts.

A curve showing the secondary emission ratio of Cs-CsO-Ag surface for various bombarding voltages is illustrated in Fig. 2. This is typical of the type of surfaces frequently used in the multipliers to be described later.

The method of preparation of this surface is very similar to that used in the preparation of the photoelectric cathode for a high vacuum cesium photocell. A matte silver sheet is oxidized to the second yellow by passing an electrical discharge through oxygen at low pressure. Then, after removing the oxygen from the vacuum system, cesium is admitted. The amount of cesium required is slightly less than that necessary to give maximum photosensitivity. The surface is then baked at 200 degrees centigrade for a few minutes to promote the reaction between the cesium and the silver oxide. This surface, when cooled, should be an excellent emitter.

2. Multiplier Efficiency

There are two ways of considering the efficiency of a multiplier. The first is the efficiency of secondary emission as a source of electrons, in terms of amperes per watt power supplied, while the second considers gain obtainable for a given over-all voltage as a function of the number of stages and voltage per stage. The second of these two considerations is more important from a practical standpoint, but both are worthy of some discussion.

Considering, first, the power efficiency, we have a target bombarded with a primary current I_0 at V_0 volts velocity. The power supplied by the primary beam is $V_0 I_0$ and, if the secondary emission ratio is R , the current I emitted is $I_0 R$. Therefore, the current per watt is

$$\frac{I}{W} = \frac{R}{V_0} \frac{I_0}{I_0} = \frac{R}{V_0} \quad (2)$$

Hence the most efficient point of operation is that at which the secondary emission curve shows the greatest gain per volt.

From Fig. 2 the curve of the gain per volt plotted against bombarding voltage, as shown in Fig. 3, can readily be calculated. This curve shows that at its maximum around thirty volts the emission is sixty milliamperes per watt, dropping to forty-five milliamperes per watt

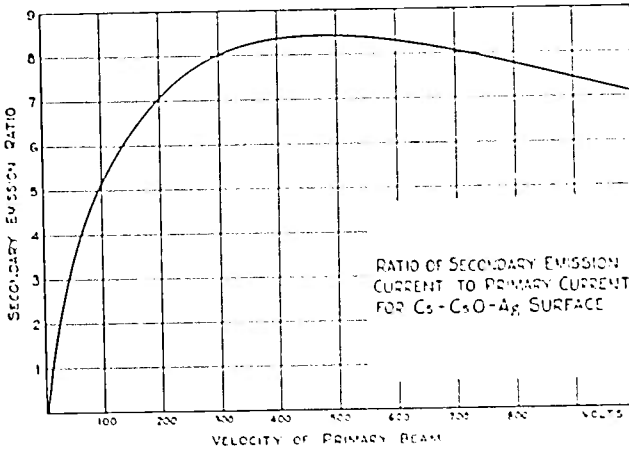

Fig. 2

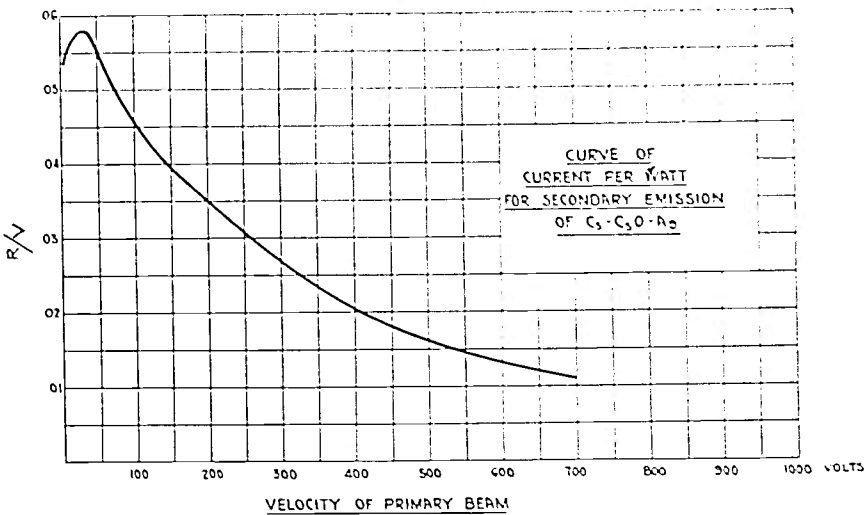

Fig. 3

at 100 volts, and seventeen milliamperes per watt at 500 volts. For comparison, it might be mentioned that a good thoriated tungsten thermionic cathode will deliver from fifty to seventy-five milliamperes per watt, while a very good oxide-coated cathode may run as high as one hundred milliamperes per watt. Thus, while secondary emission is not the most efficient way of obtaining an electron current, it compares rather favorably with other methods.

It is, of course, desirable to operate a multiplier under conditions such that maximum gain is had for a given over-all voltage. This condition may be determined as follows: Let R be the gain per stage, V_0 the voltage per stage, n the number of stages, and $V = nV_0$ the over-all voltage. The total gain is

$$G = R^n.$$

We can find the condition of maximum gain as n or V_0 is changed; i.e.,

$$\frac{dG}{dV_0} = R^{(V/V_0)-1} \left(\frac{V}{V_0} \frac{dR}{dV_0} - \frac{V}{V_0^2} R \log_e R \right) = 0. \quad (3a)$$

In other words, the maximum occurs when

$$\frac{dR}{dV_0} = \frac{R}{V_0} \log_e R. \quad (3b)$$

It is interesting to compare this with the slope of the emission curve when the power consumption is a minimum as obtained from (2)

$$\frac{dR}{dV_0} = \frac{R}{V_0}. \quad (4)$$

For cesiated silver, these two points are fairly close together, so that a multiplier built to give close to the maximum gain also is fairly efficient from the standpoint of power consumption.

The question of maximum over-all gain will be made clearer by reference to Fig. 4. This family of curves shows the gain that can be obtained from multipliers with various numbers of stages plotted against voltage. These curves show that the most efficient multiplier is one operated with from forty to fifty volts per stage. Run in this way, very high gains may be obtained. For example, a ten-stage multiplier at 500 volts will have a gain of 30,000, while a fifteen-stage multiplier at 800 volts will multiply the initial current ten million times. It should be noted that the curves in Fig. 4 and the over-all voltages given do not include the voltage between the collector and the last target, as this will depend upon the use to which the tube is to be applied.

3. "Noise" in Multiplier Output

Regarding the question of "noise" in these multipliers, the first consideration will be that of the statistical fluctuation of the useful electron current through the tube. Assume that we have a source of electrons, for example a photoelectric cathode, and that the electrons

from it impinge upon a secondary emitting target. The noise from the secondary electrons emitted will consist of two parts: first, the multiplied shot noise in the initial beam, and second, the fluctuation noise of the secondary emission from the target. For every target in the multiplier we shall have these two effects occurring simultaneously.

As yet, very little work has been done on the question of statistical fluctuation in secondary emission, either from a theoretical or an experimental standpoint, and there is some disagreement among the few

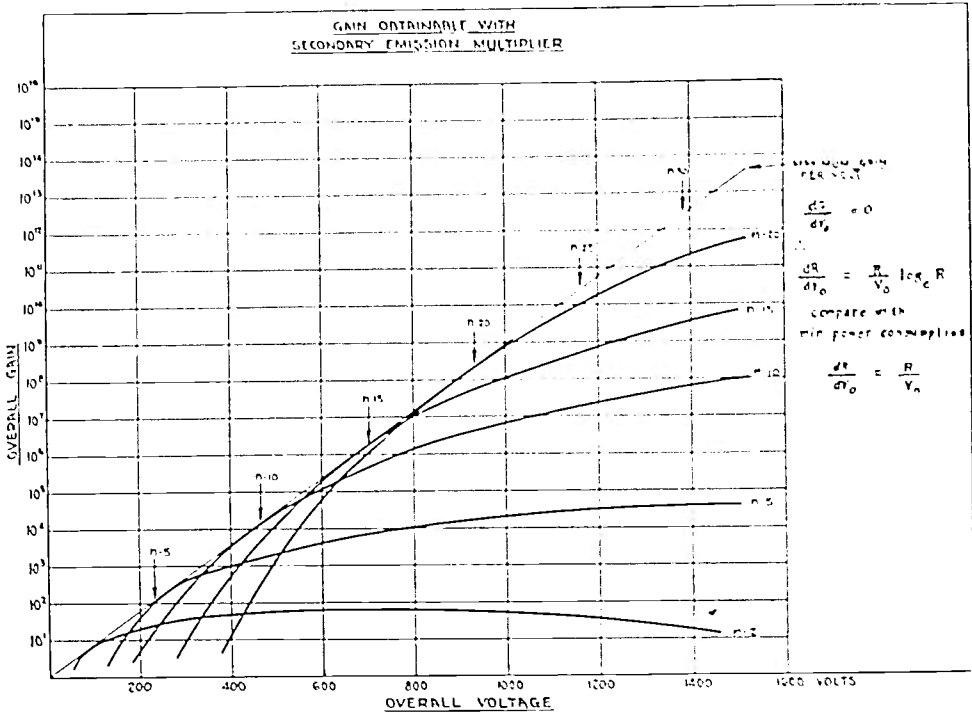

Fig. 4

experimental results available. However, these results indicate that the general magnitude of the effect is the same as the temperature limited shot noise from a thermionic cathode delivering a current equal to the secondary emission current.⁶

Let us, then, make the two following assumptions:

1. Shot noise from an emitter is multiplied by the subsequent stages in the same way in which an ordinary signal is multiplied.
2. Secondary emission from a target is subject to shot effect such that

$$i_n^2 = KI$$

⁶ A. W. Hull and N. H. Williams, *Phys. Rev.*, vol. 25, p.147 (1925); Penning and Kruithof, *Physica*, vol. 2, pp. 793-804; August, (1935); L. J. Hayner, *Physics*, vol. 6, pp. 323-333; October, (1935).

where,

I is the output current,

$K = 2eF$,

e = the charge on an electron,

F = frequency band over which noise is measured.

On the basis of these two assumptions, the total noise output from a phototube multiplier having an over-all gain G and n stages of uniform gain per stage, would be

$$i_n^2 = \frac{G^{(n+1)/n} - 1}{G^{1/n} - 1} 2eFI = K'I. \tag{5}$$

The table given below indicates the agreement between the measured noise output of several types of multipliers, and the values calculated from (5).

TABLE I

No. of Stages	Gain	K'/K Observed	K'/K Calculated
3	60	77	80
3	28	40	41
3	6.8	12.1	12.3
2	29.5	36.2	36.0
1	6.0	7.2	7.0

This agreement is sufficiently close to indicate that (5) based on the two assumptions made above is accurate to the extent necessary for any practical noise calculation.

Rewriting (5) in terms of R and neglecting 1 in the numerator in comparison with G we have

$$i_n^2 = \frac{R^{n+1}}{R - 1} 2eFI$$

or in terms of the original photoelectric current

$$i_n^2 = \frac{R^{2n+1}}{R - 1} 2eFI_0. \tag{5a}$$

Let us compare the noise output with the signal output, where the light producing the original photocurrent is modulated so as to produce a signal $i_s = kI$, k being the modulation factor. Under these conditions, the signal-to-noise ratio S_M is given by

$$\begin{aligned}
 S_M^2 &= \frac{i_s^2}{i_n^2} = k^2 \left(\frac{R^{2n}}{R^{2n+1} - 1} \right) I_{\text{cathode}} \\
 &= \frac{k^2}{2eF} \frac{R - 1}{R} I_{\text{cathode}}.
 \end{aligned} \tag{6}$$

The signal-to-noise ratio S for the original photocurrent is obviously given by

$$S^2 = \frac{i_s^2}{i_n^2} = \frac{k^2}{2cF} I.$$

The signal-to-noise ratio from the multiplier, therefore, only differs from the fundamental limit imposed by the photoelectric emission, by the factor

$$\sqrt{\frac{R-1}{R}}. \tag{7}$$

It should be pointed out here that if, instead of assuming that the shot noise due to secondary emission was the same as that from a saturated thermionic emission, we had assumed

$$i_n^2 = p2cF I$$

where p is some factor which has a value near unity, (7) becomes

$$\frac{R-1}{R-(1-p)}. \tag{7a}$$

From these equations it is evident that if R is large, the signal-to-noise ratio obtainable from these multipliers is practically that determined by the shot effect in the original photoelectric current.

Let us consider the improvement obtainable over the conventional amplifier by the use of a phototube multiplier. In the case of the thermionic amplifier, the noise limit is determined by the thermal noise in the first coupling impedance. The noise voltage input to the first tube is

$$e_n^2 = 1.6 \times 10^{-20} F r$$

$r = \text{input resistance}$

while the signal will be

$$e_s^2 = k^2 r^2 I^2$$

and the signal-to-noise ratio

$$S_A = \sqrt{\frac{e_s^2}{e_n^2}} = k \sqrt{\frac{r}{1.6 \times 10^{-20} F}} I.$$

This is to be compared with the corresponding ratio for the multiplier

$$S_M = k \sqrt{\frac{R-1}{R 2eF}} I.$$

For example, let us calculate the value of photoelectric current in each case which will give a signal-to-noise ratio of five when $k = 1/2$. Using the following condition (typical of those met with in television practice):

$$F = 10^6 \text{ cycles}$$

$$r = 10^4 \text{ ohms}$$

$$R = 5 \text{ per stage}$$

we find the current must be

$$8 \times 10^{-9} \text{ amperes}$$

when a conventional amplifier is used; whereas the current need only be

$$4 \times 10^{-11} \text{ amperes}$$

in the case of the multiplier photocell. Thus, it is seen that only 1/200 of the light is required to produce this signal-to-noise ratio when a multiplier photocell is used.

It is interesting to consider the case where the secondary emission ratio is not the same for every stage. If the gains per stage be $R_1, R_2, R_3, R_4 \dots R_n$, the total gain will be the product of these factors, while the noise output will be

$$i_n^2 = 1 + R_n(1 + R_{n-1}(1 + \dots (1 + R_1)))2eF I_0$$

and the signal-to-noise ratio is therefore

$$S_M = \left\{ 1 + \frac{1}{R_1} \left(1 + \frac{1}{R_2} + \frac{1}{R_2 R_3} + \dots \right) \right\}^{-1/2} \left(\frac{I}{2eF} \right)^{1/2} \quad (8)$$

In this expression R_1 is the most important factor determining the signal-to-noise ratio. A multiplier which is to combine high signal-to-noise ratio with very efficient voltage operation should, therefore, be run with a high gain for the first one or two stages and the remaining stages set for greatest over-all gain per volt.

Where a multiplier is to be used in connection with an electron source other than a photoelectric cathode, as for example a television transmitting tube or "iconoscope," the noise output will be

$$i_n^2 = m^2 G^2 + \frac{G - 1}{G^{1/a} - 1} 2peFI \quad (9)$$

where m is the root-mean-square fluctuation on the cathode-ray beam to be multiplied. The second term is, of course, the noise generated in the multiplier and is in general much lower than the first term.

There are two other factors which limit the sensitivity of these multipliers. The first of these is thermionic emission from the secondary emission targets. Since all good secondary emitters have a low work function, they emit electrons in appreciable numbers even at room temperature. This difficulty may be overcome by running the tube at low temperature. However, this precaution need only be taken when the device is being used to detect an absolute minimum of current. Under any ordinary condition of operation, even where a gain of several millions is employed, the tube can be satisfactorily run at room temperature.

The final factor to be considered is noise due to positive ions. The magnitude of this effect will depend upon the configuration of the tube, the degree of exhaust, and the temperature of the walls of the tube. The last two factors mentioned, while troublesome, can be overcome if proper precautions are taken. Therefore, it may be said that the shot noise of electron emission sets the fundamental limit to the sensitivity of the secondary emission multiplier.

4. *Frequency Response*

The frequency response of the secondary emission multiplier is flat over a very wide range of frequencies. As far as the lower limit of frequency response is concerned, the multiplier performs equally well at very low frequencies (including direct current) as at an intermediate frequency. A number of factors influence the high-frequency response. Basically, the limits are due to the spread of the time of flight of electrons in the tube and to the time of secondary emission. This will set an upper limit at many hundreds of megacycles. In addition to this, the upper limit is determined by the nature of the voltage supply for the targets and the output circuit. The latter factors are controllable and can be made as high as desired. Between the upper limit and a direct-current signal, the frequency response is essentially uniform.

II. MAGNETIC SECONDARY EMISSION MULTIPLIER

1. *Theory of Operation*

The magnetic multiplier is based upon the use of a crossed magnetic and electrostatic field to separate and focus the secondary electrons from one target to the next. This configuration of fields and electrodes was first suggested by Slepian in 1919, for use as a high current cathode.

The general arrangement of a multiplier based on this principle is shown in Fig. 5. It consists of two rows of electrodes, the bottom row being secondary emitters, while the upper row serves solely to maintain a transverse electrostatic field between the two sets of elements.

Each target in the bottom row is made positive with respect to the preceding one so that it will produce secondary electrons when struck by electrons originating from the latter. A magnetic field is established in the tube at right angles to its axis and to the field between the two rows of plates. Electrons leaving any of the lower plates are bent by

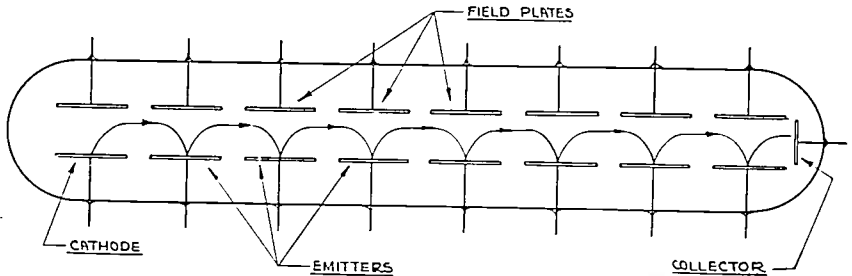

Fig. 5—Magnetic secondary emission multiplier.

the combined fields in such a way that they strike the next target, giving rise to secondary electrons which are in turn deflected on to another target, and so on through the tube.

This will be made clear by a consideration of the paths of the electrons under the influence of crossed fields. Let us assume, as a first approximation, that the potential difference between successive tar-

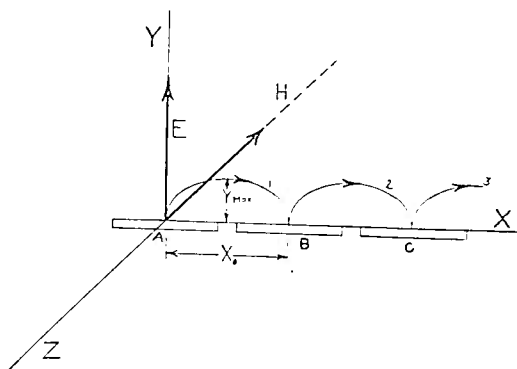

Fig. 6

gets is small compared with the potential between the targets and the top plates. Also, assume that the initial velocities are zero. The system as described can be represented by a rectangular co-ordinate system shown in Fig. 6, the targets lying along the axis of the tube, the electrostatic field E between the two rows of plates being in the y direction and the magnetic field H being in the negative z direction. The equations of motion of the electrons are therefore

$$\begin{aligned}
 m\ddot{x} &= eH\dot{y} \\
 m\ddot{y} &= eE - eH\dot{x} \\
 m\ddot{z} &= 0.
 \end{aligned}
 \tag{10}$$

A solution of these equations of motion leads to the following expression for the electron paths

$$\begin{aligned}
 x &= \frac{E}{H^2} \frac{m}{e} \left(\frac{eHt}{m} - \sin \frac{eHt}{m} \right) \\
 y &= \frac{E}{H^2} \frac{m}{e} \left(1 - \cos \frac{eHt}{m} \right) \\
 z &= 0.
 \end{aligned}
 \tag{11}$$

These are the equations of a cycloid. The paths of the electrons will, therefore, appear as shown in Fig. 6, leaving cathode *A* along path 1, then after striking target *B* cause electrons to leave along path 2 following a cycloidal trajectory to target *C*.

From these equations it can be seen that the distance between points of impact will be

$$X_0 = 2\pi \frac{E}{H^2} \frac{m}{e} \tag{12}$$

while the maximum vertical displacement will be

$$Y_0 = \frac{2E}{H^2} \frac{m}{e}. \tag{13}$$

Actually, the conditions we have used in making these calculations are not exactly those found to exist in the tube, for under the conditions assumed the electrons would reach each target with zero velocity. In the multiplier tube, the targets are made successively more positive, so that the electrons will strike them with sufficient velocity to produce secondary electrons. In order to maintain an equal field between each target and its top plate, it is necessary also to make the top plates successively positive with respect to each other. This introduces a component of electric fields in the *x* direction. Furthermore, the fields in the *x* and *y* directions are not constant, but become, under operating conditions, very complicated indeed. It is not possible to determine analytically the electron paths in the fields actually known to exist in these multipliers; therefore, for the present, we must base our calculations on the approximations given above.

So far, we have neglected the effect of initial velocities on the trajectories. If the initial velocities λ_0 , μ_0 , and ν_0 in the *x*, *y*, and *z*

directions are introduced as boundary conditions into the solution of (10), the equations of the paths become

$$x = \alpha\beta t + \frac{\mu_0}{\alpha} - \beta' \sin(\alpha t + \theta) \tag{14}$$

$$y = \beta - \frac{\lambda_0}{\alpha} - \beta' \cos(\alpha t + \theta) \tag{15}$$

$$z = v_0 t \tag{16}$$

where,

$$\alpha = \frac{e}{m} H$$

$$\beta = \frac{1}{\alpha} \frac{E}{H} = \frac{E}{H^2 e/m}$$

$$\beta' = \sqrt{\left(\beta - \frac{\lambda_0}{\alpha}\right)^2 + \left(\frac{\mu_0}{\alpha}\right)^2}$$

$$\theta = \tan^{-1} \frac{\mu_0/\alpha}{\beta - (\lambda_0/\alpha)}$$

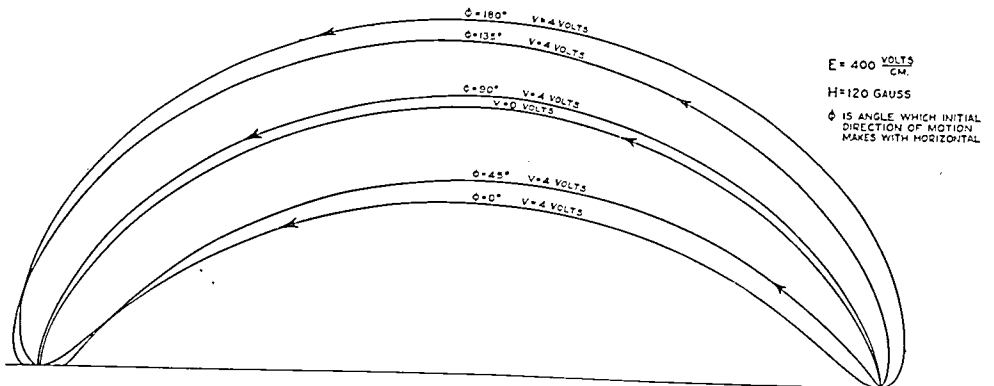

Fig. 7

These equations represent trochoidal paths, which degenerate into cycloids when the initial velocities become zero. Fig. 7 shows a family of these paths traced out by electrons having four volts initial velocity and emitted in various directions in the x, y plane.

It will be seen that the defocusing even at its maximum is only a very small fraction of the distance between points of impact. A general expression for the fractional defocusing (i.e., the distance ΔX that an electron with a given initial velocity strikes the target from the point where an electron with zero initial velocity impinges divided by the

total path distance X_0 along the x axis) can be derived from (10) and (14). This equation takes the form

$$\frac{\Delta X}{X_0} = \frac{1}{\pi} \left(\frac{\mu_0}{\alpha\beta} - \theta \right) \quad (17)$$

and can be used to calculate the axial defocusing for any value of initial velocity.

From (16) it can be seen that there will be a transverse defocusing if the initial velocity in the z direction is not zero. This transverse spreading can be calculated by substituting the time of flight between two stages into the equation

$$z = v_0 t.$$

This leads to an equation for the displacement ΔZ from the center of the targets as follows

$$\frac{\Delta Z}{X_0} = \frac{H}{2E} \sqrt{2V_{0z}e/m} \quad (18)$$

where V_{0z} is the initial velocity of the electron in the z direction expressed in units of potential.

It should be noted that the transverse displacement is cumulative from stage to stage. However, due to the statistical nature of the effect, the spreading of all the electrons as they traverse the tube will be proportional to the square root of the number of stages, rather than to the number of stages.

It was shown that the ratio of maximum height that the electrons rise above the targets is

$$\frac{Y_{\max}}{X_0} = \frac{1}{\pi}$$

in the case where the initial velocities are zero. The existence of initial velocities increase the maximum height slightly. Using (10) and (15), it can be shown that the equation for the maximum becomes

$$\frac{Y_{\max}}{X_0} = \frac{\beta + \beta' - (\lambda_0/\alpha)}{2\pi} \quad (19)$$

As yet, no accurate measurement has been made on the velocity distribution for secondary emission from cesiated surfaces; however, measurements have been made which show that 85 per cent of the electrons leaving a target have less than three volts initial velocity.

Using the value $V_0 =$ three electron volts to calculate the defocusing in an actual multiplier operated under the following conditions

$$E = 400 \text{ volts per centimeter}$$

$$H = 120 \text{ gauss}$$

$$V_0 = 3 \text{ volts}$$

we find,

$$\frac{\Delta X}{X_0} = 0.02$$

$$\frac{\Delta Z}{X_0} = 0.3$$

$$X_0 = 0.97 \text{ centimeter.}$$

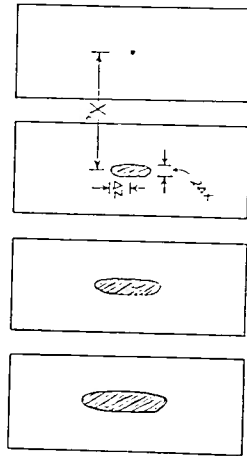

Fig. 8

This means that electrons leaving from a point on the cathode spread into an elliptical spot on the first target. This in turn is spread into a larger ellipse on the second target, the size of the spot increasing as the electrons progress down the tube. This is illustrated schematically in Fig. 8.

Eventually, the spot becomes so large that some of the electrons miss the target entirely, and there is a dropping off of the efficiency of the subsequent stages. The transverse spreading is such that there would be a serious loss after a comparatively few stages unless special precautions, that will be described later, are taken to prevent this type of defocusing.

Finally, the relative height above the targets to which the electrons rise will be

$$\frac{Y_{\max}}{X_0} = 0.4.$$

Thus the top row of plates must be placed at a distance slightly greater than this above the targets, to avoid collecting any current. The actual spacing used is one half the distance between target centers.

2. Design and Construction of Magnetic Multiplier

A schematic diagram of the actual application of the principles, described above, to a multiplier phototube is shown in Fig. 9. Photoelectrons are focused upon a target *2a*. Secondary electrons from this electrode will be focused on target *3a* giving rise to further electrons, and so on, for as many stages as are desired.

The plates are mounted in the tube in such a way that the upper and lower plates are as close together as is possible in order to make E_y large and thus increase the current that can be drawn away from a target before space-charge limitations occur. This minimum spacing, as was shown above, is half the distance between centers of successive targets. With this construction it is found that the current that can be drawn from the tube is limited only by the power that can be dissipated from the final stages in overcoming the heat generated by electron impacts.

In order to limit the sidewise spreading, the electrodes are mounted on vertical strips of mica. Charges which accumulate on these vertical walls so alter the field as to introduce an additional lens action which limits sidewise spreading. With this arrangement, the limit to the number of stages which may be used is set by the axial defocusing. However, this defocusing is so small as to permit the use of a great many stages. The upper limit to the number of stages has not been determined experimentally although multipliers employing as many as twelve stages without a decrease in gain per stage have been constructed.

When multipliers are operated at high gains into high impedance loads, some difficulty is encountered from oscillation. This can be eliminated by surrounding the collector electrode with a shield grid as shown in Fig. 9. The grid serves as an electrostatic shield and prevents changes of collector potential from reacting upon earlier stages. It also results in the alteration of the output characteristic from that of a triode to that of a conventional screen-grid tetrode.

For operation of the device, it is necessary that the upper electrodes be at a fixed positive potential with respect to the corresponding lower electrode, and that the voltage steps between adjacent electrodes be equal. In order to decrease the number of leads required, it has been found advantageous to connect upper electrodes to lower targets farther down in the tube. Satisfactory results have been attained when

each upper electrode is connected to the next succeeding lower target.

Since the first few targets draw almost no current, their potential can be supplied very satisfactorily from a voltage divider or bleeder. In order to decrease further the number of leads in a multiplier employing many stages, it has been found practicable to incorporate the bleeder for the initial stages inside the tube. Resistors for this purpose must be able to withstand the evacuating, baking, and activating processes involved in the tube construction. In the case of the tube shown in Fig. 9, the first five stages are supplied from an internal divider. The remaining stages may be supplied from an external bleeder. However, for the sake of economy in power required for operation, it may be well to supply the output stage and the last few targets from

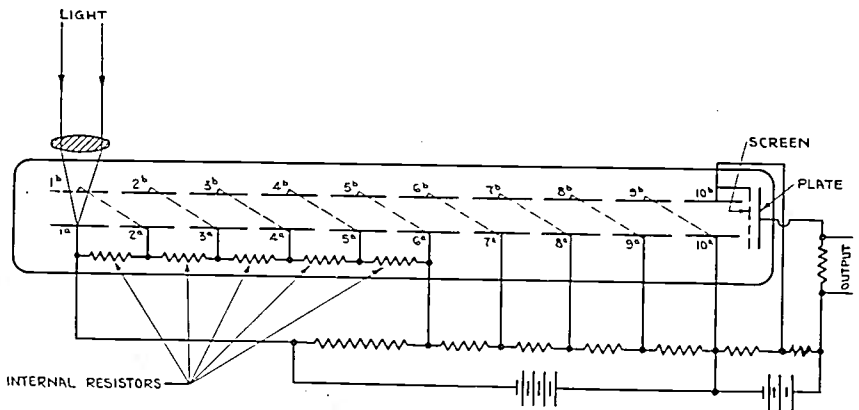

Fig. 9

a separate voltage supply, as the target currents may become quite high. In Fig. 9, the output is supplied from a separate source, the other stages being supplied from resistance voltage dividers.

It has been found possible to operate the device with alternating voltages on the electrodes. The operation will, of course, occur over only a portion of each cycle. The frequency of the applied alternating current must exceed the highest frequency which the multiplier is to transmit.

As a means of supplying the requisite magnetic field, permanent magnets have been found to be very satisfactory. These are superior to electromagnets from the standpoint of size and the fact that no external power is required.

In Fig. 10 is shown the effect of varying the magnetic field, while Fig. 11 is a similar curve for the effect of the over-all voltage. Both of these curves exhibit secondary maxima as well as the major peak. The secondary maxima are caused by more complex electron paths

where one or more of the lower electrodes are missed by the electron stream.

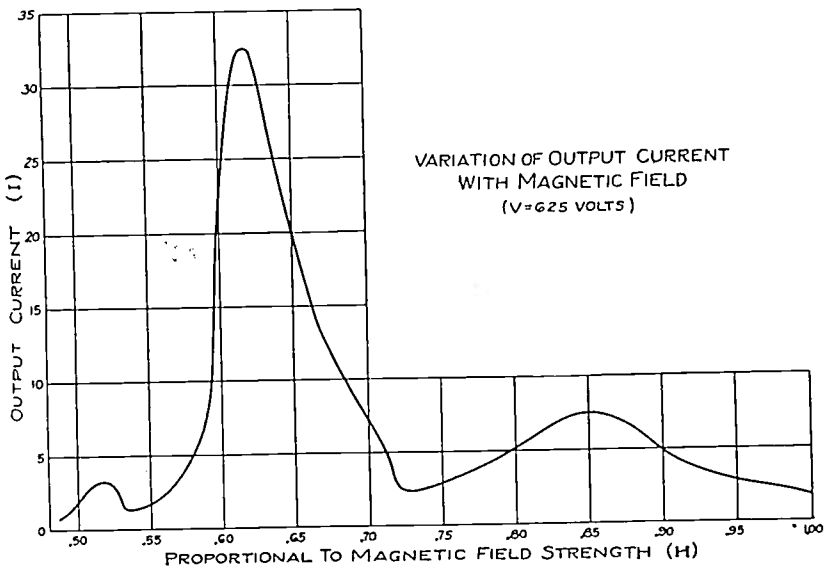

Fig. 10

The primary maximum is sufficiently broad so that ordinary fluctuations in line voltage do not result in appreciable variations in the

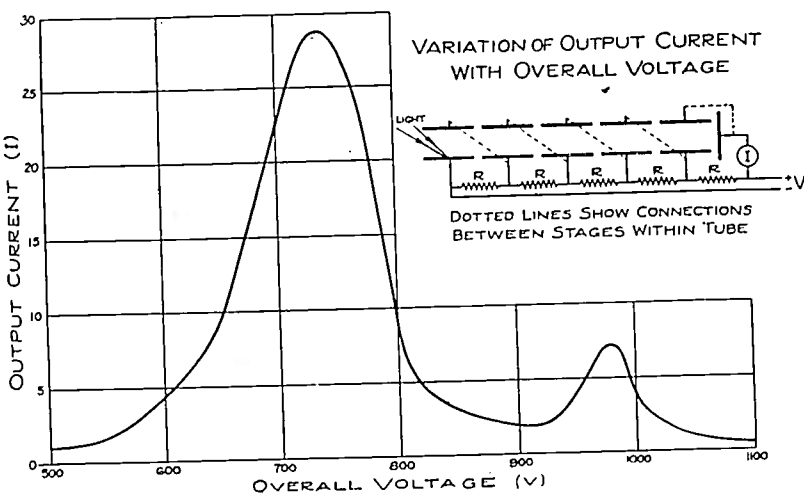

Fig. 11

output from the multiplier. If the current to any one stage is plotted as a function of the voltage to that stage alone or as a function of over-all voltage, characteristic curves are obtained similar to those of Fig. 11.

A photograph of the internal structure of a twelve-stage multiplier in which the voltage divider for the first five stages is incorporated in the tube, is shown in Fig. 12.

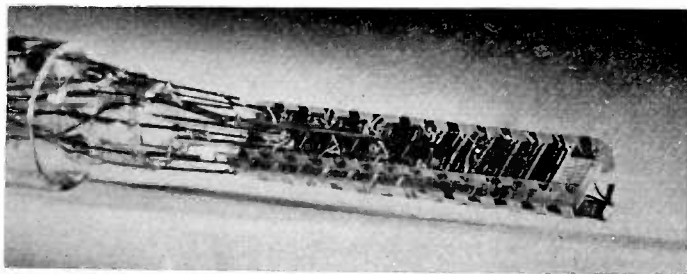

Fig. 12

III. ELECTROSTATIC MULTIPLIER

Where the application of a secondary emission multiplier does not permit the use of a magnetic field, it is necessary to use a multiplier in which the electrons are focused by electrostatic fields alone.

The problems involved in designing the focusing system for such a multiplier are similar to many of those encountered in an electron microscope. It can be shown that in general a radially symmetric electrostatic field will have the properties of a lens over portions of the

LENS SYSTEM

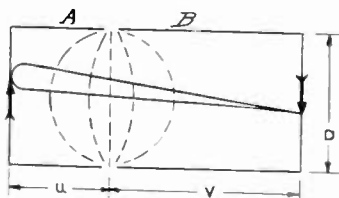

$$u \approx \frac{2}{3} D$$

$$v \approx \frac{4}{3} D$$

$$m = 1$$

Fig. 13

field near the axis of symmetry. The radial distance from the axis over which this condition applies will depend upon the field configuration. The focusing system of the electrostatic multiplier is based on the field between two coaxial cylinders. Since it is desirable to have a minimum of separate voltages to operate the tube, one cylinder is made part of one target, while the other is connected to the next succeeding emitter. The configuration is made such that electrons from an area in the center of the first target will come to a focus at the center of the next

target and that the magnification of the electron image formed will be unity.

This electron "optical" system will be made clearer by reference to Fig. 13. In this diagram the lens is formed between the cylinders *A* and *B*, *A* being at ground potential, while *B* is at the potential *E*. The electrons are emitted from the cathode in *A* with a very low velocity, are deflected by the "lens" formed between the two cylinders, and are focused on to the screen or electrode in *B* striking it with a velocity of *E* electron volts. The magnification of this system will depend upon the object and image distance from the lens, but instead of $m = v/u$, we have, from the varying index of refraction of the medium along the "optical" path (i.e., electron path), $m = v/2u$.

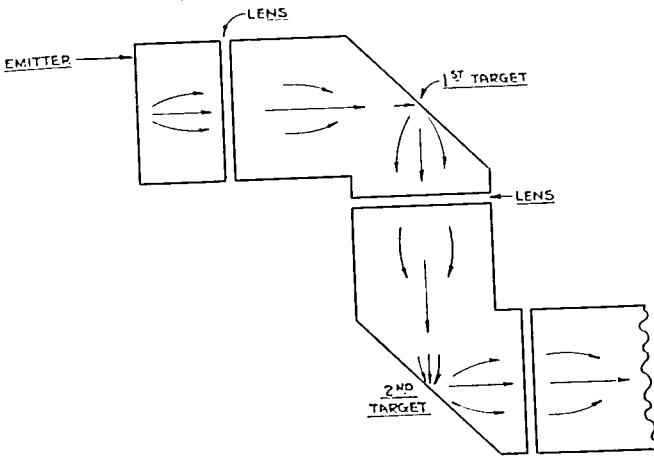

Fig. 14—L type multiplier.

The focal length is independent of the voltage between *A*, *B*, but is dependent on the diameter of the cylinders. It is found that in order to get good focus and unity magnification, the dimensions should be

$$u + v = 2D$$

with,

$$u = \frac{2D}{3} \quad \text{and} \quad v = \frac{4D}{3}.$$

The dimensions are only approximate, as the exact dimensions depend also upon the separation between cylinders. There will be some defocusing and lack of sharpness resulting from the initial velocities of the electrons (i.e., "chromatic" aberration) and also from aberrations in the lens system. This is not serious when the arrangement is used in a multiplier unless a very large number of stages is to be used.

The application of this optical system leads to the so-called L type multiplier whose construction is shown in Fig. 14. This multiplier is

quite satisfactory from the standpoint of focus. However, the field at each target drawing away the secondary electrons is rather weak and the multiplier becomes space-charge limited at rather small current values. Further, the emitting spot on the initial cathode must be small if accurate focus is to be maintained.

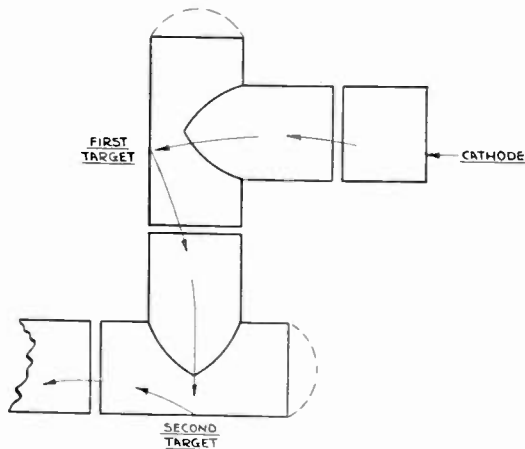

Fig. 15—T type multiplier.

A second type of multiplier has been designed which does not depend upon so sharp a focus and which has a higher collecting field at the targets. This is the T type multiplier which is shown in Fig. 15. This multiplier is built so that the cylindrical exits from the targets are as short as possible and yet long enough so that electrons entering

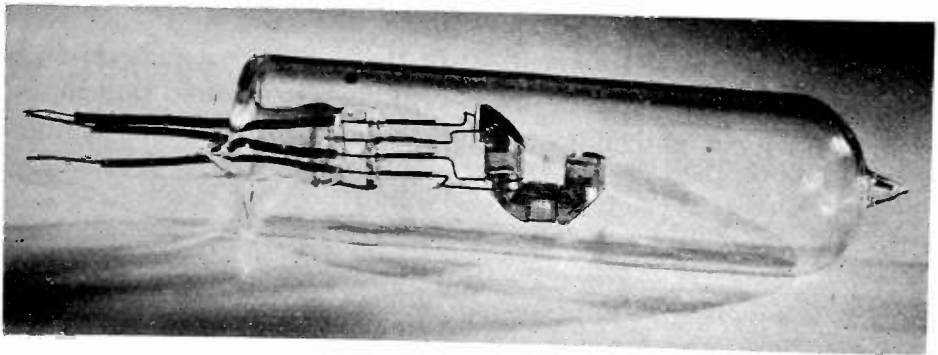

Fig. 16

through the stem of the T will not be deflected sufficiently by the field from the succeeding electrode to miss the target. The targets are formed by sensitizing the whole inside of the cylindrical crossarm of the T. Even with this arrangement, where currents of the order of a milliamperes are to be used, it is necessary to operate the multiplier at a

fairly high voltage per stage, that is, 200 to 400 volts, if space-charge effects are to be avoided. Figs. 16 and 17 show multiplier phototubes of the L and T type.

IV. APPLICATIONS

The most obvious application of these multipliers is as a photoelectric amplifier. This use is very much simplified in view of the similarity between the photoelectric and secondary emissive surfaces. The most convenient type of multiplier to use for this purpose is the one combining electrostatic and magnetic fields. This is because of its excellent focusing characteristics and because of the high current output obtainable. A tube of this type having a gain of several millions or an output of ten or more amperes per lumen is but little larger than an ordinary receiving tube. A voltage of about 1500 volts is required

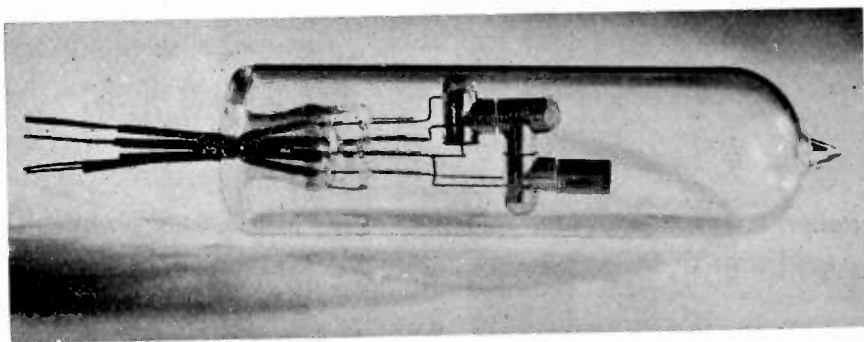

Fig. 17

for operation, and since the current consumed is small, may be supplied from a small socket power unit.

Since the tube serves to replace not only a phototube but also its accompanying amplifier, there is obviously a great gain in simplicity and a saving in bulk. In addition, these multipliers are very stable, are insensitive to external interference, and have an excellent frequency characteristic. An even more important factor is that the noise output is determined by the shot noise of photoelectric effect and therefore allows an increase of sixty to one hundred times in signal-to-noise ratio under ordinary operating conditions for extremely low values of light. These facts combine to make this type of multiplier a very excellent means of converting a light signal into an electrical signal. In order to compare the size of this tube with that of a conventional receiving tube Fig. 18 is included comparing a ten-stage multiplier with an RCA 59.

The applications of multiplier phototubes are extensive including

in particular pickup from sound film, facsimile, automatic door control, alarm systems, automatic sorting machines, etc.

Although at present the most important application of the secondary emission multiplier is as a phototube it has a number of other applications which may become increasingly important. In general, these multipliers can be used in connection with any device where the signal to be amplified is generated in the form of an electron current. This use includes types of electron commutator tubes such as are used for high speed switching, secret sound systems, and frequency multi-

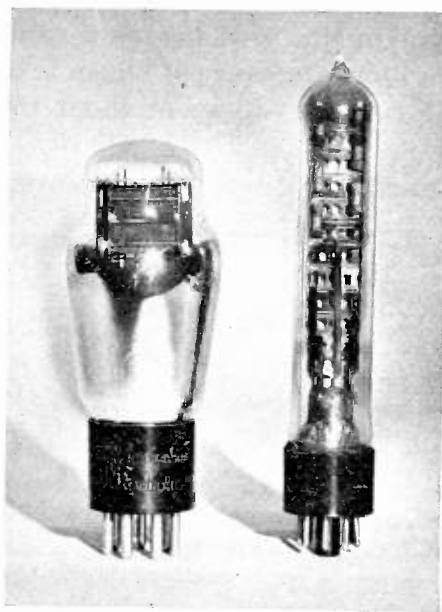

Fig. 18

pliers. One use in particular should be mentioned; that is, the application of the multiplier to the "iconoscope." For this purpose, an electrostatic multiplier is found to be the most satisfactory in that it avoids the use of a magnetic field which interacts detrimentally with the low velocity electrons in the tube. A multiplier used in this way serves not only as a very efficient means of coupling the tube to the television terminal equipment, but also replaces part or all of the picture amplifier.

As a voltage-controlled amplifier, the device does not lend itself so readily. This is because, in general, to couple the input of a voltage-controlled amplifier to its external circuit, it is necessary to use some form of coupling impedance and this, as in the case of a conventional thermionic amplifier, will limit the signal-to-noise ratio obtainable.

If the conventional type of thermionic cathode and control grid are used in connection with a multiplier, the problem of securing results superior to those obtainable with an ordinary vacuum tube presents considerable difficulties. There is the possibility of obtaining a higher per cent control per volt applied to the grid by deliberately throwing away a large fraction of the cathode current to gain this control, then using a multiplier to bring the average current back to a higher level. This is still in its initial experimental stages, and it is too early yet to say what the outcome will be. It should be noted also that this type of tube offers excellent opportunities to be used as a multiple-duty tube by using the control obtainable at various targets operated on different parts of their emission or focusing characteristics.

The secondary emission multiplier is too new an instrument to be able to foretell the full extent of its application; however, even now there is evidence that it may become a serious rival to the thermionic amplifier in many of the fields which that device has occupied alone for so long, and may also open up new fields in the realm of the electronics of small currents.

ACKNOWLEDGMENT

The authors wish to express their appreciation for the valuable assistance rendered by the other members of the Electronic Research Laboratory.



REVIEW OF BROADCAST RECEPTION IN 1935*

BY

R. H. LANGLEY

(Consulting Engineer, New York City)

Summary—Basic radio industry figures for 1935 are given and are compared with 1934 and earlier years. Increases in average price, total units sold, and total retail dollar volume to date are noted, and predictions, based on the consensus of opinion at the time of writing, for the final 1935 figures are given. The vital statistics of the industry (old firms who have dropped out and new firms that have come in) are reviewed.

The trend in cabinet design and the growth and decline of the various types are shown by the relative percentages of the 1935 offerings, and are compared with earlier years.

The numerous technical improvements which the industry's engineers have made in 1935 are catalogued and briefly discussed. The increasing number of medium priced, high fidelity models and the further expansion of the frequency range into the ultra-short-wave region are noted as the chief engineering contributions.

The metal tube is recorded as the most important element in the 1935 sales programs, and as a potent factor in emphasizing the obsolescence of old receivers.

Emphasis is placed upon the increased effort in 1935 to bring about a further reduction in noise level. The increased stress on the noise-reducing antenna and the tendency to make this one remaining haphazard element a matter of engineering design and professional installation is noted.

WE CAN think of the radio industry as a family. It is a very large family and its members are scattered over the country.

They do not see each other as often as they should, and when they do see each other, they do not talk as much or as freely as they might. But the industry, like a family, has certain tendencies and traditions, and in 1935, as in earlier years, we can see these tendencies working themselves out in the product. In 1935 no member of the family has departed very far from the traditions.

There has been the same perennial crop of deaths and births, old firms going out and new firms coming in, the same obvious effort on the part of each manufacturer to have models just like the models that some other manufacturer was building, and to sell them at a few cents less, and the same movement of engineers from one allegiance to another. On the credit side of the ledger, however, we can again record increasing prices and increasing sales, coupled with, and in no small measure resulting from, the continued effort on the part of the engineers to improve and perfect the product, and to give ever-increasing value.

* Decimal classification: R090. Original manuscript received by the Institute, December 4, 1935. Presented before New York meeting, December 4, 1935.

Looking back at 1935 in its broadest aspects, it is probably safe to say that it has done more to convince the owner of a two- or three- or four-year-old radio of the fact that his receiver was obsolete, than did any previous year. Relinquishing none of the technical ground gained in 1934, and without introducing any radical changes in the apparatus itself, the industry has forged ahead to increase both the electrical and mechanical perfection of its product.

The year 1935 has seen a gratifying increase in the demand for the services of the professional radio engineer. Some of the larger units in the industry have added to their engineering staffs and the tendency noted earlier in the year toward what has been called syndicated design does not seem to have attained any threatening proportions. It must be apparent to every thoughtful manufacturer that while the large and well-equipped laboratories can be of great service to him, he must nevertheless have his own capable engineering staff to cope with the multitude of problems that come with actual final design and production, and to create those essential features which distinguish his line and energize his advertising and sales efforts. This increasing recognition of the engineer promises a sounder and more rational organization of the industry.

The engineers have probably not worked under as great a pressure as they did in 1934, but they have worked more thoughtfully and more productively. They have translated a number of the promises and makeshifts of 1934 into substantial realities. It would be difficult to point to a single feature of the 1934 product that has not been noticeably improved in 1935, and these improvements prove, if proof were necessary, the importance and the advantages of sound engineering, and the necessity for providing time for the completion of earlier developments.

From an actuarial point of view, a radio manufacturing enterprise still seems to be a very poor risk. The death rate has never been less than twenty per hundred, that is to say, at least one fifth of the manufacturers in business in any one year have succumbed to some fatal financial malady. This has been the sad fact year after year ever since 1923, and 1935 proves to be no exception. In fact the death rate shows an increase. Of the 110 firms who were on our lists in 1934, 27 did not reappear in 1935. Thus the death rate today stands at 25.4 per hundred.

The birth rate, on the other hand, has been on the decline since 1931, and the number of receiver manufacturers has been slowly shrinking. In 1935 only 19 new firms appeared. At the close of 1934 the population of the industry was 110. Today, at the close of 1935,

the number has fallen to 102. In view of the fact that a very small proportion of the industry still does a very large proportion of the business, further shrinkage will undoubtedly occur. When we recall that in 1925 there were 430 manufacturers, whereas in 1929, the industry's most profitable year, there were only 96, we can infer that the health of the industry as a whole may vary inversely with the number of manufacturers.

Between January 1 and November 31, 1935, 1126 different models of broadcast receivers have been offered. This is a decrease below the totals for 1934 and 1933. It is, however, an average of eleven models per manufacturer, and 3.75 new models per day for every business day of the year. The complete radio show of 1935 would be a stupendous affair. Allowing a minute for the examination of each model, it would take a week of long evenings to see them all. But the decrease below the totals of over 1500 models for 1933 and 1934 is most encouraging. The automobile industry has been cutting down on the number of models for the past few years, and we can hope that the radio industry is following its illustrious example.

Our explanation last year of this offering of so many models was that it expressed a continuing uncertainty as to what a broadcast receiver should be, and we noted that the instrument was still being changed in its basic specifications. There have been no such basic changes in 1935, and this and other evidence indicate that we are rapidly approaching the point where there will be general agreement among the engineers on the fundamental elements of the design, so that the greater part of the effort can be spent in perfection of detail, and in completing the many lines of research that have been laid aside in the rush to build many models only slightly different from each other. An excellent beginning has been made in these important directions in 1935.

You will remember that the price of broadcast receivers showed a healthy increase in 1934, and that this increase stimulated, rather than retarded, sales. It is gratifying to be able to report that 1935 shows a further increase in average price, with every indication of a similar result.

The average advertised price of broadcast receivers in 1935, computed on November 21 from all information then available, was \$73.11. This is to be compared with the 1934 average of \$59.60 and the 1933 average of \$48.28. The price increase from 1933 to 1934 was 22 per cent; the increase from 1934 to 1935 is slightly over 22 per cent.

At the close of each year, the total retail value of the receivers is divided by the total number to obtain the average price at which they

were sold. This figure was \$34.39 for 1933 and \$45.50 for 1934, showing an increase of 32 per cent, and on this basis it may be confidently predicted that the average price at which 1935 receivers are being sold will be very close to \$55.00.

We predicted a year ago that 15 per cent more units would be sold in 1934 than had been sold in 1933. When the figures were known, it turned out that the increase had been 19 per cent. It is more difficult to make a prediction for 1935, but the consensus of opinion at the time of writing seems to indicate an increase of about 17 per cent. This would give total sales of 5,500,000 units, and a retail value of \$302,000,000 as against \$200,390,000 for 1934. The record, of course, was made in 1929 when the total retail value was \$592,000,000.

In the matter of cabinet design, we noted last year the apparent decline of the console type from 62 per cent of all offerings in 1932 and 55 per cent in 1933, to 36 per cent in 1934. In the year just past this trend has been much less marked, the console amounting in 1935 to 33 per cent of all offerings. Much advertising emphasis, however, has been placed behind the console, and it is to be hoped that 1936 will see it again on the increase. The small chest or "cigar-box" type is rapidly passing out of the picture and has been relegated to a back-page position in the publicity, only 15 per cent of the models offered falling in this category. The table models have increased in size and beauty as well as price and have more to recommend them than ever before. They account for 36 per cent of the offerings. The freak furniture models, with a few unimportant exceptions, have pretty well disappeared. As a suggestion of possible future trends, we note the reappearance of a table type not seen for many years, in which the loud speaker is placed beside the chassis, rather than above it, and in which the cabinet is of more generous proportions.

The design and finish of the cabinets themselves is now almost entirely in the modern style, and in general along much more conservative and pleasing lines than in 1934. The glaring "moderns" of 1934 and earlier years, with their light-colored and strongly grain-marked veneers, are rapidly disappearing along with archaic Queen Anne and spool-leg styles. Some very striking and excellent examples of the best modern style have appeared in 1935.

There has been a noticeable decline in the number of phonograph combinations. In 1934, 25 per cent of the manufacturers included such models in their lines. In 1935 only 3.5 per cent of the offerings are combination models.

There has been an increase in farm receivers, with operation either from a 32-volt line or from a six-volt battery arranged to be kept

charged by a wind-driven generator. Farm sets of these types were included in practically all of the 1935 lines.

Automobile receivers account for almost 12 per cent of the offerings and it is anticipated that over 1,000,000 of them will be sold, as against 780,000 in 1934.

The AC-DC model is still increasing, perhaps because it is not only a solution of the problem of giving radio service for the least money, but also because a demand for it continues in 85 large cities where irregular direct-current areas still exist. In 1935, 20 per cent of the offerings were of this type.

The average number of tubes per receiver for all 1935 receivers is unchanged from the six of 1934. The average in 1933, it will be recalled, was eight.

The outstanding innovation in 1935 was the introduction of a series of all-metal tubes. Although widely publicized and heralded as a revolutionary improvement in releases intended for the general public and probably of great commercial importance, it is generally conceded that they represent a relatively minor forward step from the engineering point of view, keeping in mind that their successful manufacture in quantity was an outstanding accomplishment. They undoubtedly indicate the direction in which radio tube design will move in the next few years.

It will be interesting to review the degree of adoption of metal tubes by the manufacturers of radio receivers in 1935. Although 47 per cent of the manufacturers used all-metal tubes in one or more models, only 21 per cent of all the models introduced in 1935 employed any metal tubes. In general, where only a few of the tubes were metal, the new type tubes were used in the intermediate-frequency amplifier. Where all but one or two of the tubes were glass, the metal rectifier was usually avoided, presumably because the form first made available was inconveniently large and therefore did not readily fit into partially completed chassis designs. Frequently, also, one or more dual-purpose glass tubes were employed to avoid the use of the multiplicity of metal tubes which otherwise would have been required.

Mention must also be made of the metal-glass tube, which usually consisted of a glass envelope enclosed in a metal housing and fitted with an octal base. This type of tube was largely the result of the delay in reaching successful quantity production of the all-metal tubes, and it is reasonable to assume that it was a martyr to the metal-tube cause and therefore will soon pass out of the picture. Receivers which were originally designed for its use and factory-equipped with it, are intended to be able to carry on by using all-metal tubes as replacements.

Better technique in the mechanical design of receiver components has made possible the manufacture of broadcast receivers which cover frequencies as high as sixty megacycles. An increasing number of receivers in 1935 cover the frequency band between 140 and 410 kilocycles, making available to the user the aviation weather reports broadcast on those frequencies. Increasing the upper frequency limit to as much as sixty megacycles was a difficult and important achievement.

The year 1935 has seen the introduction of many additional high fidelity models, particularly in the medium priced field. These models are the result of skillful engineering and emphasize the obsolescence of the receivers of earlier years. Each of these receivers has included some means for the essential manual adjustment of the selectivity, but the tendency is away from the absorption circuits of 1934 and toward ingenious electrical and mechanical arrangements for varying the coupling of one or more of the intermediate-frequency transformers.

Many of this year's receivers have been provided with some means for regulating the bass response, in addition to the customary treble control. In most cases, this took the form of an additional manually operated control, but arrangements for automatic bass compensation have also been developed, so arranged that the relative bass response increases in inverse proportion to the output of the receiver.

In step with improvement in the electrical fidelity of 1935 receivers, the loud speaker system has received attention. Where a single loud speaker is employed, innovations in the design of the cone or of the method of supporting the cone have been developed, with a view toward improving the uniformity of response over a wide range of frequencies. The use of separate high- and low-frequency speakers is becoming increasingly common, and it is the usual practice to provide some form of dividing network to split properly the output of the receiver between the two speakers. In general, the lower priced high fidelity receivers have employed a single large and carefully designed loud speaker, while high fidelity receivers of the higher grade are usually offered with two or more loud speakers.

The improvement in loud speakers has caused more attention to be paid to the design of speaker mountings and the acoustic design of cabinets. Utilization of the improved low-frequency performance of the receiver has been facilitated by the provision of more massive cabinets made of thicker stock and, in some cases, provided with an ingenious substitute for an infinite baffle. The tendency of the higher audio frequencies to travel in a beam-like path has resulted in the provision of deflectors mounted in front of the speaker to improve the distribution

of the high notes. This has been done in most of the high fidelity receivers. In an effort to overcome cabinet resonance, dummy speakers having a low natural frequency and intended to absorb undesirable responses, have also been employed.

Improvements in the selectivity of the new receivers, particularly in the high-frequency bands, have made the requirements for the indicator and the selector mechanism increasingly stringent. The excellent drive mechanisms of 1934 have been improved in smoothness and freedom from backlash, and various ingenious arrangements have been developed.

Indicators have shown two distinct trends during the year; more space has been provided for calibrations of larger size and greater completeness, and dial size has in many cases been greatly increased, this improvement having been made even in relatively small table-model receivers.

A minor improvement which occurred for the first time in 1935 is the application of a cathode-ray tube as a resonance indicator in broadcast receivers. This device is characterized by freedom from inertia and by a customer appeal not usually associated with indicators of the meter type. Refinements have also been made in the conventional resonance indicators of the shadow type to increase their apparent sensitiveness and hence their usefulness on the short-wave bands. The use of some form of resonance indicator is becoming increasingly common.

The widespread sale of the "turret-top" type of automobile has presented a serious problem to the automobile radio designer. This problem has been met by the design of special antennas suitable for installation under the running boards and connected to the receiver by means of a low impedance shielded transmission line, and by the development of high gain antenna couplers to make the most of the limited amount of energy which is picked up by the new type of automobile antenna. The automobile manufacturers have finally realized the advantage to their dealers of simple and satisfactory auto radio installations, and they have in many cases provided mounting holes for a recommended make of receiver and have modified their ignition systems to minimize disturbances to radio reception. The technique of shielding and installation has been so improved that spark-plug suppressors usually are no longer essential when the receiver is installed in a modern car.

A study of broadcast reception would be incomplete without considering the problem of man-made static and similar disturbances. In 1935, progress has been made in the development and particularly in

the marketing of improved all-wave antenna systems, many of the new types requiring no manual switching when changing frequency bands. Receiver manufacturers have begun to realize the importance of a properly designed antenna system for both broadcast and short-wave reception, and in many cases their advertised list prices include such systems. Some reduction in noise has also been obtained by continuing the joint efforts on the part of several interested groups toward a reduction in the production of electrical disturbances. Appliance manufacturers, especially those who also manufacture radio receivers, have shown an increasing tendency to design improved products and advertise them as "nonradio interfering." Another factor which should contribute materially to the reduction of noise in urban areas is the gradual but steady decline of the trolley car, perhaps the worst single offender.

The radio engineer has at his command today technical facilities for providing any degree, within broad limits, of sensitivity, selectivity, and fidelity. In 1934 he expanded these facilities to include the short-wave signals and broadcasts from overseas. In 1935, in addition to the long list of improvements we have just reviewed, he has been able to devote considerable time to the important matter of noise reduction. Extraneous sounds have marred programs in the broadcast range ever since broadcasting began, and yet it probably is true that 1935 has seen more of an advance in practical expedients to overcome them than any previous year.

There are four general lines of attack on this difficulty. The first and most obvious is to increase the power of the transmitters, so that the signals will override the noise. The second is to eliminate the sources of disturbance. Much important work has been done in this direction, but there still remains, and probably always will remain, a minimum noise level below which further reduction is quite impractical and many locations in which much higher levels are unavoidable. The third line of attack is to prevent the noise from entering the receiver. This, as we have noticed, has made important strides in 1935. Not only have efficient devices been provided, but an increasing public consciousness of their advantages has been brought about. The increasing use by the listener of the short-wave signals has emphasized the necessity for this important work. The excellent progress of 1935 promises to establish definitely the necessity for engineering design and professional installation of the pickup system.

The elimination of noise has its important relation to high fidelity. It permits the successful use of the higher audio frequencies, and, of at least equal importance, it permits the successful use of a much

greater dynamic range. As a means of enhancing public enjoyment of programs, therefore, it ranks high. If it is the most difficult factor to bring under full engineering control, so much the more should the engineer devote himself to it.

Until 1935, this problem of noise elimination had been left for a relatively small number of specialists to study. During the past year, however, the entire engineering profession has recognized the importance of the problem. We can confidently look forward to the day when the homemade haywire antenna will be a thing of the past, and when noise, at least of the man-made variety, will reach the receiver only because there remains no way of getting the signal there without it.

This is a difficult year to single out particular developments for final emphasis. From a business angle there can be little doubt that first place should go to the metal tube. From the technical and engineering angle, however, the outstanding advances are the increased fidelity of medium priced receivers and the further expansion of the frequency range into the ultra-short-wave field. The new high fidelity receivers are bringing increased enjoyment on our unexcelled American programs to the thousands who have bought them. This is an engineering accomplishment of which the industry may well be proud. The expansion of the frequency range, however, may be the key to a whole world of broadcasting, with program services not yet imagined. The receiver engineers have opened additional gates in new directions for more and better radio service to mankind.

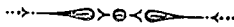

RADIO DEVELOPMENTS DURING 1935*

BY

C. M. JANSKY, JR.

(Jansky and Bailey, Washington, D. C.)

Summary—The year 1935 has not been marked by any startling outstanding achievements in the field of broadcast transmission and reception. In the equipment field there has been a decided trend towards better fidelity characteristics and higher efficiency. New and improved apparatus for the study of radio transmission phenomena is continually yielding fundamental data. The accumulation of these data is resulting in gradual changes in policies of the Federal Communications Commission with respect to the allocation structure which are in accordance with sound engineering principles. New antenna structures are receiving widespread trial. Progress has been made in ultra-high-frequency broadcasting and in the application of frequency modulation methods. Plans have been developed for a coaxial cable which aside from other applications made have an important bearing on the future of high fidelity broadcasting.

BROADCAST TRANSMISSION DEVELOPMENTS AND PROGRESS DURING THE YEAR 1935

SINCE the scope of this paper is limited to the developments which have taken place during the calendar year, 1935, it is not possible to point to any specific outstanding achievement either in the design of transmission and reception equipment or in the field of allocation engineering which may be expected to revolutionize broadcasting. Rather, there has been a more general recognition of engineering fundamentals resulting in certain trends in the art which may be expected to bring about a more efficient use of the scientific knowledge which forms a basis for the entire industry.

In the field of transmitter engineering there has been continued improvement to a point where equipment has now reached a standard of excellence which appears likely to meet all requirements for some time to come. Of particular importance is the attention which manufacturers have directed towards the production of equipment which, when properly installed and properly adjusted, is capable of high fidelity performance. Although for some years commercial equipment has been capable of transmitting a range of audio frequencies from thirty to 10,000 cycles with little variation, the advent of the high fidelity receiver indicated that there was considerable room for improvement both in audio harmonic content and carrier noise level. Careful attention to these items has resulted in a marked improve-

* Decimal classification: R090. Original manuscript received by the Institute, January 17, 1936. Presented before New York meeting, December 4, 1935.

ment, and many transmitters installed in 1935 were capable of excellent performance in both of these respects. Most of this gain has been obtained by more careful engineering design, although one manufacturer has introduced a novel method of reducing carrier noise by bucking out the hum components at the input. Another is introducing the principle of stabilized feedback to reduce both noise and harmonic content. In general, transmitters developed this year are capable of one hundred per cent modulation with audio harmonics not exceeding three to five per cent, and the carrier noise is down at least sixty decibels from 100 per cent modulation on an unweighted basis.

During 1934 there was installed at WLW, Cincinnati, the world's first 500-kilowatt transmitter. While no additional 500-kilowatt stations were authorized during 1935, there is a strong possibility that the regulations regarding clear channel stations will be changed so as to permit or perhaps even require the use of powers considerably in excess of the present limit of fifty kilowatt in certain instances. The use of 500 kilowatts at WLW has greatly stimulated research and development work directed towards the production of new high fidelity, high powered transmitters. Since the cost of power for the operation of such stations is a matter of considerable importance, attention of engineers has been directed to obtaining high efficiency with the result that by the time the Federal Communications Commission sees fit to authorize additional 500-kilowatt stations, high grade efficient equipment capable of meeting the exacting requirements of commercial broadcasting will be available.

Mention should be made of the fact that along with improvements and standardization in the transmitter field advances have been made in the design and construction of associated apparatus. To mention a few, there is an increasing trend towards complete alternating-current operation of both transmitters and speech input equipment, tubes of greater uniformity and longer life have been developed, more electrical transcription recordings of wide frequency response and with low background noise have been made available, as has a new model non-directional dynamic microphone.

The attention directed toward higher standards of performance has put the problem of maintaining high fidelity equipment squarely upon the station engineer. Manufacturers have recognized this fact with the result that an increasing number of transmitters are equipped with cathode-ray modulation indicating devices; also new and better standardized units for the rapid measurement of harmonic content, noise level, and frequency response have been made available. It may be expected that before long such checking equipment will be found at practically every broadcast station installation.

During the year there has been much study of the performance of antenna and ground systems. The objective has been to develop specifications for radiation systems capable of producing the strongest field intensities throughout the areas to be served for given amounts of power and, in the case of clear channel stations, to develop systems which would permit the delivery of service to the largest possible areas without objectionable fading.

Practically all of the major antenna installations this year were of the type in which the tower itself is the main radiating element. Attempts to improve the efficiency of such radiators by top loading, both tuned and untuned, have been made, but there has been insufficient time to evaluate the results obtained. A significant trend is the introduction of towers, both guyed and self-supporting, having a uniform cross section from bottom to top. With such towers, it is expected that the current distribution will more nearly approach the theoretical sine-wave value for a filamentary wire.

The trend towards the use of directional antenna systems to meet specific conditions has continued. In a limited number of instances the purpose of these antennas has been to direct the major radiation towards centers of population. In most instances, however, directional antennas have been used to reduce radiation in one or more directions with the view of protecting other stations operating on the same channel. Directional antennas in use are of widely different characteristics depending upon the specific interference problems to be met.

There has been an increased recognition on the part of the broadcast industry of the importance of field intensity measurements as a basis for evaluating the efficiency of the entire broadcast plant. Somewhat slower, nevertheless substantial, progress has been made in the evolution of broadcast station coverage by methods of study involving measurements of signal strength along with measurement of other factors affecting reception.

Field intensity measuring apparatus capable of making automatic recordings of fading signals has been in constant use for determining the nighttime interference-producing characteristics of distant stations and the action of directional antennas. During the first six or seven months of 1935 an extensive program of recording on a large number of clear channel stations was undertaken. The extent of such work has shown the need for new and improved field intensity measuring equipment designed to facilitate the making of accurate recordings, and such equipment has been recently developed.

Of considerable importance in the field of broadcasting are the trends in the field of allocation engineering as evidenced by the ex-

pressed policies of the Federal Communications Commission and its engineering department. While it has long been recognized that shared channel stations could use considerably more power in the daytime than at night without undue interference, for a long time no shared channel station was allowed to use a daytime power assignment greater than two and one-half times its nighttime assignment. However, during 1935 the regulations for regional stations were changed allowing such stations in many instances to use daytime powers five times as great as the nighttime power. Obviously, this has resulted in the purchase of many new transmitters capable of delivering five kilowatts, which transmitters have been in most cases of the latest and most improved types available.

Recognizing the fact that broadcast antenna installations differ greatly in their efficiency and recognizing that improvements in antenna efficiency may in some instances produce a far greater increase in coverage than any reasonable increase in power, the Commission has adopted certain regulations with respect to the heights and efficiencies of antenna structures it will consider satisfactory. To date, no attempt has been made to make existing broadcast stations erect antenna structures in accordance with the new regulations except where applications for changes in frequency, transmitter location, or power are involved. The procedure is to require that any applicant requesting such a change so modify his antenna system as to make it meet the new requirements providing, of course, it does not already do so.

Two other rules directly affecting the equipment and operation of the broadcast station were adopted in 1935 by the Federal Communications Commission. The first of these, amending rule 139, requires all transmitters to be capable of delivering the authorized power with a modulation percentage of 85 per cent, the combined audio-frequency harmonics at this point not to exceed ten per cent. The amended rule also provides that after November 1, 1936, all stations shall have in operation an approved modulation monitor equipped with a meter of specified speed as well as a peak-indicating light or alarm. Provision is made for test of the modulation monitor by the National Bureau of Standards. Such a monitor will reduce the present tendency on the part of some stations to overmodulate to a certain extent, with a resulting gain in quality, particularly on high fidelity receivers.

The second regulation, rule 132, is somewhat general and provides that all station equipment shall be designed, constructed, and operated in accordance with good engineering practice. It lays the foundations for future requirements affecting all of the factors influencing fidelity

of transmission and safety to personnel and property. Thus it is clear that the Federal Communications Commission, as a regulating body, is standing behind the engineer (in fact, prodding him a bit) in his efforts to provide more satisfactory service to the broadcast listener.

Worthy of note at this time is the interest directed towards experimental broadcasting in the ultra-high-frequency portions of the spectrum. During recent months quite a number of additional broadcast stations for this portion of the frequency spectrum have been authorized. The potentialities of ultra-high-frequency broadcasting were well illustrated by the paper¹ recently given before the Institute describing the results of the experiments conducted by Edwin H. Armstrong on a broadcast system using frequency modulation. It was demonstrated that this system resulted in marked improvement in the signal-to-noise ratio.

In the Spring of 1935, the American Telephone and Telegraph Company announced plans for an experimental coaxial cable installation between New York and Philadelphia. While most of the newspaper accounts of this proposal emphasize its importance in connection with television, we should not lose sight of the fact that such a cable would provide a large number of communication circuits of high fidelity for the interconnection of broadcast stations. Should the experimental cable prove to be successful, the erection of additional coaxial cables throughout the country would greatly simplify the problems of high fidelity network broadcasting, and could become the nerve center for an ultimate chain of television stations.

All of the gains and developments in the broadcast field during 1935 are steps toward bringing the program to the listener with the most accurate re-creation possible. No attempt has been made to list the outstanding accomplishments in the program field during 1935. All of the networks, as well as many alert independent stations, have enlarged their program service, and the number of remarkable pickup jobs precludes the possibility of listing in this paper. It is interesting to note the continued improvement in type of program and presentation in conjunction with the increased ability of the technical equipment of the stations to transmit such programs. There should be an even greater gain in this respect as the listeners follow the trend and install improved receiving equipment. The record of 1935 indicates clearly that the ultimate object of high fidelity reception in the average home is not to be achieved suddenly, but rather will result from a gradual "stepping-up" of all elements making up the system.

¹ Edwin H. Armstrong, "A method of reducing disturbances in radio signaling by a system of frequency modulation," New York meeting, November 6, 1935.

A REVIEW OF RADIO COMMUNICATION IN THE FIXED SERVICES FOR THE YEAR 1935*

By

C. H. TAYLOR

(R. C. A. Communications, Inc., New York City)

Summary—International communication has been bettered by the opening of eight radiotelegraph and of nine radiotelephone direct circuits. The first around-the-world two-way telephone conversation took place this year in New York over wire to San Francisco, by radio to Java, by radio to Amsterdam, by wire to London and by radio to New York, a total distance of 23,000 miles. Many nations improved their national point-to-point radio communications. In the United States five cities were added to the national networks. The Pan American Airways completed a network of eleven stations in Alaska and built a chain of stations across the Pacific Ocean. To make their installations at Midway and Wake, particularly the latter, an uninhabited island, many difficulties were overcome; for commercial circuits of relatively short length, ultra-short waves were used. The value of these wavelengths for emergency installations was illustrated by their use in the bridging of a forty-mile gap created by the hurricane of September 2, 1935 in the wire-telephone-line circuit between Miami and Key West. General advantage was taken of the technical advances in the art to install improved equipment. The study of the ionosphere continued. John H. Dellinger of the National Bureau of Standards was able recently to associate a fading phenomena which recurs in fifty-four days with the rotation of the sun.

INTRODUCTION

THIS review briefly covers the developments in point-to-point communications for commercial purposes during the year 1935. The importance of radio communications in the fixed service field has not been lessened. Commercial centers scattered over the surface of the globe are pressing for improved intercommunication and in most instances these expansions to existing facilities are being made by new radio circuits.

NEW INTERNATIONAL CIRCUITS

The continued demand from the international business for direct service is shown by the following new radiotelegraph circuits opened to the public during the year 1935 between Rome and Shanghai, Tokyo and Rio de Janeiro, Tokyo and Amsterdam, Warsaw and Rio de Janeiro, Warsaw and Buenos Aires, Prague and Buenos Aires, London and Addis Ababa, Ethiopia, and the United States and Tahiti.

* Decimal classification: R090. Original manuscript received by the Institute, November 21, 1935. Presented before New York meeting, December 4, 1935.

A similar demand is evidenced in the international telephone field by the opening of the following direct radiotelephone circuits between Paris and Moscow, London and Tokyo, Berlin and Tokyo, Tokyo and Siam, Malaya and the Philippine Islands, London and Reykjavik, Copenhagen and Reykjavik, the United States and Santo Domingo, and the United States and Honduras.

The Paris-Moscow radiotelephone circuit was set up to relieve the congestion on wire lines—a notable addition to the use of radio circuits to supplement wire line circuits.

The attainment of long-distance telephony to truly world-wide proportions is well illustrated by the fact that there was carried out during April, 1935, the first around-the-world two-way telephone conversation. The circuit extended from New York City completely around the world, by wire to San Francisco, by radio to Java, by radio to Holland, by wire to London, and by radio back to New York City, a total distance of some 23,000 miles. The conversations took place between officials of the American Telephone and Telegraph Company located in separate rooms in the long-distance telephone building in New York City. This world-circling connection was made possible through the fact that there exist at the several points noted, effective transoceanic short-wave telephone stations which could be inter-connected. The success of this linked circuit test naturally entailed the very close co-operation of the several communication agencies involved.

NEW NATIONAL RADIO CIRCUITS

In the national areas, the expansion of radio communication facilities continued unchecked in all parts of the world. Within the United States, Detroit, Seattle, Los Angeles, Philadelphia, and Camden have been added to the domestic direct radiotelegraph networks.

This year has seen the opening of new circuits, the extension of existing facilities, and the authorization of new construction for radiotelegraph purposes particularly in China, New Zealand, Afghanistan, Russia, Chile, and the French Colonies. Similarly for radiotelephone purposes in Colombia, in China, in Chile, between Italy and the Italian Colonies and between England and South Africa.

The number of wire-telephone systems of cities and town connected to existing radiotelephone circuits has increased in Brazil, in Colombia, in Argentina, in Paraguay (through Argentine) and in the Philippine Islands. Mention must also be made of the new networks set up for specific services such as that for police work in the States of São Paulo, Brazil, and for aviation in Alaska and over the Pacific Ocean from California to Manila.

In addition to the above listed expansions in the short-wave field, the year 1935 is conspicuous for the steadily increased use of ultra-short waves for fixed services. The most important of these new circuits are between Barcelona, Spain, and the Balearic Islands, the Islands of Molokai and Oahu of the Hawaiian Group, England and the Channel Islands, the mainland and coastal islands of Norway, England and Ireland, and the islands of Japan.

A hurricane in Florida on September 2 provided opportunity for radio to serve in an emergency rôle. The storm washed out a forty-mile section of pole line carrying wire-telephone circuits between Miami and Key West isolating Key West and Havana. Since it was evident that months would elapse before the wire circuits would be replaced upon a permanent basis, some small aviation radio transmitters, together with suitable receivers all battery operated, were hurried to the scene. This equipment, operating on frequencies between four and five megacycles, with transmitter powers of about five watts, proved to be quite satisfactory for temporarily bridging the forty-mile gap. Two emergency circuits were established and the radio transmitters and receivers were arranged for remote control from the Miami and Key West telephone offices.

NEW STATIONS AND EQUIPMENT

Early in the year the Mackay Radio and Telegraph Company opened its new central transmitting station at Brentwood near New York City, N. Y. This company also rebuilt its central receiving station at Southampton, N. Y., and opened a new receiving station at Honolulu. New stations were opened by R.C.A. Communications, Inc., at Detroit, Seattle, and Los Angeles. The Mutual Telephone Company built and opened an ultra-short-wave radiotelephone circuit between Molokai and Maui, Territory of Hawaii. The Pan American Airways built and put into service, a complete chain of radio stations across the Pacific Ocean; these stations are located at Alameda and Los Angeles, California, Hawaii, Midway, Wake, Guam, Manila and Macau. The stations at Midway and Wake, particularly the latter point, required lengthy and careful planning because of the inaccessibility of these stations by regular or normal transportation facilities. This company also extended its facilities in the Territory of Alaska by the addition of eleven stations. At many stations obsolescent transmitters have been replaced by new units of larger output and power. Greater use has been made of directive and directional types of antennas and more highly selective receivers are being installed to enable circuits to be worked with greater freedom from interference.

AUTOMATIC OPERATION OF INSTALLATIONS

The trend to design of installations, the equipment which can be operated without attendance, continues to increase in the short-wave radiotelegraph field. The new installations built by RCA Communications, Inc., for their domestic service have their transmitting units designed and installed for operation unattended. Similarly, the new receiving station of the Mackay Radio and Telegraph Company at Honolulu runs without attendance. At each of the above installations all servicing of the remotely controlled equipment is directed from the associated terminal. The American Telephone and Telegraph Company has operated successfully during this year totally unattended ultra-high-frequency radiotelephone terminals at Green Harbor and Provincetown. Similar installations have been made by the British Post Office at Stranraer, England, and Belfast, Ireland.

The Mackay Radio and Telegraph Company during several months of 1935, keyed one of its commercial high power telegraph transmitters by means of a three-meter control circuit between New York City and Brentwood, N. Y., a distance of approximately forty miles. This ultra-high-frequency circuit, using unattended transmitters and receivers, gave satisfactory service twenty-four hours per day and was used for telegraph speeds on commercial traffic up to 200 words per minute.

A new domestic circuit between New York and Philadelphia, Pa., which R.C.A. Communications, Inc., brought into service in December operates with unattended ultra-high-frequency relay stations at New Brunswick, N. J., and at Arney's Mount, near Trenton, N. J.

AUTOMATIC OPERATION OF EQUIPMENT

The operation of printers on radiotelegraph circuits received a real impetus from the success of the two-channel multiplex printer equipment used by R.C.A. Communications, Inc., on their New York-London circuit. This Higgett System had been developed by the cables and radio group in London and used successfully on the British Imperial radio circuits to South Africa, India, and Australia. The R.C.A. Communications, Inc., multiplex system has been in commercial use between New York and San Francisco throughout the year 1935. Traffic has been carried on two channels during this period and in November three-channel operation was started. The use of facsimile equipment was not materially expanded during the year. Photoradio service in the national and international fields continued to have commercial value. A photoradio transmission direct from San Francisco to London was made in connection with this year's automobile speed record run of Sir

Malcolm Campbell's "*Blue Bird*." The new ultra-high-frequency R.C.A. Communications, Inc., circuit between New York and Philadelphia introduces a service based on the use of facsimile type of equipment.

TECHNICAL ADVANCES

The trend toward higher power transmitters continued although this is to some extent disguised by the greater use now being made of directive types of antennas. The increased use of crystals with zero temperature coefficient is contributing to the higher order of frequency stability obtained on the more modern transmitters. Fortunately there has also been a reduction in the number of transmitters using modulated emissions for telegraph purposes and a general improvement in frequency stability. This has been materially helped by the improved equipment used for frequency measurements by the Tropical Radio Company, R.C.A. Communications, Inc., and the American Telephone and Telegraph Company at their monitoring stations.

The National Bureau of Standards in the United States extended the range and usefulness of its standard frequency transmissions by adding the frequencies of ten and fifteen megacycles to the former transmission frequency of five megacycles. It is now possible to compare local frequency control apparatus at practically any point in the world with standard frequency transmissions of one or the other of the National laboratories.

The fixed services have taken advantage of the improvements made in vacuum tubes and their associated circuits throughout their newer equipment. These have been of considerable assistance in the exploitation of the field below ten meters. The special tubes now available have made it possible, during this year, to build greatly improved equipment for use in this band. Considerable progress has been made in the study of wave propagation on these frequencies but exact information on the effects of atmospheric diffraction on fairly long-distance communication is still rather meager. In the field below one meter, the developments during the year were generally limited to improvements in apparatus.

The trend to increased use by medical science and industry of apparatus employing high-frequency currents has changed appreciably the magnitude of our interference problems. Use of such apparatus is becoming widespread throughout the United States, and widely separated receiving installations have complained of interference which has been traced to operation of this type of apparatus.

The studies of the ionosphere by a large number of laboratories initiated in previous years have continued during 1935. Short-wave

radiotelephone signal variations over transatlantic and transpacific paths have been investigated in an effort to gain a better understanding of the transmission medium, particularly as affected by magnetic disturbances. Extensive studies of transmission angles and wave paths have been carried on using pulse signals transmitted across the Atlantic. Data published during the year were of principal importance in further correlating conditions of ionization with the position of the sun. The information now available permits communication companies to select frequencies and to design directive antennas on a somewhat more logical basis than has been the case heretofore.

John H. Dellinger of the National Bureau of Standards reported, during the year, the observation of a sudden disturbance of high-frequency transmission lasting about fifteen minutes and recurring at intervals of approximately fifty-four days which corresponds to twice the rotational period of the sun. These fadings occur only on the illuminated side of the globe.

ACKNOWLEDGMENT

The writer desires to acknowledge the valuable contribution of material for this review by officials of Mackay Radio and Telegraph Company, Tropical Radio Company, American Telephone and Telegraph Company, and the Pan American Airways, Inc.



A REVIEW OF RADIO COMMUNICATION IN THE
MOBILE SERVICES*

BY

CLIFFORD N. ANDERSON

(Bell Telephone Laboratories, Inc., New York City)

Summary—Developments in radio communication in the mobile services during 1935 have been largely in the nature of gradual improvement of existing equipments and services.

In the marine field, the safety-of-life aspect is assuming increased importance. Rearrangements have been made of the frequencies and the schedules of radio beacons to avoid interference thereby making the system more effective. The improvement of radio compasses, regulations regarding motor lifeboat equipment and public address alarm systems, requirements for radio auto alarms and experimentation with collision prevention equipment are other items on which progress has been made the past year. The development in marine radiotelegraphy has been chiefly along the lines of greater application of the high frequencies. Directional antennas at the shore receiving stations have mitigated the effects of interference. Facsimile transmission of weather maps and press is being tried out. Improvements have been made in radiotelephone equipments of various powers and frequency ranges for various types of marine service. A system utilizing ultra-high frequencies was put into operation at Philadelphia during the year. Three commercial stations are in operation in the two-megacycle range, the one at Seattle having been opened this year.

Radio is an important factor in the operation of modern air lines. Special mention should be made of the important rôle played by radio in the newly established transpacific service by the Pan American Airways. Improvements have been made during the year in airway beacons and radio compasses; airport traffic control and blind landing systems are being tried out. In addition to the beacon and communication receiver, a small five-watt transmitter has been made available for the use of itinerant flyers in communicating with airports.

The use of radiotelephony with police cars is the most important application of radio with automobiles. There are two general types of this service, both of which have expanded materially during the past year. One consists of a one-way service from police headquarters to the cars and is usually conducted on a frequency in the range of 1500 to 2500 kilocycles. The other is a two-way service generally operating in the ultra-high-frequency range of 30,000 to 40,000 kilocycles. Another phase of telephony with automobiles is the use of broadcast receivers in pleasure cars. Under-the-car antennas, made necessary by introduction of all metal automobile tops, inclusion of the radio control as a part of the instrument board, and the use of circuits for reducing ignition noise are the more important features of 1935 developments.

RADIO communication in the mobile services includes the application of radio to the marine, aviation, police, and similar fields. Here radio affords the only means of rapid communication and plays an important rôle in increasing the safety of life and the protection of property.

* Decimal classification: R090. Original manuscript received by the Institute, January 9, 1936. Presented before New York meeting, December 4, 1935.

Developments in radio communication in the mobile services during 1935 have been largely in the nature of a gradual improvement of existing equipments and services.

I. MARINE

1. Aid to Navigation—Safety of Life at Sea

A. *Direction and Position Finding*

In addition to the possibility of summoning aid in case of distress, radio also offers means for direction and position finding which is an important factor in promoting safety of life. It will be recalled that there are two general radio methods of position finding at sea. One involves the use of two or more direction finding stations on shore which determine the bearings of the radio signals from the ship. Either the point of intersection of these bearings or the individual bearings themselves are transmitted to the ship. In the other method, a radio compass on board ship is used to obtain bearings from a number of fixed radio beacons on shore or on lightships. This latter method is the more favored one primarily because of the infinite number of ships which can be accommodated without any delay and because of the value of a radio compass on shipboard in locating a vessel in distress.

In 1935 there was a total of 124 marine direction finding stations in the world, of which 43 are in the United States and 14 in Canada.

There are about 290 marine radio beacons distributed around the world and operating in the frequency range of 285 to 315 kilocycles. As of November first, there were 109 radio beacons at lighthouses and lightships in United States waters. Three new stations were put into operation during the past year; viz., Gloucester, Mass.; Harbor Beach, Mich.; and Cape Arago, Oregon. Nine other beacons will be placed in operation shortly—six on lightships in Nantucket and Long Island Sounds, a seventh on the lightship at Heald Bank in the Gulf of Mexico, and two at lighthouses in Lake Michigan at Minneapolis Bank and Green Bay.

The radiated power of the Cape Cod station was increased during the summer. A low power beacon with a range of only about five miles was installed on Nantucket Lightship to enable ships to avoid collisions. This beacon has a characteristic warble note which is transmitted one minute preceding the regular beacon signal.

Two new Canadian beacons were established during the past year, one on Sable Island and one at Natashkwan in the Gulf of St. Lawrence. Another station at East Point, Prince Edward Island, is scheduled for completion by the end of the year. The power of the beacon of Sambro Bank Lightship was increased.

The frequencies and schedules of beacon signals of United States and Canadian beacons were changed at a conference of representatives of the two governments so as to make essentially one unified system. Interference was thereby eliminated and provisions were made for future extensions. The frequency spacing between beacon assignments was fixed at two kilocycles, and adequate geographical separation was provided between beacons operating on the same or adjacent frequencies.

Several electrical and mechanical improvements have been made in the conventional types of radio compasses. The selectivity and sensitivity have been increased and several models have been brought out for use on yachts and similar vessels where space is a premium. One new model for large vessels has the loop wheel mounted at a forty-five-degree angle with the magnetic or gyro repeater compass mounted inside the wheel.

One promising type of radio compass depends primarily upon the shift in phase, as well as the change in intensity, which occurs in a loop when it is oriented with respect to the incoming radio wave. This type lends itself to a visual method of setting the loop instead of the audio method employed in the conventional types. Furthermore, the 180-degree ambiguity in the direction of the signal is eliminated. The precision of the compass itself is in most cases a few tenths of a degree. The actual bearing is a function of the calibrations of both the mariner's compass and the radio compass but usually under favorable conditions bearings can be obtained with errors less than one degree at 200 miles.

B. Auto Alarm

During the past year requirements for radio auto-alarm equipments were formulated and were approved by the Federal Communications Commission. Many vessels are not required by law to carry more than one operator and in some cases a continuous watch on board ship might be dispensed with if there were some means of attracting attention in case a distress signal were received. International regulations provide for a distress signal of twelve four-second dashes with one-second intervals. The requirements were concerned primarily with limits of frequency, signal intensity, and timing.

C. Motor Lifeboat Equipment

As of January 1, 1936, regulations of the Department of Commerce require that motor lifeboats on passenger vessels greater than 2500 gross tons or whose routes lie more than 200 miles off shore must

be equipped with radio. Equipments have been developed to meet the requirements. In general, the transmitter, receiver, dynamotor equipment, and dry batteries for the receiver are mounted in a small metal weatherproof cabinet. Storage batteries are used for the transmitter supply.

D. Collision Prevention Equipment

The French liner *Normandie* is provided with equipment which, it is claimed, can detect an obstacle as small as a fishing boat when within two miles. The equipment operates on the principle of reflection of radio waves. It is placed forward on the ship and sweeps back and forth across a fairly wide angle.

E. Public Address Alarm System

Recent regulations by the Department of Commerce require that after January 1, 1938, all ocean and coastwise vessels of American registry must be equipped with a public address system by which the bridge can reach all parts of the ship. One such system was installed the past year on the *S.S. Colombia*. This particular system utilizes the hull of the vessel as a conductor. By means of individual wire circuits, two-way communication is provided between the bridge and certain selected points.

2. Radiotelegraph

The trend toward the use of higher frequencies (five to sixteen megacycles) has continued during the year. Of about 2000 vessels of American registry with radio, about 450 are now equipped for operation on these higher frequencies. Radio was compulsory equipment on 275 of these vessels. There is a tendency to provide frequency stability on ships comparable with that of the coastal stations. Except in the more expensive sets, crystals are not used because of the number of frequencies on which the ship may be called to operate and in some cases interference conditions may require that the ship transmit slightly off the nominal frequency. However, the use of master oscillators with temperature control and increased isolation of the oscillator from the power amplifier have gone far to improve the stability of ships' transmitters. In some cases frequency monitoring sets are also provided.

The main single-conductor ship's antenna is usually employed for transmitting on both the high and low frequencies. There is some advantage to be gained, however, in decreased noise pickup by using a smaller receiving antenna and in many cases horizontal doublets are used.

Directional antennas are now in use at many of the coastal receiving stations to reduce interference. One form consists of a number of antenna sections so arranged that by a series of switches, groups of sections can be selected to obtain the proper orientation of the directional pattern. Another type consists of a Bellini-Tosi scheme of large crossed loops. The loops are tuned and the vertical antenna effect is balanced out.

The ship-to-pier service in New York harbor which was inaugurated in 1933 has been extended to include all the major piers.

Equipments for facsimile reception of weather maps, press, etc., are being installed on four ships for trial.

3. Radiotelephone

Marine radiotelephony with transoceanic vessels is given in the following countries: Bahamas, Nassau; Bermuda, St. Georges; Canada, Drummondville and Yamachiche; France, Pontoise (Paris) and St. Nazaire (under construction); Germany, Norddeich; Great Britain, Rugby and Baldock; Italy, Coltano and Nodica; and the United States, Ocean Gate and Forked River, New Jersey. The frequencies employed in this service are in the four-, eight-, thirteen- and eighteen-megacycle bands.

There are more than a score of large passenger vessels equipped for this service, all of foreign registry. The vessels added the past year were the *S.S. Normandie* and the *S.S. Transylvania*.

The powers of the ship transmitters range from about seventy to 1000 watts. Some of the large transmitters use crystal oscillators but most of the smaller ones employ master oscillators. Voice control of the transmitting carrier is used in the higher powered sets. Simple vertical transmitting antennas are used for the most part while horizontal doublet receiving antennas outnumber other types. The use of privacy in ship-shore radiotelephone service was introduced early in 1935 on circuits with the *S.S. Bremen*.

Another class of marine radiotelephone service which continues to develop is that to the smaller vessels in harbors and along the coast. According to the 1935 Berne Lists there are some seventy-seven coastal stations in the world giving this form of service. Except for a few stations in the United States and in Europe, the service is not arranged to connect with the wire telephone network, the messages being written down at the land station and sent on to the destination by wire telegraph. The frequencies employed lie generally in the range of 1500 to 3500 kilocycles. Regional allocations of frequencies in this range have been made in North America and also in Europe, the European plan

having been further worked out during the past year by an agreement between the countries bordering on the Baltic Sea.

The United States Coast Guard have utilized radiotelephony for a number of years as an aid to their operations. It is not designed, however, for connection with the wire telephone network. At present there are twenty coastal stations in this service.

The more recent development of small-boat telephony in the United States has been in the direction of a commercial telephone service operated in conjunction with the wire telephone network. This has called for boat equipment designed to be almost entirely automatic in its operation and simulating as much as possible in its use the usual telephone procedure on land. Since there is no technical attendance, the equipment must be capable of running one or two weeks without maintenance. An outstanding feature of this type of telephone service is the provision of means for calling the individual boats by the shore traffic operator. In one system this is done by dialing a two-tone signal which, in turn, actuates a bell on the boat whose selector code corresponds to the signal dialed. This system is quite immune from false operation and the reliability is such that boats can be consistently signaled even under conditions when the speech is only partially intelligible.

In the United States there are four radiotelephone stations in service, two of which were opened during the year.

	FREQUENCIES (kc)	SERVICE DATE	OPERATING COMPANY
Boston, Mass.	2110 and 2506	1934	New England Telephone and Telegraph Company.
Lorain, Ohio	2158 and 2550	1934	Lorain County Radio Corporation.
Philadelphia, Pa.	38,600	1935	Atlantic Communications Corporation.
Seattle, Wash.	2126 and 2522	1935	The Pacific Telephone and Telegraph Company.

In addition, stations have been installed at New York, Los Angeles, and San Francisco preparatory to undertaking service.

Two types of boat equipment are available for service in the two-megacycle range. Equipment utilizing fifty-watt crystal controlled transmitters and crystal controlled receivers has been available for several years. During the year five-watt equipment has been developed which is less expensive but has a more limited range than the fifty-watt equipment.

An ultra-high-frequency system was placed in operation in Philadelphia during the past year employing a fifty-watt shore transmitter located on top of one of the tall buildings in the business section. Two

outlying unattended receivers are used. The boat transmitters are rated at five watts. Crystal controlled transmitters and receivers, voice controlled transmitting carriers and a neon type carrier-operated device to prevent high noise when no carrier is being received are some of the features employed on both the shore and ship ends of the circuit. Selective signaling is used to call in the particular boat desired. Five tugs are at present equipped and over water transmission ranges of the order of twenty to thirty miles are being obtained.

II. AVIATION

1. General

Radio communication with transport airplanes is used at present exclusively as an aid to navigation and operations as distinct from a means for communication by the passengers. Pilots are becoming increasingly more dependent upon radio for navigation as it enables them to determine their courses, positions, and the weather conditions which lie ahead. Much of the dependability of modern air transportations is due in a large measure to the use of radio and many services would be too hazardous without it. At some airports there are regulations against flying in foggy weather unless equipped with radio. Airport traffic control (on 278 kilocycles) is a feature which is being tried out at Newark, Cleveland, Chicago, and St. Louis.

Radiotelephony is used for communications with planes on the overland airways in the United States where the distance between ground stations is comparatively short. Telephony makes it unnecessary to carry an operator. For the long overwater stretches such as the Caribbean and transpacific courses flown by the Pan American Airways, continuous-wave telegraphy is used and a radio operator is carried. One of the advantages of this method of operation is the ability to communicate with marine vessels.

The numbers of airports and planes—radio equipped and un-equipped—are shown in the following table:

	JAN. 1, 1935	OCT. 15, 1935
Number of airports and landing fields	2297	2374
Number of commercial airport radio stations	127	165
Number of planes of all descriptions	8733	9133
Number equipped for one-way radio	449	500
Number equipped for two-way radio	326	365

2. Radio Communication Equipment

The trend of domestic commercial air service is distinctly toward larger and faster ships and longer hops. This has reacted upon the number of frequencies required, power, etc. Whereas, a few years

ago, provision was made for only a single frequency—either a night frequency of about 3000 kilocycles or a day frequency of about 6000 kilocycles—the requirements soon demanded that two frequencies be available in the equipment with provisions for a simple and quick change-over. Now the flight operation requirements call for at least three frequencies in each of the day and night bands and on one air line a total of eight frequencies is provided. The frequency range of the telegraph equipment for planes in the Caribbean and Pacific services is from 250 kilocycles to 12,000 kilocycles. This enables the plane to work on 500 kilocycles with marine vessels in addition to the regular three-, six-, and eight-megacycle aviation frequencies. In Europe, communication is mainly on the low frequencies: 325 to 336 kilocycles and 500 kilocycles for telegraphy and 340 to 350 kilocycles for telephony. Of late there have been experiments with frequencies of the order of 6500 kilocycles.

The power of the radio transmitters normally employed at airports is 400 watts. A new type permits any one of ten different crystal controlled frequencies to be selected in a few seconds and is particularly adapted for remote control.

The power of the transport airplane sets at present is about fifty or sixty watts, although there is some tendency to want this power increased in order to improve the reliability of communication. Storage batteries are generally used as power supply with a charging generator geared to the airplane motor. The Navy and the Coast Guard employ geared 800-cycle generators and plans are being considered for transport planes for providing auxiliary gas-engine-driven 800-cycle generators to supply the radio equipment and other electrical appliances.

Both fixed and trailing wire antennas are used. On some airlines, a trailing wire without an end weight is being employed. The antenna is tuned by a tuning unit located in the tail of the ship. Since the antenna wire is not reeled in but is allowed to drag along the ground during take-off and landing, it has been found that the wire has to be replaced after each transcontinental round trip. There has been, therefore, especially on the new and larger ships, a tendency to revert to a fixed antenna extending in most cases from the tail to the cockpit. The "Clipper" planes used in the transpacific flights are equipped with a fixed antenna extending from the wing tips to the center and then back to the tail for high-frequency communication and a weighted trailing wire for communication on 500 kilocycles.

Increasing interest has been shown the past year in radio equipment for the itinerant flyer. In its simplest form this equipment consists of a beacon receiver with which he keeps on his course, obtains

weather reports, and other communications from the ground, the latter on 278 kilocycles. A low power (five-watt) transmitter operating on 3105 kilocycles (calling) and 3120 kilocycles (working) has been made available for communication to the ground when desired.

Communication with the stratosphere balloon *Explorer II* on a frequency of thirteen megacycles was maintained throughout its flight from Rapid City, South Dakota. No unusual transmission characteristics were noticed.

3. Radio Beacons

There are at present 191 airway beacons operating on frequencies between 200 kilocycles and 400 kilocycles. The powers of the beacon transmitters are for the most part about one kilowatt. Using a simple beacon receiver, the pilot not only obtains weather reports, but by means of the *A* and *N* signals in alternate quadrants, he can tell when he is on the course.

Service trials are being made at Pittsburgh of a beacon which permits of visual as well as aural reception. In addition, weather and other information is transmitted from a nondirectional antenna on a slightly different frequency. This latter transmission is more satisfactory for radio compass observations as it is continuous rather than intermittent as in the case of transmissions from the crossed loops and the weather broadcasts are not interrupted by the course signals.

4. Radio Compasses and Direction Finder Stations

The use of radio compasses is very useful when flying on courses other than those provided with *A* and *N* beacons. There are three general forms. One is a simple standard rotating loop type by which the bearing is obtained by the usual method of setting the loop for the minimum audio signal. A second type is a Bellini-Tosi system of crossed loops. As used on the transpacific flights, a vertical rod 64 inches high is employed to support the four guy wires which form the two loops. The frequency range is from 250 kilocycles to 2000 kilocycles.

A third type which is gaining a favor and of which several commercial models have been made available during the past year, depends primarily upon the change in phase of the received carrier as the plane of the loop crosses the plane of the incoming signal wave. This is of the general type used with considerable success by Wiley Post in his record flight around the world. A visual indicator enables the bearing to be taken without losing the audio signal and the usual 180-degree ambiguity in the sense of the direction is avoided. In some arrangements the rotating loop is enclosed in a fixed streamlined housing.

The use of fixed direction finder stations on shore in connection with the transpacific flight tests is a novel feature as far as aviation is concerned. Modified Adcock direction finding systems have been installed at San Francisco, Hawaii, and Midway. The frequency range is 250 to 6000 kilocycles.

5. Blind Landing Systems

Experiments are continuing with "blind landing" systems. Radio transmitters and lights to assist airmen in making blind approaches to the landing area when visibility is poor have been placed in operation during the past year at Newark, N. J., and Washington, D. C. Sites have been selected at thirteen additional cities.

The system is one developed by the United States Army in which the essential plane equipment consists of a radio compass, a ninety-megacycle radio receiver which flashes a light when actuated by a radio marker beacon on the ground, a sensitive altimeter and a gyro-directional indicator together with the usual flight instruments. On the ground are two radio stations transmitting on slightly different frequencies, one 1500 feet from the airport and the other two miles. At each radio station there is an auxiliary radio marker beacon (90 megacycles) to flash the light in the airplane whenever the craft passes over the transmitter.

III. TELEPHONY WITH AUTOMOBILES

1. Broadcast Receivers

There have been an increasing number of cars equipped with radio. In 1932, 143,000 auto sets were sold; in 1933, 724,000; in 1934 the total sold was 780,000; and in 1935, about a million. One indication of how their use may be of value apart from entertainment is the traffic bulletins given on week ends by one metropolitan New York broadcast station indicating which roads are least congested.

With the introduction of all-metal car tops, antennas are generally mounted underneath the car. Spark-plug resistors for suppressing ignition noise have generally been discarded. Instead various other expedients are used such as balancing circuits with a noise pickup coil used in a push-pull arrangement with the car antenna, careful filtering of the power supply, or careful shielding of the input circuit and transmission line with the ground end of the antenna coil grounded at a point on the car frame at which the circulating noise currents are not mutual to the receiver input. About sixty per cent of the sets employ a vibrator with tube rectification for plate voltage supply, thirty per cent employ a vibrator with mechanical rectification, and ten per cent

use dynamotors. The recent trend is to make the radio control apparatus an integral part of the instrument board. The radio sets are usually mounted behind the instrument board. In some cases the loud-speaker is part of the receiver while in others it is mounted on the dashboard or above the windshield. The latter method is the more satisfactory from the viewpoint of the passengers in the rear seat.

2. Police

The use of radio frequencies for police purposes is an important one in that it falls in the general class of protection of life and property along with the use of some of the frequencies employed for marine and aviation communication. Detroit, in 1923, was the first municipality of any size to use radio successfully for police purposes. The growth was slow; by 1930 only eleven cities had police radio systems. At the beginning of 1932, the number had increased to twenty-nine; two years later (1934), seventy cities and five states were equipped. More recent figures are given below.

	JAN. 1, 1935	OCT. 15, 1935
Municipal Police (1500-2500 kc)		
Number of municipalities	165	207
Number of stations	168	212
Municipal Police (30,000-40,000 kc)		
Number of municipalities	137	191
Number of stations (including mobile transmitter units)	312	622
State Police (1500-2500 kc)		
Number of states	9	12
Number of stations	44	65
State Police (30,000-40,000 kc)		
Number of states	2	3
Number of stations (including mobile transmitter units)	5	9
Total		
Number of municipalities	302	398
Number of states	11	15
Number of stations (including mobile units)	529	908

The twelve states which operate a police alarm system in the 1500- to 2500-kilocycle band are Illinois, Indiana, Iowa, Massachusetts, Michigan, Minnesota, Missouri, New York, Ohio, Pennsylvania, Texas, and Washington. Pennsylvania has only one station in the above band (1600 kilocycles), utilizing telegraphy on 190 kilocycles for the most of the traffic. Kansas, Massachusetts, and North Carolina operate in the ultra-high-frequency range.

Where the communication is one way only, that is, from the headquarters station to the police cars, frequencies in the range of 1500 to 2500 kilocycles are generally used because of the greater transmission range. The transmitting powers generally range from fifty to 5000

watts. Where two-way transmission is desired, the ultra-high frequencies are generally used primarily because of antenna considerations on the cars and also because of the greater number of available frequencies. The powers employed at the headquarters station in these cases are generally fifty watts or less. At Newark and the trial installation at Boston, however, the power is 500 watts or greater. The ranges of the headquarters stations under favorable conditions are of the order of ten to fourteen miles.

The powers of the transmitters on the cars are in the neighborhood of five watts with ranges of about two to four miles. The transmitter is usually located in the trunk or the rear compartment. A vertical six-foot steel rod attached to the trunk serves as the common transmitting and receiving antenna. Either a manual push-button or an automatic voice switch is used to transfer the antenna from the receiver to the transmitter and to start the transmitter when the operator speaks.

Communications are almost entirely between the headquarters dispatcher and the cars although in Boston arrangements are planned for connecting into the telephone switchboard of the police department.

IV. MISCELLANEOUS

The number of geophysical stations increased from 109 as of January 1 to 128 on October 15. These stations are mainly used for prospecting parties of oil companies. The frequencies used are in the neighborhood of 1600 kilocycles.

As far as is known there have been no developments during the past year in telephony with moving trains or in communication between the engine and caboose of long freight trains.



PROGRESS IN ALLIED FIELDS TO RADIO*

BY

O. H. CALDWELL

(Radio Today, New York City)

ABSTRACT

During 1935, a number of further applications of the principles of the radio tube and of vacuum tube amplification have been made outside of the fields of space radio itself.

The detection and demonstration of electrical impulses from the human brain have shown, by means of sensitive amplifiers, that electromotive forces of the order of fifty microvolts occur cyclically ten to twenty times a second. These characteristic impulses, most noticeable from surgically exposed brain surfaces, can be recognized even through the heavy skull walls of any normal individual by means of the high amplification available.

While facsimile is finding new uses over telegraph wires for transmitting messages as originally written, another 1935 development sends newspaper photographs over ordinary telephone circuits at will. Portable apparatus has been developed with which the newsman can go to any ordinary public phone or booth, scan his photograph by a photocell, "play" it into the telephone mouthpiece as he would a phonograph, and in a few minutes the picture is at headquarters 100 or 3000 miles away, at the cost of an ordinary long-distance phone call.

New synthetic musical instruments made available during the year, seem at last to satisfy the musicians, and so have opened up new commercial opportunities in the field of electronic music.

One-tube local-fee generators are now being turned out in quantities rivaling radio transmitters, and such local applicators useful in arthritis and sciatica, may soon become as common as infrared or ultraviolet lamps.

In sound motion pictures, refinement of apparatus has continued, especially in recording, and the general sound quality of pictures released during the year, has very noticeably improved.

Introduction of the metal radio tube has speeded the development of tube-controlled welding processes, and rapid extensions are now being made in the fields of spot and seam welding.

Tube amplifiers in sensitive instruments on the recent stratosphere flight played important parts in obtaining the scientific records of the expedition.

The new electron-impact amplifier of Zworykin may provide astronomy with a new and more sensitive electrical eye that will far outrun even the power of the great 200-inch telescope now being built, as well as encourage various other new applications of electron amplifiers.

* Presented before New York meeting, December 4, 1935.

AN EXPERIMENTAL TELEVISION RECEIVER USING A CATHODE-RAY TUBE*

By

MANFRED VON ARDENNE
(Berlin, Lichterfelde-Ost, Germany)

Summary—The circuits which have proved especially suitable for receiving television broadcasts from Berlin are described. The arrangements in the high-frequency portion, conditions during rectification, the production of synchronizing impulses of constant amplitude, and a relaxation oscillator circuit producing symmetrical voltages of large amplitude, are discussed. Photographs of television pictures prove the quality obtained.

THIS paper describes the design of a 1934 receiver developed as a result of research on high-frequency aperiodic amplifiers begun in 1925, of research on the cathode-ray tube for television begun in 1929, of practical television research begun in the author's laboratories in 1930, and of the practical experience under field strength conditions, which the public later on will have to take into account. The latter experience was gained by experiments conducted some months ago with the television transmitter in Berlin.

The transmitter in Berlin uses the modulation method of O. Schriever¹ which differs basically in many ways from arrangements found in the publications relating to the receiver in the RCA system.² Attention is called especially to the method of cutting off the synchronizing impulses. Other characteristic differences in the solution of the technical problems are found in the utilization of the direct-current component of the television picture, made possible by the aforementioned modulation method.

CONNECTIONS AND CONSTANTS OF THE (INTERMEDIATE FREQUENCY) PICTURE RECEIVER

Fig. 1 represents the connections in the picture portion of the intermediate-frequency receiver. At an average signal strength of about one-half millivolt per meter the receiver supplied sufficient output when small half-wave, indoor antennas were used. Less favorable receiving conditions necessitated outdoor antennas which were connected

* Decimal classification: R583 X R361. Original manuscript received by the Institute, November 30, 1934; revised manuscript received by the Institute, January 8, 1935; translation received by the Institute, March 7, 1935.

¹ O. Schriever, "The latest technical devices for television broadcasting," *Fernsehen und Tonfilm*, vol. 4, p. 35, (1933).

² R. S. Holmes, W. L. Carson, and W. A. Tolson, "An experimental television system," *Proc. I.R.E.*, vol. 22, pp. 1266-1285; November, (1934).

to the receiver by a transmission line. Usual circuits are used in heterodyne mixer stages.

The scanning standards used in Berlin, namely twenty-five pictures per second, 180 lines, picture aspect ratio 5:6, necessitate the uniform transmission of a frequency band of about 0.450 megacycle in order to make the vertical detail equal to the horizontal detail. As is well known, the communication band is twice as wide as the modulating-frequency band, in our case 0.9 megacycle. This is needed for perfect reproduction.

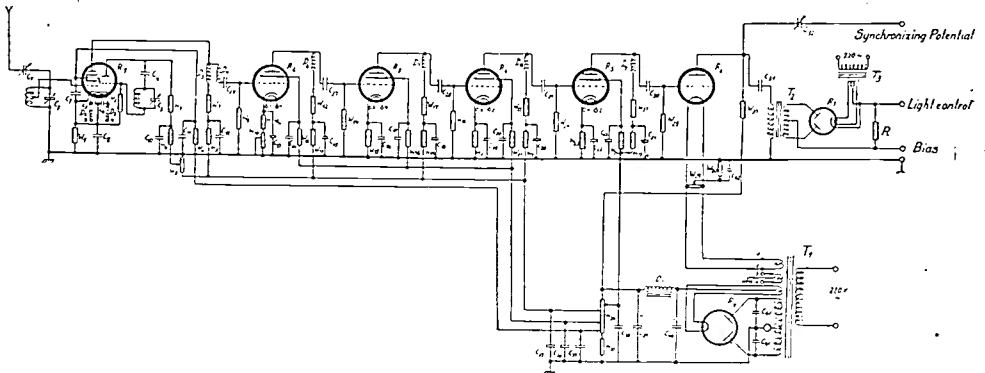

Fig. 1—Circuit of the superheterodyne television receiver (Type 1,934,135) for the 500,000-cycle frequency band of the Berlin transmitter.

With a carrier frequency of say 1.0 megacycle (using both side bands), an aperiodic amplifier having a frequency range of about 0.5 to 1.5 megacycles is required. Such amplifiers have been available for many years. The author has already reported design calculations, as well as numerous results of measurements on these.³ Briefly, the stage constants which have been calculated for this frequency band, normal stray capacities, and the specified type of tube are:

Type of Tube:	Telefunken RENS 1284
Plate resistor	5500 ohms
Self-inductance in anode circuit	0.3 millihenry
Voltage amplification (within frequency range mentioned)	16-18

Due to the absence of feedback, screen-grid tubes offer considerable advantages, both because of the ease of calculation of amplification as well as their satisfactory operation. However, in the tube mentioned above input and output capacities are from two to three times greater than in other multielement tubes which have been used previously.

³ von Ardenne, "Aperiodic amplification of broadcast waves," *Jour. High-Frequency Tech.*, vol. 33, no. 5, (1929).

The inductance inserted in series with the plate resistor resonates with the stage capacity, forming an oscillating circuit which is rendered almost aperiodic by the plate resistor, and whose natural frequency is around 1.5 megacycles. The comparatively great voltage amplification per stage could be realized only by the use of this inductance in the anode circuit, despite stage capacities as great as twenty to thirty micromicrofarads. The method of using inductance in aperiodic amplifiers had previously been introduced and applied.⁴ It was possible to get the necessary voltage amplification of 10^5 with relatively few stages and a relatively low plate supply current.

The apparatus could be operated either with both side bands or, preferably, with one side band. Better results were obtained with one side band and, therefore, another frequency curve was chosen, the form of which was arrived at by a design of the coupling unit whose constants differed somewhat from those given above, and by special selection and damping of the transformer supplying the intermediate-frequency rectifier. The amplification characteristic, increasing from the low-frequency end, reaches its maximum at 0.5 megacycle. Up to about 0.9 megacycle the curve falls off only slightly. The drop is more rapid above 0.9 megacycle, and is followed by a very steep drop at 1.4 megacycles. The carrier frequency is adjusted so that half of the total amount of amplification lies in the range between 0.5 and 0.9 megacycle. In the lower modulation-frequency range where both side bands are demodulated, twice the amplitude is available. This overaccentuation of the low frequencies is equalized because the amplifier has only half the amplification over this range. The result is a smooth frequency characteristic which rises slightly at higher frequencies. The frequency-response curve corresponds closely to the curve of an amplifier with choke-resistance coupling. This feature explains the great efficiency and economy of this method. The only disadvantage perhaps may be that it is necessary to employ the correct heterodyne frequency. The proper operation of the heterodyne can be simplified by means of simple markings, by using stable oscillating circuits which are only slightly affected by temperature, or, by the use of simple indicators for the carrier frequency, similar to those used with wavemeters.

The difficulties⁵ accompanying the use of only one side band can be eliminated to such an extent by means of the above frequency characteristic and by a suitable choice of carrier frequency, that it is not possible to detect, by observation of the picture, that single side-band

⁴ von Ardenne, "On a new device measuring field strength," *Elek. Nach.-Tech.*, vol. 7, p. 438, (1930).

⁵ F. Schroeter, "The present status of television broadcasting," *Telefunkenzeitung*, no. 66, p. 15, (1934).

transmission is being used. This arrangement, single side-band operation, permits the use of modulating frequencies of 0.7 to 0.8 megacycle. This diminishes the band width required for the reception of the Berlin transmissions.

CONCERNING THE ARRANGEMENT OF THE INTERMEDIATE-FREQUENCY RECTIFIER

The voltage appearing at the output of the last intermediate-frequency amplifier stage is fed to the detector and to an amplitude filter which will be discussed later (Fig. 2). The type of modulation used at the Berlin transmitter makes possible the utilization of the direct-current component of the picture signal for background control. The author has made a series of comparative tests from the Berlin

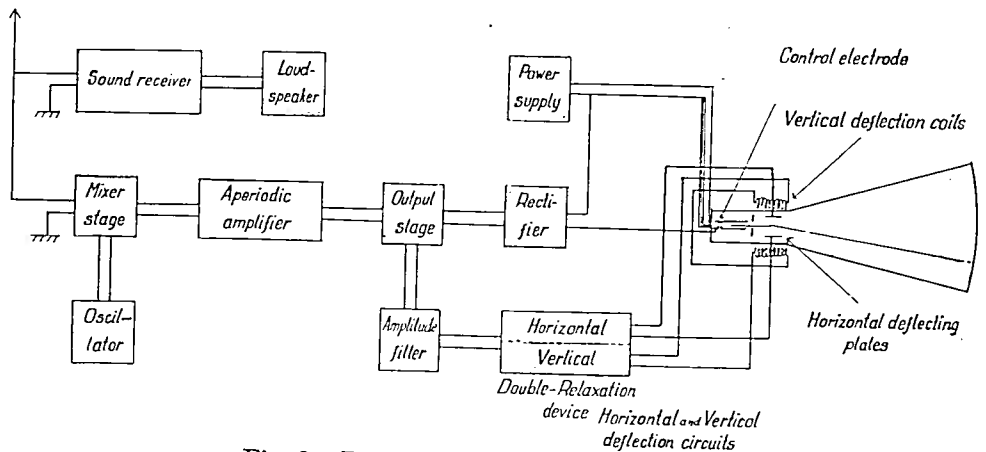

Fig. 2—Diagram of television receiver.

transmitter, in which picture reception could be carried on either with or without this direct-current component. These tests showed that, for a large percentage of pictures, the use of the direct-current component is a prerequisite for high-grade picture reproduction, particularly when reproducing pictures with dark shadows. In such tests the picture variations, when the direct-current component is omitted, are prohibitive.

The differences appear particularly great in the reception of film titles. Direct-current background control is accomplished most directly by coupling the second detector to the grid of the cathode-ray tube. The simplest way is to have rectification take place in the cathode-ray tube itself. Such rectification, however, has the disadvantage that the emission current of the cathode-ray tube is only utilized for a fraction of the time, so that comparatively dim pictures result. To prove this statement we refer to Fig. 3. In fact the operating conditions are even less satisfactory than shown in the illustration because, as required by

the synchronizing level, the operating point is moved toward the more negative grid voltages. If the intermediate-frequency voltage supplied by the final stage is adapted to feed the cathode-ray tube, that is, if the peak value of the intermediate frequency reaches that grid voltage value corresponding to the greatest beam current with which sharp spot definition is obtained, then, despite this rectification in the cathode-ray tube, the greatest average picture brightness is only one third of that which is possible with other methods of operation.

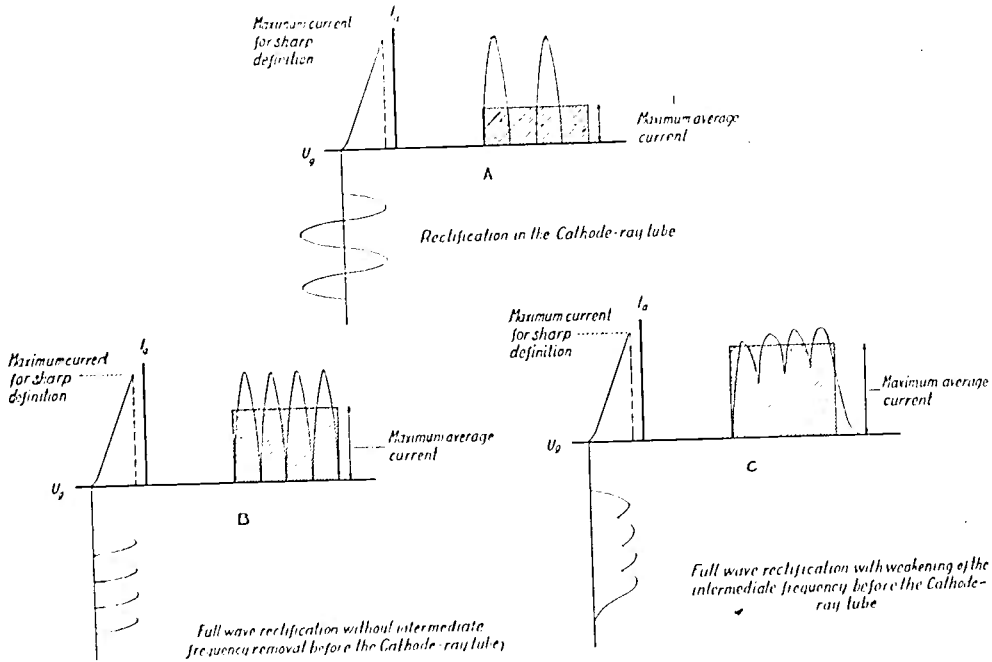

Fig. 3--Variation between intermediate frequency rectification and maximum beam current of the cathode-ray tube.

Since a reserve of brightness must be available, rectification within the cathode-ray tube is practically out of the question. More satisfactory results are obtained if a separate full-wave rectifier is placed ahead of the cathode-ray tube because then sixty to eighty per cent of the maximum emission current can be utilized. How much of the maximum beam current may be used depends upon the amount of parallel capacity which may be added across the rectifier output to remove the intermediate-frequency components from it. Experience has shown that it is not easy to get perfect results from a full-wave rectifier. At high frequencies large asymmetries are caused by small differences of stray capacities of transformer windings to ground. The alternating of brighter and darker pattern points indicates these asymmetries. Under very unsatisfactory conditions the asymmetry may become so great that one half of the wave remains unused. To avoid

such difficulties it is necessary to increase the intermediate frequency greatly. At an intermediate frequency of six megacycles, it is possible to use satisfactorily a cathode-ray tube with half-wave rectification in the same way as with full-wave rectification, as shown in Fig. 3. The use of shunt capacity across the rectifier output to remove intermediate-frequency components from it tends to decrease picture detail by attenuating the higher modulation frequencies. This method then must be used with care; the trouble may be greatly diminished by the use of a high intermediate frequency. A correct compromise may be made easily by the proper selection of resistance R in Fig. 1. This resistance can have a value as high as 10^4 ohms without noticeably affecting the picture sharpness if the circuit and equipment has little capacity. With a resistor of that value the voltage variations required for modulation of the cathode-ray tube can be attained with a relatively small receiver output. When full-wave rectification was used intermediate frequencies up to 1.5 megacycles were still visible on the television screen. Due to the presence of a certain amount of intermediate frequency the television pattern acquires an appearance similar to that of a newspaper half tone.

AN AMPLITUDE LIMITING CIRCUIT OF SPECIAL DESIGN FOR THE SEPARATION OF EXTREMELY CONSTANT SYNCHRONIZING IMPULSES

According to Schriever's proposal,¹ the Berlin transmitter is modulated in the following manner:

The darkest shadow of the picture corresponds to a certain residual antenna current, which at present is established at the transmitter at a value between twenty-five and thirty-five per cent. Picture modulation is accomplished by varying the antenna current between this value and the maximum value in accordance with the instantaneous illumination at the element of the picture being scanned. The synchronizing signals are transmitted on the other hand by cutting off the antenna current completely. This occurs at the completion of each line and at the completion of each picture. The duration of the synchronizing pulses at present is five to seven per cent of the scanning time for a line or a picture, respectively. The resulting large difference in frequency permits the separation of horizontal and vertical synchronizing impulses by means of frequency separating circuits.

This procedure, which has shown good results in practice, has the advantage that only a fraction of the transmitter output (at present about one tenth) is used for synchronizing, that is, is lost as far as the transmission of the picture signal is concerned. In addition the cathode-

ray tube beam is cut off at the end of each line and at the end of each picture, due to the pulses, so the return traces of the electron beam remain invisible. This blanking-out effect is necessary, not only for the return of the electron beam to the top of the scan after each complete frame, but also for the return of the beam at the completion of scanning each line, because otherwise the attainable contrast interval will be limited in accordance with the ratio of the speed scanning—speed retrace. Moreover, when intermediate-frequency reception is used, the spot intensity also varies periodically during the retrace. If, therefore, this trace is not blanked out, very disturbing streaks will be visible in the dark portions of the picture.

In order to illustrate present procedure, an oscillograph of the intermediate-frequency voltage provided by a receiver tuned to the

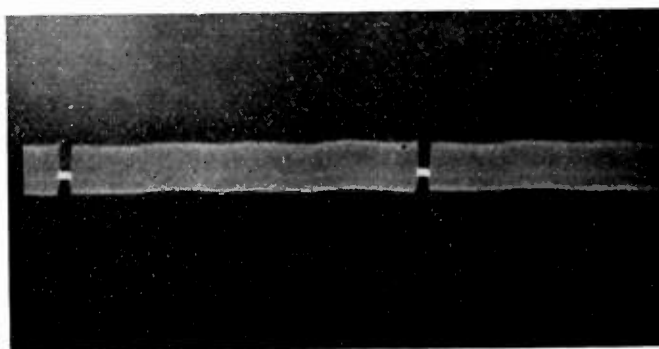

Fig. 4—Oscillogram of carrier wave of Berlin television transmitter. No picture modulation.

Berlin transmitter is shown in Fig. 4. This was made under conditions of no picture modulation, and shows that even under the comparatively good receiving conditions at the author's laboratory in Lichterfelde, interference voltages may amount to as much as one eighth to one fifth of the intermediate-frequency output during absence of picture modulation.

One of the chief difficulties in television consists in obtaining exactly similar synchronizing impulses which are not only entirely free of picture signal content but also are affected least by the mean disturbance voltage from the receiver. Even very slight variations, particularly in the intensity of the synchronizing impulse, suffice to cause a considerable displacement of lines or a change in picture size (height of the picture). The result is a lack of sharpness in the picture and unpleasant picture flicker. Changes in synchronizing impulse intensity naturally have more effect the greater the synchronizing power. The problem of securing steady synchronizing impulses from the mixture of

voltages at the intermediate-frequency output was solved by the insertion of a tube having the characteristic curve shown in Fig. 6. The operating point of the grid of this tube is made strongly negative (in Fig. 5, for example -5 volts), thereby preventing the disturbing voltages during transmission of synchronizing impulses from reaching the value at which plate current of this amplitude filter begins to flow. As soon as the synchronizing impulse is over (assuming correct division of the receiver output voltage) a current always flows in this tube, the mean value of which is about equal to half the maximum value of the tube characteristic. This current does not depend on the respective modulation values during the picture modulation interval (i.e., on the picture content) because the characteristic after reaching its upper break drops again. For the type of tube in Fig. 5 and the voltage

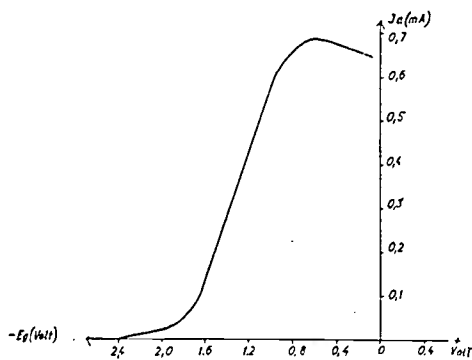

Fig. 5—Characteristic curve of amplitude filter using screen-grid tube.

selected, the drop in the characteristic after reaching its upper break is attained by the familiar current distribution effect (retarded field arrangement). The proper selection of the auxiliary grid voltage makes it easy to bring the drop to a value which gives practically ideal independence from the degree of modulation of the transmitter prevailing during the picture modulation interval. In the final analysis this process is based on the selection and utilization of a very small modulation interval at the transmitter, for example, an interval of from twenty to twenty-five per cent of the total modulation interval so as to allow always the same current. The regularity of the resultant synchronizing impulses is so absolute that extremely stable synchronization is afforded, even without the use of additional frequency selecting stages. The pictures have remained flawless and stable over periods of several hours.

PROPERTIES OF THE HIGH VACUUM TELEVISION TUBE USED

High vacuum tubes of the Leybold and von Ardenne Oszillographen-Gesellschaft, Köln-Bayental, were used in the arrangement de-

scribed. A detailed account of the history of these tubes has been reported⁶ recently and the author will give only brief data.

The electron-optical arrangement of this type of tube operates with double electrostatic concentration according to George,⁷ of a similar type to that employed in practically all modern television tubes. In the ordinary design this type of tube has only two deflecting plates which are charged by the horizontal deflection potential in accordance with the author's publication mentioned in this paragraph. Symmetry, with reference to the anode, is maintained by the use of push-pull output tubes to drive the horizontal deflecting plates.⁸ The low-frequency vertical deflection is accomplished by means of deflecting coils fed with current from a relaxation oscillator. These deflection arrangements permit the maintenance of spot sharpness to the extreme edges of the screen. These conditions prevail, not only for wide deflection angles but also at high beam currents and small beam sections.

Furthermore, by reducing the distance between the electron gun and the fluorescent screen by the length which is required by a pair of plates, a corresponding increase in the sharpness of the spot results as a corresponding decrease in the over-all length of the tube as compared with a double electrostatic deflection type of tube. Finally, through the use of magnetic deflection in the vertical direction it is possible to adjust precisely the size of the picture from the outside of the tube. Thus, all the advantages of magnetic deflection are available without the disadvantage of requiring a large amount of electrical energy for deflection at the higher frequencies.

Fig. 6 is an enlargement of a section of a television picture on the fluorescent screen. No lack of illumination control is noticeable with this type of tube. A size of 18×22 centimeters is used. At an anode voltage of 4000 volts pictures of these sizes were so brightly illuminated that the bright parts of the picture reached and exceeded the brightness at which a strong flicker occurred when twenty-five pictures per second were shown. The screen has a white-black tone, which imparts a very pleasant quality to the picture.

The relaxation device described in the following paragraph was used to produce perfect scanning on the screen.

⁶ von Ardenne, "On the construction of Braun tubes with a high vacuum for television and measuring purposes," *Jour. High-Frequency Tech.*, vol. 44, no. 5, (1934).

⁷ R. H. George: "A new type of hot cathode oscillograph and its application to the automatic recording of lightning and switching signals," *Jour. A.I.E.E.*, vol. 48, p. 534, (1929).

⁸ The same solution is also to be found on page 1282 of reference 2, "An Experimental Television System," which was published at the same time as the author's book.

CIRCUIT OF THE PUSH-PULL THYRATRON RELAXATION DEVICE

The following method has proved itself to be a simple one for the production of relaxation oscillations which are sufficiently linear for television use.



Fig. 6—Magnified section of received picture.

The voltage difference between the ignition and extinguishing points of a grid-controlled gaseous discharge tube is adjusted to a value that is small compared with the charging voltage source. The ignition value is chosen so that breakdown occurs at the level of about one half of the charging source voltage. Under such operating conditions a sufficiently linear rise in current for television purposes is obtained,

even when the capacity which is in parallel with the thyatron is charged through a resistance. This is because the portion of the curve used is only a very small part of the central portion of the usual charging curve, and thus it is sufficiently linear. The resulting relaxation voltage is usually either too small (even if the anode supply of the cathode-ray tube is used as a charging voltage) or, if it is large enough, requires such heavy discharges that the life of a gaseous discharge tube is critically shortened. Also, the relaxation voltage is not symmetrical with respect to ground. For this reason the method of connection shown in Fig. 7 was selected, in which the relaxation voltage is amplified in a supplementary amplifier stage. In this diagram, tubes with a large voltage amplification factor are used, as well as plate resistors which are large compared with the internal resistance of the tube. The operating characteristic of a stage designed in this manner is so linear over a wide range (depending on the magnitude of the anode voltage used) that up to seventy or eighty per cent of the voltage at the plate supply may be linearly controlled. Even with one stage this percentage is as great or greater than may be obtained by charging the relaxation condenser through a tube which gives a constant load current (such as tubes using saturation or suitably connected dual grid tubes) without subsequent amplification. The output voltage is effectively doubled when the push-pull circuit is used. This circuit has the added advantage of providing deflection potentials symmetrical with respect to ground which are required when operating high vacuum tubes. Using such circuits and a plate voltage of 1000, sufficiently undistorted relaxation voltages of magnitudes up to 1500 volts have been produced.

The antiphase voltage required for controlling the grid of the symmetric stage is tapped off of the plate resistor of the main stage, as shown in Fig. 7. Formerly the plate resistor was used as a voltage divider to supply the correct grid potential. Now, the actual voltage division takes place in the grid circuit of the symmetric stage. This arrangement has the advantage of dividing the hum voltage as well as the signal voltage, so that less smoothing is necessary.

In Fig. 7 resistances are provided in the discharge circuit of the relaxation tubes which not only act as protective resistances for the gaseous discharge tubes, but also have, in conjunction with the output stage,⁹ the important function of accelerating the recurrence of the relaxation oscillations. It was possible with these resistances to accelerate the relaxation recurrence to as much as one third of the original value.

⁹ The same trick is also referred to in the paper mentioned in reference 2 *Proc. I.R.E.*, vol. 22, November, (1934).

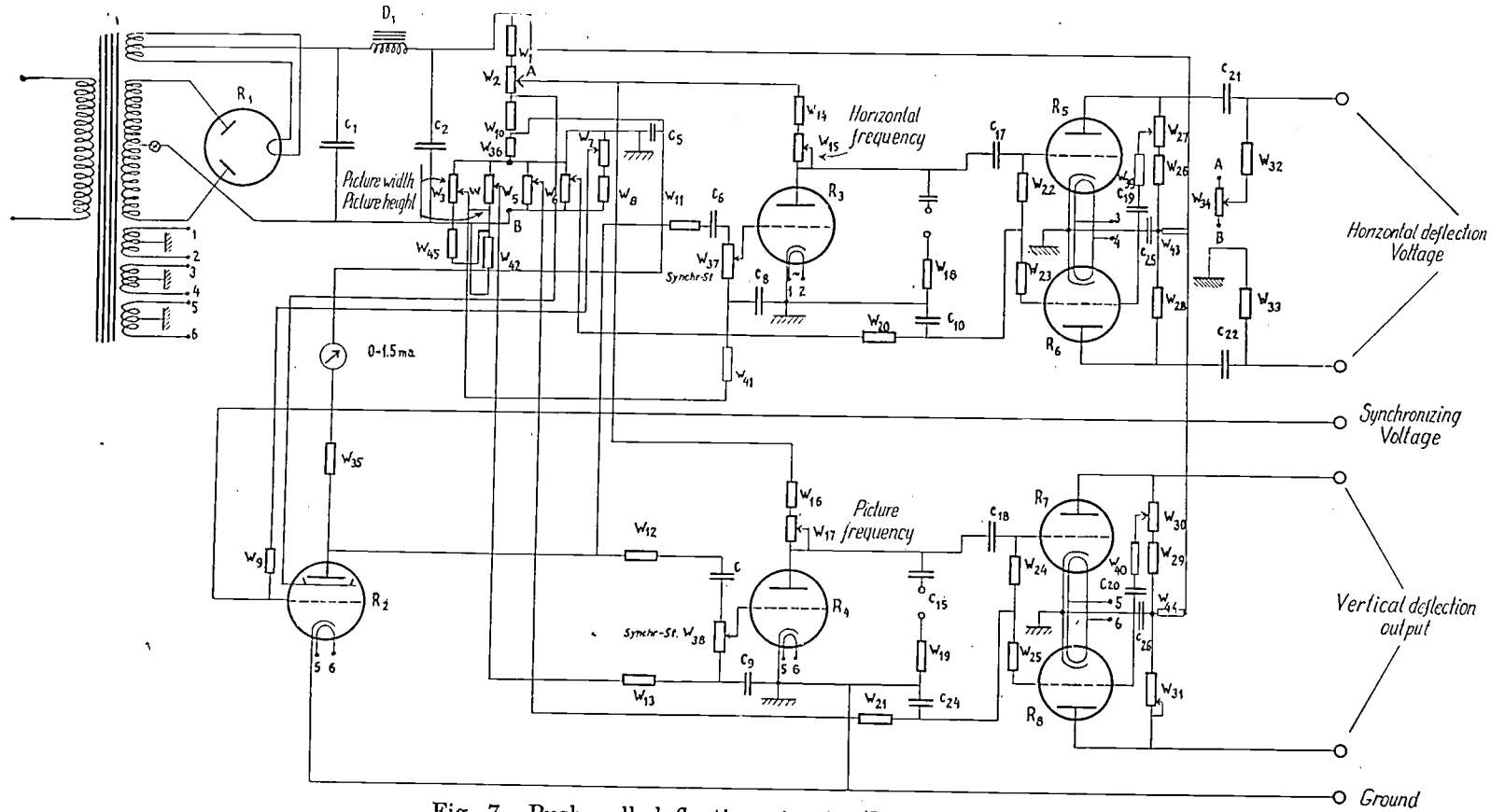

Fig. 7—Push-pull deflection circuit. (Type 1933/34.)

On the left-hand side of Fig. 7 is shown the amplitude filter described in a preceding paragraph. The coupling of the synchronizing grids of the two discharge tubes to the amplitude filter is accomplished with condensers of different sizes. These condensers are so chosen that frequency components of the horizontal and vertical synchronizing impulses are transmitted without undue loss.

A number of decoupling devices are provided in this wiring diagram in order to prevent coupling between the two relaxation parts, as well as to prevent reactions of the relaxation potential amplifier on the re-

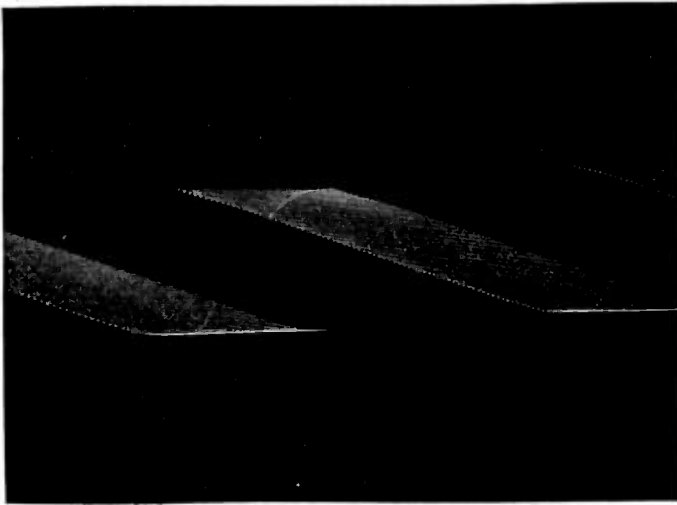

Fig. 8—Oscillogram showing quality of scanning pattern. Vertical deflection frequency 25 cycles; horizontal deflection frequency 2500 cycles; high vacuum tube with anode voltage 4000; lens $f. 2.8$.

laxation generator. Extensive elimination of such disturbances, as well as a high degree of attenuation of the hum voltage, are necessary for stable synchronization by the impulses of the transmitter. Fig. 8 is an oscillogram of a television pattern, taken with a rotating camera. The relaxation apparatus, described above, and a Leybold high vacuum tube were used. The reader can see the constant high intensity of the light spot, the satisfactory linear course of the electrostatic horizontal deflection, as well as of the magnetic vertical deflection and even the vertical return line which occurs in the oscillogram in less than $1/2000$ of a second. The return time obtained with magnetic deflection was sufficiently short, since the vertical synchronizing impulses last longer than $1/1000$ of a second.

PRACTICAL EXPERIENCE IN RECEPTION FROM THE BERLIN TELEVISION TRANSMITTER

With the arrangement¹⁰ described in this paper the Berlin transmitter was regularly received in Lichterfelde for extended periods. A very sharp 180-line picture, almost free from faults, was received. Its



Fig. 9—Unretouched snapshot of 180-line picture received from Berlin transmitter.

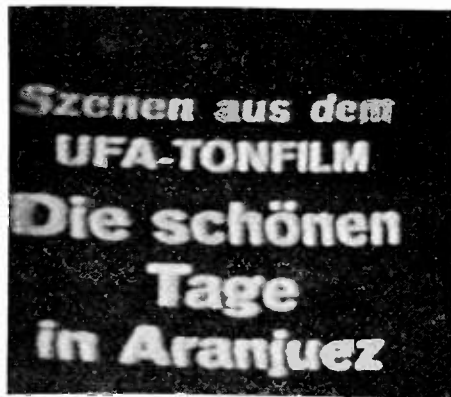

Fig. 10—Showing reception of a film title.

quality was hardly noticeably below that of the picture at the monitor at the transmitter. When using the above-mentioned type of tube, picture brightness was great enough to permit photographing the received pictures with an exposure time of a fraction of a second. Sharp pictures, therefore, could be produced in spite of the constant motion of the films from which they were transmitted.

¹⁰ A number of patents were applied for on these ideas. They will be exploited for television purposes by the C. Lorenz Company, Berlin-Tempelhof. Above investigations were supported by the C. Lorenz Company.

Some unretouched characteristic photographs are shown in Figs. 9, 10, and 11. They were taken when double side-band transmission was still in use. Single side-band operation gives pictures of greater sharpness. Such pictures are shown in a recently published book¹¹ by the author.

The immediate impression at the television receiver is that of a sharp picture, much more satisfactory than these photographs, because



Fig. 11—Another received picture.

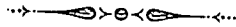

Fig. 12—Showing the effect of purposely inserted interference from a sparking commutator.

of the motion of the film and the constant transition to new screen pattern elements. Synchronization was unusually stable, both horizontally and vertically, so that the pictures remained perfectly framed for several hours. The picture in Fig. 12 proves how little the synchronization is subject to disturbances. This picture was taken during an artificially created disturbance, the peak potentials of which amounted to fifty per cent of the voltage obtained from the dark value of the

¹¹ von Ardenne, "Television Reception," Berlin, January, (1935), Weidmannsche Buchhandlung.

transmitted signal. Good synchronization was maintained despite this extraordinarily unfavorable condition. The disturbance in the pictures, which causes a slight variation in the length of the scanning lines, was not any more noticeable (that is subjectively) than the disturbance of the picture content which is due to light modulation. In other words, a condition has been arrived at where the synchronization is no more subjected to disturbances than the light control circuit of the cathode-ray tube. Disturbances to the latter source, of course, are unavoidable. The use of a separate circuit for synchronization would not appreciably improve the picture quality.



LOSSES IN TWISTED PAIR TRANSMISSION LINES AT RADIO FREQUENCIES*

By

C. C. HARRIS

(Tropical Radio Telegraph Company, Hingham, Massachusetts)

Summary—It is generally believed that the losses in twisted pair transmission lines at radio frequencies are high, but the magnitude of the losses at frequencies between one and fifteen megacycles is perhaps not so well appreciated. This discussion deals with the use of several kinds of twisted pair conductors available in the market, when used as transmission lines between an antenna system and a radio receiver. The conductors tested are frequently used for this purpose, but were not designed or intended for use at these frequencies. They are commonly used for 110- to 220-volt direct- and alternating-current house lighting and appliance requirements, telephone drops, high tension ignition, etc.

A BRIEF résumé of the fundamentals of transmission line theory may be helpful to the general reader in visualizing line performance.

The four primary constants of a line are:

R —series resistance in ohms per unit length

L —series inductance in henrys per unit length

C —shunt capacitance in farads per unit length

G —shunt leakage conductance in micromhos per unit length

Figs. 3 and 4 illustrate the variation of alternating-current resistance with frequency for several common sizes of solid and stranded copper wires, based on resistivity of 1724 electromagnetic units and twenty degrees centigrade temperature.

The series inductance and the shunt capacitance of open-wire or concentric type lines may be readily calculated with sufficient accuracy for practical purposes. The inductance decreases as the spacing between the wires is decreased, and the shunt capacitance varies in inverse relation to the separation between wires.

The leakage conductance G is the most erratic of the primary constants, and is a most important factor in attenuation. It is the most difficult value to determine for alternating currents and, as stated by E. I. Green,¹ it is customary to employ an equivalent value of G which includes all the losses in the power transmitted over the pair except the normal I^2R or copper loss in the conductors.

* Decimal classification: R282.1. Original manuscript received by the Institute, May 14, 1935.

¹ E. I. Green, "The transmission characteristics of open-wire telephone lines," *Bell. Sys. Tech. Jour.* vol. 9, pp. 730-759; October, (1930).

As pointed out by Sterba and Feldman,² the two important parameters of a transmission line are the propagation constant, and the characteristic or surge impedance, both complex quantities in which the primary constants and frequency appear. The propagation constant is expressed mathematically as

$$P = \sqrt{R + j\omega L} \cdot \sqrt{G + j\omega C}. \quad (1)$$

The attenuation constant is the real part of the propagation constant and, though also a complex quantity, is shown by K. S. Johnson³ to reduce to

$$\alpha = \frac{R}{2} \sqrt{\frac{C}{L}} + \frac{G}{2} \sqrt{\frac{L}{C}} \quad (2)$$

at high frequencies. The first term represents the series loss and is commonly referred to as the series component of attenuation. The second term represents the shunt loss and is called the leakage component of attenuation.

The characteristic or surge impedance of a line is given by the familiar expression

$$Z_0 = \frac{\sqrt{R + j\omega L}}{\sqrt{G + j\omega C}}. \quad (3)$$

At high frequencies it reduces to

$$Z_0 = \sqrt{\frac{L}{C}}. \quad (4)$$

It can be seen that any practical line having high shunt capacitance and low series inductance may be expected to offer greater attenuation and to have a lower surge (or image) impedance than a line having a lower value of C and higher L .

The question as to a method of measuring losses in twisted pairs was discussed with A. E. Thiessen of the General Radio Company, who suggested the procedure used, as shown in Figs. 1A and 1B. The characteristic impedance of each sample of line was measured by the familiar resistance substitution method for open-ended and short-circuited termination, taking the geometric mean of these as the image impedance. This measurement on each sample of line was checked at several frequencies between 1.6 and 13 megacycles immediately be-

² E. J. Sterba and C. B. Feldman, "Transmission lines for short-wave radio systems," Proc. I.R.E., vol. 20, pp. 1163-1202; July, (1932); *Bell Sys. Tech. Jour.*, vol. 11, pp. 411-450; July, (1932).

³ K. S. Johnson, "Transmission circuits for telephone communication," D. Van Nostrand, (1927).

fore running the loss measurements. The resistor R in Fig. 1 together with the attenuator output resistance was equivalent to the characteristic impedance of the line to be measured. The radio-frequency oscillator was then adjusted to approximately fifty microvolts, at about 1600 kilocycles, corresponding to an average good radio signal, and the receiver sensitivity adjusted to correspond to normal receiving conditions. The output was noted on the power level indicator. Then, a length of the particular type of line was inserted between the attenu-

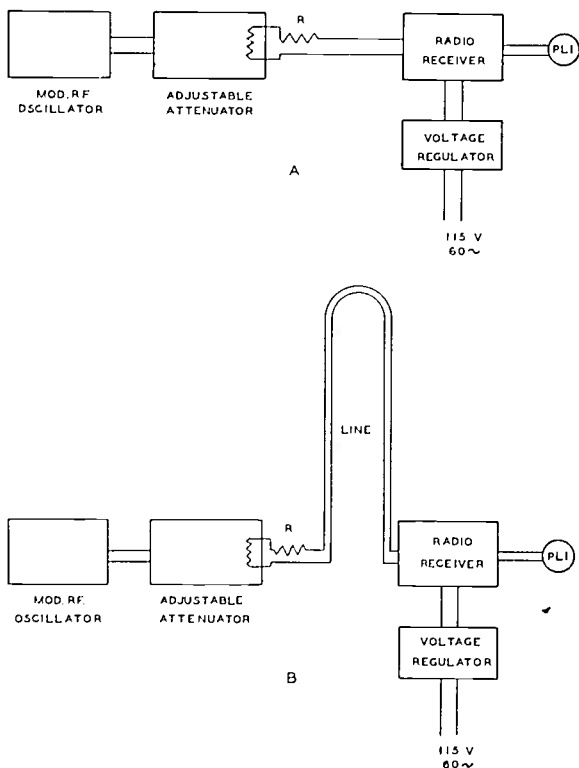

Fig. 1—Apparatus arrangement for measuring losses in twisted pair type transmission lines.

ator and receiver as shown in Fig. 1B. The attenuator was readjusted to bring the receiver output back to the level noted above, the receiver and oscillator adjustments remaining fixed. The attenuation change was therefore the line loss at that particular frequency. The process was repeated at a number of frequencies between 1.6 and 13 megacycles to obtain the points for the loss curve. The losses measured in this manner for four kinds of twisted pair lines are shown in Fig. 2 together with the losses for other types of lines (either calculated or taken from the work of other investigators) for comparison. Description of the twisted pairs on which measurements were made as well as the other types of lines, follows.

Description of Lines Shown in Fig. 2

Line A—#14 solid copper weatherproof twisted pair (so-called telephone wire). Loss and impedance measurements made after the wire had been out in the weather for six months. Condition at time of measurement, wet and rain-soaked. Radio-frequency impedance 125 ohms. Length of line measured, 281 feet. Circles in Fig. 2 show observed losses for this line.

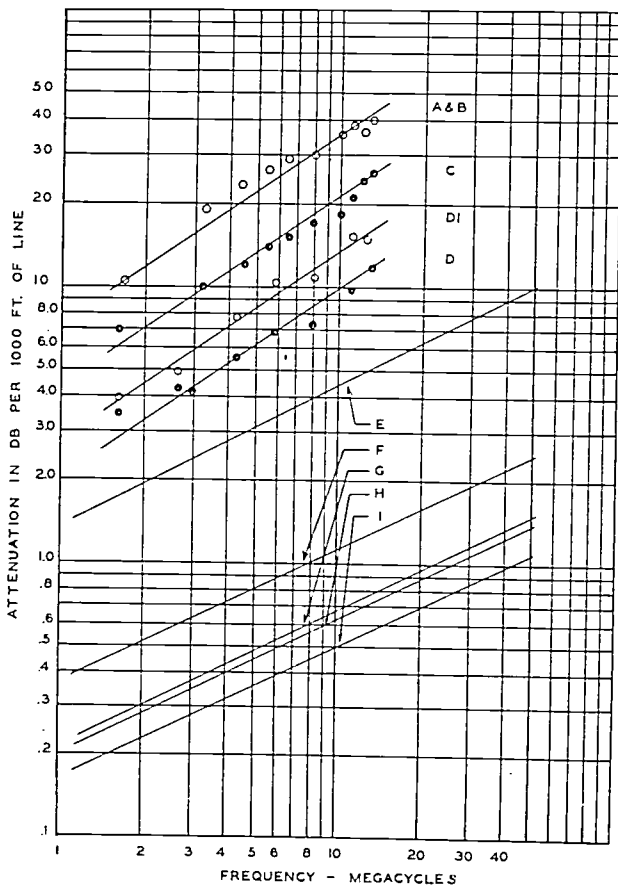

Fig. 2—Transmission line losses at radio frequencies. Points of curves A, B, C, and D are measured values. Losses shown for lines E to I are calculated. Description of lines start on this page.

Line B—Belden #8835 twisted pair lead-in wire. Conductors 7 #30 B&S copper, cotton separator, rubber insulation, treated cotton braid over both wires. This line had been exposed to the weather for two or three weeks. Condition at time of measurement, dry. Radio-frequency impedance 106 ohms. Length of line measured, 100 feet. The observed losses on this sample were somewhat more scattered than those for the other lines in Fig. 2, but their average seemed to be the same as for Line A.

Line C—Packard #544B high tension single conductor ignition cable, twisted manually. Conductors 19 #30 copper, rubber insulation, varnished black cambric covering on each wire. This wire had been exposed to the weather for over one year. Condition at time of measurement, wet and snow-covered. Radio-frequency impedance 148 ohms. Length of line measured, 247 feet. Dots in Fig. 2 are observed losses.

Line D—Simplex twisted pair conductors 7 #22 copper, paper separators, sixty per cent three-sixty-fourths-inch thick rubber insulation, light black cotton braid paraffine treated over each conductor. Condition at time of measurement, damp but not raining. Curve *D* Fig. 2 shows the losses on a brand new length of this line. Curve *D1* shows the losses for the same line taken twenty-four hours later. Radio-frequency impedance of line at this time was 153 ohms. Length of line measured, 510 feet.

Line E—Western Electric three-eighths-inch coaxial type short-wave transmission line. Outer conductor three-eighths-inch outside diameter copper tubing, 0.032-inch wall. Inner conductor #12 B&S hard drawn copper wire, separated by Isolantite beads spaced one and one-half inches apart. Loss figures taken from Bell Laboratories data, which give the impedance as approximately seventy ohms.

Line F—Riverhead type of four-wire transmission line. Conductors #14 B&S hard drawn copper, spaced 1.3 inches. Radio-frequency impedance 200 ohms. Isolantite spacer insulators every 25 feet. Fig. 2 is the calculated loss neglecting leakance.

Line G—Western Electric one and three-eighths-inch coaxial type short-wave transmission line. Outer conductor one and three-eighths-inch outside diameter seamless copper pipe, 0.083-inch wall, hard drawn. Inner conductor three-eighths-inch outside diameter copper tubing, 0.032-inch wall, separated by special Isolantite insulators spaced approximately sixteen inches apart. Loss figures taken from Bell Laboratories data, which give the impedance as approximately seventy ohms.

Line H—Two-wire open type balanced transmission line, conductors #10 B & S copper. Curve *H* Fig. 2 shows calculated loss neglecting leakance, based on calculated impedance of 440 ohms.

Line I—This is copied from Fig. 11 in the article by Sterba and Feldman.² It is their observed losses in a two-wire 600-ohm line of 0.162-inch (#6 AWG) copper. The authors state observed values are about sixty-six per cent higher than computed values. In all probability similar divergence would be encountered if measurements were made on Lines *F* and *H*.

It will be seen that in the measurement procedure shown in Figs. 1A and 1B the generator output impedance was matched for the line sending end to avoid reflection loss at that point, but that the receiv-

ing end was terminated by the receiver without carefully matching impedances. This is the condition commonly encountered in the use of such lines. The radio receiver used was a stock model superheterodyne type, with its input modified for operation on 200- to 500-ohm balanced lines at frequencies above seven megacycles. Generally when these lines are used in radio receiving systems, the sending or antenna end impedance is not matched and additional losses due to reflection are usually present. For instance, if a 150-ohm line is connected directly to a 700-ohm antenna, the impedance ratio of over 4.5 would be expected to result in a reflection loss of about 2.5 decibels (assuming small phase angles) in addition to the line loss.

The primary object of these measurements was to obtain approximate numerical values of the losses in this type of line over the frequency range of one to fifteen megacycles. The losses being so great, it was not deemed worth while to go any further with the study, or to investigate the slight departure from linearity in leakage conductance derived from the measured losses and impedances. The values of this conductance would seem to indicate that the losses shown in Fig. 2 may be a little low at the fifteen-megacycle end of the range, and a little high at the one-megacycle end.

During this work the capacitance between conductors, measured by bridge at 1000 cycles, varied as much as several hundred per cent with weather conditions. Considerable variation in the 1000-cycle capacitance in different sections of the same type of twisted pair line was also observed, as well as appreciable changes in impedance and attenuation at high frequencies with weather.

If the insulation or dielectric material is poor, leakage conductance will take place. In outdoor lines continually exposed to the weather deterioration of insulation is accompanied by greater absorption of moisture and water, directly affecting the leakage and effective capacitance and consequently the attenuation and impedance. Irregularities in the quality of insulation, tightness of twisting, and tension of suspension will also affect the impedance and attenuation.

With such irregularities as mentioned above it is difficult to maintain balance in these lines from day to day or from day to night. The unbalance is often sufficient to increase the radiation resistance to such proportions that the line ceases to act as a line but functions as an antenna, picking up stray disturbances and signal fields and destroying entirely the properties of the antenna to which the line is connected. To illustrate, in one instance the discrimination and total gain from a directive antenna designed to provide a gain of thirteen decibels at 15.9 megacycles over a half-wave vertical doublet was entirely lost in

350 feet of twisted pair line (C) between the antenna and the receiver. We have also found that the insertion of a few feet of this kind of conductor in a balanced system will destroy balance and inject sufficient stray energy into the receiver to impair the performance of the antenna system.

High losses in twisted pairs are not limited to high frequencies, but have been noted in the voice range. Measurements made on four

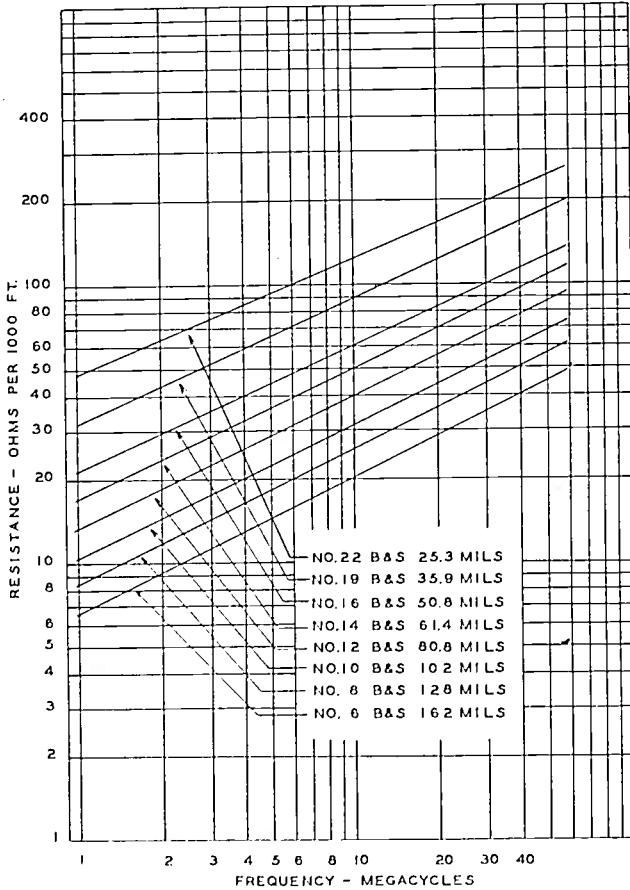

Fig. 3—Calculated alternating-current resistance of solid round copper wires, by Equation 209 and Tables 17 and 19, Bureau of Standards Bulletin No. 74.

miles of line A, Fig. 2, which had been up about a year in the tropics showed a loss of ten decibels at 1000 cycles during very wet weather.

There have recently been put on the market what are probably improved twisted pairs recommended for use with noise eliminating antenna systems for broadcast receivers in homes. One wire company announced the development of an improved 72-ohm twisted pair intended primarily for use in amateur stations where other forms of lines may be impractical. It is stated that the losses in this type of

line are less than 1.5 decibels per thousand feet at 3.5 megacycles, four decibels at seven megacycles, and 5.2 decibels at fourteen megacycles. There is obviously some error in these figures, as they will be found to be less than the calculated loss neglecting leakance at each

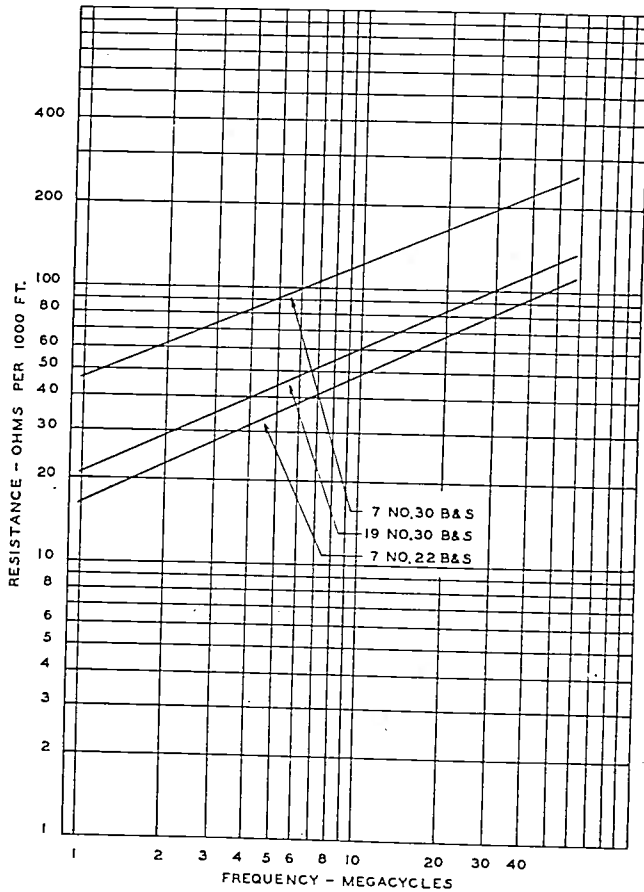
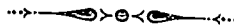

Fig. 4—Calculated alternating-current resistance of stranded copper wires, by Equation 209 and Tables 17 and 19, Bureau of Standards Bulletin No. 74.

frequency. None of these improved types of conductor has been investigated by us, but it would appear from Fig. 2 that very great improvements, perhaps beyond practical limits, will have to be made in twisted pairs before the losses will be comparable with those for open-wire or air-spaced types of lines at frequencies above one or two megacycles.



PRESENT PRACTICE IN THE SYNCHRONOUS OPERATION OF BROADCAST STATIONS AS EXEMPLIFIED BY WBBM AND KFAB¹

By

L. McC. Young

(Columbia Broadcasting System, Chicago, Illinois)

Summary--This paper briefly covers the history of synchronization of broadcast stations in the United States and abroad. The WBZ-WBZA system, as developed by Westinghouse, is described as typical of the "derived-carrier" type of synchronization. A new system of synchronization and equipment, developed by Bell Telephone Laboratories and the Western Electric Company and used successfully by WBBM and KFAB for the past year, is described in detail. In this system the station carriers are continuously compared and continuously and automatically corrected to a reference standard frequency transmitted by wire line.

THE synchronization of two or more radio stations as a means of securing greater coverage on a single wavelength was first suggested in 1924 by Frank Conrad of the Westinghouse Electric and Manufacturing Company. This was a very logical suggestion from one who pioneered in radio broadcasting and contributed many other developments which had advanced the art to its state at that time.

To make synchronization possible much equipment, then unknown, such as frequency control apparatus and frequency multipliers, had to be developed. In March, 1925, for the first time in the history of broadcasting a piezoelectric oscillator was installed at WBZA, Boston, for controlling its frequency (900 kilocycles) and very shortly thereafter similar equipment was installed at WBZ, Springfield, Massachusetts. The first attempts to operate WBZ and WBZA on the same frequency were made using crystals ground to zero beat. This was not very satisfactory as the crystal oscillators as developed at that time were not very stable.

By the end of 1925 many of the necessary developments such as stable frequency control and multiplier apparatus had been made in the Westinghouse laboratories.

In January, 1926, Frank B. Falknor started the work of synchronizing WBZ and WBZA. Fig. 1 is a block diagram of the original WBZ-WBZA synchronizing system. A fifty-kilocycle piezo oscillator at WBZ generated the basic frequency. From this oscillator a frequency of 900 kilocycles was derived by multiplication through three stages:

* Decimal classification: R550. Original manuscript received by the Institute, May 3, 1935. Presented before Chicago Section of the Institute, March 22, 1935.

first from 50 to 150 kilocycles, then from 150 to 450 kilocycles, and then from 450 to 900 kilocycles. The fifty-kilocycle oscillator also fed a line amplifier to the land line connected to WBZA at Boston. There similar multiplying equipment was used and a synchronized frequency of 900 kilocycles was established. Experience soon showed that fifty kilocycles was too high for transmission over open land wires as considerable losses were encountered during damp and rainy weather due to leakage between the lines. The master frequency was then lowered to twenty-five kilocycles and an additional multiplier was used at each station. The new master frequency, however, was generated by a stable tube oscillator as a piezo oscillator for that low a frequency had not been developed. This scheme was continued until November 11, 1928,

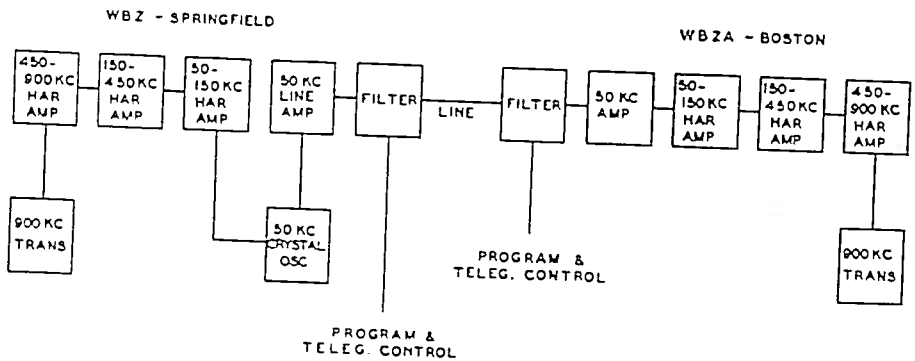

Fig. 1—Original WBZ-WBZA synchronizing system.

when the new allocation plan changed the frequency of WBZ and WBZA to 990 kilocycles and accordingly the master frequency was changed from 25 to 27.5 kilocycles.

In December, 1929, the multiplying equipment at WBZA was changed to multivibrators operating from 55 to 990 kilocycles and in addition a crystal filter was used between the multivibrator and the transmitter. This was very successful and a little later the equipment at WBZ was changed so that the transmitter operated directly from a 990-kilocycle crystal and multivibrators were used to divide the frequency from 990 to 165 kilocycles and from 165 to 27.5 kilocycles for feeding the synchronizing line.

Later the transmitter at Boston was moved to Millis, Mass., and its power was increased to fifteen kilowatts. The Springfield transmitter was reduced to one kilowatt and the call letters of the two stations were interchanged.

The synchronizing frequency of these stations has since then again been halved, to 13.75 kilocycles, for better transmission over the land line, and the system now in use is shown in Fig. 2. A 990-kilocycle

crystal oscillator unit located at WBZA in Springfield controls the frequency of both stations. This is fed through a 990-kilocycle buffer amplifier and directly to the WBZA one-kilowatt transmitter. The buffer amplifier also feeds two multivibrators dividing the frequency from 990 to 110 kilocycles and from 110 to 13.75 kilocycles. The output of this last multivibrator is fed through a two-stage line amplifier, putting about fifteen watts into the line through a 13.75-kilocycle band-pass filter. At the WBZ end at Millis the line comes into a 13.75-kilocycle band-pass filter and then into a 13.75- to 27.5-kilocycle doubler, then through a 27.5-kilocycle saturated amplifier and then through a coupling tube which controls a 165-kilocycle oscillator which is coupled

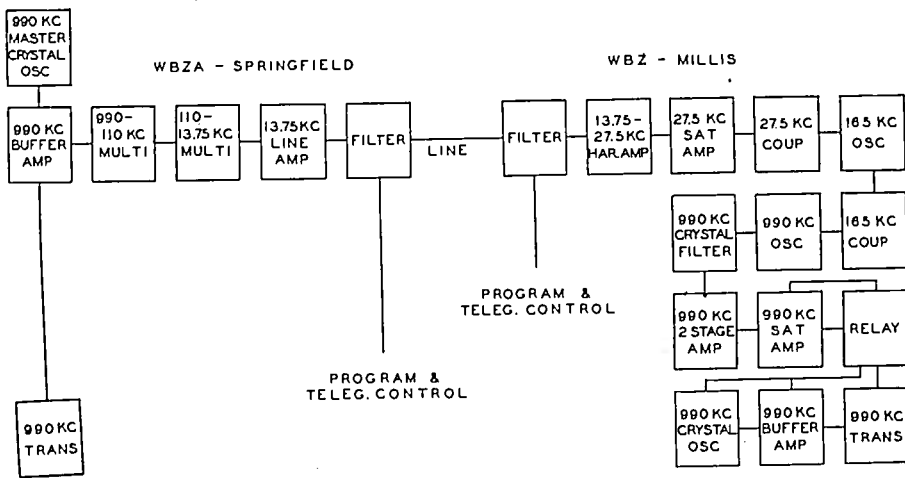

Fig. 2—Present WBZ-WBZA synchronizing system.

through another tube to a 990-kilocycle oscillator. This is fed through a 990-kilocycle cascade crystal filter and then through a two-stage 990-kilocycle power amplifier. This in turn is fed through a 990-kilocycle transmission line to a 990-kilocycle saturated amplifier, which is located on the crystal control panel of the main transmitter from which it is fed to the first stage of the transmitter. The WBZ transmitter is also equipped with the regular 990-kilocycle crystal oscillator unit.

In the event of loss of the synchronizing frequency or any of the associated amplifying equipment at the Millis end, the transmitter is operated from its own crystal oscillator unit. This is accomplished automatically by the use of a sensitive relay in the input of the 990-kilocycle saturated amplifier which controls two other relays. One connects in the crystal oscillator and the other disconnects the plate circuit of the saturated amplifier and connects it to the plate of a buffer power amplifier in the regular crystal control unit of the transmitter.

The line between Springfield and Millis is open wire with the exception of a few sections of cable. Impedance mismatches were found at these points of change from open wire to cable and from cable to open wire. The transmission characteristics of the line have been greatly improved by the use of specially designed impedance matching transformers which pass all frequencies from thirty to 14,000 cycles. In addition to the synchronizing frequency this line also carries the program and the telegraphic order circuit. A double low-pass filter with a ten-kilocycle cutoff keeps the synchronizing frequency from getting back in the speech equipment fed to the line.

In July, 1926, KDKA and KYW were synchronized experimentally by F. B. Falknor. A master frequency of five kilocycles was generated at Pittsburgh by a high precision tuning fork. This frequency was then multiplied up to 570 kilocycles through suitable harmonic amplifiers and fed to the KDKA transmitter. A 62-meter radio circuit was used to connect Pittsburgh and Chicago. The five-kilocycle frequency was amplified and used to modulate the 62-meter carrier. At Chicago the 62-meter radio was received and the five-kilocycle tone was fed through a tuning fork of substantially five kilocycles and of low damping. This was necessary to remove the fading effects and was able to take care of a 10,000-to-1 fading range. This frequency was then multiplied up to 1,020 kilocycles and fed to the KYW transmitter. This system was successful and was operated a sufficient number of times to demonstrate that the scheme could be used should there be an economic demand for it.

Falknor, in his article,¹ has given credit to the Westinghouse engineers and personnel responsible for the synchronization developments. Being the author of the paper, he has given himself much less credit than is actually due him for, as assistant to Frank Conrad, he was directly in charge of most of the synchronization developments up to the time he left the Westinghouse Company. Since that time Ralph N. Harmon and the personnel of WBZ and WBZA have carried on the developments which are now incorporated in the present scheme.†

S. D. Gregory in the paper² which he presented before the Radio Club of America in June, 1931, gives the history of their synchronization in considerable detail, and to him this writer is indebted also for recent information concerning the present scheme as has been described.

¹ F. B. Falknor, "A history of synchronization," *Cit. Radio Call Book Mag. and Tech. Rev.*, vol. 12, pp. 38-40; March, (1931).

² S. D. Gregory, "Synchronization of Westinghouse radio stations WBZ and WBZA," *Proc. Radio Club Amer.*, vol. 8, pp. 79-83; August, (1931).

The National Broadcasting Company in an experimental setup in 1930 synchronized WEAJ, WGY, and KDKA. A standard reference frequency was transmitted between these stations over telephone circuits. According to C. W. Horn,³ it was found that when the stations were held in a fixed phase relation no disturbance was encountered, the mush area disappeared and an increase of field strength resulted in the areas formerly adversely affected.

WEAJ and WTIC, both fifty-kilowatt stations and separated 85.5 miles, were operated synchronously for a time on 660 kilocycles. A zone of bad quality of about ten miles wide was encountered over New Haven and widening extended to the northwest.

WJZ and WBAL, separated by about 145 miles and having powers of 50 and 2.5 kilowatts, respectively, have been synchronized since March, 1931, on 760 kilocycles. These stations are controlled by an audio frequency transmitted on a wire line and the station frequency is obtained by multipliers. A common program only is used when synchronized. According to K. A. Norton,⁴ in the area of equal signals between these stations slow fading is observed due to slippage and equal to the sum and difference of the field strengths. No serious distortion is found where ground waves have a ratio equal to, or greater than, three to one.

In June, 1929, WHO and WOC, separated by 153 miles, operated on the same frequency with powers of five kilowatts each. The system, developed by the Bell Telephone Laboratories, was built up on the use of two highly stabilized crystal oscillator units at the two stations. A monitoring receiver was set up at a midway point and the incoming carriers from the two stations were received and modulated by an audio frequency of a level sufficient to override the programs and then detected. The resulting audio tone was carried by land wire from the receiving point to WOC station. The level of this tone was proportional to the resultant of the combined carriers. WHO was used as a reference frequency and the frequency of WOC was corrected manually every ten minutes. This gave an average of two cycles per minute of absolute isochronism. The service rendered was about twice the service on shared time. Later, however, this scheme was abandoned and one station of fifty kilowatts was located east of Des Moines and intended to serve both areas formerly served by the two stations operating on substantially the same frequency.

Also in 1929 the Bell Telephone Laboratories made experimental

³ C. W. Horn, "The importance of phase control in synchronizing," *Electronics*, vol. 1, p. 423; December, (1930).

⁴ K. A. Norton, "Note on the synchronization of broadcast stations WJZ and WBAL," *Proc. I.R.E.*, vol. 22, pp. 1087-1089; September, (1934).

synchronization tests, with the co-operation of the Columbia Broadcasting System, using first stations WABC and WCAU, and in the fall WABC and WHK, and a short while later WABC, WHK, and WKBW.⁵ These stations were operated synchronously only for the duration of these tests.

In England, in 1925, the British Broadcasting Company operated experimentally two stations on a common wavelength.^{6,7} These were 5GB, Daventry Experimental Station, and 5IT, Birmingham. They had powers, respectively, of twenty kilowatts and one kilowatt, and operated on 610 kilocycles. They were separated by a distance of 38 miles. A reference frequency station was operated at Daventry on 305 kilocycles and having a power of 2.5 kilowatts. A doubler was used at each station and supplied the transmitter frequency from the received signals from the reference frequency station. With no modulation a stationary interference pattern was found to exist. With common program, distortion was found where the field strengths were comparable. Normal reception was found where the ratio of the field strengths was equal to, or greater than five to one. If there was a carrier frequency difference of greater than five cycles an additional distortion was found and under this condition good service was only obtained where a field strength ratio of ten to one, or greater, was present. When different programs were used a field strength ratio of from 100 to 200 to one was necessary for good service.

In 1926 four stations, Edinburgh, Hull, Bradford, and Bournemouth, were operated experimentally sharing the one frequency of 1040 kilocycles, and in 1927 Bournemouth and nine of the eleven relay stations were operated on the same frequency. The system used consisted of a frequency generated at each station by a tube controlled tuning fork. These forks were made of mild steel for low damping and low coupling and had a coefficient of one eighth of a cycle per degree centigrade. These stations were kept on the same frequency by manually adjusting the forks against the received signal from one used as a standard. Coarse adjustments of up to five hundred parts in a million could be made by changing the fork temperature. Fine adjustments up to about ten parts in a million were made by adjustments of the plate voltage of the tube controlling the fork. The station frequencies were at first derived from these forks through three stages of multipliers:

⁵ G. D. Gillett, "Some developments in common frequency broadcasting," *Proc. I.R.E.*, vol. 19, pp. 1347-1369; August, (1931).

⁶ P. P. Eckersley and A. B. Howe, "The operation of several broadcasting stations on the same wavelength," *Jour. I.E.E.* (London), vol. 67, pp. 772-785, (1929); *Proc. Wireless Sect.*, March 6, (1929).

⁷ P. P. Eckersley, "The simultaneous operation of different broadcast stations on the same channel." *Proc. I.R.E.*, vol. 19, pp. 175-194; February, (1931).

1000 to 10,000 cycles, and from 10,000 to 100,000 cycles, and then from 100,000 to 1,000,000 cycles. In all sixteen tubes were required and were found hard to adjust and sensitive to filament and plate voltage changes. These multipliers were later abandoned for doublers and the frequency of the forks was adjusted to 1015.625 cycles and the station frequencies of 1040 kilocycles were then derived through ten doubler stages.

In Germany the Telefunken and Lorenz Companies have developed synchronizing equipment for some of the German broadcast stations. The Telefunken Company has used a reasonably high control frequency suitable for transmission over open-wire lines. The Lorenz Company has used a lower control frequency which is suitable for use over open-wire or cable circuits. Three stations, at Berlin, Stettin, and Magdeburg were tied together with lines supplied from a 2000-cycle fork. In 1930, Cologne, Münster, and Aachen were operated on the same frequency by use of a quartz crystal maintained within ± 0.005 degree centigrade. Later Frankfurt, Trier, Freiburg, and Cassel as one chain, and Hanover, Flensburg, Bremen, and Magdeburg as another chain, were operated on a common frequency. Master control frequency for these stations was derived from a standard crystal of 1000 kilocycles and divided to 2000 cycles for a control frequency used on the connecting land lines. The stations used separate crystals and their frequencies were divided and corrected against the controlled frequency of 2000 cycles. An accuracy of one part in 10^7 to 10^8 was realized. Later forks have been developed which have maintained frequency to one part in 10^9 .

In Sweden the stations at Malmo and Halsingborg have been operating on the same frequency. These are connected by land line and are arranged for operation by either a high or a low control frequency.

This covers briefly the history of synchronized broadcasting up to a year or so ago.

Successful synchronous operation of two or more broadcast transmitters demands a precision of frequency maintenance never before required in broadcasting. Not long ago it was considered quite satisfactory if broadcast stations maintained their assigned frequency within ± 500 cycles. More recently Federal Radio Commission requirements brought these limits down to ± 50 cycles. With the advent of synchronization to the broadcast problem, frequency maintenance of 0.1 cycle or less is necessary. The modern synchronizing equipment must meet and better this requirement and at the same time must be commercially operable and not require laboratory care.

WBBM at Chicago and KFAB at Lincoln, Nebraska, have been operating on the clear channel frequency of 770 kilocycles since the new allocation of frequencies went into effect in November, 1928. They have been using powers of twenty-five and five kilowatts, respectively. Under normal daytime operation the fair service area of both stations were reduced by the presence of low-frequency beats caused by the slight difference and variance of their carrier frequencies. At night it was necessary to share time. Synchronization offered these two part-time stations a means of utilizing full time on the air and at the same time of materially improving their secondary service areas. A new type of synchronizing apparatus was available commercially which was found would solve the equipment problem.

In 1932, application was made to the Federal Radio Commission for an experimental license to use this newly developed equipment to operate these stations on a common frequency using separate programs during the daytime and with a common program during the night hours in which both stations were operating.

License to operate these stations in accordance with the application was granted by the Federal Radio Commission during the latter part of 1933.

Synchronized operation of WBBM at Chicago and KFAB at Lincoln, Nebraska, was started January 27, 1934, and has continued since that time. The method and equipment are different from any other system that has been used commercially. Both were developed by the Bell Telephone Laboratories and the Western Electric Company.

Briefly, this method consists of the continuous comparison of the locally generated carrier frequency, which is to be controlled, with a standard frequency transmitted by wire line and the continuously automatic correction of the locally generated carrier to agree with the standard frequency. This method of frequency control has the distinct advantage of not interrupting the station carrier in the event of failure of any of the synchronizing equipment or of the wire line supplying the standard frequency. The only effect of such failures is the removal of the control from the carrier frequency and the dependence then upon the stability of the local oscillator to maintain this frequency. Highly stable quartz crystal oscillators are employed in this equipment and the frequency deviation which might occur during a comparatively short interruption of the control is of such a small order as still to permit synchronous operation of the stations without a serious or noticeable impairment of service to the listening public.

Fig. 3 is a block diagram of the synchronizing equipment used at

these two stations. It is composed of two panels, the oscillator amplifier and the frequency regulator panel. Referring to this diagram, the four-kilocycle standard frequency is received by wire line and amplified through the four-kilocycle amplifier. This amplifier, being selective, removes considerable of the noise and extraneous frequencies which may be present in the four-kilocycle supply. This amplified four kilocycles is then fed to a harmonic generator consisting of an over-loaded amplifier, the output of which contains four kilocycles and its harmonics. By means of a tuned circuit in the output of the harmonic generator the fifth harmonic of the four kilocycles is selected. This frequency, twenty kilocycles, is then used to control a ten-kilocycle multivibrator. The multivibrator, thus locked electrically in step with the four-kilocycle standard frequency, furnishes an output of ten kilo-

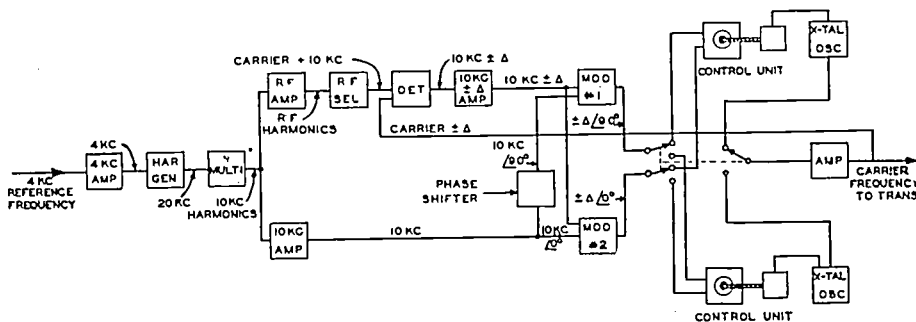

Fig. 3—Western Electric synchronizing equipment.

cycles and all the harmonics of ten kilocycles up to and through the broadcast band. The output of the multivibrator is split into two separate paths. One is fed to a highly selective ten-kilocycle amplifier and the other is fed to a broadly tuned radio-frequency amplifier.

The output of the ten-kilocycle amplifier is in turn divided. One branch supplies ten kilocycles directly to the input circuit of modulator No. 2, consisting of two tubes, biased nearly to cutoff. The other branch of the ten-kilocycle amplifier contains a phase shifting network which retards the phase of the ten-kilocycle current by ninety degrees after which it is supplied to the input of modulator No. 1. Thus the modulators Nos. 1 and 2 are each supplied at ten kilocycles, but the phase in modulator No. 1 is ninety degrees behind that in No. 2.

The output of the radio-frequency amplifier is fed through a radio-frequency selector. This selector is adjusted to select the particular harmonic ten kilocycles higher in frequency than the carrier to be controlled. This selected harmonic, having been derived from the four-kilocycle standard frequency, is therefore an absolute reference against which the carrier may be checked. The selected harmonic, together

with the carrier frequency, is fed to a detector. If the carrier frequency is exactly correct, as referred to the standard, the output of the detector will be ten kilocycles which is the amount the carrier differs from the selected radio-frequency harmonic. If the carrier frequency differs from the correct value by $\pm\Delta$ cycles, the output of the detector will then be ten kilocycles $\pm\Delta$. The output of the detector is then fed through a ten-kilocycle $\pm\Delta$ amplifier. The amplified ten kilocycles $\pm\Delta$ is now fed to modulators No. 1 and 2 which are also energized with ten kilocycles $\angle 90^\circ$ and ten kilocycles, respectively. The output of modulator No. 1 contains therefore the difference frequency between ten kilocycles and the ten-kilocycle $\pm\Delta$ or $\pm\Delta$. The output of modulator No. 2 likewise contains the difference frequency $\pm\Delta$ but $\angle 90^\circ$ from that in No. 1 modulator as the ten-kilocycle input to modulator No. 1 was retarded ninety degrees by the phase shifting network.

It is now seen that the output of the frequency regulator panel is essentially a two-phase alternating current of frequency equal to the deviation of the station carrier from agreement with the standard frequency. This two-phase output is used to operate a small synchronous control unit which drives a variable air condenser connected in parallel with the quartz crystal of the oscillator which is to be controlled. If the frequency of the oscillator under control is higher or lower than the standard, this control unit will operate to increase or decrease the capacity across the quartz crystal as is required to bring the oscillator frequency to the proper value. When the oscillator frequency is exactly correct, Δ is equal to zero and there is no rotation of the control unit. It should be noted that the crystal oscillators and control units are in duplicate, either one of which may be thrown into service by the operation of a switch, and the carrier generated from the one in use is amplified through a two-stage buffer amplifier which prevents changes in output circuit impedance from being reflected back into the oscillator and causing frequency changes. Both the frequency regulator panel and the oscillator-amplifier panel have a separate and complete power supply consisting of filament and plate transformers and a rectifier and filter for the plate supply together with time delay relay circuits for the mercury-vapor rectifier tubes. In the oscillator panel the line voltage is supplied through voltage regulators to prevent frequency changes due to power line fluctuations.

The oscillators are calibrated as units to the assigned carrier frequency of the station. The quartz crystal in the oscillator is maintained at a constant temperature by a heater supplied with power through a three-element rectifier tube acting as a relay. The grid voltage of this

tube is in phase with the plate voltage when the oscillator temperature is low and consequently current flows into the heater. When the crystal temperature reaches the proper value the contacts of a mercury thermostat close, applying an out-of-phase grid voltage to the rectifier tube, thus preventing a flow of current into the heater. The heater circuits of both oscillator units are on continuously so that both oscillator units are always maintained at the proper operating temperature.

Identical equipment such as that described is used at the transmitter of each station. Fig. 4 is a block diagram of the WBBM-KFAB synchronizing system.

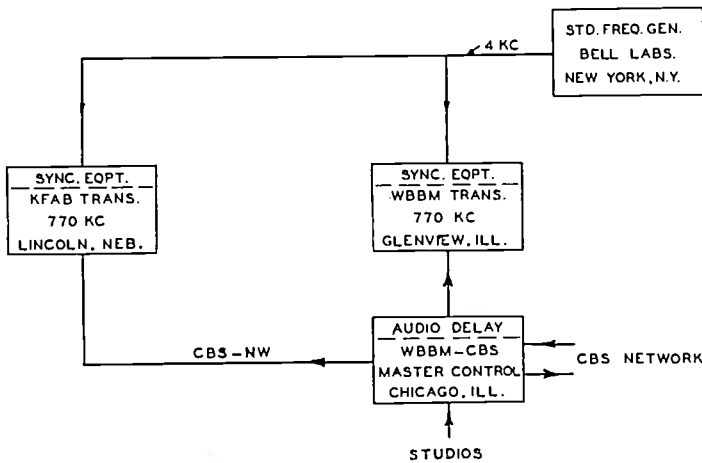

Fig. 4—WBBM-KFAB synchronizing system.

So far in the description of the method of the synchronization of WBBM and KFAB, we have concerned ourselves only with getting the two carriers in substantially perfect synchronization. When this condition is obtained and maintained, the two stations can operate during the daytime on a separate program basis with no attendant carrier interference. But when two synchronized stations operating on a common program basis are separated by more than 100 miles of wire line, another problem of extreme importance presents itself. WBBM and KFAB transmitters have a great-circle separation of about 466 miles and the shortest wire-line separation is approximately 500 miles. Time is required for the audio program material to travel over the wire lines and the program leaving Chicago does not arrive in Lincoln until twenty-six milliseconds later.

In order that no echo distortion be present in the combined radio signal as received by a broadcast listener the audio program must leave both transmitters at exactly the same time. A time displacement as small as five milliseconds in common audio from two sources

may be observed as an echo by the careful listener. For perfect reception from WBBM and KFAB in the area obtaining reception through the combined signals, it is necessary that the program going to the WBBM transmitter be retarded the same as the program reaching the KFAB transmitter at Lincoln. This is accomplished by using suitable audio-frequency delay equipment in the circuit between the Chicago studio and the WBBM transmitter.

The equipment used was designed by and built under the supervision of E. L. Plotts of the WBBM engineering department. A brief description of the two types used is as follows: The first was an acoustical audio delay and, as the name implies, was constructed to use the delay in sound which occurs as it is propagated through air. The program was supplied to a dynamic horn unit of good response. In this unit the electrical energy was converted to audio energy and then attenuated through the air in a lead pipe until the desired delay was obtained. The lead pipe was acoustically terminated and the sound waves were then reconverted into electrical energy by the use of a dynamic microphone. The output of this microphone was amplified and equalized to be substantially flat from eighty to five thousand cycles. This acoustical audio delay was used successfully for about nine months.

In the meantime an electrical audio-frequency delay equipment was designed and built. This new equipment was free from most of the inherent troublesome characteristics of the acoustical delay system. It consisted of an electrical network simulating a loaded telephone line. This network was made up of T type filter with M derived end sections and was so designed as to eliminate the distortion usually present in filter networks. Fourteen amplifiers were used, one being inserted at the equivalent of each thirty-eight or thirty-nine miles of circuit. The over-all frequency characteristic is somewhat better than the present network facilities.

For over a year WBBM and KFAB have been operating experimentally on 770 kilocycles with synchronized carrier. Observations immediately following the beginning of the synchronized operation of these stations showed an interference in the received combined signals of sixty and 120 cycles appearing in a beat envelope. It was of comparatively low level and was most noticeable during the periods of low level and lulls in the program. This was due to the slight sixty-cycle hum being present in both KFAB and WBBM signals and those sixty-cycle sources of supply differing slightly in frequency. The sixty-cycle hum has been practically eliminated from both transmitters and inter-

ference from that source has been unnoticed in field observations since April 24, 1934.

The general results have far exceeded the predictions of the most optimistic technical experts concerned with the project. The total mail of the two stations containing adverse criticism has been insignificant. In the investigation of these few cases none had any just basis for criticism against the synchronized operation. For the past thirteen months, the author has spent the major portion of his time observing the operation of these stations. He has traveled over 25,000

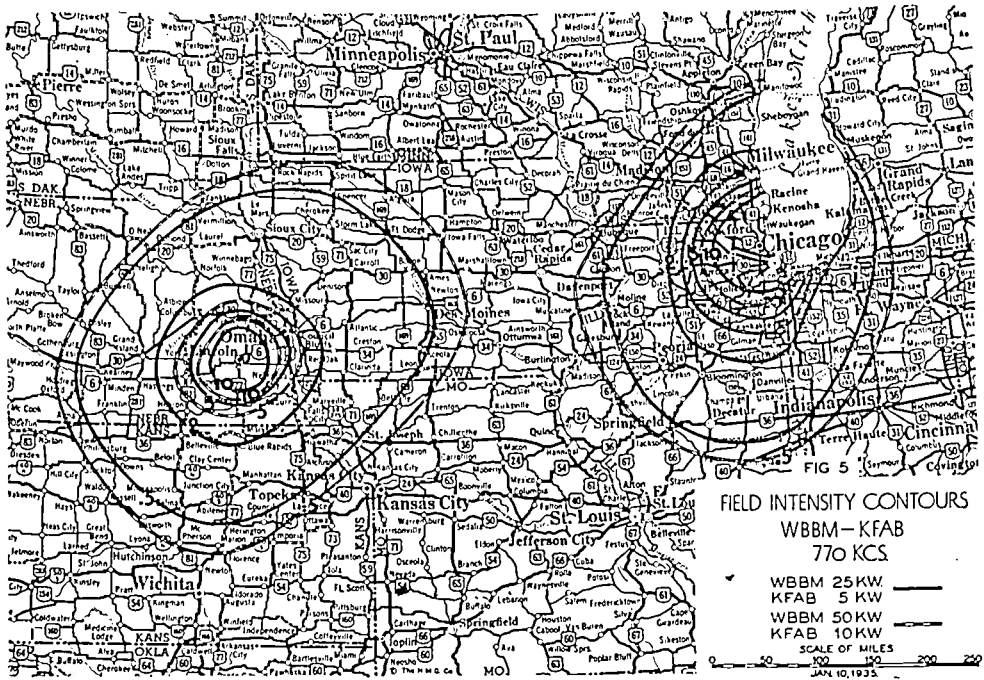

Fig. 5

miles in a field car with a field intensity measuring set, an Esterline Angus recording meter, a high fidelity Philco 800 auto radio receiver, and a standard high quality Philco 18 receiver. Daytime field strength measurements and fading records at night of synchronous operation and of WBBM alone have been made in seventy towns and cities in the area between Columbus, Ohio, and Denver, Colorado, and Duluth, Minnesota, and Tulsa, Oklahoma. During July, 1934, Iowa was combed in search of the expected mush area. Continuous observation, using the high fidelity auto receiver, was made in the field car, traveling over 1400 miles during the night periods of synchronization and common programs. No mush area was found. Very little poor quality due

to fading was noticed. However, during many of the observations, several entire fifteen-minute periods would remain without appreciable fading dips, while one or both of the individual station identification announcements at the intervening breaks would show fading.

This fact, itself, indicates that in the middle area between the stations the service has been materially improved. Other observations show that the service areas of both stations have been increased. Field strength surveys of both stations have been made and are shown in Fig. 5. The dashed contour lines indicate the expected field strength pattern when the two stations operate on the recently authorized increased power. This authorization permits WBBM to operate on fifty kilowatts and KFAB to operate on ten kilowatts. Present indications are that these stations will be operating on their new power status by the middle of April. The change in power is a horizontal one and is expected in no way to change the present good synchronous operation of these stations. It is expected, however, to extend and better the service areas of both stations.

EDITOR'S NOTE:—Since the receipt of the above manuscript a paper entitled "The present-day status of broadcast synchronizing" has been published in "*Electronics*," vol. 8, p. 174, June, (1935).

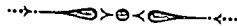

GRID TEMPERATURE AS A LIMITING FACTOR IN
VACUUM TUBE OPERATION*

EY

I. E. MOUROMTSEFF AND H. N. KOZANOWSKI

(Westinghouse Electric and Manufacturing Company, East Pittsburgh, Pa.)

Summary—A method for determining the grid dissipation at which primary or thermionic emission from the grid begins has been devised. By means of suitable rectifiers and an alternating-current source, the grid is heated during positive half cycles and the presence of primary emission is determined during negative half cycles. A variation of this method also enables one to measure the grid dissipation limited by primary emissions when the plate is heated. Sample values of grid limits for individual tubes of familiar types are given. The effect of gas on permissible grid dissipation is briefly discussed.

THE complete charts of plate and grid characteristics of a vacuum tube¹ permit the precalculation of tube output, efficiency, necessary grid excitation—in short, of all quantities involved in tube operation for any set of operating conditions. However, the practical use of tubes within the rather wide premises of the charts is naturally limited by several physical factors such as maximum plate dissipation, maximum permissible voltage between tube elements, permissible grid dissipation, and so forth. These upper limits depend only on the physical properties and the dimensions of the tube parts. For conservative operation they must not be exceeded. The study of the limitation imposed on vacuum tubes in operation by the grid is the subject of the present discussion.

If a reasonable amount of power output at high efficiency is required from a tube operated as an amplifier or self-oscillator its grid must be driven well into the positive potential region. During the part of the cycle when the grid is positive electronic current flows to the grid structure, which is heated by the impinging electrons and hence its temperature rises. At the same time the grid emits secondary electrons, thus decreasing the apparent grid current and input power as read on a grid input meter. Therefore, to determine the *true* grid dissipation, one must have information concerning the actual number of impinging electrons when their arrival may be masked by simultaneous secondary emission. Therefore, the power dissipated in the grid can

* Decimal classification: R253. Original manuscript received by the Institute, April 29, 1935. Presented before joint U.R.S.I.-I.R.E. meeting, Washington, D. C., April 26, 1935.

¹ H. N. Kozanowski and I. E. Mouromtseff, "Vacuum tube characteristics in the positive grid region by an oscillographic method," Proc. I.R.E., vol. 21, pp. 1082-1097; August, (1933).

normally be divided up into two parts: First, grid input supplied by the excitation stage; this can be directly observed on grid circuit meters, or calculated.² Second, grid input proportional to the secondary emission current; this input, as can readily be shown, is supplied by the plate power source and cannot be *directly* determined. A method of calculating the total or *true* grid dissipation directly from the tube charts is discussed in a paper on class C amplifiers.³ We shall concentrate our attention at this time on establishing the physical limits which the grid sets on vacuum tube operation.

With a given amount of power dissipated in the grid per cycle, the grid temperature rises continuously until a state of thermal equilibrium is reached in which the amount of heat developed by electrons striking the grid is equal to the amount of heat radiated by the grid over an interval of time equal to an operating cycle. Naturally, the greater the power dissipated the higher is the final temperature of the grid. Thus it is very important to determine the point at which the grid temperature becomes objectionable and even dangerous in tube operation. The immediate results of the phenomena connected with too high a grid temperature are:

1. Thermionic or "primary" emission of electrons by the grid acting as a hot body.
2. Liberation from the grid of occluded or adsorbed gases.
3. Unwarranted increase of plate or filament temperature by the heat radiated from the grid.
4. Melting or burning-out of grid wires.

First, grid limitation will be discussed only from the viewpoint of thermionic emission from the grid itself.

This action, if very pronounced, can actually be observed in some maladjusted amplifiers or oscillators. It can be recognized by a reverse grid current flowing for a short time *from* a negative grid after oscillations have been intentionally stopped or blocked. However, primary grid emission can be present during oscillation without being visually recorded. It introduces into the plate current a direct-current component which actually flows during the entire oscillating cycle, causing unwarranted loss of power as additional plate dissipation and bringing down the efficiency of the oscillator. The phenomenon can easily become cumulative and the tube will eventually "run" away. In addition, the existence of primary emission during the "inactive" half cycle when plate voltage is at its highest may also contribute to

² H. P. Thomas, "Determination of grid driving power in radio-frequency power amplifiers," *Proc. I.R.E.*, vol. 21, pp. 1134-1142; August, (1933).

³ *Ed. Note:* Published in *Proc. I.R.E.*, vol. 23, pp. 752-778; July, (1935).

the well-known and troublesome "flash-back phenomenon" within the tube.

The lowest temperature at which appreciable primary emission begins depends entirely on the thermionic properties of the grid surface. With grids made of tungsten, tantalum, or molybdenum, one might presumably be justified in expecting that no such emission will occur in practice as with these refractory metals emission starts to be appreciable only at fairly high temperatures hardly attainable under normal operating conditions. Yet, simple measurements, by a method which will be described, can demonstrate that such an expectation is by far not always fulfilled. In fact, due to the ever-present possibility of contamination of the grid surfaces by deposits having a

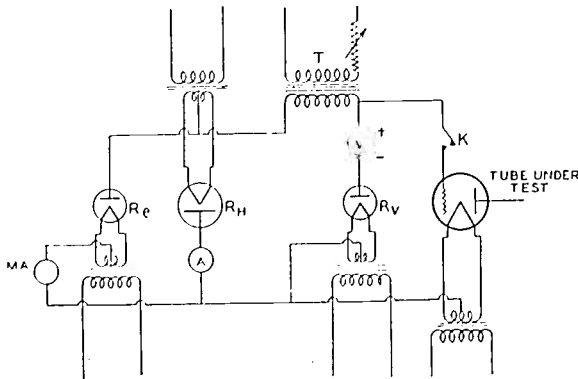

Fig. 1—Circuit for measurement of primary grid emission.

low work function, primary emission can often be observed even at rather dull temperatures. Contamination can ordinarily be traced to evaporation from the filament or cathode of active thorium or oxides. There is also the possibility that various materials used in tube manufacture, and primarily in cleaning tube parts, may contain sodium or other highly emissive substances which may form active spots on the grid surface.

The simple circuit of Fig. 1 can be used for studying conditions of grid dissipation at which primary or thermionic emission occurs. The vacuum tube to be investigated is connected to the sixty-cycle transformer T which supplies alternating potential to the grid with respect to the filament. The plate is either free or connected back to the filament. If the filament is heated, electronic current flows to the grid during each positive half cycle, the circuit being completed through the mercury-vapor rectifier R_H . Normally there is no current on the negative half cycle of the grid voltage. The power supplied to the grid on the positive half cycle is totally converted into heat. A voltmeter,

V , in series with a small mercury-vapor rectifier tube, R_V , measures the average positive grid voltage. From the reading of this voltmeter and the ammeter A in series with the rectifier R_H one can readily determine the power which is being supplied to the grid. Experience has shown that wave shape error is small. Now, if the grid voltage is raised slowly so that thermal equilibrium is established at any moment, one finds that with a certain amount of power dissipated in the grid, a meter, MA , connected in series with the rectifier tube R_e shows a deflection. This proves that during the *negative* half cycle there is an electronic current *from the grid* and that the grid is emitting thermionically. By proper adjustment of the sixty-cycle grid excitation voltage one can maintain this *primary grid emission current* at any value—several microamperes or several milliamperes—very steadily. Thus by the use of this method the grid is heated on positive half cycles and the presence of emission is detected on successive negative half cycles.

In order to give concrete values of grid dissipation at which primary electron emission can be observed, a few values of limiting grid dissipation are given in Table I. They are from measurements taken on available *individual* tubes of familiar types and, therefore, should not be considered as representative of average dissipations measured on a large number of standard tubes. All values in the second column correspond to an emission current of 0.1 milliampere, in the third column to 1.0 milliampere. These arbitrary values were chosen purely to illustrate grid dissipation values encountered in practice.

TABLE I

Tube Type	Limiting Dissipation in Grid—Watts	
	0.1 milliampere Emission Current	1.0 milliampere Emission Current
203-A	32 watts	
211	24	50 watts
845	19	40
204-A	62	27
849	92	95
851	165	140
852	19	210
848	270	29
207	350	490
863	410	500
		710

The general behavior of the variation of electron emission with grid input power is shown in the curves of Fig. 2 which were taken with the plate cold. One curve is for a normal 203-A tube while the other is for an abnormal tube having exceptionally high primary electron emission. The dotted curve shows the emission from the abnormal tube after the grid had been flashed at high continuous grid dissipation

for a short time. This, however, cannot be recommended as a safe procedure in improving tube characteristics as the tube can easily be damaged in this process and because the improvement achieved is not permanent; actually, further study has shown that, unfortunately, the emissive properties of the grid are restored gradually while operating under normal conditions.

The limits of the table, although interesting *per se* give practical values only for water-cooled tubes. In the case of radiation-cooled

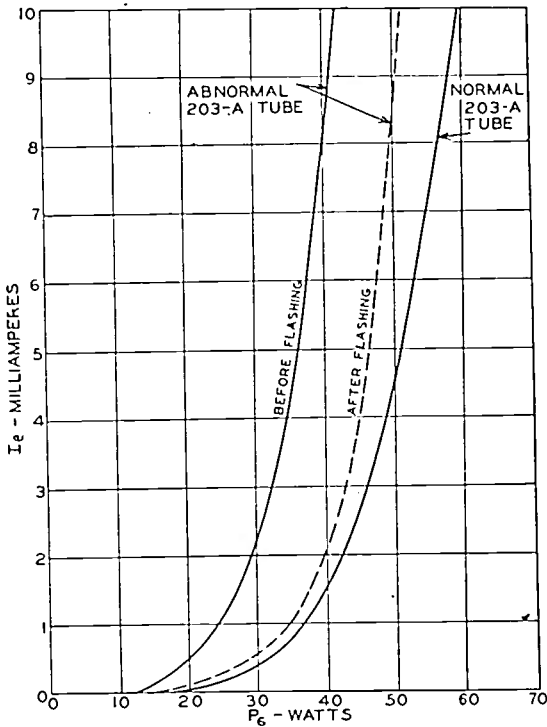

Fig. 2—Grid emission as function of grid power input.

tubes, they represent only the uppermost values of permissible grid dissipation. In actual operation a much smaller input to the grid must be used, since in the measurements the plate is cold, while in normal use it is also heated by plate loss. If the plate is hot, thermal equilibrium in the grid corresponding to a given electron emission from the grid will be reached for lower values of grid input power.

Measurements with a hot plate are somewhat more complicated, as they require means for heating the plate without at the same time blurring the measurement of the primary grid emission.

The circuit of Fig. 3, was developed and used to advantage in the study of grid emission with plate at operating temperature. As before, the grid input power is applied through a rectifier tube R_h , and the

grid input is found from the readings of the two meters A and V in the circuit. But the grid emission indicator, MA , instead of being permanently in the circuit, is connected to the grid only when one wishes to determine the presence of primary emission. This is done by means of the key K , which disconnects the grid input circuit and simultaneously applies a high negative bias to the grid, cutting off the plate current completely. The plate of the tube is heated by a separate transformer T_p , energized from the same source as the grid transformer, and 180 degrees out of phase with the latter. Thus the plate and grid are alternately positive with respect to the filament and stay at zero voltage for the remainder of the cycle due to the action of the rectifiers R_p and R_h . This arrangement permits a free flow of electrons

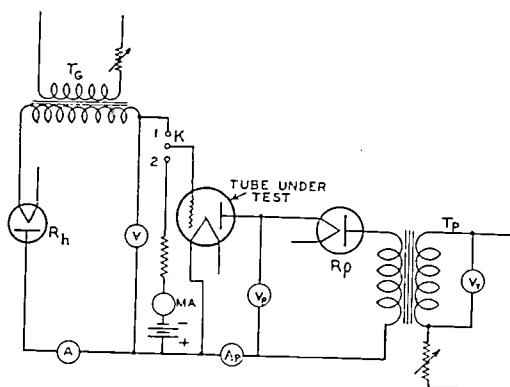

Fig. 3—Circuit for grid emission tests with heated plate.

to each electrode *in turn* unhampered by any negative voltage on the other. If the power supply transformers are amply dimensioned the voltage waves are practically pure sine, allowing for easy calculation of plate and grid inputs. In taking readings the plate dissipation is adjusted to any desired value and the grid dissipation is gradually raised until by tapping the key K , one obtains an indication of electron emission. In this way the limitation of grid input under actual operating conditions of plate dissipation can be studied. Fundamentally, the reduction of the permissible grid dissipation is a linear function of the plate loss. This can be demonstrated analytically. Let us assume that the total power dissipated in the grid, q_g , is radiated to the plate. Then one can write

$$q_g = k(T_g^4 - T_p^4). \quad (1)$$

Here k is a constant for a given material and tube structure; T_g and T_p are grid and plate temperatures, respectively. A similar relation exists for the radiation from the plate into the surrounding space.

$$q_p + q_g = k_1(T_p^4 - T_0^4) \quad (2)$$

where T_0 is the temperature of the exterior medium and q_p is the power directly dissipated in the plate. From (2) we may write

$$T_p^4 = \frac{q_p + q_g}{K_1} + T_0^4. \tag{3}$$

Substituting T_p^4 into (1) we obtain

$$q_g = k \left(T_g^4 - \frac{q_p + q_g}{K_1} - T_0^4 \right). \tag{4}$$

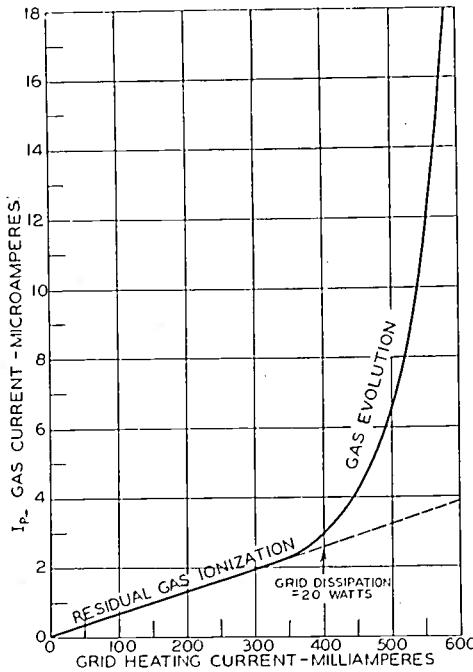

Fig. 4—Gas current as a function of grid dissipation. Individual 203-A tube. Plate voltage, 45 volts negative.

Finally, differentiation of the last equation with respect to q_p yields

$$\frac{dq_g}{dq_p} = \frac{-k}{k + k_1}, \tag{5}$$

because the temperatures T_g and T_0 are constant, since T_0 is room temperature and T_g is grid temperature for constant emission. This equation shows that the relation connecting plate and grid loss in the conditions postulated is linear. This has been confirmed experimentally. Thus, in addition to grid dissipation limit with a cold plate one needs to measure only one more point corresponding to any convenient plate dissipation. Then one will know the limit for any plate dissipation.

tion. As an example of the reduced grid dissipation limit we can mention that with a 204-A tube the grid input for a grid emission current of 0.1 milliamperes drops from 62 watts with a cold plate to 39 watts at the rated plate dissipation of 250 watts, or 35 per cent.

During the described measurements it can quite frequently be observed that in the case of radiation-cooled tubes occluded or adsorbed gas is liberated from the grid in amounts sufficient to kill the emission of the thoriated filament used. The phenomenon to occur first as the grid temperature is gradually being raised—electron emission, or gas liberation—depends on the tube design and also on the degree of outgassing of tube parts. The gas liberation limit may vary greatly from tube to tube of any given type.

The grid dissipation limit corresponding to the beginning of gas liberation can easily be determined in the scheme of Fig. 1 if negative plate voltage is applied so that positive ions are attracted to the plate. The ions form "gas current" which can be read on a microammeter inserted in the plate circuit. At lower grid temperatures gas current is proportional to grid input current, because it depends on the ionization of purely residual gas. But, as shown in Fig. 1, when one gradually increases the grid dissipation the gas current rises abruptly as the heated grid begins to supply new quantities of gas. The corresponding grid input power is then the practical grid dissipation limit. With some tubes this may be lower than the actual thermionic emission limit as recorded on the milliammeter in the circuit of Fig. 1.

The described methods of measuring grid dissipation limits on individual tubes may be of assistance to the manufacturer in checking and improving his manufacturing processes. The knowledge of the real physical limitation inherent in the grid may contribute to more clear-cut rating of tubes.

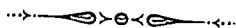

TERRESTRIAL MAGNETISM AND ITS RELATION TO WORLD-WIDE SHORT-WAVE COMMUNICATIONS*

By

HENRY E. HALLBORG

(R.C.A. Communications, Inc., New York City)

Summary—The functioning of short-wave circuits is found to be closely related to the geographical distribution of terrestrial magnetic activity. Circuit fading and magnetic fluctuations may be correlated in terms of horizontal intensity communication limits. North American magnetogram studies have provided a direct relationship between short-wave communication effectiveness and north latitude. The world may be allocated into zones of commercially effective, disturbed, and dead sectors with respect to any communication center.

The relative performance of east-west versus west-east transatlantic communication, and the application of magnetic analysis to international broadcasting is considered.

The magnetic history of the year 1932 with respect to mean intensity and range shows the core of the earth to have magnetic retentivity. The correspondence of magnetic, earth current, and signal variations is illustrated.

Europe is shown to be more favorably located geographically and diurnally with respect to freedom from terrestrial disturbances to communications than is North America.

A knowledge of concurrent magnetic activity, and the systematic charting of its cycles of daily variations is found essential to the most effective use of facilities, at all times and seasons, in the maintenance of a world-wide radio communications service.

I. INTRODUCTION

THE intimate relationship that exists between the prevailing state of terrestrial magnetism, and the performance of short-wave circuits has been known to radio engineers from the date of the earliest short-wave experiments to the inauguration of commercial short-wave service. All users of short waves are familiar with the occasional violent fadings and swingings of signals and with the further fact that fading varies widely from day to day, and hour to hour, in a vagarious and fortuitous manner.

These apparently inexplicable phenomena have stirred the interest and ingenuity of the engineer. There has resulted the development and design of equipment which largely compensates for nearly all types of fading, except that which accompanies the most severe magnetic storms. The challenge to uninterrupted communication presented by

* Decimal classification: R113.5. Original manuscript received by the Institute, May 3, 1935. Presented before joint I.R.E.-U.R.S.I. meeting, Washington, D.C., April 26, 1935.

magnetic storms has led to a study of terrestrial magnetic ranges in relation to radio circuit disturbances in various parts of the world. Some of the important phases of this work, as investigated by R.C.A. Communications, Inc., are briefly outlined in this paper.

II. MAGNETIC LIMITS FOR COMMUNICATION

The work of evaluating the magnetic variables which relate themselves most closely to change in the commercial capacity of a short-wave communications system is a laborious one. It demands systematic and analytical comparisons. It has provided many contradictions and false leads, but in the light of added experience, has become reasonably straightforward and logical, as the accompanying results will testify.

When this research was first initiated, variations in both the horizontal and vertical intensity ranges of terrestrial magnetism as daily reported by the Cheltenham Observatory were compared to the daily logs of RCA short-wave circuits. These comparisons led to the conclusion that circuit performance responds more closely to the horizontal intensity ranges than to the vertical, in the ratio of at least two to one. The horizontal magnetic ranges have consequently been applied in all subsequent correlations. It was soon realized that the published daily range figures were wholly inadequate for correlation purposes. Arrangements were accordingly made to obtain daily magnetograms from Cheltenham and Tucson, and later from Niemeck, Germany. In the meantime, the RCA earth-current recorder at Riverhead, L.I., was put into operation, in order that concurrent radio and magnetic observations might also be available. The work of correlation has continued from direct studies of the earth-current records and magnetograms. The Tucson magnetograms, due to initial circuit comparisons, have been used as a reference base.

When a particular observatory is used as a reference base, it is quite possible to relate a change in the horizontal intensity range, to a definite condition of the circuit. For instance, Tucson horizontal intensity ranges have produced relative limits of circuit disturbance as follows:

<i>Horizontal Magnetic Intensity Range</i>	<i>Circuit Disturbance</i>
60 gammas	Moderate
100 gammas	Severe

These horizontal intensity ranges apply normally to a six-hour time period. When the period of time is one hour, the limits become 10 gammas and 17 gammas, respectively, namely one sixth of the six-hour values.

III. VARIATION OF HORIZONTAL RANGE WITH NORTH LATITUDE

Through the courtesy of the United States Coast and Geodetic Survey, complete magnetic observations for the year 1931 were made

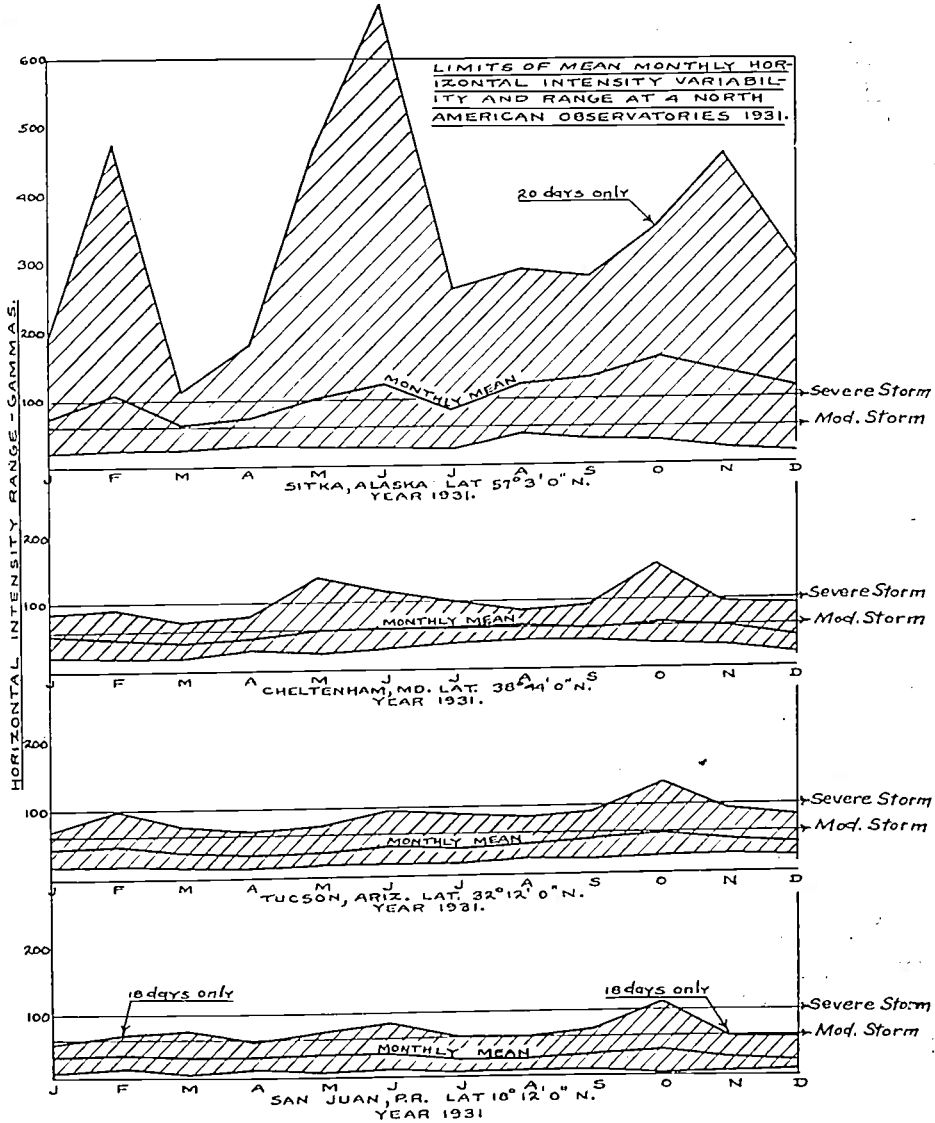

Fig. 1—Observed monthly mean, and variability ranges of horizontal intensity at four North American magnetic observatories during 1931.

available from the magnetic observatories at San Juan, Puerto Rico; Tucson, Arizona; Cheltenham, Md.; and Sitka, Alaska. These data were used to study the variation of horizontal range with latitude and season. Three significant magnetic values were obtained for each month from the logs of these four observatories; namely,

- (A) Mean monthly value of horizontal range.
- (B) Upper monthly limits of horizontal range (average of three highs).
- (C) Lower monthly limits of horizontal range (average of three lows).

The comparative monthly averages of horizontal range and the indicated variability of horizontal intensity at the above four North American observatories are illustrated in Fig. 1.

At the right of Fig. 1 are entered the communication limits of 60 gammas for a moderate disturbance, and 100 gammas for a severe disturbance. It will be observed that the average horizontal intensity range at San Juan, the low latitude station, at no time during 1931 reaches a value equivalent to a moderate circuit disturbance. At Sitka, the high latitude station, on the other hand, a large portion of the average horizontal range is above the limit equivalent to a severe circuit disturbance. The increasing difficulty of maintaining good commercial short wave communication service in high latitudes is apparent.

The data of Fig. 1, when averaged to include the mean annual horizontal intensity range for the whole year of 1931, provided a very definite relationship between horizontal range and North latitude. In Fig. 2 are plotted the upper and lower annual means of variability, and the resulting annual mean of horizontal intensity as a function of North latitude. This figure strikingly illustrates the manner in which the annual average horizontal range and its degree of variability builds up as the north magnetic pole is approached.

The application to Fig. 2 of the observed circuit disturbance limits of 60 and 100 gammas, brings out the interesting fact that, for the magnetic conditions prevailing in 1931, American short-wave circuits below latitude 43° north are relatively free of disturbance, from 34° to 56° north moderately disturbed, and above 56° north severely disturbed. A similar situation unquestionably exists with respect to the earth's southern hemisphere. The lack of suitably located observatories in the southern hemisphere makes this point more difficult to establish.

IV. THE WORLD'S SHORT-WAVE COMMUNICATION ZONES

The north magnetic pole is approximately located by the United States Coast and Geodetic Survey as 71° north latitude, and 96° west longitude. This places it geographically in the Boothia-Peninsula, near the Gulf of Boothia, in Northern Canada.

The data of Fig. 2 may be applied to a determination of the world's short-wave communication zones for the year 1931. These zones will

increase and decrease in extent in conformity with the eleven-year magnetic and solar cycle, but it will suffice here to show how they were defined from the magnetic records of the year 1931.

On an azimuthal map of the world, around any communication center, such as New York, a circle is described about the location of

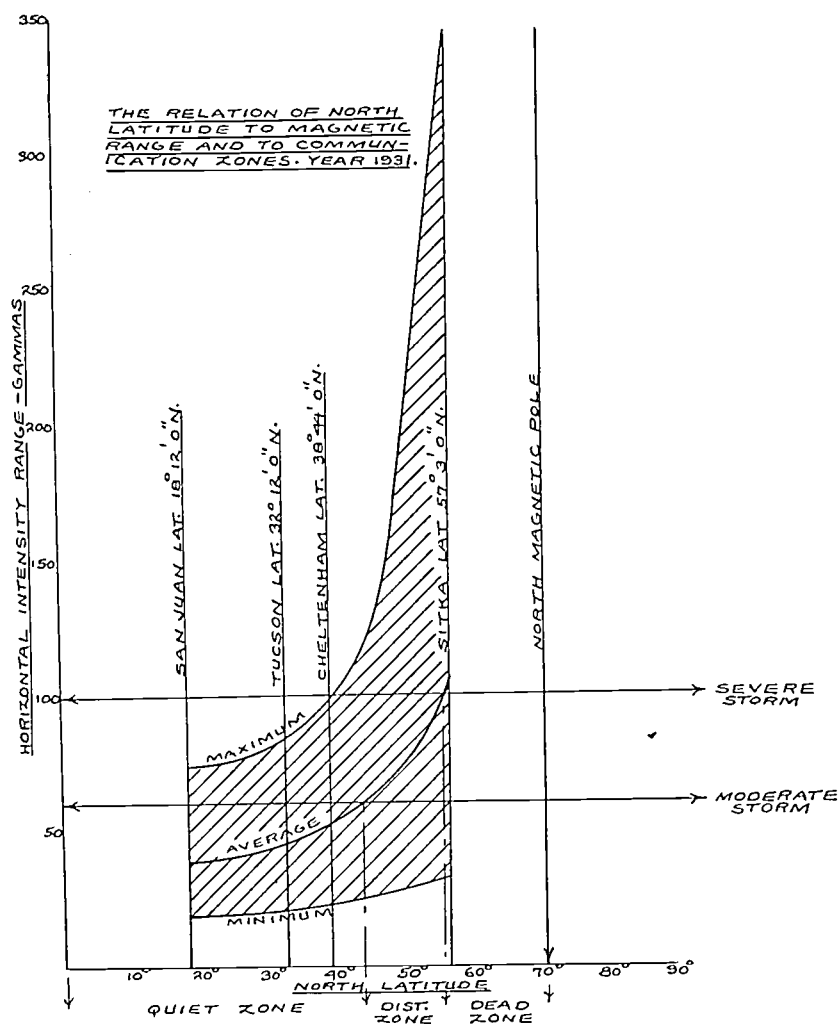

Fig. 2—The variation of horizontal intensity range with north latitude for the year 1931.

the north magnetic pole as a center. If the polar radius of this circle is equal in degrees of latitude to that between the intersection in Fig. 2, of the *severe storm* line, with the average horizontal range, i.e., $71^{\circ} - 56^{\circ} = 15^{\circ}$, the resulting circle centered as above defines the locus of a commercially dead area, and dead sector, for that particular center of communication. If now the polar radius is made that between the magnetic pole, and the point where the yearly horizontal range is

intersected by the *moderate storm line*, i.e., $71^{\circ}-43^{\circ}=28^{\circ}$, the locus of a disturbed area, and a disturbed sector, is circumscribed around the previously determined dead area. The magnetically disturbed region, with respect to the given center of communication, then consists of three continuous sectors, a center dead sector, and two flanking disturbed sectors. In a similar manner all important centers of communication may be charted with respect to their world-wide communication zones.

Figs. 3, 4, and 5 show the disposition of communication zones around New York, San Francisco, and Berlin, respectively.

The dead sector with respect to New York, Fig. 3, is seen to cut out all the important cities of the Far East, precluding the possibility of establishing satisfactory continuous direct communication with the Orient from New York.

The dead sector with respect to San Francisco, Fig. 4, is seen to eliminate all of Northern Europe. The Far East, on the other hand, is entirely in the quiet sector from San Francisco. It will be at once suggested that short-wave communication to the Orient from New York will become practicable by using San Francisco as a relay point. The full use of short waves in world-wide commercial communications therefore involves the necessity of working around, rather than through, magnetically disturbed zones.

The generally superior position of Europe with regard to the dead sector is seen in Fig. 5, which shows the distribution of communication zones centering around Berlin. Due to the greater distance of Berlin from the magnetic pole, its dead sector cuts out a smaller region, and one not commercially valuable, due to the geographical distribution of continents. The conclusion, therefore, is obvious that nature has been kinder to Europe in the matter of world-wide distribution of short-wave communication zones, than it has been to North America.

It is to be noted that, while the zones here outlined are based upon yearly averages of horizontal intensity ranges, it is clear, from Fig. 2, that on certain quiet days, it will be possible to work successfully across the dead sectors, but hardly with sufficient regularity to establish commercial service.

V. EAST-WEST AND WEST-EAST COMMUNICATION

The interrelationship of terrestrial magnetic variations and short-wave circuit performance also permits an analysis of the much discussed question of east-west versus west-east transatlantic short-wave communication. A study of magnetograms from the Tucson observatory for the year 1932 sheds much light on this question. Fig. 6

AZIMUT

NOTE:

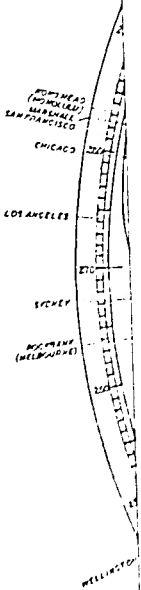

Fig.

intersected by the *moderate storm line*, i.e., $71^{\circ}-43^{\circ}=28^{\circ}$, the locus of a disturbed area, and a disturbed sector, is circumscribed around the previously determined dead area. The magnetically disturbed region, with respect to the given center of communication, then consists of three continuous sectors, a center dead sector, and two flanking disturbed sectors. In a similar manner all important centers of communication may be charted with respect to their world-wide communication zones.

Figs. 3, 4, and 5 show the disposition of communication zones around New York, San Francisco, and Berlin, respectively.

The dead sector with respect to New York, Fig. 3, is seen to cut out all the important cities of the Far East, precluding the possibility of establishing satisfactory continuous direct communication with the Orient from New York.

The dead sector with respect to San Francisco, Fig. 4, is seen to eliminate all of Northern Europe. The Far East, on the other hand, is entirely in the quiet sector from San Francisco. It will be at once suggested that short-wave communication to the Orient from New York will become practicable by using San Francisco as a relay point. The full use of short waves in world-wide commercial communications therefore involves the necessity of working around, rather than through, magnetically disturbed zones.

The generally superior position of Europe with regard to the dead sector is seen in Fig. 5, which shows the distribution of communication zones centering around Berlin. Due to the greater distance of Berlin from the magnetic pole, its dead sector cuts out a smaller region, and one not commercially valuable, due to the geographical distribution of continents. The conclusion, therefore, is obvious that nature has been kinder to Europe in the matter of world-wide distribution of short-wave communication zones, than it has been to North America.

It is to be noted that, while the zones here outlined are based upon yearly averages of horizontal intensity ranges, it is clear, from Fig. 2, that on certain quiet days, it will be possible to work successfully across the dead sectors, but hardly with sufficient regularity to establish commercial service.

V. EAST-WEST AND WEST-EAST COMMUNICATION

The interrelationship of terrestrial magnetic variations and short-wave circuit performance also permits an analysis of the much discussed question of east-west versus west-east transatlantic short-wave communication. A study of magnetograms from the Tucson observatory for the year 1932 sheds much light on this question. Fig. 6

AZIMUTHAL MAP OF THE WORLD AROUND NEWYORK.

LEGEND.
 ——— PRESENT CIRCUITS.
 - - - - - FUTURE CIRCUITS.

NOTE: BEARINGS AND DISTANCES ARE FROM ROCKY POINT, N.Y.
 OBTAINED BY COMPUTATION

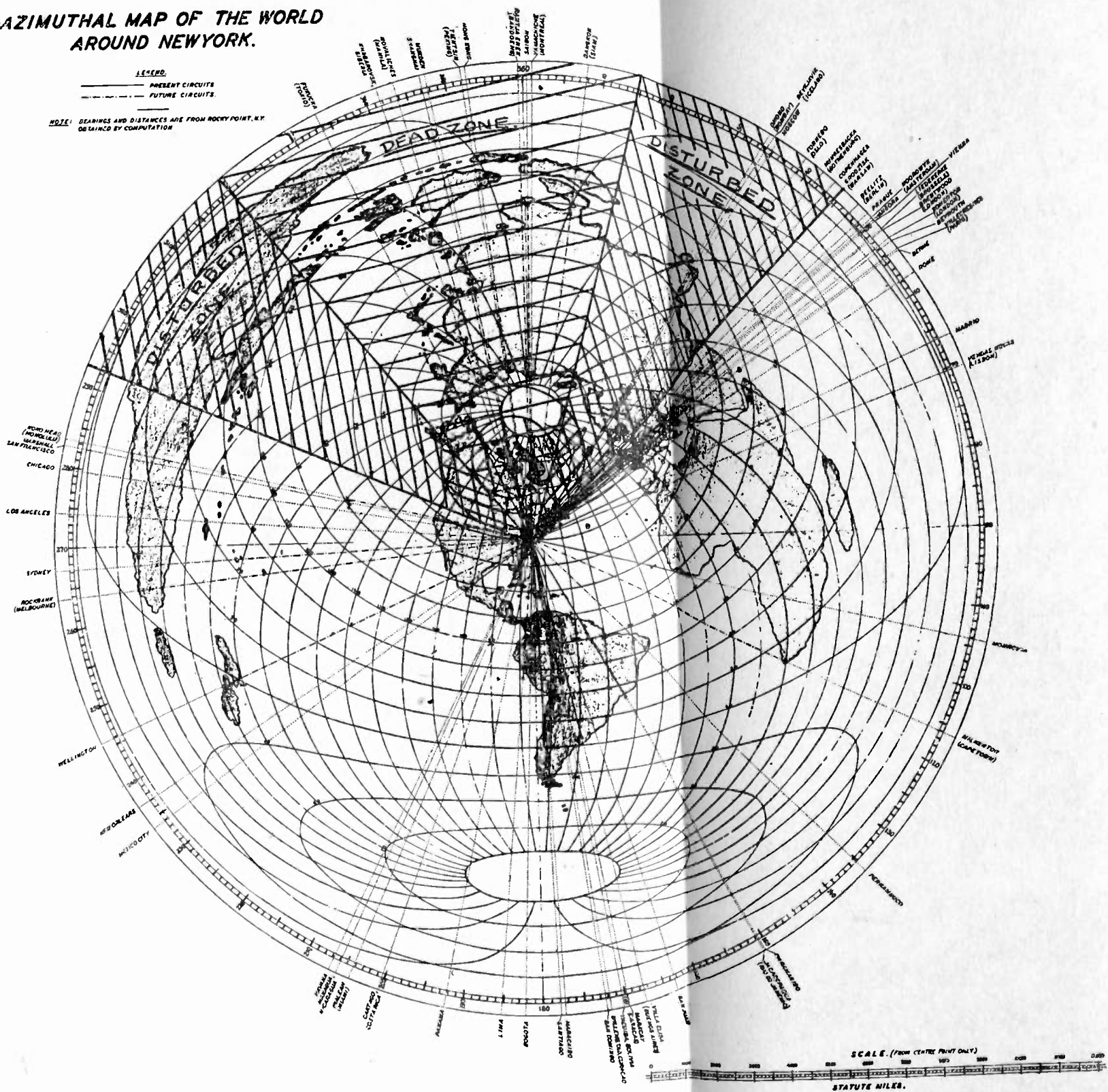

Fig. 3—Disturbed and dead short-wave commercial communication zones from New York as a center, during 1931.

intersected by the *moderate storm line*, i.e., $71^{\circ}-43^{\circ}=28^{\circ}$, the locus of a disturbed area, and a disturbed sector, is circumscribed around the previously determined dead area. The magnetically disturbed region, with respect to the given center of communication, then consists of three continuous sectors, a center dead sector, and two flanking disturbed sectors. In a similar manner all important centers of communication may be charted with respect to their world-wide communication zones.

Figs. 3, 4, and 5 show the disposition of communication zones around New York, San Francisco, and Berlin, respectively.

The dead sector with respect to New York, Fig. 3, is seen to cut out all the important cities of the Far East, precluding the possibility of establishing satisfactory continuous direct communication with the Orient from New York.

The dead sector with respect to San Francisco, Fig. 4, is seen to eliminate all of Northern Europe. The Far East, on the other hand, is entirely in the quiet sector from San Francisco. It will be at once suggested that short-wave communication to the Orient from New York will become practicable by using San Francisco as a relay point. The full use of short waves in world-wide commercial communications therefore involves the necessity of working around, rather than through, magnetically disturbed zones.

The generally superior position of Europe with regard to the dead sector is seen in Fig. 5, which shows the distribution of communication zones centering around Berlin. Due to the greater distance of Berlin from the magnetic pole, its dead sector cuts out a smaller region, and one not commercially valuable, due to the geographical distribution of continents. The conclusion, therefore, is obvious that nature has been kinder to Europe in the matter of world-wide distribution of short-wave communication zones, than it has been to North America.

It is to be noted that, while the zones here outlined are based upon yearly averages of horizontal intensity ranges, it is clear, from Fig. 2, that on certain quiet days, it will be possible to work successfully across the dead sectors, but hardly with sufficient regularity to establish commercial service.

V. EAST-WEST AND WEST-EAST COMMUNICATION

The interrelationship of terrestrial magnetic variations and short-wave circuit performance also permits an analysis of the much discussed question of east-west versus west-east transatlantic short-wave communication. A study of magnetograms from the Tucson observatory for the year 1932 sheds much light on this question. Fig. 6

AZIMUTHAL MAP OF THE WORLD AROUND NEWYORK.

LEGEND.
 ——— PRESENT CIRCUITS
 - - - - - FUTURE CIRCUITS

NOTE: BEARINGS AND DISTANCES ARE FROM ROCKY POINT, N.Y.
 OBTAINED BY COMPUTATION

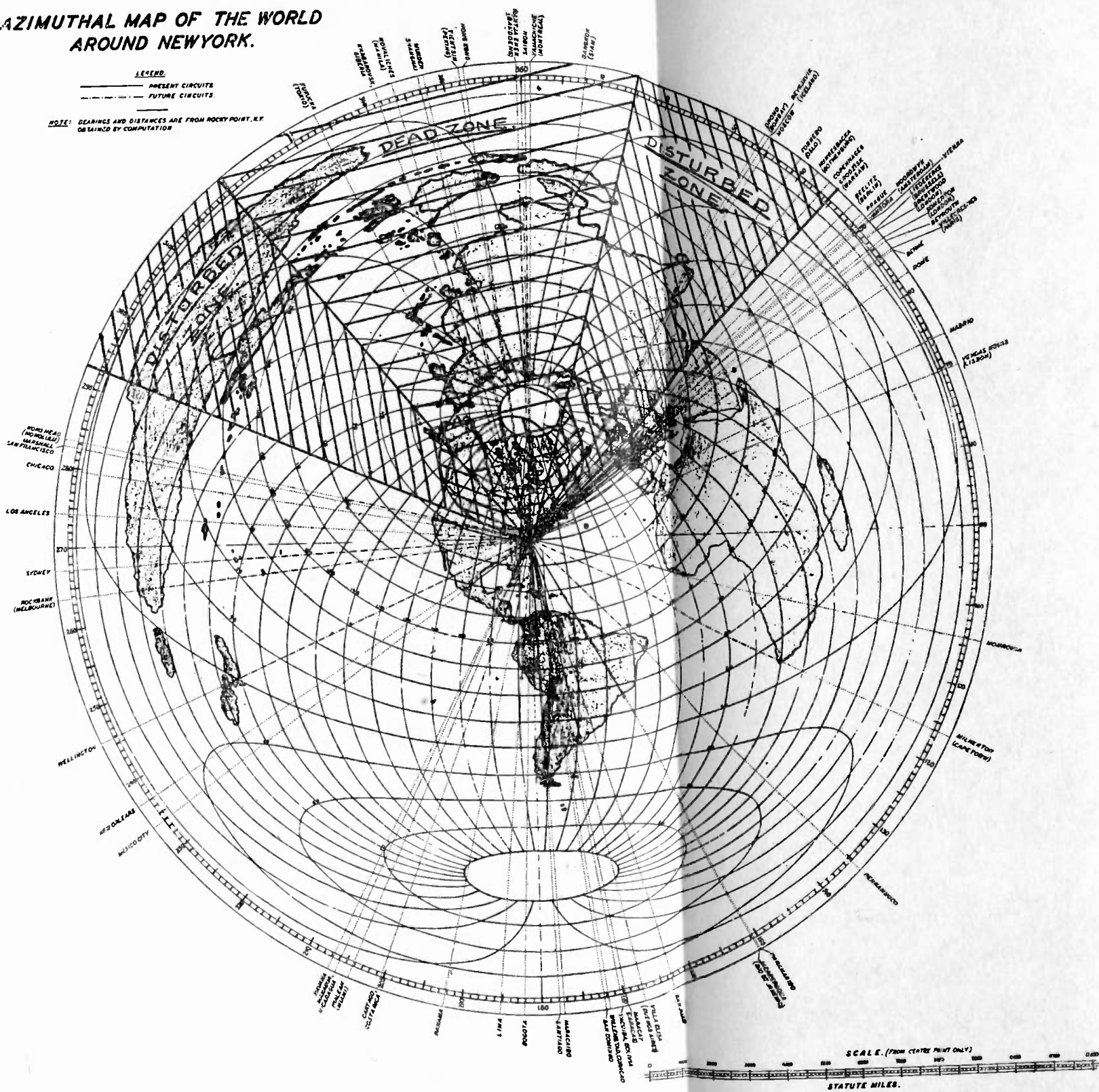

Fig. 3—Disturbed and dead short-wave commercial communication zones from New York as a center, during 1931.

ATHAL MAP OF THE WORLD
OUND SAN FRANCISCO

LEGEND
PRESENT CIRCUITS
FUTURE CIRCUITS

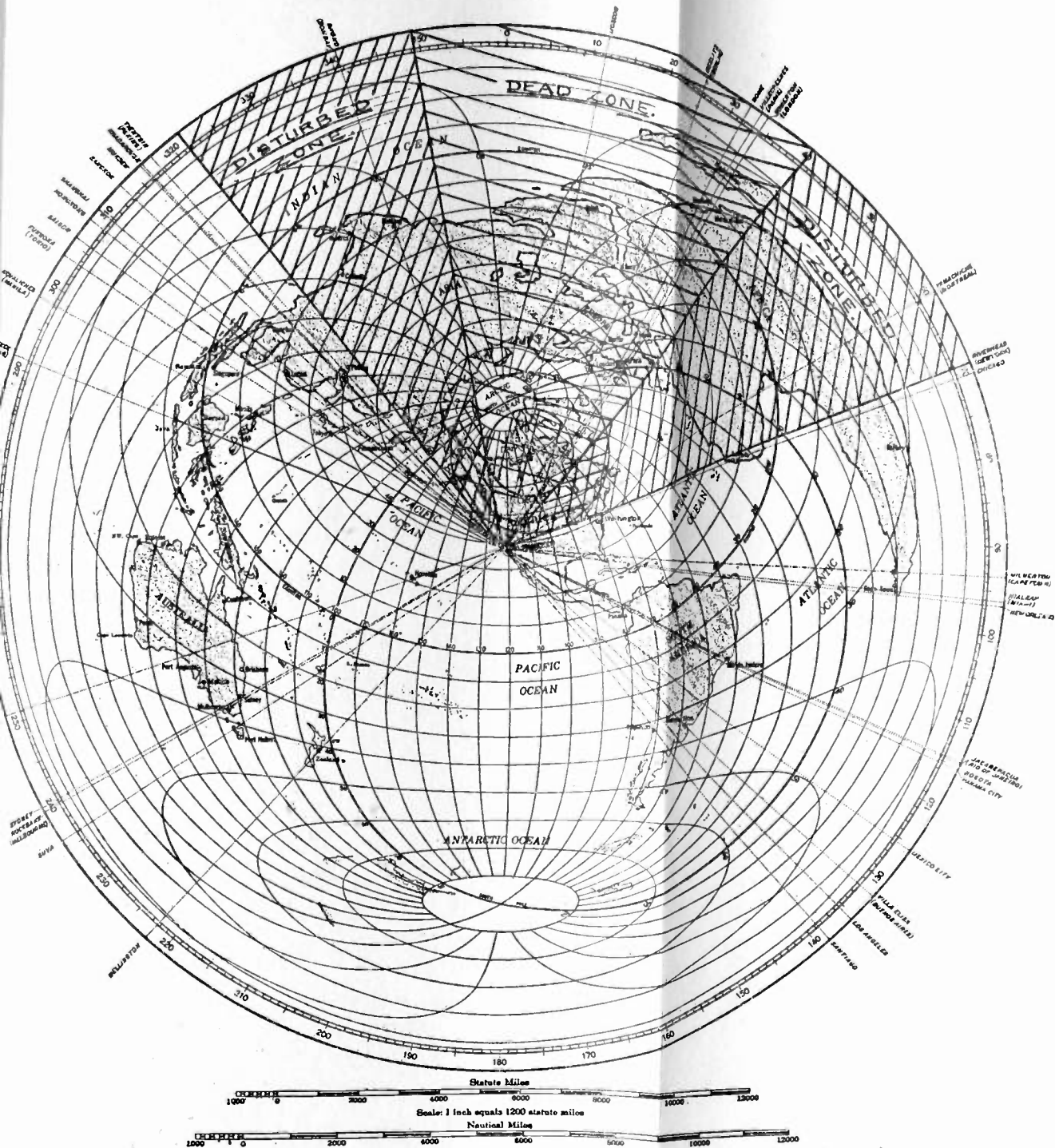

Fig. 4—Disturbed and dead short-wave commercial communication zones from San Francisco as a center, during 1931.

shows the monthly average of horizontal range at Tucson for each hour of the day, and each month of the year 1932. The time indicated is Eastern Standard Time. Full black sectors represent values of hourly range above 10 gammas, corresponding to the range limit above that for a moderate circuit disturbance.

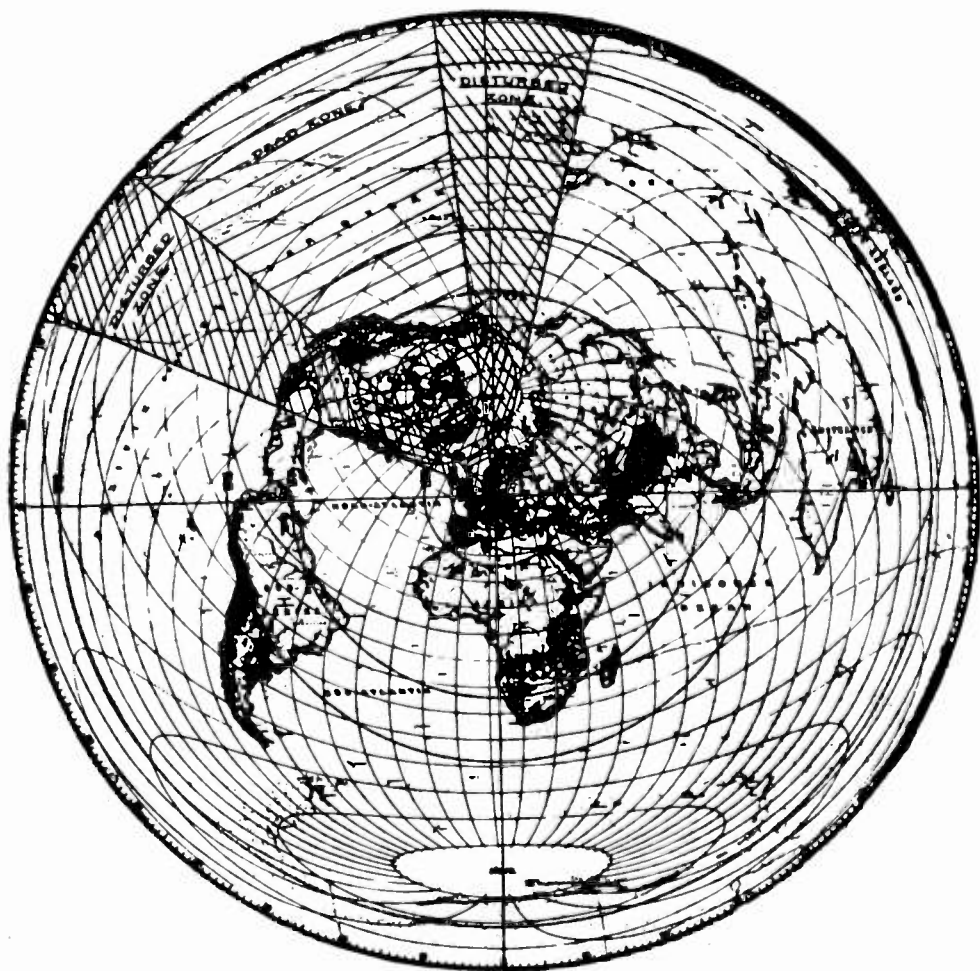

Fig. 5—Disturbed and dead short-wave commercial communication zones from Berlin as a center, during 1931.

The London and the New York business day is indicated in terms of Eastern Standard Time at the top of the chart. The London business day occurs five hours earlier than the New York business day. The effect of this time displacement upon the mean magnetic diurnal characteristic is important. The London business day occurs over a magnetic period that includes all of the most quiet portions of the day, and a relatively small percentage of the disturbed portions. The New York business day, on the other hand, includes a smaller part of the



shows the monthly average of horizontal range at Tucson for each hour of the day, and each month of the year 1932. The time indicated is Eastern Standard Time. Full black sectors represent values of hourly range above 10 gammas, corresponding to the range limit above that for a moderate circuit disturbance.

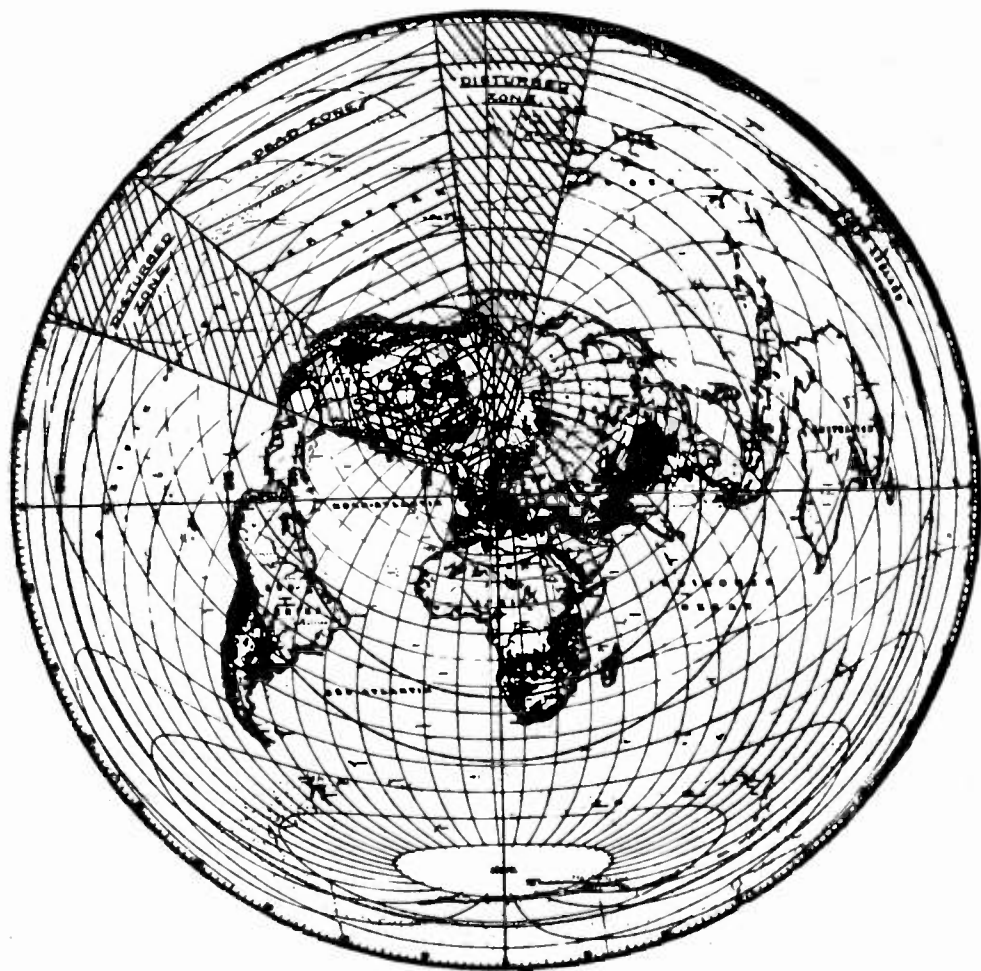

Fig. 5—Disturbed and dead short-wave commercial communication zones from Berlin as a center, during 1931.

The London and the New York business day is indicated in terms of Eastern Standard Time at the top of the chart. The London business day occurs five hours earlier than the New York business day. The effect of this time displacement upon the mean magnetic diurnal characteristic is important. The London business day occurs over a magnetic period that includes all of the most quiet portions of the day, and a relatively small percentage of the disturbed portions. The New York business day, on the other hand, includes a smaller part of the

quiet portions, and a larger part of the disturbed periods of the day. The practical communications significance of this condition is that short-wave reception from Europe is relatively easier than is New York

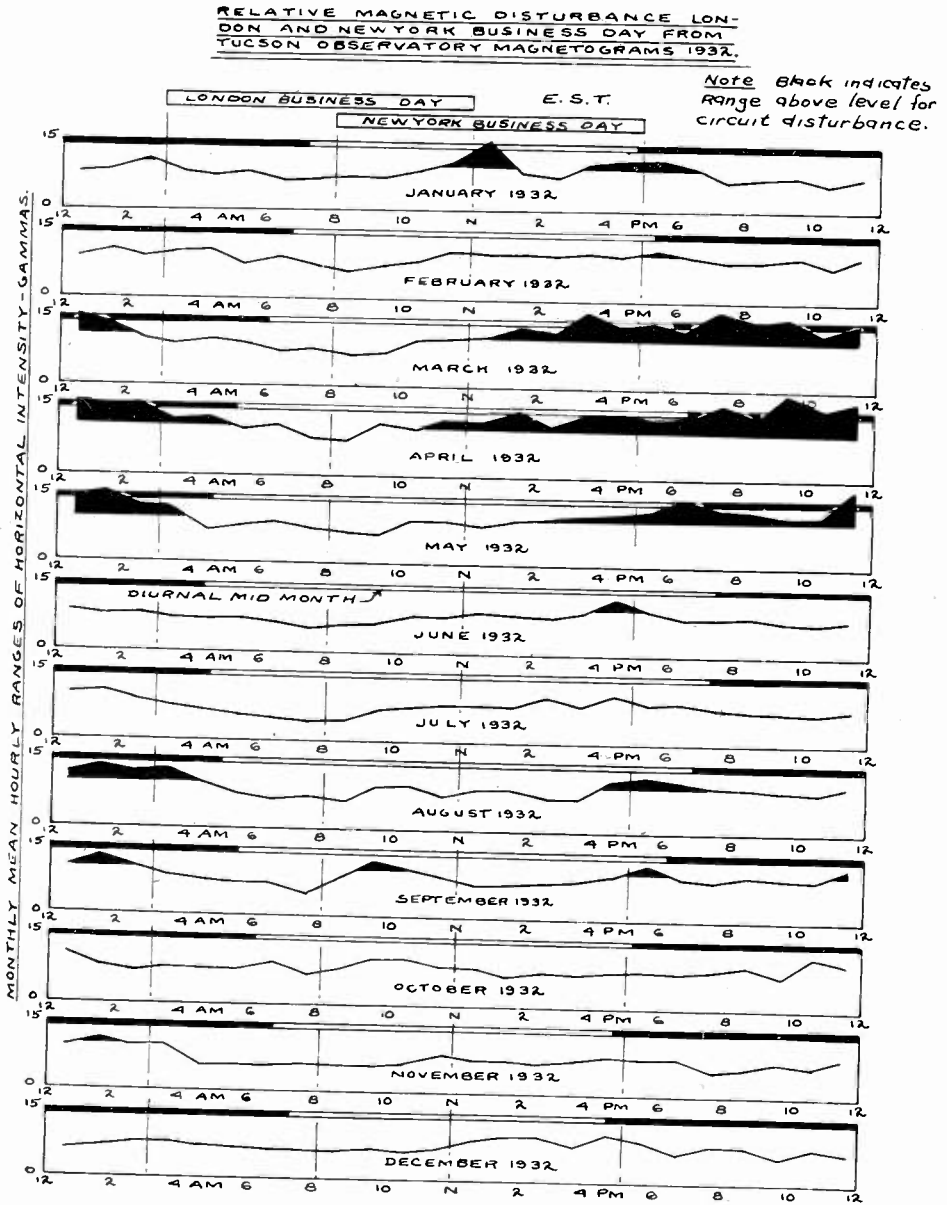

Fig. 6—Relative communication effectiveness of the London and New York business day from magnetogram studies during 1932.

reception in Europe. It also explains the prevailing use of higher power transmitters in American than have been found necessary in Europe for transatlantic working.

The chart also shows that the month of July is a particularly

favorable one for short-wave operation, in contrast to pioneer experience with long waves, when this month was always handicapped by severe static interference.

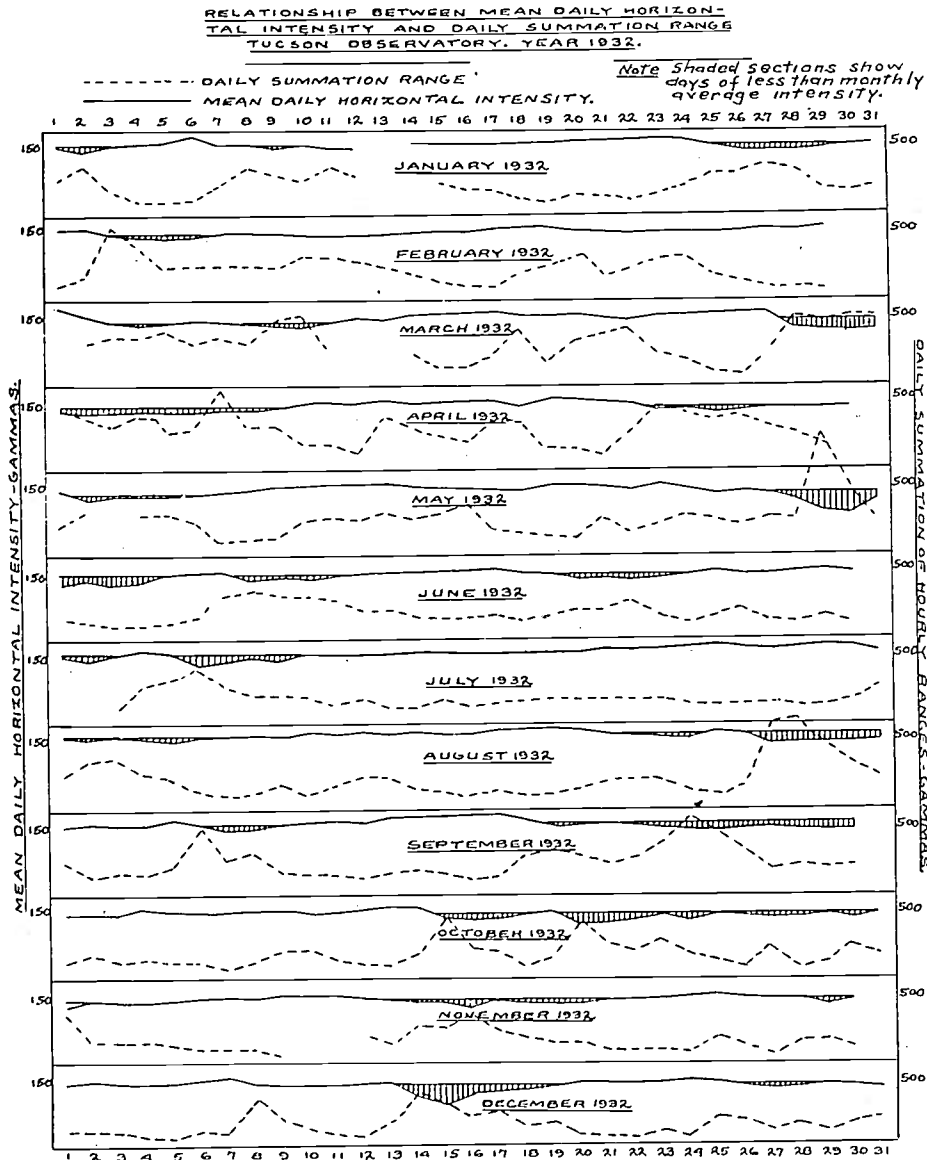

Fig. 7—The lowering of mean horizontal earth intensity with accompanying retentivity characteristic from Tucson magnetograms for the year 1932.

VI. MAGNETIC HISTORY OF THE YEAR 1932

Two properties of the horizontal component of the earth's field have a bearing upon communications; namely, the mean daily intensity and the daily summation range. The mean daily horizontal

intensity is important since it is associated with the most suitable frequency, and the daily summation range with the relative degree of fading that will be encountered. These two factors may also be looked upon purely from the physical viewpoint of the earth as a permanent magnet. The mean daily horizontal intensity measures the resulting state of the earth's field day by day, and the daily summation range its daily variable modulations by disturbing emanations from the sun.

In Fig. 7 is shown the magnetic history of the year 1932 at Tucson with respect to mean daily horizontal intensity, and daily summation range. The mean daily intensity is that above the arbitrary zero level of the magnetograms, and is not the absolute value. The daily summation range is the sum of the observed hourly horizontal ranges for each twenty-four hours.

The cross-hatched portions of the mean horizontal intensity curve, solid line, indicate those days which have a mean intensity below the monthly average. The dotted line represents the daily summation horizontal range. A sharp rise in the dotted line indicates the onset of a magnetic storm.

This chart clearly shows that a magnetic storm is definitely associated with a drop in the mean horizontal intensity. The more severe the storm, the lower is the mean horizontal intensity. The storm produces proportional demagnetization.

An interesting fact developed by this chart is the apparent retentivity of the earth considered as a permanent magnet. For instance, referring to the storm of May 29th, 1932, the mean daily horizontal intensity remains below the monthly normal for six days after the solar impacts have definitely subsided. Other storms, of lesser magnitude, all indicate retentivity to a very marked degree. This feature of lowered mean intensity after storms is of importance in short-wave communications, since the mean horizontal intensity is related to the most favorable frequencies no less than the summation range is related to fading, dispersion, and signal absorption.

VII. DIURNAL HISTORY OF A SEVERE MAGNETIC STORM

The hour-by-hour history of the days centering around the severe magnetic storm of May 29, 1932, is shown in Fig. 8. The solid lines represent hourly mean horizontal intensity values, and the dotted lines the hourly values of horizontal range. Intensity values above the monthly mean are shown in solid black, and horizontal range values above 15 gammas are shaded. The average intensity for the month is shown at the top of the chart for the purpose of comparison. The shaded areas of range indicate values that are sufficient to disturb

short-wave communication seriously. The most violent fluctuations of range are seen to occur when the mean horizontal intensity is lowest on May 29. This condition is also consistent with the previously observed variation of horizontal intensity and range with latitude shown

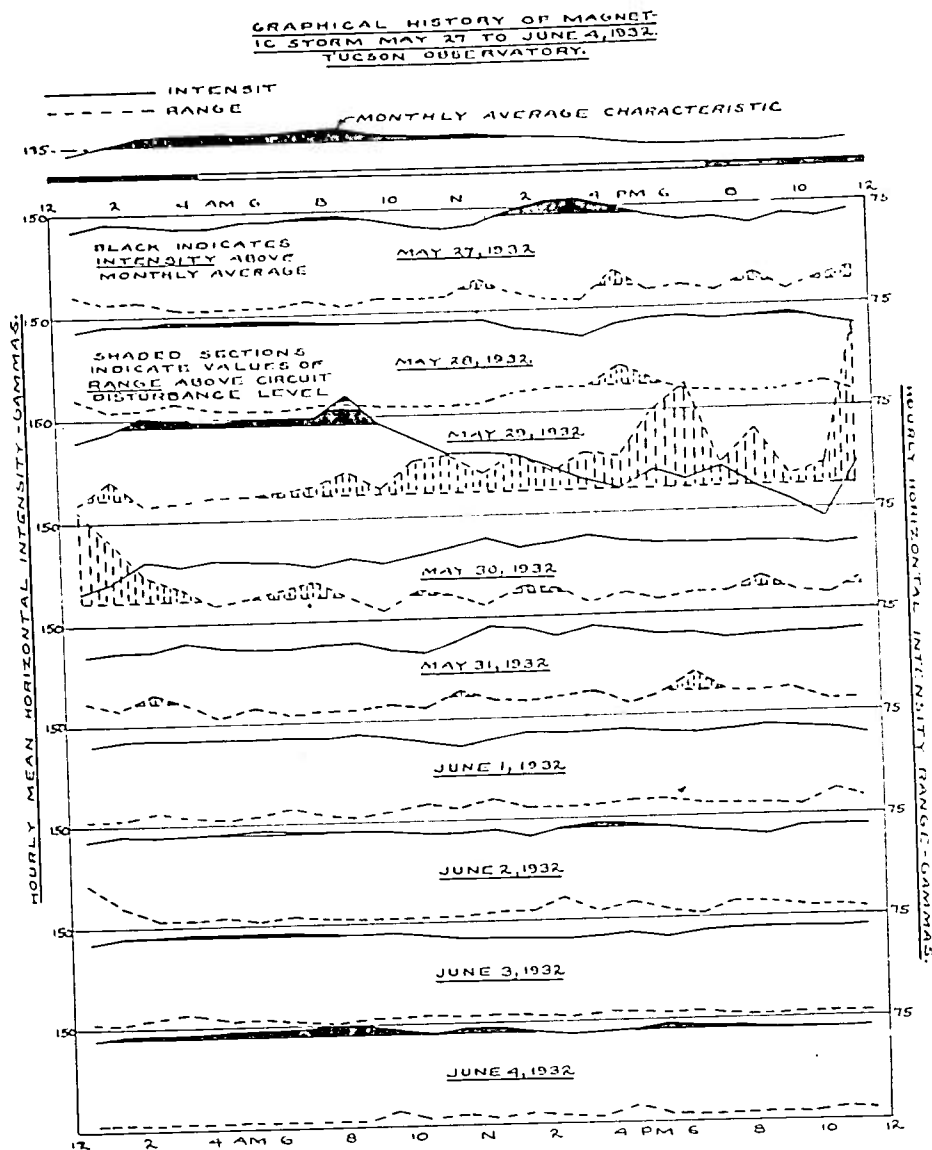

Fig. 8—Hour-by-hour variations of horizontal intensity and range during the magnetic storm of May 27 to June 4, 1932.

in Fig. 2. It is a matter of record that the mean horizontal intensity diminishes with latitude and is theoretically zero at the magnetic pole. Fig. 2 shows that as the mean horizontal intensity diminishes, its instability, or range, increases with accompanying detrimental effect upon short-wave communication.

Fig. 8 indicates that a period of six days, namely from May 29 to June 4 elapses before the diurnal characteristic returns approximately to the monthly normal shown at the top of the chart.

If the sun be considered the source of this magnetic storm, which upset normal transmission conditions for a week, it is evident that the solar disturbance started at 6 A.M. on the 29th and subsided at 4 A.M. on the 30th, or a period of only twenty-two hours.

VIII. MAGNETICS AND INTERNATIONAL BROADCASTS

In no field of radio communication does terrestrial magnetism play a more important rôle than in that of international broadcasting. The interrelation of terrestrial magnetism and the concurrent condition of the ionosphere is unquestionably an intimate one. It is probable that no change in the condition of the ionosphere, either diurnal, seasonal, cyclic, or sporadic occurs without its corresponding reaction upon the earth's magnetic state. Discrepancies of time occurrence and relative amplitude are inevitable, in view of the above-noted sluggishness and retentivity of the earth's core. The dense magnetic core of the earth is a huge permanent magnet, superimposed upon which are the modulations due to the recurring transients of the encircling ionosphere.

The approximate twenty-seven-day cycle of magnetic storm recurrence has been investigated by many observers. Magnetic storm recurrence is believed to be due to the existence on the sun of relatively fixed exciting areas which the writer has calculated to be located principally in a solar equatorial zone of width about 28 degrees of solar latitude. These areas are periodically aimed at the earth, at regular intervals, depending upon the rotational period of the sun, and the position of the earth on the ecliptic. The earth in effect, scans the solar exciting areas. The first six months of the year registers that portion of the exciting area in the northern solar hemisphere, and the last six months in the southern solar hemisphere. During that portion of the scanning process, when the earth is between 14 and 23.50 degrees of solar latitude, we experience a transition period, in which magnetics are light, and not readily predictable.

For several years the writer has constructed a running chart of magnetic activity from analysis of magnetograms from the Tucson observatory. This chart utilizes the principle of twenty-seven-day recurrence. A solar rotation of the sun's reversing layer is indicated by twenty-seven days arranged horizontally across the sheet. Each of the twenty-seven days is subdivided into four consecutive periods of six hours each; i.e., midnight to 6 A.M., 6 A.M. to noon, noon to 6 P.M., and 6 P.M. to midnight. The sum of the observed horizontal intensity

ranges for each six-hour period is plotted for each day. It is thus possible to determine from the chart the portion of the day that has the greatest magnetic activity. Values of horizontal range in excess of the circuit disturbance level of 60 gammas, for each six-hour period, are entered in solid black. The chart provides at a glance the approximate time of the circuit disturbance, its magnitude, its duration, and the time of probable recurrence.

The nature of this chart for the years 1933 and 1934 is shown in Fig. 9. The existence of a well-defined exciting area for example is indicated in the spring of 1933. Its magnetic activity may be considered to center between the dates January 27 to May 15, 1933. The equivalent solar dimensions are 93 degrees of longitude, and 28 degrees of latitude. This particular solar exciting area therefore has a longitudinal length of 715,000 solar miles and an equatorial latitudinal depth of 214,000 solar miles.

The chart of Fig. 9 provides a reasonably accurate means for the prediction of magnetically disturbed days. Supplementing Fig. 9, which contains information as to seasonal and secular change at Tucson, charts giving an hour-by-hour analysis of each solar rotation as registered at Riverhead have been provided. Fig. 10 shows the Riverhead hour-by-hour analysis of earth-current variability for the solar rotation of March 8 to April 3, 1935. The relative earth-current activity of each day, and each hour, of the solar rotation, is indicated by comparing the lengths of heavy lines at the right and bottom of the chart, respectively. It is thereby possible to select days and hours for international broadcasts with greater probability of success.

IX. RIVERHEAD EARTH-CURRENT RECORDER

Recognizing the importance of concurrent information as to magnetic variability and radio fading, R.C.A. Communications, Inc., has installed an earth-current recorder at its transatlantic receiving center at Riverhead, Long Island. This installation consists of a recording millivoltmeter registering continuously the drop caused by earth currents in a series resistor inserted in a long-wave antenna wire six miles in length. The antenna bears south 20 degrees east, and is grounded at both ends.

A comparison of the registrations of earth-current variability at Riverhead and summation range at Tucson for six-hour periods during the month of July, 1934, is shown in Fig. 11. The earth-current variability is expressed as a percentage, obtained by noting the increase of length of the mean earth-current envelope in terms of the hourly time axis.

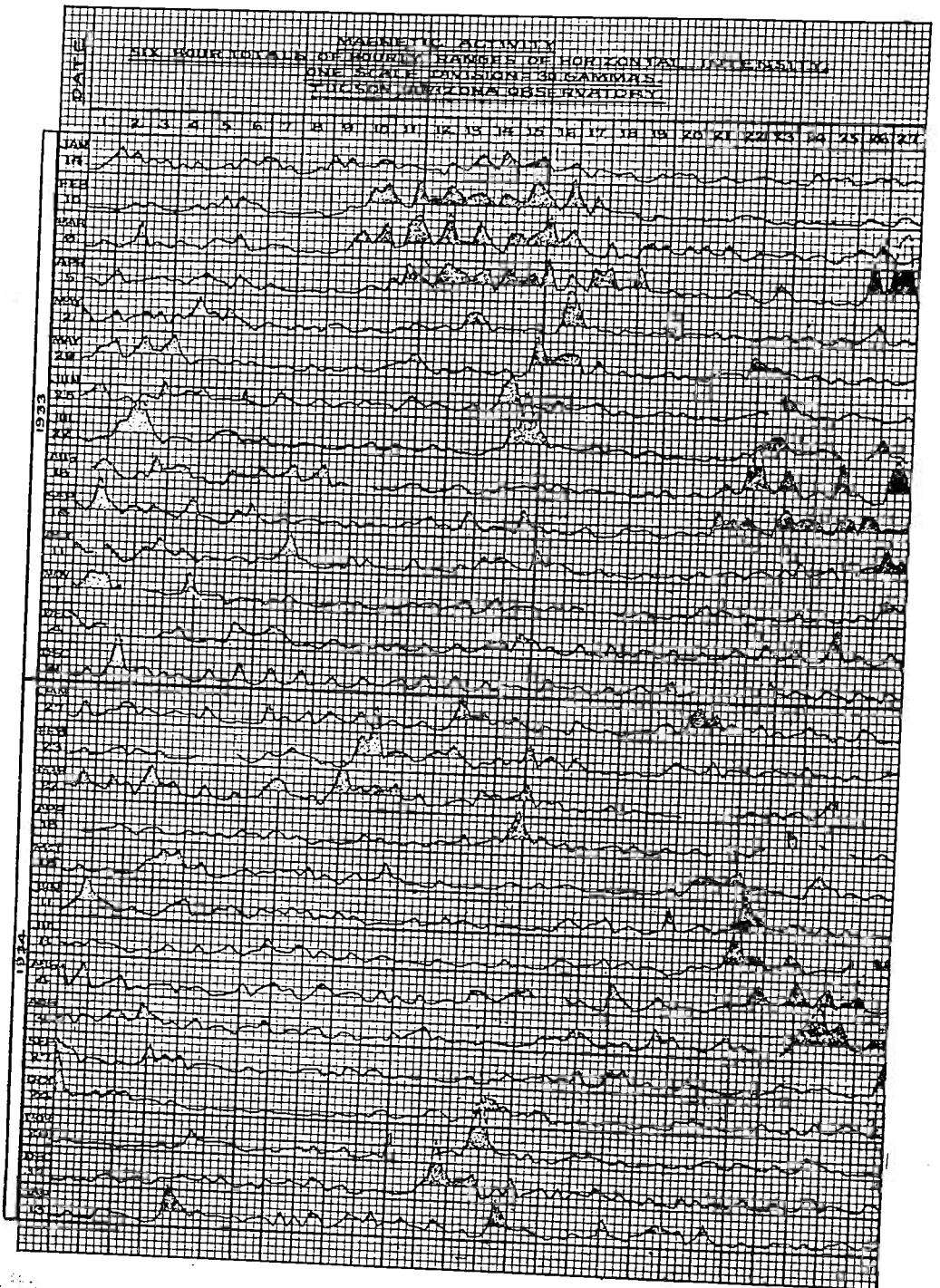

Fig. 9—Daily magnetic activity chart for the years 1933 and 1934, showing twenty-seven-day recurrence from Tucson magnetograms.

X. SIMULTANEOUS EARTH-CURRENT AND SIGNAL VARIATIONS

The relation of signal strength to earth-current and magnetic varia-

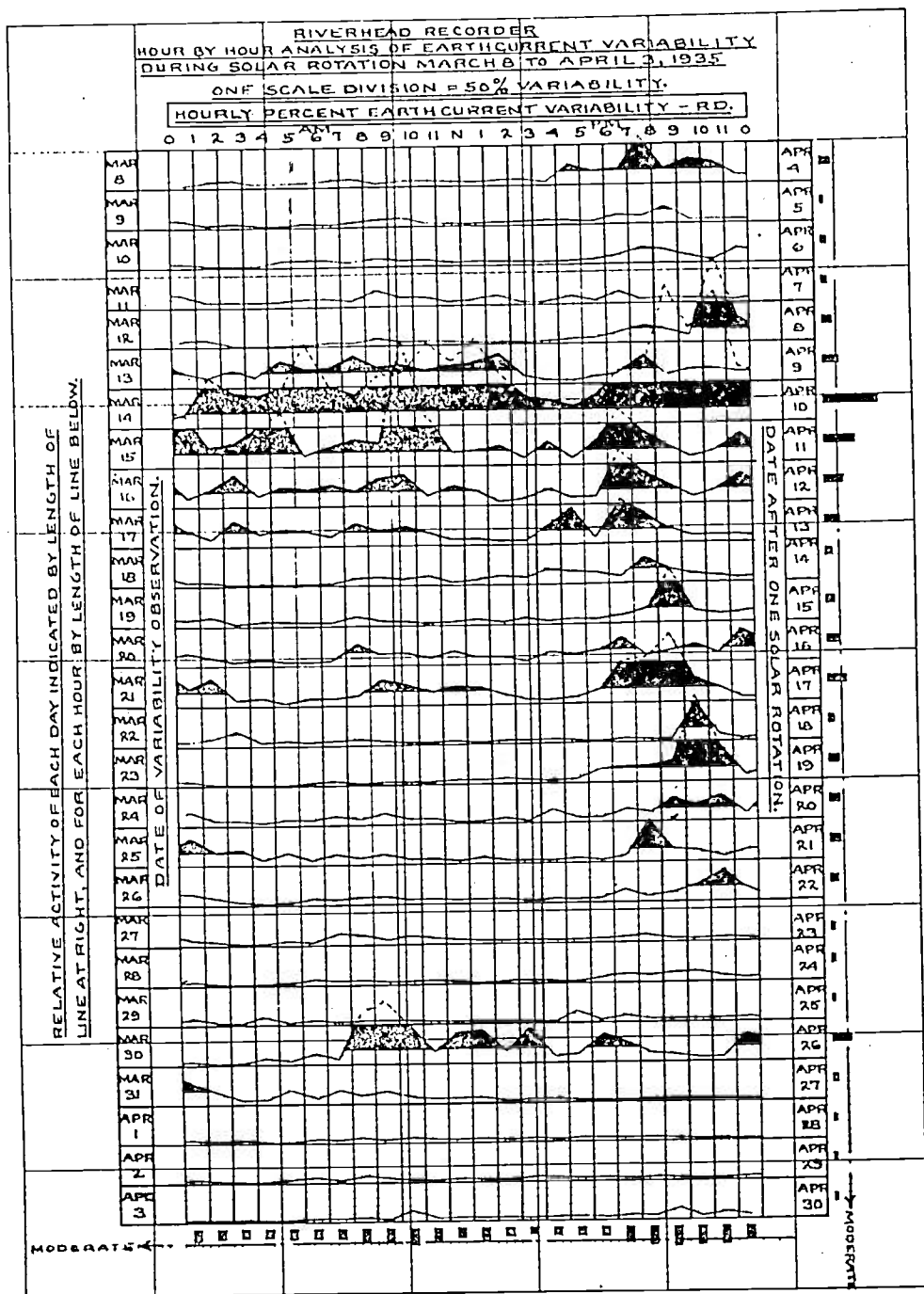

Fig. 10—Hour-by-hour distribution of earth-current variability at Riverhead during the solar rotation March 8 to April 3, 1935.

tion has been studied in an extended series of arrival angle investigations on North Atlantic short-wave circuits. The relationship is some-

times found to be extremely close, and at other times only indifferently so. In Fig. 12 is shown a simultaneous earth-current and signal variations record of a 14,830-kilocycle signal from a Rocky Point, L.I., antenna having a tilt of ten degrees, recorded on December 21, 1934, at Noordwijk, Holland. Signals of eighteen- and forty-degree tilts were also simultaneously recorded but these are deleted from the figure for

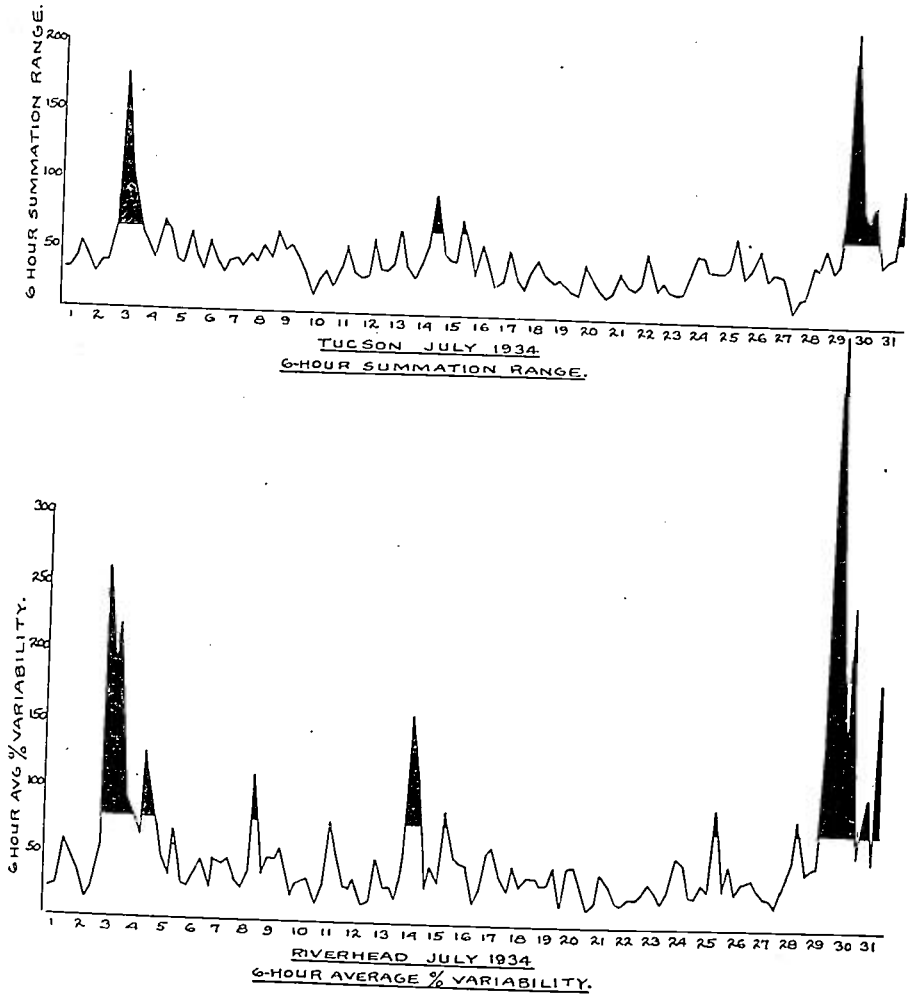

Fig. 11—Concurrent magnetic and earth-current activity comparison, from analysis of Tucson magnetograms and Riverhead earthograms for the month of July, 1934.

clearness. The eighteen- and forty-degree signals showed the same amplitude trends. A very definite interrelationship between signal strength and earth field on this particular day is indicated. Signal arrival angles and their spread are also definitely associated with ionosphere and magnetic variations. The relationships of radio and terrestrial magnetism must be conceded to be intimate but extremely

complicated. Long periods of observation are essential to bring out definite trends.

XI. SUMMARY OF COMMUNICATIONS RÔLE PLAYED BY MAGNETICS

It is evident that the rôle played by terrestrial magnetism in the development and operation of a world-wide short-wave communications system is an important one.

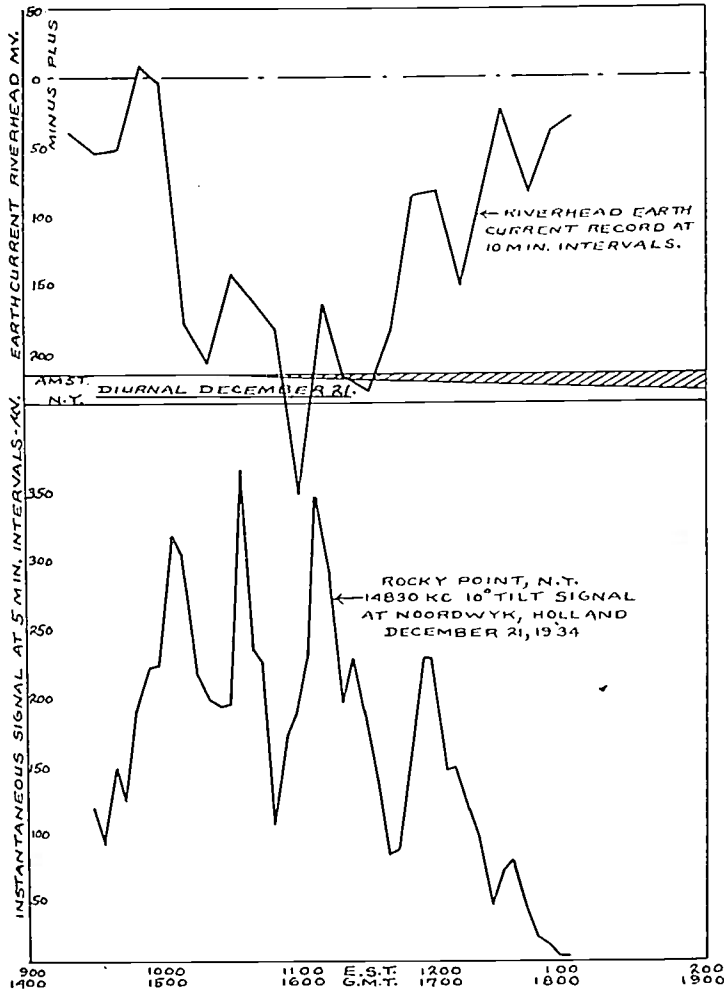

Fig. 12—Simultaneous variations of Riverhead earth current and 14,830 kilocycles, Rocky Point signal received in Holland December 21, 1934.

Terrestrial magnetism definitely defines zones of world-wide communication; it provides limits for the degree of circuit disturbance; it supplies means for the selection of the most favorable periods for international broadcasts; it furnishes a measure for relative equipment reliability; it furnishes an indication of the perpetual state of the ionosphere; but above all, it permits the most effective use of facilities, at all times and seasons, in the maintenance of a world-wide radio communications service.

LOW-FREQUENCY TRANSMISSION OVER TRANSATLANTIC PATHS*

BY

H. H. BEVERAGE

(R.C.A. Communications, Inc., New York City)

AND

G. W. KENDRICK

(Tufts College, Massachusetts)

Summary—Continuous records of field intensity taken at several receiving points and on various types of antenna systems are compared. Evidence of incoherent low-frequency fading is found. Several measures of variability are discussed and changes observed are compared with variations in earth potentials. Abnormally low group velocities for low-frequency transmission are discussed.

IN A previous paper, evidence of incoherent low-frequency field intensity variations over transatlantic paths was considered.¹ However, in the observations reported in that paper, continuous records of the field intensities of several low-frequency stations operating on closely proximate frequencies were recorded at a single receiving point, and the observations reported did not include observations on the same station at several receiving points. In observations of the type formerly reported, the possibility remains that some of the observed differences may have been due to fortuitous and obviously inherently incoherent changes in transmitted power at the several transmitters.

As mentioned in this previous paper, variations of the character described make it difficult to obtain a close check of day-to-day field intensity variations at a given hour, such as 10 A.M., E.S.T. This difficulty applies to checks between the field intensities for two stations when received at a given point, as well as to checks between the variations of a single station when measured at different points.

Since a long and very valuable series of data in the form of 10 A.M., E.S.T. observations on low-frequency transatlantic field intensities exists,² measurements of these values have continued at two or more receiving points, and have been supplemented by frequent continuous records of the diurnal changes in these field intensities at these points. While ample evidence exists to establish the value of the 10 A.M. observations and their susceptibility to statistical treatments, little infor-

* Decimal classification: R270. Original manuscript received by the Institute, May 20, 1935. Presented before joint I.R.E.-U.R.S.I. meeting, Washington, D.C., April 27, 1934.

¹ Kenrick and Pickard, Proc. I.R.E., vol. 22, pp. 344-358; March, (1934).

² See the many papers published in the Proc. I.R.E. by L. W. Austin.

mation has thus far been made available in the literature as to the degree of coherence to be expected in daily observations of this type when taken along the same great-circle path at distances separated by a number of wavelengths.³ The primary objects of the observations reported in this paper were as follows:

1. To determine the probable error of isolated 10 A.M. observations from the same station at two points separated by a number of wavelengths.
2. To determine whether or not the variations in the field intensity of the same low-frequency station are more coherent at two points of observation separated by a number of wavelengths than are the variations of the field intensity of different transmitters when observed at the same point.
3. To extend the continuous recording to a study of short time variabilities associated with magnetic storms and earth currents.
4. To investigate the group velocity of low-frequency signals.

COMPARISON OF DIURNAL VARIABILITIES OVER VARIOUS PATHS

The results of the observations have indicated that the differences observable in the diurnal changes of the signals received from GBR when recorded at Boston, Mass., and Riverhead, L. I., are fully as substantial as the differences between the fading curves of SPL and GBR at Riverhead or GBR and DFY at Boston. Examples of these latter departures have already been reported.¹

Still more surprising characteristics of these differences than were at first suspected are, however, shown in Figs. 1 and 2 which seem typical of conditions found to exist over the paths in question. It will be noted that the ratio of day-to-night field intensities is substantially greater (sometimes as much as 2:1) in the case of the Rugby-Riverhead path than in the case of the Rugby-Boston path and that the night maxima frequently occur at different times. Nevertheless, the dip in field intensity due to European sunset and American sunrise phenomena, similar to those already shown,¹ are present in both records and are in substantial accord.

A comparison of the Rugby-Riverhead and Warsaw-Riverhead

³ L. W. Austin, "A method of representing radio wave propagation conditions," *Proc. I.R.E.*, vol. 19, pp. 1615-1617; September, (1931). Austin clearly recognized that there were considerable departures in amplitude and direction in his daily 10 A.M. observations between various low-frequency channels. He believed these to be due to transmission phenomena. He was, however, not in a position to establish to what extent the observed changes might be due to changes at the transmitters or to errors in measurement. He was, therefore, strongly in support of observations such as those reported in the previous paper¹ and their extension as herein described.

paths is shown in Fig. 3. In general, it seems probable that some of the random differences in the detail of the fading curves are associated with phase interference phenomena analogous to those connected with the random fading existing at higher frequencies. These phenomena may be responsible for departures in the fading detail of the records which frequently result in minor incoherent maxima and minima near 10 A.M., rendering it difficult to make checks of point observations of

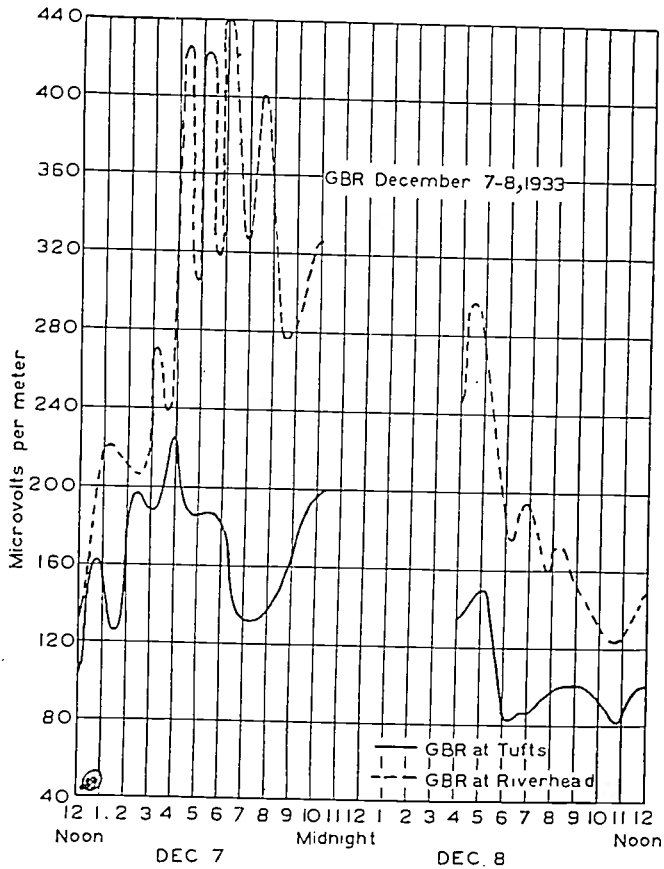

Fig. 1—Comparative field intensity variations of GBR as received at Riverhead, L.I., and Medford, Mass., on December 7 and 8, 1933, E.S.T.

low-frequency field intensities. However, it seems less plausible that consistent departures in day-to-night field intensity ratios between two points of observations separated by only about twelve wavelengths can be due to a consistent interference pattern.

That such a consistent difference exists is illustrated in Fig. 4 where a plot of the ratio of maximum to minimum field is presented for all the periods during which continuous records on the same station were available at Riverhead as well as at Boston.

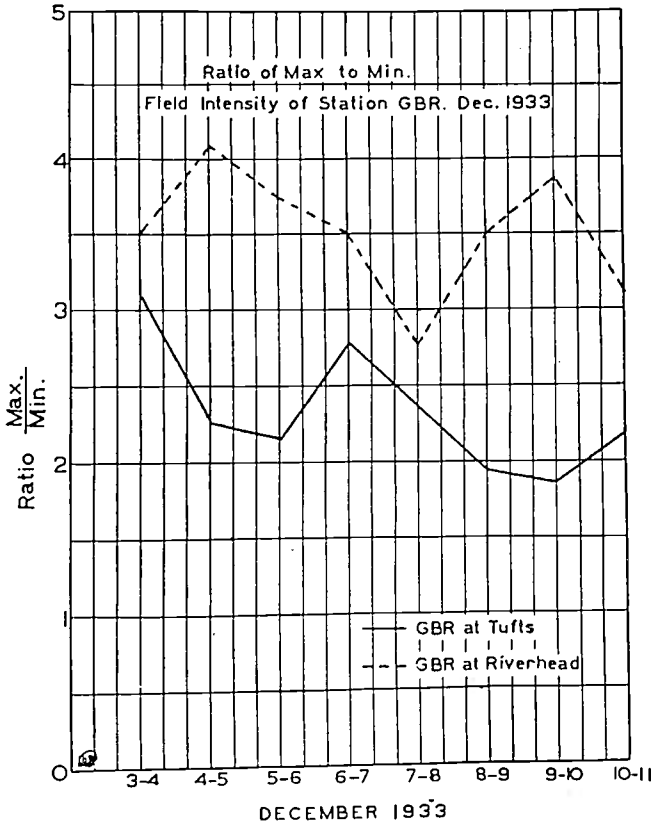

Fig. 2—Maximum to minimum field ratios for GBR as received at Riverhead, L.I., and at Medford, Mass., December 3 to 11, 1933. Note consistent difference in the ratios.

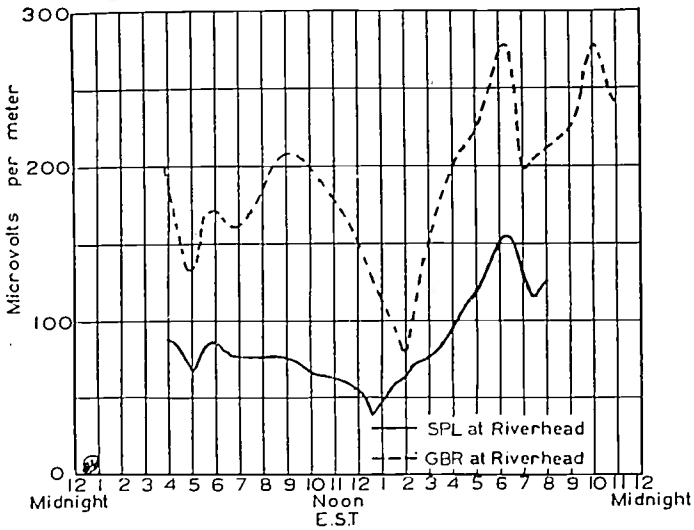

Fig. 3—Comparison of Warsaw-Riverhead and Rugby-Riverhead records of March 23, 1934. Note large difference in maximum to minimum field intensity ratios during morning fading.

Again it is natural to suspect such consistent differences to be associated with differences in the characteristics of the receiving systems employed rather than transmission phenomena, and precautions were hence taken to assure the linearity and comparability of the records at both points.

Inasmuch as the use of directive antenna systems is essential if reasonable continuity is to be secured (due to the unfavorable signal-to-noise ratio usually experienced on these frequencies) it was suspected that differences in pickup associated with the directive systems

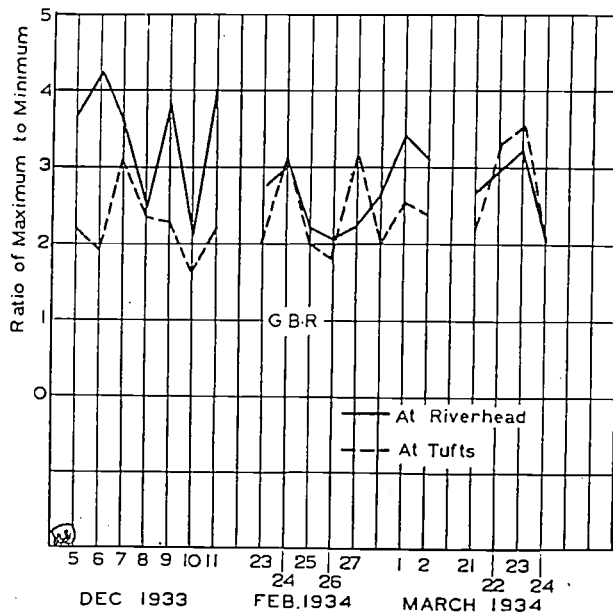

Fig. 4—Comparison of maximum to minimum field ratios on GBR as received at Riverhead and Medford on dates indicated.

employed might be responsible for the observed variations, since these systems in general respond differently to changes in polarization angles or wave tilt. Accordingly, a comparison between the respective directional systems employed (i.e., a wave antenna at Riverhead and a barrage array at Boston) was made by referring each to a reference vertical antenna during alternate two-minute intervals. The results of these measurements on GBR are shown in Fig. 5. It will be noted that the departures between Riverhead and Boston are much greater than those between the two types of antenna systems. The result of these measurements, therefore, clearly indicates that no substantial part of the observed differences in mean day-to-night ratio are attributable to the particular antenna systems, and, inasmuch as the same receivers were employed at different levels during the comparison, any

lack of linearity therein was also effectively eliminated from consideration. The authors are not ready to discuss the explanation of this surprising difference, although it seems more probable that it is associated with phenomena similar to the sunrise "dips" which reproduce at various points of observation rather than with simple phase interference phenomena such as are noted on the higher frequencies.

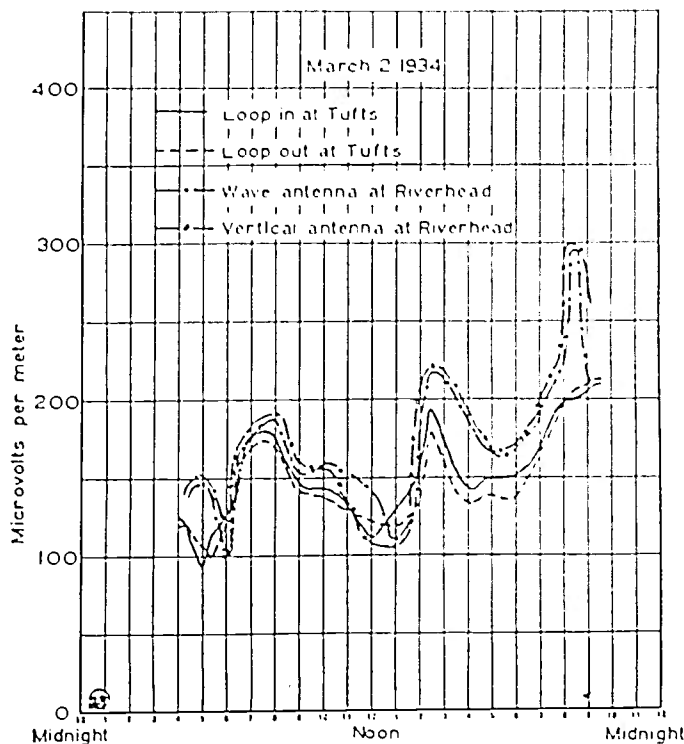

Fig. 5—Comparison of GBR signal at Riverhead and Boston on two antenna systems at each point. Note departures between points of observation are much greater than between antenna systems.

RELATION OF LOW-FREQUENCY TRANSMISSION AND EARTH POTENTIAL CHANGES

What is, so far as is known, a new aspect of the low-frequency transatlantic observations has been concerned with a study of the relation of these field intensities to earth potential changes. Earth potential records are available both at Riverhead and Boston, and on numerous occasions disturbances in field intensities which are apparently associated with earth current changes have been observed. In some cases, these changes were recorded simultaneously, although with variable detail at both points, while in other cases only one point of observation was effected. Some striking examples of these phenomena are shown in Figs. 6, 7, and 8. As detailed a correspondence as

shown in these records is by no means generally associated with earth-current disturbances, although considerable turbulence in field intensity usually accompanies the periods of earth-current disturbance which, of course, closely follow magnetic storm disturbances. These longer time disturbances usually result in a flattening of the field intensity curves.¹ The close correlation in detail is, however, usually most readily observable in connection with certain short time earth potential disturbances which are fairly well isolated from major poten-

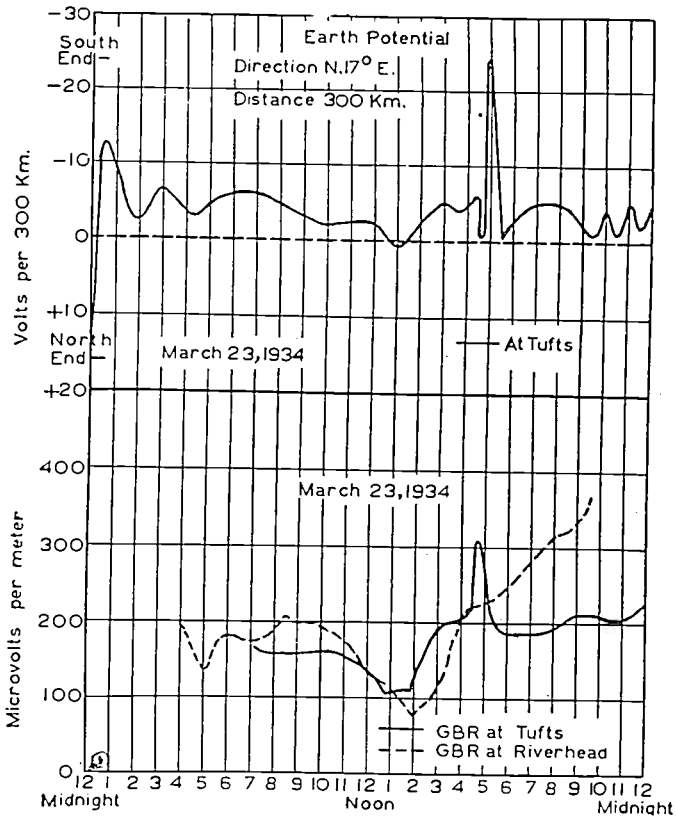

Fig. 6—Plot of field intensity variations from GBR on March 23, 1934, E.S.T. Note close correlation between rapid change in signal intensity at Boston and change of Boston magnetic field. Also note negligible effect on GBR field intensity at Riverhead.

tial swings. In the case of more complicated disturbances it appears that variable lag factors may result in a loss of detailed correspondence. The fact that the disturbances are frequently observable at one point only is, of course, also evidence showing that the field intensity curves frequently show wide departures.

GROUP VELOCITY FOR LOW-FREQUENCY TRANSATLANTIC SIGNALS

Another low-frequency phenomenon which may or may not be relevant to this discussion is the surprising reduction in group velocity

for low-frequency transatlantic signals indicated by the studies of Loomis and Stetson.⁴ They have derived figures for the time of group frequency propagation of the signals from GBR (16.2 kilocycles) and NSS (17.8 kilocycles) over the path from Rugby to Washington as a result of a study of published time signal corrections.

The figure for the group frequency time of propagation arrived at from this study indicates a lag of 0.04 second. If we assume this to represent the group retardation time in the medium as contrasted

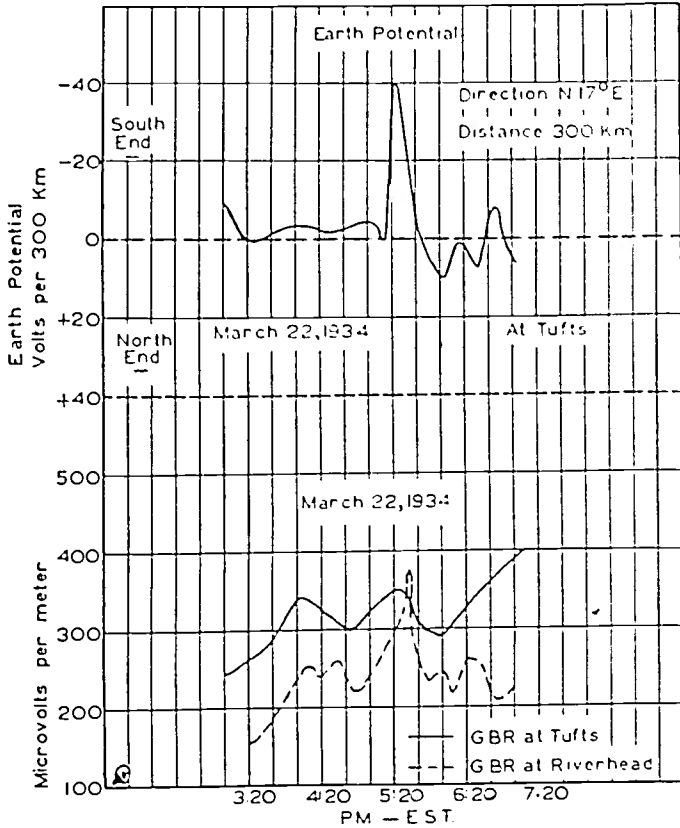

Fig. 7—Plot of field intensity variations from GBR on March 22, 1934. Note close correlation between rapid change in signal intensity at Riverhead and change of Boston magnetic field. Also note negligible effect on Boston field.

with effects conceivably associated with common group retardations or time lags in the terminal equipment, we arrive at an apparent velocity of group propagation of less than one half the accepted values for the velocity of light in free space.

Such a striking departure in group velocity encouraged a further experimental study of these group propagation times. It appeared probable that if any such great departures in group velocity existed,

⁴ Loomis and Stetson, "An apparent lunar effect in time determination at Greenwich and Washington," *Royal Astronom. Soc.*, April, (1933).

they should be functions of frequency, particularly in view of the fact that previous values for the group velocity of high-frequency radio

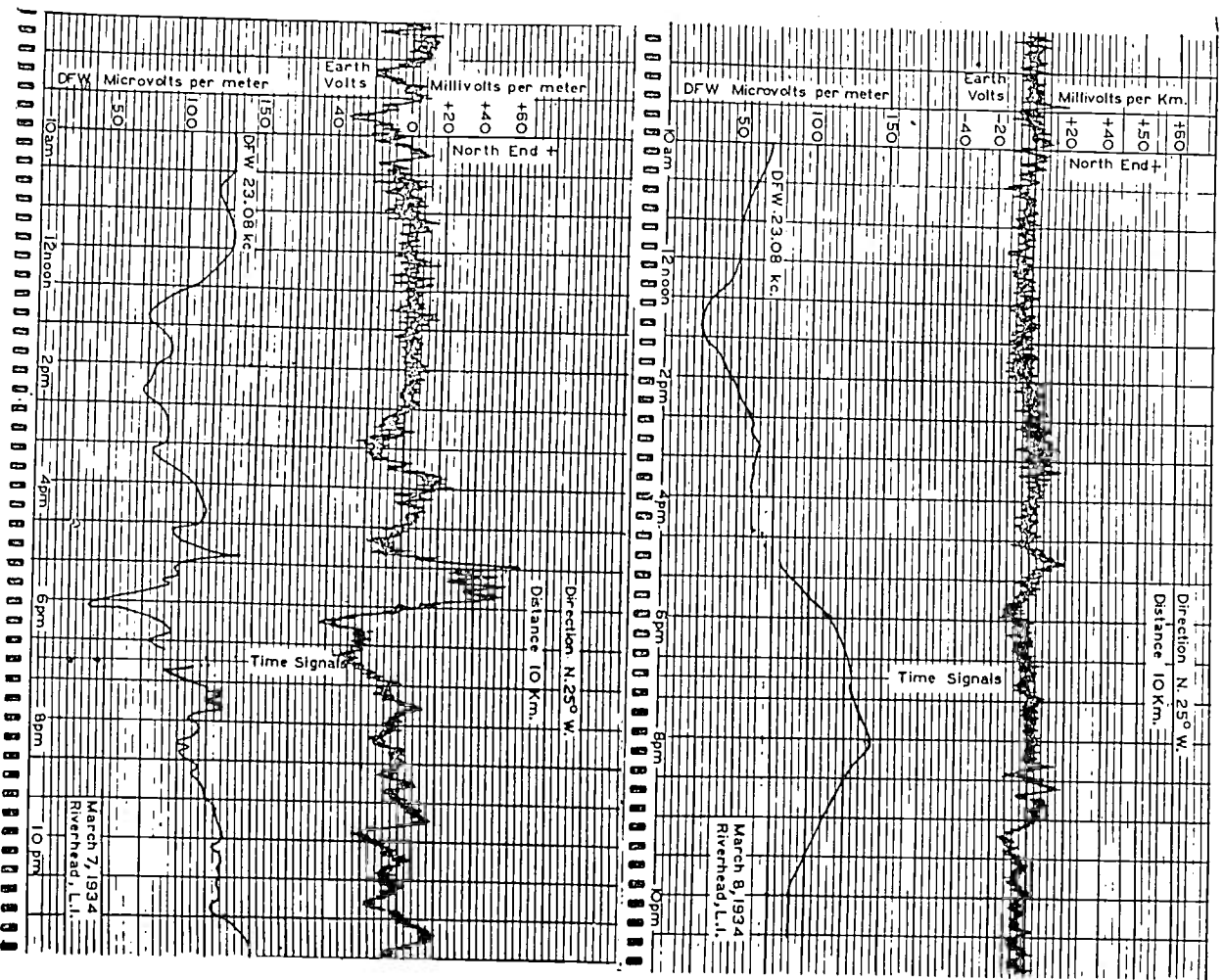

Fig. 8—Comparison of transmission from DFW (23.08 kilocycles) on March 7, 1934, and March 8, 1934. Note close relation between field intensity variation and earth potential changes on March 7 and normal gradual rise in field intensity on March 8. Also note the higher field intensity during the forenoon of the disturbed day, March 7.

signals have been in close accord with the accepted values for C ; i.e., the velocity of light in free space.⁵

⁵ See, for instance, Quäck and Mögel, "Double and multiple signals with short waves," *Proc. I.R.E.*, vol. 17, pp. 791-823; May, (1929).

Oscillograms were taken at Boston and Riverhead on DFY (16.55 kilocycles) and DGU (9650 kilocycles) on simultaneous transmissions of time signals on both frequencies provided by special schedules through the kind co-operation of the German administration. The results between the two points of observation checked each other (usually within about two or three milliseconds) and the indicated time lags of the low-frequency dashes of from 11 to 21 milliseconds checked well with the mean value of the difference in time lags of 13.1 milliseconds reported for the transmitters from oscillograms taken at the Nauen transmitters. The mean lags at the transmitters were reported as 34.3 milliseconds for DFY and 21.2 milliseconds for DGU. While it was obviously impracticable, due to variable transmission conditions, to make oscillograms reliably of the same dots at all points, and since relay lag changes of a few milliseconds could well be expected,

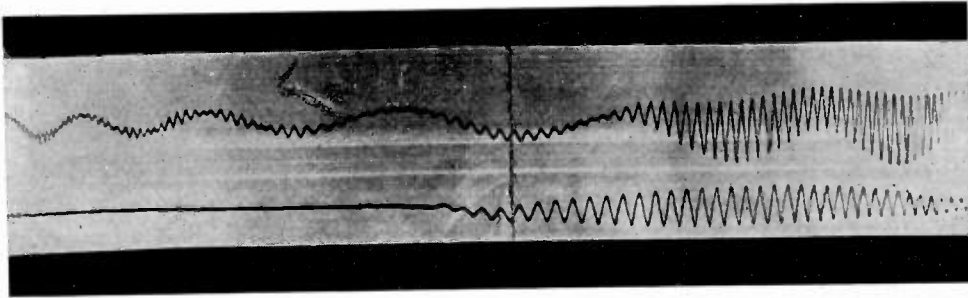

Fig. 9—Oscillogram showing measured time lag of DFY vs. DGU of 14 milliseconds as observed at Boston, 7 P.M., April 22, 1934. (Actual transmission difference indicated is only one or two milliseconds when corrected for reported differential relay lag at transmitter of 13+ milliseconds.)

for different dots, it will be noted that the corrected signals give the same time of propagation for both signals within a probable error of two or three milliseconds. Variations of this amount may be expected, caused not only by variations in relay lag corrections but by uncertainties in reading the low-frequency records due to superimposed noise and also to possible group retardations of the order of a few milliseconds in the receiving and recording equipment. Examples of the records taken are shown in Figs. 9 and 10. It will be noted that the setups were different at the two receiving points. The good agreement obtained is considered as evidence for the relative unimportance of receiving equipment corrections. Fig. 9 utilized a string oscillograph and Fig. 10 a cathode-ray setup.

There appears, therefore, to be little evidence at the time these observations were taken, for any large difference in propagation time, certainly not of the order of 20 milliseconds such as would be indicated by the values reported by Loomis and Stetson. More conclusive evi-

dence as to possible periodic differences and refinements in timing for the measurements of possible small differences of course await a more extended series of measurements. It is hoped that more precise measurements of this sort may be available in the near future.

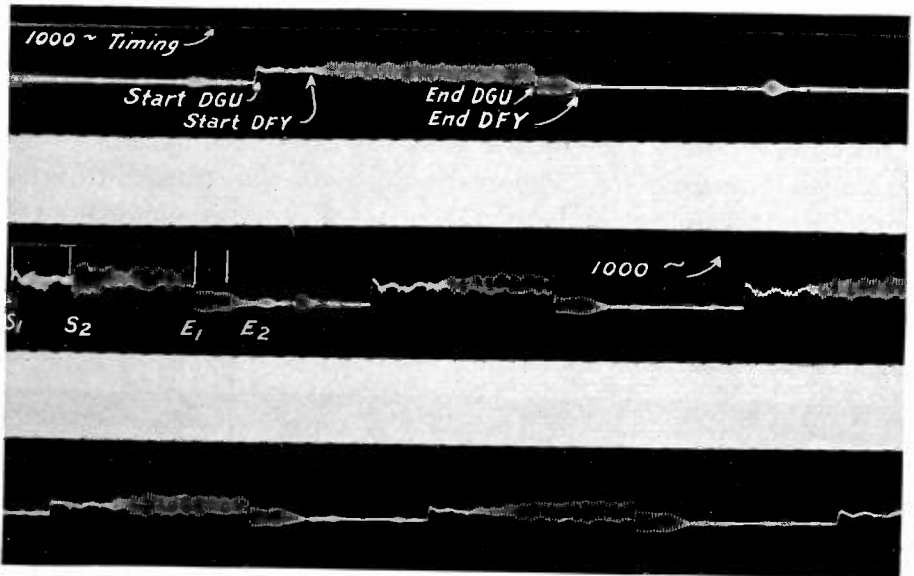

Fig. 10—Oscillogram taken at Riverhead on April 24, 1934, showing measured time lag of DFY vs. DGU of 21 milliseconds which compares with the 20.3 milliseconds relay correction supplied by the German administration. The time lag is determined from the start of the signals indicated as S₁ and S₂. The lag determined from the ends of the signals (E₁ and E₂) is less, probably due to multipath transmission on DGU.

ACKNOWLEDGMENT

The writers wish to express their appreciation to the National Research Council for a grant-in-aid-of-research which made possible the observations in the vicinity of Boston.



A STUDY OF GROUND-WAVE RADIO TRANSMISSION*

BY

R. C. HIGGY

(The Ohio State University, Columbus Ohio)

AND

E. D. SHIPLEY

(Radio Consultant, Columbus, Ohio)

Summary--The excellent agreement between the value of ground-wave field intensities, observed in Ohio, and the Sommerfeld theory is described. The application of this theory in predicting signal intensities is also indicated.

THE results described in this article grew out of one of the many engineering problems involved in the design of the radio communication network for the State Highway Patrol of Ohio. The particular problem involved here is the determination of how the field strength is functionally related to the distance from the transmitter. There are several empirical and semiempirical formulas that give a correlation between field strength and distance traversed by the propagated electromagnetic wave. It is generally admitted that the Austin Cohen formula, or any other relation that views the in-transit dissipation as causing exponential damping, is too pessimistic to govern extensively design procedure.

The authors, after a preliminary investigation, decided to use the van der Pol ground-wave approximation to the Sommerfeld theory. The effective value of the vertical component of electric intensity, due to the ground wave, is as follows:

$$E = \frac{K\sqrt{P}}{R} \cdot f(\rho) \text{ microvolts per meter.}$$

In this expression P is the power input to the antenna (vertical three-eighths wave in this case) in watts, R is the distance in miles from the transmitting antenna to the point where E is measured, $f(\rho)$ is the damping function shown in Fig. 1, and K is the antenna radiation constant, or field strength at one mile per root watt, when attenuation is neglected. The variable ρ is defined as follows:

$$\rho \equiv \frac{0.00844R}{\sigma\lambda^2 \cdot 10^{13}}$$

where σ is the effective conductivity in electromagnetic units of the ground, and λ is the transmitting wavelength measured in kilometers.

* Decimal classification: R113.7. Original manuscript received by the Institute, April 3, 1935.

The following approximation to $f(\rho)$ is also shown in Fig. 1:

$$f_A(\rho) = \frac{2. + 0.3\rho}{2. + \rho + 0.6\rho^2} \approx f(\rho).$$

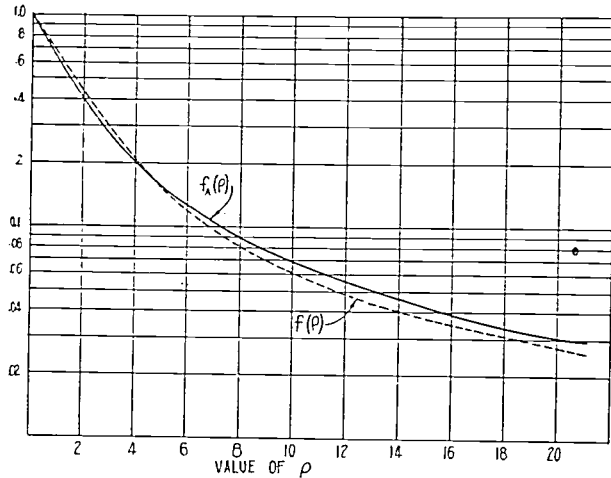

Fig. 1.

For most purposes the difference between $f(\rho)$ and its approximation $f_A(\rho)$ is inconsequential, and, therefore, $f_A(\rho)$, due to its closed form expression involving ρ yields a simple way of studying some of the

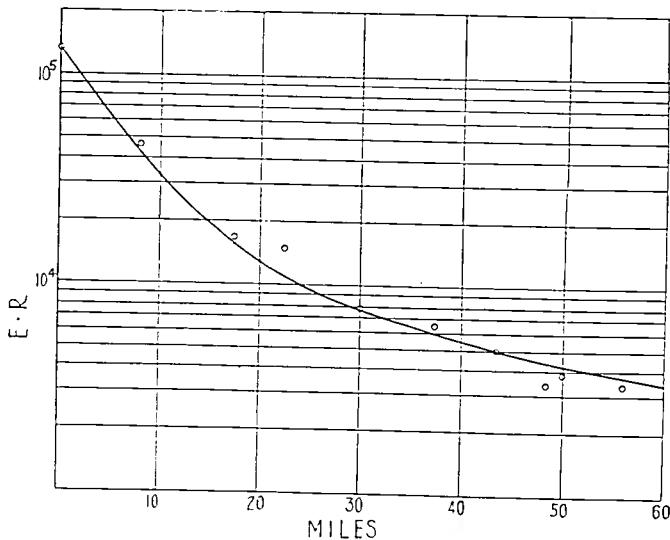

Fig. 2—WPHC, Massillon, Ohio. Transmission east. $K\sqrt{P} = 130,000$, $\sigma = 0.68 \times 10^{-13}$, $\lambda = 0.188$ kilometer.

salient features of the damping function. However, the subsequent theoretical curves to appear in this article will be based upon $f(\rho)$, rather than $f_A(\rho)$, due to the fact that a closer agreement with observed values is thereby obtained.

The purpose of this paper is to exhibit several cases of close agreement between the above theory and observed field intensities. Figs. 2, 3, 4, and 5 are graphs of $E \cdot R$ vs. R . The points indicated by circles

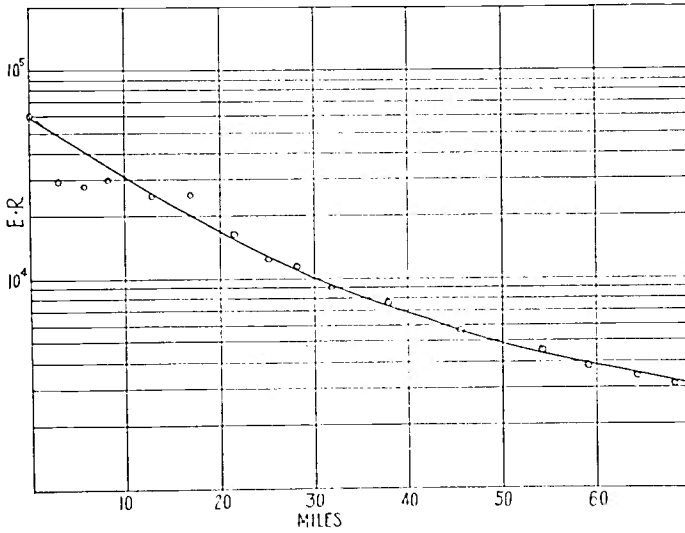

Fig. 3—WPGG, Findlay, Ohio. Transmission south. $K\sqrt{P} = 60,000$, $\sigma = 1.63 \times 10^{-13}$, $\lambda = 0.178$ kilometer.

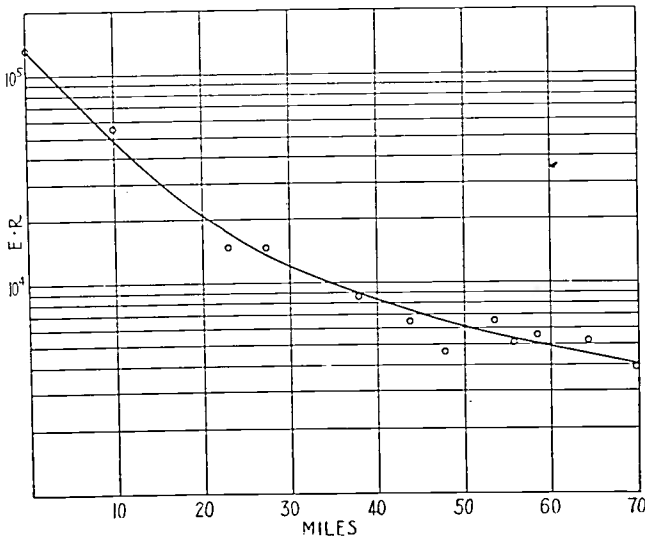

Fig. 4—WPHC, Massilon, Ohio. Transmission west. $K\sqrt{P} = 130,000$, $\sigma = 0.96 \times 10^{-13}$, $\lambda = 0.188$ kilometer.

were experimentally obtained by making daytime field strength measurements at several distances from the source in some convenient direction, while the curves were obtained from the previously discussed theory by choosing appropriate values for $K\sqrt{P}$, λ , and σ .

Since the conductivity, σ , is the only medium constant that enters this simplified ground-wave theory, it is rather striking that such fine agreement with measured field intensities is obtainable. However, the authors do not wish to imply that the above high order of correlation between theoretical and observed field strengths is to be consistently expected. In fact, there are two very good reasons why one should expect marked disagreement: In the theory σ is assumed to be constant which certainly is not exactly valid or even approximately true in many

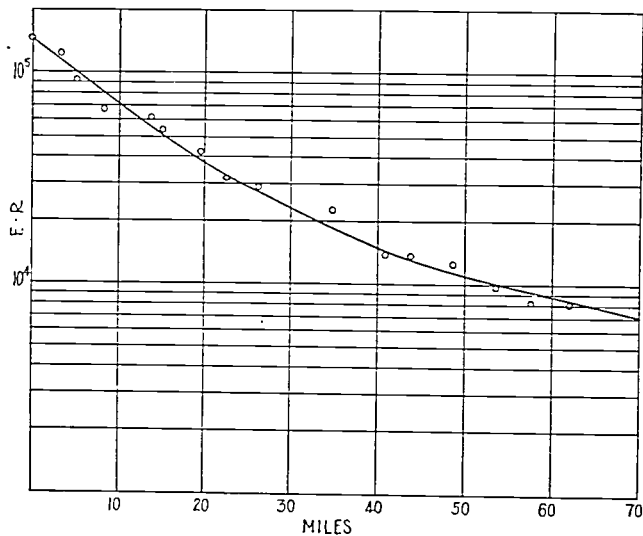

Fig. 5—WPGG, Findlay, Ohio. Transmission east. $K\sqrt{P} = 145,000$,
 $\sigma = 1.40 \times 10^{-13}$, $\lambda = 0.188$ kilometer.

cases, and the theory obviously does not take into account topographic discontinuities such as rivers, mountains, cities, etc. In other words, the amount of reliance to be placed in the above theory, when it is used in an a priori sense, must remain a matter of engineering judgment.

The writers have found several cases where the graph of $E \cdot R$ vs. R is very irregular, and in the majority of these cases have been rather fortunate in establishing a correlation between these irregularities and topographic or geologic discontinuities. However, the authors feel that the data at their disposal are insufficient in scope to yield any certainty to a discussion of this phase of the subject at the present time.



AN ANALYSIS OF DISTORTION IN CLASS B AUDIO AMPLIFIERS*

By

TRUE MCLEAN

(School of Electrical Engineering, Cornell University, Ithaca, New York)

Summary—The more important defects of class B audio-frequency amplifiers are classified and examined in detail. A general method of determining harmonic components introduced by curvature and asymmetry of the combined plate current curves of a pair of tubes is given, with a tabulation of results in a practical case.

The main body of the paper deals with an accurate quantitative determination of the harmonic components introduced in the output by the effects of irregular grid currents on regulation of the driver amplifier, and the characteristics of practical coupling transformers. The effects of loading the driver amplifier are analyzed, and it is shown that a class A driver has minimum regulation when unloaded, and a class B driver has minimum regulation when loaded to the limit of anode dissipation. Class A and class B drivers are compared, and a general figure of merit for any driving system is proposed. It is shown that distortion due to grid currents in the output tubes can be reduced as far as desired by proper design, the only limit is economic.

Methods of impedance correction and removal of reactance effects in coupling transformers by the addition of capacitors are discussed. Building out the transformer reactances into filter sections results in a wider transmitted band, more uniform transmission in the band, suppression of components contributing to adjacent channel interference, and lowered nonlinear distortion because of improved uniformity of load impedance. In the case of the driver input network, the gain may also be increased by overneutralization of tube capacities.

Miscellaneous effects such as transformer core saturation and power supply regulation are briefly treated.

DURING the last four years class B audio amplifiers have found widespread acceptance for use as high level modulators in large radio transmitters. The large economies attainable as compared with other practical systems have made possible the construction of very large units,¹ and in many cases the choice has been made in favor of the class B audio amplifier even when the size of unit was small enough to make the cost difference unimportant. But the high level system has not won universal acceptance even in large units,² largely because there remains a lingering suspicion that class B audio amplifiers cannot be constructed and operated with as low audio harmonic distortion as a well-built low level system.

* Decimal classification: R148.1×R363.2. Original manuscript received by the Institute, August 23, 1935.

¹ Proc. I.R.E., vol. 21, pp. 944-957; July, (1933), and vol. 22, pp. 1151-1180; October, (1934).

² Electronics, p. 38, February, (1935).

It is the purpose of this paper to present a fairly complete analysis of the imperfections of class B audio amplifiers, and to indicate some ways the difficulties can be overcome without resorting to the design of special tubes.

Distortion in audio systems has been commonly classified in three general types, (1) frequency discrimination, (2) nonlinear, or overloading, which results in the introduction of frequencies not present in the signal input, and (3) phase, or delay distortion. These three types are usually thought of as independent, but in the class B audio amplifier conditions may easily be such that with improperly designed coupling transformers distortion of type (1) may be somewhat dependent on amplitude, and type (2) may produce components whose amplitude is a function of signal frequency. Requirements for good performance with respect to type (3) are so easily met in the case of audible programs that they need not be discussed here.

The basic theory of the class B audio amplifier has been ably treated by Barton.³ Three assumptions are commonly made when discussing theory and performance; first, the over-all curve of grid voltage vs. plate current for a pair of tubes may be made essentially linear up to the saturation limit by proper choice of bias voltage. Second, the coupling transformers are either assumed to have ideal characteristics, or merely to introduce some discrimination near the ends of the useful band of frequencies because the open-circuit inductances are not infinite, and the leakages not zero. Third, the tubes are assumed to be perfectly matched, and the transformer windings perfectly balanced. In common practice the violation of these common assumptions is the principal cause of poor performance, ordinary operating defects excepted.

In making an analysis, it is easiest to examine defects one at a time, considering other defects absent for the moment, and examine interactions, if any, after the principal effects have been studied singly.

Consider first the nonlinear distortion produced by departures from the ideal linear output-current vs. grid-voltage relation. Assume for the present that the load is a pure constant resistance, that the grid voltage is a pure sine function in time and supplied from an ideal generator of zero internal impedance, and that the coupling transformers are ideal. In Fig. 1. are shown typical plate-current and grid-current curves for specified circuit conditions, taken on a general purpose triode (nominal class C rating 1000 watts) following the methods

³ Proc. I.R.E., vol. 19, pp. 1131-1150; July, (1931), and vol. 19, pp. 1884-1885; October, (1931). For early description of principles, see British Patent No. 275, series of 1915, and U. S. Patent No. 1,128,292 issued to E. H. Colpitts, February 16, 1915.

outlined by Barton.³ In this case, however, maximum output power was not the desired goal, and the load resistance selected was chosen from a large family of sample curves so that a specified output power is obtained with the best efficiency consistent with low harmonic content. The tube used is capable of considerably higher output, but at the expense of poorer efficiency and higher distortion. The main advantage to be gained by conservative output values is that the performance is much more uniform throughout normal tube life, especially near the end. For the conditions of Fig. 1 it is especially pertinent to remark that a considerable number of commercial tubes from two different manufacturers showed remarkably small variations in the plate-current curves, and very wide variations in the grid-current curves. As

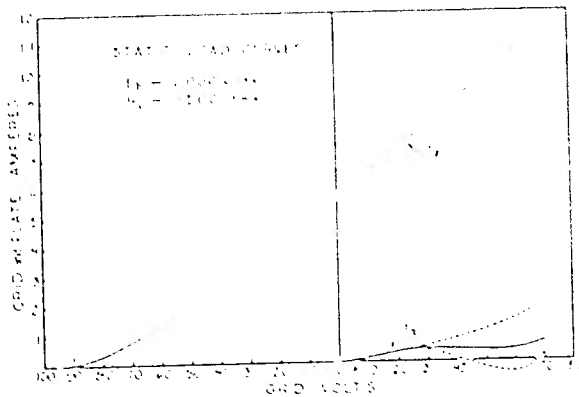

Fig. 1—Plate and grid-current curves for 1000-watt (nominal) general purpose triode. Full line grid-current curve is about average for the tubes measured. Dotted curves indicate roughly the extreme range of variations due to secondary emission from the grid.

the tubes wear out, the changes in plate-current curves are very slight, but the grid current-curves generally change considerably in the direction of increased secondary emission. Fig. 1 is accurately drawn from a considerable amount of experimental data.

Various rapid and short-cut methods have been suggested for the harmonic analysis of a curve such as that of Fig. 1.⁴ Most such schemes are open to the objection that they are not general in application, and it is all too easy to fall unsuspectingly into serious errors, especially when the application is not identical to the conditions for which the method is designed. The best general methods that have come to the attention of the author are to be found in "Electric Circuit Analysis" by M. G. Malti. The notation used here is from Malti.

The plate-current curve of Fig. 1 yields varying amplitude coefficients for the harmonics depending on the bias voltage chosen, and

⁴ See for example, Proc. I.R.E., vol. 22, pp. 1090-1101; September, (1934).

whether or not the second tube is an exact duplicate. It has been found impracticable to reduce the even harmonic content due to tube unbalance to a low value by simply matching tubes unless one has available a large and expensive stock to explore. If the driver circuit is equipped

TABLE I

p	B_p^*	Per cent
1	1.083	100
3	-0.01813	1.675
5	-0.00373	0.344
7	0.00393	0.363
9	0.000586	0.0542
11	0.001414	0.1304
r-m-s	0.019	1.755

* Values of B_p are in amperes.

with individual adjustments of both bias and excitation, a very satisfactory balance can be forced with almost any pair of commercial tubes. On this basis, the analysis given in Table I assumes identical tubes, since it has been found by experiment that by proper adjustments of differential bias and excitation, almost any pair of tubes can be made to "track" together very well over the entire range of output power.

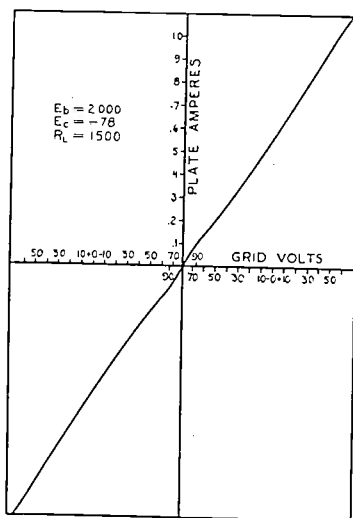

Fig 2—Combined plate-current curves for two tubes having the characteristics of Fig. 1. The value of bias voltage is chosen to give a transition that results in minimum distortion.

The analysis tabulated is for the bias voltage giving minimum total distortion. The over-all curve for two tubes is shown in Fig. 2. Applying a sine voltage the resulting current wave has the symmetries

$$f(x) \equiv -f(-x); f(x) \equiv -f(\pi + x); f(x) \equiv f(\pi - x) \quad (1)$$

which result in the series

$$f(x) = \sum B_p \sin px \quad (p = \text{odd integer}). \quad (2)$$

If unbalance exists, the symmetries

$$f(x) \equiv -f(-x) \text{ and } f(x) \equiv -f(\pi + x)$$

are destroyed, and the resulting series is

$$f(x) = \frac{A_0}{2} + \sum A_q \cos qx + \sum B_p \sin px \quad (q = \text{even integer}). \quad (3)$$

In this particular case the even harmonic terms tend to converge more rapidly than the odd terms, because of the physical character of the curve being analyzed. If separate direct-current meters are connected in the tube plates, and they indicate an unbalance near full output, a rough approximation of the second harmonic introduced can be made quickly if the input is a pure sine wave. The unbalance is

$$\frac{I_1 - I_2}{I_1 + I_2}$$

which is twice the amplitude of the total cosine series. Since the convergence is very rapid in this case, it is almost all second harmonic, so the per cent second harmonic is roughly

$$\frac{A_2}{B_1} \doteq \frac{I_1 - I_2}{I_1 + I_2} \times 50 \text{ per cent.} \quad (4)$$

The next step is to determine the grid current as a function of time for a sinusoidal grid voltage wave. On Fig. 1 is shown a grid-current curve that is about an average of the tubes studied. The dotted curves represent roughly the limits of variation that may be expected. Tubes giving a steady rising curve indicating the absence of secondary electron emission from the grid seem to be exceptional, and the effect must certainly be taken into account when designing a driver amplifier. In Fig. 3 the grid current curve has been reduced to a time function. The process is simply to project a sine wave on to the curve of Fig. 1 and plot the resulting ordinates on an axis of electrical degrees, which is proportional to time.

In determining the distortion of final output which is due to reaction of the grid current on the driver, use is made of an assumption that is known in advance to be false, but which leads to a very close approximation, if the distortion is not extremely large. The accuracy improves as distortion is lowered. The assumption is that the grid-voltage wave is sinusoidal. This is true only when there is no distortion due to driver regulation, and the latter item is what is to be determined. The apparent impossibility of the situation is removed by re-

course to a method of exhaustion. The grid current is determined for an undistorted voltage wave. The distortion effect in the driver is then determined. This leads to a new voltage wave, which in turn leads to a corrected grid-current wave, and the circle can be traversed as many times as needed to give the desired approximation. Fortunately, however, the distortions that can be tolerated in a good audio system are small enough, so that the first approximation is excellent, and if the driver regulation is good enough to make the design at all acceptable, the corrections to the first approximation are very small indeed.

The grid current, in returning to the cathode, flows through half the secondary winding of the interstage transformer, and whatever equipment is used to supply bias voltage. The resistance offered to the grid current is composed of the resistance of the bias supply, plus the resistance of half the transformer secondary, plus the total primary circuit resistance reduced by the square of the turns ratio. The total primary resistance is composed of the effective plate impedance of the driver tubes plus the transformer primary winding resistance. Let us lump all these resistance values into a single quantity hereafter called the driver resistance. More will be said later about the part due to the driver tubes. No method seems to be known by which the leakage reactance of a practical transformer can be totally eliminated. For several years designers of communication transformers have progressively reduced the leakage effects, but the efforts of late seem to be meeting the law of diminishing return. The leakage inductance of the driver transformer is the only appreciable reactance element in the driver circuit (unless a direct-current generator is used for bias, in which case its internal inductance may have a very bad effect). The inductance which is effective is that measured across one half the secondary, with the primary winding closed on itself. Let us call this the driver inductance.

The grid current flowing through the driver circuit will produce voltage drops across the resistance and inductance which reduce the voltage realized at the grids below open-circuit value that would be reached if there were no grid current. The drop due to resistance is of course at any instant the product of the grid current and the driver resistance. But the drop due to inductance is proportional to the instantaneous rate of change of the grid current, so that the total drop is

$$e_d = Ri_g + L \frac{di_g}{dt}. \quad (5)$$

The instantaneous grid-current values are obtained from the current

curve of Fig. 3. In order to evaluate the derivative, a series of tangents were drawn to the current curve, and the slopes plotted. The base scale of all curves is electrical degrees for one-half cycle. The ordinates of the current curve are milliamperes, and those of the derived curve, milliamperes per electrical degree. Equation (5) requires that the time rate be measured in amperes per second, so that the inductive drop can be found in volts if L is in henrys. Electrical degrees are converted to seconds by dividing the scale by 360 times the applied frequency.

The curves of Fig. 3 are computed from measurements on a practical driver amplifier constructed at Cornell University which had a driver resistance measured as defined above equal to 67.4 ohms, and an inductance of 0.00264 henry. The peak grid current in the case at

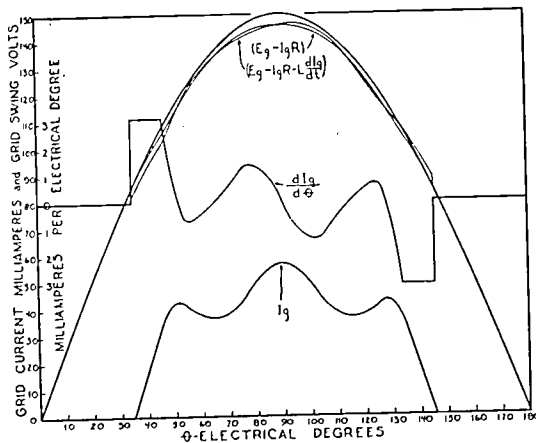

Fig. 3—Showing the grid current of Fig. 1 reduced to a time function, along with the first differential of the time function. The assumed grid voltage is sinusoidal, shown as a large half-sine wave. Directly below are shown the first approximation curves of grid voltage corrected for resistance drop alone, and for total drop at 1000 cycles. The driver circuit constants are given in the text.

hand is 57 milliamperes, which results in a resistive drop of 3.84 volts. The peak grid voltage assumed is 150 volts. This is a maximum departure of the actual grid voltage from the undistorted value, a little over 2.5 per cent. It will be seen later that the harmonic distortion introduced is much less than the maximum departure.

The drop due to driver inductance can be evaluated by changing scales of the derived grid-current curve. In order to show the greatest effect, a frequency of 1000 cycles was chosen for the input voltage. If the frequency is much lower, the inductive drop becomes very small, if much higher, important harmonic components pass out of the audible band. At this frequency, the maximum ordinate (3.2 milliamperes per degree) of the derived curve becomes 1150 amperes per second rate of change of grid current. Through the driver inductance

this produces a drop of 3.03 volts. In Fig. 3 are shown a large half-sine wave for the assumed undistorted grid voltage, and two other waves of grid voltage; one for a frequency low enough to make the inductive effect negligible, showing the resistive drop alone; and the other for 1000 cycles, showing the combined effects of the drops instantaneously added.

The above analysis made on an instantaneous basis is of interest mostly from an academic point of view. It offers a simple way of showing what happens. Of greater interest from the design viewpoint is an analysis made from the steady-state components of the grid current found from the equivalent Fourier series.

TABLE II
GRID-CURRENT CURVE

p	$B_p \dagger$	Per cent*	$pB_p \dagger$	Per cent*
1	42	100	42	100
3	-12.43	29.6	-37.3	89
5	-5.41	12.9	-27.05	64.3
7	-1.363	3.25	-9.54	22.7
9	7.23	17.2	65	155
11	-1.316	3.13	-14.47	34.5
13	-2.58	6.14	-33.5	80
15	-0.04	0.1	-0.6	1.4

$Z_0 = \frac{E_m}{B_1} = 3670 \text{ ohms.}$

* Percentages refer to fundamental.
† Values of B_p are in milliamperes.

DISTORTION COMPONENTS

p	E_R^*	Per cent†	E_L^*	Per cent†	$\sqrt{E_R^2 + E_L^2}$	Per cent
1	2.83	1.885	0.697	0.465	2.91	1.94
3	-0.839	0.559	0.619	0.413	1.044	0.696
5	-0.365	0.243	0.449	0.299	0.578	0.386
7	-0.092	0.0613	0.1583	0.0155	0.183	0.122
9	0.488	0.325	1.08	0.72	1.184	0.79
11	-0.089	0.0593	0.24	0.16	0.256	0.17
13	-0.174	0.116	0.556	0.37	0.583	0.389
15	-0.0027	0.0018	0.01	0.0067	0.0104	0.007
r-m-s	1.059	0.706	1.464	0.976	1.805	1.20

* E_R and E_L are in volts.
† Percentages refer to maximum grid excitation.

In Table II are given the results of a 120-point schedule analysis carried out to the fifteenth harmonic. The data indicate a monotonic convergence of the sequence of amplitude coefficients toward zero for higher order harmonics, so detailed figures were not carried out, since the labor is considerable. This table shows quantitatively what was evident by inspection of the curves of Fig. 3, that there is present in the grid-current wave a pronounced ninth harmonic.

In order to evaluate the distortion components analytically it is necessary to substitute the Fourier series representing the grid current in (5). This gives the components due to resistance drop directly, but

to obtain the inductive drop, it is evidently necessary to differentiate the series. It is to be specially noted that *differentiation of the series results in the multiplication of each amplitude coefficient by a factor equal to the order of the harmonic. Hence the convergence of the sequence of coefficients is adversely affected.*

Substituting (2) in (5) gives

$$e_d = R \sum B_p \sin (p \cdot 2\pi ft) + 2\pi fL \sum p B_p \cos (p \cdot 2\pi ft) \quad (6)$$

since $i_v = f(x)$ and $x = 2\pi ft$.

In Table II the coefficients of the derived series are listed along with the originals. It is to be noted that the amplitude coefficient of the ninth harmonic has risen to a value 55 per cent greater than the fundamental. Reduction of the value of driver inductance constitutes the only means of control over a situation that may be very bad indeed. Here is an example of nonlinear type distortion proportional to input frequency.

Two methods of computing total harmonic percentages are in common use; arithmetic addition of components expressed as a percentage of the fundamental, and root-mean-square effective addition similarly expressed. Both methods are rather unsatisfactory because they fail to take into account the psychological factor of variable sensitivity of the ear, and the rather complex effects of masking of the distortion components by the desired tones.⁵ Some sort of weighted average would appear to be better, but no satisfactory set of factors by which the components might be multiplied seems to be available. The presence of appreciable high order harmonic distortion due to driver inductance in a system that is otherwise good, does not produce an effect like that commonly recognized as nonlinear distortion. It is recognized as a faint high pitched hiss or scratch that rises and falls with the program level.

Distortion due to high order audio harmonics that may pass without detection on a listening test may still produce a very bad condition of adjacent channel interference.⁶ A good selective receiver located near a transmitter suffering with this defect will often have no difficulty detecting components as far as fifty kilocycles removed from the carrier. Fortunately a very effective cure for the trouble is available. The inductive drop effect can be highly suppressed in the driver and a low-pass filter connected between the modulator and the modulated amplifier.

Although it is physically impossible to construct a practicable

⁵ Proc. I.R.E., vol. 21, pp. 682-689; May, (1933).

⁶ Proc. I.R.E., vol. 22, pp. 295-313; March, (1934).

driver transformer without leakage inductance by methods now known, this effect may be completely canceled as far as its external action is concerned, by making the undesired inductance serve as a circuit element in a wave filter section. The addition of a small capacity across the primary of the driver transformer, combined with the leakage inductance, forms a half section of a simple two-element "constant K " type low-pass filter.⁷ Its terminating impedance on the mid-shunt end is the plate impedance of the driver tubes. If the value of the capacity is chosen so that the mid-shunt iterative impedance of the half section equals the tube impedance, the section will then offer its mid-series iterative impedance (corrected for turns ratio) to the grids of the output tubes. In an ideal filter this is a pure resistance, up to the

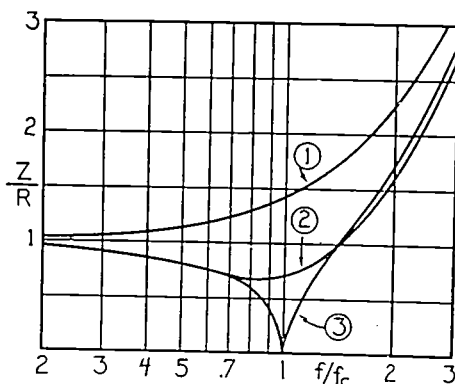

Fig. 4—Impedance characteristics of half-section filter built out of interstage transformer. The scales are reduced to ratios applicable to any particular transformer. Curve 1 is the modulus for a practical transformer without correction. Curve 2 is the actual modulus for the corrected network. Curve 3 is the characteristic of an ideal filter section terminated in its iterative impedance. (See footnote 7.)

cutoff frequency. Practically, the improvement obtained is worthwhile, but does not approach the ideal because of rather large mismatch of impedance terminating the filter section as the cutoff frequency is approached. Fig. 4 shows the impedance curves of a practical driver circuit, corrected and uncorrected, along with the well-known curve for the ideal filter section. It is apparent that the improvement in effective driver regulation is greatest at the cutoff frequency, and falls off on either side. To prevent loss of high-frequency response of the amplifier due to the capacity load introduced in the driver circuit, the cutoff frequency must be placed about 1.5 times the highest frequency desired in the useful band. This sets an upper limit on the leakage inductance the driver transformer may have, since all other quantities are determined by other necessary considerations.

⁷ T. E. Shea, "Transmission Networks and Wave Filters," p. 225 *et seq.*

It is commonly assumed that the modulated amplifier, viewed from the modulator plates through the output transformer, offers a pure and constant resistance load to the class B amplifier. In practice two things invalidate this assumption. In the first place the output transformer, like the driver transformer, has a finite leakage inductance. As the signal frequency approaches the upper limit of the useful band, the actual impedance rises in magnitude, and develops an appreciable phase angle in the inductive direction. A transmission loss appears, which is calculable by well-known insertion loss formulas.⁸ In the second place, the impedance offered the transformer secondary by the modulated amplifier is not constant, because in almost all cases, a radio-frequency choke and by-pass condenser is used to keep currents of carrier frequency from reaching the modulator coupling transformer. An excellent opportunity presents itself to accomplish several very desirable effects at once, by building out this network into a full π section of constant K type low-pass filter. All that is needed is a condenser of right size connected from plate to plate of the class B tubes, and selection of radio-frequency choke and by-pass condenser of the right values. The network is terminated by a pure resistance equal to the ratio of direct plate voltage to direct plate current in the modulated amplifier. The series arm of the filter section is composed of the transformer leakage inductance (in terms of the secondary) plus the inductance of the radio-frequency choke. The shunt arms are the condenser added from plate to plate on the modulators, and the radio-frequency by-pass condenser in the modulated amplifier. In contrast to the driver circuit, a considerable latitude of choice of values is possible. If a cutoff frequency of about twenty kilocycles is chosen, and the radio-frequency choke and condensers adjusted accordingly, a very uniform transmission vs. frequency curve up to fifteen kilocycles results, and the impedance has practically zero phase angle. The magnitude of the modulator load impedance rises at the higher frequencies in the useful band, but the effects of this are small. This is because the equivalent generator impedance of a class B amplifier is not constant, but depends on output level, and rises to a fairly high value at low outputs. In practical programs, the energy content around fifteen kilocycles is low. The addition of this filter section greatly reduces the transmission of distortion components above the cutoff, and produces a marked improvement in interference on near-by channels. The impedance relations for the network are plotted in Fig. 5.

The selection of a suitable tube and transformer combination for the driver amplifier is a problem involving the compromising of a con-

⁸ K. S. Johnson, "Transmission Circuits," p. 89.

siderable number of conflicting considerations. The free use of rational design methods is badly cramped by the very small selection of available commercial tube types. Two cases are worthy of consideration. The driver may consist of low impedance low- μ tubes in strict class A operation. The driver may also be another smaller class B stage using general purpose or high- μ tubes. Calculations in the first case are relatively simple, since the internal equivalent generator impedance of the tubes is constant.⁹ In the second case the instantaneous internal impedance of the driver varies considerably, both in average value with signal level and also instantaneously with varying electrical angle in the signal frequency cycle.

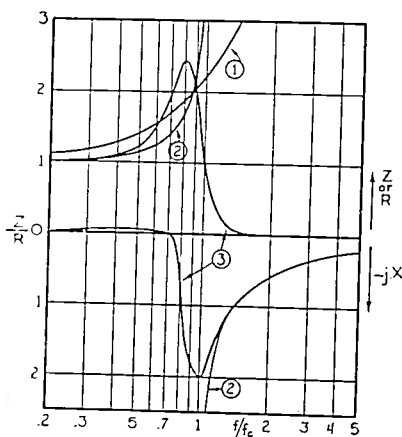

Fig. 5—Impedance characteristics of full-section filter built out of the output transformer. The scales are ratios as in Fig. 4. Curve 1 is the modulus of the transformer alone terminated in a constant resistance. Curve 2 is the resistance and reactance of an ideal filter section terminated in its iterative impedance. Curve 3 is the resistance and reactance of the actual network terminated in a constant pure resistance.

Considering first the strict class A case, the curves of Fig. 1 determine at once the required peak-grid swing of the output stage. The grid current determines an analysis such as Table II, as soon as operating limits and bias are selected. The driver tubes are essentially unloaded (unless a load resistor is used) and will develop a voltage at the plates equal to μ times the operating bias if the excitation is brought up to the useful limit of class A operation. This determines the transformer turns ratio at once if it is desired to make the driver and output stage overload at the same signal level. This is a desirable condition since it allows a maximum step-down ratio of the coupling transformer, and therefore a minimum driver impedance. From the tube impedance and transformer ratio, the equivalent driver impedance may then be determined, and the performance calculated as

⁹ Proc. I.R.E., vol. 21, pp. 591-600; April, (1933).

above. The procedure may be reversed by making a decision as to how much driver distortion may be tolerated, and then fitting together empirically a desirable combination of tube and transformer design. Commercial tubes are available at the present writing only in very wide steps as to size, and the only ways to reach an optimum size of driver is to resort to the unsatisfactory practice of parallel operation of smaller tubes, or operation at other than recommended voltages and plate currents.

Throughout the normal class A region of operation, general purpose and low- μ tubes follow the three-halves power law reasonably well. The plate impedance may be approximately evaluated in terms of the plate current, as follows:

$$\text{If,} \quad i_p = k \left(\frac{e_p}{\mu} + e_o \right)^{3/2} \quad \text{and} \quad \frac{\partial e_p}{\partial i_p} = R_p \quad (7)$$

then,

$$R_p = \frac{2\mu}{3\sqrt{k^2 i_p}} \quad (8)$$

Commercial tubes do not seem to follow this relation closely, but the agreement is fair if the range of values covered is not too wide. The agreement is better for low impedance tubes than for high impedance types.

Output voltage under approximately no-load conditions is of interest when considering driver amplifiers. The maximum voltage increases directly with applied plate voltage, if the bias is adjusted for constant plate current. The usual limitation is plate heating, and a safe plate dissipation must be maintained. If then, as the plate voltage is raised, the bias is adjusted to reduce the plate current in proportion so that the product of plate current and plate voltage, and therefore the watts dissipation, are held constant, the gain in output voltage will be greater than the relative increase in plate voltage. This is because the output voltage is still the product of μ times the bias. There will be a rise in plate impedance, but from (8) it is seen to be much less than proportional to the rise in available output voltage.

The output stage demands a definite maximum grid excitation voltage for its operation. For definite driver distortion requirements a definite driver impedance is determined. *A general factor of merit for a driver amplifier is then its maximum unloaded output voltage divided by the square of its plate impedance.* This is assuming that for each case the transformer ratio is adjusted to give the same grid excitation voltage on the class B amplifier. This factor of merit follows from the

simple fact that the driver transformer reduces the voltage in proportion to its turns ratio, but reduces the plate impedance by the square of this same ratio. These relations indicate that a substantial improvement in driver regulation may be obtained for any given tube by operating at increased plate voltage, even though it may be necessary to reduce the plate current to keep the plate loss within safe or recommended limits. There is a definite limit to this process, since many tubes begin to develop uneven or spotty plate heating under excess plate voltage in class A operation. Irregularities in the grid mesh and imperfect electrode alignment greatly exaggerate this difficulty.

If the driver amplifier is purposely loaded by connecting a resistor on the secondary terminals of the transformer, the specification of transformer ratio is changed. The output stage still demands the same excitation voltage, and the plate output voltage of the driver is reduced

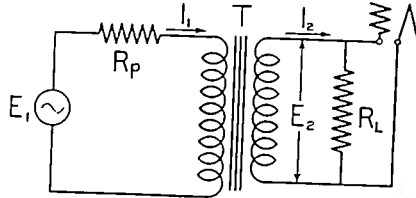

Fig. 6—Equivalent circuit of driver amplifier, showing only details necessary to the analysis given in the text.

from the no-load value by the internal tube drop due to the reflected load current. Consider the circuit of Fig. 6 in which the assumed conditions are: (a) the tube is operated in conformity with strict class A limits (I.R.E. definitions) with grid never positive, and plate current never zero; (b) the output voltage E_2 is maintained constant to satisfy the requirements of the class B stage; the plate voltage and bias of the driver are constant, (c) the driver grid excitation is held constant at a peak value just under the bias voltage; (d) the driver transformer is an ideal transformer for the present discussion.

Let us call the voltage generated by the driver tubes $E_1 = \mu E_g$ and the ratio of transformer primary to secondary turns T . R_p is the equivalent tube plate impedance of whatever combination is used, single, parallel, or push-pull. R_L is the connected load resistance. Z_D is the equivalent driver impedance as viewed from the class B grids.

The circuit equations are

$$E_1 = I_1 R_p + I_2 R_L T; \quad I_2 = T I_1; \quad E_2 = I_2 R_L \quad (9)$$

and when the currents are eliminated,

$$\frac{E_1}{E_2} = \frac{R_p}{R_L T} + T = \text{constant.} \quad (10)$$

This is a quadratic in the unknown transformer ratio T . Solving for T we have

$$T = \frac{1}{2} \cdot \frac{E_1}{E_2} \pm \sqrt{\frac{1}{4} \left(\frac{E_1}{E_2} \right)^2 - \frac{R_p}{R_L}} \quad (11)$$

Since only real values of T are admissible in an ideal transformer, the discriminant

$$\frac{1}{4} \left(\frac{E_1}{E_2} \right)^2 - \frac{R_p}{R_L}$$

must be positive or zero. This restricts the values of R_L to a range of values above a definite minimum, below which the assumed output voltage E_2 cannot be obtained.

$$R_L \geq 4R_p \left(\frac{E_2}{E_1} \right)^2 \quad (12)$$

Whenever,

$$R_L > 4R_p \left(\frac{E_2}{E_1} \right)^2$$

equation (11) indicates two discrete real values of T . Either one may be physically used, and satisfy the assumed conditions as to output voltage E_2 , but the equivalent driver impedance is not the same for the two possible values of T . Obviously one would choose the value giving the lower driver impedance.

The admittance of the driver as seen from the class B grids is

$$Y_D = \frac{T^2}{R_p} + \frac{1}{R_L}$$

Eliminating R_L by substituting its value solved from (10) we have

$$Z_D = \frac{R_p E_2}{T E_1} \quad (13)$$

in which we have E_1 , E_2 , and R_p from initial conditions assumed, and T from (11). Clearly, to minimize the driver impedance, the larger of the two values of T must be chosen, that is, the sign of the radical in (11) must be positive.

Equation (11) shows further that for real values, the range of values of the larger of the two roots T_1 is bounded

$$\frac{1}{2} \cdot \frac{E_1}{E_2} \leq T_1 \leq \frac{E_1}{E_2}$$

and the ratio of extreme values is two.

Considering R_L as the independent variable, it is desirable to find the condition that results in a minimum driver impedance. Evidently from (13) this is when T is a maximum. But from (11) T reaches its maximum when $R_L \rightarrow \infty$; T_1 is less, and Z_D greater for any finite value of R_L .

We therefore reach the important conclusion that for the conditions assumed *the equivalent driver impedance is a minimum when the driver amplifier is unloaded*, and the connection of a load resistor of any value whatever on the transformer secondary results in a rise in the driver impedance, which in turn damages the performance by increased harmonic distortion. If the transformer ratio is fixed, the addition of a load resistor lowers the value of Z_D , but at the expense of driver output voltage.

It is entirely possible to have a secondary emission effect in the grid-current curves giving a negative resistance low enough to cause parasitic oscillations in some cases. If the transformer leakage inductance and secondary capacity form a tuned circuit of low damping, it may be necessary to use a load resistor on the secondary to control the situation, but a better result is indicated by a redesign of the transformer for lower leakage. This results in raising the parasitic frequency, and along with this higher parasitic circuit damping usually follows. Small diode rectifier tubes may also be connected to the class B grids. If the rectifiers are properly biased, they may be made to draw current at the beginning of the negative resistance region, and by proper choice of series resistors, a very desirable net current curve may be obtained. This at once removes all danger of parasitic oscillation, and makes the class B tubes very easy to drive, resulting in low distortion due to driver regulation.¹⁰

If a class B stage is used as a driver the determination of distortion due to driver regulation may still be made by the methods given above, except that in addition to the grid-current curve, a curve of instantaneous differential plate impedance must be used in place of the constant value used for a class A driver. In contrast to the class A driver which works best unloaded, the class B driver must be loaded, and heavily. If it is unloaded, or lightly loaded, the plate currents will be low, and under these conditions, especially with high- μ tubes, the plate impedances are very high. Equation (8) shows that to bring down the driver impedance the current must be high. In class B operation the peak plate currents may be very much higher than the steady currents of class A operation for the same plate loss, but in spite of

¹⁰ For a complete discussion of this and other allied effects, see G. W. Fyler, Proc. I.R.E., vol. 23, pp. 985-1012; September, (1935).

this, the reduction of impedance with rising current is so relatively moderate (being a cube-root function) that even when the class B driver is so heavily loaded that its average dissipation exceeds that of the equivalent class A circuit the net regulation is much poorer. The available plate output voltage is slightly less than the class A, so no help may be expected from higher transformer ratios. Using the factor of merit as above, to compare two push-pull driver amplifiers using tubes with the same plate dissipation rating, the class B amplifier always suffers. In the cases of commercial tubes examined by the author, the ratio of merit as defined is about two to one in favor of the class A circuit.

A further disadvantage of class B amplifiers as drivers, is that the driver will introduce its own distortion similar to the output stage (Table I). In general the phases of the components in driver and output stage are such that the distortions add in the final output. Examination of Fig. 1 and Fig. 2 indicates that some compensation may be had by operating the driver at a bias below optimum, and load resistance also below optimum. The tendency is to stagger the points of inflection, making the curvatures opposing as far as possible. Unfortunately, the control is very poor, and only a very rough compensation seems practicable. To make matters worse, both reduced bias and reduced load resistance tend to increase the plate loss of the driver. If the excitation is reduced to keep the dissipation within bounds, the plate current falls, the available output falls, and a lower transformer ratio is required for necessary excitation of the output stage. All of these effects tend heavily to damage the already unfavorable factor of merit relative to the class A driver. The nonlinear distortion of a properly operated class A driver is exceedingly low.

An effect which often contributes appreciably to nonlinear distortion in any transformer coupled amplifier is the nonlinear relation between magnetomotive force and flux in ferromagnetic cores. A comprehensive study of this effect is beyond the scope of the present paper. J. Albert Wood, Jr., has recently made such a study in the Cornell Engineering College Laboratories, and will present the results in a separate paper. He has kindly furnished the author a sample hysteresis loop taken on a ring sample of 47 per cent nickel steel such as that used in the transformers in the 1000-watt class B amplifier referred to above. A sinusoidal flux is assumed, and the required magnetomotive force to produce it determined as a function of time from the hysteresis loop. Under these assumptions with no net direct current through the transformer windings, the exciting current has the symmetry

$$f(x) \equiv -f(\pi + x)$$

which results in the Fourier series

$$f(x) = \sum A_p \cos px + \sum B_p \sin px. \quad (14)$$

The amplitude coefficients are given in Table III. The units are oersteds, corresponding to the abscissas of the loop, Fig. 7.

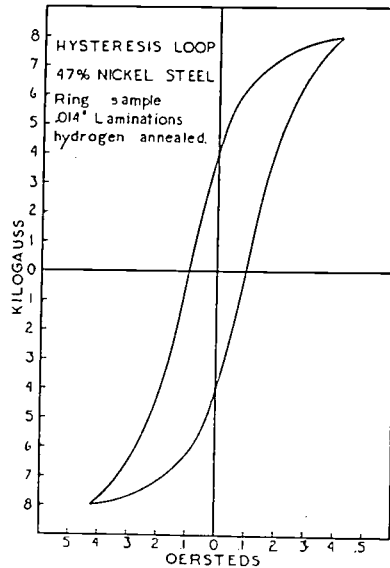

Fig. 7—Hysteresis loop of core material used in the transformers. Harmonic analysis given in Table III. The maximum density of eight kilogauss was chosen as the point where the harmonic content of the magnetizing current goes through a fairly abrupt change.

TABLE III
FOURIER SERIES COEFFICIENTS OF HYSTERESIS LOOP

p	A_p	B_p	C_p	Per cent
1	0.1138	0.313	0.333	100
3	-0.02053	-0.0742	0.076	22.8
5	0.0000922	0.0222	0.0222	6.67
7	0.00349	-0.00722	0.00802	2.41
r-m-s				23.9

If design information is available on the transformers, the flux density may be computed by well-known methods from the voltage and frequency. From a loop taken at the required density, an analysis similar to Table III is made. Then from the harmonic components, the exciting current of the transformer is found by converting oersteds to ampere turns per centimeter and multiplying by the ratio of magnetic path length to winding turns. The equivalent generator and load impedances connected to the transformer must be known. Distortion components are then determined in exactly the same way as in the case of grid-current reaction on the driver. The same method of exhaustion is used, and again the first approximation is very good, in fact better than before.

As an example, consider the output transformer. Everywhere else in the system, low flux densities may be used and the harmonic content easily made vanishingly small compared to other unavoidable effects. In the output transformers, however, designing for very low flux densities is expensive. In the present case, the core was designed to have a density of eight kilogauss when the amplifier is delivering full output at sixty cycles. It would therefore have the same density at half maximum voltage and thirty cycles. In view of the low energy content of practically all programs (except pipe organ) in the frequency region below sixty cycles, it was decided not to design for full output at thirty cycles, since it would about double the cost of the transformer. Using the eight-kilogauss density and coefficients of Table III, and the average equivalent generator and load impedances for this particular case, the harmonic percentages introduced in the output are, third 0.23 per cent, fifth 0.067 per cent, and seventh 0.0243 per cent. It is evidently unnecessary to carry the analysis further. There are, no discontinuities in the loop to make one suspicious of the existence of prominent harmonics of high order. A flux density of about eight kilogauss seems to be a rather definite point in the changes of hysteresis loop with density. As the value is reduced, the harmonic percentages fall rather slowly. But if the value is exceeded, the loop develops long sharp nearly horizontal points, due to pronounced saturation, and the harmonic percentages take a sudden and large rise. The change becomes more critical and occurs at a lower density for the 78 per cent nickel alloy, and the reverse is true of silicon steels in general.

Distortion of the frequency discrimination type is introduced entirely by the reactive elements in the coupling devices between the tubes of successive stages in the amplifier. The methods of computing transmission losses of this kind are well known.^{8,11} The range of uniform response can be appreciably widened by the scheme of building out the transformers into filter sections as discussed above.¹² This is theoretically possible at the low-frequency end also, but the size of condensers and chokes required make it much cheaper and easier to be generous in the transformer designs. At the high-frequency end of the band where leakage reactances are the limitation, correction by building out appears to be better, since drastic reduction of transformer leakages by the use of many interleaved winding sections results in the introduction of high winding capacities and serious resonances due to capacity couplings.

¹¹ F. E. Terman, "Radio Engineering," p. 142 *et seq.*

¹² This was apparently first done by W. S. Mortley.

If the driver amplifier is restricted to class A operation, there are no appreciable grid currents to cause regulation troubles in the input transformer, and a fairly high step-up ratio is feasible from a line or voltage amplifier input. The higher this ratio is made, the smaller is the required signal input to operate the driver. The limitation on practical ratio is the distributed capacity of the secondary winding plus the input capacity of the tube grids. It has long been known that the input impedance of a triode is greatly affected by the connected load impedance in the plate circuit.¹³ Van der Bijl gave a general equation for the input impedance in terms of electrode capacities, amplification factor, and plate resistance, and an arbitrary connected load impedance. In the present case where the plate circuit is substantially unloaded, the general equation for input capacity simplifies to

$$C = C_{of} + C_{op}(\mu + 1). \quad (15)$$

Hazeltine showed in the Neutrodyne patents that the effect of the grid-plate capacity could be reduced, canceled, or reversed by the connection of a neutralizing condenser from the grid to a point in the output circuit having a potential of opposite phase to that of the plate.¹⁴ In the case of a push-pull amplifier the circuit is very simple, and results in the lattice capacity bridge almost universally used for neutralizing radio-frequency amplifiers. The addition of neutralizing capacities alters (15) to

$$C = C_{of} + C_{op}(\mu + 1) - C_n(\mu - 1). \quad (16)$$

It is evident by inspection that the neutralizing condenser reduces the input capacity, and by making it sufficiently large the input capacity may be made effectively negative, and have the effect of reducing the distributed secondary winding capacity of the input transformer. This offers the opportunity of designing input transformers of such high ratio that they would have very poor performance if used without compensation, and then reducing the effective winding capacity by overneutralization to the point where the equivalent net capacity has the right value to combine with the leakage inductance and a loading condenser on the primary winding to form a low-pass filter section in the same manner as the class B output circuit. By this method the gain may be increased about seven decibels over the best value practicable without the compensation, and a very uniform response curve obtained up to at least twenty kilocycles. An improvement in constancy and phase angle of the primary input impedance is

¹³ H. J. van der Bijl, "The Thermionic Vacuum Tube," (1920), p. 205 *et seq.*

¹⁴ *Loc. cit.*, pp. 204-206.

also obtained. No theoretical limit in possible increase of ratio is apparent, but the overneutralization may introduce enough feedback to cause singing if carried too far. This has been found to occur at frequencies near the upper audible limit when input transformers having multisection secondaries are used.

An effect that may cause a great deal of trouble is regulation of the power supply.⁶ The variety of effects possible with generator and rectifier power supplies with various types of filters is so great, that no general solution appears feasible. One important point determining the solution in any particular case is the fundamental difference in the power demand characteristics of a class B audio amplifier as compared to a class B radio-frequency amplifier as ordinarily used in a low level modulated system. The demand of the final radio-frequency class B stage is constant, if integrated over a period greater than the reciprocal of the lowest frequency of modulation. But the demand varies through the modulation cycle in proportion to the modulation envelope. Thus if the carrier is fully modulated, the current demanded by the amplifier varies all the way from zero (or nearly zero, depending on bias adjustment) to a maximum of twice the average value, and at modulation frequency. At full modulation, therefore, there is present in the supply line a current that is the steady demand, plus an effective alternating component equal to the direct current divided by the square root of two, and at modulation frequency.

In contrast to this, the demand of the class B audio stage is not only variable in the modulation cycle, but has no appreciable steady component at any time with average program input. The demand varies in proportion to input level, and flutters in an irregular manner at what might be termed "syllable frequency" for want of a better name. To compare with the class B radio-frequency stage, assume similar conditions of a constant sinusoidal tone for each, of such amplitude as to give complete modulation on one hand, and full output on the other. The instantaneous demand of the radio-frequency stage is then

$$i = I_{av}(1 + m \sin \omega_a t) \quad (17)$$

(assuming that the carrier component is by-passed). The demand of the audio stage on the other hand in terms of the maximum plate current is

$$i = \frac{2}{\pi} I_m - \frac{4}{3\pi} I_m \cos 2\omega_a t - \frac{4}{15\pi} I_m \cos 4\omega_a t \\ - \frac{4}{35\pi} I_m \cos 6\omega_a t - \dots \quad (18)$$

If, as is usually the case, the supply regulation is determined at program frequencies almost entirely by the final filter condenser, it is seen at once that the regulation will be three times as great for the radio-frequency stage, if the two are operating at the same value of direct current. This is because the component of lowest frequency in the audio stage demand is twice the frequency of signal input.

If the comparison is made on the basis of the same final transmitter output to antenna, the direct-current demand of the radio-frequency stage is between two and a half and three times greater than the audio, if both systems are working at the same supply voltage. Fortunately for the cost of filter systems, the radio-frequency amplifier will tolerate a considerably greater regulation than the audio.

The only interaction effect of importance that has been found is that due to the presence of the building-out condenser on the driver transformer primary, mentioned above. The presence of this capacity destroys the assumption that the driver is unloaded. At the higher audio frequencies the charging current is appreciable, and puts an appreciable load on the plate circuit. This invalidates the assumptions under which (16) was developed. Thus the build-out condenser not only introduces a transmission loss at the upper end of the band due to its own charging current, but an additional loss in the input transformer network by upsetting the impedance adjustments made by the neutralizing condensers. After several trials it was found possible to build a driver transformer with such low leakage reactance that compensation was not worth while, and the interaction difficulty was automatically removed.

CONCLUSIONS

The final limit in reducing nonlinear distortion in a class B audio amplifier is determined by the analysis of the plate-current curve, Fig. 1. All other sources of harmonic components may be reduced by adequate design to amounts well below the limits set by the curvature and irregularities of the plate-current curve. Any further improvement must first reduce these effects.

Distortion due to regulation in the driver amplifier caused by the grid currents of the output tubes can be reduced as far as one cares to go by the addition of sufficient driver tube capacity, and special care in the design of the coupling transformer to keep its leakage reactance at a very low figure. The presence of secondary electron emission effects in the output tubes reduces the average and maximum grid currents, and makes the tubes easier to drive as far as tube capacity in the driver is concerned, but due to the reversed curvature and pos-

sible negative slope of the grid current curve, some of the high order harmonic components of the grid current vs. time curves may be greatly increased in amplitude. This places a rather severe limit on the permissible total inductance in the grid circuit of the output tubes.

Provided that maximum flux densities are held within strict limits, the nonlinear distortion components introduced by the ferromagnetic cores of the coupling transformers are too small to warrant special attention.

Building out the output transformer into a π -section low-pass filter is well worth while, since it accomplishes four useful results at once; it reduces the transmission loss at the upper end of the useful band; it makes the load resistance offered the amplifier plates more constant; it practically removes any reactive component in the load impedance; and it reduces adjacent channel interference.

The building out of the class A input transformer of the driver into a filter, in combination with the large reduction in circuit capacity attainable through neutralization, accomplishes for the input circuit the same advantages as realized in the output circuit, and in addition makes possible the design of special input transformers of much higher ratio, with a consequent increase in amplification that is well worth while.

With commercially available tubes, much better performance is possible with a low impedance class A driver, than can be obtained with a class B driver having the same total plate dissipation ability.

ACKNOWLEDGMENT

The writer wishes to express his thanks to Professor W. C. Ballard, Jr., for the contribution of important fundamental ideas in the early part of the investigation; to Dr. J. Albert Wood, Jr., for the magnetic data; to Mr. Walter Garlick, Jr., and the American Transformer Company for some very ingenious transformer designs, and for numerous experimental models; and to Mr. Howard G. Smith for much valuable assistance throughout, and for correcting the manuscript.

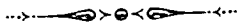

NOTES ON PIEZOELECTRIC QUARTZ CRYSTALS*

BY

ISSAC KOGA

(Tokyo University of Engineering, Tokyo, Japan)

Summary—The chief characteristics of quartz plates cut at various angles to the crystal axes are described, with particular attention to the effect of temperature on frequency of oscillation. Methods of reducing these temperature effects lead to the manufacture of zero temperature coefficient plates. Their application to existing transmitters previously employing X-cut plates is described.

Particularly stable oscillators using two crystals in a single circuit are also described.

I. VIBRATION OF PIEZOELECTRIC CRYSTAL PLATE

WHENEVER there is an electrically maintained vibration in such an oscillator as the Pierce circuit, by employing a sufficiently thin piezoelectric crystal plate bounded by two principal parallel planes in an arbitrary orientation referred to the original crystal form, the period of vibration is either

(1) dependent only upon the thickness of the plate and not upon the form and dimensions of the contour of the principal surfaces (*thickness vibration*) or

(2) dependent only upon the form with its orientation to the original crystal axes and dimensions of the contour of the principal surfaces and not upon the thickness (*contour vibration*¹).

This fact is easily verified in, for example, quartz, tourmaline, cane sugar, tartaric acid, Rochelle salt, sodium chlorate, etc.²

It is well known that sometimes these two kinds of vibrations are observed to be coupled with each other mechanically,³ or electrically, or mechanically and electrically, but as this is a secondary phenomenon we will not consider it further in this paper.

Now if the principal surfaces of a crystal plate extend to infinity, that is, if a crystal be bounded only by two infinite parallel planes, then frequencies and modes of vibrations can be completely calculated.

* Decimal classification: R355.65. Original manuscript received by the Institute, May 16, 1935; revised manuscript received by the Institute, July 15, 1935. Presented before Tenth Annual Convention, Detroit, Mich., July 1, 1935.

¹ This name is tentatively given by the writer for the sake of convenience. Some German writers say "Querschwingung."

² I. Koga and T. Nakamura, "Measurement of the elastic constants of cane sugar, tartaric acid, Rochelle salt, and natrium chlorate by means of piezoelectric vibration," Supplementary Issue, *Jour. I.E.E.* (Japan), p. 134, April, (1933).

³ F. R. Lack, "Observations on modes of vibrations and temperature coefficients of quartz plates," *Proc. I.R.E.*, vol. 17, p. 1123-1141; July, (1929); *Bell Sys. Tech. Jour.*, vol. 8, p. 515; July, (1929).

As a free elastic vibration is nothing but a system of standing waves produced by the interference of two *similar* waves propagated in *opposite* directions, no waves other than plane waves, the wave fronts of which are exactly parallel to the boundary surfaces, can contribute to the production of standing waves in such a plate, for if a wave front be not plane the wave produced by reflection at a plane boundary surface cannot be *similar* to the incident wave, while a plane wave, the wave front of which is not parallel to the boundary surface, is not reflected in the direction exactly *opposite* to the incident wave.

The general solution⁴ from the above consideration, available for a plate cut in any orientation from any crystal, gives the following important conclusions:

(1) A crystal plate of infinite extension has three and only three modes of thickness vibration with corresponding fundamental frequencies expressed in the form

$$f = \frac{1}{2a} \sqrt{\frac{c}{\rho}} \quad (1)$$

where a is the thickness and ρ is the density of the plate.

Three values of c 's (adiabatic elastic constants) as well as the directions of displacements can be evaluated if the orientation of the principal planes of the plate be given.

(2) If a sufficient strain in any one of the three modes of thickness vibration can be produced by an electric field normal to the principal surfaces, then that mode of thickness vibration may be realized in an oscillator such as the Pierce circuit.

(3) The well-known fact that sometimes several mechanical vibrations at frequencies very close to the value given by (1) happen to appear is surely due to the finiteness of the principal surfaces of the plate provided that the two principal surfaces are sufficiently parallel.

(4) Table I shows the values of the c 's for quartz plates of various orientations. This table is based on the following values of adiabatic elastic constants⁵

$$\left. \begin{aligned} c_{11} &= 85.45 \times 10^{10} \text{ dynes/cm}^2, & c_{12} &= 7.26 \times 10^{10} \text{ dynes/cm}^2 \\ c_{33} &= 105.67 \times 10^{10} \text{ dynes/cm}^2, & c_{13} &= 14.37 \times 10^{10} \text{ dynes/cm}^2 \\ c_{44} &= 57.09 \times 10^{10} \text{ dynes/cm}^2, & c_{14} &= -16.87 \times 10^{10} \text{ dynes/cm}^2 \end{aligned} \right\} (2)$$

⁴ I. Koga, "Thickness vibrations of piezoelectric oscillating plates," Supplementary Issue, *Jour. I.E.E.* (Japan), p. 33, April, (1932); *Jour. I.E.E.* (Japan), vol. 52, no. 6, p. 498; June 10, (1932); vol. 52, no. 9, p. 736; September 10, (1932); *Physics*, vol. 3, p. 70; August, (1932); *Rep. Radio Researches*, vol. 2, p. 157; September, (1932); *Phil. Mag.*, vol. 16, p. 275; August, (1933).

⁵ W. Voigt, "Lehrbuch der Kristallphysik," pp. 754 and 789, (1928).

used in the relations between stresses and strains

$$X_x = c_{11}e_{xx} + c_{12}e_{yy} + c_{13}e_{zz} + c_{14}e_{yz}, \text{ etc.}, \quad (3)$$

the relation of co-ordinate axes to the crystal form of quartz being shown by Fig. 1. Although there are two kinds of quartz crystals, namely, right-handed and left-handed, we need not distinguish between them as far as the present paper is concerned, since the same mathematical expressions are always available for both right-handed and left-handed quartz, as long as we relate the coördinate axes to the crystal faces r , r' , and m as shown in Fig. 1.

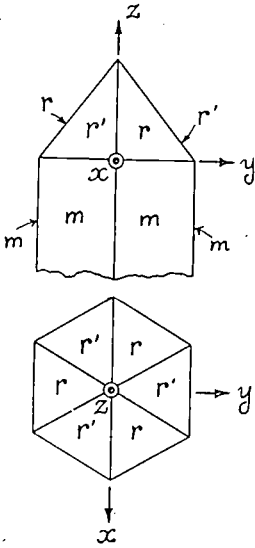

Fig. 1—Relation of co-ordinate axes to the crystal form of quartz.

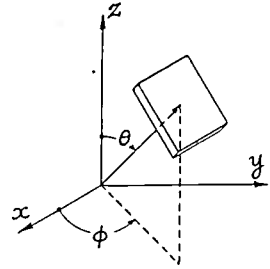

Fig. 2—Relation between rectangular co-ordinates and polar co-ordinates for the normal to a crystal plate.

In Table I, θ and ϕ denote the colatitude and longitude of a normal to the principal surfaces and are given by the following relations with the direction cosines l , m , n . (See also Fig. 2.)

$$l = \sin \theta \cos \phi, \quad m = \sin \theta \sin \phi, \quad n = \cos \theta. \quad (4)$$

For example, the values of the c 's for the plate cut normally to the direction ($\theta=75^\circ$, $\phi=90^\circ$) are 113.33×10^{10} dynes/cm², 39.01×10^{10} dynes/cm², and 31.86×10^{10} dynes/cm², and the values for the plate cut normally to the direction ($\theta=60^\circ$, $\phi=15^\circ$) are 95.12×10^{10} dynes/cm², 46.25×10^{10} dynes/cm², 49.81×10^{10} dynes/cm².

TABLE I
VALUES OF c 's IN THE FREQUENCY EQUATION (1) FOR DIFFERENT ORIENTATIONS OF CRYSTAL CUT

$\theta \backslash \phi$	-30° and 90°	-25°, 85°, and 95°	-20°, 80°, and 100°	-15°, 75°, and 105°	-10°, 70°, and 110°	-5°, 65°, and 115°	0°, 60°, 120°, and 180°	
0°	105.67 57.09 57.09	105.67 57.09 57.09	105.67 57.09 57.09	105.67 57.09 57.09	105.67 57.09 57.09	105.67 57.09 57.09	105.67 57.09 57.09	180°
15°	110.76 59.10 47.44	110.74 59.20 47.41	110.56 59.31 47.42	110.28 59.91 47.11	109.94 60.47 46.88	109.55 61.10 46.64	109.11 61.78 46.40	165°
30°	121.94 50.38 37.99	121.87 50.49 37.94	121.24 51.25 37.81	120.21 52.44 37.64	118.95 53.90 37.45	117.14 55.86 37.31	115.21 57.91 37.18	150°
45°	129.06 40.46 31.23	128.69 40.70 31.37	127.59 41.39 31.77	125.80 42.56 32.38	123.36 44.26 33.14	120.35 46.46 33.94	116.87 49.13 34.74	135°
60°	127.27 34.93 28.99	125.74 37.03 28.42	124.41 36.87 29.91	122.10 37.98 31.10	119.00 39.34 32.85	115.13 40.90 35.16	110.64 42.52 38.03	120°
75°	113.33 39.01 31.86	112.53 40.33 31.34	111.37 42.49 30.34	109.00 45.54 29.64	105.78 48.83 29.59	101.84 52.13 30.23	97.30 55.27 31.63	105°
90°	93.32 49.22 39.10	92.93 50.99 37.72	91.84 54.71 35.09	90.17 58.90 32.57	88.12 62.90 30.62	86.26 65.99 29.39	85.45 67.22 28.98	90°
105°	75.44 60.02 48.74	76.16 60.91 47.13	78.56 61.92 43.73	82.48 61.69 40.01	87.31 60.28 36.62	92.37 58.05 33.78	97.30 55.27 31.63	75°
120°	84.97 48.01 58.21	86.48 47.80 56.91	90.25 47.22 53.72	95.12 46.25 49.81	100.42 44.54 46.23	105.68 44.17 41.34	110.64 42.52 38.03	60°
135°	98.33 37.45 64.97	99.29 37.43 64.13	101.74 37.12 61.88	105.18 36.70 58.86	109.08 36.16 55.53	113.05 35.49 52.20	116.87 49.13 34.74	45°
150°	106.15 36.95 67.21	106.52 36.95 66.82	107.95 35.99 65.36	109.17 36.99 64.14	111.00 37.12 62.18	113.16 37.09 60.06	115.21 57.91 37.18	30°
165°	105.70 47.28 64.32	107.41 45.65 64.23	107.59 45.72 63.98	107.89 45.83 63.58	108.25 45.99 63.05	108.67 46.18 62.44	109.11 61.78 46.40	15°
180°	105.67 57.09 57.09	105.67 57.09 57.09	105.67 57.09 57.09	105.67 57.09 57.09	105.67 57.09 57.09	105.67 57.09 57.09	105.67 57.09 57.09	0°
	30° and 150°	25°, 35°, 145°, and 155°	20°, 40°, 140°, and 160°	15°, 45°, 135°, and 165°	10°, 50°, 130°, and 170°	5°, 55°, 125°, and 175°	0°, 60°, 120°, and 180°	$\theta \backslash \phi$

$c = (\text{value given in the table}) \times 10^{10}$ dynes/cm².

Figs. 3, 4, and 5 show respectively the distribution of c 's corresponding to $\phi = 90^\circ$, $\phi = 65^\circ$, and $\phi = 60^\circ$. The curved surfaces generated

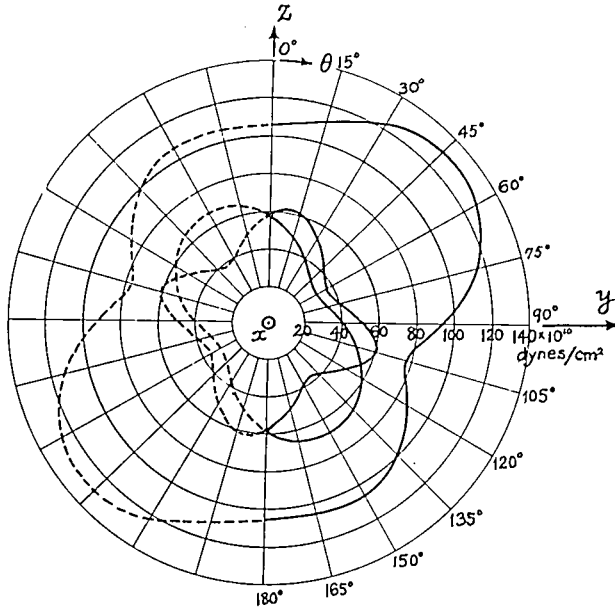

Fig. 3—Values of c 's in the frequency equation (1) when the normal to a plate is in the plane $\phi = -30^\circ$ or 90° .

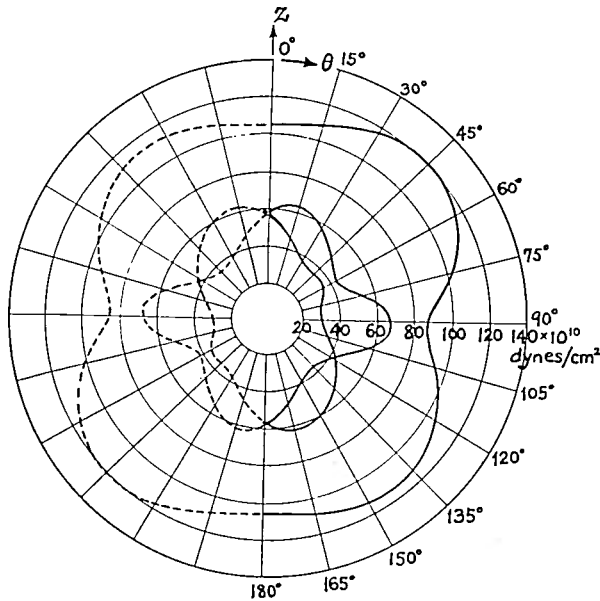

Fig. 4—Values of c 's in the frequency equation (1) when the normal to a plate is in the plane $\phi = -5^\circ$, 65° , or 115° .

by the continuous values of c 's touch at $\theta = 0^\circ$ and $\theta = 180^\circ$, and at $\theta \simeq 90^\circ \pm 35^\circ$ when $\phi = 0^\circ$, 60° , and 120° . All values of c 's are symmetrical with respect to the planes of $\phi = 0^\circ$, 60° and 120° .

(5) In a quartz plate cut perpendicular (*X*-cut, $\theta = 90^\circ$, $\phi = 0^\circ$, 60° , or 120°) or parallel ($\theta = 90^\circ$, $\phi = -30^\circ$, 30° , or 90°) to one of the three electrical axes, only one mode of thickness vibration can be realized, in which the displacement at any point is always in the direction of that electrical axis.

The fundamental frequency of vibration for the latter (*Y*-cut) is given by (1) where

$$\left. \begin{aligned} c &= \frac{1}{2} (c_{11} - c_{12}) \sin^2 \theta + c_{44} \cos^2 \theta + c_{11} \sin 2\theta \\ \rho &= 2.654 \text{ gram/cm}^3. \end{aligned} \right\} \quad (5)$$

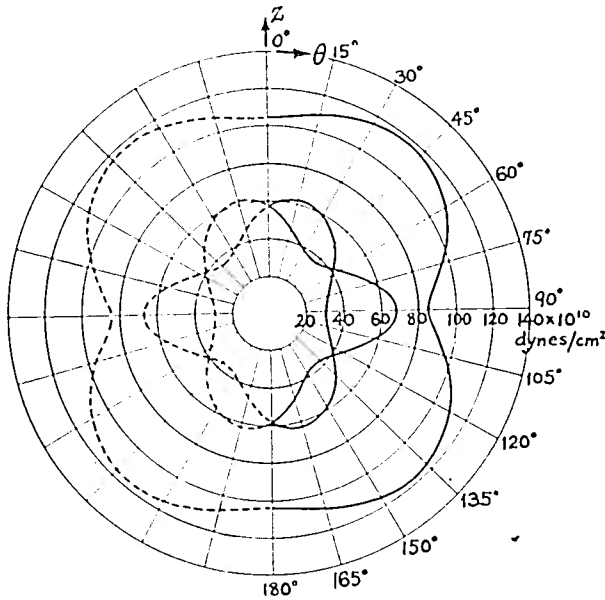

Fig. 5—Values of c 's in the frequency equation (1) when the normal to a plate is in the plane $\phi = 0^\circ$, 60° , or 120° .

These values are tabulated in the third column of each bracket in Table I, and are also shown in Fig. 3.

As a *Y*-cut plate corresponds to $\theta = 90^\circ$ in this group, its fundamental frequency can be obtained by putting the value 39.10×10^{10} dynes/cm² in place of c in (1) Thus,

$$f = \frac{1}{a} \times 0.192 \times 10^6 \text{ cycles.} \quad (6)$$

For an *X*-cut plate (first column of last bracket in Table I), $c = c_{11} = 85.45 \times 10^{10}$ dynes/cm² so that

$$f = \frac{1}{a} \times 0.284 \times 10^6 \text{ cycles.} \quad (7)$$

(6) In a tourmaline plate cut normally to the principal axis Z , only one mode of thickness vibration can be realized, in which the displacement at any point is always in the direction of the principal axis (longitudinal vibration) and the frequency is given by

$$= \frac{1}{2a} \sqrt{\frac{c_{33}}{\rho}} = \frac{1}{a} \times 0.360 \times 10^6 \text{ cycles.} \quad (8)$$

II. QUARTZ PLATES OF ZERO TEMPERATURE COEFFICIENT FOR SHORT-WAVE OSCILLATORS

We do not doubt the established fact that a valve-maintained quartz oscillator is the most satisfactory apparatus for producing high-frequency alternating currents of extremely stable frequency. Recently the practice has been to place quartz plates in thermostatically controlled compartments in order to eliminate even the minor effect of temperature upon the oscillating frequency of quartz. This procedure,

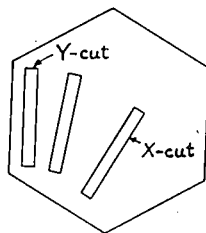

Fig. 6—Trial cutting to find the plate of zero temperature coefficient in the intermediate orientation between X- and Y-cut plates.

however, results in a number of inconveniences. Since it appeared possible to eliminate the effect of temperature variation on the frequency of quartz, we hoped to dispense completely with the necessity of temperature control. Having this in mind, we first performed the following experiment. The idea on which it was based was very simple. Since it was well known that the temperature coefficients of frequency of X-cut and Y-cut quartz plates are negative and positive, respectively, we expected the possibility of getting a zero temperature coefficient plate by cutting quartz in some orientation intermediate between the X-cut and the Y-cut (Fig. 6). Experimentally we succeeded,⁶ but it was found, at the same time, that the form and dimensions of the contour of the principal surfaces have great influence upon the temperature coefficient, so that we decided to abandon this plate, because of difficulties in manufacture.

⁶ I. Koga, "Influence of temperature upon frequency of oscillating quartz plate," Supplementary Issue, *Jour. I.E.E.* (Japan), p. 1, April, (1929).

In 1932, we realized that the characteristics involved in this plate had been much more complicated than expected. From the theory of thickness vibration, the wavelength of the electric wave which corresponds to the frequency of vibration of a plate one millimeter thick (so-called wave constant according to Cady) should necessarily change as shown in Fig. 7, when the orientation of the cutting of the plate is rotated about the optical axis. (Insert the values of c 's for $\theta = 90^\circ$ in Table I into (1).) In this figure the parts of curves shown by full lines mean that we can realize the oscillation easily, while the parts in broken lines mean that the piezoelectric action is not sufficient to realize the oscillation easily.

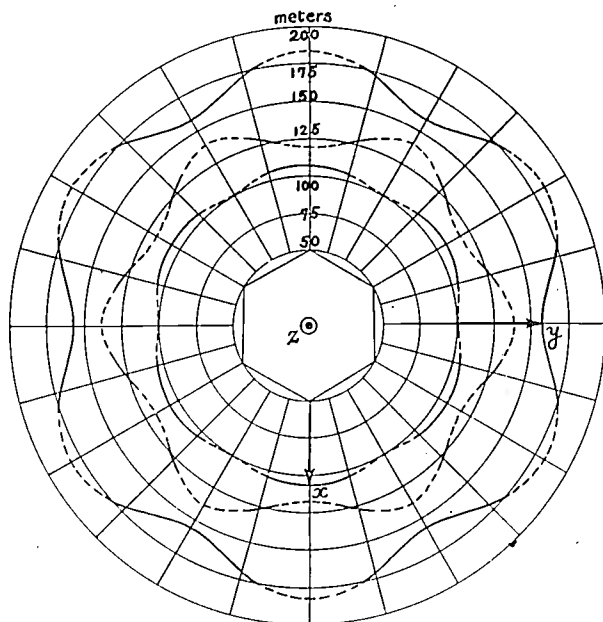

Fig. 7—Wave constants of quartz plates cut parallel to the optical axis. Broken lines show the difficulty in the realization of piezoelectric oscillation.

A glance at this figure reveals at once that the period of vibration which is realizable does not continuously change from X -cut to Y -cut, so that we cannot expect the existence of a zero temperature coefficient plate in the intermediate orientation between X -cut and Y -cut plates from the mere fact that their temperature coefficients are opposite in sign.

In fact, we were aware afterwards that if the plate is sufficiently thin, we could no longer get the zero temperature coefficient plate, and that the zero temperature coefficient could only be obtained when the thickness of the plate is considerable compared with the dimensions of the principal surfaces. That was also the reason why the temperature

coefficient was greatly influenced by the form and dimensions of the contour of the plate.

In connection with this fact we observed the characteristics as shown in Fig. 8 by changing the thickness of the plates of given form and dimensions (dimensions of the principal surfaces being always twenty-five by thirty millimeters). These results show that even a Y-cut plate can have zero temperature coefficient if the dimensions are properly selected.⁷

As mentioned above we hoped that the orientation of cutting for zero temperature coefficient plates could be definitely fixed in order to simplify manufacture and to guarantee uniformity of characteristics in the finished product.

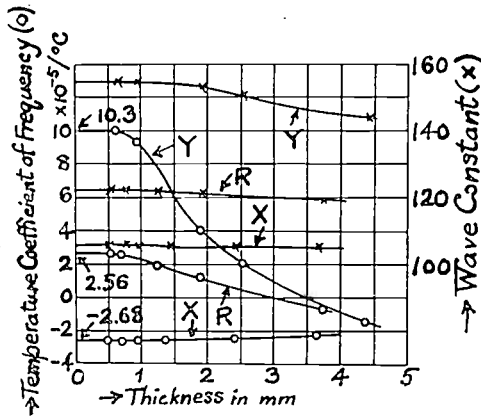

Fig. 8—Change of wave constant and temperature coefficient due to thickness.

To meet these requirements, we must use a sufficiently thin plate, for in thin plates all the characteristics are always fixed by the orientation of cutting, and at the same time, the frequency of vibration may be easily adjusted to a desired value merely by varying the thickness of the plate, and this may be done without any deleterious effect on the characteristics.

Now, to get the orientation of a zero temperature coefficient plate, we must search in a region where the frequency of the plate of a given thickness varies continuously with orientation, and avoid such regions as were explored during the first trial already described at the beginning of this chapter.

One of the best ways of doing this is to observe the characteristics of plates which have been cut so that their principal surfaces have various orientations about the *electrical* axis, since in this case

⁷ W. A. Marrison, "A high precision standard of frequency," Proc. I.R.E., vol. 17, p. 1103-1122; July, (1929); Bell Sys. Tech. Jour., vol. 8, p. 493; July, (1929).

(1) there is only one mode of thickness vibration capable of being maintained in the oscillator circuit, and its frequency of vibration varies continuously with the variation of orientation as explained at the end of the last chapter; moreover

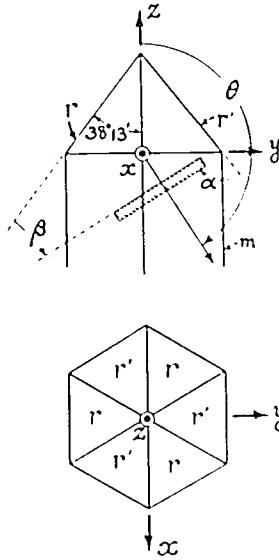

Fig. 9—Explanation of the meanings of θ , α , and β appearing in Tables II, III, and IV and Figs. 10, 11, and 12.

(2) since, as we have already recognized experimentally in 1932, the temperature coefficients of R -cut and R' -cut plates ^s corresponding

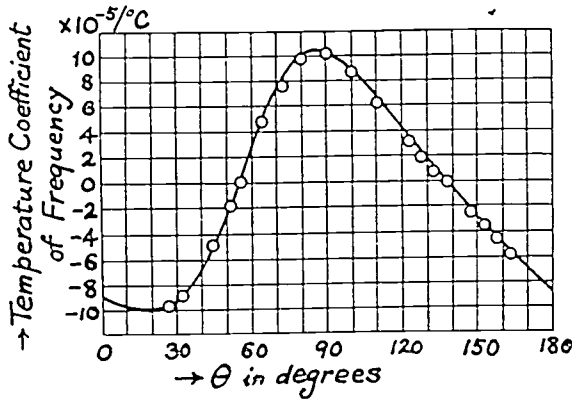

Fig. 10—Change of temperature coefficient due to the change of cutting orientation.

to $\theta = 128^\circ 13'$ and $\theta = 51^\circ 47'$ are, respectively, positive and negative, we may expect to find an orientation with zero temperature coefficient.

^s I. Koga, Japanese Patent No. 95637, January 15, 1932 and No. 99670, November 16, 1932.

Experimental results obtained in 1933^{9,10} are shown in Figs. 9 and 10 and Table II. The temperature coefficient of frequency is zero at angles $\theta \sim 55^\circ$ and $\theta \sim 138^\circ$. The detailed observations in the neighbor-

TABLE II
RELATION BETWEEN THE ORIENTATIONS OF CRYSTAL CUT AND
TEMPERATURE COEFFICIENT OF FREQUENCY

0	Thickness	Frequency	Temperature Coefficient
Degree	mm	kc	$\times 10^{-5}/^\circ\text{C}$
27	0.71	2715	-10.0
32	0.47	3978	-9.0
45	0.63	2709	-4.8
52	0.62	2690	-1.8
64	0.56	2981	+4.8
73	0.57	2980	+7.6
80	0.65	2691	+9.8
90	0.73	2688	+10.3
100	0.71	2981	+8.7
110	0.84	2689	+6.3
123	0.90	2700	+3.2
128	0.92	2689	+2.0
133	0.93	2696	+0.9
138	0.94	2690	-0.2
148	0.95	2690	-2.4
153	0.95	2690	-3.4
158	0.94	2690	-4.5
163	0.93	2693	-5.5

Dimensions of principal surfaces: 22 mm \times 27 mm, the shorter sides being parallel to the electrical axis.

hood of these angles showed that the change of frequency due to temperature is not linear^{11,12} but somewhat complicated as shown in Figs. 11 and 12. Numerals given in these figures correspond to those in Tables III and IV. Test pieces were all rectangular plates and their principal surfaces were made parallel to the electrical axis within half a minute by means of an X-ray spectrometer.

We see from these results that if $\theta = 54^\circ 43' \sim 54^\circ 45'$ the frequency of vibration is practically independent of the temperature at room temperatures.

From the data given above, we further determined¹³ the temperature coefficients of the adiabatic elastic constants ($c_{11} - c_{12}$), c_{44} and c_{14} in (5). Once the temperature coefficients of the adiabatic elastic

⁹ I. Koga and K. Ichinose, "Piezoelectric oscillating quartz plate of zero temperature coefficient," Supplementary Issue, *Jour. I.E.E. (Japan)*, p. 135, April, (1933).

¹⁰ I. Koga and N. Takagi, "Piezoelectric quartz oscillating plates with temperature coefficients less than $10^{-7}/^\circ\text{C}$," *Jour. I.E.E. (Japan)*, vol. 53, no. 10, p. 940; October 10, (1933).

¹¹ I. Koga et M. Shoyama, "Caracteristiques frequence-temperature de plaque de quartz oscillant a' coefficient de temperature nul," *Comptes Rendus*, tome 200, no. 14, p. 1224; April 1, (1935).

¹² I. Koga and N. Takagi, "Thermal characteristics of thin oscillating quartz plates," *Jour. I.E.E. (Japan)*, vol. 54, no. 5, p. 399; May 10, (1934).

¹³ I. Koga and N. Takagi, "Temperature coefficients of elastic constants of quartz," *Jour. I.E.E. (Japan)*, vol. 53, no. 12, p. 1141; December 10, (1933).

constants are obtained, we can calculate the temperature coefficient of frequency for any value of θ . The "curve" in Fig. 10 is drawn from val-

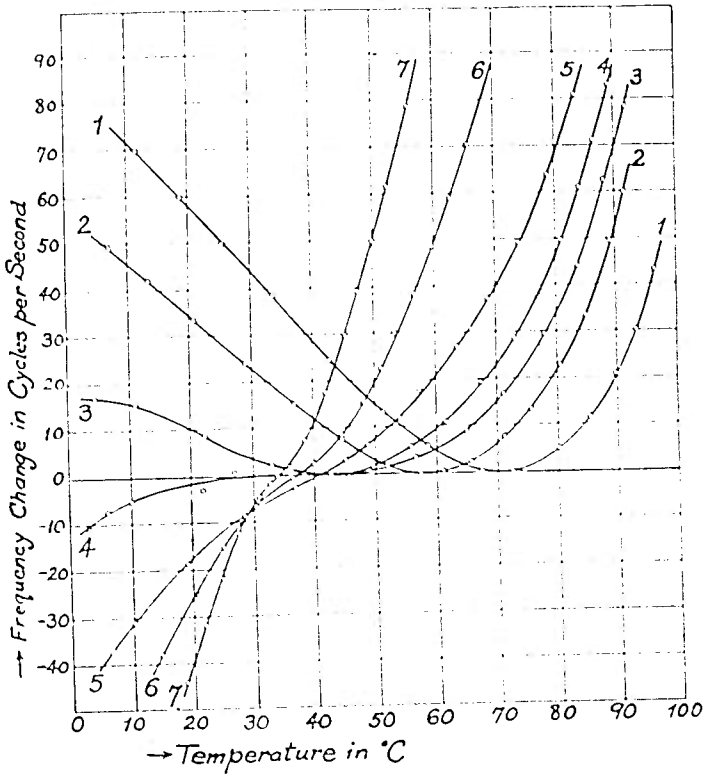

Fig. 11—Frequency temperature relation at $\theta \approx 55^\circ$. Numerals correspond to those in Table III.

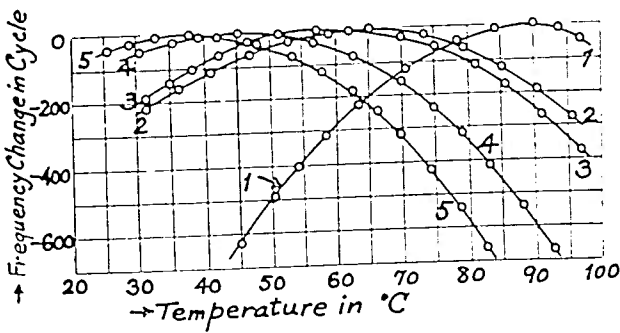

Fig. 12—Frequency temperature relation at $\phi = 138^\circ$. Numerals correspond to those in Table IV.

ues thus calculated, while the measured values given in Table II are plotted with small circles in the same figure showing how well they agree.

TABLE III
TEMPERATURE COEFFICIENTS OF PLATES AT $\theta \approx 55^\circ$

	α	θ	Dimensions (mm)	Frequency (kc)
1	$2^\circ 51'$	$54^\circ 38'$	$0.62 \times 21.3 \times 27.0$	2692.4
2	$54.5'$	$41.5'$	$0.62 \times 23.2 \times 28.5$	2689.8
3	$56'$	$43'$	$0.62 \times 21.1 \times 27.0$	2691.0
4	$58'$	$45'$	$0.62 \times 22.1 \times 27.0$	2692.7
5	$3^\circ 02.5'$	$49.5'$	$0.62 \times 22.0 \times 27.0$	2691.4
6	$07.5'$	$54.5'$	$0.62 \times 22.1 \times 27.1$	2692.1
7	$16'$	$55^\circ 03'$	$0.62 \times 22.0 \times 27.0$	2687.7

α = angle measured by means of X-ray spectrometer.

$\theta = \alpha + 90^\circ - 38^\circ 13'$

Shorter sides of the principal surfaces are parallel to the electrical axis.

III. IMPROVEMENT OF SHORT-WAVE WIRELESS TRANSMITTERS FOR COMMERCIAL SERVICE BY MEANS OF OSCILLATING CRYSTALS WITH ZERO TEMPERATURE COEFFICIENT

X-cut quartz crystals have been generally used in Japan in high-frequency transmitters for commercial service because their temperature coefficients are lower than those of other well-known types.

TABLE IV
TEMPERATURE COEFFICIENTS OF PLATES AT $\theta \approx 138^\circ$

	θ	β	Dimensions (mm)	Frequency (kc)
1	$136^\circ 06'$	$7^\circ 53'$	$0.504 \times 25.9 \times 29.9$	5014.6
2	$137^\circ 10'$	$8^\circ 57'$	$0.541 \times 25.8 \times 29.6$	4661.9
3	$137^\circ 44'$	$9^\circ 31'$	$0.542 \times 22.2 \times 28.3$	4654.6
4	$138^\circ 13'$	$10^\circ 00'$	$0.540 \times 25.0 \times 29.7$	4678.3
5	$138^\circ 47'$	$10^\circ 34'$	$0.542 \times 25.0 \times 29.2$	4653.6

β = angle measured by means of X-ray spectrometer.

$\theta = \beta + 90^\circ + 38^\circ 13'$

Shorter sides of the principal surfaces are parallel to the electrical axis.

Since X-cut plates do not function satisfactorily at very high frequencies, the frequencies of the plates are generally chosen under 2500 kilocycles (120 meters) and two or three stages of frequency doublers with power amplifiers are employed to attain the desired frequency and power. Moreover, as the X-cut quartz plates on the market have temperature coefficients of about 20 to 30×10^{-6} per degree centigrade they are placed in temperature controlled compartments which are generally completely lined with thick metal, so that the stray capacity of the electrodes and wires to the quartz plates increases the equivalent capacity between grid and cathode of the oscillator tube and makes the oscillator unstable. Further, considerable attention is required to maintain the thermostat equipment in working condition. Therefore, to find some means to dispense with the thermostat was highly desirable from a practical point of view.

Early in July of 1933, we tested¹⁴ the short-wave plates of small temperature coefficient referred to in the previous chapter, in a high power radio transmitter at Yosami (near Nagoya), the transmitting station of the Japan Wireless Telegraph Company, incorporating, at the same time, certain circuit improvements. Because the results were excellent, the company decided in March, 1934, to incorporate these improvements in all of the transmitters in their stations. This work was completed in August, 1934, and since that time, the thermostat has disappeared entirely.

The principal points gained as a result of these improvements are as follows:

(1) *Frequency of crystal is doubled.* Since the new crystal plates vibrate very easily at very high frequency, the frequency of these crystals is always chosen between 2500 and 6000 kilocycles, making it possible to employ not more than two stages of frequency doublers in order to obtain any frequency for commercial service.

(2) *Oscillator tube is changed.* Triode Type UX-210 has long been used as the crystal oscillator tube. This type of tube was replaced by the pentode Type UY-247 because it can deliver considerably more power to the plate circuit with less power dissipated in the crystal than was the case with the Type UX-210. Moreover the stability of frequency using the pentode was found to be superior to that obtainable with the UX-210. Figs. 13 and 14 show respectively the characteristics of the triode and of the pentode oscillator. As is readily seen from Fig. 14, in the pentode oscillator, the frequency variation due to the variation of impedance in the plate circuit (see the effect of R and C), is of the order of one part in 10^5 in the working condition, so that the tube stage next to the crystal oscillator need no longer be treated as a buffer amplifier but may be operated at full power as an ordinary amplifier.

Frequency variation due to about ten per cent change in any one of the following, (a) fluctuation of the plate voltage, (b) grid-bias voltage, (c) resistance of grid leak, and (d) filament terminal voltage, was found to be considerably less than one part in 10^5 . When the quartz plate is transferred together with its holder from one transmitter to another of the same type, the frequency change of the oscillator is also less than one part in 10^5 , so that if we wish to interchange the frequencies of two transmitters, we need only interchange the crystals together with their holders.

(3) *One stage employing Type UX-860 tube was omitted.* Before the

¹⁴ I. Koga, M. Nagaya, and T. Kusakari, "Improvement of short-wave commercial radio transmitter by the employment of oscillating quartz plate of very small temperature coefficient of frequency," *Jour. I. E. E. (Japan)*, vol. 53, no. 10, p. 917; October 10, (1933).

improvements were made, there were three stages of frequency doublers using Type UX-860 tubes. Since, however, the frequency of the crystal had been doubled and the power output of the crystal oscillator circuit and the next stage to it had been increased, one stage of frequency doubler could be omitted without any reduction of the output in the last stage of the transmitter.

(4) *Crystal oscillator in a transmitter.* A crystal oscillator employing an ordinary crystal plate has to be started some time prior to

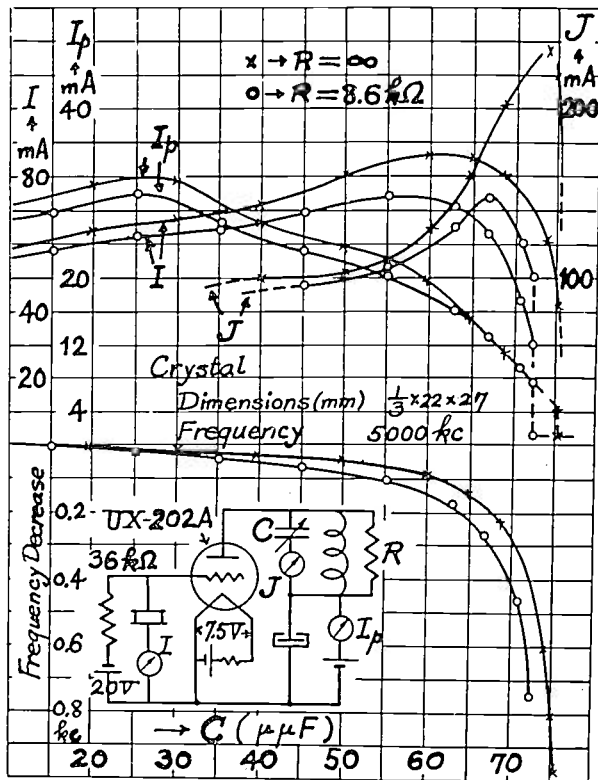

Fig. 13—Characteristics of triode crystal oscillator.

actual use of the transmitter, because the frequency of the crystal oscillator will gradually change due to the temperature rise caused by the mechanical vibration of the crystal, even though the temperature within the thermostatically controlled compartment is kept constant. Accordingly, two complete oscillators with crystals in operating state were always kept in a transmitter to assure quick change of frequency. But as there is practically no influence of temperature upon the new crystal plate, it is now quite sufficient to provide only one crystal-oscillator circuit. At present three crystals corresponding to three different wave frequencies are provided in each transmitter and any

one of them can be connected by means of a dial switch to the oscillator tube.

(5) *Crystal holder is specially designed.* Under present operating requirements, it is necessary to adjust the frequency of a transmitter exactly to the assigned frequency. This adjustment is almost impossible if we intend to rely upon fine adjustment by varying the thickness of the plate, since this operation is too delicate for even a very skilled work-

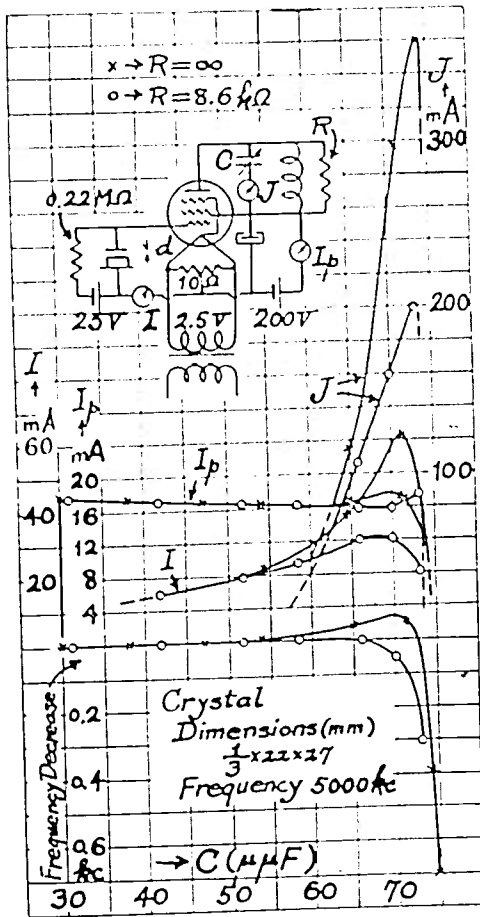

Fig. 14—Characteristics of pentode crystal oscillator.

man. With the older types of crystals, it has been customary to make this final adjustment of frequency by varying the ambient temperature of the crystal. This procedure is obviously not applicable to the new type of crystal.

Since an oscillator with the new type of crystal is very easily maintained in oscillation, it is possible to change its frequency readily even more than one part in 10^3 by varying the air gap between the crystal and one of its electrodes without any reduction in the output

power of the oscillator. Fig. 15 shows the dependence of frequency upon air gap d (see also Fig. 14) between the quartz plate and the upper electrode. The details of construction of the holder are shown in Fig.

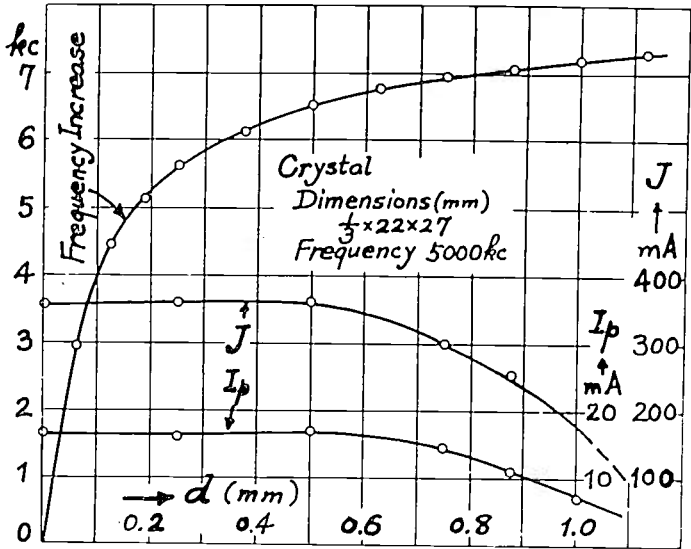

Fig. 15—Influence of air gap between crystal plate and electrode upon the frequency and amplitude of oscillation.

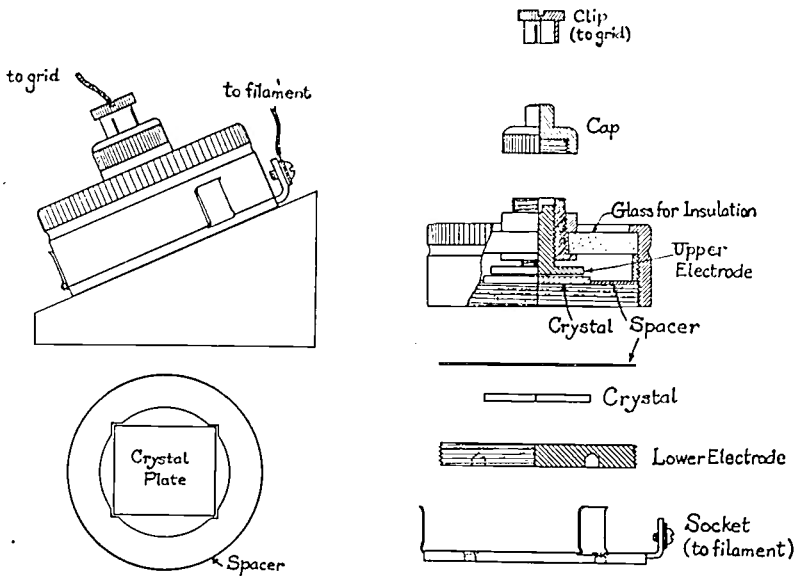

Fig. 16—Crystal holder.

16. The upper electrode for the crystal can be finely adjusted and fixed at any position to provide a certain air gap above the crystal plate in order to get exactly the required frequency. To make the electrodes

sufficiently parallel, we use a metal spacer of uniform thickness shown in the same figure, and the lower electrode is used only to keep this spacer in place. If this container is used in an inclined position, the quartz plate is held by notches in the spacer, so that a stability of frequency better than one part in 10^5 is still obtained.

After the improvements described above were made, the over-all frequency fluctuations of the transmitters from the assigned frequencies always remained within about five parts in 10^5 . As the temperature coefficient of frequency of the crystal is always less than 2×10^{-6} per degree centigrade the frequency variation due to changes in temperature is always within 2.5 parts in 10^5 , since the ambient temperature of the crystal remains between 15 degrees and 40 degrees centigrade throughout the year.

At present, the Ministry of Communications, the International Telephone Company (Kokusai Denwa Kaisha, the sole company for international radiotelephone service in Japan) and the Broadcasting Corporation of Japan are preparing to employ the new type of quartz plates. In short, Japanese stations are all about to make the same improvements.

Recently, we had an opportunity to test the new type of crystal in the transmitter used for the ship-to-shore radiotelephone service provided by the International Marine Radio Company, Limited, on the "Berengaria" of the Cunard Line, through arrangements made by H. H. Buttner, vice president of the Mackay Radio and Telegraph Company. The radio operator on the "Berengaria" stated "the Ocean-gate, N. J., frequency checking station reported the carrier stability good and comparing favorably with the thermostatically controlled crystals in general use . . . the frequency of the crystal was 4412.82 kilocycles at 20 degrees centigrade and 4412.875 kilocycles at 50 degrees centigrade. The variation is thus only 0.055 kilocycle for a change in temperature of 30 degrees centigrade."

IV. CRYSTAL OSCILLATORS OF SPECIAL CONNECTIONS

Although usually a single crystal plate is used for stabilizing frequency, two or more crystals may also be used in one circuit. Such circuits with several crystals have some interesting properties. We will discuss two examples of such circuits.

Consider the Pierce oscillator: In this circuit, the change of frequency due to a change in the plate circuit is not as serious as a change in the grid circuit. Suppose that we wish to eliminate even this minor effect, the following method will be found one of the best:

As the oscillating crystal equipped with its electrodes can be con-

sidered to be an electrical circuit, we see that the necessary impedance in the plate circuit can also be obtained by a crystal plate of proper dimensions. Thus we can replace the plate circuit by another crystal circuit as shown in Fig. 17. As the crystal circuit blocks direct current, anode current is supplied through a resistance or a choke coil D . If the air gap between an electrode and the crystal Q is made adjustable,

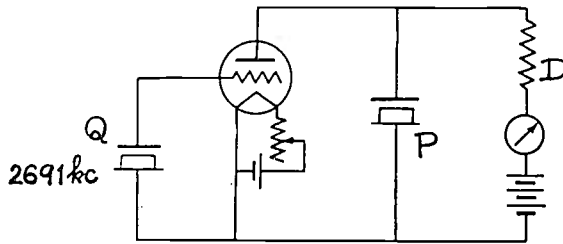

Fig. 17—Crystal oscillator in which the plate circuit is replaced by another crystal.

oscillation starts very easily even if the dimension of P is not so precisely adjusted. Fig. 18 shows the change of frequency and anode current due to variation in air gap (in microns) between crystal P and one of its electrodes. From this figure, we see that variation in frequency, due to a slight change in the air gap with time, would be negligible.

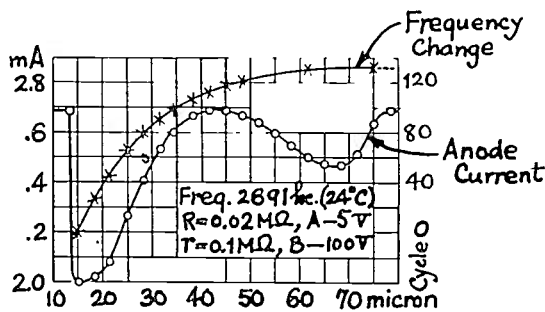

Fig. 18—Change of frequency and plate current due to the change in air gap for crystal P in Fig. 17.

Incidentally, it may be added that variation of frequency due to the variation of grid-leak resistance from 0.03 to 0.1 megohm, plate circuit resistance D from 0.01 to 0.02 megohm, filament terminal voltage from 4.5 to 5.5 volts, anode voltage from 100 to 70 volts, was observed to be about 30 cycles, 4 cycles, 1 cycle, 0.5 cycle, respectively, at the oscillating frequency of 2691 kilocycles.

The most interesting feature of this oscillator is that neither inductance nor condenser is used, so that there is practically no danger of frequency variation due to stray induction.

It goes without saying that this idea is also applicable to many other types of oscillators.

Another example of a special oscillator. If two crystals *A* and *B* of the same frequency be connected in parallel or in series (two crystals may be placed one upon the other) as shown in Figs. 19 and 20, the frequency of oscillation is, of course, nearly equal to that when only *A* or *B* is used. But even if the ambient temperature of the crystals be

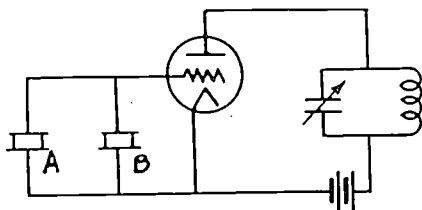

Fig. 19—Two crystals of nearly the same frequency connected in parallel.

varied over a very wide range, as long as the oscillation is maintained the frequency is always intermediate between the values obtained with *A* and *B* used individually.

This phenomenon can be explained as follows: In general, when oscillation is maintained in the oscillator, we may consider that the impedances of the several parts are of such values as are necessary to satisfy the condition of oscillation. Now, if the ambient temperature

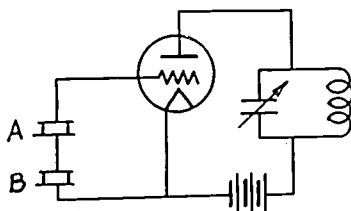

Fig. 20—Two crystals of nearly the same frequency connected in series.

be varied, the impedance for the original frequency in the crystal circuit will change, so that the frequency must also change to recover the original value of impedance (both in magnitude and phase angle, but especially in the latter, because the change in the former is not considerable). In this case, the necessary change of frequency is generally very small, because a very slight change of frequency is generally quite sufficient to change the impedance of the crystal. Practically, we may neglect the change of impedance in other parts of the oscillator due to such a slight change of frequency, thus we can simplify the treatment.

For the sake of convenience, let us suppose that the impedances of the two crystals connected in series be changed slightly to some dif-

ferent values Z_A and Z_B , respectively, from a certain common value, the phase angle of the resultant impedance for the original frequency is surely intermediate between Z_A and Z_B . Therefore, the necessary frequency change to recover this change of phase angle is of a certain intermediate value between the changes of frequencies necessary in the case when the crystals A and B are used alone. It is needless to repeat the explanation when two crystals are in parallel.

The most interesting application of this connection is the compensation of temperature effect upon the oscillating frequency by connecting (in series or in parallel) two crystal plates of opposite

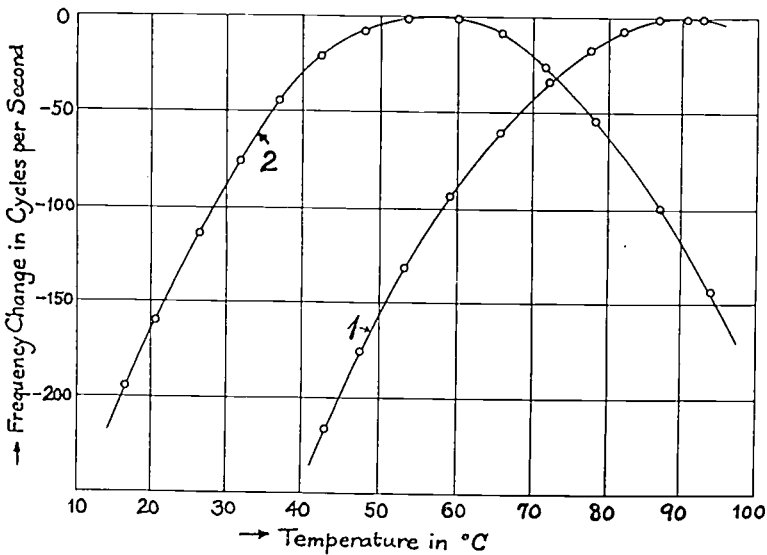
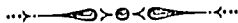

Fig. 21—Frequency temperature curve for the oscillator shown in Fig. 20.

temperature coefficients. For example, two plates of about 4860 kilocycles were placed one upon the other in a holder. The temperature coefficients of the frequency when the plates were used individually were about -38 cycles/ $^{\circ}\text{C}$ ($-7.8 \times 10^{-6}/^{\circ}\text{C}$) and about plus 42 cycles/ $^{\circ}\text{C}$ (plus $8.7 \times 10^{-6}/^{\circ}\text{C}$). Curve 1 in Fig. 21 shows the result when the two plates are placed one upon the other. If we slightly decrease the thickness of the plate of positive temperature coefficient, the maximum point of the curve moves to the left as shown by curve 2 in the same figure. The flat part of the curve near the maximum point shows that the maximum deviation of frequency due to the change of temperature from about 36 to 77 degrees centigrade is only fifty cycles, which corresponds to a variation of less than $10^{-6}/^{\circ}\text{C}$. Therefore, if we adjust the thickness of both crystal plates so that the oscillating frequency becomes maximum at a required frequency and mean operating

temperature, the result will be as striking as that with a plate of temperature coefficient less than $10^{-6}/^{\circ}\text{C}$.

As we have already described in the second section, we cannot get a crystal plate of absolutely invariable frequency over a very wide range of temperature, because the change of frequency due to temperature variation is not always exactly linear. Since it appears, from the above results, that the frequency temperature characteristics of a crystal oscillator can be greatly improved by the employment of two crystal plates in the circuit, we are continuing our experiments.



which is very long, but at a glance we see readily that the ratio c/T , that is the reciprocal of the Young's modulus, say M , may be transformed symbolically into a convenient form as follows:

$$\frac{1}{M} = (l^2s_1 + m^2s_2 + n^2s_3 + mns_4 + nls_5 + lms_6)^2, \quad (5)$$

in which s_1, s_2, \dots have no quantitative meaning, but s_1^2 is to be replaced by s_{11}, s_1s_2 by s_{12} and so on, s_{11}, s_{12}, \dots being the elastic moduli. This expression is not difficult to remember.

For example, in quartz and tourmaline, remembering that $s_{15}, s_{16}, s_{25}, s_{26}, s_{34}, s_{35}, s_{36}, s_{45}, s_{46}$ are all zero and $s_{11} = s_{22}, s_{23} = s_{13}, s_{24} = -s_{14}, s_{55} = s_{44}, s_{56} = 2s_{14}, s_{66} = 2(s_{11} - s_{12})$, Young's modulus M in any direction is expressed by

$$\begin{aligned} \frac{1}{M} &= l^4s_{11} + m^4s_{11} + n^4s_{33} + m^2n^2s_{44} + n^2l^2s_{44} + 2l^2m^2(s_{11} - s_{12}) \\ &\quad + 2l^2m^2s_{12} + 2l^2n^2s_{13} + 2l^2mns_{14} + 2m^2n^2s_{13} - 2m^3ns_{14} \\ &\quad + 4l^2mns_{14} = (1 - n^2)^2s_{11} + n^4s_{33} + (1 - n^2)n^2(s_{44} + 2s_{13}) \\ &\quad + 2mn(3l^2 - m^2)s_{14}. \end{aligned} \quad (6)$$

As a particular case, Young's modulus in the direction perpendicular to the optical axis z is given by putting $n=0$ in (6)

$$\frac{1}{M} = s_{11} \text{ or } M = \frac{1}{s_{11}}, \quad (7)$$

or putting $n=0$ in (5) directly,

$$\begin{aligned} \frac{1}{M} &= (l^2s_1 + m^2s_2 + lms_6)^2 \\ &= l^4s_{11} + m^4s_{11} + 2l^2m^2(s_{11} - s_{12}) + 2l^2m^2s_{12} \\ &= (l^2 + m^2)s_{11} = s_{11}. \end{aligned} \quad (8)$$

In sodium chlorate, remembering that $s_{11} = s_{22} = s_{33}, s_{44} = s_{55} = s_{66}, s_{12} = s_{13} = s_{23}$ and that all other elastic moduli are zero,

$$\frac{1}{M} = s_{11}(l^4 + m^4 + n^4) + (s_{44} + 2s_{12})(m^2n^2 + n^2l^2 + l^2m^2). \quad (9)$$

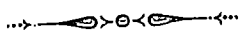

DISCUSSION ON "THE GRID-COUPLED DYNATRON"*

F. MALCOLM GAGER

Tatuo Hayasi:¹ In his interesting paper entitled "The Grid-Coupled Dynatron," Mr. Gager pointed out that the output of a tetrode dynatron oscillator can be increased by feeding back the oscillation voltage from the anode circuit to the inner-grid circuit.

I would like to call attention to the fact that the same investigation had already been made by myself about three years ago. The experiment was carried out in the autumn of 1932 and the report was presented on April 10, 1933, to the Radio Research Committee of the National Research Council of Japan. The paper was published in English in the *Report of Radio Research in Japan*, Vol. IV, No. 1, March, 1934. The paper, consisting of three parts, was entitled "Experimental and Analytical Studies of Negative Resistance Oscillators by Means

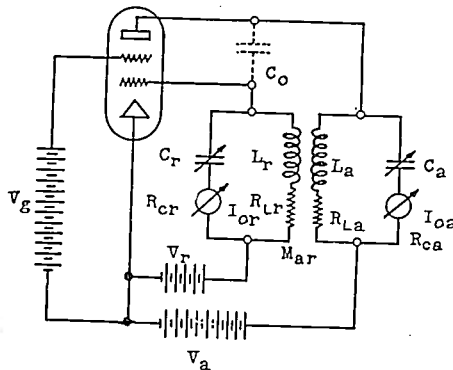

Fig. 1—Retroactive dynatron oscillator of the first kind.

of Secondary Electrons." My studies on the "Retroactive Dynatron Oscillator" were described in the first section of the second part of the paper. Oscillators with coupling of the anode to the outer-grid as well as to the inner-grid were fully studied. Fig. 1 of this discussion is the replica of Fig. 19 of the original paper and this circuit was named "The Retroactive Dynatron Oscillator of the First Kind." Fig. 2 of Mr. Gager's paper is but a special case of my generalized circuit, when the inner-grid condenser C_r is made zero.

The augmentation of output by regeneration was already verified in my experiment. In addition, in the case $C_r \neq 0$, the amplitude increased almost two-fold by regeneration.

Several other systems of the retroactive dynatron oscillator were described in the same paper. Some of them are much superior to Gager's circuit in their behavior of augmenting the amplitude.

F. Malcolm Gager:² The author points out that in his article on page 1054, the first paragraph of his conclusions states, in substance, that there are other circuits in the author's notebooks which have their advantages. In addition the author particularly directs the attention of Mr. Hayasi to the words "other

* Proc. I.R.E., vol. 23, pp. 1048-1055; September, (1935).

¹ Department of Physics, Faculty of Science, Osaka Imperial University, Osaka, Japan.

² Department of Physics, Boston College, Chestnut Hill, Massachusetts.

combinations such as simple or compound coupling from the oscillatory circuit to some control electrode simultaneously, etc." It is a fact that Fig. 2 of the author's paper is his simplest circuit to produce the results mentioned, and, in consequence, was used as an example. The author has excited both grids of the tetrode dynatron and has even experimented with equivalent push-pull systems.

As to priority of investigation the author offers the following. In the fall of 1930 the author with Mr. J. B. Russell, Jr., continued some experimental dynatron investigations. Subsequently the dynatron oscillator circuit was subjected to solution on the Massachusetts Institute of Technology differential analyzer with the invaluable aid of Lieutenant James E. McGraw of the United States Army. The results and other related material are presented in a paper "A Quantitative Study of the Dynatron" by F. M. Gager and J. B. Russell Jr., Proc. I.R.E., vol. 23, pp. 1536-1566; December, 1935. While watching the differential analyzer solve the nonlinear differential equations of the oscillatory system the first notebook records of the principles set forth in the paper under discussion were made. This was in the year 1931. Other notebook entries and experimental evidence bear the dates of January, 1932, May and June, 1932, and in addition some entries were made in December, 1932, with Mr. D. G. Fink assisting in the laboratory work.

Mr. Hayasi has used the term regeneration in too broad a sense though this is perhaps due to difficulties with terminology between the languages. In Mr. Hayasi's replica of his Fig. 19 he would not consider such a circuit as "an amplifier tied back on itself" because oscillations can be produced without the aid of the tuned circuit in the control grid. Furthermore, such a circuit as reproduced could be a positive plate-current oscillator with some aid from secondary emission. The author has preferred for several basic reasons to discuss "characteristic sweeping" whether the dynamic characteristic is a single or multivalued function; see "Methods of Increasing the Amplitude" in the paper under discussion.

It appears that Mr. Hayasi has independently investigated some of the phases of the complete work on the oscillatory system described by the author, and the author does not doubt that Mr. Hayasi has performed his work admirably.

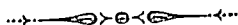

BOOK REVIEWS

Communication Networks—Vol. II, by Ernst A. Guillemin, Assistant Professor of Electrical Engineering, Massachusetts Institute of Technology. 585 pages. Published by John Wiley and Sons, Inc., New York. Price \$7.50.

In the first volume of this work Dr. Guillemin confined his attention to networks having lumped constants. This second volume opens with a discussion of the difference between lumped constant and distributed constant circuits; and then devotes three chapters to the long smooth line. Starting with the fields around the conductors, the problem is reduced to the conventional pair of differential equations involving the parameters L , C , G , and R ; and the formal solutions of these equations are interpreted as wave equations. The concepts of characteristic impedance, of attenuation and phase functions, and of reflection coefficients are introduced. Then follows a discussion of group velocity, a subject on which the average communication engineer is not too well versed.

The second quarter of this volume deals with generalized four-terminal networks. A brief introduction to matrix algebra is included and some use is made of this tool in treating the problem at hand. The iterative and image impedances and the propagation functions are presented in terms of wave propagation, thus tying in the basic four-terminal network with the long smooth line and with the filters which are to follow. As part of this theory of generalized networks, two chapters are devoted to Foster's reactance theorem and its extensions, and to the subject of transformations which give equivalent networks.

Chapters VII and VIII, on lumped lines and ladder structures, prepare for the filter theory. In them the author develops such ideas as those of cutoff frequencies, transmission ranges and mid-shunt terminations.

The third quarter of the book takes up filter theory. The division here is not so much into types like low-pass and band-pass, as into the basic types such as constant- k and m -derived. To a considerable extent this presentation follows the methods of Zobel for ladder networks, and those of Cauwer and Bode for lattice networks. The greater flexibility of the lattice networks in design is pointed out; and methods are given for arriving at the ladder networks which are equivalent to them.

The last section of the work deals with the transient behavior of filters and long lines, the distortion that may be produced by them, and the theory of those networks which are used either to simulate a line or to correct for the distortion which the line introduces.

At the end of each chapter is a rather generous list of problems. No answers are given for the reason that for most of these problems there is no simple numerical answer. The problems are of the type which demands a review of the immediate subject and invites an interpretation that will fix concepts and correlate that subject with others.

In the introduction to his first volume, Dr. Guillemin pointed out that the student (and this work must be studied, not just read) must expect to wade through some material that may seem rather dry before he emerges to see the operation of the network from a new angle. The general method of attack is academic. The author is concerned with the deeply underlying basis of the sub-

ject. There are no tables or formulas in bold type for the engineer who has to build a particular network, on the job, now. This is no handbook.

But there is considerable emphasis on the engineering significance. Examples of this are the curves which show the dependence of attenuation and distortion upon the different parameters of a line, and the curves which show the relation between the m -parameter of a filter, the coverage as a fraction of the nominal bandwidth, and the tolerance or variation of some property within the covered band.

This work recommends itself not only to the advanced student in school but also to the practicing engineer who realizes that continued progress results only from continuing study.

*E. B. FERRELL

Handbook of Chemistry and Physics—Twentieth Edition, 1935, by Charles D. Hodgman, Editor in Chief. Published by Chemical Rubber Publishing Co., Cleveland, Ohio. 1951 pages. Price \$6.00.

The 1935 edition of this well-known and increasingly useful annual handbook, is larger than the 1934 edition by the inclusion of some new material and the elaboration of material carried over from previous editions.

The sections are: Mathematical Tables, page 5; Properties and Physical Constants, page 279; General Chemical Tables, page 827; Specific Gravity and Properties of Matter, page 998; Heat, page 1193; Hygrometric and Barometric Tables, page 1339; Sound, page 1358; Electricity and Magnetism, page 1364; Light, page 1472; Quantities and Units, page 1613; and Miscellaneous, page 1820.

The table "Physical Constants of Organic Compounds" has been enlarged in scope and arranged in paragraphs instead of tabular form. Of interest also are the "Formula Index of Organic Compounds," the "Pronunciation of Chemical Words" and sections relating to X-ray spectra, colorimetry, and photometry. Certain general chemical formulas and information as well as data are included.

A few radio formulas and tables and brief tables of standard vacuum tube characteristics are given. It is noted that the tube tables are not as nearly up-to-date as might be expected.

†B. E. SHACKELFORD

* Bell Telephone Laboratories, Inc., Deal, New Jersey.

† RCA Manufacturing Company, RCA Radiotron Division, Harrison, New Jersey.

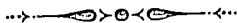

CONTRIBUTORS TO THIS ISSUE

Anderson, Clifford N.: Born September 22, 1895, at Scandinavia, Wisconsin. Received Ph.B. degree, University of Wisconsin, 1919; M.S. degree, 1920. Supervising principal of schools, Amery, Wisconsin, 1913-1917. Ensign, Aircraft Radio, U.S.N.R.F., 1917-1918. Instructor, engineering physics, University of Wisconsin, 1919-1920; standardizing laboratory, General Electric Company, Lynn, Massachusetts, 1920-1921; Fellow to Norway, American Scandinavian Foundation, 1921-1922; department of development and research, American Telephone and Telegraph Company, 1922-1934; Bell Telephone Laboratories, Inc., 1934 to date. Associate member, Institute of Radio Engineers, 1919; Fellow, 1934.

Beverage, Harold H.: Born October 14, 1893, at North Haven, Maine. Received B.S. degree in electrical engineering, University of Maine, 1915. Testman, General Electric Company, 1915-1916; assistant in Alexanderson's radio laboratory, Schenectady, 1916-1920; in charge of communication receiver laboratory, Radio Corporation of America, 1920-1929; chief communications engineer, R.C.A. Communications, Inc., 1930-1932; chief research engineer, 1932 to date. Received Morris Liebmann Memorial Prize, 1923. Associate member, Institute of Radio Engineers, 1915; Member, 1926; Fellow, 1928.

Caldwell, Orestes H.: Born 1888, at Lexington, Kentucky. Received B.S. degree in electrical engineering, Purdue University, 1908. Assistant technical editor, *Western Electrician*, 1907; assistant technical editor, *Electrical Review*, 1908; Westinghouse Electric and Manufacturing Company, 1909; associate editor, *Electrical World*, 1910-1918; editor, *Electrical Merchandising*, 1916-1927, 1929-1935; editor, *Radio Retailing*, 1925-1927, 1929-1935; Federal Radio Commissioner, 1927-1928; Editor, *Electronics*, 1929-1935; Editor, *Radio Today*, 1935 to date. Member, Institute of Radio Engineers, 1928.

Hallborg, Henry E.: Born April 24, 1884, at Stockholm, Sweden. Received B.S. degree in electrical engineering, Brown University, 1907. Development engineer, National Electric Signalling Company, Brant Rock, Mass., 1909-1912; supervisor engineer and engineer-in-charge, New Brunswick and Belmar, New Jersey, stations, Marconi Wireless Telegraph Company, 1912-1914; expert radio aide, Navy Department, 1914-1923; consulting engineer, C. Brandies Company, 1923-1925; engineering staff, R.C.A. Communications, Inc., 1925 to date. Associate member, Institute of Radio Engineers, 1912; Member, 1914; Fellow, 1927.

Harris, Charles C.: Born May 6, 1898, at St. Louis, Missouri. Radio operator aboard ships, 1916-1918; operator and engineer, tropical shore stations, Tropical Radio Telegraph Company, 1918-1925; radio engineer and assistant to general manager, 1927 to date. Associate member, Institute of Radio Engineers, 1926; Member, 1927.

Higgy, Robert C.: Born December 7, 1901, at Columbus, Ohio. Radio instructor, United States Army School of Military Aeronautics, Ohio State Uni-

versity, 1918; associate editor, American Radio Relay League, 1922; assistant, department of electrical engineering, Ohio State University, 1923-1925. Received B.S. degree in electrical engineering, Ohio State University, 1925. Radio engineer in charge of WOSU, 1925-1927; director, WOSU, 1927 to date. Instructor in electrical engineering, 1927-1930; engineer-in-charge, State Highway Patrol, radio division, 1934 to date; engaged in consulting work, 1927 to date. Associate member, Institute of Radio Engineers, 1926.

Jansky, C. M., Jr.: Born at Delton, Michigan. Received B.S. degree in physics, University of Wisconsin, 1917; M.S. degree, 1919. Instructor, in charge of University's broadcast and experimental station, associate professor, radio engineering, department of electrical engineering, University of Minnesota, 1920-1929. Member of the four National Radiotelegraph Conferences. Consulting engineer, Jansky and Bailey, Washington, D.C., 1929 to date. Associate member, Institute of radio Engineers, 1918; Member, 1925; Fellow, 1928.

Kenrick, Gleason W.: Born May 25, 1901, at Brockton, Massachusetts. Received B.S. degree in physics, Massachusetts Institute of Technology, 1922; M.S. degree in physics, 1922; Sc.D. degree in mathematics, 1927. Department of physics, Massachusetts Institute of Technology, 1920-1922; department of development and research, American Telephone and Telegraph Company, 1922-1923; instructor in electrical engineering, Massachusetts Institute of Technology, 1923-1927; Moore School of Electrical Engineering, University of Pennsylvania, 1927-1929; assistant professor of electrical engineering, Tufts College, 1929-1934; consulting physicist (radio), Bureau of Standards, 1930-1931; professor of physics, University of Puerto Rico, 1934 to date; consultant, R.C.A. Communications, Inc., 1934 to date. Associate member, Institute of Radio Engineers, 1923; Member, 1929; Fellow, 1933.

Koga, Issac: Born December 5, 1899, at Kashii, near Fukuoka, Japan. Received E.E. degree, Tokyo Imperial University, 1923; University Hall student, 1923-1925; lecturer, 1925 to date; Electrical Research Institute, Tokyo Municipality, 1926-1929; assistant professor, Tokyo University of Engineering, 1929-1933; professor, 1933 to date. Nonmember, Institute of Radio Engineers.

Kozanowski, Henry N.: Born August 15, 1907, at Buffalo, New York. Received B.S. degree, University of Buffalo, 1927; M.A. degree, 1929, Ph.D. degree in Physics, University of Michigan, 1930. Graduate teaching assistantship, University of Buffalo, 1927-1928; research assistant, University of Michigan, 1929-1930; research assistant, power tube section, Westinghouse Electric and Manufacturing Company, 1930-1935; RCA Manufacturing Company, Inc., RCA Victor Division, 1935 to date. Member, American Physical Society. Associate member, Institute of Radio Engineers, 1934.

Langley, Ralph H.: Born January 5, 1889, at New York City. Received E.E. degree, Columbia University, 1913. Engineer, Wireless Improvement Company, 1913; Marconi Wireless Telegraph Company of America, 1914; radio department, General Electric Company, 1920; engineer-in-charge, development of first commercial superheterodynes, 1923; receiver development, 1922-1927; assistant to the president and director of engineering, Crosley Radio Corporation, 1927-1930; in charge of construction, fifty-kilowatt station WLW, Mason, Ohio, 1928; consulting engineer, New York City, 1930 to date. Delegate to

Fourth International Radio Conference, 1928; member, board of directors, Radio Manufacturers Association, 1929-1930. Member, American Institute of Electrical Engineers and Acoustical Society of America. Fellow, Radio Club of America. Associate member, Institute of Radio Engineers, 1912; Member, 1916; Fellow, 1929.

Malter, Louis: Born 1907, at New York City. Received B.S. degree, City College of New York, 1926; M.A. degree, Cornell University, 1931. Taught physics, C. C. N. Y., 1926-1928. Acoustical engineer, Radio Corporation of America, 1928-1930; acoustical engineer, RCA Photophone, 1930. Research Fellow, Cornell University, 1930-1933. Acoustical engineer, Dictograph Products Company, summer, 1932; electronic research laboratory, RCA Manufacturing Company, Inc., 1933 to date. Member, Sigma Xi and American Physical Society. Nonmember, Institute of Radio Engineers.

McLean, True: Born January 22, 1899, at New York City. Graduated in electrical engineering, Cornell University, 1922. Department of development and research, Western Electric Company, 1922-1923. Instructor in electrical engineering, Cornell University, 1923-1930; assistant professor, 1930 to date. Nonmember, Institute of Radio Engineers.

Morton, George A.: Born March 24, 1903, at New Hartford, New York. Received B.S. degree in electrical engineering, Massachusetts Institute of Technology, 1926. Research laboratory, General Electric Company, 1926-1927. Received M.S. degree, Massachusetts Institute of Technology, 1928; Ph.D. degree in physics, 1932. Research associate and instructor, Massachusetts Institute of Technology, 1927-1933. Electronic research laboratory, RCA Manufacturing Company, Inc., RCA Victor Division, 1933 to date. Member, American Physical Society. Associate member, Institute of Radio Engineers, 1935.

Mouromtseff, Iliá Emmanuel. Born December, 1881, at St. Petersburg, Russia. Received M.A. degree, Engineering Academy, St. Petersburg, 1906; Diploma-Ingenieur degree, Institute of Technology, Darmstadt, Germany, 1910. Radio laboratory, Russian Signal Corps, 1911. Member, technical staff, Westinghouse Electric and Manufacturing Company 1923 to date. Associate member, Institute of Radio Engineers, 1934.

Shipley, Elwood D.: Born February 3, 1907, at Fairview, Ohio. Received B.S. degree in electrical engineering, Ohio State University, 1929; M.S. degree, 1930. Assistant instructor in electrical engineering, Ohio State University, 1929-1930. Mathematics department, Bell Telephone Laboratories, Inc., summer, 1930. Robinson Fellow in electrical engineering, Ohio State University, 1930-1932; assistant instructor in mathematics department, 1932-1933. State Highway Patrol, radio division, 1934. Radio consultant, Columbus, Ohio, 1934 to date. Nonmember, Institute of Radio Engineers.

Taylor, Charles H.: Born August 22, 1875, at Hayes, Middlesex, England. Graduate, Heriot-Watt College, Edinburgh, 1895. Engineering department, Marconi's Wireless Telegraph Company, Ltd., and American Marconi Company, 1899-1919; communications engineering department, Radio Corporation of American and R.C.A. Communications, Inc., 1920 to date. Member, Institute of Radio Engineers, 1913; Fellow, 1915.

Von Ardenne, Manfred: Born January 20, 1907, at Hamburg, Germany. Studied physics, Berlin University, 1925-1926. Research work on resistance amplifiers, multiple tubes, end-stage amplifiers, high-frequency measurements, cathode-ray tubes, and television with cathode-ray tubes in his own laboratory, Lichterfelde, 1928 to date. Junior member, Institute of Radio Engineers, 1927; Associate, 1929.

Young, Louis McComas: Born June 9, 1894, at Boonsboro, Maryland. Received B.S. degree in electrical engineering, Johns Hopkins University, 1917; Certificate of Proficiency, radio engineering, University of Paris and Ecole Supérieure d'Electricité, 1919. United States air service, 1917-1919; U. S. Signal Corps radio laboratories, 1920-1929; engineer-in-charge, research section, 1922-1927. Westinghouse Electric and Manufacturing Company, radio engineering and radio broadcast departments, 1929-1933; supervisor of synchronization, WBBM, Columbia Broadcasting System, 1934 to date. Nonmember, Institute of Radio Engineers.

Zworykin, Vladimir K.: Born 1889 in Russia. Received E.E. degree, Petrograd Institute of Technology; studied physics under Professor Boris Rosing, and started first experiments in television. In 1912 entered laboratory of College de France, Paris, to do X-ray research under Professor P. Langevin. During World War served as officer in Radio Corps of Russian Army. Research Laboratory, Westinghouse Electric and Manufacturing Company, 1920-1929. Received Ph.D. degree, University of Pittsburgh, 1926. Research laboratory, RCA Manufacturing Company, Inc., RCA Victor Division, working on television, electron optics, photoelectric cells, and allied problems, 1929 to date. Received Morris Liebmann Memorial prize, 1934. Member, Institute of Radio Engineers, 1930.

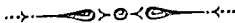

"It's for You"

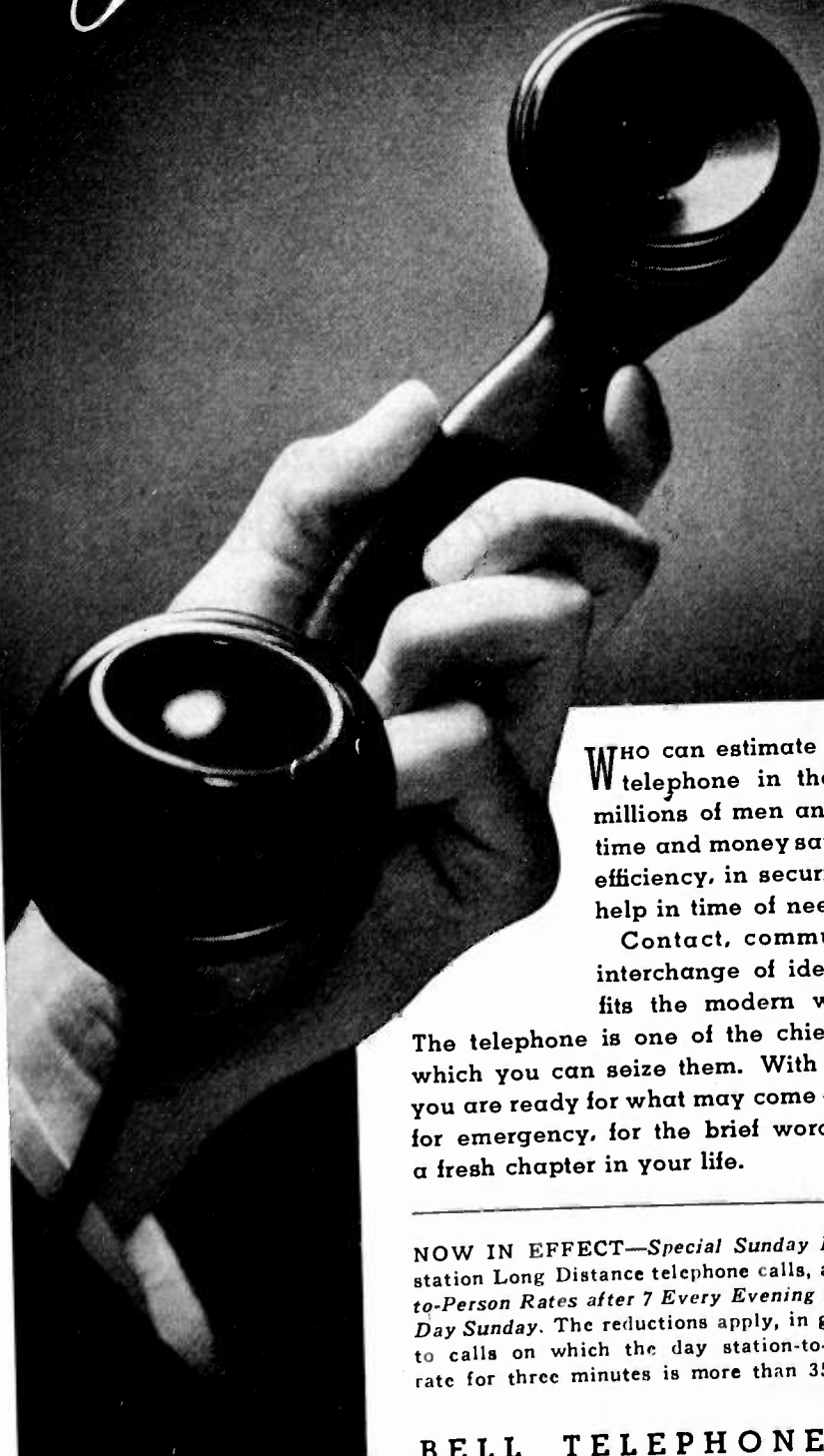

WHO can estimate the value of the telephone in the daily lives of millions of men and women . . . in time and money saved, in increased efficiency, in security and priceless help in time of need!

Contact, communication, swift interchange of ideas — these benefits the modern world offers you. The telephone is one of the chief instruments by which you can seize them. With it at your elbow you are ready for what may come — for opportunity, for emergency, for the brief word that may open a fresh chapter in your life.

NOW IN EFFECT—*Special Sunday Rates* for station-to-station Long Distance telephone calls, and *Reduced Person-to-Person Rates after 7 Every Evening and All Day Sunday*. The reductions apply, in general, to calls on which the day station-to-station rate for three minutes is more than 35 cents.



BELL TELEPHONE SYSTEM

When writing to advertisers mention of the PROCEEDINGS will be mutually helpful.



Behind the Microphone . . .



AEROVOX CONDENSERS

FROM tiny mica units in crystal oscillator circuit to banks of oil-filled filter capacitors, AEROVOX keeps many transmitters on the air year after year. ● Likewise p.a. systems and sound movie equipments, particularly in remote places where failures won't be tolerated. ● So, if that's the kind of service you seek, please get in touch with us.

Oil-filled oil-impregnated paper units . . . round and rectangular cans.

Mica capacitors in greatest variety . . . metal cased and bakelite molded units.

Metal-cased paper condensers . . . uncased paper sections for new assemblies and for lasting replacements.

Largest line of metal-can, cardboard case and tubular electrolytes . . . any capacity, combination, voltage rating.

DATA New 1936 Catalog covers general line of AEROVOX condensers and resistors. Any special requirements can be met. Just send your specifications for engineering aid and quotations.

AEROVOX

CORPORATION

71 Washington St.,

Brooklyn, N. Y.

X

When writing to advertisers mention of the PROCEEDINGS will be mutually helpful.

The Institute of Radio Engineers

Incorporated

330 West 42nd Street, New York, N.Y.

APPLICATION FOR ASSOCIATE MEMBERSHIP

(Application forms for other grades of membership are obtainable from the Institute)

To the Board of Directors
Gentlemen:

I hereby make application for Associate membership in the Institute of Radio Engineers on the basis of my training and professional experience given herewith, and refer to the members named below who are personally familiar with my work.

I certify that the statements made in the record of my training and professional experience are correct, and agree if elected, that I will be governed by the constitution of the Institute as long as I continue a member. Furthermore I agree to promote the objects of the Institute so far as shall be in my power, and if my membership shall be discontinued will return my membership badge.

.....
(Sign with pen)

.....
(Address for mail)

.....
(Date)

.....
(City and State)

Sponsors:

(Signature of references not required here)

Mr. Mr.

Address Address

City and State City and State

Mr.

Address

City and State

The following extracts from the Constitution govern applications for admission to the Institute in the Associate grade:

ARTICLE II—MEMBERSHIP

Sec. 1: The membership of the Institute shall consist of: * * * (c) Associates, who shall be entitled to all the rights and privileges of the Institute except the right to hold any elective office specified in Article V. * * *

Sec. 4: An Associate shall be not less than twenty-one years of age and shall be a person who is interested in and connected with the study or application of radio science or the radio arts.

ARTICLE III—ADMISSION AND EXPULSIONS

Sec. 2: * * * Applicants shall give references to members of the Institute as follows: * * * for the grade of Associate, to three Fellows, Members, or Associates; * * * Each application for admission * * * shall embody a full record of the general technical education of the applicant and of his professional career.

ARTICLE IV—ENTRANCE FEE AND DUES

Sec. 1: * * * Entrance fee for the Associate grade of membership is \$3.00 and annual dues are \$6.00.

ENTRANCE FEE SHOULD ACCOMPANY APPLICATION

TRIPLETT INSTRUMENTS ARE *Distinctive*

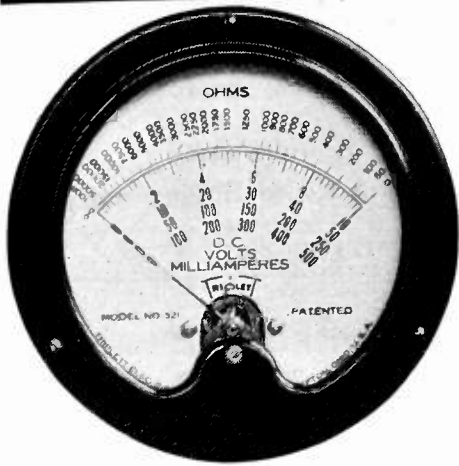

MODEL 521

**MODERN
EXTERNALLY**

**PRECISION BUILT
INTERNALLY**

MODEL 521 VOLT-OHM-MILLIAMMETER

Is an example of extreme accuracy with long readable scale on metal dials. While guaranteed to be accurate within 2%, graphs made by prominent engineers show scales are accurate to 1%. Something that Triplet care in manufacturing make possible. Permanent accuracy is a marked achievement in all Triplet instruments.

Body $4\frac{3}{8}$ " , Flange $4\frac{1}{4}$ " , Body Depth $1\frac{1}{2}$ " , Scales $3\frac{1}{8}$ " in length. Knife edge pointers. Molded bakelite case. Finest materials. Flush mounting.

A truly magnificent instrument of very wide application at a remarkably low price.

Triplet Electrical Instrument Co.
213 Harmon Dr., Bluffton, Ohio
Please send me your New 1936 Catalogue

Name of Ind.
Name of Company
Address
City State

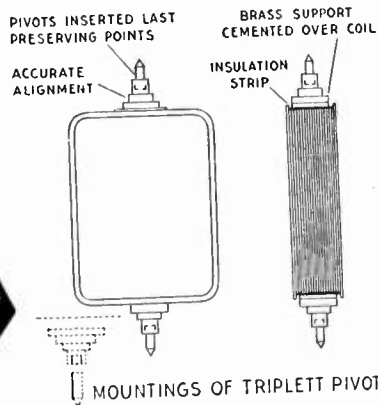

WHY ACCURACY CAN BE GUARANTEED WITHIN 2%

Triplet's Method as illustrated insures true alignment of moving element without strain and with maximum insulation against breakdowns. The pivot points are protected perfectly by the method of assembly—attaching them just before inserting in their sapphire jewel bearings.

*Triplet Instruments Represent
Precision Without Extravagance*

TRIPLETT MANUFACTURES

A complete line of electrical instruments for radio, electrical and general industrial purposes—both standard and custom built. Prices on application. Write for catalogue.

MAIL THE COUPON TODAY!

TRIPLETT
Precision
ELECTRICAL INSTRUMENTS

When writing to advertisers mention of the PROCEEDINGS will be mutually helpful.

ENGINEERING DIRECTORY

QUARTZ CRYSTALS

for Standard or Special
Radio Frequency Applications

Write for Catalog

BLILEY ELECTRIC CO.
230 Union Station Bldg.
ERIE, PENNA.

**Cathode Ray Tubes
and Associated
Equipment For All
Purposes**

*Write for Complete
Technical Data*

**ALLEN B. DUMONT
LABORATORIES**
UPPER MONTCLAIR, N.J.

PRACTICAL RADIO ENGINEERING

One year Residence Course
Advanced Home Study Course
Combined Home Study-Residence
Course

Write for details

**Capitol Radio Engineering
Institute**
Washington, D.C.

MICROPHONE APPLICATIONS

Our engineering department will co-
operate, without obligation, in the
selection of suitable microphones for
standard or special applications.

SHURE BROTHERS

"Microphone Headquarters"
215 WEST HURON ST. CHICAGO, U.S.A.



GUTHMAN Coils

Radio Coils designed and
engineered to suit your re-
quirements by coil special-
ists. Correspondence is in-
vited.

EDWIN I. GUTHMAN and CO., Inc.
1036 West Van Buren St., CHICAGO, ILLINOIS

FOR MANY YEARS

the Professional Engineering Directory
has helped consulting engineers, design-
ers, and laboratory men make the right
contacts in the radio industry. Perhaps we
can help you with your problems too. For
further information write to

Advertising Department
**INSTITUTE OF RADIO
ENGINEERS**

330 West 42nd Street
NEW YORK CITY, N.Y.

*For the Engineering Consultant
who can handle a little extra business this year
For the Designer
who can manage some additional work*

we suggest the Professional Engineering Directory of the I.R.E. PROCEEDINGS. Manufacturers who need services such as yours and organizations with special problems come to our Professional Engineering Directory for information. Your name and special services announced here will put you in line for their business. For further information and special rates for I.R.E. members write to the Institute of Radio Engineers.

When writing to advertisers mention of the PROCEEDINGS will be mutually helpful.

SO THAT THERE MAY BE

Safety

AT THE DANGER LINE

USE CORNELL-DUBILIER CONDENSERS

THE age old danger of icebergs has been greatly minimized by the consistently dependable watchfulness of the U. S. Coast Guard. As soon as an iceberg is sighted, signals are broadcast every three minutes with unfailing regularity. So that there may be no interruption in the operation of the transmitting and receiving equipment used, Cornell-Dubilier Capacitors are specified.

PROTECT your equipment and apparatus at the danger line by using the condensers that have been the "standard of comparison" for twenty-six years.

THE Type DH series of Dykanol "B" condensers were designed to fulfill the specifications of marine and submarine apparatus manufacturers. Hermetically sealed in sturdy non-corrosive containers, the handy compactness of these units makes them ideal where space is at a premium. Available in single and multiple capacity sections.

THE No. 127 transmitting and broadcast engineer's catalog is now available. Your copy will be forwarded on request.

PHOTO COURTESY U. S. COAST GUARD

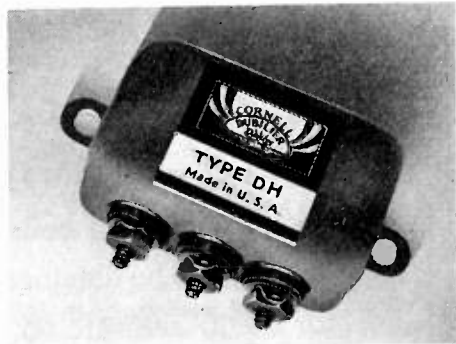

CORNELL-DUBILIER

CORPORATION

4379 BRONX BOULEVARD • NEW YORK

When writing to advertisers mention of the PROCEEDINGS will be mutually helpful.

Alphabetical Index to Advertisements

A	
Aerovox Corporation	X
American Tel. & Tel. Company	IX
C	
Central Radio Laboratories	XVIII
Cornell-Dubilier Corporation	XV
E	
Eric Resistor Corporation	XVII
Engineering Directory	XIV
G	
General Radio Company	Cover IV
I	
Institute of Radio Eng.	XI, XII, XVI, Cover III
T	
Triplett Electrical Instrument Company	XIII

PROCEEDINGS BOUND VOLUMES



VOLUME 23 (1935) of the Proceedings is now available in bound form to members of the Institute. It may be obtained in Buckram or Morocco leather for \$9.50 and \$11.00 respectively. Foreign postage is \$1.00 additional per volume.

Bound copies of Volumes 18 and 19 (1930 and 1931) are also available at the same prices.

When writing to advertisers mention of the PROCEEDINGS will be mutually helpful.

ONE YEAR AGO-

THIS ADVERTISEMENT

ANNOUNCED AN ENTIRELY

NEW TYPE OF RESISTOR



Use

ERIE
SPACE-SAVING
INSULATED
RESISTORS

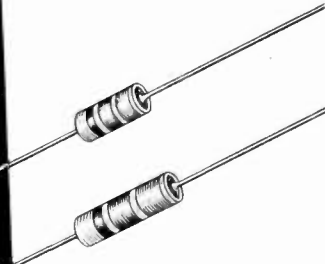

Available in production quantities in 1/4 and 1/2 watt units.

One year ago, this advertisement announced a revolutionary new resistor, unbelievably small in size for its rating and completely insulated by a ceramic shell.

On the basis of this improved design, claims of savings in set manufacturers' production costs, more efficient chassis designs and elimination of many wiring difficulties were made.

Now, twelve months later, experience has shown that Erie Insulated Resistors have fully lived up to these predictions. If you are not familiar with this outstanding development in carbon resistors, we will be glad to send you a generous supply of samples.

MANUFACTURERS OF
 CARBON RESISTORS
 AND SUPPRESSORS

ERIE RESISTOR CORPORATION

AUTOMATIC INJECTION
 MOLDERS OF
 THERMO-PLASTICS

TORONTO ERIE, PENNSYLVANIA LONDON

When writing to advertisers mention of the PROCEEDINGS will be mutually helpful.

S M O O T H N E S S S

above all



Multi-prong tubes and involved circuits demand the smoothest of smooth control . . . and Centralab Radiohm with its non-rubbing contact provides a gliding smoothness . . . that solves the Control

Problem in the modern receiver. Specify CENTRALAB for ultra-smooth attenuation.

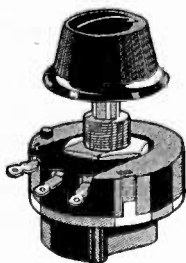

CENTRAL RADIO LABORATORIES
Milwaukee, Wis.

Centralab *Radiohm*

When writing to advertisers mention of the PROCEEDINGS will be mutually helpful.

EMPLOYMENT PAGE

PHYSICS (particularly "Electronics") Professor, Ph.D. Formerly head of the department of physics at well-known University. Now Director of research and development laboratory of prominent electrical manufacturer at good salary. Desires to return to University professorship or research fellowship at University to study problems in applied physics and electronics for industrial concern. Is widely known for his numerous successful electrical patents and technical papers. Desire for academic environment only reason for change. Box No. 151, c/o Institute of Radio Engineers.

Prominent Midwest Manufacturer wants CHIEF ENGINEER

familiar with design, manufacture, and operation of modern broadcast and other transmitters. Special reference to larger radio frequency components, antennas and transmission lines, some electro-medical and surgery equipment. Sales, advertising, or editorial ability will help. Opportunity for an organizer with practical ideas and desire to work to connect with rapidly growing concern. Outline training and experience briefly and state salary expected. Box No. 152, c/o Institute of Radio Engineers.

WANTED. Development engineer educated and experienced in radio and electronics for laboratory and office work on oscillators, tube testers, and vacuum tube measuring instruments. Permanent position with small yet reputable company. Thorough knowledge and experience greatest asset. Situation is very urgent. Location New York City. Box No. 153, c/o Institute of Radio Engineers.

ENGINEERING POSITIONS

Advertisements on this page are accepted from Institute members who desire new positions and organizations which are interested in employing Institute members. A nominal charge of \$2.00 is made for each insertion. Information on the preparation of material and closing dates for its acceptance will be mailed on request.

Rapid Reactance Measurements

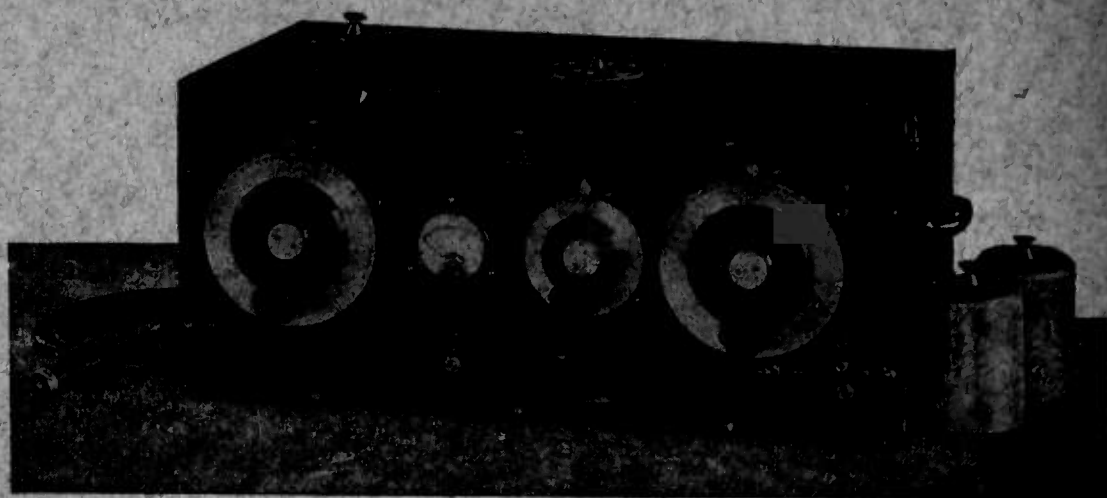

The rapid and accurate measurement of circuit elements, particularly in equipment already assembled and in operation, often presents a difficult problem to the radio engineer.

The General Radio Type 421-A Reactance Meter was designed to eliminate these difficulties. By means of this instrument coils and condensers may be checked over a range of 0 to 500 micromicrofarads for capacitance and over a very wide inductance range the exact extent of which is dependent upon the frequency at which measurements are made.

The Reactance Meter is direct reading to 0.2 micromicrofarads. Its frequency range is 125 to 300 kilocycles and 550 to 4,000 kilocycles. The instrument is complete and ready for operation from a 50-60 cycle 115 volt a-c power source.

Type 421-A Reactance Meter \$445.00

Write for Circular 74-R for Detailed Description

GENERAL RADIO COMPANY
Cambridge A, Massachusetts

