

VOLUME 23

MARCH, 1935

NUMBER 3

PROCEEDINGS  
*of*  
**The Institute of Radio  
Engineers**



**Application Blank for Associate Membership on Page XIII**

---

# Institute of Radio Engineers Forthcoming Meetings

---

**TENTH ANNUAL CONVENTION**  
**DETROIT, MICHIGAN**  
July 1, 2, and 3, 1935

---

**JOINT MEETING**  
**American Section, International Scientific**  
**Radio Union and Institute of Radio En-**  
**gineers, Washington D. C.**  
April 26, 1935

---

**CONNECTICUT VALLEY SECTION**  
March 21, 1935

---

**DETROIT SECTION**  
March 15, 1935

---

**LOS ANGELES SECTION**  
March 19, 1935

---

**NEW YORK MEETING**  
March 6, 1935  
April 3, 1935

---

**PHILADELPHIA SECTION**  
March 7, 1935  
April 4, 1935

---

**WASHINGTON SECTION**  
March 11, 1935

---

PROCEEDINGS OF

The Institute of Radio Engineers

Volume 23

March, 1935

Number 3

Board of Editors

ALFRED N. GOLDSMITH, *Chairman*  
 R. R. BATCHER  
 H. H. BEVERAGE  
 F. W. GROVER  
 J. W. HORTON  
 G. W. PICKARD  
 K. S. VAN DYKE  
 L. P. WHEELER  
 L. E. WHITTEMORE  
 WILLIAM WILSON

CONTENTS

PART I

Institute News and Radio Notes.....	185
February Meeting of the Board of Directors.....	185
Papers for 1935 Convention.....	185
Report of Secretary for 1934.....	186
Committee Work.....	190
Institute Meetings.....	192
Personal Mention.....	198

PART II

*Technical Papers*

Vacuum Tubes for Generating Frequencies Above One Hundred Megacycles.....	C. E. FAY AND A. L. SAMUEL	199
Designing Resistive Attenuating Networks.....	P. K. McELROY	213
Multirange Rectifier Instruments Having the Same Scale Graduation for all Ranges.....	FREDERICK EMMONS TERMAN	234
Barkhausen-Kurz Oscillator Operation with Positive Plate Potentials.....	L. F. DYTRT	241
Automatic Syntraction of Two Broadcast Carriers..	VERNE V. GUNSOLLEY	244
Maintenance of Electron Emission from the Filament of a Triode After Its Low Tension Supply is Disconnected.....	R. L. NARASIMHAIYA	249
Discussion on "High Quality Radio Broadcasting," by Stuart Ballantine.....	HANS RÖDER	256
Book Reviews: "Nineteenth Edition-Handbook of Chemistry and Physics," by Charles D. Hodgman.....	H. M. TURNER	261
"Electron Tubes in Industry," by Keith Henney....	R. R. BATCHER	261
Correction.....		263
Contributors to This Issue.....		264

*Copyright, 1935, by the Institute of Radio Engineers*

# The Institute of Radio Engineers

---

## GENERAL INFORMATION

**INSTITUTE.** The Institute of Radio Engineers was formed in 1912 through the amalgamation of the Society of Wireless Telegraph Engineers and the Wireless Institute. Its headquarters were established in New York City and the membership has grown from less than fifty members at the start to several thousand.

**AIMS AND OBJECTS.** The Institute functions solely to advance the theory and practice of radio and allied branches of engineering and of the related arts and sciences, their application to human needs, and the maintenance of a high professional standing among its members. Among the methods of accomplishing this is the publication of papers, discussions, and communications of interest to the membership.

**PROCEEDINGS.** The PROCEEDINGS is the official publication of the Institute and in it are published all of the papers, discussions, and communications received from the membership which are accepted for publication by the Board of Editors. Copies are sent without additional charge to all members of the Institute. The subscription price to nonmembers is \$10.00 per year, with an additional charge for postage where such is necessary.

**RESPONSIBILITY.** It is understood that the statements and opinions given in the PROCEEDINGS are views of the individual members to whom they are credited, and are not binding on the membership of the Institute as a whole. Papers submitted to the Institute for publication shall be regarded as no longer confidential.

**REPRINTING PROCEEDINGS MATERIAL.** The right to reprint portions or abstracts of the papers, discussions, or editorial notes in the PROCEEDINGS is granted on the express condition that specific reference shall be made to the source of such material. Diagrams and photographs published in the PROCEEDINGS may not be reproduced without making specific arrangements with the Institute through the Secretary.

**MANUSCRIPTS.** All manuscripts should be addressed to the Institute of Radio Engineers, 330 West 42nd Street, New York City. They will be examined by the Papers Committee and the Board of Editors to determine their suitability for publication in the PROCEEDINGS. Authors are advised as promptly as possible of the action taken, usually within two or three months. Manuscripts and illustrations will be destroyed immediately after publication of the paper unless the author requests their return. Information on the mechanical form in which manuscripts should be prepared may be obtained by addressing the secretary.

**MAILING.** Entered as second-class matter at the post office at Menasha, Wisconsin. Acceptance for mailing at special rate of postage is provided for in the act of February 28, 1925, embodied in Paragraph 4, Section 412, P. L. and R., and authorization was granted on October 26, 1927.

---

Published monthly by

**THE INSTITUTE OF RADIO ENGINEERS, INC.**

Publication office, 450-454 Ahnaip St., Menasha, Wis.

BUSINESS, EDITORIAL, AND ADVERTISING OFFICES

Harold P. Westman, *Secretary*

330 West 42nd Street, New York, N. Y.

## INSTITUTE SECTIONS

- ATLANTA**—Chairman, Henry L. Reid; Secretary, Philip C. Bangs, 23 Kensington Road, Avondale Estates, Ga.
- BOSTON**—Chairman, E. L. Chaffee; Secretary, Roland G. Porter, Northeastern University, Boston, Mass.
- BUFFALO-NIAGARA**—Chairman, L. E. Hayslett; Secretary, E. C. Waud, 235 Huntington Ave., Buffalo, N. Y.
- CHICAGO**—Chairman, Alfred Crossley; Secretary, J. Kelly Johnson, Wells-Gardner Company, 816 N. Kedzie St., Chicago, Ill.
- CINCINNATI**—Chairman, Armand Knoblauch; Secretary, George F. Platts, Crosley Radio Corporation, Cincinnati, Ohio.
- CLEVELAND**—Chairman, Carl J. Banfer; Secretary, J. S. Hill, 3325 Beachwood Ave., Cleveland Heights, Ohio.
- CONNECTICUT VALLEY**—Chairman, J. A. Hutcheson; Secretary, C. B. De Soto, American Radio Relay League, 38 La Salle Rd., W. Hartford, Conn.
- DETROIT**—Chairman, A. B. Buchanan; Secretary, E. C. Denstaedt, Detroit Police Department, Detroit, Mich.
- LOS ANGELES**—Chairman, H. C. Silent; Secretary, N. B. Neely, 1569 Munson Ave., Los Angeles, Calif.
- NEW ORLEANS**—Chairman, J. A. Courtenay; Secretary, C. B. Reynolds, Radiomarine Corporation of America, 512 St. Peter St., New Orleans, La.
- PHILADELPHIA**—Chairman, E. D. Cook; Secretary, R. L. Snyder, 103 Franklin Rd., Glassboro, N. J.
- PITTSBURGH**—Chairman, C. K. Krause; Secretary, H. V. Noble, c/o Gulf Research and Development Company, 327 Craft Ave., Pittsburgh, Pa.
- ROCHESTER**—Chairman, H. J. Klumb; Secretary, H. A. Brown, 89 East Ave., Rochester, N. Y.
- SAN FRANCISCO**—Chairman A. H. Brolly; Secretary, R. D. Kirkland, Mackay Radio and Telegraph Company, 22 Battery St., San Francisco, Calif.
- SEATTLE**—Chairman, R. C. Fisher; Secretary, C. E. Williams, 2340 Delmar Dr., Seattle, Wash.
- TORONTO**—Chairman, A. B. Oxley; Secretary, L. M. Price, Radio Valve Company of Canada, 189 Dufferin St., Toronto, Ont., Canada.
- WASHINGTON**—Chairman, E. K. Jett; Secretary, W. B. Burgess, 2900-26th St. N. E., Washington, D. C.

## GEOGRAPHICAL LOCATION OF MEMBERS ELECTED FEBRUARY 6, 1935

### Elected to the Associate Grade

California	Glendale, 360 W. Broadway	Read, G. W.
	Half Moon Bay, Kelly Ave.	Silva, W.
	Los Angeles, 524 N. Sierra Bonita Ave.	Daily, C. R.
Georgia	Atlanta, 1048 Woodland Ave. S.E.	Fowler, N. B.
Maine	South Portland, 28 Margaret St.	Robbins, I. L.
Michigan	Ann Arbor, 711 Packard St.	Misener, G. C.
Minnesota	Fergus Falls, Radio Station KGDE	Engelter, G. H.
New Jersey	Magnolia, Evesham Ave.	Banca, M. C.
New York	Long Island City, 32-14-38th St.	Gorbunoff, A.
	New York City, 47 E. 64th St.	Carlbach, W. M.
	New York City, Bell Tel. Labs., 463 West St.	Kammerer, F. W.
	New York City, 1 Seaman Ave.	Trettel, L. M.
Ohio	Cleveland, 2866 E. 100th St.	Malsom, D.
Pennsylvania	Philadelphia, 743 Garland St.	Freeland, E. C.
	Philadelphia, 163 W. Roosevelt Blvd.	Schnitzer, B. E.
	Philadelphia, 4134 Glendale St.	Scott, F. M.
	Philadelphia, 979 N. Lawrence St.	Stec, C.
Rhode Island	Providence, 205 Unit St.	Altieri, E. S. A.
Argentina	Buenos Aires, Paysandu 39	Penin, R. L.
Australia	Waverley, Sydney, Cinesound, Ebley St.	Cross, C. E.
England	Exmouth, Devon, 23 Rosebery Rd.	Short, H. E.
	Knightsbridge, London S.W.	De Laszlo, S. P.
France	Seine, 4 Rue du Ponceau, Chatillon-sous-Bagneux	Rullier, A.
Japan	Kumamoto, c/o Kumamoto Central Broadcasting Station	Sadahiko, H.
Sweden	Blocket, Lidingo 3	Stannow, J. C.

### Elected to the Student Grade

Georgia	Atlanta, Georgia School of Tech., Box 22	Preston, J. G.
Massachusetts	Cambridge, M.I.T. Dormitories	Monderer, B. A.
	Cambridge, M.I.T. Dormitories	Mueller, C. W.
	Cambridge, M.I.T. Dormitories	Pepperberg, L.
	Somerville, 191 Willow Ave.	Packard, L. E.
New Jersey	Union City, 141-33rd St.	Zweifel, F. A.
New York	Port Chester, 32 Indian Rd.	Fingerle, W., Jr.
Washington	Pullman, 734 College Station	Allison, G. P.
Canada	Outremont, P. Q., 660 Querbes Ave.	Bloom, D.

## APPLICATIONS FOR MEMBERSHIP

Applications for transfer or election to the various grades of membership have been received from the persons listed below, and have been approved by the Admissions Committee. Members objecting to transfer or election of any of these applicants should communicate with the Secretary on or before March 30, 1935. These applications will be considered by the Board of Directors at its meeting on April 3, 1935.

### For Transfer to the Fellow Grade

New York Rochester, Stromber-Carlson Tel. Mfg., Co., 100 Carlson Rd.. Graham, V. M.

### For Transfer to the Member Grade

Maryland Baltimore, 3310 Windsor Ave. .... Plummer, W. E.  
 New York New York City, 2344 University Ave..... Taylor, S. G.  
 Pennsylvania Philadelphia, 21 Gordon Lane, Chestnut Hill..... Ellsworth, W. C.  
 Pittsburgh, P.O. Drawer 2038..... Noble, H. V.

### For Election to the Member Grade

California San Francisco, 57 Post St..... Metcalf, H. E.  
 New York New York City, 90 West St..... Smith, M. T.  
 England Chesham Bois, Bucks., 17 Woodside Ave..... Dobell, H.  
 Jamaica Kingston, Telegraph Office, G.P.O..... Guilfoyle, T. J.

### For Election to the Associate Grade

California Culver City, 3847 Goldwyn Ter..... Kimball, H. R.  
 Inverness, Box 167..... Schoenfeld, E.  
 La Canada, Route 1, Box 748 P..... Wachner, D. L.  
 Long Beach, 115 E. 12th St..... Tapp, J. E.  
 Los Angeles, 753 S. Bonnie Brae St..... Everett, F. A. M.  
 Los Angeles, 1324 Calumet Ave..... Smith, C. D.  
 District of Columbia Washington, 3500-14th St. N.W..... Jensen, J. O.  
 Washington, 1332 Irving St. N.W..... Judson, L. H.  
 Illinois Chicago, Radio Station WJJD, 201 N. Wells St..... Coleman, H. E.  
 Chicago, 4349 W. 14th St..... Mages, M.  
 Chicago, 6555 N. Campbell St..... Mitchell, D. H.  
 Kentucky Owensboro, 124 W. 18th St..... Carter, M. D.  
 Owensboro, 121 W. 23rd St..... Hammond, C. R.  
 Massachusetts Cambridge, Box 27, Mass. Inst. of Technology..... Greene, F. M.  
 Ware, 16 Walnut St..... Fitzgerald, J. A.  
 Michigan Detroit, 12731 Marlowe..... Bascom, E. R.  
 Detroit, 15880 Steel Ave..... Dudeck, P. H.  
 New Jersey Camden, RCA Victor Company..... Wendt, K. R.  
 Hackettstown, 143 Main St..... Cortright, R. D.  
 New York Brooklyn, 180 Gates Ave..... Phillips, J. J.  
 Buffalo, 33 Condon Ave..... Horn, M. V.  
 East Aurora, 55 Park Pl..... Andrews, R. W.  
 New York City, 463 West St..... Corbin, J. E.  
 New York City, 200 Broadway..... Schatt, M.  
 Schenectady, 13 State St..... Goodhue, W. W.  
 Schenectady, General Engineering Lab., General Electric Co. .... Murchow, A. J.  
 Ohio Cincinnati, WKRC, Inc., Hotel Alms..... Dieringer, F. A.  
 Pennsylvania Philadelphia, Philadelphia Storage Battery Co., Ontario and C Sts..... Smith, D. B.  
 Rutledge, P.O. Box 222..... Clapp, R. G.  
 Texas Beaumont, Seismo. Dept., c/o Sun Oil Co..... Grenader, P.  
 Lubbock, 2413-14th St..... Hewett, R. C.  
 Wisconsin Madison, 229 Van Deusen St..... Creutz, J.  
 Milwaukee, 785 N. Cass St..... Naughton, G. J.  
 Australia Camperdown, Victoria..... Emeny, T. F.  
 Brazil Rio de Janeiro, Rua da Carioca 45-3°..... Labre, J., Jr.  
 Canada Bowmanville, Ont., P.O. Box 297..... Crowe, F. C.  
 Channel Islands St. Peter-In-The-Wood, Guernsey, "Longfrie"..... James, E. A.  
 China Hongkong, 1 Hollywood Rd..... Chan, A.  
 Hongkong, 231 Prince Edward Rd..... Derby, P. W.  
 Colombia Medellin, c/o All America Cables, Apartado 121..... Tarr, L. H.  
 England Baling, London W. 13, 16 Cranmer Ave..... Smith, S. J.  
 Oakworth, Nr. Keighley, Yorks., "Inglenook"..... Almond, R.  
 Shelf, Nr. Halifax, Yorks., 73 Cooper Lane..... Asquith, E.  
 France Clamart, Seine, 6 Rue du Pavé Blanc..... Bussat, R. M. A.  
 Malta Calafarna, R. A. F. Base..... Swinney, E.  
 Mexico Nuevo Laredo, Tam., Matamoros 1308..... Cuesta, N., Jr.

## *Applications for Membership*

### For Election to the Student Grade

California	Berkeley, 2418 Ashby Ave. . . . .	Morrison, K. G.
	Palo Alto, Box 1301, Stanford University . . . . .	Oliver, B. M.
Indiana	Terre Haute, 229 N. 5th St. . . . .	Reedy, P. H.
Michigan	Detroit, 12093 Engleside . . . . .	Abfalter, H. F.
Minnesota	Minneapolis, 531 Walnut St. S.E. . . . .	Baranovsky, C.
New Jersey	Camden, 1135 Haddon Ave. . . . .	Schaevitz, H.
	Collingswood, 830 Stokes Ave. . . . .	Moon, D. M.
	Moorestown, 308 E. 3rd St. . . . .	Barbier, W. H.
	Union City, 512-37th St. . . . .	Braun, H. C.
New York	Troy, 197 Hoosick St. . . . .	Christaldi, P. S.
	Troy, 197 Hoosick St. . . . .	Ferry, R. N.
Pennsylvania	Emsworth, 151 Center Ave. . . . .	McConnell, R. H.
	Philadelphia, 7703 Hasbrook Ave. . . . .	Senn, G. F.
Tennessee	Lebanon, Tarver Ave. . . . .	Smith, G. G.



## OFFICERS AND BOARD OF DIRECTORS, 1936

(Terms expire January 1, 1936, except as otherwise noted)

### *President*

STUART BALLANTINE

### *Vice-President*

GEORG HEINRICH BARKHAUSEN

### *Treasurer*

MELVILLE EASTHAM

### *Secretary*

HAROLD P. WESTMAN

### *Editor*

ALFRED N. GOLDSMITH

### *Directors*

O. H. CALDWELL

V. M. GRAHAM

R. A. HEISING

J. V. L. HOGAN

L. M. HULL, *Junior Past President*

F. A. KOLSTER

GEORGE LEWIS

H. M. TURNER

A. F. VAN DYCK

### SERVING UNTIL JANUARY 1, 1937

ARTHUR BATCHELLER

C. M. JANSKY, JR., *Senior Past President*

WILLIAM WILSON

### SERVING UNTIL JANUARY 1, 1938

E. L. NELSON

L. E. WHITEMORE

HARADEN PRATT



## INSTITUTE NEWS AND RADIO NOTES

### February Meeting of the Board of Directors

The February meeting of the Board of Directors was held on the 6th at the Institute office and those present were Stuart Ballantine, president; Melville Eastham, treasurer; O. H. Caldwell, Alfred N. Goldsmith, Virgil M. Graham, R. A. Heising, C. M. Jansky, Jr., F. A. Kolster, George Lewis, E. L. Nelson, Haraden Pratt, H. M. Turner, A. F. Van Dyck, L. E. Whittemore, William Wilson, and H. P. Westman, secretary.

Twenty-five applications for Associate membership and nine for Student grade were approved.

Committees to serve during 1935 were appointed and will be listed in the April PROCEEDINGS.

The 1934 Report of the Secretary was accepted and an abridged form of it appears in this issue.

A committee comprised of A. F. Van Dyck as chairman, L. C. F. Horle, and R. H. Langley was appointed to investigate the existing laws requiring the licensing of professional engineers. It is expected that a report on this subject will be published on the PROCEEDINGS when it is available.

The Emergency Employment Service now has a registration of 702 of whom 524 are members of the Institute. Thirteen jobs were handled during January and four placements made.

An invitation from the Society of Motion Picture Engineers to be represented on a Sectional Committee on Motion Pictures was declined with thanks because activities in that field at the present time are not sufficiently close to those in the radio field. However, it was agreed that the Institute would name representatives on such subcommittees as will consider matters of interest to our membership.

### Papers for 1935 Convention

The program of technical papers to be presented at our Tenth Annual Convention, to be held in Detroit on July 1, 2, and 3, is now being prepared. While invitations have already been extended to organizations active in radio engineering work, it is not possible to invite individually each independent worker in the field. Those interested in presenting papers at the Convention should forward them to the secretary by not later than April first so the committee may have an opportunity of reviewing them to determine their suitability for presentation.

## REPORT OF SECRETARY 1934

**T**HIS annual report by the secretary is published for the information of the membership and covers the more important matters concerning Institute operation during 1934.

The secretarial staff carries on the routine operation of the Institute and presents to the Board of Directors all problems which have not already been provided for either by the Constitution or policies established by the Board. Many problems require an extensive study which cannot be reasonably supplied by the Board of Directors. These are placed before standing committees when such exist, or special committees are organized for their consideration. The committee reports are addressed to the Board of Directors and the final decisions and actions are approved by that governing body. The mechanical acts of placing these recommendations and policies in practice are then delegated to the secretarial staff.

It is evident that the operation of the Institute could not long be maintained without the substantial efforts and time given to its affairs by the Board of Directors and committees, and the debt which the Institute membership owes to the men who serve thereon is no small one.

### Finances

In an endeavor to supply as large a service as possible, the Institute has been operated at a financial deficit for the past three years. This deficit has been made up from reserves accumulated in the past. The drain on reserves has not been dangerous, although substantial, and it is estimated that the budget for 1935 will be balanced. At the end of this report will be found a comparative balance sheet prepared by our auditors.

### Membership

The active membership at the end of the year was 4,854 as compared with 5,199 for 1933, a reduction of seven per cent. The membership reduction in 1933 was nineteen per cent.

In spite of this reduction in membership, there has been an increase in the number of members who reside outside of the United States and its possessions and that group now represents twenty-three and three-tenths per cent of the entire membership, the largest proportion which this group has ever reached.

573 applications for membership were received as compared with 504 during 1933.

## Sections

The seventeen sections of the Institute continue in active operation and averaged seven and one-half meetings each for the year. The Annual Meeting of the Sections Committee, at which matters of importance to these groups were discussed, was held during the Ninth Annual Convention.

## Proceedings

All papers submitted for publication in the PROCEEDINGS are reviewed by the Papers Committee and Board of Editors. Of the eighty-seven papers so reviewed, fifty-nine were accepted for publication and twenty-eight rejected. Seven papers were returned to the authors for revision. Ninety-one papers and discussions were published and twenty-five book reviews prepared and published.

A further reduction in the number of pages in the PROCEEDINGS was necessitated for economic reasons. To obtain as great value as possible from the material published, the editorial groups have examined papers much more critically than at any time in the past several years and it will be noted from the above figures that over thirty per cent of the papers reviewed were rejected. It is highly probable that under more favorable financial conditions, a number of these would have been accepted for publication.

## Meetings

The Ninth Annual Convention held in May in Philadelphia, was attended by almost a thousand members and their guests and was the largest convention held during the past several years.

Thirty-two technical papers were presented and we had the pleasure of welcoming Vice President van der Pol who journeyed to America to attend this meeting. All who attended are indebted to William Diehl and his convention committee for the preparations which made this meeting so successful.

The Rochester Fall Meeting was attended by 286 and was held on November 12, 13, and 14. Thirteen papers were presented.

## Emergency Employment Service

The Emergency Employment Service which was established in 1932 has continued in operation. The total registration at the end of 1934 was 695 of whom 519 were Institute members. 110 were placed in jobs which were considered to be permanent and 137 obtained work which was known to be temporary. No charges are made for enrollment or placement and Institute members are given preference in all cases.

Nonmembers are placed only when Institute members of satisfactory qualifications are not available.

Unemployed members who have not registered will assist the Institute and themselves by doing so. The range of jobs filled covers practically every type of work found in the radio field.

### Deaths

With deep regret, there is recorded below the names of those members whose deaths occurred during 1934.

Ennis, J. B., Jr.

Everest, A. R.

Filz, E. W.

Holt, P. E.

Maul, G. E.

Morecroft, J. H.

Rosenwald, E. D.

Squier, G. O.

Suadicani, G.

### Acknowledgment

Acknowledgment is made of the sincere efforts which the secretarial staff has made in meeting the unusual problems which the present unsettled conditions have developed.

Respectfully submitted,

  
Secretary

The Institute of Radio Engineers, Inc.  
COMPARATIVE BALANCE SHEET

December 31, 1934 and 1933

<i>ASSETS</i>	December 31, 1934	December 31, 1933	INCREASE DECREASE
<i>CURRENT ASSETS</i>			
Cash.....	\$ 7,479.81	\$ 3,460.37	\$4,019.44
<i>ACCOUNTS RECEIVABLE—CURRENT</i>			
Dues.....	1,133.90	712.72	421.18
Advertising.....	1,149.29	589.20	560.09
Reprints.....	20.14	112.85	92.71
<i>INVENTORY</i> .....	8,672.94	6,962.54	1,710.40
<i>ACCRUED INTEREST ON INVESTMENT</i> .....	408.33	529.97	121.64
<i>TOTAL CURRENT ASSETS</i> .....	18,864.41	12,367.65	6,496.76
<i>INVESTMENTS—AT COST</i> .....	41,606.62	49,692.12	8,085.50
(Market Value 12/31/34 \$23,661.25)			
<i>ACCOUNTS RECEIVABLE DUES—COLLECTIONS DEFERRED</i> .....	3,569.77	5,344.36	1,774.59
<i>FURNITURE AND FIXTURES</i>			
Less—Reserve for Depreciation.....	2,833.44	3,258.02	424.58
<i>PREPAID EXPENSES</i>			
Unexpired Insurance Premiums.....	58.43	66.05	7.62
Stationery Inventory—Estimated.....	200.00	400.00	200.00
Section Expense.....		81.50	81.50
Salaries.....	68.40		68.40
<i>TOTAL ASSETS</i> .....	\$67,201.07	\$71,209.70	\$4,008.63
	December 31, 1934	December 31, 1933	INCREASE DECREASE
<i>LIABILITIES AND SURPLUS</i>			
<i>ACCOUNTS PAYABLE</i> .....	\$ 1,304.52	\$ 3,132.55	\$1,828.03
<i>SUSPENSE</i> .....		105.95	105.95
<i>ADVANCE PAYMENTS</i>			
Dues.....	1,267.95	1,169.99	97.96
Subscriptions.....	3,297.96	3,025.18	272.78
<i>TOTAL LIABILITIES</i> .....	5,870.43	7,433.67	1,563.24
<i>FUNDS</i>			
Morris Liebman Memorial Fund Principal and Unex- pended Income.....	10,077.87	10,077.87	
Associated Radio Manufacturers Fund.....	1,997.80	1,997.80	
<i>TOTAL FUNDS</i> .....	12,075.67	12,075.67	
<i>SURPLUS</i>			
Balance, January 1.....	51,700.36	60,034.14	8,333.78
Deduct—Operating Loss for Year.....	2,445.39	8,333.78	5,888.39
<i>SURPLUS—DECEMBER 31</i> .....	49,254.97	51,700.36	2,445.39
<i>TOTAL LIABILITIES AND SURPLUS</i> .....	\$67,201.07	\$71,209.70	\$4,008.63

Patterson and Ridgeway, Certified Public Accountants  
74 Trinity Place, New York, N. Y.

## Committee Work

### ADMISSIONS COMMITTEE

A meeting of the Admissions Committee which was attended by E. R. Shute, chairman; Austin Bailey, I. S. Coggeshall, L. C. F. Horle, and H. P. Westman, secretary, was held on February 6. An application for transfer to the grade of Fellow was approved as were four out of five applications for transfer to Member grade. The remaining application was tabled pending the obtaining of additional data. Seven applications for admission to the grade of Member were considered and four approved. Two were denied and one tabled pending further information.

### STANDARDIZATION

#### EXECUTIVE COMMITTEE OF THE STANDARDS COMMITTEE—I.R.E.

A meeting of the Executive Committee of the Institute's Standards Committee was held on the afternoon of February 5 in the Institute office and those present were Haraden Pratt, chairman; J. V. L. Hogan, J. C. Schelleng, B. J. Thompson (representing B. E. Shackelford), H. A. Wheeler, and H. P. Westman, secretary.

Each of the technical committee chairmen presented a report on the activities of his committee and discussed the various problems which have arisen either in the arrangement of personnel or as concerns the work of the committee. The meeting was closed with a general discussion of the scope of the projects.

#### TECHNICAL COMMITTEE ON ELECTRO-ACOUSTIC DEVICES—I.R.E.

On January 18 a meeting of the Technical Committee on Electro-Acoustic Devices of the Institute's Standards Committee was held in the Institute office. Those present were H. F. Olson, chairman; Sidney Bloomenthal, Knox McIlwain, Hans Roder, V. E. Whitman, Harold Zahl, and H. P. Westman, secretary. This was the first meeting of the committee held and the opening discussion concerned the scope of its activities. Before reviewing the existing report for modifications and deletions, a number of additional new items were placed on the agenda for future meetings. Standards prepared by other organizations in the field will be obtained prior to reviewing the definitions in the report. The section on performance indexes and tests was examined briefly and certain modifications outlined for consideration in detail at the next meeting.



## TECHNICAL COMMITTEE ON ELECTRONICS—I.R.E.

## Subcommittee on Small High Vacuum Tubes

The Subcommittee on Small High Vacuum Tubes, operating under the Technical Committee on Electronics of the Institute's Standards Committee, met in the Institute office on January 25. P. T. Weeks, chairman; M. Cawein, L. W. Chubb (representing Lee Sutherlin), G. F. Metcalf, H. A. Pidgeon, E. W. Schafer, and H. P. Westman, secretary, were present. Comments from the Electronics Committee to questions concerning the preparation of bibliographical material and an index were first considered. The definitions on amplifier classification were then considered and a new definition for class AB proposed. New material was substituted for a published method of measuring ionization. Definitions were prepared for tubes having six, seven, and eight electrodes as well as for multielectrode and multiunit tubes.

## Subcommittee on Photoelectric Devices

The Subcommittee on Photoelectric Devices established by the Technical Committee on Electronics met in the Institute office on January 31. Dayton Ulrey, chairman; Ben Kievit, Jr., B. J. Thompson, J. R. Wilson, and H. P. Westman, secretary, attended. This was the initial meeting of the subcommittee and its scope of operation was considered first. The definitions in the section on phototubes were considered and a number of modifications proposed. Some of the existing definitions are modified slightly, others more drastically, and it is recommended that some be deleted entirely. Certain literal symbols were discussed and modifications recommended. The material on the testing of phototubes was considered and some minor changes recommended.

## TECHNICAL COMMITTEE ON TRANSMITTERS—I.R.E.

The first meeting of the Technical Committee on Transmitters was held on January 11 at the Institute office and was attended by J. C. Schelleng, chairman; Raymond Asserson, E. B. Ferrell, Raymond Guy, D. G. Little, W. B. Lodge (representing A. B. Chamberlain), D. S. Rau, Paul Watson, and H. P. Westman, secretary. The scope of activities of the committee was first considered and then a series of recommendations for the addition of new material to the existing report prepared. It was felt that the existing material on measurements and tests of transmitters and antennas was unnecessarily lengthy and might reasonably be reduced. The field was divided definitely into two sections, antennas and transmitters, and various members of the committee were requested to prepare material for consideration at the next meeting.

The second meeting of the committee was held on February 7 at the Institute office and J. C. Schelleng, chairman; Raymond Asserson, P. S. Carter, E. B. Ferrell, Raymond Guy, D. G. Little, E. G. Port, H. E. Young, and H. P. Westman, secretary, were present. It was agreed that the preparation of material for the rating and testing of transmitters and antennas might best be handled through the formation of definite subcommittees and chairmen of these were appointed. A final date for the completion of the report was set. Some extensive material already prepared was considered and commented on for the benefit of the subcommittees which will give it further attention.

---

## Institute Meetings

### ATLANTA SECTION

A meeting of the Atlanta Section was held at the Atlanta Athletic Club on December 20 with H. L. Reid, chairman, presiding. Fourteen attended the meeting and seven were present at the dinner which preceded it.

The meeting was devoted to a "Demonstration of the New Philco High Fidelity Radio Receiver" by the chairman who presented a concise history of radio before proceeding with the demonstration.

### BOSTON SECTION

E. L. Chaffee, chairman, presided at the January 18 meeting of the Boston Section held at the Massachusetts Institute of Technology. Twenty were present at the dinner which preceded the meeting and the attendance at the meeting was 100.

A paper on "Problems of Television Amplification" was presented by C. W. Carnahan of the Hygrade Sylvania Corporation. It was pointed out that the fundamental requirement of a television amplifier is the amplification of an extremely wide range of frequencies with high gain and a minimum of phase distortion. Capacitance in tubes and circuit elements renders simple resistance-capacitance coupled amplifiers unsatisfactory.

Three methods of overcoming the effects of shunt capacitance were described. The first is by compensation for a given stage by peaking the gain of the next stage. Two methods of accomplishing this were given. The second involves compensation in each amplifier stage by the use of low-pass filter sections. Three possible forms of these sections were shown and difference in transient behavior between two sections having almost the same steady state characteristics was brought out.

The third method of compensation was by feedback from a subsequent stage or neutralization. The conventional method of capacitance neutralization by capacitance feedback from the subsequent stage using standard types of tubes was discussed. The chief difficulty is the shunt capacitance of the intermediate stage which may be overcome by providing an extra electrode with a negative mutual conductance, the negative value being obtained by secondary emission or by the virtual cathode produced by a space-charge grid. The latter method has additional advantages and led to a short discussion of the desirability of special tubes for television purposes.

The requirements of the input stage were discussed in terms of signal-to-noise ratio and the importance of the sensitivity of the photoelectric devices was indicated. The Farnsworth electron multiplier, an ingenious preamplifying adjunct of his original pick-up tube was discussed in detail and compared with the Zworykin iconoscope. The Farnsworth tube was demonstrated and the paper was discussed by the chairman, C. W. Haller, H. Hamilton, and F. V. Hunt.

#### BUFFALO-NIAGRARA SECTION

The January 9 meeting of the Buffalo-Niagara Section was held at the New York Telephone Building in Buffalo. Seventy-two were present and the meeting was in charge of L. E. Hayslett, chairman.

The evening was devoted to an inspection of panel dial central office equipment and long line broadcast circuit equipment with A. J. Rokicki of the New York Telephone Company and H. E. West of the American Telephone and Telegraph Company as hosts. Those present were divided into several groups and provided with guides who showed and explained the operation of the various telephone, teletype, wire-photo, broadcast, panel type machine switching, and other circuits and their associated apparatus.

#### CINCINNATI SECTION

The Cincinnati Section met on December 18 at the University of Cincinnati with R. E. Kolo, chairman, presiding.

A paper on "Trend in Loud Speaker Design" was presented by Austin Armer of the Magnavox Company. After defining the term "loud speaker" he presented the history of its development with particular attention to the early work of Sir Oliver Lodge, the experiments with magnetic speakers by Pridham and Jensen, and the work on dynamic speakers by Rice and Kellogg. A discussion of speakers considering their various impedances as electrical characteristics and the treatment of sound pressure measurements followed. The paper was

concluded with a discussion of high fidelity receivers and speakers developed for these purposes. A large number of those present participated in the general discussion.

As this was the annual meeting of the section, officers for 1935 were elected, and are as follows: chairman, Armand Knoblaugh of the Baldwin Piano Company; vice chairman, Tom C. Rives, Signal Corps, Wright Field; secretary-treasurer, George F. Platts, Crosley Radio Corporation.

The January 15 meeting of the Cincinnati Section was held jointly with the local section of the American Institute of Electrical Engineers at the Union Gas and Electric Company auditorium. E. R. Jonas, chairman of the AIEE section, presided and 300 were in attendance.

A paper on "Transmutation" was presented by K. K. Darrow, physicist of Bell Telephone Laboratories. Dr. Darrow briefly reviewed the history of previous attempts at transmutation from the early alchemists to the modern physicists. He pointed out that there is perhaps no other line of scientific endeavor which has met with such consistent failure inasmuch as up to 1919, transmutation had never been effected. Although transmutations effected since then have not resulted in tangible, weighable products, the possibilities are quite promising. He showed a number of lantern slides of actual transmutations taking place in the familiar Wilson Chamber.

#### DETROIT SECTION

A. B. Buchanan, chairman, presided at the January 18 meeting of the Detroit Section held in the Detroit News Conference Room. 110 were present and twenty-one attended the dinner before the meeting.

"Application of the Cathode Ray Oscillograph" was the subject of a paper presented by E. O. Johnson of the RCA Manufacturing Company. An extensive discussion of the theory and operation of the cathode ray tube was first presented. By means of slides and equipment he described how the luminous spot is formed on the screen and the effects upon it of various voltages applied to the elements of the tube. Circuits used with the tube for obtaining sweep voltages were described and demonstrated. Interpretation of the figures obtained on the screen was outlined and a complete oscillograph was placed in operation. The various uses of it in checking the performance of a superheterodyne receiver were then described and demonstrated. Various additional problems suggested by those in attendance were discussed.

## LOS ANGELES SECTION

The November 27 meeting of the Los Angeles Section was held jointly with the local section of the American Institute of Electrical Engineers in the auditorium of the Richfield Building in Los Angeles.

August Hund, consulting engineer, presented a paper on "Recent Developments of Radio Tubes Without Filaments." In it, Dr. Hund reported on a considerable amount of original work which he has done in the development of tubes not requiring heated elements for the emission of electrons. The paper was discussed by Messrs. Dailey, Johnson, and Silent.

Paul Johnson, chairman of the electrical engineers section, presided and 100 were in attendance. Sixty were present at the informal dinner which preceded the meeting.

## NEW YORK MEETING

The regular New York Meeting of the Institute was held on February 6 at the Engineering Societies Building and was presided over by President Ballantine.

A paper on "Radiotelephone Apparatus for Mobile Applications" was presented by F. M. Ryan and F. X. Rettenmeyer of the Bell Telephone Laboratories. Mr. Ryan described high-frequency radiotelephone transmitting and receiving apparatus for aviation and marine applications including a ten-frequency transmitter in which the channel selection is accomplished by the operation of a telephone dial. A new type of radio compass with a visual indicator was also described.

Mr. Rettenmeyer described ultra-high-frequency transmitting and receiving equipment for mobile and fixed stations of police and other radiotelephone systems for both one-way and two-way service. The apparatus described was available for inspection and ultra-high-frequency units of the type employed in the Newark, New Jersey, police installation recently placed in operation were among those shown. A number of the 650 members and guests in attendance participated in the discussion.

## PHILADELPHIA SECTION

The Philadelphia Section met on January 3 at the Engineers Club. E. D. Cook, chairman, presided and 100 were present. Ten attended the dinner which preceded the meeting.

A paper by B. J. Thompson and W. R. Ferris of RCA Radiotron on "Input Resistance of Vacuum Tubes at High Frequencies" was presented by Mr. Thompson. A theoretical analysis showed that with no direct current flowing to the grid of a vacuum tube, there should be an effective shunt resistance between grid and cathode inversely propor-

tional to the product of the transconductance of the tube, the square of the transit time of electrons between cathode and anode, and the square of the operating frequency. Experimental data concerning this relationship showed an effective input resistance of 20,000 ohms at a frequency of thirty megacycles for a conventional type of radio-frequency amplifier tube. The paper was discussed by Messrs. Cook, Kellogg, Landon, Linder, Luck, Maloff, and Mouradian.

#### PITTSBURGH SECTION

C. K. Krause, chairman, presided at the December 15 meeting of the Pittsburgh Section held in the Fort Pitt Hotel.

"Design Considerations in Modern High Fidelity Receivers" was the subject of a paper presented by David Grimes of Philco Radio and Television Corporation. He discussed first the requirements and problems dealing with the design and use of high fidelity receivers. It was pointed out that sixty-cycle modulation was so prevalent in most broadcast transmitters that a receiver cut-off of not less than seventy cycles was necessary to avoid excessive hum. An upper cut-off frequency of 7500 cycles is necessary to prevent interstation interference due to carrier drift or excessive high-frequency modulation. Distortion tests of transmitters should use two or more tones simultaneously to check on modulation between tones and the harmonics and combination harmonics present, many of which would not be harmonious. The paper was closed with the listing of a number of problems still to be solved. Messrs. Gabler, McKinley, Parke, Sutherlin, Swedlung, and others of the 104 members and guests in attendance participated in the discussion.

#### SAN FRANCISCO SECTION

"Design and Construction of Transmitting Tubes" was the subject of a paper presented at the January 16 meeting of the San Francisco Section held at the Bellevue Hotel. A. H. Brolly, chairman, presided and thirty-three were present. Eleven attended the dinner which preceded the meeting.

The paper was presented by J. A. McCullough, president of McCullough-Eitel and Company, and in it he described many problems involved in the design of air-cooled transmitting tubes. The qualities of the various materials used were given as well as data on the dimension, shaping, and placement of elements. Evacuation of tubes was discussed and a number of sample tubes displayed.

#### SEATTLE SECTION

On January 25 a meeting of the Seattle Section was held at the University of Washington and was presided over by R. C. Fisher, chairman. Fifty-five were present.

A paper on "The Photoelectric Pilot" was presented by C. L. Hill of the Photoelectric Pilot Corporation of Tacoma, Washington. This device comprises a magnetic compass, light source, optical system, photoelectric tube, amplifier, relays, and motor driven mechanism for operating steering gear. The construction and operation of the system was explained with the aid of a working model. It serves primarily to maintain a vessel on a predetermined course and has been used extensively on private and commercial craft with a high degree of success. The paper was discussed by Messrs. Bouson, Libby, Mossman, Renfro, Tolmie, Willson, and others.

#### TORONTO SECTION

The Toronto Section held its February 6 meeting at the University of Toronto to hear a paper on "Intermediate-Frequency Transformer Design" presented by Mr. F. H. Sheer of the S. W. Sickles Company. He described methods of measuring the effective goodness of coils. The capacitance variation method which employs an oscillator and voltmeter was used chiefly. He then described the effect on transformer characteristics of different wires, methods of coil winding, shield materials and sizes, and mica and air condensers. Obtaining best coupling consistent with good selectivity was explained in detail as well as the coil characteristics required for high fidelity receivers. Graphs were shown to indicate the improved selectivity given by the use of three circuit transformers. The effect of direct-current load resistance on diode selectivity was shown. Constructional developments of intermediate-frequency transformers and trimmer units were illustrated.

The paper was discussed by Messrs. Fox, Hepburn, Nesbit, and Pipe, of the seventy-eight members and guests present.

#### WASHINGTON SECTION

The Washington Section met on January 14 at the auditorium of the Potomac Electric and Power Company. The attendance was 115 and thirty-one were present at the dinner which preceded the meeting. E. K. Jett, chairman, presided.

A paper on "Radio Apparatus for Mobile Applications" was presented by F. M. Ryan and F. X. Rettenmeyer of the Bell Telephone Laboratories. They described and had available for inspection a number of pieces of equipment. These were the Western Electric 14A transmitter having a power rating of 400 watts and a frequency range from two to eighteen megacycles with selection of operating frequency determined by the operation of a telephone type dial, its companion superheterodyne receiver, a new loop type direction finder with visual indicating device, and transmitting and receiving equipment for police service in the thirty to forty-two megacycle band.

### Personal Mention

F. T. Alker has been promoted to engineer-in-chief of the Hungarian Broadcast Station at Lakihegy.

Previously U. S. radio inspector, G. W. Earnhart has become chief engineer of KWYO at Sheridan, Wyo.

R. W. Erwin is now doing consulting work for the Ever Ready Company of Sydney, Australia, having formerly been with the National Carbon Company in San Francisco.

W. R. Foley has been promoted to inspector for the Federal Communications Commission with headquarters at Norfolk, Va.

H. C. Forbes, previously with General Household Utilities Company, has been made chief engineer of automotive radio for Colonial Radio Corporation, Buffalo, N. Y.

Formerly with General Household Utilities Company, W. S. Harmon has become an engineer for Emerson Radio and Phonograph Company of New York.

C. S. Hultberg is now chief engineer for L'Tatro Products Corporation of Decorah, Iowa, formerly being on the staff of Hygrade Sylvania Corporation.

Previously with Hazeltine Service Corporation, J. K. Johnson has been made chief engineer of Wells-Gardner and Company of Chicago.

A. S. Milinowski, Jr., has joined the engineering staff of RCA Radiotron at Harrison, New Jersey.

V. H. K. Morch formerly with Tung Sol Lamp Works has been made manager of the Sound Film Department of Philips, Copenhagen, Denmark.

A. B. Oxley of Philco Products, Ltd., of Canada, has been transferred to the London branch of that organization, in charge of engineering.

W. J. Polydoroff is now a consulting engineer of Aladdin Radio Industries, Ltd., of Greenford, Middlesex, England.

Formerly at Grand Island, Nebraska, G. K. Rollins has been made inspector for the Federal Communications Commission at Atlanta, Ga.

K. B. Ross, formerly with General Manufacturing Company, has joined the engineering staff of Meissner Manufacturing Company, Chicago.

Previously with Mackay Radio and Telegraph Company, J. C. Walter is now employed by Wired Radio at Ampere, N. J.

P. H. Wang has joined the engineering staff of the Bureau of International Telegraphs, Shanghai, China.

W. H. West has opened a consulting practice in St. Louis, Mo., recently being connected with KSD.



## VACUUM TUBES FOR GENERATING FREQUENCIES ABOVE ONE HUNDRED MEGACYCLES\*

By

C. E. FAY AND A. L. SAMUEL

(Bell Telephone Laboratories, Inc., New York City)

*Summary*—The failure of the conventional vacuum tube to oscillate above some critical frequency is analyzed and illustrated by data on a tube which will oscillate at frequencies up to 300 megacycles.

A Barkhausen tube giving output of the order of five watts in the range from 450 to 600 megacycles is described. For higher frequencies (up to 2500 megacycles) spiral-grid Barkhausen tubes have been used.

By departing from conventional construction principles it is possible to extend the operation of negative grid oscillators above 300 megacycles, one tube described giving six watts at 500 megacycles with an efficiency of 19 per cent. By further refinement appreciable power has been obtained at 1000 megacycles and the possibilities have by no means been exhausted.

AS A RESULT of the increasing technical importance of the ultra-high frequency range of the radio spectrum, the development of vacuum tubes for these frequencies has been receiving some attention. When an attempt is made to operate conventional vacuum tubes at very high frequencies one of two things happens; either it is found that a limiting frequency is reached when the external circuit is reduced to substantially zero, or in the more usual case, the tube simply fails to oscillate before this circuit limitation is reached. In the second case an increase in the applied potentials to several times their normal values will sometimes extend the range. Under such circumstances calculations usually reveal that the period of the desired oscillations has become comparable with the time required for the electrons to traverse the region between the cathode and the anode. These two limitations, the one set by circuit requirements, and the other set by the electron transit time are always encountered at ultra-high frequencies. They become operative with the usual tubes at or around one hundred megacycles. For frequencies above this, two courses are open; the first a still further refinement of existing techniques, the second an application of radically different methods of operation.

\* Decimal classification: R330×R133. Original manuscript received by the Institute, September 28, 1934. Presented before joint meeting I.R.E. and American Section, U.R.S.I., April 27, 1934, Washington, D.C.

An example of what may be accomplished with a tube of more or less conventional design is illustrated by the tube shown in Fig. 1. This triode, the Western Electric No. 304A, is a low power tube designed particularly for use in the frequency range from 50 to 300 megacycles.

The principal construction features of this tube are:

1. The close spacings of the elements, particularly of the grid and filament, to give a high mutual conductance and short electron paths.

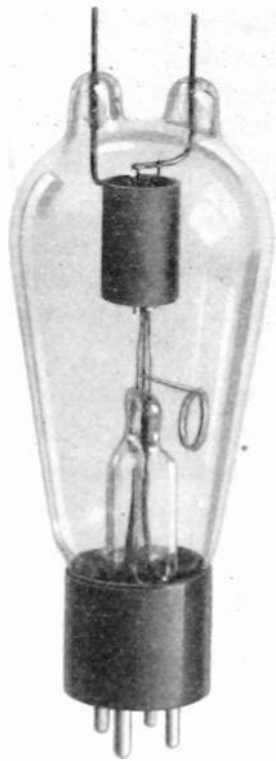

Fig. 1—Western Electric No. 304A vacuum tube.

2. The method of supporting the grid and plate directly from their respective leads which are short and heavy to give low lead inductance and resistance and a minimum value of stray interelectrode capacitance.

3. The complete absence of auxiliary supporting members either of metal or insulating material with their attending losses.

4. The use of hard glass.

5. The use of graphite as an anode material to permit high energy dissipation from a relatively small electrode.

TABLE I  
CHARACTERISTICS OF HIGH-FREQUENCY TRIODE 304A

Filament Voltage . . . . . 7.5 Volts  
 Filament Current . . . . . 3.25 Amperes

At a Plate Voltage of 1000 Volts and Plate Current of 0.050 Ampere

Amplification Factor . . . . . 11  
 Mutual Conductance . . . . . 2300 Micromhos  
 Plate Resistance . . . . . 4800 Ohms

Interelectrode Capacities

Plate to Grid . . . . . 2.5 Micromicrofarads  
 Grid to Cathode . . . . . 2.0 Micromicrofarads  
 Plate to Cathode . . . . . 0.67 Micromicrofarads

Rating as Class C Oscillator or Amplifier

Maximum Direct Plate Voltage . . . . . 1250 Volts  
 Maximum Direct Plate Current . . . . . 0.10 Ampere  
 Maximum Continuous Plate Dissipation . . . . . 50 Watts

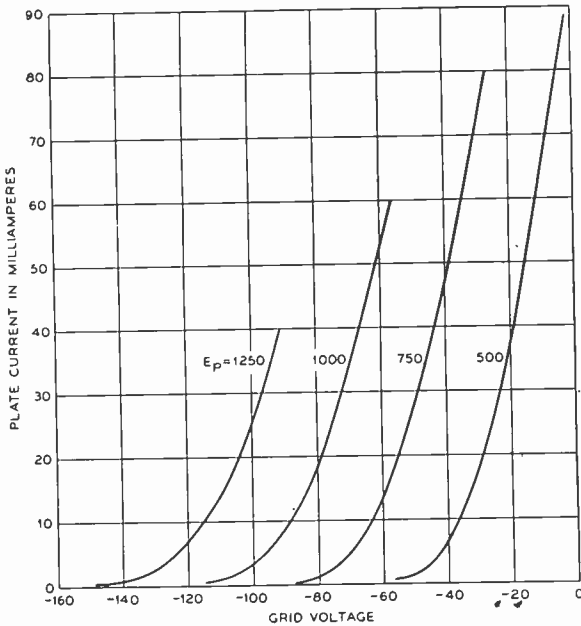

Fig. 2—Static characteristic curves. Western Electric No. 304A vacuum tube.

The tube constants and operating conditions are given in Table I and a plot of the static characteristic is shown in Fig. 2. A thoriated tungsten filament is used.

The interelectrode capacitances have not been reduced to unusually low values, as this is possible only by wide spacing of the electrodes which increases the electron transit time, or by shrinking of axial dimensions which reduces the power rating. The dimensions of this tube are about optimum for its power rating and frequency range. Curves of the output and efficiency obtained from No. 304A tubes are shown in Fig. 3. These curves were obtained with a push-pull circuit employing two tubes. The curves are characteristic of the behavior of negative grid tubes in general as the frequency limit is ap-

proached, the limiting frequency, of course, depending upon the particular design. Specific values might be mentioned; at 100 megacycles or 3 meters, the output is 55 watts per tube and the efficiency 50 per cent; at 200 megacycles or 1.5 meters the output is 34 watts and the efficiency 35 per cent; and at 300 megacycles or 1 meter the output is 12 watts at 17 per cent. The frequency limit with 750 volts on the anode is 400 megacycles or 75 centimeters.

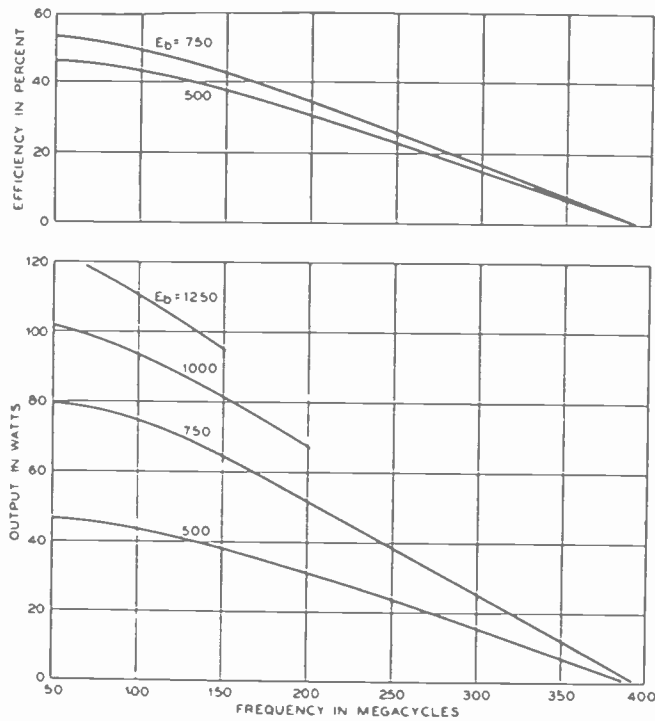

Fig. 3—Output and efficiency obtainable from No. 304A tubes in push-pull oscillator.

At still higher frequencies it has been customary to turn to other methods of operation. For example Barkhausen in 1920 discovered that with certain tubes, oscillations in the centimeter wavelength range are produced when the grid is maintained at a high positive potential and the plate at or near the cathode potential, that is, just reversing the more usual arrangement. When so operated, it is found that there exist preferred frequencies of operation determined by the electrode spacings and the applied electrode potentials. These conditions are such that the electron transit time is approximately equal to the period of one complete oscillation. Still other higher frequency modes can be obtained. One of these higher modes is particularly easy to excite in a structure in which the grid is in the form of an unshorted helix. This latter type is usually referred to as the spiral-grid Bark-

hausen tube as contrasted with the more usual form in which the grid is of relatively low impedance from end to end, such as one which has longitudinal wires in the grid structure.

It has been found that for frequencies up to about 600 megacycles the best outputs and efficiencies can be obtained from a tube having a straight wire squirrel-cage type of grid. A Barkhausen type oscillator developed for the range from 450 to 600 megacycles (67 to 50 centi-

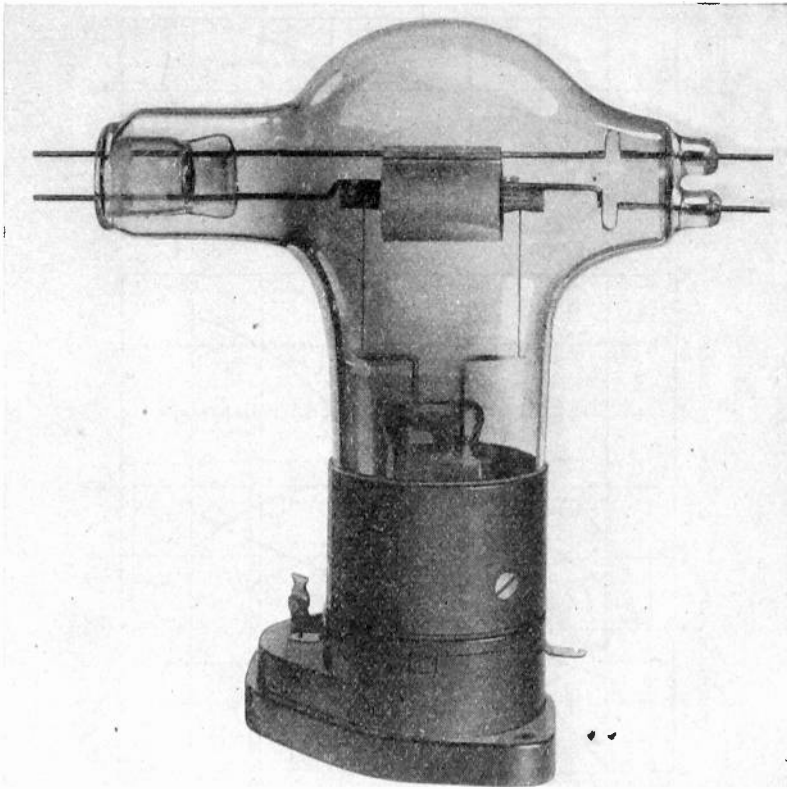

Fig. 4—Barkhausen type oscillator tube No. 160Y.

meters) is shown in the photograph Fig. 4. The grid structure of this tube consists of a cage of longitudinal tungsten wires attached to cooling collars at each end, and is capable of dissipating 150 watts safely. Such a design is made necessary by the relatively low efficiency of such an oscillator. As the grid voltage must be increased to increase the frequency and the grid current also increased to maintain the correct operation conditions for best efficiency, there exists a definite frequency limit for a given tube of this type which is set by the allowable grid dissipation. We have found that the longitudinal wire-cage

type of grid gives better efficiency than other types of grid structure in this mode of oscillation. The filament is a wire of pure tungsten.

The output and efficiency obtained from this Barkhausen tube in the 450- to 600-megacycle range are shown in Fig. 5. These output curves represent the optimum conditions at each point. The optimum grid voltage, grid current, and plate voltage are shown. In order to illustrate better the behavior of this type of tube, Fig. 6 shows the variation in output and frequency with grid voltage for a fixed adjust-

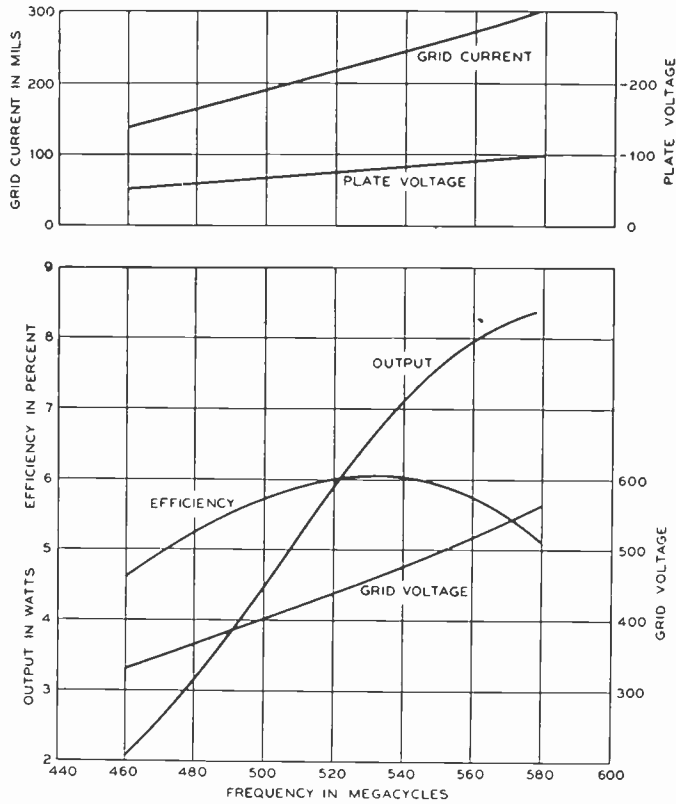

Fig. 5—Output and efficiency obtainable from the No. 160Y tube.

ment of the tuned circuit, the plate voltage and grid current (or filament current) being adjusted for a maximum output at each point. Since at optimum adjustment the grid current is not space-charge-limited, the adjustment of filament emission is critical. The curves of Fig. 5 were obtained by taking values relating to the optimum points of curves similar to Fig. 6. Thus in Fig. 6, the optimum point of both efficiency and output would be taken as being that for a grid voltage of 445 volts, at which point the output is 6.4 watts and the efficiency 6.05 per cent with the frequency about 529 megacycles. With the circuit tuning fixed, it is seen that the frequency change is fairly small over a considerable range of grid voltage.

Fig. 7 shows the variation in output and efficiency produced by varying the grid current, all other adjustments remaining fixed. This

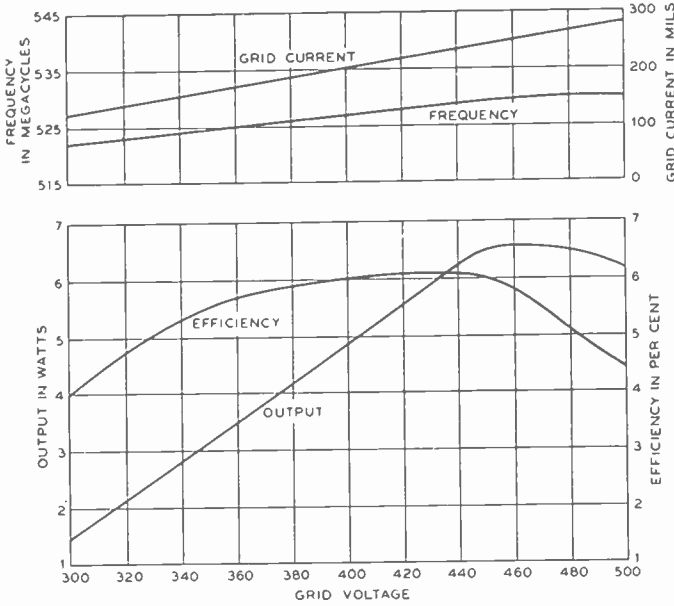

Fig. 6—Result of variation of grid voltage, tuning fixed, No. 160Y tube.

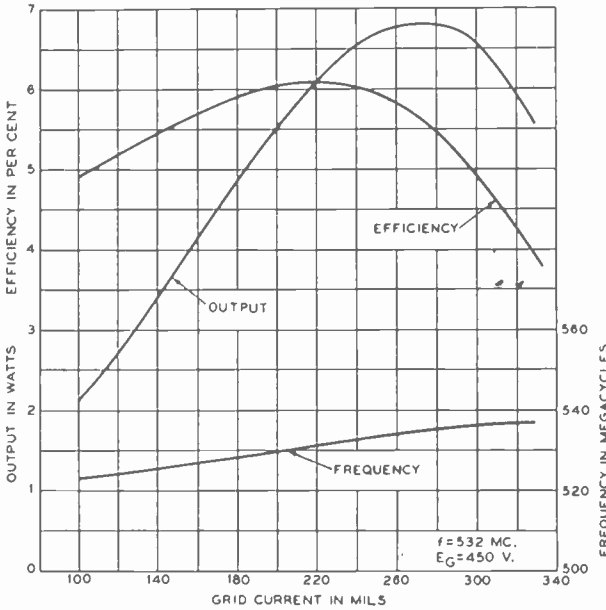

Fig. 7—Result of variation of grid current, other adjustments fixed, No. 160Y tube.

change in grid current is produced by varying the filament temperature, since the grid current is not space-charge-limited over the range of efficient operation indicated. It will be noted here as in the previous

figure that the peaks of output and efficiency do not coincide. The variation in space-charge condition with change in filament current alone is responsible for the variation of frequency, since all voltages were maintained constant as was the circuit tuning. As a more nearly space-charge-limited current is reached with increasing electron emission, the output falls rapidly. The curves could not be extended beyond the range shown because of energy limitations of the grid structure.

For frequencies much higher than 600 megacycles (wavelengths below 50 centimeters) it is found that the power input requirements for efficient operation of tubes of the type just described are in excess of that which can be tolerated in the grid structures. Operation at very much less than optimum input results in a considerable loss in output as indicated in Figs. 6 and 7.

The spiral-grid type of tube, however, will produce oscillations of wavelengths shorter than those predicted by the simple electron transit time considerations, and although its efficiency is considerably below the best obtainable from the other type of Barkhausen tube, at wavelengths much below 50 centimeters it will give greater output. We have constructed tubes of this type ranging in outputs from a few tenths of a watt at 12 centimeters to 1.5 watts at 24 centimeters and several watts at 60 centimeters.

It should be pointed out that all of the power measurements reported in this paper were obtained by dissipating the power in small lamps which were calibrated photometrically. The power reported, therefore, is a somewhat conservative estimate of that actually generated, as no account is taken of power radiated from the system or dissipated in the circuit although it was attempted to keep such losses a minimum. This power therefore represents the useful power obtainable. Whereas at frequencies below 600 megacycles these lamp bulbs may be placed in a small tuned circuit coupled to the oscillating circuit, for frequencies above 600 or 700 megacycles this no longer becomes feasible. It was thought best, therefore, to introduce the lamp load directly into the oscillating circuit. This requires either a variable resistance load or special circuit arrangements to insure that the proper output impedance for the tube has been provided. By the use of adequate precautions this technique has been applied to frequencies as high as 3000 megacycles.

A spiral-grid Barkhausen tube consists primarily of an ordinary cylindrical three-element structure except that the grid is in the shape of an unshorted helix both ends of which may be brought out of the envelope. In the normal mode of oscillation the main external circuit (in the form of a Lecher system) may be connected between the two



grid terminals. Just as in the usual Barkhausen oscillator the grid is maintained at a high positive direct-current potential. The plate potential is, however, usually quite large, and negative with respect to the cathode. Sample tubes of this type are shown in Fig. 8.

The more important geometric parameters of a spiral-grid Barkhausen tube can very conveniently be expressed as four dimensionless ratios and one length. The arbitrary choice of the expanded length of the grid helix gives as a possible set of ratios the following: (1) plate

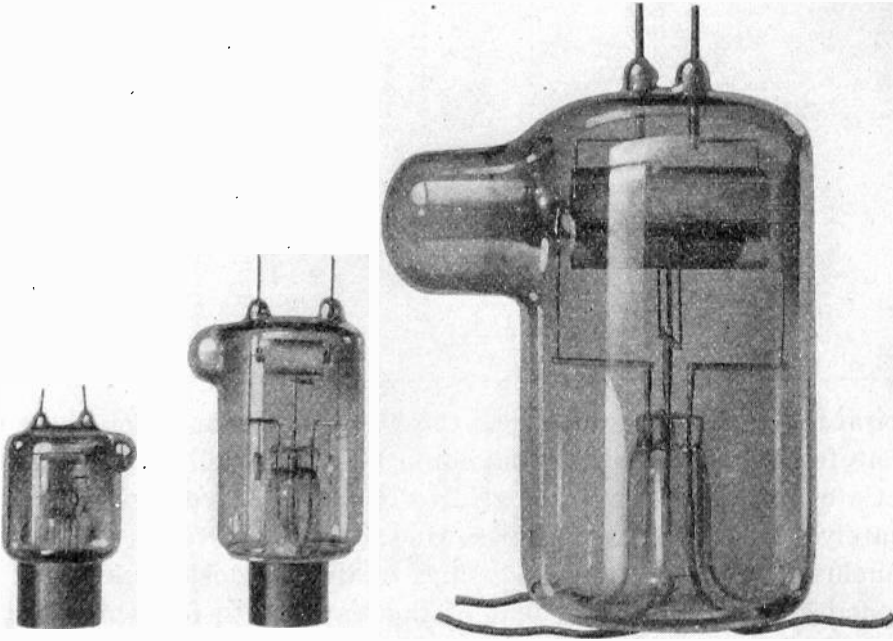

Fig. 8—Spiral-grid tubes designed for 12, 25, and 60 centimeters respectively

diameter to grid diameter, (2) grid diameter to grid wire size, (3) grid wire size to grid pitch, and (4) grid pitch to grid length. The first of these together with the applied potentials determines the relative lengths of time required for the electrons to traverse the cathode-grid and grid-plate regions. The second determines the rigidity of the grid structure and in a measure the permissible power input. The third is in reality the fraction of the grid plane occupied by wire and determines the fraction of the emitted electrons which strike the grid directly and in so doing never reach the grid-plate region. The fourth factor is the total number of turns in the grid spiral and has a bearing on the impedance of the grid as a circuit element.

A study of the variation in design parameters with frequency based

upon the results obtained with some seventy experimental tubes, supplemented by dimensional considerations leads to some very interesting conclusions. The first of these is that the optimum wavelength bears a linear relationship to the expanded length of the grid spiral. This is illustrated in Table II which compares the length of the grid

TABLE II  
COMPARISON OF GRID WIRE LENGTH TO OPTIMUM WAVELENGTH, SPIRAL-GRID TUBES

Grid Wire Length in Cm	Optimum Wavelength in Cm	Ratio
16.3	13.5	1.21
18.6	18.6	1.00
19.7	14.5	1.36
20.4	18.0	1.13
21.4	17.5	1.22
21.3	25.0	0.85
22.3	20.2	1.10
25.2	18.6	1.35
30.6	25.0	1.22
32.0	23.6	1.36
32.0	25.5	1.25
33.4	25.0	1.33
42.6	29.0	1.47
42.6	29.5	1.44
42.6	30.2	1.41
42.6	30.7	1.38
53.2	43.5	1.22
80.0	65.0	1.23
Average		1.24

spiral for a series of tubes with the wavelengths at which these tubes were found to deliver the maximum power. It will be noticed that a ratio of expanded length of grid to optimum wavelength of approximately 1.24 is indicated over a wide range of wavelengths. A second conclusion is that optimum values of the dimensionless ratios mentioned above are independent of the wavelength for which the tube is designed. Graphic evidence of this is presented by the largest and smallest tube shown in Fig. 8 for which these ratios were approximately the same. A third conclusion is that there exists a maximum output at any given wavelength for a tube of a given design and this output is proportional to the square of the optimum wavelength for which the tube is designed. The efficiencies of all tubes of this type studied so far have invariably been very low, usually between 0.5 and 1 per cent.

A recognition of the inherent advantages of the negative grid oscillator has led us to consider the design of such tubes for use at frequencies above 300 megacycles. The limitation previously mentioned due to the appreciable electron transit time may be overcome by the use of higher voltages or closer electrode spacings. Practical voltage limits are soon reached so that close spacings seem inevitable. This introduces serious mechanical problems and reduces the power dissipating ability of the elements. The other limitation set by circuit

requirements makes necessary low interelectrode capacitances and short heavy leads to decrease lead inductance. The importance of low resistance leads is evident when one realizes that the charging currents to even very small interelectrode capacitances can reach large values at very high frequencies.

A triode developed with the above considerations in mind, for use at frequencies up to 600 megacycles is shown in Fig. 9. It will be noticed that this tube bears scant similarity to the conventional negative grid tubes in its construction. In spite of its small size, the plate of this tube can dissipate 40 watts safely. A thoriated tungsten filament is

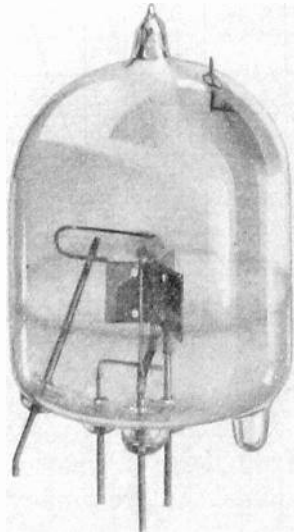

Fig. 9—Negative grid—feedback oscillator tube No. 149Y.

used. The operating characteristics are given in Table III and a plot of the static characteristics in Fig. 10.

TABLE III  
CHARACTERISTICS OF HIGH-FREQUENCY TRIODE 149Y

Filament Voltage	2.0	Volts
Filament Current	3.5	Amperes
At a Plate Voltage of 400 Volts and Plate Current of 0.050 Ampere		
Amplification Factor	5.0	
Mutual Conductance	1800	Micromhos
Plate Resistance	2750	Ohms
Interelectrode Capacities		
Plate to Grid	1.8	Micromicrofarads
Grid to Cathode	1.0	Micromicrofarads
Plate to Cathode	0.75	Micromicrofarads
Rating as Class C Oscillator		
Maximum Direct Plate Voltage	400	Volts
Maximum Direct Plate Current	0.075	Ampere
Maximum Continuous Plate Dissipation	30	Watts

They are not very much different from those of an ordinary low power tube, except in the capacities. The curves of Fig. 11 show the output

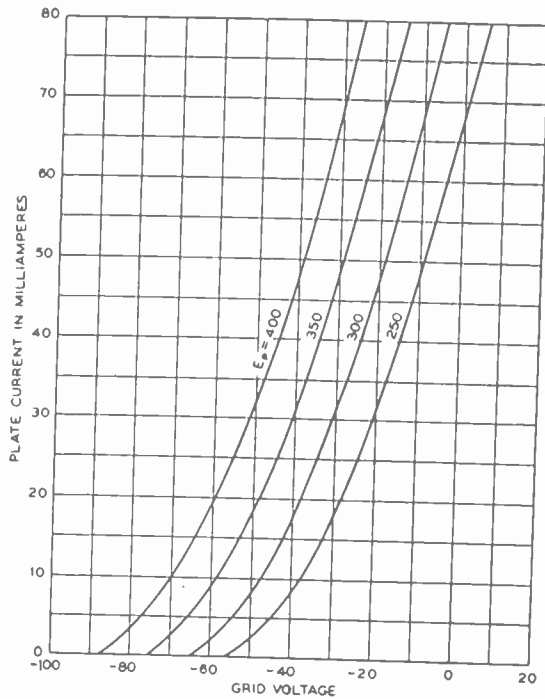

Fig. 10—Static characteristic curves No. 149Y tube.

and efficiency obtained from two of these tubes in push-pull at two different plate voltages over the frequency range from 750 to 200

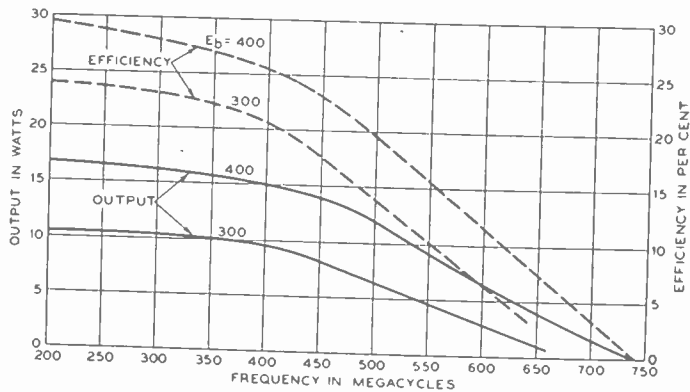

Fig. 11—Output and efficiency obtainable from No. 149Y tubes in push-pull oscillator.

megacycles, that is, from a wavelength of 40 centimeters to 1.5 meters. Fig. 12 shows the effect of varying the plate voltage on the output and efficiency at 500 megacycles.

It is of interest to compare the results obtained with this tube with the results obtained with the tubes previously described. Some comparative data are tabulated in Table IV. As a final comparison

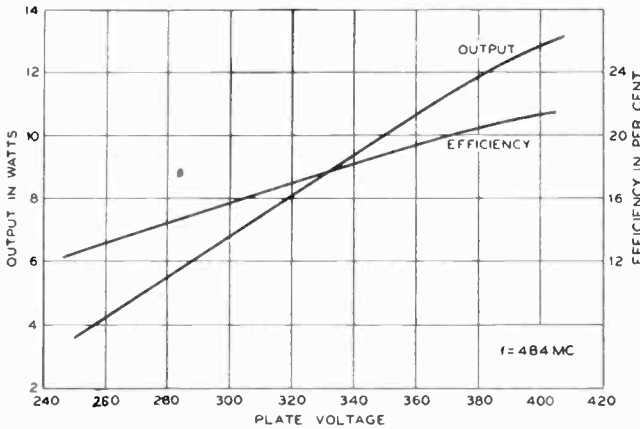

Fig. 12—Variation of output and efficiency with plate voltage of No. 149Y tubes in push-pull oscillator at 500 megacycles.

the outputs obtainable as a function of frequency for all the types discussed are shown in Fig. 13. The solid curves are for individual tubes while the dotted curve connects the maximum values obtained with different tubes of the spiral-grid type.

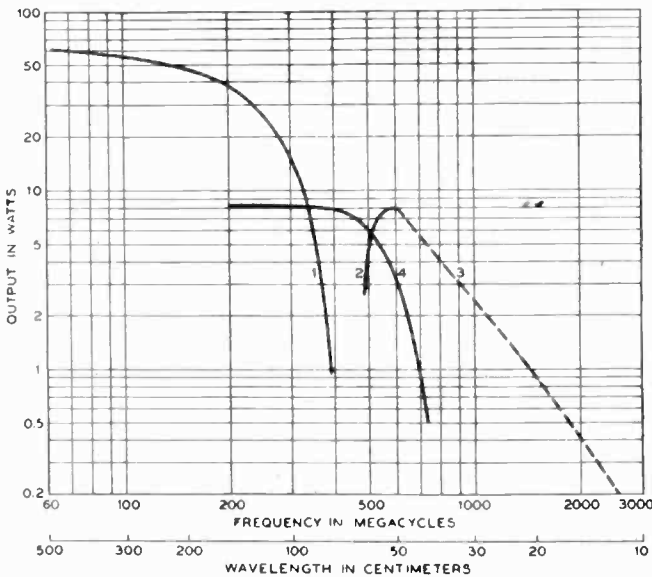

Fig. 13—Composite plot of outputs obtained.

1. Western Electric No. 304A.
2. Barkhausen type No. 160Y.
3. Optimum spiral-grid tube for each frequency.
4. Negative grid—feed-back type, No. 149Y.

TABLE IV  
COMPARISON OF OUTPUTS AND EFFICIENCIES

Frequency	Negative Grid Tube 304A		Negative Grid Tube 149Y		Positive Grid Tube 160Y		Optimum Spiral-Grid Tube	
	Output	Efficiency	Output	Efficiency	Output	Efficiency	Output	Efficiency
100	55	50						
200	34	35	8.5	29				
300	12	17	8.0	28				
400			7.5	26				
500			6.0	19				
600			3.1	11	4.5	6		
700			0.9	3	8.0	5		
1000							5.5	1
2000							2.5	1
							0.4	1

Frequency in megacycles. Output in watts. Efficiency in per cent.

The negative grid tube compares very favorably with other types of oscillators in respect to output and always at a much higher efficiency. In some of our more recent developments we have been able to obtain as much as 2 watts at 30 centimeters by further departures from conventional practice and we feel that this by no means represents the limit of the possibilities of this type of generator.

#### Bibliography

##### Negative Grid Tubes

- (1) E. D. McArthur and E. E. Spitzer. Proc. I.R.E., vol. 19, p. 1971; November, (1931).
- (2) I. E. Mouromtseff and H. V. Noble. Proc. I.R.E., vol. 20, p. 1328; August, (1932).
- (3) W. Kroebel, *Ann. der Phys.* vol. 14, p. 80; July, (1932).
- (4) L. Rohde, *Hochfrequenz. und Elektroakust.*, vol. 40, p. 3; July, (1932).
- (5) B. J. Thompson and G. M. Rose, Proc. I.R.E., vol. 21, p. 1707; December, (1933).

##### Positive Grid Tubes

- (6) H. Barkhausen and K. Kurz, *Phys. Zeit.*, vol. 21, p. 1; January, (1920).
- (7) H. Collenbusch, *Ann. der Phys.*, vol. 13, p. 191; April 8, (1932).
- (8) E. W. B. Gill and J. H. Morrell, *Phil. Mag.*, vol. 44, p. 161; July, (1922).
- (9) H. E. Hollmann, Proc. I.R.E., vol. 17, p. 229; February, (1929).
- (10) K. Kohl, *Erg. der ex. Naturwiss.*, vol. 9, p. 275, (1930).
- (11) H. N. Kozanowski, Proc. I.R.E., vol. 20, p. 957; June, (1932).
- (12) E. C. S., Megaw, *Jour. I.E.E.* (London), vol. 72, p. 313; April, (1933).
- (13) J. S. McPetrie, *Phil. Mag.*, vol. 16, p. 544; September, (1933).
- (14) G. Potapenko, *Phys. Rev.*, vol. 39, p. 625 and p. 638; February 15, (1932); vol. 40 p. 988; June 15, (1932); and vol. 41, p. 216; July 15, (1932).
- (15) H. G. Clavier, *Electrical Communication*, vol. 12, p. 3; July, (1933).



## DESIGNING RESISTIVE ATTENUATING NETWORKS\*

By

P. K. McELROY

(General Radio Company, Cambridge, Mass.)

*Summary*—This paper represents a collection of material, largely old but in part new, which is to advantage presented in one place for ease of reference and use, and which is not known to be available elsewhere in this collected form.

Herein are recorded, in outline, the derivations of expressions for calculating the various elements of resistive attenuating networks or, in more common parlance, pads. The derivations are general, for the case where the networks are inserted between unequal terminal impedances; simplifications yield the more familiar expressions for corresponding elements of networks inserted between equal impedances.

Inspection of these expressions shows that the process of calculation can be facilitated by a tabulation of the values of several factors which are multiplied by the terminal impedances in obtaining the resistances of the individual elements. These factors are all functions of the ratio between the power put into the pad and the power delivered to the load. A tabulation is provided of values of the most useful of these factors for a large number of attenuation values. There are also tables and curves showing the smallest attenuation possible in a tapered T or L pad as a function of the ratio of the two unequal impedances between which it is inserted, together with the reflection loss between the same impedances with no network inserted.

### I. INTRODUCTION

RESISTIVE attenuating networks, both fixed and adjustable, have in recent years been finding ever-increasing use, both in fixed plant equipment and as measuring implements in laboratory and experimental work. While purely resistive networks give the correct attenuation only when inserted between purely resistive impedances of the correct magnitude, they are the most satisfactory compromise (largely because most easily designed and built) for general-purpose use where the intention is that powers of all frequencies shall be attenuated equally. Further, in evaluating the corrections to be applied when a network is inserted between impedances other than those for which it was designed, it is advantageous to be able to use a network which has definite and simple characteristics (magnitude and phase angle of its image impedances).

Computation of the resistance values of the several elements of a network is rather tedious if this work has to be carried through from the very beginning with no other help than the literal formulas involving the various parameters.

\* Decimal classification: R383. Original manuscript received by the Institute, February 28, 1934.

All of these formulas for the resistance values of the individual elements of the many different networks may be expressed primarily in terms of one parameter  $k$ , which is, by arbitrary definition, greater than or equal to unity. The quantity  $k^2$  is the ratio of the power delivered by the source into the input end of the network to the power delivered from the output end of the network into the load, when terminated correctly, i.e., with its two image impedances. The quantity  $k$  is the ratio of the input to the output voltage or current of the network, provided proper correction has been made in case input and output impedances are dissimilar. The constants  $k^2$  and  $k$  are related to the number  $n$  of decibels attenuation by the following relations:

$$k^2 = \log_{10}^{-1} \left( \frac{n}{10} \right)$$

$$k = \log_{10}^{-1} \left( \frac{n}{20} \right).$$

When the expressions for the resistance values of the network elements are written in terms of the parameter  $k$ , it will be seen that the resistance of each element is equal to the product of three factors:

- (1) The value in ohms of the proper one of the two terminating impedances of the network.
- (2) A factor (a or b; see Tables II, IV, VI, and VIII) depending on the type of network in a given family of related network (e.g., T, H, or balanced H). This factor will be a small integer or the reciprocal of a small integer.
- (3) A factor which is a function primarily of  $k$  and, in the case of networks inserted between unequal impedances, additionally a function of a convenient parameter  $s$ , which is defined as the square root of the ratio of the two terminal impedances. By this definition  $s$  may be seen to be identical with the turns or voltage ratio of an ideal transformer which would match these two terminating impedances to one another.

Computation of networks is greatly facilitated by a tabulation of the values of the factors listed under subheadings (2) and (3) of the preceding paragraph. Presentation of such tables in what is hoped to be easily usable form is the primary purpose of this paper. Incidental to the accomplishment of this primary purpose there will be brief derivations of the various expressions involved and a tabulation of those expressions in conjunction with schematic wiring diagrams showing the internal connections of the different networks. No attempt will be made to present in its entirety the mathematics of these derivations, although in all cases it has been completely carried through.



## II. THEORETICAL DERIVATIONS OF EXPRESSIONS FOR THE RESISTANCE VALUES OF ELEMENTS OF THE VARIOUS NETWORKS

The derivations will in each instance first be made for the general case where the network is being used between two unequal impedances  $Z$  and  $z$  (assumed to be purely resistive impedances, since the network elements are also to be purely resistive) and then reduced to the special, but more often encountered, case where the network is used between two equal impedances  $z$ . In the case of unequal terminating impedances, the larger is designated by  $Z$  and the smaller by  $z$ . This is done merely as a matter of convenience when thinking about the networks and to keep the value of the parameter  $s$  (see table of symbols below) greater than unity. The formulas, however, are not predicated upon the use of this convention, and hence are quite as accurate if the relative sizes of  $Z$  and  $z$  are transposed.

To be rigorous, using the generally accepted terminology,<sup>1</sup> the impedances  $Z$  and  $z$  really represent the so-called "image impedances" of the network, and as such are functions of the network alone, not of the circuits in which it may be placed. The behavior of the network when inserted between impedances not equal to its image impedances may be determined completely if its image impedances are known. However, since in these derivations certain conditions of impedance match at the terminals of the networks are assumptions basic to the problem, the terminal and the image impedances are identical in character. Because it is felt that the average reader will understand more easily and clearly, the strict concept of image impedances has been abandoned in this paper in favor of the looser but more obvious one of terminal impedances. If the reader more familiar with the subject will read the paper with this paragraph in mind, he should experience no difficulty in reconciling it to his present concepts.

Immediately below are listed the symbols to be used throughout this paper with their definitions:

$n$  = attenuation in decibels

$$k^2 = \log_{10}^{-1} \left( \frac{n}{10} \right) = \begin{array}{l} \text{ratio of input to output power for a pad} \\ \text{having an attenuation of } n \text{ decibels.} \end{array}$$

$$k = \log_{10}^{-1} \left( \frac{n}{20} \right)$$

$$r = \frac{1}{k} = \log_{10}^{-1} \left( - \frac{n}{20} \right)$$

<sup>1</sup> T. E. Shea, "Transmission Networks and Wave Filters," pp. 81 ff.

$z$  = each terminating impedance (when termination is symmetrical)

$Z$  = larger terminating impedance } (when termination is asymmetrical)  
 $z$  = smaller terminating impedance }

$$s = \sqrt{\frac{Z}{z}}$$

$$\bar{z} = \sqrt{Zz} = \frac{Z}{s} = zs$$

$u =$  } (resistive) elements of the networks, their natures being defined in the several diagrams of internal network connections scattered throughout the paper.  
 $v =$  }  
 $w =$  }

### 1. T Type and Related Networks

#### (a). Definitions

A T type network (also called Y type or midshunt type) consists of three resistors, two series and one shunt, symmetrically disposed and resembling a letter T (see Fig. 1). They form a common type of

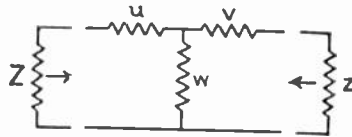

Fig. 1

pad for matching impedances at each end, and are much used in adjustable networks, instead of the  $\pi$  type connection (see sections II 2(a), II 2(b), and Fig. 2), since the switch arms necessary in a step-by-step or continuously adjustable network may all be connected to a common electrical point.

In networks of this type, each impedance looking through the network toward the other impedance sees an impedance equal to its own.

#### (b). Derivations

Setting down the expressions for these two just-enunciated conditions of impedance match provides two of the three simultaneous equations necessary to solve for the resistance values of the three elements of the network. The third is obtained by equating the ratio of the input and output powers of the network to the quantity  $k^2$ . The powers are expressed in terms of  $i^2z$ , since this yields a simpler and more usable equation than would be obtained by the expression of the powers in terms of  $e^2/z$ . This comes about because the single shunt resistor  $w$  serves to divide the current flowing into the network, thus diverting part of it from the output circuit.

$$Z = u + \frac{w(v+z)}{w+v+z} \quad (1)$$

$$z = v + \frac{w(u+Z)}{w+u+Z} \quad (2)$$

Power from  $Z$  into network is

$$W_Z = i_Z^2 Z. \quad (3)$$

Power from network into  $z$  is

$$W_z = i_z^2 z = \left\{ \left( \frac{w}{w+v+z} \right) i_Z \right\}^2 z. \quad (4)$$

Dividing (3) by (4),

$$\frac{W_Z}{W_z} = k^2 = \frac{i_Z^2 Z}{\left\{ \left( \frac{w}{w+v+z} \right) i_Z \right\}^2 z} = \left( \frac{w+v+z}{w} \right)^2 \frac{Z}{z}. \quad (5)$$

But, by definition,  $Z/z = s^2$ , whence

$$k^2 = \left( \frac{w+v+z}{w} \right)^2 s^2. \quad (6)$$

Taking the square root of (6) and using the positive sign, since  $k$  and  $s$  are by nature positive,

$$k = \left( \frac{w+v+z}{w} \right) s. \quad (7)$$

(c). *Formulas*

(i). When terminating impedances are unequal:

Solving (1), (2), and (7) for values of  $u$ ,  $v$ , and  $w$  in terms of  $k$ ,  $s$ ,  $Z$ , and  $z$  yields

$$u = Z \frac{\left( k^2 + 1 - \frac{2k}{s} \right)}{k^2 - 1} \quad (8)$$

$$v = z \left( \frac{k^2 + 1 - 2ks}{k^2 - 1} \right) \quad (9)$$

$$w = 2 \frac{Z}{s} \left( \frac{k}{k^2 - 1} \right) = 2z \left( \frac{k}{k^2 - 1} \right). \quad (10)$$

(ii). When terminating impedances are equal:

$$Z = z, s = 1, \text{ and } u = v.$$

Placing  $s=1$  in (8), (9), and (10), we get

$$v = z \left( \frac{k-1}{k+1} \right) \quad (11)$$

$$w = 2z \left( \frac{k}{k^2-1} \right). \quad (12)$$

## 2. $\pi$ Type and Related Networks

### (a). Definitions

This network (also called  $\Delta$  type or mid-series type) consists of three resistors, one series and two shunt, symmetrically arranged in the shape of a Greek letter  $\pi$ , hence the name (see Fig. 2).

As with the T type networks, each impedance looking through the network toward the other impedance sees an impedance equal to its own.

### (b). Derivations

Setting down the expressions for these two conditions of impedance match provides two of the necessary three equations. The third is obtained by equating the ratio of the input and output powers of the network to the quantity  $k^2$ . The powers are expressed in terms of  $e^2/z$ . In this case, the single series resistor  $v$  serves to divide the voltage applied to the input end of the network, thus reducing the amount available across the output end.

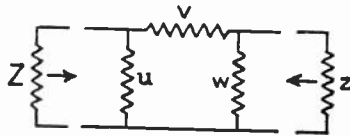

Fig. 2

$$Z = \frac{u \left( v + \frac{wz}{w+z} \right)}{u + v + \frac{wz}{w+z}} \quad (13)$$

$$z = \frac{w \left( v + \frac{uZ}{u+Z} \right)}{v + w + \frac{uZ}{u+Z}} \quad (14)$$

From power ratio relation we obtain

$$k^2 = \left\{ \frac{v + \frac{wz}{w+z}}{\frac{wz}{w+z}} \right\}^2 \frac{z}{Z} = \left( \frac{vw + vz + wz}{wz} \right)^2 \frac{1}{s^2}. \quad (15)$$

Taking the square root of (15),

$$k = \frac{vw + vz + wz}{swz}. \quad (16)$$

(c). Formulas

(i). When terminating impedances are unequal:

Solving (13), (14), and (16) for values of  $u$ ,  $v$ , and  $w$  yields

$$u = Z \left( \frac{k^2 - 1}{k^2 - 2ks + 1} \right) \quad (17)$$

$$v = \frac{Z}{2s} \left( \frac{k^2 - 1}{k} \right) = \frac{\bar{z}}{2} \left( \frac{k^2 - 1}{k} \right) \quad (18)$$

$$w = z \left( \frac{k^2 - 1}{k^2 - 2\frac{k}{s} + 1} \right). \quad (19)$$

(ii). When terminating impedances are equal:

$$Z = z, s = 1, \text{ and } u = w.$$

Placing  $s = 1$  in (17), (18), and (19), we get

$$v = \frac{z}{2} \left( \frac{k^2 - 1}{k} \right) \quad (20)$$

$$w = z \left( \frac{k + 1}{k - 1} \right). \quad (21)$$

### 3. L Type and Related Networks

(a). Definitions

This network consists of two resistors, one series and one shunt, asymmetrically arranged in the shape of a letter L (see Figs. 3 and 4).

In these L type networks, only *one* of the two impedances when looking through the network toward the other impedance sees an impedance equal to its own. In the general case, where the input and out-

put impedances of the network are not equal, there are four possible conditions. The L network may be so inserted that its series arm points either to the larger or the smaller of the two terminating impedances. Further, either the larger or the smaller of the two terminating impedances may see an impedance equal to its own. Not all of these possibilities can be realized for all combinations of values of  $k$  and  $s$  (attenuation and impedance ratio, respectively), as may be seen from an inspection of the expressions given below in section II 3 (c) (i). Certain combinations of  $k$  and  $s$  will be seen to produce anomalous conditions, requiring one of the elements to be *negative* in resistance. In consideration of L type networks then, it will be necessary, for the reasons outlined, to regard  $s$  in its unrestricted sense, when it may also be less than unity, indicating a reversal in the relative sizes of  $Z$  and  $z$ . In any case, however, as noted previously, the formulas given are correct.

(b). Derivations

Setting down the expression for the one condition where one impedance looks into an impedance equal to its own provides one of the two necessary simultaneous equations. The other is obtained by equating the ratio of input and output powers of the network to the quantity  $k^2$ . The powers are expressed in terms either of  $i^2z$  or of  $e^2/z$ , depending on which method will yield the simpler expression in any particular case (i.e., on whether one is looking at the series- or the shunt-element end of the L type network, respectively). Two sets of expressions must be derived for the two conditions enumerated in the last (parenthesized) clause of the previous sentence.

(i). Case where impedance is matched at series-resistor end of pad:

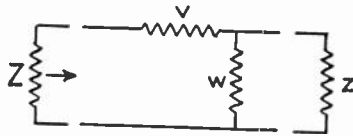

Fig. 3

$$Z = v + \frac{wz}{w + z} \quad (22)$$

From the power ratio relation we obtain

$$k^2 = \left( \frac{w + z}{w} \right)^2 \frac{Z}{z} = \left( \frac{w + z}{w} \right)^2 s^2 \quad (23)$$

Extracting the square root of (23),

$$k = \left( \frac{w + z}{w} \right) s. \quad (24)$$

(ii). Case where impedance is matched at shunt-resistor end of pad:

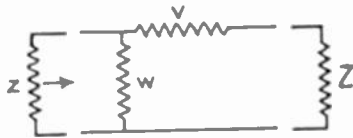

Fig. 4

$$z = \frac{w(v + Z)}{v + w + Z}. \quad (25)$$

From the power ratio relation we obtain

$$k^2 = \left( \frac{v + Z}{Z} \right)^2 \frac{Z}{z} = \left( \frac{v + Z}{Z} \right)^2 s^2. \quad (26)$$

Extracting the square root of (26),

$$k = s \left( \frac{v + Z}{Z} \right). \quad (27)$$

(c). Formulas

(i). When terminating impedances are unequal:

Solving (22) and (24) for values of  $v$  and  $w$  yields, for the case where impedance is matched at series-resistor end of pad,

$$v = zs \left( \frac{ks - 1}{k} \right) = \bar{z} \left( \frac{ks - 1}{k} \right) = \bar{s}(s - r) \quad (28)$$

$$w = zs \left( \frac{1}{k - s} \right) = \bar{z} \left( \frac{1}{k - s} \right). \quad (29)$$

Solving (25) and (27) for values of  $v$  and  $w$  yields, for the case where impedance is matched at shunt-resistor end of pad,

$$v = \frac{Z}{s}(k - s) = \bar{z}(k - s) \quad (30)$$

$$w = \frac{Z}{s} \left( \frac{k}{ks - 1} \right) = \bar{z} \left( \frac{k}{ks - 1} \right) = \bar{z} \left( \frac{1}{s - r} \right). \quad (31)$$

(ii). When terminating impedances are equal:

$$Z = z \text{ and } s = 1.$$

Placing  $s = 1$  in (28), (29), (30), and (31) yields

$$v = z \left( \frac{k-1}{k} \right) = z(1-r) \quad (32)$$

$$w = z \left( \frac{1}{k-1} \right) \quad (33)$$

$$v = z(k-1) \quad (34)$$

$$w = z \left( \frac{k}{k-1} \right) = z \left( \frac{1}{1-r} \right) \quad (35)$$

} For case where impedance is  
 matched at series-resistor  
 end of pad.  
 } For case where impedance is  
 matched at shunt-resistor  
 end of pad.

#### 4. Bridged T Type Networks

##### (a). Definitions

This network consists of four resistors, connected to one another and to source and load as shown by Fig. 5.

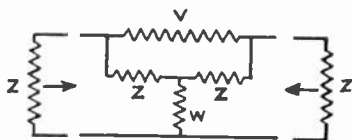

Fig. 5

It will be seen to be a hybrid T and  $\pi$  type network. It is useful primarily in an adjustable network, since only two of the resistance arms need be adjusted, in distinction to three in the case of the T type network. Its disadvantage, however, is that there are no electrically common points between the two adjustable arms, and that necessitates insulating from each other the two switch arms which vary the two adjustable elements  $v$  and  $w$  of the network. This difficulty is not encountered in a T or an L type network.

Formulas are given for this type of network only for the case where it is inserted between equal impedances, since it is not a very important or often used type of network and the derivations are much more complicated.

##### (b). Derivations

The derivations are, in general, similar to those required for the previous types of networks. The complication of the circuits, however, makes it impossible to determine the impedance looking into the network or the voltage or current division by simple inspection. All these must be done by the use of Kirchoff's laws. No attempt will be made here even to outline the tedious mathematics necessary, but the results will be given in the next paragraph.



## (c). Formulas

Expressions for elements  $v$  and  $w$ :

$$v = z(k - 1) \quad (36)$$

$$w = z\left(\frac{1}{k - 1}\right). \quad (37)$$

## 5. Smallest Possible Loss Tapered Matching Networks Inserted Between Unequal Impedances

(a). Case for  $T$  or  $\pi$  Type Networks

The minimum loss possible in a  $T$  or  $\pi$  type network inserted between unequal impedances occurs when the network reduces to an  $L$  type network. This is, however, a unique sort of  $L$  type network, in which each of the terminating impedances looks into an impedance equal to its own, whereas, in general, in the ordinary  $L$  type network only one of the terminating impedances is thus matched.

In the case of a  $T$  type network, this condition occurs for a value of  $k$  such that the smaller series resistor  $v$ , the one adjacent to the smaller terminating impedance (observing the arbitrary convention that  $z$  is the smaller) becomes zero. In the case of a  $\pi$  type network, this condition occurs for a value of  $k$  such that the larger shunt resistor  $u$ , the one adjacent to the larger terminating impedance, becomes infinite. Imposing these two last-mentioned conditions upon (9) and (17), and solving for  $k$ , each yields the same expression:  $k = s \pm \sqrt{s^2 - 1}$ . Since both  $s$  and  $k$  have been arbitrarily chosen greater than or equal to unity, the sign in the above expression is not optional, but must be plus, so that  $k = s + \sqrt{s^2 - 1}$ . The number,  $n$ , of decibels loss equals  $20 \log_{10} k$ . For table and curve of these values, see second column, Table X and curve 1, Fig. 6. Further discussion of this subject is contained in an article by A. E. Thiessen.<sup>2</sup>

(b). Case for  $L$  Type Networks

The minimum loss possible in an  $L$  type network inserted between unequal impedances occurs when the network reduces to either a single series or a single shunt resistor. This condition is encountered when the value of  $k$  is such that the associated shunt resistor  $w$  becomes infinite or the associated series resistor  $v$  becomes zero, respectively. Imposing these two last-mentioned conditions upon (29) and (30), and solving for  $k$ , each yields the same identity,  $k = s$ . If  $s$  is less than unity, impose conditions instead on (31) and (28), respectively, whence,  $k = 1/s$ . The

<sup>2</sup> A. E. Thiessen, "Impedance matching networks," *Electronics*, March, (1931).

number,  $n$ , of decibels loss equals  $20 \log_{10}k$ . For table and curve of these values, see third column, Table X and curve 2, Fig. 6.

(c). Allowance for Reflection Loss

In the cases described under section II, parts 5 (a) and (b) immediately above, it must be realized that the smallest possible number,  $n$ , of decibels loss in the optimum pad of the type chosen does not all represent avoidable loss. Were the impedances, in the absence of the network, matched by an ideal transformer, this loss would *all* be avoidable; otherwise, there is an unavoidable loss due to the iron and copper losses in an actual transformer, or, without a transformer, to reflection occasioned by impedance mismatch, and this loss should be subtracted from the tabulated losses given for the various conditions before there is available a fair measure of the avoidable power loss caused by the addition of the network; in other words, a measure of the price in power loss that is paid for matching impedances, in both directions for T or  $\pi$  type, or in only one direction for L type networks.

## 6. Reflection Loss

The reflection loss due to impedance mismatch is the ratio of the power which would be delivered by a generator into an impedance equalling its own to the power delivered by the same generator into an impedance different from its own. This reflection loss can easily be shown to correspond to the value of  $k$  which follows:

$$k = \left( \frac{1 + s^2}{2s} \right).$$

The number,  $n$ , of decibels loss equals  $20 \log_{10}k$ . For table and curve of these values, see fourth column, Table X and curve 3, Fig. 6. A more complete set of curves, including curves for reflection loss where the impedances have phase angles other than zero, can be found in T. E. Shea's book.<sup>3</sup>

## III. PRACTICAL USE OF TABLES IN CALCULATING ELEMENTS OF NETWORKS

It will be noted that in Tables II, IV, and VI below, the resistance values of some of the network elements are or could be expressed as the products of several factors and the quantity  $Z/s$ . This quantity is, by definition, identical with the quantity  $zs$ , or, more simply, identical with the quantity  $\bar{z}$ , and it is so written in some of the alternative forms of the expressions for the resistance values of the elements;  $\bar{z}$  is the geometric mean of the two unequal terminating impedances. It

<sup>3</sup> *Loc. cit.*, p. 103, Fig. 49.

is logical to expect, particularly with the derived equations as support, that the resistances of the network elements common to the two ends of the network (reference is here made to the shunt element of a T type network, the series element of a  $\pi$  type network, and both elements of an L type network) should be functions alone of  $\bar{z}$  rather than of either  $Z$  or  $z$ .

No tabulations of  $s$  or  $\bar{z}$  have been made. It is felt that it would not only be hopeless to attempt to prognosticate the combinations of  $Z$  and  $z$  to be encountered in practice, but that both  $s$  and  $\bar{z}$  in the ordinarily encountered cases could be obtained readily and with ease directly from tables of square roots usually available in some reference book of tables in the library of every engineer, or by the aid of logarithms.

### 1. T Type and Related Networks

#### (a). Values of Factors $a$ and $b$ for Various Members of T Type Family

A T type network is completely unilateral, unsymmetrical with respect to the two sides of the line in which it is inserted, and, accordingly, not balanced to ground.

An H type network is bilateral, that is, symmetrical with respect to the two sides of the line in which it is inserted, but has only one shunt resistor and is, accordingly, not balanced to ground. Since the H type network has twice as many series resistors as the T type network, each series resistor has only half the resistance of the analogous resistor in the T type or reference case, because the total amount of series resistance on each side of the shunt resistor must be the same in each instance if the terminating impedances are the same.

A balanced H type network is both bilateral and balanced to ground, since it has two equal shunt resistors. Because there are twice as many, both of series and of shunt resistors, in a balanced H type network, each series and shunt resistor has only half the resistance of its analogue in the reference (T type) case.

In the light of these statements, two tables were prepared, Table I showing the internal connections of the various types of networks of this family and Table II giving the expressions for the resistance values of the several elements and the values of the factors  $a$  and  $b$  for all of the six arrangements shown in Table I. These Tables I and II will be found in numerical order at the end of the paper.

#### (b). Method of Using Table IX to Facilitate Computation

##### (i). Case where terminating impedances are unequal:

The expressions given below have been rewritten from (8), (9), and (10), and will be found repeated in Table II:

$$u = a \left[ Z \left( \frac{k^2 + 1}{k^2 - 1} \right) - \bar{z} \left( \frac{k}{k^2 - 1} \right) \right]$$

$$v = a \left[ z \left( \frac{k^2 + 1}{k^2 - 1} \right) - \bar{z} \left( \frac{k}{k^2 - 1} \right) \right]$$

$$w = b \bar{z} \left( \frac{k}{k^2 - 1} \right).$$

These expressions suggest the use of Table IX to supply the values for quantities  $(k^2+1)/(k^2-1)$  and  $k/(k^2-1)$ , both necessary for calculating elements  $u$  and  $v$ , but only the latter necessary for calculating element  $w$ . Note the  $\bar{z}[k/(k^2-1)]$  occurs in all three individual expressions for elements  $u$ ,  $v$ , and  $w$ , and should be calculated only once, for use in all three equations.

(ii). Case where terminating impedances are equal:

Inspection of formulas for this case in Table II below shows that tabulations of the quantities  $(k-1)/(k+1)$  and  $k/(k^2-1)$  will be used in calculating elements  $v$  and  $w$ , respectively.

## 2. $\pi$ Type and Related Networks

(a). *Values of Factors  $a$  and  $b$  for Various Members of  $\pi$  Type Family*

Reasoning similar to that under section III, 1 (a) above produces Tables III and IV, and analogous to Tables I and II previously described.

(b). *Method of Using Table IX to Facilitate Computation*

(i). Case where terminating impedances are unequal:

Inspection of formulas for this case in Table IV below shows that only tabulations of the quantities  $k$  and  $k^2$  will be used in calculating elements  $u$  and  $w$  and tabulation of the quantity  $[(k^2-1)/k = (k-r)]$  will be used in calculating element  $v$ .

(ii). Case where terminating impedances are equal:

Inspection of formulas for this case in Table IV below shows that tabulations of the quantities  $[(k^2-1)/k = (k-r)]$  and  $(k+1)/(k-1)$  will be used in calculating the elements  $v$  and  $w$ , respectively.

## 3. L Type and Related Networks

(a). *Values of Factors  $a$  and  $b$  for Various Members of L Type Family*

Again, reasoning similar to that under section III, 1 (a) above produces the two Tables V and VI, analogous to Tables I and II.

(b). *Method of Using Table IX to Facilitate Computation*

(i). Case where terminating impedances are unequal:

Inspection of formulas for this case in Table VI below shows that only tabulations of the quantities  $r$  and  $k$  will be used in calculating elements  $v$  and  $w$ .

(ii). Case where terminating impedances are equal:

Inspection of formulas for this case in Table VI below shows that tabulations of the quantities  $[(k-1)/k = (1-r)]$  and  $k$  will be used in calculating element  $v$ , and of the quantities  $1/(k-1)$  and  $[k/(k-1) = 1/(1-r)]$  in calculating element  $w$ .

#### 4. Bridged T Type and Related Networks

(a). *Values of Factors  $a$  and  $b$  for Various Members of Bridged T Type Family*

Reasoning similar to that used in the three previous cases gives the two Tables VII and VIII, analogous to Tables I and II.

(b). *Method of Using Table IX to Facilitate Computation*

(i). Case where terminating impedances are equal:

Inspection of formulas for this case in Table VIII below shows that tabulations of the quantities  $k$  and  $1/(k-1)$  will be used in calculating elements  $v$  and  $w$ , respectively.

#### 5. Suggestions for Remediating Difficulties which May Be Encountered in Designing Networks

(a). When the impedance of a network is low or its attenuation high, the shunt resistors may be found to be very small. This is an unfortunate condition if it is desired to adjust the resistance values quite accurately or if the network is to be inserted and removed from the circuit by use of a switch. In the latter case, both the unavoidable absolute magnitude and the fluctuation in value of the switch resistance will cause, respectively, a steady (fixed) and a superposed (randomly varying) inaccuracy in the network. (The error is greater and more serious in the attenuation of the pad, but present also in the impedance match.) The remedy for this condition is to use two or more networks connected in series with one another, each having a fraction of the total amount of loss desired and so chosen that the sum of the attenuations of the individual networks adds up to the total attenuation desired. The gain in size of the shunt element is very rapid when a large attenuation is cut to half or less of its former value, as may be seen by reference to the proper columns of Table IX.

(b). Another method of increasing the resistance value of an element is to shift from one family of networks to another. If either the series or the shunt element of a T type network, or of a series L type network (an L type network in which impedance is matched looking at the series element end of the network), is too small for design purposes, the resistance value may be increased by substituting, respectively, a  $\pi$  type network, or a shunt L type network (an L type network in which impedance is matched looking at the shunt element end of the network). (While it is not strictly rigorous, the abridged terminology for the two arrangements of L type networks, explained in the parentheses in the above sentence, will henceforth be used where its compactness will render the text less obscure.) The ratio of gain by this procedure depends upon the attenuation of the network, and is, for a change from a T type to a  $\pi$  type network, equal to  $(k+1)^2/2k$ , or about 2:1 at 1 decibel, 17:1 at 30 decibels, and 500:1 at 60 decibels. For a change from a series L type to a shunt L type network, the ratio is equal to  $k$  and the corresponding figures are approximately 1:1 at 1 decibel, 32:1 at 30 decibels, and 1000:1 at 60 decibels. Since the ratio by which a small resistance value of an element can be multiplied by changing from one type of network to another is quite large at high values of attenuation, this manipulation must be used with care. Otherwise, it is possible, while increasing the small resistance value of a shunt element to one which is practical to manufacture and adjust, simultaneously to increase so greatly the resistance value of a series element that it is (1) very difficult to manufacture and adjust because of its high resistance and (2) unsuitable for use over a wide range of frequencies because of its appreciable reactive component.

(c). The converse of the case described in section III, part 5 (b) above is likewise true. In case either the series or the shunt element of a  $\pi$  type or shunt L type network has too large a resistance, this may be reduced by shifting in the opposite sense the family of network employed.

(d). It has been noted previously that a T type is preferable to a  $\pi$  type network where the attenuation is to be made adjustable continuously or in steps by switching means, since all three switch arms, which adjust the three different elements of the network, may be so arranged in the circuit as to be all at the same point electrically. On the other hand, if either type of network is to be chosen as being easier to construct when a fixed attenuation is desired, the  $\pi$  type network would be so selected. This is because the three resistors are all connected to one another in the same way as the three sides of a triangle

are joined. The three resistors may thus be wound on a single winding form and connected directly to one another in order as they are wound, whereas in a T type network similarly constructed, the third resistor is connected, not to the adjacent end of the second, but back a step, to the junction of the first and second resistors. It is simply a question of facility of manufacture. In spite of this fact, however,  $\pi$  type networks are little used in practice except for special purposes.

#### IV. TABULATION OF NUMERICAL DATA

The values of the various factors involved in the tables in this section have been calculated to at least five significant figures. In some instances the values of  $r$ ,  $k$ , and  $k^2$  are given to more than five significant figures in case the nature of some of the calculations to be made for those particular attenuations was such that this larger number of significant figures was necessary to give answers for the factors concerned which would themselves be good to five significant figures. Likewise, some of the factors have been calculated to more than five significant figures so that when differences between succeeding factors (needed to determine incremental resistance values of the several elements in networks adjustable in steps by switching) are obtained, they will be good to five significant figures.

For assistance in contracting the number of significant figures in the tabulation, indication in the customary manner has been made when a terminating 5, 50, or 500 is really on the smaller, rather than on the larger, side of the value given in the table.

While the tables have been calculated with some care, it is almost inevitable that some errors creep in. The author will be indebted to any who will be kind enough to call such errors to his attention.

##### 1. Smallest Possible Networks and Reflection Loss Between Unequal Impedances

The curves in Fig. 6 are plotted from the information given in Table X, which was obtained by calculation using the formulas given in sections II, 5 (a); II, 5 (b); and II, 6 above.

One point concerning the parameter  $s$  is not obvious to the reader and should, on that account, be stressed. That point is that the loss figures given are correct for a given impedance ratio, whether the ratio is greater than (as has been generally postulated, for convenience, in this paper) or less than unity, the value of the ratio in the second case being the reciprocal of its value in the first case. That is to say, the loss figures hold whether the impedance ratio is  $Z/z$  or  $z/Z$ . Referring to the formulas used in these calculations or, where necessary, back further

to the derivations, the reader can, without great difficulty, demonstrate to himself mathematically the truth of this statement: whether one uses the parameter  $s$  or its reciprocal  $1/s$ , the attenuations of minimum loss pads and amount of reflection loss are identical for both values of the parameter.

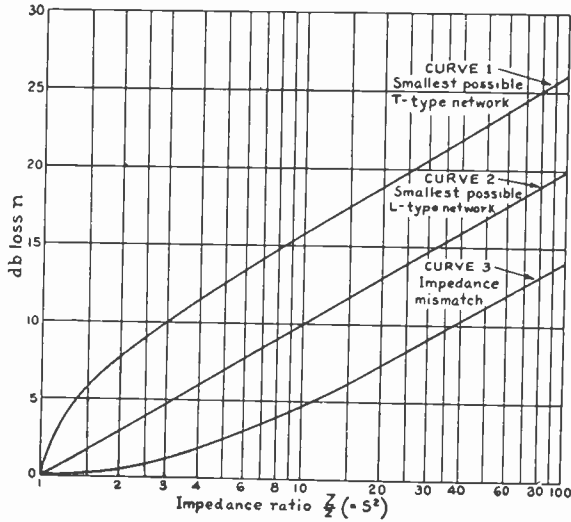

Fig. 6

2. Tabulation of Applicable Factors

Reading across the page, from left to right, the columns of Table IX below contain, in order, the tables of values of the factors which follow:

$$n, r, k, k^2, \left(\frac{k-1}{k+1}\right), \left(\frac{k+1}{k-1}\right), \left(\frac{k}{k^2-1}\right), \left[\left(\frac{k^2-1}{k}\right) = (k-r)\right],$$

$$\left(\frac{k^2+1}{k^2-1}\right), \left[\left(\frac{k-1}{k}\right) = (1-r)\right], \left[\left(\frac{k}{k-1}\right) = \left(\frac{1}{1-r}\right)\right], \left(\frac{1}{k-1}\right),$$

and  $n$  (repeated).

Included in the values of  $n$  for which computations have been made are enough to enable one to design uniformly adjustable networks of at least twenty equal steps for eight different convenient and useful values of incremental attenuation per step: 0.1, 0.2, 0.5, 1.0, 1.5, 2.0, 3.0, and 5.0 decibels.

Aside from the relations, obvious from inspection or previously recorded, between these several factors, two obscure ones may be noted. When unity is negligible in comparison with  $k^2$ , (1) the value of factor  $k/(k^2-1)$  becomes the same as of  $r$ , and (2) the value of factor  $(k^2-1)/k$  becomes the same as of  $k$ . Carrying the values to the number of significant figures used in these tables, this identity of values comes about at approximately  $n=50$  decibels.



TABLE I

Type of Network	Used between unequal impedances	Used between equal impedances
T	 Diag. 1.	 Diag. 4.
H	 Diag. 2.	 Diag. 5.
Balanced-H	 Diag. 3.	 Diag. 6.

Note: → Indicates that impedance is matched at that junction.

TABLE II

u	v	w	Diag.	a	b
$a \left[ Z \left( \frac{k^2+1}{k^2-1} \right) - 2z \left( \frac{k}{k^2-1} \right) \right]$	$a \left[ z \left( \frac{k^2+1}{k^2-1} \right) - 2z \left( \frac{k}{k^2-1} \right) \right]$	$bz \left( \frac{k}{k^2-1} \right)$	1	1	2
			2	$\frac{1}{2}$	2
			3	$\frac{1}{2}$	1
	$az \left( \frac{k-1}{k+1} \right)$	$bz \left( \frac{k}{k^2-1} \right)$	4	1	2
			5	$\frac{1}{2}$	2
			6	$\frac{1}{2}$	1

TABLE III

Type of Network	Used between unequal impedances	Used between equal impedances
$\pi$	 Diag. 7.	 Diag. 10.
O	 Diag. 8.	 Diag. 11.
Balanced-O	 Diag. 9.	 Diag. 12.

Note: → Indicates that impedance is matched at that junction.

TABLE IV

$u$	$v$	$w$	Diag.	$a$	$b$
$bZ \left( \frac{k^2 - 1}{k^2 - 2ks + 1} \right)$	$a\bar{z} \left( \frac{k^2 - 1}{k} \right)$	$bz \left( \frac{k^2 - 1}{k^2 - 2\frac{k}{s} + 1} \right)$	7	$\frac{1}{2}$	1
			8	$\frac{1}{4}$	1
			9	$\frac{1}{4}$	$\frac{1}{2}$
	$az \left( \frac{k^2 - 1}{k} \right)$	$bz \left( \frac{k + 1}{k - 1} \right)$	10	$\frac{1}{2}$	1
			11	$\frac{1}{4}$	1
			12	$\frac{1}{4}$	$\frac{1}{2}$

TABLE V

Type	Used between unequal impedances		Used between equal impedances		
L					
	Diag. 13.	Diag. 16.	Diag. 19.	Diag. 22.	
	U				
		Diag. 14.	Diag. 17.	Diag. 20.	Diag. 23.
Bal. U					
		Diag. 15.	Diag. 18.	Diag. 21.	Diag. 24.

Note: → Indicates that impedance is matched at that junction.

TABLE VI

$v$	$w$	Diag.	$a$	$b$
$a \frac{Z}{s} \left( \frac{ks - 1}{k} \right)$ or $a\bar{z}(s - r)$	$b \frac{Z}{s} \left( \frac{1}{k - s} \right)$	13	1	1
		14	$\frac{1}{2}$	1
		15	$\frac{1}{2}$	$\frac{1}{2}$
$a \frac{Z}{s} (k - s)$	$b \frac{Z}{s} \left( \frac{k}{ks - 1} \right)$ or $b\bar{z} \left( \frac{1}{s - r} \right)$	16	1	1
		17	$\frac{1}{2}$	1
		18	$\frac{1}{2}$	$\frac{1}{2}$
		19	1	1
$az \left( \frac{k - 1}{k} \right)$ or $az(1 - r)$	$bz \left( \frac{1}{k - 1} \right)$	20	$\frac{1}{2}$	1
		21	$\frac{1}{2}$	$\frac{1}{2}$
$az(k - 1)$	$bz \left( \frac{k}{k - 1} \right)$ or $bz \left( \frac{1}{1 - r} \right)$	22	1	1
		23	$\frac{1}{2}$	1
		24	$\frac{1}{2}$	$\frac{1}{2}$





TABLE VII

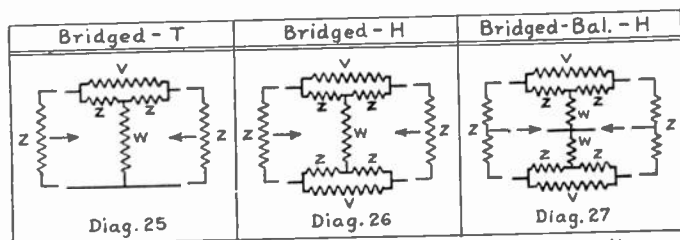

Note: → Indicates that impedance is matched at that junction.

TABLE VIII

$u$	$v$	Diag.	$a$	$b$
$az(k-1)$	$bz \left( \frac{1}{k-1} \right)$	25	1	1
		26	$\frac{1}{2}$	1
		27	$\frac{1}{2}$	$\frac{1}{2}$

TABLE X

$\frac{Z}{z} = s^2$	$n = \text{number of db loss}$		
	For smallest loss tapered T type matching network	For smallest loss tapered L type matching network	Due to impedance mismatch
	$n = 20 \log_{10} (s + \sqrt{s^2 - 1})$	$n = 20 \log_{10} (s)$	$n = 20 \log_{10} \left( \frac{1 + s^2}{2s} \right)$
1	0	0	0
1.1	2.7029	0.4139	0.00986
1.2	3.7654	0.7918	0.03604
1.4	5.1808	1.4613	0.12234
1.7	6.6103	2.3045	0.30219
2.0	7.6555	3.0103	0.51153
3.	9.9560	4.7712	1.2494
5.	12.540	6.9897	2.5527
10	15.795	10.000	4.8073
20	18.920	13.010	7.4135
30	20.719	14.771	9.0354
50	22.967	16.990	11.141
100	25.999	20.000	14.066



## MULTIRANGE RECTIFIER INSTRUMENTS HAVING THE SAME SCALE GRADUATION FOR ALL RANGES\*

BY

FREDERICK EMMONS TERMAN  
(Stanford University, California)

*Summary*—It is shown that the character of the scale in a rectifier instrument depends only upon the impedance of the network connected across the rectifier input. Combinations of single series and shunt elements are shown which enable this impedance to be constant and at the same time permit various voltage and current sensitivities. This makes possible rectifier voltmeters, ammeters, and volt-ammeters having any desired number of ranges that all accurately follow a single scale. By adding a uniform scale the usefulness of the multirange meter can be extended, and a truly universal alternating-current—direct-current instrument having good accuracy results.

THE usefulness of the rectifier meter as a sensitive voltage and current measuring device for audio frequencies is too well known to need reviewing. Ordinary instruments of this type have the disadvantage that the law according to which the scale must be graduated depends upon the series resistor in the case of voltmeters, or the shunt resistance in the case of ammeters. It is the purpose of the present paper to show how this limitation of the usual rectifier meter can be avoided, and how a single instrument can be made to follow accurately a single scale for all ranges.

### CHARACTERISTICS OF RECTIFIER METERS

The characteristics of rectifier instruments have been described at length elsewhere in the literature.<sup>1</sup> The properties of particular importance are: *First*, with the usual range of current densities the rectified direct current which is delivered to the direct-current instrument is very nearly proportional to the alternating current passed through the rectifier element; *second*, the resistance which the rectifier offers to the flow of alternating current increases as the alternating current decreases. These properties are illustrated in Fig. 1.

The effect upon the ordinary rectifier voltmeter is to cause the instrument deflection to be nearly linearly proportional to voltage where the resistance in series with the rectifier is so large that the varying rectifier resistance has relatively little effect upon the alternating-current flow. On the other hand, when the series resistance is low, as

\* Decimal classification: 621.374. Original manuscript received by the Institute of Radio Engineers, March 7, 1934.

<sup>1</sup> See Joseph Sahagen, "The use of the copper-oxide rectifier for instrument purposes," Proc. I.R.E., vol. 19, p. 233; February, (1931).

is the case when the voltage for full scale deflection is small, the varying resistance of the rectifier element becomes more important and the scale graduations become bunched at the lower end.

When the rectifier instrument is used as an ammeter the scale is substantially linear when there is no shunt across the rectifier input. As the rectifier element is shunted, however, the voltage across the instrument becomes largely controlled by the shunt resistance, and the scale graduations are bunched at the lower end because of the increasing resistance of the rectifier at low current densities.

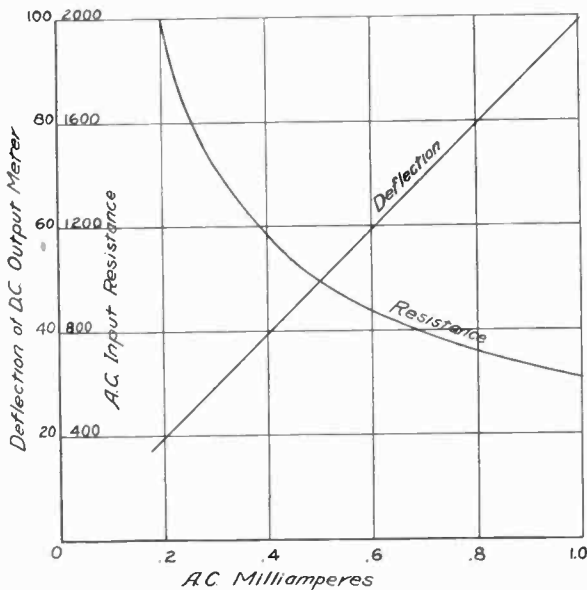

Fig. 1—Rectified direct current, and resistance to the alternating current expressed in terms of the alternating current delivered to a typical copper-oxide rectifier type of instrument.

The consequence of this behavior of ordinary rectifier voltmeters and ammeters is that it is necessary to have a separate scale for each range if good accuracy is to be obtained without recourse to a special calibration curve. Combined volt-ammeters are obviously even less satisfactory.

#### A METHOD OF OBTAINING THE SAME SCALE FOR ALL RANGES

The above limitations involved with the use of ordinary multipliers can be overcome by making use of the fact that *the law according to which the scale of a particular rectifier instrument must be graduated depends only upon the equivalent resistance of the network connected across the rectifier terminals, and does not depend upon the multiplying factor which this network introduces.*

This statement can be readily proved by using Thèvenin's theorem, according to which any network can be reduced to an equivalent source consisting of a voltage  $e$  in series with an equivalent resistance  $R_{eq}$  where  $e$  is the voltage developed at the output terminals when the output load is removed, and  $R_{eq}$  is the resistance looking into the network from the output terminals with the ultimate source of voltage short-circuited. By keeping the equivalent resistance  $R_{eq}$  constant while varying the nature of the network it is obviously possible to change the multiplying factor without altering the equivalent circuit of the instrument, and hence leaving the law of scale variation unchanged.

Almost any sort of attenuation network can be employed. The ones most satisfactory for ordinary purposes, and also the simplest, are shown in Fig. 2 and combine a single shunt element with a single

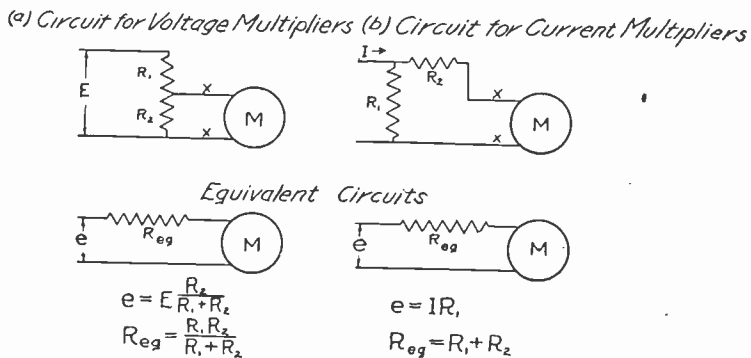

Fig. 2—Multiplying networks which can be used for rectifier voltmeters and ammeters in which the different ranges follow the same scale graduations, together with the equivalent circuit according to Thèvenin's theorem.

series element. In the network of Fig. 2(a), which is primarily adapted to voltage measurements, the effective network resistance  $R_{eq}$  is the impedance across the output terminals  $xx$  when looking into the network with  $E$  short-circuited. This gives

$$\text{equivalent resistance } R_{eq} = \frac{R_1 R_2}{R_1 + R_2}. \quad (1)$$

The equivalent voltage  $e$  is the open circuit potential across  $xx$ , and so is

$$\text{equivalent voltage } e = E \frac{R_2}{R_1 + R_2}. \quad (2)$$

It is apparent by an examination of (2) that the multiplying factor depends upon the ratio  $R_1/R_2$  and can be varied over a wide range while maintaining  $R_{eq}$  constant.



The exact relations which  $R_1$  and  $R_2$  must satisfy to give any particular full scale deflection while maintaining  $R_{eq}$  constant can be readily worked out as follows:

Let,

$R_m$  = resistance of rectifier meter to alternating current at full scale deflection

$I_m$  = alternating current which must be delivered to the rectifier input to give full scale deflection

$V$  = value of  $E$  required to give full scale deflection

Then by making use of (2) and the equivalent circuit

$$I_m = \frac{V R_2}{R_1 + R_2} / (R_{eq} + R_m). \quad (3)$$

Next by combining (3) and (1) to eliminate  $R_2$  we get the value of  $R_1$  required for a given value of  $V$  in terms of  $R_m$ ,  $I_m$ , and  $R_{eq}$ :

$$R_1 = \frac{V}{I_m \left( 1 + \frac{R_m}{R_{eq}} \right)}. \quad (4)$$

Knowing  $R_1$  and  $R_{eq}$ , one can now calculate  $R_2$  by (1),

$$R_2 = \frac{R_1 R_{eq}}{R_1 - R_{eq}}. \quad (4a)$$

Examination of these equations shows that the possibility of using the same scale for all ranges arises as a result of operating the instrument so that the ohms per volt varies with the multiplying factor. In general, the higher the voltage range the lower will be the ohms per volt. The linearity of the scale also increases as the ratio  $R_{eq}/R_m$  is made larger, with the highest possible value of  $R_{eq}/R_m$  fixed by the lowest range desired; i.e., when  $R_2 = \infty$ .

The network of Fig. 2(b) is primarily adapted for current multipliers. The equivalent resistance of this network is the resistance measured across the output terminals  $xx$  when the source of current is open-circuited. This open-circuit condition applies because the constant current source can be thought of as an infinitely large voltage in series with an infinitely large resistance. We hence have

$$R_{eq} = R_1 + R_2 \quad (5)$$

$$e = I R_1. \quad (6)$$

## MULTIRANGE RECTIFIER INSTRUMENTS HAVING THE SAME SCALE GRADUATION FOR ALL RANGES\*

By

FREDERICK EMMONS TERMAN

(Stanford University, California)

*Summary*—It is shown that the character of the scale in a rectifier instrument depends only upon the impedance of the network connected across the rectifier input. Combinations of single series and shunt elements are shown which enable this impedance to be constant and at the same time permit various voltage and current sensitivities. This makes possible rectifier voltmeters, ammeters, and volt-ammeters having any desired number of ranges that all accurately follow a single scale. By adding a uniform scale the usefulness of the multirange meter can be extended, and a truly universal alternating-current—direct-current instrument having good accuracy results.

THE usefulness of the rectifier meter as a sensitive voltage and current measuring device for audio frequencies is too well known to need reviewing. Ordinary instruments of this type have the disadvantage that the law according to which the scale must be graduated depends upon the series resistor in the case of voltmeters, or the shunt resistance in the case of ammeters. It is the purpose of the present paper to show how this limitation of the usual rectifier meter can be avoided, and how a single instrument can be made to follow accurately a single scale for all ranges.

### CHARACTERISTICS OF RECTIFIER METERS

The characteristics of rectifier instruments have been described at length elsewhere in the literature.<sup>1</sup> The properties of particular importance are: *First*, with the usual range of current densities the rectified direct current which is delivered to the direct-current instrument is very nearly proportional to the alternating current passed through the rectifier element; *second*, the resistance which the rectifier offers to the flow of alternating current increases as the alternating current decreases. These properties are illustrated in Fig. 1.

The effect upon the ordinary rectifier voltmeter is to cause the instrument deflection to be nearly linearly proportional to voltage where the resistance in series with the rectifier is so large that the varying rectifier resistance has relatively little effect upon the alternating-current flow. On the other hand, when the series resistance is low, as

\* Decimal classification: 621.374. Original manuscript received by the Institute of Radio Engineers, March 7, 1934.

<sup>1</sup> See Joseph Sahagen, "The use of the copper-oxide rectifier for instrument purposes," Proc. I.R.E., vol. 19, p. 233; February, (1931).

is the case when the voltage for full scale deflection is small, the varying resistance of the rectifier element becomes more important and the scale graduations become bunched at the lower end.

When the rectifier instrument is used as an ammeter the scale is substantially linear when there is no shunt across the rectifier input. As the rectifier element is shunted, however, the voltage across the instrument becomes largely controlled by the shunt resistance, and the scale graduations are bunched at the lower end because of the increasing resistance of the rectifier at low current densities.

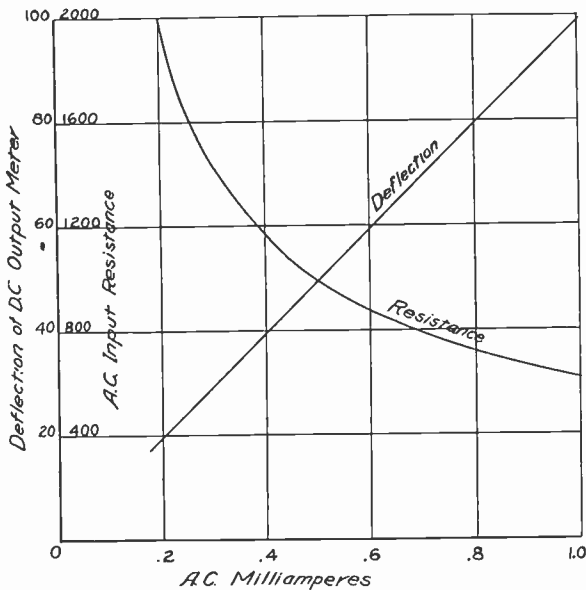

Fig. 1—Rectified direct current, and resistance to the alternating current expressed in terms of the alternating current delivered to a typical copper-oxide rectifier type of instrument.

The consequence of this behavior of ordinary rectifier voltmeters and ammeters is that it is necessary to have a separate scale for each range if good accuracy is to be obtained without recourse to a special calibration curve. Combined volt-ammeters are obviously even less satisfactory.

#### A METHOD OF OBTAINING THE SAME SCALE FOR ALL RANGES

The above limitations involved with the use of ordinary multipliers can be overcome by making use of the fact that *the law according to which the scale of a particular rectifier instrument must be graduated depends only upon the equivalent resistance of the network connected across the rectifier terminals, and does not depend upon the multiplying factor which this network introduces.*

This statement can be readily proved by using Thèvenin's theorem, according to which any network can be reduced to an equivalent source consisting of a voltage  $e$  in series with an equivalent resistance  $R_{eq}$  where  $e$  is the voltage developed at the output terminals when the output load is removed, and  $R_{eq}$  is the resistance looking into the network from the output terminals with the ultimate source of voltage short-circuited. By keeping the equivalent resistance  $R_{eq}$  constant while varying the nature of the network it is obviously possible to change the multiplying factor without altering the equivalent circuit of the instrument, and hence leaving the law of scale variation unchanged.

Almost any sort of attenuation network can be employed. The ones most satisfactory for ordinary purposes, and also the simplest, are shown in Fig. 2 and combine a single shunt element with a single

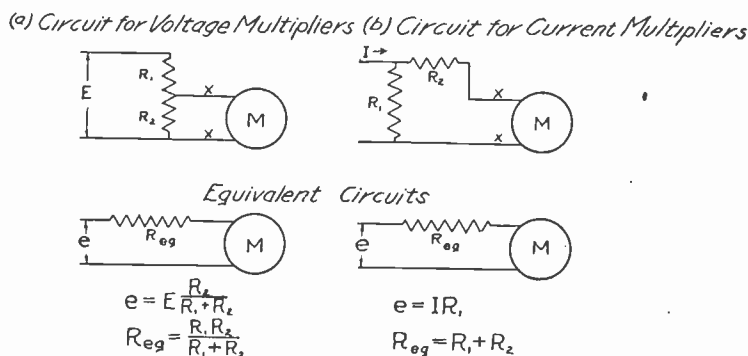

Fig. 2—Multiplying networks which can be used for rectifier voltmeters and ammeters in which the different ranges follow the same scale graduations, together with the equivalent circuit according to Thèvenin's theorem.

series element. In the network of Fig. 2(a), which is primarily adapted to voltage measurements, the effective network resistance  $R_{eq}$  is the impedance across the output terminals  $xx$  when looking into the network with  $E$  short-circuited. This gives

$$\text{equivalent resistance } R_{eq} = \frac{R_1 R_2}{R_1 + R_2}. \quad (1)$$

The equivalent voltage  $e$  is the open circuit potential across  $xx$ , and so is

$$\text{equivalent voltage } e = E \frac{R_2}{R_1 + R_2}. \quad (2)$$

It is apparent by an examination of (2) that the multiplying factor depends upon the ratio  $R_1/R_2$  and can be varied over a wide range while maintaining  $R_{eq}$  constant.

The exact relations which  $R_1$  and  $R_2$  must satisfy to give any particular full scale deflection while maintaining  $R_{eq}$  constant can be readily worked out as follows:

Let,

$R_m$  = resistance of rectifier meter to alternating current at full scale deflection

$I_m$  = alternating current which must be delivered to the rectifier input to give full scale deflection

$V$  = value of  $E$  required to give full scale deflection

Then by making use of (2) and the equivalent circuit

$$I_m = \frac{V R_2}{R_1 + R_2} / (R_{eq} + R_m). \quad (3)$$

Next by combining (3) and (1) to eliminate  $R_2$  we get the value of  $R_1$  required for a given value of  $V$  in terms of  $R_m$ ,  $I_m$ , and  $R_{eq}$ :

$$R_1 = \frac{V}{I_m \left( 1 + \frac{R_m}{R_{eq}} \right)}. \quad (4)$$

Knowing  $R_1$  and  $R_{eq}$ , one can now calculate  $R_2$  by (1),

$$R_2 = \frac{R_1 R_{eq}}{R_1 - R_{eq}}. \quad (4a)$$

Examination of these equations shows that the possibility of using the same scale for all ranges arises as a result of operating the instrument so that the ohms per volt varies with the multiplying factor. In general, the higher the voltage range the lower will be the ohms per volt. The linearity of the scale also increases as the ratio  $R_{eq}/R_m$  is made larger, with the highest possible value of  $R_{eq}/R_m$  fixed by the lowest range desired; i.e., when  $R_2 = \infty$ .

The network of Fig. 2(b) is primarily adapted for current multipliers. The equivalent resistance of this network is the resistance measured across the output terminals  $xx$  when the source of current is open-circuited. This open-circuit condition applies because the constant current source can be thought of as an infinitely large voltage in series with an infinitely large resistance. We hence have

$$R_{eq} = R_1 + R_2 \quad (5)$$

$$e = I R_1. \quad (6)$$

We note here that for constant  $R_{eq}$  but varying sensitivity we merely tap the fixed resistance ( $R_1 + R_2$ ) at varying points. This arrangement is very similar to the Ayrton-Mather universal shunt so commonly used with galvanometers, but we are here interested in a load of varying resistance rather than a shunt which will always give the same multiplying factors when used with different galvanometers. The design formulas for the current network can be worked out as follows, where  $J$  is the line current  $I$  for full scale deflection:

$$I_m = \frac{JR_1}{R_{eq} + R_m} \quad (7)$$

Solving  $R_1$  we obtain the required resistances in terms of the line current  $J$  required to give full scale deflection, the alternating-current resistance  $R_m$  of the rectifier input, and the equivalent resistance  $R_{eq}$  desired:

$$R_1 = \frac{I_m}{J} (R_{eq} + R_m) \quad (8)$$

$$R_2 = R_{eq} - R_1. \quad (9)$$

We note that in this case we are able to use the same scale for all ranges by virtue of the fact that the number of volts required for full scale deflection is allowed to increase as higher current ranges are used. In order to obtain a linear scale it is necessary that  $R_{eq}/R_m$  be made large, and this means high voltage drop for full scale deflection. The maximum sensitivity which can be obtained for a particular scale is when  $R_2 = 0$ , and increases with the  $R_{eq}$  being employed.

#### EXAMPLE

The possibilities of the principles that have been outlined above can be shown by working out a specific case. The meter that will be employed is the one whose characteristics are shown in Fig. 1, and we note that in order to obtain full scale deflection it is necessary that the alternating current be exactly 1.0 milliampere. The alternating-current resistance for this full scale current is 618 ohms. The value of  $R_{eq}$  was arbitrarily selected such as to make the most sensitive range correspond to a full scale deflection of 2.5 milliamperes, and is accordingly 412 ohms. With this value of  $R_{eq}$  the law according to which this scale must be graded is illustrated in the lower arc in Fig. 3. By making use of (8) and (9) we are able to calculate resistances  $R_1$  and  $R_2$  required for various ranges using the equivalent circuit of Fig. 2(b), with the results tabulated in Table I.

In order that the instrument may follow this same scale when used as a voltmeter,  $R_{eq}$  must be made the same as above, nearly 412 ohms. Calculations based on (4) and (4a) give the results shown in Table II.

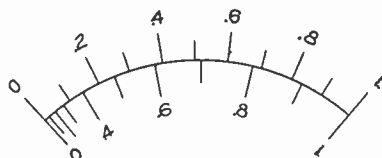

Fig. 3—Scales used in universal rectifier meter having characteristics shown in Fig. 1. The uniform upper scale is used for voltages and currents, for the one-milliampere alternating-current scale, and for high full scale alternating voltages. The nonuniform scale is for  $R_{eq} = 412$  ohms, and is for all alternating current ranges except one milliampere, and for the lower alternating voltage ranges.

The results of Tables I and II show what can be done in the way of multirange voltmeters, ammeters, and volt-ammeters using rectifier instruments. We note, however, that in the voltmeter we have a lower ohms per volt and less linearity at high ranges than would be obtained

TABLE I  
Single Scale Milliammeter

$R_m = 618$	$I_m = 1.0$	$R_{eq} = 412$	
Milli-amperes for full scale	$R_1$	$R_2$	Volts drop (full scale)
2.5	412	0	0.618
5	206	206	0.824
10	103	309	0.927
25	41.2	370.8	0.989
50	20.6	391.4	1.009
100	10.3	401.7	1.020
250	4.12	407.9	1.026
500	2.06	409.9	1.028
1000	1.03	411.0	1.029

TABLE II  
Single Scale Voltmeter

$R_m = 618$	$I_m = 1.0$	$R_{eq} = 412$	
Volts for full scale	$R_2$	$R_1$	Ohms per volt (full scale)
2.5	700	1,000	531
5	519	2,000	456
10	459	4,000	426
25	430	10,000	410
50	421	20,000	405
100	416	40,000	401.5
250	414	100,000	401
500	413	200,000	400.5
1000	412.4	400,000	400.5

by the usual simple series resistance, and in the ammeter we have lost the one-milliampere range. These advantages can be retained however by using an instrument having a dual scale as shown in Fig. 3. The linear scale can be used directly for the one-milliampere range, and by use of the conventional series resistance ( $R_2 = \infty$ ), will be satisfactory for the higher voltage ranges where the series resistance is much greater than the meter resistance. At the same time, the lower voltage ranges and all the current ranges except for one milliampere will follow the nonuniform scale exactly.

It will be noted that this layout has developed the full possibilities of the rectifier instrument. We have available all current ranges from one milliampere up, and all voltage ranges from 2.50 up. The ohms per

volt is good, the voltage drop when the instrument is used for current measurement is not excessive, and we have employed only two scales. It will be further noted that one of these scales is linear, so that by disconnecting the direct-current instrument from the rectifier we can use it as a multirange direct-current voltmeter and ammeter by the use of suitable shunt and series resistors, thus making it possible to have a truly accurate universal instrument that will measure both direct and alternating voltages and currents at practically any magnitude with good accuracy.





## BARKHAUSEN-KURZ OSCILLATOR OPERATION WITH POSITIVE PLATE POTENTIALS\*

BY

L. F. DYTRT  
(Cedar Rapids, Iowa)

*Summary*—The experimental results presented in this article are chiefly concerned with the wavelength—plate-potential characteristic and the oscillator behavior. They indicate that the wavelength characteristic has two discrete portions, one containing a long-wave class of oscillations and the other a shorter wave class. In the particular experiments described, these two were found to be separated by a short interval in which the oscillator functioned unstably. The results further reveal that this type of generator will operate only while the plate potential remains below a certain critical value.

A THEORETICAL analysis of the operation of a Barkhausen-Kurz oscillator when the plate electrode of its vacuum tube is at a higher potential than the filament would lead one to expect normal functioning so long as the plate potentials are less than a certain critical value, and a discontinuance of operation when they are greater. At the critical potential, the plate space charge is assumed to be destroyed, and all electrons entering the grid-plate space are then collected on the plate. Since no electrons are thus able to return to the grid, electric oscillations cease. These inferences have been experimentally confirmed in a recent study which was made at Iowa State College; and, in the course of this same study, some interesting data were obtained on the oscillator performance when the plate potentials are below the critical value.

Before describing the results of this investigation, however, a brief account will be given of the conditions under which the oscillator tests were made and the procedure followed. During any performance test, the positive grid potential and the total emission current (sum of grid and plate currents) were held fixed, while the plate potential was varied. The latter quantity ranged from zero to the value at which the oscillator ceased functioning. For each different plate potential applied, the wavelength of the oscillations was determined, and the grid-circuit and plate-circuit currents were noted. A series of such tests each made at a different grid potential illustrated the effect of this factor on oscillator performance. Both grid and plate potentials were measured relative to the negative terminal of the filament as may be seen from the wiring diagram in Fig. 1.

\* Decimal classification: R355.9. Original manuscript received by the Institute, March 2, 1934. From a thesis submitted to the Graduate Faculty of Iowa State College in partial fulfillment of the requirements for the degree of Doctor of Philosophy.

The particular oscillator used in this investigation, a view of which is shown in Fig. 2, produced normal Barkhausen-Kurz oscillations<sup>1</sup> for positive plate potentials ranging from zero up to about 1.50 volts.

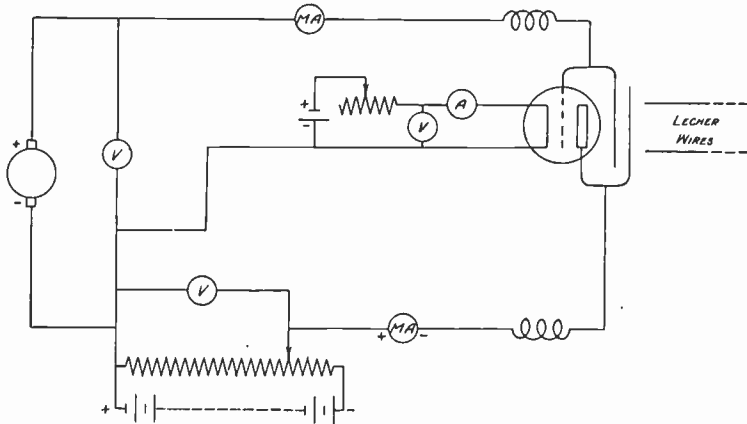

Fig. 1—Wiring diagram of the oscillator when connected to produce normal Barkhausen-Kurz oscillations.

At this latter voltage, it began operating unstably, and continued so until a potential of 1.75 volts was reached. Here a resumption of stable functioning occurred, but on wavelengths which were decidedly longer

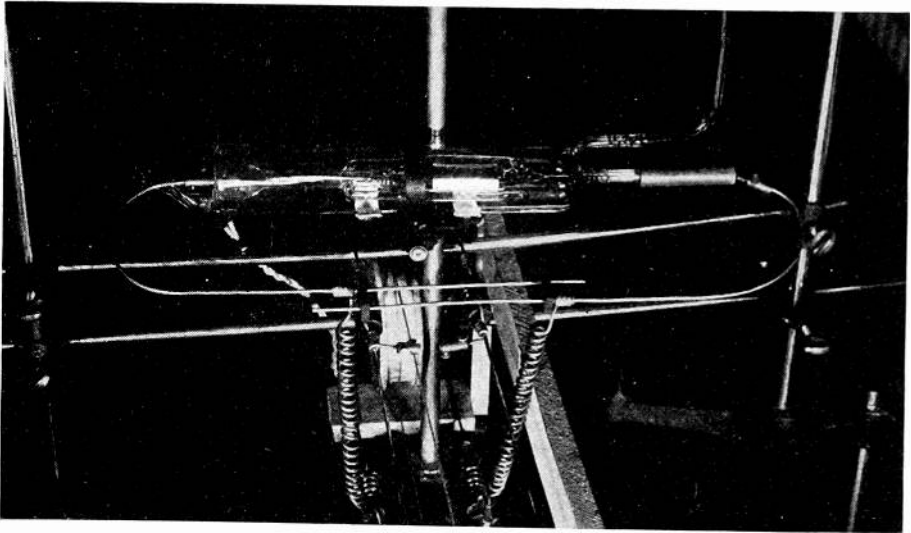

Fig. 2—View of the Barkhausen-Kurz oscillator used in this investigation.

than those last noted; in two distinct cases this increase amounted to 11.0 per cent and 19.0 per cent. In the region of unstable operation, oscillations could occasionally be detected, but it was impossible to

<sup>1</sup> By normal Barkhausen-Kurz oscillations are meant those which are produced when the plate of the triode is at either the same potential as the negative terminal of the filament or at one of lower value.

obtain any consistent data regarding them. The longer wave oscillations which had appeared at a plate potential of 1.75 volts continued to be produced therefrom up to a limiting or critical voltage. When potentials exceeding this latter were applied, the oscillator ceased functioning. Observations indicated that the magnitude of the critical voltage is a constant for any given set of operating conditions, but is different for distinct sets as will be illustrated later. From the results described thus far, it is evident that the limiting plate potential predicted from theoretical considerations was actually found to exist.

The results of two series of performance tests each made at a different grid potential showed that the longer wave oscillations possess some of the traits which are known to belong to those in the shorter wave, Barkhausen-Kurz class. Their wavelengths, for instance, were very noticeably affected by changes in magnitude of the grid potential, and also somewhat by that of the plate. An increase in the first of these quantities caused a reduction in the wavelength, while an increase in the second apparently resulted in a slight addition to it. Precise plate-potential—wavelength characteristics could not be obtained because of the very small changes produced in wavelength by the necessarily limited values of voltage increments.

The size of the voltage ranges in which the longer wave oscillations were noted is dependent on a number of factors, as the following cases show. When the grid of the oscillator triode had a potential of 200 volts, and oscillations having wavelengths varying from 2.12 to 2.18 meters were being produced, the range began at a plate potential of 1.75 volts and extended to 4.50 volts; in another instance when the grid potential amounted to 150 volts, and the wavelengths ranged from 2.50 to 2.65 meters, the plate potential interval extended from 1.75 volts to 6.00 volts. It should be added, however, that the oscillation intensities in the second of the above-mentioned cases were greater than in the first. A statement made in a previous paragraph to the effect that critical plate potentials are different for distinct sets of operating conditions is seen to be supported by the figures in these illustrations, in the first instance the critical potential being 4.50 volts, and in the second 6.00 volts.

While no attempt has been made to recount all of the phenomena observed during this investigation, it is believed that the results presented herein give a fair idea of the behavior of a Barkhausen-Kurz oscillator when operated with positive potentials on the plate of its triode. In a further experimental study which is to be carried on in this field, efforts will again be made to obtain reliable data in the voltage region which separates the normal Barkhausen-Kurz oscillations from those in the longer wave class.

## AUTOMATIC SYNTRACTION OF TWO BROADCAST CARRIERS\*

BY

VERNE V. GUNSOLLEY

(Minneapolis, Minnesota)

*Summary*—There is described a phase meter which is adapted to controlling automatically the space phase between two carriers at any desired point in the area of common frequency broadcasting.

*Experimental results of syntraction between a crystal controlled oscillator and broadcast carrier are given.*

IN THE December, 1931, issue of *Radio Engineering* the writer expounded a system of automatic phase control. The purpose of this article is to outline developments of the principle that are worthy of more extended consideration.

As is well known, when two carriers are impressed on a rectifier, the beat frequency appears in the output circuit. If the beat frequency is sufficiently low, a direct-current ammeter in the circuit will pulsate in step with the beat. The slower the beat, the more accurately the pointer indicates the momentary phase relation between carriers. At very low beat frequencies, therefore, the direct-current meter becomes a phase meter.

If the moving element of the direct-current meter is caused to control a small capacitance and this capacitance is connected in the tuned circuit of one of the radio oscillators which is causing the beating, an adjustment of the circuit constants may be made such that as the carriers pass through zero beat and the fluctuation of the variable capacitance stops; any further tendency of the controlled oscillator to drift in phase or frequency will be compensated by the tuning effect of the small capacitance. On the other hand, should the uncontrolled oscillator drift slightly, the motion of the phase meter would change the capacitance and shift the frequency of the controlled oscillator also, thereby causing the two waves automatically to be kept in practically constant phase displacement. This method of automatically holding the waves in space phase is termed "syntraction."

Fig. 1 shows the phase meter with the variable capacitance formed between the fixed plates *C, C*. An aluminum vane *V* is attached to the pointer. As the pointer deflects, the capacitance between the fixed plates varies. Fig. 2 illustrates the synttractor applied to a crystal controlled oscillator. The phase meter *A* is placed in the circuit for con-

\* Decimal classification: R 355.6×R 550. Original manuscript received by the Institute, February 21, 1934; revised manuscript, May 31, 1934.

venience in phase adjustment. At *B* there is shown the capacitance controlling phase meter—the synttractor. The glass cover prevents de-

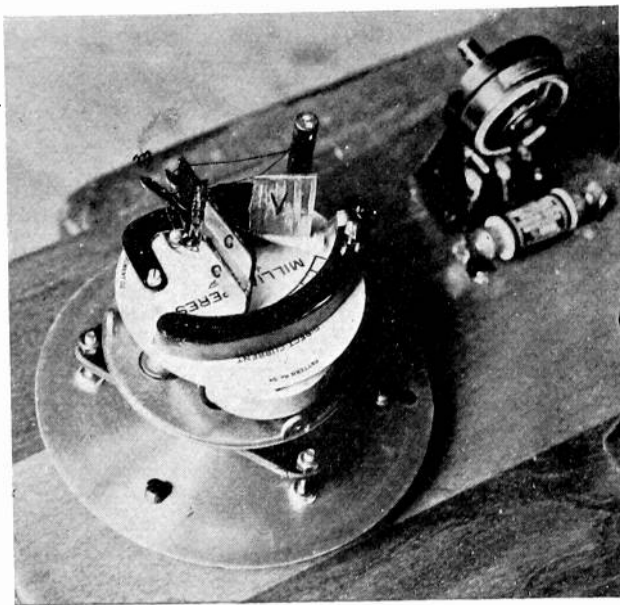

Fig. 1

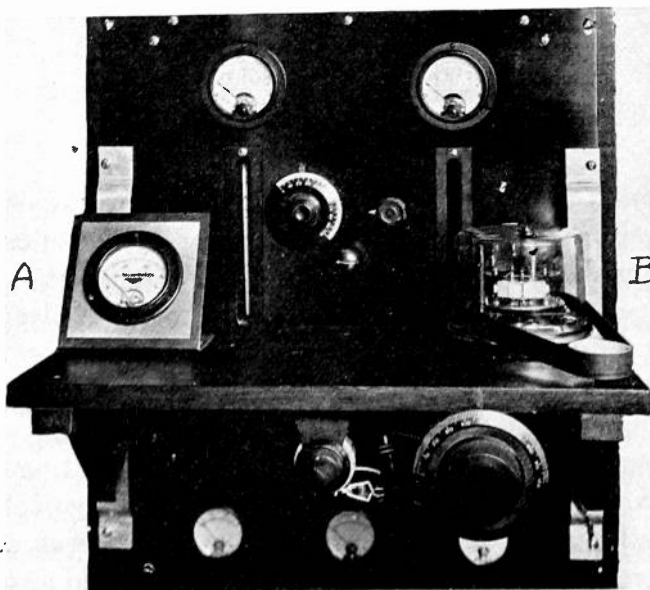

Fig. 2

flection by windage and an arrangement is incorporated permitting adjustment of the position of the movable wing which supports the two capacitor plates *C, C'*; to permit adjustment of the phase.

In practice, one radio-frequency source is the local carrier, controlled by a crystal oscillator such as shown in Fig. 2, whereas the other source is the carrier from the remote broadcast station with which space phase operation is desired. Amplitude variations in the remote carrier are minimized by automatic volume control.

### EXPERIMENTAL RESULTS

In the first experiments, the syntractor was applied to an ordinary dynatron oscillator which could be tuned over the broadcast band up to about 930 kilocycles. The receiver and oscillator were tuned to WCCO, 810 kilocycles. On the first attempt, the syntractor "pulled" the oscillator into step. After a little practice at the controls, it was

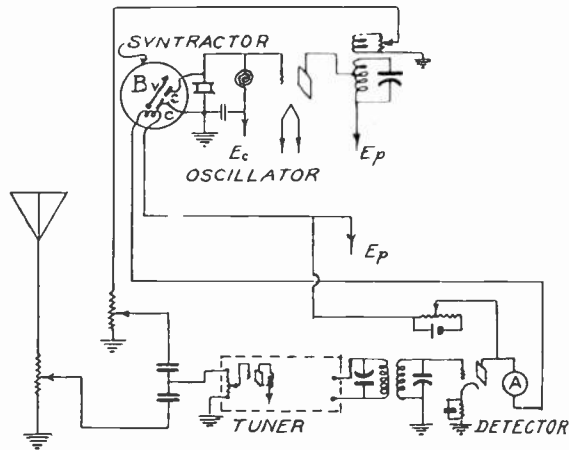

Fig. 3

found possible to maintain syntraction even when the oscillator main tuning capacitor was readjusted to detune the oscillator as much as 500 cycles. This wide range of control made it possible to hold syntraction for days at a time despite wide variations in line voltage on the receiver, and without attention to the apparatus other than that of switching it on in the morning and off at night. Syntraction occurred automatically as the oscillator and receiver warmed up.

After special attention to the problem of attenuating the oscillator output to about the same level as the signal intensity of station WLW, first successful syntraction with a distant station was accomplished. Automatic volume control had not been incorporated at that time and the experiment was attended with some difficulty due to fading of the signal from WLW.

These tests having proved the practicability of the device thus far, the final step was to test its control of a crystal oscillator. It was further desired to determine whether the higher frequencies cause greater dif-

faults in the performance of the apparatus. The connections to the crystal control were essentially as shown in Fig. 3. As was to be expected, the syntractor could not control the frequency over so wide a range as before because of the persistence of the crystal. However, the range of control available was sufficient and this test on 1,460 kilocycles was successful.

By varying the phase between carriers, any conditions normally heard in the broadcast band due to carrier interference could be reproduced at will.

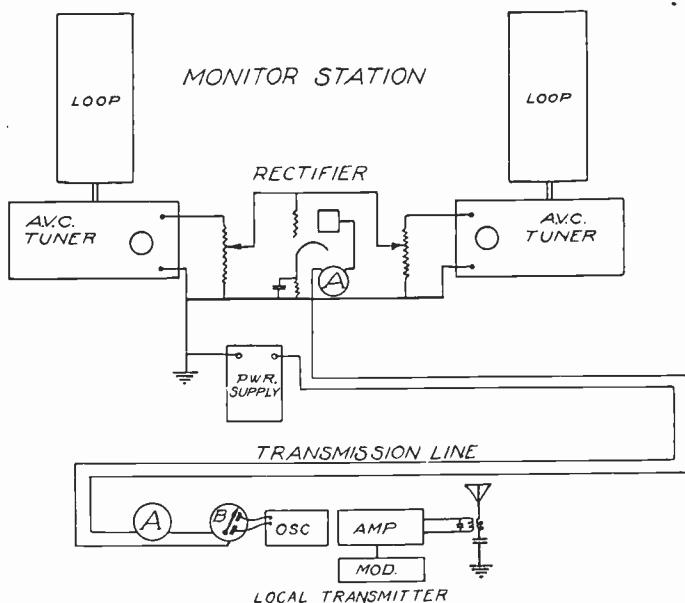

Fig. 4

#### PRACTICAL APPLICATION

While no actual installation has been made, it appears that the first essential in successful syntraction is to obtain a good carrier signal from each of the two stations to be synttracted. Fig. 4 shows how this may be done. The local transmitter is connected by a telephone line to a monitor station out in the field. There are two receivers with automatic volume control at the monitor, equipped with directional apparatus. One receiver is tuned to the local transmitter and the other to the remote transmitter. The carriers are fed to the rectifier with equal intensity by the use of attenuators, so that the phase meter *A* and the syntractor *B* behave exactly as in the illustration already given.

The problem is different for different stations. For instance, if the stations are widely separated and of low power, extreme sensitivity, directivity, and a wide range of automatic volume control are required. It is difficult in such cases to keep the local carrier from interfering, so

the monitor station must be put farther afield. This necessitates a longer transmission line and may result in locating the phase control too far out of the center of population to be served. In some cases, therefore, it may be desirable to move the transmitter to a new location relative to the population center, to permit centralizing the point of syntraction.

While loops are shown, the result of all work to date points toward the diamond-shaped directive antenna as the most practical solution. Loops are very satisfactory for signals sufficiently comparable in strength.

#### CONCLUSION

In any consideration of the merits of syntraction the following features should be kept in mind.

(a) The land line need be no longer than just necessary to permit satisfactory reception of the carriers. For most reliable operation of the syntractor under difficult conditions of monitoring, the signals should be equal, but the syntractor works very satisfactorily otherwise with signals having a ratio of four to one.

(b) The land line transmits the beat frequency only, and, since its resistance is a very small fraction of the total circuit resistance, and since the syntractor is highly damped by the oil bath shown in Fig. 1, most line disturbances have practically no effect on the operation.

(c) No radio-frequency transmission lines are required. Multi-vibrators are unnecessary.

(d) The precision of crystal control need be no greater than customary, for, whether it is a small fraction of a cycle or 15 cycles the precision of syntraction is the same. In any case it is greater than the most precisely matched system of independent crystal control.

(e) In the writer's opinion, all methods, of time-phase synchronization more or less fail to maintain space-phase synchronization. Since any receiver is located in the region of space-phase phenomena its response will not be as constant under time-phased control as under space-phased control; that is, by syntraction.

By syntraction, the distant carrier is phased at the moment it arrives at the monitor station rather than at the moment it leaves the remote transmitter. The local transmitter thus has its frequency automatically shifted, to agree with frequency shifts of the incoming carrier due either to instability of its crystal control or to any Doppler effect.

If the center of syntraction is chosen in the center of the most desirable broadcasting area, the "standing wave" pattern will have maximum stability, and reception will be as constant as the forces of nature permit over the largest possible portion of the chosen area.



## MAINTENANCE OF ELECTRON EMISSION FROM THE FILAMENT OF A TRIODE AFTER ITS LOW TEN- SION SUPPLY IS DISCONNECTED\*

BY

R. L. NARASIMHAIYA

(Department of Physics, Central College, Bangalore, India)

**Summary**—It is found that when abnormally high anode or grid voltages are applied to certain types of dull emitter receiving triodes so that the anode or grid current is a considerable fraction (greater than fifteen per cent) of the normal filament current, the electrode currents persist even after the low tension cell feeding the filament is switched off. But this electron emission from the filament without the low tension battery is maintained at normal and even subnormal electrode potentials if the tube is made to generate oscillations under high efficiency régime. It is shown that the maintenance is caused by the heating of the filament by the anode or the grid current, as the case may be, passing through it.

A high negative grid current of the order of a few milliamperes flows during a small fraction of each cycle when the tube is generating such oscillations, and this is shown to be the result of secondary electron emission from the grid.

### I. INTRODUCTION

IN A preliminary note by the author,<sup>1</sup> it was observed that certain types of dull emitter receiving tubes were capable of maintaining oscillations in the anode circuit even when the low tension battery supplying the heating current for the filament was disconnected therefrom. The diagram of the circuit used is shown in Fig. 1. The oscil-

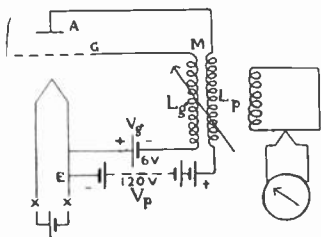

Fig. 1—Oscillations persist after breaking the filament circuit at *xx*.

latory circuit consisted simply of  $L_p$  and its associated self-capacitance and the tube filament-anode capacitance. As the grid-current oscillogram showed a negative peak current of as much as ten milliamperes, a tentative explanation that the electrons repelled from the negative

\* Decimal classification: R138. Original manuscript received by the Institute, January 19, 1934; revised manuscript received by the Institute, August 27, 1934.

<sup>1</sup> Numbers refer to Bibliography.

grid bombarding the filament might serve to maintain the temperature of the filament at the required level was suggested in the same note. A more detailed investigation however showed this explanation to be incorrect. Experiments to be described hereafter point out to quite a different source from which is abstracted the energy required to keep the filament hot.

## II. MAINTENANCE OF EMISSION UNDER STATIC CONDITIONS

When points *A* and *E* (Fig. 1) were connected to one pair of the deflecting plates of a cathode ray oscillograph, the anode voltage swing was found to exceed 300 volts. It was therefore considered desirable to study the static characteristics of the tube under these conditions. With the grid at  $-2$  volts, the anode voltage was increased steadily up to 300 volts, and the anode current was observed, first with the filament switch closed and then with the switch open. As the tube was rated for a maximum plate voltage of 150, higher voltages were applied for only a few seconds, an interval just sufficient in fact to take the meter readings. As is well known for tubes with coated filaments,<sup>2,3</sup> saturation was not obtained. Up to about 180 volts, the anode current was reduced to zero, though somewhat tardily, when the filament switch was opened. The time taken (ranging from a few seconds to a minute or two minutes) by the anode current to fall to zero when the filament circuit was switched off increased with the increase in the current. Finally, when the anode current exceeded 35 milliamperes, corresponding to anode voltages greater than 180, the current, when the filament battery was switched off, did not fall to zero at all but dropped to about 20 milliamperes and stayed there. With such high values of anode potentials that the current was about 80 milliamperes or more, there was scarcely any decrease in the anode current when the low-tension battery was disconnected. Next, the anode was maintained at a low voltage of 24 and the grid raised from 0 to 50 volts. Once again the electron emission from the filament continued after the switching off of the low tension cell, if the sum of the grid and anode currents exceeded some 35 milliamperes. In fact, the emission could be maintained, with the anode earthed and the grid kept at a high positive voltage, or the grid earthed or even made negative and the anode kept at a high positive voltage, so long as either the grid or the anode current exceeded about 35 milliamperes. (Fig. 2.) This shows that the anode current or the grid current or the two together traversing the length of the filament cause it to remain hot and thereby emit electrons.

For the Cossor 215P, the minimum anode maintenance current, to

ensure the steady operation of the tube after the low tension supply was cut off was observed to be 20 milliamperes, a value less than one seventh of the normal filament current of 150 milliamperes. If tubes having filaments of still higher emission efficiency could be manufactured so that a current of say 10 milliamperes flowing through the filament would cause copious emission, the phenomenon might find useful fields of application.

A very interesting feature of the filaments of these tubes, that emerges out of the foregoing considerations, is their extraordinarily

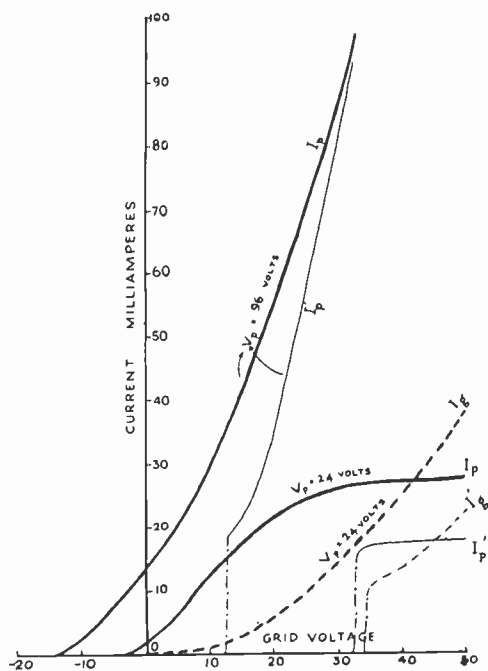

Fig. 2—Grid current ( $I_g$ ) and anode current ( $I_p$ ) characteristics of Cossor 215P tube. The thick lines ( $I_p$ ,  $I_g$ ) were obtained in the usual way with the filament battery on, and the thin lines ( $I_p'$ ,  $I_g'$ ) give the current values after the battery is disconnected.

high-emission efficiency. Thus let us consider the case where the emission without the low tension cell is maintained steadily by an anode current of 40 milliamperes. The power consumed in the filament, even assuming that the 40 milliamperes traverse the entire length of the filament, is  $I^2R = 0.04^2 \times 14$  watts, i.e., 22.4 milliwatts, where  $R = 14$  is the resistance in ohms of the filament when hot. This gives, at a very conservative estimate, an efficiency of 40,000/22.4 or 1800 milliamperes per watt, a figure considerably in excess of the maximum (990 milliamperes per watt) given by Chaffee.<sup>4</sup>

### •III. MAINTENANCE OF EMISSION UNDER DYNAMIC CONDITIONS

It should be noticed that while under static conditions, the tube requires an abnormal anode potential or grid potential or both for the maintenance of emission, under dynamic conditions, i.e., when generating oscillations, normal rated values suffice (with Cossor 215P, emission is maintained for hours together with the anode at 96 volts and the grid at  $-1.5$  volts), provided a high mean anode current flows. This means that the tube should generate oscillations working at a high efficiency and consequently under nonsinoidal conditions. For only then will the mean anode current be considerably greater than the steady current. Thus with the grid of the Cossor 215P at  $-6$  volts and the anode at 144 volts, the static anode current of 14 milliamperes could be made to rise to a mean current of 80 milliamperes under oscillating conditions by using a coil of low ohmic resistance and low self-capacitance in the plate oscillatory circuit. The range of frequencies tried was from 6 megacycles to 15 kilocycles per second and in every case it was found that the largest mean anode current could be obtained when no extra condenser was used in parallel with the coil.

Below is given a list of the constants of the tubes that were found capable of maintaining filament emission without direct feeding.

TABLE I

Tube	Filament Volts	Filament Current (amps.)	Impedance $R_t$ (ohms)	Amplification Factor ( $\mu_0$ )	Mutual Conductance (ma/volt)
Cossor 210 H.F.	2.0	0.10	20,000	20	1.0
Cossor 210 L.F.	2.0	0.10	12,000	10	0.83
Cossor 215 P.	2.0	0.15	4,500*	6.5*	1.4*
Cossor 220 P.	2.0	0.20	4,000	8	2.0
Cossor 220 P.A.	2.0	0.20	4,000	16	3.0

\* These values were experimentally determined. The rest of the figures are manufacturer's rated average values.

Cossor tubes 210R.C. ( $R_t=50,000$  ohms) and 210H.L. (22,000 ohms) failed to exhibit the maintenance phenomenon, probably owing to their higher resistances. It must be mentioned here that the factor governing the maintenance phenomenon is the tube resistance (anode volts/anode current) and not the alternating-current impedance ( $R_t$ ), though the latter is listed in Table I. Cossor 230X.P. also did not maintain the emission owing perhaps to the comparatively greater length of its filaments and high normal filament current. Of the various Marconi (types H210, P215), Mullard (types PM1HF, PM2, PM3), and Phillips (types A415, A425, B405, B409) dull emitter tubes tried, none was found able to maintain the emission. The anode currents with every one of these tubes approached fairly definite saturation limits, and in

no case was it possible to increase the current beyond about 25 milliamperes.

One might naturally suppose that this method of working a tube would shorten its life or affect its behavior. However, it does not appear to do so. For, one of the tubes that was very frequently subjected to this treatment for hours together at a time over a period of more than a year and a half, was found at the end of the period to yield characteristic curves practically the same as those before the period. None of the other tubes listed in Table I either, showed any change in their behavior after they were made to maintain oscillations without low tension feeding, although, of course, they were not experimented upon over long periods of time. It must be added that these remarks do not apply to tubes maintaining emission under static conditions.

#### IV. NEGATIVE GRID CURRENT DURING OSCILLATIONS

With a view to studying the conditions under which the negative grid current, referred to in the earlier part of this paper, is produced during these oscillations, oscillograms of the plate and grid voltages and currents were taken using a cathode ray oscillograph. The linear time base circuit adopted was essentially that described by Appleton, Watson Watt, and Herd.<sup>5</sup> In Fig. 3 the four curves (*a*), (*b*), (*c*), and (*d*) are exhibited in their proper phase relationships, the line *O* representing in every case the zero axis and the other line the calibrated value marked against it. In the three phase diagrams, (*e*), (*f*), and (*g*), the *X*- and the *Y*-axes are also drawn.

On examining (*a*) and (*b*), it is seen that the negative grid current occurs during the positive swing of the grid voltage and further when the anode voltage (curve *c*) itself is intensely positive. This indicates that the negative current is the result of secondary electron emission by the grid. To test if the particular tube could give the required large negative grid current with the electrode potentials indicated by the oscillograms, a grid-voltage—grid-current static characteristic (Fig. 4) was obtained for the Cossor 215P. The large negative current at positive grid potentials that is revealed by the curve clearly shows the effect to be due to secondary electron emission. The dotted portion *ab* (Fig. 4) represents the change in current with time. When negative current set in, it was observed that after a few seconds the current rapidly rose to zero and became positive again though the grid was held at the same potential. Of course the voltage had to be reversed soon after, to prevent the grid getting dangerously hot. When the tube is generating oscillations, this reversal is effected automatically and with far greater rapidity during the course of each cycle. The observed

instability of the grid current might be due to the change in filament temperature and in the current sent into or drawn from the filament, as mentioned by Becker.<sup>3</sup>

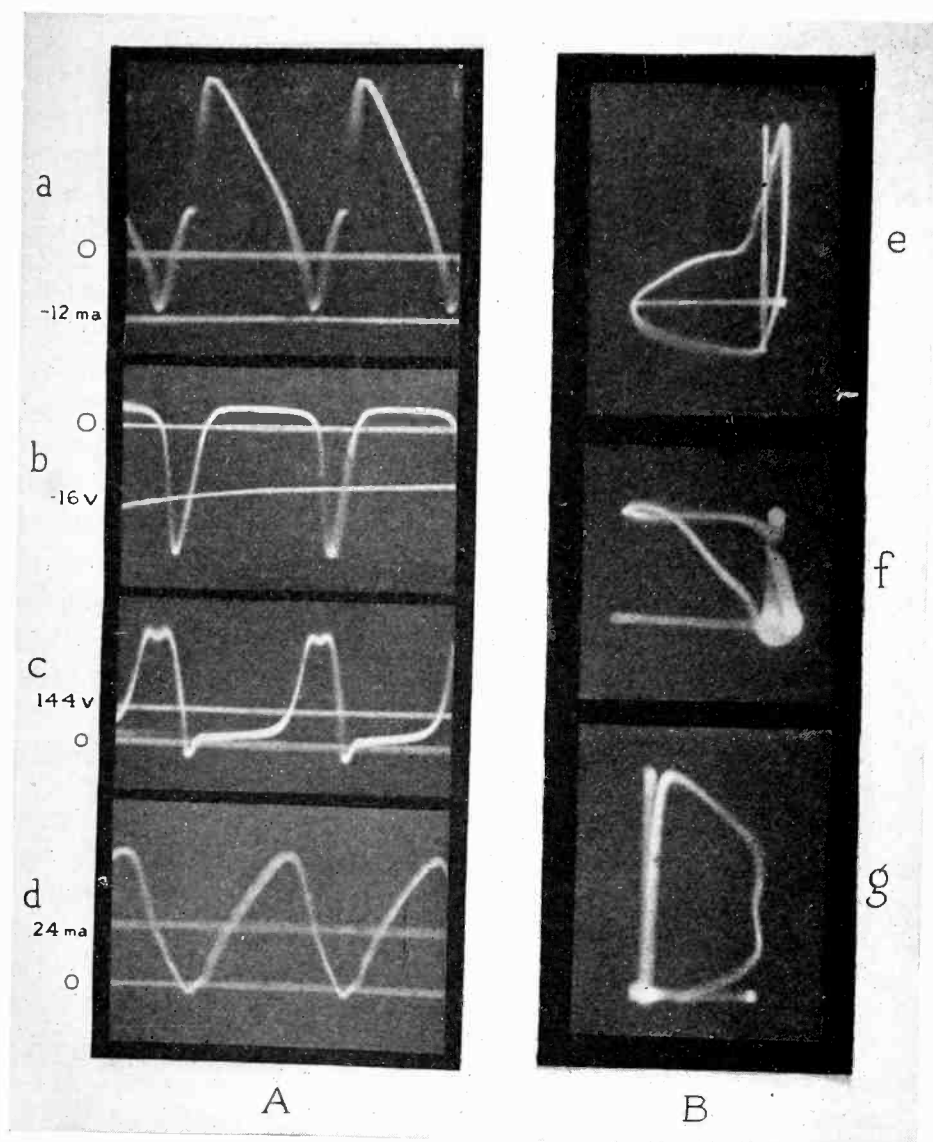

Fig. 3—Cathode ray oscillograms.

- A. The wave forms, positioned according to their phase relationships.
- Wave form of the grid current.
  - Wave form of the grid voltage.
  - Wave form of the anode voltage.
  - Wave form of the anode current.
- B. The phase diagrams. Values to the right of the Y-axis (the vertical line) and the top of the X-axis (the horizontal line) are positive.
- X-axis—grid voltage; Y-axis—grid current.
  - X-axis—grid voltage; Y-axis—anode voltage.
  - X-axis—anode voltage; Y-axis—anode current.

Kozanowski and Mouromtseff also have obtained negative grid current with positive potentials as a result of secondary electron emission using the "condenser discharge oscillograph" method described in their recent paper.<sup>6</sup>

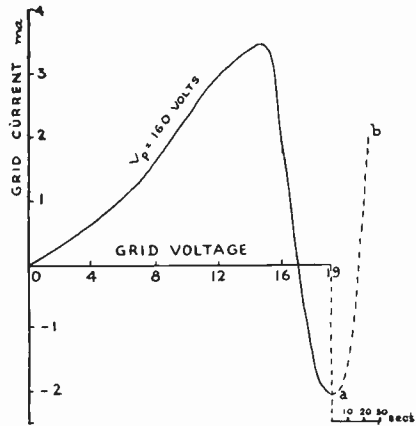

Fig. 4—Grid-voltage—grid-current characteristic of Cossor 215P tube, showing the negative grid current with positive grid voltages.

#### ACKNOWLEDGMENT

In conclusion, I desire to express my indebtedness to Professor A. Venkata Rao Telang for his sympathetic guidance throughout the progress of this work and to Dr. E. P. Metcalfe for his helpful suggestions.

#### Bibliography

- (1) *Current Science*, vol. 1, p. 130, (1932).
- (2) H. Rothe, *Zeit. für Physik*, vol. 36, p. 737, (1926).
- (3) J. A. Becker, *Phys. Rev.*, vol. 34, p. 1323, (1929).
- (4) E. L. Chaffee, "Theory of Thermionic Vacuum Tubes," p. 126, Fig. 45, (1933).
- (5) E. V. Appleton, R. A. Watson Watt, and J. F. Herd, *Proc. Roy. Soc. A*, vol. 111, p. 615, (1926).
- (6) H. N. Kozanowski and I. E. Mouromtseff, *Proc. I.R.E.* vol. 21, p. 1082; August, (1933).



## DISCUSSION ON "HIGH-QUALITY RADIO BROADCASTING"\*

STUART BALLANTINE

Hans Roder:† In section 10 of his paper on "High Quality Radio Broadcasting," Mr. Ballantine reports about a remarkable discrepancy between measured and calculated values observed for the vertical field pattern of antennas of the guyed cantilever type. About one and one-half years ago I made a study of the same problem and the results obtained will supposedly be of interest to the readers of the above paper.

In Mr. Ballantine's analysis, on which the curves shown in his Fig. 42 are based, a current distribution on the radiator tower is assumed which is equal to that resulting on a vertical wire of *uniform* cross section. Analytical and experimental results, however, do not agree. Taking into account the finite conductivity of the earth does not explain the discrepancy either. As possible sources, Mr. Ballantine mentions the ground system, the guy wires or the non-sinusoidal current distribution along the radiator.

The latter possibility is, in the writer's opinion, the most probable one. The cantilever type radiator represents a conductor whose inductance and capacity per unit length are nonuniformly distributed. The center portion of the radiator has large capacity and low inductance per unit length; the end sections have small capacity and high inductance. It would be very interesting to know the current distribution on this type of radiator. With the current distribution being known, the determination of the radiation pattern is a relatively simple matter. However, since the tower is a very complicated structure, an exact computation of the current distribution is impossible. For an *approximate* determination of the current distribution, we can assume that the current distribution is approximately equal to that on a concentric transmission line whose inner conductor is made up by two conical and one cylindrical section (Fig. 1). For purposes of computation, we replace the conical sections by cylindrical sections of the same average diameter. The dimensions assumed for the outer conductor and for the various sections are given in Fig. 2.<sup>1</sup> Considering the structure now as an open-ended transmission line with a voltage of  $E$  volts existing at the upper end, current and voltage can be determined section by section by means of the well-known transmission line formulas. As a result, the current distribution shown in Fig. 3 (curve  $A_{50}$ ) is obtained. It is seen that the curve of *current distribution does not show a current node* despite the fact that the physical height of the antenna is greater than one-half wavelength. A vertical wire of uniform cross section would have the current distribution of curve  $B$ , Fig. 3. The current loop in  $A_{50}$  occurs at a much lower height than that in curve  $B$ . The large capacity in the portion of the radiator having large cross section tends to result in a concentration of the current at that portion, with the sections above receiving less current than they would in the case of a uniform cross section.

If we now suppose that curve  $A_{50}$  represents the current distribution along the cantilever type radiator, we have, as a next step, to find the vertical radiation pattern resulting therefrom. Curve  $A_{50}$  can be very well approximated by the function:

\* Proc. I.R.E., vol. 22, no. 5, pp. 564-629; May, (1934).

† General Electric Company, Bridgeport, Conn.



$$I_z = I_0 \left( 1 - \sin \frac{2\pi}{Z_0} (z - h) \right),$$

whereby<sup>1</sup>

$Z$  = distance above ground

$Z_0 = 880$  feet

$h = 408$  feet

$h_0 =$  height of antenna = 620 feet

$\lambda =$  wavelength = 349 meters = 1146 feet.

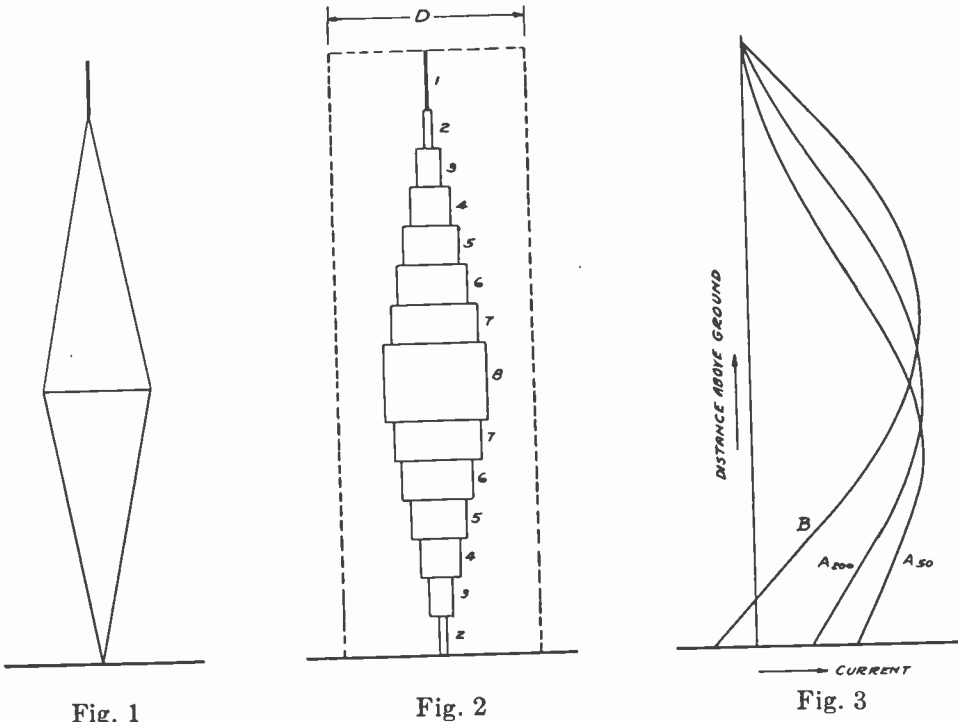

Fig. 1

Fig. 2

Fig. 3

Fig. 1—Cantilever type radiator.

Fig. 2—Cantilever type radiator replaced by nonuniform concentric transmission line.

$D = 50$  feet or  $200$  feet.

Diameter of inner sections in feet

1— $\frac{1}{2}$	3— $6\frac{1}{2}$	5— $14\frac{1}{2}$	7— $22\frac{1}{2}$
2— $2\frac{1}{2}$	4— $10\frac{1}{2}$	6— $18\frac{1}{2}$	8— $26\frac{1}{2}$

Total height in feet  
 $h/\lambda = 0.542 (= 195^\circ)$ .

Fig. 3—Current distribution for transmission line of Fig. 2.

The electrical field (including the effect of a perfectly conducting earth) follows from the relation

$$E = \text{const.} \int_0^{h_0} I_z \cos(v \sin \theta) \cos \theta dv,$$

where  $\theta$  is the elevation angle and

$$v = 2\pi \frac{z}{\lambda}.$$

<sup>1</sup> The dimensions given in Fig. 2 and Fig. 3 correspond to those of the WABC antenna. (Height of tower,  $h_0 = 620$  feet; frequency 860 kilocycles; wavelength 349 meters.)

The integral can be evaluated numerically and yields curve  $A_{60}$ , Fig. 4, for the vertical field pattern of the guyed cantilever type radiator. Curve  $B$  would result for a vertical wire of the same height (corresponding to curve  $B$  in Fig. 3). The values of electrical field strength as measured by Mr. Ballantine are also shown in the same figure. Curve  $A_{60}$  does not show a minimum and, in general, checks Mr. Ballantine's curves much closer as does curve  $B$  for the vertical radiator of uniform cross section. There is quite a discrepancy at high elevation angles, and no doubt some of this is due to the radiation from the guy wires. Another point disregarded in the above analysis is the fact that the transmission line was assumed to be of nonmagnetic material, while the antenna tower actually is built of steel, thus resulting in higher inductance per unit length than existing if the same structure was built of nonmagnetic material.

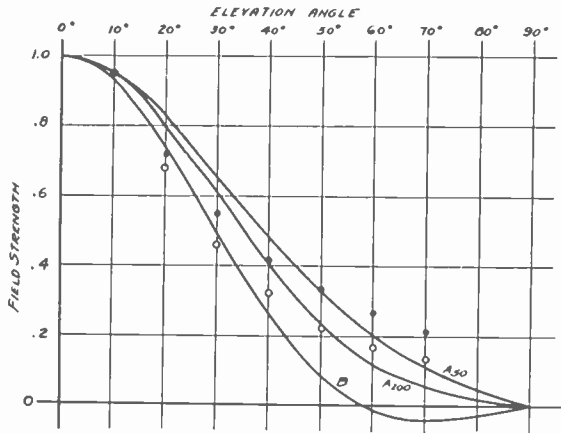

Fig. 4—Vertical field patterns.

$A_{60}$  cantilever type radiator; return conductor 50-foot diameter.

$A_{200}$  cantilever type radiator; return conductor 200-foot diameter.

$B$  vertical wire, uniform cross section.

Circles: WABC western side; measured by S. Ballantine.

Dots: WABC eastern side; measured by S. Ballantine.

To be sure, the above analysis is by no means a rigorous one. There is, for instance, from a purely physical standpoint, not the slightest justification for the assumption of a return conductivity cylinder.<sup>2</sup> On the other hand, on account of the analogies between antennas and transmission lines, it seems to be highly probable that the current distribution in the actual antenna is very similar to that obtained in the above transmission line. It may be objected that the diameter of the return cylinder (50 feet in the above analysis) is chosen on a purely arbitrary basis and is perhaps too small. This is true, but if the diameter is increased, no fundamental change is obtained for the curves of the current distribution and field strength.<sup>3</sup> A return cylinder of 20 feet in diameter yields the curves  $A_{200}$  in Figs. 2 and 3, which still show the same general character as

<sup>2</sup> A more rigorous treatment would be as follows: The tower can be subdivided as in Fig. 1, each section being of circular cross section. Since the radial dimensions are small with respect to the wavelength it is permissible to let the current be concentrated in the tower axis. Assuming a certain current distribution (for instance,  $A_{10}$  in Fig. 3), the electric and magnetic field around the axis can be worked out. There exist, at the radiator surface, certain boundary conditions for the vectors of the electric and magnetic field. By successive corrections of the assumed current distribution, it is evidently possible to find the actual current distribution for which those boundary conditions are fulfilled.

<sup>3</sup> This result is easily understood if one remembers the fact that the surge impedance of a concentric transmission line does not change appreciably with increasing diameter of the outer conductor if the diameter of the inner conductor is small.

do the curves  $A_{10}$ . For still greater diameters, the transmission line formulas surely do not hold any longer, thus making the above method inapplicable.

I wish, in this note, to call attention to the following points:

1. With a radiator tower, being made of steel and having nonuniform cross section, the use of the  $h/\lambda$  ratio becomes futile because the current distribution on such a tower is different from that of a wire of equal height and of uniform cross section.

2. The portion of such a tower having large cross section tends to hold the current back from the sections lying beyond it rendering those sections less effective in their radiation.<sup>4</sup> The conventionally used steel mast on the top is, for this reason, expected to have only a slight effect on the intensity and radiation pattern.

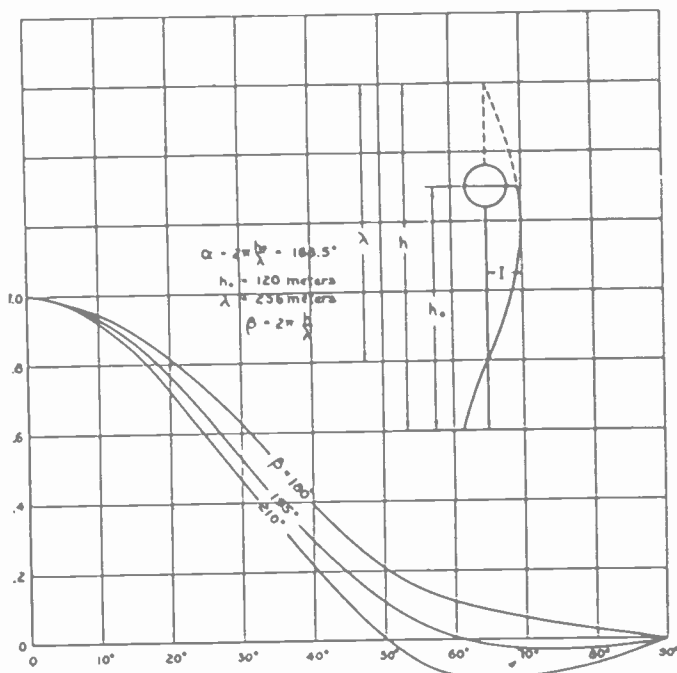

Fig. 5

3. Measurements of antenna impedance made at the tower base cannot yield definite conclusions about the current distribution along the radiator and, consequently, cannot permit conclusions regarding ground and sky-wave radiation. In addition, since such measurements include the insulator at the tower base with its capacity and resistance, they are liable to be considerably in error if used for determining the current distribution and natural frequency.

However, how important these points are, can only be determined by a careful measurement of the current distribution along the tower.

As far as sky-wave radiation is concerned it has been noted that radiators of the guyed cantilever type are not very effective in sky-wave suppression.

<sup>4</sup> This also holds for the ordinary self-supporting radiator tower. It has been shown experimentally that a tower of this type has less ground-wave radiation than a vertical uniform wire of the same height. ("Control of radiating properties of antennas," by C. A. Nickle, R. B. Dome, W. W. Brown, Presented before Ninth Annual Convention of the Institute of Radio Engineers, Philadelphia, Pa., May 29, 1934.

Although usually they are higher than one-half wavelength their performance as regards sky-wave suppression is not so good as that of a one-half wave antenna of uniform cross section, but somewhat better than that of an ordinary one-fourth wave antenna excepting radiation from the guy wires (which are necessary for this type of antenna), the reason for this deficiency can probably be found in a nonsinusoidal current distribution. The current distribution necessary to obtain suppression of the sky wave is characterized by having a current node at a certain distance above ground. Fig. 5 shows this current distribution for an antenna of  $h_0/\lambda = 0.47$  and the theoretical radiation patterns resulting therefrom. The current distribution is obtained by a capacity at the top of the tower. The cross section of the vertical radiator is uniform.

Mr. Ballantine makes, on pages 623 and 624, reference to high vertical antennas used in Europe, notably to the antenna at Breslau. I would like, however, to call attention to the point that the design of the Breslau antenna was evidently from the very beginning guided by the desire to build an antenna with weak sky-wave and strong ground-wave radiation and this was obtained by using a vertical copper rod of uniform cross section strung up inside of a wooden tower and by careful adjustment and measurement of the current distribution. The publications of Dr. O. Böhm, who designed the Breslau antenna, will be of great interest to those interested in this problem.<sup>5</sup> On the other hand, in the design of the guyed cantilever type radiator, the paramount feature of proper current distribution was apparently not given due consideration, resulting in certain effects not as satisfactory as those obtained with the Breslau antenna.

*NOTE* (January 29, 1935): Since this article was written (June, 1934), reference was made several times in the literature to nonsinusoidal current distribution along cantilever type radiators. In *Electronics*, vol. 7, p. 288, 1934, E. A. Laport mentions the possibility of this phenomenon, without giving details for his reasoning. In *Broadcast News*, December, 1934, H. E. Gihring and G. H. Brown report about measurements taken for determining the current distribution along a model cantilever type tower. In Fig. 8 of their paper they show a measured example of current distribution which comes very close to those arrived at in my article above.

<sup>5</sup> O. Böhm, "On the radiation of broadcast waves." *Telefunken Zeitung*, no. 57; April, (1931).

"Long-wave broadcast antennas with suppressed sky-wave radiation." *Telefunken Zeitung*, no. 60; March, (1934).

"Broadcast transmitting antennas with vertically concentrated radiation," *Hochfrequenztechnik und Elektroakustik*, vol. 42, 137; October, (1933).



## BOOK REVIEWS

**Nineteenth Edition Handbook of Chemistry and Physics**, edited by Charles D. Hodgman. Published by the Chemical Rubber Co., Cleveland, Ohio. 1,904 pages. Price \$6.00.

This handbook contains a wealth of material in its 1,904 pages, exclusive of the index, of which more than 1,200 contain information that is likely to be of value to the radio engineer. About 115 pages have been added in this edition. Among the new features that will appeal to the user are the insertion of yellow index pages at the beginning of each section, the extension of the table of integrals to include 381 standard forms which will meet the requirements of most engineers, X-ray crystallographic data, thermodynamic properties of refrigerants, and method for finding the density of moist air from the temperature, pressure, and dew point. The space devoted to the various sections is as follows: mathematical tables—278 pages; properties of elements and compounds, and physical constants—484; general chemical tables—193; heat and hygrometry—159; sound—6; electricity and magnetism—50; light—142; quantities and units—117; and miscellaneous including calculation of circuit constants, characteristic of electron tubes, photographic formulae, etc.—101. The physical and mathematical tables are particularly good. It contains a tremendous amount of miscellaneous information that is sure to be of value.

\*H. M. TURNER

**Electron Tubes in Industry**, by Keith Henney. Published by McGraw-Hill Co. New York City. 490 pages. Price \$5.00.

It has been a common occurrence in the fields of communication that the unimportant by-products and sidelines of one year become important fields of endeavor in their own right the next. Many production processes have been revolutionized by the application of automatic control mechanisms, sorting, gaging, and inspection devices based on applications of electron tubes. While it will not be surprising to communication engineers that such tubes are widely used, yet the very multiplicity of the successful devices that are described in this book will be a revelation to many. To them the very knowledge that such problems exist will doubtless provoke new ideas along these lines.

The impressive growth of such applications during the past couple of years has been due to the relative simplicity of the circuits; usually but a single tube is used, and when more are necessary the others generally comprise simple amplifiers.

Since many of the processes were developed by the various industries, published data are very scattered. This book presents an admirable selection of technical details covering selected examples of electron tube devices, describing controlling, measurement indicating, counting, sorting, and safety processes found in American industrial plants. The thing that is important is that the tubes utilized are readily available in this country. The usual publicity accorded develop-

\* Yale University, New Haven, Conn.

ments of this nature is of a spectacular nature and furnishes but little useful data whereby others interested can determine whether the plan warrants consideration for their own problems.

The author starts with concise information as to electron tube circuits and proceeds with amplifier design. Those amplifiers that have specific applications, such as amplifiers for extremely low frequencies and direct currents, etc., are especially featured.

In the photocell sections the devices discussed include color matching, sorting, gaging, safety controls, timing and many automatic inspection methods. The gaseous triode, such as the "thyatron" and "grid glow tube" also is given considerable attention in the production of alternating-current power from direct-current sources, timing sequences, stroboscopic analysis, relay operation, micrometric measurements, etc. A great many actual developments along these lines are described and mentioned, and a complete list here is impossible.

The author has selected the descriptive matter with care and has adequately interpreted and condensed the material so that under one cover a complete résumé of these applications is available. While not a "How to make it" book the descriptions contain enough details of the circuit and fundamental principles so that any item can be reproduced. It is recommended as a reference book for any engineer, not only in the electrical and communication fields, for whom the listing of the special tubes now available and their applications will be of interest, but also for plant executives and production managers who can thereby keep abreast of manufacturing control processes.

Numerous bibliographic notes are included of the original sources of information. By far the greater part of these references are in native publications insuring that the reference is not difficult to obtain if needed and also that the tubes and other parts used are readily procurable in this country. The book is well illustrated with photographs and circuit diagrams.

\*R. R. BATCHER

\* New York City.



## CORRECTION

The following corrections to the paper "Theory of Electron Gun" which appeared in the December, 1934, issue of the Proceedings, has been submitted by the authors.

Page 1393, line 6: The minus sign of this equation should be a plus sign.

Page 1395, lines 2 to 5: This sentence should be enclosed in parenthesis and on line 3 the word *Richardson's* should be substituted for *Maxwell's*.

Page 1395, Fig. 7: Horizontal scale should be in mm. instead of cm.

Page 1404, Fig. 19: The topmost and lowermost curves should be labeled  $f_2$  and  $f_1$ , respectively, instead of  $F_2$  and  $F_1$ .

Page 1407, third line from the bottom: The expression  $\cos \theta = \sqrt{\rho^2 - r_0^2}/\rho$  should read  $\cos \theta = \sqrt{\rho^2 - r_0^2}/\rho$



CONTRIBUTORS TO THIS ISSUE

**Dytrt, L. F.:** Born, 1906, at Cedar Rapids, Iowa. Received B.S. degree in electrical engineering; M.S. degree in electrical engineering; Ph.D. degree, 1933, Iowa State College; graduate course, University of Pittsburgh branch. Westinghouse Company, 1929. Nonmember, Institute of Radio Engineers.

**Fay, C. E.:** Born December 2, 1903, at St. Louis, Missouri. Received B.S. degree in electrical engineering, Washington University, 1925; M.S. degree, 1927. Technical staff, Bell Telephone Laboratories, Inc., 1927 to date. Associate member, Institute of Radio Engineers, 1926.

**Gunsolley, Verne V.:** Born, 1896, at Des Moines, Iowa. Research engineer, Kansas Light and Power Company, 1921; consulting radio engineer, 1927; United Sound Engineering Company. Associate member, American Institute of Electrical Engineers, 1924. Nonmember, Institute of Radio Engineers.

**McElroy, P. K.:** Born August 7, 1899, at Toledo, Ohio. Received B.A. degree in physics, Harvard University, 1920; M.A. degree in physics, 1921. Instructor, physics department, Harvard University, 1921-1922; acoustical research for Hammond V. Hayes, summer-1920; design work for G. W. Pierce, summer-1921; production, design, and engineering departments, General Radio Company, 1921 to date. Member, Phi Beta Kappa. Associate member, Institute of Radio Engineers, 1925; Member, 1927; Fellow, 1931.

**Narasimhaiya, R. L.:** Born December 28, 1902, at Hiriur, Mysore, South India. Received B.S. degree in physics, University of Mysore, 1923; M.S. degree, University of Allahabad, 1929. Science master, Department of Public Instruction, Mysore, 1923-1929; demonstrator in physics, Central College, Bangalore, 1929 to date. Nonmember, Institute of Radio Engineers.

**Samuel, A. L.:** Born December 5, 1901, at Emporia, Kansas. Received B.A. degree, College of Emporia, 1923; B.S. and M.S. degrees in electrical engineering, Massachusetts Institute of Technology, 1926; coöperative student, (intermittently), 1923-1926. General Electric Company, Lynn, Massachusetts, 1923; research laboratory, Schenectady, New York, summer-1927; instructor, electrical engineering department, Massachusetts Institute of Technology, 1926-1928; member technical staff, Bell Telephone Laboratories, Inc., 1928 to date. Member, American Physical Society. Member, American Institute of Electrical Engineers. Associate member, Institute of Radio Engineers, 1924.

**Terman, Frederick Emmons:** Born June 7, 1900, at English, Indiana. Received B.A. degree, 1920; E.E. degree, Stanford University, 1922; D.S. degree, Massachusetts Institute of Technology, 1924. Associate professor of electrical engineering, in charge of communication, Stanford University. Associate member, Institute of Radio Engineers, 1925.



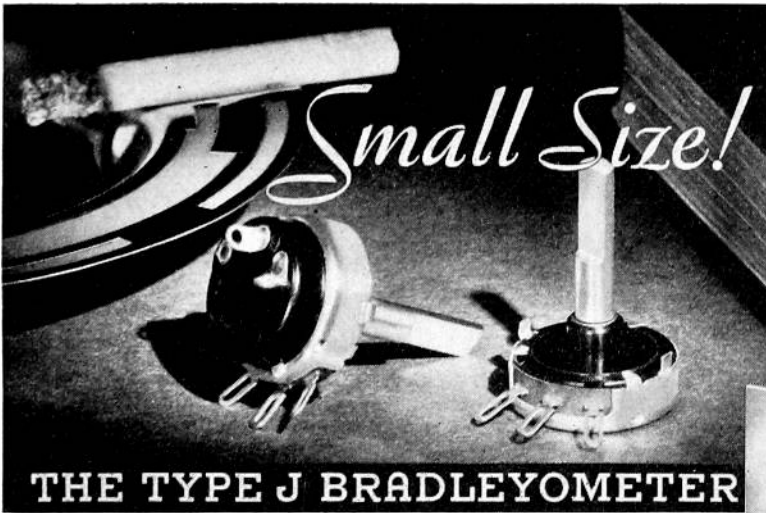

*Small Size!*

**THE TYPE J BRADLEYOMETER**

The Type J Bradleyometer is made in two types: Type J is a volume control without line switch; Type JS with line switch. Both units are amazingly compact. The solid molded resistor never wears out—it never changes. The dependability is inherent.

**A Compact Volume Control that is Unaffected by Wear and Extreme Humidity Changes**

The small size of the new Type J Bradleyometer is creating much favorable comment among radio engineers. Never before has so reliable a volume control been made so small.

But, even more important than its small size, is the resistor construction which makes the Type J Bradleyometer impervious to moisture and, therefore, unaffected by wide changes in humidity. Hard service and long wear have no deteriorating effects upon the remarkable solid molded resistors of the Types J and JS Bradleyometers.

Since the Types J and JS units are interchangeable with others built to R. M. A. standards, every radio receiver can now be improved with these dependable volume controls. Every radio engineer should have technical data on these units. Write today.

**ALLEN - BRADLEY COMPANY**  
116 W. Greenfield Avenue, Milwaukee, Wis.

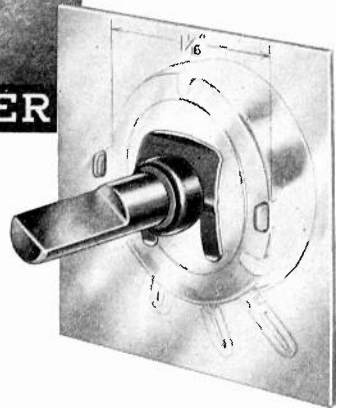

**EASY TO MOUNT**—The control is snapped into place on the panel with a C-washer. No threaded sleeves or nuts—no subsequent loosening.



**A SOLID MOLDED RESISTOR—NOT A FILM-TYPE UNIT**—The Type J resistor is homogeneous—in longitudinal section the material is varied to suit specified resistance-rotation curves. After molding, the unit cannot change. Hard service cannot alter its performance. Practically any resistance-rotation curve shape can be provided including straight logarithmic, modified logarithmic, or linear.

**ALLEN-BRADLEY RADIO RESISTORS**



*When writing to advertisers mention of the PROCEEDINGS will be mutually helpful.*



# HQ

# CONSTANT DEPENDABILITY

*The  
True Measure of Hidden Quality  
in Cornell-Dubilier Condensers*

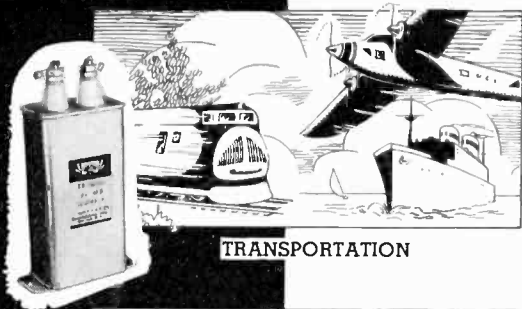

TRANSPORTATION

Space and weight are at a premium in today's means of transportation. C-D answers the problem with an extensive line of capacitors. A typical example is the T-D oil condenser. Fully 50% smaller and 70% lighter in weight, for a given capacity and voltage, than comparative makes now available.

IGNITION. NOISE ELIMINATION. TRAIN CONTROL. MOBILE RADIO. AIRCRAFT. AIRWAY BEACON. SUBMARINE.

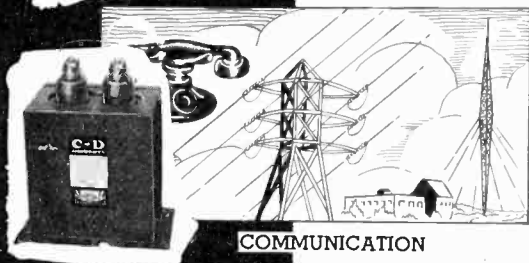

COMMUNICATION

The importance of continuous operation without breakdown cannot be stressed too heavily by broadcasting stations. That is why C-D's are specified almost universally. For instance, the T-C type, impregnated with non-inflammable pyranol.

RADIO BROADCAST. ULTRA HIGH FREQUENCY. LOW FREQUENCY. CARRIER CURRENT. TELEPHONE. TALKING PICTURE.

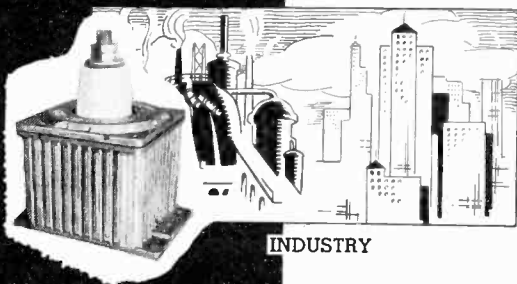

INDUSTRY

Modern industry keyed to high speed production must rely on even the smallest unit. For instance, the rugged Bombarder type, specifically designed to withstand the severe service encountered in vacuum tube plants.

POWER FACTOR CORRECTION. ELEVATOR. FRACTIONAL H. P. MOTORS. OIL BURNER. REFRIGERATOR. BOMBARDER. NEON SIGN. ARC PREVENTION.

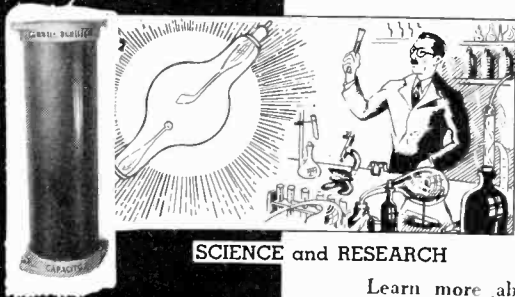

SCIENCE and RESEARCH

Costly breakdowns in X-Ray equipment are taboo. That is why C-D hi-voltage condensers are specified in 9 out of 10 cases. They instill a measure of confidence that only a quality product can give.

X-RAY. THERAPEUTIC. TELEVISION. STANDARDS. ELECTRONIC. STROBOSCOPIC. FILTERING. RESONANCE. FEVER MACHINES.

Learn more about the details of the Hidden Quality Condensers, "the standard by which all other makes are measured." Write to the engineering division today.

# CORNELL-DUBILIER CORPORATION

4379 BRONX BOULEVARD

NEW YORK

*When writing to advertisers mention of the PROCEEDINGS will be mutually helpful.*

1885



1935

## FIFTY YEARS OF PROGRESS

---

IN 1885, fifty years ago, the American Telephone and Telegraph Company was formed.

There were few telephones then and service was slow, uncertain and limited to separate communities. In that year the largest number of telephones in any one city was 8400, in New York.

New York now has 1,500,000; Chicago, 800,000; Philadelphia, 350,000.

From your own Bell telephone you may talk with any one of 17,000,000 other telephones in this country and most of those in foreign lands. Today, 93% of all the world's tele-

phones are within reach of the Bell telephone in your home or office.

This year marks also the Twentieth Anniversary of the opening of the first transcontinental line, from New York to San Francisco, and the Eighth Anniversary of the opening of transatlantic service.

The work of improving Bell telephone communication is never ended . . . it goes on and on toward a constantly higher standard of service. Further improvements as important as those of the past half-century will come through Bell System research, manufacturing and unified operation.



**BELL TELEPHONE SYSTEM**

*When writing to advertisers mention of the PROCEEDINGS will be mutually helpful.*

*Announcing*

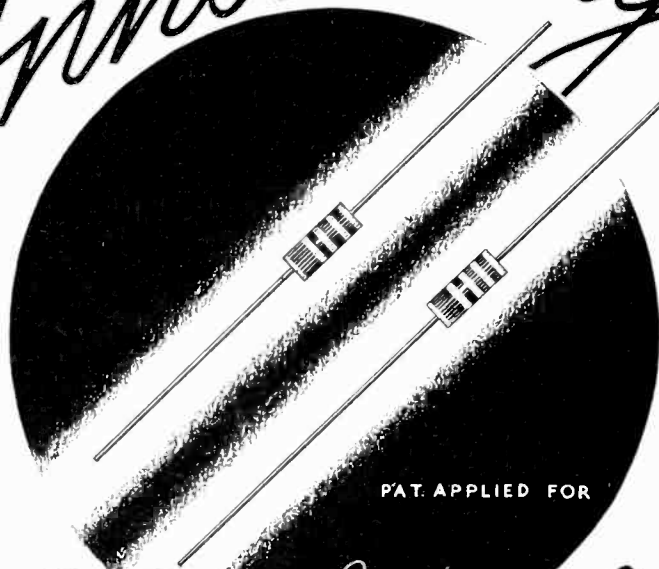

# ERIE *Insulated* RESISTORS

## COMPLETE CERAMIC INSULATION

Ceramic tube completely encloses body of resistor. "Shorts" and "grounds" impossible, even in smallest installation spaces. Leads brought out at ends parallel to body to facilitate wiring and insulation.

## IMPROVED COLOR CODING

Color bands completely encircle ceramic shell. Absence of usual color dot makes it possible to read resistance regardless of position of resistor. First three bands starting with widest give resistance value; fourth band represents tolerance—a hitherto impractical feature.

## SMALLER SIZE

Dimensions including ceramic shell smaller than corresponding non-insulated Erie Resistor. Over-all size not including leads: 11/64" x 7/16"

## NO CHANGE IN PRICE

Quantity production now available on 1/4 watt units in any desired resistance values. Production on 1/2 watt and larger sizes in near future. ALL PRICES SAME AS NON-INSULATED ERIE RESISTORS. Write for samples to test in your own laboratory.

# ERIE RESISTOR CORPORATION

ERIE, PA.

Factories in ERIE, PA. - TORONTO, CANADA - LONDON, ENG.

*When writing to advertisers mention of the PROCEEDINGS will be mutually helpful.*

# The Institute of Radio Engineers

Incorporated

330 West 42nd Street, New York, N.Y.

## APPLICATION FOR ASSOCIATE MEMBERSHIP

(Application forms for other grades of membership are obtainable from the Institute)

To the Board of Directors  
Gentlemen:

I hereby make application for Associate membership in the Institute of Radio Engineers on the basis of my training and professional experience given herewith, and refer to the members named below who are personally familiar with my work.

I certify that the statements made in the record of my training and professional experience are correct, and agree if elected, that I will be governed by the constitution of the Institute as long as I continue a member. Furthermore I agree to promote the objects of the Institute so far as shall be in my power, and if my membership shall be discontinued will return my membership badge.

.....  
(Sign with pen)

.....  
(Address for mail)

.....  
(Date)

.....  
(City and State)

### Sponsors:

(Signature of references not required here)

Mr. .... Mr. ....

Address ..... Address .....

City and State ..... City and State .....

Mr. ....

Address .....

City and State .....

The following extracts from the Constitution govern applications for admission to the Institute in the Associate grade:

#### ARTICLE II—MEMBERSHIP

Sec. 1: The membership of the Institute shall consist of: \* \* \* (c) Associates, who shall be entitled to all the rights and privileges of the Institute except the right to hold any elective office specified in Article V. \* \* \*

Sec. 4. An Associate shall be not less than twenty-one years of age and shall be a person who is interested in and connected with the study or application of radio science or the radio arts.

#### ARTICLE III—ADMISSION AND EXPULSIONS

Sec. 2: \* \* \* Applicants shall give references to members of the Institute as follows: \* \* \* for the grade of Associate, to three Fellows, Members, or Associates; \* \* \* Each application for admission \* \* \* shall embody a full record of the general technical education of the applicant and of his professional career.

#### ARTICLE IV—ENTRANCE FEE AND DUES

Sec. 1: \* \* \* Entrance fee for the Associate grade of membership is \$3.00 and annual dues are \$6.00.

*ENTRANCE FEE SHOULD ACCOMPANY APPLICATION*



# Variable I.F. COUPLING

*provides* **SELECTIVITY**  
*or* **FIDELITY**, *as you*  
*choose*

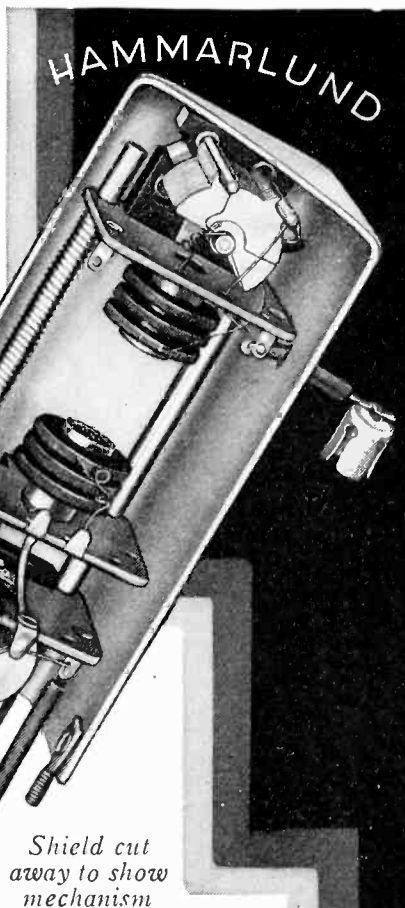

*Shield cut  
away to show  
mechanism*

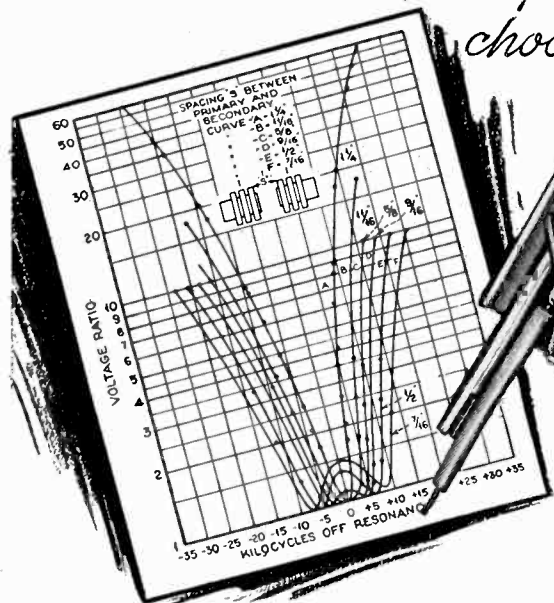

**N**OW, the greatest single improvement in receiver flexibility in recent years.

**CONTINUOUS VARIABLE SELECTIVITY**, from a needle-sharp peak to the flat top required for fidelity—without affecting tuning.

The transformer, basically, is the time-tested Hammarlund I.F.T. design, with new triple-type, pie-wound Litz coils and air-dielectric condensers. Plus the startling feature of *continuously variable coupling between the coils.*

Adjustment of coupling in each transformer may be fixed at any

point, or continuously varied by panel-control, either individually or ganged in groups, according to selectivity desired.

The diagram shows the variable selectivity characteristics of a single transformer only.

Designed primarily for use in the new **COMET Super-“PRO”** Receiver, soon to be announced, these transformers may easily be adapted to other superheterodynes.

Code No. VT-465 (465 kc.). List price \$5.50 each, less 40% to experimenters.



Canadian Office:

41 West Ave. North,

Hamilton, Ontario



Hammarlund Manufacturing Co.  
424-438 W. 33rd St., New York

... Check here for details of new Variable-Coupling I. F. Transformer.

... Check here for 1935 General Catalog.

Name .....

Address .....

..... IRE-3

*When writing to advertisers mention of the PROCEEDINGS will be mutually helpful.*



# Background!

Picture two men applying for an important position. As far as you can judge by eye and ear, both seem to have about the same qualifications. But one has something the other lacks—a broad and successful background of experience in your particular field. His performance "under fire" is definitely proved. And he is the one you choose.

*For many years the International Resistance Company has been concentrating the efforts of a large organization on the manufacture of quality resistance units only. Thus IRC Resistors come to you with a background of PROVED PERFORMANCE in almost any type of application you might name.*

## INTERNATIONAL RESISTANCE COMPANY

2100 Arch St.

PHILADELPHIA, PA.

TORONTO - LONDON - COPENHAGEN - MILAN - PARIS - BERLIN



---

*When writing to advertisers mention of the PROCEEDINGS will be mutually helpful.*





---

## A better way to connect remote control flexible shafts to radio receivers

---

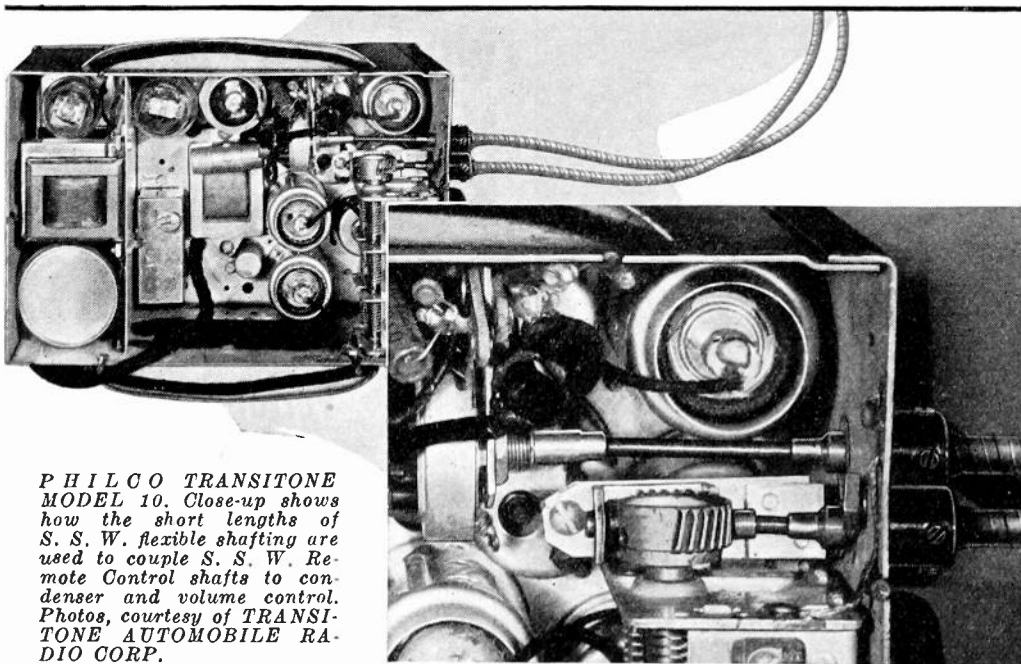

*PHILCO TRANSITONE MODEL 10. Close-up shows how the short lengths of S. S. W. flexible shafting are used to couple S. S. W. Remote Control shafts to condenser and volume control. Photos, courtesy of TRANSITONE AUTOMOBILE RADIO CORP.*

The method illustrated, was developed by PHILCO with S. S. WHITE cooperating. Instead of connecting the S. S. WHITE remote control flexible shafts direct to the solid shafts of the condenser and volume control, short lengths of the same shafting, with end fittings attached, are used inside the receiver as couplings.

*These flexible coupling shafts provide automatic alignment of the shafts of the condenser and the volume control with their respective holes in the receiver case, thus facilitating assembly of these units in the receiver.*

They also have the advantage of preventing any noise which may be caused by vibration of the outside shafts, from being

communicated to the sensitive parts of the receiver circuit.

*In the case of auto radios, the smaller the size of the receiver the better. It is possible that the use of flexible coupling shafts may permit of a rearrangement of receiver parts and a reduction in overall dimensions.*

Since these coupling shafts can be made up in any length and can be equipped with end fittings of varied design, they are practicable for all receivers.

*Call on us freely for further information about the use of flexible coupling shafts or for assistance in working out specific applications. No obligation is involved.*

---

**The S. S. WHITE Dental Mfg. Co. - INDUSTRIAL DIV.**  
**150-8 West 42nd. St. New York, N. Y.**

---

*When writing to advertisers mention of the PROCEEDINGS will be mutually helpful.*



**WHEN VERY ACCURATE  
MEASUREMENTS ARE  
REQUIRED ....**

*Specify* **TRIPLIET**  
5 INCH  
**Portable Instruments**

*This instrument is accurate within 1% . . . and, like the entire line of Triplet Precision Instruments, invariably preferred by engineers, experimenters, and in laboratories where very accurate readings are vital.*

Built in all popular ranges, this 5" instrument affords, in Model No. 525, a DC scale length of  $3\frac{1}{2}$ " . . . and in Model No. 535, an AC scale length of  $3\frac{1}{8}$ " . . . *with full mirror scale and knife edge pointer!* Marked binding posts on the lower edge of the Bakelite case afford easy lead connections.

Compare this, or any other Triplet Instrument, on every essential: advanced design . . . rugged, precision construction . . . and dependable, permanent accuracy. Prove for yourself their superiority . . . greater worth . . . and lasting satisfaction.

Your Jobber Can Supply You

**THE TRIPLIET ELECTRICAL  
INSTRUMENT CO.**

127 Main St., Bluffton, Ohio

**MAIL TODAY FOR DETAILS**

The Triplet Electrical Instrument Co.  
127 Main St., Bluffton, Ohio

Send me the facts on Triplet Instruments.

Name .....

Address .....

City ..... State .....

*When writing to advertisers mention of the PROCEEDINGS will be mutually helpful.*

# RADIO AND SCIENTIFIC LITERATURE

## Rider's Manuals

### THE "STANDARD" OF THE RADIO INDUSTRY

Engineers—Research Laboratories—  
Technical Schools—Patent Attorneys  
—Broadcasting Stations—all—who  
require accurate information about  
the electrical structure and compo-  
nents of American made radio re-  
ceivers produced during the past 15  
years—turn to Rider's Manuals.

The world's most complete tabulation  
of receiver circuit diagrams and re-  
lated data. More than 5100 pages  
covering from 1920 to 1935.

Volume I .. 1000 pages .. \$7.50  
Volume II .. 800 pages .. \$6.50  
Volume III .. 1070 pages .. \$7.50  
Volume IV .. 1064 pages .. \$7.50  
Volume V .. 1200 pages .. \$7.50

*Write for descriptive literature*

**JOHN F. RIDER, Publisher**  
1440 Broadway New York City

## PUBLISHERS

This Radio and Scientific  
Literature page is run to help  
you acquaint the readers of  
the Proceedings with your  
radio and technical publica-  
tions.

For further information as  
to rates, etc., address:—

Advertising Department  
Institute of Radio Engineers  
330 West 42nd Street  
New York, N.Y.

## Alphabetical Index to Advertisements

	A	
Aerovox Corp. ....		XXI
Allen-Bradley Company .....		IX
American Tel. & Tel. Co. ....		XI
	C	
Central Radio Laboratories .....		XXII
Cornell-Dubilier Corp. ....		X
	E	
Erie Resistor Corp. ....		XII
	G	
General Radio Co. ....		Outside Back Cover
	H	
Hammarlund Manufacturing Co. ....		XV
	I	
International Resistance Co. ....		XVI
I.R.E. ....		XIII, XIV, Inside Back Cover
	P	
Professional Eng. Directory .....		XX
	R	
Radio and Scientific Literature .....		XIX
	S	
S. S. White Dental Mfg. Co. ....		XVII
	T	
Triplett Elec. Inst. Co. ....		XVIII

*When writing to advertisers mention of the PROCEEDINGS will be mutually helpful.*

# PROFESSIONAL ENGINEERING DIRECTORY

## BLILEY ELECTRIC CO.

*Designers and Manufacturers  
of*

**QUARTZ CRYSTALS**  
*for*

*Standard or Special Requirements*

*Write for Catalog*

230 Union Station Bldg.  
ERIE, PENNA.

## PRACTICAL RADIO ENGINEERING

One year Residence Course  
Advanced Home Study Course  
Combined Home Study-Residence  
Course

*Write for details*

**Capitol Radio Engineering  
Institute**  
Washington, D.C.

## Cathode Ray Tubes and Associated Equipment For All Purposes

*Write for Complete  
Technical Data*

ALLEN B. DUMONT  
LABORATORIES  
UPPER MONTCLAIR, N.J.

## FOR MANY YEARS

the Professional Engineering Directory has helped consulting engineers, designers, and laboratory men make the right contacts in the radio industry. Perhaps we can help you with your problems too. For further information write to

*Advertising Department*  
**INSTITUTE OF RADIO  
ENGINEERS**

330 West 42nd Street  
NEW YORK, N.Y.

### *For the Engineering Consultant*

*who can handle a little extra business this year*

### *For the designer*

*who can manage some additional work*

### *For the Patent Attorney*

*who is anxious to develop a larger clientele*

we suggest the Professional Engineering Directory of the PROCEEDINGS I.R.E. Manufacturers and organizations with special problems who need services such as yours come to the Professional Engineering Directory for information. Your name and special services announced here will tell them what you do and where to find you. Further information will be furnished on request. Special rates to members of the Institute.

*When writing to advertisers mention of the PROCEEDINGS will be mutually helpful.*

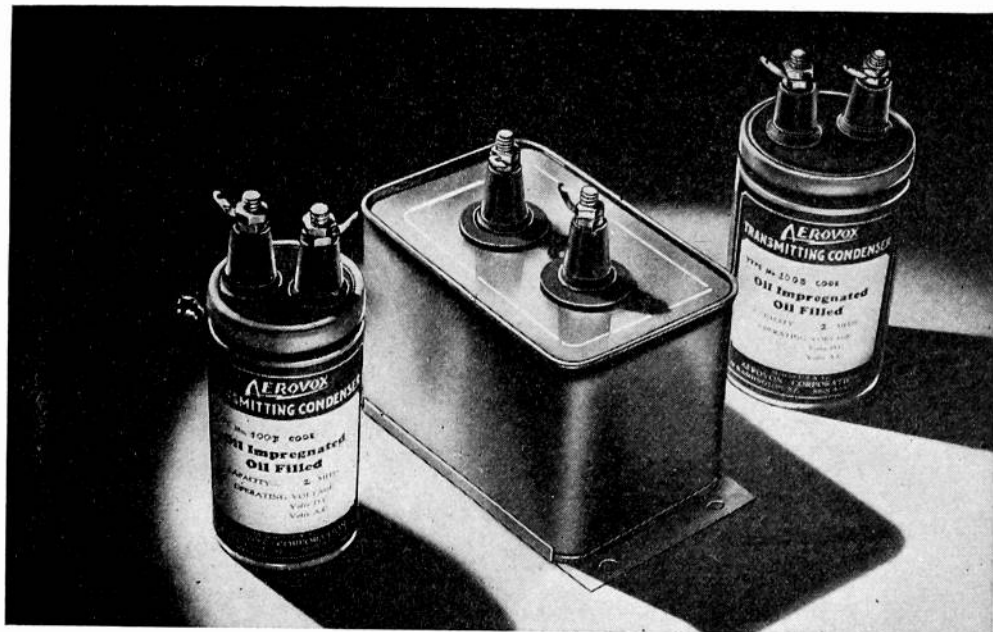

# Built to Stand the Gaff!

Sturdy oil-filled containers, hermetically sealed, positively seepage-proof.

Pure linen paper . . . finest paper dielectric available.

Plate flutter prevented by special section reinforcement or clamping.

Genuine high-tension pillar insulator terminals.

Cool operation . . . conservative ratings . . . maximum service life.

FOR those transmitters that must operate hour after hour, day after day, and over a period of years without replacements, Aerovox Oil-Filled Condensers are the logical choice.

A carefully engineered product . . . in round and rectangular containers . . . mass-produced for lowest prices at which quality components have ever been offered.

**Write for Data:** New 1935 Catalog covering Aerovox line of condensers and resistors, available on request. Also sample copy of monthly Research Worker. And do not hesitate to submit your capacitance and resistance problems for our engineering collaboration.



# AEROVOX

C O R P O R A T I O N

71 Washington St.

Brooklyn, N.Y.

*When writing to advertisers mention of the PROCEEDINGS will be mutually helpful.*



★ PICKET FENCE ATTENUATION

Some volume controls soon work on the picket-fence attenuation principle. The insulating oxide that forms on the contact surface and in time causes noisy attenuation is definitely eliminated in CENTRALAB'S smooth, non-rubbing contact.

The new CENTRALAB RADIOHM supplied in both high and low resistance units is never noisy and continues to give smooth, easy, constant performance thru the years.

Specify CENTRALAB on all original equipment.

CENTRALAB Division of Globe-Union Mfg. Co., Milwaukee



THE NEW  
PATENTED  
RADIOHM

**Centralab**  
CRL  
**RADIOHMS**

*When writing to advertisers mention of the PROCEEDINGS will be mutually helpful.*

# Take Your Choice

Every member of the Institute of Radio Engineers will want to wear one of these three attractive emblems. All of these emblems are appropriately colored to indicate the various grades of membership and each emblem is approximately the size of the following illustrations.



The **Lapel Button** is of 14k gold, with background enameled in the membership color, and with the lettering in gold. The screw-back on the back of this button fastens it securely to your coat.

\$2.75 postpaid—any grade.



The **Pin** is also of 14k gold. It is provided with a safety catch and is appropriately colored for the various grades of membership.

\$3.00 postpaid—any grade.



The **Watch Charm** handsomely finished on both sides, is also of 14k gold. This charm is equipped with a suspension ring for attaching to a watch fob or chain.

\$5.00 postpaid—any grade.

*Orders, accompanied by checks made payable to the Institute of Radio Engineers, should be addressed to*

**THE INSTITUTE OF RADIO ENGINEERS**

330 West 42nd Street  
NEW YORK, N.Y.

*Send in your order now!*

# AND NOW . . . . . . . . MODULATION MONITORING

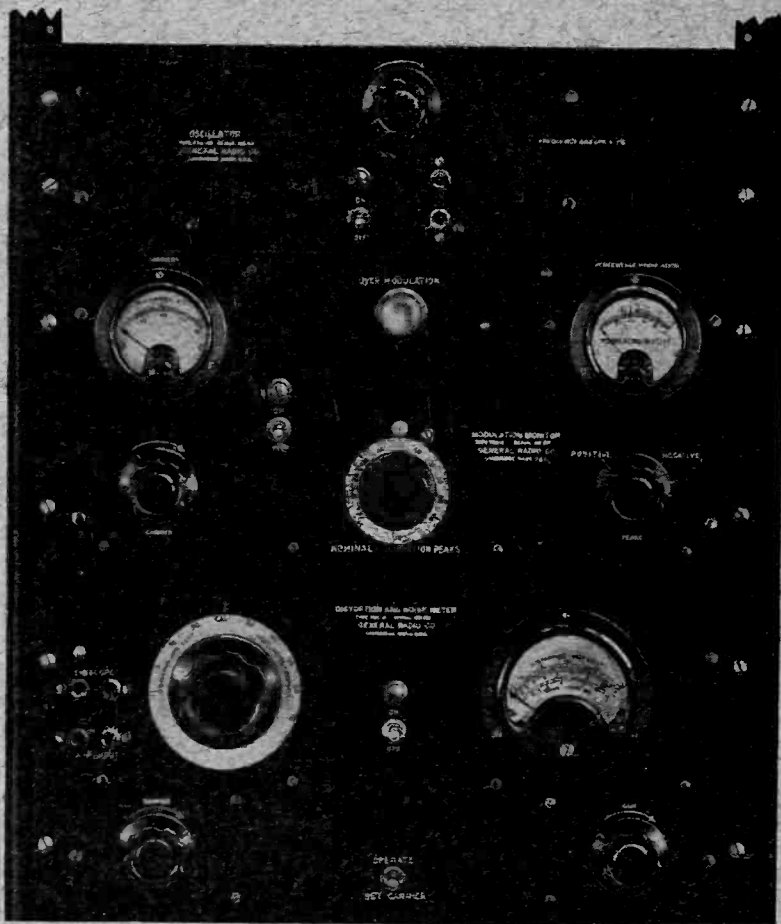

General Radio Class 730-A Transmission Monitoring Assembly

Continuous high-speed modulation monitoring—automatic and instantaneous over-modulation indication—percentage modulation measurements on both positive and negative peaks—measurement of carrier noise and hum levels—combined audio-frequency harmonic distortion of modulated envelope—harmonic distortion in:—speech-input amplifiers, field amplifiers, program amplifiers, line amplifiers and public address equipment—noise and hum levels of a-f amplifiers, wire lines and other equipment associated with the broadcast station.

All of these are measured simply, directly, and economically with the new **GENERAL RADIO CLASS 730-A TRANSMISSION MONITORING ASSEMBLY** Price \$462.00 Complete and ready to operate.

Detailed specifications in Bulletin M-R

**GENERAL RADIO COMPANY**  
30 STATE STREET, CAMBRIDGE A, MASSACHUSETTS