

VOLUME 23

JANUARY, 1935

NUMBER 1

PROCEEDINGS
of
The Institute of Radio
Engineers



Form for Change of Mailing Address or Business Title on Page XVI

Institute of Radio Engineers Forthcoming Meetings

TENTH ANNUAL CONVENTION
DETROIT, MICHIGAN
July 1, 2, and 3, 1935

DETROIT SECTION
January 18, 1935

LOS ANGELES SECTION
January 15, 1935

NEW YORK MEETING
January 2, 1935
February 6, 1935

PHILADELPHIA SECTION
January 3, 1935
February 7, 1935

PITTSBURGH SECTION
January 15, 1935

SAN FRANCISCO SECTION
January 18, 1935

WASHINGTON SECTION
January 14, 1935

PROCEEDINGS OF

The Institute of Radio Engineers

Volume 23

January, 1935

Number 1

Board of Editors

ALFRED N. GOLDSMITH, *Chairman*

R. R. BATCHER

G. W. PICKARD

H. H. BEVERAGE

K. S. VAN DYKE

F. W. GROVER

L. P. WHEELER

G. W. KENRICK

L. E. WHITTEMORE

WILLIAM WILSON

CONTENTS

PART I

Institute News and Radio Notes.....	1
December Meeting of the Board of Directors.....	1
Survey of Engineering.....	1
Radio Emmission of Standard Frequencies.....	1
Committee Work.....	3
Institute Meetings.....	4
Personal Mention.....	8

PART II

Technical Papers

Transmission and Reception of Centimeter Waves.....	
..... I. WOLFF, E. G. LINDER, AND R. A. BRADEN	11
Horizontal Rhombic Antennas.. E. BRUCE, A. C. BECK, AND L. R. LOWRY	24
A New System for the Remote Control of Radio Broadcast Receivers... JESSE B. SHERMAN	47
The Secondary Emission Phototube.....	
..... HARLEY IAMS AND BERNARD SALZBERG	55
The Temperature Coefficient of Inductance, with Special Reference to the Valve Generator..... E. B. MOULLIN	65
A Note on Fundamental Suppression in Harmonic Measurements..... HERBERT M. WAGNER	85
Contributors to this Issue.....	89

The Institute of Radio Engineers

GENERAL INFORMATION

INSTITUTE. The Institute of Radio Engineers was formed in 1912 through the amalgamation of the Society of Wireless Telegraph Engineers and the Wireless Institute. Its headquarters were established in New York City and the membership has grown from less than fifty members at the start to several thousand.

AIMS AND OBJECTS. The Institute functions solely to advance the theory and practice of radio and allied branches of engineering and of the related arts and sciences, their application to human needs, and the maintenance of a high professional standing among its members. Among the methods of accomplishing this is the publication of papers, discussions, and communications of interest to the membership.

PROCEEDINGS. The PROCEEDINGS is the official publication of the Institute and in it are published all of the papers, discussions, and communications received from the membership which are accepted for publication by the Board of Editors. Copies are sent without additional charge to all members of the Institute. The subscription price to nonmembers is \$10.00 per year, with an additional charge for postage where such is necessary.

RESPONSIBILITY. It is understood that the statements and opinions given in the PROCEEDINGS are views of the individual members to whom they are credited, and are not binding on the membership of the Institute as a whole. Papers submitted to the Institute for publication shall be regarded as no longer confidential.

REPRINTING PROCEEDINGS MATERIAL. The right to reprint portions or abstracts of the papers, discussions, or editorial notes in the PROCEEDINGS is granted on the express condition that specific reference shall be made to the source of such material. Diagrams and photographs published in the PROCEEDINGS may not be reproduced without making specific arrangements with the Institute through the Secretary.

MANUSCRIPTS. All manuscripts should be addressed to the Institute of Radio Engineers, 330 West 42nd Street, New York City. They will be examined by the Papers Committee and the Board of Editors to determine their suitability for publication in the PROCEEDINGS. Authors are advised as promptly as possible of the action taken, usually within two or three months. Manuscripts and illustrations will be destroyed immediately after publication of the paper unless the author requests their return. Information on the mechanical form in which manuscripts should be prepared may be obtained by addressing the secretary.

MAILING. Entered as second-class matter at the post office at Menasha, Wisconsin. Acceptance for mailing at special rate of postage is provided for in the act of February 28, 1925, embodied in Paragraph 4, Section 412, P. L. and R., and authorization was granted on October 26, 1927.

Published monthly by

THE INSTITUTE OF RADIO ENGINEERS, INC.

Publication office, 450-454 Ahnaip St., Menasha, Wis.

BUSINESS, EDITORIAL, AND ADVERTISING OFFICES

Harold P. Westman, *Secretary*

330 West 42nd Street, New York, N. Y.

INSTITUTE SECTIONS

- ATLANTA—Chairman, Henry L. Reid; Secretary, Philip C. Bangs, 23 Kensington Road, Avondale Estates, Ga.
- BOSTON—Chairman, E. L. Chaffee; Secretary, Roland G. Porter, Northeastern University, Boston, Mass.
- BUFFALO-NIAGARA—Chairman, L. E. Hayslett; Secretary, E. C. Waud, 235 Huntington Avenue, Buffalo, N. Y.
- CHICAGO—Chairman, Hugh S. Knowles; Secretary, John S. Meck, The Fensholt Company, 549 W. Washington St., Chicago, Ill.
- CINCINNATI—Chairman R. E. Kolo; Secretary, Helen Hymans, Crosley Radio Corporation, Cincinnati, Ohio.
- CLEVELAND—Chairman, F. T. Bowditch; Secretary, C. H. Shipman, 14805 Ardenall Ave., East Cleveland, Ohio.
- CONNECTICUT VALLEY—Chairman, K. S. Van Dyke; Secretary, C. B. De Soto, American Radio Relay League, 38 La Salle Rd., W. Hartford, Conn.
- DETROIT—Chairman, Samuel Firestone; Secretary, E. C. Denstaedt, Detroit Police Department, Detroit, Mich.
- LOS ANGELES—Chairman, H. C. Silent; Secretary, N. B. Neely, 1569 Munson Ave., Los Angeles, Calif.
- NEW ORLEANS—Chairman, J. A. Courtenay; Secretary, C. B. Reynolds, Radiomarine Corporation, 512 St. Peter St., New Orleans, La.
- PHILADELPHIA—Chairman, E. D. Cook; Secretary, R. L. Snyder, 103 Franklin Road, Glassboro, N. J.
- PITTSBURGH—Chairman, C. K. Krause; Secretary, H. V. Noble, c/o Gulf Research and Development Company, 327 Craft Ave., Pittsburgh, Pa.
- ROCHESTER—Chairman, H. J. Klumb; Secretary, H. A. Brown, 89 East Ave., Rochester, N. Y.
- SAN FRANCISCO—Chairman A. H. Brolly; Secretary, R. D. Kirkland, Mackay Radio and Telegraph Company, 22 Battery St., San Francisco, Calif.
- SEATTLE—Chairman, Howard Mason; Secretary, Raymond C. Fisher, 602 N. C St., Tacoma, Wash.
- TORONTO—Chairman, A. B. Oxley; Secretary, L. M. Price, Radio Valve Company of Canada, 189 Dufferin St., Toronto, Ont., Canada.
- WASHINGTON—Chairman T. McL. Davis; Secretary, C. L. Davis, Washington Building, 15th and G Sts. N. W., Washington, D. C.

**GEOGRAPHICAL LOCATION OF MEMBERS
ELECTED DECEMBER 5, 1934**

Elected to the Associate Grade

California	Oakland, 304 Foothill Blvd. Apt. 50.....	Ranche, D. R.
Connecticut	Bridgeport, General Electric Co., Bldg. 33-E.....	Vrooman, D. F.
Dist. of Columbia	Washington, 2217 Washington Circle, N.W.....	Hunt, C. M.
Louisiana	New Orleans, 518 St. Peter's St.....	Bailey, H. M.
	New Orleans, 338 Carondelet St.....	Gray, C. D.
Maryland	Baltimore, 5813 Gwynn Oak Ave.....	Gerhold, N. S.
Michigan	Detroit, 1226 Lillibridge.....	LeBarre, S. D.
New Jersey	East Orange, 256 Prospect St.....	Cleveland, R.
	East Orange, 376 Prospect St.....	Smith, D. Y.
	Teaneck, 979 Belle Ave.....	Graf, C. A.
New York	Brooklyn, 180 Gates Ave.....	Bainbridge, A. S.
North Dakota	Jamestown, 502 Milw. St.....	Koth, C.
Pennsylvania	Ardmore, 2938 Haverford Rd.....	Taylor, E. A.
	Haverford, Haverford College.....	Rittenhouse, I. H.
	Philadelphia, 1816 N. 17th St.....	Schuck, O. H.
	Philadelphia, 1510 Chew St.....	Smith, W. F., Jr.
	Pittsburgh, c/o U.S. Airways Radio Station, Municipal Air- port.....	Harrison, A. E.
Utah	Riverdale, KLO Transmitter, Rt. 4, Box 216A.....	Cozzens, W. D.
Argentina	Buenos Aires, Tacuari 471, 5° Piso C.....	Tenac, S. C.
Canada	Toronto 3, Ont., 48 Marmaduke St.....	Clark, W. B.
England	Liverpool 13, Lancs., 361 Queen's Dr.....	Lunt, C.
Germany	Pforzheim, Hohenstaufenstr 17.....	Landmann, A.
India	Bangalore, Dept. of Communication Eng., Indian Institute of Science.....	Rao, V. L.
	Jubbulpore, c/o Mr. Karam Singh.....	Ahluwalia, B. S.
	Nellore, c/o District Board Engineer.....	Durrani, U.
Ireland	Belfast, Whitehouse Park, Whitehouse.....	Donaghy, J. L.
Italy	Monza, Casella Postale 66.....	Jenny, F.
Japan	Fukuchiyama, Nr. Kyoto, Shimoshin.....	Takagi, T.
New Zealand	Auckland, 38 Winstone Bldgs., 69-77 Queen St.....	McRae, I. H.
	Gisborne, Waerenga-a-hika R.D.....	Paulson, E. J.

Elected to the Junior Grade

Pennsylvania	Quakertown, 19 Belmont Ave.....	Afflerbach, E. K.
--------------	---------------------------------	-------------------

Elected to the Student Grade

Dist. of Columbia	Washington, 508 Potomac Park Apts., 21 and C St., N.W....	Lohnes, G. M.
Massachusetts	Brookline, 2 Charles St.....	Bacon, F. S., Jr.
	Cambridge, M. I. T. Dormitories.....	Peterson, A.
Mississippi	Sherard.....	Ratliff, W. H., Jr.



APPLICATIONS FOR MEMBERSHIP

Applications for transfer or election to the various grades of membership have been received from the persons listed below, and have been approved by the Admissions Committee. Members objecting to transfer or election of any of these applicants should communicate with the Secretary on or before January 31, 1935. These applications will be considered by the Board of Directors at its meeting on February 6, 1935.

For Election to the Associate Grade

California	Glendale, 360 W. Broadway Half Moon Bay, Kelly Ave Los Angeles, 524 N. Sierra Bonita Ave	Read, G. W. Silva, W. Daily, C. R.
Georgia	Atlanta, 1048 Woodland Ave. S.E.	Fowler, N. B.
Maine	South Portland, 28 Margaret St.	Robbins, I. L.
Michigan	Ann Arbor, 711 Packard St	Misener, G. C.
Minnesota	Fergus Falls, Radio Station KGDE	Engelter, G. H.
New Jersey	Magnolia, Evesham Ave	Banca, M. C.
New York	Long Island City, 32-14-38th St New York City, 47 E. 64th St New York City, Bell Tel. Labs., 463 West St New York City, 1 Seaman Ave	Gorbunoff, A. Carlebach, W. M. Kammerer, F. W. Treitel, L. M.
Ohio	Cleveland, 2866 E. 100th St	Malgom, D.
Pennsylvania	Philadelphia, 713 Garland St. Philadelphia, 163 W. Roosevelt Blvd Philadelphia, 4131 Glendale St. Philadelphia, 979 N. Lawrence St	Freeland, E. C. Schnitzer, B. E. Scott, F. M. Stec, C.
Rhode Island	Providence, 205 Unit St.	Altieri, E. S. A.
Argentina	Buenos Aires, Paysandu 39	Penin, R. L.
Australia	Waverley, Sydney, Cinesound, Ebley St	Cross, C. E.
England	Exmouth, Devon, 23 Rosebery Rd Knightbridge, London S.W.	Short, H. E. De Lasso, S. P.
France	Serne, 4 Rue du Ponceau, Chatillon-sous-Bagneux	Rullier, A.
Japan	Kumamoto, c/o Kumamoto Central Broadcasting Station	Sadahiko, H.
Sweden	Blocket, Lidings 3	Stannow, J. C.

For Election to the Student Grade

Georgia	Atlanta, Georgia School of Tech, Box 22	Preston, J. G.
Massachusetts	Cambridge, M I T. Dormitories Cambridge, M I T. Dormitories Cambridge, M I T. Dormitories Cambridge, M I T. Dormitories Somerville, 191 Willow Ave	Monderer, B. A. Mueller, C. W. Pepperberg, L. Packard, L. E.
New Jersey	Union City, 141-33rd St	Zweifel, F. A.
New York	Port Chester, 32 Indian Rd	Fingerle, W., Jr
Washington	Pullman, 724 College Station	Alhaon, G. P.
Canada	Outremont, P. Q., 660 Querbes Ave	Bloom, D.

OFFICERS AND BOARD OF DIRECTORS, 1934

(Terms expire January 1, 1935, except as otherwise noted)

President

C. M. JANSKY, JR.

Vice President

BALTH. VAN DER POL, JR.

Treasurer

MELVILLE EASTMAN

Secretary

HAROLD P. WESTMAN

Editor

ALFRED N. GOLDSMITH

Directors

W. G. CADY, *Junior Past President*

O. H. CALDWELL

J. V. L. HOGAN

L. C. F. HORLE

C. W. HORN

E. L. NELSON

E. R. SHUTE

A. F. VAN DYCK

H. A. WHEELER

Serving until January 1, 1936

R. A. HEISING

L. M. HULL, *Junior Past President*

F. A. KOLSTER

H. M. TURNER

Serving until January 1, 1937

ARTHUR BATCHELLER

WILLIAM WILSON

INSTITUTE NEWS AND RADIO NOTES

December Meeting of the Board of Directors

The regular meeting of the Board of Directors was held on December 5 at the Institute office and those present were C. M. Jansky, Jr., president; O. H. Caldwell, J. V. L. Hogan, L. C. F. Horle, C. W. Horn, F. A. Kolster, E. L. Nelson, E. R. Shute, H. M. Turner, A. F. Van Dyck, H. A. Wheeler, William Wilson, and H. P. Westman, secretary.

Thirty applications for Associate membership, one for Junior, and four for Student grade were approved.

The Rochester Section was authorized to hold the 1935 Rochester Fall Meeting on November 18, 19, and 20.

The National Convention will be held in Detroit on July 1, 2, and 3, 1935, with headquarters at the Hotel Statler.

An invitation from the Radio Manufacturers Association to appoint a representative on a committee to consider the problem of reducing interference to radio reception was accepted.

Survey of Engineering

The U. S. Department of Labor in cooperation with the American Engineering Council is preparing to make a survey of all engineering professions in the United States. It is expected that unsigned confidential questionnaires will be received from about 100,000 individuals and give data on salary trends, types of employers and duties over the past several years, educational background, and other facts designed to give a true picture of the engineer's status. This is believed to be the most comprehensive nation-wide study ever made of a professional group and it is hoped that the results may be of immediate practical application to the problem of engineering employment. The Institute is supplying a complete list of its members in the United States for this purpose and it is anticipated that the members will receive these questionnaires in the near future. You are urged to devote the necessary time to filling in this questionnaire and seeing that it is returned promptly so as to facilitate this extremely valuable analysis of conditions in the professions.

Schedule of Radio Emissions of Standard Frequency

The National Bureau of Standards announces changes in its schedule of standard frequency emissions from its station WWV,

Beltsville, Md., near Washington, D. C. The changes will substantially increase the service available to transmitting stations for adjusting their transmitters to exact frequency, and to the public for calibrating frequency standards and transmitting and receiving apparatus.

The emissions will be on two days a week instead of one day as formerly, and will be on the three frequencies, 5000, 10,000, and 15,000 kilocycles per second, instead of the single frequency, 5000. The changes are the result of experimental emissions made by the Bureau on 10,000 and 15,000 kilocycles, with the aid of a large number of organizations and persons who observed the received signals at various places. These tests showed that service could be rendered at all distances in the daytime by the use of the three frequencies. With the use of 5000 kilocycles alone it was necessary to have emissions at night in order to give service at distances greater than a few hundred miles from Washington. With the use of the three frequencies no night emissions will be necessary.

Of the emissions now scheduled, those on 5000 kilocycles are particularly useful at distances within a few hundred miles from Washington, those on 10,000 kilocycles are useful for the rest of the United States, and those on 15,000 kilocycles are useful in the United States and other parts of the world as well.

Beginning February 1, 1935, and continuing each Tuesday and Friday thereafter (except legal holidays) until further notice, three frequencies will be transmitted as follows: noon to 1 p.m., Eastern Standard Time, 15,000 kilocycles; 1:15 to 2:15 p.m., 10,000 kilocycles; 2:30 to 3:30 p.m., 5000 kilocycles.

The emissions consist mainly of continuous, unkeyed carrier frequency, giving a continuous whistle in the phones when received with an oscillating receiving set. For the first five minutes the general call (CQ de WWV) and the announcement of the frequency are transmitted. The frequency and the call letters of the station (WWV) are given every ten minutes thereafter.

The accuracy of the frequencies transmitted is at all times better than a part in five million. From any of them, using the method of harmonics, any frequency may be checked. Information on how to receive and utilize the signals is given in a pamphlet obtainable on request addressed to the National Bureau of Standards, Washington, D. C.

The Bureau desires to receive reports on reception of these emissions, especially because radio transmission phenomena change with the seasons of the year. The data desired are approximate field intensity, fading characteristics, which of the three frequencies is re-

ceived best, and the suitability of the signals for frequency measurements. It is suggested that in reporting on intensities, the following designations can be used where field intensity measurement apparatus is not used: (1) hardly perceptible, unreadable; (2) weak, readable now and then; (3) fairly good, readable with difficulty; (4) good, readable; (5) very good, perfectly readable. Statements are desired as to the intensity of atmospherics and as to whether fading is present or not, and if so, its characteristics, such as time between peaks of signal intensity. Correspondence should be addressed to the National Bureau of Standards, Washington, D. C.

Committee Work

STANDARDIZATION

I. R. E. STANDARDS COMMITTEE

A meeting of the Executive Committee of the Institute's Standards Committee was held at the Institute office on November 27 and was attended by Haraden Pratt, chairman; J. V. L. Hogan, H. F. Olson, J. C. Schelleng, B. E. Shackelford, H. A. Wheeler, and H. P. Westman, secretary.

The meeting was devoted to an analysis of the problems facing the Standards Committee and its technical committees. Procedures for operation were outlined and a tentative schedule of meetings for the various committees proposed.

TECHNICAL COMMITTEE ON ELECTRONICS—I. R. E.

A meeting of the Subcommittee on Small High Vacuum Tubes operating under the Technical Committee on Electronics of the Institute's Standards Committee was held at the Institute office on December 5. Those present were P. T. Weeks, chairman; M. Cawein, George Lewis, H. A. Pidgeon, E. W. Shafer, and H. P. Westman, secretary.

The scope of operation of this committee was first outlined and the balance of the meeting devoted to a discussion of certain general and specific recommendations to be considered in the work of reviewing and preparing additions to the 1933 Standards Report.

TECHNICAL COMMITTEE ON VACUUM TUBES—A. S. A.

The Technical Committee on Vacuum Tubes operating under the Sectional Committee on Radio held a meeting in the Institute office on November 16. It was attended by M. J. Kelly, chairman; George Lewis, Walter Lyons (representing N. P. Case), D. F. Schmidt, and Gordon Thompson.

The scope of operation of this committee was reviewed first and a number of items to be considered by it were outlined and arrangements made for their consideration. The material being prepared by the Subcommittee on Electronics operating under the Sectional Committee on Electrical Definitions is to be reviewed to ascertain what additional material may be suitable for recommendation.

Institute Meetings

CLEVELAND SECTION

F. T. Bowditch, chairman, presided at the October 26 meeting of the Cleveland Section held at the Case School of Applied Science at which a paper on "Amateur Radio at the National Soaring Contest" was presented by L. S. Fox of the National Carbon Company.

He first described the various types of gliders giving their capabilities and notes on their records as to length of flights, duration, and elevation attained. In the earlier contests, only one radio ground station was used but in the last contest two mobile and one ground station were employed. The mobile stations followed the flights as closely as possible and in one case were able to summon an ambulance from the city and have it at hand in a very few minutes after a crash occurred. The fixed station was used to keep the fliers informed as to air conditions. Transmission occurred at about fifty-six megacycles and the gliders carried small transceivers weighing about fifteen pounds.

Photographs and a motion picture film were used to illustrate the paper and one of the transceivers was exhibited and its design and construction discussed. The attendance was thirty-two.

The November meeting was held on the 30th at Case School of Applied Science and Chairman Bowditch presided. A paper on "Crystal Audio Devices and their Circuit Requirements" was presented by C. M. Chorpening, chief engineer of Astatic Microphone Laboratory. In it he sketched the development of crystals by Brush Laboratories, and their use in pick-ups, microphones, recorder heads, and loud speakers. Graphs showed the types of response obtained when various elements of the circuit were changed. The various effects of different coupling systems were illustrated and methods of changing the response characteristics of the device and circuit shown.

The report of the Nominating Committee was read as was a letter concerning the obtaining of new members. Professor Martin was appointed as Membership Committee chairman. The attendance was thirty-six.

CONNECTICUT VALLEY SECTION

K. S. Van Dyke, chairman, presided at the November 22 meeting of the Connecticut Valley Section held at the Hotel Garde in Hartford.

Reuben Lee of the Westinghouse Electric and Manufacturing Company presented a paper on "New Slants on Filter Networks" in which he described common types of filters. The characteristic graphs for a single low-pass telephone section were presented to illustrate the cut-off frequency, the manner in which the attenuation varied, and the effect of proper and improper termination. Power supply filters were then discussed and it was pointed out that they differed from telephone filters in their termination and formulas were given for computing the attenuation of choke-input filters.

Many angles of the problem were presented in the discussion which included mechanical analogies, crystal filters, and various details of electrical filters. Messrs. Ellsworth, Lamb, Madsen, McNamara, Noble, and Van Dyke of the thirty-two who were present participated in the discussion.

DETROIT SECTION

A meeting of the Detroit Section was held on November 16 in the Detroit News Conference Room. Samuel Firestone, chairman, presided and the attendance was sixty-five of whom nine were present at the informal dinner which preceded the meeting.

A paper by S. W. Edwards of the Detroit office of the Federal Communications Commission was on the subject "Field Strength Measurement." In it he outlined the history of this work from the first spot measurements in 1924. He pointed out that the first actual survey was made on Broadcast Station WEAJ in 1926 and described the present methods used in making surveys. Radials are drawn and a 250-watt oscillator set up at a selected site. A preliminary survey is made not more than a few wavelengths away from the transmitter. If these measurements indicate the location to be poor, a new site is tried. The final survey maps show contour outlines for signal strengths of 10,000, 2,000, and 500 microvolts per meter.

Some of the troubles experienced in these surveys attributable to proximity to electrical circuits and power lines were described. By means of slides he illustrated the effect of power circuits, near-by buildings, hills, and other factors on the field of an antenna. As an illustration of the use of field strength maps for advertising purposes, he showed one in which all territory within the 500-microvolt/meter line was covered by pictures indicating the industries and things for which the various cities and sections were noted.

NEW YORK MEETING

The December meeting of the Institute in New York City was held on the 5th at the Engineering Societies Building and was devoted to "A Review of Radio Developments during 1934." Its purpose was to bring to the attention of Institute members the advances which have been made in radio. It is realized that many advances are not known to everyone and the full effects of some are not evident immediately except to specialists in the particular field. Five subdivisions were made.

"Radio Communication in the Fixed Services" was reviewed by Haraden Pratt, chief engineer of the Mackay Radio and Telegraph Company; "Radio Communication in Mobile Services" was treated by I. F. Byrnes, chief engineer of the Radiomarine Corporation of America; "Radio Broadcast Transmission" was covered jointly by H. A. Chinn of the Columbia Broadcasting System and C. W. Horn of the National Broadcasting Company; "Radio Broadcast Reception" was discussed by R. H. Langley, consultant of New York City, and "Allied Fields" was the scope of the review prepared by J. K. Henney of "*Electronics*."

The meeting was presided over by President Jansky. A. F. Van Dyck, chairman of the New York Program Committee, pointed out the reasons for presenting this type of program and the hope that it might be made an annual event. The attendance was four hundred fifty.

PHILADELPHIA SECTION

The Philadelphia Section met on November 1 at the Engineers Club. E. D. Cook, chairman, presided and the attendance was ninety-two. Those present at the dinner which preceded the meeting numbered nine.

A paper on "The Compandor, an Aid Against Static in Radio-telephony" was presented by R. C. Mathes, associate wire transmission research director of Bell Telephone Laboratories.

The necessity of using commercial radio telephone circuits without interruption prompted the development of the Compandor. This consists of terminal vacuum tube circuits which operate on signals in the audio-frequency range so as to intensify the weaker sounds and at the receiving point restore them to normal. Speech intensity is limited to a range of about fifteen decibels which can usually be transmitted above the noise level. Without it, the speech range would cover about thirty decibels and frequently the weaker sounds are masked by noise.

The audio-frequency amplifying tubes are provided with a fluctuat-

ing grid bias obtained by rectifiers and filters. This bias is proportional directly or to some root of the original envelope. By this means variable amplification or loss can be provided at each end of the circuit operated by the fluctuating intensity of the speech within the time of a single syllable. Thus the envelope of the most useful signal intensities can be altered as desired for transmission through a noisy link and restored substantially to its original form at the receiving terminus.

Oscillographs of speech waves before, during, and after passing through the Comandor were shown. Phonograph records demonstrated its effect on speech passed over the equivalent of the transatlantic circuit. The original speech, its modification by the compressor, and its restoration to normal by the expander under varying static intensities were illustrated and the improvement readily detected.

Messrs. Bedford, Beers, Chambers, Cook, Kellogg, Luck, McIlwain, Stone, and Wolff participated in the discussion.

PITTSBURGH SECTION

The November 13 meeting of the Pittsburgh Section was held jointly with the American Institute of Electrical Engineers section in the William Penn Hotel. Three hundred were present.

A paper by S. G. Hibben of the Westinghouse Lamp Company was presented on the subject of "Lights, Highlights, and Side Lights on European Nights." It was based upon Mr. Hibben's observations while traveling through most of the large countries of Europe during the past several months. Demonstrations were made using modern and future lamps and lighting systems. Since the eye is most sensitive to yellow light sodium-vapor lamps give the greatest light and shadow detail and are used in some European countries for lighting roads used for high speed night traffic. Cadmium-vapor lighting was described as being excellent for "make-up" being rich in green and blue while zinc-vapor having an abundance of pink was an excellent "beautifier" making skin appear clearer and more pleasing. A mercury lamp was used for approximating sunlight conditions. Various combinations of lights gave startling and pleasing effects.

ROCHESTER FALL MEETING

The Rochester Fall Meeting for 1934 was held at the Sagamore Hotel in Rochester on November 12, 13, and 14. The detailed program of the meeting was published in the November PROCEEDINGS.

The attendance totaled 286 of which 250 were not local. Fifteen

states and four foreign countries, Australia, Canada, Germany, and Sweden, were represented as were 126 companies and fourteen institutions and governmental departments.

SAN FRANCISCO SECTION

The San Francisco Section met on November 21 at the Bellevue Hotel with Ralph Shermund, vice chairman, presiding. Twenty-four were present and half of these attended the dinner which preceded the meeting.

A paper on "New Developments in Decibel Meters and Photronic Cells" was presented by H. L. Olesen of the Weston Electrical Instrument Corporation. It was discussed by Messrs. Freiermuth, Gary, Greaves, Linden, Royden, Somers, and Whitten.

SEATTLE SECTION

A meeting of the Seattle Section was held on September 14 at the University of Washington and Howard Mason, chairman, presided. The attendance was twenty-five.

A. W. Clement of Bell Laboratories presented a paper on "Filters for Program Systems" in which he outlined the requirements and problems involved in the filters installed on the new program circuits between Chicago and San Francisco. These are capable of handling frequencies between fifty and 8,000 cycles and graphs were exhibited to illustrate the degree to which amplitude and delay distortion had been minimized. Newer methods developed for the design and pre-calculation of filters and similar networks were shown. The results of listening tests made on a loop of two transcontinental circuits employing these elements as compared with a high quality reference circuit were given.

Personal Mention

E. H. I. Lee of the Federal Communications Commission, engineering department, has been transferred as inspector in charge of the Detroit, Michigan, office.

L. W. Nuesse, Lieutenant, U.S.N., has been transferred from Philadelphia to Washington, D. C.

J. H. Pressley has left Zenith Radio Corporation to join the staff of Philco Radio and Television Company in Philadelphia.

W. R. Wilson of the Canadian Marconi Company has been transferred from Yamachiche to Mt. Royal, Quebec, Canada.

Previously with Lear Developments, R. S. Yoder has joined the engineering staff of Galvin Manufacturing Corporation of Chicago, Ill.

A. V. Loughren formerly with RCA Victor Company, has joined the engineering staff of the General Electric Company at Bridgeport, Conn.

Previously with Freed Television and Radio Corporation, R. F. Shea has become chief research engineer for the Empire Electrical Products Company of New York City.

P. G. Andres formerly with the Yaxley Manufacturing Company is now engineer in charge of construction of the Indiana State Police Radio System, Indianapolis.

L. B. Bender has been promoted from Major to Lieutenant Colonel in the U.S. Army Signal Corps and transferred from Columbus, Ohio, to Wright Field, at Dayton, Ohio, in charge of the Aircraft Radio Laboratory.

C. W. Brewington, Lieutenant Commander, U.S.N., has been transferred from the U.S.S. Vestal to the U.S.S. Trever basing at San Diego, Calif.

Geoffrey Builder previously at the University of Sydney, Australia, has become engineer in charge of the Standards Laboratory for Amalgamated Wireless at Sydney.

E. W. Dannals is now with Premier Crystal Laboratories of New York City having previously been in charge of WEVD.

J. B. Dow, Lieutenant, U.S.N., is now at the Bureau of Engineering, Washington, D. C., having been transferred from the U.S.S. Utah.

Having previously been with the Governments Electrotechnical Works, Nicholas Feldman has joined the engineering staff of Valsts Elektrotehniska Fabrika of Riga, Latvia.

Formerly doing graduate work at the Technical Institute of Vienna, P. M. Honnell has joined the staff of the Texaco Development Corporation at Houston, Texas.

Previously with Thordarson Electric Manufacturing Company, W. C. Howe has joined the electrical engineering staff of the Webster Company of Chicago, Ill.

C. K. Jen has become Professor of Physics and electrical engineer at the National Tsing Hua University at Peiping, China, having formerly been with the National University of Shantung.

H. W. Kitchin, Lieutenant Commander, U.S.N., has been transferred from Cavite, P.I., to the Navy Yard at Bremerton, Wash.

M. K. Kunins formerly in charge of the Buffalo office of the Federal Communications Commission is now associated with *Radio World* as technical editor.

Previously with L. M. Ericsson, E. O. Lofgren has joined the faculty of Royal Technical University of Stockholm, Sweden.

E. H. Loftin formerly located in New York City has established an office as business consultant in Washington, D. C.

F. J. Mecedo formerly with the Radio Corporation of New Zealand has joined the staff of Turnbull and Jones, Ltd., of Wellington.

W. D. Mallinson of Standard Telephones and Cables, Ltd., has been transferred from England to Sydney, New South Wales, Australia.

Previously with U.S. Radio and Television Corporation, L. P. Morris has joined the staff of General Household Utilities.

Formerly with Hygrade Sylvania Corporation, D. W. Short has joined the transmitter department of the RCA Victor Company of Camden.

Previously with Burgoyne Wireless, Ltd., A. R. Twiss is now production engineer for Regentone, Ltd., of Isleworth, Middlesex, England.

E. M. Webster formerly Lieutenant Commander of the U.S.S. Coast Guard has become assistant chief of the telegraph section of the engineering division, Federal Communications Commission, Washington, D. C.



TECHNICAL PAPERS

TRANSMISSION AND RECEPTION OF CENTIMETER WAVES*

BY

I. WOLFF, E. G. LINDER, AND R. A. BRADEN

(RCA Victor Co., Camden, New Jersey)

Summary—Apparatus is described consisting of a new type split-anode magnetron, which has been used to generate 2.5 watts of energy at 9 centimeters wavelength, with an efficiency compared to direct-current plate dissipation of 12 per cent. The methods used for measuring the tube output energy and the radiated energy are explained. Measurements of attenuation made with this apparatus up to distances of 16 miles line-of-sight through air indicate that an inverse distance law for field strength is obeyed. Modulation of the waves by means of variation in the transmission of an ionized gas is described. A summary is given of some experiments which have been made using rectifying crystals, positive grid tubes, and magnetrons as centimeter wave detectors.

IN THIS article a general description is given of practical apparatus for the generation and reception of centimeter waves. Data are presented with regard to the attenuation of nine-centimeter waves through the air. More detailed information with regard to separate parts of the equipment will be presented in a series of separate publications.

As is well known, wavelengths as low as seventeen centimeters have been used successfully for communication across the English Channel¹ and continuous waves of as low as one centimeter have been produced in the laboratory by C. E. Cleeton and N. H. Williams at the University of Michigan,² these one-centimeter waves, however, having a very small energy. It has been the aim of this development to study the production of electromagnetic waves of a length less than 10 centimeters. Since the apparatus which is used to produce the shorter waves is essentially the same as that used in the neighborhood of 10 centimeters, with the exception of a reduction in size, the results which are described here are also applicable to production of the shorter waves.

* Decimal classification: R355.5 × R361. Original manuscript received by the Institute, August 29, 1934. Presented before Ninth Annual Convention, Philadelphia, Pa., May 30, 1934. Presented before Rochester Fall Meeting, Rochester, N. Y., November 12, 1934.

¹ *L'Onde Electrique*, vol. 11, p. 53, (1932).

² *Phys. Rev.* vol. 45, p. 234, (1934).

The split-anode magnetron tube which has been described by Okabe³ has been used as the basis for this development. A number of essential improvements have been made which have added greatly to its stability and power handling capacity. A brief note describing this tube has already been published by Linder;⁴ a more detailed paper will be published soon.

We have called the tube which has been developed an end-plate magnetron as a descriptive designation. It has been capable of developing outputs of two and one-half watts at nine centimeters. The efficiency, comparing nine-centimeter generated energy to the sum of anode and end-plate dissipation, is approximately twelve per cent. The power generated in the oscillating circuit was determined by a heat radiation method similar to that described by Wenstrom.⁵ A

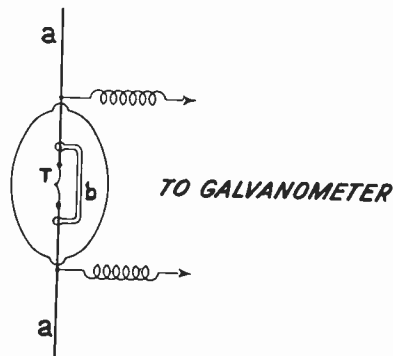

Fig. 1—Half-wave thermojunction radiation indicator.

thermocouple, connected to a galvanometer was fastened against the glass bulb near the region of the plate for the purpose of indicating temperature. The magnetron was then set into oscillation and the galvanometer deflection noted. The direct-current plate power input was measured. Oscillations were then stopped by detuning the transmission line with consequent increase in plate temperature because the energy absorbed by the oscillations was no longer being taken away. Plate potential was next reduced until the galvanometer gave the same deflection as when oscillations were taking place, indicating that the temperature of the plate was the same. The direct-current power being absorbed was measured again. The reduction in plate power which was necessary to maintain the plate at the same temperature represented the energy going into oscillations. The difference between the direct-current plate input when oscillating and that when not oscillating is the power generated.

³ Proc. I.R.E., vol. 17, p. 652; April, (1929).

⁴ Phys. Rev., vol. 45, p. 656, (1934).

⁵ Proc. I.R.E., vol. 20, p. 113; January, (1932).

This method is valid only if the heat radiation pattern from the tube is the same when the tube oscillates or does not oscillate. For this reason an ordinary split-anode magnetron was used instead of an end-plate magnetron, since the radiation pattern of the latter changes when going from a nonoscillating to an oscillating state. This is due to the fact that when oscillating the end plates are hotter than the regular plates, whereas the reverse is true when not oscillating.

By means of this procedure, a radiation indicator for nine-centimeter waves was calibrated in terms of energy in the oscillating circuit of the magnetron. The radiation indicator consisted of a half-wave antenna having a thermojunction at its mid-point and was placed at a fixed distance from the radiating antenna. It is shown in Fig. 1. The antenna wires a were of 0.010-inch "dumet" wire. The junction T consisted of 0.007-inch constantin and chromel, and was 0.5 centimeter long. The resistance of the junction was 10 ohms. A U-shaped glass brace b supported the antenna wires a , while the thermocouple was welded in place, and while it was sealed into the glass bulb. The bulb was about two centimeters in diameter, and was highly evacuated. This calibrated indicator could then be used to measure the oscillation energy of any other tube, end-plate or otherwise.

The radiated power has been checked by measuring the field strength at points on a sphere about the transmitter, using a radiation indicator similar to that described above, and also by lighting one-watt lamps. It was found to be over one watt. In determining the radiated output using the thermojunction, the following procedure in making measurements and calculations was used.

The thermojunction and galvanometer were calibrated for sensitivity using an audio frequency. A calculation having shown that negligible skin effect was to be expected in wires of the diameter and resistivity of the junction wires at 3000 megacycles, we assumed that its sensitivity would remain the same at the higher frequencies.

To compute field strength we used the formula $E = (R_T + R_R + R_m)I/l$ where I is the current in the thermojunction in amperes, E the field strength in volts per centimeter, l the effective length, R_T the resistance of the junction, R_R the radiation resistance, and R_m miscellaneous other losses such as leaky chokes, effective resistance of wires not in the thermojunction, and dielectric absorption. The effective length and radiation resistance are given by Carter.⁶ For a half-wave antenna, $l = \lambda/\pi$, and R_R is approximately 74 ohms. Using the above formula, the field strength was calculated giving in conjunction with the directional characteristic, all the information required to compute

⁶ Proc. I.R.E., vol. 20, p. 1004; June, (1932).

this point certain of the electrons no longer have sufficient velocity to reach the anodes and describe longer spiral paths to the end plates.

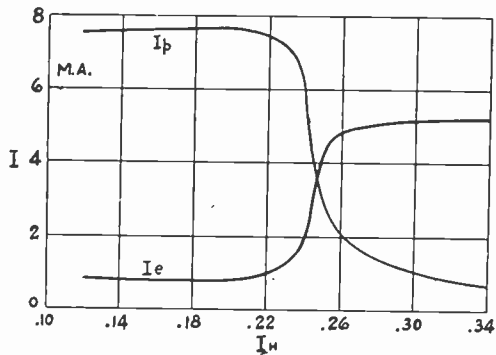

Fig. 4—Plate-current—magnetic-field characteristics, nonscillating condition, end-plate magnetron.

The effect of oscillations is shown in Fig. 5. The upper curve is proportional to the oscillation intensity. The characteristics are similar to those of the nonscillating condition except for greater currents in

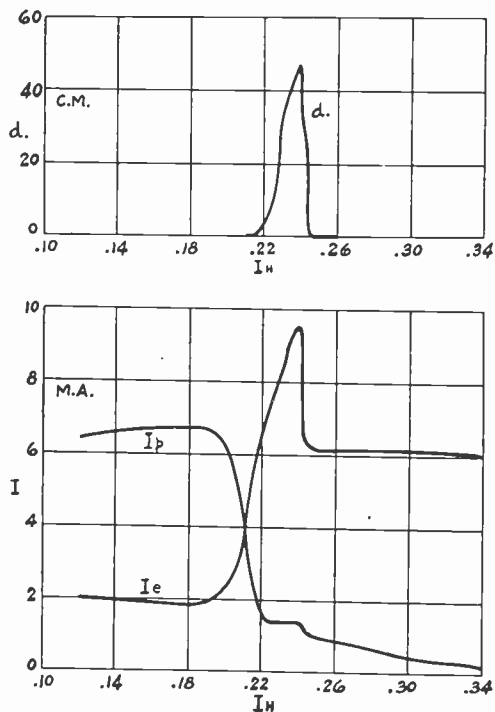

Fig. 5—Plate-current—magnetic-field characteristics, oscillating condition, end-plate magnetron.

the oscillation region. This is caused by an increase in filament emission which is probably a result of additional heating by electron bombardment and possibly some secondary emission.¹⁰

¹⁰ E. C. S. Megaw, *Nature*, vol. 132, p. 854, (1933).

The transmission and radiation systems are shown in Fig. 6, and consist merely of a dipole antenna in the focus of a parabolic reflector.

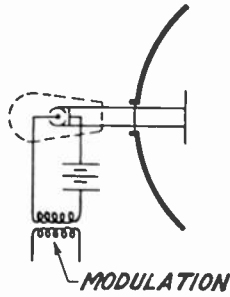

Fig. 6—Plate modulation and radiation system; nine-centimeter transmitter.

The length of the transmission line must be adjusted to correspond to the wavelength being generated, the distance from the shorting bar,

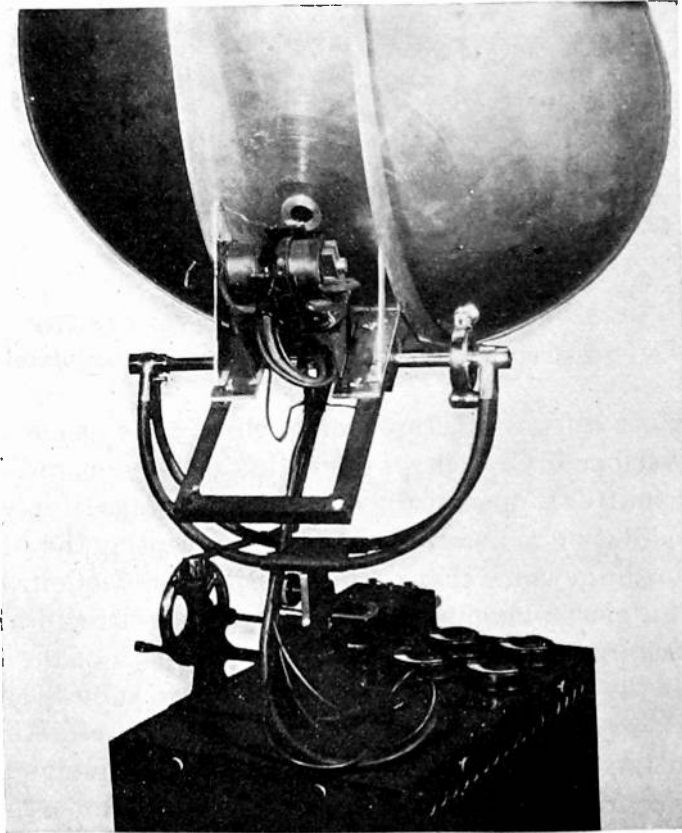

Fig. 7—Nine-centimeter transmitter with power supply units.

which is adjacent to the anodes, to the antenna being a multiple of a half wavelength. A photograph of the complete transmitter is shown in Fig. 7.

the energy flux density and energy flux on a sphere about the transmitter. R_m was assumed negligible, making the computed value of E and therefore the radiated energy too small if this assumption is not justified.

In explaining the action of the end-plate magnetron, we shall first review briefly the theory of the simple split-anode magnetron when used as an electronic oscillator.

A diagrammatic representation of such a tube with attached radiating circuit is shown in Fig. 2. In order to generate oscillations, the anode potential and magnetic field must be adjusted so that electrons which leave the filament are deflected by the magnetic field so that they barely graze the anode. With this adjustment it has been found that the tube has a negative resistance characteristic which encourages the generation of oscillations at the natural frequency of any circuit

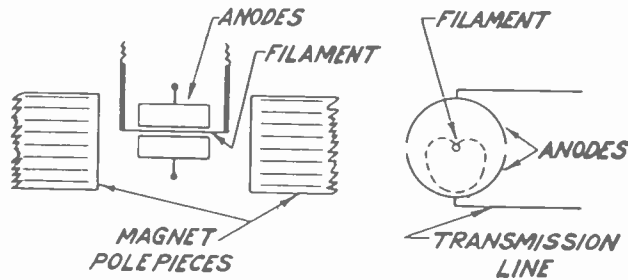

Fig. 2—Split-anode magnetron.

which is attached to it. As the frequency is made higher so that the time of transit of the electron between filament and anode becomes an appreciable part of the period, an additional condition for oscillation must be fulfilled; namely, that the period of the electron for a complete transit in the tube be equal to the period of the radiated wave.

Slutzkin and Steinberg,⁷ Ranzi,⁸ and Kilgore⁹ have shown that when an ordinary split-anode magnetron is used in a uniform magnetic field very little output results when the tube is aligned so that the filament is parallel to the magnetic lines of force. Maximum output results when the tube is tilted so that the filament is approximately at three to ten degrees to the magnetic field. This has been justified theoretically as necessary so that the electrons which are emitted from the filament and which are caused to rotate in the space between the filament and the plate, can spiral out the end of the plate without causing injurious space charge effects.

⁷ *Ann. der Physik*, vol. 1, p. 658, (1929).

⁸ *Nuovo Cimento*, vol. 6, p. 249, (1929).

⁹ *Proc. I.R.E.*, vol. 20, p. 1741; November, (1932).

If this theory is valid, it is evident that similar results can be obtained with probably better control by applying an electrostatic field along the axis of the filament with the field in such a direction as to draw the electrons out. Experiment has shown that this deduction is justified and that when an electrostatic field is applied as indicated, the tube may then be aligned so as to have the filament parallel to the magnetic field. A tube constructed to attain this result is shown in Fig. 3. The adjustment of the ratio of end-plate voltage to anode voltage is quite critical but the values of both together may be varied over quite wide ranges providing this ratio is kept constant. It will

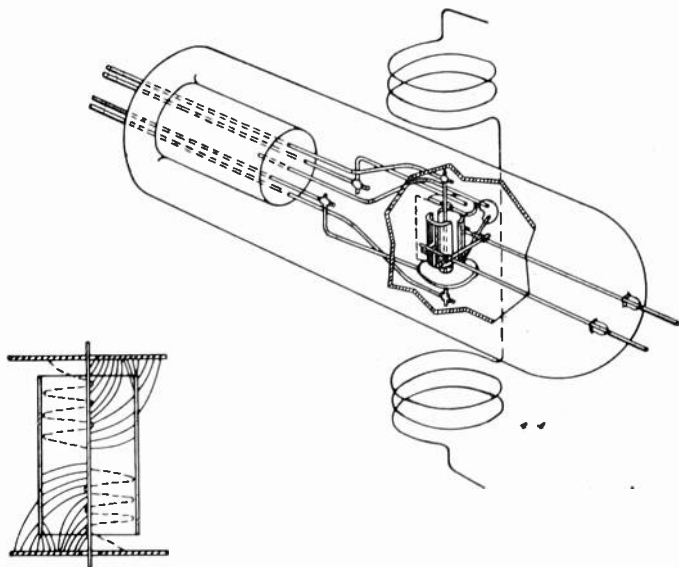

Fig. 3—End-plate magnetron.

be noticed that a bar is placed across the transmission line and close to the anodes of the tube. This bar performs several functions. It prevents the formation of long-wave parasitic oscillations to which the remainder of the antenna and transmission line would be resonant, by placing a short for these oscillations between the anodes and the transmission line. At the same time, it stabilizes the production of the nine-centimeter waves by providing a small looped circuit which is tuned to this frequency.

The anode current and end-plate current, magnetic field strength characteristics for a typical end-plate magnetron, are shown in Fig. 4 for a condition where oscillations are not excited. It will be noted that the anode current I_p decreases very rapidly when the magnetic field becomes strong enough so that the electron paths graze the plates. The end-plate current I_e undergoes a simultaneous increase. Beyond

this point certain of the electrons no longer have sufficient velocity to reach the anodes and describe longer spiral paths to the end plates.

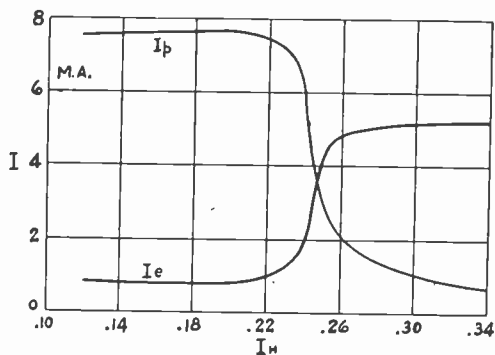

Fig. 4—Plate-current—magnetic-field characteristics, nonoscillating condition, end-plate magnetron.

The effect of oscillations is shown in Fig. 5. The upper curve is proportional to the oscillation intensity. The characteristics are similar to those of the nonoscillating condition except for greater currents in

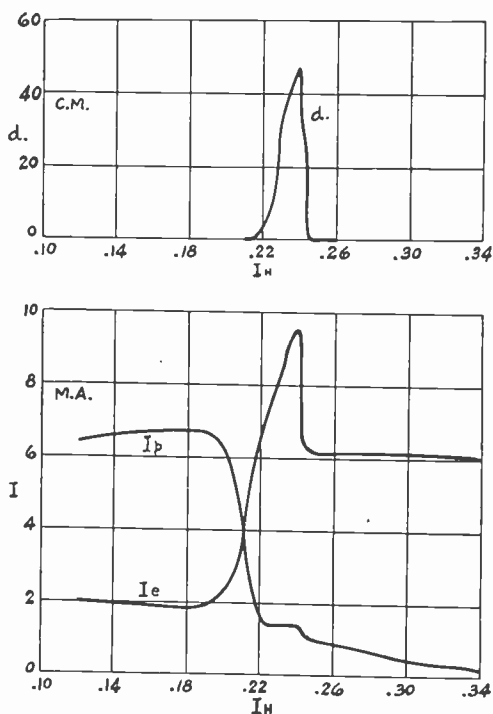

Fig. 5—Plate-current—magnetic-field characteristics, oscillating condition, end-plate magnetron.

the oscillation region. This is caused by an increase in filament emission which is probably a result of additional heating by electron bombardment and possibly some secondary emission.¹⁰

¹⁰ E. C. S. Megaw, *Nature*, vol. 132, p. 854, (1933).

The transmission and radiation systems are shown in Fig. 6, and consist merely of a dipole antenna in the focus of a parabolic reflector.

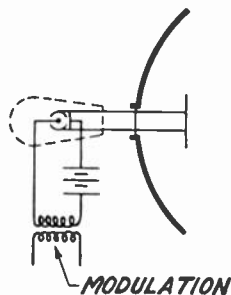

Fig. 6—Plate modulation and radiation system; nine-centimeter transmitter.

The length of the transmission line must be adjusted to correspond to the wavelength being generated, the distance from the shorting bar,

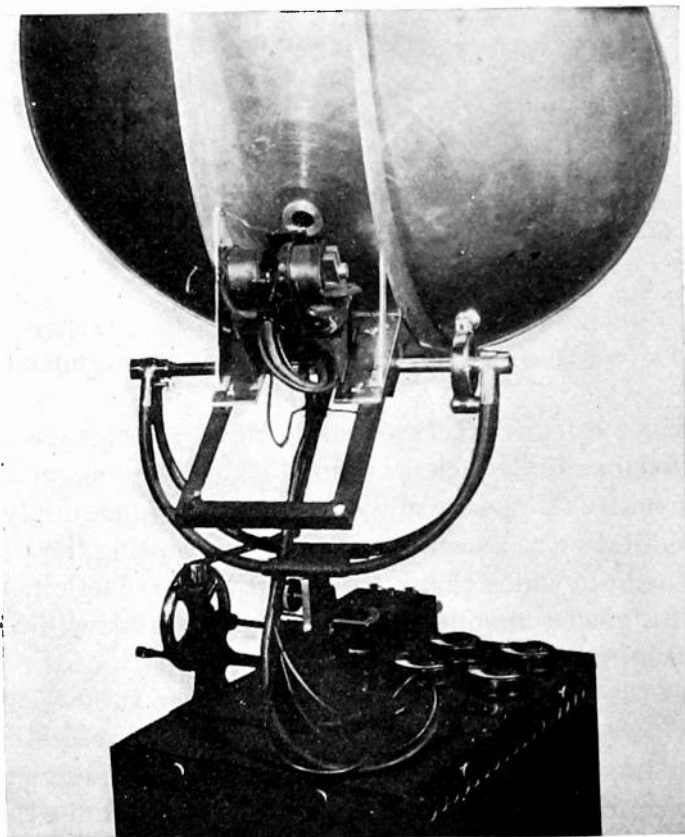

Fig. 7—Nine-centimeter transmitter with power supply units.

which is adjacent to the anodes, to the antenna being a multiple of a half wavelength. A photograph of the complete transmitter is shown in Fig. 7.

Since the radiated output is sensitive to anode—end-plate voltage ratio, modulation can be obtained by varying either of them. This is accomplished by placing the secondary of a transformer in series with the supply voltage, as shown in Fig. 6. Another type of modulation which may have wide application has been developed, and is described in recent articles by Linder, and Linder and Wolff.¹¹ It was devised so as to be able to control the amount of frequency modulation. As is well known, a certain amount of frequency modulation accompanies the variation in output which is accomplished by varying the plate circuit voltage on an electronic oscillator, although this is nowhere near as serious for the magnetron oscillator as it is for the Barkhausen type, since the constant magnetic field supplies a stabilizing influence. Nevertheless, as more refined receivers are developed, this frequency modula-

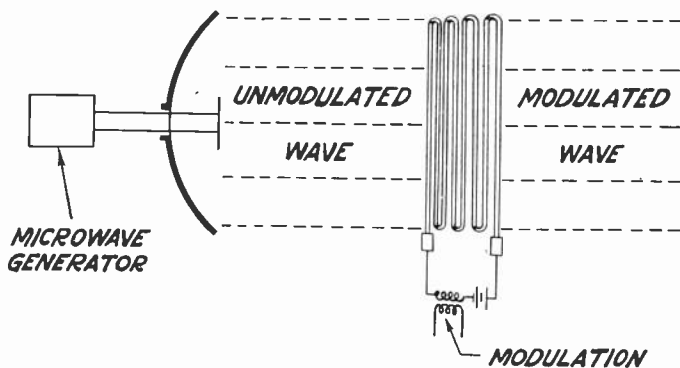

Fig. 8—Diagrammatic representation of ionic modulator.

tion may cause difficulties. In order to eliminate this effect, a system has been developed in which an unmodulated wave is radiated, allowing the transmitter to operate under constant voltage supply conditions, and the modulation is accomplished by intercepting the unmodulated beam by a medium which changes its absorption, reflection, and index of refraction for electromagnetic waves. The modulating device consists of a gas discharge tube which is placed in the path of the wave, Figs. 8 and 9. As the current through this discharge tube is changed, the ion density varies, resulting in variable index of refraction, and absorption for the electromagnetic waves. Sufficient voltage to maintain a discharge continuously is supplied from a rectifier unit. In series with this direct-current supply is the secondary of a transformer whose primary is attached to a modulating source. It can be shown experimentally that modulation can be obtained by passing the beam through this gas, in which case the modulation is obtained largely by absorp-

¹¹ Proc. I.R.E., vol. 22, p. 791; June, (1934); *Nature*, vol. 133, p. 259, (1934).

tion, or by using the tube as a reflector, in which case the modulation is caused mostly by variation in refraction.

It is interesting to note the similarity of the action of the discharge tubes on the short waves and that of the Heaviside layer on longer wavelengths. The tube is differentiated from the Heaviside layer in having a much greater ion density (of the order of a million times) and

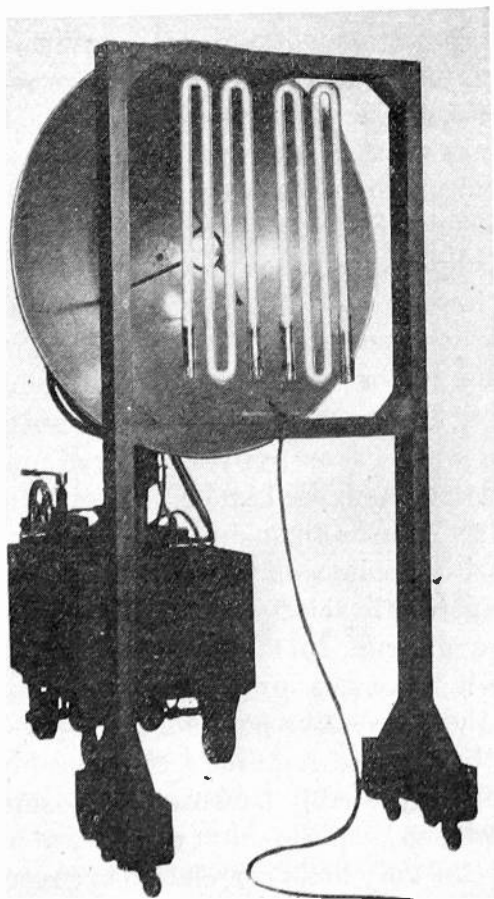

Fig. 9—Transmitter with ionic modulator.

the various absorption and refraction effects are therefore concentrated in a much smaller space. Since the waves being used are approximately only one three-thousandth as long as broadcast waves the phenomena caused by reflections from the Heaviside layer such as fading can be demonstrated in the laboratory.

The maintenance of electronic oscillations depends considerably more on the constancy of the supply voltages than oscillations which are dependent entirely on circuit constants. For this reason, in our apparatus all of the supply units are provided with special regulators

for maintaining these voltages constant. The magnet unit has an electron tube constant current regulator which compensates both for variations in the resistance of the field magnet, caused by heating of its coils, and for variations in the supply voltage. The anode and end-plate supply is a constant voltage device which compensates for changes in the supply voltage. The filament supply can either be a constant current or a constant voltage regulator.

A number of measurements of attenuation of the nine-centimeter waves were made in which the distance between the receiver and the source was varied, while the intensity of the received signal was measured by a crystal receiver followed by an audio amplifier and thermionic voltmeter. These experiments were all made with the receiver and transmitter at a sufficient height above the ground so that intervening objects were not interposed. It was found that an inverse distance law for field strength was followed, up to the greatest distances at which measurements were taken, which was 16 miles. No attenuation due to absorption by the atmosphere was noted.

Certain types of crystal detectors are quite sensitive for the reception of centimeter waves. Iron pyrites has been found to be the most efficient of those tried. As is well known, these crystals are, however, notably unstable as regards their detecting efficiency, it being necessary to find a sensitive point and maintain a contact at this sensitive point in order to get satisfactory operation. We have found that it is considerably more difficult to find sensitive points for the shorter wavelengths than it is for the lower frequencies and that the sensitivity at one of these sensitive points is more likely to vary for the shorter wavelengths. It also requires a considerably smaller pressure on the contact point, probably because a very small area of contact must be used in order to keep the shunt capacity at a low enough value. There also seems to be very little correlation between the relative sensitivity of points on the crystal for a frequency such as one kilocycle and 3000 megacycles. Between 60 and 3000 megacycles it is somewhat better, but still there are wide variations.

For these reasons, we have been experimenting with tube detectors to take the place of crystals. The so-called positive grid detectors have been described by Carrara¹² and Holman,¹³ and have been used successfully by Marconi¹⁴ at longer wavelengths. In order to make use of the same detectors for centimeter waves, care in the design of the tube is required to eliminate discontinuities in the transmission line feeding

¹² *Proc. I.R.E.*, vol. 20, p. 1615; October, (1932).

¹³ *Funktechnische Monatshefte*, vol. 7, p. 249, (1933).

¹⁴ *Electrician*, vol. 109, p. 758, (1932).

it and to obtain proper alignment of the elements. In operating these tubes, the plate potential is usually adjusted so that the faster electrons which are accelerated by the grid just reach the plate; in terms of plate-current—plate-potential characteristics, very close to cut-off.

With the plate potential given this adjustment, the tube will act as a detector over a wide range of grid voltages even when it is impossible to apply sufficient potential to obtain electron resonance for 3000 megacycles. However, particularly in well-aligned tubes, the sensitivity varies considerably with the grid potential showing a series of peaks which correspond to electron transit times which are multiples of the period. A curve showing relation between sensitivity and grid

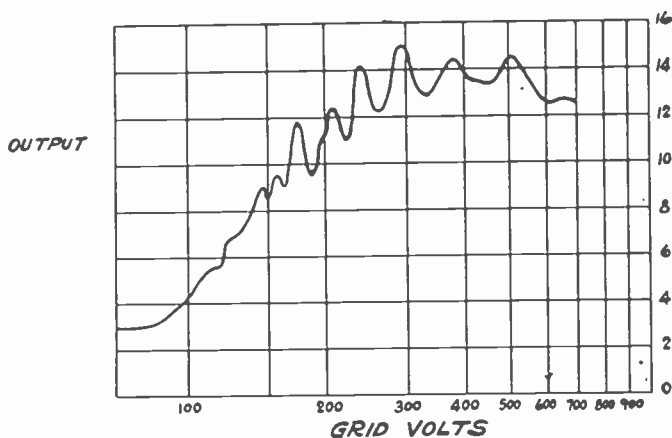

Fig. 10—Sensitivity—grid-potential characteristic, positive-grid detector, at 3300 megacycles.

potential for a typical tube is shown in Fig. 10. Some of the peaks correspond to transit time as much as 10 times the period. In experiments which were made at lower frequencies (600 megacycles), where it was possible to obtain the fundamental electron resonance as well as the higher order peaks, the sensitivity at the fundamental was found to be a number of times that at any other peak. Computations showed that 10,000 volts would have been necessary on the grid of the tube, which was used, to get fundamental resonance at 3000 megacycles. This would have destroyed the tube. A complete receiver employing a positive grid tube is shown in Fig. 11.

The magnetron tube also can be used as a detector. A special split-anode magnetron was built with elements of reduced size and in a small diameter glass envelope so that the magnetomotive force needed for the required field could be held as low as possible, see Fig. 12. The radio frequency was supplied symmetrically to the two anodes; the audio

frequency was obtained by placing the primary of a transformer in the leads which supply the two anodes in parallel. The connections are

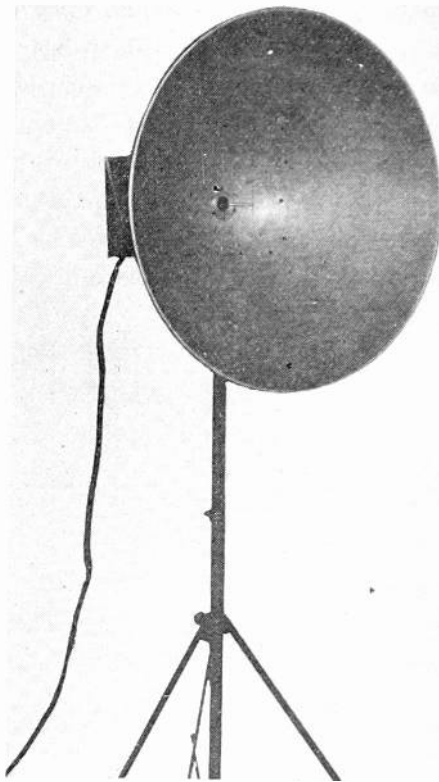

Fig. 11—Receiver using positive-grid detector.

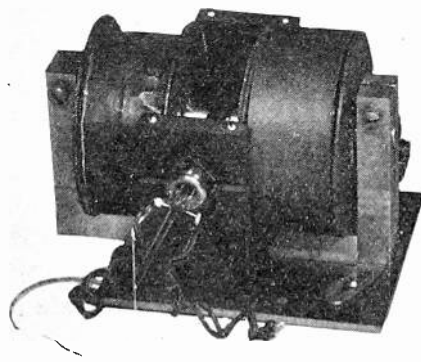

Fig. 12—Magnetron detector.

shown in Fig. 13. Detecting action is obtained for any magnetic field strength if the plate potential is adjusted so that operation is taking place either on the upper or lower bend of the plate-current—plate-

potential characteristic. Although detection takes place for all electron rotation speeds, providing the right relation between applied potential

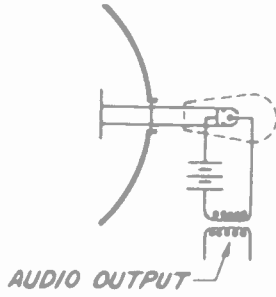

Fig. 13—Circuit, magnetron detector.

and magnetic field exists, a much greater increase in sensitivity is obtained if the field is adjusted so that the electron rotation period is equal to that of the impressed field. When the tube is adjusted for this condition, it is the most sensitive detector with which we have experimented.



HORIZONTAL RHOMBIC ANTENNAS*

By

E. BRUCE, A. C. BECK, AND L. R. LOWRY

(Bell Telephone Laboratories, Inc., New York City)

Summary—This paper discusses the theoretical methods employed by the authors in dimensioning horizontal rhombic receiving antennas. Experimental proof is given of the engineering accuracy of the directivity calculations on which this work is based. There are included brief descriptions of the antenna-to-transmission-line coupling circuits and the resistance terminations for rhombic antennas.

INTRODUCTION

AN introductory discussion has been given in a previous paper¹ of a type of antenna which maintains a desirable degree of directivity throughout a broad continuous range of frequencies. This structure was descriptively termed the "diamond-shaped" antenna in that paper, but it has since become known as the "rhombic" antenna and will be so designated here.

This paper discusses, in some detail, the theoretical methods employed by the authors in dimensioning horizontal rhombic receiving antennas from data obtained by preliminary surveys of the incident plane angles of wave arrival at the proposed receiving site.

Experimental proof is given of the engineering accuracy of the directivity calculations on which this work is based. Checking measurements were made on small-scale rhombic antennas operating at correspondingly short wavelengths. Confirming data were also obtained on large, adjustable rhombic antennas during the reception of European signals.

The paper also includes a brief discussion of the antenna-to-transmission-line coupling circuits employed and, in addition, the resistance terminations located at the end of the antenna remote from the receiver, used for suppressing standing waves and promoting unidirectivity. Some of the performance curves obtained on these devices are reproduced.

ANTENNA DIMENSIONS

Before designing any highly directive receiving antenna system, it is desirable to have a knowledge of the direction of arrival, the angu-

* Decimal classification: R120. Original manuscript received by the Institute, September 20, 1934.

¹ E. Bruce, "Developments in short-wave directive antennas," *Proc. I.R.E.*, vol. 19, pp. 1406-1433; August, (1931).

lar spread, and the angular variation in direction of the waves to be received. Such information has been obtained by employing the methods described by Friis, Feldman, and Sharpless.²

In general, the principal axis of the antenna departs very little from the true bearing of the station to be received. However, the average vertical direction of the waves in the incident plane and their angular variation have an effect upon the determination of the correct dimensions of a horizontal rhombic receiving antenna.

Without careful consideration, one might be led to believe that the theoretical effectiveness of a horizontal rhombic receiving antenna would increase without limit, for a stable wave direction, as the properly related dimensions are increased. It will be shown that, for a given incident wave angle above the horizontal, the optimum dimensions have quite definite values.

The essential dimensions of this type of antenna are its height above ground, the length of a side element, and the inclination angle of these elements in respect to the wave direction. At frequencies higher than about fifteen megacycles, this type of antenna is relatively so inexpensive that it is usually economically possible to select a combination of these dimensions which will produce the maximum signal output.

At lower frequencies, the increasing cost, particularly of the pole height required for maximum output, demands that a careful analysis be made of effective compromise designs. One such design method involves a sacrifice in antenna height, which sacrifice can be partially compensated for by an increase in element length. Thus the economic balance involves a weighing of supporting structure costs against the cost of land. Again, cases may arise where the recommended antenna height is practicable but a sacrifice in element length is essential. The effect of this sacrifice on the directive pattern can be partially compensated for by a readjustment of the tilt angle of the elements. The directive pattern may also be aligned with the wave angle when both height and element length are reduced, but only at an output sacrifice.

The designer's first problem is to choose between the maximum output arrangement and the various compromise designs. In the case of a transmitting antenna, the problem is to create as large a field as possible at the distant receiving point, for a given amount of transmitter power. As long as the increase in antenna cost is smaller than the corresponding cost of an increase in transmitter power, no compromise

² H. T. Friis, C. B. Feldman, and W. M. Sharpless, "The determination of the direction of arrival of short radio waves," *Proc. I.R.E.*, vol. 22, pp. 47-78; January, (1934).

static rather than set noise is practically always the circuit limitation, no real harm will result from using the compromise height design with its accompanying economic saving.

In general, compromise in element length results in a loss in both the antenna output signal level and in static discrimination. This procedure is recommended only for exceptional cases where a restriction in available land exists, or where a broad directional characteristic is required because of a highly variable wave direction.

DIRECTIVITY EQUATIONS

In the appendix of this paper will be found the derivation, for the stated assumptions, of the three-dimensional directivity equation for a horizontal rhombic receiving antenna terminated by its characteristic impedance. The principal antenna dimensions will be apparent by reference to Fig. 1.

If the horizontal component β , of the angle made by the wave direction with the principal antenna axis, is set equal to zero in the final resulting equation in the appendix, the directivity equation for the incident plane passing through the principal axis is as follows:

$$I_R = k \left[1 + ae^{-j(4\pi/\lambda)(H \sin \Delta + \alpha)} \right] \cdot \left[\frac{\cos \phi}{1 - \sin \phi \cdot \cos \Delta} \right] \cdot \left[1 - e^{-j(2\pi l/\lambda)(1 - \sin \phi \cdot \cos \Delta)} \right]^2 \quad (1)$$

where,

I_r = receiver current

k = proportionality factor

H = height above ground

l = wire element length

ϕ = one half of side apex angle

Δ = angle made with ground by wave direction in incident plane

a = amplitude ratio of ground reflected field to incident field

α = apparent phase angle lag caused by ground reflection

λ = wavelength

Since the principal axis of the antenna is nearly always directed toward the distant transmitter, the conditions which will maximize the above expression are of prime interest. The determination of these conditions is greatly simplified by the assumption of a perfect ground. Fortunately this is not a radical assumption for the case of horizontally polarized waves at the usual incident angles. This may be verified by

reference to Fig. 2 where the values of a and α are plotted for several ordinarily encountered ground constants.

Using the perfect ground assumption, the amplitude of (1) is given by,

$$I_R = k' \left\{ \sin \left[\frac{2\pi H}{\lambda} \sin \Delta \right] \right\} \cdot \left[\frac{\cos \phi}{1 - \sin \phi \cdot \cos \Delta} \right] \cdot \left\{ \sin^2 \left[\frac{\pi l}{\lambda} (1 - \sin \phi \cdot \cos \Delta) \right] \right\}. \quad (2)$$

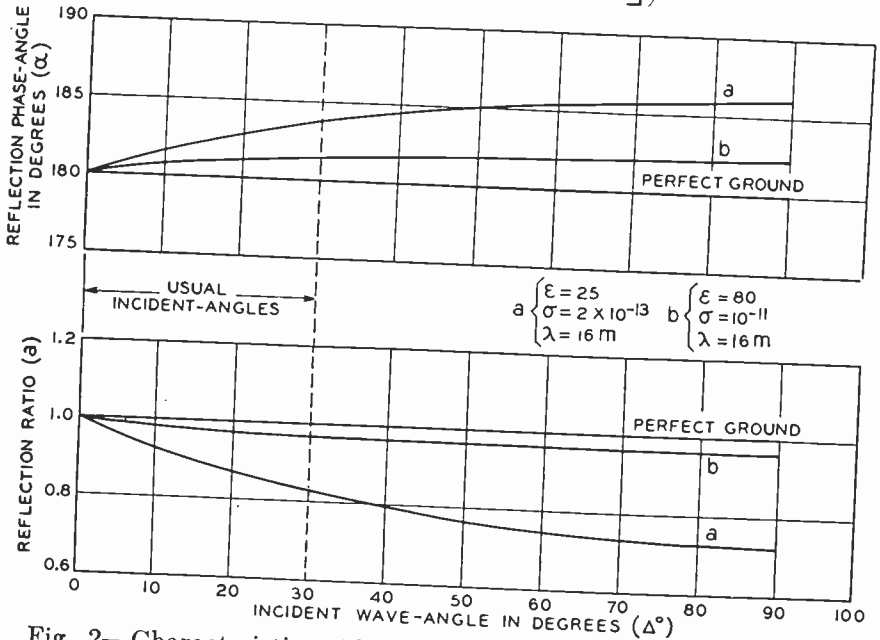

Fig. 2—Characteristics of horizontally polarized wave reflections from various types of ground.

In this equation the first bracketed term may be referred to as the “height” factor, the second as the “asymmetrical directivity” factor, and the third as the “phasing” factor.

MAXIMUM OUTPUT DESIGN METHOD

In maximizing (2), it is necessary to deal with three variables, the antenna dimensions H , l , and ϕ . Differentiating with respect to each of these variables, while holding the other two constant, and equating to zero, the following three expressions are obtained:

$$\frac{\delta I_R}{\delta H} = 0 \text{ when} \quad H = \frac{\lambda}{4 \sin \Delta} \text{ for the lowest practical height} \quad (3)$$

$$\frac{\delta I_R}{\delta l} = 0 \text{ when}$$

$$l = \frac{\lambda}{2(1 - \sin \phi \cdot \cos \Delta)} \text{ for the major ear of the directive diagram (4)}$$

$$\frac{\delta I_R}{\delta \phi} = 0 \text{ when}$$

$$\begin{aligned} \tan \left[\frac{\pi l}{\lambda} (1 - \sin \phi \cdot \cos \Delta) \right] \\ = - \frac{2\pi l \cdot \cos^2 \phi \cdot \cos \Delta (1 - \sin \phi \cdot \cos \Delta)}{\lambda (\sin \phi - \cos \Delta)} \end{aligned} \quad (5)$$

Substituting (4) into (5), it is found that,

$$\sin \phi = \cos \Delta. \quad (6)$$

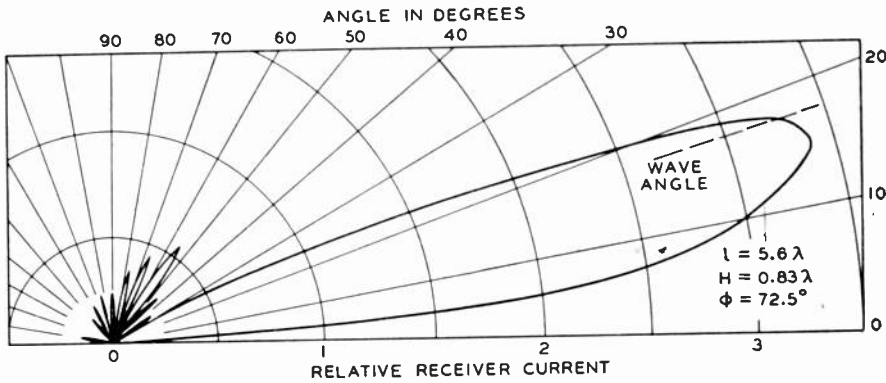

Fig. 3—Maximum output design. Receiver current diagram of incident plane directivity for a 17.5-degree wave angle.

This result determines the fact that, regardless of antenna height the best tilt angle ϕ , is the complement of the wave angle Δ , where the optimum element length is used. Taking this result and substituting it back into either (4) or (5) results in,

$$l = \frac{\lambda}{2 \sin^2 \Delta}. \quad (7)$$

The value of l in (7) together with the height given by (3), and the tilt angle given by (6) determine the dimensions of the horizontal rhombic antenna with maximum output for any given wave angle Δ .

As an example of the use of the above equations, Fig. 3 is the resulting incident plane directive pattern with the antenna designed for the given wave angle of 17.5 degrees. Fig. 4 is a plot of the antenna out-

put versus the azimuth angle for the fixed incident angle of 17.5 degrees as obtained by using these dimensions in the three-dimensional directivity equation in the appendix.

Note in Fig. 3 that the directive pattern does not have its maximum radius at the line indicating the given wave direction even though the greatest possible amplitude for that wave angle has been determined.

It is believed that this method of design has a definite application where overriding set noise by the largest possible signal output is paramount. In cases where discrimination against random static is desirable, or where the received wave direction is unstable, an alignment of the mean wave direction with the optimum radius of the directive dia-

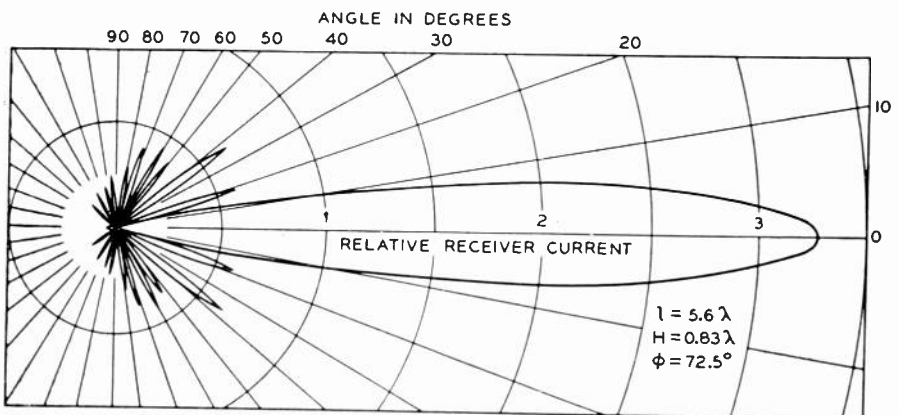

Fig. 4—Maximum output design. Receiver current versus azimuth angle for a 17.5-degree wave angle.

gram becomes necessary. Such an alignment can be achieved by the method described below, but only by a small sacrifice in the amplitude³ of I_R at the required wave angle.

THE ALIGNMENT DESIGN METHOD

Since by our previous method of design the height factor of (2) was aligned with the wave angle, it is necessary to change either or both of the dimensions l and ϕ to secure the best output under the limiting alignment condition. This limiting condition is obtained as follows:

$$\frac{\delta I_R}{\delta \Delta} = 0 \text{ when}$$

³ To compare the energy gain of one antenna with another, the amplitudes of I_R , which are proportional to effective voltages, should be corrected for the differences in radiation resistance of the antennas.

$$H = \sin \phi \cdot \tan \Delta \cdot \tan \left(\frac{2\pi H}{\lambda} \sin \Delta \right) \left\{ \frac{\lambda}{2\pi(1 - \sin \phi \cdot \cos \Delta)} - \frac{l}{\tan \left[\frac{\pi l}{\lambda} (1 - \sin \phi \cdot \cos \Delta) \right]} \right\}. \quad (8)$$

Substituting (3) into (8) gives:

$$\tan \left[\frac{\pi l}{\lambda} (1 - \sin \phi \cdot \cos \Delta) \right] = 2 \left[\frac{\pi l}{\lambda} (1 - \sin \phi \cdot \cos \Delta) \right]. \quad (9)$$

This is a transcendental equation of the form $\tan x = 2x$, whose roots, to four significant figures, are

$$X = 0, \quad 0.3710\pi, \quad 1.466\pi, \quad 2.480\pi, \quad 3.486\pi, \quad \text{etc.}$$

Alignment of the major ear of the directive pattern with the wave angle occurs only for the first solution greater than zero. Therefore, we have for this condition,

$$l = \frac{0.371\lambda}{1 - \sin \phi \cdot \cos \Delta}. \quad (10)$$

To obtain the dimensions for greatest output in the alignment design case, l and ϕ in (2) are no longer independent variables, but are related by (10). We can, therefore, eliminate either one we choose from (2) and maximize this new equation for the required dimensions.

Substituting (10) into (2) gives

$$I_{R'} = k'' \left[\sin \left(\frac{2\pi H}{\lambda} \sin \Delta \right) \right] \left[\frac{\cos \phi}{1 - \sin \phi \cos \Delta} \right] \quad (11)$$

and,

$$\frac{\delta I_{R'}}{\delta \phi} = 0 \text{ when} \quad \sin \phi = \cos \Delta. \quad (12)$$

Since (12) is identical with (6), the recommended design for directive pattern alignment with the wave angle is obtained by changing only the antenna length, which was given for the maximum output design by (7). By substituting (12) into (10), this becomes,

$$l = \frac{0.371\lambda}{\sin^2 \Delta}. \quad (13)$$

Therefore, alignment design is obtained by the use of (3), (6), and (13). This shows that to change from maximum output design to alignment design it is only necessary to reduce the length to approximately

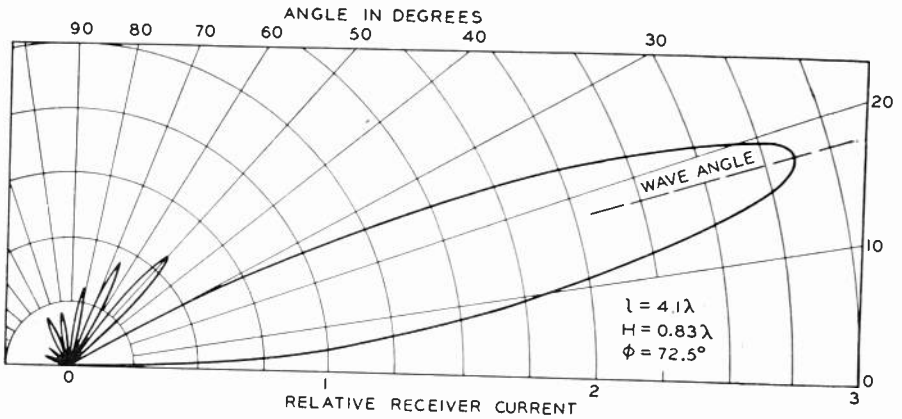

Fig. 5—Alignment design. Receiver current diagram of incident plane directivity for a 17.5-degree wave angle.

seventy-four per cent of the value recommended for maximum output.

Figs. 5 and 6 are examples of the directive patterns secured by such alignment design for a wave angle of 17.5 degrees. Comparison of these diagrams with Figs. 3 and 4 shows a small loss in I_R resulting

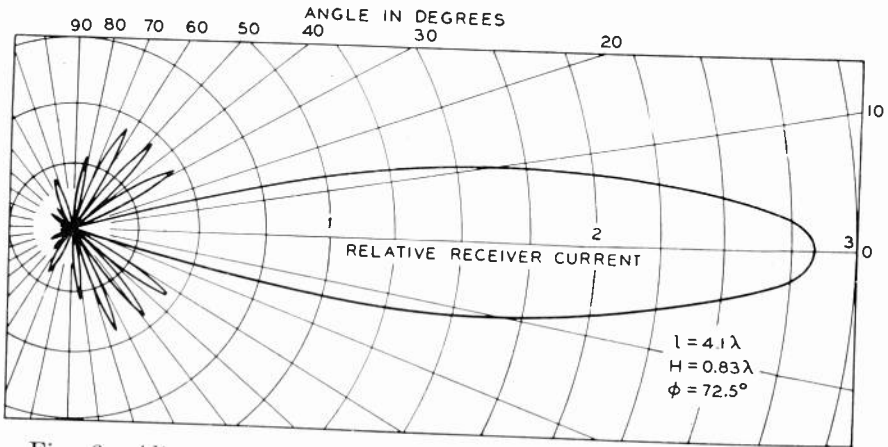

Fig. 6—Alignment design. Receiver current versus azimuth angle for a 17.5-degree wave angle.

from such design. Figs. 7 and 8 are similar alignment design plots for a wave angle of 11 degrees.

COMPROMISE DESIGN METHODS

When an antenna output sacrifice must be tolerated to obtain smaller dimensions, it is often desirable to design the system for direc-

tive pattern alignment with the wave angle, as mentioned above. The methods of accomplishing this result will now be given.

The effect on the directive pattern of reducing the height can be largely compensated for by increasing the length.

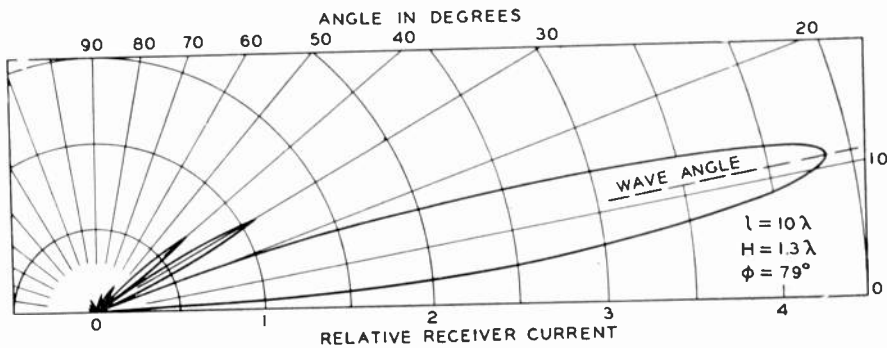

Fig. 7—Alignment design. Receiver current diagram of incident plane directivity for an 11-degree wave angle.

Substituting (6) into (8) gives,

$$\frac{H}{\tan\left(\frac{2\pi H}{\lambda} \sin \Delta\right)} = \frac{\lambda}{2\pi \sin \Delta} - \frac{l \cdot \sin \Delta}{\tan\left(\frac{\pi l}{\lambda} \sin^2 \Delta\right)} \quad (14)$$

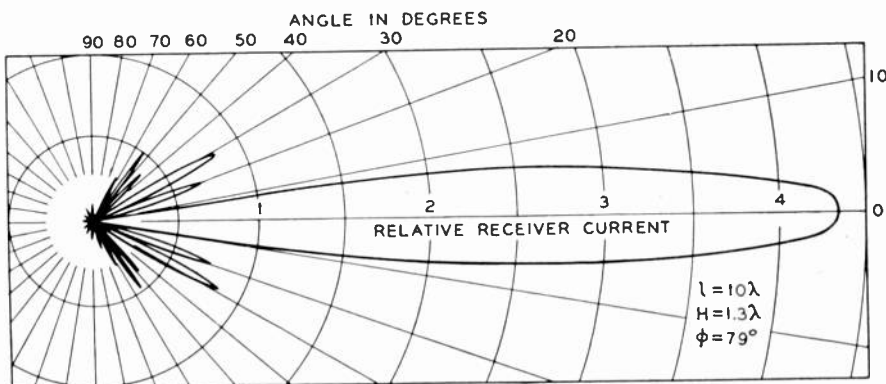

Fig. 8—Alignment design. Receiver current versus azimuth angle for an 11-degree wave angle.

When both Δ and H are specified, this equation gives the element length l to be used with the reduced height. Figs. 9 and 10 are examples of the directive diagrams resulting from a reduced height of one-half wavelength and an incident wave angle of 17.5 degrees. These last-mentioned figures may be directly compared with Figs. 5 and 6 to determine what effect the sacrifice in height and the increased length has had.

The effect on the directive pattern of reducing the length can be minimized by changing the tilt angle ϕ . When the height given by (3) is used, the new tilt angle can be obtained by writing (10) as

$$\sin \phi = \frac{l - 0.371\lambda}{l \cos \Delta} \quad (15)$$

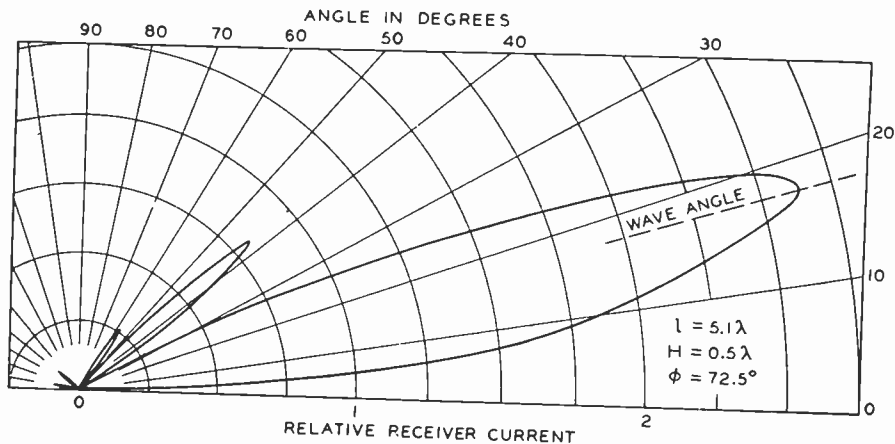

Fig. 9—Compromise height design. Receiver current diagram of incident plane directivity for a 17.5-degree wave angle and a height of one-half wavelength.

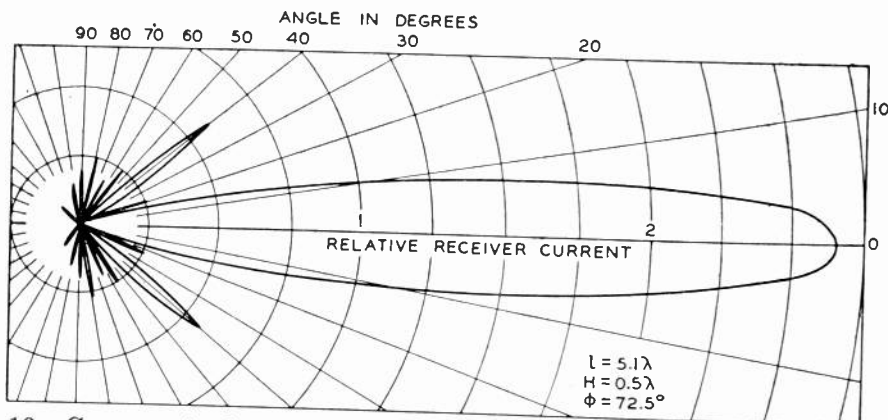

Fig. 10—Compromise height design. Receiver current versus azimuth angle for a 17.5-degree wave angle and a height of one-half wavelength.

If it is desired to align the directive pattern with the wave angle when the height and length are both reduced from the recommended values, (8) can be solved for the new tilt angle. Any of these compromise designs will, of course, reduce the antenna output.

LIMITATIONS OF RESULTS

The accuracy of the calculations in this paper is based on the following assumptions:

1. Negligible effect by wire attenuation.
2. Negligible mutual coupling between elements.
3. The rate of change of the effective voltage with varying dimensions is large as compared with the rate of change of radiation resistance.

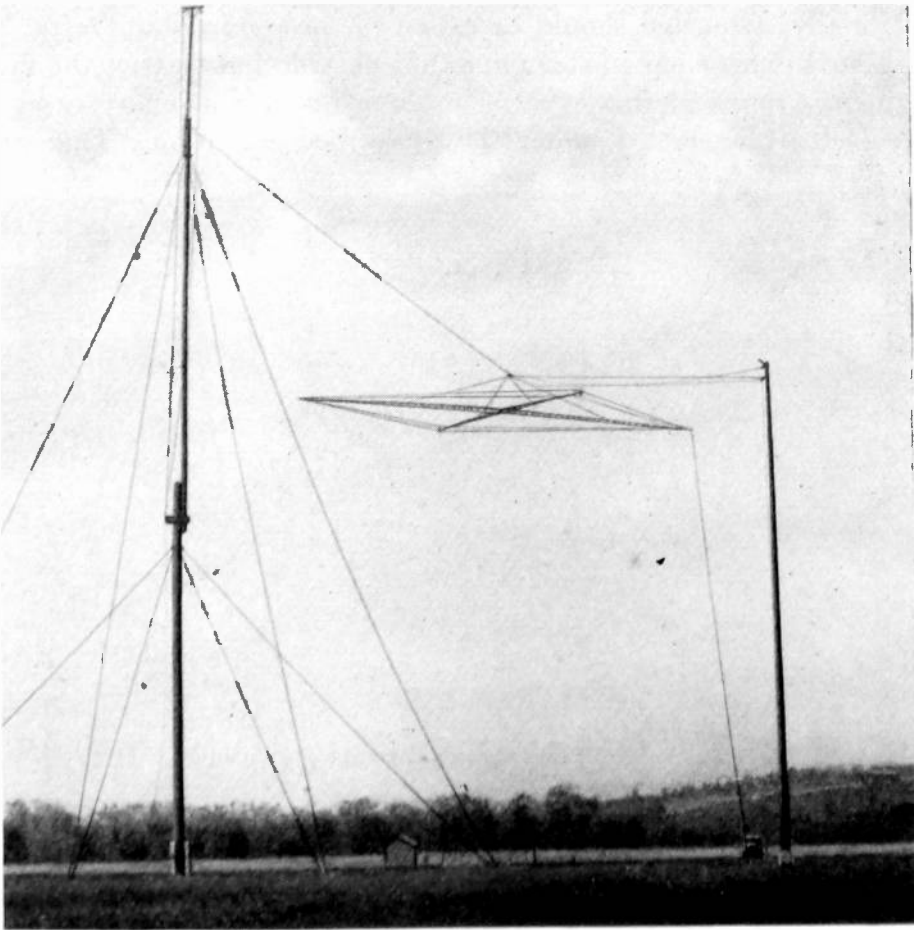

Fig. 11—Test antenna used at four meters for experimental checks of directivity calculations.

The validity of the assumptions has been checked to engineering accuracies in the ultra-short-wave experiments to be described, where the shape of the directive pattern predicted by these equations agreed well with experiment. However, theory and experiment have both shown that ordinary ground has an appreciable influence on the wire attenuation when the antenna heights are of the order of only small fractions of a wavelength. This effect increases as the antenna dimen-

sions are extended. In such unusual cases, this behavior should be carefully investigated even though calculations including large wire attenuations have shown surprisingly little effect upon the directive diagrams. Approximate values for the variation of radiation resistance with dimensions, for terminated rhombic antennas, indicate that (3) is probably warranted provided that the antenna is not extraordinarily small.

Finally, attention should be called to these important facts: The suggested dimensions in this paper not only do not restrict the broad frequency range of this type of antenna but are in many cases the broadest arrangements under the prescribed conditions. This state-

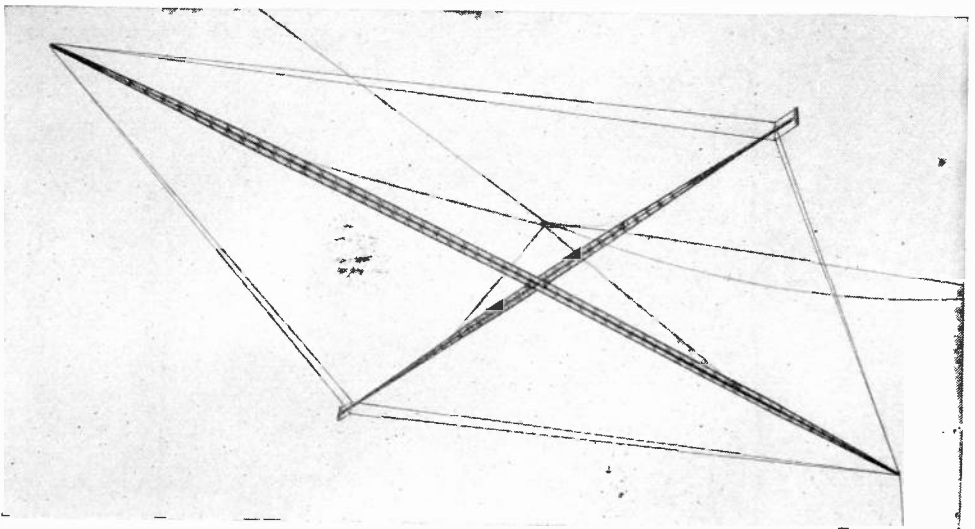

Fig. 12—A detail view of the antenna shown in Fig. 11.

ment is based on a large number of calculated directive diagrams, for various frequencies, and has been substantiated by operating tests. Also, in certain applications, as with ultra-short waves where the direction of wave propagation is substantially horizontal ($\Delta=0$), the derived equations place no restrictions on the antenna size.

EXPERIMENTAL CHECKS OF DIRECTIVITY CALCULATIONS

One method employed for experimentally checking the calculations of directivity was by means of a model small enough to permit continuous rotation of the antenna in respect to a fixed wave direction. A simple transmitter and a double detection receiving set, which employed a calibrated intermediate-frequency attenuator, both operating at about four meters, were utilized for this work. Even at these wavelengths, the physical dimensions of the antenna were rather large so

that it was necessary to build an antenna smaller in wavelength dimensions than is usually recommended for commercial installations. As previously stated, any antenna for regular service would be designed for its own specific conditions, so that this antenna is not to be taken as a recommended design. However, this fact has no bearing on the results of these tests, for there was no intention of using this movable antenna for any purpose other than experimentally checking the directivity equations.

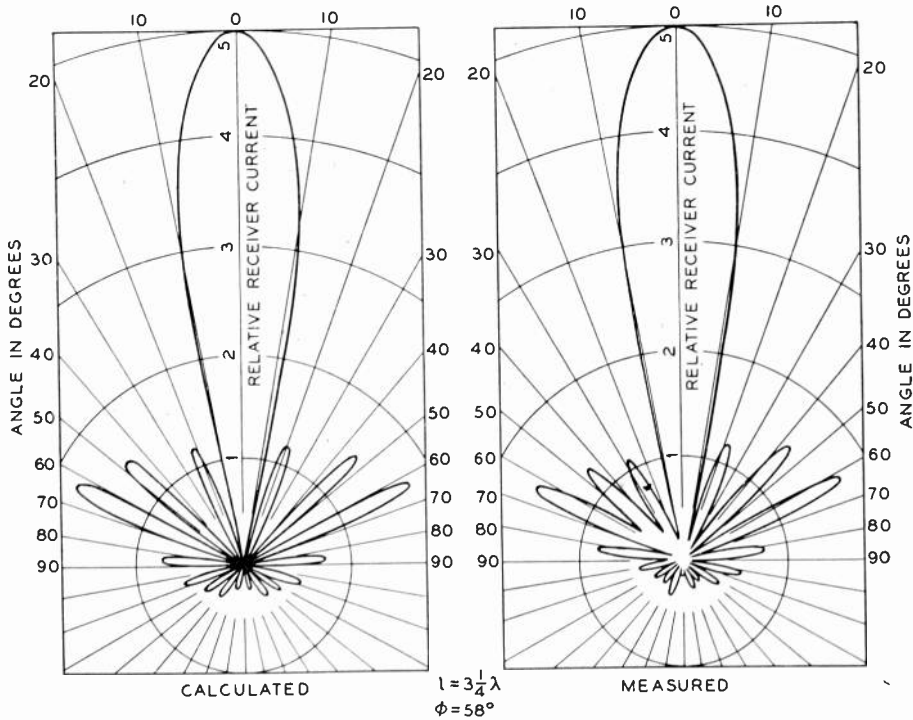

Fig. 13—Receiver current diagrams of test antenna output current versus azimuth angle for a 2.7-degree wave angle.

A photograph of the test installation is shown in Fig. 11. The antenna wires were mounted on a latticework cross of lightweight wood suspended by a system of ropes from two wooden poles. This permitted the hoisting of the entire antenna system to any height up to several wavelengths, and rotating it to any desired angular position. The antenna is shown in more detail in the photograph of Fig. 12. It was constructed of two space-tapered wires in parallel, spaced in order to lower the antenna impedance to permit the matching of the open wire transmission line which was attached to one end. Each element was three and a quarter wavelengths long. The receiving set was placed in a small pushcart at the other end of the transmission line so that

the line length did not need to be changed with antenna movements. An antenna of this size had a measured gain of fourteen decibels over a half-wave horizontal dipole at the same height.

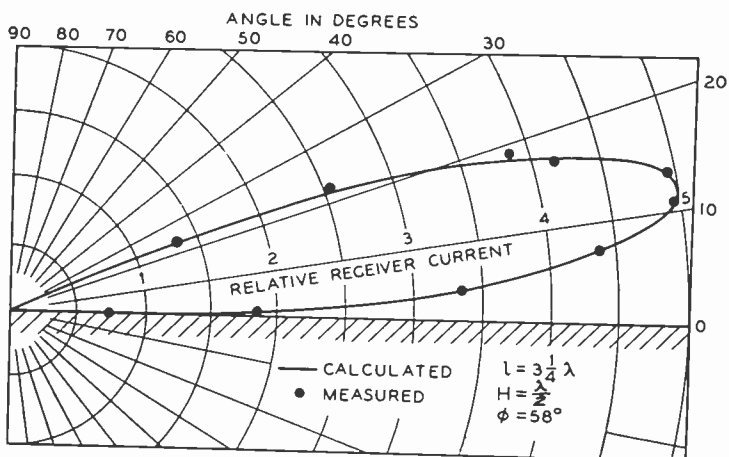

Fig. 14—Receiver current diagram of incident plane directivity with test antenna one-half wavelength above ground. Major lobe only.

The horizontal plane directive pattern was experimentally determined by measuring the antenna angle and signal output at each maximum and minimum and at fixed angles on the major lobe, as the antenna was rotated about its vertical axis. The pattern measured in

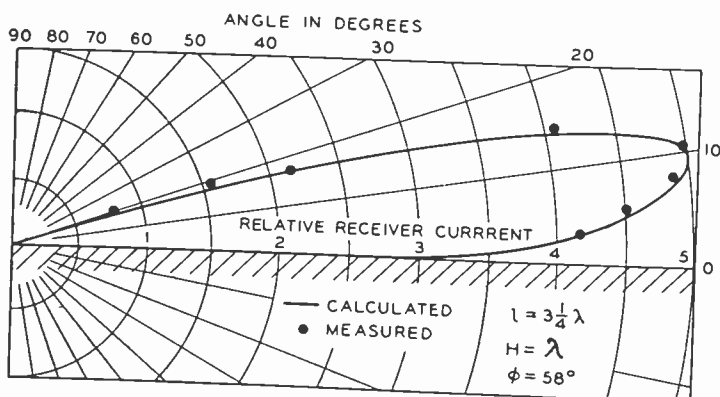

Fig. 15—Receiver current diagram of incident plane directivity with test antenna one wavelength above ground. Major lobe only.

this manner is shown in Fig. 13. In this figure is also shown, for comparison purposes, the pattern calculated for these conditions by the equations derived in the appendix. The agreement between these two patterns is quite evident.

To check the vertical directivity of the system, a portable oscillator was raised from the ground to the top of a one-hundred foot pole in front of the antenna. Because of the limited range of arrival angles so obtained, only the major lobe of the directive pattern could be traced out. Fig. 14 gives the calculated major lobe for these conditions (equations corrected to actual path length difference between direct and reflected waves) with the antenna one-half wavelength above ground, and Fig. 15 is the pattern at a height of one wavelength. The circles on these curves are the measured values. These patterns show that the directivity does not change very rapidly with changes in antenna height.

Experimental checks of these directivity calculations have also been obtained on the larger antennas ordinarily used for long-distance reception. A large horizontal rhombic antenna was constructed with a

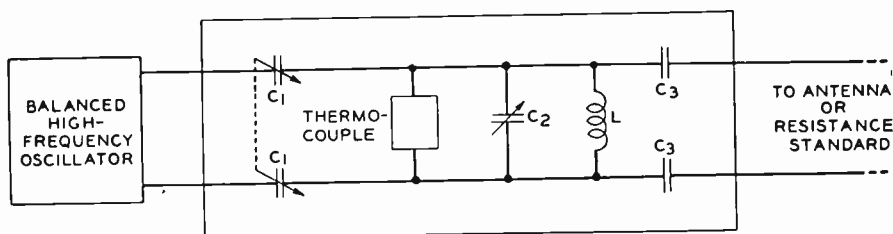

Fig. 16—Schematic diagram of impedance measuring equipment.

motor-driven winch to adjust its interior angles, thus providing control of the directivity of the antenna. This antenna could be "steered" so that either the major lobe or the first null could be used to receive or discriminate against the components of the received signal. The angle of arrival of these components was measured by the methods described by Friis, Feldman, and Sharpless.² The agreements were at all times close. This work was incidental to some fading studies, the results of which also checked qualitatively the directivity calculations.

These substantial agreements between calculated and measured values are an indication of the accuracy secured in theoretically predicting antenna directivity when using the stated assumptions. It is believed, therefore, that they establish the validity of the design methods now being used for commercial applications of this type of antenna.

STANDING WAVE SUPPRESSION

To obtain the unidirectional characteristics usually desired and to provide a constant terminal impedance over a broad frequency range,

the end of the rhombic antenna, remote from the receiver, is terminated in its equivalent characteristic impedance to prevent wave reflections.

The termination was originally adjusted by determining the greatest front-to-back signal reception ratios which could be obtained with

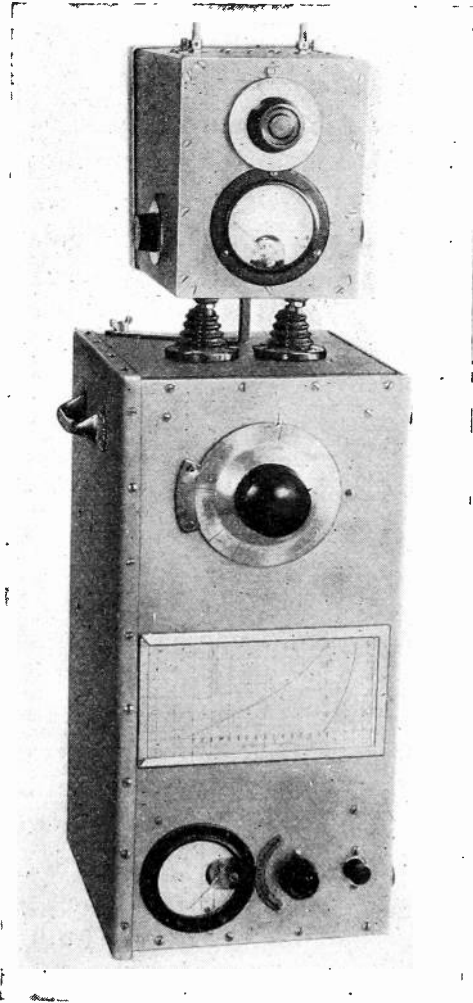

Fig. 17—Impedance measuring equipment and balanced oscillator.

the terminating graphite resistors or the other circuits employed. This method of testing proved both cumbersome and erratic for the following reasons: Radiating field oscillators had to be placed at sizable distances both in front and in the rear of the antenna. Manipulating these oscillators, for frequency runs, proved inconvenient. Furthermore, properly elevating the oscillators was impracticable because of the large heights required to simulate the actual average wave angles usu-

ally encountered. When the oscillators were at more reasonable heights above ground, the front-to-back signal ratios could rarely be reproduced since the wave direction was unstably situated on the lower steep edge of the incident plane directive diagram.

The procedure for testing the termination has been simplified through the measurement, by a substitution method, of the antenna terminal impedance as the frequency is varied over the required frequency band. By readjusting the termination, until these measured values are constant, the required value is obtained.

The schematic diagram of the impedance measuring equipment employed is shown in Fig. 16. In the actual apparatus, the individual parts are separately shielded and symmetrically arranged so that the assembly can be attached to a portable balanced oscillator used for other work. Such a combination is shown in the photograph of Fig. 17.

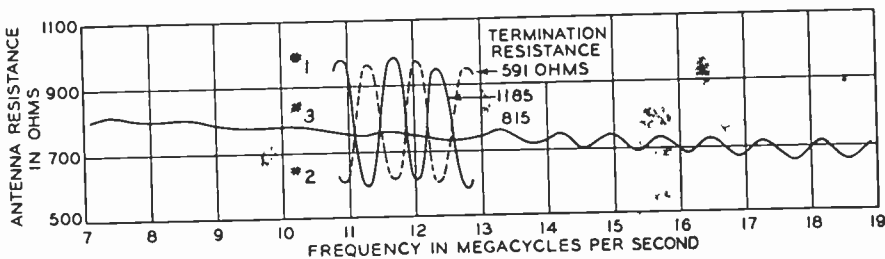

Fig. 18—Rhombic antenna terminal resistance versus frequency for three values of termination resistance.

Again referring to Fig. 16, the condensers marked C_1 control the degree of coupling while maintaining an accurate balance to ground. C_2 is a condenser used for antiresonating the complete circuit, this antiresonance being indicated by a thermocouple deflection. The condensers labeled C_3 are large blocking condensers which have been added to the circuit to permit the measurement of the value of the variable substitution resistance without the necessity of disconnecting that resistance. A pencil lead is usually employed as this resistor.

The measurement consists in replacing the antenna by a value of resistance R which gives the same thermocouple deflection. The reactive components involved are tuned out in each case by adjusting the condenser C_2 . The change in the dial setting of this condenser, as the resistance is substituted for the antenna, permits the determination of the reactive component of the antenna impedance.

Curve 3, in Fig. 18, shows the terminal resistance versus frequency of a properly terminated experimental antenna constructed by the authors. Curve 1, of that figure, results from a termination resistance which is too large while that in curve 2 is too small. Incidentally, it is

interesting to note that the value of the measured terminal resistance of this antenna is lower than the resistance required, at the other end of the antenna, for the correct termination. This behavior is probably an effect of the radiation resistance of the system.

When a lumped termination resistance is employed, measurements reveal that it operates as if paralleled by a small effective capacity, a

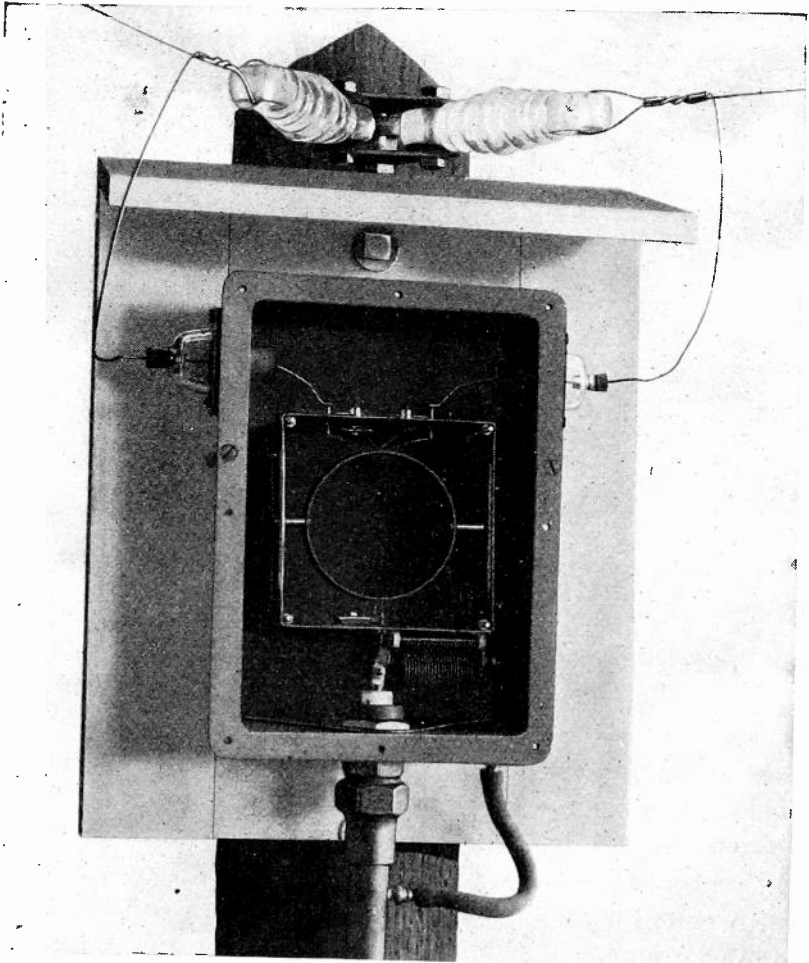

Fig. 19—Experimental equipment for coupling a rhombic antenna to a concentric pipe transmission line.

capacity probably due to the proximity of the adjacent converging antenna wires. This capacity prevents the resistance from acting as an entirely satisfactory termination. Its effect can be minimized through a proper distribution of the termination resistance over a short length of the converging part of the antenna. This distribution tends to isolate the harmful capacities by means of the resistances and also introduces

a small effective series inductance which is helpful in neutralizing the residual capacity reactance. Other circuits have been devised, but this one is often employed because of its simplicity and ruggedness.

ANTENNA-TO-PIPE-LINE COUPLING CIRCUITS

Concentric pipe transmission lines are usually favored for receiving antenna installations as they can be buried in the ground to give a substantial and weatherproof construction, free from reactions on adjacent antennas. This pipe line runs up one pole of a rhombic antenna and terminates adjacent to the output terminals of the antenna.

Large terminated rhombic antennas, built with number 12 American wire gauge wire, present a terminal impedance, balanced to ground, of nearly 800 ohms resistance. Where the ratio of the inner diameter of the outer pipe to the outer diameter of inner pipe of the transmission

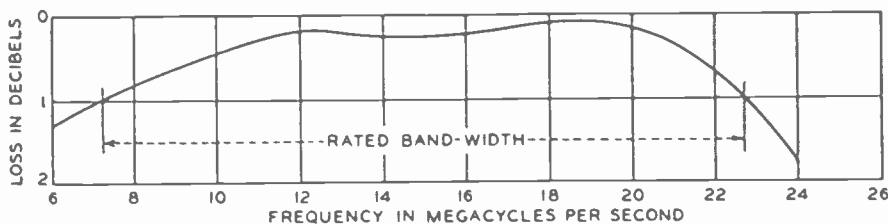

Fig. 20—Loss versus frequency curve for the experimental coupling equipment, shown in Fig. 19, when used to connect an antenna balanced impedance of 778 ohms in parallel with 5 micromicrofarads to a pipe-line unbalanced resistance of 80 ohms.

line is the optimum value⁴ of 3.6, the characteristic impedance of the line is about 77 ohms. The problem is, therefore, to transform properly a balanced resistance of about 800 ohms into an unbalanced resistance of about 80 ohms without appreciable losses over the entire operating range of the antenna.

Fig. 19 is a photograph of a simple type of coupling circuit developed for experimental use. Fig. 20 is the measured loss versus frequency curve obtained when the device is connected between the stated impedances. The broad frequency range is primarily the result of a high coefficient of coupling. Balance is obtained by symmetrically disposing two primary windings in series about two secondary windings in parallel. A still greater operating range may be obtained through a more elaborate arrangement. Note in Fig. 19 (cover removed) that the boxes and pipe line are gas-tight so that nitrogen pressure can be applied, if desired, to prevent moisture absorption through "breathing."

⁴ E. J. Sterba and C. B. Feldman, "Transmission lines for short-wave radio systems," *Proc. I.R.E.*, vol. 20, pp. 1163-1202; July, (1932).

CONCLUSION

The original paper¹ on rhombic antennas, in discussing the situation regarding short-wave communication, stated that the main limitations in this field were three in number:

- (a) Inherent receiver noise.
- (b) External noise (static, man-made noises, etc.)
- (c) Signal fading.

That paper attempted to show that the design of the receiving antenna system has an important bearing upon overcoming all three of these difficulties.

In the present paper, the authors have indicated how progress in overcoming two of these limitations, through refinements in the horizontal rhombic type of antenna, has been made.

Improvements in the selection of the receiving antenna dimensions have greatly helped the noise situation. Termination and coupling circuit developments now allow many of these antennas to operate one circuit or several circuits simultaneously within a four-to-one frequency range.

APPENDIX

Calculations of Three-Dimensional Directivity

Antenna: Horizontal rhombus.

Wave polarization: Horizontal.

Far-end termination: Characteristic impedance.

Ground constants: General case.

Assumptions: Negligible wire attenuation and leakage.

Negligible mutual coupling.

Uniform characteristic impedance.

Nomenclature: (See Fig. 1)

P = point under consideration

l = element length

ϕ = one half of side apex angle

Δ = angle made with ground by wave direction in incident plane

β = angle made by horizontal component of wave direction with principal axis drawn through receiver and termination

H = height above ground

X = wire distance of point P from R for element (2) as well as for element (1)

ϵ = r-m-s space voltage

E = r-m-s space voltage and phase at P due to ϵ , direct propagation

E' = r-m-s space voltage and phase at P due to ϵ , after ground reflection

E_{P_1} and E_{P_2} = wire voltage at P in element (1) or element (2), direct propagation

E_{P_1}' and E_{P_2}' = same as above but for ground reflection

a = amplitude ratio of ground reflection to direct space voltage

α = apparent phase angle change after ground reflection

λ = wavelength

I_R = receiver current

Z_0 = characteristic impedance

R = receiver impedance

T = far-end termination impedance

Voltages Induced in Wire.

For a directly propagated wave in element (1)
 R being the reference point for phases,

$$E_{P_1} = \epsilon \cdot \cos(\phi - \beta) \cdot e^{+j(2\pi/\lambda) \cdot \sin(\phi - \beta) \cdot \cos \Delta \cdot X} dX.$$

For reflected wave in element (1) ($X=0$ to l)

$$E_{P_1}' = a \cdot \epsilon \cdot \cos(\phi - \beta) \cdot e^{+j\{2\pi/\lambda[X \cdot \sin(\phi - \beta) \cdot \cos \Delta - 2H \sin \Delta] - \alpha\}} dX.$$

Similarly for element (3) ($X=0$ to l)

$$E_{P_3} = \epsilon \cdot \cos(\phi + \beta) \cdot e^{+j(2\pi/\lambda) \cdot \sin(\phi + \beta) \cdot \cos \Delta \cdot X} dX.$$

$$E_{P_3}' = a \cdot \epsilon \cdot \cos(\phi + \beta) \cdot e^{+j\{2\pi/\lambda[X \cdot \sin(\phi + \beta) \cdot \cos \Delta - 2H \sin \Delta] - \alpha\}} dX.$$

Also for elements (2) and (4) ($X=0$ to l) where respective side apexes are now reference points for phases,

$$E_{P_2} = -E_{P_3} \cdot e^{+j(2\pi l/\lambda) \cdot \sin(\phi - \beta) \cdot \cos \Delta}$$

$$E_{P_2}' = -E_{P_3}' \cdot e^{+j(2\pi l/\lambda) \cdot \sin(\phi - \beta) \cdot \cos \Delta}$$

and,

$$E_{P_4} = -E_{P_1} \cdot e^{+j(2\pi l/\lambda) \cdot \sin(\phi + \beta) \cdot \cos \Delta}$$

$$E_{P_4}' = -E_{P_1}' \cdot e^{+j(2\pi l/\lambda) \cdot \sin(\phi + \beta) \cdot \cos \Delta}.$$

Receiver current where $T = Z_0$ and $R = Z_0$

$$\begin{aligned}
I_R &= \int_0^l \frac{E_{P1} + E_{P1'} + E_{P3} + E_{P3'}}{2Z_0} \cdot e^{-j(2\pi/\lambda)X} \\
&+ \int_0^l \frac{E_{P2} + E_{P2'} + E_{P4} + E_{P4'}}{2Z_0} \cdot e^{-j(2\pi/\lambda)X} \cdot e^{-j(2\pi/\lambda)l} \\
I_R &= \int_0^l \frac{\epsilon \cdot \cos(\phi - \beta)}{2Z_0} \cdot [1 + ae^{-j[(4\pi/\lambda)H \sin \Delta + \alpha]}] \cdot e^{-j(2\pi/\lambda)[1 - \sin(\phi - \beta) \cdot \cos \Delta]X} dX \\
&+ \int_0^l \frac{\epsilon \cdot \cos(\phi + \beta)}{2Z_0} \cdot [1 + ae^{-j[(4\pi/\lambda)H \sin \Delta + \alpha]}] \cdot e^{-j(2\pi/\lambda)[1 - \sin(\phi + \beta) \cdot \cos \Delta]X} dX \\
&- \int_0^l \frac{\epsilon \cdot \cos(\phi - \beta)}{2Z_0} \cdot [1 + ae^{-j[(4\pi/\lambda)H \sin \Delta + \alpha]}] \cdot e^{-j(2\pi/\lambda)[1 - \sin(\phi + \beta) \cdot \cos \Delta]} \\
&\quad \cdot e^{-j(2\pi/\lambda)[1 - \sin(\phi - \beta) \cos \Delta]X} dX \\
&- \int_0^l \frac{\epsilon \cdot \cos(\phi + \beta)}{2Z_0} \cdot [1 + ae^{-j[(4\pi/\lambda)H \sin \Delta + \alpha]}] \cdot e^{-j(2\pi/\lambda)[1 - \sin(\phi - \beta) \cos \Delta]} \\
&\quad \cdot e^{-j(2\pi/\lambda)[1 - \sin(\phi + \beta) \cos \Delta]X} dX \\
I_R &= \frac{\epsilon \cdot \cos(\phi - \beta)}{2Z_0} \cdot [1 + ae^{-j[(4\pi/\lambda)H \sin \Delta + \alpha]}] \cdot [1 - e^{-j(2\pi/\lambda)[1 - \sin(\phi + \beta) \cdot \cos \Delta]}] \\
&\quad \cdot \int_0^l e^{-j(2\pi/\lambda)[1 - \sin(\phi - \beta) \cdot \cos \Delta]X} dX \\
&+ \frac{\epsilon \cdot \cos(\phi + \beta)}{2Z_0} \cdot [1 + ae^{-j[(4\pi/\lambda)H \sin \Delta + \alpha]}] \cdot [1 - e^{-j(2\pi/\lambda)[1 - \sin(\phi - \beta) \cdot \cos \Delta]}] \\
&\quad \cdot \int_0^l e^{-j(2\pi/\lambda)[1 - \sin(\phi + \beta) \cdot \cos \Delta]X} dX \\
I_R &= +j \frac{\epsilon \lambda}{4\pi Z_0} \cdot \frac{\cos(\phi - \beta)}{1 - \sin(\phi - \beta) \cdot \cos \Delta} \cdot [1 + ae^{-j[(4\pi/\lambda)H \sin \Delta + \alpha]}] \\
&\quad \cdot [1 - e^{-j(2\pi/\lambda)[1 - \sin(\phi + \beta) \cdot \cos \Delta]}] [1 - e^{-j(2\pi/\lambda)[1 - \sin(\phi - \beta) \cdot \cos \Delta]}] \\
&+ j \frac{\epsilon \lambda}{4\pi Z_0} \cdot \frac{\cos(\phi + \beta)}{1 - \sin(\phi + \beta) \cdot \cos \Delta} \cdot [1 + ae^{-j[(4\pi/\lambda)H \sin \Delta + \alpha]}] \\
&\quad \cdot [1 - e^{-j(2\pi/\lambda)[1 - \sin(\phi - \beta) \cdot \cos \Delta]}] [1 - e^{-j(2\pi/\lambda)[1 - \sin(\phi + \beta) \cdot \cos \Delta]}] \\
I_R &= j \frac{\epsilon \lambda}{4\pi Z_0} \cdot \left[\frac{\cos(\phi - \beta)}{1 - \sin(\phi - \beta) \cdot \cos \Delta} + \frac{\cos(\phi + \beta)}{1 - \sin(\phi + \beta) \cdot \cos \Delta} \right] \\
&\quad \cdot [1 + ae^{-j[(4\pi/\lambda)H \sin \Delta + \alpha]}] \\
&\quad \cdot [1 - e^{-j(2\pi/\lambda)[1 - \sin(\phi + \beta) \cdot \cos \Delta]}] \cdot [1 - e^{-j(2\pi/\lambda)[1 - \sin(\phi - \beta) \cdot \cos \Delta]}]
\end{aligned}$$

which is the final equation including phase relations.

A NEW SYSTEM FOR THE REMOTE CONTROL OF RADIO BROADCAST RECEIVERS*

By

JESSE B. SHERMAN

Summary—A system for the remote control of radio broadcast receivers has been developed in which tuning is effected by rotating the dial of a suitably designed rheostat which, by varying the field currents in a motor of novel construction, produces movement of the rotor and condenser gang synchronously with the rotation of the dial. Control of volume is effected by a switching arrangement which automatically removes from the circuit unused volume controls, allowing independent control of volume.

I. GENERAL

A SATISFACTORY system for remote control of radio receivers must afford control with as great a degree of facility as may be had at the receiver itself, and the addition of the system to the set should not affect the original facility of operation of the set. It is essential that the system be capable of accomodating any number of control units; and that additional control units be readily attached at small cost. Considering present prices of complete receivers, it becomes apparent why the cost of individual control units must be low. Present small cheap receivers located wherever reception is desired might well take the place of a single remotely controlled set with large remote speakers, were it not for the inferior performance of the midget receiver, particularly with respect to tone quality. The greatest possible flexibility of operation is of course secured from several independent sets; a single receiver affords only single channel reception, but the individual control units of a remotely controlled receiver can at least be made independent of one another in operation. Particularly should the complete spectrum of the receiver be available at the remote stations; the choice of programs should not be restricted to a limited number of preselected stations, nor should a continuous tuning range involve any tedious juggling of push buttons.

The special motor to be described fulfills the above tuning requirements.¹

II. PRINCIPLE OF MOTOR

Assume two pairs of field coils *AA* and *BB*, arranged as in Fig. 1. If a bar of magnetic material be pivoted at its mid-point at the center

* Decimal classification: R360. Original manuscript received by the Institute, July 31, 1934.

¹ U.S. Patent No. 1,953,435.

of the field system, then the application of the voltage E_1 only will cause it to be in equilibrium in the position AA . Likewise, if the voltage E_2 only is applied, the equilibrium position will be BB . If both electromotive forces are applied, and are equal each to the other, the direction of the resultant field will lie midway between the component fields. The rotor will then assume an equilibrium position 45 degrees from either of the two preceding positions. Obviously, the resultant field can be given any intermediate direction and magnitude by suitable variation of the relative field strengths.

Suppose it is desired to move the rotor through 90 degrees. Let the current through one pair of fields, say AA , be set to some fixed

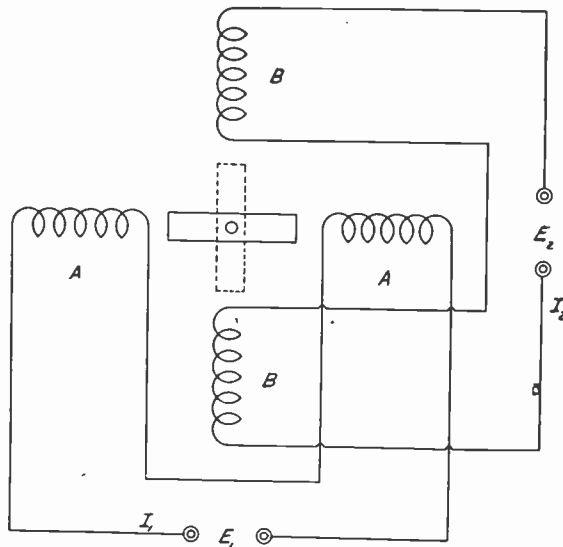

Fig. 1—Pertaining to motor principle.

value and the current through BB made so small that the rotor is substantially in the position AA . Now let the current I_1 be increased until it is equal to I_2 , when the rotor will have moved to the 45-degree position. Then maintaining I_1 constant, let the current I_2 be decreased, and the remaining 45 degrees will be covered.

As actually constructed, the motor has been built for 30-volt, 60-cycle operation along the lines of a two-phase induction motor, with closed rotor winding. Rotation of the rotor is readily secured through 180 degrees by varying the fields through 90 degrees as described above, then reversing one pair of field connections, and repeating the cycle of variation. By arranging a suitable reversing mechanism to operate at the 90-degree point on the rheostat controlling the fields, smooth continuous operation may be had through 180 degrees.

III. RHEOSTAT

The starting point in considering a rheostat for controlling the fields is the premise that the movement of the rotor must be directly proportional to the rotation of the controlling device. Since the angular displacement of the rotor is not by any means proportional to the current in either field circuit, and hence is not connected by a first-power relation with the amount of resistance in the field circuit, it is necessary to design a rheostat having a suitably tapered resistance-displacement characteristic.

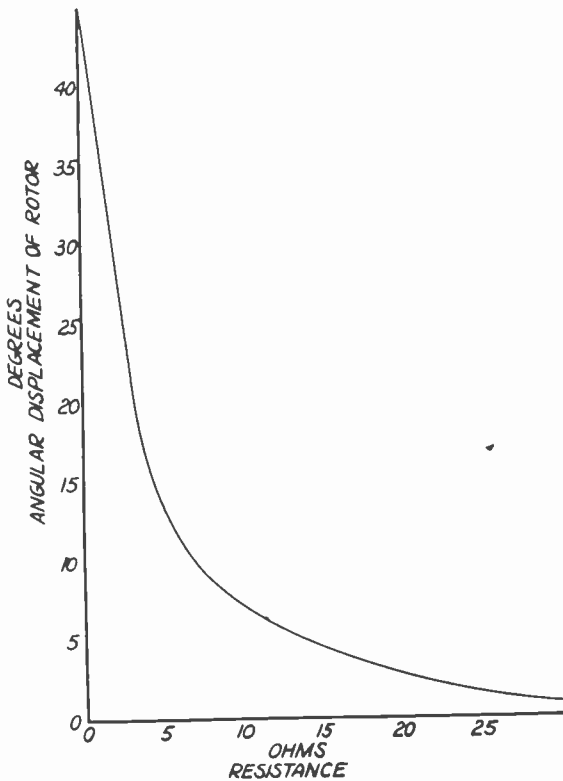

Fig. 2—Resistance-displacement characteristic. Motor rotation as a function of field resistance; one field at maximum.

Fig. 2 shows the displacement characteristic secured by an empirical determination of required resistance, and Figs. 3 and 4 show current and power relations. Observations were taken through 45 degrees only, since the performance through 45 degrees is repeated in further rotation.

It was found impracticable to design a rheostat following exactly these relations, because of the excessive size required for this combination of displacement characteristic and power dissipating ability. However, it was found entirely feasible to approximate the requirements,

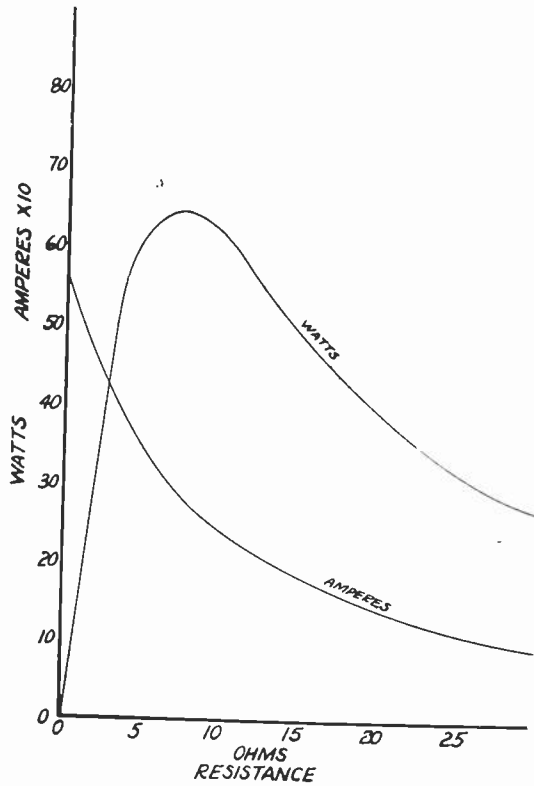

Fig. 3—Rheostat characteristics.

the only appreciable deviation being at the high resistance, low current end of the resistance. The rheostat as constructed is about four inches

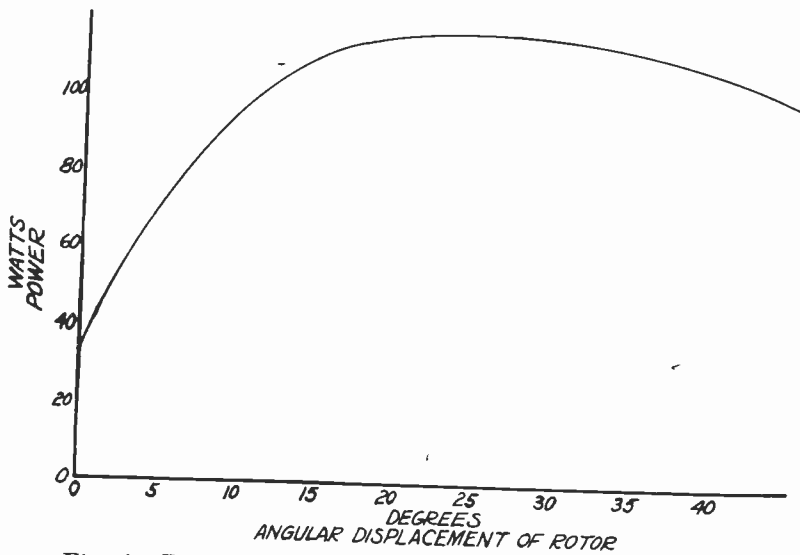

Fig. 4—Power consumption characteristic. Variation of total circuit consumption.

in diameter and about one and one-half inches deep. The "tracking" of the rheostat dial with the motor rotor shows no deviation exceeding two degrees.

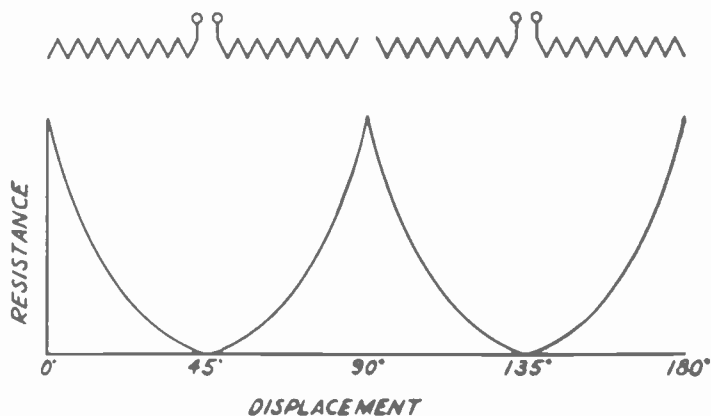

Fig. 5—Rheostat characteristic.

The rheostat has four sections of identical resistance, since the same mode of motion obtains for each 45 degrees of motor rotation. The total winding occupies about 330 degrees. The electrical order is shown in Fig. 5, the displacement scale being that of rotor movement. The

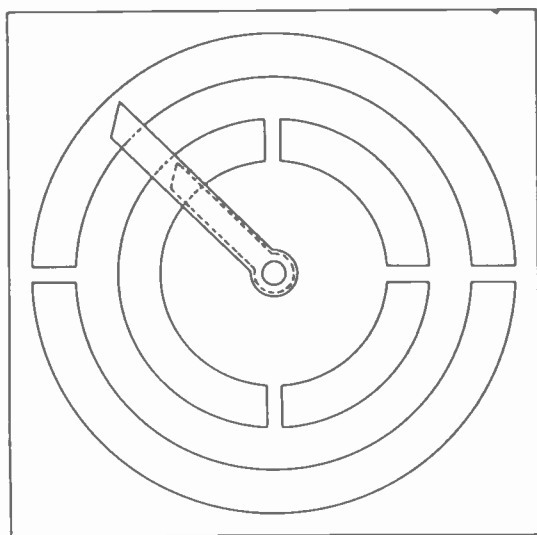

Fig. 6—Field reversing switch.

reversing switch mentioned previously operates at the 90-degree point. It is attached directly to the rheostat shaft and is set within the winding so that it does not add to the over-all depth of the unit. Fig. 6 shows its arrangement.

The control for the rheostat is arranged so that it is normally disengaged from the rheostat. To operate, the control knob is depressed against the pressure of a light spring; this engages the control shaft with the rheostat, first closing a pair of contacts which close the motor circuit. The electrical disengagement prevents any power consumption except during the actual tuning, while the mechanical disengagement prevents the rheostat dial from being turned without movement of the motor. If this latter disengagement did not take place, disturbance of the control knob after a station had been tuned in would destroy the agreement between remote and chassis dials, until the motor was again operated.

IV. TORQUE

For this motor, torque assumes a meaning somewhat different from the case of a conventional machine in which the rotor is rapidly performing successive revolutions. In the present case, the important factor is the torque tending to restore static equilibrium when the rotor is displaced a certain angular distance from a given equilibrium position determined by the relative field strengths. Due to the variation in field strengths, the torque is not constant throughout the range of rotation.

A simple method was developed for the experimental determination of the variation of torque. A pointer and lever arm were attached to the motor shaft. A spring balance was attached to the end of the lever arm, and a scale arranged upon which the pointer would indicate. With the rotor in any equilibrium position, the torque required to displace it is FL (gram-centimeters, say), the spring balance being maintained perpendicular to the shaft. An arbitrary angular deviation of six degrees was selected. Maximum voltage was then maintained across one field, and the current through the other varied from zero to maximum. At each position, the tension of the spring balance was adjusted to produce the selected deviation of six degrees, in both clockwise and counterclockwise directions. The torque for the two directions has been plotted against displacement to give the curves of Fig. 7. As indicated, it varies from about 330 gram-centimeters with one field at minimum to about 800 gram-centimeters with both fields at maximum.

Experimental utilization of the motor to drive various typical commercial condenser gangs indicates that the torque developed is more than sufficient for the work required. However, in order to secure smooth motion without backlash between control and gang, it is essential to use a gang having a minimum of bearing friction. This condition is easily realized in present low-cost condensers fitted with ball bear-

ings. It is necessary also to employ for the manual control either a knob attached directly to the gang shaft, or some form of disengageable vernier, in order that there may be no unnecessary friction.

A pair of contacts actuated by a small arm attached to the condenser shaft serves to open the primary circuit of the receiver power transformer when the dial has been rotated to zero.

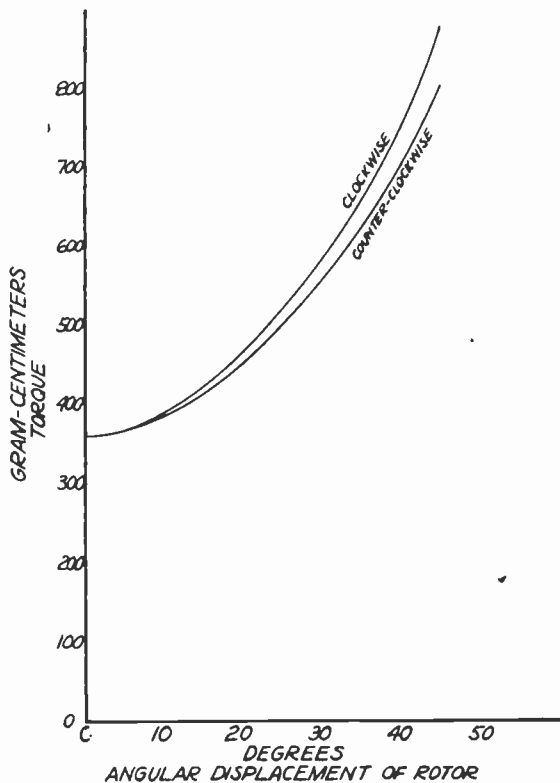

Fig. 7—Torque characteristic. Torque required to produce arbitrary deviation of six degrees from equilibrium position at different settings. One field constant—other varied. Transformer terminal voltage = 35.0.

V. VOLUME CONTROL

Besides control of tuning, it is of course necessary to have means for control of volume. There are in general two ways of effecting this:

1. The volume control may be placed in the remote unit and the necessary wires, usually either two or three in number, brought through the cable to the remote unit.

2. The volume control may remain in the receiver and be controlled by means similar to the tuning scheme.

The number of wires in the cable will be about the same in either case. The latter method is usually the more expensive. The former ap-

pears to be decidedly preferable, but imposes some limitation on the location of the volume control in the circuit, since the capacity and other cable effects may be detrimental to the operation of the receiver for some volume control circuits.

Fig. 8 shows a complete set-up of motor and volume control circuits, with remotely located volume control. In order that any number of controls may be used and be capable each of independent use, a simple magnetic switching arrangement has been worked out. When it is desired to use a particular volume control, the push button operat-

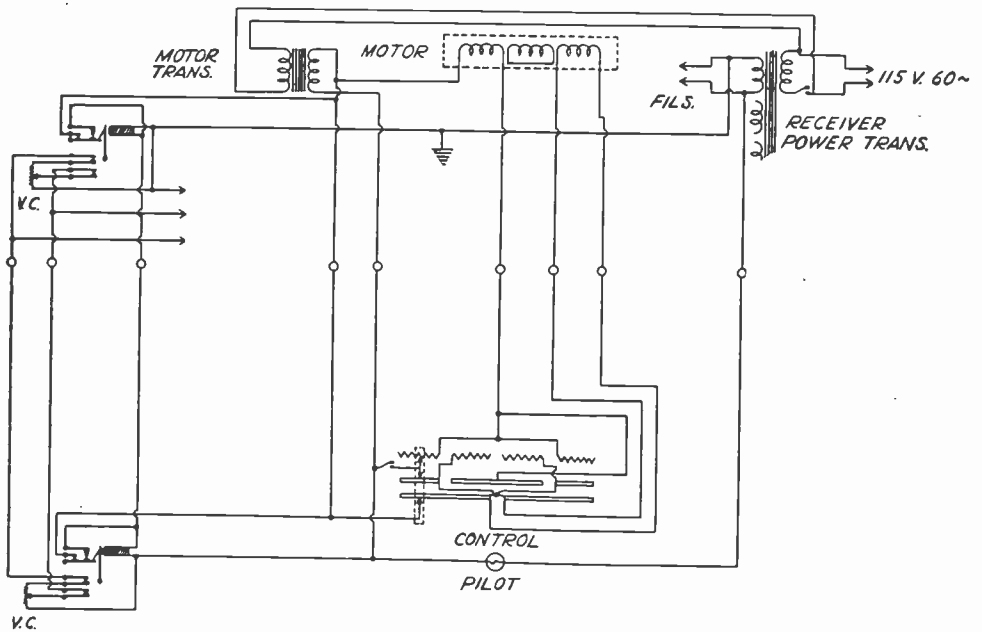

Fig. 8—Complete circuit diagram.

ing the magnetic switch at that station is pressed; this places the control in the circuit; at the same time the coils of all the other magnetic switches are momentarily energized, tripping their respective contactors and disconnecting all volume controls but the one in use. This switching circuit operates on the 30-volt motor transformer.

VI. FURTHER APPLICATION OF THE MOTOR

Use of the motor which has been described is not limited to the control of radio receivers. It can be applied to the distant control of any device whose torque requirement lies within the ability of the motor. A suggested use is as an indicator or monitor of a remote operation or process to which has been attached the controlling rheostat.

THE SECONDARY EMISSION PHOTOTUBE*

By

HARLEY IAMS AND BERNARD SALZBERG

(Research and Development Laboratory, R.C.A. Radiotron Company, Inc.,
Harrison, New Jersey)

Summary—A type of phototube is described in which the secondary electron emission from an auxiliary cathode (bombarded by the photo-electrons) is utilized to obtain amplification of the primary photocurrent. Phenomena of secondary emission, particularly as applied to the vacuum phototube, are discussed. The operating performance of a typical developmental embodiment is illustrated, and it is shown that its static sensitivity is comparable with that of a corresponding gas phototube; that as regards fidelity, it retains the freedom of the vacuum phototube from the considerable loss in response at the higher audio frequencies which is inherent in the gas phototube; and that on the basis of noise produced by the microscopic fluctuations of its current, it is somewhat superior to the comparable gas tube, and approximately equivalent to a vacuum phototube having the same emission and followed by an amplifier having an over-all gain equivalent to the secondary emission amplification. Life tests indicate that the stability of these tubes is entirely comparable with that of the vacuum phototube, both as regards secondary emitter and photocathode behavior. In addition to the usual applications, various incidental uses of these phototubes are suggested.

INTRODUCTION

IMPROVEMENTS in the sensitivity and fidelity of phototubes are desirable for economic reasons. The sensitivity of such tubes has been progressively increased until it is now possible to obtain, by careful treatment, a photo-emission in vacuum of about 50 micro-amperes per lumen (2870 degrees Kelvin tungsten sensitivity) with a Cs-O-Ag photocathode of the type described by Koller.¹ This vacuum sensitivity may be further enhanced by filling the tube with an inert gas at low pressure. In this case the photo-emission is augmented by the products of the collision ionization which takes place during the transit of the photo-electrons from cathode to anode, and by the secondary reaction of the positive ions on the cathode. Gas amplification of this kind, however, is not entirely satisfactory, for while the sensitivity at low frequencies is increased five- or tenfold the response at the higher audio frequencies becomes poorer and poorer with increasing frequency, ultimately approaching that of the vacuum phototube. This sluggishness of response of the gas phototube has been ascribed² to the

* Decimal classification: 535.38. Original manuscript received by the Institute June 28, 1934.

¹ L. R. Koller, *Gen. Elec. Rev.*, vol. 31, p. 476, (1928); *Phys. Rev.*, vol. 33, p. 1082, (1929).

² K. H. Kingdon and H. E. Thomson, *Physics*, vol. 1, no. 6, p. 343, (1931).

time lag of the processes involved in the thermionic emission (from spots on the cathode) caused by the impinging positive ions. Unlike the droop in the response frequency characteristic which is caused by the shunt capacitance of the tube and its associated parts, the effects of this type of falling off cannot be completely equalized by linear circuit elements.

In the type of phototube which is described here (to which the name "secondary emission phototube" has been given) the vacuum sensitivity is magnified by making use of the secondary emission from an auxiliary cathode bombarded by the photo-electrons—a process which is intrinsically free from the delay mechanism associated with gas amplification. Secondary emission has also been employed by Hull to amplify thermionic currents at high frequencies.³

TUBE STRUCTURE

The general scheme of operation consists in causing the electrons emitted from the irradiated photocathode to be drawn to a secondary emitter cathode, the surface of which is bombarded by these electrons at a velocity sufficiently high to result in appreciable secondary emission to a neighboring collector. The configuration of the elements of an ideal phototube of this type should accordingly be arranged to meet the following specifications:

(1) As much of the available incident radiation as possible should be permitted to strike the photocathode. The interception or absorption of the incident radiation by the secondary emitter cathode and collector should be reduced to a minimum, in order to realize the maximum over-all sensitivity.

(2) The disposition and shape of the electrodes should be such that the surfaces of the photocathode and secondary emitter cathode can be properly oxidized by a glow discharge in oxygen. The latter process constitutes an important preliminary step in the usual preparation of these electrodes, and it necessitates a fairly uniform field intensity.

(3) As much of the photo-emission as possible should be caused to strike the secondary emitter cathode. The fraction of the photo-emission intercepted by the collector or diverted to it (as by orbital motion) should be reduced to a minimum in order to realize the full benefit of the amplification process.

(4) The greatest possible ratio of secondary electron emission to primary electron current should be obtained at the auxiliary cathode, so that the available amplification will be a maximum. A brief discus-

³ A. W. Hull, *Proc. I.R.E.*, vol. 6, no. 1, p. 5; February, (1918). See also, in connection with applications to phototubes, British Patents 328,451; 332,733; and 364,006.

sion of the surface preparation of the secondary emitter cathode is undertaken in the following section.

(5) As much of the secondary emission current as possible should be collected, with a minimum voltage at the collector. To provide sharply saturating emission, and thus permit a minimum collector voltage, the surface of the secondary emitter cathode should preferably be a plane parallel to the plane of the collector grid.

(6) The capacitances between various electrodes should be reduced as much as possible, to minimize shunting effects at the higher frequencies. In these tubes, with the load connected in series with the collector, the effective shunting capacitance consists of the photocathode-to-collector capacitance in parallel with collector-to-secondary-emitter capacitance. The reduction of these capacitances can be effected by providing only enough electrode area to make full use of the incident radiation, separating the electrodes by as large a distance as possible consistent with (2), (3), and (5) above, and reducing the residual capacitances contributed by leads, basing, etc.

In a commercial tube these ideal requirements must necessarily be tempered by consideration of feasibility of manufacture, allowable space and shape, and limitations imposed by circuit applications.

The first of our attempts to devise a secondary emission phototube resulted in an output slightly over three times the photocathode current. Later consideration of the factors outlined above has doubled this gain. For example, the change from a rod-shaped secondary emitter to a rectangular one resulted in a reduction of the number of photoelectrons which took an orbital path around that element and reached the collector without producing secondary electrons. Fig. 1 illustrates a developmental sample built in accordance with these ideas. It consists of a conventional photocathode, a plate-shaped secondary emitter cathode, and a flattened collector grid surrounding it; the latter two electrodes are situated approximately about the center of curvature of the photocathode and turned edgewise to the incident radiation. These features result in a minimum interception of light consistent with bulb limitations, permit a fairly uniform degree of oxidation of the cathode surfaces, and result in a low effective tube shunt capacitance. Both cathodes are of the conventional $Cu-O-Ag$ variety, and the surface treatments of the two cathodes are in most respects identical; this results in simplified manufacturing procedure. The optimum bombardment of the secondary emitter cathode and the maximum collector current which it is possible to obtain with this particular form of structure are secured by suitable adjustment of grid spacing, wire turns, and wire diameter.

SECONDARY EMITTER CATHODE

A surface bombarded with electrons will emit secondary electrons. In general, this secondary emission depends upon the character of the surface and the velocity of the primary (bombarding) electrons.⁴ The magnitude of the current which may be collected by a neighboring electrode depends, in addition, upon the field available at the secondary emitter to draw away the electrons.

The maximum yield of secondary electrons varies with the nature of the secondary emitter cathode surface. Generally it is greatest for

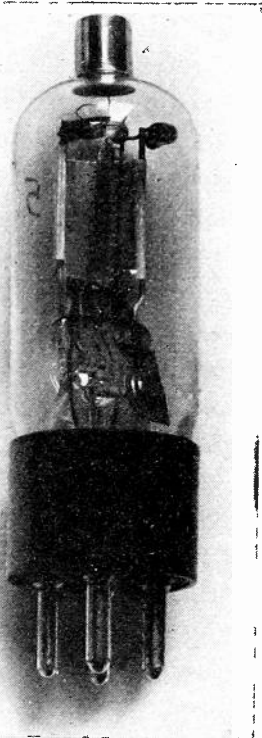

Fig. 1—A typical developmental secondary emission phototube. The data and characteristic curves given here were taken on a tube of this kind.

films of alkali metal on oxidized metal surfaces (such as that used in the developmental sample shown in Fig. 1), for which it may reach values as great as eight or ten times the initial current. Also, the maximum ratio of the number of secondary electrons per primary electron is obtained only at a fairly high primary electron velocity. As an example in Fig. 2 is shown the ratio of secondary electrons to primary ones as a function of primary electron velocity for one sample of a

⁴ A concise summary of these matters may be found in "Electrical discharges in gases, Part 1," by K. T. Compton and I. Langmuir, *Rev. Mod. Phys.*, vol. 2, no. 2, p. 171; April, (1930). A short bibliography of various papers dealing with the subject will also be found there.

surface of oxidized silver sensitized with caesium, one of the surfaces with which we have experimented. In this test the bombarding electrons were concentrated into a beam, and the field utilized to draw away the secondary electrons was made sufficiently strong virtually to saturate this secondary emission. It will be observed that the ratio of yield increases fairly rapidly with impact voltage up to about 300 volts, increases more slowly up to 900 volts, remains almost constant up to about 1300 volts, and decreases very slowly thereafter. The rapid increase in yield at the lower voltages is a rather fortunate state of affairs from a practical viewpoint; thus the yield at 250 volts, a voltage which is readily obtained, is already three quarters the maximum realizable.

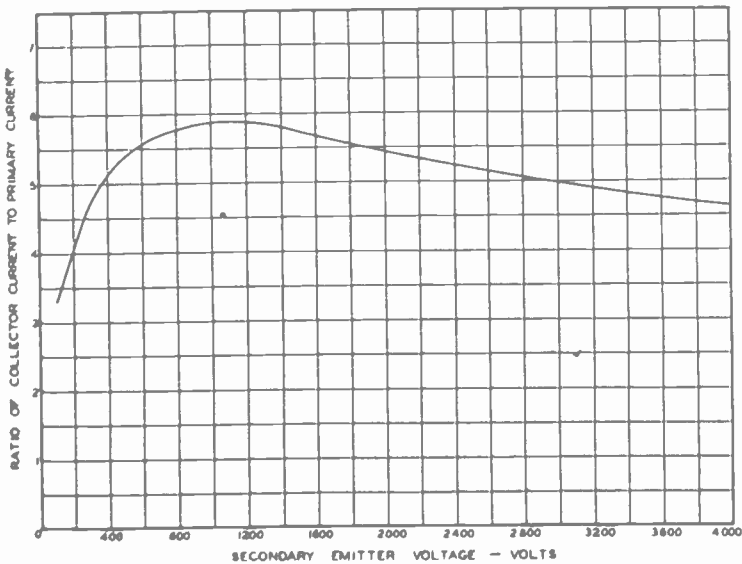

Fig. 2—The ratio of collector current to primary current as a function of the secondary emitter potential. These data were taken on a beam tube, the secondary emitter consisting of an oxidized silver surface sensitized with caesium.

If the collector voltage is maintained at a value high enough to overcome the space-charge drop, the relation between primary and secondary electron currents is found to be linear, and independent of the collector voltage. Furthermore, the time of transit of electrons in fields as strong as those set up in phototubes of this type is very short compared with the duration of any contemplated light alternations, and also the time required for the incident electrons to knock secondary electrons out of the secondary emitter cathode is negligible. Consequently, the amplification provided by this process is linear, and the only important sources of possible distortion in such phototubes lies in the shunt capacitances of the tube and associated circuits, and that occasioned by any departures from ideal operation.

CHARACTERISTICS

The static characteristics of a typical tube of the kind shown in Fig. 1 are given in Figs. 3, 4, 5, and 6. Fig. 3 shows the relations between the various electrode currents and the collector voltage, with a constant light of 0.1 lumen from a tungsten filament lamp at a color temperature of 2870 degrees Kelvin, and with a constant potential of 200 volts on the secondary emitter. For these conditions the primary photo-emission is sensibly independent of the collector voltage, and is merely a function of the incident radiation. The collector current is negative and rather small for collector voltages less than the secondary emitter voltage, since this condition represents secondary emis-

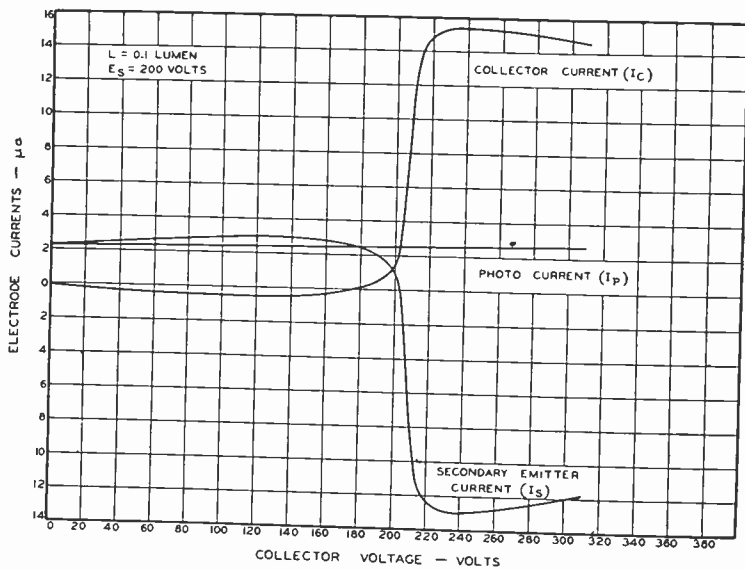

Fig. 3—The variation of the electrode currents with collector voltage for a typical tube of the kind shown in Fig. 1.

sion from the collector to the secondary cathode. At higher collector voltages the secondary emission is drawn from the auxiliary cathode to the collector, and the collector current rises to a broad maximum. The diminishing current for the highest collector voltages is caused by the attraction of an increasing number of photo-electrons, which therefore produce no secondary electrons at the auxiliary cathode. The overall sensitivity under normal conditions of operation is approximately 150 microamperes per lumen, with a photocathode having a sensitivity of 27 microamperes per lumen. The effective amplification, defined as the ratio of collector current to primary photocurrent, is approximately six in the working range. This value is not the true ratio of secondary emission to primary electron current at the auxiliary cathode, however, because part of the photo-emission is intercepted by the collector; the

actual value of the ratio of secondary electron current to primary current is somewhat larger.

In Fig. 4 is shown the negative resistance characteristic of the secondary emitter cathode. The current to this electrode is plotted as a function of electrode voltage, for 0.1 lumen of incident radiation and a constant collector potential of 250 volts. The primary photocurrent and collector current are also indicated on this diagram. A negative resistance of 10.4 megohms, and a negative transconductance of 1.27 micromhos are obtainable with a primary photocurrent of approximately 2.45 microamperes.

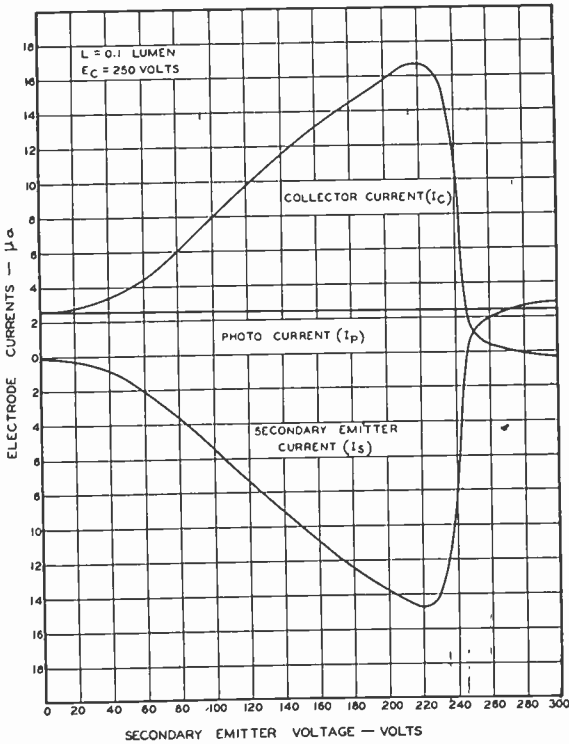

Fig. 4—The variation of the electrode currents with secondary emitter voltage. The negative resistance and negative transconductance characteristics of the secondary emitter cathode are exhibited here.

Fig. 5 is a typical output family of curves, in which the collector current is shown as a function of the collector voltage (over the usual operating range) for various values of luminous flux, with no impedances in the external circuits, and with the secondary emitter potential equal to 200 volts. The load impedance may be drawn directly on this diagram to indicate the path of operation, and the shape of the output current determined in the conventional manner. Several resistor loads are indicated on this diagram, and it will be seen that for such loads the output current will be virtually a replica of the impressed

radiation; that is to say, the tube possesses sensibly the normal linearity of the more usual type of vacuum phototube.

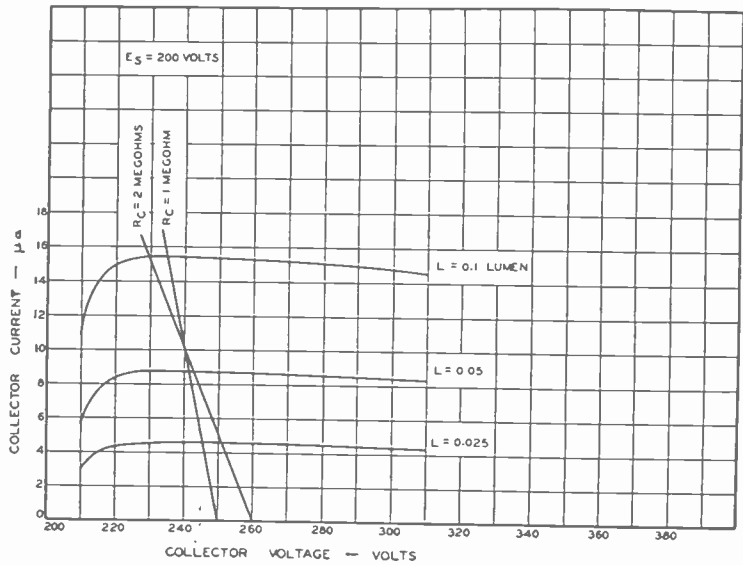

Fig. 5—A typical output family.

In Fig. 6 is shown the frequency characteristic of a secondary emission phototube. This was obtained by impressing a pulsating flux of the form $L_0(1 + \sin at)$, having an average value $L_0 = 0.15$ lumen, and read-

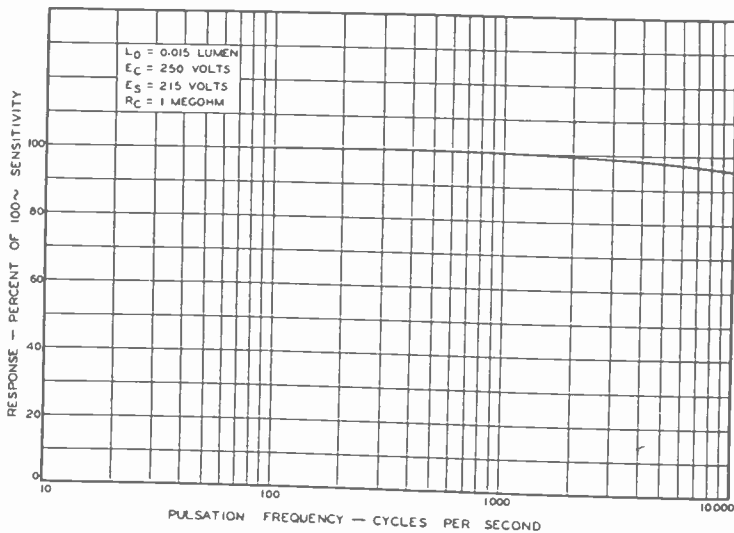

Fig. 6—The response—pulsation-frequency characteristic. The ordinates represent the ratio of response to that of a vacuum -863 type.

ing the alternating voltage developed across a one-megohm resistor connected in series with the collector. The collector voltage supply was

250 volts, and the secondary emitter cathode was kept at a constant potential of 215 volts. The ordinates do not represent the actual alternating output voltage, but are the ratio of these readings to similar readings obtained with a vacuum phototube identical in all other respects with the -868 type. This procedure was adopted in order to display prominently the difference in the behavior of the tubes alone. Since the load resistor and the test circuit were the same for each tube, the slight droop in the frequency response characteristic at the higher frequencies may be attributed to the higher output capacitance of the secondary emission phototube. The interelectrode capacitances of the tube shown in Fig. 1 are approximately $C_{ps} = 1.00$, $C_{pc} = 1.70$, and $C_{sc} = 2.40$, all expressed in micromicrofarads. When the load is connected in the collector voltage supply, the effective shunting capacitance is $C_T = C_{pc} + C_{sc} = 4.10$, as compared with a capacitance $C = 3.00$ of a typical commercial phototube such as the -868. The decreasing response at the higher frequencies may be minimized by reducing the value of the output resistance, or may be compensated for by including suitable inductive circuit elements in the output load.

Preliminary measurements of the fluctuation noise in these tubes indicate that under normal operating conditions the mean-square noise voltage is quite closely proportional to the product of the primary photocurrent and the square of the effective amplification of the tube, and that the spectrum of the noise is characterized by no predominating frequency band. These facts may be summed up by the statement that, as regards noise, the tube is approximately equivalent to a vacuum phototube having the same photo-emission followed by an amplifier having an over-all gain equivalent to the effective amplification due to secondary emission.

In contrast, previous measurements of the fluctuation noise in gas phototubes indicate that the noise is present principally at the lower frequencies, and that it increases (particularly at the higher currents) with increasing anode potential more rapidly than the photo-electric current.⁵

Because thermionic tubes which employ secondary emission processes have commonly shown variations during life, a number of life tests have been run to check the stability of these phototubes. Such tests show that the secondary emission amplification does not vary appreciably under normal operating conditions. The essential difference between the thermionic tubes and the phototubes is that in the thermionic tubes material from the cathode is being deposited during

⁵ F. von Orbán, *Zeit. für tech. Phys.*, vol. 13, no. 9, pp. 420-424, (1932), and vol. 14, no. 4, pp. 137-143, (1933).

activation and life upon the secondary emitter surface, changing its characteristics, whereas in the phototubes the secondary emitter surface remains substantially unchanged, provided the tubes are operated at normal temperatures.

APPLICATIONS

Phototubes of this kind are suitable for the usual applications in sound movies, facsimile transmission, television, automatic inspection, etc. In addition, because of their negative resistance properties, they may be used as stable self-oscillators. The presence of the additional electrode also makes it possible to utilize various combinations of impedances and connections in the external circuits so as to obtain increasing or decreasing nonlinear output voltage vs. incident radiation characteristics.

CONCLUSIONS

The properties of the secondary emission phototube are such that it will probably find many commercial uses. The sensitivity may be six times that of a comparable vacuum phototube of conventional design, and at the higher audio frequencies is superior to a gas-filled phototube. While the interelectrode capacitance is somewhat higher in the secondary emission phototube, circuit constants may be modified to minimize ill effects. The fluctuation noise of this tube is less than that in a gas-filled one, and is approximately equivalent to that of a vacuum type, followed by an equal amount of amplification. The life of the secondary emission phototube is substantially the same as the life of the usual vacuum type. Its negative resistance properties, and the presence of an additional electrode, will increase the number of possible uses.



THE TEMPERATURE COEFFICIENT OF INDUCTANCE, WITH SPECIAL REFERENCE TO THE VALVE GENERATOR*

BY

E. B. MOULLIN

(Engineering Laboratory, Oxford University, Oxford, England)

Summary—This paper discusses the manner in which the inductance of a coil depends on temperature, and has been written as a contribution to the problem of the temperature coefficient of frequency of a valve generator. Preliminary consideration shows that when a coil expands without change of form, it will have a temperature coefficient of inductance equal to the coefficient of linear expansion of the metal of which it is made. Such copper coils would give a negative temperature coefficient of frequency of about eight parts in 10^6 per degree centigrade. Since valve generators are sometimes found to have a temperature coefficient much greater than eight parts in 10^6 , it is necessary to consider the effect of deforming the coil.

The first type of coil examined is a concentric cable; this form is amenable to exact analysis, and the results are a valuable guide to the behavior of more common forms of coil. The temperature coefficient of "internal inductance" and of self-capacitance is calculated and found to modify the net temperature coefficient by a negligible amount; accordingly, it is argued these effects can be ignored in all forms of coil. The core is then supposed to buckle under temperature stress and this is found to make the net coefficient less than that of linear expansion. The next example is a long solenoid wound on a form which constrains one diameter, so that the cross section becomes elliptical. The effect of this deformation is found to be a second-order quantity and tends to reduce the temperature coefficient. The result for a long solenoid is considered to be an upper limit for helical coils. An approximate solution is then obtained for the elliptical deformation of a single-turn circle and the result is found to be negligible. The next example is a two- or three-turn coil in which the radial expansion is greater than the axial. It is here found that if the coil form prohibits axial expansion, the temperature coefficient of inductance would be some 40 per cent greater than that of linear expansion. The circuit as a whole, coil plus leads, is then examined, and it is argued that with probable dispositions of the coil and leads, the net coefficient cannot usually be appreciably greater than that of linear expansion.

It is suggested, in conclusion, that if a valve generator is found to have a temperature coefficient of frequency which is notably greater than half the coefficient of linear expansion of the metal of the coil, then the dominant cause is not change of inductance.

I. INTRODUCTION

THE conditions of the present day demand that the frequency of a radio transmitter shall remain constant within extremely narrow limits. For immobile stations working on an assigned wavelength, the desired constancy can be attained by the use of crystal or tuning fork control, or by the help of an elaborate drive system. But these methods of solution are impracticable for mobile stations, being

* Decimal classification: R145.3. Original manuscript received by the Institute, April 6, 1934.

precluded by considerations of space and cost and ability to work over a range of wavelength.

It is obvious that temperature must affect the frequency of a simple generator since it affects the geometrical dimensions of the coils and capacitances. Possibly it may affect the frequency through other agencies also. The temperature of the coils and condensers will depend both on the ambient temperature of the surroundings and on the power wasted in them. If the temperature depends appreciably on the power loss, the coils and condensers will not be at the same temperature, since they have very different heat capacities, cooling surfaces, and power losses.

If coils and condensers can be built so as to be self-compensating for temperature change, they will improve the frequency stability of a given radio transmitter. Attempts have been made to produce such coils.

The temperature coefficient of a coil must be measured by observing the relation between its temperature and the frequency of some generator of which it forms a part. A coefficient so obtained is the true temperature coefficient of that coil when associated with the particular generator, but it does not follow necessarily that the same coefficient would be obtained if it were associated with some other generator, and it does not necessarily follow that this coefficient is the temperature coefficient of inductance, tempting as it may be to assume that it is.

There are not many recorded measurements of the temperature coefficient of a coil and generator, but such as there are show that temperature coefficients of frequency of the order of 30 parts in 10^6 per degree centigrade are met with. The writer has discussed the problem with those responsible for building radio transmitters and, rightly or wrongly, has gathered the impression that temperature coefficients of 30 parts in 10^6 per degree centigrade are by no means uncommon and may be exceeded, also that the coefficient is commonly attributed to change of inductance.

When the problem of inductance change with temperature is considered from its simplest basic principles, it is astonishing that the coefficient can be as large as 30×10^6 per degree centigrade. This has led the writer to make a detailed and rather ponderous mathematical attack on the problem.

II. TEMPERATURE COEFFICIENT OF AN UNSUPPORTED METAL COIL WHICH EXPANDS UNIFORMLY IN ALL DIMENSIONS

In the electromagnetic system of units, in which magnetic permeability is considered to be a dimensionless constant, an inductance has

the dimensions of a length. Hence it follows that if a coil expands uniformly, without change of form, the temperature coefficient of inductance must be equal to the temperature coefficient of linear expansion of the metal of which it is made. A similar argument applies to the temperature coefficient of capacitance.

The tables of Kaye and Laby give the temperature coefficient of linear expansion of copper as 16.7 parts in 10^6 per degree centigrade. Thus for a copper coil, the temperature coefficient of inductance should be of the order of 17 parts in 10^6 , whereas the apparent value has been observed to be twice this, or more.

A discrepancy of at least 2 to 1 is surprising, and shows that the problem must be examined in detail before attempting to design self-compensating devices.

The same tables state that the temperature coefficient of brass is 18.9, bronze 17.7, gunmetal 18.1, and phosphor bronze 16.8. Hence, any alloy which is predominantly copper has a temperature coefficient near 17×10^{-6} per degree centigrade. The coefficient for aluminium is 25.5, duralumin 22.6, and aluminium bronze 17.0.

Hence, the temperature coefficient of inductance cannot be sensitive to the exact composition of the alloy. It is probable that the constraint of supports and the effect of overstrain cause a coil to deform when it is heated: Is it reasonable to assume that inductance is sufficiently sensitive to shape as to account for the temperature coefficient's being twice that of linear expansion? The writer's experimental and theoretical experience being contrary to this explanation, he has been led to attempt a detailed analysis of the changes of inductance which result from small deformations of shape, and at the same time to examine the importance of other factors which have an indirect effect on the apparent temperature coefficient. This analysis appears to show that the temperature coefficient of inductance of a copper coil is never far from 17×10^{-6} degrees centigrade, hence either the inductance changes from some cause as yet unsuspected, or the observed temperature coefficients of inductance are apparent and not real. If the first, then devices for self-compensation must be designed to act according to a law which at present is undiscovered. If the second, then devices for self-compensation must not be designed to give constant inductance but designed to change the inductance in a manner which depends on the particular generator with which the coil is associated. If the temperature coefficient of inductance is in fact about 17×10^{-6} degrees centigrade, then self-compensation for constant inductance can improve the frequency stability by only about eight parts in 10^6 degrees centigrade—an improvement which would be of comparatively

little importance in the present stage of the art, save in extreme cases where the power loss heats the coil enormously, or where the range of ambient temperature is very great, as in airplanes.

III. AN ANALYSIS OF THE VARIOUS FACTORS WHICH CHANGE THE INDUCTANCE OF A COIL

The first form of a coil to be considered is a concentric cable, because this form is amenable to exact mathematical treatment. Since this form of coil is not used in practice, it may appear to be only of academic interest to consider it. But this is not so, since the analysis shows that it is very closely related to the problem of a coil having very few turns, the form of coil used in short-wave practice, where frequency stability is a serious problem.

The other form of coil which is partly amenable to exact treatment is the closely-wound toroid, or very long solenoid. This form is also examined.

These solutions are used also to assist in reaching approximate solutions for coils consisting of a few widely spaced turns.

IV. THE CONCENTRIC CABLE

It is well known that the inductance per unit length of a concentric cable, solid inner conductor radius a , tubular external conductor of inner radius b , and outer radius c , is given by the expression

$$L = 2 \log_e \frac{b}{a} + \frac{1}{2} + \frac{1}{(c^2 - b^2)} \left\{ \frac{2c^4}{c^2 - b^2} \log \frac{c}{b} - \frac{3c^2 - b^2}{2} \right\}. \quad (1)$$

This expression has no dimensions; hence, since a , b , and c will all increase by the same fractional amount for a uniform change of temperature, there will be no change in the inductance per unit length. That is to say, the inductance increases with temperature only because the cable increases in length.

The expression for L consists of three distinct terms, each of which may be said to have distinct physical significance. The first term is due to the energy of the magnetic field in the tubular space. The second and third terms are due respectively to the energy of the magnetic field which is situated in the inner core and within the outer tube of thickness $(c - b)$.

As the frequency tends to infinity, the field within the conductor tends to zero and hence the inductance tends to the value

$$L' = 2 \log_e \frac{b}{a}. \quad (2)$$

The inductance at any specified frequency can be evaluated in terms of complex Bessel functions, and the result will be found in Heaviside's collected papers. It differs from the limiting values expressed by (2) by an amount which will be termed the "internal inductance."

(a) *Internal inductance at high frequencies and its temperature coefficient.*

The full expression for the internal inductance is too cumbersome to deal with, but it is well known that all skin effect phenomena approach rapidly a simple asymptotic expression which is a function of a certain parameter Z , where

$$Z^2 = \frac{8\pi^2 n a^2}{\rho}$$

in which a is the radius and ρ the specific resistance of the round wire. Usually the asymptotic expression is sensibly correct if the value of Z is greater than about 4. In the wave band between 15 and 100 meters, Z for copper wires is usually greater than 20 for radii of practical interest. Using the asymptotic form of the expression, it can be shown that

$$L = 2 \log_e \frac{b}{a} + \frac{1}{Z\sqrt{2}} \left(1 + \frac{a}{b} \right), \quad (3)$$

where Z refers to the core.

The first term of (3) has no temperature coefficient but the second term has, since Z varies as $1/\sqrt{\rho}$. Let α be the temperature coefficient of linear expansion, and η that of resistance. Then

$$L_T = \left\{ 2 \log_e \frac{b}{a} + \frac{1}{Z\sqrt{2}} \frac{(1 + \frac{1}{2}\eta T)}{(1 + \alpha T)} \left(1 + \frac{a}{b} \right) \right\} (1 + \alpha T). \quad (4)$$

To compare the relative importance of the internal inductance, it is necessary to take a numerical example. Let $a = \frac{1}{2}$ centimeter, $b = 10$ centimeters, and $n = 10^7$ cycles ($\lambda = 30$ meters). Then it may be found that $Z = 350$.

$$\begin{aligned} \therefore L_T &= \left\{ 6 + \frac{\left(1 + \frac{\eta}{2} - \alpha \right) T}{500} \right\} (1 + \alpha T) \\ &\doteq 6 \left\{ 1 + \left(\frac{\eta}{6000} + \alpha \right) T \right\} \\ &= 6 \left\{ 1 + \left(\frac{0.7}{10^6} + \frac{16.7}{10^6} \right) T \right\} \text{ for copper.} \end{aligned}$$

Hence, the temperature increase of resistance causes the internal inductance to increase and makes the net temperature coefficient about 5 per cent greater than the coefficient of linear expansion. To the first order the effect can be ignored.

The internal inductance is not changed appreciably by curvature or by the proximity of other wires. Hence the expression which is correct for a concentric cable is approximately correct for any practical form of coil having only a few turns. The relative importance of the temperature coefficient of internal inductance becomes less as the "external inductance" increases. Hence it is likely to be of greater importance for a single turn coil or concentric cable than for a helix of few turns or a solenoid. Hence "internal inductance" may be dismissed as an inappreciable cause of temperature coefficient.

(b) *Temperature coefficient of self-capacitance of a concentric cable.*

If the concentric cable has an inductance L and a length l , it can be shown that

$$\text{apparent inductance} \doteq L \left(1 + \frac{4}{3} \pi^2 \frac{l^2}{\lambda^2} \right) \quad (5)$$

where the wavelength is λ and $\lambda \gg l$.

If $l = 2$ meters, $\lambda = 30$ meters, ($L = 1.205 \mu h/cm$ if $b/a = 20$),

$$\text{apparent inductance} = L \times 1.06.$$

If such a concentric cable is the inductance of a generator whose capacitance remains constant, then, to the first order, λ^2 varies as l . Then the self-capacitance correction will have a temperature coefficient equal to that of linear expansion. For the numerical case considered this will increase the net temperature coefficient by about 5 per cent of itself.

The expression which is exact for a cable will be approximately correct for a helix having widely spaced turns. It is not clear how to estimate the effect for a long solenoid. Hence, it seems that for coils such as are used in short-wave practice, the self-capacity effect cannot increase the effective temperature coefficient by more than a small fraction of itself.

To sum up, it appears from analysis that if a copper coil expands without change of form, its temperature coefficient is unlikely to exceed 18×10^{-6} degrees centigrade; this means that the frequency of a generator should not change from this cause by more than 9 parts in 10^6 per degree centigrade.

It is now necessary to investigate the effect of deformations.

V. CHANGE OF INDUCTANCE FROM DEFORMATION

(a) *Concentric cable with core slightly displaced.*

If a concentric cable were used as the inductance of a generator, the core would become hotter than the sheath since it has greater resistance and less cooling surface. Hence the core would expand more than the sheath, and would buckle if its ends were not free to expand.

The inductance can be calculated for a cable with an eccentric core. Let a be the radius of the core, b the inner radius of the sheath, and d the eccentricity; then it is well known that

$$L = 2 \log_e (\beta + \sqrt{\beta^2 - 1}) \text{ per unit length}$$

where,

$$\beta = \frac{a^2 + b^2 - d^2}{2ab}.$$

If d is small compared with $(b^2 - a^2)$, this expression reduces to

$$L = 2 \left\{ 1 - \frac{\frac{d^2}{b^2}}{\log_e \frac{b}{a}} \right\} \log_e \frac{b}{a}. \quad (6)$$

Take the previous numerical example in which $a = 0.5$ centimeter and $b = 10$ centimeters; then if $d = 1$ millimeter,

$$L = 2 \left(1 - \frac{33}{10_e} \right) \log_e \frac{b}{a}.$$

The eccentricity could not be uniform along the length and to the first order the core would deflect into a sine curve of amplitude D . Then the change of inductance will be proportional to the mean square eccentricity and consequently will be half that given by (6). It can be shown that the relation between D and T is given by the equation.

$$\left(\frac{\pi D}{l} \right)^2 = 4\alpha T.$$

Adding the inductance due to successive arcs ds placed with eccentricity $y = D \sin \pi x/l$, it follows that

$$L_T = \left[1 + \left\{ 1 - \frac{2}{\pi^2} \frac{l^2}{b^2 \log_e \frac{b}{a}} \right\} \alpha T \right] 2 \log_e \frac{b}{a}. \quad (7)$$

The net coefficient will be negative so long as l is greater than, say, $4b$. If $l = 10b$, the net coefficient would be about 5α and negative. In practice the net coefficient would depend enormously on the rigidity of the end fixings, but the analysis suffices to show that the deformation is almost certain to make the temperature coefficient less than that of linear expansion.

If the outer sheath is supposed to be unaffected by the temperature of the core, the inductance will decrease with rise of temperature because such will decrease the ratio b/a . If the core remains central and b constant, it can be shown that

$$\begin{aligned} L_T &\doteq 2 \left(1 - \frac{\alpha T}{\log_e \frac{b}{a}} \right) \log_e \frac{b}{a} \\ &= 2 \left(1 - \frac{\alpha T}{3} \right) \log_e \frac{b}{a}, \quad \text{if } \frac{b}{a} \doteq 20. \end{aligned} \tag{8}$$

If the core is free to expand through a bush at the ground end of the sheath, the buckling of the core will be avoided and the net coefficient due to "load heating" will be negative and about 5×10^{-6} degrees centigrade. The coefficient due to ambient temperature would be that of the copper, namely 16.7×10^{-6} degrees centigrade.

(b) *Concentric cable with elliptical core and sheath.*

It is conceivable that overstrain in the metal may cause the cross section of core and sheath to deform when they are heated. To estimate the effect which such a change would have on the inductance, we shall suppose the core and sheath develop a slight ellipticity. It is well known that the inductance per unit length of a cable formed by two confocal elliptic cylinders is

$$L = 2 \log (z + \sqrt{z^2 - 1})$$

where,

$$z = \frac{a_1 a_2 - b_1 b_2}{a_1^2 - b_1^2} = \frac{a_2 \left(1 - \frac{b_1}{a_1} \frac{b_2}{a_2} \right)}{e_1^2}$$

in which a_1, b_1 , etc., have their usual significance, and where the confocal property requires that

$$a_2^2 = a_1^2 + \lambda, \quad b_2^2 = b_1^2 + \lambda.$$

Now,

$$e_1^2 = 1 - \frac{b_1^2}{a_1^2}$$

$$e_2^2 = 1 - \frac{b_2^2}{a_2^2}$$

$$= \frac{a_1^2}{a_2^2} e_1^2.$$

Let $a_1 = R_1(1+x)$ and $b_1 = R_1(1-x)$, where x is a very small fraction, and R_1 is the radius of the original circle.

Then,

$$e_1^2 = \frac{a^2 - b^2}{a^2} = \frac{4R^2x}{(R+x)^2} \doteq 4x.$$

Now $a_2/a_1 \doteq R_0/R_1$. As before we shall assume that $R_0/R_1 \doteq 20$. Hence it follows that $e_2 \doteq 1/20 e_1$.

Hence if the core is flattened slightly, so that x is 1 per cent, we must suppose the sheath is flattened by 1/400 per cent. If $R_1 = 1/2$ centimeter and $R_0 = 10$ centimeters, this supposes that perpendicular diameters of the core differ by 0.2 millimeter and perpendicular diameters of the sheath differ by 1/100 millimeter (0.4 mil.). Thus, to the accuracy of good machining, we may consider it as an elliptic core in a circular sheath.

Let $a_1/a_2 = y$, where y is of the order of 1/20. It follows that

$$\frac{b_1}{a_1} \frac{b_2}{a_2} = \sqrt{1 - e_1^2} \sqrt{1 - y^2 e_1^2}$$

$$\doteq 1 - \frac{1}{2} (1 + y^2) e_1^2 - \frac{1}{8} (1 + y^2)^2 e_1^4$$

$$\therefore 1 - \frac{b_1}{a_1} \frac{b_2}{a_2} = \frac{1}{2} (1 + y^2) e_1^2 \left\{ 1 + \frac{1}{4} (1 + y^2) e_1^2 \right\}$$

$$\therefore z = \frac{(1 + y^2) \left\{ 1 + \frac{1}{4} (1 + y^2) e_1^2 \right\}}{2y}$$

$$\doteq \frac{(1 + y^2)(1 + x)}{2y} \doteq \frac{1 + x + y^2}{2y}$$

and hence z is of the order of 10.

$$\begin{aligned}
\therefore z + \sqrt{z^2 - 1} &\doteq 2z \left(1 - \frac{1}{4z^2} \right) \\
&\doteq \frac{1+x}{y} \\
&= \frac{a_2}{a_1} (1+x) \\
&= \frac{R_0(1+xy^2)}{R_1(1+x)} (1+x). \\
\therefore L &= 2 \log \left\{ \frac{R_0(1+xy^2)}{R_i} \right\} \\
&\doteq 2 \left(1 + \left(\frac{R_i}{R_0} \right)^2 \frac{x}{\log \frac{R_0}{R_i}} \right) \log \frac{R_0}{R_i}. \quad (9)
\end{aligned}$$

Hence, if x is 1 per cent, the inductance would be increased by about eight parts in 10^6 , if $R_0/R_i=20$. Thus it would seem that small malformations of cross section are not competent to change the inductance appreciably.

Finally it would seem most unlikely that a tubular inductance can have a temperature coefficient of inductance greater than the coefficient of expansion of the metal. In practice the temperature coefficient is likely to be less than that of expansion and might even be negative.

VI. CHANGE OF INDUCTANCE DUE TO DEFORMING A COIL OF CONVENTIONAL SHAPE

We shall suppose first that a rise of temperature causes a change in the shape of the turns, but that the axial expansion is uniform along the length of the coil. We shall then suppose the shape of the turns is unchanged but that the axial expansion of the coil differs from the radial expansion.

(a) Deformation of the turns.

Exact solution is practicable for this deformation only when the coil is a long solenoid; an approximate solution can be obtained for a single turn coil, and the solution for a coil having a finite number of turns must be inferred by the aid of the two limiting expressions.

(1) Long Solenoid. If a coil is a long and closely wound solenoid, the inductance is proportional to the square of the number of turns per unit length and to the length and cross-sectional area of the tube. The

inductance is independent of the shape of the cross-sectional area. If a given round solenoid is flattened, the inductance will decrease by an amount proportional to the decrease of area. Let a circular tube be flattened into an ellipse of small eccentricity e , the perimeter remaining constant.

The perimeter l of an ellipse of major semiaxis a and small eccentricity e is expressed by the equation

$$l = 2\pi a \left(1 - \frac{e^2}{4} - \frac{3e^4}{64} \right).$$

Let the tube start as a circle of radius R and be flattened into an ellipse of semiaxes a and b , where $e^2 = 1 - b^2/a^2$. Then $l = 2\pi R$.

$$\begin{aligned} \text{Area} &= \pi ab \\ &= \pi a^2 \sqrt{1 - e^2} \\ &= \frac{\pi R^2 \sqrt{1 - e^2}}{\left(1 - \frac{e^2}{4} - \frac{3e^4}{64} \right)^2} \\ &\doteq \pi R^2 \left(1 - \frac{3}{32} e^4 \right). \end{aligned}$$

Let $b = R(1 - x)$, where x is very small.

Then it follows that $e^2 = 4x$.

$$\therefore \text{Area} = \pi R^2 \left(1 - \frac{3}{2} x^2 \right). \quad (10)$$

The decrease of inductance is proportional to the decrease of area, which is expressed by (10). The correction term $(3/2x^2)$ is almost certainly an upper limit and a short coil would probably decrease in inductance by a smaller amount.

Now suppose a long solenoid is constrained so that one diameter of the tube remains constant while the expansion of the wire causes the previously circular turns to become slightly elliptical. Let the fixed radius be R ; this now becomes the semiminor axis of the ellipse.

First imagine the circle is allowed to expand uniformly and hence that its radius would become $R(1 + \alpha T)$; then let one diameter be compressed a fractional amount αT . Then by (10)

$$\begin{aligned} \text{area} &= \pi R^2 (1 + 2\alpha T) \left(1 - \frac{3}{2} \alpha^2 T^2 \right) \\ &\doteq \pi R^2 (1 + 2\alpha T - \frac{1}{2} \alpha^2 T^2). \end{aligned} \quad (10a)$$

Hence such a deformation in the process of expansion causes only a second order change of inductance.

(2) Single Turn Circle. The inductance of a coil is often defined as the flux threading it per unit current; this definition draws attention to the area of the circuit. But if the circuit is only a single turn, the inductance depends mainly on the perimeter and very little on the area. That is to say, the inductance per unit length of perimeter changes very slowly with the form and area of the turn. An alternative definition of inductance is twice the energy stored in the circuit per unit of current squared. If the field strength is H at a given point of space, then the energy may be considered to be distributed through the medium at the rate of $H^2/8\pi$ per unit volume. If the circuit is a single turn, the field is intense only close to the wire, and there it tends to the value $H=2/r$, whatever be the shape of the turn. Hence the total energy is dominated by the field close to the wire and thus it is seen that L depends only slightly on the form and area of the coil. Also this can be inferred from the formal integral which expresses the external inductance of a circuit; this is

$$L = \iint \frac{ds \cdot ds' \cos \epsilon}{r} \quad (11)$$

where ds , etc., is described by the figure (see Fig. 1) and in which the outer contour follows the center line of the wire and the inner contour is any parallel contour in the surface of the wire. Consideration of the

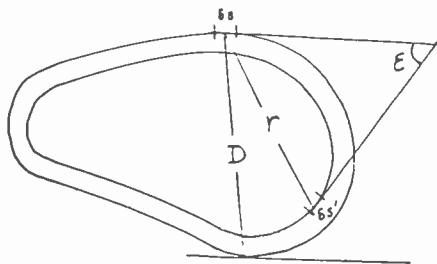

Fig. 1

figure will show that the main contribution comes from elements ds' which are near ds . For it is only such which have r small, and also in a large part of the summation $\cos \epsilon$ is very small. Hence, $ds \int (ds' \cos \epsilon / r)$ will tend to be approximately equal to $ds \log D/a$, where D is shown in the figure and a is the radius of the wire.

The integration can be performed for a circle and for any rectangular figure. The result for a circle, a rectangle, and a regular polygon is well known. V. J. Bashenoff¹ has collected the results for a circle,

¹ PROC. I.R.E., vol. 15, p. 1013; December (1927) and *Wireless Engineer*, May, (1929).

a regular octagon, hexagon, pentagon, square, equilateral triangle, and isosceles right-angled triangle and expresses them all in the form

$$L = 2l \left\{ \log \frac{2l}{r} - \theta \right\}, \tag{12}$$

where l is the total perimeter of the figure, r is the radius of the wire, and θ is a constant depending on the form of the figure.

The appropriate values of θ are shown below.

- (1) Circle..... $\theta = 2.451$
- (2) Regular octagon..... $\theta = 2.561$
- (3) Regular hexagon..... $\theta = 2.636$
- (4) Regular pentagon..... $\theta = 2.712$
- (5) Square..... $\theta = 2.853$
- (6) Equilateral triangle..... $\theta = 3.197$
- (7) Isosceles right-angled triangle..... $\theta = 3.332$.

It is important to notice that this general formula expresses L in terms of the perimeter and it is at once obvious that the form of the circuit has comparatively little effect. This may be seen by the help of a numerical example. Suppose a wire of 1 centimeter diameter is bent into a circle of 20 centimeters diameter. The perimeter is 63 centimeters and $\log 2l/r = 5.55$. It may be found that $L = 6.188$ cm/cm. If this same wire is deformed into a square, it may be found that the inductance is decreased by only 13 per cent, though the area is decreased by 21.5 per cent. If the same wire is deformed into an octagon it may be found that the inductance is decreased by only 3.55 per cent. Hence the inductance of a single turn of given perimeter cannot be sensitive to small deformations.

Bashenoff¹ has evaluated θ for rectangles having various ratios of length a to breadth b . Some of his values are as follows:

$\frac{a/b}{l \sqrt{A}}$	1	1.5	2.34	4	9
θ	2.853	2.866	3.006	3.269	3.826
	4	4.08	4.37	5	6.67

He shows that when $a/b > 12$, then $\theta = \log_e l^2/A$, where A is the area of the circuit, to an accuracy closer than 1 per cent.

It should be noticed that the expression for the inductance of a single turn (12) is of the same form as that for a concentric cable. Perhaps this is more obvious if Bashenoff's limiting value of θ is used, viz.,

$$\log l^2/A \doteq 2 \log 2a - \log ab.$$

Hence,

$$\begin{aligned} L &= 4a(\log 4a - \log r - 2 \log 2a + \log a + \log b) \\ &= 4a \log \frac{b}{r}. \end{aligned} \quad (13)$$

This is the inductance of two long parallel wires separated by a distance b ; it is twice the inductance of the same length of concentric cable having radii b and r . The inductance of a circular turn 20 centimeters in diameter, of a 1-centimeter rod, is 6.188 cm/cm. The inductance of a concentric cable having diameters 20 centimeters and 1 centimeter is 6 cm/cm. Hence if the given circular turn is straightened out and put inside a tube of the same diameter as the original turn, the inductance is decreased only by 3 per cent. Hence the preliminary discussion of the concentric cable was not inappropriate to the problem of a single turn circuit.

The calculation of the inductance of a slightly eccentric ellipse leads to intractable integration. But probably we can determine the result from a principle due to Bashenoff. Bashenoff suspects that all plane figures which have the same ratio of l/\sqrt{A} have the same inductance. His proposition is demonstrably inexact. For example l/\sqrt{A} for an isosceles triangle is 4.56, and $\theta=3.197$; the rectangle for which $l/\sqrt{A}=4.56$ has $\theta=3.08$. Again an isosceles right-angled triangle has $l/\sqrt{A}=4.82$ and $\theta=3.33$, whereas the rectangle in which $l/\sqrt{A}=4.82$ has $\theta=3.19$. He quotes an example in which the measured inductance of a certain ellipse ($a/b=2.3$) agreed within 0.1 per cent with the value calculated by using the value of θ appropriate to the particular value of l/\sqrt{A} ($l/\sqrt{A}=4.02$). It is impossible to say how exact his method of calculation is for an ellipse. However, we shall apply it to find the inductance of an ellipse of small eccentricity e . Using the previous expression for the perimeter of an ellipse, it may be found that

$$l/\sqrt{A} \doteq 2\sqrt{\pi} \left(1 + \frac{3}{64} e^4 \right).$$

Now let $b=R(1-x)$, then as before $e^2=4x$.

$$\therefore l/\sqrt{A} = 2\sqrt{\pi}(1 + x^2).$$

Using the values of θ for a circle and an octagon, we may express the value of θ for any figure in which l/\sqrt{A} lies between the respective values for these two figures, by the equation

$$\theta = 2.451 \left\{ 1 + 0.493 \left(\frac{l}{\sqrt{A}} - 2\sqrt{\pi} \right) \right\}.$$

Hence for an ellipse

$$\theta = 2.451 \left\{ 1 + 1.742 \times \frac{3}{4} x^2 \right\} \quad (14)$$

$$\therefore \frac{L_c - L_e}{L_c} = \frac{3.2x^2}{\log \frac{2l}{r} - 2.451} \quad (15)$$

Taking the same example of a rod 1 centimeter in diameter, bent into a circle of 20 centimeters diameter,

$$\frac{L_c - L_e}{L_c} = \frac{3.2}{3.1} x^2 \doteq x^2. \quad (16)$$

Hence, if this expression is correct, the decrease is one third less than the amount for a corresponding deformation of a long solenoid, as derived from (10). It confirms the hypothesis that (10) expressed an upper limit for the change. The fractional change is insensitive to large changes of l/r .

If the circular turn is free to expand, but one diameter is maintained at its original value R , then corresponding with (10a) the temperature coefficient will be $\alpha(1 - \alpha T)$, and hence elliptical deformation during expansion will make a second order change in the temperature coefficient.

(b) *Coils in which the radial expansion differs from the axial.*

We shall now suppose that each turn remains a circle but the axial expansion differs from the radial; such a condition may involve a slight untwisting of the helix or a tension in the wire.

(1) Many Turn Solenoid of any Length. The inductance of a single turn solenoid of length b , radius R , and total turns N , is expressed by the equation

$$L = \frac{2KR^2N^2}{b}$$

where the parameter K is a function of b/R , and has been tabulated.

It may be found that K can be expressed by the equation²

$$K = \frac{2\pi^2b}{0.868R + b}$$

to an accuracy of ± 2 per cent so long as $b/R > 0.4$.

² See also H. A. Wheeler, PROC. I.R.E., vol. 16, p. 1398; October, (1928), and R. R. Batcher, PROC. I.R.E., vol. 17, p. 580; March, (1929).

Hence,³

$$L \doteq \frac{4\pi^2 R^2 N^2}{0.868R + b}. \quad (17)$$

If the radius increases with temperature coefficient α and the axial length with temperature coefficient γ , it follows that

$$L_T = L_0 \left[1 + \left\{ \frac{(0.868R + 2b)\alpha - b\gamma}{(0.868R + b)} \right\} T \right]. \quad (18)$$

By arranging the ratio γ/α suitably, the temperature coefficient can be made zero, and it follows that this will occur when

$$\gamma/\alpha = 2 \left(1 + 0.217 \frac{R}{b} \right). \quad (19)$$

It may be found from this that the temperature coefficient is zero if the axial expansion is 3.1 times the radial for a coil in which $b/R = 0.4$, and if $\gamma = 2.22\alpha$ for a coil in which $b/R = 2$.

Coils are sometimes made by fixing separate turns to an insulating rod, which can be made of a material having a very small temperature coefficient. In such circumstances the axial expansion can be sensibly zero, and then the net temperature coefficient of inductance will be

$$2\alpha \left(\frac{1 + 0.434R/b}{1 + 0.868R/b} \right). \quad (20)$$

It follows from this expression that such a method of construction cannot cause the temperature coefficient to exceed twice that of linear expansion of the metal, and even when $b = 2R$ the coefficient is only 1.7α .

The foregoing expressions take no account of the radius of the wire and are valid only if the coil has many turns in its length. It is not strictly applicable to a helix of only a few turns. The behavior of such a coil may be investigated by calculating the inductance of a coil consisting of several coaxial turns each of radius R , of wire of radius r , placed with a distance d between the planes of successive turns.

The mutual inductance between two equal circles in parallel planes separated by a distance x is

³ If b/R lies between 0.4 and 0.05 it may be found that

$$L \doteq \frac{4\pi^2 R^2 N^2}{0.868R + b} \left(1.025 + 0.11 \frac{R}{b} \right).$$

$$M = 2l \left(\log \frac{2l}{x} - 2.451 \right)$$

whereas the self-inductance of one turn is

$$L = 2l \left(\log \frac{2l}{r} - 2.451 \right).$$

By means of these two expressions the self-inductance of any number of turns can be found.

Thus the self-inductance of a two-turn coil is

$$L = 4l \left(\log \frac{2l}{r} - 2.451 + \log \frac{2l}{d} - 2.451 \right). \quad (21)$$

This expression shows that the proximity of the two circles increases the self-inductance per unit length of wire by an amount equal to half the self-inductance per unit length of a similar circle made of wire of radius d . When $R/r=20$, the fractional increment for various values of d/r is shown in the table below.

d/r	4	6	8	10
Increment per cent of inductance	55	41	32	25

If α is the temperature coefficient of the metal, and γ that of axial expansion, it follows that

$$4l \times L_T \doteq 4l \left\{ \log \frac{2l}{r} - 2.451 + \log \frac{2l}{d} - 2.451 + (\alpha - \gamma)T \right\} \quad (1 + \alpha T)$$

$$\therefore L_T \doteq L_0 \left[1 + \left\{ \left(1 + \frac{1}{L_0} \right) \alpha - \frac{\gamma}{L_0} \right\} T \right]. \quad (22)$$

The temperature coefficient is zero if

$$\gamma = \alpha(1 + L_0). \quad (23)$$

It follows from this that if $R/r=20$, $\gamma=4.55\alpha$ if $d/r=4$, and $\gamma=4.25\alpha$ if $d/r=10$.

If axial expansion is prevented, then the temperature coefficient of a two-turn coil is about 22 per cent greater than it would be if uniform expansion had been permitted.

Thus, a copper coil consisting of two turns clamped to rigid terminal blocks, will have a temperature coefficient of inductance of about

20×10^{-6} degrees centigrade. Hence, this deformation is not competent to account for a large increase of temperature coefficient.

The self-inductance of a three-turn coil is

$$L = 6l \left\{ \log \frac{l}{r} - 2.451 + 2 \left(\log \frac{2l}{d} - 2.451 \right) - 0.457 \right\}. \quad (24)$$

This may be interpreted by saying that the proximity of the three coils increases the self-inductance per unit length of each by an amount which is less than the self-inductance per unit length of a similar coil wound with wire of radius d .

When $R/r=20$, the fractional increment for various values of d/r is shown in the table below.

d/r	4	6	8	10
Per cent increment of inductance	100	66	50	36

If α , γ , and L_0 have their previous significance, then it can be shown that

$$L_T \doteq L_0 \left\{ 1 + \left(1 + \frac{2}{L_0} \right) \alpha + \frac{2\gamma}{L_0} T \right\}. \quad (25)$$

If a three-turn coil is clamped to rigid terminal blocks, which prevent axial expansion, then the temperature coefficient is increased in the ratio $(1+2/L_0):1$. If $R/r=20$, this ratio will be approximately equal to 1.4.

Thus if axial expansion is prohibited, the temperature coefficient will be greater than that of linear expansion by an amount which depends on the number of turns; the increment ranges from 22 per cent for two turns to 100 per cent for a very great number. This type of deformation cannot do more than double the temperature coefficient.

Self-compensation will occur in a three-turn coil, for which $R/r=20$, if $\gamma=4\alpha$ when $d/r=4$ and if $\gamma=3\alpha$ when $d/r=10$.

The process of evaluation turn by turn is laborious, and it is interesting to compare the results obtained for the two-turn and three-turn coil with those which would have been obtained from the approximate equations (19) and (20). Thus for the given two-turn coil with $d/r=4$, self-compensation occurs if $\gamma=4.55\alpha$, whereas (19) gives $\gamma=4.2\alpha$. For the three-turn coil in which $d/r=4$, self-compensation occurs when $\gamma=4\alpha$, whereas (19) gives $\gamma=3.1\alpha$. If axial expansion is prevented then the temperature coefficient is 1.22α and 1.4α when $d/r=4$, for the two-turn and three-turn coil, respectively, whereas (20) gives in these circumstances 1.19α and 1.34α . Hence it would appear that (19)

and (20) give results which are substantially correct for a coil having very few turns, so long as the ratio d/r is not greater than, say, 4.

THE CIRCUIT AS A WHOLE

So far coils have been considered in the idealized form of separate circles and no account has been taken of the leads which must be provided to connect the coil to the capacitance. Nevertheless, the temperature coefficient which is of interest is that of the complete circuit, coil plus leads. It is impossible to make a general discussion of this problem because much depends on the disposition of the leads.

Suppose the coil consists of an integral number of turns ending in rigid terminal blocks, to which run a pair of parallel leads. We have seen that the coil proper will have a temperature coefficient of the order 1.5α . Let the distance between the parallel leads be held rigid and let their length be free to expand. Then a rise of temperature will cause an increase of inductance because the length increases, and a decrease of inductance since the radius of the rods increases without a corresponding increment of their distance apart. The temperature coefficient of the leads will thus be less than α . The temperature coefficient of coil plus leads will thus be less than, say, 1.5α by an amount depending on the relative importance of the leads. The net result is a circuit in which the temperature coefficient is not much greater than α .

Now suppose that the coil and leads are disposed like the carbon filament of an incandescent lamp, the leads being fixed only at the end remote from the coil. It is possible that the result of bending the rod into a coil may be to make the radial and axial expansion of the coil greater than that of the metal. But if expansion causes the size of the coil to grow unduly, it can do so only by robbing some length from the leads. It will be noticed that the inductance of a two- or a three-turn coil has been expressed in terms of the total length of wire and a factor of the form $\log l/r$. The logarithmic factor changes slowly with the variables, and consequently the inductance per unit length of wire is not sensitive to the size of the coil. Consequently the fractional increase in the inductance of the coil will be approximately equal to the fractional increase of the wire in it. Also the inductance per unit length of leads will be of the same order as the inductance per unit length of coil. Hence, stealing from the leads and adding to the coil will increase the inductance of the whole circuit by considerably less than the increase of inductance of the coil. With reasonably proportioned leads it seems probable that the net temperature coefficient would not differ very much from α .

No doubt it is possible to construct coils in which the leads have

a very important effect on the temperature coefficient of the circuit.

For example, consider the single turn circle and parallel leads disposed as shown in Fig. 2. The radial expansion of the circle is prevented by the rollers shown diagrammatically in the figure. The increase of circumference of the circle will cause the parallel leads to approach one another. The inductance of the circle will increase in proportion to α , but the inductance of the leads will decrease because they are pushed closer together. By proportioning the leads suitably, the net temperature coefficient could be made zero or it could be made to have a large negative value.

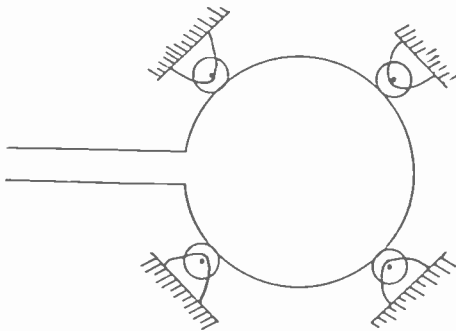

Fig. 2

The author believes that the arrangement described by Fig. 2 is the basis of the action of the self-compensated coil described by Ure, Grainger, and Cantello.⁴

VIII. CONCLUSION

This analysis appears to show that the construction of a coil would require to be very unusual if it is to have a positive temperature coefficient of inductance which is, say, greater than one and a half times the coefficient of linear expansion of the metal. If such large positive temperature coefficients exist in practice, the cure may lie in attention to the disposition of the leads, but this is improbable.

If a valve generator is found to have a negative temperature coefficient of frequency which is greater than the temperature coefficient of linear expansion of copper, then possibly this may not be caused by increase of inductance *per se*. It might be caused in certain circumstances by the temperature increase of resistance changing the relative phase of the grid and anode voltage, and thereby necessarily causing a change of frequency.

⁴ *Jour. I.E.E.* (London), vol. 72, p. 528, (1933).

A NOTE ON FUNDAMENTAL SUPPRESSION IN HARMONIC MEASUREMENTS*

BY

HERBERT M. WAGNER

(RCA Radiotron Company, Inc., Harrison, New Jersey)

Summary—The measurement of the harmonic components of a periodic wave having a fundamental amplitude which predominates can sometimes be advantageously accomplished by using a network to suppress the fundamental component from the input terminals of the harmonic analyzing device. In this paper the method is discussed in connection with various harmonic analyzers and a few calculations are given to show the effectiveness of a bridge type of fundamental suppressing circuit.

IN AN experimental investigation of the wave form distortion introduced by iron-core communications transformers, carried on at the Massachusetts Institute of Technology, there was developed a circuit for the measurement of small harmonic components of a complex wave. Part of this circuit has as its purpose the exclusion of the fundamental component of the wave from the input of the harmonic analyzing device. The specific means employed in suppressing the fundamental is described in this paper, while various aspects of the general problem are briefly discussed.

FUNDAMENTAL SUPPRESSING CIRCUIT

Numerous circuits can be devised for completely or partially eliminating the fundamental component of a complex wave without affecting the magnitudes of its harmonic components to an unduly large degree. One example of this type of network is a high-pass filter having its nominal cut-off frequency slightly below the frequency of the second harmonic. Wolff¹ has used an alternating-current bridge balanced at fundamental frequency to measure the total harmonic content of periodic waves. The power circuit analyzer of McCurdy and Blye² utilizes a fundamental suppressing input circuit ahead of the first amplifying tube. In this case a low-pass filter is part of the network used to balance out the fundamental component of the voltage to be analyzed.

* Decimal classification: 537.7. Original manuscript received by the Institute, October 6, 1933; revised manuscript received by the Institute, March 5, 1934.

¹ I. Wolff, "The alternating current bridge as a harmonic analyzer," *Jour. Opt. Soc. Amer.*, vol. 15, pp. 163-170, (1927).

² R. G. McCurdy and P. W. Blye, "Electric wave analyzers for power and telephone systems," *Trans. A.I.E.E.*, p. 1167, (1929).

The particular fundamental suppressing circuit used in this work is shown in Fig. 1. The voltage to be analyzed is applied at the input terminals, while the harmonic components appearing across the output

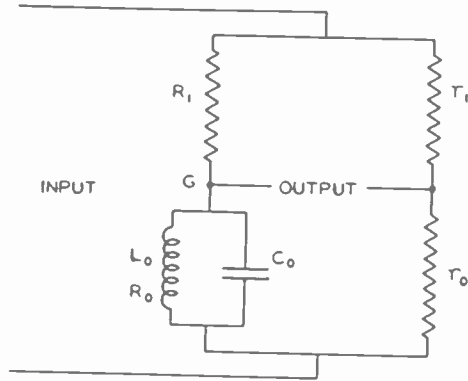

Fig. 1—Fundamental suppresser.

are measured by means of a harmonic analyzer.³ The bridge circuit as used here had approximately the following constants to balance at a fundamental frequency of 24 cycles:

Coil: $L_0 = 4.59$ henrys, $R_0 = 20$ ohms;

Condenser: $C_0 = 9.53$ microfarads;

Resistances: $R_1 = 24,000$ ohms, $r_1 = r_0 = 50,000$ ohms.

A few calculations have been made with these constants to show the effectiveness of a fundamental reducer of this type. These calculations assume infinite input impedance of the harmonic analyzer (connected to the bridge output terminals) and are given in the table below:

Harmonic	Fundamental	Second	Third	Fourth	Fifth
Frequency (cycles per second)	24	48	72	96	120
Output voltage per volt applied to input	0	0.4999	0.5000	0.5000	0.5000
Phase displacement between input and output voltage (degrees)	—	2.20°	1.24°	0.88°	0.69°

All of the harmonics of voltage, except the fundamental of the periodic wave, have their amplitudes reduced almost exactly one half. Their relative phase positions are changed but slightly.

³ A. G. Landeen, "Analyzer for complex electric waves," *Bell Sys. Tech. Jour.*, vol. 6, pp. 230-247; April, (1927); J. W. Horton, "The empirical analysis of complex electric waves," *Trans. A.I.E.E.*, vol. 46, pp. 535-540, (1927).

ADVANTAGES AND DISADVANTAGES

Some advantages which may be credited to the use of a fundamental reducing circuit in the measurement of harmonics which are small in magnitude compared with the fundamental component are as follows:

- (1) The circuit permits the measurement of voltages of somewhat unsteady frequency.
- (2) It simplifies the manipulations of the analyzer.
- (3) It prevents the generation of objectionable harmonics in the analyzer itself.

An analyzer which depends directly upon a very sharply tuned circuit for selecting individual harmonic components of the complex wave may be disturbed considerably by slight frequency fluctuations, such as normally occur on power mains. When a large fundamental component is mainly responsible for the high degree of selectivity demanded, the use of a fundamental eliminator permits of reduced selectivity and thereby makes the analyzer less sensitive to slight changes in frequency. The tuning of the analyzer is simplified under these conditions.

Types of analyzers utilizing nonlinear elements, such as vacuum tubes and iron-core transformers, preceding the point at which the individual harmonics are selected, should profit in the matter of internal generation of harmonics when this is due to the large fundamental component.

The oscillograph is an example of a wave analyzer which might be used advantageously with a fundamental reducer, together with a vacuum tube amplifier. If a schedule analysis were made from an oscillogram with the fundamental component completely absent, very much smaller percentage harmonics of a complex wave could be detected than with an oscillogram of the usual type.

One inconvenient feature of the very effective bridge type of fundamental eliminator is its failure to fit in readily with grounding requirements of both the circuit under test and the harmonic analyzer. It is possible to couple the output of the bridge to the harmonic analyzer by means of a high impedance transformer, although careful shielding of the transformer may be necessary to guard against interference from stray fields. No coupling transformer was used in the experimental investigation of distortion undertaken here, which was carried out at a low frequency. The bridge was grounded at the point marked *G* in Fig. 1 as this was convenient for the particular measuring circuit.

EXAMPLE OF FUNDAMENTAL SUPPRESSION FOR A SPECIFIC MEASUREMENT

A possible method of measuring the distortion present in the plate circuit of a vacuum tube with a sinusoidal voltage impressed on the grid circuit is illustrated in Fig. 2. Up to reasonably high values of frequency and for moderate distortion, the fundamental component of the voltage across the load resistance R is almost exactly 180 degrees

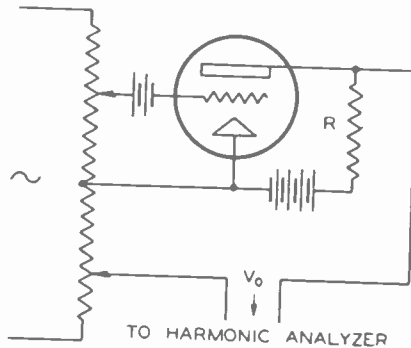

Fig. 2—Arrangement for measuring distortion in a vacuum tube amplifier.

out of phase with the impressed voltage. Under these conditions the fundamental can be almost completely suppressed from the harmonic analyzer by measuring a voltage V_0 consisting of the distorted voltage across the load resistance in series with a sinusoidal voltage from the input circuit. The voltage taken from the tube input circuit is adjusted so as very nearly to balance out the fundamental component of the plate circuit voltage.

ACKNOWLEDGMENT

The author wishes to express his appreciation to Professor E. L. Bowles of the Massachusetts Institute of Technology, under whose general direction work was being done which led to the utilization of the fundamental suppressing circuit described here.



CONTRIBUTORS TO THIS ISSUE

Beck, Alfred C.: Born July 26, 1905, at Granville, New York. Received E.E. degree, Rensselaer Polytechnic Institute, 1927. Test department, New York Edison Company, summers, 1926-1927. Instructor in mathematics, Rensselaer Polytechnic Institute, 1927-1928. Member, technical staff, Bell Telephone Laboratories, Inc., 1928 to date. Member, Sigma Xi. Associate member, Institute of Radio Engineers, 1930.

Braden, R. C.: Received B.S. degree, University of Minnesota, 1923; M.S. degree, 1925. Teaching Fellow, University of Minnesota, 1924-1925. Engineering department, Zenith Radio Corporation, 1925-1926; engineer, Radio Corporation of America, 1926-1930; engineering department, RCA Victor Company, Inc., 1930 to date. Associate member, Institute of Radio Engineers, 1923.

Bruce, Edmond: Born September 28, 1899, at St. Louis, Missouri. Attended George Washington University 1919; received B.S. degree in electrical engineering, Massachusetts Institute of Technology, 1924. Transatlantic Communication Service, U.S. Navy, 1917-1919; engineer, Clapp-Eastham Company, 1921-1923; engineer, Western Electric Company, 1924-1925; research engineer, Bell Telephone Laboratories, Inc., 1925 to date. Recipient, Morris Liebmann Memorial Prize, 1932. Associate member, Institute of Radio Engineers, 1926; Member 1929.

Iams, Harley: Born March 13, 1905. Received A.B. degree, Stanford University, 1927. Westinghouse Student Course, 1927-1928. Facsimile and television development, Westinghouse research department, 1928-1930; sound film development, Tanar Corporation, 1931; television, RCA Victor Company, Inc., 1931-1933; research and development laboratory, RCA Radiotron Company, Inc., 1933 to date. Associate member, Institute of Radio Engineers, 1931.

Linder, Ernest G.: Born 1902, at Waltham, Massachusetts. Received B.A. degree, University of Iowa, 1925; M.S. degree, 1927. Instructor in physics, State University of Iowa, 1925-1927; instructor, California Institute of Technology, 1927-1928; Detroit Edison Research Fellow, Cornell University, 1928-1932; received Ph.D. degree, Cornell University, 1931. Research division, RCA Victor Company, Inc., 1932 to date. Member, American Physical Society. Non-member, Institute of Radio Engineers.

Lowry, Lewis R.: Born February 27, 1904, at Riceville, Iowa. Attended Washington State College 1922-1923; University of Washington 1923-1927; received B.S. degree in electrical engineering, University of Washington, 1927. Pacific Telephone and Telegraph Company, summers, 1922-1926. Member, technical staff, Bell Telephone Laboratories, Inc., 1927 to date. Associate member, Institute of Radio Engineers, 1927.

Moullin, E. B.: Born 1893. Graduated in engineering, Cambridge University, England, 1916. University lecturer, Cambridge University, 1920-1929; reader in engineering science, Oxford University, 1929 to date. Member, Radio

Research Board, Department of Scientific and Industrial Research of Great Britain, and of various subcommittees of the same Board. Author of "Radio Frequency Measurements," and "Principles of Electromagnetism." Member, Institute of Radio Engineers, 1927.

Salzberg, Bernard: Born July 22, 1907. Received E.E. degree, Polytechnic Institute of Brooklyn, 1929; M.E.E. degree, 1933. Transmitter, operating, and research and development divisions, RCA Communications, Inc., 1929-1931; research and development laboratory, RCA Radiotron Company, Inc., 1931 to date. Junior member, Institute of Radio Engineers, 1925; associate, member 1930.

Sherman, Jesse B.: Born February 8, 1910, at New York City. Received B.S. degree in electrical engineering, Cooper Union Night School of Engineering 1933. Service manager, Colen-Gruhn Company, Inc. Student, Evening Engineering Division, New York University. Junior member, Institute of Radio Engineers, 1928; associate member, 1932.

Wagner, Herbert M.: Born September 22, 1910, at Boston, Massachusetts. Received B.S. degree in electrical engineering, Massachusetts Institute of Technology, 1932; M.S. degree, 1933. Research assistant and curator of apparatus, Massachusetts Institute of Technology, 1932-1933. Research engineer, RCA Radiotron Company, Inc., 1933 to date. Associate member, American Institute of Electrical Engineers. Student member, Institute of Radio Engineers, 1932.

Wolff, Irving: Received B.S. degree, Dartmouth College, 1916. Nontechnical work, 1916-1919; instructor, Iowa State College, 1919-1920; instructor, Cornell University, 1920-1923; received Ph.D. degree, Cornell University, 1923. Research on polarization capacity. Heckscher Research Council, 1923-1924; research on electro-acoustics, Radio Corporation of America, 1924-1929; RCA Victor Company, Inc., 1930 to date. Fellow, American Association for the Advancement of Science and Acoustical Society of America; Member, American Physical Society. Associate member, Institute of Radio Engineers, 1927.





Type J Bradleyometer with cover removed to show contact mechanism and terminals.

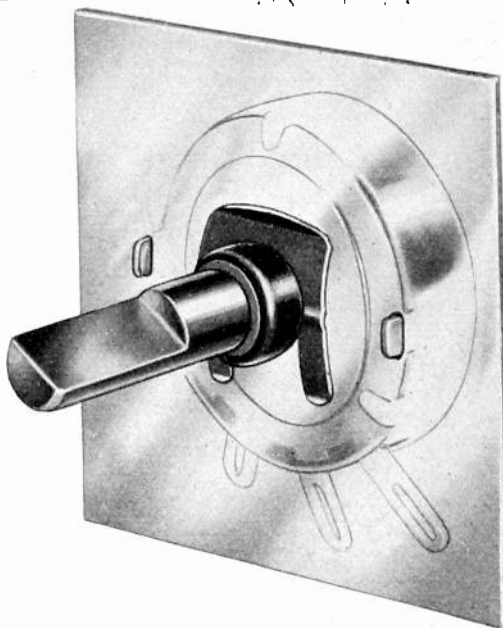

Type J Bradleyometer - rear view—showing hot-solder-dipped terminals and cover.

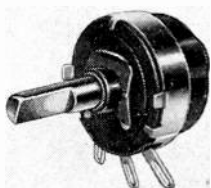

Front view of Type JS Bradleyometer showing locking projections which prevent rotation on panel.



Type JS Bradleyometer showing unit with line switch in bakelite housing.

ULTRA-COMPACT!

The New Type J Bradleyometer



A SOLID MOLDED RESISTOR —NOT A FILM-TYPE UNIT

The Type J Bradleyometer outperforms film-type resistors, because hard service and climatic variations cannot alter its resistance-rotation curve. The solid molded resistor is of homogeneous cross-section. In longitudinal section, the material is varied to suit individual resistance specifications, but after molding, the unit cannot change. Practically any resistance-rotation curve shape can be provided, including straight logarithmic, modified logarithmic, or linear resistance-rotation curves.

For volume control without tone compensation, the new Type J Bradleyometer possesses unusual advantages. The extreme compactness of the control has been achieved without sacrificing its electrical performance. The unique construction of the resistor unit makes possible practically any resistance-rotation curve. Long life and dependable performance are noteworthy qualities of the Type J Bradleyometer.

Such unusual mechanical features as snapping the control into place on the panel with the C-washer and the insulation of the shaft reduce receiver assembly costs. The Type J unit is interchangeable with others built to R. M. A. standards.

Send for Type J Bradleyometer data.

ALLEN-BRADLEY COMPANY
116 W. Greenfield Ave., Milwaukee, Wis.

SPARK PLUG SUPPRESSORS

Allen-Bradley Spark Plug Suppressors are standard equipment on the nation's motor cars. They are made in five types for service in any auto-radio installation. The superiority of Allen-Bradley Suppressors is generally recognized. Performance curves will be submitted gladly upon request.

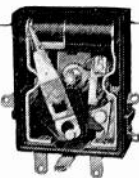

Type ATS Bradleyometer has never been surpassed for volume control with tone compensation.

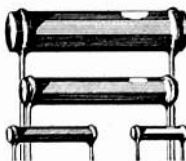

FIXED RESISTORS
Fixed resistors of solid molded construction, used by the largest manufacturers of radio receivers, are made in four sizes, with or without leads. The production of these units represents years of research in the making of stable fixed resistors. They are color-coded to meet R. M. A. specifications.

ALLEN-BRADLEY RADIO RESISTORS

When writing to advertisers mention of the PROCEEDINGS will be mutually helpful.

THE TUBE THAT CAME FROM A POINT OF VIEW



THAT MONEY CANNOT BUY!

● True scientists have always been driven by a passion for truth. As some one phrased it, they were "born into a scientific attitude of mind." And paramount to all their other interests is their unwavering *desire to know*.

It is a proud brotherhood numbering such great figures as Galileo, Newton and Edison as members. And Sylvania is proud that their engineers, in a modest way, have deserved inclusion in this group. For it was their research that led to the development of the 6.3 volt tubes that made auto radio possible. And at various other times they have contributed to the growth of our industry with important research and experimental work.

It is a policy of Sylvania—just as much so as its AaA1 credit rating—that these engineers shall continue to make important contributions.

Set manufacturers are invited, at all times, to write for engineering consultation on circuit and design problems. Our facilities are placed at your disposal without cost or obligation. Hygrade Sylvania Corporation, Emporium, Pa.

Sylvania

(Reg. U. S. Pat. Off.)

THE SET-TESTED RADIO TUBE

When writing to advertisers mention of the PROCEEDINGS will be mutually helpful.

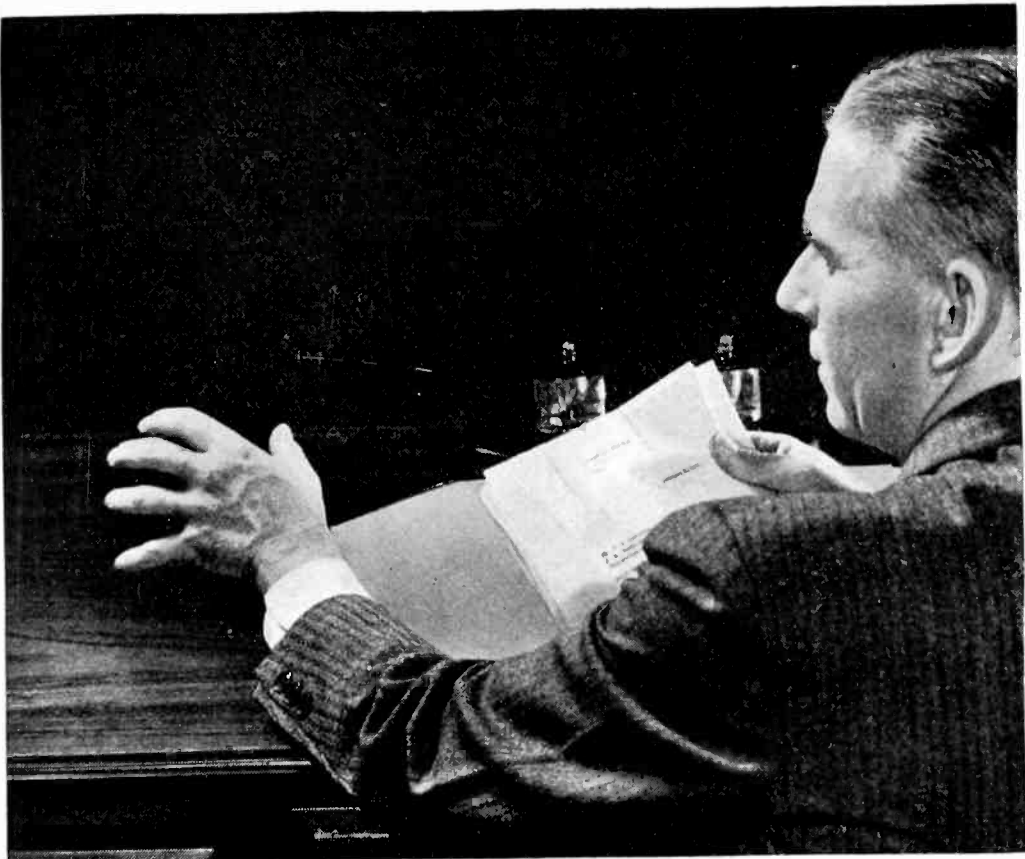

IF THE *Telephone* **WERE NOT THERE!**

MANY times each day you reach for the telephone on your desk at the office or in its familiar spot at home. It is an old and trusted friend. You scarcely give a thought to what it means to a busy day.

Yet suppose the telephone were not there! Suppose—for a week—or a month—you could not call anybody by telephone and nobody could call you! The whole

machinery of business and the home would be thrown out of gear. Orders would be lost—efficiency and profits reduced. You would be out of touch with the world about you.

America needs quick, reliable telephone service to get things done in the brisk, crisp American manner. And it enjoys the best service in the world.

Greater progress has been made in this country because of the Bell System's one policy, one system and universal service.

America leads in telephone service. In relation to population, there are six times as many telephones in this country as in Europe and the telephone is used nine times as much.



BELL TELEPHONE SYSTEM

When writing to advertisers mention of the PROCEEDINGS will be mutually helpful.



THEY QUALIFY!

From Alaska to Montevideo, Los Angeles to New York, Hong Kong to Peiping, you will find IRC RESISTORS in regular use in the radio equipment of leading airlines. Here all of the adverse conditions met in years of ordinary use—plus many new ones besides—may be encountered in a few hours. Here human lives and the fulfillment of important schedules may depend upon the ability of parts to function properly at all times. . . . Yet standard IRC units meet even the most exacting requirements!

INTERNATIONAL RESISTANCE CO.

2100 Arch St.,

Philadelphia, Pa.

187 Duchess St., Toronto, Ontario, Canada

When writing to advertisers mention of the PROCEEDINGS will be mutually helpful.

The Institute of Radio Engineers

Incorporated

330 West 42nd Street, New York, N.Y.

APPLICATION FOR ASSOCIATE MEMBERSHIP

(Application forms for other grades of membership are obtainable from the Institute)

To the Board of Directors
Gentlemen:

I hereby make application for Associate membership in the Institute of Radio Engineers on the basis of my training and professional experience given herewith, and refer to the members named below who are personally familiar with my work.

I certify that the statements made in the record of my training and professional experience are correct, and agree if elected, that I will be governed by the constitution of the Institute as long as I continue a member. Furthermore I agree to promote the objects of the Institute so far as shall be in my power, and if my membership shall be discontinued will return my membership badge.

.....
(Sign with pen)

.....
(Address for mail)

.....
(Date)

.....
(City and State)

Sponsors:

(Signature of references not required here)

Mr. Mr.

Address Address

City and State City and State

Mr.

Address

City and State

The following extracts from the Constitution govern applications for admission to the Institute in the Associate grade:

ARTICLE II—MEMBERSHIP

Sec. 1: The membership of the Institute shall consist of: * * * (c) Associates, who shall be entitled to all the rights and privileges of the Institute except the right to hold any elective office specified in Article V. * * *

Sec. 4. An Associate shall be not less than twenty-one years of age and shall be a person who is interested in and connected with the study or application of radio science or the radio arts.

ARTICLE III—ADMISSION AND EXPULSIONS

Sec. 2: * * * Applicants shall give references to members of the Institute as follows: * * * for the grade of Associate, to three Fellows, Members, or Associates; * * * Each application for admission * * * shall embody a full record of the general technical education of the applicant and of his professional career.

ARTICLE IV—ENTRANCE FEE AND DUES

Sec. 1: * * * Entrance fee for the Associate grade of membership is \$3.00 and annual dues are \$6.00.

ENTRANCE FEE SHOULD ACCOMPANY APPLICATION

87 19788 10 97
 805
 2
 5
 198
 19
 9999

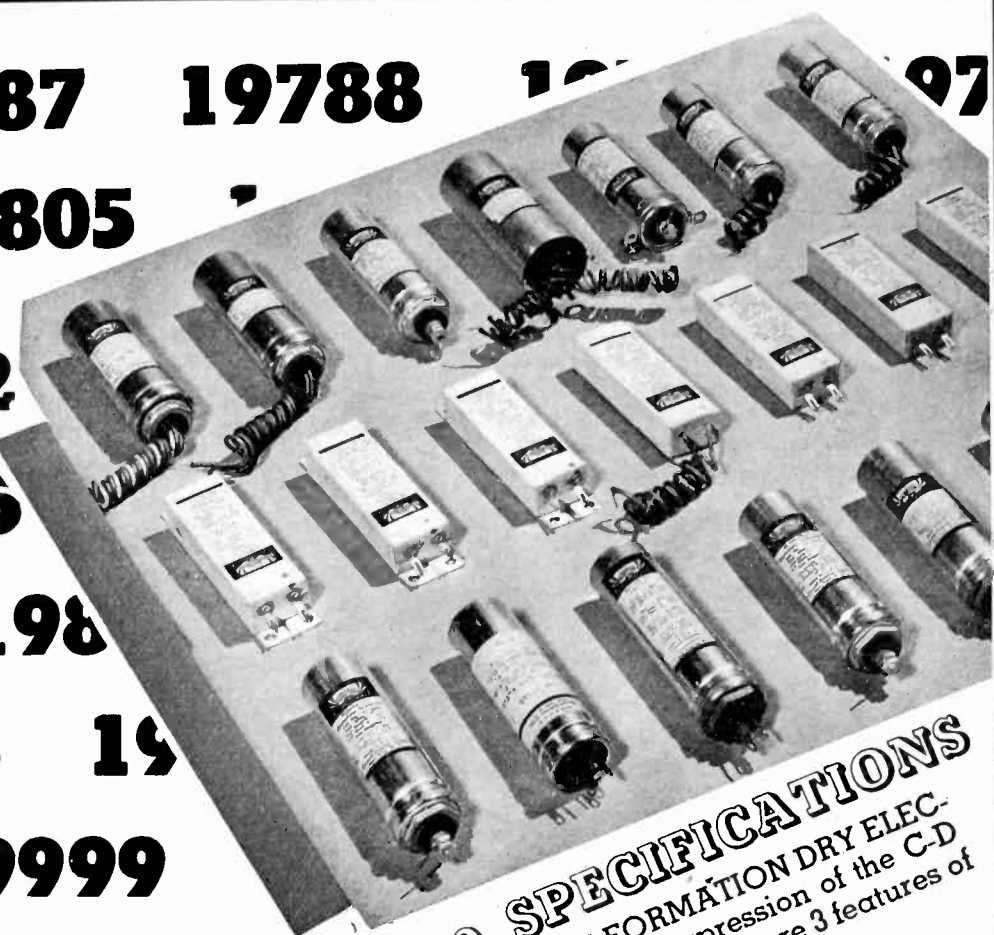

AND NOW

MORE than 20,000 SPECIFICATIONS

Always C-D advances! Our NEW, HIGH-FORMATION DRY ELECTROLYTIC CONDENSER is the most recent expression of the C-D program of advancement and improvement! Here are 3 features of the fastest selling electrolytic condenser in the world!

1. Negligible leakage characteristics. 300 microamperes for 8MFD at 450 v.
2. Long life.
3. Low power factor.

LOOK TO **C-D** IN 1935!!
 OUR PRODUCTS MEET YOUR
 EVERY REQUIREMENT!

Sounds interesting, doesn't it? Why, not apply to our engineering dept. for data?



CORNELL-DUBILIER
 CORPORATION

4379 BRONX BOULEVARD • NEW YORK

When writing to advertisers mention of the PROCEEDINGS will be mutually helpful.

THERE IS NO SUBSTITUTE FOR

Here is another example of the marked difference between the performance of standard production Erie units and those of six leading competitors. Resistors "C" & "E" which have slightly lower noise characteristics than Erie Resistors have the greater voltage coefficients.

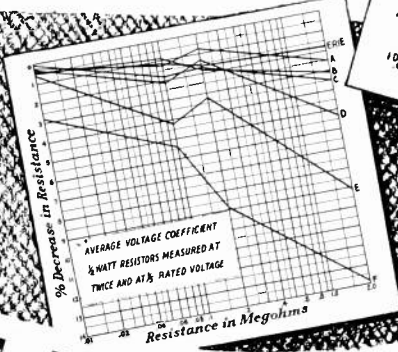
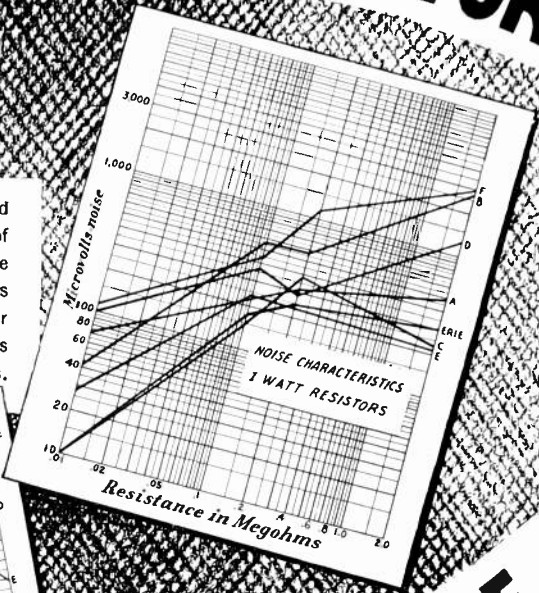

ALL-ROUND PERFORMANCE

It has always been a policy of this company to make an improvement in any one electrical characteristic of Erie Resistors only when it does not adversely affect the others.

For this reason Erie Resistors today present a uniformly superior record in every characteristic. Such all-round performance is responsible for the successful operation of millions of Erie Resistors in radio sets today.

The third of a series of advertisements dealing with the balanced performance of Erie Resistors

ERIE RESISTOR CORPORATION

ERIE, PA.

Factories in ERIE, PA. - TORONTO, CANADA - LONDON, ENG.

When writing to advertisers mention of the PROCEEDINGS will be mutually helpful.

Let S. S. WHITE Engineers aid you with your REMOTE CONTROL design

As the leading manufacturer of flexible shafts, we have been privileged to cooperate with many radio set and equipment manufacturers in working out remote control applications.

In a number of instances we have developed special shafts and special fittings to meet requirements, and we are prepared to do this whenever conditions warrant.

All Radio Engineers are invited to submit their requirements or designs for recommendations. No obligation is involved.

Are you familiar with these S. S. WHITE Remote Control developments?

No. 150L53 FLEXIBLE SHAFT—a 5-layer, 43-wire shaft having a minimum of torsional deflection under load, equal deflection when turned in either direction, and ample flexibility for free operation in curves of small radius.

No. 170A1 METALLIC CASING—a rugged rust-resistant casing only .255" outside diameter.

Shown in the illustration, left to right, approximately two-thirds actual size.

1. Shafting with ends swaged accurately square for square hole, collet or set screw attachment. Casing with integral formed flange and male nut.
2. Conventional die-cast gear end fitting on flexible shaft. Casing with plain end.
3. Conventional machined shaft end fitting. Casing with integral formed flange and female nut. We are prepared to make machined ends to specifications.
4. Shafting with regular square swaged ends ready for attachment of end fitting. Casing with plain end.
5. Shafting with ends octagonally swaged for easy calibration of control unit, condenser or volume control. Casing with integral enlarged end.
6. Shafting with intermediate square swages for cutting to length in the field.

Flexible Shafting is also used inside the receivers for coupling purposes, permitting easier assembly and arrangement of parts.

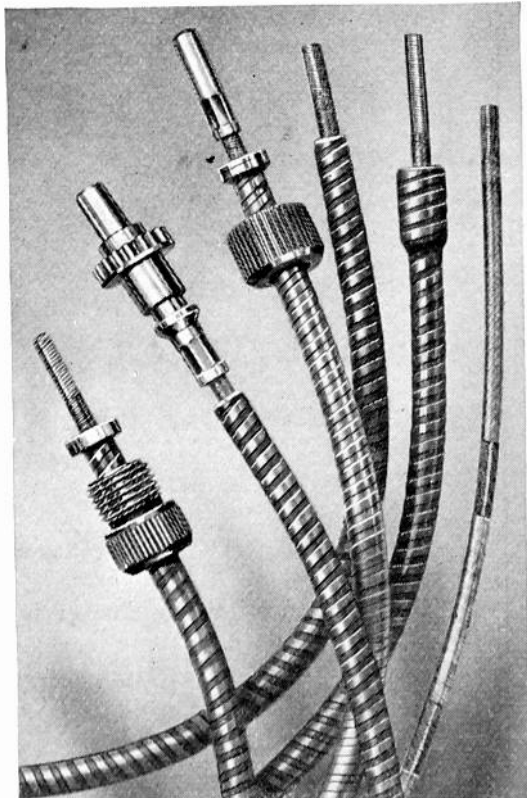

The S. S. WHITE Dental Mfg. Co. - INDUSTRIAL DIV.
150-8 West 42nd. St. New York, N. Y.

When writing to advertisers mention of the PROCEEDINGS will be mutually helpful.

CHANGE IN MAILING ADDRESS OR BUSINESS TITLE

Members of the Institute are asked to use this form for notifying the Institute office of a change in their mailing address or the listing of their company affiliation or title in the Year Book.

The Secretary,
THE INSTITUTE OF RADIO ENGINEERS,
330 West 42nd Street,
New York, N.Y.

Dear Sir:

Effective please note change in my address
(date)
for mail as follows:

FROM

.....
(Name)

.....
(Street Address)

.....
(City and State)

TO NEW ADDRESS)

.....
(Street Address)

.....
(City and State)

Please note following change in my Year Book listing.

.....
(Title)

.....
(Company Name)

.....
(Company Address)

ISOLANTITE is the choice of leaders

Parts by the
Hammarlund
Manufactur-
ing Company
of New York.

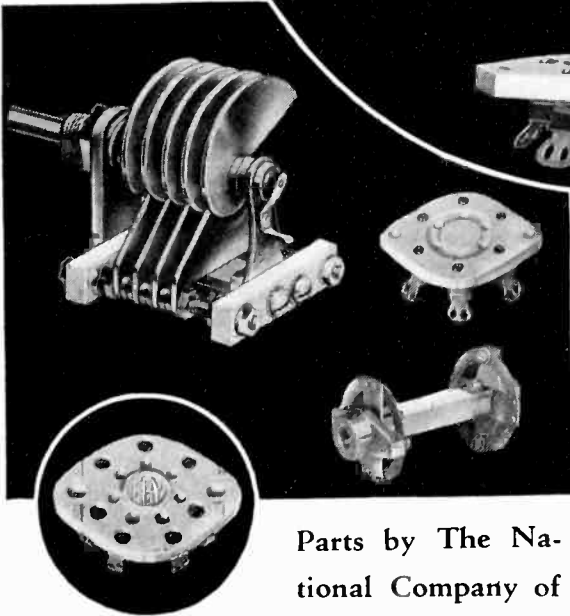
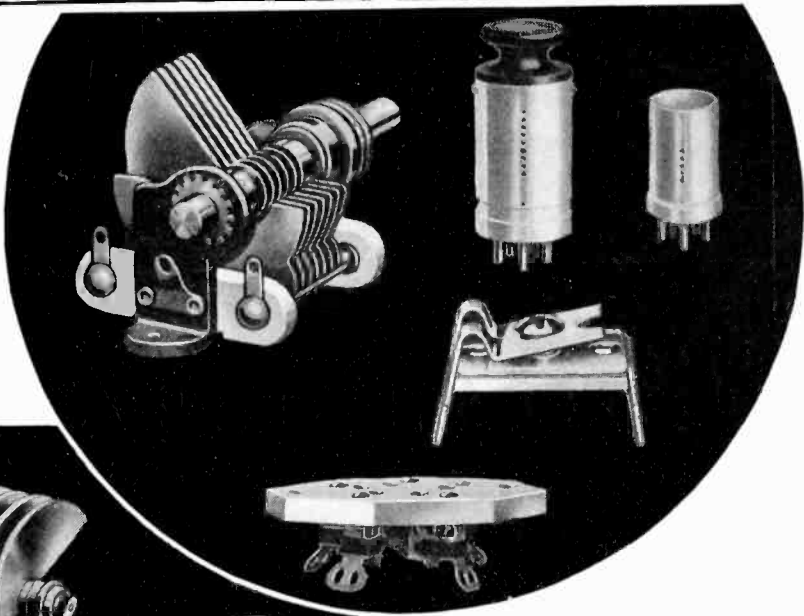

Sockets by Hugh H.
Eby, Inc., of
Philadelphia

Parts by The Na-
tional Company of
Malden, Mass.

The foremost "com-
ponent parts" manu-
facturers employ ISO-
LANTITE insulation.
What better endorse-
ment of a good product
could be asked?

Write for a copy of our Bulletin 100-F

Isolantite Inc.

Factory at Belleville, N. J.

NEW YORK SALES OFFICE: 233 BROADWAY

When writing to advertisers mention of the PROCEEDINGS will be mutually helpful.



ELECTROLYTICS Look Alike, BUT—

There's a difference . . . in internal details, chemistry, efficiency, reliability, life, reputation. Having pioneered in dry electrolytic technique, Aerovox offers you:

- A complete line . . . metal can, cardboard container and tubular types . . . any capacity, working voltage, combination, mounting
- Metal can type hermetically sealed . . . preventing loss or absorption of moisture . . . balanced condition throughout long life. Adequate dissipation of internal heat.
- Cardboard container and tubular types effect economy without sacrificing essentials. Encased in two wax-impregnated cardboard boxes . . . sturdy construction . . . no electrostatic coupling when mounted close together.
- All internal parts of aluminum . . . eliminates corrosion or foreign chemical action.
- Special composition spacers . . . affords safety against surge voltages . . . no deterioration . . . much longer service life.
- All types positively dry . . . free from leakage, seepage or corrosion either internally or externally.

Insist on these features. Don't accept paper substitutes of lower capacity when Aerovox electrolytics offer higher capacity at lower cost . . . with positive satisfaction. Millions of Aerovox electrolytics in daily use tell their own story.

FREE DATA 1935 Catalog just off press, sent on request. Also sample copy of monthly Research Worker. And do not hesitate to submit your condenser and resistor problems for our engineering collaboration.



AEROVOX

C O R P O R A T I O N

71 Washington Street

Brooklyn, N. Y.

When writing to advertisers mention of the PROCEEDINGS will be mutually helpful.

THE NEW TWIN INSTRUMENT

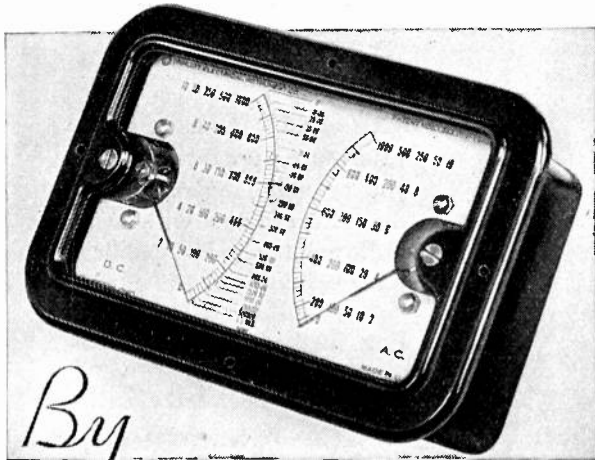

By TRIPLET

This unit is appropriately named the "NEW TWIN" because it is made up of any combination of two DC or AC instruments. Both are housed in a bakelite case that takes up a minimum of space. This unit has many outstanding advantages: To take simultaneous readings of both instruments when connected in the same

circuit, such as ammeters and voltmeters; to balance loads in three-wire circuits; to observe line fluctuations when load readings are taken; to measure antenna and modulation current; to determine filament and plate voltages. It has a multitude of other applications where quick, accurate, double readings are essential.

The scales of each instrument are arranged side by side. The pointers are always directed in the line of vision. No longer is it necessary to look from one meter to another. The "New Twin" enables you to observe two readings at a glance. The instrument accuracy itself may be lost several times its rated value if readings are not correctly made.

The combinations in the New Twin Triplet are made up of scales corresponding to the 3" individual instruments in single, double and triple ranges—AC-DC, Thermo-Couple and Copper-Oxide for panel mounting.

Your Jobber Can Supply You
Triplet Electrical Instrument Company
112 Main Street Bluffton, Ohio

Mail Coupon for Details!

Triplet Electrical Instrument Company
112 Main Street
Bluffton, Ohio

Gentlemen:

Please send your latest literature on the "New Twin" Instrument.

Name

Address

City State

When writing to advertisers mention of the PROCEEDINGS will be mutually helpful.

RADIO AND SCIENTIFIC LITERATURE

● *Rider's Manuals* **VOLUME V**

of this series has just been published.

1200 pages.

946 models.

113 manufacturers.

The Rider Manual series, now consisting of five volumes totals in excess of 5100 pages and contains technical information in the form of schematics, values, voltage, chassis data, etc., on more than 5200 models of American made commercial receivers, testing units and power amplifiers.

Engineers — Research Laboratories — Technical Schools—Broadcasting Stations—all who require information about the electrical structure of American receivers made during the past 15 years—turn to Rider's Manuals.

Up to date to October 1934

Write for descriptive literature

JOHN F. RIDER, Publisher
1440 Broadway New York City

PUBLISHERS

●
This Radio and Scientific Literature page is run to help you acquaint the readers of the Proceedings with your radio and technical publications.

For further information as to rates, etc., address:—

●
Advertising Department
Institute of Radio Engineers
330 West 42nd Street
New York, N.Y.

Alphabetical Index to Advertisements

	A	
Aerovox Corp.		XVIII
Allen-Bradley Co.		VII
American Tel. & Tel. Co.		IX
	C	
Central Radio Laboratories		XXII
Cornell-Dubilier Corp.		XIII
	E	
Erie Resistor Corp.		XIV
	G	
General Radio Co.		Outside Back Cover
	H	
Hygrade Sylvania Corp.		VIII
	I	
International Resistance Co.		X
I.R.E.		XI, XII, XVI, Inside Back Cover
Isolantite Inc.		XVII
	P	
Professional Eng. Directory		XXI
	R	
Radio and Scientific Literature		XX
	S	
S. S. White Dental Mfg. Co.		XV
	T	
Triplett Elec. Inst. Co.		XIX

When writing to advertisers mention of the PROCEEDINGS will be mutually helpful.

PROFESSIONAL ENGINEERING DIRECTORY

BLILEY ELECTRIC CO.

*Designers and Manufacturers
of*

QUARTZ CRYSTALS

for

Standard or Special Requirements

226A Union Station Bldg.
ERIE, PENNA.

Cathode Ray Tubes and Associated Equipment For All Purposes

*Write for Complete
Technical Data*

ALLEN B. DUMONT
LABORATORIES
UPPER MONTCLAIR, N.J.

PRACTICAL RADIO ENGINEERING

One year Residence Course
Advanced Home Study Course
Combined Home Study-Residence
Course

Write for details

Capitol Radio Engineering
Institute
Washington, D.C.

FOR MANY YEARS

the Professional Engineering Directory has helped consulting engineers, designers, and laboratory men make the right contacts in the radio industry. Perhaps we can help you with your problems too. For further information write to

Advertising Department
INSTITUTE OF RADIO
ENGINEERS
330 West 42nd Street
NEW YORK, N.Y.

For the Engineering Consultant

who can handle a little extra business this year

For the designer

who can manage some additional work

For the Patent Attorney

who is anxious to develop a larger clientele

we suggest the Professional Engineering Directory of the PROCEEDINGS I.R.E. Manufacturers and organizations with special problems who need services such as yours come to the Professional Engineering Directory for information. Your name and special services announced here will tell them what you do and where to find you. Further information will be furnished on request. Special rates to members of the Institute.

When writing to advertisers mention of the PROCEEDINGS will be mutually helpful.



Centralab

FROM START to FINISH



In the control room of the studio—and in the distant radio receiver that captures the feeble impulses,

Centralab plays an important part. Sound projection controls for the studio . . . volume controls and fixed resistors in the receiver . . . all bear a heritage of quality that has made the name CENTRALAB famous with engineers, manufacturers and servicemen the world over.

A new book on sound projection controls is now available . . . write for it on your stationery.

Centralab

DIVISION OF GLOBE-UNION MFG. CO. INC.
MILWAUKEE, WIS.

RADIOHMS
FIXED RESISTORS SUPPRESSORS

When writing to advertisers mention of the PROCEEDINGS will be mutually helpful.

Take Your Choice

Every member of the Institute of Radio Engineers will want to wear one of these three attractive emblems. All of these emblems are appropriately colored to indicate the various grades of membership and each emblem is approximately the size of the following illustrations.



The **Lapel Button** is of 14k gold, with background enameled in the membership color, and with the lettering in gold. The screw-back on the back of this button fastens it securely to your coat.

\$2.75 postpaid—any grade.



The **Pin** is also of 14k gold. It is provided with a safety catch and is appropriately colored for the various grades of membership.

\$3.00 postpaid—any grade.



The **Watch Charm** handsomely finished on both sides, is also of 14k gold. This charm is equipped with a suspension ring for attaching to a watch fob or chain.

\$5.00 postpaid—any grade.

Orders, accompanied by checks made payable to the Institute of Radio Engineers, should be addressed to

THE INSTITUTE OF RADIO ENGINEERS

330 West 42nd Street

NEW YORK, N.Y.

Send in your order now!

ELECTRON OSCILLOGRAPH

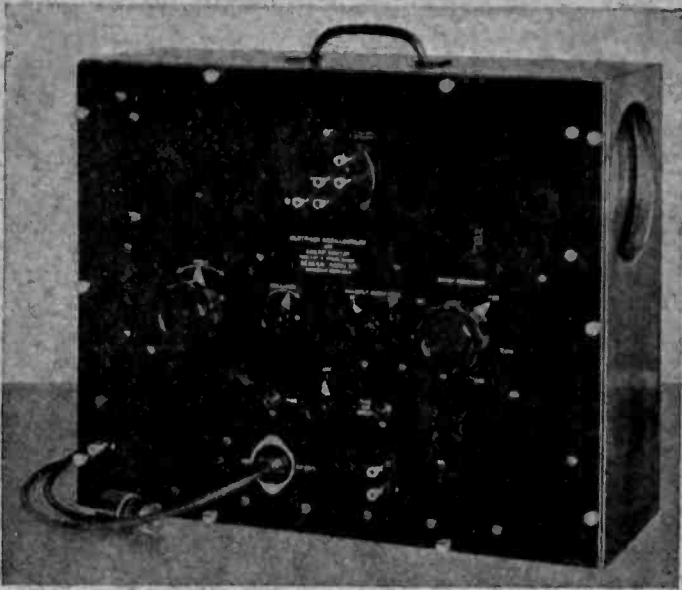

A complete single-element oscillograph in a single portable container—tube—power supply—Bedell sweep circuit—operating from A.C. mains. As convenient to use as a voltmeter, and has far more applications in the development laboratory.

The screen (five-inch diameter) is of the new non-retentive type, permitting photographs of transients. Sensitivity 75 volts per inch (vertical), and 90 volts per inch (horizontal).

Type 687 Electron Oscilloscope
with Sweep Circuit. Price \$184.00.

Described in Bulletin 634-R.

GENERAL RADIO COMPANY
CAMBRIDGE A MASSACHUSETTS