

VOLUME 22

NOVEMBER, 1934

NUMBER 11

PROCEEDINGS
of
The Institute of Radio
Engineers



Form for Change of Mailing Address or Business Title on Page XVI

Institute of Radio Engineers

Forthcoming Meetings

ROCHESTER FALL MEETING

November 12, 13 and 14, 1934

BUFFALO-NIAGARA SECTION

November 21, 1934

CONNECTICUT VALLEY SECTION

November 22, 1934

LOS ANGELES SECTION

November 20, 1934

NEW YORK MEETING

November 7, 1934

December 5, 1934

PHILADELPHIA SECTION

November 1, 1934

December 4, 1934

SAN FRANCISCO SECTION

November 21, 1934

WASHINGTON SECTION

November 12, 1934

PROCEEDINGS OF

The Institute of Radio Engineers

Volume 22

November, 1934

Number 11

Board of Editors

ALFRED N. GOLDSMITH, *Chairman*

R. R. BATCHER
H. H. BEVERAGE
F. W. GROVER
G. W. KENRICK

G. W. PICKARD
K. S. VAN DYKE
L. P. WHEELER
L. E. WHITTEMORE

WILLIAM WILSON

CONTENTS

PART I

Frontispiece, John Ambrose Fleming, Recipient of the Medal of Honor, 1933.....	1232
Institute News and Radio Notes.....	1235
October Meeting of the Board of Directors.....	1235
Rochester Fall Meeting.....	1235
Committee Work.....	1237
Institute Meetings.....	1238
Personal Mention.....	1240

PART II

Technical Papers

An Experimental Television System	
Introduction.....	E. W. ENGSTROM 1241
The Transmitter.....	R. D. KELL, A. V. BEDFORD, and M. A. TRAINER 1246
The Receivers.....	R. S. HOLMES, W. L. CARLSON, and W. A. TOLSON 1266
The Radio Relay Link for Television Signals.....	CHARLES J. YOUNG 1286
The "Sound Prism".....	O. H. SCHUCK 1295
Discussion on "Resistance Tuning," by Sewall Cabot.....	
.....	E. W. HEROLD and SEWALL CABOT 1311
Discussion on "Maintaining the Directivity of Antenna Arrays," by F. G. Kear.....	
.....	H. S. STOKES and F. G. KEAR 1313
Book Reviews: "Electrical Communication," by Arthur L. Albert.....	
.....	H. A. AFFEL 1315
"Motor and Generator Standards," "Carbon Graphite and Metal-Graphite Brush Standards," and "Laminated Phenolic Products Standards," by the National Electrical Manufacturers Association.....	
.....	R. R. RAMSEY 1315
"Thermionic Emission," by Arnold L. Reimann.....	
.....	B. E. SCHACKELFORD 1316
"Servicing Superheterodynes," by John F. Rider.....	
.....	HAROLD A. WHEELER 1316
"Earth, Radio and the Stars," by Harlan True Stetson.....	
.....	T. R. GILLILAND 1317
Contributors to This Issue.....	1318

The Institute of Radio Engineers

GENERAL INFORMATION

INSTITUTE. The Institute of Radio Engineers was formed in 1912 through the amalgamation of the Society of Wireless Telegraph Engineers and the Wireless Institute. Its headquarters were established in New York City and the membership has grown from less than fifty members at the start to several thousand.

AIMS AND OBJECTS. The Institute functions solely to advance the theory and practice of radio and allied branches of engineering and of the related arts and sciences, their application to human needs, and the maintenance of a high professional standing among its members. Among the methods of accomplishing this is the publication of papers, discussions, and communications of interest to the membership.

PROCEEDINGS. The PROCEEDINGS is the official publication of the Institute and in it are published all of the papers, discussions, and communications received from the membership which are accepted for publication by the Board of Editors. Copies are sent without additional charge to all members of the Institute. The subscription price to nonmembers is \$10.00 per year, with an additional charge for postage where such is necessary.

RESPONSIBILITY. It is understood that the statements and opinions given in the PROCEEDINGS are views of the individual members to whom they are credited, and are not binding on the membership of the Institute as a whole. Papers submitted to the Institute for publication shall be regarded as no longer confidential.

REPRINTING PROCEEDINGS MATERIAL. The right to reprint portions or abstracts of the papers, discussions, or editorial notes in the PROCEEDINGS is granted on the express condition that specific reference shall be made to the source of such material. Diagrams and photographs published in the PROCEEDINGS may not be reproduced without making specific arrangements with the Institute through the Secretary.

MANUSCRIPTS. All manuscripts should be addressed to the Institute of Radio Engineers, 330 West 42nd Street, New York City. They will be examined by the Papers Committee and the Board of Editors to determine their suitability for publication in the PROCEEDINGS. Authors are advised as promptly as possible of the action taken, usually within two or three months. Manuscripts and illustrations will be destroyed immediately after publication of the paper unless the author requests their return. Information on the mechanical form in which manuscripts should be prepared may be obtained by addressing the secretary.

MAILING. Entered as second-class matter at the post office at Menasha, Wisconsin. Acceptance for mailing at special rate of postage is provided for in the act of February 28, 1925, embodied in Paragraph 4, Section 412, P. L. and R., and authorization was granted on October 26, 1927.

Published monthly by

THE INSTITUTE OF RADIO ENGINEERS, INC.

Publication office, 450-454 Ahnaip St., Menasha, Wis.

BUSINESS, EDITORIAL, AND ADVERTISING OFFICES

Harold P. Westman, *Secretary*

330 West 42nd Street, New York, N. Y.

INSTITUTE SECTIONS

- ATLANTA—Chairman, Henry L. Reid; Secretary, Philip C. Bangs, 23 Kensington Road, Avondale Estates, Ga.
- BOSTON—Chairman, E. L. Chaffee; Secretary, Roland G. Porter, Northeastern University, Boston, Mass.
- BUFFALO-NIAGARA—Chairman, L. E. Hayslett; Secretary, E. C. Waud, 235 Huntington Avenue, Buffalo, N. Y.
- CHICAGO—Chairman, Hugh S. Knowles; Secretary, John S. Meck, The Fensholt Company, 549 W. Washington St., Chicago, Ill.
- CINCINNATI—Chairman R. E. Kolo; Secretary, Helen Hymans, Crosley Radio Corporation, Cincinnati, Ohio.
- CLEVELAND—Chairman, F. G. Bowditch; Secretary, C. H. Shipman, 14805 Ardenall Ave., East Cleveland, Ohio.
- CONNECTICUT VALLEY—Chairman, K. S. Van Dyke; Secretary, C. B. De Soto, American Radio Relay League, 38 La Salle Rd., W. Hartford, Conn.
- DETROIT—Chairman, Samuel Firestone; Secretary, E. C. Denstaedt, Detroit Police Department, Detroit, Mich.
- LOS ANGELES—Chairman, H. C. Silent; Secretary, N. B. Neely, 1569 Munson Ave., Los Angeles, Calif.
- NEW ORLEANS—Chairman, J. A. Courtenay; Secretary, C. B. Reynolds, Radiomarine Corporation, 512 St. Peter St., New Orleans, La.
- PHILADELPHIA—Chairman, E. D. Cook; Secretary, R. L. Snyder, 103 Franklin Road, Glassboro, N. J.
- PITTSBURGH—Chairman, C. K. Krause; Secretary, H. V. Noble, c/o Gulf Research and Development Company, 327 Craft Ave., Pittsburgh, Pa.
- ROCHESTER—Chairman, H. J. Klumb; Secretary, H. A. Brown, 89 East Ave., Rochester, N. Y.
- SAN FRANCISCO—Chairman A. H. Brolly; Secretary, R. D. Kirkland, Mackay Radio and Telegraph Company, 22 Battery St., San Francisco, Calif.
- SEATTLE—Chairman, Howard Mason; Secretary, Raymond C. Fisher, 602 N. C. St., Tacoma, Wash.
- TORONTO—Chairman, A. B. Oxley; Secretary, S. A. Goldhamer, Northern Electric Company, 131 Simcoe St., Toronto, Ont., Canada.
- WASHINGTON—Chairman T. McL. Davis; Secretary, C. L. Davis, Washington Building, 15th and G Sts. N. W., Washington, D. C.

The Institute of Radio Engineers

GENERAL INFORMATION

INSTITUTE. The Institute of Radio Engineers was formed in 1912 through the amalgamation of the Society of Wireless Telegraph Engineers and the Wireless Institute. Its headquarters were established in New York City and the membership has grown from less than fifty members at the start to several thousand.

AIMS AND OBJECTS. The Institute functions solely to advance the theory and practice of radio and allied branches of engineering and of the related arts and sciences, their application to human needs, and the maintenance of a high professional standing among its members. Among the methods of accomplishing this is the publication of papers, discussions, and communications of interest to the membership.

PROCEEDINGS. The PROCEEDINGS is the official publication of the Institute and in it are published all of the papers, discussions, and communications received from the membership which are accepted for publication by the Board of Editors. Copies are sent without additional charge to all members of the Institute. The subscription price to nonmembers is \$10.00 per year, with an additional charge for postage where such is necessary.

RESPONSIBILITY. It is understood that the statements and opinions given in the PROCEEDINGS are views of the individual members to whom they are credited, and are not binding on the membership of the Institute as a whole. Papers submitted to the Institute for publication shall be regarded as no longer confidential.

REPRINTING PROCEEDINGS MATERIAL. The right to reprint portions or abstracts of the papers, discussions, or editorial notes in the PROCEEDINGS is granted on the express condition that specific reference shall be made to the source of such material. Diagrams and photographs published in the PROCEEDINGS may not be reproduced without making specific arrangements with the Institute through the Secretary.

MANUSCRIPTS. All manuscripts should be addressed to the Institute of Radio Engineers, 330 West 42nd Street, New York City. They will be examined by the Papers Committee and the Board of Editors to determine their suitability for publication in the PROCEEDINGS. Authors are advised as promptly as possible of the action taken, usually within two or three months. Manuscripts and illustrations will be destroyed immediately after publication of the paper unless the author requests their return. Information on the mechanical form in which manuscripts should be prepared may be obtained by addressing the secretary.

MAILING. Entered as second-class matter at the post office at Menasha, Wisconsin. Acceptance for mailing at special rate of postage is provided for in the act of February 28, 1925, embodied in Paragraph 4, Section 412, P. L. and R., and authorization was granted on October 26, 1927.

Published monthly by

THE INSTITUTE OF RADIO ENGINEERS, INC.

Publication office, 450-454 Ahnaip St., Menasha, Wis.

BUSINESS, EDITORIAL, AND ADVERTISING OFFICES

Harold P. Westman, *Secretary*

330 West 42nd Street, New York, N. Y.

INSTITUTE SECTIONS

- ATLANTA—Chairman, Henry L. Reid; Secretary, Philip C. Bangs, 23 Kensington Road, Avondale Estates, Ga.
- BOSTON—Chairman, E. L. Chaffee; Secretary, Roland G. Porter, Northeastern University, Boston, Mass.
- BUFFALO-NIAGARA—Chairman, L. E. Hayslett; Secretary, E. C. Waud, 235 Huntington Avenue, Buffalo, N. Y.
- CHICAGO—Chairman, Hugh S. Knowles; Secretary, John S. Meck, The Fensholt Company, 549 W. Washington St., Chicago, Ill.
- CINCINNATI—Chairman R. E. Kolo; Secretary, Helen Hymans, Crosley Radio Corporation, Cincinnati, Ohio.
- CLEVELAND—Chairman, F. G. Bowditch; Secretary, C. H. Shipman, 14805 Ardenall Ave., East Cleveland, Ohio.
- CONNECTICUT VALLEY—Chairman, K. S. Van Dyke; Secretary, C. B. De Soto, American Radio Relay League, 38 La Salle Rd., W. Hartford, Conn.
- DETROIT—Chairman, Samuel Firestone; Secretary, E. C. Denstaedt, Detroit Police Department, Detroit, Mich.
- LOS ANGELES—Chairman, H. C. Silent; Secretary, N. B. Neely, 1569 Munson Ave., Los Angeles, Calif.
- NEW ORLEANS—Chairman, J. A. Courtenay; Secretary, C. B. Reynolds, Radiomarine Corporation, 512 St. Peter St., New Orleans, La.
- PHILADELPHIA—Chairman, E. D. Cook; Secretary, R. L. Snyder, 103 Franklin Road, Glassboro, N. J.
- PITTSBURGH—Chairman, C. K. Krause; Secretary, H. V. Noble, c/o Gulf Research and Development Company, 327 Craft Ave., Pittsburgh, Pa.
- ROCHESTER—Chairman, H. J. Klumb; Secretary, H. A. Brown, 89 East Ave., Rochester, N. Y.
- SAN FRANCISCO—Chairman A. H. Brolly; Secretary, R. D. Kirkland, Mackay Radio and Telegraph Company, 22 Battery St., San Francisco, Calif.
- SEATTLE—Chairman, Howard Mason; Secretary, Raymond C. Fisher, 602 N. C. St., Tacoma, Wash.
- TORONTO—Chairman, A. B. Oxley; Secretary, S. A. Goldhamer, Northern Electric Company, 131 Simcoe St., Toronto, Ont., Canada.
- WASHINGTON—Chairman T. McL. Davis; Secretary, C. L. Davis, Washington Building, 15th and G Sts. N. W., Washington, D. C.

GEOGRAPHICAL LOCATION OF MEMBERS ELECTED OCTOBER 3, 1934

Elected to the Associate Grade

California	San Pedro, U.S.S. Lexington, K Div.....	Jones, E. J.
	Stockton, 1222 E. Poplar St.....	Hamma, T. G.
Illinois	Chicago, 3420 N. Lincoln St.....	Stromatt, F. C.
Louisiana	Shreveport, 2737 Murray St.....	Neil, W. L.
Maryland	Rockville, Box 74.....	Meyers, A. H.
Massachusetts	Boston, 891 Hyde Park Ave.....	Vickerson, A. H.
New Jersey	Camden, c/o H. E. Sunde, RCA Victor Company, Inc.....	Lal, G. D.
	Jersey City, 3 Fairview Ave.....	Dolan, F. J.
New York	Long Island City, 37-06-36th St.....	Thompson, S. T.
Texas	Tyler, 123 W. Houston St.....	Davis, A. F.
Australia	Croxtton N. 16, Melbourne, 4 Emmaline St.....	Collins, R. J.
	Sydney, 71 York St.....	Court, T. P.
Brazil	Rio de Janeiro, Rua Paulino Fernandes 35.....	Sales, M., Jr.
Canada	Toronto, Ont., 231 Donraven Dr.....	Knudsen, K. J.
	Montreal, P.Q., 4407 Earnscliff Ave.....	Young, J. M.
England	Coventry, G. E. C. Telephone Works.....	Crocker, C. H.
	Darwen, Lancs., 25 Gregory St.....	Shaw, B.
	Horsham, Sussex, 33 Rushams Rd.....	Anderson, J. L. D.
	Southport, Lancs., 47 Ash St.....	Marsh, J.
Japan	Hamamatsu, Hamamatsu Technical College.....	Takayanagi, K.
	Tokyo, 13, Haramachi, Koishikawaku.....	Isoo, T.
Palestine	Tel-Aviv, 12 Hamelitz St.....	Margalith, A.
Russia	Moscow 2, Malii, Nikolo-Peskovskii 13 kv 9.....	Arshinoff, S.
	Moscow 17, Novo-Kuznetskaja N. 3, kv 8.....	Nudeh, A.
	Moscow, Lushnetskaja ulitsa 17.....	Vinogradsky, B.

Elected to the Junior Grade

Iowa	Sioux City, 926 Whitcher Ave.....	Parks, L. W.
------	-----------------------------------	--------------

Elected to the Student Grade

Michigan	Detroit, 5260 Three Mile Dr.....	Frater, G. E.
----------	----------------------------------	---------------



APPLICATIONS FOR MEMBERSHIP

Applications for transfer or election to the various grades of membership have been received from the persons listed below, and have been approved by the Admissions Committee. Members objecting to transfer or election of any of these applicants should communicate with the Secretary on or before November 30, 1934. These applications will be considered by the Board of Directors at its meeting on December 5, 1934.

For Election to the Associate Grade

California	Oakland, 304 Foothill Blvd. Apt. 50	Ranche, D. R.
Connecticut	Bridgeport, General Electric Co., Bldg. 33-E	Vrooman, D. F.
Dist. of Columbia	Washington, 2217 Washington Circle, N.W.	Hunt, C. M.
Louisiana	New Orleans, 518 St. Peter's St.	Bailey, H. M.
	New Orleans, 338 Carondelet St.	Gray, C. D.
Maryland	Baltimore, 5813 Gwynn Oak Ave.	Gerhold, N. S.
Michigan	Detroit, 1226 Lillibridge	LeBarre, S. D.
New Jersey	East Orange, 256 Prospect St.	Cleveland, R.
	East Orange, 376 Prospect St.	Smith, D. Y.
	Teaneck, 979 Belle Ave.	Graf, C. A.
New York	Brooklyn, 180 Gates Ave.	Bainbridge, A. S.
	New York City, c/o R.C.A. Institutes, 75 Varick St.	Paulson, E. J.
North Dakota	Jamestown, 502 Milw. St.	Koth, C.
Pennsylvania	Ardmore, 2938 Haverford Rd.	Taylor, E. A.
	Haverford, Haverford College	Rittenhouse, L. H.
	Philadelphia, 1816 N. 17th St.	Schuck, O. H.
	Philadelphia, 1510 Chew St.	Smith, W. F., Jr.
	Pittsburgh, c/o U.S. Airways Radio Station, Municipal Air- port	Harrison, A. E.
Utah	Riverdale, KLO Transmitter, Rt. 4 Box 216A	Cozzens, W. D.
Argentina	Buenos Aires, Tacuari 471, 5° Piso C.	Tenac, S. C.
Canada	Toronto 3, Ont., 48 Marmaduke St.	Clark, W. B.
England	Liverpool 13, Lancs., 361 Queen's Dr.	Lunt, C.
Germany	Pforzheim, Hohenstaufenstr 17	Landmann, A.
India	Bangalore, Dept. of Communication Eng., Indian Institute of Science	Rao, V. L.
	Jubbulpore, c/o Mr. Karam Singh	Ahluwalia, B. S.
	Nellore, c/o District Board Engineer	Durrani, U.
Ireland	Belfast, Whitehouse Park, Whitehouse	Donaghy, J. L.
Italy	Monza, Casella Postale 66	Jenny, F.
Japan	Fukuchiyama, Nr. Kyoto, Shimoshin	Takagi, T.
New Zealand	Auckland, 38 Winstone Bldgs., 69-77 Queen St.	McRae, I. H.

For Election to the Junior Grade

Pennsylvania	Quakertown, 19 Belmont Ave.	Afflerbach, E. K.
--------------	-----------------------------	-------------------

For Election to the Student Grade

Dist. of Columbia	Washington, 508 Potomac Park Apts., 21 and C. St., N.W.	Lohnes, G. M.
Massachusetts	Brookline, 2 Charles St.	Bacon, F. S., Jr.
	Cambridge, M. I. T. Dormitories	Peterson, A.
Mississippi	Sherard	Ratliff, W. H., Jr.

OFFICERS AND BOARD OF DIRECTORS, 1934

(Terms expire January 1, 1935, except as otherwise noted)

President

C. M. JANSKY, JR.

Vice President

BALTH. VAN DER POL, JR.

Treasurer

MELVILLE EASTMAN

Secretary

HAROLD P. WESTMAN

Editor

ALFRED N. GOLDSMITH

Directors

W. G. CADY, *Junior Past President*

O. H. CALDWELL

J. V. L. HOGAN

L. C. F. HORLE

C. W. HORN

E. L. NELSON

E. R. SHUTE

A. F. VAN DYCK

H. A. WHEELER

Serving until January 1, 1936

R. A. HEISING

L. M. HULL, *Junior Past President*

F. A. KOLSTER

H. M. TURNER

Serving until January 1, 1937

ARTHUR BATCHELLER

WILLIAM WILSON



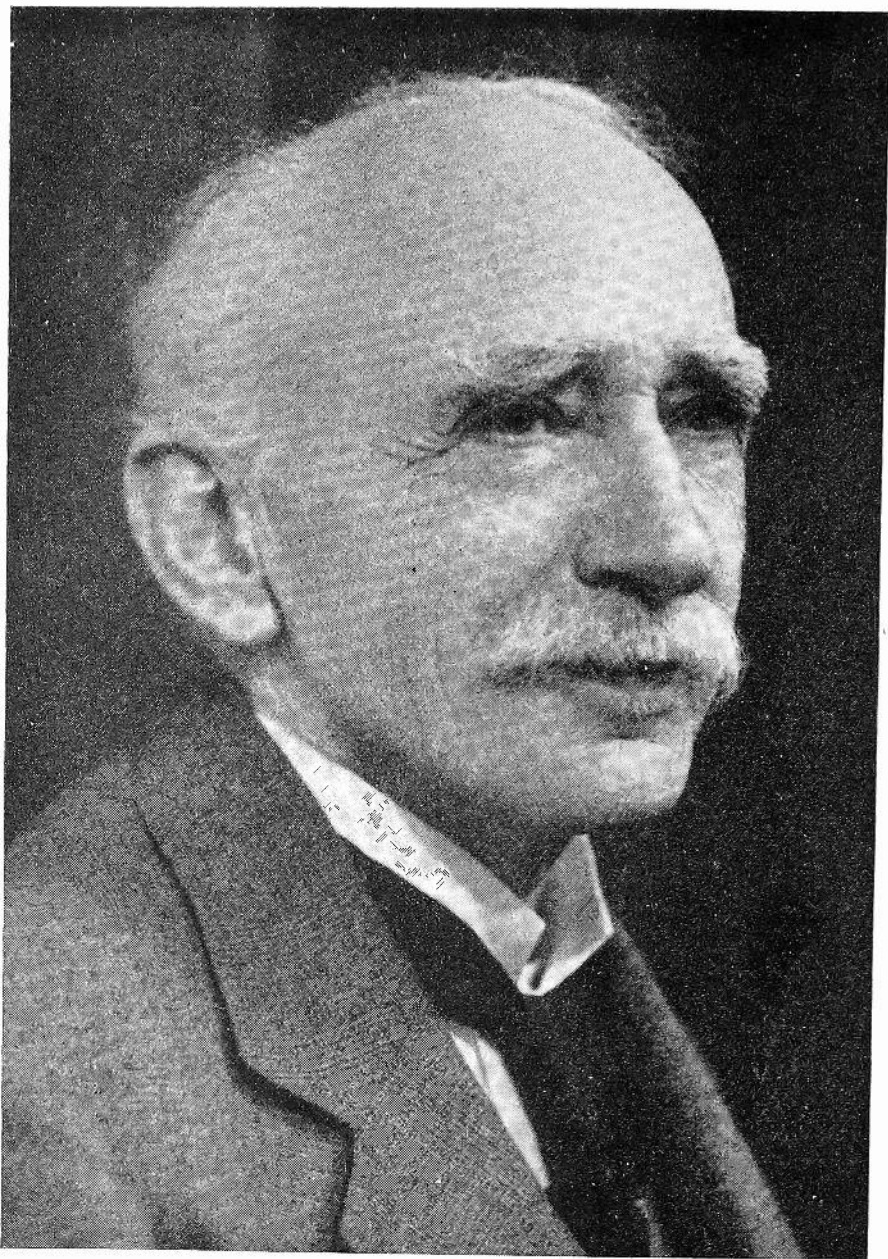

JOHN AMBROSE FLEMING
Recipient, Institute Medal of Honor, 1933

JOHN AMBROSE FLEMING

Recipient, Institute Medal of Honor, 1933

John Ambrose Fleming was born at Lancaster, England, on November 29, 1849. His early schooling was received in London. In 1870 a degree of Bachelor of Science was bestowed on him by the University of London and a Doctorate of Science in 1879. Cambridge conferred a Master of Arts degree in 1882. He was elected a Fellow of St. Johns College in Cambridge and an Honorary Fellow in 1927.

After being science master in two public schools he became the first professor of mathematics and physics at University College, Nottingham, in 1881, leaving there in 1882 to become an electrical advisor to the Edison Electric Light Company of London. For a short time he held a similar position with the Edison Telephone Company and was one of the scientific witnesses in the celebrated legal action which ended in government control of the telephone system. During this time he maintained a consulting practice and was retained by the Cities of Exeter, Taunton, Plymouth, Peterborough, and Douglas. The Edison Company and Swan Electric Light Company amalgamated in 1883, and Sir Ambrose remained as advisor to the joint company for ten years. In 1885 he was appointed the first professor of electrical engineering in University College, London, a position he occupied for forty-two years.

In 1899 he was appointed scientific advisor to Marconi's Wireless Telegraph Company and assisted Mr. Marconi in the design and erection of the first high power radio station at Poldhu in Cornwall for attempted transatlantic wireless communication. During that time he invented the two-element thermionic valve for rectifying high-frequency oscillations and the detection of electric waves. This valve was the precursor of all subsequent forms of vacuum tubes. For this invention he received the Albert Medal of the Royal Society of Arts in 1921. He was the recipient also of the Faraday Medal of the Institution of Electrical Engineers of London in 1928, the Hughes Gold and Silver Medals of the Royal Society of London in 1910, the Duddell Medal of the Physical Society of London in 1931, and the Medal of Honor of the Institute of Radio Engineers in 1933.

He became a Fellow of the Royal Society of London in 1892 and in 1874 read the first paper at the inaugural meeting of the Physical Society of which he is an original member. He was elected a member of the Institution of Electrical Engineers in 1882 and an Honorary Member in 1922. He is an Honorary Member of the Royal Engineers Institute of Chatham, the Society of Engineers, London; the Institute of Physics, the Royal Philosophical Society of Glasgow; the Lancaster Astronomical and Scientific Association, and the Society of Engineers of Leige, Belgium.

He has published some twenty scientific books and about a hundred scientific papers on various subjects. Among his electrical inventions is the direct reading potentiometer which is now in universal use. His cymometer was one of the first devices for measuring the length of electric waves and small values of inductance and capacitance.

He resigned his professorship at University College in 1926 and gave up most of his advisory work although he is still president of the Television Society of England and of the Victoria Institute or Philosophical Society of Great Britain. He resides at Sidmouth in Devonshire.



INSTITUTE NEWS AND RADIO NOTES

October Meeting of the Board of Directors

A regular meeting of the Board of Directors was held on October 3 at the Institute office and those present were: C. M. Jansky, Jr., president; Melville Eastham, treasurer; O. H. Caldwell, Alfred N. Goldsmith, J. V. L. Hogan, L. C. F. Horle, C. W. Horn, F. A. Kolster, E. L. Nelson, E. R. Shute, H. M. Turner, A. F. Van Dyck, H. A. Wheeler, William Wilson, and H. P. Westman, secretary.

Twenty-five applications for Associate membership, one for Junior grade, and one for Student membership were approved.

The death of Calvin W. Rice, secretary of the American Society of Mechanical Engineers was noted with deep regret.

An invitation to nominate a trustee member to assist in formulating guiding policies of Engineering Index, Inc., a recently formed non-profit-making membership corporation which has taken over the Engineering Index Service previously maintained by the American Society of Mechanical Engineers, was accepted.

Melville Eastham was appointed chairman of the Industrial Relations Committee to succeed Dr. Hull who found it impossible to give the necessary time to the work.

During June, July, August, and September, sixty-four new registrations were received by the Emergency Employment Service bringing the total to 740. Of the 563 members registered, 370 are unemployed while 109 of the 177 nonmembers registered are unemployed. Seventy-six jobs were handled during these four months and sixty-five men placed. Of the jobs filled, twenty-two were assumed to be permanent and forty-three were known to be temporary.

Rochester Fall Meeting

The Rochester Fall Meeting for 1934 will be held on Monday, Tuesday, and Wednesday, November 12, 13, and 14 at the Hotel Sagamore in Rochester. As in the past, a series of important papers will be presented and an exhibition of technical equipment will be held. The program is given below:

MONDAY, NOVEMBER 12th

9:00 A.M.	Registration
	Opening of Exhibits
10:00 A.M.-12 Noon	Technical Session
	"Iron-Core Tuning Systems," by A. Crossley, Consulting Engineer.

- “High Fidelity Reproducers with Acoustical Labyrinths, (with demonstration),” by B. Olney, Stromberg-Carlson Telephone Manufacturing Company.
- 12:30 P.M. Group Luncheon
- 2:00 P.M.—4:00 P.M. **Technical Session**
 “Automatic Reactance Control Systems,” by Charles Travis and Murray Clay, RCA License Laboratory.
 “Putting the Ultra-High Frequencies to Work, (with demonstration),” by L. C. F. Horle, Consulting Engineer and C. J. Franks, Radio Frequency Laboratories.
 “Diode Coupling Considerations,” by J. R. Nelson, Raytheon Production Corporation.
- 4:00 P.M.—6:00 P.M. Inspection of Exhibits
 Meeting of RMA Committee on Receivers
 Meeting of RMA Committee on Television
- 6:30 P.M. Group Dinner
- 8:00 P.M. Joint Session with Radio Club of America
 “Transmission and Reception of Centimeter Waves, (with demonstration),” by I. Wolff, E. G. Linder, and R. A. Braden, RCA Victor Company.

TUESDAY, NOVEMBER 13th

- 9:00 A.M. Registration
- 9:30 A.M.—12:30 P.M. **Technical Session**
 “The Use of Cathode Ray Tubes in Receiver Distortion Measurements, (with demonstration),” by Henry W. Parker, Rogers Radio Tubes, Ltd., and F. J. Fox, Rogers Majestic Corporation.
 “Converter Tubes at High Frequencies,” by W. A. Harris, RCA Radiotron Company.
 “Input Losses in Vacuum Tubes at High Frequencies,” by B. J. Thompson and W. R. Ferris, RCA Radiotron Company.
- 12:30 P.M. Group Luncheon
- 2:00 P.M.—4:00 P.M. **Technical Session**
 “New Equipment for the Radio Designer and Engineer,” by C. J. Franks, Radio Frequency Laboratories.
 “Detector Distortion,” by Kenneth W. Jarvis, Consulting Engineer.
- 4:00 P.M.—6:00 P.M. Inspection of Exhibits
 Meeting of RMA Committee on Vacuum Tubes
 Meeting of RMA Committee on Sound Equipment
- 6:30 P.M. Stag Banquet
 Toastmaster, W. E. Davison
 Speaker, Judge John W. Van Allan
 Demonstrations

WEDNESDAY, NOVEMBER 14th

- 10:00 A.M.—12:30 P.M. **Technical Session**
 Joint Technical Session with RMA Engineering Division on Radio Interference.

"Desirability of Reduction of Radio Interference from the Viewpoints of:"

The Consumer—O. H. Caldwell

The Public Utilities—J. O'R. Coleman

The Radio Manufacturer—L. F. Muter

The Radio Dealer—Benjamin Gross

The Federal Communications Commission—C. B. Jolliffe

Summary—A. N. Goldsmith

"Investigation and Suppression of Inductive Interference," by H. O. Merriman, Radio Branch, Department of Marine, Canada

12:30 P.M.

Group Luncheon

2:00 P.M.

Technical Session

Radio Interference (continued)

Discussion by Interested Organizations on Promotion of Interference Reduction.

Past experience indicates the desirability of making hotel reservations well in advance if accommodations at the Sagamore are desired.

Committee Work

ADMISSIONS COMMITTEE

The Admissions Committee met at the Institute office on the evening of September 11 and those present were: E. R. Shute, chairman; Austin Bailey, Arthur Batchellor, I. S. Coggeshall, L. C. F. Horle, C. W. Horn, and H. P. Westman, secretary.

An application for admission to the grade of Fellow was approved as was one of two applications for transfer to Fellow. Of fourteen applications for admission to Member, twelve were approved, one was rejected, and the last tabled pending the obtaining of additional data. For transfer to the grade of Member, seven applications were considered. Of these five were approved, one rejected, and one tabled for further information.

NEW YORK PROGRAM

The New York Program Committee met on the afternoon of July 12 at the Institute office and A. F. Van Dyck, chairman; Austain Bailey, J. L. Callahan (representing H. H. Beverage), H. A. Chinn (representing E. K. Cohan), D. G. Fink (representing J. K. Henney), L. C. F. Horle, R. H. Langley, and H. P. Westman, secretary, were in attendance. A schedule of papers was prepared for all meetings through February 6, 1935.

Institute Meetings

CLEVELAND SECTION

The Cleveland Section held a meeting on September 27 at the Case School of Applied Science with Chairman F. T. Bowditch, presiding. The attendance was fifty-four.

A paper on "Loud Speaker Design and Manufacture" was presented by A. A. Armer, sales manager of the Magnavox Company of Fort Wayne, Ind. The subject was introduced with an outline of the early history of moving-coil speakers showing the various major changes in design and price.

The use of the strap form of magnet instead of the pot type was discussed and the influence of price on design, methods of reducing hum, type of cone materials, and cone angle were covered. The necessity for mechanical matching of parts for best transfer of power was stressed. The operation of the cone as a plunger for frequencies below about 300 cycles and its behavior as a vibrating diaphragm at higher frequencies were discussed from the point of view of their effect on the response characteristics of the speaker.

The permanent magnet type of speaker was then considered and it was pointed out that a large strap form of magnet was much less expensive in this country than the use of cobalt steel which would permit a much shorter magnet and which is commonly used in England. A reel of motion pictures was then shown to illustrate the process of loud speaker manufacturer.

DETROIT SECTION

Samuel Firestone, chairman, presided over the September 21 meeting of the Detroit Section which was held in the Detroit News Conference room. Fifty-five were present.

E. J. Abbott, a research physicist of the Department of Engineering Research of the University of Michigan, presented a paper on "Sounds and Noises." In it Dr. Abbott gave an outline of the noise measurement field showing the equipment used and illustrating a number of cases in which a study of machinery with noise measuring equipment resulted not only in quieter and smoother equipment but also a reduction in production costs. After summarizing the possible troubles encountered in measuring noises such as standing waves and variation in ear sensitivity at different sound levels, the speaker described the equipment developed for production testing. He showed the result of tests in which the data obtained from the measuring equipment were compared with the averages of a group of twenty observers who were asked to

rate a number of different types of machine noises according to their loudness and their disagreeableness. Even though single observers varied widely in their findings, the averaged results were in remarkable agreement. To measure the average noise of machines, the microphone pick-up is swung rapidly around and the readings made with a sluggish meter which averages the results. A number of those present participated in the discussion.

NEW YORK MEETING

A New York meeting was held on October 3 in the Engineering Societies Building in New York City. President Jansky presided and about 400 members and guests were present.

A paper on "All-Wave Broadcast Receivers and All-Wave Antennas" was presented by V. D. Landon of the RCA Victor Company. In it he pointed out that one reason for the sudden popularity of short waves was the improvement made in receivers of this type. Design problems of the preselector, the detector-oscillator, and the intermediate-frequency amplifier were discussed. Suitable frequency coverage and band divisions were suggested. The relation between signal strength, antenna length, and frequency was discussed and the design for an antenna transformer to reduce variations in antenna efficiency with length was covered. Noise reducing antennas were discussed including those of all-wave type. A transformer system, the frequency range of which may be extended to any desired degree, was outlined. The result of polarization and directional effects in antennas were shown and diversity reception considered briefly.

The second paper of the evening was by W. S. Barden of the Radio Corporation of America and was entitled "A Discussion of All-Wave Antenna Resonance."

The problem of dummy properties for all-wave receiver testing and development was discussed from the standpoint of antenna performance as affected to a major degree by distributed inductance, capacitance, and resistance. The behavior of distributed systems of inductance and capacitance was considered analytically by means of transmission line theory and was demonstrated by the use of an artificial line which was provided with numerous small lamps to indicate current densities along the line. The line was operated in various modes and the current distribution could readily be noted.

SAN FRANCISCO SECTION

A. H. Brolley, chairman, presided at the September 19 meeting of the San Francisco Section which was held in the laboratory of Heintz and Kaufman, Ltd., South San Francisco.

A new cold-cathode vacuum tube invented by P. T. Farnsworth was the subject of the meeting. R. M. Heintz presented a sketch of the history of this tube and some of its many interesting features were outlined and discussed. The importance of its development and some of its possibilities were also considered. D. K. Lippincott then explained the theory of operation of the tube as developed up to the present time. The circuits used in connection with it were covered by Philip Ekstrand who demonstrated the operation of the tube as an oscillator. A number of the 158 members and guests in attendance participated in the discussion.

Personal Mention

A. W. Peterson, Lieutenant, U.S.N., has been transferred from the U.S.S. West Virginia to Balboa, Canal Zone, as assistant district communication officer.

D. S. Rau of RCA Communications has been transferred from Rocky Point to New York City.

Formerly of Washington, D. C., J. R. Ruhsenberger, Lieutenant, U.S.N., has been transferred to VF Squadron 3B basing at New York City.

Previously with Bell Telephone Laboratories, H. J. Scott has joined the faculty of the University of California, Berkeley, Calif.

S. B. Slavin of RCA Communications is now at Honolulu, T.H., having formerly been at Inverness, Calif.

S. A. Staege formerly with the Westinghouse Electric and Manufacturing Company is now a consultant for Black-Clawson and Company of Hamilton, Ohio and the Shartle Brothers Machine Company division at Middletown, Ohio.

M. Takaya has left Japan to become an electrical engineer for the Bureau of Weights and Measures of Manchoukuo.

Formerly at the University of Chekiang, T. C. Tsao has become director of the telephone administration of the Chekiang Provincial Government at Hanchow, China.

W. S. Bachman previously with Delaware Chemical Engineering Company is now a test engineer for the General Electric Company at Bridgeport, Conn.

Formerly with Crosley Radio Corporation, Edward Austin has been made engineer in charge of the radio control laboratory for the Philadelphia Storage Battery Company of Philadelphia.

T. H. Clark has left the George E. Marshall Company and is now assistant to the director of the electrical research section of the RCA Radiotron Company at Harrison, N.J.

TECHNICAL PAPERS

AN EXPERIMENTAL TELEVISION SYSTEM*

By

E. W. ENGSTROM

(RCA Victor Company, Inc., Camden, N. J.)

Summary—During the first part of 1933 a complete experimental television system was placed in operation in Camden, New Jersey. Practical tests were made under conditions as nearly as possible in keeping with probable television broadcast service. Program material was obtained from studio pick-up and outdoor pick-up. The outdoor pick-up was from a point a mile from the studio and transmitter. In addition, a studio program originating in the Empire State Building in New York was relayed to Camden by radio and broadcast in Camden. The transmitter used an iconoscope as the pick-up element and the receiver a kinescope as the reproducing element.

This paper is an introduction to a group of three papers which describe the transmitter terminal equipment and the transmitter, the New York-to-Camden radio relay circuit, and the receiver apparatus.

PART I—INTRODUCTION

A GROUP of papers has been published in these PROCEEDINGS describing an experimental television system on which tests were made in the metropolitan area of New York during the first half of 1932.¹ These tests indicated many of the objectives for continued research in the laboratory. In order to make practical tests on the next stage of television research, a complete system was built in Camden and operated during the first several months of 1933.

In the New York tests the major limitation to adequate television performance was the studio scanning apparatus. This consisted of a mechanical disk, flying-spot type, for an image of 120 lines. Even for small areas of coverage and for 120 lines, the resulting signal amplitude was unsatisfactory. In the Camden system, an iconoscope was used as

* Decimal classification: R583. Original manuscript received by the Institute, June 25, 1934. Presented before Ninth Annual Convention, Philadelphia, Pa., May 29, 1934.

¹ E. W. Engstrom, "An experimental television system"; V. K. Zworykin, "Description of an experimental television system and the kinescope"; R. D. Kell, "Description of experimental television transmitting apparatus"; G. L. Beers, "Description of experimental television receivers"; Proc. I.R.E., vol. 21, pp. 1652-1706; December, (1933); and L. F. Jones, "A study of the propagation of wavelengths between three and eight meters," Proc. I.R.E., vol. 21, pp. 349-386; March, (1933).

the pick-up device. The iconoscope and its operation have been described in the PROCEEDINGS by Zworykin.² The use of the iconoscope permitted transmission of greater detail, outdoor pick-up, and wider areas of coverage in the studio. Experience indicated that it provided a new degree of flexibility in pick-up performance, thereby removing one of the major technical obstacles to television.

The picture characteristics for this experimental television system included 240-line progressive scanning, 24 frames per second. The choice of 240 lines was not considered optimum,³ but all that could be satisfactorily handled in view of the status of development. It is of interest to compare the resulting image and electrical specifications with those for the New York tests. These are given in Table I.

Aspect ratio	1.33 (4×3)
Frame repetition frequency	24 per second
Video frequency (picture frequency)	
Assumed that each arbitrary picture element is square and requires one-half cycle and that 10 per cent of the time is required for control functions.	

TABLE I

Scanning lines	Picture element	Maximum video frequency	Maximum video communication band
120	19,200	256,000	512,000
240	76,780	1,024,000	2,048,000

In the New York tests the picture and sound transmitters were widely separated in frequency to simplify apparatus requirements. In our analysis of television systems, it had been decided desirable that there be two transmitter carriers, one for picture and one for sound. It had further been concluded that the picture carrier should include the video signal, synchronizing impulses, etc. Thus the problem of television reproduction requires the reception and utilization of two transmitted carriers with their respective modulations (one for picture and control signals and the other for sound), without interference from each other and without interference from other television stations. These considerations plus a study of station allocation in a national system, receiver design and tuning problems, and other related factors, indicated that the two carriers for one station should be adjacent, their spacing being dependent upon image detail, and transmitter and receiver selectivity characteristics. For these tests it was assumed that

² V. K. Zworykin, "The iconoscope—a modern version of the electric eye," *Proc. I.R.E.*, vol. 22, pp. 16–32; January, (1934).

³ E. W. Engstrom, "A study of television image characteristics," *Proc. I.R.E.*, vol. 21, pp. 1631–1651; December, (1933).

a television channel for picture and sound should be 2000 kilocycles wide and that the picture and sound carriers should be spaced by 1000 kilocycles. This particular channel width and carrier spacing are not given as optimum but rather as practical limitations for the tests. Diagrammatically, a television channel of this type is shown in Fig. 1.

In the Camden tests, the picture carrier was at 49,000 kilocycles and the sound carrier 50,000 kilocycles. This spacing of 1000 kilocycles, when compared with the maximum video frequency band of Table I for 240 lines, indicates that the system did not permit use of the full arbitrarily assumed frequency band. The combined transmitter and receiver selectivity characteristic was such as to pass a frequency band approximately 0.6 of the carrier spacing and, also, in this case 0.6 of the maximum video frequency of Table I.

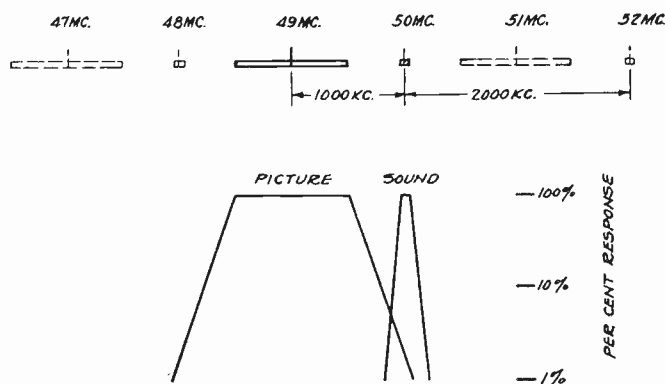

Fig. 1—Over-all transmitter and receiver selectivity characteristics.

Since the tests were essentially for the purpose of obtaining experience with the system fundamentals and with the terminal apparatus, the picture and sound transmitters had nominal outputs. The two transmitters were located in one of the RCA Victor buildings and the antennas on masts above the building. The studio and control apparatus were located in another building about 1000 feet direct-line distance from the building housing the transmitters. Most of the receiving tests were made at a point four miles from the transmitter.

One of the problems in television is to provide facilities for program pick-up at points remote from the studio and transmitter. In this experimental system a pick-up point was located approximately one mile from the studio. Here an outdoor program was televised and relayed to the main studio and transmitter by radio. Fig. 2 indicates the Camden system.

Another problem in television is to tie groups of stations together for network service. The interconnecting link might either be a special land wire or radio. In this experimental system tests were made on

radio relaying of television programs between New York and Camden. A program originating in the Empire State Building studio was transmitted by radio, relayed at an intermediate point, received and broadcast in Camden. For these tests 120-line scanning was used, since this was the standard for the New York equipment. Fig. 3 indicates the complete system.

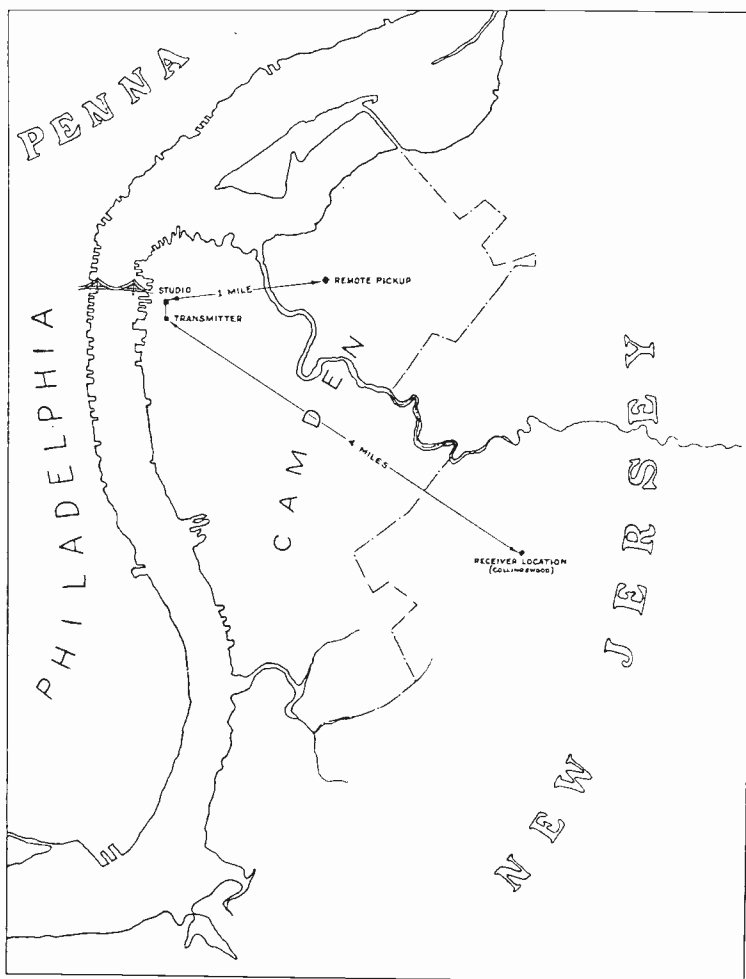

Fig. 2

The increase of image detail (from the New York tests—120 to 240 lines) widened very considerably the scope of the material that could be used satisfactorily for programs. Experience with this system indicated that even with 240 lines, for critical observers and for much of the program material, more image detail was desired. The desire was for both a greater number of lines and for a better utilization of the detail capabilities of the system and lines chosen for the tests. The iconoscope type pick-up permitted a freedom in subject material and conditions roughly equivalent to motion picture camera requirements.

As in the New York tests, much valuable experience was obtained in constructing and placing in operation a complete television system having standards of performance abreast of research status. Estimates of useful field strengths were formulated. The need for a high power television transmitter was indicated. Further studies were made of interference caused by automobile and airplane ignition systems. Con-

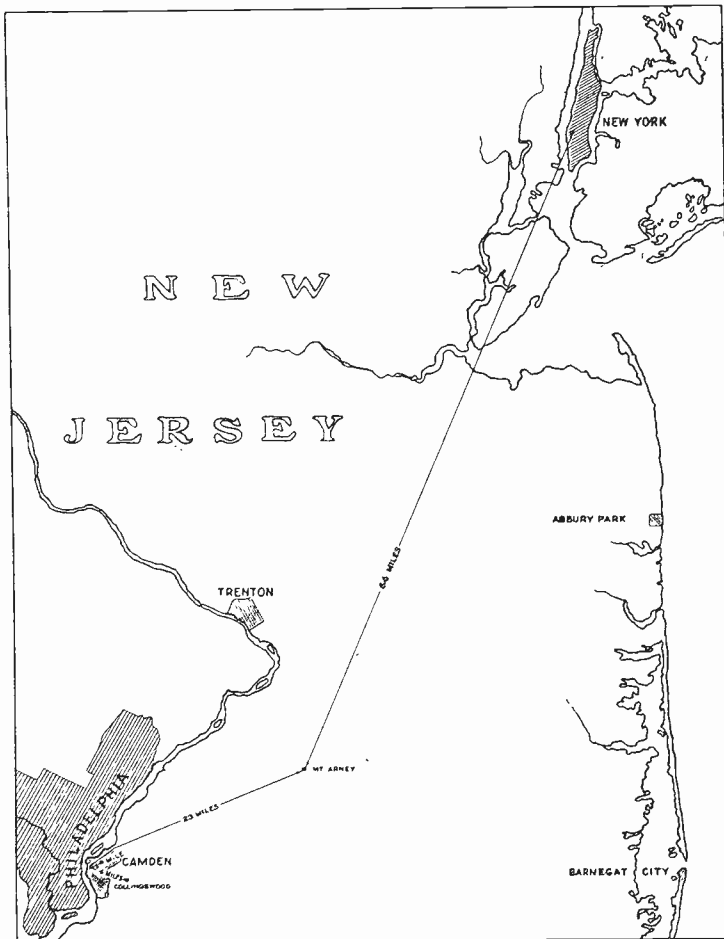

Fig. 3

sideration was given to receiver antenna problems. Technical and lay opinion was obtained on receiver operation, image characteristics, and entertainment possibilities. Some work was done on program, studio, and pick-up technique. Again the tests indicated directly or as a result of analysis the objectives for further research. It is the purpose of this group of papers to describe the system, the experimental apparatus, and the tests that were made. The description is divided into three parts: the transmitter, radio relay circuit, and receiver.

Acknowledgment is made to all members of the RCA organization who participated in the work.

AN EXPERIMENTAL TELEVISION SYSTEM*

BY

R. D. KELL, A. V. BEDFORD, AND M. A. TRAINER

(RCA Victor Company, Inc., Camden, N. J.)

Summary—A description is given of an experimental television pick-up and transmitting installation which used a special form of cathode ray tube, the iconoscope, as the signal generating device. The installation included facilities for remote pick-up of outdoor scenes and the relaying of programs by radio. The transmitted subject matter for the tests included motion picture film, studio scenes, and outdoor scenes. Description is given of video frequency amplifiers having uniform frequency response from about 20 cycles to 600,000 cycles per second. Discussions are given on several of the problems which arose in the use of the iconoscope.

PART II—THE TRANSMITTER

AFTER the completion of the Empire State experimental television installation, work was concentrated on producing a picture containing greater detail, using the same type of terminal equipment. The number of scanning lines was increased from 120 to 180. This number of lines gave a television signal having a satisfactory signal-to-noise ratio only when motion picture film was scanned. The light obtainable in the studio was of too low a value to be usable.

The results indicated that the iconoscope offered the most satisfactory solution of the problem of increased detail. Due to its mode of operation, as has already been explained,¹ the sensitivity of the iconoscope was sufficient to allow a further increase in the number of scanning lines. With considerable increase in detail, there was still sufficient sensitivity to make possible the use of the camera with light conditions suitable for a regular motion picture camera. This device also gave television the hoped-for freedom of operating conditions. It has made possible the broadcasting of outdoor events as well as studio scenes.

Early preliminary tests with the iconoscope had indicated that the resolution of the system was no longer limited by the television elements. Strictly speaking, these elements are only the kinescope and iconoscope; the resolution of each is considerably greater than could be transmitted through the remainder of the system. In using film transmission of 180 lines, all component parts had been designed to

* Decimal classification: R583. Original manuscript received by the Institute, June 25, 1934. Presented before Ninth Annual Convention, Philadelphia, Pa., May 29, 1934.

¹ V. K. Zworykin, "The iconoscope—A modern version of the electric eye," Proc. I. R. E., vol. 22, no. 1, pp. 16-32; January, (1934).

pass the top theoretical frequency of 500 kilocycles. Without major changes, it was found possible to extend this range to 600 kilocycles.

The conventional method of calculating the maximum video frequency required for a given number of lines is as follows:

$$f = \frac{1}{2}a^2Rn \text{ or } a = \sqrt{2f/nR}$$

where f is the maximum frequency in cycles, a is the number of scanning lines, n is the frame repetition frequency, and R is the aspect ratio of the picture. This equation gives the fundamental frequency which would be generated by scanning a pattern composed of alternate black and white vertical bars in which each bar has a width equal to the line pitch. The line pitch is the distance between centers of adjacent scanning lines. A system capable of transmitting the maximum frequency given by this equation and having a scanning spot of diameter no greater than the line pitch, would resolve the bars in so far as peaks of black and white are concerned. This would hold for any horizontal displacement of the test pattern. With the same test pattern in a horizontal position so that the bars lie along the scanning lines and with the bars and lines coinciding, proper resolution is again obtained. If the pattern is now moved vertically a distance equal to half the line pitch—due to each line covering half of a white bar and half of a black bar—no signal will be generated and the resolution will be zero regardless of the frequency band the system is capable of transmitting. For intermediate positions of the pattern, the resolution will vary gradually from 100 per cent to zero.

It is axiomatic that for best resolution of random picture subject matter, equal resolution should be obtained along all axes. The equation given above fails to fill this demand for at least two axes at right angles to one another, using even the basic test pattern upon which the equation is founded. Analyses for other axes are difficult but observations indicate that they would generally support the same conclusion. Therefore, the above equation makes the number of scanning lines too low to secure the maximum amount of detail in a given video frequency band width.

In television we are not interested in viewing uniform bars in various positions, any more than we wish to listen to sine waves of sound, but such bars and waves are considered best for analytical purposes. Tests made with a calibrated resolution pattern projected upon the plate of the iconoscope and with a variable number of scanning lines showed the resolution to be substantially equal along horizontal and vertical axes when the number of scanning lines, a , was approximately 1.25 times that calculated by the equation given above.

This justifies the introduction of an additional constant, k , making the formula

$$f = \frac{1}{2}a^2Rnk \text{ or } a = \sqrt{2f/nRk}$$

where k equals $1/(1.25)^2$ or 0.64. From the above corrected equation the 600-kilocycle channel is found to give equal vertical and horizontal detail when 240 lines are used at a repetition rate of 24 pictures per second. With this number of scanning lines a complete television installation was made having facilities for transmitting studio, film, and outdoor scenes. The method of synchronizing the transmitter and receivers was the same as previously described.² Impulses having an amplitude greater than the picture signal were transmitted at the end of each scanning line and at the end of each frame.

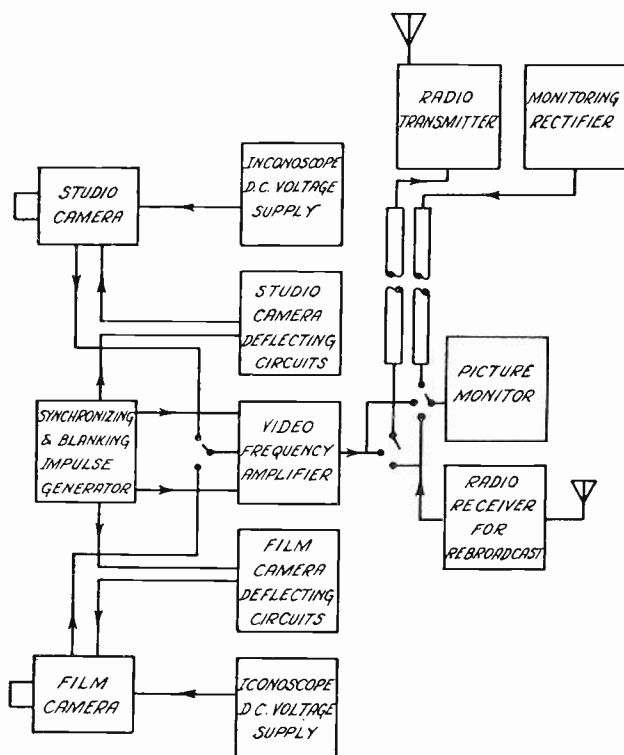

Fig. 1

The relationship of the major components of the installation is shown in the block diagram, Fig. 1. The film and studio cameras are practically identical. In the film camera a motion picture projector was used to project the image upon the iconoscope plate, while in the studio camera a photographic lens formed the image of the scene to be transmitted on the iconoscope plate. Fig. 2 is a photograph showing

² R. D. Kell, "Description of experimental television transmitting apparatus," Proc. I.R.E., vol. 21, no. 12, pp. 1673-1691; December, (1933).

the general appearance of a studio camera. Fig. 3 shows the general arrangement of parts in the camera. The partition (*a*) through the center is an electrostatic shield separating the video frequency amplifier from all other voltages applied to the iconoscope. This shielding is quite essential due to the magnetic and electrostatic fields around the deflecting coils and plates. The deflecting coils for causing the scanning beam to move vertically are seen at (*b*). The deflecting plates for

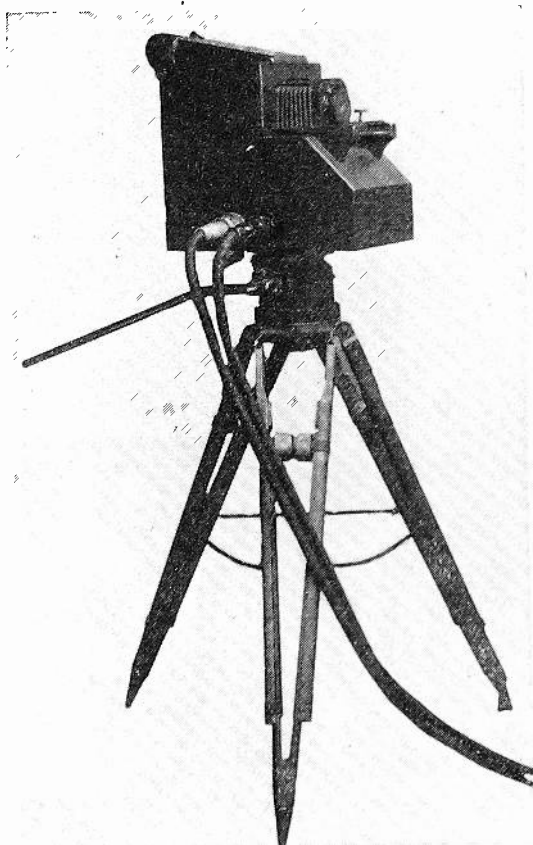

Fig. 2

causing the beam to move horizontally are not visible in the photograph. They are mounted directly on the electron gun structure. The leads from the plates are brought out through the base with the other voltage leads.

The amplifier (*c*) consists of three stages. The third stage has an output impedance sufficiently low to allow the video frequencies to be transmitted to the control room through a considerable length of special cable. A section of this cable is shown in Fig. 4. It consists of a shielded flexible insulating tube containing a single conductor for carrying the video frequencies. Since the capacity of a concentric

cable is dependent upon the ratio of the diameters of the two conductors, the inner conductor of the cable was made as small as physically practical and the flexible tube was made as large as convenient for handling. All other amplifier voltages are carried by the conductors fitted around the central tube. An external shield and braid complete the cable. A similar cable is used to supply all deflecting and operating voltages for the iconoscope. The horizontal deflecting voltage is supplied through the central conductor in this cable. The circuits for

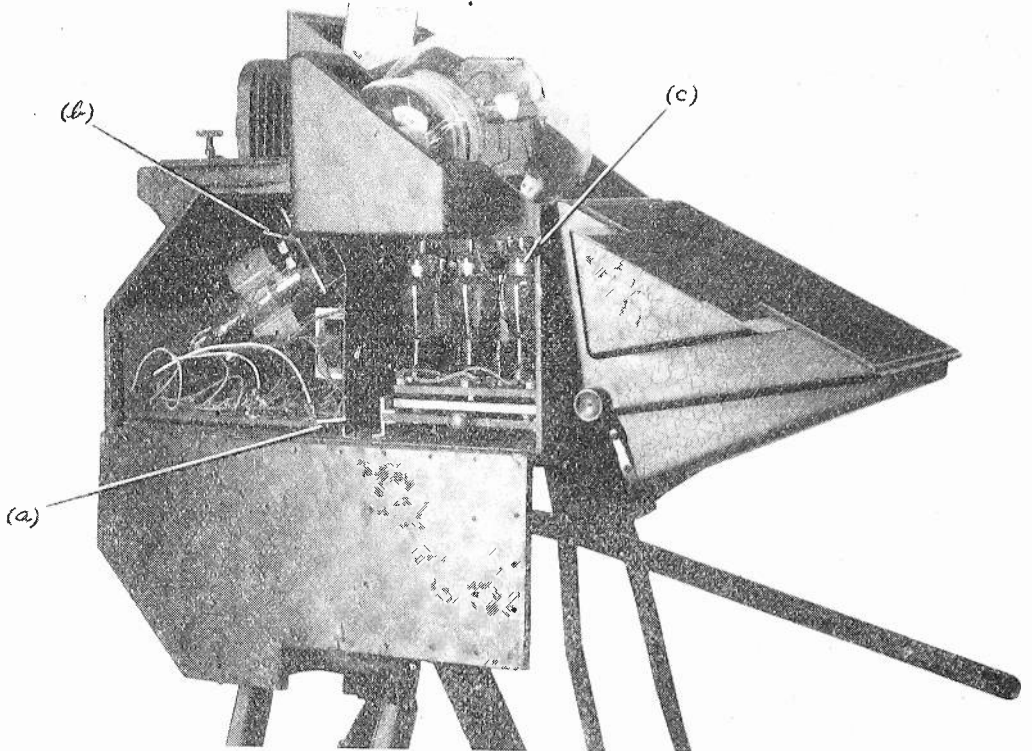

Fig. 3

causing the electron beam of the iconoscope to scan the photo-electric mosaic plate are similar to those used for deflecting the beam of the receiving kinescope, the greatest difference being due to the fact that the mosaic plate is not at right angles to the electron gun.

Since the scanning beam and the optical image strike the same side of the iconoscope mosaic, it is impractical for the axis of both the electron gun and the lens to be at right angles to the mosaic plate. The use of standard lenses requires that the plate be perpendicular to the optical axis of the lens. This requires that the scanning beam strike the plate at an angle. An outline of an iconoscope is shown in Fig. 5(a).

If the iconoscope is subjected to the regular scanning a "keystone"

shape pattern will be formed due to the longer beam path to the top of the mosaic plate as shown in Fig. 5(b). The deflecting means serve only to vary the direction of travel of the electron scanning beam.

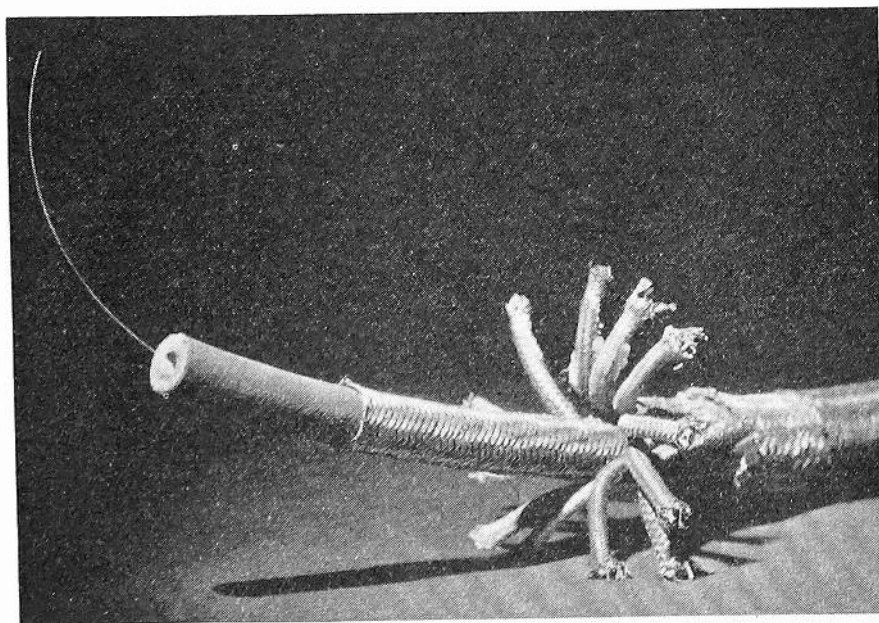

Fig. 4

Hence, the amplitude of the deflection at the plate depends upon the distance from the deflecting means to the plate. In order to scan a rectangular area, Fig. 5(d), on the iconoscope plate and avoid dis-

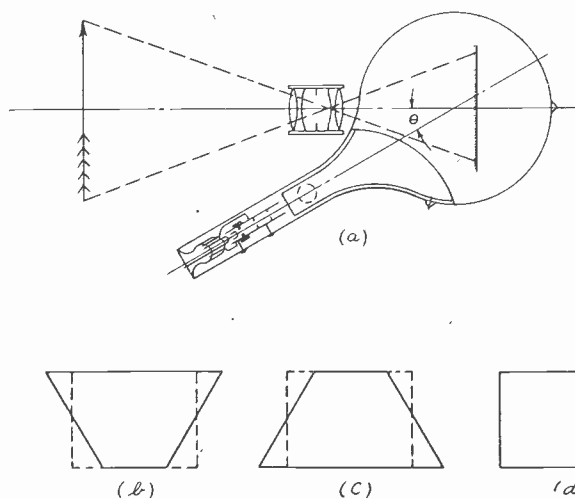

Fig. 5

tortion of the transmitted picture, it is necessary to deflect the beam by the scanning action in such a way that if it fell upon a plate at right angles to the average axis of the beam, it would scan a pattern such as Fig. 5(c). The required horizontal scanning voltage wave is

obtained by modulating the horizontal saw-tooth in amplitude by the vertical saw-tooth wave. The modulation requirements are unusual in that, to produce a symmetrical scanning pattern, the modulated horizontal saw-tooth wave must contain no component of the vertical saw-tooth wave. Furthermore, the modulated wave must retain a good saw-tooth (or triangular) wave shape throughout its cycle of modulation. Due to the very extended range of harmonics and the precise phase relations required to form a good saw-tooth wave, wave filters have been found to be of little aid in the problem of separating the modulating and modulated waves after they are once mixed. It has been found much easier to guard against any mixing of the waves

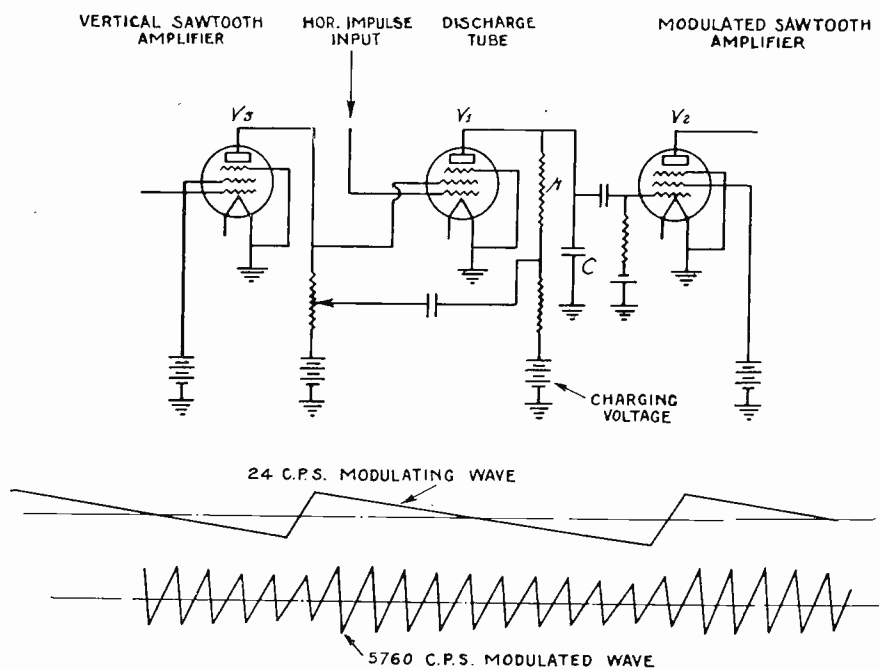

Fig. 6

in the modulating process, by using a special type of balanced modulation.

A circuit arrangement for accomplishing this is shown in Fig. 6. The horizontal deflecting circuit makes use of a condenser C charged through a high resistance r and intermittently discharged by a four-electrode vacuum tube V_1 . This arrangement produces a saw-tooth wave of voltage across the condenser C which is amplified and applied to the deflecting plates. During the vertical scanning cycle, the amplitude of the condenser charges on the condenser C in the horizontal deflecting circuit is decreased at a constant rate by decreasing the supply voltage to the charging resistor, r , by means of a vertical saw-tooth of voltage. To maintain the discharge always equal to the charge,

the control-grid or the screen-grid voltage of V_1 is also varied in exact proportion by means of the vertical saw-tooth of voltage. The combined action of these two vertical saw-tooth voltages on the horizontal saw-tooth generating circuit is to produce the desired amplitude modulation of the horizontal deflection of the scanning beam.

As previously mentioned, the resolution of the iconoscope is considerably better than the rest of the system is capable of transmitting. As a result of this, it is possible to scan an area considerably smaller than the full size of the iconoscope plate before the resolution of the iconoscope becomes the limiting factor. This makes possible an unusual flexibility in the use of the camera. By changing the horizontal and

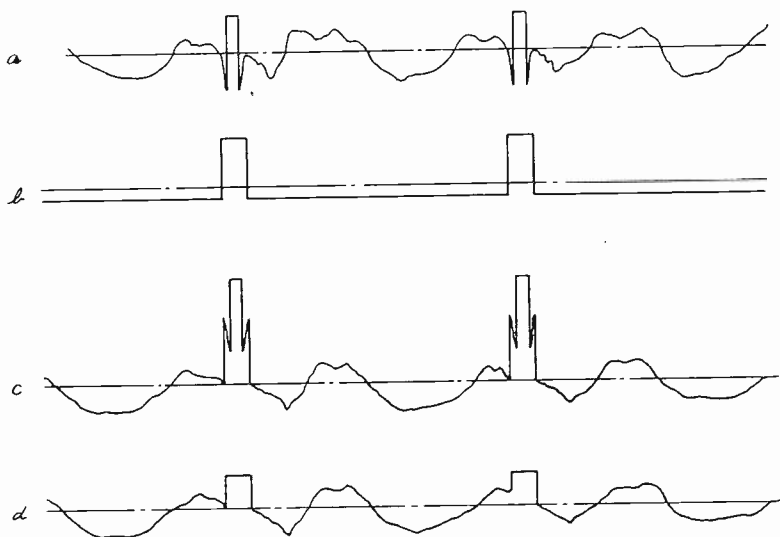

Fig. 7

vertical scanning amplitudes simultaneously, the effect of moving the camera forward or away from the subject is obtained without physically moving the camera. By adjusting the position of the scanning pattern to various sections of the mosaic, the effect of turning the camera may also be obtained. This shifting of the scanned area with respect to the entire area of the mosaic is accomplished by introducing direct-current components into the saw-tooth deflecting circuits. The combined result of these two controls makes possible various effects; for example, first showing a close-up of a person, moving slowly away to take in the full scene, and again moving forward to a close-up of another person; all this apparent movement of the camera being accomplished by purely electrical means.

The principles of operation of the iconoscope have already been discussed and will only be outlined here. The picture signal generated by the iconoscope is produced by the electron beam discharging the

elemental condensers forming the surface of the mosaic. The current released as a signal at any picture element is a function of the illumination of the point under scanning and also upon the time the scanning beam covers the elemental picture area. In other words the signal generated is not only a function of illumination but also a function of the velocity of the scanning beam. This means that to produce a picture signal which is truly representative of the light values of the picture, the velocity of the scanning beam must be constant. By careful design of the circuits for deflecting the scanning beam, this has been practically accomplished during the actual picture scanning time. But during the reversal and return of the scanning beam the velocity cannot be constant and undesirable signals are generated. The total signal generated has the general appearance of that shown in Fig. 7(a). The undesired signal generated during the reversal and return of the scanning beam may have an amplitude of several times the useful picture signal and, of course, it must be removed from the final transmitted television signal. To do this a square wave shaped signal generated by the disk that produces the synchronizing impulses is introduced into the amplifier. The wave shape of this signal is shown in Fig. 7(b). The amplitude of the signal is such that the white parts of the undesired signal are shifted with respect to the axis to a point that corresponds to black, as shown in Fig. 7(c). The picture frequency amplifier is so arranged that this combined signal is of such a polarity and amplitude that the undesired signal swings the grid of an amplifier tube beyond cut-off. The result is a signal in which the amplitude of the blanked-out section is, for practical purposes, a constant with respect to the axis, as shown in Fig. 7(d).

Fig. 8 is a photograph of an electrical impulse signal generator. A disk containing two circular rows of apertures is driven by a motor at 1440 revolutions per minute or 24 revolutions per second. An illuminated optical slit is imaged on each of the two rows of apertures. Behind each row is a phototube with its associated amplifier. One set of apertures is of sufficient width to generate the wave which blanks out the amplifier signal during the return line time of the iconoscope horizontal scanning beam. These are the impulses used to remove all extraneous signals, as previously described. They occupy a time equal to 10 per cent of the horizontal scanning cycle. The vertical impulse is sufficiently long to produce a black signal for a time interval slightly longer than the vertical return line time on the kinescope. This serves to extinguish the kinescope scanning beam during its vertical return across the screen.

The synchronizing impulses are generated by the light passing

through the second set of apertures in the disk. These signals are introduced into the amplifier after the signal level for black has been set by the cut-off action of the amplifier. They are so phased that they occur at the beginning of the blank or black sections. Since all signals generated in the iconoscope pass through the limiting tubes that remove the undesired signals, it is impossible for any picture signal to become of such an amplitude as to interfere with the proper synchronization of the receivers. Furthermore, since the synchronizing impulses

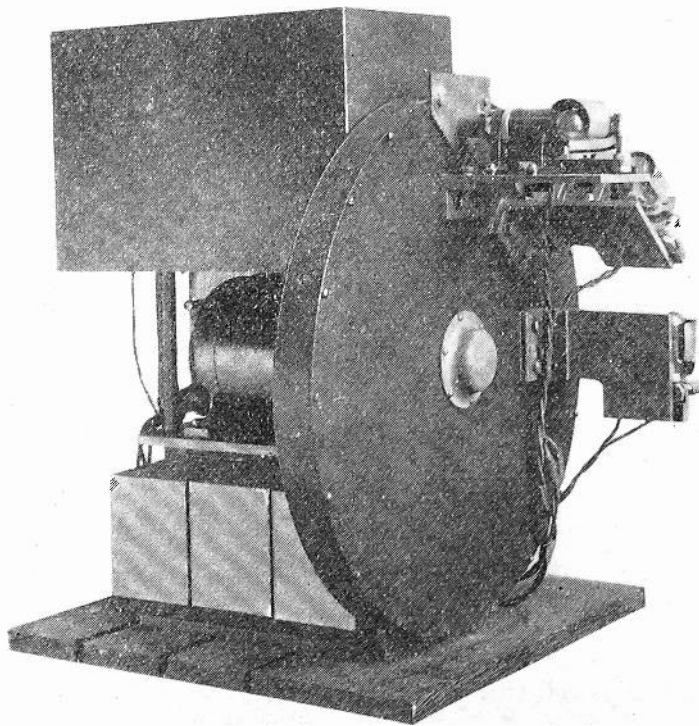

Fig. 8

are superimposed upon the blank sections or "pedestals," the height of the synchronizing impulses will remain constant, thus facilitating the use of amplitude separation of synchronizing signals from the picture signals at the receiver. The appearance of a complete signal as viewed on an oscilloscope is shown in Fig. 9.

The peak signal obtained directly from the iconoscope is approximately 0.001 volt across 10,000 ohms. With this input, an amplifier having a voltage gain of 2000 is sufficient to supply signal at a two-volt level. A typical amplifier stage is shown in Fig. 10. The response of the amplifier at the high frequencies is equalized by placing a small inductance L in series with each plate resistor R . The value of the

inductance for a given circuit may be determined by a very simple rule which gives a flat amplifier characteristic and negligible phase distortion. The plate resistor in an amplifier stage should be equal in ohms to the effective reactance of the tube and distributed capacity

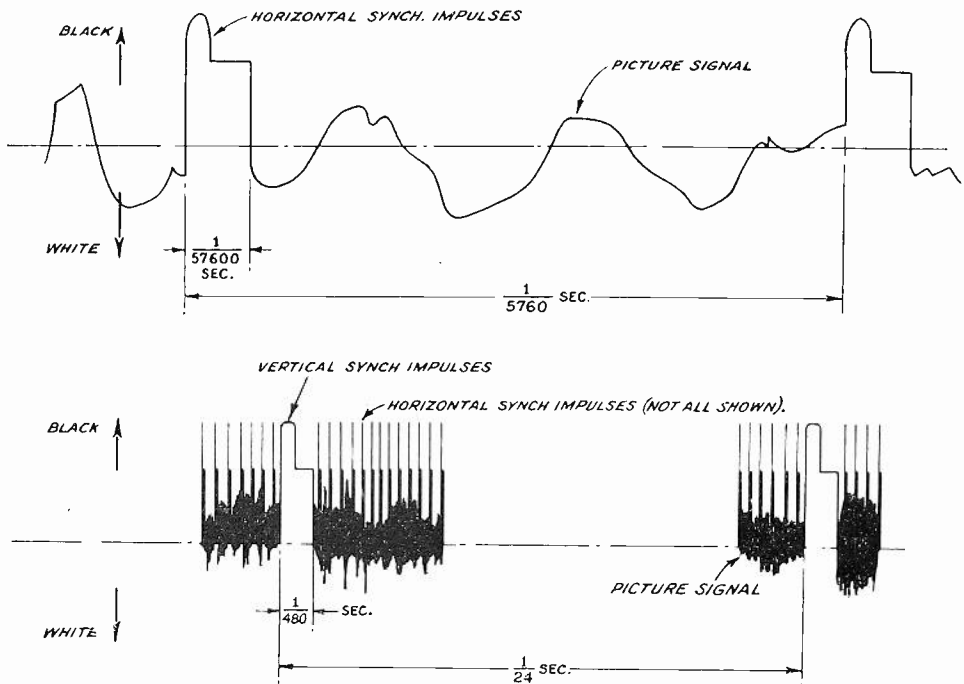

Fig. 9

C_{ef} at the highest frequency which it is desired to pass. The reactance of the inductance in the plate circuit at this frequency should be equal to one half the value of the plate resistor. In order to obtain a flat frequency response at the low frequency end, plate filters are used. Each plate supply is filtered through a resistor R_f by-passed by a con-

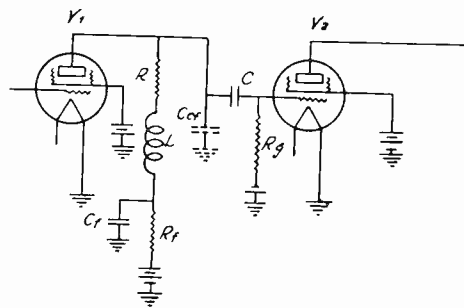

Fig. 10

denser C_f . The circuit constants are so selected that, as the reactance of the coupling condenser between stages rises as the signal frequency is lowered, tending to cause a loss in voltage applied to the grid of the following stage, the reactance of the by-pass condenser on the plate filter rises, increasing the effective plate circuit impedance. This bal-

ance of constants makes possible not only a flat frequency response but a response free from phase distortion at the lowest desired frequency. A frequency response curve of the complete picture amplifier is shown in Fig. 11.

Fig. 12 is a view of the main television signal control room. These racks contain the circuits for amplifying and mixing the picture signals, blanking signals, and synchronizing impulses. They contain the deflecting and control circuits for both studio and motion picture icono-

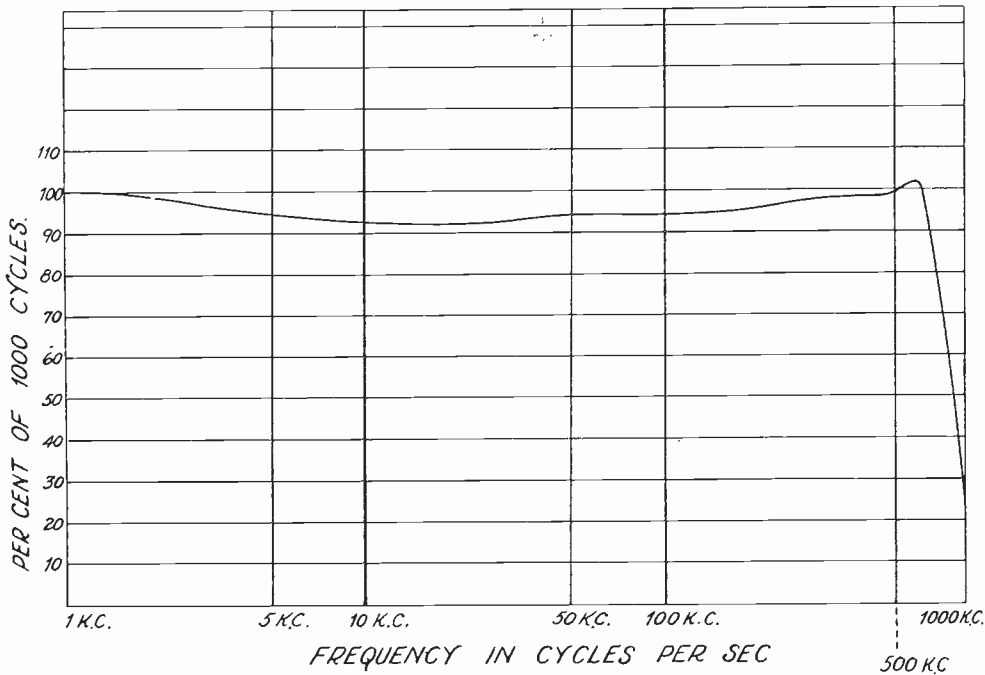

Fig. 11

scope, a monitor for checking the operation of the system, and all switching facilities to change the input to the radio transmitter from studio to motion picture or to the radio receiver used to receive the signals from a remote pick-up point. All sound circuits are also provided in these racks.

The video frequency signal generated in this portion of the system is at a level of approximately two volts across 30 ohms. The low impedance output is such as to match the impedance of a special cable. This cable carries the signal underground from the control room to the radio transmitter, a cable distance of 1500 feet. Fig. 13 shows the frequency response of this cable before and after equalization. In order to make the switching of the output of the video frequency amplifier practicable, it was necessary to prevent the direct current

from flowing through the cable. This requirement made capacity coupling into the cable necessary.

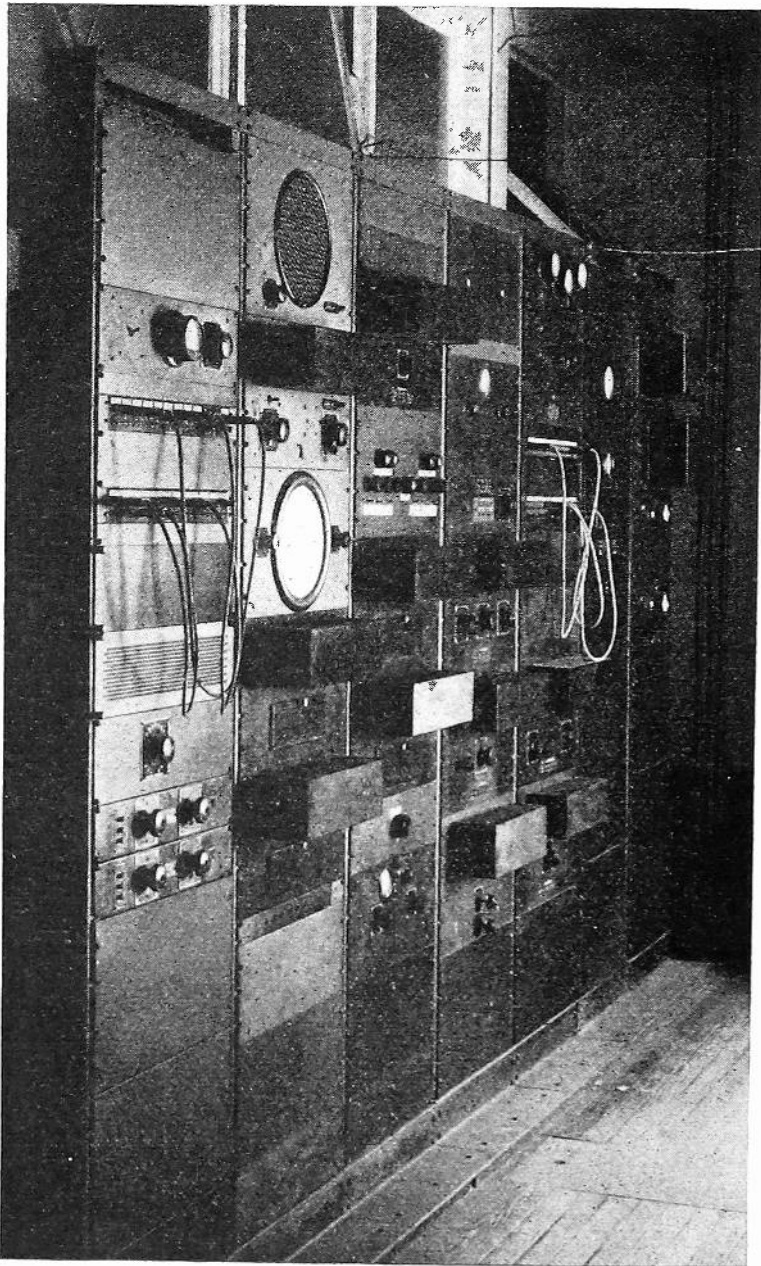

Fig. 12

Since the line impedance and distant termination were only 30 ohms, the problem of coupling into such a low impedance was unusual. The circuit arrangement is shown in Fig. 14. Here again the filter in the plate circuit was made to have such a value that, as the drop across the coupling condenser increases with decreasing frequency, the impedance in the plate circuit also increases, maintaining the

voltage across the cable a constant. Even with this circuit arrangement it was necessary to use coupling and filter condensers of 1000 micro-

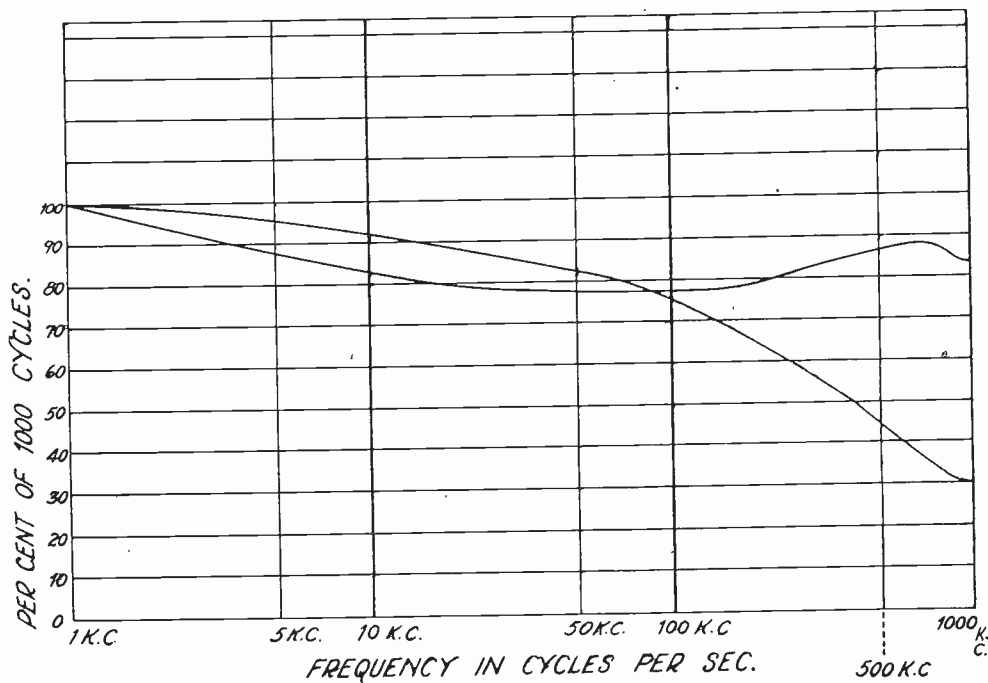

Fig. 13

farads each in order for the phase shift at 24 cycles per second to be unobjectionable.

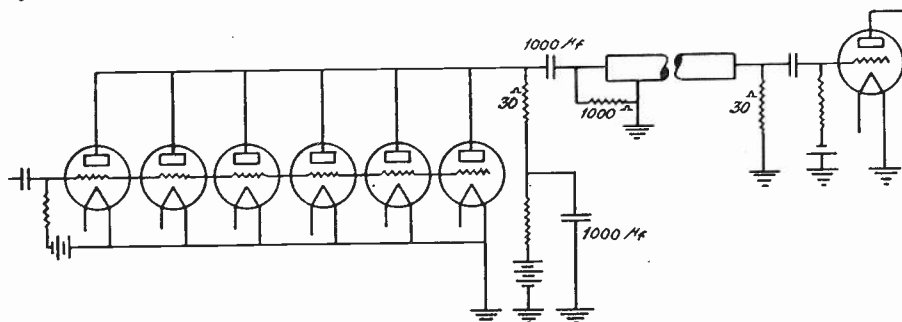

Fig. 14

Both sound and picture radio transmitters were crystal controlled. The spacing between carriers was accurately maintained at 1000 kilocycles. The power amplifier of the sound transmitter consisted of a pair of RCA-831 tubes in push-pull. These were modulated by means of a high fidelity class B amplifier. A carrier power of 600 watts was obtained. The frequency response of this transmitter is shown in Fig. 15.

The picture transmitter contained a pair of RCA-846's in push-pull as the final power amplifier. The modulator was a conventional plate modulator containing a pair of RCA-848's, which had sufficient power to modulate the four-kilowatt carrier. Because of the high input capacity of these tubes, it was necessary to use six RCA-831's in parallel to maintain constant voltage over the required frequency range, on the grids of the RCA-848's. These in turn required three RCA-860's in parallel to maintain constant voltage on their grids. The modulation reactor was designed to maintain a fairly uniform impedance over the entire frequency range.

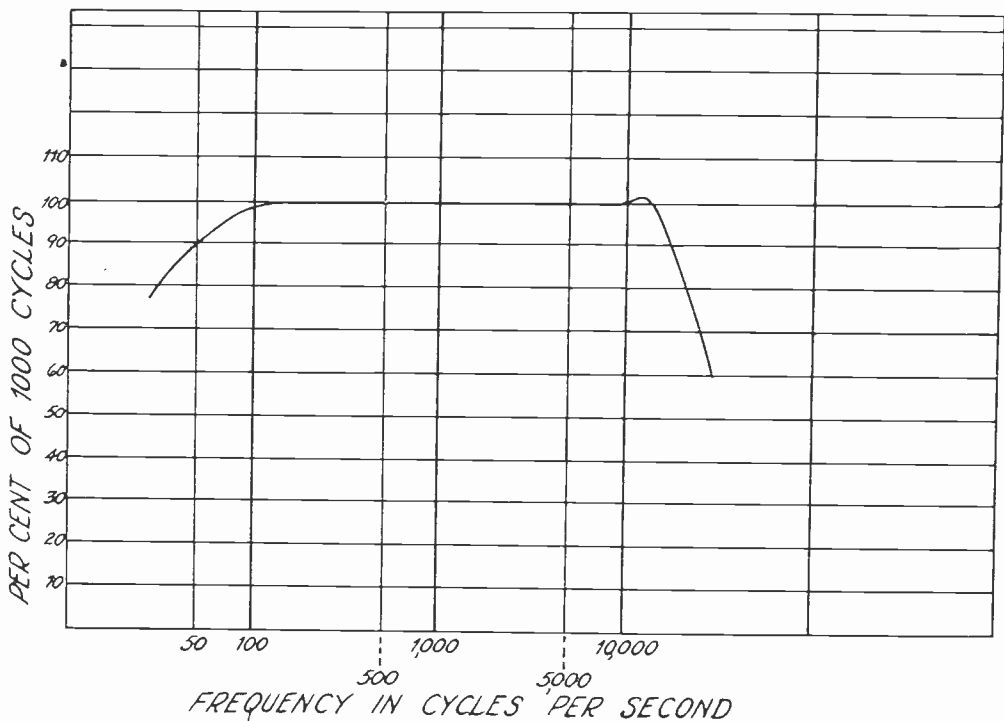

Fig. 15

To secure the greatest possible effective height of the transmitting antennas, a new type of structure was developed. Fig. 16 shows the general arrangement. A hollow steel pole forms the antenna and one side of the transmission line for conveying the signal to the upper end of the pole. The other side of the transmission line is a copper conductor spaced from the pole as shown. Power is supplied to the pole by a balanced transmission line tapped on to the pole and the copper wire a quarter wavelength above the point where the feeder wire is attached to the pole. By standing wave phenomena this arrangement effectively insulates the structure from ground as far as the operating frequency is concerned. The dotted lines indicate the voltage distribution on the system. This arrangement has the advantage of using a metal structure

which may be either guyed or self-supporting, in which the top section only serves as the radiator, while the bottom is effectively grounded for strength and protection against lightning.

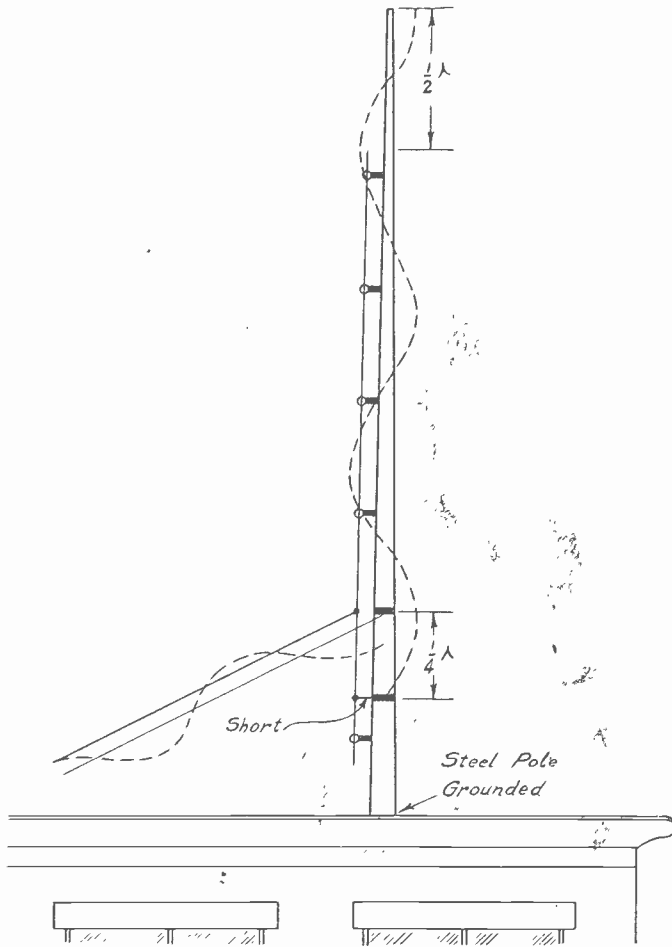

Fig. 16

To demonstrate the possibilities of taking a television camera to a point of interest such as a football game or other news event, and relaying the signals by radio to the central broadcast station for re-

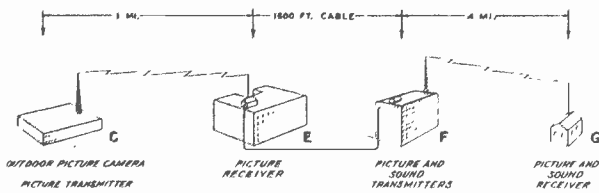

Fig. 17

broadcast, an installation was made at a point approximately one mile from the main laboratory. The elements involved in this relay circuit are shown pictorially in Fig. 17. The camera installation at the

remote pick-up point is represented at *C*. The radio transmitter connects this installation to *E* which is the radio receiver and amplifier for supplying signal to the cable connecting to the main transmitter at *F*. The final receiving station is represented at *G*. At the pick-up point *C* a complete transmitting installation was made. A view of the relay installation is shown in Fig. 18. It consists of a synchronizing impulse generator, three racks of circuits, and a radio transmitter. The first rack is the video frequency amplifier, the second the monitor for checking the operation of the installation, and the third contains

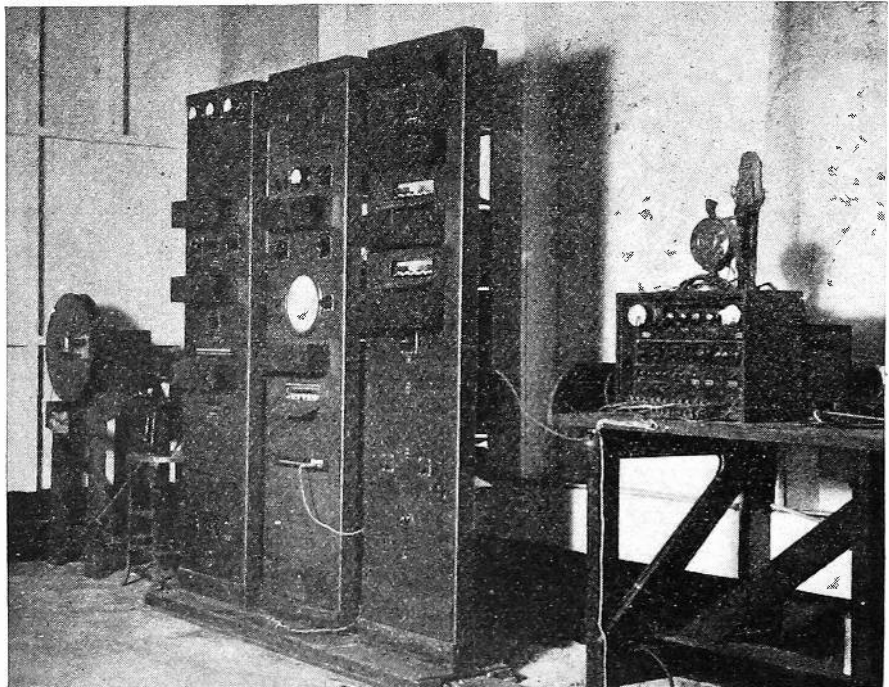

Fig. 18

all the voltage supplies and circuits for the operation of the iconoscope. Fig. 19 is a front view of the thirty-watt crystal controlled transmitter used for transmitting the signal back to the laboratory. Directive V type antennas were used at both the transmitter and receiver of the relay circuit.

Operating the complete installation for a considerable time gave us much valuable and practical information. The installation involved all of the elements of a flexible and practical television system. Sources of program material were studio, motion picture film, relayed pictures from the Empire State Building in New York, and remote pick-up of a street scene located a mile from the main control room. All signals were carried by cable a reasonable distance from the control room to the radio transmitter. Our principal problems were those concerned directly with terminal facilities. The radio transmitter was considered

only as an element necessary in the testing of this equipment. However, as a result of the tests using such a wide band of modulation frequencies, it was found that the service area was definitely limited by

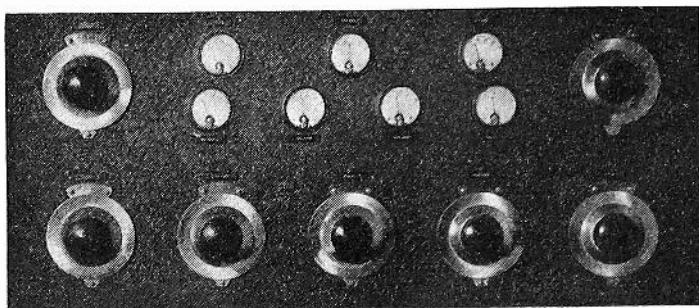

Fig. 19

the low power of the transmitter rather than by the height of the transmitting antenna. The development of a high power ultra-high-frequency transmitter capable of being modulated over a wide band of frequencies is now being carried forward.



Fig. 20

The quality of the transmitted pictures may be judged by Figs. 20, 21, and 22. These are time exposure photographs of the picture on the kinescope in the monitoring rack in the main control room. Figs. 20 and 21 were each taken with stationary frames of moving picture

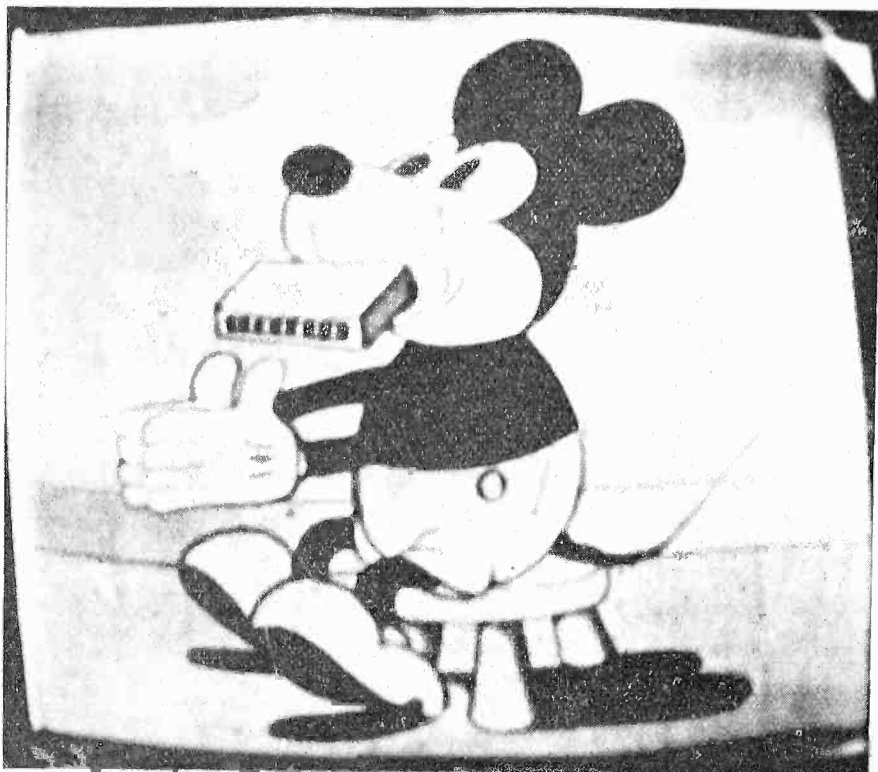

Fig. 21

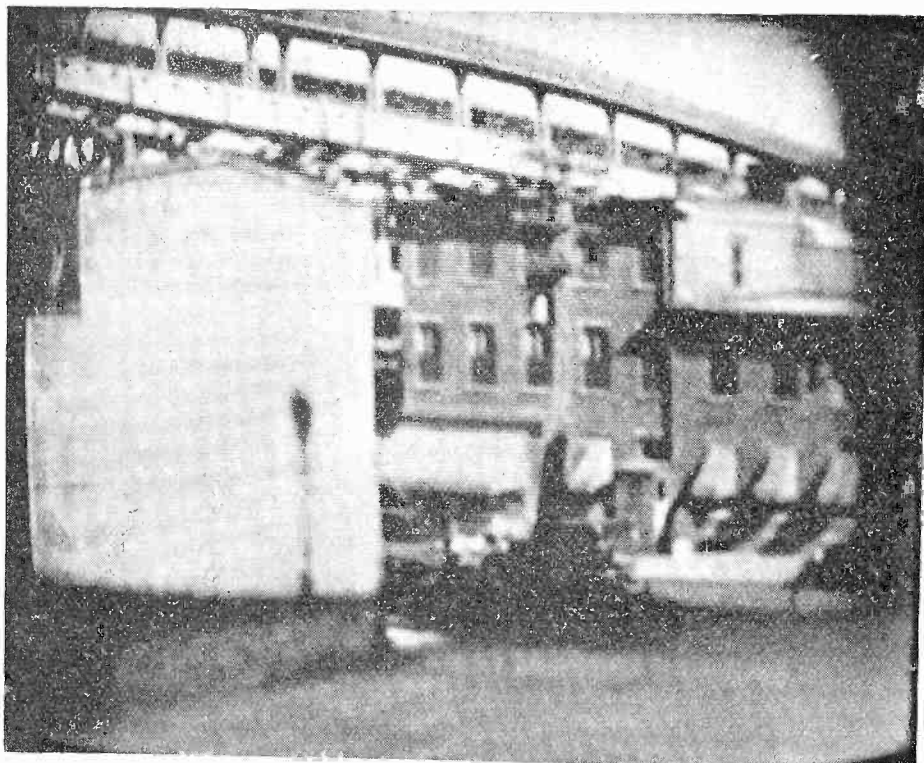

Fig. 22

film projected upon the iconoscope by a standard moving picture machine. Fig. 22 was taken with the studio camera pointed out the window and focused upon an adjacent street corner and buildings. The immediate foreground shows the court between two laboratory buildings and the upper background shows part of the Delaware River bridge.

These pictures do not reveal the well-known gain in apparent transmitted detail that occurs when moving subjects are televised. The line structure may be observed upon close examination, but it is not considered objectionable. Incidentally, the fact that the lines are distinguishable after a time exposure of a half minute is a tribute to the steadiness of the picture and the accuracy of the synchronization of the transmitter and receiver scanning patterns.

ACKNOWLEDGMENT

The authors express appreciation for the assistance of Messrs. J. Evans and J. P. Smith. Mr. Evans was responsible for the design and operation of all radio transmitters used in the tests. He also developed the special transmitting antenna described. Mr. Smith was responsible for the installation and operation of the outside pick-up.



AN EXPERIMENTAL TELEVISION SYSTEM*

BY

R. S. HOLMES, W. L. CARLSON, W. A. TOLSON
(RCA Victor Company, Inc., Camden, N. J.)

Summary—Several television receivers were built and operated as a part of the experimental television system set up in Camden during the early part of 1933. The receiver arrangements, including sound, picture, synchronizing, and deflecting circuits are described together with some of the factors influencing the design. The performance of the receivers is discussed and characteristic curves are given.

PART III—THE RECEIVERS

GENERAL

IN THE experimental television system set up and operated in Camden during the first part of 1933, tests were made to obtain, under practical operating conditions, a measure of the improvements made during the year that had elapsed since the previous tests made in New York City.¹ These advancements were reflected in the receiver design as improvement in performance, simplification of operation, more efficient apparatus arrangement, and the ability to reproduce images of greater detail—240 lines.

The receivers used for the previous tests in New York consisted of two separate superheterodyne receivers, independently tuned. This arrangement was entirely satisfactory for a preliminary experimental set-up, but in looking toward a more practical arrangement it was felt desirable to provide a receiver with only a single tuning adjustment which would control reception of both the sound and picture signals. This can be accomplished by combining the sound and picture transmissions in an orderly manner throughout the television band (40 to 80 megacycles).

One such system would be to transmit both the sound and picture signals on a single carrier by means of double modulation. This could be accomplished in a number of ways, but all are subject to the possibility of serious cross-talk in some portion of the circuit, either in the transmitter or in the receiver, and are inefficient in transmitter power utilization. A further disadvantage is that the transmission channel would be very wide, necessitating very wide band radio- and

* Decimal classification: R583. Original manuscript received by the Institute, June 25, 1934. Presented before Ninth Annual Convention, Philadelphia, Pa., May 29, 1934.

¹ E. W. Engstrom, "An experimental television system," *Proc. I.R.E.*, vol. 21, no. 12, pp. 1652-1654; December, (1933).

intermediate-frequency systems in the receiver, resulting in costly construction and difficulty in tuning.

Another transmission system permitting single dial tuning consists in systematically allocating the sound and picture carriers in the television band. One such allocation system would be to group all the sound carriers at one end of the television band and space the corresponding picture carriers in the same order over the remainder of the band. With this arrangement the tuning condensers of the two receivers could be geared together in the proper ratio and controlled by a single knob. The difficulty with this system is that numerous beats would be generated between the two oscillators and the incoming carriers. The elimination of these extraneous beat frequencies would result in serious complications in the design of receiver equipment.

Another system consists in alternating the sound and picture carriers throughout the television band, with each sound carrier adjacent to its accompanying picture carrier and spaced a fixed frequency away. A television channel then consists of a picture carrier and modulation plus an accompanying sound carrier and modulation. This system was chosen for the Camden set-up. One complete television channel was provided in Camden, with the picture transmitter operating at 49 megacycles and the sound transmitter operating at 50 megacycles.

The receiver had a single radio-frequency tuning system which consisted of two coupled radio-frequency circuits having sufficient band width to accept both carriers and their side bands simultaneously, and a heterodyne oscillator which beat with the two carriers to produce two intermediate frequencies one megacycle apart. The radio-frequency system tuned over the proposed television band of 40 to 80 megacycles. Two first detector tubes supplied the resulting intermediate frequencies to two separate intermediate amplifiers, which were tuned to 6 and 7 megacycles for the sound and picture signals, respectively. Since the sound intermediate amplifier was relatively sharp, it furnished a sharp reference for tuning the receiver, and assured that when the sound was tuned in, the picture signal was also properly tuned. No cross-talk occurred between the sound and picture signals in the receiver since the signal level is low at the first detectors and the intermediate amplifiers are entirely separate.

The system of carrier spacing and the resulting receiver operation can be readily seen by reference to Fig. 1. In the upper part of the figure is shown the television channel with the sound carrier (*S*) and its side bands and the picture carrier (*P*) with its side bands. The probable location of the adjacent channel stations is also illustrated.

In the lower part of the figure are shown the characteristics of the double intermediate amplifiers of the receiver, the sound intermediate selectivity characteristic *A* being relatively sharp, as it is required to pass only a relatively narrow band of frequencies, and the picture intermediate selectivity characteristic *B* being broad to pass a wide band of frequencies. The high-frequency transmissions indicated by the scale in the upper part of the figure have been converted into intermediate frequencies when referred to the receiver characteristics indicated by the companion scale in the lower part of the figure, but the channel frequency separation remains unchanged.

When the receiver is tuned in the normal manner so that the sound carrier *S* in terms of its intermediate frequency is properly tuned with

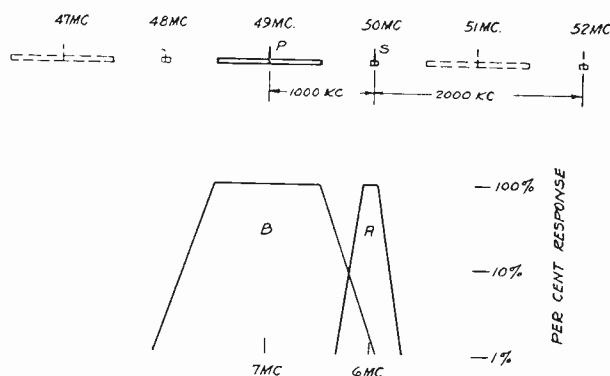

Fig. 1—Channel arrangement and receiver selectivity characteristic.

respect to curve *A*, then the corresponding picture intermediate frequency is also correctly tuned in the center of curve *B*.

A guard band was provided between the edge of the picture selectivity curve and the accompanying sound carrier, and also an additional guard band to the proposed adjacent sound channel on the other side.

ANTENNA

In the majority of locations where receivers were tested, an inside antenna approximately a half wavelength long was found to be satisfactory. In more remote or particularly bad locations, it was necessary to erect an outside antenna and connect it to the receiver by means of a transmission line. This antenna was usually of the Zeppelin type, with a half wavelength exposed. Satisfactory transmission lines were usually of the form of two wires spaced one or two inches apart. Directive antennas were used in some instances, and, as was expected, gave a better signal than nondirective antennas.

RADIO-FREQUENCY CIRCUIT AND OSCILLATOR

The antenna was coupled to the first tuned circuit in the receiver by a small coupling capacitor. This method of coupling gave slightly better results than magnetic coupling between 40 and 80 megacycles, the frequency range of the receiver. The radio-frequency and oscillator system are shown in Fig. 2. From the antenna coupling capacitor, the signal was impressed on the high side of the first radio-frequency circuit. This circuit was coupled by a combination of capacitive, inductive, and conductive coupling to the second tuned circuit to which were connected the grids of the two first detector tubes in parallel. The coupling and loading of the radio-frequency circuits were adjusted so that the band width of the combination was substantially 1.5 mega-

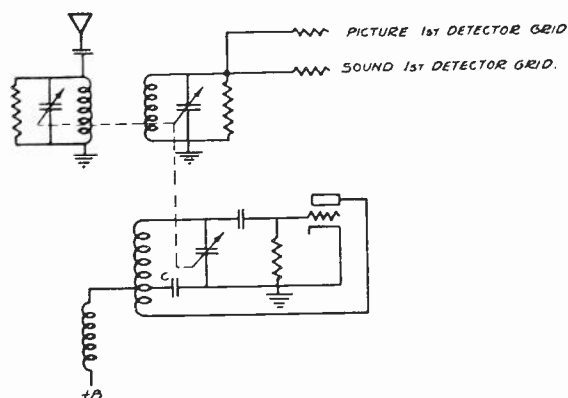

Fig. 2—Radio-frequency and oscillator system.

cycles over the tuning range of 40 to 80 megacycles. The gain from the antenna to the grids of the first detectors remained substantially constant over this band.

An RCA-56 tube was found to be satisfactory over the range when used in the oscillator circuit of Fig. 2. At the high-frequency end of the range the circuit of the oscillator was essentially a straight feedback circuit, on account of the high impedance of the tuning condenser compared to that of the padding capacitor C . As the capacity of the tuning condenser was increased, lowering the frequency, the ratio of these impedances decreased, thus effectively increasing the feedback in the oscillator and maintaining a substantially uniform oscillation. The padding capacitor C also performed the usual function of properly aligning the oscillator and radio-frequency circuits over the 40- to 80-megacycle band. The oscillator operated at a higher frequency than the incoming carriers and heterodyned them to 6 and 7 megacycles. A combination of capacitive, inductive, and conductive coupling between the oscillator and first detector circuit maintained a substantially

uniform oscillator voltage on the first detector grids. The oscillator and the two radio-frequency circuits were all tuned by the variable gang condenser.

SOUND CHANNEL

A schematic diagram of the sound channel is shown in Fig. 3. The sound intermediate-frequency amplifier consisted of a first detector and three intermediate-frequency stages tuned to 6 megacycles, having an over-all gain from first to second detector grids of approximately 10,000 with a band width of 130 kilocycles at 90 per cent of the peak amplitude. It was sufficiently wide to allow for oscillator drift

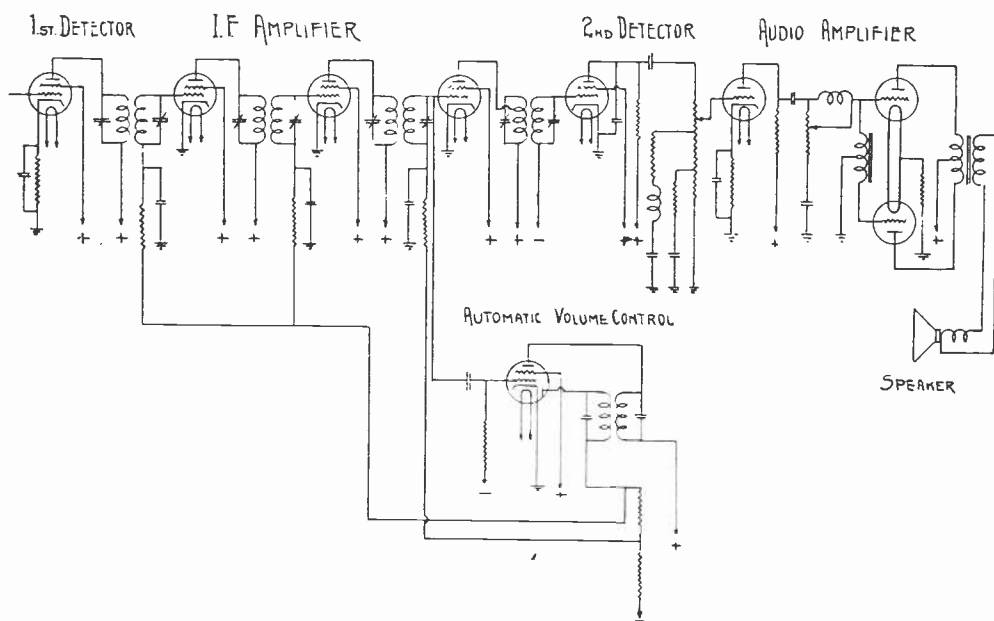

Fig. 3—Receiver sound channel.

and permit easy tuning of the receiver. Extensive filtering was provided in the supply leads to the intermediate-frequency stages to prevent regeneration. An automatic volume control stage was incorporated in parallel with the last intermediate-frequency stage and controlled the bias on all three intermediate-frequency tubes, with full control on the first two and partial control on the last one. In this manner, the signal on the grid of the second detector was maintained substantially constant for signals in excess of about 100 microvolts impressed on the antenna post.

With the wide spacing between carriers chosen for these tests, there was no serious problem of cross-talk or "monkey chatter" from the side bands of the picture transmitter such as is encountered in wide band broadcast receivers. The proposed spacing between adjacent television channels should also prevent any interference from

this source. With the intermediate-frequency band width of 130 kilocycles, no side band cutting occurred in the intermediate-frequency system. Therefore, conditions were ideal for providing excellent high fidelity sound reception. Following the screen-grid second detector was a tone-compensated volume control. An audio amplifier with a band-pass tone control supplied the audio signal to push-pull 45's in the output stage. The loud speaker was a special high fidelity unit having good response to 8 kilocycles.

PICTURE CHANNEL

The schematic circuit of the picture channel is shown in Fig. 4. The picture intermediate-frequency amplifier consisted of five stages

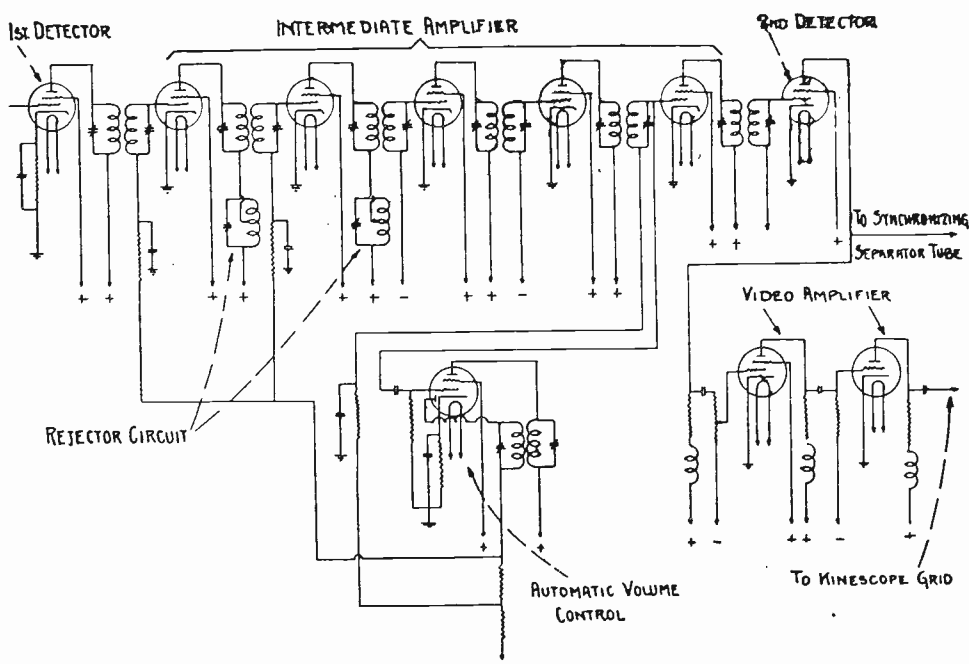

Fig. 4—Receiver picture channel.

tuned to 7 megacycles, having an over-all gain of approximately 10,000 and a band width of 1200 kilocycles at 90 per cent of maximum amplitude. This characteristic is shown in Fig. 5. (This figure also shows the sound intermediate-frequency characteristic.) The number of intermediate-frequency stages chosen for the picture intermediate amplifier was determined by the intermediate-frequency gain and band width required, and was not determined on the basis of required selectivity. The six band-pass transformers in the amplifier did not of themselves furnish sufficient selectivity to prevent cross-talk from the sound signals into the picture channel. In order to increase the attenua-

tion, rejector circuits tuned to the sound frequency were coupled to the second and third picture intermediate transformers. The net attenuation at 6 megacycles compared to 7 megacycles was about 50, which, combined with the cut-off of the video amplifier, effectively eliminated any interference on the picture due to the sound signal. The wide band-pass characteristic in the picture intermediate-fre-

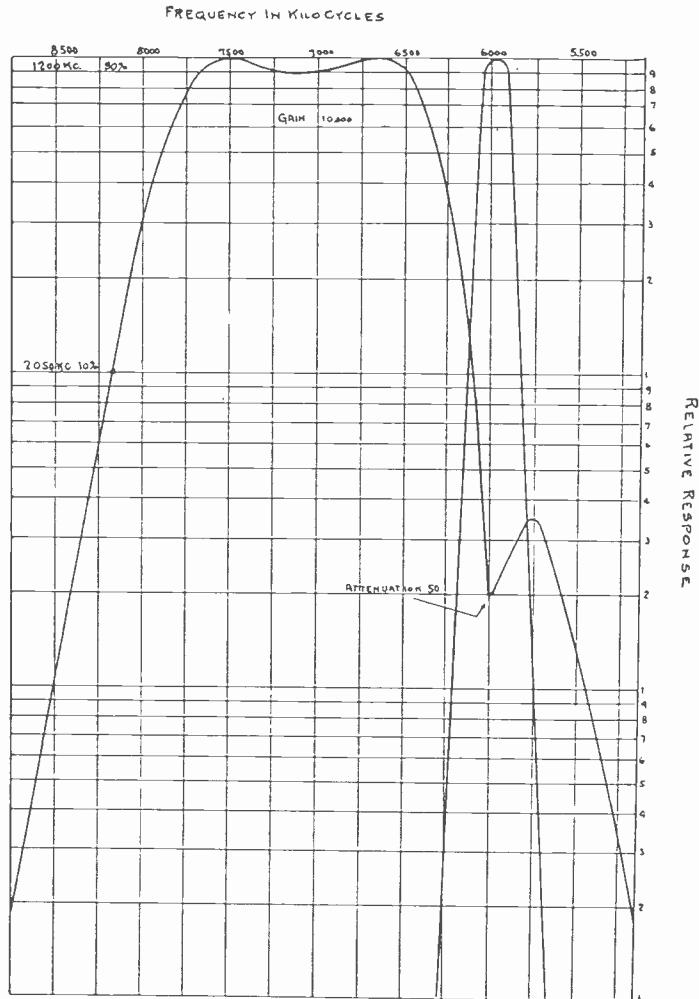

Fig. 5—Sound and picture intermediate-frequency characteristics.

quency stages was obtained by winding the transformers with resistance wire and adjusting the coupling between the primary and secondary windings to give a flat-topped response. Extensive filtering was provided in the supply leads to prevent any possible regeneration due to common coupling through the supply circuits.

An automatic volume control stage in parallel with the last intermediate-frequency stage controlled the bias on the first two and last intermediate-frequency tubes to maintain the signal on the second

detector grid constant when the signal on the antenna post of the receiver exceeded approximately 100 microvolts.

Following the second detector, the video signal was applied to the video amplifier, whose frequency characteristic is shown in Fig. 6, and to the synchronizing separating circuit. The output of the video amplifier was applied to the grid of the kinescope.

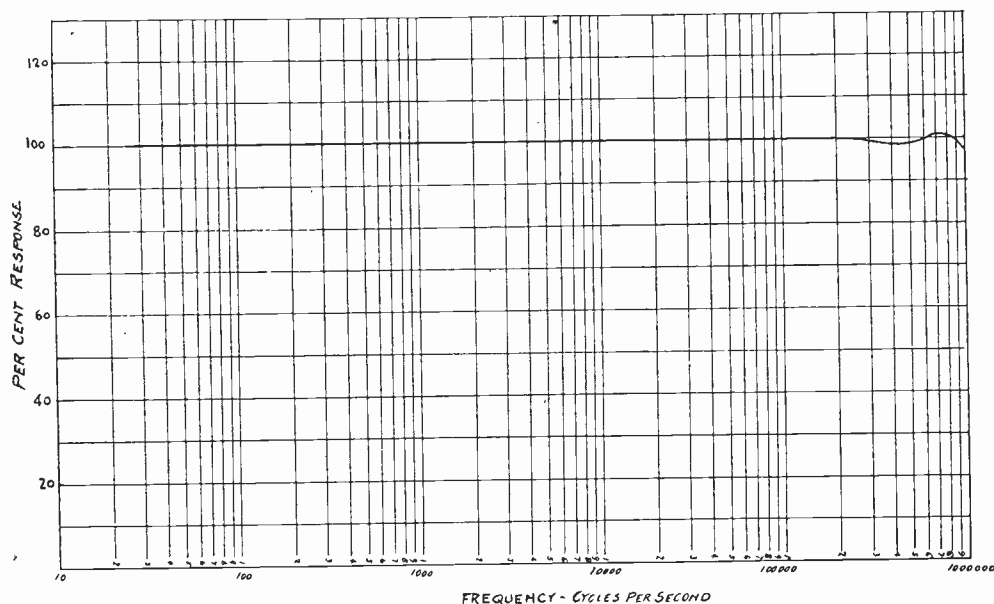

Fig. 6—Receiver video amplifier characteristics.

SYNCHRONIZATION

In order to reproduce the picture represented by the received signals, it is necessary that the scanning point on the mosaic of the iconoscope and the scanning point on the kinescope be maintained in synchronism. A random variation of synchronization at the receiver, corresponding to the linear equivalent of one picture element, will result in a loss of 50 per cent of the normal resolving power. This made it imperative that the synchronizing signals be separated in such a manner that integration would not seriously distort the wave fronts of the synchronizing signals. If it is assumed that such distortion shall be less than one-half picture element, the variation in timing of adjacent synchronizing signals, due to integration of video or extraneous signals, must be less than 0.5 microsecond for horizontal synchronizing signals and 800 microseconds for vertical synchronizing signals, approximately. It was found that with the signal-separating methods employed in these receivers, such a condition was obtainable under normal operating conditions.

Fig. 7 shows a section of the received signal voltage wave taken over a period of time equivalent to that of four scanning lines. The section is taken at the bottom of the picture in order to include the vertical synchronizing impulse. It should be noted that the horizontal

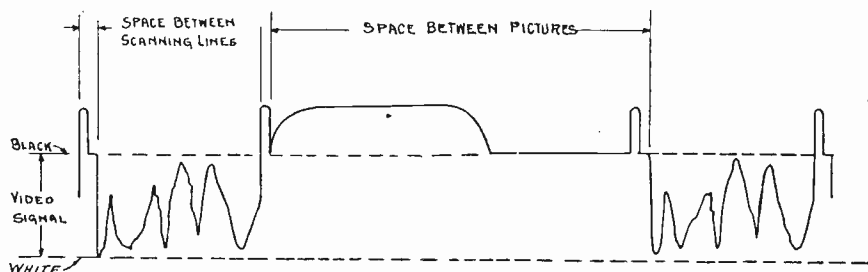

Fig. 7—Composite signal as received.

synchronizing impulses are superimposed upon the “black” signal between scanning lines, and the vertical impulse is superimposed upon the “black” signal between pictures. The fact that the video signal cannot go beyond the “black” amplitude assures that the video signals

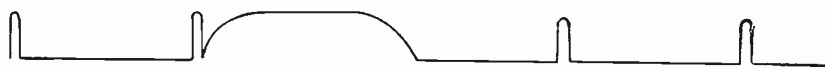

Fig. 8—Received signal after removal of video component.

will not interfere with the synchronizing action. The circuit and operating characteristics of the arrangement used for removing the video component from the incoming signal are shown in Figs. 9 and 10, respectively. Referring to Fig. 9, it should be noted that the bias battery potential is such as to make the grid of the tube positive with

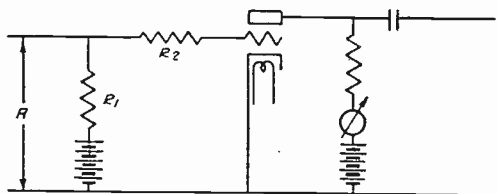

Fig. 9—Circuit for removal of video component from composite signal.

respect to its cathode. The positive potential of the grid is limited by the presence of R_2 in series with this circuit. R_2 is made very large with respect to the grid-cathode resistance for positive values of grid potentials. Thus, for all values of positive potential applied at A , substantially all the voltage appears across R_2 rather than across the grid-cathode circuit. For all values of negative potential at A in excess of the positive bias potential, the grid is negative with respect to its cathode, and the resistance is very high compared with R_2 ; thus the effect of the series resistance is negligible. The net effect of

such a response characteristic is shown by comparison of Fig. 7 with Fig. 8, which shows the signal after the video component has been removed.

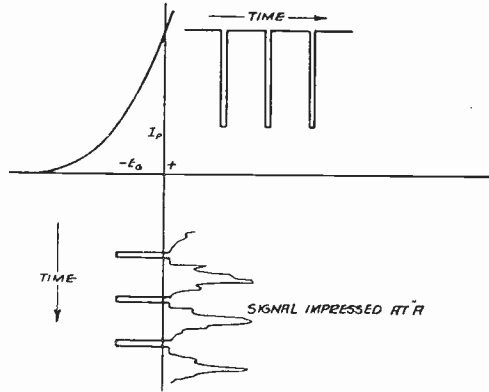

Fig. 10—Operating characteristic of circuit for removal of video component from composite signal.

Due to the wide divergence between the time constants of the horizontal and vertical synchronizing signals, either may be removed

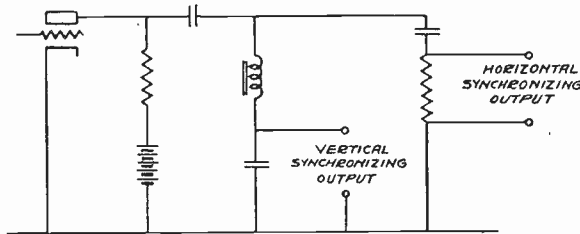

Fig. 11—Circuit for separation of vertical and horizontal synchronizing signals from the composite synchronizing signal by means of very simple frequency selective circuits. Figs. 11 and 12 show the circuit and char-

A - RESPONSE OF VERTICAL SYNCHRONIZING OUTPUT CIRCUIT.
B - RESPONSE OF HORIZONTAL SYNCHRONIZING OUTPUT CIRCUIT

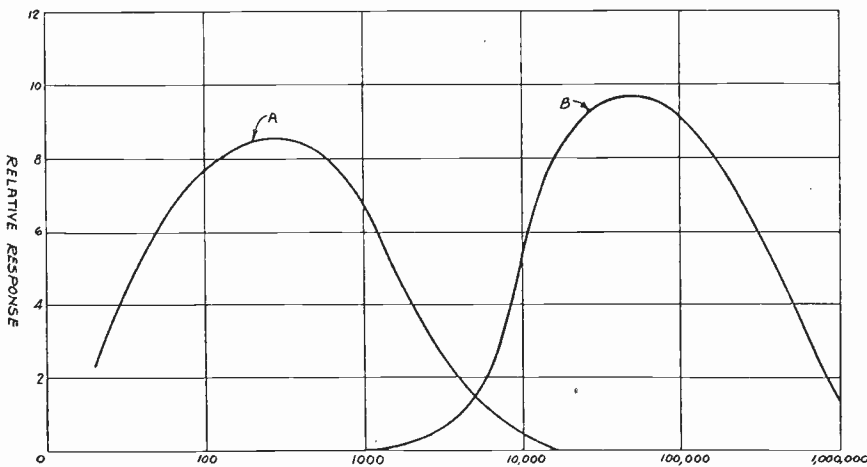

Fig. 12—Response characteristics of circuit shown in Fig. 11.

acteristics of the arrangement utilized for separating the horizontal and vertical synchronizing signals and confining them to their respec-

tive channels, while Fig. 13 shows the horizontal and vertical signals after separation. The horizontal and vertical synchronizing signals were then applied, respectively, to the horizontal and vertical deflection oscillators.



Fig. 13—Synchronizing signals after passing through separating circuit.

DEFLECTING CIRCUITS

General

The oscillator used for producing a voltage of saw-tooth wave form must, in general, meet three fairly definite requirements. It must produce an output having a sharply peaked wave form. For horizontal deflection the ratio of the duration of the peak to the time for a complete cycle should not be greater than 1:15. For vertical deflection this ratio should not be greater than 1:80. As an alternative to this

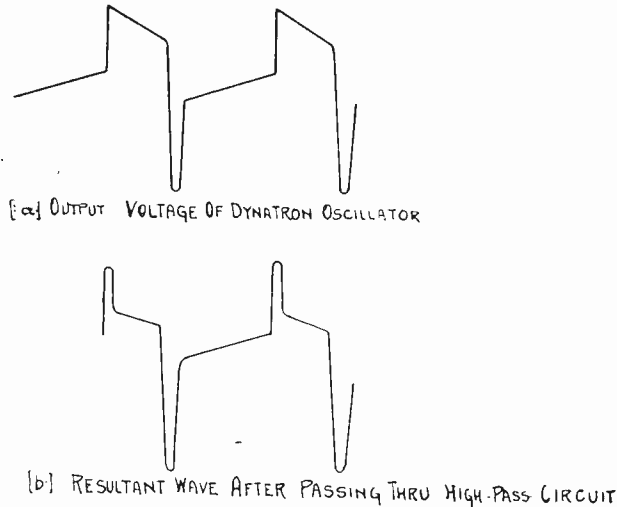

Fig. 14—Voltage wave shapes obtainable with dynatron oscillator.

requirement, the oscillator may produce an output having a wave front sufficiently steep so that impulses having the required characteristic can be secured through the use of high-pass circuits. Fig. 14 shows the output voltage wave of a special dynatron circuit, together with the wave shape resulting from the use of a high-pass coupling circuit to the next tube. The second requirement of an oscillator for deflection purposes is that it must be capable of synchronization over the range of free-oscillating frequencies covered by the "drift" of the oscillator

under operating conditions. The third requirement for a deflection oscillator is that the drift of the free-oscillating frequency shall be small. The reason for this requirement is apparent, since it minimizes the difficulties encountered in synchronization. An oscillator known

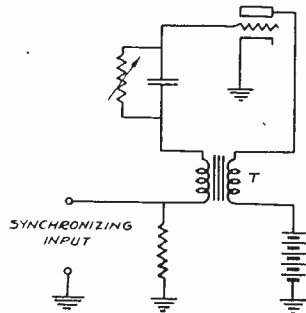

Fig. 15—The blocking oscillator.

as a blocking oscillator was chosen as most satisfactorily meeting all the above requirements.

The blocking oscillator is similar in circuit to, but having constants differing from, a conventional inductively coupled sine wave oscillator. A typical circuit is shown in Fig. 15. The coupling, damping, grid

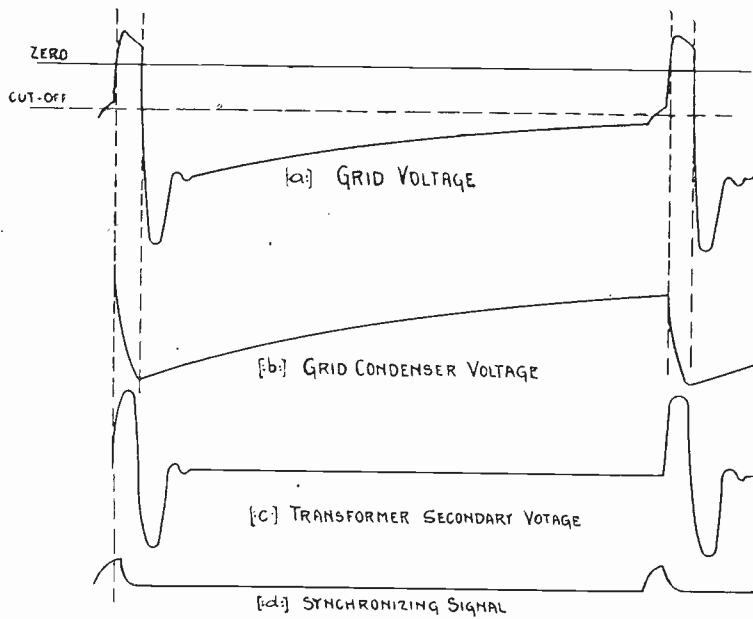

Fig. 16—Blocking oscillator circuit voltage.

condenser, and grid leak are so proportioned that the grid current drawn during the positive portion of the grid voltage wave is sufficient to built up a negative voltage across the grid condenser greater than the value required for plate current cut-off. This action is shown by the graphs of grid-circuit potentials shown in Fig. 16. At the conclusion

of one cycle of oscillation at the natural period of the transformer T , the circuit is maintained in an inoperative condition, by virtue of the high negative grid bias, until the charge on the grid condenser is dissipated by the grid leak to the point where the grid potential is just sufficient to allow plate current to flow. At this point the above cycle of operation repeats itself. The next cycle may be initiated at any time before this point is reached, by applying to the grid a positive impulse of sufficient amplitude to cause plate current to flow. This function is normally performed by the synchronizing impulse, as shown by (d) of Fig. 16.

VERTICAL DEFLECTING CIRCUIT

The choice between the use of magnetic and static fields for deflection of the cathode ray beam in the vertical direction is made relatively simple by virtue of the fact that the fundamental frequency is very low (24 per second), thus presenting a minimum of difficulty in passing a current of saw-tooth wave form through a comparatively large inductance. The fact that a highly inductive deflecting coil may be employed permits the use of a low voltage, low current output tube, whereas the voltage requirements for static deflection are not reduced by the low operating frequency. For static deflection, the impedance and phase-shift requirements considerably complicate the design of a suitable output transformer and make necessary the use of a low impedance output tube. A consideration of the foregoing indicated the use of magnetic deflection in the vertical direction as being best suited to the purposes of the tests to be made.

Fig. 17 shows the voltage wave shape required to produce a saw-tooth wave form of current through a pure resistance, a pure inductance, and a circuit containing both resistance and inductance. Such a required voltage wave may be produced in a very simple circuit, as shown by Fig. 18. Condenser C is charged in series with resistor r at a substantially constant rate through resistor R . The periodic positive impulses from the blocking oscillator are applied to the grid circuit of the discharge tube, the plate circuit of which is connected across the charging source and resistor R . The discharge tube thus periodically discharges C by a definite amount. The voltage wave across C is saw-tooth in shape, while that across r is a pure impulse. It is evident that by properly proportioning C and r , it is possible to produce a voltage wave shape having the required amount of saw-tooth and impulse components to force a saw-tooth of current through any given combination of output tube and deflecting coils.

The design of a suitable structure for the application of a mag-

netic deflecting field to a cathode ray tube is influenced by several considerations. Assuming that a linear saw-tooth wave form of flux is produced normal to the axis of the cathode ray beam, a linear saw-tooth deflection of the beam will result only if the flux field is of constant density throughout the range of movement of the beam. A second effect of nonuniform flux distribution is defocusing due to the

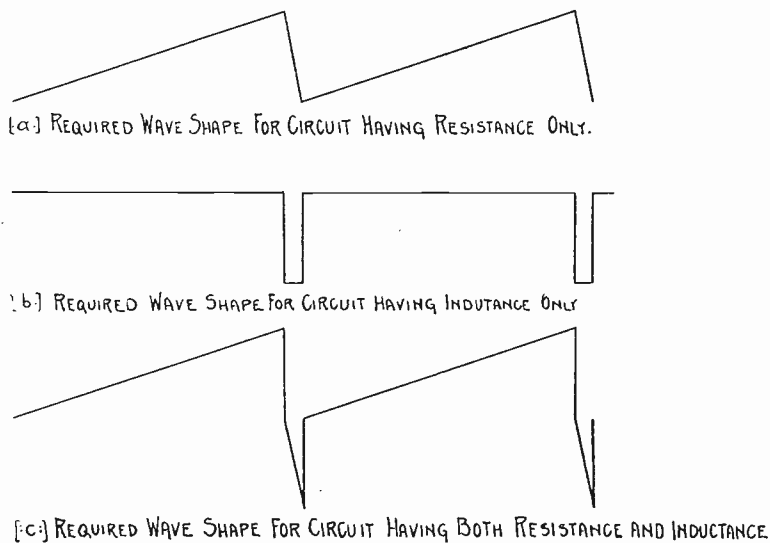

Fig. 17—Wave shape required to force a saw-tooth current wave through resistive and inductive circuits.

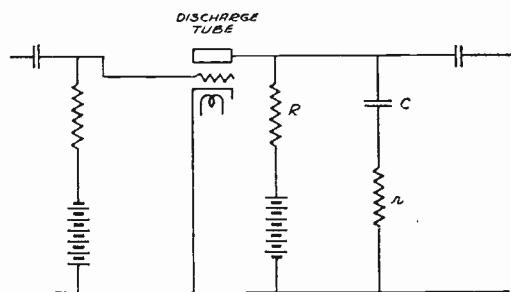

Fig. 18—Circuit for producing a composite wave having saw-tooth and impulse components.

finite size of the beam at the point of deflection. It is obvious that a nonuniform distribution of flux will produce deflection of the electrons by an amount depending upon the flux density at each point in the cross section of the beam, thus resulting in a partial destruction of the focus on the fluorescent screen. Components of the deflecting flux which act along the path of the beam in a direction parallel to the motion of the electrons also produce defocusing, since such components constitute a focusing field varying in accordance with the instantaneous density of the deflecting field. Such considerations imposed limitations

on the design of the magnetic deflecting structure and resulted in the adoption of a form which differs markedly from one based entirely upon considerations of magnetic efficiency alone. The magnetic yoke employed in the receiver is shown by Fig. 19.

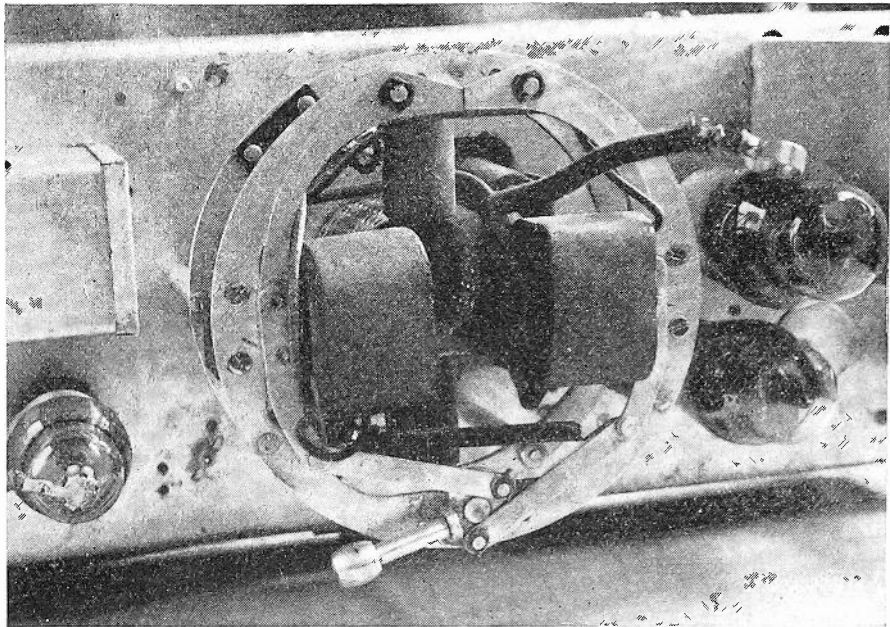

Fig. 19

HORIZONTAL DEFLECTING CIRCUIT

The choice between magnetic and static fields for horizontal (5760 cycles) deflection is somewhat more involved than in the case of vertical deflection. In the case of magnetic deflection, the voltage across the deflecting coils involved in producing a saw-tooth current wave increases directly as the scanning frequency. For frequencies of the order of 6000 cycles the required voltage peaks are so high as to be destructive unless the circuit design is such as to minimize the voltage requirements. The voltage may be reduced by reducing the inductance of the deflecting coils, with a corresponding increase in the current requirements. The current limits are set by the output tube used. A secondary problem is presented by the interaction between the fluxes in the vertical and horizontal deflecting yokes. The most serious results of such interaction are distortion of the scanning field and defocusing of the scanning spot. In the case of static deflection, the voltage requirements are not affected by the scanning frequency, but the required frequency band to be passed by the output transformer increases directly as the scanning frequency. From an economic standpoint there are factors favoring either system, but from the standpoint

of sharpness of focus and minimum distortion of the scanning pattern, better results were obtained with static deflection in the horizontal direction. The design of the output transformer for application of deflection potential to the static deflecting plates is limited by several considerations. Chief among these are the alternating-current potential required across the deflecting plates of the kinescope, the voltage available on the plate of the output tube, and the required frequency vs. response and frequency vs. phase characteristics. Fig. 20 shows the response and phase characteristics of the horizontal deflecting circuit which produced a deflection having a maximum variation in scanning velocity of 5 per cent and a scanning to return ratio of 13:1.

The oscillator and discharge tube circuits were diagrammatically the same for the horizontal and vertical deflecting circuits. The circuit

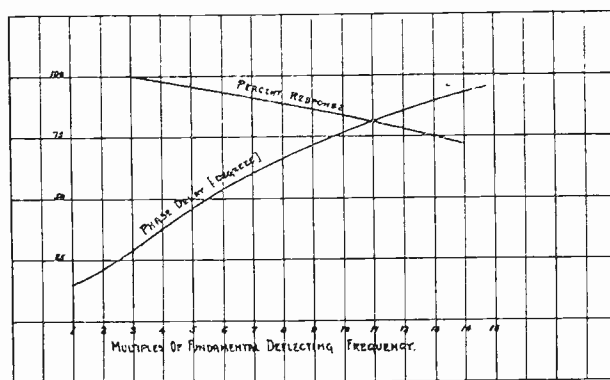

Fig. 20—Response and phase delay characteristics of horizontal deflecting circuit.

constants were, of course, proportioned to the widely different frequencies at which they operated. The complete deflecting arrangement is shown schematically by Fig. 21.

The exact position of the scanning pattern on the end of the kinescope is affected to a minor extent by the mechanical line-up of the electron gun, by a permanent magnetization of deflecting structures or other magnetic materials near by, and by the magnetic field of the earth. In order to insure the exact location of the scanning pattern in the viewing aperture, means were provided for adjusting the position of the scanning pattern in both the vertical and horizontal directions. For centering in the vertical plane a bridge arrangement was used whereby a small amount of direct current could be passed through the vertical deflecting coils in either direction. For centering in the horizontal plane an arrangement similar to that employed for vertical centering was used, except that it was entirely independent of the horizontal deflecting circuit. Both arrangements are shown in Fig. 21.

RECEIVER CONTROLS

On account of the system used for transmission of sound and picture on carriers spaced one megacycle apart and the double intermediate amplifier in the receiver, only a single tuning control was necessary, so that tuning the receiver was no more difficult than tuning a standard broadcast receiver. The major controls located on the front of the cabinet were tuning, sound volume, sound tone, picture brightness, and picture contrast. These were the controls it might be necessary to adjust when tuning from one station to another. Another group

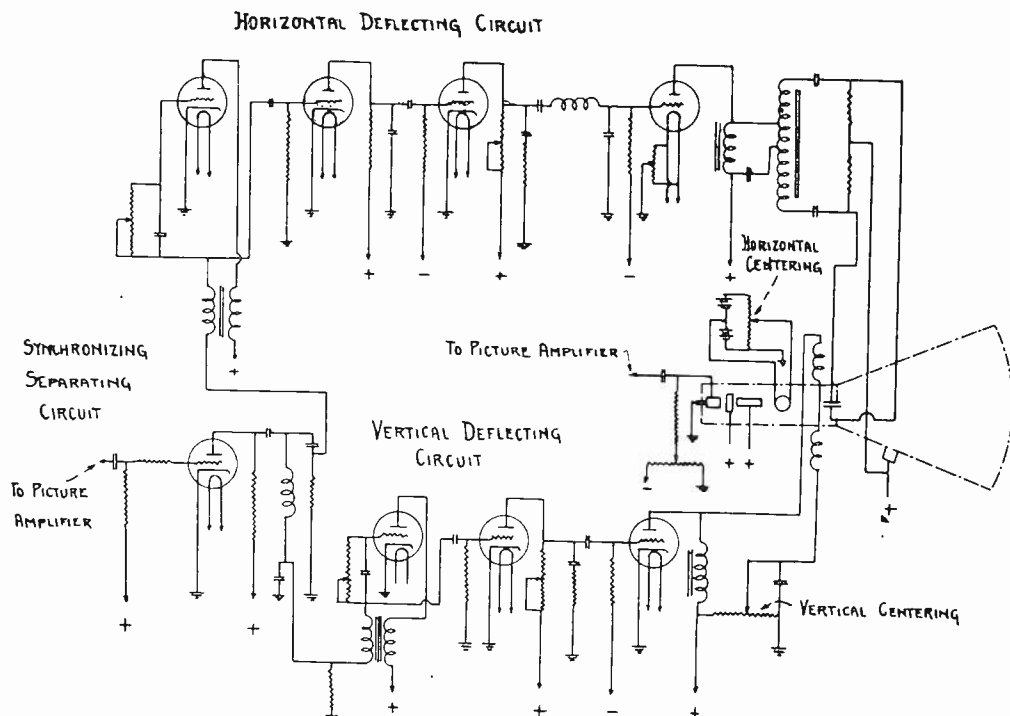

Fig. 21—Schematic arrangement of kinescope deflecting circuit.

of controls which required less frequent adjustment were arranged under the lid of the cabinet. These were focus, deflecting oscillator frequency controls, and scanning pattern size and centering. Screw driver adjustments were provided inside the receiver for scanning pattern distribution and kinescope screen-grid voltage. These adjustments needed to be changed only when the receiver was set up for operation.

GENERAL ARRANGEMENT OF THE RECEIVER

The general arrangement of the receiver is shown on Figs. 22 and 23. The parts were assembled on three units. All the radio-frequency and intermediate-frequency circuits and the video and audio amplifier were mounted on the receiver chassis, Fig. 24 and 25. The tuning capacitor was in the center, with the sound channel on one side and the



Fig. 22



Fig. 23

picture channel on the other. The deflecting circuits were on another chassis mounted below the receiver chassis. The kinescope was mounted from this chassis inside a steel shield extending up through the receiver chassis. The picture was viewed by means of a mirror mounted in the adjustable lid of the cabinet. The power supply unit was mounted in the bottom of the cabinet. The rectifiers on this unit supplied 250 volts to the receiver and kinescope chassis and first and second anode supply to the kinescope. The second anode voltage on the kinescope was 4600 volts, and the spot was focused by means of the adjustable first anode supply.

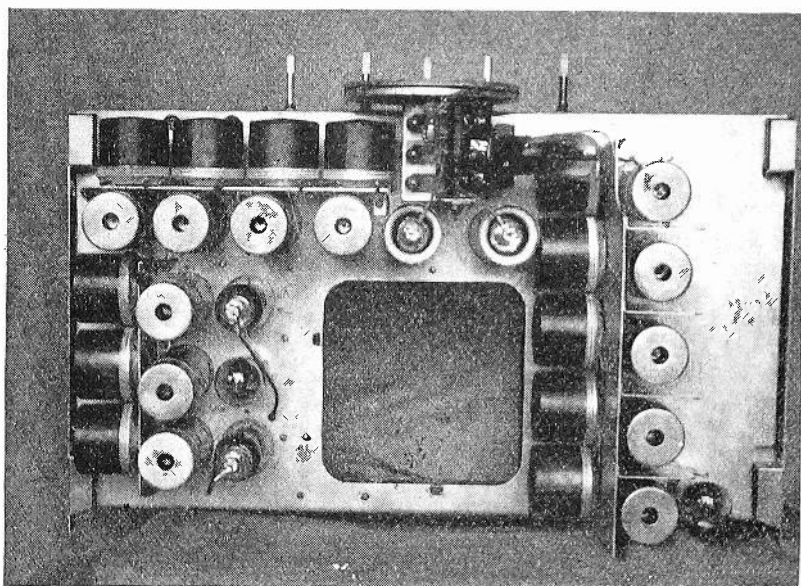

Fig. 24

OBSERVATIONS ON THE PERFORMANCE OF THE RECEIVERS

No evidence of natural fading of signals in the frequency band of 40 to 80 megacycles was noted, but considerable variation in the signal applied to the receiver was encountered in most locations. These variations were usually attributed to changes in the pick-up system, such as swinging antenna or transmission line or movement of conductors in their vicinity. These fluctuations were entirely overcome by the automatic volume controls in the receiver, even on windy days when the outside antenna was swinging considerably, or when people walked near an inside antenna and changed the standing wave patterns.

The sensitivity of the receivers was approximately 100 microvolts for both the sound and picture channels. However, a signal of 100 microvolts did not provide satisfactory operation of the picture channel, on account of the presence of random electrical variations usually referred to as "hiss" being present. This "hiss" disturbance limited

the minimum satisfactory signal to about 1000 microvolts. The sound side gave a satisfactory signal on less than 1000 microvolts. The amount of "hiss" or other interference that can be tolerated in the picture signal is greater than would be expected compared to that of the sound signal, when considered on the basis of their respective band widths. This was also noted on previous tests of a television system by Beers.² The most serious source of external interference was the ignition systems of airplanes. Interference was also created by automobiles driven within a hundred feet or so of the receiving antenna. These interferences were less troublesome than would be expected on the picture as compared to the sound, considering the great difference in band width.

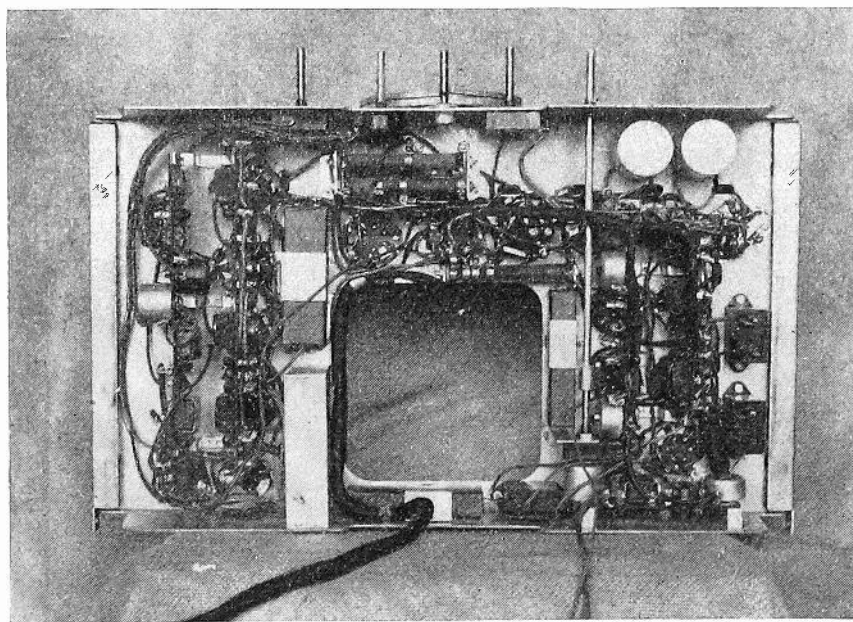

Fig. 25

In general the results of the tests were gratifying. Even when the program material originated in New York City and was relayed twice, interference and other difficulties were not serious. In all the tests the performance of the apparatus was up to expectations, and the reproduced picture and sound were satisfactory and had entertainment value.

ACKNOWLEDGMENT

The authors acknowledge the assistance of Messrs. H. C. Allen, C. D. Kentner, W. J. Poch, A. H. Turner, and M. Flaherty in the development and design of the circuits and receivers for this experimental television system.

² G. L. Beers, "Description of experimental television receivers," *PROC. I.R.E.*, vol. 21, no. 12, pp. 1692-1706; December, (1933).

AN EXPERIMENTAL TELEVISION SYSTEM*

BY

CHARLES J. YOUNG

(RCA Victor Company, Inc., Camden, N. J.)

Summary—A radio relay circuit is described for carrying 120-line television programs from a studio in New York to a broadcast station in Camden, New Jersey. Details of the actual relay station used are given as well as the characteristics of directive antennas especially designed for this service. The completed system satisfactorily relayed television pictures over this 86-mile distance.

The project was carried out jointly by the following companies: RCA Communications, Inc., RCA Victor Company, Inc., National Broadcasting Company, Inc., General Electric Company, Inc., and the Westinghouse Electric and Manufacturing Company.

PART IV—THE RADIO RELAY LINK FOR TELEVISION SIGNALS

IN THE early part of 1933 an experimental television system was placed in operation in Camden. As a part of this system it was felt very desirable that engineering information be obtained bearing on the problem of networking television stations.

The history of sound broadcasting has shown the importance of such interconnection. With television it is likely, for economic reasons, that a networked system may prove to be even more essential. At the same time the technical difficulties are multiplied enormously with the increase in channel width required, from a frequency band of 7000 cycles for good sound to a band of over 200 kilocycles for a 120-line television picture.

There are several possible methods of distributing television programs. In this country, and in Europe, it has been proposed to syndicate television programs by airplane delivery of movie film, but this is not attractive for many reasons. The two important possibilities remaining are a special wide channel wire line with the necessary repeaters, or a radio system with relaying stations. The latter was chosen for this project.

The starting point of the relay channel was the 44-megacycle transmitter on the Empire State Building in New York City. The object was to relay the television signals radiated from there to Camden where they might be rebroadcast. The video frequency band which had to be transmitted was determined as 210 kilocycles for the 120-line picture,

* Decimal classification: R583. Original manuscript received by the Institute, June 25, 1934. Presented before Ninth Annual Convention, Philadelphia, Pa., May 29, 1934.

and the length of the circuit was 86 miles air line. Preliminary study of profile maps showed that while two intermediate relay stations might be required, there was a possibility of using only one. The Empire State antenna was some 1250 feet above sea level, and there were nine hills between there and Camden almost high enough to "see" it and at the same time give promise of placing a good signal in Camden.

To fix definitely upon a site for the relay station, a field strength survey was made at each of these possible locations. The equipment used consisted of a semiportable receiver, the sensitivity of which had been determined, and approximately calibrated in microvolts per meter. It was used with a vertical half-wave antenna which could be raised on a pole some eighteen feet above ground. This apparatus was easily carried about by automobile and served its purpose very well.

During the period of the survey, test transmissions were made both from the Empire State Building, on 44 and 61 megacycles, and from Camden on 44 megacycles. The field strength observed on these transmissions showed at once that there were only two possible locations for the relay station, and that the best one was undoubtedly Arney's Mount, a few miles east of Mt. Holly, N.J. The summit of this isolated hill is 230 feet above sea level; high enough to give line of sight to the receiving point 23 miles distant at Camden, and only about 200 feet below line of sight from the New York antenna, 63 miles distant. This unequal division of the total relaying distance was justified for several reasons: first, the great height of the 44-megacycle antenna in New York; next the fact that the second lap of the relay was to be carried on 79 megacycles, which would probably require a direct optical path; and finally because a strong signal would be needed in Camden to override severe induction interference from the factories there.

As a final confirmation of the choice of Arney's Mount, an experimental television receiver¹ was set up there and picture transmissions observed alternately from New York and Camden. The pictures were fair and it was calculated that they would be entirely satisfactory when antennas of considerable height or directivity, or both, had been erected. It will be noted that in all of the survey work the observations on the second lap of the circuit were made at Arney's Mount on transmissions from Camden. It was assumed that these data would apply to transmission in the reverse direction, and it was much more practical to set up a receiver at Arney's Mount than a test transmitter.

The general plan for erection of antennas at the station was worked out before starting construction. Additional signal strength was needed

¹ G. L. Beers, "Description of experimental television receivers," *Proc. I.R.E.*, vol. 21, pp. 1692-1706; December, (1933).

to insure reliable reception from New York. The practical question was whether to obtain this by an extensive highly directive antenna near the ground, or by a small antenna high up on a tower. It was answered in favor of the tower by an observation of the vertical distribution of field strength over the location, made in an autogyro and previously reported in these PROCEEDINGS.² These measurements were confirmed by others which had been independently made in an airplane at comparable distances over Long Island.³ Apparently there was no abrupt change in signal strength as one fell below line of sight, and in this region the signal strength was roughly proportional to the elevation of the receiving antenna above ground. This generalization is, of course, subject to many rapid fluctuations in signal with altitude due to reflections from the ground surface along the transmission path. These were observed sufficiently to make certain that the final antennas were not at a minimum of field strength.

The relay station, as built on Arney's Mount, included a 165-foot steel tower, a 20-foot square steel building housing the apparatus, and three wooden poles supporting the transmitting antenna directed on Camden. There was just room enough on top of the wooded sand hill for the three structures, and the slope fell rapidly away on all sides from the 230-foot elevation of the summit to the normal ground level, which is about 100 feet above sea level in this vicinity.

The steel building was divided into two rooms, one for the receiver and one for the transmitter. The latter was double shielded with copper, and filters were provided for all circuits passing through the partition, as well as for the incoming underground power cable. These precautions made it possible to locate the receiver, which worked on the relatively weak 44-megacycle signals from New York, in the same building with the relay transmitter. The power of this relay transmitter had been set at 100 watts as this was felt to be reasonable for the experimental study of the system.

The block diagram of Fig. 1 shows the equipment installed at the relay station. The receiving antenna consisted of three vertical dipoles, connected in proper phase and feeding a 450-ohm two-wire transmission line. The upper dipole was mounted on the top of the 165-foot steel tower and a reflector was placed behind it. The other two were without reflectors and were placed in a vertical line beneath. It is interesting to note that the topmost point of this antenna array lay only 35 feet below the line of sight from the New York antenna.

² L. F. Jones, "A study of the propagation of wavelengths between three and eight meters," *Proc. I.R.E.*, vol. 21, pp. 349-386; March, (1933).

³ Bertram Trevor and P. S. Carter, "Notes on propagation of waves below ten meters in length," *Proc. I.R.E.*, vol. 21, pp. 387-426; March, (1933).

The receiver was a specially designed superheterodyne. The intermediate frequency was 8 megacycles and the circuits were adjusted to give the maximum sensitivity consistent with the necessary total bandwidth of 420 kilocycles. There was no second detector and the output was delivered at 8-megacycles into a 500-ohm concentric tube transmission line. The over-all sensitivity of the receiving system is indicated by the fact that one volt of signal was measured at the output with the antenna system exposed to an estimated field strength of 200 microvolts per meter.

The 8-megacycle receiver output was carried by the transmission line through a 20-megacycle low-pass filter into the transmitter room.

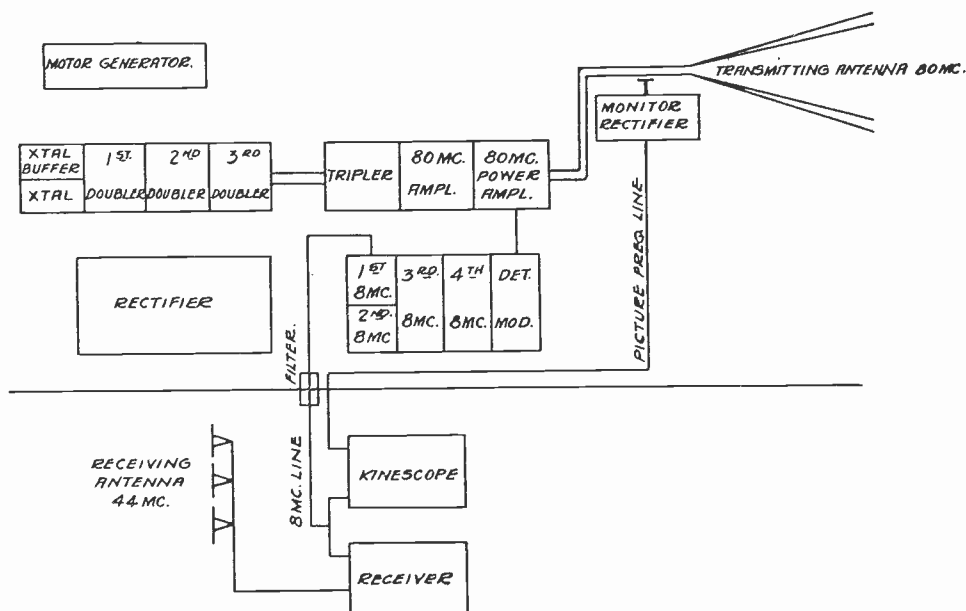

Fig. 1—Block diagram of relay station at Arney's Mount.

Here it was further amplified by four stages operating in push-pull class B, the circuits being tuned and damped to give the necessary bandwidth. The high level thus obtained excited a pair of tubes acting as a combined high power detector and modulator. In the plate circuit of this modulator an undistorted power of 200 watts at video frequency was obtained, and this was sufficient to modulate 100 per cent the power amplifier in the transmitter.

The modulator tubes were biased somewhat beyond cut-off and were operated so as to give linear detection of the 8-megacycle intermediate frequency. Thus, in the entire receiving and relaying system, there was only this one stage carrying video frequency signal. Therefore the problem of maintaining good frequency characteristic and reducing phase distortion was greatly simplified. There was only one

video frequency circuit to be considered in addition to such distortion as might occur in the radio circuits. The measured total phase shift of the transmitter was a constant $2\frac{1}{2}$ microseconds over the band used.

This method of direct transfer of modulation from one carrier to another in a single stage has the characteristic of inverting the modulation on the second carrier. In other words a positive peak on the first carrier becomes a negative on the second. This, of course, is no handicap in a relaying system, but would make it undesirable as a general method of modulation.

The radio-frequency circuits of the transmitter were more orthodox. The original crystal frequency was 3.3 megacycles and this was amplified and multiplied by a crystal buffer stage, first doubler, second doubler, third doubler, a tripler, an 80-megacycle amplifier, and a final 80-megacycle power amplifier. Some precautions were necessary in plate circuits of the power amplifier to reduce the capacity of the parts to ground and permit the wide band of modulation. The output was inductively coupled to a two-wire transmission line which passed out of the building and up the adjacent 70-foot pole to the transmitting antenna. Direct-current filament power and bias voltages for the transmitter were supplied by a motor generator and plate voltages by a 3000-volt rectifier. The proper operation of this transmitting system was due largely to the efforts of W. H. Nelson of the General Electric Company.

Another essential part of the relay installation was a kinescope used for monitoring purposes. This, by means of transfer switching, could be connected either to the receiver or to a rectifier coupled to the sending antenna. Thus a direct comparison was possible between the received and the relayed pictures.

For the link from Arney's Mount to Camden, horizontally polarized waves were used. They proved to have a real advantage when it came to receiving at Camden, as the horizontal type receiving antenna was noticeably less susceptible to pick-up of interfering electrical noise. The radiating antenna erected at Arney's Mount was designed by P. S. Carter of RCA Communications, Inc., to have a power directivity of 18 to 1 as compared with a single dipole. It was supported on three 70-foot wood poles and consisted of four wires, each 16 wavelengths or about 200 feet long. These wires formed two flat V's having a common apex and with the bisector of their open angle pointed westward toward Camden. The wires of the upper V were horizontal while those of the lower V were directly under them but sloping downward as the sides of the V spread apart. As indicated in Fig. 1, the transmission line was connected at the apex, one wire to the right sides of both V's and the

other wire to the left sides. When the angles of this antenna structure are properly chosen, both horizontal and vertical concentration of the radiation is obtained. Also the system is sharply resonant to the chosen frequency and it was found desirable to add resistance loading at the extremity of each wire, in order to broaden the tuning sufficiently for the wide transmission band. This loading had the added advantage of reducing unwanted radiation in the reverse direction.

Directivity measurements made on this antenna are shown in Figs. 2, 3, and 4. These measurements, as well as those made at Cam-

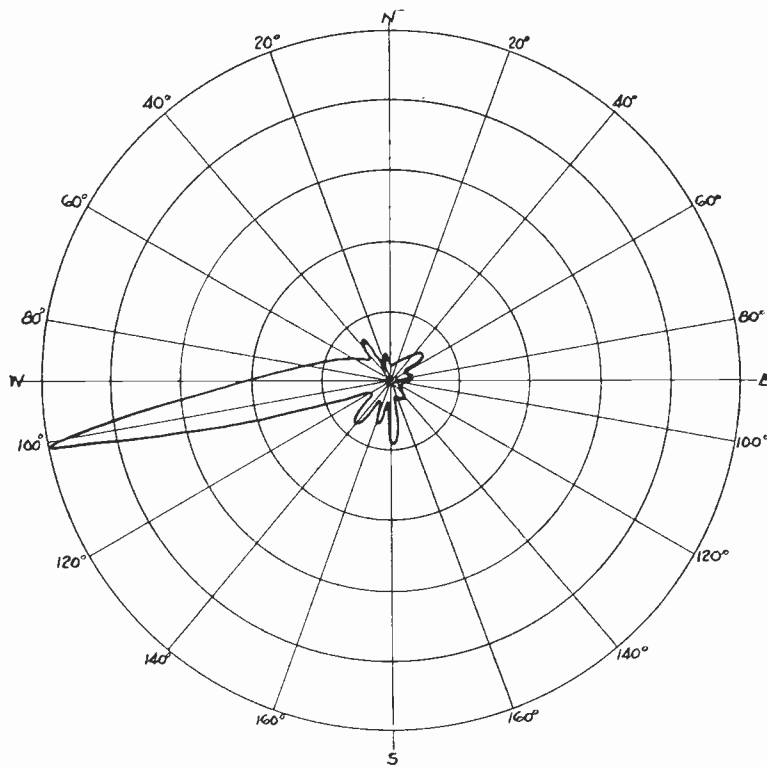

Fig. 2—Directivity of Arney's Mount transmitting antenna. Plane flying at 600 feet altitude in a circle 4.2 miles in diameter.

den, and many of the field strength surveys, were carried through by Bertram Trevor of RCA Communications, Inc. Fig. 2 was obtained by placing a field strength set in an airplane and flying in a circle around the antenna. In this case the radius of the circle was 4.2 miles and the altitude of the airplane 600 feet above the antenna. Fig. 3 shows a similar curve made by flying back and forth across the beam at a distance of 11.5 miles. In this case, while flying at an altitude of 700 feet, the conditions were quite variable and the two curves show two successive runs. It is clear from Figs. 2 and 3 that good directivity was obtained in this antenna, the beam being about 10 degrees wide at 50 per cent of its maximum value.

In order to determine the vertical directivity of the antenna, flights were made back and forth across the beam at a distance of one mile from the transmitter and at altitudes up to 5000 feet. The results are shown in Fig. 4. The curves are very irregular due to interferences of reflections. Nevertheless they demonstrate the important point that the radiation becomes small at 45 degrees and that the maximum field strengths occur at low angles, as is required for this service.

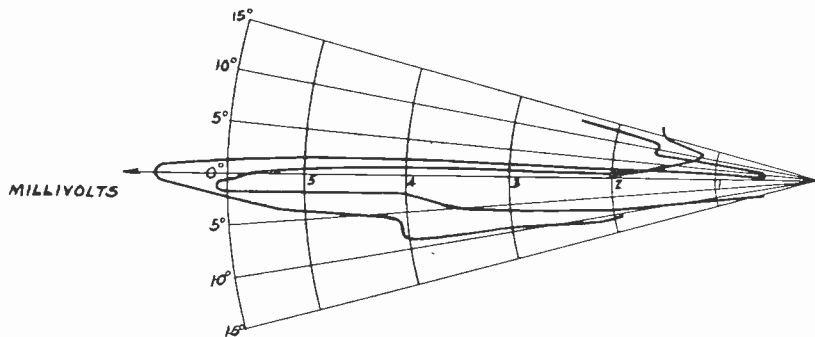

Fig. 3—Directivity of Arney's Mount transmitting antenna, plane flying at 700 feet altitude, 11.5 miles distant.

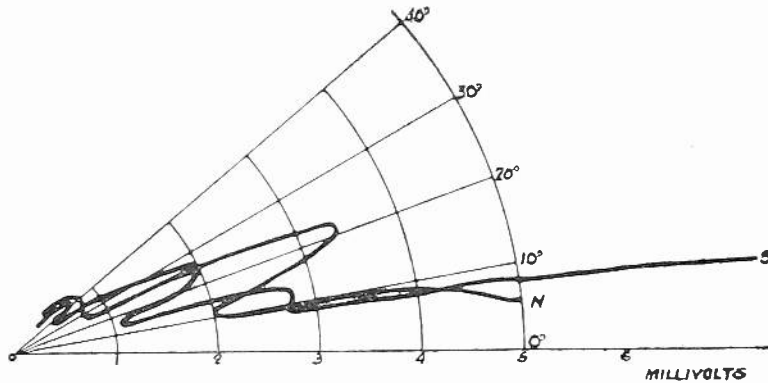

Fig. 4—Signal intensity vs. angle to horizon for Arney's Mount transmitting antenna. Data taken over a point one mile distant.

At the Camden terminal of the relay circuit the receiver and antenna were installed on the roof of one of the RCA Victor Company buildings. The receiver proper was the same as that used at Arney's Mount except that a second detector was included and the output taken at video frequency instead of intermediate frequency. A kine-scope for monitoring, and a line amplifier through which the video frequencies were sent to the control board at the studio were provided.

The receiving antenna presented somewhat of a problem as it was difficult to obtain a sufficiently good signal-to-noise ratio when operating in a city location. The field strength was of the order of 400 micro-

volts per meter. This proved ample for the 120-line picture in the evening when factory interference had ceased. By day, however, good pictures were not received until the simple horizontal dipole antenna was replaced by a horizontal V type raised 50 feet above the roof of the building, or 120 feet above the street. With this arrangement there was a tendency to balance out the noise pick-up from below, and there was a much stronger signal due to the antenna directivity. This directivity was measured by installing a small transmitter in an airplane and flying it around the receiving point. The radius of the circle flown was 20,000 feet and the height of the plane 2000 feet. Fig. 5 gives the

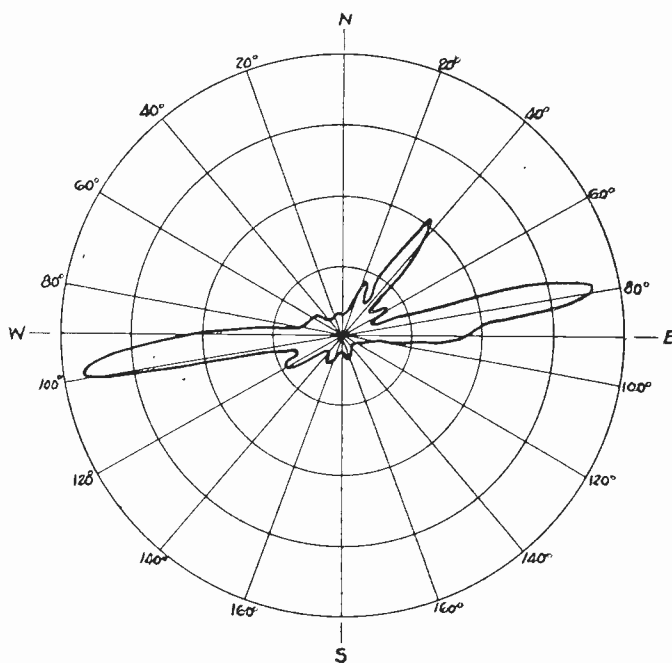

Fig. 5—Camden relay receiving antenna second detector deflection vs. bearing, plane flying at 2000 feet altitude in a circle 40,000 feet in diameter.

polar diagram thus obtained. The system gives two sharp beams, being in this case bidirectional because no resistance loading was provided at the extremities of the V.

After the relay station at Arney's Mount and the receiving station at Camden were properly adjusted, a number of television programs were relayed from the Empire State Building in New York. These were necessarily of 120-line detail, being limited to this by the studio apparatus used. After being received in Camden, the video signals went by low capacity cable to the control board and thence to the television broadcast transmitter. Received from this transmitter, the picture detail, while not as good as the original transmission, was still entirely acceptable.

It is worth pointing out that when a studio program originating in New York City was finally seen on the kinescope in the suburbs of Camden, it had passed on the way, without appreciable distortion, through three transmitters and three receivers.

ACKNOWLEDGMENT

Acknowledgment is made to the engineers of the five companies which coöperated in carrying out this project: RCA Communications, Inc., RCA Victor Co., Inc., National Broadcasting Company, General Electric Company, and Westinghouse Electric and Manufacturing Company. In addition to these men, especial credit is due to Mr. Bertram Trevor of RCA Communications, Inc., and to Mr. W. H. Nelson of the General Electric Company, who carried out much of the field work involved, and adjusted the varied equipment at the relay station.



THE SOUND PRISM*

By

O. H. SCHUCK

(Moore School of Electrical Engineering, University of Pennsylvania, Philadelphia, Penna.)

Summary—The methods of sound analysis used at present are classified into those in which an analyzing operation is performed upon a photographic record of the wave and those in which the wave is analyzed as it is being produced. It is pointed out that the methods of the first group are very laborious and that those of the second group are slow in action, making them unsuitable for analyzing sounds of relatively short duration such as those produced by persons. The need for a device to perform a rapid analysis is indicated.

A new rapid acting heterodyne wave analyzer called the "Sound Prism" is described and its operation is illustrated. The frequency spectrum is repeatedly traced on a translucent screen by a spot of light at such a rate that persistence of vision allows the eye to see the path of the spot as a steady line on the screen. The frequency spectrum is thus shown almost instantaneously so that changes in the spectrum may be continuously followed by the eye as the composition of the sound changes and the ear hears the change in quality. Sample records of analyses are given and a brief description of the work already done in the field of musical tone analysis is presented. The limitations of the sound prism in regard to resolution and speed are discussed and plans for further development are outlined.

In an appendix the problems concerned with the operation of the filter element at a high rate of frequency change are discussed.

DEVICES FOR SOUND ANALYSIS

THE available devices for sound analysis may be grouped into two broad classifications according to their method of operation. There is first the method of wave form recording and subsequent analysis of the record such as was used by D. C. Miller,¹ who recorded with the Phonodeik and analyzed the enlarged record with a Henrici analyzer; and by Sacia,² who recorded oscillographically and analyzed the record by photomechanical means. Much work has been done and continues to be done by this method, for it is accurate and reliable, and the taking of the record is virtually instantaneous. It has certain disadvantages, however, chief of which are the length of time that must elapse before the analysis is available, the large amount of labor that is necessary, and the difficulty of determining inharmonic components. Into the second group fall the various methods in which the sound wave is analyzed as it is being produced. Helmholtz³ and

* Decimal classification: 534. Original manuscript received by the Institute, May 29, 1934. Presented before Ninth Annual Convention, Philadelphia, Pa., May 29, 1934.

¹ Numbers refer to bibliography.

Rayleigh⁴ used acoustic resonators to identify the harmonics and obtain a rough idea of their strengths, while later investigators have used electrical resonance effects, first at the frequencies of the components⁵ and, more recently, by heterodyning methods at other more convenient frequencies.^{6,13} The direct resonance methods have the advantage of speed when measuring a single component, but their ability to resolve components not far separated in the frequency spectrum is limited and the adjustments necessary to analyze a large frequency range make their operation slow. Analyzers utilizing heterodyne methods can be built with much higher resolving power and greater ease of adjustment. They have therefore come into great favor in the last few years and much work has been done with such devices on the analysis of sounds that can be held steady over a considerable period of time, such as airplane⁸ and machinery noises.¹¹ In fact, they have even been used to obtain approximate analyses of tones that cannot be kept steady—those produced by human means, such as instrumental and vocal tones—by analyzing a continuous repetition of the tone.¹⁴

AN INSTANTANEOUS SOUND ANALYZER

There is a need for a device that will analyze a sound instantaneously and show the analysis immediately, so that a sound can both be heard and its analysis seen at the same time. Such a device would be of great value to the engineer in enabling him to see at once the effects of changes and adjustments made up on the source of the sound or upon reflecting or absorbing surfaces; it would likewise be valuable to the research worker in greatly expediting many investigations, and it would be of especial value to the musician in enabling him to see immediately the results of variations in technique of playing. It would be a powerful new tool in teaching and in the correction of technique, and in the study of harmony.

Such a sound analyzer has been developed in the laboratories of the Moore School of Electrical Engineering. As the sound is being produced, this device shows the frequency spectrum on a screen. Tones of short duration may thus be analyzed, and during the production of the tone changes in the analysis can be followed by the eye, as the ear hears them as changes in quality. Since it shows the spectrum of a sound, this instrument has been named by analogy with its optical counterpart, the "Sound Prism."

GENERAL DESCRIPTION OF THE SOUND PRISM

Essentially, the sound prism belongs to the class of heterodyne analyzers, various examples of which have been described in the liter-

ature. However, instead of utilizing a carrier whose frequency is adjusted by hand to give the proper beat note with each component of the complex wave being analyzed, or whose frequency is slowly varied by automatic means, it utilizes a carrier whose frequency is swept rapidly through a desired range a number of times a second. It is unique in showing visually the complete frequency spectrum of the sound being analyzed at the instant the sound is being produced. A spot of light striking a screen is moved in one coordinate in accordance with the amplitude of response of the analyzer, while it is being moved in the other coordinate in accordance with the instantaneous frequency of

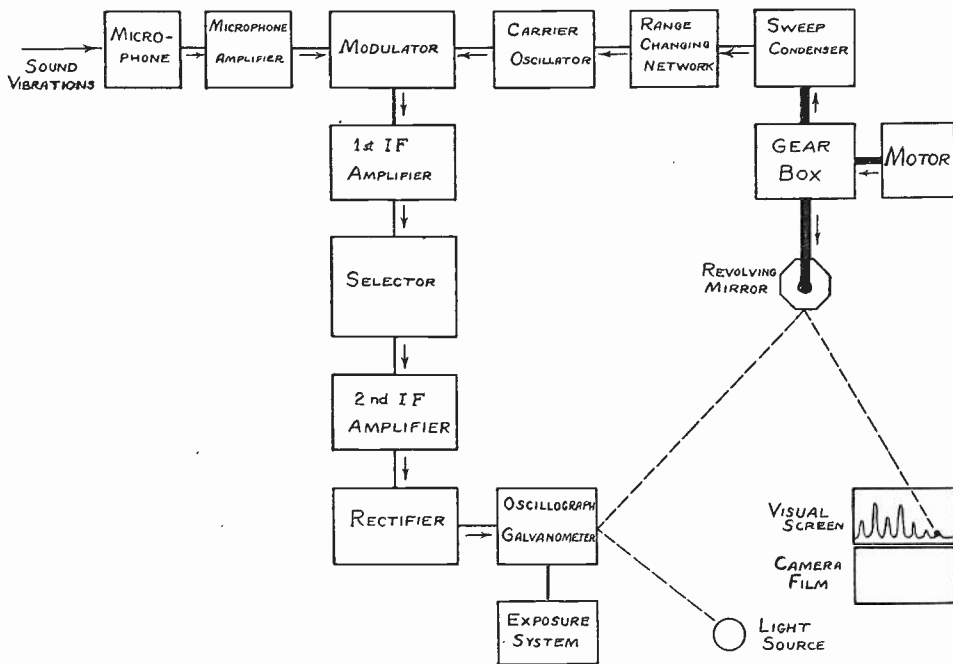

Fig. 1

the carrier, so that the amplitude-frequency spectrum is traced. The motion of the spot is sufficiently rapid and is continuously repeated at such a rate that the path of the spot is seen by the observer as a steady line of light on the screen. Permanent records of the frequency spectrum at any desired instant may also be obtained by utilizing photographic recording.

The functional diagram of Fig. 1 will serve to illustrate the purpose and operation of the several parts of the device. Sound vibrations are translated into corresponding electrical vibrations by the microphone, amplified by the microphone amplifier and led to the modulator in which they modulate the carrier frequency generated by the oscillator. The frequency of the oscillator is controlled by the position of the re-

volving sweep condenser which is driven by the motor through the gear box. Since the revolving mirror, which moves the spot of light across the screen, is geared to the sweep condenser, the horizontal position of the spot on the screen is dependent upon the instantaneous frequency of the oscillator. A range changing network is included to change the effective capacitance variation of the sweep condenser so that different frequency ranges may be obtained.

A balanced modulator is used to suppress the carrier, leaving as products of modulation the upper and lower first order side bands, the frequencies of whose components are continuously changing as the oscillator frequency changes. These are amplified by the first intermediate-frequency amplifier and applied to the selector, which passes each side band component in turn as its frequency passes through a narrow pass band; the output of the selector is amplified by the second intermediate-frequency amplifier, rectified, and caused to operate the oscillograph galvanometer to give the spot of light vertical motion on the screen.

To illustrate the operation of the sound prism, let us consider its operation with a 1000-cycle and a 2000-cycle audio component applied to the microphone and thus impressed upon the modulator. We shall consider that the selector passes a narrow band at 20,000 cycles, and that the carrier frequency drops uniformly from 25,000 cycles to 20,000 cycles during one-half revolution of the condenser. As shown in Fig. 2, at the beginning of the sweep, the side bands consist of components having frequencies of 27,000, 26,000, 24,000, and 23,000 cycles. As the carrier frequency drops, the frequencies of all of the side band components drop by a like amount, so that at time t_a when the carrier passes through 22,000 cycles, the side band components are respectively passing through 24,000, 23,000, 21,000, and 20,000 cycles. As this last component, which corresponds to the 2000-cycle audio component, passes through 20,000 cycles, it is passed by the selector and causes the spot of light to rise on the screen. Since the spot is also moving horizontally in proportion to the frequency of the carrier, it traces the frequency response curve of the selector, the peak being at a position corresponding to a carrier frequency of 22,000 cycles. Continuing its drop, the carrier frequency at time t_b passes through 21,000 cycles, the side band frequencies then passing through 23,000, 22,000, 20,000, and 19,000 cycles. The present 20,000-cycle current, which corresponds to the 1000-cycle audio component, again causes the spot of light to trace the frequency response curve of the selector on the screen, this time with the peak at a position corresponding to a carrier frequency of 21,000 cycles. It will readily be recognized that the screen may be

calibrated in terms of the difference between the carrier frequency and the frequency of the center of the pass band, and that from the positions of the peaks of the curve traced by the spot the frequencies of the audio components may be determined. Their amplitudes may also be determined, since the heights of the peaks are dependent upon the amplitudes of the respective side band components, which are in turn proportional to the amplitudes of the corresponding audio components. In the present instance there will be two peaks, one at 1000 cycles and one at 2000 cycles, this being the frequency spectrum of the sound

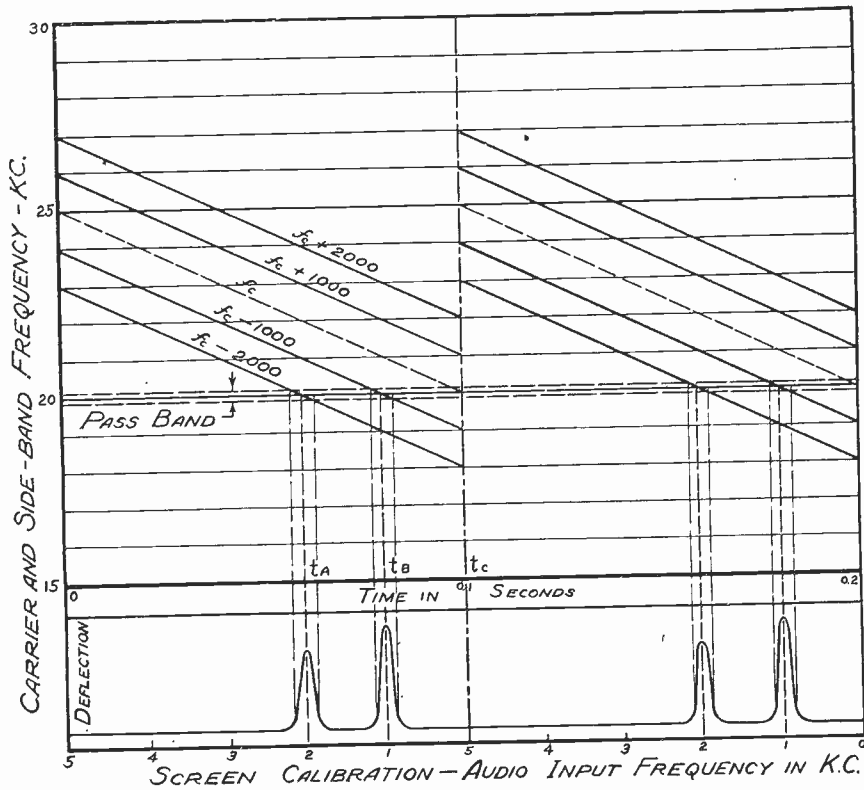

Fig. 2

reaching the microphone. Additional components in the sound will cause additional peaks in the curve, so that the frequency spectrum of the sound, whatever it may be, will be traced.

When at time t_c the carrier frequency reaches 20,000 cycles, the spot of light leaves the screen while the frequency rises discontinuously to 25,000 cycles; it then again traces the frequency spectrum as the carrier frequency drops to 20,000 cycles. This is continually repeated at such a rate, about ten times a second, that persistence of vision allows the path of the spot to be seen as a steady line of light, changing in character only when the sound changes, and following faithfully all variations in the composition of the sound.

LIMITATIONS OF THE SOUND PRISM

The great advantage of the sound prism over other devices for sound analysis lies in its ability to show visually or to record the frequency spectrum *as the sound is being produced*. This objective of substantially instantaneous analysis is, of course, not attained without some sacrifice of resolution and accuracy of frequency determination, but for much of the work for which it is especially fitted this is not a very grave fault. In studying a flute tone, for instance, we are interested in the amplitudes of the various harmonics and the changes in their amplitudes during the blowing of a note, or as dependent upon different methods of blowing, much more than we are interested in their exact numerical frequencies.

Likewise, in studying irregular sounds such as vowels and noises, we are often more interested in the distribution of sound energy in the various parts of the spectrum than in the separation of the various components. At present, components separated by less than about 200 cycles cannot be perfectly resolved; that is, there is some overlapping of the selector response curves that make up the spectrum. This is a very real difficulty, since it at present limits the use of the instrument for *exactly* analyzing musical sounds to those having fundamentals above 200 cycles.

Besides its limitations in the matter of resolving power, the sound prism is also limited in its speed of operation. Since it takes a definite time, about a tenth of a second, to make an analysis, it must be assumed that the composition of the sound remains substantially unaltered during this time. This may be otherwise stated by saying that a particular component is measured at intervals of a tenth of a second, and should not change greatly during that time. However, this is not such a serious disadvantage as might be thought, for neither the eye in seeing the analysis, nor the ear in hearing the sound, can follow changes occurring much more rapidly than this. Sounds changing more rapidly are distinctly transients, and the ear's recognition of their quality is dependent largely upon the character of the transient.¹⁵ It can therefore be said that the sound prism, in the matter of speed, is subject to about the same limitations as the human observer.

SPECIAL CONSIDERATIONS

Due to the fact that the carrier frequency is not constant but is continuously changing, transient conditions of a special sort must be dealt with in all parts of the sound prism from the modulator onward. This has necessitated certain novel design features. It was found that iron-core coils in any of the circuits carrying changing or "sweep-

ing" frequencies introduced undesirable hysteresis effects, so that air-core coils have had to be used in all those circuits, comprising the oscillator, modulator output, selector, and rectifier circuits.

The problems peculiar to the selector, which must possess the ability to respond to a narrow band of frequencies during the time the sweeping frequency applied to it passes through that band, are dealt with in the Appendix. As explained there, the resolution becomes less, the greater the speed of sweep of the frequency applied to the selector. However, the repetition of the tracing of the curve on the screen must be sufficiently frequent to allow the eye to see the curve as a steady line without too much flicker. It is therefore advisable to waste as little time as possible, after reaching the end of one sweep, before beginning the next repetition. For this reason the carrier frequency, after reaching the end of its sweep, which in the example given above is from 25,000 cycles to 20,000 cycles, is caused to change discontinuously back to 25,000 cycles and immediately to commence again its sweep downward. This is accomplished by the use of two identical rotating condensers in the oscillatory circuit, each of which is connected into the circuit in turn by a synchronous switch.

PRELIMINARY INVESTIGATIONS

Considerable work was done in conjunction with Dr. Harl McDonald of the Music Department, School of Fine Arts, University of Pennsylvania, on the original laboratory model of the sound prism in order to investigate its usefulness in analyzing musical tones. While the accuracy of the results possible with this model left much to be desired, the suitability of the instrument for this work was so conclusively demonstrated that a grant was made by the Rockefeller Foundation for the building of the more accurate instrument described in this paper, in order that extensive investigations into the factors affecting tone quality might be made.

The preliminary investigations dealt with the violin, trumpet, clarinet, oboe, piccolo, flute, bell, and the human voice. As examples of the records taken at this time, Figs. 3, 4, and 5 are shown. Great changes in the character of the clarinet tone are apparent even between notes but a semitone apart. An interesting comparison with the observations of Paget¹⁶ is given by the record of the vowel sound given in Fig. 6. Reinforcement of partials near 800, 1350, and 2300 cycles checks well with Paget's results, while an additional reinforcement near 3100 cycles is also present. The frequency modulation effect of the involuntary "burring" tremulo of the male voice recorded is also apparent. In the

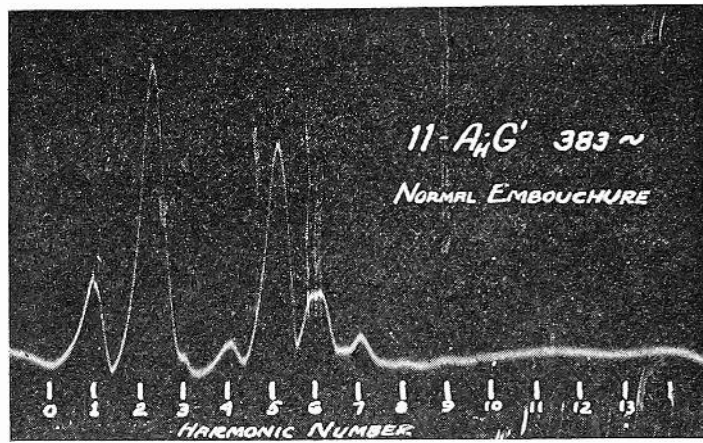

Fig. 3

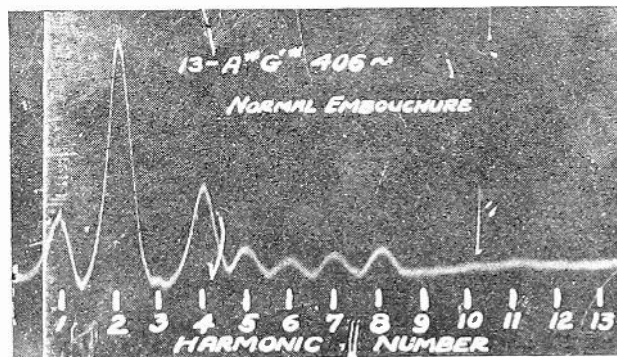

Fig. 4

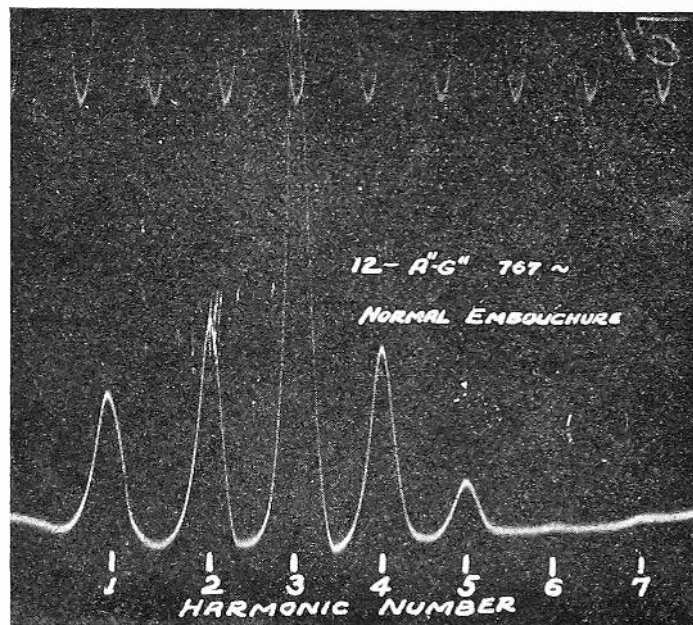

Fig. 5

investigation of the human voice the sound prism promises to prove as useful as in the work on instrumental tones.

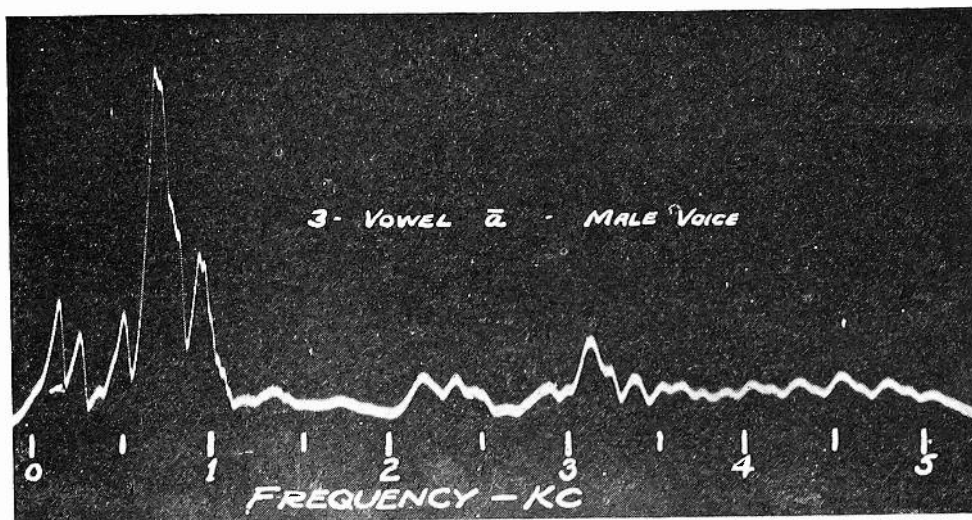

Fig. 6

PHYSICAL DESIGN OF THE SOUND PRISM

The present model of the sound prism was built in the laboratories of the Moore School of Electrical Engineering for use in musical tone analysis. In its physical design, the aim was to make the instrument self-contained, somewhat portable and completely alternating-current operated. The apparatus is mounted in rack and panel fashion on a caster-equipped base as seen in Fig. 7, so that the instrument can at least be pushed from spot to spot or carried in a truck. This form was considered most useful for the work to be done with it, most of which will probably be done in the laboratories of the Moore School.

Ease of maintenance was considered a primary factor in the design. To this end, all circuits may be tested by means of jacks from the front panel without removing any shielding, and all circuit adjustments may be made from the front panel with a screw driver. Vacuum tubes of standard modern types used in radio sets are used to permit convenient replacement.

In the normal operation of the sound prism only four controls need be used; these are therefore the only hand controls appearing on the instrument. They include an on-off switch, range switch, attenuator control, and exposure button.

Permanent records are a necessity in investigations of the type for which it is planned to use the instrument, so a photographic recording system had to be incorporated, considerations of economy and con-

venience in handling dictating the use of standard amateur roll film. In the work with the laboratory model it was found very convenient for the operator to be able to see the spectrum during the whole time of the production of the sound and to be able to take a picture at any desired

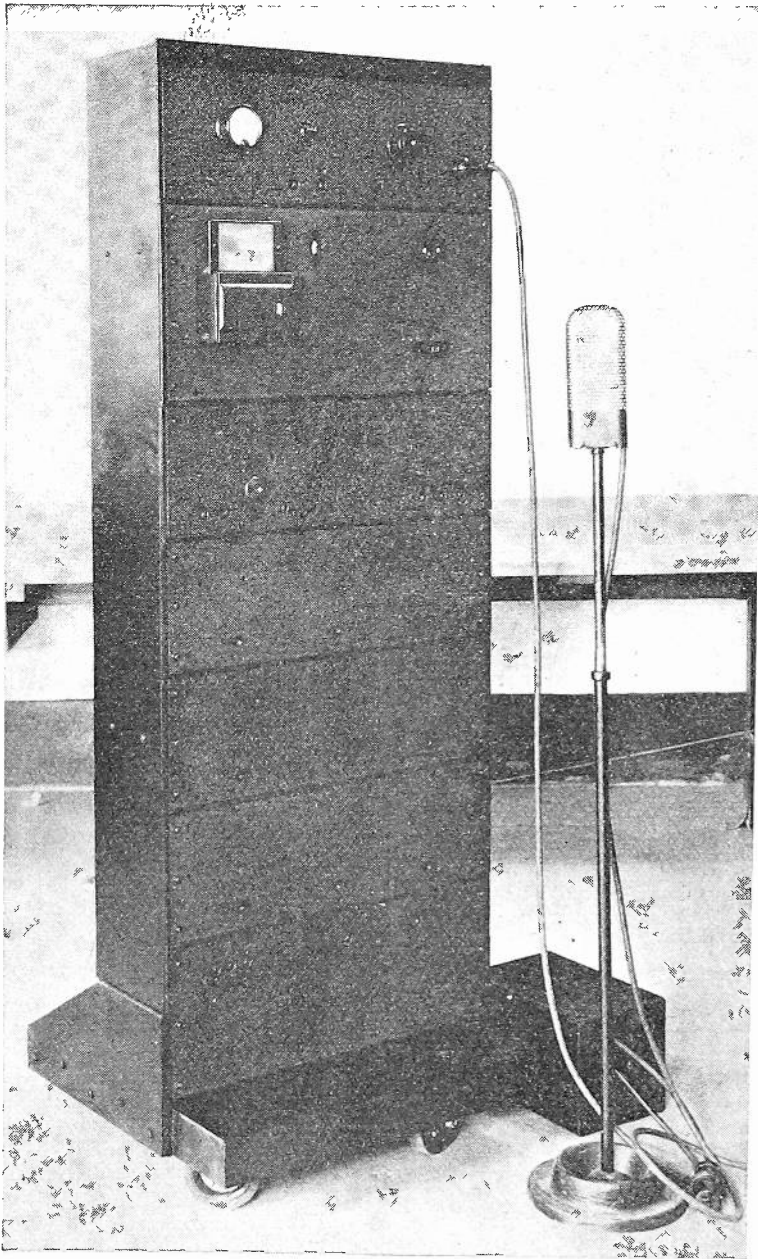

Fig. 7

instant during this time; an interesting method of enabling this to be accomplished was devised. The optical system of the new model is similar to that of well-known electromechanical oscillographs, the galvanometer deflections causing vertical movements of the spot of light on the vertical translucent screen, while the horizontal frequency

scale is obtained by the use of a revolving polygonal mirror geared to the sweep condenser shaft. Directly beneath the viewing screen is located the detachable camera body, and by passing a superposed constant direct current through the galvanometer during one sweep over the frequency range, the spot of light is caused to traverse the film instead of the viewing screen, thus making a record at any time the exposure button is pressed. The opening of the camera shutter and the application of the shifting current are synchronized with the rotation of the sweep condenser through contacts on the condenser shaft, and the proper sequence of events as well as the prevention of multiple exposures are obtained through the action of a set of interlocking relays actuated by the exposure button. The spot of light is off the viewing screen for only the one sweep required to take the picture, so that the operator sees only a momentary flicker when he presses the exposure button, the spectrum being continuously visible both before and after the exposure.

In order to extend the audio-frequency range and to increase the accuracy of measurement of components, a ribbon microphone and high quality audio amplifier are used. This combination will give dependable results up to about 14,000 cycles. Any one of five frequency ranges, 0-500, 0-2000, 0-5000, 2000-10,000, and 5000-19,000 cycles, may be selected by the range switch, the second, third, and fourth being the ranges with which most of the work will be done, while the first and fifth are auxiliary ranges for special purposes. Attainment of a number of ranges with the use of but one rotating condenser depends upon the use of series and shunt capacitances in combination with the rotating condenser, the arrangement being similar to that used in the oscillator circuit of many superheterodyne radio receivers.

PLANS FOR FURTHER DEVELOPMENT

The limitations of the sound prism in the matter of speed of operation and resolving power are due, as explained in the Appendix, to the characteristics of the selector. This part is truly the heart of the sound prism, and its further development is sorely needed. Either more efficient coils, perhaps with iron-dust cores, or a change in the electrical circuit of the selector might lead to improved operation. On the other hand, the development of a multisection mechanical filter seems a very promising direction of attack on this problem.

A thorough investigation into the behavior of multisection filters with various kinds of transient forces applied, including a frequency sweeping through the pass band, is at present being planned. This work will be done with a large and heavy mechanical model in order to allow

recording on a chart of the vibration in each section, and it is hoped that the results obtained with this model will give sufficient insight into the behavior of the sound prism selector to enable further development to be intelligently directed.

At present, the amplitude calibration is linear, but it would be highly desirable to have a logarithmic amplitude scale graduated directly in decibels. For slowly varying amplitudes the automatic volume control circuit used on radio receivers can be made to give a very good logarithmic scale,¹⁷ but for the rapid variations encountered in this apparatus a feed-back control cannot be used. Some form of rectifier or transmission device with an inherent logarithmic characteristic must be used. Work has been done by Howard Sheppard at the Moore School on the use of 58 tubes as diode rectifiers in such a way as to give a fairly good logarithmic scale over a range of about 40 decibels. This apparatus may later be applied to the sound prism.

While the model now being built will give records of the spectrum at any desired instant during the production of a tone, it would be desirable for many purposes to have a continuous record showing the changes in the spectrum throughout the duration of the tone. A camera with moving film is being planned to accomplish this, the successive spectra being recorded one above the other for ready identification and comparison of the amplitudes of the components. This will enable study of the building-up and dying-down characteristics of tones, and should also prove of value in studying reverberation.

ACKNOWLEDGMENT

The writer wishes to express his sincere thanks and deep appreciation for the encouragement, helpful suggestions, and criticisms given by Mr. Charles Weyl and Mr. Knex McIlwain, both of the Moore School Faculty. Mr. McIlwain was the faculty adviser in charge of the work and the recipient of the Rockefeller Foundation Faculty Research Grant under which the new model has been built and under which certain investigations are to be made with it. The writer is likewise greatly indebted to Dr. Harl McDonald of the School of Fine Arts of the University of Pennsylvania for his encouragement, help, and coöperation in the preliminary investigations into the suitability of the sound prism for musical tone analysis, and to Mr. Howard Sheppard and Mr. Stanley Flack, who were at that time graduate students at the Moore School, for their assistance in this work. Especial thanks are due to the trustees of the Rockefeller Foundation for their financial assistance in making possible the building of the new model, and to the Civil Works Administration for furnishing additional funds and labor.

APPENDIX

Selector Problems

The selector acts as a special form of filter, since it must transmit a sweeping-frequency wave during the time its frequency is passing through the pass band. This is an unusual requirement for a filter and involves a new viewpoint in considering its operation. The name "selector" is therefore used to distinguish it in its operation from the usual filter, which is normally assumed to operate on steady state, constant-frequency waves, filter characteristics being normally calculated or measured by determining the transmission loss for a number of discrete, constant frequencies. However, the characteristic of the selector of interest here is its transmission loss, as a function of frequency and therefore also of time, to a constant-amplitude wave whose frequency, while continuously decreasing, passes through the pass band. It is obvious that this transient transmission characteristic, which we shall call the transient response curve, is the portrayal of an occurrence, while the usual steady state transmission characteristic, which we shall call the static response curve, is the portrayal of a relationship. The transient response curve is identical with the static response curve when the speed of sweep is very low, but when it is high enough for the present purpose, important differences are observed.

The usual form of heterodyne analyzer operating with a high intermediate frequency* utilizes a mechanically resonant filter circuit to secure high resolving power. This is a vibrating system of a single degree of freedom, analogous to a single tuned electrical circuit. During the experimental work on the sound prism, it was observed that the transient response curve of a single tuned electrical circuit to a constant-amplitude, sweeping-frequency electromotive force showed surprising differences from the static response curve, which is, for a system of a single degree of freedom, merely the resonance curve of the circuit. Fig. 8 shows the response curves of a single tuned electrical circuit, curve *A* being the static response curve and curves *B* and *C* being transient response curves taken with different speeds of sweep. It is seen that as the speed of sweep increases, the peak of the curve changes position and height, and what is more important to the present use, secondary maxima appear on the "following" side of the curve.

* A number of heterodyne analyzers have also been built utilizing an intermediate frequency of zero, i.e., zero beat between the carrier wave and the component to be measured,^{6,7,8} while one has been built utilizing a carrier frequency of twelve cycles.¹⁰ A low intermediate frequency is undesirable in the present case because of the small number of cycles of the intermediate frequency that occur while the frequency is sweeping through the pass band. One form of heterodyne analyzer has been developed using a mechanical band-pass filter,¹¹ the purpose in this case being to secure a square-topped transmission characteristic.

The "following" side is here used to mean that part of the curve which is traced after the primary peak has been traced. If the frequency is decreasing, the shift of the primary maximum is toward the lower frequency end of the scale and the secondary maxima occur at frequencies lower than that of the primary maximum, while if the frequency is increasing, the shift is toward the higher frequencies and the secondary maxima appear on the high-frequency side of the curve. The shift of the primary maximum and the occurrence of the secondary maxima in the response curve of a system with a single degree of freedom have also been observed by Barrow¹⁸ and have been mathematically determined by Lewis.¹⁹ While the shift in the frequency of the primary maximum and the decrease in its amplitude can be allowed for

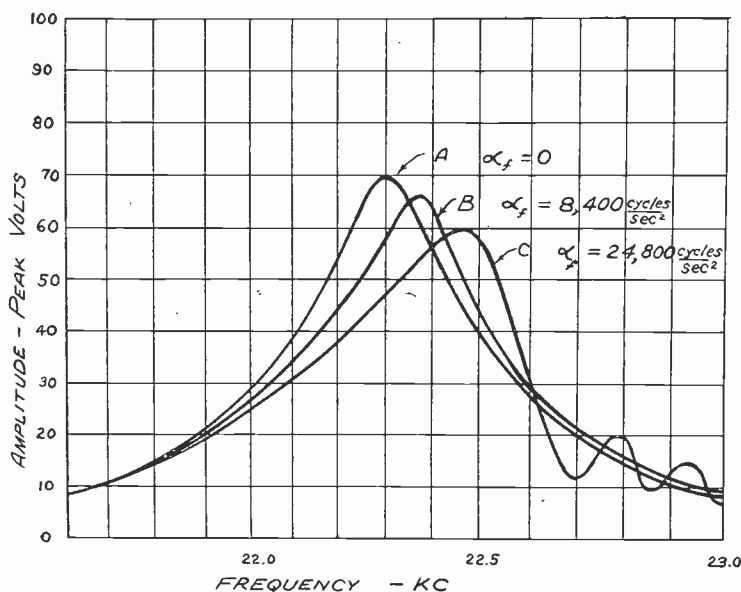

Fig. 8

in calibration, the presence of the secondary maxima would be ruinous to the indications of the sound prism, since they could completely mask the presence of weak components near a strong component. It is, therefore, not feasible to use a system of a single degree of freedom as the selector in the sound prism.

Using several tuned circuits separated by stages of vacuum tube amplification does not eliminate the secondary maxima, since the response curve for such a combination is that of one circuit raised to a power. It was found, however, that a chain of tuned circuits with loose coupling between successive sections could be made to give a narrow response curve without secondary maxima if a sufficient number of sections are used, and this form of selector is therefore used in the sound prism. A wiring diagram of this selector is given in Fig. 9. The width

of the pass band depends upon the resistance in each circuit and upon the amount of coupling, and the necessity for using practical electrical components with reasonable space requirements therefore limits the resolving power attainable with such an electrical selector. Work is being done on a mechanical analog of this selector which will make possible higher resolving power.

Because of the loose coupling between successive sections there is a tremendous drop in energy level from the first to the last section of the selector. Extreme care in the design and construction of the shielding is therefore necessary, and high amplification both preceding and following the selector is required.

Besides causing the secondary maxima to appear more prominently in the transient response curve of a system of a single degree of freedom, increasing the speed of frequency sweep also changes the shape of the primary curve, causing it to become broader, as may be seen in Fig. 8. The transient response curve of the chain of coupled tuned circuits

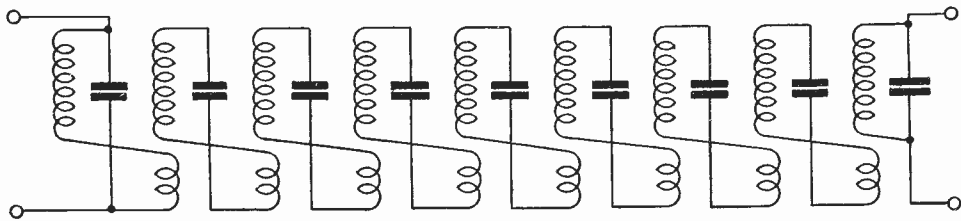

Fig. 9

used in the selector likewise exhibits such a shift and broadening as the speed of sweep is raised. It is therefore important, if maximum resolving power is to be attained, to keep the speed of sweep as low as is consistent with visual perception of the path of the spot of light on the screen as a steady line. Speed of operation and resolving power of a heterodyne analyzer are inextricably interdependent. This interdependence has been investigated by Salinger,²⁰ who states that for reasonable accuracy the inequality $F/\sqrt{\gamma} > 4$ must be satisfied. Here γ is the speed of sweep in cycles per second per second and F is the cut-off frequency of a low-pass filter used as the filter in a zero beat heterodyne analyzer. While Salinger develops this criterion for a zero beat heterodyne analyzer using a low-pass filter, he merely states that it likewise holds good for a heterodyne analyzer having a band-pass filter to pass a high intermediate frequency. The writer does not consider that this criterion is applicable to the selector of the sound prism, although it is recognized that some interdependence certainly does exist. For this case $F/\sqrt{\gamma} = 0.5$ rather than 4. Salinger attacks the problem by assuming that the transmission characteristic of the filter remains unchanged and

applies to it the Fourier integral expression for a sweeping frequency. The resulting response curve is symmetrical about the center of the static pass band, which is at zero cycles in the case he considers. This symmetry is most assuredly not the case with the response curves observed here, for there is a distinct shift of the primary maximum, and the secondary maxima appear on only one side of the curve, the "following" side. As has been pointed out,²¹ the response of a filter to transients depends upon the form of the filter and not only upon its static transmission characteristic. Further work on this question is needed. Since the rigorous mathematical investigation of the transient response of a multisection filter to a sweeping-frequency wave is extraordinarily difficult, it is hoped that the experimental work with the large scale mechanical model mentioned above will throw some light, even though of an empirical nature, on the problem.

Bibliography

- (1) D. C. Miller, "Science of Musical Sounds."
- (2) C. F. Sacia, *Jour. Opt. Soc. Amer.*, vol. 9, p. 487, (1924).
- (3) Helmholtz, "On the Sensations of Tone," Ellis, (1885).
- (4) Rayleigh, "Theory of Sound," (1894).
- (5) Wegel and Moore, *Trans. A.I.E.E.*, vol. 63, p. 457, (1924).
- (6) Grützmaker, *Zeit. für Tech. Physik*, vol. 10, p. 570, (1929).
- (7) Cockcroft, Coe, Tyacke, and Walker, *Jour. I.E.E. (London)*, vol. 63, p. 69, (1925).
- (8) T. Theodorsen and H. Konig, *Phys. Rev.*, ser. 2, vol. 37, p. 1718, (1931).
- (9) Moore and Curtis, *Bell Sys. Tech. Jour.*, vol. 6, p. 217; April, (1927).
- (10) RCA Victor Voltage Analyzer, VE 14.
- (11) Marvin, *Elec. Eng.*, vol. 50, p. 349, (1931).
- (12) Osbon and Oplinger, *Jour. Acous. Soc. Amer.*, vol. 5, p. 37, (1933).
- (13) L. B. Arguimbau, "Wave Analysis," *Gen. Radio Exp.*, vol. 8, nos. 1-2, June-July, (1933).
- (14) E. Meyer, *Zeit. für Tech. Physik*, vol. 12, p. 606, (1931).
- (15) Backhaus and Greifswald, *Zeit. für Tech. Physik*, vol. 13, p. 31, (1932).
- (16) Paget, "Human Speech" p. 86, Harcourt, Brace and Co., London, (1930).
- (17) Ballantine, *Electronics*, vol. 2, p. 472, (1931).
- (18) W. L. Barrow, *Annalen der Physik*, vol. 5, Band 11, Heft 2, October 9, (1931).
- (19) F. M. Lewis, "Applied mechanics," *Trans. A.S.M.E.*, vol. 54, p. 253, (1932).
- (20) H. Salinger, *Elek. Nach. Tech.*, vol. 6, p. 293, (1929).
- (21) Y. Rocard, *L'Onde Elec.*, vol. 11 pp., 295 and 363, (1932).



Discussion on "Resistance Tuning"

SEWALL CABOT

E. W. Herold:¹ The most interesting and novel application of negative resistance to tuning as proposed by Mr. Cabot gives much food for thought. Having done some work with negative resistances during the past year, the writer wishes to make a few comments on the system proposed by Mr. Cabot.

Mr. Cabot suggests, in a typical design, a negative resistance having a value of 5000 ohms with a total shunt capacitance of 10×10^{-12} farads. This writer believes these to be reasonable figures, by no means impossible of attainment. At the date of writing, however, the dynatron method of obtaining negative resistance has not been developed to the point at which a negative resistance of such a value can be obtained with reproducible characteristics unless excessive cathode current be permitted in the dynatron. A more satisfactory device is believed to be one employing negative transconductance as a means of obtaining negative resistance. For example, the type 57 tube using a direct coupled connection between second and third grids permits a reasonably stable negative resistance of as low as 3500 ohms to be obtained with a cathode current of only seven milliamperes and the characteristics are largely independent of secondary emission effects. This application of the type 57 tube has been described in a paper presented before the Washington Section of the Institute on April 9, 1934. The writer is now preparing this paper for publication. There is no commercially available tube, however, which, to the writer's knowledge, fulfills satisfactorily the combined features of screen-grid amplification and negative plate resistance utilized by Mr. Cabot in the pliodynatron which he suggests.

Since the selectivity, the stability, and the gain of the circuit proposed by Mr. Cabot all depend on a relatively small difference between a positive and a negative resistance, the writer does not believe that any negative resistance familiar to him is sufficiently constant to permit satisfactory operation in the circuit of Mr. Cabot. For example, the figures which Mr. Cabot suggests for a practical amplifier are a negative resistance of 5007.7 ohms and a positive resistance of 5000 ohms. A 0.15 per cent reduction in the negative resistance (corresponding to 7.7 ohms) is then sufficient to permit oscillation and smaller changes than this would cause very large changes in the gain and the selectivity. The problem of making any vacuum tube type of negative resistance hold a constant value within 0.1 per cent is analogous to holding the transconductance to this order of stability; by such an analogy, a type 58 tube would be required to hold its transconductance within two micromhos of its original value over a period of time. Such stability is unlikely even if no change in operating conditions be postulated.

It should also be pointed out that the linear analysis used by Mr. Cabot sometimes gives misleading results when applied to neutralization of positive with negative resistance, as has often been observed in regeneration theory. A nonlinear analysis would depart from that of Mr. Cabot at any finite signal voltage to some extent, the departure being the greater the larger the signal. The performance of the system would therefore depend somewhat on signal amplitude and upon the amount of nonlinearity of the negative resistance.

* *Proc. I.R.E.*, vol. 22, pp. 707-731; June, (1934).

¹ RCA Radiotron Company, Inc., Harrison, New Jersey.

The promising features of resistance tuning make it highly desirable that an experimental study of the system be made and it is to be hoped that Mr. Cabot will publish on this point soon.

Sewall Cabot:² It would appear from Mr. Herold's discussion of resistance tuning that the type 57 tube should prove of considerable value in increasing the frequency range and general stability.

My experiments with resistance tuned circuits were conducted largely with ordinary production shield-grid tubes used as dynatrons with cathode currents of the order of about 10 milliamperes, grid polarizing voltages of about 100 volts, and plate polarizing voltages of about 50 volts. Under these conditions the secondary emission from the plate about equaled the primary emission falling on it so the direct-current component of plate current was about zero. The negative resistance attained was limited to values greater than about 10,000 ohms without overheating the tube, and the maximum frequency to which the circuit could be tuned was about 600 kilocycles.

At one extreme of the practical operating negative resistance range of the $\Delta E_p/\Delta I_p$ curve the effective negative resistance tended to decrease with load. This caused instability and a tendency to hang in oscillation once oscillations were started.

At the other extreme, the effective negative resistance tended to increase with load causing the effect of automatic volume control with perfect stability.

In between these two extremes best results were attained. The circuit acted very much like a well-behaved regenerative circuit where it was possible smoothly to adjust toward the floating point, without showing tendency toward instability.

² Brookline, Massachusetts.



DISCUSSION ON "MAINTAINING THE DIRECTIVITY OF ANTENNA ARRAYS"*

F. G. KEAR

Howard S. Stokes:¹ For radio range use, as indicated by Dr. Kear, the successful substitution of insulated tower radiators for the loop antennas was predicated to a great extent on the availability of a highly stable antenna system. The Airways Division (now known as Air Navigation Division) has been studying antenna stabilization as applied to radio ranges and is at present making investigations that include the subject matter of Dr. Kear's paper. In some cases, the Division's conclusions have not been identical with those of Dr. Kear.

Some time ago, we observed, for instance, that connecting a circuit across the mid-points of the hybrid coil secondaries, as indicated in Fig. 14(a) on page 864, results in a loss of most of the stabilizing action. As long as the transmission lines running to the two antennas have the same input impedance, the voltages induced in the secondary windings of both the left and right halves of the hybrid coil equal the voltage drops across these sections. There is thus no voltage across the mid-points of the secondary windings. As soon as one tower becomes detuned, however, a voltage appears across the mid-points of these windings and some current flows through the circuit connected between these points. As uniform current flowing into both lines is essential for stability when using lines having lengths of zero or an integral number of half waves, it can be seen that the current flowing off through the 90-degree artificial line shown on Fig. 14(a) will cause a loss of stability. The zero-length lines referred to consist of transmission lines connected in series with artificial lines having negative phase constants equal to the electrical lengths of the transmission lines. Such lines act just as half wavelength lines, as far as stabilizing action is concerned.

If either of the circuits shown in Fig. 14 were used, only the out-of-phase energy supplied to the towers would be stabilized, and as pointed out above, this stabilization would be only partial if the circuit shown in Fig. 14(a) were used. If an amount of inphase energy sufficient to put the resultant antenna current in quadrature were fed to the towers, the stability of the resultant field pattern would probably be little better than might be expected were no attempt at stabilization made.

The advantage of the hybrid coil where it is desired to employ the antennas "directionally part of the time and nondirectionally the remainder" is rather obscure. If, as one would infer, Dr. Kear refers to transmitting with antennas out of phase part of the time and in phase part of the time, the advantage seems questionable, for the same result may be obtained by simply reversing the connections to one transmission line.

Although we have found a high degree of stabilization essential for dependable radio range signals, the necessity for elaborate measures to obtain stabilization in the broadcast band appears rather doubtful. The tower radiators used at radio range stations have a capacitative reactance at their average operating frequency of something like 700 ohms, while the antenna circuit resistance is

* Proc. I.R.E., vol. 22, no. 7, pp. 847-869; July, (1934).

¹ Air Navigation Division, Bureau of Air Commerce, Department of Commerce, Washington, D. C.

about six ohms—roughly a ratio of reactance to resistance of one hundred to one. Tower radiators as used in broadcasting, however, have reactances and resistances that are generally of the same order of magnitude, and, consequently, under these conditions, a certain percentage change of reactance may be expected to result in a much smaller effect. Our experience seems to indicate that rain and snow cause the severest detuning normally encountered. During a moderately heavy rain, we have found that the capacity of the tower to ground increases about one-half of one per cent, while during a very heavy rain, it may increase as much as one and one-half per cent. The phase shift between antenna currents that might be expected in various simple directive arrays has been calculated for circuit constants encountered in the broadcast band. With the antennas fed in quadrature (one 45-degree and one 135-degree line), which is the most unstable condition to which it is necessary to resort in obtaining the desired patterns, the worst phase shift likely to be caused by a very heavy rain would be about three degrees. It would seem that such a shift, occurring as it does infrequently, except possibly in a very few areas, would not be particularly objectionable.

Frank G. Kear:² Mr. Stokes' comments are of particular interest since he has had considerable experience in the installation and adjustment of the phase control system as applied to the Department of Commerce radio range beacon stations.

It is true that the hybrid coil arrangement is unsatisfactory in many ways. When used with lines which are an even number of quarter waves long, however, phase stability can be secured. Since frequently only a small amount of inphase component is required, the loss in stability due to failure to stabilize this component is not very great. Where cardioid patterns are desired for broadcast station work, an entirely different arrangement is employed without the use of a hybrid coil, and a considerable improvement in stability is secured over the usual excitation method. On the other hand, cardioid patterns for airways use can be produced with hybrid coils and, theoretically perfect *course* stability secured since the point at which course indications are obtained is still controlled although the maxima and minima may shift.

In so far as the directional-nondirectional feature is concerned, the use of concentric lines and unbalanced-to-ground coupling transformers makes it very unwise to reverse the connections of one line. As the airways habitually employ two-wire lines, this detail no doubt has not come to Mr. Stokes' attention.

No doubt certain types of broadcast station antennas do possess a reasonably high degree of inherent stability. However, many of the stations now in operation, especially those using the lower frequencies, have a large amount of loading at the base of the antennas, making their stability comparable to that of the range beacon towers. When it is mandatory that the minimum field in an interference zone be maintained, as is the usual condition for broadcast directive antennas, it seems that it is highly essential that every known means be employed to insure the constancy of this minimum. Hence, I am forced to disagree with the conclusion of Mr. Stokes in his last paragraph.

² Washington Institute of Technology, Washington, D. C.



BOOK REVIEWS

Electrical Communication, by Arthur L. Albert. John Wiley and Sons, New York City. 440 pages. Price \$5.00.

To attempt in some 400 pages to do justice to the title of the book is an ambitious undertaking. It is evident that, if the subject is to be treated without slighting any of its many ramifications, the amount of detail presented on any one topic must necessarily be limited. The book is therefore not to be considered as a complete encyclopedia on the subject, nor should the reader look for the unusual in method of presentation or great originality in subject matter.

As indicated by the author in his preface, it is intended to be very general in its scope and well balanced in subject matter. It is prepared for use as a college textbook or for the average educated person who may be interested in the art as a whole rather than any specialized line. This objective has been satisfactorily attained.

Possibly radio engineers will be disappointed to find the chapter "Wireless Communication" only about 35 pages long, but the groundwork for a fairly comprehensive understanding of this subject has been laid by such chapters as "Electrical Fundamentals of Communication," "Receivers and Loudspeakers," "Networks and Electric Wave Filters," and "Electron Tube Theory."

The book is thoroughly up to date; in fact, the material consists chiefly of well-chosen abstracts of papers, essays, etc., on the subject, largely published within the last decade. It is replete with references from the original sources, so that one whose appetite is whetted by what he reads may delve into individual items more deeply. By far the most numerous sources of information are Bell System publications. Perhaps the volume could be more fairly titled "Electrical Communication in the United States," for there are very few references to foreign contributions.

The typography and illustrations are of a high class, and, so far as the reviewer could determine, very few errors are present. Attributing the term "audion" to Fleming, on page 333, is a slip-up which is evidently not characteristic of the volume as a whole.

*H. A. AFFEL

Motor and Generator Standards, price \$2.00.

Carbon, Graphite and Metal-Graphite Brush Standards, price 25 cents.

Laminated Phenolic Products Standards, price 25 cents.

Published by the National Electrical Manufacturers Association, New York City.

NEMA is the National Electrical Manufacturers Association, the organization of electrical manufacturers formed by the merger of the Associated Manufacturers of Electrical Supplies and the Electric Power Club. It takes the place in the industry of these two named organizations and of the Electrical Manufacturers Council, the oldest of which was organized in 1908.

"NEMA Standards and Practices" represent the result of many years' re-

* American Telephone and Telegraph Company, New York City.

search and investigation by this organization, its predecessors, their Sections and Committees.

The "NEMA Motor and Generator Standards" is a reference work of practical information concerning the manufacture, test, and performance of the smaller alternating- and direct-current motors and generators. This book, representing, as it does, standardized practice in the United States, assists in harmonizing practices in the industry, promotes production economies, and assists in the proper selection of electric motors and generators.

The "NEMA Carbon, Graphite and Metal-Graphite Brush Standards" is a reference work of practical information concerning the manufacture, dimensions and definitions of brushes. These standards cover a range sufficiently wide to enable the designer to select brushes suitable for any type of equipment.

The "NEMA Laminated Phenolic Products Standards" is a reference work of practical information concerning the manufacture, test, and performance of laminated phenolic plates, tubing, and rods used in the manufacture of electrical apparatus and supplies.

Anyone interested in the installation or repair of electrical machinery will do well to consult these publications.

*R. R. RAMSEY

Thermionic Emission, by Arnold L. Reimann, Research Laboratories of the General Electric Co., Ltd., Wembley, England. Published by John Wiley & Sons, Inc., New York. 324 pages. Price \$5.00.

Dr. Reimann has produced an excellent study of the modern theory of electron emission and its experimental basis. The book serves as a landmark in its field, and may be compared only with Richardson's "The Emission of Electricity from Hot Bodies" the first edition of which was published in 1916, and Dushman's survey in "Reviews of Modern Physics" October, 1930.

Dr. Reimann's book, written from the critical viewpoint, surveys briefly the older experiments and theory but gives its main attention to the modern work along these lines. This results naturally in occasional conclusions unacceptable to some but interesting nevertheless.

Chapter I is a general survey of the field. Chapters II, III, and IV deal with clean metals, contaminated metals, and oxide cathodes, respectively. Chapter V relates to modern mathematical theory and Chapter VI to the emission of ions.

Bibliographies are given at the end of each chapter. Publication dates of the references are included in the bibliographies, but if included in the text or in footnotes, would have simplified the use of the book and presented the picture more readily.

†B. E. SHACKELFORD

Servicing Superheterodyne, by John F. Rider, 1934 (revised edition), 278 pages, published by the author, New York. Price \$1.00.

This book is intended primarily as a brief manual to assist radio service men in servicing the current superheterodyne models of radio broadcast receivers. It contains a great variety of data which should be valuable in this kind of work. There is an easily understood discussion of superheterodyne principles and circuits. Many partial and several complete circuit diagrams are included

* Indiana University, Bloomington, Indiana.

† RCA Radiotron Company, Inc., Harrison, New Jersey

by way of illustration. Special attention is given to the many recent improvements in tubes and circuits. One chapter is devoted to simple rules for troubleshooting. A good share of the data has been obtained on superheterodyne receivers of very recent design and manufacture, so that the book is recommended for its up-to-date general information.

*HAROLD A. WHEELER

Earth, Radio and the Stars, by Harlan True Stetson, Research Associate in Geophysics, Harvard University. Published by Whittlesey House, McGraw-Hill Book Co., Inc., New York. 336 pages. Price \$3.00.

Recent research including much of the author's own work in the fields of astronomy, geology, and radio are brought together and presented in an interesting and readable book.

The importance of the moon is discussed at some length with reference to variations in latitude, longitude, and radio reception. The radio engineer may be surprised at the pronounced relation which the author finds between the moon and radio reception. In one instance the author shows an eleven-to-one change in radio field intensity as related to the hour angle and declination of the moon.

Chapters on earth and ocean tides are included while one chapter is given to theories concerning the structure of the interior and crust of the earth.

Four chapters are allotted to discussion of the sun and sun spots with the observed effects on human affairs, the earth's magnetism, the ionosphere, and radio reception.

The effects of solar eclipses and meteors on radio reception are also considered.

In one of the early chapters the author discusses the greater distance obtained in radio reception at night over that obtained during the day. An increase in height of the reflecting layer is shown diagrammatically to account for the difference. The fact that the importance of absorption is not discussed at length until a later chapter may serve to confuse the reader somewhat on this point.

In the final chapters the author discusses radio and the stars, illuminations of the night sky, cosmic clouds, and cosmic rays. "Cosmecology" is suggested as a new word to denote the science that "brings together the various avenues of approach to a fuller knowledge of the earth in its relation to the cosmic scheme in which our planet is placed."

The book is abundantly illustrated with curves and photographs and contains a bibliography at the end.

†T. R. GILLILAND

* Hazeltine Service Corporation, Bayside, L. I., New York.

† National Bureau of Standards, Washington, D. C.



CONTRIBUTORS TO THIS ISSUE

Bedford, A. V.: Born January 6, 1904, at Winters, Texas. Received B.S. degree in electrical engineering, University of Texas, 1925; M.S. degree in electrical engineering, Union College, 1928. Test department and research laboratory, General Electric Company, 1925-1930; engineering department, RCA Victor Company, Inc., 1930 to date. Associate member, Institute of Radio Engineers, 1931.

Carlson, Wendell L.: Born 1897 at Jamestown, New York. Graduated Bliss Electrical School, 1918. Associate in radio receiver development for the Navy as a civilian, Washington Navy Yard, 1918-1923; radio engineering department, General Electric Company, 1923-1930. Received Charles A. Coffin award, General Electric Company, 1925, for accomplishments in superheterodyne development; engineering department, RCA Victor Company, Inc., 1930 to date. Associate member, Institute of Radio Engineers, 1919.

Engstrom, E. W.: Born August 25, 1901, at Minneapolis, Minnesota. Received B.S. degree in electrical engineering, University of Minnesota, 1923. Radio engineering department, General Electric Company, 1923-1930; engineering department, RCA Victor Company, Inc., 1930 to date. Associate member, Institute of Radio Engineers, 1925.

Holmes, R. S.: Born May 26, 1902, at Murray, Nebraska. Received B.S. degree in electrical engineering, University of Nebraska, 1923. Radio engineering department, General Electric Company, 1923-1930; engineering department, RCA Victor Company, Inc., 1930 to date. Associate member, Institute of Radio Engineers. 1925.

Kell, R. D.: Born June 7, 1904, at Kell, Illinois. Received B.S. degree in electrical engineering, University of Illinois, 1926; postgraduate work, University of Illinois, 1926-1927. Assistant in Alexanderson's radio laboratory, Schenectady, New York, 1927-1930; RCA Victor Company, Inc., 1930 to date. Nonmember, Institute of Radio Engineers.

Schuck, O. H.: Born September 20, 1909, at Philadelphia, Pennsylvania. Received B.S. degree in electrical engineering, Moore School of Electrical Engineering, University of Pennsylvania, 1931; received M.S. degree in electrical engineering, 1932. Commercial research, 1932-1933; engineering department, International Resistance Company, 1933 to date. Member, Eta Kappa Nu, Tau Beta Pi, Sigma Tau, Sigma Xi, and A.I.E.E. Nonmember, Institute of Radio Engineers.

Tolson, W. A.: Born November 2, 1896, at San Angelo, Texas. Received B.S. degree in electrical engineering, Texas A. and M., 1923. Radio engineering department, General Electric Company, 1923-1930, engineering department, RCA Victor Company, Inc., 1930 to date. Member, Institute of Radio Engineers, 1928.

Trainer, M. A.: Born July 25, 1905, at Philadelphia, Pennsylvania. Received B.S. degree in electrical engineering, Drexel Institute, 1927. Assistant in Alexanderson's radio consulting laboratory, General Electric Company, 1927-1930; engineering department, RCA Victor Company, Inc., 1930 to date. Nonmember, Institute of Radio Engineers.

Young, Charles J.: Born 1899. Received A.B. degree, Harvard University, 1921; additional work in electrical engineering, Harvard Engineering School, 1922. Radio engineering department, General Electric Company, 1922-1929; RCA Victor Company, Inc., 1930 to date. Nonmember, Institute of Radio Engineers.





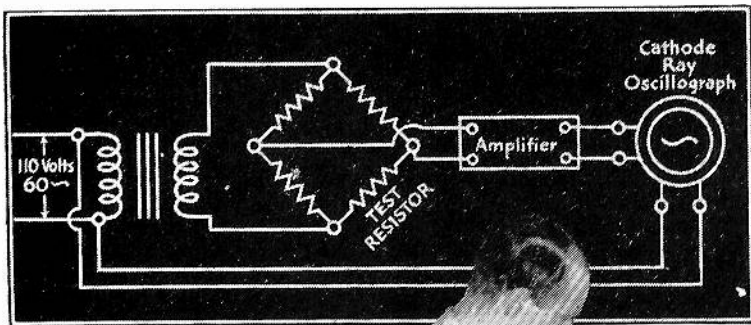

The oscillograms shown below were made with a cathode ray oscillograph. The circuit diagram is shown at the left. Constant test conditions were maintained for the three tests, the only change being the insertion of test units of identical resistance in the arm of the bridge marked "test resistor".

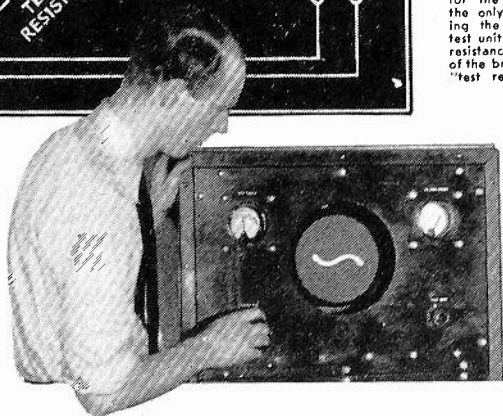

VOLTAGE CHARACTERISTIC TESTS

—that reveal the inherent superiority of Allen-Bradley Radio Resistors

Actual Oscillograms

The following oscillograms, produced with a cathode ray oscillograph, show graphically the superiority of Allen-Bradley fixed resistors over ordinary resistance units. All tests were made under identical conditions of resistance, voltage, amplification, etc.



No. 1 — This oscillogram shows the constancy of resistance with varying potentials across the terminals of a wire-wound type of resistor, using an alternating E.M.F. Note how closely oscillogram No. 3 of an Allen-Bradley resistor approximates this performance.



No. 2 — This oscillogram shows the wide changes of resistance with variations in voltage obtained in testing an average composition unit; note how inferior is its performance when compared with the Allen-Bradley fixed resistor as shown in oscillogram No. 3.



No. 3 — This oscillogram shows the small variation of resistance with varying voltage with an Allen-Bradley composition fixed resistor when an alternating E.M.F. is applied. Note how closely the Allen-Bradley resistor approximates the performance of a wire-wound resistor.

Allen-Bradley radio resistors have an exceptionally low voltage coefficient. As every radio engineer knows, if the inspection tests of suppliers and users of radio resistors are made with differing potentials across the resistors, wide discrepancies occur unless the units under test possess low voltage characteristics. Allen-Bradley resistors, of the order of 1 megohm, show variations in resistance of not more than 1½% between the zero voltage and the maximum or peak voltage of the cycle, whereas average resistors of the same resistance show changes exceeding 2½ times the Allen-Bradley values.

What LOW Voltage Coefficients mean to your receivers

A low voltage characteristic reflects the inherent quality of the fixed resistor and is an indication of the stability of resistance with age. It usually indicates a minimum of microphonic disturbance, a factor of increasing importance in high fidelity receivers.

In applications where large audio voltages exist across resistors, it is necessary that the resistors have low voltage characteristics to minimize the introduction of harmonics which result from the variation of resistance under varying audio voltages. For the best performance of your receivers, specify Allen-Bradley fixed resistors.

ALLEN-BRADLEY CO
116 W. Greenfield Ave., Milwaukee, Wis.

ALLEN-BRADLEY RESISTORS

FIXED RESISTORS • VARIABLE RESISTORS • SPARK PLUG SUPPRESSORS

When writing to advertisers mention of the PROCEEDINGS will be mutually helpful

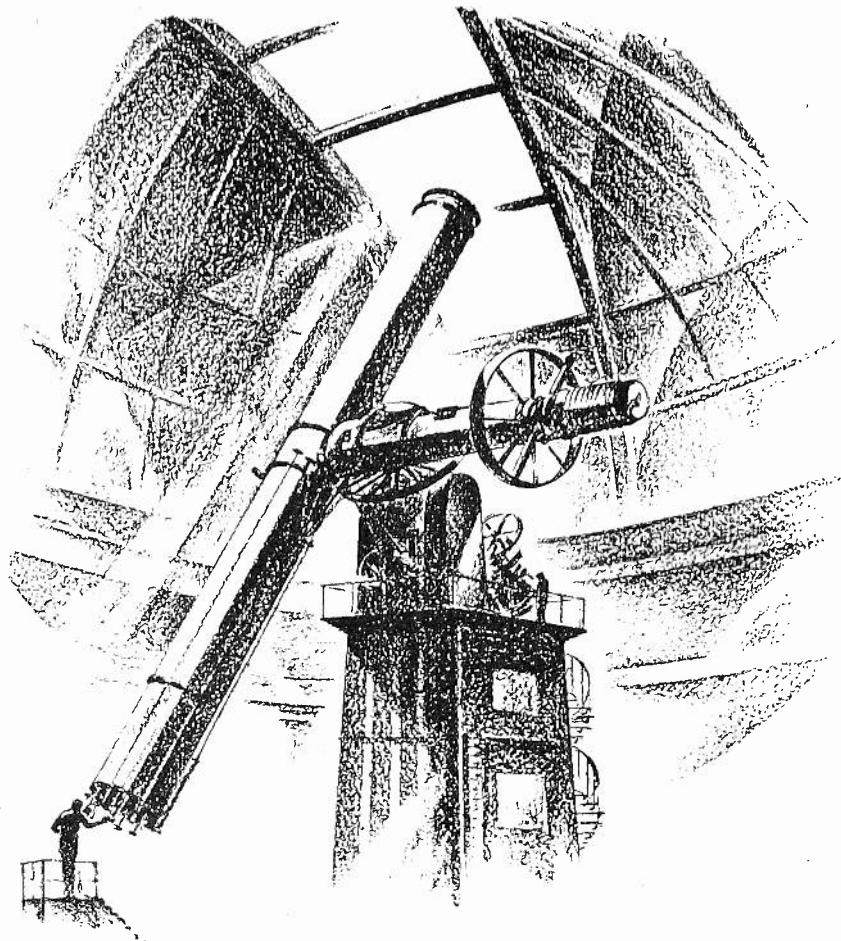

V I S I O N

For centuries, man looked upward to the stars for new worlds of knowledge. Today radio science offers a realm of research equally broad and rich!

Engineers of the Hygrade Sylvania Corporation hold a leading position in the exploration of this new field. Hygrade Sylvania first pioneered in the development of the more efficient 6.3 volt tubes. And recently, this com-

pany established a complete new plant for similar development in the fields of broadcasting and electronics.

Set manufacturers are invited to write for engineering consultation on circuit and design problems. The facilities of Hygrade Sylvania are placed at your disposal without cost or obligation. Hygrade Sylvania Corporation, Emporium, Pa.

Sylvania
(Reg. U. S. Pat. Off.)



THE SET-TESTED RADIO TUBE

© 1933, H. S. C.

When writing to advertisers mention of the PROCEEDINGS will be mutually helpful.

**MORE IMPORTANT THAN
ANY MATERIAL THING**



MORE important than millions of telephones and millions of miles of wire is the fundamental policy of the Bell System. It is founded on a spirit of fair dealing with the public, with employees and with those who have invested their money in the business.

• • •

“The fact that the responsibility for such a large part of the entire telephone service of the country rests solely upon this Company and its Associated Companies also imposes on the management an unusual obligation to the public to see to it that the service shall at all times be adequate, dependable and satisfactory to the user. Obviously, the only sound policy that will meet these obligations is to continue to furnish the best possible telephone service at the

lowest cost consistent with financial safety. This policy is bound to succeed in the long run and there is no justification for acting otherwise than for the long run. . . .

“Earnings must be sufficient to assure the best possible telephone service at all times and to assure the continued financial integrity of the business. Earnings that are less than adequate must result in telephone service that is something less than the best possible. . . . The margin of safety in earnings is only a small percentage of the rate charged for service, but that we may carry out our ideals and aims it is essential that this margin be kept adequate. . . . This is fundamental in the policy of the management.”

Quoted paragraphs from an address by Walter S. Gifford, president of the American Telephone and Telegraph Company, at Dallas, October 20, 1927.

BELL TELEPHONE SYSTEM



When writing to advertisers mention of the PROCEEDINGS will be mutually helpful



AEROVOX makes all three ... and Everything in Between

ELECTROLYTIC, paper, mica ... from smallest to largest ... all types ... all voltages and capacities. Also complete line of resistors ... carbon and wire-wound vitreous-enamel coated ... fixed and adjustable ... all wattages and resistance values.

ELECTROLYTICS

Aerovox offers hermetic sealing, preventing loss or absorption of moisture ... metal can containers for better dissipation of internal heat ... special composition spacers for safety against surge voltages and for longer life ... all internal parts of aluminum to eliminate corrosion. In all sizes, can styles, capacities, combinations. Also in cardboard case and tubular form. Choice of mountings.

No matter what your requirements, Aerovox can meet them ... meet them with better products ... more advanced engineering ... and right prices. Insist on Aerovox ... in yellow and black cartons ... with guarantee slip.

PAPER

Aerovox offers higher safety factor with more liberal use of highest grade linen paper dielectric ... thorough impregnation under vacuum ... and in oil-filled units bathed in oil after thorough dehydration, with no air pockets in proximity to sections, an effective heat-dissipating circulation of oil through the section for maximum safety and life ... thorough sealing and no leakage.

MICA

Aerovox offers highest grade mica and tinfoil sections thoroughly impregnated prior to molding in genuine bakelite ... positive sealing and protection against extreme temperature, moisture and chemical action ... finest dielectric India ruby mica for generous margin of safety ... small cal action ... finest dielectric physical dimensions. In several styles and voltage ratings ... all standard capacities.

SEND FOR DATA on any and all types of condensers as well as resistors in which you may be interested. Also sample copy of the Aerovox Research Worker ... a monthly engineering service ... the cream of the crop of practical data.



AEROVOX

C O R P O R A T I O N

71 Washington Street

»

«

Brooklyn, N.Y.

When writing to advertisers mention of the PROCEEDINGS will be mutually helpful

The Institute of Radio Engineers

Incorporated

330 West 42nd Street, New York, N.Y.

APPLICATION FOR ASSOCIATE MEMBERSHIP

(Application forms for other grades of membership are obtainable from the Institute)

To the Board of Directors
Gentlemen:

I hereby make application for Associate membership in the Institute of Radio Engineers on the basis of my training and professional experience given herewith, and refer to the members named below who are personally familiar with my work.

I certify that the statements made in the record of my training and professional experience are correct, and agree if elected, that I will be governed by the constitution of the Institute as long as I continue a member. Furthermore I agree to promote the objects of the Institute so far as shall be in my power, and if my membership shall be discontinued will return my membership badge.

.....
(Sign with pen)

.....
(Address for mail)

.....
(Date)

.....
(City and State)

Sponsors:

(Signature of references not required here)

Mr. Mr.
Address Address
City and State City and State

Mr.
Address
City and State

The following extracts from the Constitution govern applications for admission to the Institute in the Associate grade:

ARTICLE II—MEMBERSHIP

Sec. 1: The membership of the Institute shall consist of: * * * (c) Associates, who shall be entitled to all the rights and privileges of the Institute except the right to hold any elective office specified in Article V. * * *

Sec. 4. An Associate shall be not less than twenty-one years of age and shall be a person who is interested in and connected with the study or application of radio science or the radio arts.

ARTICLE III—ADMISSION AND EXPULSIONS

Sec. 2: * * * Applicants shall give references to members of the Institute as follows: * * * for the grade of Associate, to three Fellows, Members, or Associates; * * * Each application for admission * * * shall embody a full record of the general technical education of the applicant and of his professional career.

ARTICLE IV—ENTRANCE FEE AND DUES

Sec. 1: * * * Entrance fee for the Associate grade of membership is \$3.00 and annual dues are \$6.00.

ENTRANCE FEE SHOULD ACCOMPANY APPLICATION

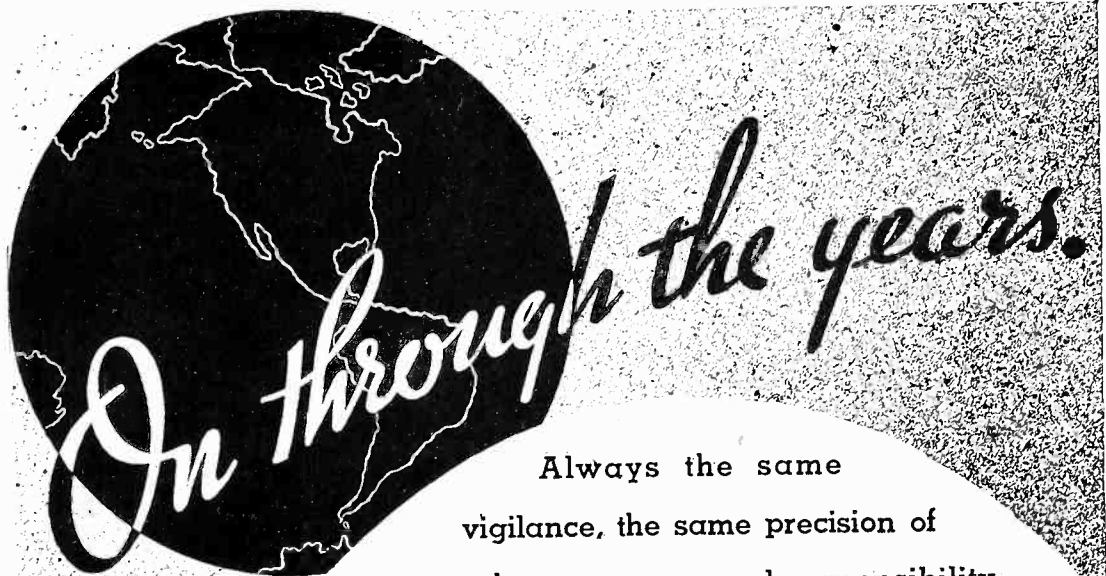

Always the same
vigilance, the same precision of
test, the same personal responsibility.

One condenser . . . one billion condensers. A
quest for greater perfection . . . for the condenser that
will never be built.

The factory . . . laboratories . . . a gigantic machine,
speeding its tiny units to the far corners of the globe.
Oil . . . paper . . . mica . . . electrolytics . . . to wherever
the quality of a condenser plays a part in the indus-
trial whole.

⊗ *Write for our latest technical data
prepared especially by the research
division to help you solve your con-
denser problems. Our engineering
staff is at your service.*

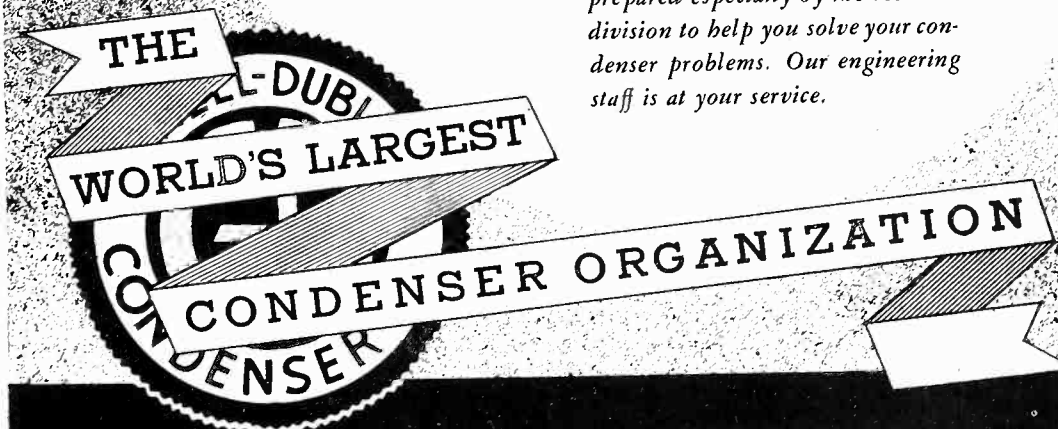

CORNELL-DUBILIER
CORPORATION

4379 BRONX BOULEVARD • NEW YORK

When writing to advertisers mention of the PROCEEDINGS will be mutually helpful

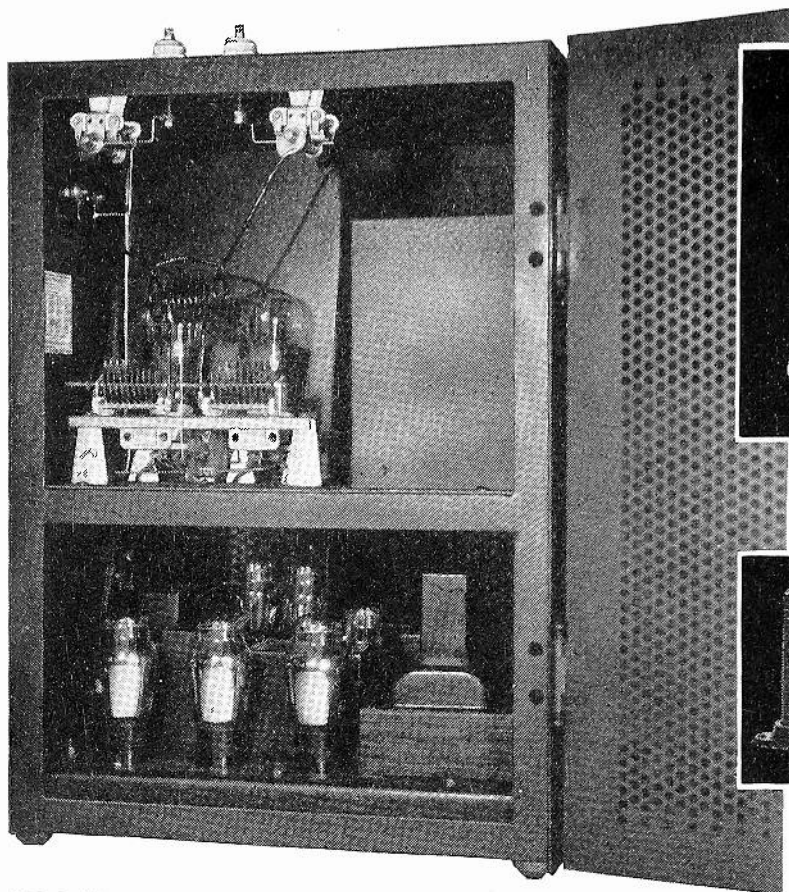

RCA Victor "Terra-Wave"—Ultra-short-wave Police telephone and telegraph transmitter, type ET-5004, using ISOLANTITE insulation.

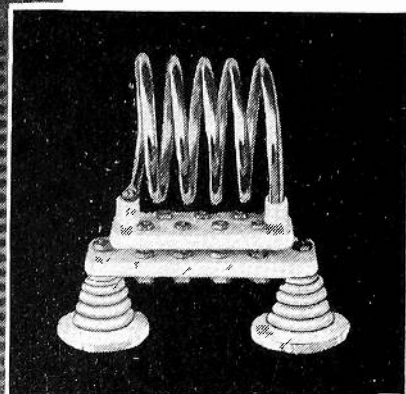

Short-wave power coils by Premier Crystal Laboratories are insulated with ISOLANTITE.

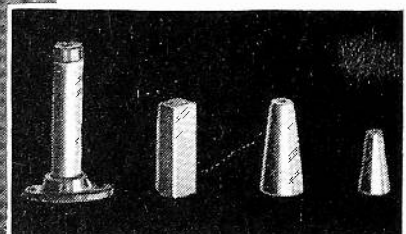

Standard ISOLANTITE stand-off insulators used in transmitter construction.

Dependability Must Be There!

The new and rapidly developing field of Police Radio Communication—indispensable for curbing criminal activity—requires extreme dependability in transmitter construction. That is why manufacturers of police and other short-wave radio communication equipment employ ISOLANTITE insulation.

ISOLANTITE coil supports, stand-off insulators, tube sockets and bases, and many other elements too numerous to mention, are contributing daily to these exacting requirements.

For dependability and precision, specify ISOLANTITE insulation. Write for a copy of our Bulletin 100-F giving full details.

Isolantite Inc.

Factory at Belleville, N. J.

NEW YORK SALES OFFICE: 233 BROADWAY

When writing to advertisers mention of the PROCEEDINGS will be mutually helpful

FIELD TESTED FOR TWO YEARS...

ANNOUNCED TODAY!

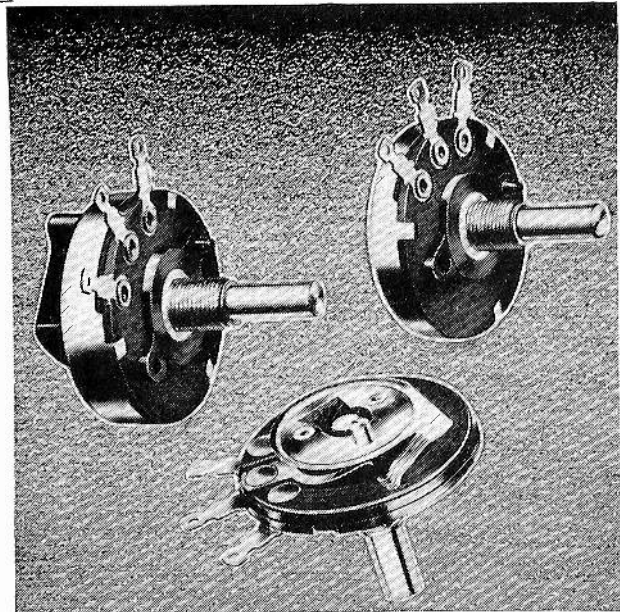

VOLUME CONTROLS

IRC Volume Controls are a logical development of the IRC method of applying resistance coatings to insulating bases, used so successfully for years in the well-known Metallized resistors.

Nor is this their only recommendation. For two years prior to this general announcement, they have seen extensive service under all conditions of use in radio receivers produced by various manufacturers. Constantly increasing orders from these same firms tell their own story of quality coupled with sound economy.

The IRC Volume Control is especially designed to resist humidity. The resistance coating is permanently bonded at a high temperature, to a hard, moisture-proof base. Contact is made by three slider fingers that always follow the same course and which positively eliminate any jumps in resistance due to shifting of the points of contact. Wear is reduced to a minimum.

Write for Catalog M-26 describing this new IRC development in detail.

INTERNATIONAL RESISTANCE CO.

2100 ARCH ST.

PHILADELPHIA, PA.

In Canada, 187 Duchess St., Toronto, Ont.



BY THE MAKERS OF METALLIZED, PRECISION AND POWER WIRE WOUND RESISTORS

When writing to advertisers mention of the PROCEEDINGS will be mutually helpful

CHANGE IN MAILING ADDRESS OR BUSINESS TITLE

Members of the Institute are asked to use this form for notifying the Institute office of a change in their mailing address or the listing of their company affiliation or title in the Year Book.

The Secretary,
THE INSTITUTE OF RADIO ENGINEERS,
330 West 42nd Street,
New York, N.Y.

Dear Sir:

Effective please note change in my address
(date)

for mail as follows:

FROM

.....
(Name)

.....
(Street Address)

.....
(City and State)

TO NEW ADDRESS)

.....
(Street Address)

.....
(City and State)

Please note following change in my Year Book listing.

.....
(Title)

.....
(Company Name)

.....
(Company Address)

Two More Proofs of BALANCED PERFORMANCE

of ERIE RESISTORS

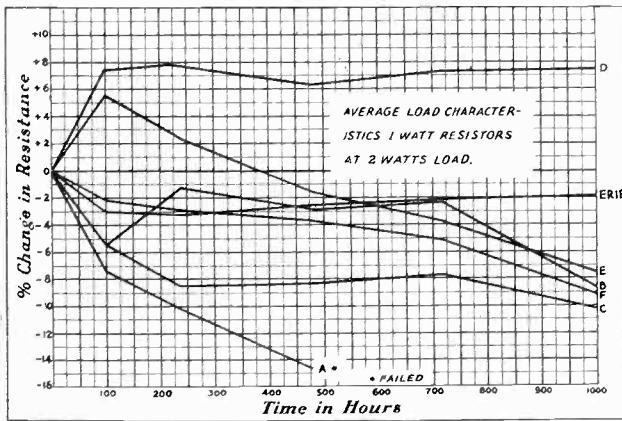
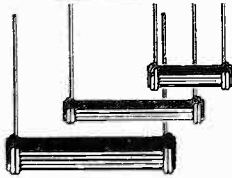
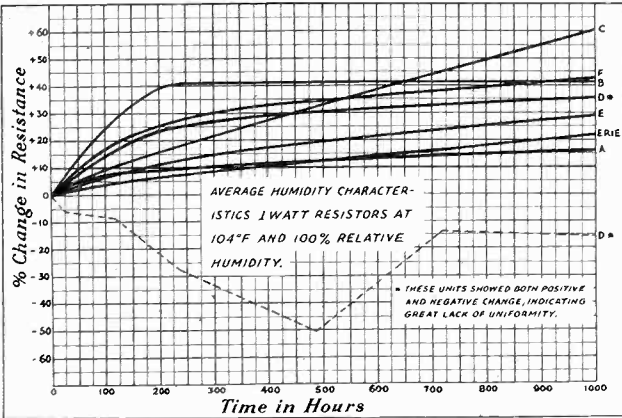

The second of a series of advertisements dealing with the balanced performance of Erie Resistors. Watch for number three.

Take a few minutes to study these load and humidity test charts. They show two more reasons why Erie Resistors are the only make that gives all-round performance that is so essential to efficient set operation.

Note, for example, that Resistors "A" have a slightly lower humidity change than the Erie Resistors tested. But see their relative positions in the load test chart—Resistors "A" have next to the highest change in resistance value of the seven competitive makes, while the Erie Resistors maintain their uniformly superior position.

Last month we showed the same comparative results in two other characteristics—voltage coefficient and temperature coefficient.

It is because of the lack of uniformity in the various characteristics of many makes of resistors that we say "Check Everything" before you approve or buy any resistors.

ERIE RESISTOR CORPORATION

ERIE, PA.

Factories in ERIE, PA. - TORONTO, CANADA - LONDON, ENG.

When writing to advertisers mention of the PROCEEDINGS will be mutually helpful

RADIO AND SCIENTIFIC LITERATURE

● *Rider's Manuals*
**THE
 "STANDARD"
 OF THE
 RADIO
 INDUSTRY**

Engineers—Research Laboratories—
 Technical Schools—Colleges—Broad-
 casting Stations—all—who require in-
 formation about the electrical struc-
 ture and components of American
 radio receivers produced during the
 past 14 years, turn to Rider's Man-
 uals.

The world's most complete compila-
 tion of information pertaining to
 American radio receivers. Absolutely
 authentic.

Now available in four volumes totaling
 more than 4000 pages. Up to date to
 March 1934.

Write for descriptive literature

JOHN F. RIDER, Publisher
 1440 Broadway New York City

PUBLISHERS

●
 This Radio and Scientific
 Literature page is run to help
 you acquaint the readers of
 the Proceedings with your
 radio and technical publica-
 tions.

For further information as
 to rates, etc., address:—

●
 Advertising Department
 Institute of Radio Engineers
 330 West 42nd Street
 New York, N.Y.

Alphabetical Index to Advertisements

	A	
Aerovox Corp.		X
Allen-Bradley Co.		VII
American Tel. & Tel. Co.		IX
	C	
Central Radio Laboratories		XXII
Cornell-Dubilier Corp.		XIII
	E	
Erie Resistor Corp.		XVII
	G	
General Radio Co.		Outside Back Cover
	H	
Hygrade Sylvania Corp.		VIII
	I	
Iliffe & Sons, Ltd.		XX
International Resistor Co.		XV
I.R.E.		XI, XII, XVI, Inside Back Cover
Isolantite Inc.		XIV
	P	
Professional Eng. Directory		XIX
	R	
Radio and Scientific Literature		XVIII
	T	
Triplett Elec. Inst. Co.		XXI

When writing to advertisers mention of the PROCEEDINGS will be mutually helpful

PROFESSIONAL ENGINEERING DIRECTORY

BLILEY ELECTRIC CO.

*Designers and Manufacturers
of*

QUARTZ CRYSTALS

for

Standard or Special Requirements

226A Union Station Bldg.
ERIE, PENNA.

**Cathode Ray Tubes
and Associated
Equipment For All
Purposes**

*Write for Complete
Technical Data*

ALLEN B. DUMONT
LABORATORIES
UPPER MONTCLAIR, N.J.

PRACTICAL RADIO ENGINEERING

One year Residence Course
Advanced Home Study Course
Combined Home Study-Residence
Course

Write for details

Capitol Radio Engineering
Institute
Washington, D.C.

E. F. JOHNSON COMPANY WASECA, MINNESOTA, U. S. A.

Designers and Manufacturers of
Radio Transmitting Equipment in-
cluding:

Tank Circuit Inductors and Capacitors
R. F. Impedance Matching Networks
Harmonic-Reduction Filters
Antenna Coupling Systems
Artificial Lines and Building-Out Sections
for Antenna Phase Control

Write for complete information

For the Engineering Consultant

who can handle a little extra business this year

For the designer

who can manage some additional work

For the Patent Attorney

who is anxious to develop a larger clientele

we suggest the Professional Engineering Directory of the PROCEEDINGS I.R.E. Manufacturers and organizations with special problems who need services such as yours come to the Professional Engineering Directory for information. Your name and special services announced here will tell them what you do and where to find you. Further information will be furnished on request. Special rates to members of the Institute.

When writing to advertisers mention of the PROCEEDINGS will be mutually helpful

RECORDING RADIO RESEARCH...

"The Wireless Engineer" is a monthly journal solely devoted to the interests of advanced amateur experimenters and professional wireless engineers.

It is Great Britain's acknowledged medium for the publication of authoritative scientific and technical wireless information.

"The Wireless Engineer" is an essential companion to the I.R.E. Proceedings. It devotes 25 pages each month to a comprehensive summary of technical radio articles appearing in current publications all over the world, and gives an annual index to every abstract.

MONTHLY
2/6 net.

Foreign
Subscription
£1. 12. 0.
per annum,
post free

THE WIRELESS ENGINEER

AND
EXPERIMENTAL WIRELESS
A Journal of Radio Research and Progress

Published By
ILIFFE & SONS, LTD., Dorset House, Stamford St., London, S. E. 1, England

When writing to advertisers mention of the PROCEEDINGS will be mutually helpful

TODAY'S
Most Modern
Precision
Measuring
Instruments

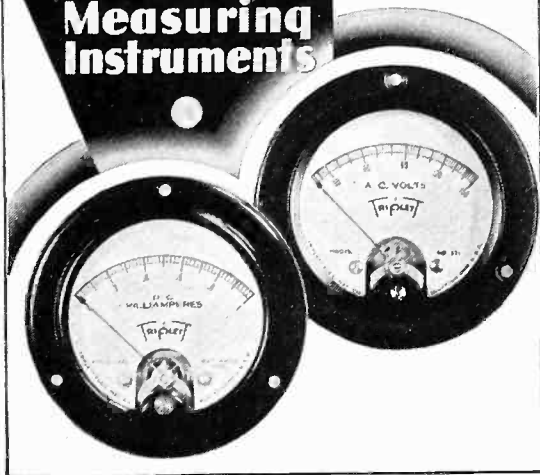

WHEN selecting your instruments for use in radio circuits you eliminate all guess work when you specify Triplet. There is a Triplet instrument for every radio application, designed for your particular needs. Your transmitter circuits should have Triplet instruments for best operating results, appearance and all-around efficiency.

D. C. Triplet instruments are of the moving coil type; A. C. Triplet instruments are of the repulsion iron type. Expertly designed. Craftman-

ship unsurpassed. Bakelite and metal cases—2", 3", 5" round panel styles. Also rectangular square and fan styles. Portable 3" have tilting scales; 5" have mirror scales.

Ultra sensitive instruments for special and standard applications; relays for low current operation; thermo-couple for high frequency; rectifier type for sensitive A.C. measurements. Every modern application where good instruments are required.

Consult your jobber for all standard instruments. Send your inquiries to

**THE TRIPLET
 ELECTRICAL
 INSTRUMENT
 COMPANY**

100 Main Street
BLUFFTON, OHIO



MAIL TODAY FOR DETAILS !

Triplet Electrical Instrument Company
 100 Main Street
 Bluffton, Ohio

Gentlemen:

Please send your latest literature on Triplet Instruments.

Name

Address

City

When writing to advertisers mention of the PROCEEDINGS will be mutually helpful



Not alone in the various complicated phases of commercial and broadcast radio, but in dozens of other fields CENTRALAB Controls play an important part . . . in mining, surveying, navigation, surgery, aeronautics, optometry, dentistry, scientific research, etc., a thousand and one electronic devices depend upon CENTRALAB for smooth performance.

CENTRAL RADIO LABORATORIES : MILWAUKEE



Centralab
CRL

When writing to advertisers mention of the PROCEEDINGS will be mutually helpful

MEMO

SUBJECT: Rochester Fall Meeting.

DATE: November 12, 13, 14, 1934.

PLACE: Sagamore Hotel, Rochester,
N. Y.

REMARKS: Papers on high fidelity,
ultra high frequencies, broadcast re-
ceiver design, conference on reduction
of radio interference and exhibition of
equipment.

TEST IT IN USE

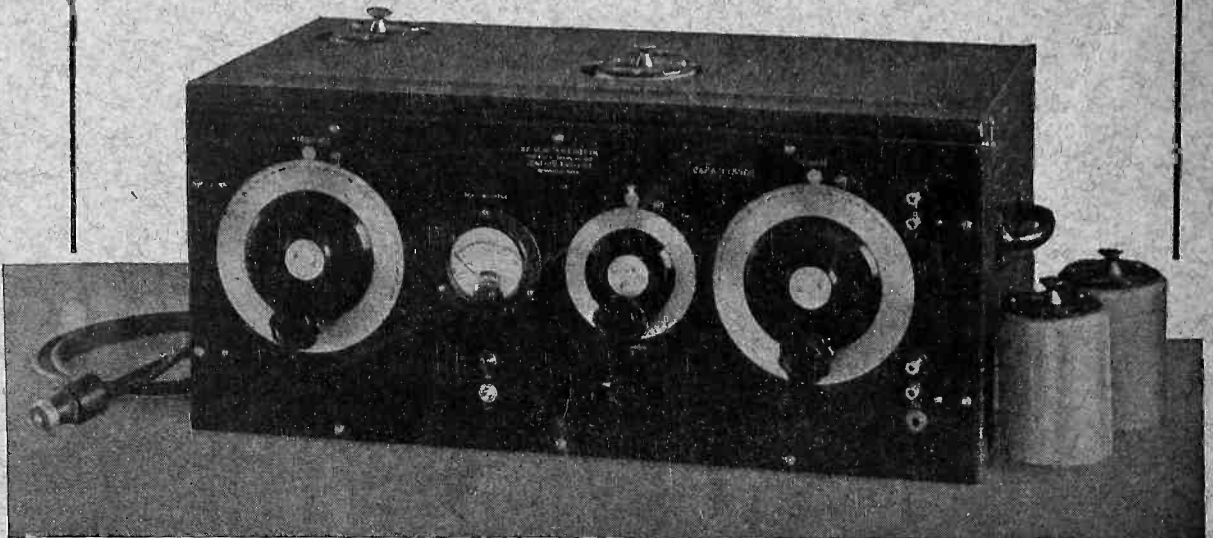

The Type 421-A Reactance Meter measures coils and condensers under operating conditions, at operating frequency—exactly as though they were assembled in the finished circuit.

The Type 421-A Reactance Meter measures capacitance and inductance over wide ranges. Simple and rapid in operation, it is an invaluable addition to the radio-receiver laboratory. Completely mains-operated (110-volt 60-cycle). Licensed under Hazeltine patents.

Type 421-A Reactance Meter
Range 125 kc—300 kc
550 kc—1500 kc
1500 kc—4000 kc

Price \$445.00

Described in Bulletin EX-3404-R.

GENERAL RADIO COMPANY
CAMBRIDGE A MASSACHUSETTS