

VOLUME 22

MAY, 1934

NUMBER 5

PROCEEDINGS
of
**The Institute of Radio
Engineers**



**Ninth
Annual Convention
Philadelphia, Pennsylvania
May 28, 29, 30, 1934**

Form for Change of Mailing Address or Business Title on Page XIX

INSTITUTE OF RADIO ENGINEERS NINTH ANNUAL CONVENTION

HOTEL BENJAMIN FRANKLIN, PHILADELPHIA, PA.

MAY 28, 29 AND 30, 1934

CONDENSED PROGRAM

Sunday—May 27

4:00 P.M.—6:00 P.M. Registration.

Monday—May 28

- 9:00 A.M. Registration and opening of exhibition rooms for inspection.
- 10:00 A.M.—12 Noon. Official welcome and technical session. Addresses by C. M. Jansky, Jr., President of the Institute; W. F. Diehl, Chairman of the Convention Committee; Harold Pender, Dean of the Moore School of Electrical Engineering, University of Pennsylvania; and W. R. G. Baker, Vice President and General Manager, RCA Victor Company, Inc.
Technical Session—Crystal Ballroom.
- 10:00 A.M.—12 Noon. Official greetings at ladies headquarters.
- 12 Noon—2:00 P.M. Luncheon and inspection of exhibits.
- 12 Noon—2:30 P.M. Ladies luncheon and shopping tour.
- 2:30 P.M.—4:30 P.M. Trip No. 1. Ladies inspection trip to WCAU studios.
- 2:00 P.M.—4:00 P.M. Technical Session—Crystal Ballroom.
- 3:00 P.M.—4:00 P.M. Technical Session—Betsy Ross Room.
- 4:00 P.M.—6:00 P.M. Annual meeting, Sections Committee, Independence Room.
- 4:00 P.M.—6:00 P.M. National Association of Broadcasters, Engineering Committee Meeting, Lafayette Room.
- 4:00 P.M.—6:00 P.M. Inspection of exhibits.
- 8:00 P.M. Trip No. 2. Franklin Institute.

Tuesday—May 29

- 9:00 A.M. Registration and opening of exhibition rooms for inspection.
- 10:00 A.M.—12 Noon. Technical Session—Crystal Ballroom.
- 10:00 A.M.—12 Noon. Technical Session—Betsy Ross Room.
- 12 Noon—5:00 P.M. Trip No. 3. Ladies luncheon and bridge at the Pennsylvania Athletic Club.
- 12 Noon—3:00 P.M. Trip No. 4. RCA Victor plant, Camden. Luncheon will be served at the plant through the courtesy of the RCA Victor Company.
- 3:00 P.M.—5:00 P.M. Technical Session—Crystal Ballroom.
- 3:00 P.M.—5:00 P.M. R.M.A. Service Managers meeting, Independence Room.
- 7:00 P.M. Informal Banquet—Crystal Ballroom.

Wednesday—May 30

- 9:00 A.M. Registration and opening of exhibition rooms for inspection.
- 10:00 A.M.—12 Noon. Technical Session—Crystal Ballroom.
- 10:00 A.M.—12 Noon. Technical Session—Betsy Ross Room.
- 10:00 A.M.—5:00 P.M. Trip No. 5. Ladies sight-seeing trip including visit to Valley Forge where luncheon will be served.
- 12 Noon—2:00 P.M. Luncheon and inspection of exhibits.
- 2:00 P.M.—4:00 P.M. Technical Session—Crystal Ballroom.

PROCEEDINGS OF
The Institute of Radio Engineers

Volume 22

May, 1934

Number 5

Board of Editors

ALFRED N. GOLDSMITH, *Chairman*

R. R. BATCHER

H. H. BEVERAGE

F. W. GROVER

G. W. PICKARD

K. S. VAN DYKE

L. P. WHEELER

L. E. WHITTEMORE

WILLIAM WILSON

CONTENTS

PART I

Condensed Program of Ninth Annual Convention.....	Cover II
Frontispiece, George Owen Squier.....	532
Institute News and Radio Notes.....	535
Ninth Annual Convention.....	535
April Meeting of the Board of Directors.....	555
Committee Work.....	556
Institute Meetings.....	557
Errata to "Propagation of High-Frequency Currents in Ground Return Circuits," by H. W. Wise.....	563

Part II

Technical Papers

High Quality Radio Broadcast Transmission and Reception.....	STUART BALLANTINE	564
The Retarding-Field Tube as a Detector for any Carrier Frequency.....	H. E. HOLLMANN	630
Some Notes on the Influence of Stray Capacitance Upon the Accuracy of Antenna Resistance Measurements.....	EDMUND A. LAPORT	657
Note on Audio-Frequency Atmospherics.....	E. T. BURTON	670
A Chopper Utilizing Contacts Vibrating in a Vacuum.....	F. G. KELLY	672
Contributors to This Issue.....		675

The Institute of Radio Engineers

GENERAL INFORMATION

INSTITUTE. The Institute of Radio Engineers was formed in 1912 through the amalgamation of the Society of Wireless Telegraph Engineers and the Wireless Institute. Its headquarters were established in New York City and the membership has grown from less than fifty members at the start to several thousand.

AIMS AND OBJECTS. The Institute functions solely to advance the theory and practice of radio and allied branches of engineering and of the related arts and sciences, their application to human needs, and the maintenance of a high professional standing among its members. Among the methods of accomplishing this is the publication of papers, discussions, and communications of interest to the membership.

PROCEEDINGS. The PROCEEDINGS is the official publication of the Institute and in it are published all of the papers, discussions, and communications received from the membership which are accepted for publication by the Board of Editors. Copies are sent without additional charge to all members of the Institute. The subscription price to nonmembers is \$10.00 per year, with an additional charge for postage where such is necessary.

RESPONSIBILITY. It is understood that the statements and opinions given in the PROCEEDINGS are views of the individual members to whom they are credited, and are not binding on the membership of the Institute as a whole. Papers submitted to the Institute for publication shall be regarded as no longer confidential.

REPRINTING PROCEEDINGS MATERIAL. The right to reprint portions or abstracts of the papers, discussions, or editorial notes in the PROCEEDINGS is granted on the express condition that specific reference shall be made to the source of such material. Diagrams and photographs published in the PROCEEDINGS may not be reproduced without making specific arrangements with the Institute through the Secretary.

MANUSCRIPTS. All manuscripts should be addressed to the Institute of Radio Engineers, 33 West 39th Street, New York City. They will be examined by the Papers Committee and the Board of Editors to determine their suitability for publication in the PROCEEDINGS. Authors are advised as promptly as possible of the action taken, usually within two or three months. Manuscripts and illustrations will be destroyed immediately after publication of the paper unless the author requests their return. Information on the mechanical form in which manuscripts should be prepared may be obtained by addressing the secretary.

MAILING. Entered as second-class matter at the post office at Menasha, Wisconsin. Acceptance for mailing at special rate of postage is provided for in the act of February 28, 1925, embodied in Paragraph 4, Section 412, P. L. and R., and authorization was granted on October 26, 1927.

Published monthly by

THE INSTITUTE OF RADIO ENGINEERS, INC.

Publication office, 450-454 Ahnaip St., Menasha, Wis.

BUSINESS, EDITORIAL, AND ADVERTISING OFFICES

Harold P. Westman, *Secretary*

33 West 39th Street, New York, N. Y.

INSTITUTE SECTIONS

- ATLANTA—Chairman, Henry L. Reid; Secretary, Philip C. Bangs, 23 Kensington Road, Avondale Estates, Ga.
- BOSTON—Chairman, E. L. Chaffee; Secretary, G. W. Kenrick, Tufts College, Mass.
- BUFFALO-NIAGARA—Chairman, L. Grant Hector; Secretary, E. C. Waud, 235 Huntington Avenue, Buffalo, N. Y.
- CHICAGO—Chairman, Hugh S. Knowles; Secretary, John S. Meck, The Fenscholt Company, 549 W. Washington St., Chicago, Ill.
- CINCINNATI—Chairman, R. E. Kolo; Secretary, Helen Hymans, Crosley Radio Corporation, Cincinnati, Ohio.
- CLEVELAND—Chairman, F. G. Bowditch; Secretary, C. H. Shipman, 14805 Ardenall Ave., East Cleveland, Ohio.
- CONNECTICUT VALLEY—Chairman, K. S. Van Dyke; Secretary, C. B. De Soto American Radio Relay League, 38 La Salle Rd., W. Hartford, Conn.
- DETROIT—Chairman, Samuel Firestone; Secretary, E. C. Denstaedt, Detroit Police Department, Detroit, Mich.
- LOS ANGELES—Chairman, H. C. Silent; Secretary, N. B. Neely, 1569 Munson Ave., Los Angeles, Calif.
- NEW ORLEANS—Chairman, J. A. Courtenay; Secretary, C. B. Reynolds, Radiomarine Corporation, 512 St. Peter St., New Orleans, La.
- PHILADELPHIA—Chairman, W. F. Diehl; Secretary, R. L. Snyder, Bell Telephone Company of Pennsylvania, 1835 Arch St., Philadelphia, Pa.
- PITTSBURGH—Chairman, Lee Sutherland; Secretary, A. P. Sunnergren, West Penn Power Company, 14 Wood St., Pittsburgh, Pa.
- ROCHESTER—Chairman, Arthur L. Schoen; Secretary, Earl C. Karker, Mechanics Institute, 55 Plymouth Ave., Rochester, N. Y.
- SAN FRANCISCO—Chairman, G. T. Royden; Secretary, R. C. Shermund, 2300-16th Ave., San Francisco, Calif.
- SEATTLE—Chairman, Howard Mason; Secretary, Raymond C. Fisher, 602 N. C. St., Tacoma, Wash.
- TORONTO—Chairman, W. F. Choat; Secretary, G. E. Pipe, Rogers-Majestic Corporation, Toronto, Ont., Canada.
- WASHINGTON—Chairman, T. McL. Davis; Secretary, C. L. Davis, Washington Building, 15th and G Sts. N. W., Washington, D. C.

**GEOGRAPHICAL LOCATION OF MEMBERS ELECTED
APRIL 4, 1934**

Transferred to the Fellow Grade

Illinois Chicago, Zenith Radio Corp..... Jarvis, K. W.

Transferred to the Member Grade

District of Washington, 1820 Clydesdale Pl. Berkner, L. V.
Columbia Cambridge, Massachusetts Institute of Technology Tucker, C. E.
Massachusetts Red Bank, P.O. Box 107 Jansky, K. G.
New Jersey Victoria Park, Man., "Dalton Hall" Stanford, N. C.
England

Elected to the Member Grade

Michigan Ann Arbor, 1548 Broadway Wuerfel, R. P.
England North Finchley, N.12, 16 Lyndhurst Ave..... Twiss, A. R.

Elected to the Associate Grade

California Los Angeles, c/o Radio Inst. of Calif., 1117 Venice Blvd. Chu, H. C.
Los Angeles, Box 1002, Station C..... Ford, B. C.
San Francisco, 202 Green St..... Somers, F. J.

District of Bellevue, Vacuum Tube Section, Naval Research Lab..... Dorband, E. F.
Columbia Washington, 4305 Jeniter St. N.W. Bennett, R. P.
Washington, 527 Fern Pl., Takoma Park Johnson, E. A.

Illinois Chicago, 312 N. Central Ave. Moritz, B. E., Jr.
Chicago, 2301 S. Michigan Ave. Rottmann, K. F.

Louisiana New Orleans, c/o Western Union Tel. Co., 412 Cotton Exchange
Bldg. Saunders, H. M.
Shreveport, Box 1642 Hull, F. K.

Maryland Catonsville, Baltimore, 600 Hilton Ave. Dull, M. L.

Massachusetts Arlington, 36 Pierce St. Geffine, L. W., Jr.
Cambridge, Cruft Lab., Harvard University White, T. B.

Michigan Detroit, 3500 Bedford Rd. Knubbe, H. H.
Missouri St. Louis, 4485 Chippewa St. Groetke, E. A.

New Jersey Deal, Bell Telephone Labs. Friis, R. W.
East Orange, 214 Rutledge Ave. Woehling, J. G.
Montclair, 9 Vincent Pl. Nuner, J. F.

New York Netcong, c/o General Delivery Reichard, W. C.
Brooklyn, 525-82nd St. Horton, E. A.
Buffalo, 924 Michigan Ave. Bennett, G. F.
Buffalo, c/o Colonial Radio Corp., 254 Rano St. Ficker, R. W.
Forest Hills, 5 78th Rd. Gentsch, M. F.
Mineola, 215 Grant Ave. Philipps, R. J.
Slingerlands. Dillenback, G. V.
Utica, 3 Beverly Pl. Curtis, S. T.

Ohio Columbus, 1621 Summit St. Renner, D. S.

Pennsylvania Bethlehem, Physics Dept., Lehigh University Frey, A. R.
Philadelphia, 5817 N. Woodstock St. Woll, C. F.

South Carolina Kings Creek. Moeller, C. S.

Tennessee Chattanooga, Southern Bell Tel. & Tel. Co. Staples, E. S.

Texas Dallas, 2122 Jackson St. Compton, M. V.

China Shanghai, Asia Electric Co., 45 Hochien Rd. Knox, J. B.

England Brierley Hill, Staffordshire, 29 Bell St. Brown, W. F.
Hall Green, Birmingham, 47 Cole Valley Rd. Swenney, R. F.
Hull, Yorks, 129 Park Grove. Taylor, D.
Portsmouth, Hampshire, "St. Agnes," Amberley Rd., Northe
End. Farnley, A. G.

Germany Leopoldshall, Schulstr 23 Rein, H.

Japan Fukuoka, Fukuoka Broadcasting Station Hirata, T.
Kokura, Kokura-Hosokyoku Yosuo, I.
Shizuokashi, c/o Shizuoka Hosoyoku, Yunoki Hiroshi, S.
Christchurch, 497 Cashel St. Whisker, D. R.

New Zealand

Philippine Manila, Paterno Bldg. Floro, M.

Islands Durban, Natal, c/o 464 West St. Innes-Grant, N.

South Africa

Elected to the Junior Grade

Illinois Chicago, 1515 W. Monroe St. Thrun, R. S.
New York Brooklyn, 2831 W. 2nd St. Nestor, J.
Jackson Heights, 3752-89th St. Burros, G.

Elected to the Student Grade

California Stanford University, Box J. Packard, D.
Indiana West Lafayette, 248 Chauncey Ave. Janda, H. A.
Maryland Baltimore, Physics Dept., Johns Hopkins University Jennings, B.
Missouri Parkville, Box 327. Montgomery, B. E.
New York Troy, 145-9th St. Wilson, J. H.

APPLICATIONS FOR MEMBERSHIP

Applications for transfer or election to the various grades of membership have been received from the persons listed below, and have been approved by the Admissions Committee. Members objecting to transfer or election of any of these applicants should communicate with the Secretary on or before May 31, 1934. These applications will be considered by the Board of Directors at its meeting on June 6, 1934.

For Transfer to the Member Grade

District of Columbia	Washington, 4550 Connecticut Ave.....	Jackson, W. E.
Michigan	Grand Rapids, 1500 S. Union Ave.....	Andres, L. J.
Mississippi	Greenwood, 209 Virginia St.....	Fausett, F.
New York	New York City, 222 W. 39th St.....	Cockaday, L. M.
	New York City, 2902 Grand Concourse.....	Hornung, J. L.

For Election to the Member Grade

Canada	Toronto, Ont., University of Toronto.....	Bayly, B. D. F.
England	London S. E. 7, 28 Sundorne Rd.....	Meyer, L. W.
India	Bangalore, Indian Institute of Science.....	Sreenivasan, K.

For Election to the Associate Grade

California	Los Angeles, 1117 Venice Blvd.....	Martin, C. S.
District of Columbia	Washington, 2500 K St. N.W.....	Heatwole, E. P.
Georgia	Atlanta, 328 Mell Ave. N.E.....	Hoke, G. W.
	Atlanta, 375 Blvd. N.E.....	Howard, C. W.
Kentucky	Prestonsburg.....	Davis, R. B.
Maryland	Mt. Rainier, 3732-29th St.....	Chapman, R. W.
Massachusetts	Concord, Ripley Hill Rd.....	Morse, J. E.
	Dorchester, 485 Washington St.....	Lane, A.
	Springfield, 130 Belmont Ave.....	Johannessen, H. R.
New Jersey	Passaic, 70 Jackson St.....	Siklosi, A.
New York	Fire Island, U.S.N. Radio Direction Finder Station.....	Stevens, C. A.
	New York City, 1443 Wilkens Ave.....	Berger, B.
	New York City, 400 E. 57th St.....	Libbey, B. E.
	New York City, Columbia Broadcasting System, 485 Madison Ave.....	Lodge, W. B.
North Carolina	Asheville, 40 Edgemont Rd.....	Brimley, A. H.
	Charlotte, 1804 Wilmore Dr.....	Rosekrans, P.
Pennsylvania	Middletown, 435 N. Spring St.....	Arnold, C. H.
	Pottsville, 112 E. Market St.....	Neiman, W. E.
Washington	Keyport, U. S. Naval Radio Station.....	Byer, E. D.
	White Swan.....	Freeland, C.
Australia	Casino, N.S.W., Box 27 P.O.....	Cradick, R. L.
	Melbourne, Vic., 2 Wattle Grove, Moreland N. 13.....	Woodward, C.
eylon	Jaela, Jaela Estate.....	Soysa, N.
England	Anlaby, Nr. Hull, Yorks., 7 Tranby Lane.....	Witty, R.
	Dudley, Worcs., 28 Grange Rd.....	Graham, A.
	Kenilworth, Warwickshire, Ivycote, Rosemary Hill.....	Lovelock, R. T.
	London W.9, 3 Landerdale Rd.....	Clark, F. E. T.
	Shiple, Yorks., Avondale Bldgs., Bradford Rd.....	Kinsey, C.
Territory of Hawaii	Paaui, Hamakua Mill Co.....	Fabius, A.
Irish Free State	Tralee, Co. Kerry, 100 Rock St.....	Fennell, J. A.
Japan	Tokyo, Japan Broadcasting Corp., Hibiya.....	Hukugita, H.
New Zealand	Christchurch, 99 Abberley Rd.....	Simpson, A. E. H.

For Election to the Junior Grade

California	Coronado, Box 333.....	Labowitch, D. M.
District of Columbia	Washington, 1751 Kilbourne Pl. N.W.....	Kihchel, O. D.
	Washington, 3226-13th St. N.W.....	Langenegger, J. R.
Florida	Tampa, 6700 Elizabeth Ave.....	White, J. D., Jr.
North Carolina	Greenville, Radio Station WEED.....	Humphrey, W. H., Jr.

For Election to the Student Grade

New Jersey	Grantwood, 6 Everett Pl.....	Eichhorn, C. W.
Pennsylvania	Bethlehem, 448 S. New St.....	Geiger, F. E.
	Carlisle, Beta Theta Pi House.....	Woodward, W. R.
Washington	Seattle, 4548-47th Ave. N.E.....	Frost, N.
Porto Rico	Mayaguez, P.O. Box 26.....	Marti, H.

**GEOGRAPHICAL LOCATION OF MEMBERS ELECTED
APRIL 4, 1934**

Transferred to the Fellow Grade

Illinois Chicago, Zenith Radio Corp.....Jarvis, K. W.

Transferred to the Member Grade

District of Columbia Washington, 1820 Clydesdale Pl.Berkner, L. V.
Massachusetts Cambridge, Massachusetts Institute of Technology.....Tucker, C. E.
New Jersey Red Bank, P.O. Box 107.....Jansky, K. G.
England Victoria Park, Man., "Dalton Hall".....Stanford, N. C.

Elected to the Member Grade

Michigan Ann Arbor, 1548 Broadway.....Wuerfel, R. P.
England North Finchley, N.12, 16 Lyndhurst Ave.....Twiss, A. R.

Elected to the Associate Grade

California Los Angeles, c/o Radio Inst. of Calif., 1117 Venice Blvd.....Chu, H. C.
Los Angeles, Box 1002, Station C.....Ford, B. C.
San Francisco, 202 Green St.....Somers, F. J.

District of Columbia Bellevue, Vacuum Tube Section, Naval Research Lab.....Dorband, E. F.
Washington, 4305 Jeniter St. N.W.....Bennett, R. P.
Washington, 527 Fern Pl., Takoma Park.....Johnson, E. A.

Illinois Chicago, 312 N. Central Ave.....Moritz, B. E., Jr.
Chicago, 2301 S. Michigan Ave.....Rottmann, K. F.

Louisiana New Orleans, c/o Western Union Tel. Co., 412 Cotton Exchange Bldg.....Saunders, H. M.
Shreveport, Box 1642.....Hull, F. K.

Maryland Catonsville, Baltimore, 600 Hilton Ave.....Dull, M. L.

Massachusetts Arlington, 36 Pierce St.....Geffine, L. W., Jr.
Cambridge, Cruft Lab., Harvard University.....White, T. B.

Michigan Detroit, 3500 Bedford Rd.....Knubbe, H. H.

Missouri St. Louis, 4485 Chippewa St.....Groeteke, E. A.

New Jersey Deal, Bell Telephone Labs.....Friis, R. W.
East Orange, 214 Rutledge Ave.....Woehling, J. G.
Montclair, 9 Vincent Pl.....Nuner, J. F.

New York Netcong, c/o General Delivery.....Reichard, W. C.
Brooklyn, 525-82nd St.....Horton, E. A.
Buffalo, 924 Michigan Ave.....Bennett, G. F.
Buffalo, c/o Colonial Radio Corp., 254 Rano St.....Ficker, R. W.
Forest Hills, 5 78th Rd.....Gentsch, M. F.
Mineola, 215 Grant Ave.....Phillips, R. J.
Slingerlands.....Dillenback, G. V.
Utica, 3 Beverly Pl.....Curtis, S. T.

Ohio Columbus, 1621 Summit St.....Renner, D. S.

Pennsylvania Bethlehem, Physics Dept., Lehigh University.....Frey, A. R.
Philadelphia, 5817 N. Woodstock St.....Woll, C. F.

South Carolina Kings Creek.....Moeller, C. S.

Tennessee Chattanooga, Southern Bell Tel. & Tel. Co.....Staples, E. S.

Texas Dallas, 2122 Jackson St.....Compton, M. V.

China Shanghai, Asia Electric Co., 45 Hochien Rd.....Knox, J. B.

England Brierley Hill, Staffordshire, 29 Bell St.....Brown, W. F.
Hall Green, Birmingham, 47 Cole Valley Rd.....Sweeney, R. F.
Hull, Yorks, 129 Park Grove.....Taylor, D.
Portsmouth, Hampshire, "St. Agnes," Amberley Rd., North End.....Farnley, A. G.

Germany Leopoldshall, Schulstr 23.....Rein, H.

Japan Fukuoka, Fukuoka Broadcasting Station.....Hirata, T.
Kokura, Kokura-Hosokyoku.....Yosuo, I.
Shizuokashi, c/o Shizuoka Hosoyoku, Yunoki.....Hiroshi, S.

New Zealand Christchurch, 497 Cashel St.....Whisker, D. R.

Philippine Islands Manila, Paterno Bldg.....Floro, M.

South Africa Durban, Natal, c/o 464 West St.....Innes-Grant, N.

Elected to the Junior Grade

Illinois Chicago, 1515 W. Monroe St.....Thrun, R. S.
New York Brooklyn, 2831 W. 2nd St.....Nestor, J.
Jackson Heights, 3752-89th St.....Burros, G.

Elected to the Student Grade

California Stanford University, Box J.....Packard, D.
Indiana West Lafayette, 248 Chauncey Ave.....Janda, H. A.
Maryland Baltimore, Physics Dept., Johns Hopkins University.....Jennings, B.
Missouri Parkville, Box 327.....Montgomery, B. E.
New York Troy, 145-9th St.....Wilson, J. H.

APPLICATIONS FOR MEMBERSHIP

Applications for transfer or election to the various grades of membership have been received from the persons listed below, and have been approved by the Admissions Committee. Members objecting to transfer or election of any of these applicants should communicate with the Secretary on or before May 31, 1934. These applications will be considered by the Board of Directors at its meeting on June 6, 1934.

For Transfer to the Member Grade

District of Columbia	Washington, 4550 Connecticut Ave.	Jackson, W. E.
Michigan	Grand Rapids, 1500 S. Union Ave.	Andres, L. J.
Mississippi	Greenwood, 209 Virginia St.	Fausett, F.
New York	New York City, 222 W. 39th St.	Cockaday, L. M.
	New York City, 2902 Grand Concourse.	Hornung, J. L.

For Election to the Member Grade

Canada	Toronto, Ont., University of Toronto	Bayly, B. D. F.
England	London S. E. 7, 28 Sundorne Rd.	Meyer, L. W.
India	Bangalore, Indian Institute of Science	Sreenivasan, K.

For Election to the Associate Grade

California	Los Angeles, 1117 Venice Blvd.	Martin, C. S.
District of Columbia	Washington, 2500 K St. N.W.	Heatwole, E. P.
Georgia	Atlanta, 328 Mell Ave. N.E.	Hoke, G. W.
	Atlanta, 375 Blvd. N.E.	Howard, C. W.
Kentucky	Prestonsburg	Davis, R. B.
Maryland	Mt. Rainier, 3732-29th St.	Chapman, R. W.
Massachusetts	Concord, Ripley Hill Rd.	Morse, J. E.
	Dorchester, 485 Washington St.	Lane, A.
	Springfield, 130 Belmont Ave.	Johannessen, H. R.
New Jersey	Passaic, 70 Jackson St.	Siklosi, A.
New York	Fire Island, U.S.N. Radio Direction Finder Station	Stevens, C. A.
	New York City, 1443 Wilkens Ave.	Berger, B.
	New York City, 400 E. 57th St.	Libbey, B. E.
	New York City, Columbia Broadcasting System, 485 Madison Ave.	Lodge, W. B.
North Carolina	Asheville, 40 Edgemont Rd.	Brimley, A. H.
	Charlotte, 1804 Wilmore Dr.	Rosekrans, P.
Pennsylvania	Middletown, 435 N. Spring St.	Arnold, C. H.
	Pottsville, 112 E. Market St.	Neiman, W. E.
Washington	Keyport, U. S. Naval Radio Station	Byer, E. D.
	White Swan	Freeland, C.
Australia	Casino, N.S.W., Box 27 P.O.	Cradick, R. L.
	Melbourne, Vic., 2 Wattle Grove, Moreland N. 13.	Woodward, C.
Ceylon	Jaela, Jaela Estate	Soysa, N.
England	Anlaby, Nr. Hull, Yorks., 7 Tranby Lane.	Witty, R.
	Dudley, Worcs., 28 Grange Rd.	Graham, A.
	Kenilworth, Warwickshire, Ivycote, Rosemary Hill.	Lovelock, R. T.
	London W.9, 3 Landerdale Rd.	Clark, F. E. T.
	Shiple, Yorks., Avondale Bldgs., Bradford Rd.	Kinsey, C.
Territory of Hawaii	Paaulo, Hamakua Mill Co.	Fabius, A.
Irish Free State	Tralee, Co. Kerry, 100 Rock St.	Fennell, J. A.
Japan	Tokyo, Japan Broadcasting Corp., Hibiya	Hukugita, H.
New Zealand	Christchurch, 99 Abberley Rd.	Simpson, A. E. H.

For Election to the Junior Grade

California	Coronado, Box 333	Labowitch, D. M.
District of Columbia	Washington, 1751 Kilbourne Pl. N.W.	Kihchel, O. D.
	Washington, 3226-13th St. N.W.	Langenegger, J. R.
Florida	Tampa, 6700 Elizabeth Ave.	White, J. D., Jr.
North Carolina	Greenville, Radio Station WEED	Humphrey, W. H., Jr.

For Election to the Student Grade

New Jersey	Grantwood, 6 Everett Pl.	Eichhorn, C. W.
Pennsylvania	Bethlehem, 448 S. New St.	Geiger, F. E.
	Carlisle, Beta Theta Pi House	Woodward, W. R.
Washington	Seattle, 4548-47th Ave. N.E.	Frost, N.
Porto Rico	Mayaguez, P.O. Box 26	Marti, H.

**GEOGRAPHICAL LOCATION OF MEMBERS ELECTED
APRIL 4, 1934**

Transferred to the Fellow Grade

Illinois Chicago, Zenith Radio Corp.....Jarvis, K. W.

Transferred to the Member Grade

District of Columbia Washington, 1820 Clydesdale Pl.Berkner, L. V.
Massachusetts Cambridge, Massachusetts Institute of TechnologyTucker, C. E.
New Jersey Red Bank, P.O. Box 107Jansky, K. G.
England Victoria Park, Man., "Dalton Hall"Stanford, N. C.

Elected to the Member Grade

Michigan Ann Arbor, 1548 BroadwayWuerfel, R. P.
England North Finchley, N.12, 16 Lyndhurst Ave.....Twiss, A. R.

Elected to the Associate Grade

California Los Angeles, c/o Radio Inst. of Calif., 1117 Venice Blvd. Chu, H. C.
Los Angeles, Box 1002, Station C. Ford, B. C.
San Francisco, 202 Green St. Somers, F. J.

District of Columbia Bellevue, Vacuum Tube Section, Naval Research Lab. Dorband, E. F.
Washington, 4305 Jeniter St. N.W. Bennett, R. P.
Washington, 527 Fern Pl., Takoma Park. Johnson, E. A.

Illinois Chicago, 312 N. Central Ave. Moritz, B. E., Jr.
Chicago, 2301 S. Michigan Ave. Rottmann, K. F.

Louisiana New Orleans, c/o Western Union Tel. Co., 412 Cotton Exchange Bldg. Saunders, H. M.
Shreveport, Box 1642. Hull, F. K.

Maryland Catonsville, Baltimore, 600 Hilton Ave. Dull, M. L.

Massachusetts Arlington, 36 Pierce St. Geffine, L. W., Jr.
Cambridge, Cruft Lab., Harvard University. White, T. B.

Michigan Detroit, 3500 Bedford Rd. Knubbe, H. H.
Missouri St. Louis, 4485 Chippewa St. Groetke, E. A.
New Jersey Deal, Bell Telephone Labs. Friis, R. W.
East Orange, 214 Rutledge Ave. Woehling, J. G.
Montclair, 9 Vincent Pl. Nuner, J. F.

New York Netcong, c/o General Delivery. Reichard, W. C.
Brooklyn, 525-82nd St. Horton, E. A.
Buffalo, 924 Michigan Ave. Bennett, G. F.
Buffalo, c/o Colonial Radio Corp., 254 Rano St. Ficker, R. W.
Forest Hills, 5 78th Rd. Gentsch, M. F.
Mineola, 215 Grant Ave. Philipps, R. J.
Slingerlands. Dillenback, G. V.
Utica, 3 Beverly Pl. Curtis, S. T.

Ohio Columbus, 1621 Summit St. Renner, D. S.

Pennsylvania Bethlehem, Physics Dept., Lehigh University. Frey, A. R.
Philadelphia, 5817 N. Woodstock St. Woll, C. F.

South Carolina Kings Creek. Moeller, C. S.

Tennessee Chattanooga, Southern Bell Tel. & Tel. Co. Staples, E. S.

Texas Dallas, 2122 Jackson St. Compton, M. V.

China Shanghai, Asia Electric Co., 45 Hochien Rd. Knox, J. B.

England Brierley Hill, Staffordshire, 29 Bell St. Brown, W. F.
Hall Green, Birmingham, 47 Cole Valley Rd. Swenney, R. F.
Hull, Yorks, 129 Park Grove. Taylor, D.
Portsmouth, Hampshire, "St. Agnes," Amberley Rd., North End. Farnley, A. G.

Germany Leopoldshall, Schulstr 23. Rein, H.

Japan Fukuoka, Fukuoka Broadcasting Station. Hirata, T.
Kokura, Kokura-Hosokyoku. Yosuo, I.
Shizuokashi, c/o Shizuoka Hosoyoku, Yunoki. Hiroshi, S.
Christchurch, 497 Cashel St. Whisker, D. R.

New Zealand
Philippine Islands Manila, Paterno Bldg. Floro, M.
South Africa Durban, Natal, c/o 464 West St. Innes-Grant, N.

Elected to the Junior Grade

Illinois Chicago, 1515 W. Monroe St. Thrun, R. S.
New York Brooklyn, 2831 W. 2nd St. Nestor, J.
Jackson Heights, 3752-89th St. Burros, G.

Elected to the Student Grade

California Stanford University, Box J. Packard, D.
Indiana West Lafayette, 248 Chauncey Ave. Janda, H. A.
Maryland Baltimore, Physics Dept., Johns Hopkins University. Jennings, B.
Missouri Parkville, Box 327. Montgomery, B. E.
New York Troy, 145-9th St. Wilson, J. H.

APPLICATIONS FOR MEMBERSHIP

Applications for transfer or election to the various grades of membership have been received from the persons listed below, and have been approved by the Admissions Committee. Members objecting to transfer or election of any of these applicants should communicate with the Secretary on or before May 31, 1934. These applications will be considered by the Board of Directors at its meeting on June 6, 1934.

For Transfer to the Member Grade

District of Columbia	Washington, 4550 Connecticut Ave.	Jackson, W. E.
Michigan	Grand Rapids, 1500 S. Union Ave.	Andra, L. J.
Mississippi	Greenwood, 209 Virginia St.	Fausett, F.
New York	New York City, 222 W. 39th St.	Cockaday, L. M.
	New York City, 2902 Grand Concourse.	Hornung, J. L.

For Election to the Member Grade

Canada	Toronto, Ont., University of Toronto	Bayly, B. D. F.
England	London S. E. 7, 28 Sundorne Rd.	Meyer, L. W.
India	Bangalore, Indian Institute of Science.	Sreenivasan, K.

For Election to the Associate Grade

California	Los Angeles, 1117 Venice Blvd.	Martin, C. S.
District of Columbia	Washington, 2500 K St. N.W.	Heatwole, E. P.
Georgia	Atlanta, 328 Mell Ave. N.E.	Hoke, G. W.
	Atlanta, 375 Blvd. N.E.	Howard, C. W.
Kentucky	Prestonsburg	Davis, R. B.
Maryland	Mt. Rainier, 3732-29th St.	Chapman, R. W.
Massachusetts	Concord, Ripley Hill Rd.	Morse, J. E.
	Dorchester, 485 Washington St.	Lane, A.
	Springfield, 130 Belmont Ave.	Johannessen, H. R.
New Jersey	Passaic, 70 Jackson St.	Siklosi, A.
New York	Fire Island, U. S. N. Radio Direction Finder Station	Stevens, C. A.
	New York City, 1443 Wilkens Ave.	Berger, B.
	New York City, 400 E. 57th St.	Libbey, B. E.
	New York City, Columbia Broadcasting System, 485 Madison Ave.	Lodge, W. B.
North Carolina	Asheville, 40 Edgemont Rd.	Brimley, A. H.
	Charlotte, 1804 Wilmore Dr.	Rosekrans, P.
Pennsylvania	Middletown, 435 N. Spring St.	Arnold, C. H.
	Pottsville, 112 E. Market St.	Neiman, W. E.
Washington	Keyport, U. S. Naval Radio Station	Byer, E. D.
	White Swan	Freeland, C.
Australia	Casino, N.S.W., Box 27 P.O.	Cradick, R. L.
	Melbourne, Vic., 2 Wattle Grove, Moreland N. 13.	Woodward, C.
Ceylon	Jaala, Jaala Estate.	Soysa, N.
England	Anlaby, Nr. Hull, Yorks., 7 Tranby Lane	Witty, R.
	Dudley, Worcs., 28 Grange Rd.	Graham, A.
	Kenilworth, Warwickshire, Ivycote, Rosemary Hill	Lovelock, R. T.
	London W.9, 3 Landerdale Rd.	Clark, F. E. T.
	Shipley, Yorks., Avondale Bldgs., Bradford Rd.	Kinsey, C.
Territory of Hawaii	Paauilo, Hamakua Mill Co.	Fabius, A.
Irish Free State	Tralee, Co. Kerry, 100 Rock St.	Fennell, J. A.
Japan	Tokyo, Japan Broadcasting Corp., Hibiya	Hukugita, H.
New Zealand	Christchurch, 99 Abberley Rd.	Simpson, A. E. H.

For Election to the Junior Grade

California	Coronado, Box 333	Labowitch, D. M.
District of Columbia	Washington, 1751 Kilbourne Pl. N.W.	Kichel, O. D.
	Washington, 3226-13th St. N.W.	Langenegger, J. R.
Florida	Tampa, 6700 Elizabeth Ave.	White, J. D., Jr.
North Carolina	Greenville, Radio Station WEED	Humphrey, W. H., Jr.

For Election to the Student Grade

New Jersey	Grantwood, 6 Everett Pl.	Eichhorn, C. W.
Pennsylvania	Bethlehem, 448 S. New St.	Geiger, F. E.
	Carlisle, Beta Theta Pi House	Woodward, W. R.
Washington	Seattle, 4548-47th Ave. N.E.	Frost, N.
Porto Rico	Mayaguez, P.O. Box 26.	Marti, H.

OFFICERS AND BOARD OF DIRECTORS, 1934

(Terms expire January 1, 1935, except as otherwise noted)

President

C. M. JANSKY, JR.

Vice President

BALTH. VAN DER POL, JR.

Treasurer

MELVILLE EASTHAM

Secretary

HAROLD P. WESTMAN

Editor

ALFRED N. GOLDSMITH

Directors

W. G. CADY, *Junior Past President*

O. H. CALDWELL

J. V. L. HOGAN

L. C. F. HORLE

C. W. HORN

E. L. NELSON

E. R. SHUTE

A. F. VAN DYCK

H. A. WHEELER

Serving until January 1, 1936

R. A. HEISING

L. M. HULL, *Junior Past President*

F. A. KOLSTER

H. M. TURNER

Serving until January 1, 1937

ARTHUR BATCHELLER

WILLIAM WILSON



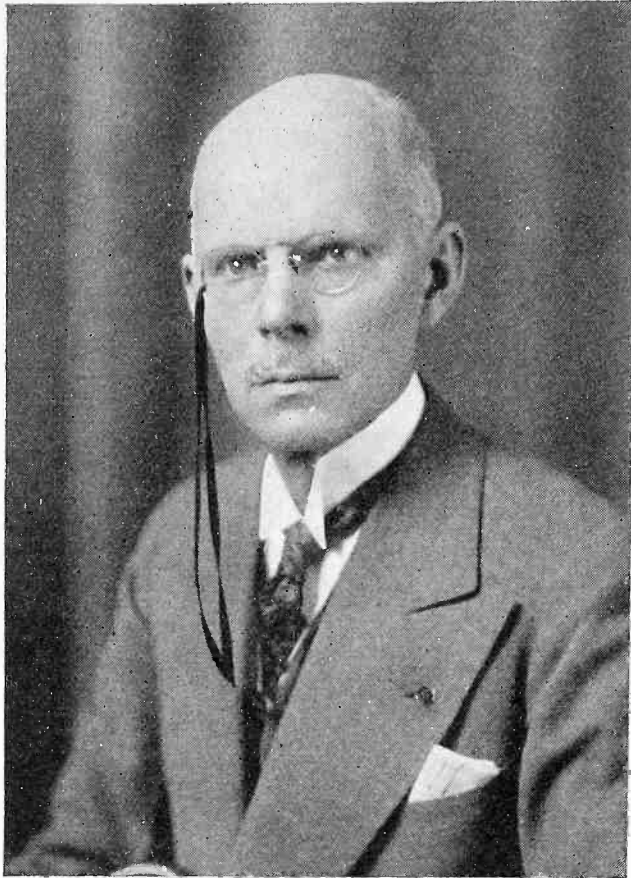

With deep regret we record the death of

George Owen Squier

General Squier was born in Dryden, Michigan, on March 21, 1865. He was graduated from the United States Military Academy in 1887 and then studied physics at Johns Hopkins University until 1891. He resumed these studies from 1902 to 1904 receiving a doctor of philosophy degree in 1903.

He was appointed second lieutenant in the United States Army in 1887, and in 1917 became Chief Signal Officer with a rank of Major General. As a representative of the Army and State Department, he attended several international conferences on communications and military subjects.

He was a recipient of many military awards and in addition was given the John Scott Medal for his photo-chronograph in 1896, the Elliott Crescent Gold Medal in 1912, and the Franklin Medal in 1919. Among his many inventions, that of wired radio has had greatest effect upon the communications system of the world.

He was a Fellow of the American Institute of Electrical Engineers, the American Philosophical Society, the American Society for the Advancement of Science, the American Physical Society, the Franklin Institute, the National Academy of Sciences, the Philosophical Society, the Physics Society of London, and the Royal Institute of Great Britain. He joined the Institute of Radio Engineers as a Fellow in 1916.

The death of General Squier occurred in Washington on March 24 as a result of an illness which confined him to the hospital about two weeks previously.

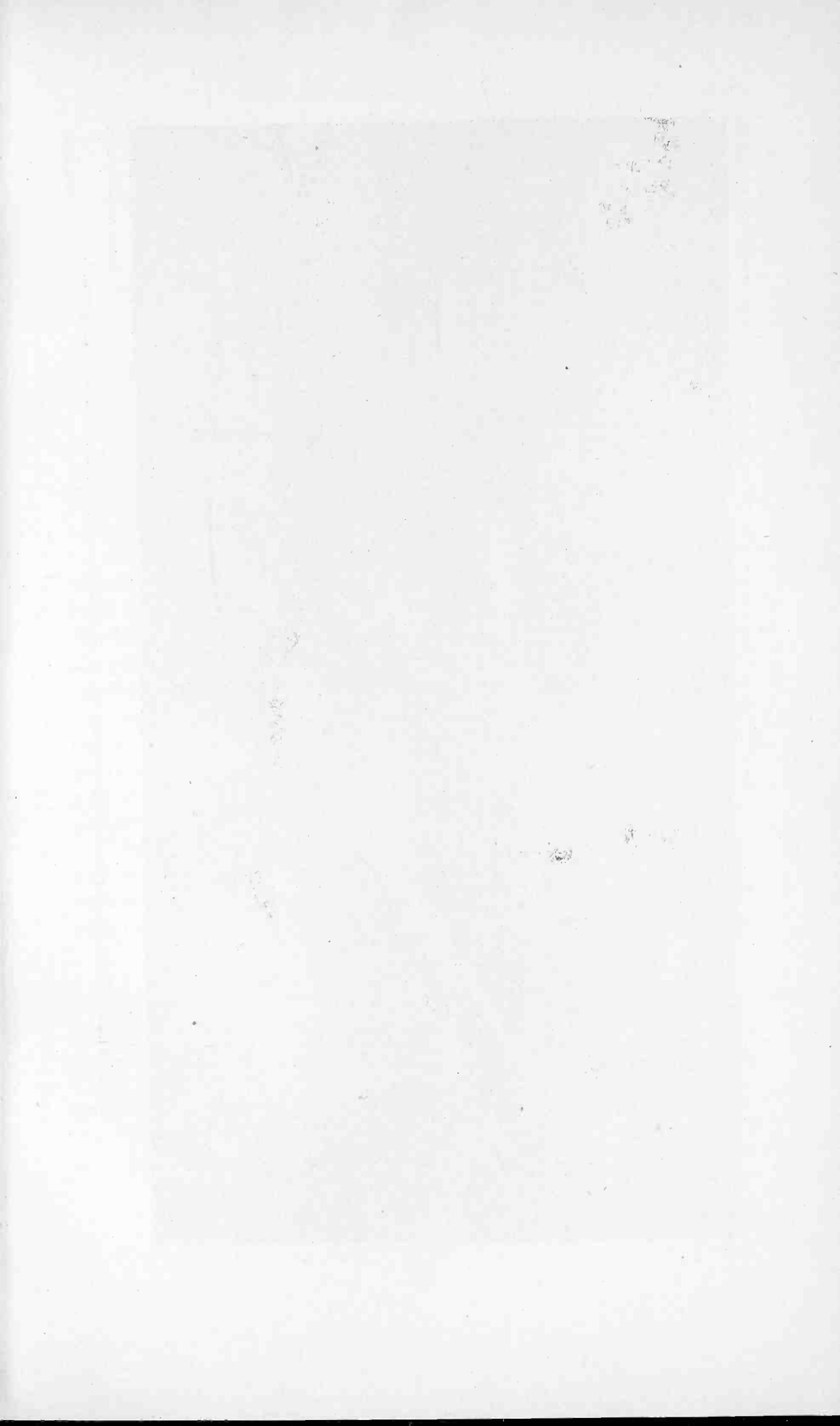

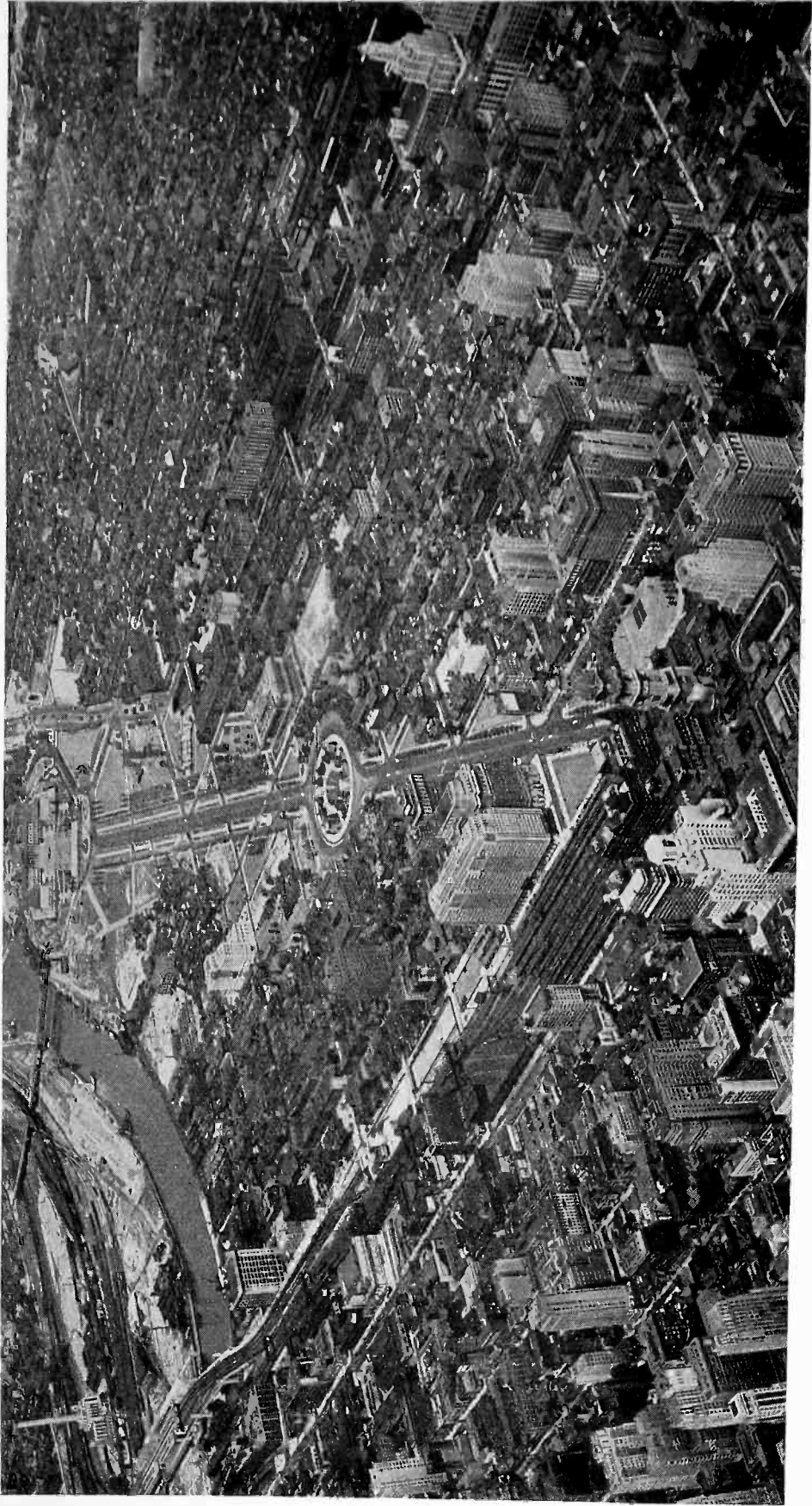

Dallin Aerial Surveys
Aerial view of Philadelphia from the southeast showing Parkway and Art Museum in background.

INSTITUTE NEWS AND RADIO NOTES

Ninth Annual Convention

The Philadelphia Section of the Institute will be the hosts at our Ninth Annual Convention which will be held on May 28, 29, and 30. The headquarters for the convention will be at the Hotel Benjamin Franklin and all activities other than inspection trips will be held therein.

We are particularly honored in having Vice President van der Pol who is making a special trip to Philadelphia to be present at the Convention as our guest. He will present a paper at the opening session of the Convention and in addition will preside at some of the following technical sessions.

An extensive program of technical papers will be presented. In an effort to permit each paper to be presented substantially in full, it has been necessary to arrange certain of the technical sessions in duplicate. Where such duplicate sessions occur, effort has been made to arrange the papers to avoid conflict in subject material. Provision will be made to permit members to circulate between parallel sessions and notices will be posted at each session as to the paper being presented at the other. A number of inspection trips have been arranged and should prove of interest to those in attendance. An interesting program of events has been scheduled for the ladies who are cordially invited to participate in this convention.

The program which follows is complete in practically all details; any changes which are made in it will undoubtedly be of a minor nature. An official program will be mailed to the membership a short time before the opening of the convention.

SUNDAY, MAY 27

4:00 P.M.—6:00 P.M. Registration.

MONDAY, MAY 28

9:00 A.M. Registration and opening of exhibition rooms for inspection.

10:00 A.M.—12:00 Noon Official welcome and technical session. Addresses by C. M. Jansky, Jr., President of the Institute; W.F. Diehl, Chairman of the Convention Committee; Harold Pender, Dean of the Moore School of Electrical Engineering, University of Pennsylvania; and W. R. G. Baker, Vice President and General Manager, RCA Victor Company, Inc.



The Photo Illustrators
Philadelphia's sky line as seen from the outer end
of the parkway.

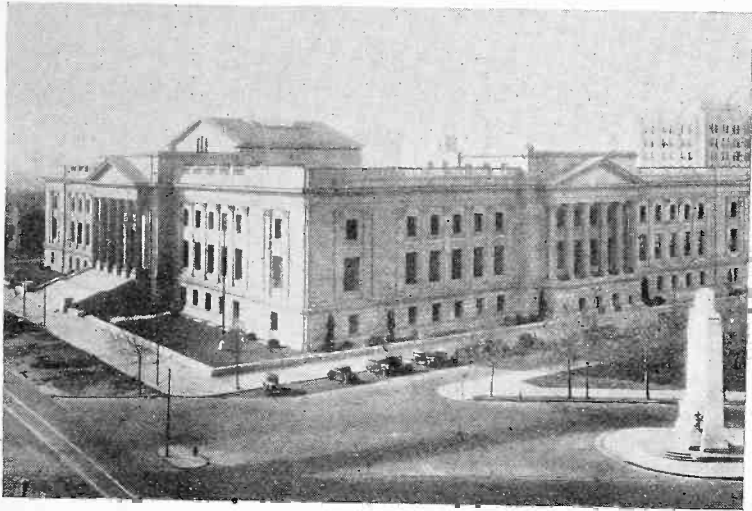

Franklin Institute Museum, which will be
visited on Monday evening.

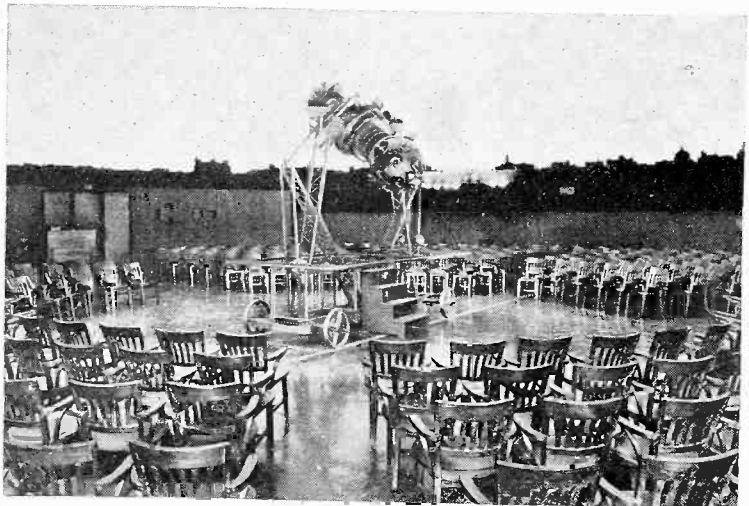

The interior of the Planetarium showing the
projection equipment.

Technical Session—Crystal Ballroom

“A Lapel Microphone of the Velocity Type,” by H. F. Olson and R. W. Carlisle, RCA Victor Company, Inc., Camden, N. J.

“Westinghouse KYW in Philadelphia,” by R. N. Harmon, Westinghouse Electric and Manufacturing Company, Chicopee Falls, Mass.

“Nonlinear Theory of Maintained Electrical Oscillations,” by B. van der Pol, Philips’ Incandescent Lamp Works, Eindhoven, Holland.

- 10:00 A.M.—12:00 Noon Official greetings at ladies headquarters.
 12:00 Noon—2:00 P.M. Luncheon and inspection of exhibits.
 12:00 Noon—2:30 P.M. Ladies luncheon and shopping tour.
 2:30 P.M.—4:30 P.M. Trip No. 1. Ladies inspection trip to WCAU studios.
 2:00 P.M.—4:00 P.M. **Technical Session—Crystal Ballroom**

“The WLW 500-Kilowatt Broadcast Transmitter,” by J. A. Chambers, Crosley Radio Corporation, Cincinnati, Ohio, G. W. Fyler, General Electric Company, Schenectady, N. Y., J. A. Hutcheson, Westinghouse Electric and Manufacturing Company, Chicopee Falls, Mass., and L. F. Jones, RCA Victor Company, Inc., Camden, N. J.

“Comparative Analysis of Water-Cooled Tubes as Class B Audio Amplifiers,” by I. E. Mouromtseff and H. N. Kozanowski, Westinghouse Electric and Manufacturing Company, East Pittsburgh, Pa.

“Some Engineering and Economic Aspects of Radio Broadcast Coverage,” by G. D. Gillett and Marcy Eager, Consulting Engineers, Washington, D. C.

3:00 P.M.—4:00 P.M. **Technical Session—Betsy Ross Room**

“Some Chemical Aspects of Vacuum Tube Production,” by R. E. Palmateer, Hygrade Sylvania Corporation, Emporium, Pa.

“Contact Potential,” by R. M. Bowie, Hygrade Sylvania Corporation, Emporium, Pa.

“Hot-Cathode Mercury Rectifier Tubes for High Power Broadcast Transmitters,” by H. C. Steiner, General Electric Company, Schenectady, N. Y.

- 4:00 P.M.—6:00 P.M. Annual meeting, Sections Committee, Independence Room.
 4:00 P.M.—6:00 P.M. National Association of Broadcasters, Engineering Committee Meeting, Lafayette Room.
 4:00 P.M.—6:00 P.M. Inspection of exhibits.
 8:00 P.M. Trip No. 2. Franklin Institute.

TUESDAY, MAY 29

- 9:00 A.M. Registration and opening of exhibition rooms for inspection.



Benjamin Franklin Hotel, Convention Headquarters.

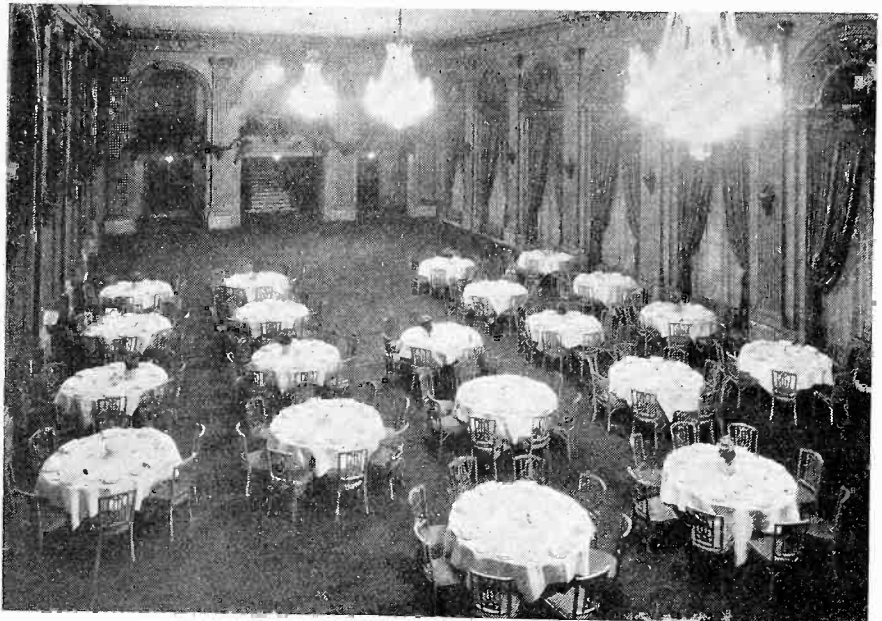

Crystal Ballroom where technical sessions and banquet will be held.

10:00 A.M.—12:00 Noon **Technical Session—Crystal Ballroom**

“Theory of Electron Gun for Cathode Ray Tubes,” by I. G. Maloff and D. W. Epstein, RCA Victor Company, Inc., Camden, N. J.

“Cathode Ray Oscillograph Tubes and Their Applications,” by W. H. Painter, and P. A. Richards, RCA Radiotron Company, Inc., Harrison, N. J.

“The ‘Sound Prism’,” by Knox Mellwain and O. H. Shuck, University of Pennsylvania, Philadelphia, Pa.

Technical Session—Betsy Ross Room

“A Mechanical Demonstration of the Properties of Waves Filters,” by C. E. Lane, Bell Telephone Laboratories, Inc., New York.

“Control of Radiating Properties of Antennas,” by C. A. Nickle, R. B. Dome, and W. W. Brown, General Electric Company, Schenectady, N. Y.

“Measurement of Harmonic Power Output of a Radio Transmitter,” by P. M. Honnell, and E. B. Ferrell, Bell Telephone Laboratories, New York City.

“Frequency Standards and Frequency Measuring Equipment,” by J. K. Clapp, General Radio Company, Cambridge, Mass.

“North Atlantic Ship-Shore Radiotelephone Transmission During 1932–1933,” by C. N. Anderson, Bell Telephone Laboratories, Inc., New York City.

12:00 Noon–5:00 P.M. Trip No. 3. Ladies luncheon and bridge at the Pennsylvania Athletic Club.

12:00 Noon–3:00 P.M. Trip No. 4. RCA Victor plant, Camden. Luncheon will be served at the plant through the courtesy of the RCA Victor Company.

3:00 P.M.—5:00 P.M. **Technical Session—Crystal Ballroom**

“An Experimental Television System”

Introduction—E. W. Engstrom

Transmitter—R. D. Kell, A. V. Bedford, M. A. Trainer

Relay Circuit—C. J. Young

Receivers—R. S. Holmes, W. L. Carlson, W. A. Tolson

RCA Victor Company, Inc., Camden, N. J.

3:00 P.M.—5:00 P.M. R.M.A. Service Managers meeting, Independence Room.

7:00 P.M. Informal Banquet, Crystal Ballroom,

WEDNESDAY, MAY 30

9:00 A.M. Registration and opening of exhibition rooms for inspection.



The RCA Victor plant as seen from the air.

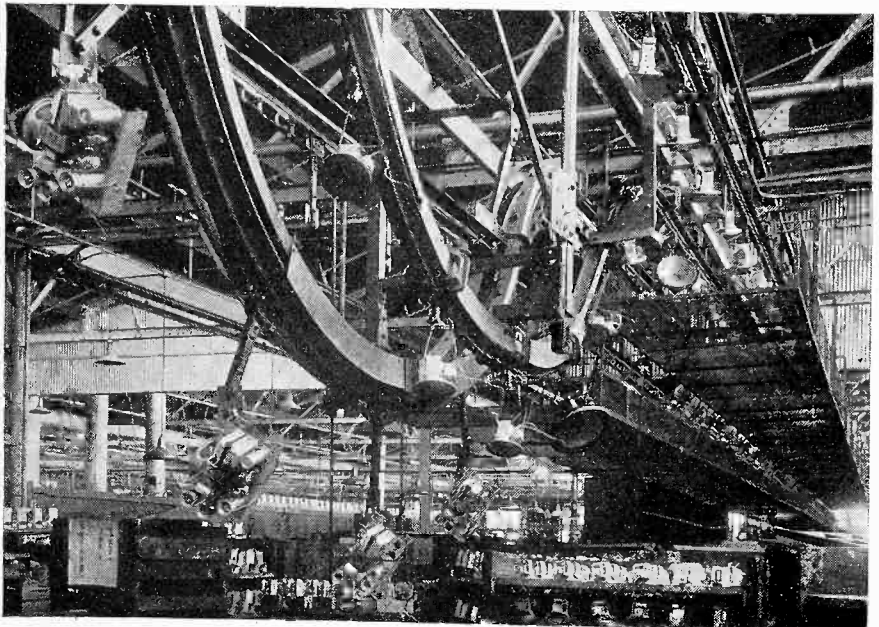

Drix Duryea, Inc.
One of the conveyer "stations" in the RCA Victor plant.

10:00 A.M.—12:00 Noon **Technical Session—Crystal Ballroom**

“The Design and Testing of Multirange Receivers,” by D. E. Harnett and N. P. Case, Hazeltine Corporation, New York.

“High Fidelity Receivers with Expanding Selectors,” by H. A. Wheeler and J. K. Johnson, Hazeltine Corporation, New York.

“Acoustic Testing of High Fidelity Receivers,” by H. A. Wheeler and V. E. Whitman, Hazeltine Corporation, New York.

“A Common Source of Error in Measurements of Receiver Selectivity,” by E. N. Dingley, Jr., Bureau of Engineering, Navy Department, Washington, D. C.

10:00 A.M.—12:00 Noon **Technical Session—Betsy Ross Room**

“Recent Studies of the Ionosphere,” by S. S. Kirby and E. B. Judson, Bureau of Standards, Washington, D. C.

“An Analysis of Continuous Records of Field Intensity at Broadcast Frequencies,” by S. S. Kirby, K. A. Norton, and G. H. Lester, Bureau of Standards, Washington, D. C.

“Modern Methods of Investigating Ionization in the Atmosphere,” by G. L. Locher, Bartol Research Foundation, Swarthmore, Pa.

“Seasonal Variation in the Ionosphere,” by J. P. Schafer and W. M. Goodall, Bell Telephone Laboratories, Inc., New York.

10:00 A.M.—5:00 P.M. Trip No. 5. Ladies sight-seeing trip including visit to Valley Forge where luncheon will be served.

12:00 Noon—2:00 P.M. Luncheon and inspection of exhibits.

2:00 P.M.—4:00 P.M. **Technical Session—Crystal Ballroom**

“Development of Transmitters for Frequencies Above 300 Megacycles,” by N. E. Lindenblad, RCA Communications, Inc., New York City.

“An Electronic Oscillator with Plane Electrodes,” by B. J. Thompson and P. D. Zottu, RCA Radiotron Company, Inc., Harrison, N. J.

“Transmission and Reception of Centimeter Waves,” by I. Wolff, E. G. Linder, and R. A. Braden, RCA Victor Company, Inc., Camden, N. J.

Technical Sessions

None of the papers which are scheduled for presentation will be available in preprint form. Consequently, sufficient time has been allowed each author to present his paper substantially in full and permit a reasonable discussion of its content. Inasmuch as the presentation of a paper before a meeting is justified only if valuable discussion

ensues, it is hoped that those interested in the subjects treated will be present and will participate actively in the consideration given each paper. Time has been provided for such discussion. Because of the large number of papers to be presented, it is absolutely essential that all technical sessions start promptly on time.

Inspection Trips

Monday, May 28th—Trip No. 1

Ladies trip to WCAU studios.

Busses will leave the hotel promptly at 2:30 P.M. for the new studios of broadcast station WCAU. An inspection of the studios will be made until 3:30 P.M. during which a women's program will be broadcast and from 3:30 to 4:30 P.M. a special program will be provided for the benefit of those present.

Trip No. 2

Franklin Institute

On Monday evening, busses will leave the hotel at 8 o'clock for a visit to the Franklin Institute. It is anticipated that both the ladies and men will participate in this trip which will hold wide general interest for all. The institute museum contains a large number of exhibitions of historical importance in the scientific and engineering field. The planetarium will be visited and a special lecture presented. The projector, which may be seen in the photograph of the planetarium, permits the casting on the hemispherical inner surface of the structure replicas of every heavenly body visible to the naked eye. Their positions, sizes, and relative brilliance are faithfully reproduced, and their motions with respect to the earth accurately demonstrated.

Trip No. 3

Ladies Trip to Pennsylvania Athletic Club

The ladies will leave the hotel at noon for the short drive to Rittenhouse Square where the Pennsylvania Athletic Club is located. On arrival at the club, luncheon will be served and the afternoon will be devoted to bridge or such other diversions as may be of interest to those present.

Trip No. 4

RCA Victor Company

Busses will leave the hotel promptly at noon. On arrival at the plant, luncheon will be served through the courtesy of the RCA Victor

Company. The manufacturing facilities of the factory will then be inspected.

Trip No. 5

Ladies Sight-Seeing Trip

This sight-seeing trip will not only cover those places of historical importance in the city of Philadelphia but will include visits to interesting suburban places among which will be Valley Forge where luncheon will be served.

Exhibition

An exhibition of component parts, manufacturing aids, and measuring devices will be held this year as in the past. Instead of holding this exhibition in a large room with booths partitioned off, it will be held in hotel rooms located on the floor above the meeting rooms. The use of rooms rather than booths permits a degree of freedom in demonstrating equipment which has not been possible previously at Institute exhibitions. Greater space which is more conveniently arranged, freedom from noise due to neighboring exhibitions and those passing by, and improved facilities for demonstrating and showing new equipment should assist greatly in making possible the interchange of knowledge for which these exhibitions have been established. The opportunities for the engineer to discuss his problems with the representative of parts manufacturers should be ample.

Banquet

The informal banquet will be held on Tuesday evening in the Crystal Ballroom of the Benjamin Franklin. The Institute awards which are presented annually will be bestowed upon their recipients during the banquet. The names of those who are to be honored with awards have not as yet been announced. An interesting program of entertainment has been prepared. Subsequent to the dinner, there will be dancing for everyone.

Reduced Railroad Rates

The railroads have granted reduced rates on the certificate plan for those attending the convention. When purchasing your one-way ticket to the convention please request a certificate for reduced return fare. At least one hundred of these certificates must be deposited at the registration desk to permit their validation. After being validated, the holder of the certificate may purchase a return trip ticket over the

same route as traveled when coming to the convention at one third the usual rate. All are urged to obtain these certificates regardless of how short their distance of travel may be to insure the minimum of one hundred certificates being deposited for validation.

Sections Committee Meeting

The Annual Meeting of the Sections Committee will be held in the Independence Room at 4 P.M. Representatives of each Institute section should be present at this meeting which plays an extremely important part in establishing Institute policies as they concern the operation of all sections. A logical representative of the section is the chairman or secretary. If neither of these officers can be in attendance, the duty may be delegated to some member of the section who can attend.

Summaries of Technical Papers

Summaries of all papers to be presented during the convention, except that by Dr. van der Pol whose trip was not planned in time to permit, follow and are arranged alphabetically according to the names of the authors.

NORTH ATLANTIC SHIP-SHORE RADIOTELEPHONE TRANSMISSION DURING 1932-1933

CLIFFORD N. ANDERSON

(Bell Telephone Laboratories, Inc., New York City)

SUMMARY

This paper extends the analysis of ship-shore radio transmission data for an additional two-year period beyond that reported on in a previous paper. Contour diagrams show the variation of signal field with time of day and distance for the winter, summer, spring, and fall seasons and for the approximate frequencies 4, 8, and 13 megacycles.

A comparison is made with the data obtained during 1930 and 1931. In general, transmission during 1932-1933 tends to be somewhat better on frequencies below about 9 megacycles and somewhat poorer on frequencies above 9 megacycles. At 4 megacycles the increase is of the order of 10 decibels and for 13 and 17 megacycles the decreases are about 6 and 10 decibels, respectively.

CONTACT POTENTIAL

R. M. BOWIE

(Hygrade Sylvania Corporation, Emporium, Pa.)

SUMMARY

The term, Contact Potential, in connection with thermionic tubes has come to include a combination of several spurious voltages which affect the operation of the tube. The particular combination depends upon the method of measurement or the application to which the tube is put. The effective contact potential varies accordingly. In this paper various methods of measurement and their relationship to certain applications are described under the headings:

- I. Floating element potential.
- II. Floating, shunted element potential.
- III. Effective current cut-off.
- IV. Calculated correction potential.

A discussion of the causes of the various spurious voltages and their methods of combination follow.

THE WLW 500-KILOWATT BROADCAST TRANSMITTER

(J. A. CHAMBERS, CROSLEY RADIO CORPORATION, CINCINNATI, OHIO, G. W. FYLER, GENERAL ELECTRIC COMPANY, SCHENECTADY, N. Y., J. A. HUTCHESON, WESTINGHOUSE ELECTRIC AND MANUFACTURING COMPANY, CHICOPEE FALLS, MASS., AND L. F. JONES, RCA VICTOR COMPANY, INC., CAMDEN, N. J.)

SUMMARY

The design, installation, and performance of the highest power broadcast station in Europe or America is described. The economies of WLW's 500-kilowatt station are compared with those of the 50-kilowatt station.

The vertical radiator is pictured and numerous measurements comparing its performance to the performance of the standard "T" antenna located several hundred yards from it are summarized.

The 500-kilowatt equipment is described in some detail. The station is unique in a number of respects, the most outstanding being the high level, class B modulator producing audio-frequency outputs of 350 kilowatts, the "isolation" operation of the control circuit, and the concentric transmission line. The test of the equipment and the more important of the performance characteristics are given

FREQUENCY STANDARDS AND FREQUENCY MEASUREMENTS

JAMES K. CLAPP

(General Radio Company, Cambridge, Mass.)

SUMMARY

This paper describes improvements in commercial primary frequency standards and interpolation equipment like that employed by many government bureaus and commercial services throughout the world. In particular, adaptation of the equipment for operation either from floating batteries or directly from the commercial alternating-current supply and improvements in crystal mounting, crystal drive circuits, multivibrators, and synchronous-motor clocks are discussed. An outline of the methods of interpolation (between known frequencies of the primary standard) in frequency measurements is given, with a brief description of the equipment used.

A COMMON SOURCE OF ERROR IN MEASUREMENTS OF RECEIVER SELECTIVITY

EDWARD N. DINGLEY, JR.

(Bureau of Engineering, Navy Department, Washington, D.C.)

SUMMARY

Receiver selectivity is usually determined by measuring the amplitude of the input signal at resonance and at various percentages off resonance required to maintain a constant audio output. The audio output contains a certain amount of noise resulting from thermal agitation (so-called "first-circuit noise"). The presence of the input signal causes an increase in noise output, the amount of increase being variable and dependent upon the frequency of the input signal in relation to the resonant frequency of the receiver. If, in measuring selectivity, the total audio output is maintained constant, then the signal component of the output is variable and the selectivity so obtained may have considerable error. This error may be eliminated by requiring the input signal to maintain a constant increment of final detector direct plate current rather than a constant audio output.

AN EXPERIMENTAL TELEVISION SYSTEM

INTRODUCTION—E. W. ENGSTROM

TRANSMITTER—R. D. KELL, A. V. BEDFORD, M. A. TRAINER

RELAY CIRCUIT—C. J. YOUNG

RECEIVERS—R. S. HOLMES, W. L. CARLSON, W. A. TOLSON

(RCA Victor Company, Inc., Camden, N.J.)

SUMMARY

During the first part of 1933 a complete experimental television system was placed in operation in Camden, N. J. Practical tests were made under conditions

as nearly as possible in keeping with probable television broadcast service. Program material was obtained from studio pick-up and outdoor pick-up. The outdoor pick-up was from a point over a mile from the studio and transmitter. In addition a studio program originating in the Empire State Building in New York was relayed to Camden by radio and broadcast in Camden. The transmitter used an iconoscope as the pick-up element and the receiver a kinescope as the reproducing element. A description is given of the transmitter terminal equipment, the transmitter, the New York to Camden relay circuit, and the receiver apparatus.

SOME ENGINEERING AND ECONOMIC ASPECTS OF RADIO BROADCAST COVERAGE

GLENN D. GILLETT AND MARCY EAGER
(Consulting Engineers, Washington, D.C.)

SUMMARY

The results of a quantitative study of the major factors affecting radio broadcast coverage are given for a frequency range from 200 to 2000 kilocycles, and for transmission conditions covering the range normally experienced in the United States.

The effects of terrain, frequency, and antenna design in limiting the maximum nighttime service range of broadcast stations are discussed, and it is shown that these limits are independent of the station power. The effect of terrain and frequency on the power required to deliver a 0.5 mv/m signal at different distances is then shown in a series of curves, and the effect of atmospheric noise and interference considered.

The economic aspects of this coverage are next considered and the power per square mile required is shown and the total costs and costs per square mile are given for the same parameters as before. The economic aspects of the proper balance between transmitter and antenna costs are considered and curves given for the frequency range considered.

These studies show that it is economically unsound to attempt to cover large areas from a single station under unfavorable transmission conditions, i.e., high frequencies and high absorption. Also that for limited service areas the use of these high frequencies imposes no material hardships and that the lower frequencies should be reserved for stations of national and regional coverage, while the lowest frequencies such as are now in use for broadcasting abroad are primarily suitable only for superpower stations of national coverage.

WESTINGHOUSE KYW IN PHILADELPHIA

R. N. HARMON

(Westinghouse Electric and Manufacturing Company, Chicopee Falls, Mass.)

SUMMARY

This paper describes briefly the early history of KYW at Chicago, leading up to the granting of a construction permit by the Federal Radio Commission to replace this transmitter with a new station in Philadelphia. Data on the directional antenna to be used are included.

Brief mention is made of antenna surveys and selection of the new site. The main discussion is focused on the radical departure in design of this new transmitter, and of the building.

THE DESIGN AND TESTING OF MULTIRANGE RECEIVERS

DANIEL E. HARNETT AND NELSON P. CASE
(Hazeltine Corporation, New York)

SUMMARY

The principal difficulties in the design of high-frequency receivers reside in the complexity of the multirange circuits. Several circuits and a unit assembly arrangement are described which improve the frequency calibration and simplify the design. Testing is facilitated by the use of simplified signal generators having "piston" attenuators. The attenuator comprises a pair of coplanar coils, coaxial coils, or condenser plates, one fixed and one movable axially in a moderately long cylindrical copper shield. The attenuation in decibels is directly proportional to the displacement of the movable element, and the calibration can be computed.

**THE MEASUREMENT OF HARMONIC POWER OUTPUT
OF A RADIO TRANSMITTER**

P. N. HONNELL AND E. B. FERRELL
(Bell Telephone Laboratories, Inc., New York)

SUMMARY

A method of determining the harmonic power output of a high-frequency radio transmitter is described in which the power delivered by the transmitter to the antenna system is measured as distinguished from the more common method of measuring harmonic field strengths at specified locations. It is essentially a comparison method. The unknown harmonic power, present with the fundamental, is compared, by means of a sufficiently selective receiving set, with a known comparison power which is supplied in the absence of the fundamental. The method in practice seems to be accurate to about one decibel.

RECENT STUDIES OF THE IONOSPHERE

S. S. KIRBY AND E. B. JUDSON
(Bureau of Standards, Washington, D.C.)

SUMMARY

From weekly measurements of the virtual heights and critical frequencies of the layers of the ionosphere made since June, 1933, the diurnal and seasonal characteristics of the three generally recognized layers E, F₁, and F₂, are shown. These results all indicate that radio waves transmitted upwards are sent back to earth by refraction, and the two latter layers show effects of magnetic double refraction. In addition, the E and F₂ layers, and another, which we tentatively call the G layer, with a virtual height between 700 and 800 kilometers, are believed to return the radio waves by reflection. The most prominent layer returning waves by reflection is the one which has been called the abnormal E layer; it is probably identical with the regular E layer, but because of the steep ion gradient which forms at times it serves to reflect the radio waves rather than to refract them.

Radio waves at normal incidence may be reflected from a layer of given ion density at much higher frequencies than they can be refracted. Reflections from this layer are usually observed at frequencies up to 5000 or 6000 kilocycles in the

summer day and evening, while in winter they have been found most frequently in the frequency band 1600 to 2500 kilocycles during the early evening. Reflections are often received from this layer and the higher F_2 layer simultaneously. No critical frequencies are observed from the reflecting E layer; reflections gradually weaken and disappear as the frequency is increased. No correlation of the appearance of abnormal E layer and thunderstorms has been found. The F_2 and G layers exhibit some of these phenomena at frequencies above the F_2 critical frequency.

AN ANALYSIS OF CONTINUOUS RECORDS OF FIELD INTENSITY AT BROADCAST FREQUENCIES

S. S. KIRBY, K. A. NORTON, AND G. H. LESTER
(Bureau of Standards, Washington, D.C.)

SUMMARY

Continuous records of the field intensities of most of the broadcast stations in the United States have been made at the Bureau of Standards receiving station near Washington, D. C. Typical records of received field intensities from several stations are presented. Maximum field intensities during ten-minute time intervals are analyzed in the following ways to illustrate sky-wave propagation phenomena at broadcast frequencies for distances up to 4000 kilometers: (1) The diurnal variation of the ten-minute maxima and the relation between these data and sunrise and sunset at the transmitting and receiving locations are given for several stations; (2a) the variation of the average values of the ten-minute maxima is shown with respect to distance and frequency for night field intensities; (2b) these variations are also shown for sky waves received during the daytime.

A MECHANICAL DEMONSTRATION OF WAVE FILTERS

C. E. LANE
(Bell Telephone Laboratories Inc., New York)

SUMMARY

The purpose of this demonstration is to illustrate the properties of wave filters by means of a large model of a band-pass mechanical filter. Wave filters will be defined and their uses discussed briefly by way of introduction. The properties of wave filters which will be demonstrated are attenuation, phase shift, and delay, and reflection as a result of impedance mismatch. These phenomena which must be taken into account in the design of electrical filters are made visible through the agency of the mechanical model.

DEVELOPMENT OF TRANSMITTERS FOR FREQUENCIES ABOVE 300 MEGACYCLES

N. E. LINDENBLAD
(RCA Communications, Inc., New York City)

SUMMARY

In a nonmathematical form, the fundamental functions of the electrons and their work cycle in the interelectrode space of a high vacuum tube are discussed. It is shown how the triode feed-back circuit becomes inoperable at very high

frequencies due to reactance and space-time characteristics. It is further shown how the space-time conditions of the electrons can be organized to maintain oscillations independent of voltage variations on the electrodes and thus independent of interelectrode reactance. Some of the more familiar arrangements such as the Barkhausen and the magnetron circuits, which are based on this principle, are discussed in some detail. With these illustrations as a background the author describes a new method of frequency multiplication at very high frequencies. This method yields much greater power outputs than hitherto possible and promises to become very useful.

Details of various means for frequency stabilization are referred to and the merits of frequency controlling devices, such as crystals and low power factor circuits, are compared.

The application of amplitude and frequency modulation to ultra-high-frequency devices is described in the light of the special problems involved.

Practical considerations of circuit arrangements are described in some detail. Several examples of transmitter design are given. These sections are illustrated with photographs.

Many important points in connection with antennas and transmission lines are discussed and the results of some measurements are given.

The paper ends with a section on propagation in which some of the results obtained by RCA Communications, Inc., engineers and others are shown.

MODERN METHODS OF INVESTIGATING IONIZATION IN THE ATMOSPHERE

G. L. LOCHER

(Bartol Research Foundation, Swarthmore, Pa.)

SUMMARY

Ionization that gives rise to the Heaviside layer is a result of cosmic rays and ultra-violet light. The distribution of ionization in the upper atmosphere and its fluctuations in intensity are intimately connected with problems of long-distance radio communication. During the last few years, substantial advances have been made in methods of measuring the ionization of the atmosphere by corpuscular radiation and light, by means of Geiger-Muller counters. A special counter is now being constructed for making a careful study of ionization in the stratosphere. The paper describes the methods used in this work and is illustrated by demonstrations of a counter set for measuring cosmic radiation in the stratosphere, and another for ultra-violet light.

THEORY OF ELECTRON GUN FOR CATHODE RAY TUBES

I. G. MALOFF AND D. W. EPSTEIN

(RCA Victor Company, Inc., Camden, N.J.)

SUMMARY

The function of the electron gun irrespective of the purpose of cathode ray tube in which it is used is to generate, to concentrate, to control an electron beam, and to focus it to a spot of a desired size. This paper describes the theory of the above-mentioned functions. The relevant part of thermionic emission is treated first, with an emphasis on distribution of velocities of emission. The initial concentration in the proximity of the cathode, the control of the beam intensity,

and the effects of space charge are presented next. Theory of thick electron lenses with variable indexes of refraction follows in order to treat the focusing action taking place.

THE "SOUND PRISM"

KNOX McILWAIN AND O. H. SCHUCK

(Moore School of Electrical Engineering, University of Pennsylvania, Philadelphia, Pa.)

SUMMARY

The methods of sound analysis used at present are classified into those in which an analyzing operation is performed upon a photographic record of the wave and those in which the wave is analyzed as it is being produced. It is pointed out that the methods of the first group are very laborious and that those of the second group are slow in action, making them unsuitable for analyzing sounds of relatively short duration such as those produced by persons.

The need for a device to perform a rapid analysis is indicated.

A new rapid acting hetrodyne wave analyzer called the "Sound Prism" is described and its operation is illustrated. The frequency spectrum is repeatedly traced on a translucent screen by a spot of light at such a rate that retentivity of vision allows the eye to see the path of the spot as a steady line or group of lines on the screen. The frequency spectrum is thus shown almost instantaneously so that changes in the spectrum may be continuously followed by the eye as the composition of the sound changes and the ear hears the change in quality. Sample records of analyses are given and a brief description of the work already done in the field of musical tone analysis is presented. The limitations of the "Sound Prism" in regard to resolution and speed are discussed and plans for further development are outlined.

In an appendix the problems concerned with the operation of the filter element at a high rate of frequency change are discussed.

COMPARATIVE ANALYSIS OF WATER-COOLED TUBES AS CLASS B AUDIO AMPLIFIERS

I. E. MOUROMTSEFF and H. N. KOZANOWSKI

Westinghouse Electric and Manufacturing Company, East Pittsburgh, Pa.)

SUMMARY

Performance of vacuum tubes used as class B audio amplifiers has been studied with a particular stress on the influence of the voltage amplification factor on the behavior of tubes. Four types of water-cooled tubes of completely identical design differing only in amplification factor have been studied. The influences of the load resistance, operating plate voltage, and no-signal current (or bias) have been graphically precalculated and compared. The limitations of water-cooling on this class of tube operation is clearly demonstrated. The methods used for this particular study are applicable to a variety of similar problems.

CONTROL OF RADIATING PROPERTIES OF ANTENNAS

C. A. NICKLE, R. B. DOME, and W. W. BROWN

(General Electric Company, Schenectady, N.Y.)

SUMMARY

Current distribution along a radiator for operation at a given frequency is usually established by fixed dimensions and proportions of the radiator. A sys-

tem of tuning is described in which the current distribution, and therefore the radiating properties, may be varied through an extremely wide range. The elementary system for a vertical radiator consists of a concentrated capacity at the top. By adjustment of the tuning of this capacity, with corresponding adjustments at the base, the current distribution is varied.

The advantages are:

- a. Comparable radiation efficiency of antennas of relatively short lengths or heights.
- b. Increased radiation efficiency of antennas for given lengths or heights.
- c. Control of angle of radiation.
- d. Reduction of ground losses of vertical radiators.

The system is considered to be particularly advantageous for applications to the range of frequency from 500 to 300,000 kilocycles.

A LAPEL MICROPHONE OF THE VELOCITY TYPE

HARRY F. OLSON AND RICHARD W. CARLISLE
(RCA Victor Company, Inc., Camden, N.J.)

SUMMARY

The requirements for satisfactory operation of a lapel microphone are shown to be (1) a wide band frequency characteristic compensated for diffraction of the voice around the head, (2) means for keeping the output constant while the head is turned, (3) satisfactory sensitivity, and (4) light weight. The first is accomplished by calculating the diffraction and compensating for it. The second is accomplished by utilizing the velocity principle and so orienting the microphone that the region of optimum sensitivity lies in the direction of the mouth when the head is turned to the side away from the microphone. Suitable compensation is used to make the output proportional to sound pressure rather than wave velocity. Satisfactory sensitivity is attained with only three ounces of total weight by carefully proportioning the microphone. The latter consists of a very thin aluminum ribbon suspended between the poles of a small permanent magnet. It occupies only one fortieth the volume of a standard velocity microphone. The over-all effective frequency characteristic is flat from 80 to 7000 cycles with a deviation of ± 2 decibels.

CATHODE RAY OSCILLOGRAPH TUBES AND THEIR APPLICATIONS

W. H. PAINTER AND P. A. RICHARDS
(RCA Radiotron Company, Inc., Harrison, N.J.)

SUMMARY

The purpose of this paper is to point out such features of a cathode ray oscillograph tube as will assist in intelligent operation of the tube. The component parts are discussed and the function of each is shown. Mention is made of the history of fluorescent materials, together with their characteristics and some precautions to be observed in their use. The relative merits of electrostatic and electromagnetic deflection are mentioned. The paper concludes with a brief résumé of operating conditions for the tubes described.

A demonstration of some interesting applications of cathode ray oscillographs follows the paper.

SOME CHEMICAL ASPECTS OF VACUUM TUBE PRODUCTION

R. E. PALMATEER

(Hygrade Sylvania Corporation, Emporium, Pa.)

SUMMARY

Even as recently as three years ago radio tube parts were made for the most part from three metals; namely, nickel, molybdenum, and tungsten. Since that time a number of alloys having suitable properties for the various parts have become available. The development of analytical and processing procedures will be discussed. Various insulation problems of tube manufacture and design will be indicated, together with materials and processes most suited for particular problems. The removal of the final gas and the influence of the method used on characteristics during the life of the tube will be reviewed.

SEASONAL VARIATIONS IN THE IONOSPHERE

J. P. SCHAFER AND W. M. GOODALL

(Bell Telephone Laboratories, Inc., New York)

SUMMARY

This paper gives the results of daily pulse experiments which have been in progress since the latter part of 1932. The seasonal variations in the ionization and effective heights of the various reflecting layers are shown by a series of contour drawings or "topographical" maps in which the variations in the virtual height is given as a function both of time of day and of frequency.

HOT-CATHODE MERCURY RECTIFIER TUBES FOR HIGH POWER BROADCAST TRANSMITTERS

H. C. STEINER

(General Electric Company, Schenectady, N.Y.)

SUMMARY

This paper describes the new and large hot-cathode mercury-vapor rectifier tube that is used in the plate power rectifier of the Crosley (WLW) 500-kilowatt broadcast transmitter.

Design features resulting in improved operation of mercury-vapor tubes are discussed together with the operating characteristics.

An analysis of the advantages of the unit half-wave type of rectifier tube is made.

AN ELECTRONIC OSCILLATOR WITH PLANE ELECTRODES

B. J. THOMPSON AND P. D. ZOTTU

(RCA Radiotron Company, Inc., Harrison, N.J.)

SUMMARY

This paper describes a new type of thermionic tube capable of producing ultra-high frequencies by means of electronic oscillations. Tubes of this type are characterized by having parallel plane electrodes, instead of cylindrical electrodes as in the conventional Barkhausen-Kurz tubes, and a fourth element called a backing plate.

The relations between wavelength and amplitude of oscillation and the various electrode potentials are discussed. It is shown that in these tubes the filament voltage is not critical, space-charge limited operation being satisfactory, and that only one mode of oscillation is obtained. Both of these factors appear to give these tubes an advantage in stability over cylindrical Barkhausen-Kurz tubes.

A tube of the flat type is described which has produced oscillations at a wavelength of less than 10 centimeters in the fundamental mode with a positive grid potential of 250 volts.

HIGH FIDELITY RECEIVERS WITH EXPANDING SELECTORS

HAROLD A. WHEELER AND J. KELLY JOHNSON

(Hazeltine Corporation, New York)

SUMMARY

A high fidelity receiver for general use requires means for continuously expanding or contracting the resultant band width of all the carrier selectors, in order that the best compromise between fidelity and selectivity may be chosen for any given operation conditions. An expanding selector ("XPS") arrangement is provided whose expansion is controlled by moving the tuning knob in the axial direction. Tuning the receiver when the band width is expanded is generally undesirable, because accurate tuning is difficult and the operator hears only part of the number of available signals. Therefore an interlocking mechanism is provided which permits the operator to tune the receiver only when the band width is contracted. The operator is thereby first constrained to follow the correct procedure of tuning with maximum selectivity, and second, expanding to improve the fidelity to the extent permitted by noise or adjacent channel interference. Several methods for expanding are available. The expanding selectors are preferably designed to make available both improved selectivity and improved fidelity.

ACOUSTIC TESTING OF HIGH FIDELITY RECEIVERS

HAROLD A. WHEELER AND VERNON E. WHITMAN

(Hazeltine Corporation, New York)

SUMMARY

Acoustic testing of radio receivers is most useful as an aid in designing the receiver to reproduce uniformly the required range of audio frequencies. The problem is fundamentally the coördination of transmitter pick-up and receiver reproduction, to give the listener the illusion of being present at the original performance. The mounting of the loud speaker and its position in the listening room materially affect the sound reproduction. The resultant effect is readily analyzed in terms of the average sound in the listening room, as measured at several positions by means of a nondirectional crystal microphone. Receivers designed on this basis are found to give excellent reproduction when the transmitter technique and other conditions are adequate for high fidelity reception.

TRANSMISSION AND RECEPTION OF CENTIMETER WAVES

I. WOLFF, E. G. LINDER, AND R. A. BRADEN
(RCA Victor Company, Camden, N.J.)

SUMMARY

Apparatus is described consisting of a new type split anode magnetron, which has been used to generate 2.5 watts of energy at 10 centimeters wavelength, with an efficiency compared to direct-current plate dissipation of 12 per cent. The methods used for measuring the tube output energy and the radiated energy are explained. Modulation of the waves by means of variation in the transmission of an ionized gas is demonstrated. Two tube detectors for centimeter waves are described, one of which is almost aperiodic as regards frequency response, while the other is electron tuned. Data on the distance at which signals can be received with existing apparatus are presented.

April meeting of the Board of Directors

The regular monthly meeting of the Board of Directors was held on April 4 in the office of the Institute. Those present were C. M. Jansky, Jr., president; Melville Eastham, treasurer; Arthur Batcheller, W. G. Cady, O. H. Caldwell, Alfred N. Goldsmith, L. C. F. Horle, L. M. Hull, E. L. Nelson, H. M. Turner, A. F. Van Dyck, H. A. Wheeler, William Wilson, and H. P. Westman, secretary.

K. W. Jarvis was transferred to the Fellow grade, L. V. Berkner, K. G. Jansky, N. C. Stamford, and C. E. Tucker were transferred to the grade of Member. A. R. Twiss and R. P. Wuerfel were elected to the grade of Member. Forty-four Associates, three Juniors and five Student members were elected.

The recommendations of the Nominations Committee for officers to be elected later in the year were considered and acted upon. The candidates whose names are to appear on the ballot were chosen, and after acceptances have been received from them, their names will be published in the JUNE PROCEEDINGS.

R. H. Manson was designated the Institute's representative on the Electrical Standards Committee of the American Standards Association.

The notice which was received from the Bureau of Standards advising that due to economic conditions they would no longer be able to supply the monthly lists of radio abstracts and references which have appeared regularly in the PROCEEDINGS was considered. A committee was appointed to investigate such possibilities as may be available to insure a continuance of these lists.

The Emergency Employment Service reported twenty-one new registrations in March bringing the total to 646. Six men were placed

in jobs believed to be permanent and eleven obtained what was known to be temporary work.

An invitation to meet jointly with the Amateur Astronomers Association on May 2, 1934, at the American Museum of Natural History of New York City to hear a paper on "Radio factors in Astronomy" by J. L. Ritchie of the American Telephone and Telegraph Company was accepted.

Committee Work

ADMISSIONS COMMITTEE

A meeting of the Admissions Committee was held on the morning of April 4 at the Institute office and was attended by A. F. Van Dyck, acting chairman; Austin Bailey, Arthur Batcheller, I. S. Coggeshall, L. C. F. Horle, and H. P. Westman, secretary.

Eight applications for transfer to the grade of Member were considered. Of these, five were approved, two were rejected, and one was tabled pending the obtaining of further information. Six applications for admission to the grade of Member were examined and three approved. The remaining three were rejected.

AWARDS COMMITTEE

The Awards Committee met on the evening of April 4 and those in attendance were H. M. Turner, chairman; R. H. Langley, A. F. Van Dyck, and William Wilson.

The committee was unable in the time available to reach its decision as to candidates for the Institute awards and another meeting will be held for that purpose.

CONVENTION PAPERS COMMITTEE

At a meeting of the Convention Papers Committee attended by William Wilson, E. W. Engstrom, and H. P. Westman, a program of technical papers for the annual convention was prepared.

MEMBERSHIP COMMITTEE

The Membership Committee met in the Institute office on the evening of April 4 and those present were I. S. Coggeshall, chairman; C. J. Burnside, H. A. Chinn, W. F. Cotter, H. C. Humphrey, T. A. McCann, C. R. Rowe, E. W. Schafer, C. E. Scholz, and J. E. Smith.

NOMINATIONS COMMITTEE

The Nominations Committee met early on the afternoon of April 4 in the Institute office and those in attendance were L. M. Hull, chairman; W. G. Cady, L. C. F. Horle, and H. P. Westman, secretary.

The committee prepared a slate of candidates for presentation to the Board of Directors in accordance with its constitutional instructions.

SECTIONAL COMMITTEE ON RADIO

A meeting of the chairmen of the Sectional Committee on Radio and the Technical Committees thereof was held at the Institute office on April 10. Alfred N. Goldsmith, chairman of the Sectional Committee on Radio, Julius Weinberger, chairman of the Technical Committee on Electro-Acoustic Devices, H. A. Wheeler, chairman of the Technical Committee on Receivers, and H. P. Westman, secretary, were present.

The personnel of the two committees represented by their chairmen was agreed upon and certain material which requires early consideration was assigned to the various committees.

Institute Meetings

BUFFALO-NIAGARA SECTION

The March meeting of the Buffalo-Niagara Section was held on the 16th at the University of Buffalo. L. Grant Hector presided and about 500 were present.

A paper on "Modern Alchemy" was presented by G. B. Pegram of the Department of Physics of Columbia University. As a part of his presentation, Dr. Pegram gave a demonstration of equipment used to detect the existence of particles projected from radioactive substances. Vacuum tube amplifiers capable of extremely high amplification are required for these purposes, and their design and construction were commented on.

CLEVELAND SECTION

A meeting of the Cleveland Section was held on February 22 at the Case School of Applied Science. It was presided over by F. T. Bowditch, chairman, and the attendance was twenty-five.

J. C. Hoover, the Detroit representative of the Hickok Electrical Instrument Company, presented a paper on "Static Testers and Tubeless Oscillators." A short account was given of the increased complexities of radio circuits and construction and their effects upon the necessary tools and knowledge for servicing. The addition of automatic volume control and noise suppression circuits has made changes necessary in the service equipment, and the dynamic type of set checker is no longer able to give all of the information necessary. Properly de-

signed equipment for making static tests are now being used. Such a device of new design and an oscillator making use of the tube in the receiving set were described and their functions outlined. A general discussion then followed.

CONNECTICUT VALLEY SECTION

A meeting of the Connecticut Valley Section was held on January 25 at Yale University, K. S. Van Dyke, chairman, presided and forty-nine members and guests were in attendance.

A paper on "Magnetron Oscillators" was presented by F. T. McNamara, Assistant Professor of Electrical Engineering at Yale University. The performance of the magnetron as an audio- and radio-frequency oscillator of both the regenerative and dynatron type was demonstrated with graphic presentation of the operating region and circuit conditions in each case. Similarities in its functioning to those with the ordinary triode vacuum tube were pointed out. Finally, electronic oscillations of the Barkhausen-Kurz type were produced in the ultra-high-frequency region in contrast to ordinary regenerative oscillations in the same region.

The February meeting of the Connecticut Valley Section was held on the 23rd at the Hotel Charles in Springfield. Chairman Van Dyke presided and thirty were present.

J. K. Clapp of the General Radio Company presented a paper on "Frequency Standards and Frequency Measurements." The speaker discussed the equipment used for comparing electrical oscillations with astronomical time observations to ascertain with high accuracy the frequency of oscillation. Methods of increasing the accuracy of checking the electrical oscillations were outlined. Ways of obtaining voltages of various frequencies from the electrical standard frequency equipment were outlined and their utilization discussed.

On the 27th of March there was held a meeting of the Connecticut Valley Section in the Hotel Charles at Springfield, Mass., which also was presided over by Chairman Van Dyke.

W. A. Bardin of the RCA License Laboratory presented a paper on "Superregeneration—Its Analysis and Application." In introducing his subject, the speaker differentiated between the terms regeneration, interrupted simple regeneration, and superregeneration. The action of the negative resistance in increasing amplification in both the dynatron and feed-back circuits was shown graphically and mathematically. The analysis of superregeneration then presented pointed out that the

value of the interruption or quenching voltage and its time constant were the factors determining the sensitivity and selectivity of circuits operating at any given frequency. An ideal selection of circuit constants was shown to give in practice voltage gains of a million and a quarter. Typical circuits using the 6F7 tube were shown and explained.

DETROIT SECTION

A meeting of the Detroit Section was held on March 23 at the Detroit News conference room. The attendance was fifty-five and fourteen were present at the informal dinner which preceded the meeting. Samuel Firestone, chairman, presided.

A paper on "Tube Manufacture and Engineering Problems Involved in the New Types" was presented by C. E. Rich of the Vacuum Tube Division of Sparks-Withington Company. The paper was arranged to present a verbal description of a trip through a manufacturing plant and described the step-by-step construction of a tube from the starting of the glass stem to the final tests and packing of the finished product. At each stage the speaker described the materials used and the difficulties normally encountered in the particular process being employed. In concluding there was presented an interesting discussion of some of the things that happen after a new type of tube has been released and is found unsuitable for production or set design purposes. A number of the members present participated in the general discussion which followed.

LOS ANGELES SECTION

H. C. Silent, chairman, presided at the January 19 meeting of the Los Angeles Section held in the Exposition Park Studios of the City of Los Angeles.

A. P. Chesney, a radio engineer for the Department of Parks of the City of Los Angeles, presented a paper on "The Use of Radio In the Department of Parks of the City of Los Angeles." This included a detailed description of the equipment now installed in the Exposition Park Studios and band stand. Diagrams were shown of the equipment and circuits recently installed, and the paper was closed with a discussion of the placement of loud speakers to provide satisfactory coverage of the complete area of seats at the Exposition Park.

A second paper on "High Quality Sound Systems" was presented by W. F. Ludlum of Harrison Sound Equipment. In opening his paper the speaker pointed out that substantial differences of opinion exist among sound system engineers. The most important requirements are a high quality reproduction and satisfactory volume at all points at

which the listener may be located. He then presented a detailed description of a satisfactory audio-frequency amplifier. Detailed treatment was made of the theory and construction of transformers for such amplifiers.

A third portion of the program was a demonstration of a new high speed camera capable of taking up to three thousand pictures per second. This was given by R. H. Griest of Electrical Research Products, Inc. A detailed description of this camera showing the timing action used was given. Some films were projected showing various seemingly instantaneous acts which had been photographed by the high speed camera and reproduced at normal speed. Thus one had the opportunity of seeing a match head slowly burn from its tip down to the wood rather than explode.

The various committee chairmen were appointed. These are as follows: W. F. Grimes, Meetings and Papers; T. E. Nikirk, Employment; W. F. Ludlum, Publicity; E. H. Schreiber, Joint Committee of Technical Societies; and E. P. Schultz, Membership.

NEW YORK MEETING

The April meeting of the Institute in New York was held on the 4th in the Engineering Societies Building and was presided over by President Jansky.

A paper on "Maintaining the Directivity of Antenna Arrays" was presented by F. G. Kear of the Washington Institute of Technology. In his paper, Dr. Kear pointed out that when a directive antenna array is used to maintain a certain minimum of signal in a given direction, or when a group of arrays are employed to provide intersecting space patterns such as in the radio range beacon, it becomes necessary to maintain an accurate and constant relation between the phase and magnitude of the several antenna currents. Slight detuning effects in one antenna of a group will seriously alter the pattern. To overcome this trouble, the antennas are excited by means of constant current transmission lines. When these lines are connected in parallel they are built up with artificial sections to 90 degrees in electrical lengths. When operated in series, they are built out to 180 degrees electrical length. Experiments show such a system to function satisfactorily and to be decidedly noncritical in adjustment. The new airways radio range beacon stations are using the arrangement with marked success, and several broadcast stations have applied its principles to their antenna systems.

An active discussion was participated in by a number of the 200 members and guests in attendance.

PHILADELPHIA SECTION

A meeting of the Philadelphia Section was held on February 1 at the Engineers Club. W. F. Diehl, chairman, presided and eighty members and guests were in attendance. Ten were present at the informal dinner which preceded the meeting.

J. W. Horton, who is at present doing research work at the Massachusetts Institute of Technology, presented a paper on "The Curious Progress of Electrical Measurements Along the Frequency Scale." The problems of measurements and measurement equipment in the radio field was presented from the standpoint of their development as the frequency band was extended into the higher frequency region. The difficulties of establishing frequency standards of satisfactory accuracy were also covered.

The March meeting of the Section was held on the 1st of the month at the Engineers Club and Chairman Diehl presided.

A paper on "Atmospheric Electricity" was presented by W. F. G. Swan, Director of the Bartol Research Foundation of the Franklin Institute. Dr. Swan discussed the nature and causes of the earth's atmospheric potential gradient together with such related matters as the electrical conductivity of the atmosphere over earth and ocean, and the effect of radioactive material in the soil and atmosphere on this conductivity. He also discussed cosmic radiation, the conductivity of the upper strata atmosphere as well as the origin and maintenance of the earth's electrical purposes. How these matters are all vital to the propagation of electrical waves through our atmosphere and their effect on radio transmission was outlined. A number of the 125 members and guests in attendance participated in the discussion. Ten were present at the informal dinner which preceded the meeting.

SAN FRANCISCO SECTION

The San Francisco Section met on February 21 at the Bellevue Hotel. Thirty-four members and guests were present and fourteen attended the informal dinner which preceded the meeting. G. T. Royden presided.

W. D. Kellogg of Broadcast Station KGO presented a paper on "The Field Strength of Broadcast Stations." It was followed by a discussion which was participated in by several of those present.

SEATTLE SECTION

A meeting of the Seattle Section was held on January 26 at the University of Washington. A. V. Eastman presided in the absence of the chairman.

A paper on "Piezo-Electric Crystals and Their Applications" was presented by Oliver Smith of the Pacific Telephone and Telegraph Company. He showed circuits for frequency stabilization and methods of cutting crystals with particular reference to the obtaining of minimum temperature coefficients. He then described the electromechanical properties of crystals and their application to microphones, loud speakers, and similar devices. A demonstration of crystal speakers and microphones was then given.

The February meeting of the section was held on the 23rd at the University of Washington. Howard Mason, chairman, presided and forty-one were present.

A paper by C. E. Magnusson of the Electrical Engineering Department of the University of Washington on the subject of "Lichtenberg Figures, Transmission Line Transients, and Lightning," was presented. Numerous slides were exhibited illustrating the characteristics of positive and negative Lichtenberg discharges with various forms of electrodes, and their interpretation was given. Dr. Magnusson then demonstrated that both the positive and negative figures are formed by the light of the spark and not by the spark directly. Both are the result of electrons and not positive ions.

WASHINGTON SECTION

On March 8 there was a meeting of the Washington Section held at the Kennedy-Warrent Apartments which was presided over by T. McL. Davis, chairman. Thirty-seven members and guests were present and nineteen attended the informal dinner which preceded the meeting.

"A Recording Frequency Monitor" was the subject of a paper presented by C. G. Lapham, assistant engineer of the Bureau of Standards. This paper described equipment used by the Bureau of Standards for monitoring its standard frequency transmissions. Methods of comparing frequencies which are integral multiples of 1000 kilocycles and lie between the range of from 3000 to 25,000 kilocycles can be made with the precision within a tenth of a cycle. The results of measurements of standard frequency transmissions over a period of several months were presented, and the records show that the absolute accuracy of the transmissions was within approximately one part in ten million.

Errata

The following corrections have been received to the paper entitled "Propagation of High-Frequency Currents in Ground Return Circuits," by W. H. Wise, published in the April, 1934, issue of the PROCEEDINGS, pages 522-527, inclusive.

Page 522, the equation in the last line of the summary should read

$$r\sqrt{1+i(\epsilon-1)/2c\lambda\sigma}$$

Page 523, the third line of the first equation should read

$$+c \times 2e^{-rx} \dots$$

Page 523, the seventh line of the second equation should read

$$-E_x = i\omega \left[\Pi_x + \frac{1}{k^2} \frac{\partial}{\partial x} \left(\frac{\partial \Pi_x}{\partial x} + \frac{\partial \Pi_y}{\partial y} + \frac{\partial \Pi_z}{\partial z} \right) \right] = i\omega \Pi_x + \frac{\partial V^*}{\partial x}$$

Page 523, the equation in the footnote should read

$$V = \int_y^\infty E_y dy$$



TECHNICAL PAPERS

HIGH QUALITY RADIO BROADCAST TRANSMISSION
AND RECEPTION*

BY

STUART BALLANTINE
(Mountain Lakes, New Jersey)

PART I

1. INTRODUCTION

THERE is probably a general feeling that the technical development of the radio broadcast system has progressed to a point where, so far as the average public taste is concerned, the performance is "good enough." The resultant attitude of *laissez faire* has been eagerly espoused by receiver manufacturers and broadcasters alike during the present economic depression. This demoralizing period has not encouraged the exercise of a critical judgment of performance, either by engineers and manufacturers or by the public. Red ink and engineering idealism are traditionally poor companions. Also the public taste in these matters has been further dulled by exposure to the quite inferior performance of the smaller types of sets—midgets and submidgets—which its reduced pocketbook has obliged it to buy.

The result has been that, in my opinion at least, we have made very little real progress in the technical improvement of broadcasting during the past five years. Let us take by way of illustration the case of the broadcast receiver. There have been many technical improvements since the days of the earphone and crystal detector: the superheterodyne method, cascaded one-way radio-frequency amplifiers, single tuning control, alternating-current tubes, the screen-grid tetrode, high level linear detection, the Rice-Kellogg loud speaker, automatic volume control, variable-mu tube, automatic intercarrier noise suppression, multifunction tubes, and improvements in selectivity have all contributed to better electrical performance. In spite of all these, however, radio receivers still sound about the same today as they did five years ago and a lot of the more recent types a great deal worse. The majority

* Decimal classification: R550. Original manuscript received by the Institute, February 13, 1934. Presented before New York Meeting, November 8, 1933; Philadelphia Section, December 7, 1933; Franklin Institute, Philadelphia, February 1, 1934.

of these improvements have contributed to operating convenience and reduction of cost but have not greatly enhanced the æsthetic value of the receiver as a musical instrument.

Although radio is meeting with wide public acceptance there is evidently some suspicion, even in lay quarters, that things are perhaps not quite what the advertisers would have us believe. At the risk of seeming to be frivolous I should like to read a clipping from a recent weekly magazine (*New Yorker*) on this subject.

The radio, except as it serves mariners, is a decivilizing achievement. It has destroyed the illusion of distance, invaded the privacy of walled enclosures, and coated the tongue of music. With other amplified and allied sounds, indiscriminately disseminated, the radio will in time cause a tone deafness no less shameful than our lost sense of smell.

I think we will all agree with the sentiment that radio too frequently "coats the tongue of music."

All in all it is perhaps not an inopportune time to stop and take stock of what has been done, to survey the present state of the art and to assess our hopes for the future. The moment also seems exceptionally ripe to attempt a resuscitation of the broadcast industry by offering the public something new—really high quality broadcast transmission and reception. Our demonstrations of high quality receivers to several hundred nontechnical persons during the past two years have indicated a high degree of interest and satisfaction, and an avid public acceptance can therefore be confidently predicted.

In this critical spirit we may approach the subject from the viewpoint of the following questions:

(1) What is an acceptable and economically realizable standard of performance for a high quality broadcast system?

(2) What are the weaknesses of the present system and what remedies can be applied to bring its performance up to this standard?

First of all, what do we mean by a high quality system? A high quality system may be taken to be one which acoustically transports the listener in fancy from his loud speaker to the studio or auditorium. It must be free from frequency, amplitude, and phase distortion and also must not introduce extraneous sounds of annoying or distracting magnitudes. Freedom from frequency distortion means that the system must be uniformly responsive over the entire range of audible frequencies. It has been known since the time of Helmholtz and Koenig that the normal ear is responsive from 30 to 16,000 or 20,000 cycles. Many impulsive sounds such as the tinkle of a bell, jingling of coins, the sounds of a triangle or tamborine require transmission up to 15,000

cycles for their full appreciation. Thus theoretically this whole range is required for high quality transmission. As a practical matter, however, since the space taken up in the radio-frequency spectrum is proportional to the upper limit of the audio-frequency modulation it is highly desirable to limit the audio-frequency transmission as much as possible without an undue sacrifice of quality. The question briefly amounts to this: We would like to modulate up to 15,000 cycles, but what is the lowest upper frequency limit that we can accept without noticeably affecting the transmission of a majority of sounds to which we desire to listen?

In order to obtain an answer to this question we made a long series of tests, using various kinds of program material—speech, symphonic music, etc., and a set of low-pass filters by means of which the higher frequencies could be cut off in systematic steps starting at 15,000 cycles and extending down to 2000 cycles. A number of observers, mostly nontechnical, whose hearing had been ascertained as normal were asked to express opinions as to the effects of the various filters. The results can be summed up as follows: *Although the reduction of the range from 15,000 to 8000 cycles could readily be detected in the case of a few special sounds, in the case of orchestral music close attention was required to detect any difference in the quality of the reproduced music.* A further reduction to 5500 cycles, however, detracted noticeably from the quality. It was concluded therefore that a 7000- or 8000-cycle band would be adequate for high quality broadcasting. With the present separation of 10,000 cycles between stations, however, the transmission of a band of this width means that the side bands will overlap to the extent of 3000 cycles. This is not desirable since it produces “monkey-chatter.” Increasing the channel separation from 10 to 15 kilocycles would permit the transmission of a 7500-cycle audio range with negligible monkey-chatter and cross-talk. This would reduce the number of available channels 33 per cent. I do not believe that a 20-kilocycle separation, involving a 50 per cent reduction in the number of channels, would be justified.

The Federal Radio Commission has recently set aside a frequency band above 1500 kilocycles, in which the channels are separated 20 kilocycles, to permit high quality broadcasting with an increased audio range to be tested experimentally.

The term “fidelity” is conventionally employed to denote the degree to which frequency distortion is absent. “High fidelity” has two aspects: First of all it infers response over a *wide range* of audible frequencies, and second it infers that the response over this range does not fluctuate. We are referring now to transmission systems having a

more or less abrupt frequency cut-off. Obviously the term high fidelity should not be used to designate a system having a wide frequency range without regard to the uniformity of response, although it is often incorrectly used in this way. We find experimentally that a system which is flat within a few decibels but whose frequency range is limited to 5000 cycles will be preferred by most people to one which fluctuates 10 decibels but which covers the entire audible range. A fact that cannot be too strongly emphasized is that within reasonable limits absence of fluctuation is more important than the extent of the frequency range.

With this in mind we may propose the following arbitrary criteria for fidelity in broadcast systems:

(1) High fidelity: Uniform response within 5 decibels from 50 to 8000 cycles or above.

(2) Medium fidelity: Uniform response within 5 decibels from 100 to 4000 cycles, or uniform response within 10 decibels from 50 to 8000 cycles.

(3) Low fidelity: Uniform response within 5 decibels from 200 to 2000 cycles, or uniform response within 10 decibels from 100 to 4000 cycles.

On the basis of these definitions nearly all radio receivers and a considerable amount of broadcast material are in the "low fidelity" class at the present time. The 5-decibel variation is selected from engineering experience of what can be accomplished today at reasonable cost.

If, in addition to being a high fidelity system as defined above, other sources of distortion and noise are absent, the system may also be designated as a "high quality" system. High fidelity, if the term is employed in its standardized sense, is necessary but not sufficient for high quality.

The specifications for an ideal high quality receiver are easily formulated; the practical engineering question, however, is: How far are we justified in going in view of the present conditions as to broadcast set-up, channel separation, land-line transmission facilities, noise, interference and so forth and also taking cognizance of likely future improvements. Our experience in the design of such receivers has led us to believe that the following specifications for high quality transmission, or reception, are realizable with present instrumentalities, and at a reasonable cost:

(1) The over-all fidelity should not fluctuate more than 5 decibels from 50 to 7500 cycles.

(2) The linearity should be such that the total harmonics at full

load are less than 5 per cent. In the case of a receiver this should correspond to an electrical power output of at least 15 watts.

The standard signal generator has given great impetus to the development of radio broadcast receivers. Measurements of over-all electrical performance, with its aid, have become an indispensable routine. As valuable as this technique is in the development of the receiver chassis *per se*, however, it does not go far enough, since it leaves out of account the performance of the loud speaker. We cannot listen to voltmeter readings, and any testing routine which fails to include the entire receiving system is of limited value, especially in view of the fact that from the viewpoint of frequency distortion the loud speaker is the weakest link in the chain.

With this thought in mind I undertook, about ten years ago, the development of a technique for making over-all electro-acoustic measurements which would be suitable for the engineering development of a high fidelity receiver. The obvious plan was to introduce into the artificial antenna a standard signal of variable modulation frequency and to measure the acoustical pressure in the sound field of the loud speaker. For the sound pressure measurements we started with the conventional technique employing a condenser microphone calibrated by means of the thermophone. It was later discovered that this calibration technique was subject to considerable error due to diffraction around the microphone and cavity resonance, as revealed by direct comparison with the Rayleigh disk. After these questions had been investigated, an improved type of precision microphone designed, and proper methods of calibration determined upon, more satisfactory progress was made.

It soon became apparent, however, that one more thing was needed—some method of making an automatic record of the sound pressure frequency characteristic, preferably on logarithmic scales of frequency and sound pressure. The need for such an automatic device arises from the fact that on account of the wide fluctuation in sound pressure with frequency which is usually encountered, the manual point-by-point method of determining the characteristic is exceedingly tedious and time-consuming. An automatic level recorder was therefore developed which could do in five minutes what formerly required hours by the old method, and with much greater accuracy. In particular it has permitted studies to be made of the performance of the receiver in its natural habitat, the living room, which although of fundamental importance had hitherto been neglected on account of the almost insuperable difficulties of measuring the rapidly shifting standing wave pattern by the point-by-point method.

With the aid of these improved instrumentalities the development of a high fidelity receiver was more effectively resumed and the project was brought to a satisfactory conclusion about two years ago.

During this development it was assumed that the broadcast transmitting system was perfect, although it was actually known from our studies of microphones that a considerable amount of frequency distortion could be expected from this source. Listening tests with a high quality receiver soon verified the expectation of microphone distortion and also brought out other defects in the transmitting system which were not noticeable with receivers of more limited capabilities. It was therefore felt desirable to investigate the transmitting end of the system with the idea of acquiring a comprehensive idea of the broadcast system as a whole and of tracing the sources of distortion which could definitely be attributed to the transmitter. This work has been carried on during the past two years with the coöperation of broadcast transmission engineers, who have willingly placed apparatus, facilities, and data at our disposal for this purpose. The performance of the transmitting apparatus has been studied under actual conditions of use in a purely fact-finding investigation.

It is the purpose of the present paper to summarize the results of this survey of the performance of the entire broadcast system, from microphone to loud speaker, to point out the major weaknesses and consider definite remedial measures, to describe the new high fidelity receivers, and to consider some of the special problems associated with this type of reception.

The transmitting system, from microphone to radio antenna, is discussed in Part I; and the receiving system from antenna to loud speaker sound field, in Part II, to be published separately.

Although somewhat in anticipation of what is to follow the more important conclusions concerning the transmitting system may be summarized as follows:

(1) Serious frequency distortion is produced by the majority of microphones in present-day use.

(2) The frequency range of a large majority of network programs is limited to 5500-6000 cycles by wire lines. Although the American Telephone and Telegraph Company has laid down a network capable of 8000-cycle transmission these facilities are seldom employed, principally because the performance of present radio receivers has not seemed to justify the higher cost.

(3) Older types of speech input equipment fall off around 5000 cycles. Older types of radio transmitters also fall off at the higher audio frequencies, but in general at a lower rate.

(4) The most prominent source of nonlinear distortion is in non-linearity of the modulation characteristic of the radio transmitter and overmodulation caused by operating at too high a volume level.

(5) Microphone placement in studios and the reverberation control treatment of studios could be improved. This work should be carried out with the aid of high quality loud speakers for monitoring and audition purposes.

Assuming that this is the general situation, what are the remedies? Concerning this the following definite recommendations may be made:

(1) Replace all carbon and condenser microphones, particularly in key studios where the majority of network programs originate. If the expense is prohibitive equalization may be resorted to as a temporary expedient. Dynamic microphones should be equalized. The newer types of microphones—crystal and ribbon—are satisfactory.

(2) Better telephone-line facilities should be employed. In the case of local lines equalization to at least 8000 cycles should be required. In the case of long-distance lines the B-22, 8000-cycle facilities should be employed just as soon as the terminal equipment is available and improved receivers are definitely on the market. This should take place within the next year, probably by next fall.

(3) Older types of speech input equipment should be replaced or remodeled for uniform transmission up to 10,000 cycles. In most cases this will merely involve changing a few transformers or choke coils.

(4) The maintenance routine should include frequent and periodic tests of the modulation characteristic of the radio transmitter. A proper modulation meter, capable of measuring both positive and negative peaks, should be provided, and the relation between these peaks and the audio input to the transmitter should be determined. The harmonic distortion at full modulation should also be measured.

(5) Old monitoring loud speakers in audition and studio control rooms should be replaced by high fidelity instruments having sound pressure characteristics flat within 4 decibels from 50 to 10,000 cycles. Studio technique should be reexamined using this better reproducing equipment.

I believe that this program of improvement, which can be carried out as a whole or in orderly steps, will adequately prepare the majority of transmitters to serve high quality receivers.

The principal conclusions regarding the receiving system may be summarized as follows:

(1) Considerable frequency distortion is produced by the majority

of loud speakers in present-day use. Their frequency range is inadequate and the output fluctuates too much over the range which they do cover. The sound pressure frequency characteristic is generally characterized by a depression in the neighborhood of 1500 cycles immediately followed by a high peak near 3000 cycles. In addition there is too much directivity so that even though the response on the axis is satisfactory, it may not be satisfactory when the listener is off to one side.

(2) Considerable frequency distortion is produced by inadequate side band transmission in the radio-frequency circuits. The amount of distortion also varies too much with the carrier frequency, making compensation impossible.

(3) The power output is inadequate.

It should be emphasized that merely increasing the frequency range and smoothing out the response is not sufficient to produce a high fidelity receiver of acceptable performance under present conditions. By extending the audio range we open the gate to all sorts of disturbances—noise, both of external and internal origin, intercarrier whistles, “monkey-chatter” due to side band overlap, nonlinear distortion both in transmitter and receiver circuits, microphone frequency distortion, and so on. These problems, peculiar to high fidelity reception, require special treatment if a commercially successful receiver is to be produced. For that reason we have incorporated a number of special devices, listed below, in the high fidelity receivers which have been developed, and which are designed to assure, (1) satisfactory high fidelity reception in the primary service area of the station or wherever an adequate field strength exists, and (2) as good reception under unfavorable conditions as can be obtained.

These receivers may be characterized as follows:

(1) Over-all (electro-acoustic) fidelity of ± 2 decibels from 70 to 7000 cycles as measured on the axis of the loud speaker at a distance of 6 feet outdoors at a height of 30 feet.

(2) Detector demodulation capability of 95 per cent.

(3) High level linear detection giving less than 1 per cent harmonic distortion at 90 per cent modulation.

(4) Undistorted power output of 15 watts.

(5) *Room compensator* to compensate for the effect of the position of the receiver in the average living room. This may be switched out when the receiver is installed in the middle of a wall, and cut in when installed in a corner to counteract the rise of low frequencies due to the “horn effect” of such a location.

(6) *Antimonkey-chatter filter*, giving a sharp "U"-shaped attenuation of 60 decibels from 7000 cycles to above 10,000 cycles to remove 10,000-cycle intercarrier whistles, and monkey-chatter due to beating of the side bands of the undesired station with the desired carrier and vice versa.

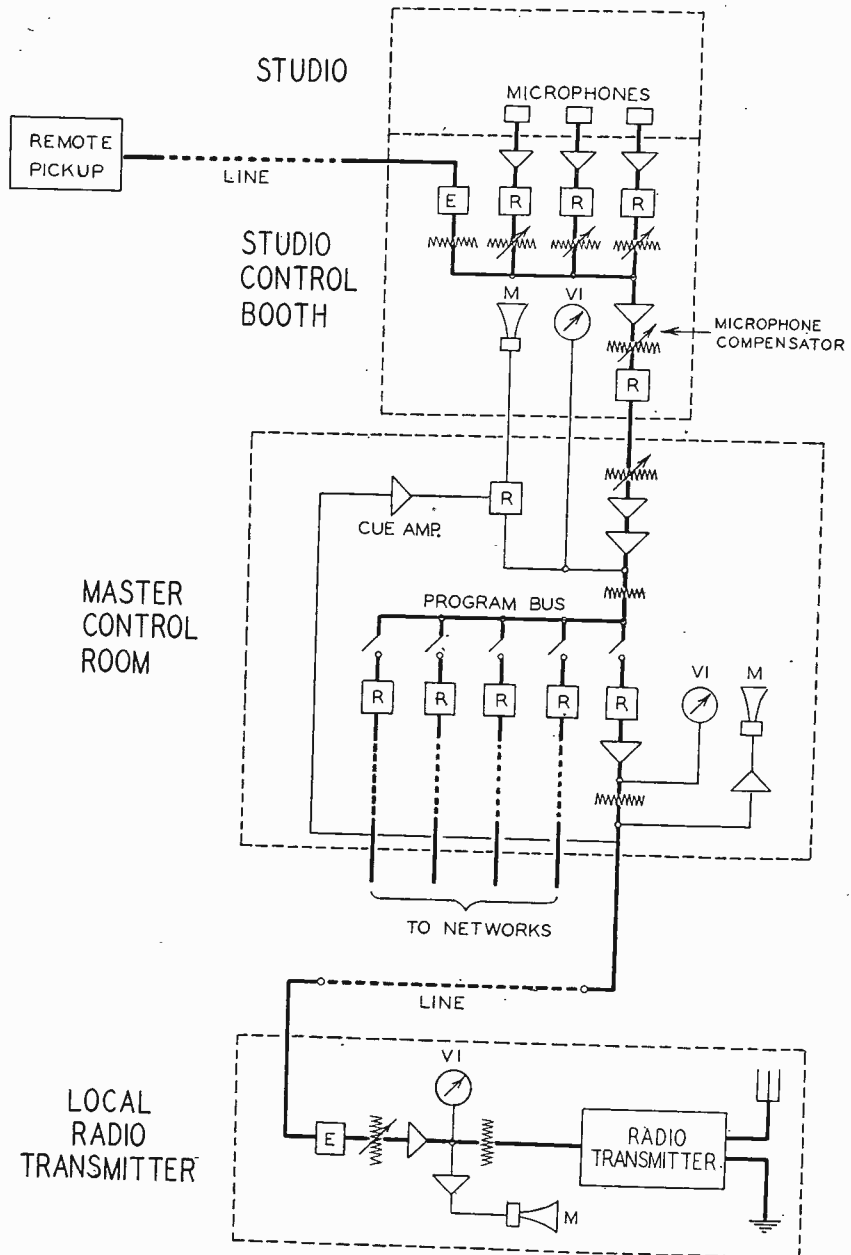

Fig. 1—Schematic diagram showing the circuit organization of a typical broadcast transmitting system.

(7) *Microphone equalizer* to compensate for the frequency distortion present in the majority of microphones in present-day use. An average type of equalization is employed.

(8) Automatic means, operated by the carrier, for reducing the

audio-frequency range at the upper end when the signal strength falls too low for satisfactory high fidelity reception under the prevailing noise conditions.

Other conventional refinements, such as automatic volume control, are of course included. These special features and the associated problems of high fidelity reception will be described in detail in Part II of this paper.

2. GENERAL PLAN OF THE TRANSMITTING SYSTEM

The broadcast transmitting system will be thought of as extending from the microphone to the antenna at the radio transmitter.

A schematic diagram of a typical system is shown in Fig. 1, representing the type of circuit layout employed in the larger broadcast centers. A single studio is represented; other studio channels will resemble this one down to the program bus. The principal elements of the system may be listed as follows:

1. Microphone
2. Studio control apparatus { Preliminary amplifier
Microphone mixers
3. Master control apparatus { Studio amplifier
Volume control
Volume indicator
Volume control
Studio channel amplifier
4. Wire line to local radio transmitter and to distant radio transmitters connected to networks. { Switching apparatus
Network channel amplifiers
Volume indicator
5. Radio transmitter { Volume control
Line amplifier
Volume indicator
Radio transmitter
Antenna

When the program originates outside of the studio building an additional wire line is involved as shown at the upper left of this diagram. In Fig. 1 this kind of program is shown routed through a studio channel so that in case of interruption an emergency program from the studio may be substituted quickly. Many of the routine remote programs are, however, brought directly to the master control point.

In all cases the control of volume level is performed at the point of origination. The levels throughout the system are carefully adjusted beforehand and thereafter remain fixed. This procedure provides the flexibility necessary for switching in an extended system.

The amplifiers, volume controls, pads, volume indicators, etc., in the audio-frequency circuits may be grouped together and referred to as *terminal apparatus*.

We shall consider the performance of these elements in order, from the viewpoint of frequency and amplitude distortion.

3. MICROPHONES

The principal types of microphones employed in the United States today are the carbon, condenser, moving-coil (dynamic), ribbon (velocity), and crystal (piezo-electric).

The older types of microphones—carbon and condenser—were designed, in accordance with the best knowledge of that time, to have a uniform voltage output over a range of frequencies in response to a uniform acoustical pressure on the diaphragm. For purposes of calibration a known acoustical pressure was applied to the diaphragm, usually by means of the thermophone. This object of design was sufficiently well achieved; both carbon and condenser microphones have a substantially uniform output for uniform diaphragm pressure between 50 and 6000 cycles. It has since been discovered, however, that when the microphone is placed in a free sound field the pressure on the diaphragm at the higher audio frequencies may be considerably in excess of the pressure in the free undistorted sound wave. This building up of pressure is apparently due to two effects; (1) reflection of sound from the microphone and its housing,¹ and (2) acoustic resonance in the cavity normally present in front of the diaphragm.² The pressure rise varies with frequency, becoming important above 1000 cycles, and if the microphone has been designed for uniform output for uniform diaphragm pressure, it produces frequency distortion. With some microphones (e.g., the carbon types) the rise may amount to as much as 15 decibels.

The existence of these effects makes it desirable to distinguish between the *wave response* of the microphone, which designates the volt-

¹ Stuart Ballantine, "Effect of diffraction around the microphone in sound measurements," *Phys. Rev.*, vol. 32, p. 988, (1928); *Proc. I.R.E.*, vol. 16, p. 1639; December, (1928).

² Stuart Ballantine, "Effect of cavity resonance on the frequency response characteristics of the condenser microphone," *Cont. from Radio Freq. Labs.*, No. 18, April, (1930); *Proc. I.R.E.*, vol. 18, p. 1206; July, (1930); *Jour. Acous. Soc. Amer.*, vol. 3, p. 319, (1932); W. West, *Jour. I.E.E.* (London), vol. 5, p. 145; June, (1930).

age generated in response to unit acoustical pressure in a free plane progressive sound wave, and the *pressure response*, which represents the voltage generated in response to unit pressure actually applied to the diaphragm.

Wave response calibration curves for several standard commercial types of microphones are shown in Figs. 2 to 15. In order that the data might be of the most practical significance the calibrations were performed with instruments actually in service and taken from studios, concert halls, etc. In all cases several instruments have been tested in order to obtain reliable averages, and to exhibit the variations between individual instruments of the same type. Plane progressive sound waves were employed and the wave response was determined by a comparison method using a precision spherical microphone which had been carefully calibrated by means of the Rayleigh disk. The details of technique have been described in earlier papers.² The frequency response relations being of primary interest, absolute values are not represented, the individual curves being simply matched in the region below 1000 cycles where they are level. The open-circuit voltage generated by the microphone, or, in the case where the microphone includes a preliminary amplifier, the voltage across the proper terminal load is taken as the "response."

The wave response frequency characteristics of several types of microphones depend upon the angle from which the sound waves are arriving. This is known as the directivity effect. As the angle of incidence, (i.e., the angle between the wave direction and the normal to the plane of the diaphragm) increases the response at the higher frequencies falls off. The lower curves in Figs. 2 to 15 represent the wave response at various azimuthal angles. The upper set of curves in Figs. 2 to 15 represent the wave response at normal incidence for several instruments of a particular type. These curves have been averaged and plotted as the curve marked $\varphi = 0$ degrees (normal incidence) in the lower part of the figures. The curves for other angles of incidence are then derived from this average curve by means of the directivity curves for the type, which may be presumed to be determined only by the geometry and to show a negligible variation between instruments of the same type. The dotted curve in the lower group represents the response at the average azimuth—usually in the neighborhood of 27 degrees—as defined later.

1. *Double-Button Carbon Microphone.*

The greatest departure from a uniform wave response is exhibited by the carbon type of microphone (Fig. 2). This instrument has been

fully described in the literature³ but no wave response calibrations appear to have been published heretofore. The response at normal incidence is uniform up to 1000 cycles beyond which it suddenly rises by about 15 decibels, where it remains up to 6000 cycles. Although the range of response in frequency is adequate, the frequency fidelity of the microphone must be rated as decidedly poor. It is rather fortunate therefore, that this type is becoming obsolete for high grade pick-up

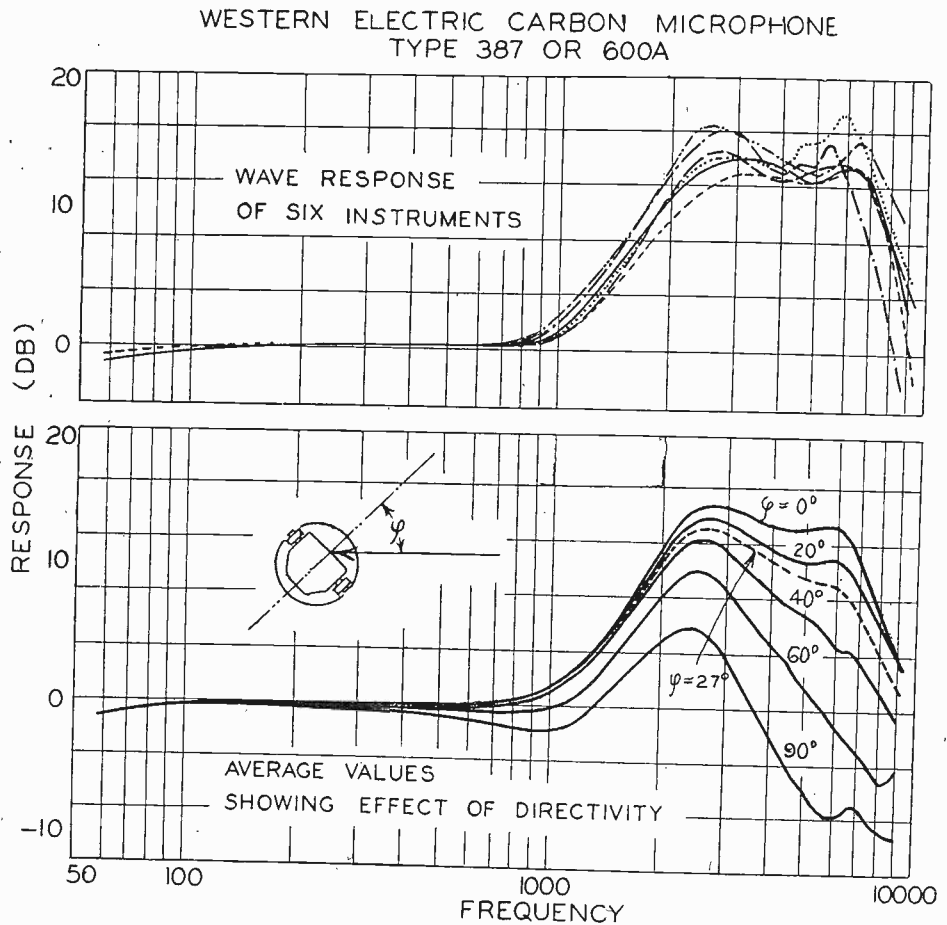

Fig. 2—Wave response of six Western Electric Type 387 or 600A carbon microphones; (upper curves) normal incidence; (lower curves) at various angles of incidence.

purposes, being used mainly for emergencies and remote pick-ups of dance orchestras and sporting events.

2. Condenser Microphone.

Wave response curves for instruments made by two principal manufacturers in the United States are shown in Figs. 3 and 4. In Fig. 3 five of the curves relate to the suspension bullet mounting with amplifier, and the sixth applies to a desk stand. In Fig. 4 all micro-

³ W. C. Jones, *Bell Tech. Jour.*, vol. 10, p. 46, (1931).

phones were mounted in a cubical housing. The curves include, therefore, the effect of these mountings in distorting the sound field and are not comparable with wave response curves for unmounted microphones which have been published. The "response" in all cases represents the output voltage across a proper resistance connected to the output of the amplifier.

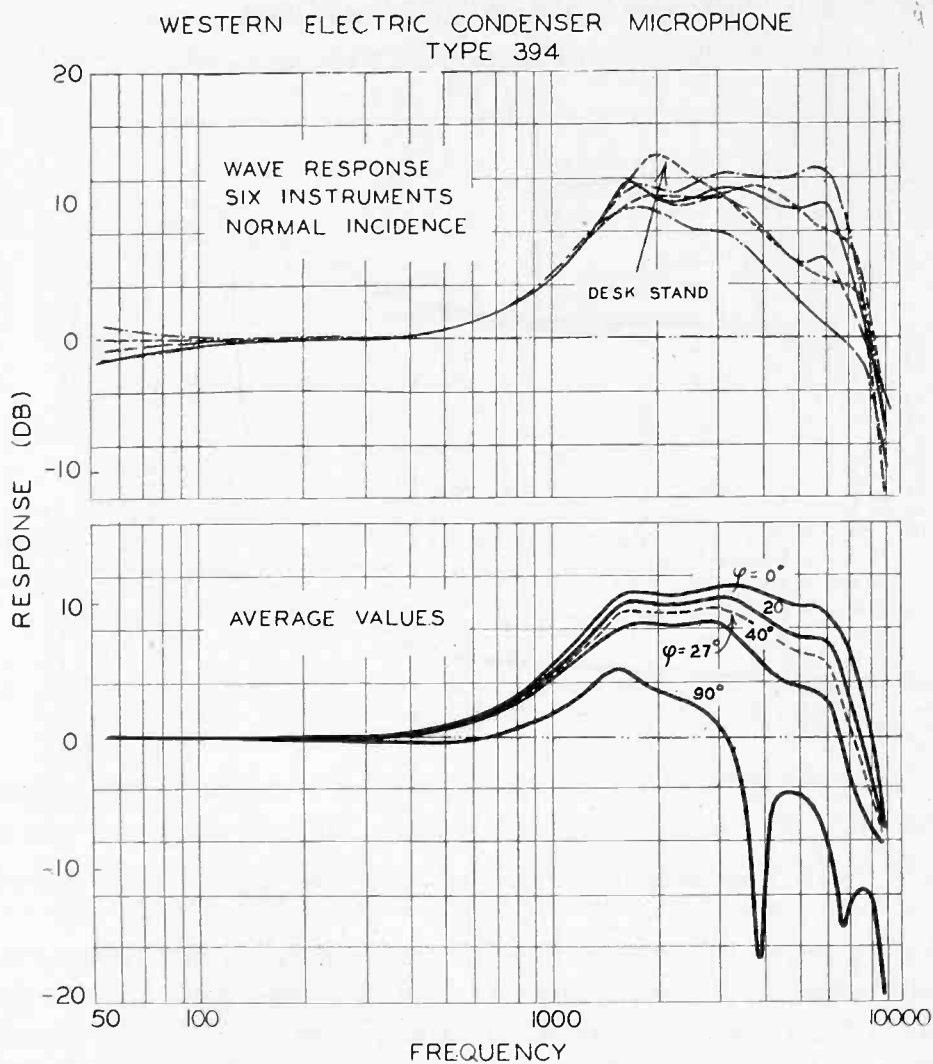

Fig. 3—Wave response of six Western Electric condenser microphones, Type 394.

While the nonuniformity in wave response of this microphone is less than that of the carbon type it is nevertheless considerable (10 decibels in the case of Fig. 3). This is not the result of poor design but is due to the fact that the microphone was designed for uniform pressure response before the effects of pressure rise were appreciated. The sensitivity of the Type 394 instrument (3 millivolts per bar) is about 10

times that of Wente's earlier condenser microphone (0.3 mv/bar).⁴ This has been largely achieved by the substitution of duralumin for steel as a diaphragm material. The lighter and more compliant membrane requires a different type of damping which in this instrument is obtained by using a multiplicity of small damping areas with low impedance vents. A flexible diaphragm is provided to equalize the pressure so as to compensate for barometric variations.

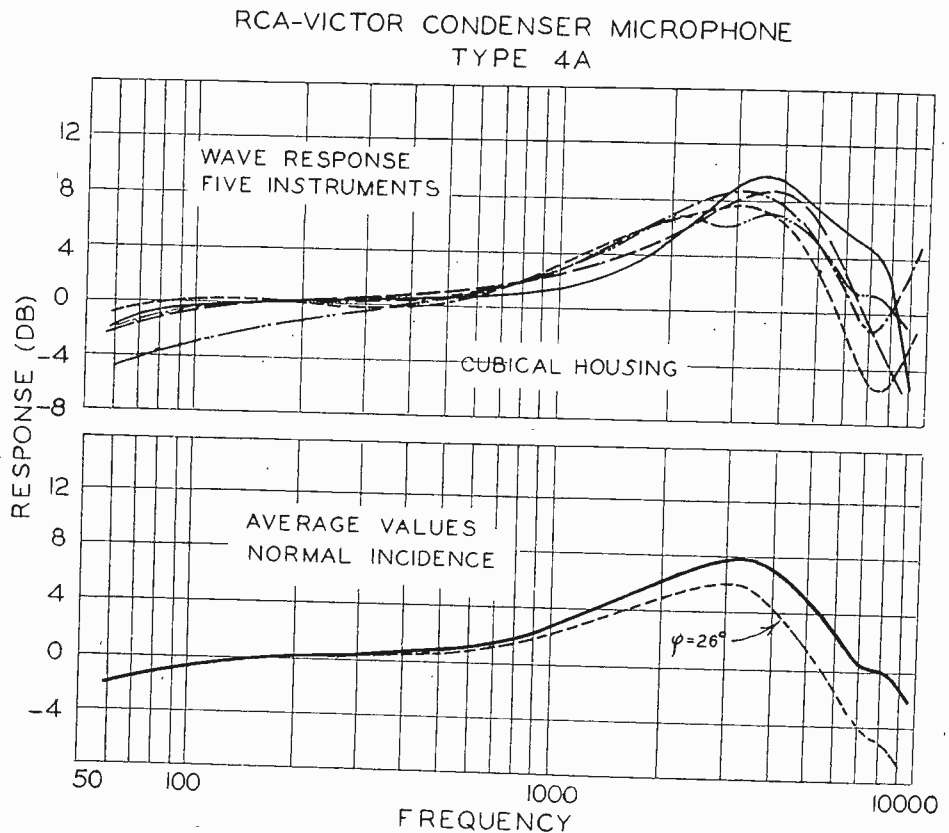

Fig. 4—Wave response of five RCA-Victor condenser microphones, Type 4A.

As a general rule an increase in condenser microphone sensitivity is usually obtained at the expense of stability (temperature and barometric). Although the question has not been investigated as thoroughly as might be desired, the sensitive commercial instruments which have been examined exhibit variations in response which are apparently attributable to lack of complete compensation for changes in the barometric pressure and in temperature. It was suspected that some of the variations between the instruments whose calibrations are shown above might have been due to this cause, and one of the instruments was placed under more detailed observation with the results shown in Fig. 5. These curves represent the pressure response as determined with the

⁴ E. C. Wente, *Phys. Rev.*, vol. 19, p. 498, (1922).

electrostatic drive⁵ and automatic recorder.⁶ Curve 1 was taken with the room at 20.7 degrees centigrade and curve 2 was taken after several hours exposure to this temperature; the barometer remained unchanged. Starting again the next day with curve 3 ($T = 21$ degrees centigrade) the microphone was put through the temperature cycle described in the legend for Fig. 5. Sufficient time was allowed at each step for all parts to reach temperature equilibrium. The absolute values of response were not recorded since the frequency response relations were of main interest; the curves in Fig. 5 are simply matched at the low-

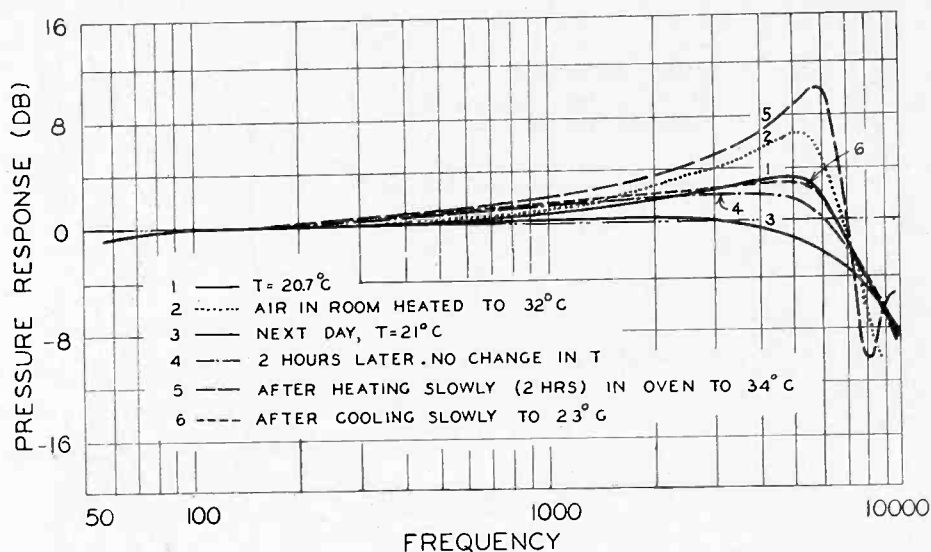

Fig. 5—Showing changes in the pressure response of a commercial condenser microphone due to variations of temperature and other causes.

frequency end. There is a definite variation with temperature of the frequency response relation. This variation may not be important in studios having air conditioning but may require consideration in other circumstances. At the conclusion of these tests the microphone was taken apart to make sure that it was in normal condition, that the equalizing diaphragm was free, etc. The same tests on a second instrument gave much the same results. Spontaneous variations of several decibels in the sensitivity of condenser microphones have also been reported by Abbott.⁷

3. Moving-Coil Microphone.

This instrument comprises essentially a dome-shaped duralumin diaphragm upon which is mounted a light coil projecting into the radial

⁵ Stuart Ballantine, *Jour. Acous. Soc. Amer.*, vol. 3, p. 319, (1932).

⁶ Stuart Ballantine, *Jour. Acous. Soc. Amer.*, vol. 5, p. 10, (1933).

⁷ E. J. Abbott, *Jour. Acous. Soc. Amer.*, vol. 4, p. 235, (1933).

magnetic field of a permanent magnet.⁸ Acoustical reactions are provided at the rear of the diaphragm by an arrangement of slots and tubes to smooth out the response. The sensitivity is approximately -80 decibels (10^{-4} volt/bar) and the output is brought up by means of a preliminary amplifier to approximately the level of the carbon microphone.

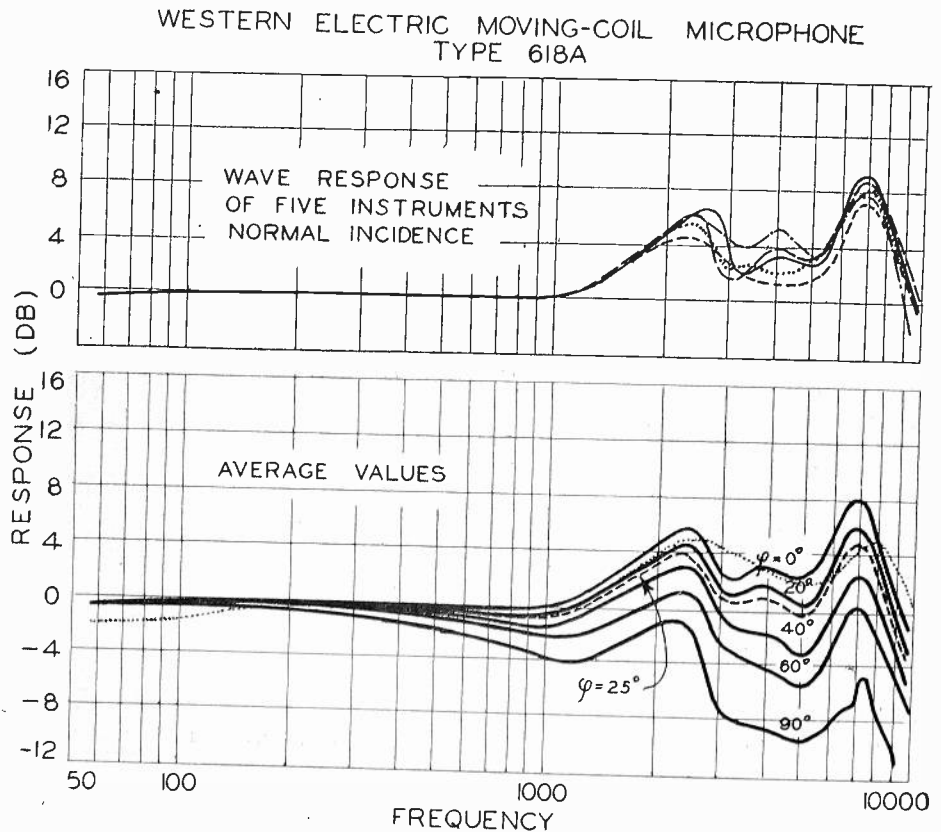

Fig. 6—Wave response of five Western Electric moving-coil microphones, Type 618A.

The response curves for five microphones of this type are shown in Fig. 6 (top) and average curves for various azimuths at the bottom of the same figure. The wave response is more nearly uniform than that of the carbon and condenser types and is chiefly characterized by a 6-decibel peak at 2500 cycles and a second 8-decibel peak at 7000 cycles. For pick-up of the highest quality these peaks can be equalized in the electrical circuits and this is justified by the apparent uniformity be-

⁸ E. C. Wentz and A. L. Thuras, *Jour. Acous. Soc. Amer.*, vol. 3, p. 44, (1931); W. C. Jones and L. W. Giles, *Jour. Soc. Mot. Pict. Engs.*, vol. 17, p. 977, (1931); A. L. Thuras, "Sensitive moving-coil microphone of high quality," *Bell Lab. Record*, vol. 10, pp. 314-318; May, (1932); L. W. Giles, "Adapting the moving-coil microphone to commercial use," *Bell Lab. Record*, vol. 10, pp. 319-322; May, (1932).

tween instruments. The circuit of an equalizer which is being used for this purpose is shown in Fig. 7.

No detailed investigation of the stability of these microphones with temperature and barometric changes was made but the construction is such as to discourage suspicion on this point.

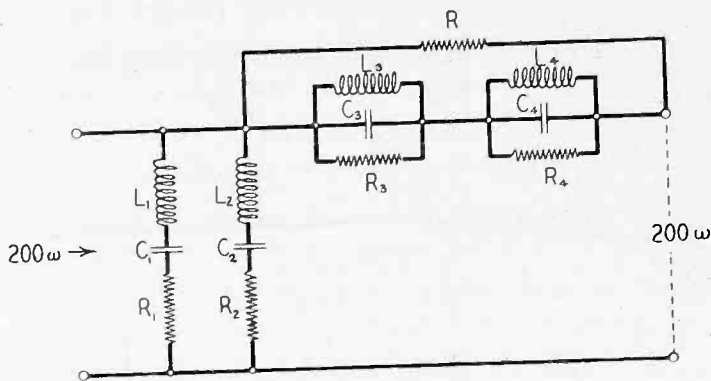

Fig. 7—Equalizer for moving-coil microphone.

These instruments are rugged, small, and convenient, particularly for studio use where a preamplifier can readily be provided. Their chief disadvantages, already noted, are the nonuniformity of response with frequency and their directivity.

4. Velocity Microphone.

This consists of a very thin duralumin ribbon suspended edgewise in the field of a permanent magnet. The principle was suggested by Gerlach and Schottky,⁹ and has recently been made available in satisfactory commercial form by the development work of Olson¹⁰ in this country. This instrument is responsive to the pressure gradient rather than to the pressure as with the other types of microphones. Since $p = -i\omega\rho\varphi$ and $v = \text{grad } \varphi$, the generated voltage, which is proportional to the pressure gradient ($\text{grad } p$) = $-i\omega\rho \text{ grad } \varphi = -i\omega\rho v$ will be proportional to the velocity in the sound field.

The wave calibrations of four instruments are shown in Fig. 8. A coupling transformer is included in the case of the instrument to step up the impedance of the ribbon to 200 ohms. The voltage across a resistor terminating the transformer was measured. The frequency response of this instrument is quite satisfactory and better than any of the preceding types. The gradual falling off in response above 3000 cycles may readily be equalized if this is considered necessary.

⁹ E. Gerlach, *Phys. Zeit.*, vol. 25, p. 675, (1924); U. S. Patent 1,557,356; W. Schottky, *Phys. Zeit.*, vol. 25, p. 672, (1924).

¹⁰ H. F. Olson, *Jour. Soc. Mot. Pict. Engs.*, vol. 16, p. 695, (1931); *Jour. Acous. Soc. Amer.*, vol. 3, p. 56, (1931).

One of the most interesting properties of this microphone is its directivity. With a plane progressive wave the response varies with the cosine of the angle between the direction of the sound wave and the normal to the ribbon. A source situated in the plane of the ribbon evokes no response. This property is often useful in discriminating

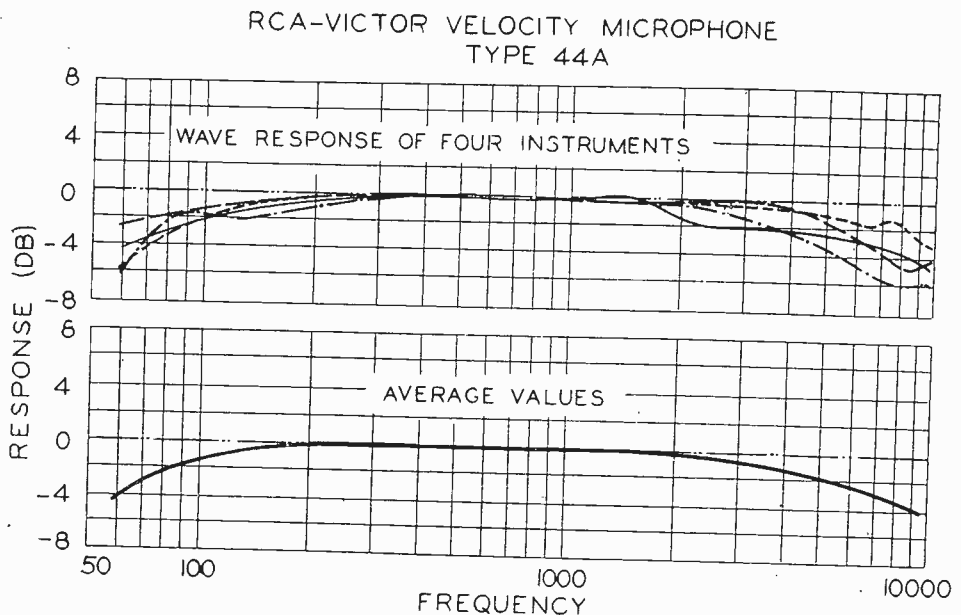

Fig. 8—Wave response (constant velocity) of four RCA-Victor velocity microphones, Type 4A.

against undesired sounds and for obtaining a desired relation between the sounds from different sources. The directional properties of this microphone place another variable at the disposal of those engaged in studio set-ups which should be of value if intelligently employed.

Due also to its directivity the response to reverberant sound in a room is one third the response of a nondirectional instrument. As Olson¹¹ has pointed out, for the same ratio of direct to reverberant sound, the velocity microphone can be placed 1.7 times as far away from the source as a completely nondirectional microphone.

Another desirable property of the instrument is the invariance of the frequency response characteristic with the angle of incidence of the sound. Whereas with the other types of microphones discussed above the higher frequencies fall off as the source moves around from the front to the back of the instrument, in this case the balance between the high and low frequencies remains unchanged at all angles of incidence.

¹¹ H. F. Olson, reference (10), p. 708.

In the sound from a point source the velocity v increases more rapidly with decreasing distance than does the pressure, p . In fact:

$$v/p = (1/\rho c)\sqrt{1 + (c/\omega r)^2}.$$

For this reason if the velocity microphone is placed too close to such a source the low frequencies tend to become accentuated. At 50 cycles the ratio $v/p = 1.65$ (4.4 decibels) at 2 feet and 1.32 (2.4 decibels) at 4 feet. Hence greater separations are required with this type of microphone than with pressure-operated types. In view of this it is rather fortunate that it is less sensitive to reverberation.

I should like to call attention at this point to a useful application of the velocity microphone in conjunction with a pressure-operated microphone for picking up sound in a reverberant room. Reverberation at low frequencies is particularly troublesome because of room resonances. A rectangular room of dimensions a , b , and c has a triple infinity of natural frequencies (*eigen frequencies*) given by:

$$f = \frac{c}{2} \sqrt{\frac{l^2}{a^2} + \frac{m^2}{b^2} + \frac{n^2}{c^2}}$$

where l , m , n are to be independently assigned integral values 0, 1, 2 The effect of these resonances, for a microphone placed at one point in the room, is an extremely irregular frequency response. At the walls the pressure is doubled while the normal component of velocity is zero. The distribution of pressure in the enclosure is entirely different from the distribution of velocity. This is shown by the two records reproduced in Fig. 9 which show the responses of pressure and velocity microphones in the same location to the sound radiated by a loud speaker driven by a variable frequency current. By combining the outputs of the two types of microphones a smoother response can be obtained at low frequencies than with either of them used alone.

Another useful application of this pressure-velocity combination may also be mentioned. The object of this is to control the amount of reverberation without the necessity of moving the microphones around in the studio with the attendant inconvenience of upsetting the balance between a performer and an orchestral accompaniment. Taking advantage of its directional properties the velocity microphone may be so oriented as to receive the greatest amount of reverberant sound and the least amount of direct sound. The pressure microphone (or another velocity microphone) is placed in its normal position. The required amount of reverberation may then be "faded-in" at the studio control

room. The obvious convenience and flexibility of this technique will appeal to those who have daily experience with such problems.

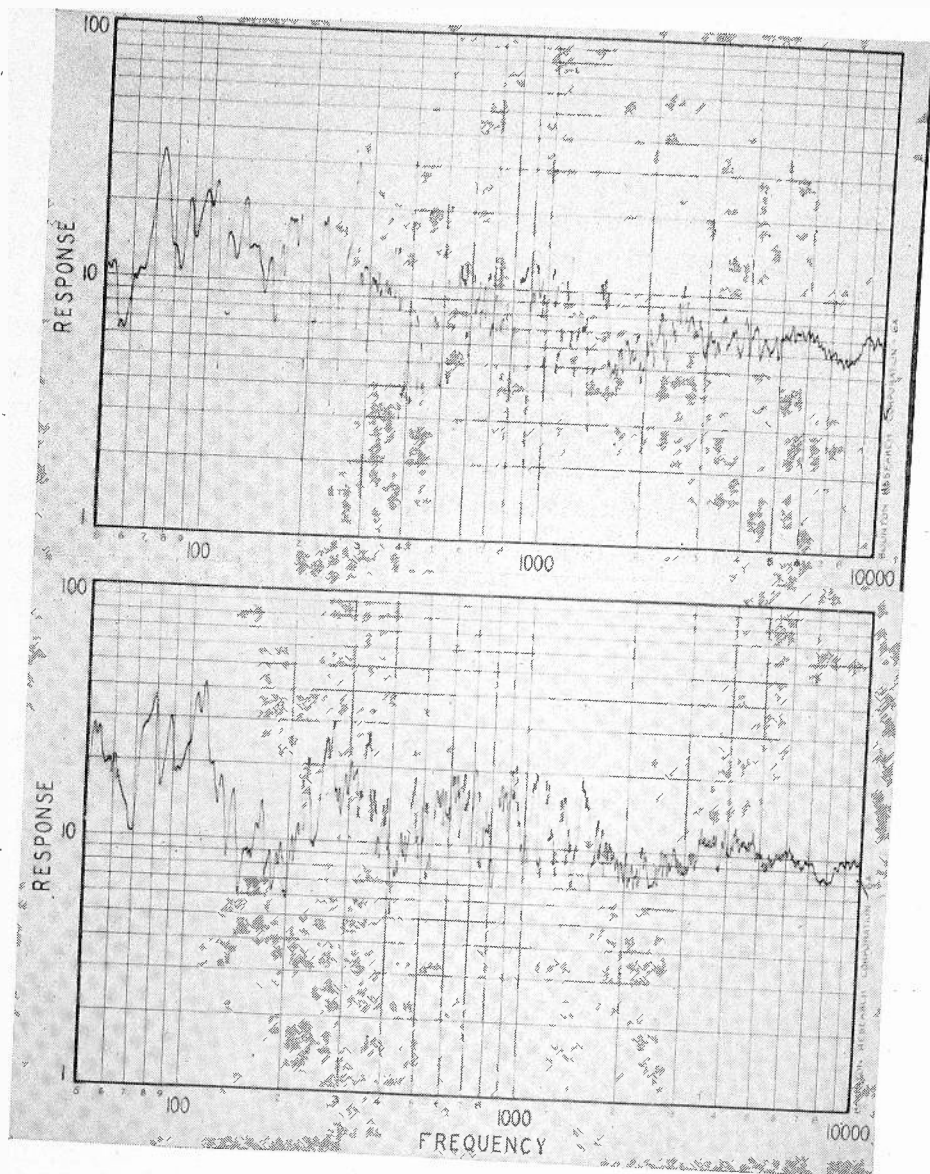

Fig. 9—Records of a loud speaker source in a reverberant room; (upper curve) pressure-operated microphone; (lower curve) velocity microphone; showing the dissimilarities of the pressure and velocity standing wave patterns.

5. Crystal (Piezo-Electric) Microphone.

A new type of microphone has recently been developed which depends for its operation upon the piezo-electric effect in Rochelle salt. Since this instrument is being made available commercially and promises to become of some importance a brief description is appended below.

Fig. 10 shows a homogeneous crystal of Rochelle salt and in dotted lines the orientation of a plate cut therefrom. The principal piezo-electric strains in such a plate when subjected to an electric field along the a axis are illustrated in the right-hand diagram. The strains are at 45 degrees to the b and c axes. A slab is now cut, as shown by the dotted lines, with sides parallel to these strains. When such a slab is provided with foil electrodes and subjected to an electric field it tends to elongate or contract, depending upon the polarity of the impressed voltage. If

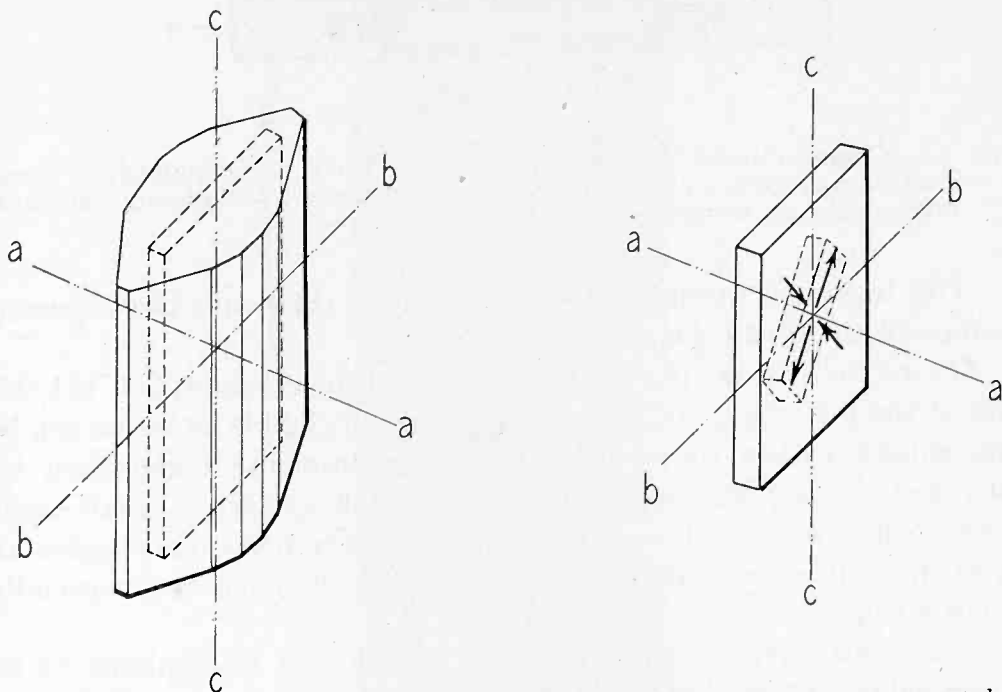

Fig. 10—Illustrating (left) orientation of slab cut from homogeneous crystal of Rochelle salt with respect to the axes; and (right) principal piezo-electric strains in such a slab in response to electric field along the a axis.

now two of these slabs, acting in opposition, are cemented together we have an element which tends to bend when a voltage is applied.¹² The action of this assembly is analogous to that of a bimetallic thermostatic strip.

Two such composite plates, sensitive to bending, are assembled as shown in Fig. 11 with an air space between them. The plates are extremely thin (of the order of 0.010 inch) and the dimensions are so chosen that the frequency of mechanical resonance lies above the frequency range over which the microphone is to operate. The assembly, with the damping and separating material 3, is mounted in a hollow

¹² C. B. Sawyer, *Proc. I.R.E.*, vol. 19, p. 2020; November, (1931); U. S. Patents 1,803,274 and 1,802,782; A. L. Williams, "Piezo-electric loud speakers and microphones," *Electronics*, vol. 4, pp. 166-167; May, (1932).

bakelite square. It is covered over with a membrane 5 which serves to seal the crystals and to prevent the communication of sound pressure to the space between them. The sound pressure acts upon the outer surfaces of the plates as shown by the arrows and tends to bend them inwards, generating voltages between the foil electrodes. The two plates are connected in parallel.

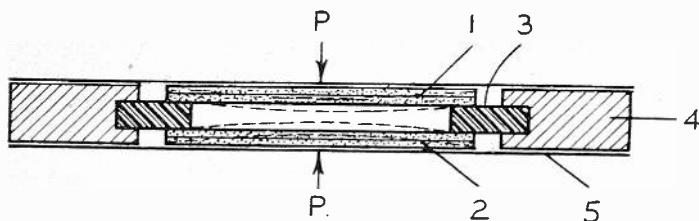

Fig. 11—Cross-sectional view of Brush "sound cell" as employed in piezo-electric microphone. 1 and 2 are composite plates; 3, damping and separating slabs; 4, mount; and 5, sealing membrane.

This ingenious assembly was developed by the Brush Development Company and is called a *sound cell*.

Owing to the small physical dimensions of the crystals ($1/4" \times 1/4"$) and of the mounting, diffraction effects are negligible as far as can be determined within the reliability of measurements undertaken by means of the Rayleigh disk (up to *circa* 15,000 cycles). A small single sound cell is practically nondirectional in its response and makes an excellent Lilliputian microphone for laboratory purposes, especially as a sonic probe.

The sensitivity of the sound cell used in the microphone to be described is 0.125 mv/bar, or -78 db (0 db = 1 volt/bar) at 20 degrees centigrade. For technological purposes several cells may be used to bring up the response to the level of other types of microphones. In the design of a multicell microphone for broadcast purposes using these cells we have studied a number of possible physical arrangements of the cells and have found a vertical arrangement satisfactory. This arrangement has the desired property of having the same response, both as to level and frequency characteristics, at all azimuths. The cells are edge-wise for horizontally incident sound and the distortion of the sound field by obstacle effect is a minimum.

The internal structure of an experimental 10-cell microphone (BRC Model 100A) is illustrated in Fig. 12. Although the cells are insensitive to vibration the whole assembly is mounted on springs to reduce the effects of gross mechanical shock. Vibrations of higher frequency are further attenuated by floating the assembly in cotton contained within the small metal cups.

The external appearance of the microphone is shown in Fig. 13. The wire mesh protective screen is purposely made cylindrical to suggest its nondirectional properties.

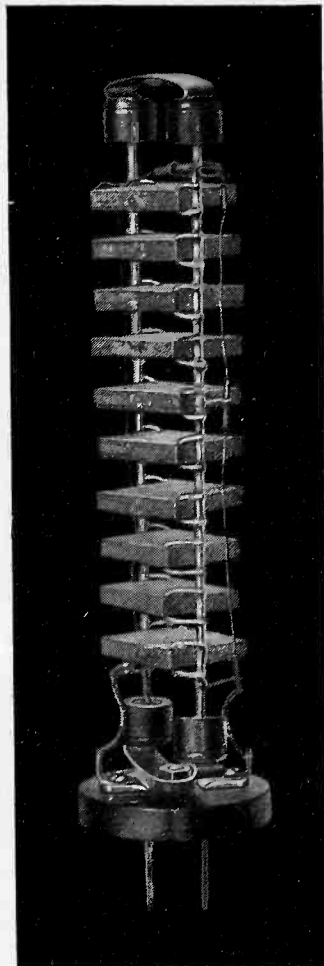

Fig. 12—Internal structure of BRC Type 100A crystal microphone showing vertical edgewise arrangement of sound cells.

A 20-cell microphone manufactured by the Brush Development Company is shown in Fig. 14. For this instrument the vertical arrangement of cells has also been adopted; the cells are mounted in vertical strips and are broadside to the sound at certain azimuthal angles.

The wave calibrations of three 4-cell BRC Model 100A microphones are shown in Fig. 15. These were floor stand models incorporating a preliminary amplifier in the base. The "response" represents the output voltage across a proper resistance terminating this amplifier. The output level is approximately 3 decibels greater than the 500-cycle

bakelite square. It is covered over with a membrane 5 which serves to seal the crystals and to prevent the communication of sound pressure to the space between them. The sound pressure acts upon the outer surfaces of the plates as shown by the arrows and tends to bend them inwards, generating voltages between the foil electrodes. The two plates are connected in parallel.

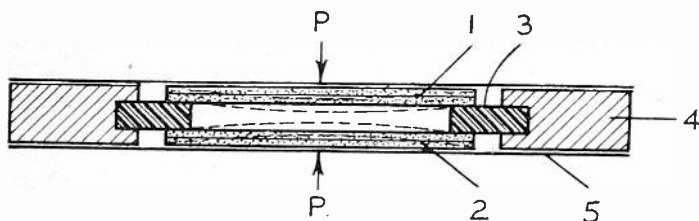

Fig. 11—Cross-sectional view of Brush "sound cell" as employed in piezo-electric microphone. 1 and 2 are composite plates; 3, damping and separating slabs; 4, mount; and 5, sealing membrane.

This ingenious assembly was developed by the Brush Development Company and is called a *sound cell*.

Owing to the small physical dimensions of the crystals ($1/4" \times 1/4"$) and of the mounting, diffraction effects are negligible as far as can be determined within the reliability of measurements undertaken by means of the Rayleigh disk (up to *circa* 15,000 cycles). A small single sound cell is practically nondirectional in its response and makes an excellent Lilliputian microphone for laboratory purposes, especially as a sonic probe.

The sensitivity of the sound cell used in the microphone to be described is 0.125 mv/bar, or -78 db (0 db = 1 volt/bar) at 20 degrees centigrade. For technological purposes several cells may be used to bring up the response to the level of other types of microphones. In the design of a multicell microphone for broadcast purposes using these cells we have studied a number of possible physical arrangements of the cells and have found a vertical arrangement satisfactory. This arrangement has the desired property of having the same response, both as to level and frequency characteristics, at all azimuths. The cells are edge-wise for horizontally incident sound and the distortion of the sound field by obstacle effect is a minimum.

The internal structure of an experimental 10-cell microphone (BRC Model 100A) is illustrated in Fig. 12. Although the cells are insensitive to vibration the whole assembly is mounted on springs to reduce the effects of gross mechanical shock. Vibrations of higher frequency are further attenuated by floating the assembly in cotton contained within the small metal cups.

The external appearance of the microphone is shown in Fig. 13. The wire mesh protective screen is purposely made cylindrical to suggest its nondirectional properties.

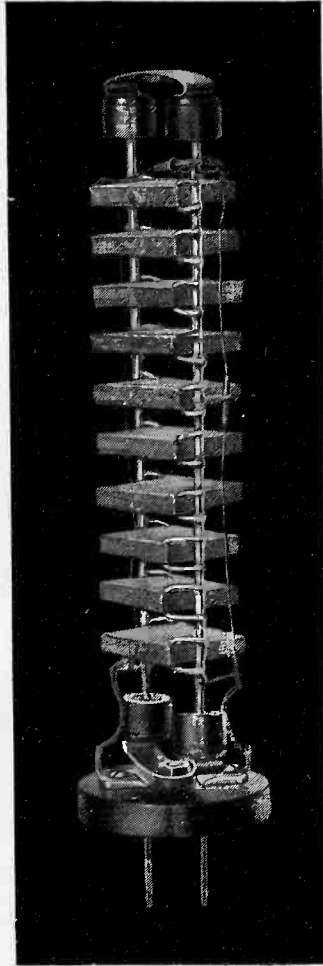

Fig. 12—Internal structure of BRC Type 100A crystal microphone showing vertical edgewise arrangement of sound cells.

A 20-cell microphone manufactured by the Brush Development Company is shown in Fig. 14. For this instrument the vertical arrangement of cells has also been adopted; the cells are mounted in vertical strips and are broadside to the sound at certain azimuthal angles.

The wave calibrations of three 4-cell BRC Model 100A microphones are shown in Fig. 15. These were floor stand models incorporating a preliminary amplifier in the base. The "response" represents the output voltage across a proper resistance terminating this amplifier. The output level is approximately 3 decibels greater than the 500-cycle

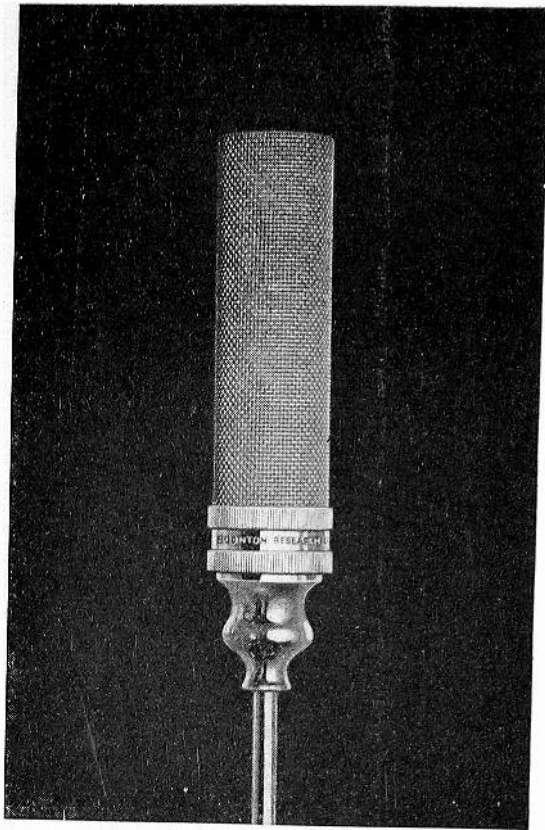

Fig. 13—External view of BRC Type 100A crystal microphone.

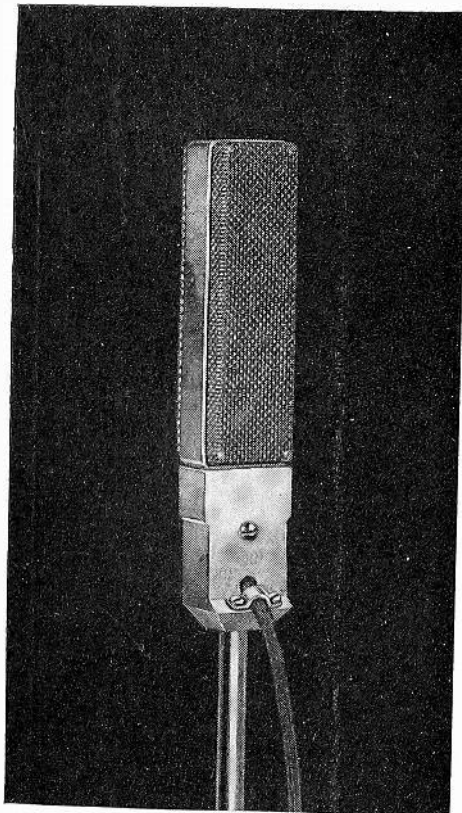

Fig. 14—Brush 20-cell crystal microphone.

response of the Western Electric 394 microphone with preliminary amplifier.

The response of the sound cell *per se* is shown by the dotted curve in Fig. 15. The response gradually rises above 3000 cycles to a maximum at mechanical resonance near 15,000 cycles after which it falls off rapidly. This rising characteristic is equalized in the preliminary amplifier giving a substantially flat response within 3 decibels up to 15,000 cycles. This type of response is obtained for sound approaching from any horizontal direction. The curves do not apply for directions of arrival having small angles with the vertical axis. In this case the

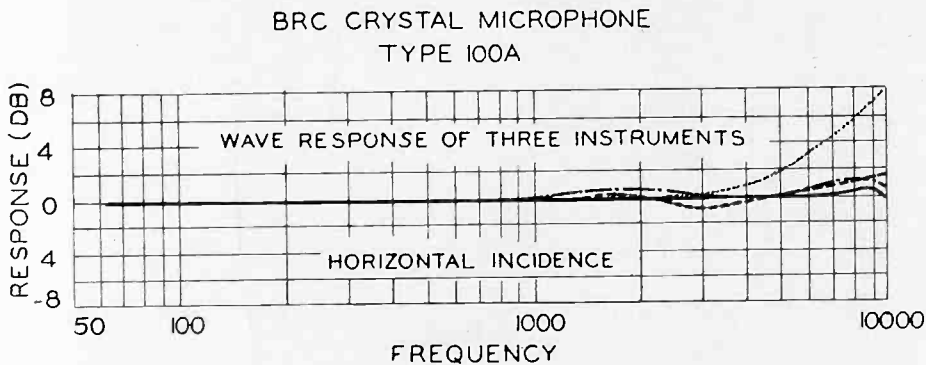

Fig. 15—Wave response of three BRC Type 100A crystal microphones with preliminary amplifier.

response falls off at the higher frequencies on account of the diffraction caused by the length of the assembly in relation to the wavelength of the sound. This diffraction is not objectionable in practice since the microphone is readily placed so that the sound arrives more or less horizontally. If desired in special applications the effect can be reduced by employing fewer sound cells or avoided entirely by the use of a single cell.

The piezo-electric effect in Rochelle salt is known to vary with temperature, but the variations which have been observed in these microphones and in piezo-electric loud speakers are very much less than those reported in the scientific literature.¹³ The latter observations were for the most part made on the piezo-electric effect produced by the application of static pressures, or slowly varying pressures. This probably accounts for the lack of agreement between these observations and those which we have made with audio-frequency variations. The effect of temperature on the response of the BRC Model 100A microphone is shown in Fig. 16. The variation amounts to about 4 decibels between

¹³ Valasek, *Phys. Rev.*, vol. 19, p. 478, (1922); Frayne, *Phys. Rev.*, vol. 21, p. 348, (1923).

15 and 32 degrees centigrade with a maximum at about 25 degrees. The variation is of approximately the same type as has been found with the high-frequency piezo-electric loud speaker.¹⁴ The change in the frequency response amounts to about 3 decibels at 10,000 cycles at the higher temperatures. These variations should not be of any technological importance even under the most unfavorable conditions likely to be encountered.

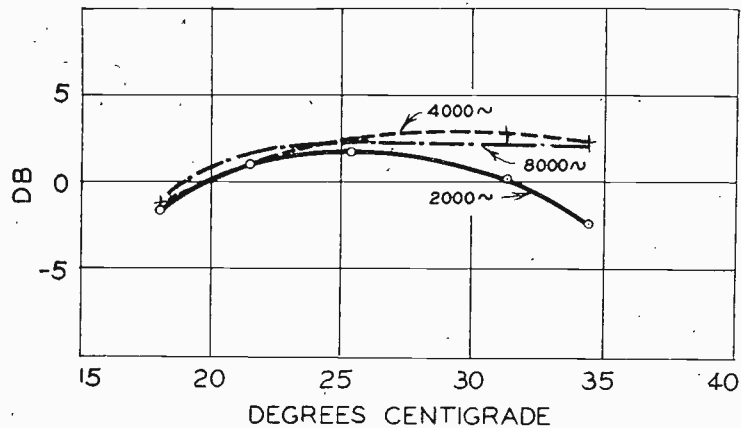

Fig. 16—Variation of response with temperature, BRC Type 100A crystal microphone.

The crystals are protected from moisture by a special dope and the effects of humidity are negligible.

The capacity of the connecting leads has the effect of reducing the response uniformly at all frequencies. The ratio of the response with and without the leads is given by

$$R_1/R_2 = C_m/(C_m + C_l)$$

where C_m and C_l represent the capacities of the microphone and leads respectively. When it is desired to locate the preliminary amplifier in the studio control room the cells may be grouped in parallel in order to keep their capacity up in relation to that of the leads. A step-up transformer is then interposed between the remote end of the line and the preliminary amplifier tube. The effect of long leads may also be reduced by interposing a step-down transformer between the microphone and line.

Fig. 17 illustrates a satisfactory arrangement in which the preliminary amplifier is located in the base of the microphone stand.

The ruggedness, insensitivity to atmospheric conditions, uniform frequency response and nondirectivity in a horizontal plane make this

¹⁴ Stuart Ballantine, Proc. I.R.E., vol. 21, p. 1406; October, (1933).

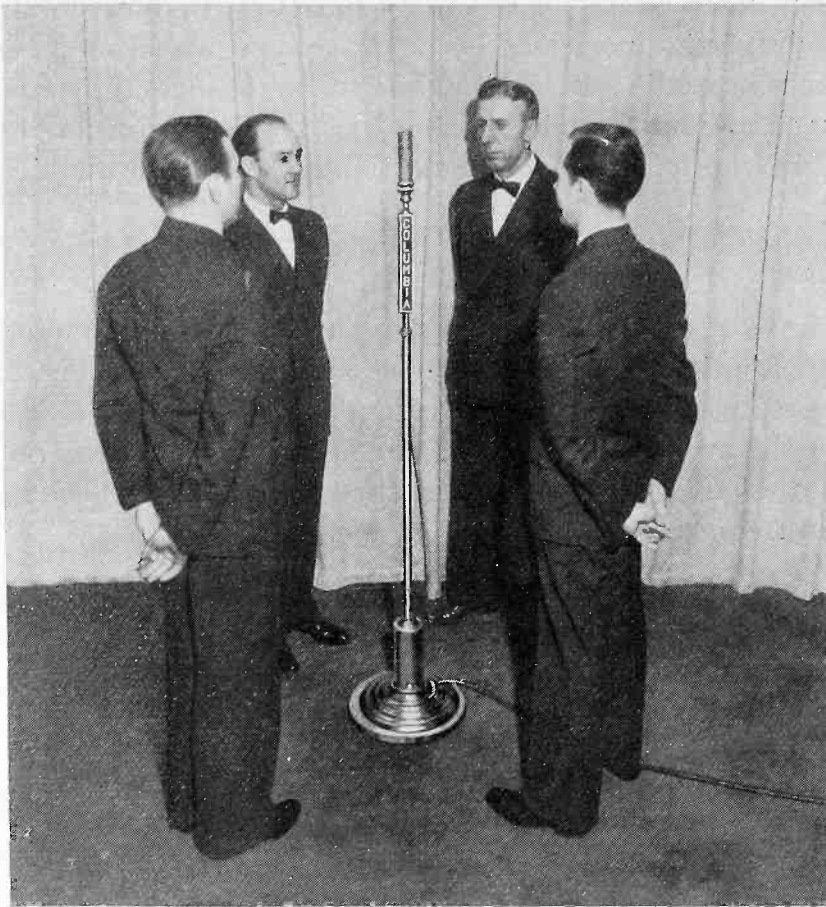

"CBS Photo"

Fig. 17—Comfortable grouping of performers about the crystal microphone made possible by its nondirectional properties.

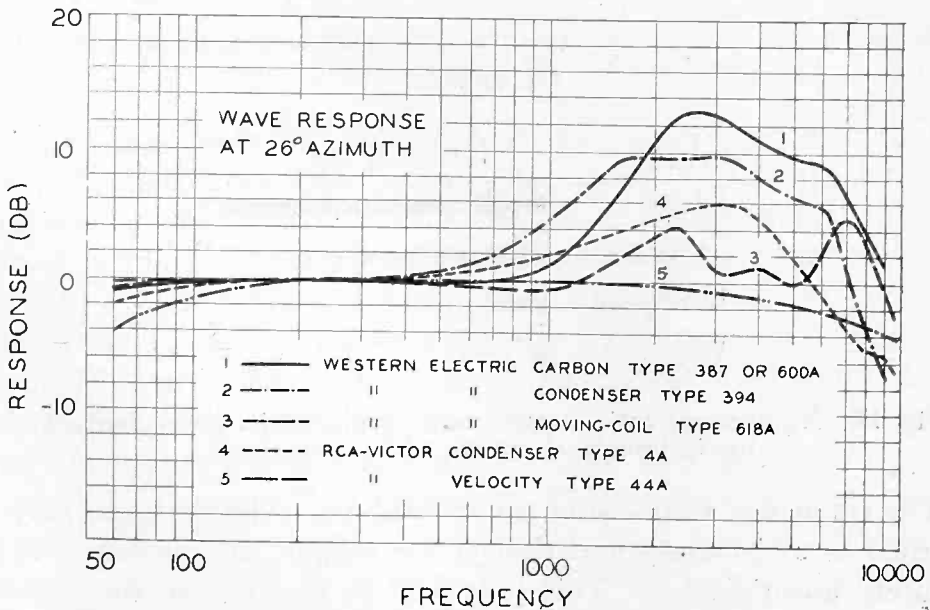

Fig. 18—Summary of wave response curves for various commercial types of microphones. Average response at 26 degrees azimuth.

an excellent microphone for broadcast purposes. Its horizontally non-directive properties, possessed by no other type, are often an especial convenience in studio set-ups, enabling the performers to be comfortably grouped around the microphone (Fig. 17) instead of having to be clustered in front of it to avoid distortion due to loss of the higher frequencies.

6. Summary.

The wave response curves for the various types of microphones, with the exception of the crystal type, are assembled in Fig. 18. The ordinates represent the response at an azimuth of 26 degrees, which we regard as the average azimuth for direct pick-up. The ordinates have no absolute significance; the various curves have simply been matched at the low frequencies.

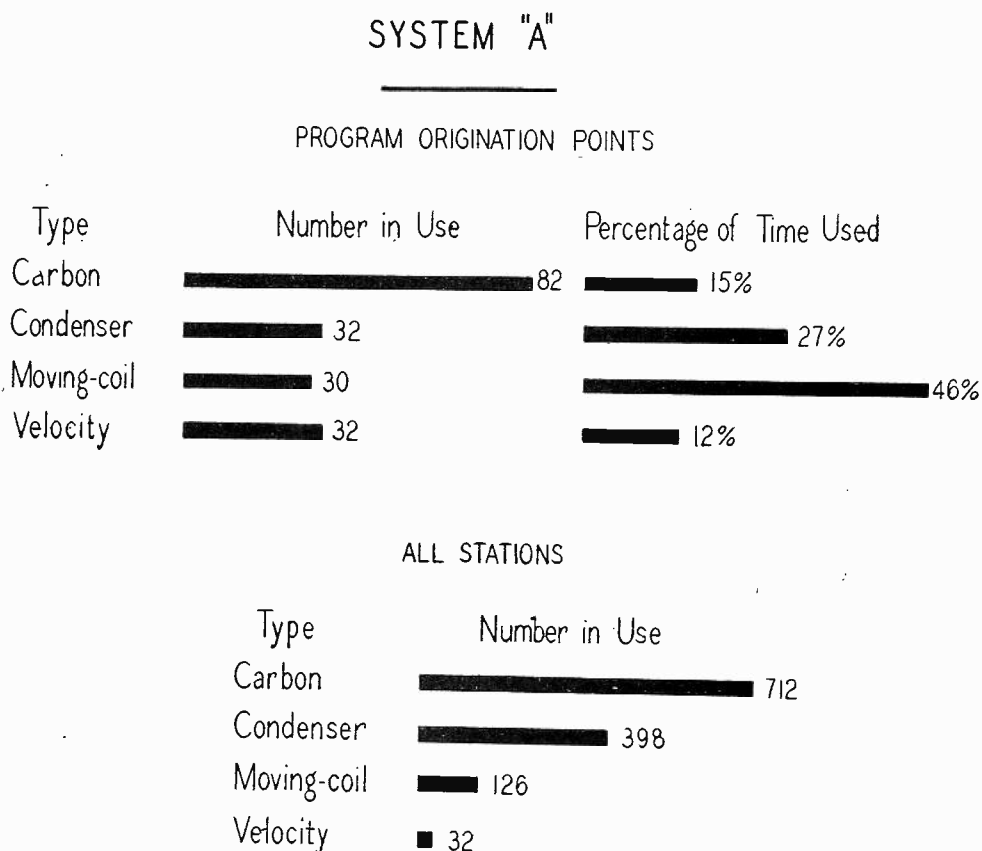

Fig. 19—Numbers of various types of microphones in use and extent of use in broadcast system "A" (78 stations).

The frequency response of the crystal and velocity types may be regarded as satisfactory and that of the carbon and condenser types definitely unsatisfactory. This judgment is based upon the abstract performance of the microphones alone, and its validity in terms of the

system would predicate the employment of receivers of reasonably high quality.

For a just appraisal of the microphone situation, we also require information concerning the numbers of the various types in use and the extent of their use. Data, ascertained from replies to questionnaires, for 145 stations associated with the two principal American broadcast systems are shown graphically in Figs. 19 and 20. The majority of pro-

SYSTEM "B"

PROGRAM ORIGATION POINTS

Type	Number in Use	Percentage of Time Used
Carbon	181	27%
Condenser	281	60%
Velocity	22	13%

ALL STATIONS

Type	Number in Use	Percentage of Time Used
Carbon	470	11%
Condenser	381	64%
Moving-Coil	64	16%
Velocity	25	9%

Fig. 20—Number of various types of microphones in use and extent of use in broadcast system "B" (67 stations).

grams of these networks originate in the larger cities such as New York, Chicago, Philadelphia, and Washington. The data for these studios are given under "Program Origination Points" and are perhaps of more significance, so far as actual extent of use is concerned, than the data for the whole country. The actual extent of use was ascertained from a month's operating records and is expressed as a percentage of the total air hours each type of microphone was employed. It is encouraging to note that in spite of the preponderance of the carbon type, the actual use of this relatively poor microphone is small. In System A, for example, the use amounts to only 15 per cent of the time, whereas the superior moving-coil type enjoys the greatest use, 46 per cent. Figs. 19 and 20 represent the situation in system A as of the fall of 1932 and in System B as of the summer of 1933.*

Several things, brought out by Fig. 18, are worth commenting upon.

First of all it is evident that, *in general, serious frequency distortion is produced by the microphone*, which in this respect is definitely the black sheep of the transmitting system. Judging from the amount of engineering and maintenance effort expended upon the frequency characteristics of other parts of the system, usually with a complete disregard or complacent acceptance of the microphone, this fact does not appear to be sufficiently appreciated even in engineering circles. In order to remedy the situation, looking toward the time when improved receivers will be in the hands of the public, it is recommended that the carbon and condenser microphones be replaced as soon as possible by better types, or at least that they be equalized. The dynamic type should also be equalized for best results. In none of these types however, will equalization remove the undesirable effects of directivity which will render the equalization perfect for sound arriving from one direction only. The equalizer may be conveniently located in some part of the circuit, preferably in the studio control room, where the impedances in both directions are pure resistances. In the case of the system shown in Fig. 1 a convenient point, marked "microphone equalizer," is shown between the output of the studio amplifier and the pad following it. Since it is common practice to employ microphones of the same type in each studio the use of one equalizer at this point is sufficient. Where microphones of different types are to be used simultaneously it is necessary, of course, to provide individual equalizers in the microphone channels.

Fig. 18 also indicates why listening tests carried out for the purpose of judging or demonstrating the performance of high quality receivers under the present practical conditions are doomed to be misleading and unsatisfactory *unless it is known definitely that the microphone at the transmitter is a good one*. This diagram furnishes a good idea of the variation in tone quality which may be expected to be heard with such a receiver (or any other receiver) as the tuning dial is rotated. This factor is destined to loom up as an important one when radio dealers attempt to sell high quality reception to the public.

Pending the improvement in the microphone situation in the transmitter system we have considered it advisable temporarily to provide microphone equalization at the receiver. This expedient, however, can only be partially successful in view of the wide differences between the

* Note added March 27, 1934: Since this time some improvements in the microphone situations at program origination points have been made in both systems.

response characteristics of different types of microphones as shown in Fig. 18. In working out the best equalization for our experimental high fidelity receivers we have averaged the curves of Fig. 18, weighing the curve for each type according to the data of Figs. 19 and 20 for its extent of use. Although the deviations from the average are still important the provision of such equalization improves the general performance of high fidelity receivers to a noticeable extent. For commercial sale it is intended to provide these receivers with switches so that the microphone equalizer may be cut out when the future improvement in the microphone situation shall justify it.

Microphone equalization at the receiver is merely a temporary expedient and not to be proposed as a final solution for the following reasons:

(1) It is obviously uneconomical to provide millions of equalizers in receivers when a few hundred equalizers in the studios will do a better job.

(2) Exact equalization for each type of microphone can be provided at the transmitter, whereas at the receiver only approximate compensation can be obtained in view of the diversity of types.

(3) It has been the experience of telephone engineers that for greatest flexibility each part of an extended system should stand on its own feet, that is to say its frequency performance should be adequate and not dependent upon compensation in another part. This, of course, cannot be asserted dogmatically because occasions arise when a deliberate and carefully planned departure is helpful. An example is wide range phonograph recording where it is helpful to accentuate the higher frequencies in recording, subjecting these to a compensatory attenuation in pick-up in view of the audibility of surface noise at these frequencies and the attenuating effect of the stylus point. In the same way it may be found desirable to accentuate the higher frequencies in modulating a broadcast transmitter, subjecting them to a compensatory attenuation at the receiver, in order to reduce the effect of external or set noise in the receiver. But this should be a carefully planned and deliberate procedure undertaken with a full and uniform participation of all parties concerned, and not at all comparable to the present haphazard microphone situation.

4. MICROPHONE PERFORMANCE IN RELATION TO STUDIO TECHNIQUE

The term *studio technique* may be taken to include microphone placement with respect to the sound source, distribution of sound sources, acoustic properties of the studio, including the distribution and absorption characteristics of the material used for reverberation

control, relation between reverberation time and frequency; and so forth.

We may distinguish between two types of pick-up: (1) *direct pick-up*, where the distances between microphone and sound source are so small that the reverberant sound is negligible in comparison with the direct sound wave; (2) *reverberant pick-up*, where the distance is so large that the direct sound is negligible in comparison with the reverberant sound.

Direct pick-up conditions usually exist for single performers and small groups in talks, sporting events, songs, sketches, etc., and reverberant pick-up conditions for large groups, orchestras, organ recitals, choirs, etc. As to the relative occurrence of the two types of pick-up, during the month of September, 1933, approximately 65 per cent of the air hours of the principal broadcast networks were occupied by direct pick-ups and 35 per cent by those of the reverberant class. The close pick-ups are therefore about twice as important as the distant ones.

In classifying the distant pick-ups as reverberant we are assuming steady state conditions, that is that the sound has lasted long enough for the sound energy at any point in the room to have reached a substantial fraction of its ultimate amplitude. Is this a fair assumption? According to Sabine's acoustical theory of rooms the sound from a source emitting energy at a uniform rate grows and decays exponentially. If the growth and decay are plotted with decibel ordinates as in Fig. 21, it will be noticed that the *decibel rate of growth is enormously greater than the rate of decay over the greater part of the amplitude range*. The case plotted in Fig. 21 is that of a large studio having an optimum reverberation time of 1 second. Assume that the steady state level is 60 decibels above the aural threshold. The sound has reached within 7 decibels of this level in 0.1 second, while it requires nine times as long as this to decay over the same range of amplitudes. It would seem therefore that in the case of music, even in rapid staccato playing, the steady state amplitudes are roughly approximated. The transient state is, however, not unimportant. There is strong evidence, for example, that our ability to localize a sound source under conditions where the reverberant sound is enormously greater than the direct sound may be due in part to the transient character of certain sounds.

At any rate let us look at these two types of pick-up from the steady state point of view. Assume a studio $20' \times 30' \times 50'$. The optimum reverberation time for a room of this volume for acceptable broadcast quality will be in the neighborhood of 0.9 second. The average absorption, assuming a uniform distribution of the absorbing material, will be about 0.3.

In the case of direct pick-up assume that the performers are located about two feet from the microphone. The energy density at a distance r from a nondirectional source emitting sound at the rate of E ergs per second is $E/4\pi r^2 c$ where c is the velocity of sound. This represents the energy in the direct wave from the source. To calculate approximately the energy density due to all subsequent reflections (in the steady state) we assume that if the absorption coefficient is α then the energy available for loss (i.e., the energy left after the first reflection) will be $E(1-\alpha)$. The reverberation sound energy density will be therefore

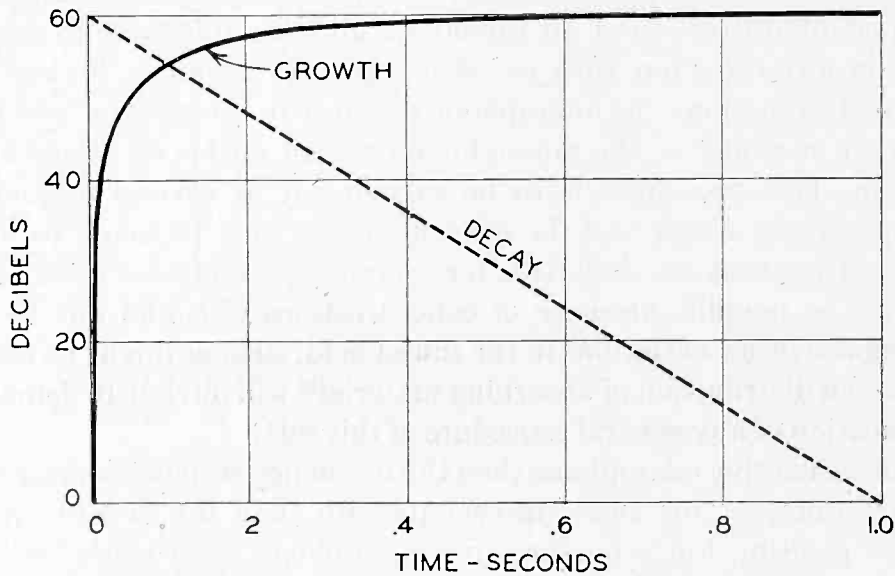

Fig. 21—Growth and decay of sound in a reverberant room.

$4E(1-\alpha)/Sac$, where s is the area of the absorbing surface. At a distance of two feet the reverberant sound energy will be 7.5 per cent of that due to the direct primary wave from the source. The corresponding mean reverberant sound pressure will be 0.27 of that due to the direct wave. This ratio of direct to reverberant sound will be increased by any directivity in the source or microphone, assuming that they face each other in the normal way.

In close pick-ups the reverberant sound may be neglected and the microphone response will be given by its wave calibration taking into consideration the angle between the source and the axis of the microphone. If we assume that the directions of the sources will not exceed 45 degrees on either side of the microphone axis and compute the average response over this angular range at various frequencies it turns out that for most directive microphones (i.e., carbon, condenser, moving-coil) the average response is approximately the same as that corre-

sponding to sound arriving from an azimuth between 25 and 30 degrees. This average response curve, shown dotted in the lower parts of Figs. 2 to 15 is thought to represent the performance of the microphone under these conditions fairly enough for engineering purposes.

For the case of reverberant pick-up assume that the studio is occupied by an orchestra up to within 10 feet of the microphone, the average distance being 25 feet. Employing the same method of computation the reverberant energy at the microphone is found to be 12 times that of the direct wave, the corresponding sound pressures being in the ratio of 3.5 to 1. In such a sound field the sound waves reach the microphone in equal quantities from all directions and the microphone may be faced in any direction with no effect upon its response. Sivian¹⁵ has proposed to compute the microphone response in this case by averaging the wave response of the microphone over all angles of azimuth and altitude. This procedure is to be carried out at several frequencies throughout the range, and the resulting curve may be taken to represent the frequency characteristic for completely diffused or reverberant sound. The possible presence of concentrations of sound due to ray-focuses and other variations in the sound field, such as might be caused by uneven distribution of absorbing material¹⁶ will obviously demand a modification of any general procedure of this sort.

For a directive microphone then the frequency response characteristics are different for close (direct) pick-up than for distant (reverberant) pick-up. For a nondirective microphone, such as the velocity and crystal types, the two response characteristics are alike—an obvious advantage. The term *directive* refers only to the effect of direction on frequency response and not upon the general level.

There is also another factor involved in reverberant pick-up which appears to have been overlooked. This has nothing to do with the microphone but depends upon the studio. According to Sabine's theory, applicable to studios which are not too dead, the steady state energy in the sound field due to a source emitting sound energy at the rate of E ergs per second is $4E/S\alpha c$. The absorption α is usually a function of the frequency. The studio thus has a frequency characteristic of its own which is superposed on that of the microphone. The reverberation time is approximately inversely proportional to the absorption so that the *studio frequency characteristic* will be proportional to the square root of the reverberation time as a function of frequency. It is apparent therefore that if the microphone is to have the same frequency response

¹⁵ L. J. Sivian, *Bell. Sys. Tech. Jour.*, vol. 10, p. 108, (1931).

¹⁶ For an example of imperfect diffusion in a reverberant room see Ballantine, *Jour. Acous. Soc. Amer.*, vol. 3, p. 350, (1932).

for direct and reverberant pick-up the reverberation time of the studio must be adjusted to the same value at all frequencies. Such an adjustment of reverberation time is not desirable on other grounds. MacNair has recently proposed a criterion for an optimum reverberation time frequency relation based upon the idea that sounds of different frequencies should decay in loudness at the same rate. On this basis the reverberation time rises with decreasing frequency below 1000 cycles. The two requirements are therefore incompatible. At present the best procedure would seem to be to adjust the reverberation time in accordance with MacNair's criterion and to compensate for the resulting nonuniform studio frequency characteristic by equalization in the electrical circuits. This equalization may be cut out for direct pick-up.

A hybrid case of interest is furnished by the live-end dead-end idea in studio construction¹⁷ which has recently been incorporated in the studios of WCAU in Philadelphia and in the Shepard studios in Boston. In this case the microphone is situated at one end of the room in an environment of comparatively high absorption. The reflected waves from the adjacent walls are of negligible intensity. The sound from an orchestra situated in the live end of the room has a chance to become diffused by repeated reflections from the near-by live walls. It thus appears justifiable to regard the sound source as spread uniformly throughout the solid angle subtended at the microphone by the boundaries of the live end of the room. This will seldom exceed 90 degrees; i.e., 45 degrees on each side of the axis. This case, therefore, resembles acoustically the first case considered, that is, of close pick-up.

The whole question of studio technique is in an unsatisfactory state and will require considerable experimental work for its settlement. The present practices will undoubtedly have to be substantially modified in order to secure the full benefits from the newer, improved microphones having uniform frequency response characteristics and having directivity characteristics which differ from those of the older types. Evidence of this is already beginning to accumulate as a result of experience with the crystal and velocity types. Needless to say the work should be carried out with the aid of the best possible reproducing systems for audition purposes, looking forward to the time when receiving apparatus of this caliber will be in general use.

5. WIRE LINES

The wire lines used in program transmission may be divided into two classes; (1) local lines connecting the studio and remote pick-up

¹⁷ F. R. Watson, *Jour. Acous. Soc. Amer.*, vol. 2, p. 103, (1930); G. T. Stanton and F. C. Schmid, *Jour. Acous. Soc. Amer.*, vol. 4, p. 44, (1932).

points such as concert halls, hotels, dance halls; etc., and those connecting the studio and a local radio transmitter; (2) long lines interconnecting a network of radio transmitters.

1. Local Lines.

Typical transmission frequency curves for three local lines between remote pick-up points in New York City and a studio building are shown in Fig. 22. These are typical local wire facilities as employed

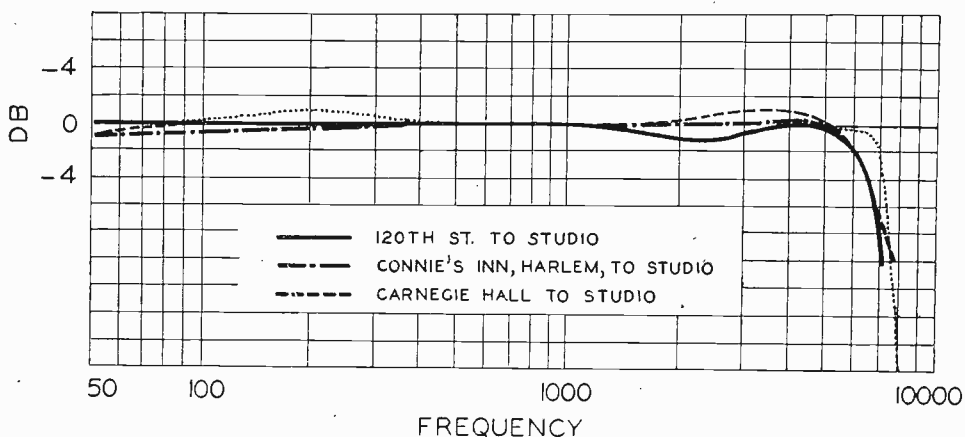

Fig. 22—Transmission of typical short wire lines between remote pick-up point and studio; (dotted curve) typical studio to local radio transmitter line.

in everyday broadcasting. The transmission is limited to about 6000 cycles. It is not a difficult matter, however, to equalize short lines for uniform transmission up to 10,000 cycles, and facilities of this type are sometimes employed.

A typical characteristic of a wire line between studio and local radio transmitter is shown by the dotted curve of Fig. 22. In this case the transmission extends to 7000 cycles (at -2 db) which is entirely adequate for practical high fidelity transmission under existing conditions.

2. Long Lines.

With regard to high quality long-distance program transmission, the American Telephone and Telegraph Company has been laying down during the past few years new long-distance cable circuits (B-22) capable of providing uniform transmission up to 8000 cycles with negligible phase distortion and cross-talk.¹⁸ Whether available now or not, it is understood that these improved wire facilities are not yet in general use. If available this lack of use is probably due to the fact that the

¹⁸ A. B. Clark and C. W. Green, *Bell Sys. Tech. Jour.*, vol. 9, p. 567, (1930).

broadcasters do not feel that the extra cost is justified by the performance of present-day radio receivers.

An idea of the frequency characteristics of long-line facilities commonly employed today is furnished by Fig. 23 which was taken on a program circuit extending from New York to Chicago and back to New York. The solid and dotted curves were taken under different conditions. The level transmission extends to about 5000 cycles.

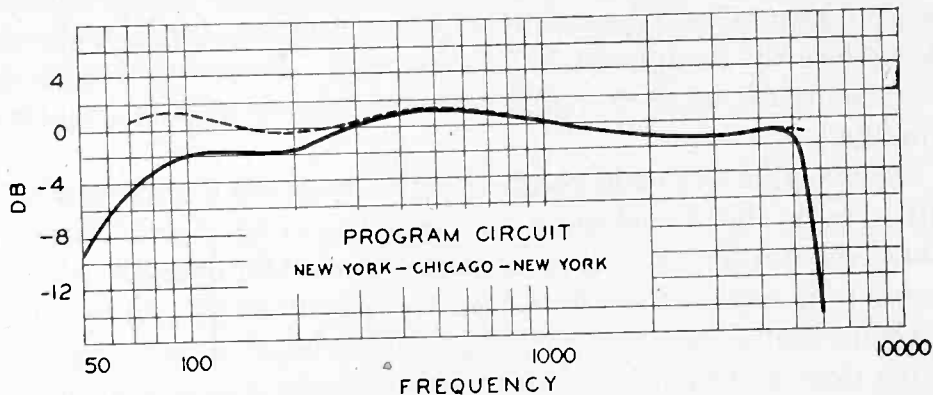

Fig. 23—Transmission of long-distance program circuit.

3. Summary.

It may be safely stated that almost all of the programs transmitted over wire lines at the present time are limited to 5000 or 6000 cycles. There is obviously room here for improvement. In the case of local lines equalization to at least 8000 cycles should be contracted for. In the case of long lines the B-22 8000-cycle facilities should be employed as soon as available and as soon as improved receivers are definitely on the market.

6. TERMINAL APPARATUS

The newer types of terminal equipment are practically free from distortion. The frequency characteristics are level within a decibel or two to 10,000 cycles, and the power handling capabilities of the amplifiers are entirely adequate at the standard operating levels.

This is not true, however, of older types of equipment which are to be found in a surprisingly large number of stations. In a typical case the transmission will be -2 decibels at 5000 cycles and -5 decibels at 6000 cycles. This apparatus should be replaced or modified.

Several cases have recently come to notice where the higher frequencies were being deliberately boosted in the speech input circuits to compensate for the falling-off in the response of present-day receivers. These unorthodox practices simply add more confusion and are

an atavistic tendency, this experiment having been tried on a large scale and abandoned about a decade ago.¹⁹ It is now well established that each part of a system should stand on its own feet without depending upon compensation in another part.

7. RADIO TRANSMITTER

1. *Frequency Distortion.*

The remarks which were made about terminal equipment apply here. As a general rule the audio-frequency range covered depends upon how modern the equipment is. The frequency distortion in modern radio transmitters built by reliable manufacturers may be regarded as negligible.

The question as to what audio range is required for acceptable high quality radio broadcasting under existing conditions (10-kilocycle channel separation, etc.) is an important one. Our opinion, which will be more fully explained in Part II of this paper, is that 7500 cycles is a good compromise, satisfying the taste of the most critical and yet not causing excessive monkey-chatter with stations on neighboring channels.

2. *Amplitude Distortion.*

The chief source of amplitude distortion in the transmitter system is nonlinearity in the modulation characteristic of the radio transmitter. This is more prevalent than is generally supposed. The relation between the applied audio voltage and the amplitude of modulation envelope of the radio-frequency signal is generally more or less linear up to a certain degree of modulation, called the "modulation capability" of the transmitter, beyond which it departs from linearity. When the audio signal peaks are allowed to exceed the modulation capability, distortion is produced which is particularly audible with a high fidelity receiver. The wider the frequency range of the receiver the more objectionable the distortion becomes. Transmissions which are not at all objectionable with a receiver reproducing up to 3000 cycles may be quite annoying with 7000-cycle reproduction. A type of distortion which is particularly audible with wide range reproduction occurs when there is a sudden bend or break in the amplitude characteristic of some circuit element. In comparison with this, "smooth distortion" such as is produced by a square-law detector, is not nearly so disagreeable. Sudden breaks of this type may occur when an amplifier draws grid current through a high impedance coupling or when a

¹⁹ Julius Weinberger, Proc. I.R.E., vol. 12, p. 774; December, (1924).

transmitter with 100 per cent capability is overmodulated. (Fig. 24.) In the latter case a highly disagreeable crackling is heard with a high quality receiver when the signal peaks exceed 100 per cent modulation.

The increased sensitivity of the high fidelity receivers to this kind of distortion increases the importance of securing a strictly linear modulation characteristic. Once this is secured it is advisable to make periodic and frequent checks as a maintenance routine, particularly following transmitter adjustments and replacement of tubes or other parts.

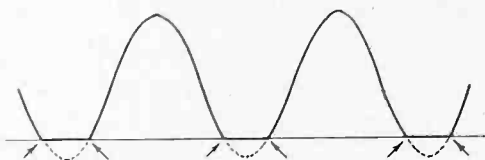

Fig. 24—Illustrating “breaks” produced by overmodulation in a radio transmitter.

Modulation linearity may be checked in several ways. One method employs a modulation meter (e.g., of the van der Pol-Posthumous type²⁰) capable of *accurately* measuring both positive and negative peaks. A curve connecting these positive and negative peaks with the amplitude of an applied sinusoidal audio voltage will be informative provided the power supply is stable and does not shift with audio level. Another method is to pick up the radio-frequency energy, rectify it by a linear diode rectifier and subject the resulting audio output to harmonic analysis. The harmonic content at various degrees of modulation will indicate the amount of nonlinearity. A third method is to plot the alternating-current output of the linear rectifier against the audio input. It is desirable in this case to measure the modulation also, at least at one audio input level, in order to correlate the results.

An example of the last method is shown in Fig. 25. While the ordinates are marked in modulation percentage the curve actually represents the audio output after rectification. The modulation was also measured up to the point where the curve starts to bend over and the audio output could thus be expressed in terms of percentage modulation up to this point. This curve was taken on a 50-kilowatt transmitter which on ordinary receivers had apparently been operating satisfactorily but on a high fidelity receiver had crackled badly at high levels. The investigation represented by Fig. 25 showed that although the modulation capability was rated at 100 per cent it was actually not over 70 per cent.

²⁰ Balth. van der Pol and K. Posthumous, *Exp. Wireless*, p. 140, (1927).

Incipient distortion could easily be detected at 70 per cent with a high fidelity receiver. Since the transmitter was made and adjusted by a reputable manufacturer it seems probable that the condition shown had been brought about by faulty maintenance and maladjustment. The condition was later improved by readjustment of the interstage and load impedances. This is merely cited as an illustration of the sort

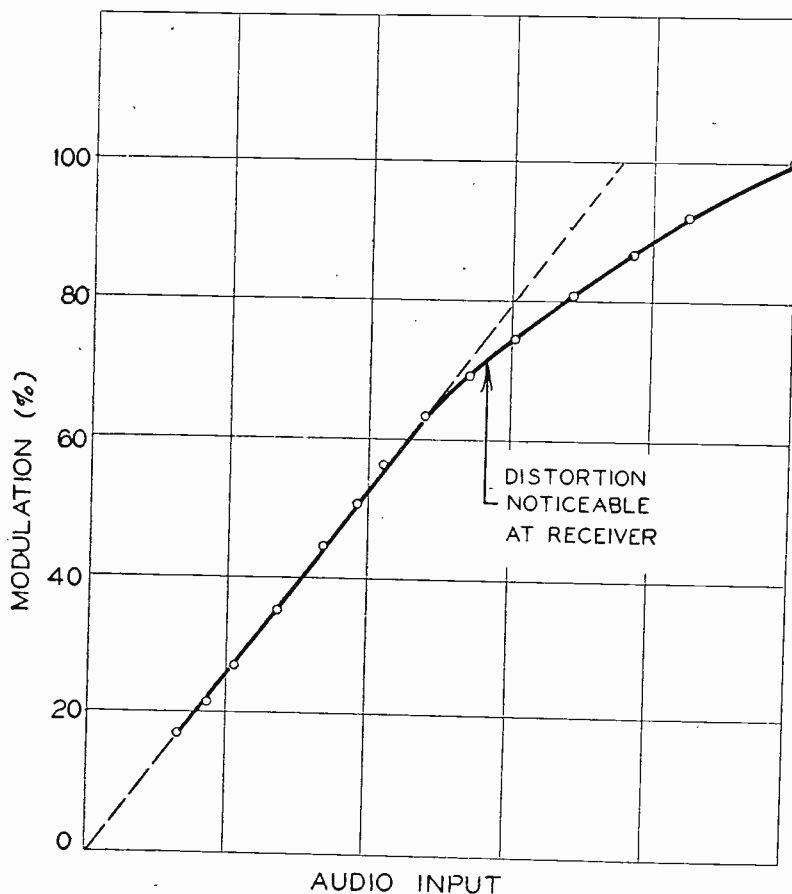

Fig. 25—Modulation characteristic of a 50-kilowatt transmitter showing incipient distortion at 70 per cent modulation.

of improvemental step which will be necessary before high quality reception can be successful. It also furnishes a contradiction to the popular notion that the quality of performance necessarily increases with the power and cost of the transmitter.

8. VOLUME LEVEL INDICATION AND CONTROL

The increased sensitivity of high fidelity receivers to distortion produced by overmodulation naturally magnifies the problem of volume level control. A greater precision of adjustment is demanded if the peaks are not to exceed the specified limits too frequently. The problem is a difficult one by the very nature of the signal.

The most common type of volume indicator in use in this country is shown schematically in Fig. 26. The ballistic behavior of the direct-current meter in the plate circuit and the circuit constants are such that pulses of applied audio voltage of increasing duration produce increasing swings of the meter up to 0.2 second duration above which the maximum swing remains constant. In speech the average syllable duration is of the order of 0.2 second so that the peak swing of the meter is an approximate measure of the mean power in the syllable.²¹ Now in the case of speech the mean syllabic power has been correlated by statistical studies with the peak amplitudes, which of course, are of main interest since they are to be kept within the limits of the apparatus. By virtue of this correlation the volume indicator becomes of use in indicating what the peak amplitudes are likely to be. In the case of

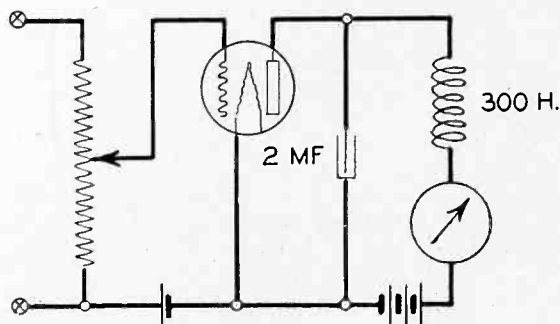

Fig. 26—Common type of volume level indicator.

other sounds, such as music, no such correlation has been established, hence the extension of the use of the indicator in these cases continues to be purely heuristic and lacks the statistical justification which has been established for speech. Surges of sound of shorter duration than 0.2 second are not reliably indicated by the peak swing of the meter and the shorter the duration the greater the error. For general use it would seem desirable to employ a device having a smaller time constant.

Photographic records of the meter swings of a volume indicator of this type are shown in Fig. 27. The upper record was taken during the playing of a piano piece; the lower curves represent part of a radio program. These records, particularly the upper one, furnish some idea of the wide ranges of deflections which confront the control operator, and indicate the difficulty of his problem of making full use of the transmitter's modulation capabilities without overmodulation. In spite of this difficulty it is surprising what can be done by vigilant and careful monitoring.

Continuous records have been made of the modulation of a number

²¹ L. J. Sivian, *Jour. Acous. Soc. Amer.*, vol. 1, no 2, part 2, p. 11, (1930).

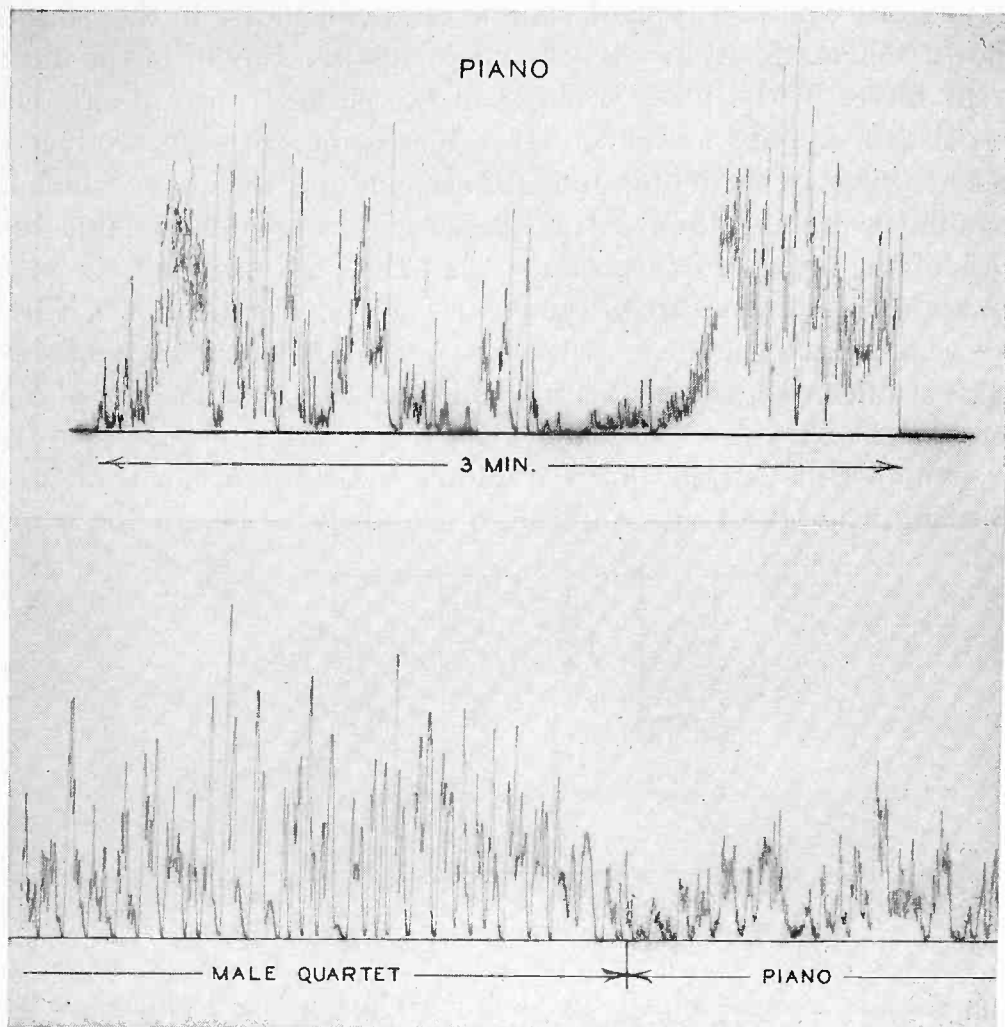

Fig. 27—Specimen record of the swings of the volume indicator meter (Fig. 26) during a typical musical program.

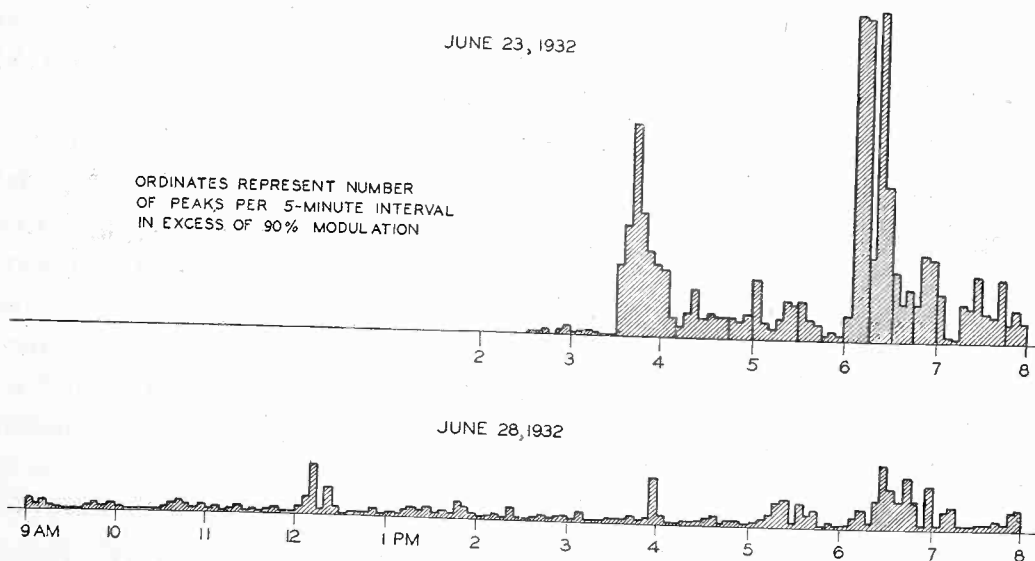

Fig. 28—Records of the modulation level of a commercial broadcast station.

of transmitters. They show variations during the day from program to program, from day to day, and from station to station which are larger than can be accounted for by the limitations of the volume indicator and must therefore be attributed to carelessness or bad technique. An example of this is shown in Fig. 28. This is a record of the overmodulation of a certain transmitter during a typical daily operating schedule. The ordinates represent the number of peaks exceeding 90 per cent

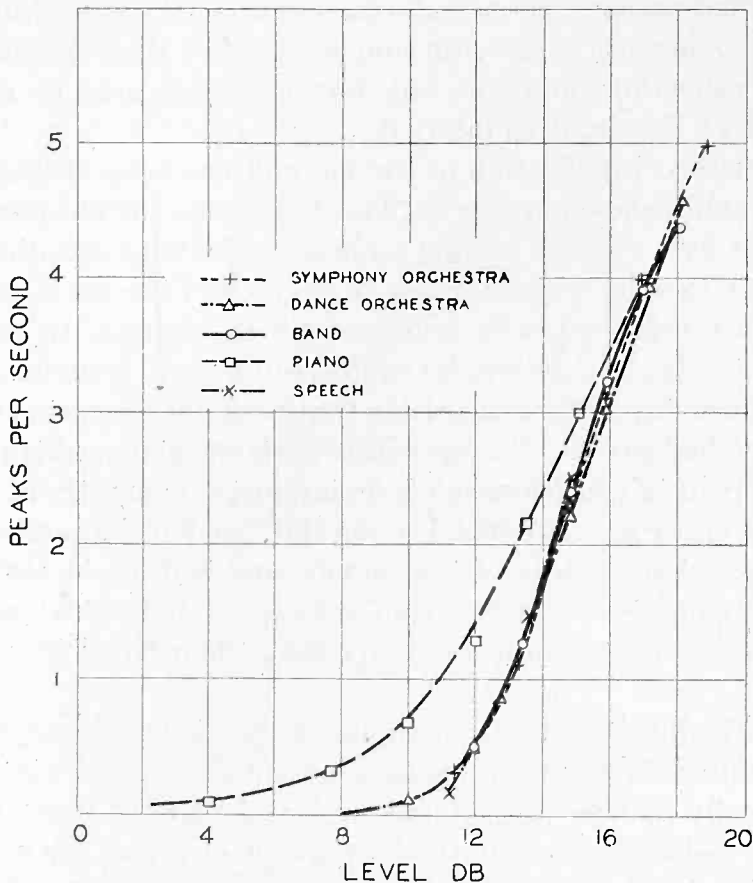

Fig. 29—Relation between peak count and volume level for various sounds.

modulation (the modulation capability of the transmitter) occurring in a 5-minute time interval, as indicated by a peak counter described below. The upper curve, taken June 23, 1932, exhibits considerable irregularity, with frequent periods of severe overmodulation. The lower record, exhibiting a considerable improvement, was obtained a few days later following a discussion of the problem with the engineers responsible for the operation of this station. This improvement is real. The operating level has not merely been reduced but the irregularities have actually been smoothed out; this is shown by the fact that there

are always some peaks present, indicating that the full modulation capability is being utilized but not unduly exceeded.

Since the peak amplitudes are of fundamental importance in determining the overloading of apparatus or overmodulation, it seems logical to use them directly for volume level indication. One method of doing this is to count the number of peaks which exceed a certain level in a given time interval and we have worked out a volume indicator along these lines. The indications of the instrument are unfortunately *a posteriori* indications, giving information after the event, and to that extent are of less use to the gain control operator than the conventional types of indication; however, this inconvenience may be reduced by cutting down the counting interval.

A statistical justification of the method has been obtained experimentally and is shown in Fig. 29. This represents the number of peaks, as counted by a counter having a maximum rate of counting of 8 per second, for various volume levels in decibels. Five kinds of program material are represented as indicated by the legend. In view of the diversity in the characteristics of these different sounds, as well as in the nuance, it is rather surprising that with one exception the curves can be matched so well. The one exception is the piano, which exhibits a greater spread in consequence of the impulsive character of its sound. The shape of the curves depends upon the speed of the counter, as well as upon the time pattern of the sounds, and is of no importance; the important thing is the general similarity of the individual curves, and in this resides the possibility of employing the method for volume indication.

This principle has also been applied in the development of an automatic monitor for the prevention of overmodulation. This apparatus automatically reduces the volume level in the speech input circuits in successive 2-decibel steps until the number of peaks per unit time is reduced to a limiting value for which the apparatus is set and which has been found empirically not to produce intolerable disturbance in high quality reception. No attempt is made, of course, to increase automatically the volume level when it falls to a low value. Operating this way the monitor backs up the volume control operator and serves to correct any errors he may make in the way of an excessive volume level. It has been our experience that most of the gross variations in volume level occur between programs. For that reason arrangements are made to restore automatically the original volume level at the end of each program interval of 15 minutes so that if the following program is correctly adjusted the volume level will not remain at an unjustified low level.

The organization of the automatic monitor is shown schematically in Fig. 30. A T-type control network, adjustable in 2-decibel steps, is inserted in the line to be controlled. An amplifier is bridged across the

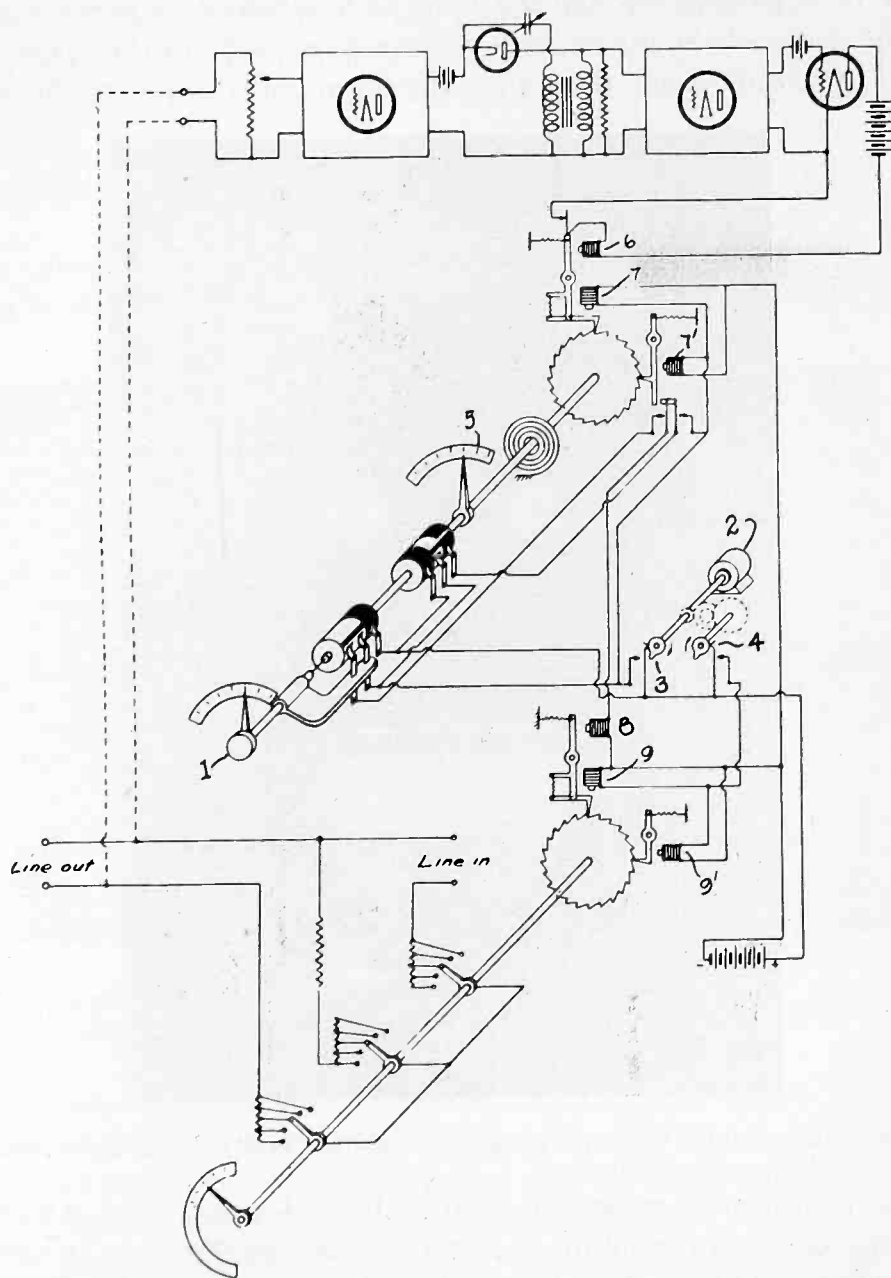

Fig. 30—Schematic diagram of automatic volume level limiter, based upon peak counts.

output end of this control or connected at some other suitable point. The signal, after amplification, is impressed upon a diode rectifier which is provided with a direct-current bias so that only peak amplitudes greater than the bias pass through. A neutralizing means prevents the

leakage of the signal through the interelectrode capacity of the diode. The peaks passing through the diode are then amplified and operate a Thyatron, or equivalent gas-discharge tube. The prevention of the signal from passing through the diode by neutralization permits greater amplification of the pulses with increased precision in the operation of the Thyatron. Each time the Thyatron breaks down the rotary

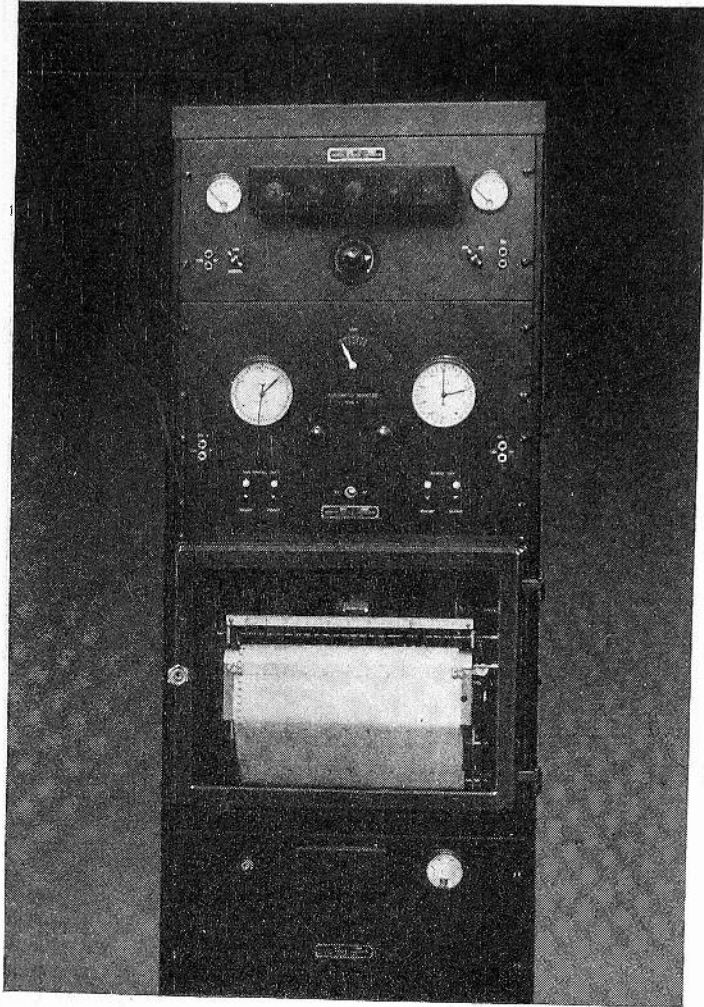

Fig. 31—Photographic view of automatic monitor and volume level recorder.

counter is moved by magnet 6 against the restoring spring. An auxiliary contact opens the circuit and restores the Thyatron to an operating condition. The number of peaks is indicated on the dial 5. Contacts are provided which can be adjusted by knob 1 so that when a given number of peaks is obtained the circuit is closed through magnet 8, operating the volume control shaft and reducing the level 2 decibels. Timing is controlled by the synchronous motor 2. At the end of each counting interval (say 30 seconds) contacts 3 are closed through magnets 7 and 7' thus restoring the counter to zero. The counter is also

restored to zero by the operation of the volume control. These processes are repeated until the volume level has been so reduced that the peak count no longer reaches the critical value for which the apparatus has been set. At the end of a 15-minute program interval contacts 4 close and the volume control is *slowly* restored to normal. With 30-second counting intervals a correction of 10 decibels in level is made in about one minute.

A photographic view of the automatic monitor is shown in Fig. 31.

An autographic recorder of conventional type is also provided to make a continuous record of the peak counts. Such permanent records

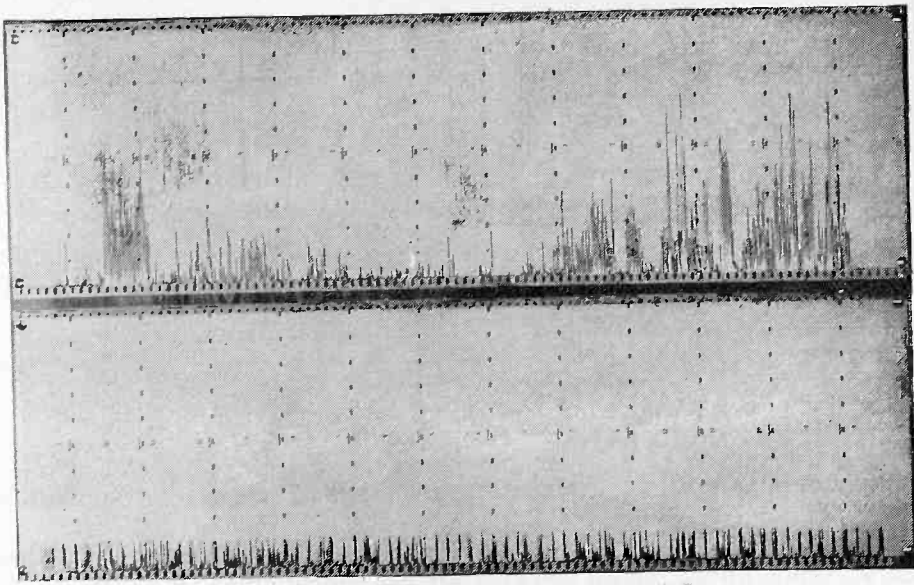

Fig. 32—Records of modulation level over an average daily period; (lower) controlled by automatic monitor; (upper) normal, uncontrolled.

of the volume level have been found valuable for supervisory purposes. Because of the limited speed of the recorder it is found advisable to provide an auxiliary counter operating over a longer counting period (2 minutes) than that used for monitoring purposes.

The performance of the monitor on commercial broadcast material is illustrated in Fig. 32. The upper record shows the number of peaks per unit time in excess of 80 per cent modulation occurring during a typical day with the automatic monitoring feature inoperative. The lower record was taken the following day with the automatic monitoring device operating.

In addition to the variation in the modulation level of a particular station during the day and from day to day there are often to be ob-

served considerable differences in the general modulation levels between stations. An example is shown in Fig. 33, which is a record of the typical daily operation of two high powered stations in the New York area. The conditions were the same as those in the upper record in Fig. 32. The station represented by the upper record is a chronic overmodulator and high quality reception from it is practically impossible.

It is felt that the recording volume indicator and automatic monitor based upon peak counting as described above, while not a complete panacea for careless monitoring is at least an effective palliative and a

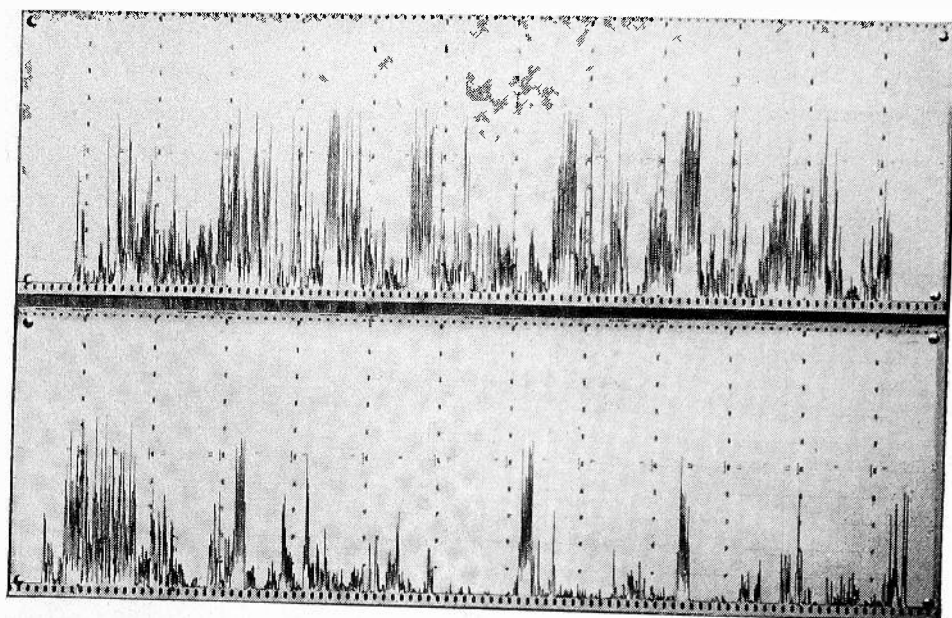

Fig. 33—Modulation level records during typical daily schedules of two broadcast stations, upper record showing almost continuous overmodulation.

progressive step in the solution of the problem of overmodulation. In particular it may point the way toward an improved use of the conventional volume control instrumentalities which in themselves do not suffer from the disadvantage of a *posteriori* indication. This may possibly be brought about by a statistical correlation of the two types of indication, a program which is now being undertaken.

9. AUTOMATIC VOLUME CONTRACTION AND EXPANSION

Another problem which frequently arises in broadcast systems is that of transmitting a wide volume range. It has been estimated that a range of 70 decibels is required for symphonic music, whereas a range of 30 to 40 decibels is the maximum which is ordinarily attained in broadcasting at the present time.

In transmission over wire lines the lower limit to which the volume

may fall is determined by the noise level and cross-talk from other circuits; and the upper limit is set by the production of cross-talk in other circuits. In recent program cable circuits the cross-talk coupling has been reduced to the point where a 40-decibel range can be handled.²² This falls short of the estimated requirements by 30 decibels and makes necessary such expedients as the manual contraction of the range by the control operator with a corresponding loss in the emotional appeal in the music.

A device was developed several years ago which promises to aid in the solution of this problem. The method consists in automatically contracting the volume range at the sending end, transmitting the contracted range, and automatically expanding it back to the original volume range at the receiving end. Both the contraction and the expansion take place according to a definite law so that if desired the original range can be restored or any fractional part can be obtained. It is obviously convenient to have these operations independent of amplitudes or volume level so that the restoration of the original range will be independent of level. The requirements for this are simply set forth. Let,

E_1 = Input voltage to contractor,

E_2 = Output voltage of contractor,

E_3 = Input voltage to expander,

E_4 = Output voltage of expander.

Denote the characteristics of the contractor and expander by

$$E_2 = f_1(E_1) \text{ (contractor),}$$

$$E_4 = f_2(E_3) \text{ (expander).}$$

Then the over-all characteristic will be

$$E_4 = f_2[k_1 f_1(E_1)].$$

If it be desired to restore the original volume range, $E_4 = k_2 E_1$. We have to solve the functional equation:

$$f_2[k_1 f_1(E_1)] = k_2 E_1 \quad (1)$$

for all E_1 . As a solution let $f_1(x) = x^{\gamma_1}$ then $f_2(x) = x^{\gamma_2}$ and

$$k_1^{\gamma_2} E_1^{\gamma_1 \gamma_2} = k_2 E_1.$$

Hence if $\gamma_1 \gamma_2 = 1$ the original range will be restored. If we want only one m th part of the original range, then $\gamma_1 \gamma_2 = m$. The symbol γ is

²² A. B. Clark and C. W. Green, reference (18), p. 569.

chosen for the index of the power-law type of operating characteristic because of the obvious photographic analogy. The contractor is analogous to the photographic negative with its gamma and the expander to the derived positive with its gamma. For perfect reproduction, as is well known, the product of the two gammas should equal unity. In the same way we speak of a contraction gamma and expansion gamma. It is natural to choose the simple values, $\gamma_1 = 1/2$ for the contractor and $\gamma_2 = 2$ for the expander. In this case the contractor cuts the input range in half (on a decibel scale) and the expander doubles it. This is also a convenient division of labor between the two devices technologically; the desired maximum range of 70 decibels is cut to 35 decibels by the contractor, which is just within the capabilities of the wire lines.

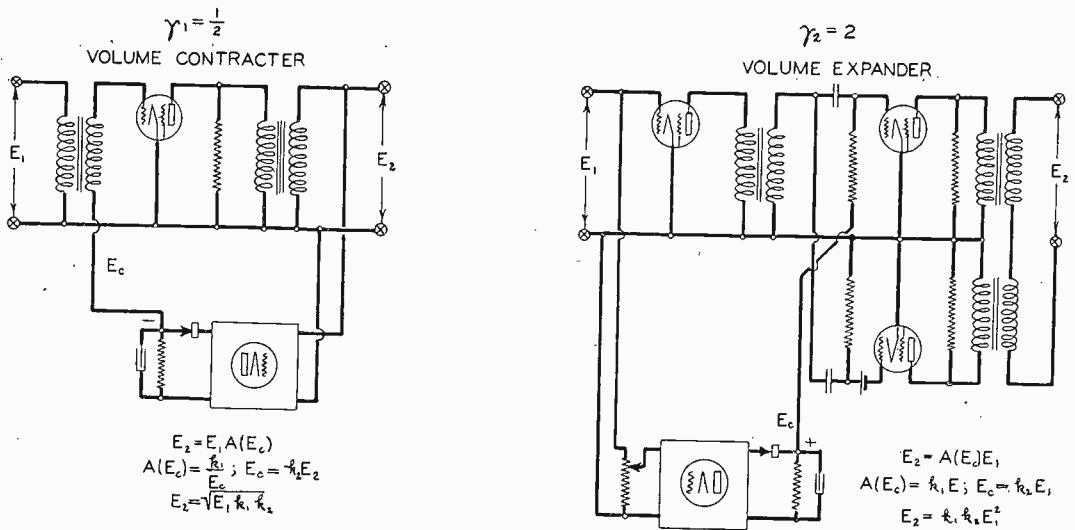

Fig. 34—Schematic diagrams of automatic contractor and expander; contraction gamma = 0.5; expansion gamma = 2.

While it is convenient to have the action of the two devices independent of the power level this is obviously not necessary provided their characteristics are complementary, but in the latter case the amplitude levels must be controlled. In the case of the transmission line this would involve having a definite transmission level between the devices at all times. Other solutions of (1) exist; in general any pair of inverse operators will do. As an example: $f_1(x) = c_1 \log ax$ for the contractor and $f_2(x) = c_2 e^{bx}$ for the expander leads to

$$E_1^{bk_1 c} = k_2 E_2$$

and the output volume range in decibels will be equal to the input volume range multiplied by $bk_1 c$. In some cases the mathematically possible characteristics are difficult to realize physically.

Power-law characteristics with $\gamma_1 = 1/2$ for the contractor and $\gamma_2 = 2$

for the expander can be realized by the arrangements shown in Fig. 34.

The contractor employs a special amplifier tube in which the gain is inversely proportional to the grid bias; that is, $A(E_c) = k_1/E_c$. The grid bias is determined by the output which is rectified and fed back to the grid for this purpose. The rectifier is linear, so that $E_c = k_2E_2$. The over-all characteristic is:

$$E_2 = \sqrt{k_1k_2E_1}$$

which is of the desired type. The time constant of the filter circuit is sufficient to prevent the introduction of alternating components into the grid circuit, yet low enough to enable the device to follow rapid changes in level. This simple arrangement works very well. A more elaborate arrangement involves placing a time-delay device in a main amplifier channel in order to delay the arrival of the signal slightly until the bias has been reduced. This was at first felt to be essential in order to take care of sudden crescendos and vigorous attack, but was later omitted in the interest of simplicity.

The special gain-bias characteristic of the amplifier tube was obtained by the variable-mu principle of construction. Two stages may be employed to cover the desired volume range in which case the characteristics of the repeater stages are $A(E_c) = k_1/E_c^{1/2}$.

The volume expander employs a stage in which the gain is proportional to the grid bias, that is $A(E_c) = k_1E_c$, where E_c is measured from the operating point. In order to obtain this linearity down to low values of gain a balancing tube is employed. The upper tube (controlled) has a linear relation between gain and bias except near plate-current cut-off. Enough counter voltage is supplied by the lower tube to give zero over-all gain at a point on the upper tube characteristic at which curvature just commences. With a proper balance the grid bias at this point gives zero gain, and for positive bias voltages the gain is proportional to the voltage. The automatic bias is derived from the input by rectification and filtering. The stage preceding the controlled stage is an isolating stage to separate the input and output circuits of the amplifier-rectifier from which the auto bias is derived.

If two stages of the k_1/E_c type are employed in the contractor the gamma is 1/3 and if two stages of the k_2E_2 type are employed in the expander a complementary gamma of 3 is obtained, restoring the original volume range.

The performance of a system having a contraction gamma of 1/2 and expansion gamma of 2 is shown in Fig. 35. It may be pointed out that the curvature of this over-all characteristic does not produce amplitude distortion of the signal but simply represents a small departure

of the volume level from the original level. The system shown is capable of handling a 70-decibel range.

The applicability of this method in other types of transmission, where it is desired to improve the signal-noise ratio, will be apparent. For example, the contractor could be installed in the speech input circuits of a radio transmitter with the expander in the radio receiver. A particularly useful application has been made in phonograph recording. Here the volume range (in the case of lateral recording) is closely

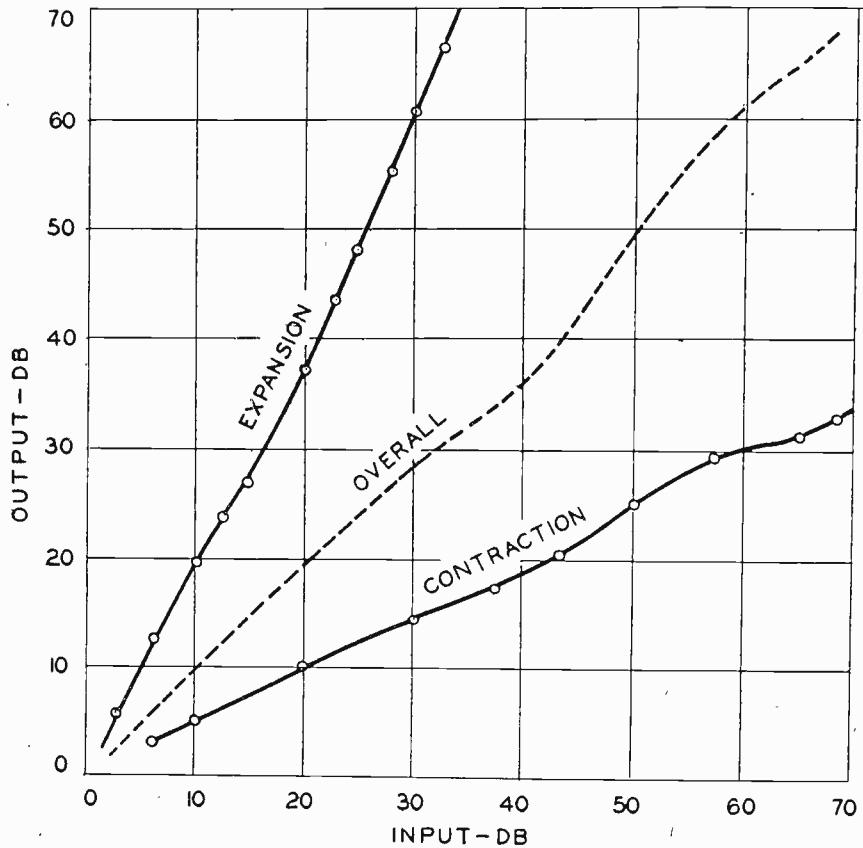

Fig. 35—Performance of automatic contractor and expander designed to handle 70-decibel volume range.

limited, on the one hand by the groove separation and on the other by surface noise. A considerable improvement may be obtained by contracting prior to cutting the wax and expanding after picking up the material from the record.

10. ANTENNA

High quality broadcast reception is limited for the present to the ground wave (or primary) range of the transmitting station. In the case of low-powered transmitters this range is limited by the field strength falling below the prevailing noise level. In the case of high powered

transmitters the primary range is more likely to be limited by the appearance of fading, particularly selective fading, since the field will usually be strong enough to override noise out to and beyond this point. Since the antenna affects the primary range in both cases a discussion of it may be considered germane to the subject of high quality broadcasting.

At one time it was an established practice to operate transmitting antennas at wavelengths above their fundamentals. A calculation of the radiation resistance of a vertical antenna below the fundamental²³ permitted a theoretical demonstration that, contrary to the accepted

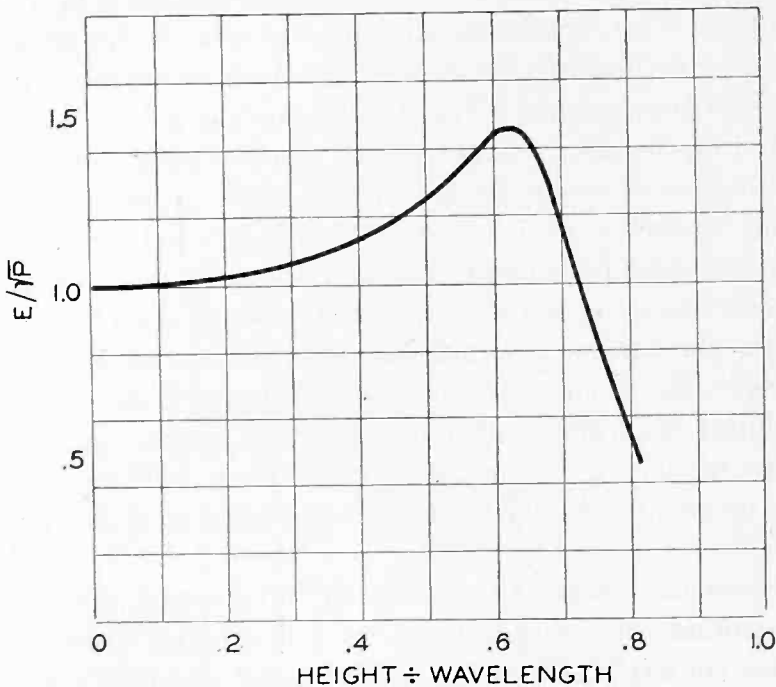

Fig. 36—Relation between ground-wave intensity and height for vertical antenna over perfect earth.

idea, the largest field strengths on the horizon for a given radiated power would be obtained by operating *below* the fundamental wavelength of the antenna.²⁴ It was pointed out that the criterion of antenna performance, for ground-wave communication, was the ratio E/\sqrt{P} , where E is the field strength on the horizon and P the radiated power. This factor was found to increase continuously as the height of the antenna was increased, for a given wavelength, reaching a maximum value at $h/\lambda = 0.625 = 5/8$. The calculated relation is reproduced in Fig. 36 using h/λ as abscissas. At the optimum point the electric field

²³ Stuart Ballantine, Proc. I.R.E., vol. 12, p. 823; December, (1924).

²⁴ *Ibid.*, p. 829.

at the receiver is 40 per cent greater than for operation at the fundamental ($1/4$ wave antenna) and 46 per cent greater than for operation considerably above the fundamental. This improvement results from the fact that under these conditions more energy is radiated along the ground, where it is wanted, and less up into the air.

The special advantages of this mode of antenna operation for broadcast purposes were recognized by P. P. Eckersley²⁵ who showed experimentally by means of vertical wires supported by balloons that the improvement predicted theoretically could actually be realized in practice.

An extension of the primary range in broadcasting is brought about on two counts: First, by increasing the strength of the ground wave, and second, by decreasing the sky wave, which produces fading by interference with the ground wave. If the receiver is located within the incipient fading distance an increase in transmitting power above the noise level improves reception and increases the primary range. In the fading zone, however, an increase in power beyond that required to produce an average field sufficient to override noise produces no further increase in service area. If automatic volume control is employed at the receiver and the fading is synchronous, a further increase of power may, however, be justified; otherwise it is wasted. We may call this critical amount of power "sufficient power." A further increase in primary range justifying the use of greater than "sufficient" radiated power, can be produced only by increasing the ratio of ground wave to sky wave.

An attempt has been made in Fig. 37 to represent the relation between the ground-wave and the sky-wave intensities from an antenna of this type over earth of average conductivity ($\sigma = 10^{-13}$ emu) and inductivity ($\epsilon = 20$). These earth constants are representative of conditions in the flat middle-western part of the United States.²⁶ The ordinates represent the electric field strength, assuming 1 kilowatt radiated power. The electric force in the ground wave is vertical; in the case of the sky wave it may have various orientations depending upon the distance. No attempt has been made in the case of the sky wave to single out the vertical component since the receiving antenna will usually also have some horizontal exposure. The ground wave has been computed by means of Sommerfeld's formula for frequencies of 500, 1000, and 1500 kilocycles. The sky wave has been computed by the

²⁵ P. P. Eckersley, T. L. Eckersley, and H. L. Kirke, *Jour. I.E.E.* (London), vol. 67, no. 388, (1929); P. P. Eckersley, *Proc. I.R.E.*, vol. 18, p. 1160; July, (1930).

²⁶ J. F. Byrnes, *Engineering Exp. Station Bull.*, No. 71, Ohio State University, (1932); C. N. Anderson, *Proc. I.R.E.*, vol. 21, p. 1459; October, (1933).

reciprocity method²⁷ taking into consideration the effect of the imperfect earth. The usual simplifying assumptions²⁸ about the ionosphere were made, namely, that the angle of reflection is equal to the angle of incidence, that 80 per cent loss occurs at reflection independent of the angle of incidence and the frequency, and that the height is 100 kilometers (62 miles). These are admittedly rough approximations, but the results are at least suggestive. Variations in the reflectivity of the

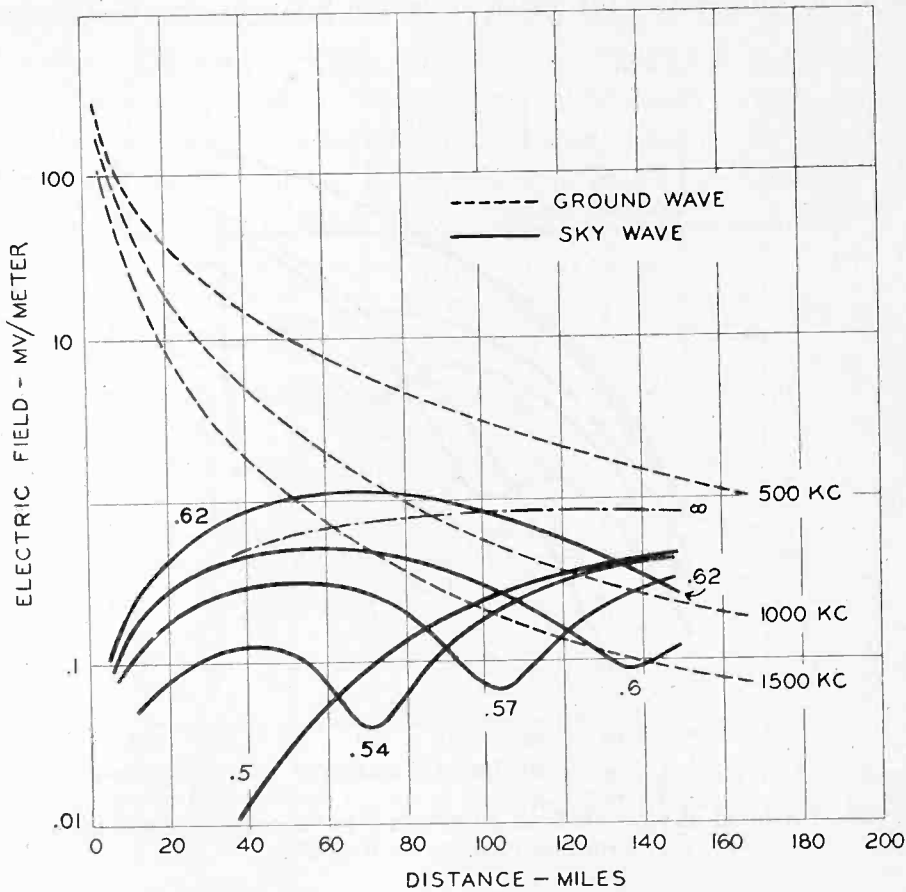

Fig. 37—Variation of ground-wave and sky-wave fields with distance; earth constants $\sigma = 10^{-13}$ emu, $\epsilon = 20$. Numbers on sky-wave curves represent ratio of height of vertical antenna to wavelength. 1 kilowatt radiated power.

ionosphere will affect the position of the sky-wave curves on the ordinate scale but will not affect the shape of the curves. The numbers on the curves represent values of the ratio of height to wavelength h/λ .

Several interesting conclusions may be drawn from these curves:

²⁷ T. L. Eckersley, *Proc. Wireless Sect. I.E.E.*, vol. 2, p. 85, (1927); Stuart Ballantine, *Proc. I.R.E.*, vol. 16, p. 513; April, (1928); W. H. Wise, *Bell Sys. Tech. Jour.*, vol. 8, p. 662, (1929); R. M. Wilmotte, *Jour. I.E.E.* (London), vol. 68, p. 1174, (1930).

²⁸ P. P. Eckersley, *Proc. I.R.E.*, vol. 18, p. 1160; July, (1930).

(1) Variations in the sky wave brought about by varying h/λ are far more important in determining the primary range than the variations in the ground wave. For example, at 1000 kilocycles if the sky-wave intensity were fixed at 1 millivolt, the 40 per cent increase in the ground-wave intensity brought about by operation at $h/\lambda = 0.62$ would only increase the primary range by 20 per cent (from 50 to 60 miles).

(2) Although $h/\lambda = 0.62$ is the best operating point from the viewpoint of ground-wave intensity it is not always the best operating

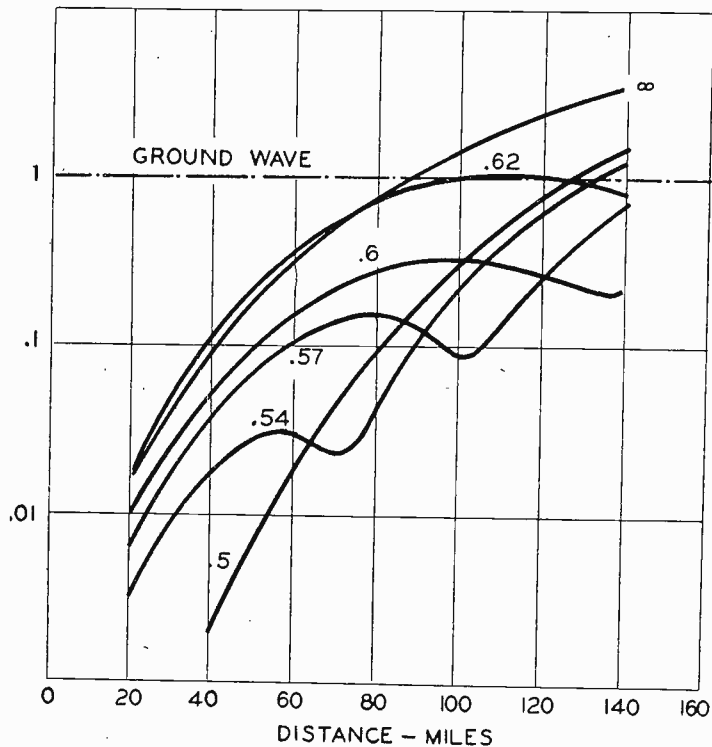

Fig. 38—Ratio of sky-wave field to ground-wave field at 1000 kilocycles; same conditions as Fig. 37.

point from the viewpoint of pushing out the incipient fading distance by reduction of the sky wave, and hence not always the best operating condition for maximum primary coverage.

(3) The best h/λ depends upon the attenuation of the ground wave, which in turn depends upon the effective conductivity of the soil and the frequency.

These points may be clearer from Fig. 38 which represents the data of Fig. 37 replotted to show the ratio of the sky wave to the ground wave for the case of 1000 kilocycles.

Up to about 80 miles the sky wave for operation at 0.62 is even larger than for the older type of operation below the fundamental ($h/\lambda = \infty$) and the 40 per cent increase in ground wave helps very little.

The sky wave has a minimum at a distance which decreases as h/λ decreases, down to 0.5 when the minimum is at zero distance. With lower values of h/λ than 0.62 there will be less fading at shorter distances and it would seem desirable to sacrifice freedom from fading at the larger distances in order to secure an improvement at the shorter distances. This can be accomplished by reducing h/λ below the optimum point $h/\lambda = 0.62$. The exact amount of reduction is a matter of judgment and depends upon the attenuation of the ground wave. In the case of Fig. 38 (1000 kilocycles, $\sigma = 10^{-13}$) $h/\lambda = 0.56$ is suggested as a suitable compromise giving not over 10 per cent fading up to 100 miles under the conditions assumed. This moves the 10 per cent fading distance out from 40 miles at $h/\lambda = 0.62$. For other frequencies the application of the same criterion gives the relation shown in Fig. 39 be-

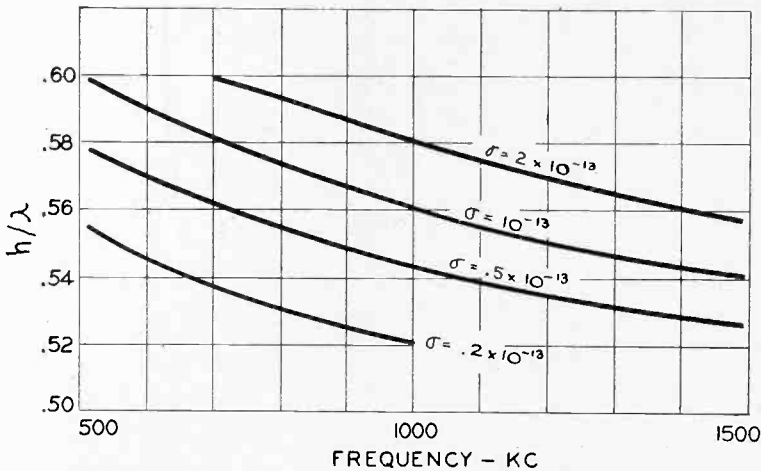

Fig. 39—Suggested relation between h/λ and frequency for vertical antenna to secure greatest fading-free primary coverage for different effective earth conductivities.

tween a desirable value of h/λ and frequency. The curve for a conductivity of 10^{-13} has been extended to other conductivities by remembering that the argument in Sommerfeld's formula is proportional to f^2/σ .

While the calculations upon which this argument rests are not, in the very nature of the problem, above reproach, and the particular values are not to be taken too seriously, nevertheless it is believed that they contain a certain amount of descriptive truth which we can summarize briefly as follows: *Although the ground wave is maximized by operating a vertical antenna so that $h/\lambda = 0.62$, this does not secure the greatest primary service range. The greatest fading-free primary range is obtained at lower values of h/λ , down to 0.5, depending upon the rate of attenuation of the ground wave.*

This rule applies only in the case where the power is "sufficient"

and of course only to the primary range out to the inner boundary of the first fading annulus. For maximum secondary coverage it would probably be desirable to work closer to $h/\lambda = 0.62$.

As an example of the application to a specific case consider that of station WABC operating on 860 kilocycles. A field intensity survey of

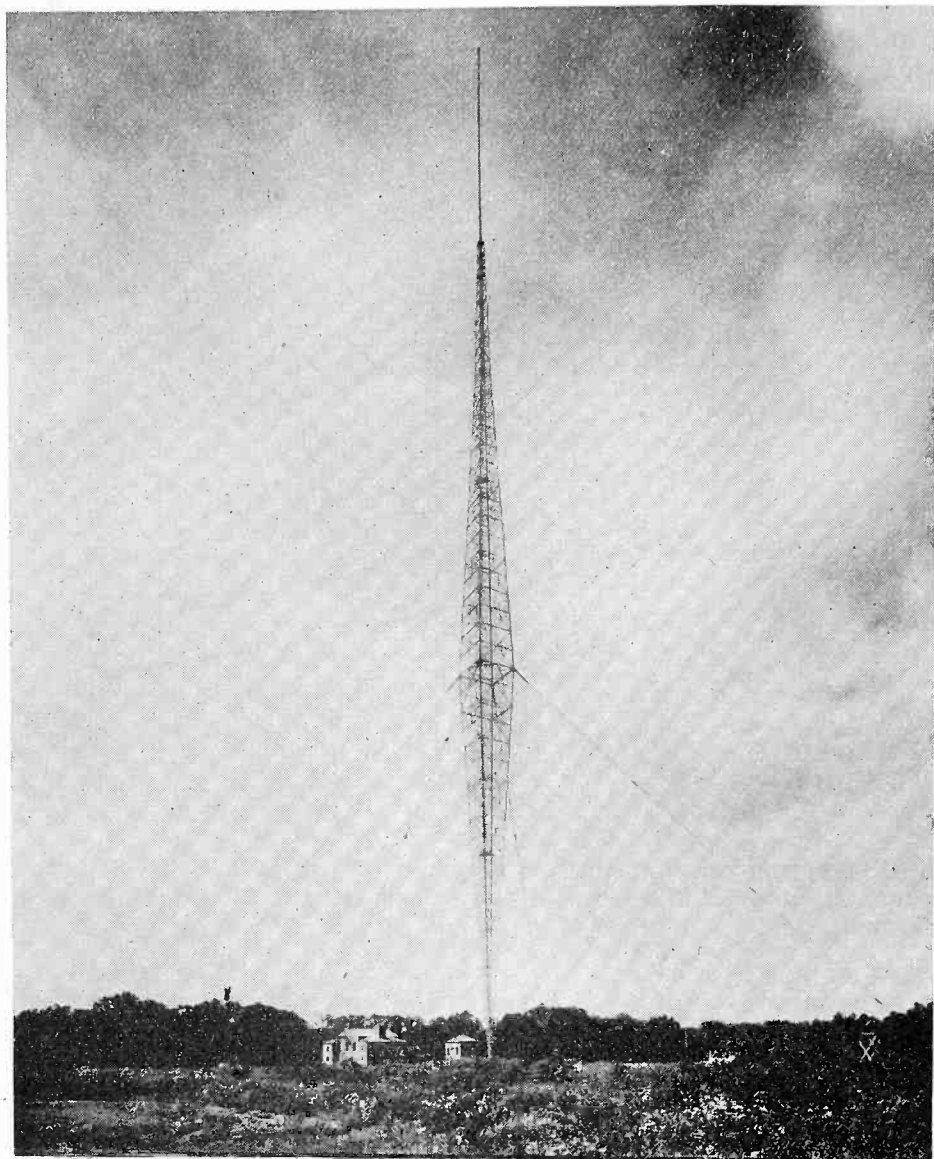

Fig. 40—Vertical antenna of guyed cantilever type as installed at WABC, Wayne, New Jersey; height = 675 feet.

the station shows a minimum attenuation to the southwest which corresponds to an effective conductivity of 5×10^{-14} emu, and a maximum attenuation to the west (over the Ramapo mountains) corresponding to 3×10^{-14} emu.²⁹ Taking $\sigma = 4 \times 10^{-14}$ as an average value we find from

²⁹ The former value (5×10^{-14} emu) for transmission over relatively flat country agrees with the value (4.5×10^{-14}) cited by Anderson as an average for New Jersey, reference (26), p. 1459.

Fig. 39 that $h/\lambda = 0.54$ is probably a good operating condition for this station.

The economical advantage of this type of antenna depends upon the transmitted power. The initial investment and cost of operation of the transmitting plant increases with the power, whereas that of the radiating structure remains constant. At the higher powers the new antenna represents a better balance between the two investments. At 50 kilowatts and present price levels the economy is definitely assured. The high antenna provides the same (or better) coverage than the older structure with twice the power. Hence we have to contrast for a 50-kilowatt station, the difference in cost of a 100-kilowatt terminal stage and a 50-kilowatt stage with the difference in cost between the two antenna structures.

The first full scale practical tests of this type of antenna were made in 1931 with the pioneer installations at stations WNAC-WAAB (Shepherd Broadcasting Company) at Boston and at station WABC (Columbia Broadcasting System) at Wayne, N. J. A novel type of structure was employed, which had been designed by N. Gerten and R. L. Jenner³⁰ of the Blaw-Knox Company. A view of the WABC antenna is shown in Fig. 40. This is a cantilever structure supported at two points; at the base, where it rests upon a single low-capacity Lapp insulator and at the waist by a set of guys. The current is carried by four copper strips at the corners of the tower. An adjustment of height can be made by raising and lowering the steel mast at the top.

These installations were followed by a number of other installations in this country by Blaw-Knox as listed in Table I.

TABLE I

Station	Location	Height	f	h/λ
WAAB	Boston, Mass.	430 feet	1410 kc	0.625
WNAC			1230	0.54
WABC	Wayne, N. J.	620 feet	860	0.54
WFEA	Manchester, N. H.	400 feet	1430	0.58
WCAU	Philadelphia, Pa.	500 feet	1170	0.61
WSM	Nashville, Tenn.	870 feet	650	0.58
WLW	Cincinnati, Ohio.	820 feet	700	0.58

The height of the WABC antenna was originally 675 feet ($h/\lambda = 0.59$) but the top mast has recently been lowered 55 feet so that at present $h/\lambda = 0.54$.

High vertical antennas have also been successfully tried in Europe, notably at Breslau,³¹ Vienna,³² and Hilversum.³³ An 1100-foot Blaw-

³⁰ U. S. Patent, 1,897,373.

³¹ F. Eppen and A. Gothe, *Elek. Tech. Zeit.*, vol. 10, p. 173, (1933).

³² *Funk Tech. Monat.*, December, (1932).

³³ *Tech. Comm. Philips Radio*, (1933).

Knox structure is being erected at Budapest. The Breslau antenna is rather novel in employing a metallic ring at the top 30 feet in diameter which acts as a capacity and is stated to be equivalent to 45 feet of tower.

In the case of the above American installations, field intensity surveys indicate that the improvement in field intensity is close to the theoretical value of approximately 40 per cent. Reports on the effect

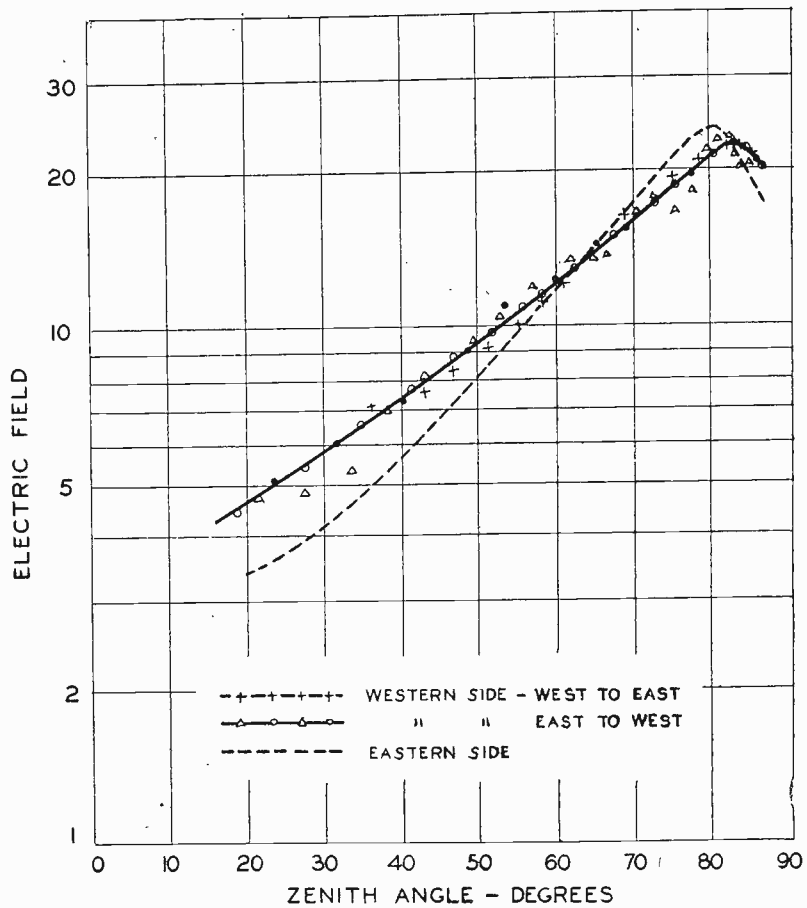

Fig. 41—Electric field strength distribution about vertical antenna at WABC, Wayne, N. J.

on fading are not so complete, although in some cases, notably WSM, Nashville, Tenn.,³⁴ a definite improvement has been noted. In the case of the Breslau and Hilversum installations in Europe, autographic records of fading have been made which clearly demonstrate an improvement over the quarter-wave antenna.

In view of the incompleteness of the evidence on fading and the difficulties of a proper investigation I have recently attempted to measure directly the energy distribution about an actual antenna using an airplane. The results are shown in Fig. 41. These are average values

³⁴ J. H. DeWitt, Jr., *Jour. Tenn. Acad. Science*, vol. 8, p. 95, (1932).

obtained from 13 flights over the antenna at WABC along an east-west line from the airdrome of the Aircraft Radio Corporation near Boonton to Paterson and return. The airplane was not equipped with a bomb-sight so a rather low altitude (4000 feet) was chosen to minimize the error in flying directly over the antenna. The airplane carried a vertical antenna. A method of correcting for the metallic parts of the airplane was found in order to derive the true vertical component of the field. From this was calculated the value of the electric force, assumed to lie along the meridians in a spherical surface surrounding the antenna. The ordinates in Fig. 41 represent the electric force at unit distance from the base of the antenna. These values for unit distance were obtained by correcting the actual values according to the inverse distance law.

Theoretically the energy distribution so obtained is not the distribution which would be observed at a great distance—the distribution which is involved in the estimation of the sky-wave intensities at a distant point. We may represent the electric force as a function of distance R and the elevation angle O as follows:

$$E = \text{const.} \frac{A(R, O)}{R}$$

where $A(R, O)$ is an attenuation factor which is a function of the angle O and the distance. A has been expressed by the van der Pol-Niessen contour integral

$$\frac{e^{ik_1 R}}{R} \left(1 + \sqrt{\frac{\rho_0(R)}{\rho'}} 2\sqrt{\rho} e^{-\rho'} \int_{\sqrt{\rho'}}^{i\infty} e^{t^2} dt \right)$$

where $\rho_0(R)$ is Sommerfeld's "numerical distance" and $\rho' = \rho_0(1 + k_2 z/k_1 R)^2$. Van per Pol and Niessen³⁵ have shown that along the earth this degenerates into Sommerfeld's expression, and for more elevated angles into the reflection or reciprocity formula, in which A is independent of the distance as we have assumed in correcting our values occurring at the inverse distance law. The higher the angle of elevation the closer we may approach the antenna before making an error in using the reflection equations. The greatest error is made near the surface of the earth at close distances. These considerations should be kept in mind in connection with Fig. 41. It is fortunate, however, that the angles involved in the production of the sky wave at reasonable distances (up to 100 miles) are less than 45 degrees and at such angles the error in using the Fig. 41 data is negligible.

³⁵ Balth. van der Pol and K. F. Niessen, *Ann. der. Phys.*, 5th ser., vol. 10, p. 485, (1931).

In comparing the experimental results, Fig. 41, with the theoretical distribution the most striking thing is the total absence of any suggestion of a minimum. It was thought at first that this might be due to the finite conductivity of the earth in the neighborhood of the transmitter which would be expected to produce a change of phase of the reflected wave and tend to fill up the minimum calculated for perfect earth. The distribution to be expected with imperfect earth was therefore calculated by means of the reflection equations, the results being

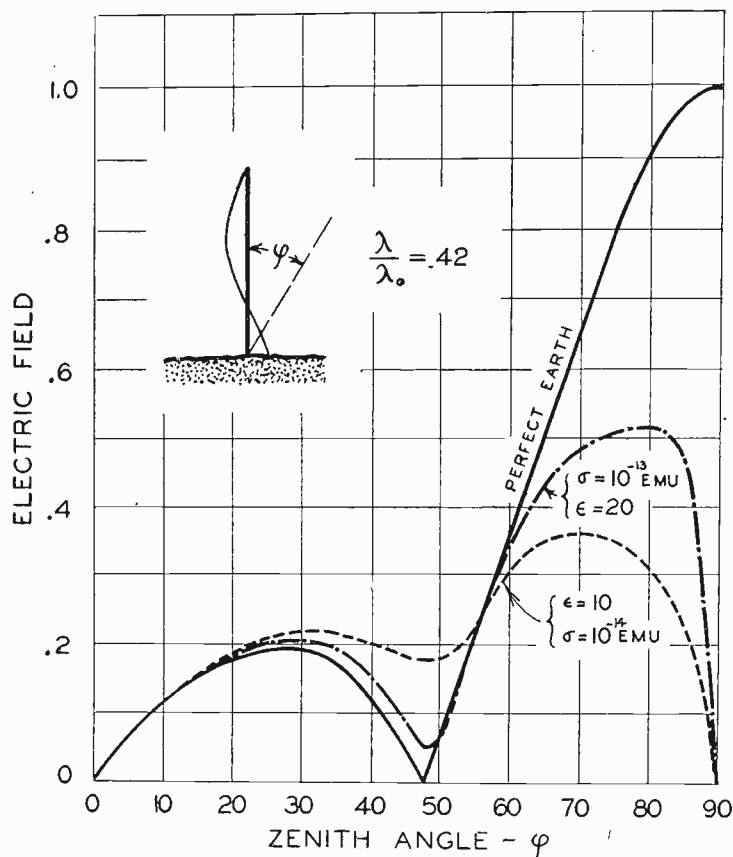

Fig. 42—Calculated electrical field distribution about vertical antenna operating at $h/\lambda = 0.6$, taking into consideration the effect of the imperfect earth.

shown in Fig. 42. The filling up of the minimum for the earth constants ($\sigma = 10^{-13}$, $\epsilon = 20$) to be expected at this location is very slight; for much poorer earth ($\sigma = 10^{-14}$, $\epsilon = 10$) there is a noticeable filling up of the minimum but not enough to explain the experimental results.

It may be concluded from these calculations that the effect of the earth is inadequate to account for the observed distribution. It is to be noted, however, that for a 10^{-13} earth at 860 kilocycles and at normal incidence the penetration of current into the earth is such that it falls to half its surface value at 12 feet and to one-tenth its surface value at 37 feet. Hence in order for the calculations to be valid the earth would

have to be homogeneous to depths of this order. Not only is the actual earth not homogeneous to this extent but the assumption of a homogeneous earth is further violated by the presence of the ground system.

The departure of the observed distribution from the theoretical calculations is probably due to the following three factors:

- (1) The ground system.
- (2) Radiation from currents induced in the guy wires.
- (3) Departure of the current distribution from the sinusoidal distribution assumed in the theoretical calculations as a result of the variation along the tower of inductance and capacity per unit length.

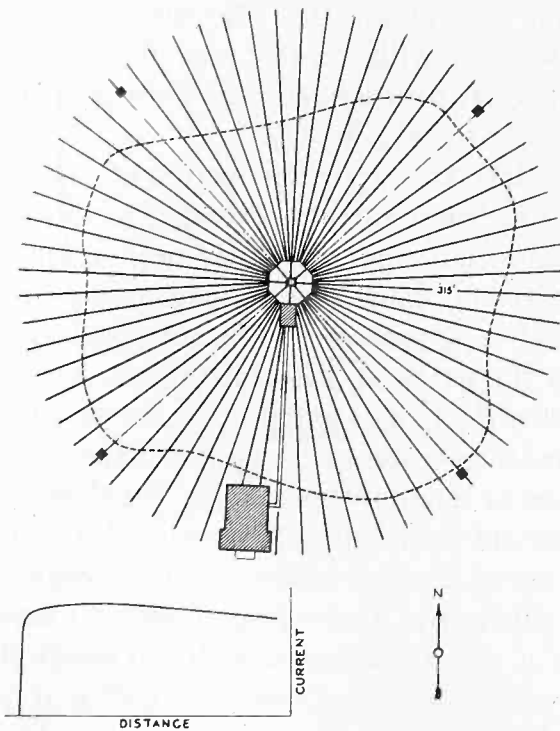

Fig. 43—Ground system as employed with WABC antenna, showing current distribution. Dotted curve, field strength contour at 2 miles.

The ground system of WABC (Fig. 43) is representative of those employed with this type of antenna. Its size would undoubtedly be more than adequate for an antenna of conventional type.³⁶ It is felt, however, that different considerations apply in the case of the vertical radiator operating above the fundamental wavelength. In the case of the half-wave antenna, for example, the current into the ground is very small and the part of the ground system near the base is less important

³⁶ H. E. Hallborg states (*Proc. Radio Club of Amer.*, February, 1931) that there is no advantage in increasing the length of ground wire beyond 5 per cent of the wavelength, (60 feet in the present case).

than the more remote parts. What we are particularly interested in from the viewpoint of decreasing the sky radiation is the efficiency of reflection at the ground. Considering an angle of 45 degrees we may note that in the case of Fig. 43 and a tower length of 675 feet the Huygen's wavelet from the middle of the tower would strike the earth at the rim of the ground system and a wavelet from an element located higher up would miss it entirely. It is felt that the radius of the ground system could be advantageously increased at least to equal the height of the antenna. This recommendation is also supported by measurements of the current distribution. A wire was dug up and the current measured at various points out to the end of the wire with the results shown in the lower part of Fig. 43. The current is substantially constant along the wire to within a few feet of the end. This indicates that the outer portions are still effective; there is in fact too much concentration of current at the ends.

It is suspected that an important source of the excess high-angle radiation is radiation from currents induced in the guy wires. Rough calculations indicate that in spite of being broken up by insulators into comparatively short lengths these conductors may carry considerable current. An effect of the guys seems to be indicated by the field strength measurements on the earth at short distances. A representative contour of constant electric field at two miles is shown by the dotted curve in Fig. 43. This pattern tends to be square-shaped with the diagonals along the directions of the four sets of guys. Further breaking up of the guys involves a considerable investment on account of the insulation cost. If h/λ is lowered, however, from its 0.62 value down to 0.5, as recommended in this paper, the voltage node will move up the tower toward the point of guy attachment with the result that some of the insulation may be safely removed from this part and used to break up the guys into smaller sections.

The discussion of this section may be summarized as follows:

- (1) The vertical antenna operating above its fundamental frequency is of advantage in securing a maximum fading-free primary coverage, and its cost is justified for the higher power transmitting plants.

- (2) For a power sufficient to override noise at the incipient fading distance the best ratio of height to wavelength will probably lie between 0.5 and 0.62 depending upon the rate of attenuation of the ground wave.

- (3) For lower power the best ratio of height to wavelength is that which produces the greatest ground-wave intensity, $h/\lambda = 0.625$.

(4) The radius of the ground system should be made at least equal to the height of the antenna.

(5) The guy cables should be broken up into short lengths and preferably armored with copper.

It is hoped that future installations of this type of antenna will provide the opportunity for testing these recommendations.

(The *Receiving System* will be treated in Part II of this paper which, it is expected, will be published in a subsequent issue of the PROCEEDINGS.)



THE RETARDING-FIELD TUBE AS A DETECTOR FOR ANY CARRIER FREQUENCY*

BY

H. E. HOLLMANN

(Heinrich-Hertz Institut für Schwingungsforschung, Berlin, Germany)

Summary—The rectifying effect of the retarding-field detector even at extremely high frequencies is due to the nonlinear retarding-field characteristic curve. The more detailed discussion of the retarding-field circuit as a "resistance transformer" shows the advantage of loading on the grid side. The extremely sensitive regulation of the retarding-field potential is avoided by high-resistance shunting of the retarding-field electrode.

As excitation and rectification cannot be superposed in a retarding-field tube without interference, a receiver has been developed with two separate tubes, and this in turn led to the twin receiver.

In the effort to apply the high-frequency voltages in a closed parallel wire system to the retarding electrode alone, a push-pull arrangement with a special tube was developed. In this tube the retarding electrode is divided into two segments. From this there was developed an exceedingly simple decimeter-wave receiver that is tuned only by means of the grid voltage.

The high sensitivity of the retarding-field detector suggests its use for the rectification of any carrier frequencies, in which, nevertheless, the internal retarding resistance creates difficulties. By capacitative short-circuiting of the high-frequency current transfer perfect no-power control of the retarding-field detector, and consequently a sensitivity greater than that of all the other rectifiers, is obtained. At the same time the retarding-field detector can deliver a regulating voltage in a suitable phase for fading compensation.

INTRODUCTION

AS IS well known, Barkhausen and Kurz used the retarding-field circuit not only for the production, but also for the reception of ultra-short waves of decimeter lengths, and were able to maintain telephone conversations over a distance of several hundred meters¹ with simple equipment. Later although the production of ultra-short waves by the retarding-field method has been discussed in detail in many publications,² as detectors the retarding-field tubes were merely used as being effective at extremely high frequencies³ without

* Decimal classification: R134. Original manuscript received by the Institute, September 1, 1933; translation received by the Institute, December 6, 1933. Note: This paper reviews and summarizes the component problems that have been discussed more fully in recent articles in the *Zeitschrift für Hochfrequenztechnik*, and in the *Elektrische Nachrichten-technik*.

¹ H. Barkhausen and K. Kurz, *Phys. Zeit.*, vol. 21, p. 1, (1920).

² See the summarizing reports:
H. E. Hollmann, *Zeit. für Hochfrequenz*, vol. 33, p. 5, (1929), and vol. 35, p. 21, (1930).

K. Kohl, "Ergebnisse der exakten Naturwissenschaften," vol. IX, (1930).

³ For examples see:

K. Okabe, *Proc. I.R.E.*, vol. 18, p. 1028; June, (1930).

S. Uda, *Zeit. für Hochfrequenz*, vol. 35, p. 129, (1930).

paying particular attention to the mechanism of demodulation. In general it was assumed that a short-wave receiver with a retarding-field tube (called a "retarding-field detector" in the following) would be most sensitive if it were regulated so that it was almost at the point of oscillation.

In spite of this insufficient knowledge of the demodulation process, however, the retarding-field detector has been used with great success in practical work in the decimeter band. As examples we need only mention the English Channel service with a 17-centimeter wave,⁴ and the latest experiments of Marconi⁵ whose success, for the most part, must be ascribed primarily to factors aiding transmission, such as an exceedingly sharp beam or superregenerative reception.

The present paper gives a detailed description and explanation of the demodulation effect of the retarding-field detector, and describes a new type of rectifier arrangement that also can be used advantageously with any wavelengths.

PART I

THE RETARDING-FIELD DETECTOR WITH DECIMETER WAVES

A. THE HIGH-FREQUENCY PART

The general principle of the retarding-field detector in reception, as developed by Barkhausen, will be explained using Fig. 1. The two

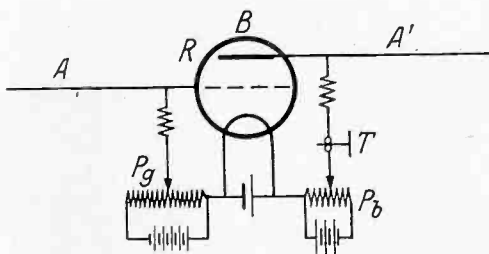

Fig. 1

antennas A and A' impress the high-frequency potential from a distant transmitter on the tube R . This receiving tube acts in a retarding-field circuit, as the grid is held at a high positive voltage E_g that can be varied by a potentiometer P_g , and thus acts as a true plate while the outside electrode, which will be designated as the "retarding electrode", B , is given a low negative or positive bias E_b with respect to the cathode by means of P_b . If the retarding potential is sufficiently negative, all electrons passing through the grid are retarded and forced back to the grid. With an increasing positive retarding potential on

⁴ G. Gutton and E. Pierret, *Comptes Rendus*, vol. 191, p. 312, (1930).

⁵ *Electrician*, January, (1933); *Alla Frequenza*, vol. 2, p. 5, (1933).

the other hand, there is a constantly increasing current i_b to the retarding electrode, until finally all the electrons passing through the grid are caught. Heretofore the rectifying effect of the retarding-field tube was thought to be due directly to the dynamic processes of the Barkhausen "electron dance" in the tube, in which the alternating

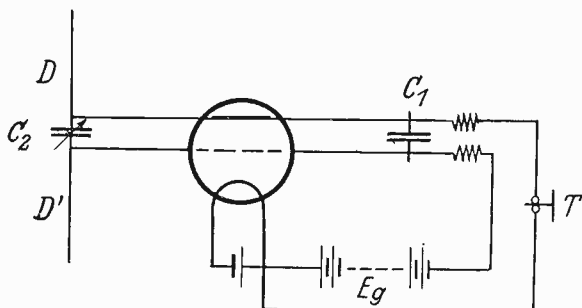
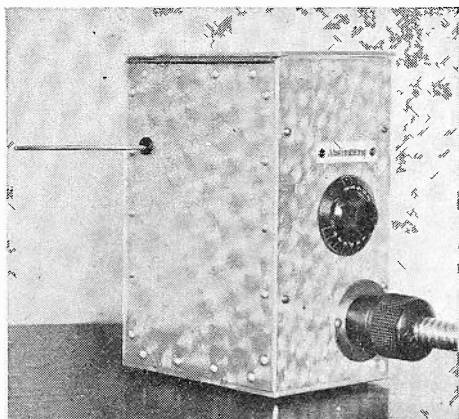
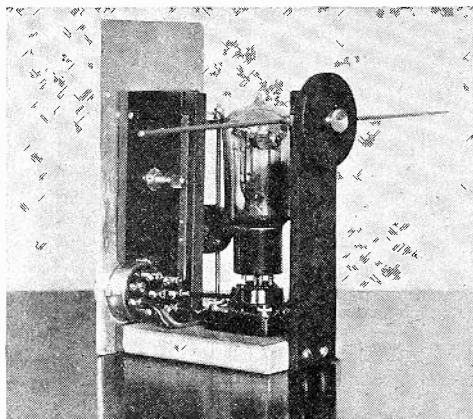

Fig. 2

voltages at the electrodes act directly on the electrons hovering about the grid and control a portion of the oscillating electrons. As the retarded current i_b was found to be proportional to the oscillation energy in investigations on decimeter transmitters, it was logical to assume such influencing of the electron hovering by the foreign potentials induced from outside, which act on the retarded current and cause the modulation of the distant transmitter to appear in the indicator T.



(a)



(b)

Fig. 3

In order to obtain as high resonance voltages as possible on the tube electrodes for the purpose of high sensitivity, the methods⁶ developed in the construction of powerful retarding-field generators have been applied to reception. Thus we obtain the arrangement of the outside high-frequency circuit for the retarding-field detector receiver given in

⁶ H. E. Hollomann, "Sitzungsberichte der preussischen Akademie der Wissenschaften," (1933).

Fig. 2, in which the retarding-field tube is connected through two-sided electrode leads in the potential loop of a Lecher wire system. This can be tuned at one end by a sliding reflection bridge C_1 , while the dipole antenna DD' is coupled to the other end. The antenna coupling can be adjusted to the optimum by the capacity C_2 , common to the two systems.

Figs. 3 (a) and (b) show a practical form of construction of the simple retarding-field detector, in which the tuning bridge C_1 can be moved conveniently by a rack and pinion. The entire receiver is screened from disturbances by a metal casing, and only the dipole antenna and the knob for moving the bridge project from it.

B. THE OUTPUT LOAD OF THE RETARDING-FIELD DETECTOR

If the external receiving system is tuned to a given transmitted wave, the electrode potentials are found to have an extremely critical influence on the loudness of reception. In order to investigate the significance of the retarding potential, measurements were made for the static "retarded characteristic," that is, the current-voltage characteristic of the retarding electrode, and the change in the retarded current from its initial value i_{b0} on receiving a constant transmitted wave. Fig. 4 shows the two resulting curves.

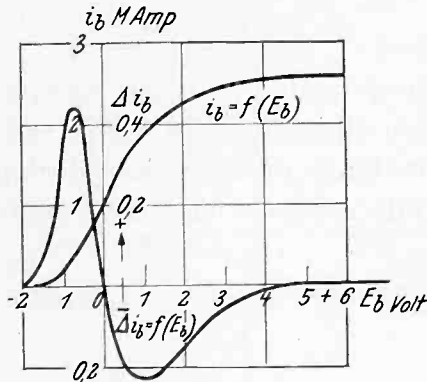

Fig. 4

If we consider the static characteristic $i_b = f(E_b)$, we find that it has a typical saturation character in which the current with a positive increasing voltage rises through a lower curved region and, after a linear section, tends to reach a limiting value through an upper curved region. With a further rise in the retarding potential the current drops again as the result of secondary emission, but this leads to the dynatron region and does not interest us here.

If this static characteristic is compared with the rectified currents Δi_b that appear on reception from a strong transmitter, it is seen that

these latter are proportional to the curvature of the retarded characteristic curve. They are of opposite sign in the upper and lower curved regions and pass through the origin in the intermediate linear region. This shows, in agreement with the investigations of Carrara,⁷ that also in the rectification of decimeter waves by the retarding-field tube, the cause is nothing other than the action of a nonlinear current which, in the final analysis, is characteristic of all detectors. Consequently the rectifying effect of the retarding-field tube is by no means restricted to extremely high frequencies, but it can be applied to any lower frequencies and this use of it will be discussed later in Part II.

If, as is the case in the simple Barkhausen receiver of Fig. 1, the retarding circuit is loaded by a resistance or by the impedance of a transformer or telephone, the dynamic work characteristic curves determine the rectified current, and this means that the retarding-field detector becomes less sensitive.

It is possible to find a simple remedy for this by making use of the special properties of the retarding-field tube. This may be done by shifting the load from the control circuit of the retarding electrode to the true output side of the retarding-field detector, that is, into the grid circuit. If the cathode emission is saturated at a sufficiently high grid potential, we must have

$$di_b = - di_g$$

because the sum of the retarded and grid currents always must equal the constant saturation current. This means that the grid characteristic must be a mirror image of the retarded characteristic, as shown in Fig. 5. If the cathode actually has ample emission and if the elec-

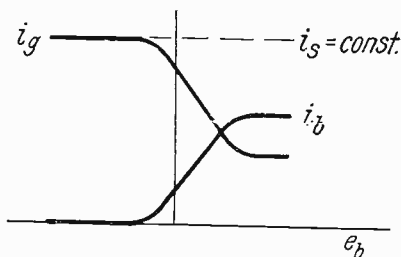

Fig. 5

trodes are accurately coaxial, then the characteristic curves of the retarding-field tube are within wide limits independent of the grid potential provided it does not fall below the value necessary to produce saturation. Consequently the retarding-field tube operates like a generator with an infinitely high internal resistance working into the ex-

⁷ N. Carrara, Proc. I.R.E., vol. 20, p. 1615; October, (1932).

ternal grid resistance R_g , and the reaction practically does not occur. If the transformation ratio of a retarding-field circuit (\dot{U}) is defined in a manner analogous to the amplification factor of a normal tube, by the ratio of the output to the input voltage, we get

$$\dot{U} = \frac{de_g}{de_b} = \frac{-di_g R_g}{de_b}$$

But if R_{ib} is the internal resistance of the retarding path, $de_b = di_b \times R_{ib}$, so that by using the transfer relation $di_b = -di_g$, we get

$$\dot{U} = \frac{R_g}{R_{ib}}$$

Thus the retarding-field circuit is represented as the ratio of two resistances, like a "resistance transformer" that steps down the external resistance R_g to the amount R_{ib} in the input circuit, so that the control power must be supplied by the input voltage.

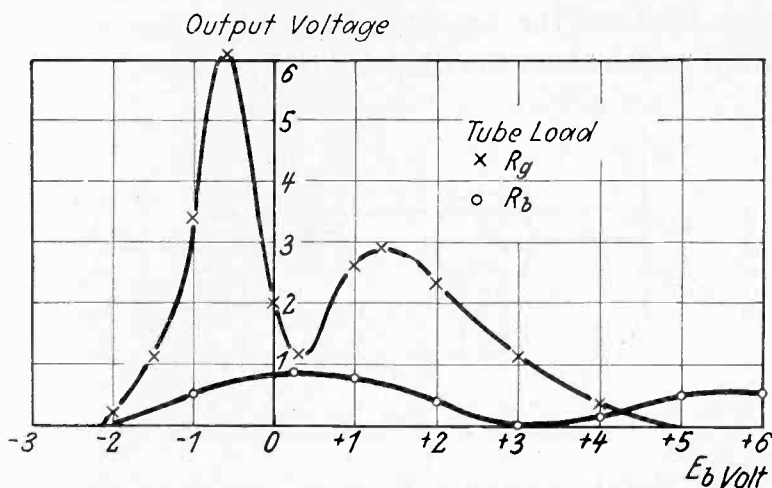

Fig. 6

These general conclusions are confirmed by experiment in the reception of decimeter waves. In Fig. 6 the loudness of a constantly modulated transmitter, as measured with a tube voltmeter, is plotted as a function of the retarding bias E_b by placing a normal amplifying transformer first in the retarding circuit and then in the grid circuit. It is evident that the load on the grid side gives much the greater volume, and the difference between the two connections obviously must become greater as the impedance of the loading resistance is made larger.

C. AUTOMATIC REGULATION OF THE WORKING POSITION

The above measurements show the importance of exact regulation of the retarding potential if full use is to be made of the sensitivity. From the practical point of view this regulation involves a complication that can be removed by loading the retarding electrode itself with a high resistance shunt. Then the resultant working position is found, in the manner shown in Fig. 7, as the point of intersection of the re-

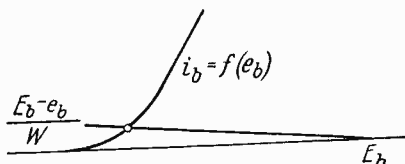

Fig. 7

tarded characteristic with the resistance line corresponding to the shunt resistance. From the practical viewpoint it has been found advantageous to make the resistance line as flat as possible because the working position then is rather independent of the shunt voltage. Consequently it is simplest to shunt the retarding electrode directly to the positive grid potential as shown in the diagram of Fig. 8.

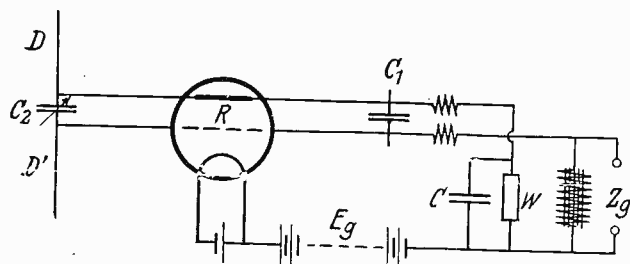

Fig. 8

But a high shunt resistance W of the order of 10^6 ohms implies such a load for the rectified current Δi_b that the dynamic retarded characteristic curve is flattened almost to the point of becoming useless, and the transformation ratio \dot{U} , in which the external load of the retarding circuit appears in the denominator, becomes very small. In order to overcome this disadvantage, the retarding circuit to pass the modulation frequency must be short-circuited by bridging the shunt resistance W with a very large capacity C which naturally can just as well be connected to the cathode.

Further, Fig. 8 shows a choke coil Z_g as a load, and this is preferable to a purely ohmic resistance as it has only a slight potential drop so that much lower grid voltages can be used.

D. TUNING AND DAMPING REDUCTION

In all previous investigations the grid potential has been kept constant at a value that was known to be advantageous. As contrasted with the data of Carrara, it has been found, however, that not only the grid voltage but also the heating influences the sensitivity of the retarding-field detector. Here we must differentiate between two different effects, namely the relation of the true rectifying effect to the grid potential, and the reduction of damping in the receiver due to the approach to self-excitation.

Consider first the dependence of the rectifying effect on the grid voltage. At the high frequencies used here the latter has an action fundamentally different from the retarding potential, because on changing the grid voltage there appear a number of periodically recurring maxima that have no relation to the true retarded characteristic curve.

In Fig. 9 there is shown such a "frequency spectrum" in which the loudness of reception of a constant transmitter was plotted as a function

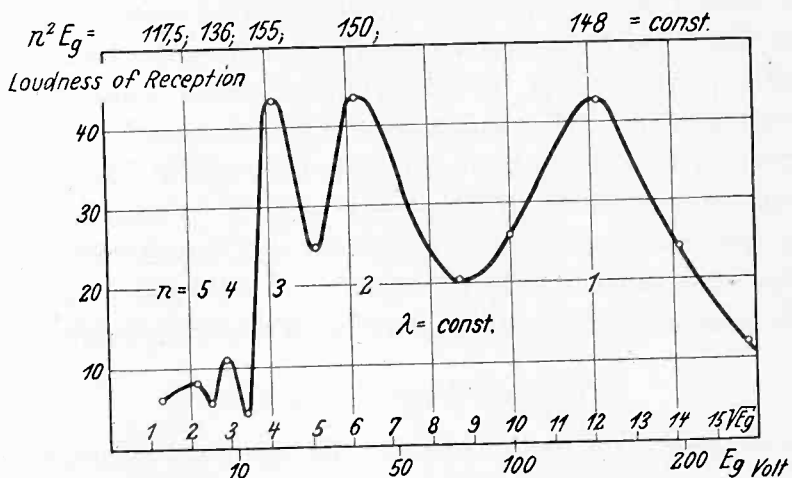

Fig. 9

tion of the grid voltage. With sufficiently strong transmitter energy it was possible to observe parallel changes in the retarding current, and this phenomenon has recently been confirmed by Gill and Donaldson⁸ with longer waves, but only for one maximum. Obviously it is a case of voltage resonances, caused by the coincidence of the receiving period with the electron travel time, or a multiple of it.

From the theory of "ultra-dynamic oscillation production" that brings the electron travel time of the retarding-field tube into relation

⁸ E. W. B. Gill and R. H. Donaldson, *Phil. Mag.*, vol. 15, p. 1177, (1933).

with the oscillation period, we get the following relation as a first approximation for the maxima of the inversion range:

$$\lambda^2 n^2 E_g = \text{constant}$$

and with a constant wavelength this is simplified to

$$n^2 E_g = \text{constant}$$

in which $n=1, 2, 3, \dots$ indicate the order of the inversions as determined by the phase angles $\phi = n\pi$ resulting from the electron inertias. The numerical values corresponding to this relation are given in Fig. 9 and good constancy is seen in the range of the lower orders, while variations are noticed at the higher orders, that might easily be due to the low grid potentials of a few volts, at which the tube is no longer saturated.

If the receiving field intensity is very low, it is necessary to increase the sensitivity of the retarding-field detector by reducing the damping which, as the retarding-field detector acts like a generator, can be done by changing the heating with a simultaneous readjustment of the voltages. But in such reception tests it has been found that, contrary to expectation, the sensitivity maximum does not lie at the threshold of self-excitation, but occurs at much lower emission currents. Exact investigation of this shows that excitation and rectification are not superposed in the retarding-field tube without interference, but that the increase in the high-frequency control voltage is balanced by a parallel decrease in the rectifying effect as a result of the reduction in damping. This also is easy to explain on the basis of the fact that the two functions require entirely different working points.

E. THE TWIN RECEIVER

This knowledge led to the idea of having the two functions of excitation and rectification take place in two separate retarding-field tubes so that each could be regulated to the best working position at any time, independently of the other. There are a number of different possibilities for such a combination of two tubes in a common resonant system, and the series connection of the two tubes in a parallel wire system as shown in Fig. 10, was found to be best. R_1 is the retarding-field detector and R_2 is the oscillator. The electrode potentials are applied from the opposite ends of the two-wire system, which are separated by capacities C_1 and C_2 . Sliding bridge B_1 is used for tuning, while the receiving dipole is coupled through B_2 . The true retarding-field detector is loaded on the grid side by the low-frequency choke Z_g and the working point is regulated automatically through W . The tun-

ing of the two-tube receiver is very little different from the simple retarding-field detector because, aside from rough voltage regulation, the retarding-field detector requires no attention. However, the excitation of the tube R_2 and also its heating can be closely regulated by the retarding-field voltage E_{b2} so that an exceedingly weak approach to oscillation is made possible.

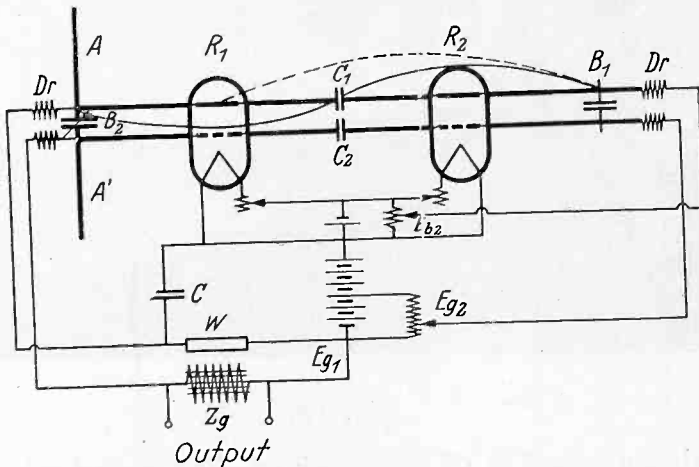

Fig. 10

In this receiver there is some difficulty, due to the fact that the mode of oscillation of the wire system, loaded by the two tubes, is no longer unique because the retarding-field detector that absorbs energy prefers an oscillation node. Therefore it is easier to adjust to the voltage distribution indicated by the broken line in Fig. 10, than to the mode of oscillation necessary for controlling the retarding-field detec-

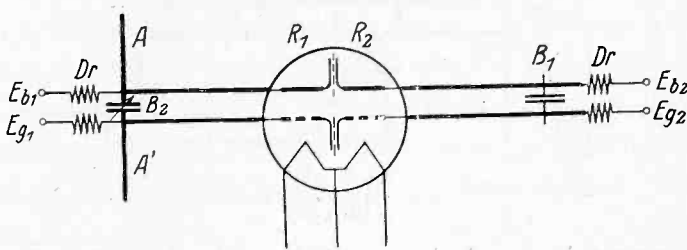

Fig. 11

tor, and represented by the solid voltage line. In order to overcome this uncertainty, the arrangement of the simple high-frequency retarding-field detector was retained which, however, can be used as a twin receiver by making a capacity subdivision of the tube electrodes as shown in Fig. 11. As can be seen from the diagram, the tube consists of two closely adjacent electrode systems connected together by capacities for the carrier frequency. In other respects the external circuit corresponds

exactly to Fig. 10, as the first system R_1 does the rectifying and the second system R_2 reduces the damping. Fig. 12 shows a photograph

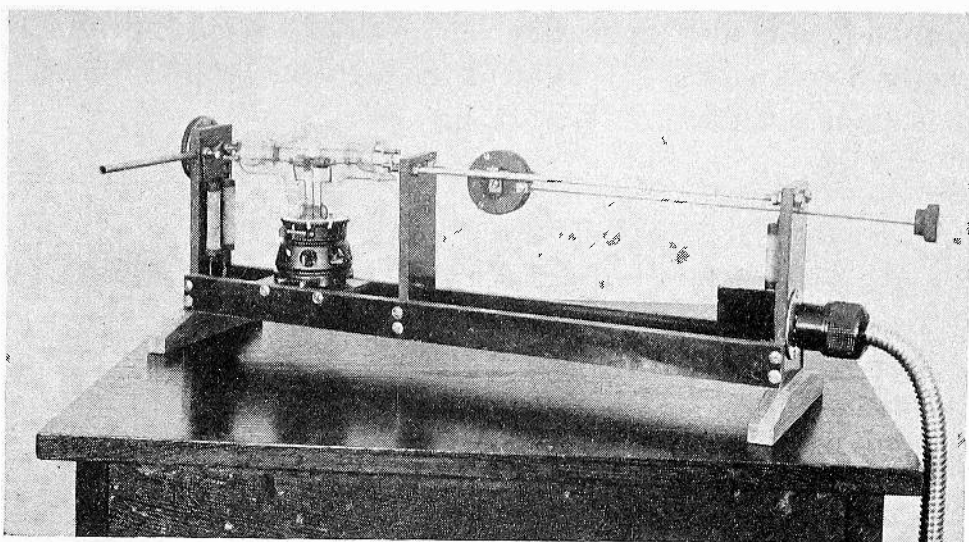

Fig. 12

of the actual construction of the receiver. The superiority of this arrangement is shown not only by a low excitation threshold, but also by very sharp voltage resonances.

As a matter of interest we also shall describe a receiver with a crystal detector as a rectifier and the damping reduced by a retarding-field tube (Fig. 13). Here the detector Dt , protected by capacities C_1 and C_2 ,

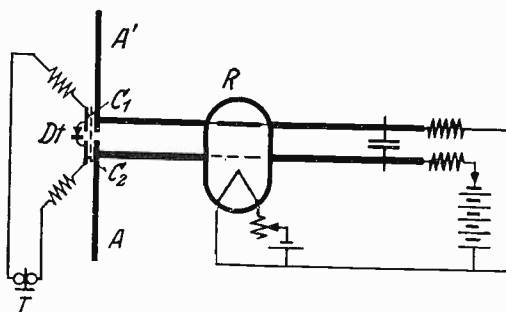

Fig. 13

lies in the current loop of the receiving dipole AA' , the damping of which can be reduced by the closely connected retarding-field generator. Although at its best this arrangement has only the sensitivity of the simple retarding-field detector, it is advantageous for many practical purposes because of its reliable operation and its simplicity.

F. THE PUSH-PULL RETARDING-FIELD DETECTOR

From the theoretical explanation of the rectifying effect it is evident that only the control voltage at the retarding electrode comes

into consideration for rectification. Nevertheless in all decimeter-wave receivers that have been described hitherto, the retarding-field tube lies with the grid and retarding electrode in the double wire excited by the receiving antenna, so that only half of the resonance voltage is rectified at the retarding electrode while the voltage component at the grid is not utilized. This can be obviated by giving up the idea of a closed resonance system and, for example, connecting the antenna directly to the retarding electrode⁷ but, of course, with such an arrangement it never will be possible to reach the control voltages that are available between the wires of a closed double wire system. In addition the reduction of damping by ultra-dynamic excitation causes difficulties because of the undefined regenerative coupling conditions.

But if it is desired to retain the Lecher parallel wire system and to use the whole resonance voltage for demodulation, it is possible to use a push-pull arrangement as shown in Fig. 14 in which each branch

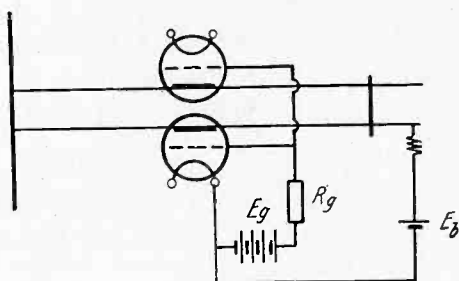

Fig. 14

of the parallel wire system is connected to the retarding electrode of a separate tube, whereby the advantage of having the electrodes at a voltage loop of the closed double wire system is retained. If both tubes have the same operating point, for instance at the lower knee of their retarded characteristic curves, the rectified currents have the same sign and consequently the rectified voltages at the two grids also have the same phase, so that the grids can be loaded by a common external resistance R_g .

The further development of this arrangement leads to the idea of combining the two separate tubes to form one single system, by dividing the retarding electrode into two parts with a single grid and cathode. In this way we get the "push-pull retarding-field tube," two different forms of which are shown in Fig. 15. The simplest form is a radial division of the retarding electrode into two cylinders B_1 and B_2 (Fig. 15(a)). Here the two retarding halves are not exactly equal electrically because the reference points for the two retarding characteristic curves are separated by about half the voltage of the filament drop so that

the same working points would require different biases E_{b1} and E_{b2} . This can be avoided if the retarding electrode is divided axially instead of radially into two equal segments, as shown in section in the arrangement of Fig. 15(b). Here, obviously, the heating voltage drop along the filament acts in the same way for both segments so that the two partial characteristic curves are equal with reference to the cathode potential.

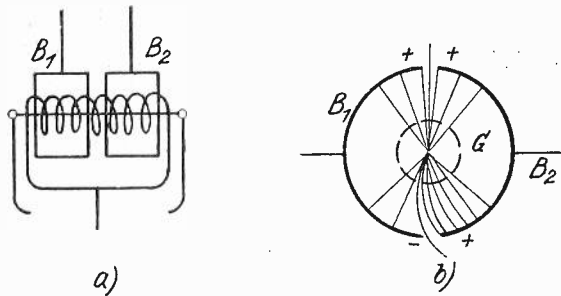

Fig. 15

If the two retarding segments are now inserted in a Lecher double wire system, we get the receiving arrangement shown in Fig. 16. Because of the push-pull control by the two retarding segments, the grid carries no high frequency, but only low-frequency modulation, and it can be brought out through the base of the tube without trouble, while low capacity leads naturally must be used for the retarding segments.

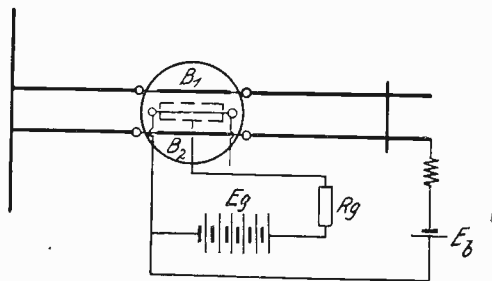

Fig. 16

Therefore the control voltage $e \sin \omega t$ no longer lies between the retarding electrode and grid, as was the case in the earlier receivers, but between the two retarding segments. If these have the same bias E_b then the potential of one segment is $e_{b1} = E_b + (e/2) \sin \omega t$ and that of the other is $e_{b2} = E_b - (e/2) \sin \omega t$. In order to make a more detailed study of the action of this push-pull control, simultaneous static characteristics were drawn for the two retarding segments by starting from different initial potentials E_b , then reducing the potential of one segment by de_{b1} and at the same time increasing the potential of the other by the same amount $de_{b2} = -de_{b1}$. The characteristic curves in Fig. 17 were obtained with an experimental tube using E_b as a parameter.

If the measurements were made on two separate tubes the characteristic curves would appear to be merely displaced by the parameter E_b and they would retain their shape. On the other hand the characteristic curves of the push-pull tube show a deformation that indicates an interaction of the retarding segments. The explanation of this is found in a deflection of the electron stream toward the segment with higher potential as shown by the field distribution of Fig. 15(b). If with the same segment potentials the electric lines of force and also the electron paths are purely radial as in a normal retarding-field tube, then

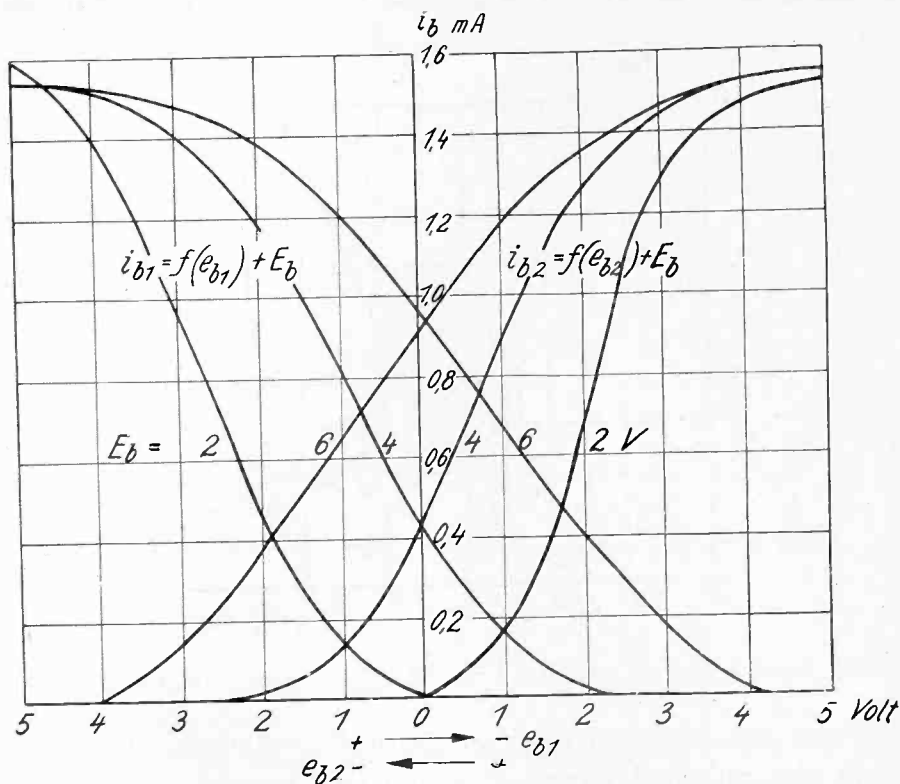

Fig. 17

with a potential difference between the segments the electric field will be distorted near the boundary, so the electron paths in the lower half of Fig. 15(b) are bent from the negative segment and toward the more positive segment. The deformation of the characteristic curves in Fig. 17 is thus explained merely by current distribution, as only part of the retarded electrons in front of the negative segment return to the grid, and the rest go to the positive segment.

The static internal resistance between the two retarding segments naturally is positive because the current increases on the more positive segment and decreases on the negative segment. The general considerations as to the conditions affecting an electron path at very high fre-

quencies can, however, be applied to this intermediate resistance, and accordingly there is an "ultra-dynamic phase displacement" between current and voltage when the frequency of the alternating circuit is of the order of magnitude of the time of passage of the electrons.^{6,9} If the ultra-dynamic phase angle reaches 180 degrees, the current-voltage curve inverts and falls instead of rises. This means that the internal resistance between the two segments becomes negative for such high frequencies and may excite an intermediate resonance system like that of Fig. 16. As in the case of the simple retarding-field tube with its oscillating system between the grid and retarding electrode, we find

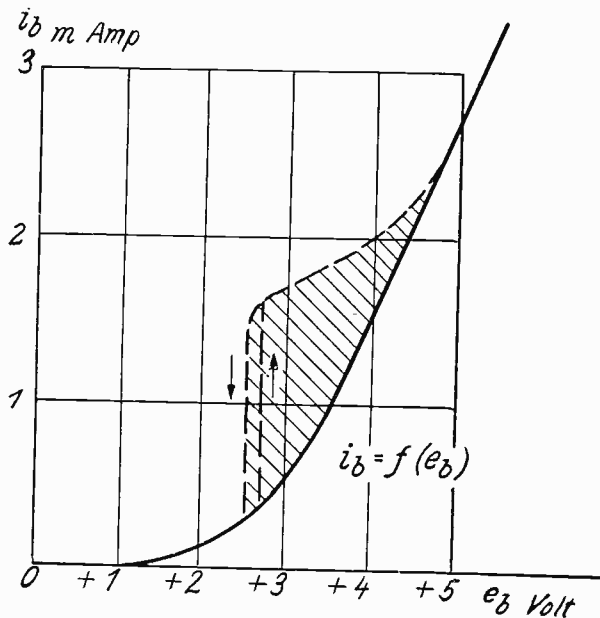

Fig. 18

here also the starting of ultra-short natural oscillations at any sudden change in the retarded current of the two segments. Thus Fig. 18 shows the static retarded characteristic curve $i_{b1} + i_{b2} = f(e_b)$ from which, with suitable tuning of the double wire system, there starts the broken line showing a loop at its lower starting point. At the same time the oscillation intensity maximum coincides with the maximum departure from the static characteristic.

The relation, $\lambda^2 E = \text{constant}$, for the ultra-dynamic inversion oscillations, was tested with the push-pull tube by observing the current $i_b = i_{b1} + i_{b2}$ going to both segments as a function of the grid voltage E_g for different resonance tunings of the Lecher wire system. Fig. 19

⁶ J. Müller, *Zeit. für Hochfrequenz*, vol. 41, p. 156, (1933).

J. Sahaneck, *Schriften der Masaryk Universität*, nos. 120 and 126, (1930).

W. E. Benham, *Phil. Mag.*, p. 457, (1931); *Elec. Communication*, vol. XI, p. 223, (1933).

shows how, from an approximately constant initial current i_{b0} due to the retarding bias E_b , individual discrete oscillation regions occur with the grid voltage increase, whose maxima shift toward higher voltages as the double wire system becomes shorter, that is, with higher resonance frequencies. The values given in the figure for the constant show that the above inversion relation is incompletely realized by experiment. Based on the above explanation of the current distribution at the two retarding segments, the cause of this is probably to be ascribed to the fact that in the push-pull tube the electron time of travel depends not only on the grid potential, but also on the nonhomogeneous field distribution and the tangential motion components of the electrons

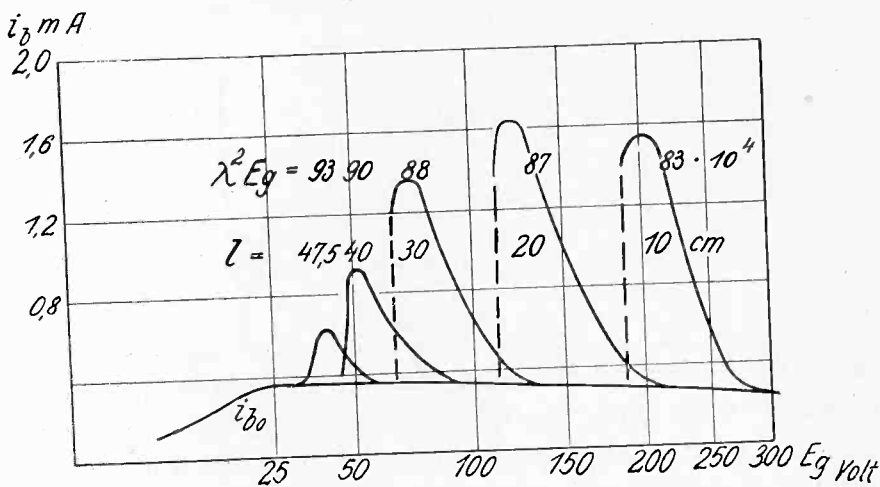

Fig. 19

in a complicated manner whose explanation must await further development of the theory.

Reception tests with the arrangement shown in Fig. 16 indicated great sensitivity as compared with other decimeter receivers. Especially remarkable is the fact that the resonance tuning is not determined to nearly the same extent by the length of the Lecher wires or by the position of the reflection bridge, as in the earlier retarding-field circuits, but to a much greater extent it is found possible with fixed external tuning to bring about resonance over a relatively wide wavelength range by variation of the grid voltage alone.

This marked dependence of the push-pull tube on resonance tuning suggests the idea of a receiver with no high-frequency part to be tuned, and consisting only of the tube itself and the antenna. Such a receiver must be tuned to a given transmitter wave by the grid potential alone.

This necessarily led to an arrangement, a diagram of which is shown in Fig. 20, in which each retarding segment is connected to the

halves of a dipole A and A' . The retarding current is applied through choke coils D and D' , and the retarding potential bias is established as the equilibrium condition between the retarding-field characteristic curve and the resistance lines of a suitable variable shunt resistance

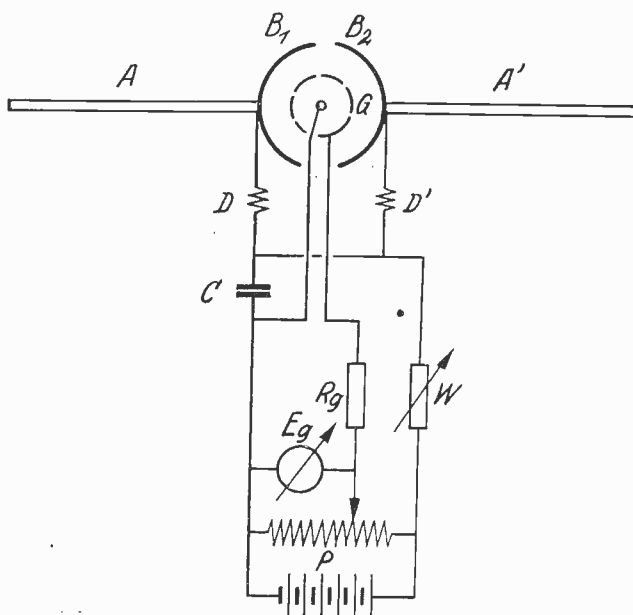

Fig. 20

W , so that the retarding circuit again must be short-circuited by the large capacity C to pass the modulation frequency. The receiver is tuned by the grid voltage potentiometer P , while the reduction of

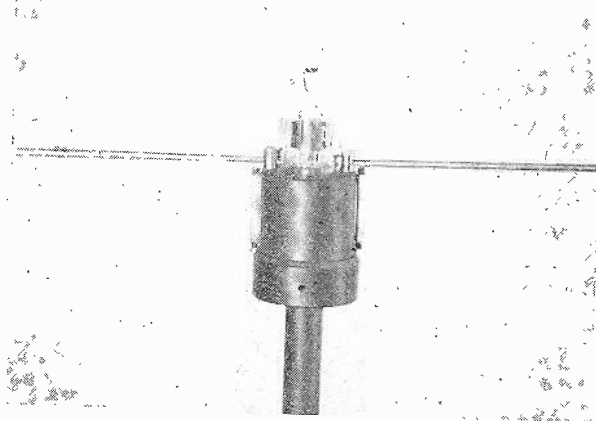

Fig. 21

damping can be regulated by heat control and by displacing the working point by means of W to the threshold of oscillation. With this push-pull arrangement there is no difficulty due to damping reduction and demodulation such as was observed in the single retarding-field detector.

Fig. 21 shows a photograph of one form of the push-pull detector in which its simplicity for practical purposes is evident. In view of the fact that sometimes the receiver may be exposed to the near-by radiation field of a decimeter transmitter, the remote tuning by means of the grid voltage is a great advantage. Practical tests showed exceedingly sharp resonance maxima with very great sensitivity so that a wave band of 40 to 80 centimeters could be covered by the grid voltage without any apparent change in sensitivity as determined by comparison with other receivers.

If the grid voltage is varied over a sufficiently wide range, there are several successive resonances as in the case of the simple retarding-field detector. Fig. 22 shows such a "frequency spectrum" obtained in reception from a transmitter with constant modulation. Here also, as

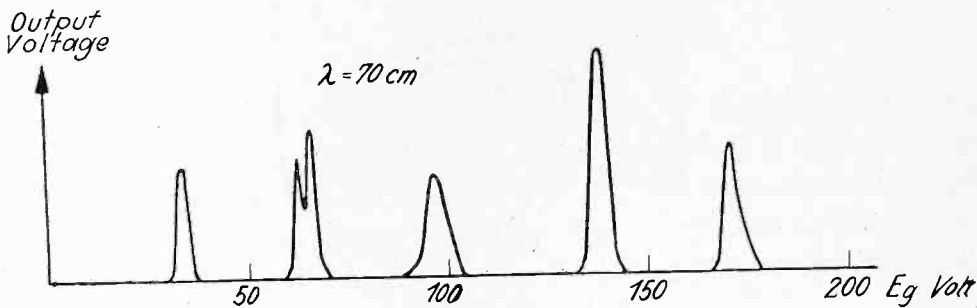

Fig. 22

in the case of the previous measurements, the nonhomogeneity of the electric fields between the retarding segments is noticed as a disturbing factor, so that the simple fundamental law ($n^2 E_g = \text{constant}$) cannot be fulfilled. It is interesting to observe the splitting of the resonance region at $E_g = 60-70$ volts, which must be due to slight dissymmetries in the construction of the tube, or to internal resonances of the electrode system.

The high sensitivity, combined with the aperiodic rectification, exposes the receiver to an especially great extent to electrical disturbances of all kinds, and to interference by neighboring transmitters of any wavelength. The interference is especially great if the transmission on the decimeter wave takes place over an intermediate wave, as is sometimes done for two-way communication,¹⁰ in which the decimeter receiver acts directly as an antenna for the intermediate frequency. In order to exclude such disturbances the entire receiver was screened statically by conductors in the plane of polarization of the dipole.

¹⁰ N. Carrara, *Alla Frequenza*, vol. 1, p. 189, (1932).

Thus, Fig. 23 shows the receiver in a grounded helix that is short-circuited by axial rods, so that only horizontally polarized waves can reach the receiver, and all other fields are screened off.

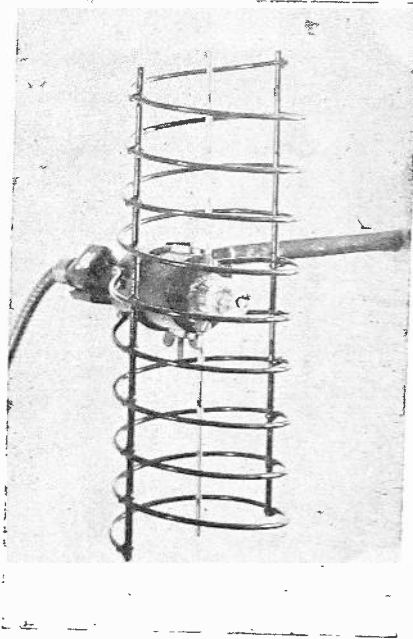

Fig. 23

PART II

THE RETARDING-FIELD TUBE AS A RECTIFIER FOR ANY CARRIER FREQUENCIES

A. THE DIRECT-CONTROLLED RETARDING-FIELD DETECTOR

In the previous section we saw that the rectifying action of the retarding-field detector depends on its nonlinear characteristic and not on the resultant phenomenon of the Barkhausen electron dance appearing only with decimeter waves. In the following we shall discuss the use of the retarding-field detector to demodulate any carrier waves and the utilization of the advantages that are offered by the retarding-field tube. When the experience obtained from reception tests with decimeter waves is applied to other frequencies, we get the retarding-field detector circuit of Fig. 24. The high-frequency voltages induced by the receiving antenna A in a resonant circuit E are applied to the retarding electrode B . In the internal retarding resistance of tube R_{i_b} they produce a high-frequency current that has a rectified component Δi_b corresponding to the curvature of the retarded characteristic in the working region. This rectified current is transmitted to the grid circuit, as a result of the current transfer, with the same intensity, and produces

the modulation voltage $i_g \times R_g$ on the grid output resistance R_g . As before, the working point on the retarding side is automatically fixed by the high resistance shunting of the retarding electrode through W , so that the high capacity C , of several microfarads short-circuits the retarding circuit.

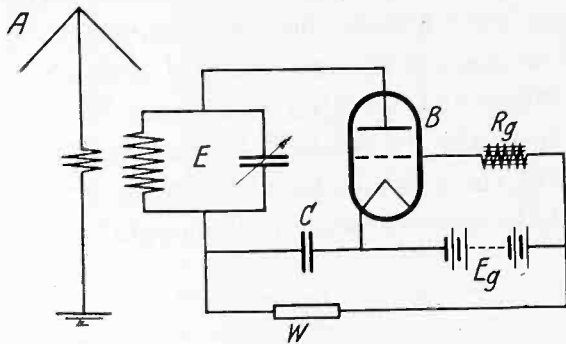

Fig. 24

Now if a constant modulated high frequency is applied to the retarding electrode, the low-frequency output loudness of the retarding-field detector follows the curve shown in Fig. 25 as the tube is gradually heated. With very slight heating a first maximum is found; then the sensitivity drops to zero, and only thereafter is a useful sensitivity region reached.

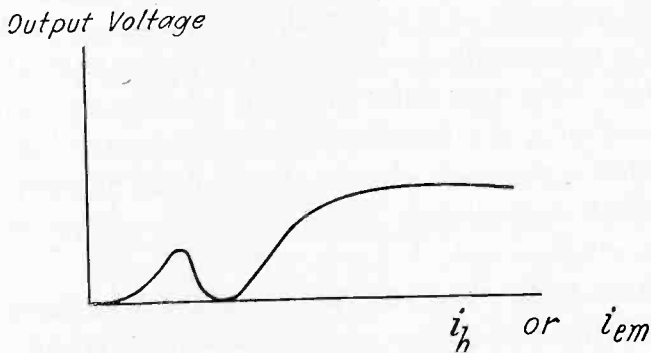

Fig. 25

The explanation of this action is found in Fig. 26 which shows some retarded characteristics with different emission currents as parameters, and the broken resistance line passing through this group of curves. With slight heating it is seen that the retarding characteristic gradually rises from the abscissa axis and is very flat, so that the resistance line intersects it in the upper curved region. This position gives the first maximum in Fig. 25. With greater heating the working point on characteristic B is in the linear middle region, which corresponds to the

zero of the sensitivity curve. Only on still greater heating will the working point be on the lower knee of the characteristic C where the retarding-field detector has the greatest sensitivity.

As compared with the normal electron tube with space-charge control, the retarding-field detector in this simple form shows a serious disadvantage, namely in the considerable power required for control. It has already been shown that the high-frequency voltage on the retarding electrode is loaded by the internal resistance R_{ib} . This load is matched only when the internal resistance of the control voltage source, which is here the "flywheel" (Schwungrad) resistance of the input circuit E , is of the same order of magnitude as R_{ib} . In the linear part of the retarded characteristic, with normal commercial tungsten

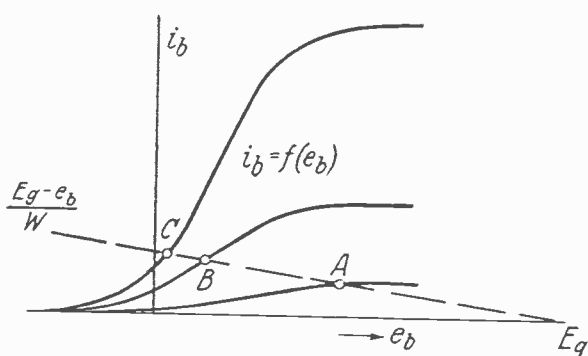

Fig. 26

tubes and grid currents of a few milliamperes, R_{ib} is about 10^3 ohms and increases to practically $3-4 \times 10^3$ ohms in the curved regions. This shows that the retarding-field detector absolutely must fail with broadcast waves of a few hundred meters, because the retarding resistance R_{ib} with a resonant circuit of 10^5 ohms "flywheel" resistance connotes prohibitive damping. A noticeable resonance voltage cannot develop on R_{ib} at all.

Conditions are better with shorter waves, such as those some meters long. Here the apparent resistance of a resonant circuit is of a lower order of magnitude as a result of the preponderance of the capacity element, and accordingly with the above values of R_{ib} damping no longer plays such a large part. As a matter of fact, reception tests on meter waves with special retarding-field tubes showed a sensitivity approaching that of modern detector tubes with grid rectification. The retarding-field detector can be considered the equal of normal plate rectification in respect to rectification.

Conditions can be improved to a limited extent if a transformer coupling is used to adapt the internal retarding resistance to the "flywheel" resistance of the receiving circuit. This may be done as shown

in the diagram in Fig. 27, in which the resonant voltage of the input circuit E is no longer applied directly to the retarding electrode, but through the inductive coupling T . This will greatly reduce the damping in the broadcast range and will increase the sensitivity six to seven times as compared to the direct-controlled retarding-field detector.

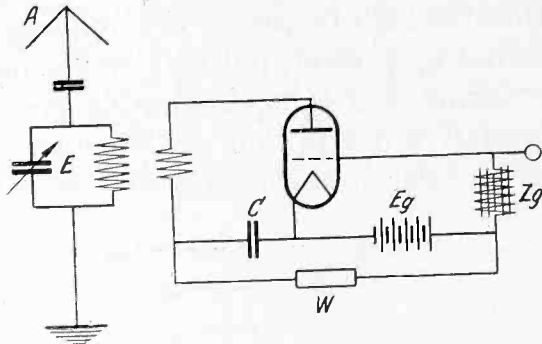

Fig. 27

This method does not entirely avoid the absorption of power in control, which becomes more noticeable when reduced power is supplied by the receiving antenna.

B. SHORT-CIRCUITING THE CURRENT TRANSFER

The power consumption for control can, however, be compensated by a circuit device so that the retarding-field detector can be controlled without the use of any power, like the normal electron tube with the

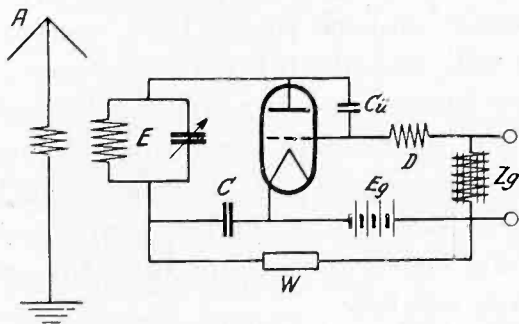

Fig. 28

grid, and thus it also can be used in the broadcast range. This new circuit for no-power control of the retarding-field detector is shown in Fig. 28. It differs from the simple diagram in Fig. 24 only in that the grid and retarding electrode of the tube are bridged by a capacity C_u of a few hundred centimeters, and the escape of the high frequency into the grid circuit is prevented by a choke D .

By this device, the high-frequency control voltage e_{st} is applied to both electrodes at the same time, and consequently it acts at point A on the retarded characteristic $i_b = f(e_b)$ in Fig. 29, as well as at point B on the transfer characteristic curve $i_g = f(e_b)$. Since, by reason of the mirror-image relation of the two characteristics, the alternating currents annul each other as is seen from the transfer relation $di_g + di_b = 0$; this only means that the high-frequency control voltage does not have to supply any alternating current, but acts on the pure saturation resistance of the retarding-field tube, amounting practically to several megohms. An alternative description of the action is that the high-frequency current transfer between grid and retarding electrode is

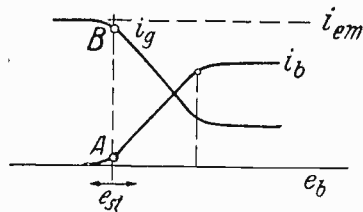

Fig. 29

compensated by $C\ddot{u}$ without affecting the retarding circuit, and therefore the bridging of the tube electrodes can be designated as "capacity short-circuiting of the current transfer." No alteration in the conversion to the low-frequency rectified currents occurs as long as the capacitive resistance of $C\ddot{u}$ is large in comparison with Z_g . The rectified currents can only be compensated through the retarding and grid circuit, where they produce the effective voltage at Z_g .

The improvement resulting from the capacitative short-circuiting of the current transfer may be shown by a comparative test of the various circuits already described. For this purpose a resonant circuit E from an auxiliary transmitter was constantly excited to a wave of about 400 meters, and operated in the various circuits of Figs. 24, 27, and 28, maintaining otherwise equal operating conditions for the tube, such as constant electrode voltage and constant heating. In order to show the damping conditions at the same time, the entire tuning curve of the various circuits was made.

The results are shown in Fig. 30, in which the tuning capacity of the input circuit in scale divisions is plotted as abscissa and the output voltage is given as ordinate in quadratic scale-divisions. From the extraordinarily flat shape of curve I which was obtained with the direct-controlled retarding-field detector of Fig. 24, we see the great damping by the internal retarding resistance R_{ib} . On the other hand curve II, obtained with the transformer adapter as in Fig. 27, not only shows a higher but also a sharper resonance maximum. Finally the superiority

of the short-circuited current transfer is exhibited in curve III, which shows almost forty-five times the output voltage as compared with the simple retarding-field detector circuit, under the prevailing test conditions. For comparison, curve IV shows the sensitivity of a normal detector with grid rectification and a modern indirectly heated tube (Telefunken REN 904), which so greatly damps the input circuit by its internal grid resistance and the grid leak that the sensitivity of the new retarding-field detector is not attained. This shows that the retarding-field detector with its rectifying effect equivalent to plate rectification can be used advantageously wherever high demodulation

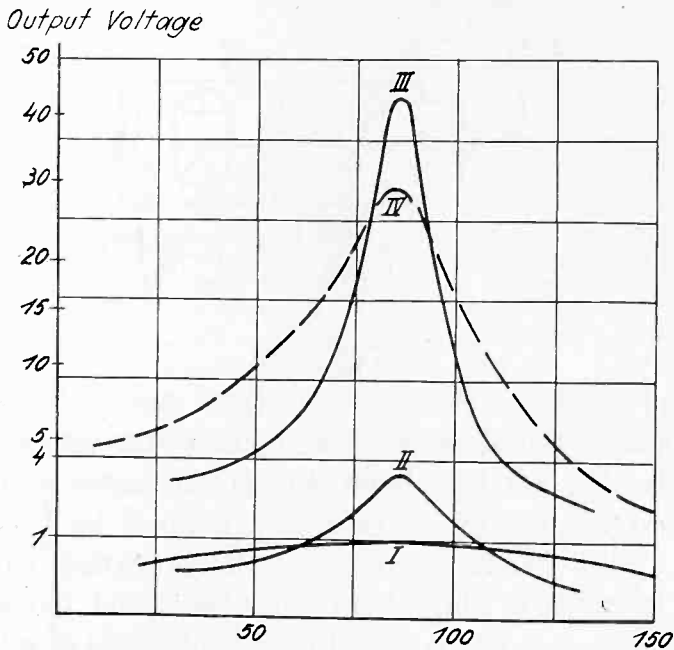

Fig. 30

frequencies are in question and where, because of low control voltages, the sensitivity must be as high as possible. As examples we need only mention the reception of high-speed telegraphy, and television on ultra-short waves, where direct high-frequency amplification does not seem to be feasible in the present state of the art.

Of course if the capacitative short-circuiting of the current transfer is used for meter waves where, with the considerable internal capacity between grid and retarding electrode, the insertion of a suitable choke in the grid lead suffices, the increase in sensitivity will be much less, by two- to threefold. The cause of this lies in the fact that, as a result of the already mentioned better utilization of the tube, the loading by R_{ib} does not act as detrimentally as in the case of broadcast waves, for example, and accordingly the removal of the load can no longer bring about any great improvement.

Naturally the damping of the retarding-field detector can also be reduced directly by regenerative coupling. In this connection it should be observed however that owing to the falling transfer curve the direction of the external regenerative coupling must be exactly reversed as compared with the normal electron tube. It also is necessary to meet the requirement that the effective power $i_o^2 R_o$ delivered to the grid resistance must be greater than the control power $i_b^2 R_{ib}$ consumed in the retarding circuit, or that, because of the transfer condition, R_o must be very much greater than R_{ib} . Therefore, it is especially convenient to put the tuning circuit E in the grid lead, as shown in Fig. 31,

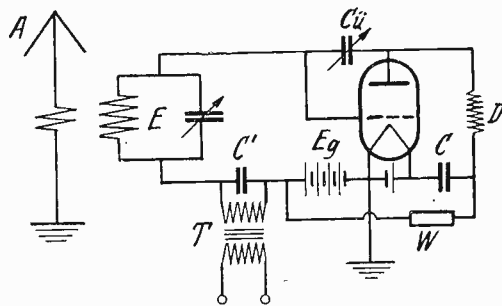

Fig. 31

so that the control voltage is communicated to the retarding electrode through $C\ddot{u}$. In this case the choke D naturally must lie in the retarding circuit and the output transformer T must be bridged by the capacity C' . With proper selection of the operating conditions the regenerative coupling of the circuit may be varied by means of $C\ddot{u}$, and the excitation may be regulated to the threshold of self-excitation.

C. FADING COMPENSATION WITH THE RETARDING-FIELD TUBE

If we take the retarded characteristics $i_b = f(e_g)$ when various high-frequency voltages are superposed, we obtain the curves in Fig. 32, which are formed by the addition of the rectified circuits Δi_b to the static retarding currents i_b . Because of the opposite phases of Δi_b in the upper and lower curved regions, the dynamic retarded characteristics seem to swing about the point P lying in the linear middle region. Through this characteristic line field passes the dashed resistance line that appears practically horizontal for a strong positive bias potential. We see from the diagram how, on the application of the high frequency, the working point A is displaced proportionally to the incident amplitude towards negative retarding potentials, while the rectified voltage Δe_b cannot follow the modulation, because of the large stabilizing modulation capacity C . This voltage change about Δe_b conse-

quently can be used directly as a regulating voltage for fading compensation since, as shown in the diagram in Fig. 33, it can be made to control the grid potential of one or more radio-frequency stages R_1 and thus also the degree of high-frequency amplification in the well-known manner. With such a radio-frequency stage in front of the

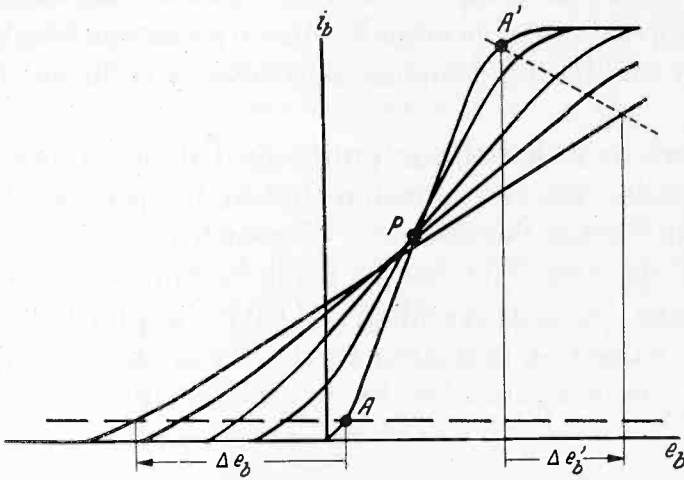

Fig. 32

retarding-field detector, the extraordinarily low damping of the plate circuit by the no-power controlled retarding-field detector is very favorable to an especially high amplification.

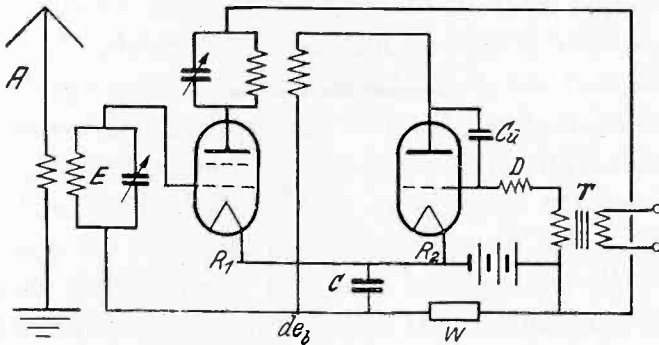

Fig. 33

For the sake of completeness it should be mentioned that the retarding-field detector also can yield a positive regulating voltage directly, such as is necessary, for example, in a special tube that with increasing control voltage reverses phase at the same time. For this purpose it is only necessary to shift the working range into the upper curvature region of the retarded characteristic, as exemplified, by the dotted resistance line in Fig. 32. In this case the working point A' shifts towards the positive retarding potential on the arrival of high

frequency, and the regulating voltage $\Delta e_b'$ is exactly opposite to the voltage Δe_b . The same thing also can be done by suitable reduction of the heating of the retarding-field tube, by means of which the working point likewise is displaced into the upper curvature region of the dotted resistance line, as has been already explained in connection with Figs. 25 and 26. Tests with a three-tube receiver built according to the criteria developed here have actually shown an astonishingly high overall sensitivity and fading compensation entirely sufficient for practical purposes.

The extent to which the retarding-field detector may come into general use in the art, is a question that at the present time depends largely on the further development of special retarding-field tubes. If the retarded characteristic can be made to approach the theoretical limits indicated by a Maxwellian velocity distribution of electrons, then we may expect an increased sensitivity of the retarding-field detector which can be approached by no other rectifier.



SOME NOTES ON THE INFLUENCE OF STRAY CAPACITANCE UPON THE ACCURACY OF ANTENNA RESISTANCE MEASUREMENTS*

BY

EDMUND A. LAPORT
(Montclair, New Jersey)

Summary—The paper shows, with an example and a generalized discussion, the effect of stray capacitance in various parts of the antenna circuit upon the observed circuit resistance. Stray capacitance at the base of a capacitive antenna decreases the apparent antenna resistance while in the case of an inductive antenna it increases it. A method of approaching the true resistance of an antenna in the presence of stray capacitance is presented, and the possibility of extending its use to the measurement of the high-frequency resistance of coils is pointed out.

I. INTRODUCTION

THIS paper concerns itself primarily with the problem of making resistance measurements at the base of grounded antennas of the type used for broadcasting. Antenna resistance measurements made without considering the influence of stray circuit capacitance can contain large errors, especially with high impedance antennas.

There are different approved and theoretically sound methods of measuring antenna resistance,¹ and the proper application of any of them should yield results in mutual agreement. This paper will demonstrate that large errors can be made which are not chargeable to the method of measurement applied. It has long been known among engineers that antenna resistance measurements were rather elusive, and that it is often difficult to obtain agreement between several sets of measurements on one antenna, even though using the same method and the same instruments. It is also well known that there is usually a considerable disagreement between theoretical and observed antenna data. These difficulties are important. The author has found that the practices and principles discussed here have been useful in reducing these difficulties.

The resistance measured at any point in an antenna system varies with the electrical position of that point, and with the addition to the system of any devices which produce an electrical effect. For this reason antenna resistance may appear to manifest several different values.

* Decimal classification: R120. Original manuscript received by the Institute, July 5, 1933.

¹ See Bureau of Standards Circular 74.

In the more common case of the grounded antenna, resistance is measured at the base where power is introduced into it. The base of the antenna is understood to mean the lower extremity of the antenna proper where it attaches to the network of elements concentrated near the base for the purpose of tuning, insulation, static draining, etc. The resistance at various points in the network near the base, of which the antenna impedance is a part, will be different for different points in the network. The terms "true antenna resistance," "reactance," or "impedance" are used to separate the antenna from the other elements of this network. Therefore "true antenna resistance" as used in this paper is that which results purely from phenomena peculiar to traveling waves in the linear conductors composing the antenna and ground system, and means the natural resistance at the point of reference in the antenna proper in the complete absence of electrical effects due to bushings, insulators, connectors, tuning equipment, etc. This resistance is the same as that implied in the usual process of calculating radiation resistance at the base of an idealized antenna where it is assumed that the antenna proceeds directly through free space to the exciting generator in series with it.

Stray capacitance means capacitance introduced into the antenna circuit by objects such as insulators or tuning apparatus which have capacitance to ground or to other parts of the circuit other than their lumped values, and which is not due to the antenna wires themselves. In the circuit of Fig. 11 the capacitance of the down-lead insulator is stray, as well as the various others which are represented between this point and ground. In this case the antenna would be considered to end at the down-lead insulator, and if the resistance was measured at this point it could be called true antenna resistance.

II. EXAMPLE.

The subject can be best introduced, perhaps, by considering a typical antenna measurement problem, after which a general treatment can be undertaken. Assume we have a broadcast antenna, and that we know its true impedance at the base, which, when operating at a mode $\lambda/\lambda_0 = 0.75$ approximately, is

$$Z_0 = 120\omega + j260\omega.$$

We desire to verify these values by measurement, and, if the resistance measurement is correct, it should disclose this value of 120 ohms. At the same time, using a precision calibrated condenser, the antenna inductance reactance can be measured; and this should show $+j260$ ohms. The resistance variation method of measurement will be used,

and the circuits are shown in Fig. 1. This circuit is tuned to exact resonance by adjusting C_1 to the point where a maximum current through the ammeter is observed. With a strictly constant voltage induced into this circuit at all times by the oscillator, known resistance is inserted at R_1 and the current again noted, from which the value of the unknown circuit resistance is readily computed. After subtracting the known resistances of the ammeter and the tuning instruments from this result, the resistance of the antenna remains. But is this the antenna resistance? If the antenna and its tuning circuit formed a simple series circuit this would be a true antenna resistance measurement. If there

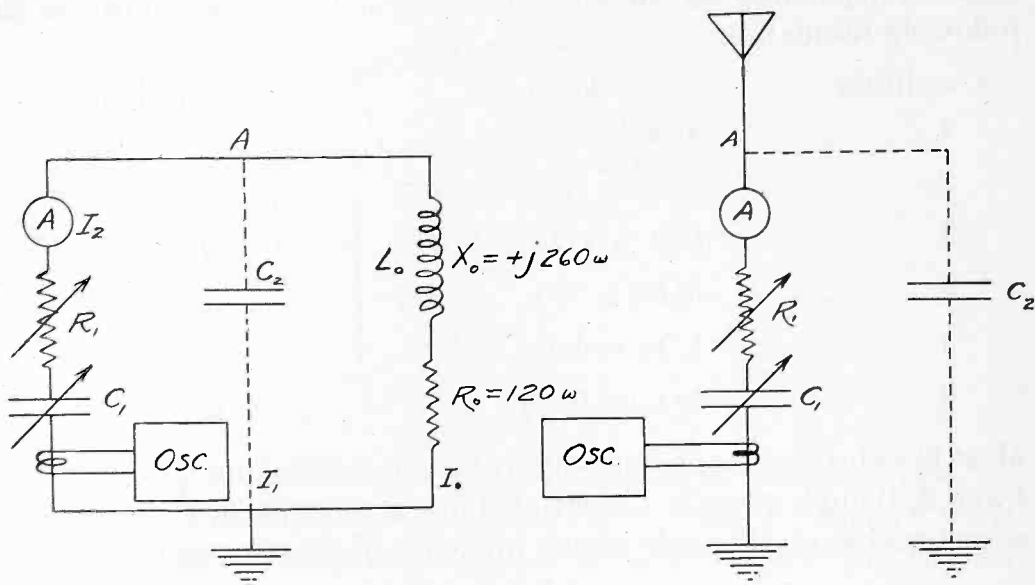

Fig. 1

are parallel admittances, such as C_2 , which can be any stray capacitance, it would not. Instead, it would be a measurement of the resistance component of the impedance of the branch circuit composed of L_0 , R_0 , and C_2 . The lower the admittance of the branch circuit, the greater the divergence from the true antenna resistance value. Continuing the example, some practical value of reactance can be assigned to the branch or stray capacitance, C_2 , so the problem can be solved numerically. Say the reactance of C_2 is $-j 1500$ ohms. There is a voltage across this reactance so there will be a current through it. The true antenna current is I_0 , but, according to the symbols of Fig. 1, the measuring instruments are in the circuit where the current I_2 flows, and this is now not equal to I_0 . Due to the presence of C_2 , to tune for a maximum value of I_2 , the tuning condenser C_1 must be adjusted for a reactance of 298 ohms, not 260 ohms. The impedance at A is now

$$Z_0 = \frac{Z_1 Z_2}{Z_1 + Z_2} = \frac{(-j1500)(120 + j260)}{120 + j(260 - 1500)} = 174 + j298 \text{ (ohms).}$$

When resistance is inserted at R_1 , the resulting current I_2 noted and the resistance computed, a value of 174 ohms will be obtained instead of the 120 ohms of antenna resistance. The error is 45 per cent.

III. ANTENNA CHARACTERISTICS

A grounded antenna excited at its base appears to the exciting generator as an impedance composed of resistance and capacitive reactance, pure resistance, or resistance and inductive reactance, in varying degrees, depending on the mode of operation, λ/λ_0 , as shown in the following tabulation:

Condition	Mode	Impedance
1.....	$\lambda/\lambda_0 > 1$	$R - jX_c$
2.....	$1.0 > \lambda/\lambda_0 > 0.5$	$R + jX_L$
3.....	$0.5 > \lambda/\lambda_0 > 0.33$	$R - jX_c$
4.....	$0.33 > \lambda/\lambda_0 > 0.25$	$R + jX_L$
5.....	$\lambda/\lambda_0 = 1.0$	R
6.....	$\lambda/\lambda_0 = 0.33$	R

Most broadcast antennas encountered in the field fall under Conditions 1 and 2, though recently Condition 3 has been utilized. For simplicity a vectorial study is made of the influence of stray capacitance upon

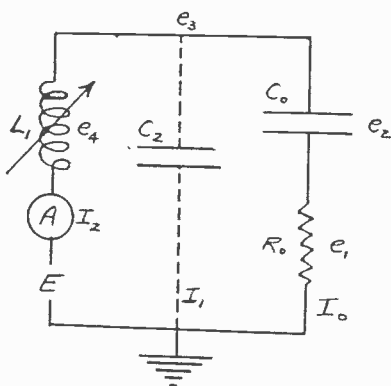

Fig. 2

both inductive and capacitive circuits. Constants with subscript zero always refer to the true antenna constants.

Discussion of Condition 1

An antenna composed of R_0 and C_0 , with stray capacitance between the base of the antenna and ground is shown in Fig. 2. To tune such an

antenna the tuning element must be an inductance. Resonance is obtained by adjusting L_1 until I_2 is maximum. When this occurs, the circuit reactance as seen from the point E is zero and only resistance remains. Looking at Fig. 3 for this condition:

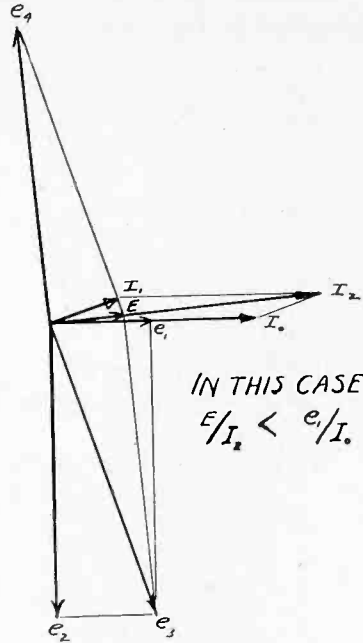

Fig. 3

True antenna resistance is e_1/I_0 . The antenna reactance is e_2/I_0 . The antenna impedance is e_3/I_0 . The current I_1 through C_2 is e_3/X_{C_2} . The combined impedance of the antenna and C_2 in parallel

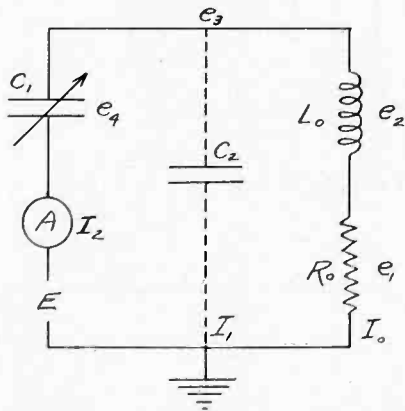

Fig. 4

is e_3/I_2 . By tuning with L_1 , variation is made in the length of e_4 , until E comes into phase with I_2 , which occurs at resonance. The resistance observed in the I_2 circuit is E/I_2 , and the observed re-resistance is less than the true resistance because $E/I_2 < e_1/I_0$.

By a similar discussion the circuit of Fig. 4 and its vector diagram Fig. 5, (Condition 2) are analyzed, and it is found that the observed resistance here is greater than the true resistance. The example previously considered is of this type. Condition 2 is shown with further complications due to the antenna tuning apparatus and the stray capacitance that can be expected to be present in Figs. 6 and 7, 8 and 9.

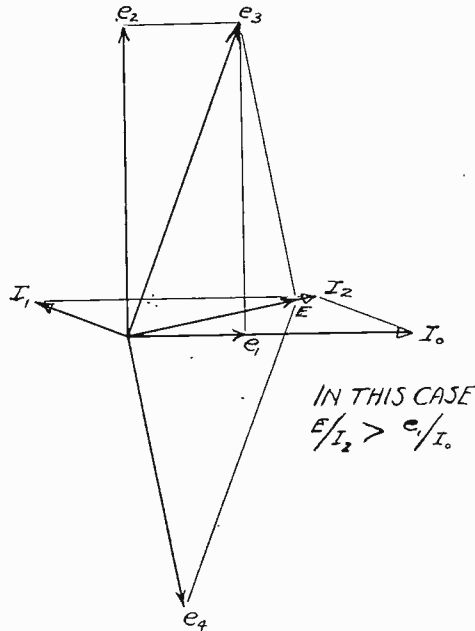

Fig. 5

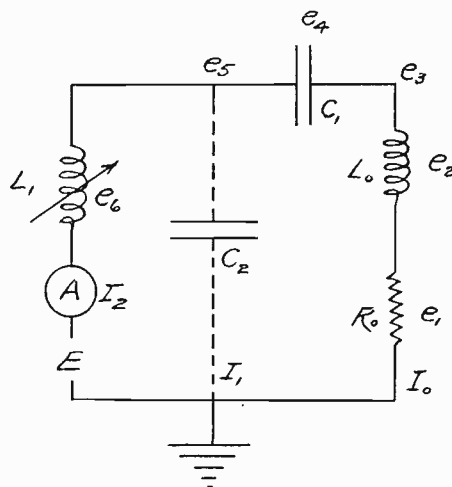

Fig. 6

IV. SOURCES OF STRAY CAPACITANCE

All of the conductors and instruments used for antenna tuning or antenna measuring have some capacitance to ground, and the amount of capacitance depends upon the size of the conductor and its distance

from ground. Since stray capacitance cannot be avoided entirely, the engineer is concerned with keeping it as low as possible when measurements are being made. Fig. 10 shows where stray capacitance exists, in one type of measuring circuit.

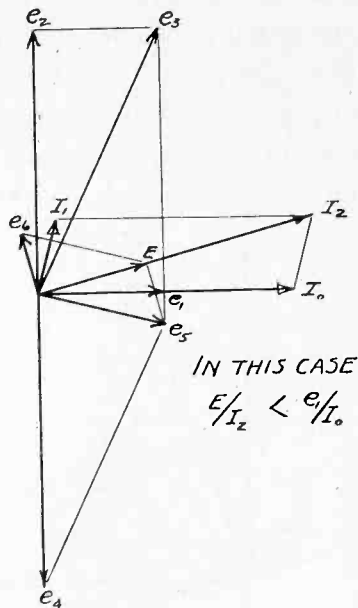

Fig. 7

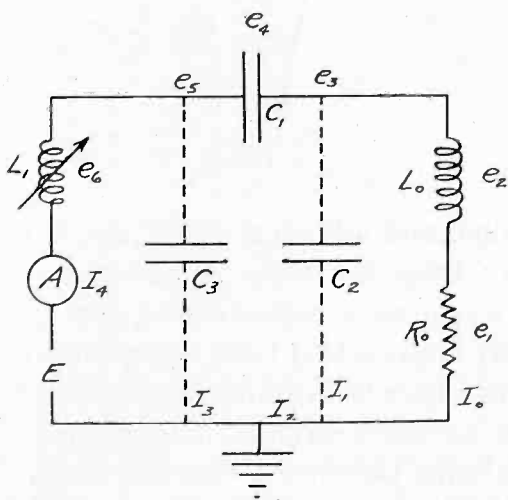

Fig. 8

The capacitance of the down-lead insulator and the entrance bushing can be considered a permanent part of the circuit because it is present during measurement as well as during power operation. The stray capacitance of the antenna series condenser, (if it is an adjustable air condenser, or a bank of fixed condensers) would change with the setting of the condenser. A static drain coil may act as a capacitance

at some frequencies, in parallel with other stray capacitance. Where movable antenna coupling coils are used the coupling-coil—tank-coil capacitance would depend upon the adjustment. Such varying values of capacitance lead to much trouble in measurement and adjustment of the circuits. It must be remembered that there may be stray capacitance present in the measuring circuit which is not present during power operation; and that there is stray capacitance in the actual tuning circuits for power operation which is not present at the time of measurement. Measurements are usually made with small laboratory type precision instruments with which it is possible, by using small

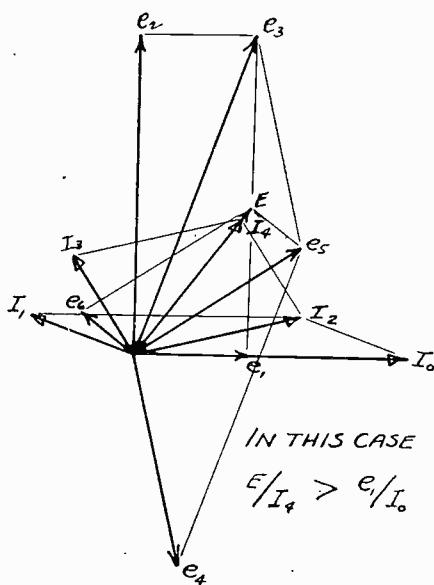

Fig. 9

wire for connections, and allowing wide spacing between instruments and to ground, to keep the stray capacitance very low. The stray capacitance due to antenna series condensers, loading and coupling coils, etc., is usually high and far from inconsiderable, especially in high power transmitters where the tuning apparatus is large. When air condensers, shielding between circuits, and shielded tuning houses are used, stray capacitance becomes a very important item.

V. WAYS TO REDUCE ERRORS IN ANTENNA MEASUREMENTS

Accurate antenna resistance measurements are desired for two principal reasons: (1) as a basis for measuring antenna input power, and (2) as engineering data for practical and theoretical uses. In the former, however, it suffices if permanent circuit resistance is obtained, whether or not this is the true antenna resistance, so long as this value is the same during operation as it was at the time of measurement. In

Fig. 11 the down-lead insulator and the lead-in bushing capacitances are permanently in circuit, and while a measurement taken at A is not antenna resistance, it is a permanent value of resistance. Certified antenna resistance and power input measurements should be made at this point in the circuit for best results.

To obtain utmost accuracy in measurements, the arrangement of the measuring instruments must be studied carefully both as to connections and placing. Fig. 10 shows a circuit arrangement for the resistance-variation method of measurement based on the principles just

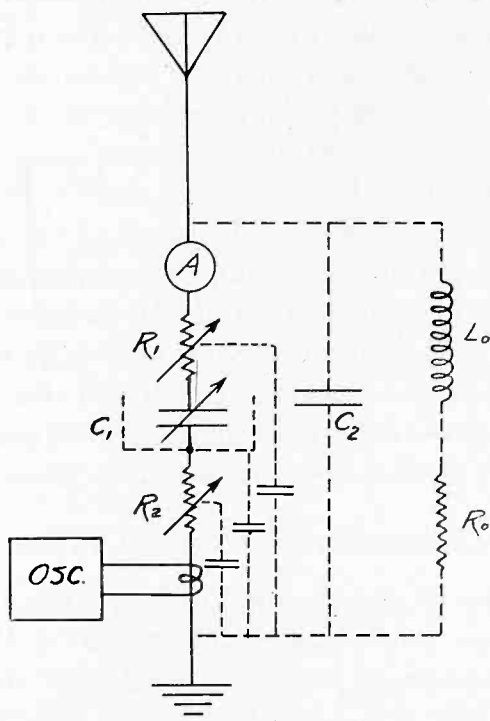

Fig. 10

discussed. The ammeter reads the current actually entering the antenna at the lead-in bushing. Next in series is the standard resistance, R_1 , so that the current through this resistance is as nearly as possible the same as that shown by the ammeter. The tuning condenser, the tuning inductance when used, a second standard resistance R_2 , the exciting voltage and ground is the order of the connections between R_1 and ground. The tuning condenser should be a precision calibrated condenser for reactance measurements, and if shielded, the shielded terminal of the condenser should go to R_2 . The manipulation of this circuit will then be as follows: Starting with the standard resistances R_1 and R_2 at zero resistance, the entire circuit is tuned to resonance by means of C_1 for a maximum antenna current. Some adjustment of the exciting

voltage may then be necessary to obtain a convenient deflection of the ammeter. When exact resonance has been found, known values of resistance are inserted at R_1 , the resulting currents noted, and the antenna resistance computed therefrom. Then R_1 is set at zero resistance, and similar measurements made using R_2 . If there is no appreciable stray capacitance from the measuring circuit to ground the resistance values given by R_2 will agree with those obtained using R_1 ; but if there is an appreciable amount of stray capacitance, the two sets of measurements will not agree. The arrangement of the instruments can then be changed to reduce stray capacitance until the two are in substantial agreement. The truest results will always be given by R_1 , and the final measurements should be made with this resistance. At the same time the capacitance of C_1 is noted, and its reactance is equal to that of the circuit at the same point where the resistance was measured. When an inductance is also used in the measuring circuit, the net resultant reactance of the tuning elements will be equal to the antenna reactance. The amount of care required in making measurements of this sort depends upon the mode of operation of the antenna. Greatest care is required with high impedance antennas, especially near mode 0.5; and least care is required at modes very close to 1.0 and 0.33. The majority of practical cases are between these limits and in general require strict caution on the part of the person making the measurements.

VI. MEASUREMENT OF ANTENNA INPUT POWER

Direct measurement of antenna input power is made by measuring the antenna resistance and the antenna current at the same point, the power being the product of the current squared and the antenna resistance. It is evident that any error in the resistance measurement produces a proportional error in the power measurement. Furthermore, since the current is not the same in all parts of the antenna tuning circuit, the antenna ammeter cannot be located at random. In Fig. 11, which shows a well-known and widely used circuit for terminating a transmission line and tuning an antenna, all the apparatus being located in a shielded tuning house, the ammeter should be located at A if the resistance was measured here. Locating the ammeter at B would give an incorrect result in the power input measurement.

If one desired to measure power by means of an ammeter at B , it is necessary to measure the circuit resistance as seen from that point. To do this it is essential that the antenna be tuned and all the apparatus permanently adjusted prior to making measurements so that stray capacitance values are fixed. But since the circuit includes the coupling coil to tank coil capacitance, it is necessary to ground the tank in-

ductance at the time of measurement. After making circuit measurements at *B*, the power can be measured with an ammeter there. This will be the antenna input power if the circuit loss is negligible. But if there is a considerable power loss in the tuning equipment, antenna input power must be measured at *A*.

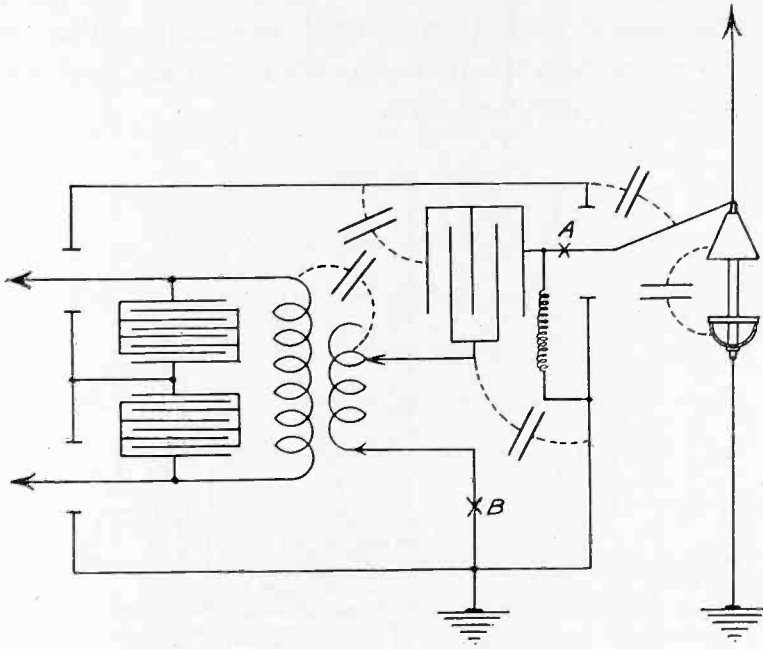

Fig. 11

VII. AGREEMENT BETWEEN THEORETICAL AND PRACTICAL ANTENNA DATA

Engineering literature contains very little quantitative data, theoretical or practical, on broadcast and similar antennas. According to the experience of many engineers, in general, it appears that the agreement between theory and measurement has been only roughly approximate. There are probably many natural reasons why this is so, besides the fact that the idealized antenna is seldom approached in real life. There are many diversions of form and proportions in practice, besides towers and surrounding conductors, ground systems, and ground conductivity, all of which introduce variations in resistance. However, it is reasonable to believe that some of the discrepancies are due to the measurements, and taking the effects of stray capacitance into account has improved the agreement between theory and observation in many cases. The preceding notes explain the difference between measuring the antenna proper and some complex circuit which includes the antenna.

Step	C_2	R	X_L	X_L/R
A	0	50 ohms	134 ohms	2.68
B	1 unit	65 "	153 "	2.36
C	2 "	87 "	169 "	1.94
D	3 "	125 "	193 "	1.54
E	4 "	184 "	208 "	1.13
F	5 "	290 "	198 "	0.68
G	6 "	378 "	111 "	0.29
H	7 "	418 "	0 "	—

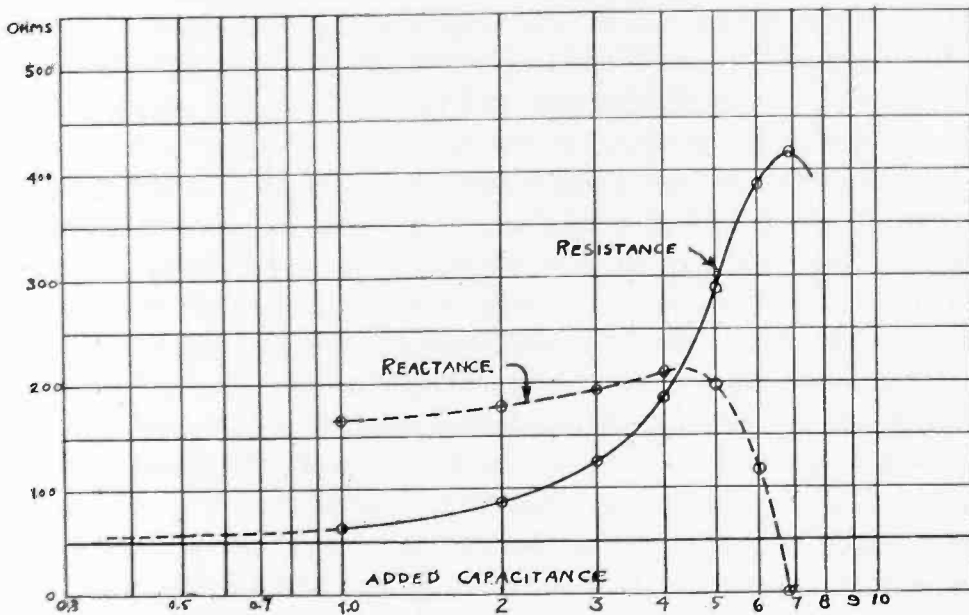

Fig. 13

These data are plotted in Fig. 13. It will be seen that, referring this to the practical case of measuring an antenna, we can measure B to H inclusive when we desire to measure A , B being the antenna circuit with its stray capacitance at the base. Measurements B to H inclusive reveal the shape of the resistance curve, enabling one to extrapolate it toward the asymptote, which is the true antenna resistance of the antenna. Experimenting with such curves it has been found that plotting them on semilogarithmic coordinate paper as shown emphasizes the asymptotic properties of the curve more clearly than other coordinate systems. In actual measurements the increments of parallel capacitance should be relatively small and accurately known.

Referring again to Fig. 12, it is interesting to note that the locus of all the voltage vectors is a circle drawn upon e_3 as a diameter.

This method may also be useful in measuring the resistance of coils with distributed capacitance.

NOTE ON AUDIO-FREQUENCY ATMOSPHERICS*

BY

E. T. BURTON

(Bell Telephone Laboratories, Inc., New York City)

A RECENT paper¹ describes the usual characteristics of musical atmospherics. Observations during August, 1933, have brought out certain additional characteristics which appear worthy of mention. This work was carried out at the time when sun-spot activity was somewhat more prominent than usual and especial watch was kept for tones of the "swish" or "long whistler" variety.

The frequency range of the amplifier and associated equipment used for this work was approximately 200 to 15,000 cycles. Aural observations showed many descending swish tones to extend as high as approximately 9000 cycles. Frequently the beginning or the ending of a descending swish was accompanied by a burst of one or more rapidly ascending high pitched tones which could be described as "squeaks."

During these observations frequent reversing tones were observed. These appeared as whistles which descended in frequency for some one or two seconds, after which they ascended rapidly. The ascent usually took place in approximately one-half second. In a few cases the direction of progression was reversed, a rapid ascent being followed by a slow descent. The reversing tones have been observed previously but were suspected to result from the overlapping of two separate tones. However, it appears in the light of these recent data that the reality of this type of tone has been established.

Trains of descending swishes were observed, following static crashes with regular spacings of some three seconds. The later swishes of a few of these trains were somewhat extended in the low-frequency range but were not noticeably affected in the high-frequency range.² In attempting to account for a phenomenon of this type, the evidence might indicate a momentary disturbance consisting of a wide band of frequencies which reaches the observation point first in its original form. Later the disturbance reaches the observer by another route, after an interval of some three seconds. During this interval the disturbance has been drawn out into its spectrum. The delay in arrival may indicate either a low velocity or a great length of path. Repetitions of the dispersed wave train may indicate repeated reflections, and the

* Decimal classification: R114. Original manuscript received by the Institute, December 22, 1934.

¹ E. T. Burton and E. M. Boardman, "Audio-frequency atmospherics," *Proc. I.R.E.*, vol. 21, p. 1476; October, (1933).

² T. L. Eckersley has described trains of descending whistlers, the later tones of which are much extended.

increased length of later tones of the train point to additional dispersion. However, according to the author's observations the additional lengthening of the later waves of the train is comparatively slight. Therefore, it appears that if the trains of descending tones are produced by multiple reflection attended by dispersion, the path followed by the later tones is probably considerably different from that of the first tone. This might indicate that the disturbance passes first through a medium of comparatively high dispersive properties; thereafter it may enter a region of lower dispersion and low attenuation which is bounded at least partially by regions of good reflecting properties for frequencies of the audio range.

Recently an early reference to musical atmospheric has come to my attention. W. H. Preece³ states that in February, 1894, telephone receivers were placed in communication lines in an attempt to hear disturbances accompanying magnetic storms. The sounds heard are described thus: At Anglesea "twangs' were heard as if a stretched wire had been struck, and a kind of whistling sound." At Lowescroft "(the) noise . . . seemed like that heard when a flywheel is rapidly revolving, and sounds appear like heavy carts rumbling in the distance." At Haverfordwest "peculiar and weird sounds were distinctly perceived, some highly pitched musical notes, others resembling murmur of waves on a distant beach. The musical sounds would very much resemble those emitted by a number of sirens driven at first slowly, then increased until a 'screech' is produced, then again dying away. Duration of each averaged about 20 seconds."

Preece further states that these sounds "accompanied or were consequent on sun spots, earth currents and the aurora borealis."

It is clear that the whistling sounds are identical with the whistlers or swishes heard more recently, and it is reasonably certain that the rumbling and murmuring sounds correspond to the somewhat steady noises which we have observed in the frequency range below 1500 cycles.⁴ The "flywheel" sound appears to be that of the overlapping swishes described by us as resembling the sound of whips or wires drawn through the air. The siren tone appears to resemble the reversing whistles described above.

It is remarkable that the duration of some tones is given as 20 seconds, while swishes observed by us have not exceeded approximately five seconds. Preece's observations were made during a period of high sun-spot activity which may account for the long duration of these tones.

³ W. H. Preece, "Earth currents," *Nature*, vol. 49, p. 554, April 12, (1894).

⁴ These have been described as "hollow rustling," "roaring," and "murmuring" sounds. See E. T. Burton "Submarine cable interference," *Nature*, vol. 126, p. 55; July 12, (1930), and E. T. Burton and E. M. Boardman, *loc. cit.*

A CHOPPER UTILIZING CONTACTS VIBRATING IN A VACUUM*

BY

F. G. KELLY

(Eastern Engineering Company, New Haven, Connecticut)

Summary—A chopper approximately the size of a radio receiving tube, for small voltages and currents, is described. A tiny contacting member with microscopic working gap provides nearly noiseless operation at 120 cycles. Vacuum contacts give proper operation at millivoltages much below values for which contacts in air are suitable.

FREQUENTLY, in experimental and industrial uses of vacuum tubes it is found desirable to amplify some continuous current component of voltage which cannot be handled by any type of amplifier except one conductively coupled. This indeed is a tragic moment for the circuit designer because continuous current amplifiers are inherently unstable if used for more than very slight gain. This is due to the fact that any shift in emission or bias of the first tube is permanently passed on amplified to succeeding ones. If in certain cases, however, the voltage component does not vary rapidly, it might be found satisfactory to convert it into an alternating-current component by means of a chopper, pass it through the usual simple and rugged alternating-current amplifier of any gain desired, and rectify the output without appreciable distortion. Even in these cases, however, the experimenter is just as unfortunate for there is no chopper commercially available which would be acceptable, except in the most unusual case.

Choppers are usually defined as motor-driven devices. What is needed, however, is a device no larger than the average receiving tube, noiseless, cheap, reliable, and capable of thousands of hours of use without attention.

The chopper to be described is the outcome of experiments in one such case, and apparently is strikingly near the ideal. The experimental model is shown in Fig. 1. The contacting members are an iron rod *R* and steel reed *V*, both copper-plated. Contact is made by magnetizing *R* sufficiently to draw *V* into contact. The reed is made very small—only 0.002 inch thick by 1/8 inch wide by 5/8 inch long—so that it will make 120 cycles per second when excited from a 60-cycle

* Decimal classification: R385.3. Original manuscript received by the Institute, September 29, 1933, revised manuscript received by the Institute, November 21, 1933.

source. Reed and rod are sealed into a glass bulb T which extends into a slender stem down around R in such a manner as to allow a coil C of smallest practicable mean turn to encircle the rod at its middle in order to allow maximum driving efficiency. The coil was kept out of the vacuum because it was feared first that the contacts might need degassing at high temperature during evacuation, and second, that the coil might later on during time give off gas spoiling the vacuum. The whole internal structure is supported by the extra strong seal to the

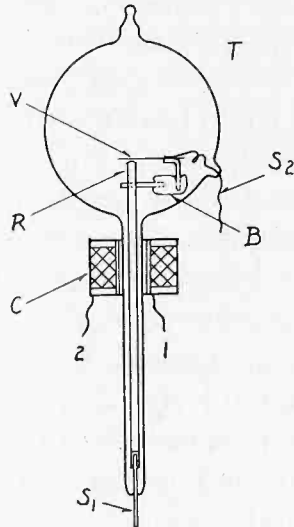

Fig. 1—Experimental model of the chopper.

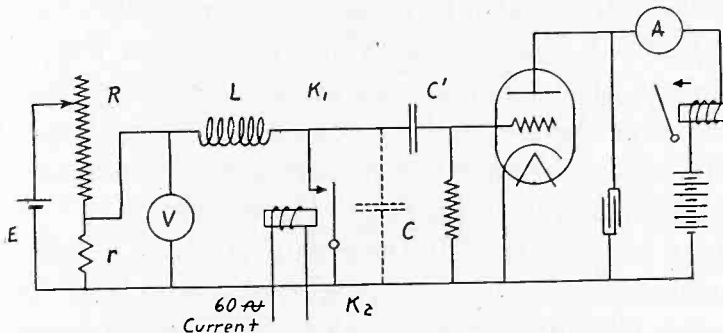

Fig. 2—A few microwatts at several millivolts is chopped and stepped up to several volts at the grid of the valve.

- L —an air-cored inductance of 0.2 henry and 30 ohms resistance
- $K_1 - K_2$ —chopper contacts
- C —total stray capacitive load to inductive surges, about $25\mu\mu f$
- C' — $50\mu\mu f$
- Grid leak—100 megohms.
- Valve—type 56.

stem at terminal S_1 , the reed and its lead being supported by and insulated from the rod by a glass bead B . The whole assembly is about the size of a type UX-210 radio receiving tube.

As an example of the possibilities of the unit let its operation in the circuit of Fig. 2 be considered. R , r , and E represent a source of electromotive force of about 40 ohms internal resistance, variable from about 0.001 to 0.050 volt. When the chopper was excited from 60 cycles alternating current making 120 complete vibrations per second, only 0.010 volt at the source was required to maintain a negative decrement in grid bias of 3 volts direct current equivalent. This was sufficient to operate the magnetic relay shown in the tube plate circuit.

The chopper was operated at 120 cycles per second for 72 hours in this circuit with no perceptible variation in performance. When the input voltage was varied the valve grid bias followed practically without delay and as nearly as could be detected in proportion, except near zero. Brief theoretical considerations (unverified by experiment) indicated that the voltage gain from source to valve grid was determined by the fixed values of resistance, inductance, and capacity of the circuit; and that the output was proportional to input except for non-linearity of the valve grid current near zero.

Apparently there were no losses at the contacts. Steady state contact resistance was less than 0.1 ohm down to 0.1 millivolt, which was as low as measurements were made. Since the vacuum around the contact was in the order of 10^{-5} millimeter of mercury no appreciable loss due to arcing was expected, especially at the low surge peaks of 3 volts.

The chopper was almost noiseless as a result of the tiny motion of the reed. Although the steady state reed gap was 0.015 inch the natural frequency of the reed was so much lower than the 120 cycles at which it worked, that when driven at this frequency it could not be seen to move with the unaided eye—probably opening less than 0.001 inch. Yet this was experimentally found to be adequate for surge peaks which would produce jump sparks $1/32$ inch long.

Contacts in air were tried in the circuit of Fig. 2 before the vacuum chopper was built. Contacts of pure silver, platinum, and silver and gold were tried; but if they worked at all at the lower inputs, they gave reduced and extremely irregular output even when freshly cleaned. They were only given up after much more effort than was spent on the vacuum chopper. The vacuum, making workable the microscopic parts, motions, and pure metal contacting surfaces, is possibly the key to the need outlined in the beginning.

Whether or not the reed experimented with would work well above 250 cycles is a question. Certainly smaller reeds are entirely practicable, and those capable of 1000 cycles are not at all out of the question. Fig. 1 is not considered a finished design of chopper by any means.

CONTRIBUTORS TO THIS ISSUE

Ballantine, Stuart: Born September 22, 1897, at Germantown, Pennsylvania. Operator, Marconi Company, summers, 1913, 1914, 1915; H. K. Mulford Company, bacteriologists, 1916; Bell Telephone Company of Pennsylvania, 1917; Expert Radio Aide, U. S. Navy, in charge of development of radio direction finder apparatus, Philadelphia Navy Yard, 1917-1920; organized Philadelphia Section of the Institute, Chairman until 1926. Studied mathematics at Drexel Institute, 1919; mathematical physics, graduate school, Harvard University, 1920-1921. With L. M. Hull organized technical work at Radio Frequency Laboratories, Inc., Boonton, New Jersey, 1922-1923. John Tyndall Scholar in mathematical physics, Harvard University, 1923-1924. Privately engaged in scientific research at White Haven, Pennsylvania, 1924-1927. In charge of research division, Radio Frequency Laboratories, 1927-1929. President, Boonton Research Corporation, 1929 to date. Recipient Morris Liebmann Memorial Prize, 1931, Institute of Radio Engineers, Fellow American Physical Society and Acoustical Society of America; Member, Franklin Institute. Associate member, Institute of Radio Engineers, 1916; Fellow, 1928.

Burton, Everett T.: Born Indiana, April 21, 1893. Received A.B. degree, 1920; M.A. degree, 1924, Indiana University. Junior engineer, Chalmers Motor Company, 1926. Lieutenant, U. S. Engineers Corps, 1917-1918. Research department, Western Electric Company and Bell Telephone Laboratories, Inc., 1920 to date. Associate member, Institute of Radio Engineers, 1930.

Hollman, Hans Erich: Born November 4, 1899, at Solingen, Germany. Educated at Humanistic High School, Solingen; passed examination, 1917. Enlisted in army, March, 1918; returned from France as prisoner of war, February 20, 1920. Began study of electrotechnics, Technical High School, Darmstadt, 1920; laboratory engineer, Radio Works, Darmstadt, 1924-1926; passed examination and received prize offered by General Department of the High School for an essay on acoustics; received degree of doctor, June, 1928; continued investigations on microwaves, Physikalischen Institut of the Technische Hochschule, Darmstadt, as a scholar for the Notgemeinschaft der Deutschen Wissenschaft; transferred, Easter, 1930, to Heinrich-Hertz Institut für Schwingungsforschung in Berlin; in 1932 became assistant in the high-frequency department; since Easter, 1932, scientific assistant, Telefunken Gesellschaft.

Kelly, Frederick G.: Born November 20, 1902, at Birmingham, Alabama. Received B.S. degree in electrical engineering, Georgia School of Technology, 1924; M.S. degree in electrical engineering, Yale University, 1925; finished Westinghouse college graduate course, 1926. Engineer, Westinghouse electrical instrument and oscillograph departments, 1926-1928; development engineer, Automatic Signal Corporation, 1928-1932; development engineer, Eastern Engineering Company, 1932 to date. Associate member, A.I.E.E. Associate member, Institute of Radio Engineers, 1933.

Laport, Edmund Abner: Born July 2, 1902, at Nashua, New Hampshire. Graduated, Morrill School of Mechanic Arts. Commercial radio operator, 1921. Westinghouse Electric and Manufacturing Company, 1922; General Electric Company, 1923; Lieutenant E-V (s) USNR, 1926; Westinghouse Electric and Manufacturing Company, 1924-1933. Installed three medium power radiophone stations in China for Ministry of Communications, 1928. Appointed section engineer in charge of radio installations and field engineering, 1930-1933; installed and commissioned five 50,000-watt broadcast stations, including Rome, 1930, and Milan, 1932. Consulting engineer associated with Paul F. Godley, 1932 to date. Associate member, Institute of Radio Engineers, 1925; Member, 1927.



Quality

• in Flexibility

The Bradleyometer, by virtue of its unique resistor element which is not obtainable in any other control, can be supplied with practically any resistance-rotation curve for over 100 different connection combinations.

• in Performance

The design of the resistor element together with the precision manufacturing methods used in its construction result in an output of Bradleyometers of unequalled uniformity. This, in turn, assures a continuous output of radio receivers of optimum performance.

• in Workmanship

Carefully selected raw materials, precision manufacturing methods, and continuous checking of production processes guarantee long life and deluxe performance for all Bradleyometers.

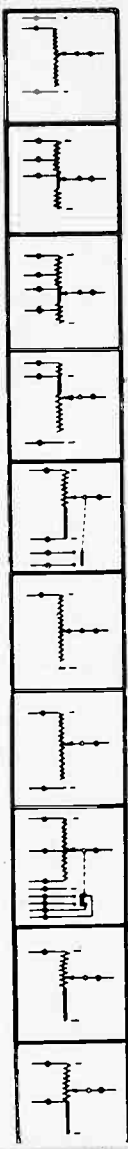
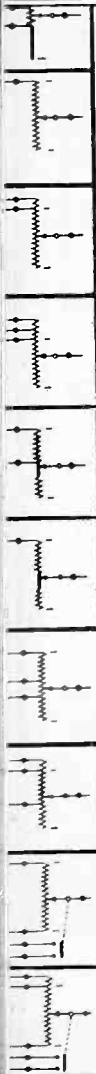
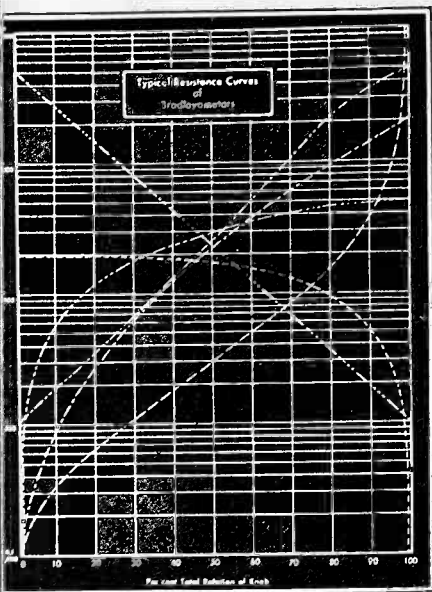

Volume Control De Luxe



A Quiet A. C. Relay for Remote Control

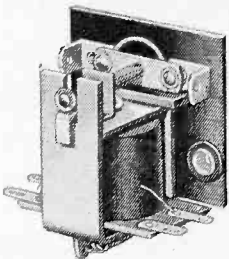

Allen-Bradley scores another triumph in this new quiet A. C. remote control relay for radio receivers. When operated by remote control, this relay connects or disconnects the main power pack circuit of the receiver. Send for specifications and prices today.

The Bradleyometer, now available in over 100 circuit combinations, represents the highest attainment in variable resistors for volume control, tone control, and automatic tone correction with volume control. Allen-Bradley engineers, foremost in the field of radio resistor design, have pioneered in the development of this volume control de luxe.

The slight extra cost of the Bradleyometer adds immeasurably to the quality of the receiver. Make your receivers outstanding in performance by using the Bradleyometer—the Volume Control De Luxe. Let Allen-Bradley engineers send you performance data, today.

Allen-Bradley Co.
116 W. Greenfield Ave., Milwaukee, Wis.

Bradleyometer

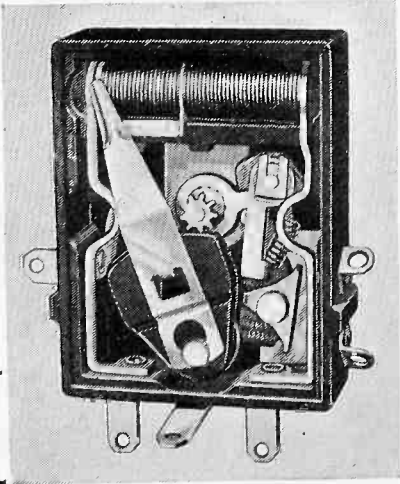

When writing to advertisers mention of the PROCEEDINGS will be mutually helpful.

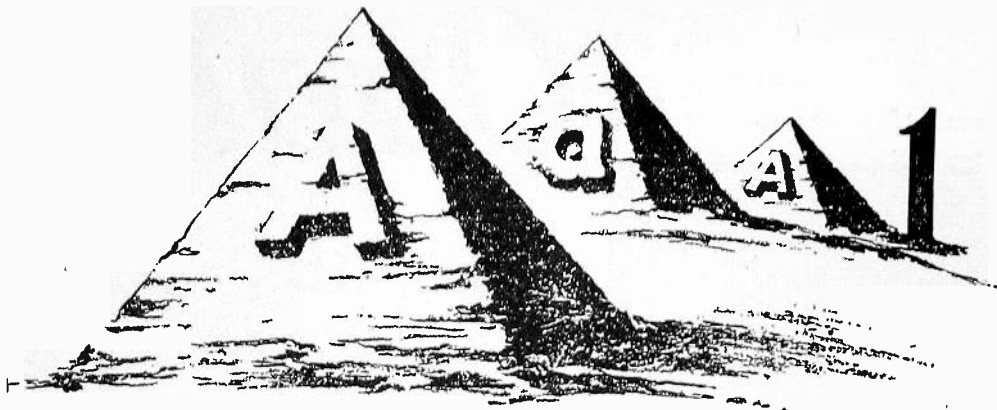

UNCHANGING

IN THE past decade of fluctuating values, few old standards have remained unchanged. Almost alone in this respect, the financial ratings published by leading financial directories have stood as reliable standards of any organization's stability.

Throughout both booms and depressions, the financial rating of the Hygrade Sylvania Corporation has remained consistently AaA1!



Sylvania's farsighted engineering, and willingness to cooperate with set manufacturers in solving circuit and design problems have proved a sound basis for stable operation!

Our engineers will work with manufacturers in their own plants or in Hygrade Sylvania's laboratories. Write for consultation . . . no obligation incurred.

Hygrade Sylvania Corporation, Emporium, Penna.

Sylvania

(Reg. U. S. Pat. Off.)



THE SET-TESTED RADIO TUBE

When writing to advertisers mention of the PROCEEDINGS will be mutually helpful.

© 1933, H. S. C.

"YOU'RE CONNECTED!"



SMILING, the installer takes his leave. He's been courteous, careful, quick. He seemed to know just where the telephone should go. Just how to place it so that nothing should be marred. And now—"You're connected!"

A few days ago, having a telephone in this house was only an idea. A husband talked it over with his wife. They decided to go ahead. Now the telephone is a reality—tangible, delightful, vitally important to the family that lives here. Tonight Mother can visit with her friends, talk to relatives miles away, call the doctor should he be needed.

A new neighbor has been linked with the millions of other telephone equipped homes that make America one neighborhood. Another household has discovered the security and convenience brought by the Bell System's unified service of communication.

Those who already have telephone service can save many steps each day—through the house, up and down stairs—by having extensions placed in those rooms which are most frequently used. Greater convenience, greater privacy, at small extra cost. Installations are quickly made. Just call the Business Office of your Bell Telephone Company.



BELL TELEPHONE SYSTEM

When writing to advertisers mention of the PROCEEDINGS will be mutually helpful.

RECORDING RADIO RESEARCH...

"The Wireless Engineer" is a monthly journal solely devoted to the interests of advanced amateur experimenters and professional wireless engineers.

It is Great Britain's acknowledged medium for the publication of authoritative scientific and technical wireless information.

"The Wireless Engineer" is an essential companion to the I.R.E. Proceedings. It devotes 25 pages each month to a comprehensive summary of technical radio articles appearing in current publications all over the world, and gives an annual index to every abstract.

MONTHLY
2/6 net.

Foreign
Subscription
£1. 12. 0.
per annum,
post free

THE
**WIRELESS
ENGINEER**

AND
EXPERIMENTAL WIRELESS
A Journal of Radio Research and Progress

Published By

ILIFFE & SONS, LTD., Dorset House, Stamford St., London, S. E. 1, England

When writing to advertisers mention of the PROCEEDINGS will be mutually helpful.

The Institute of Radio Engineers

Incorporated

33 West 39th Street, New York, N. Y.

APPLICATION FOR ASSOCIATE MEMBERSHIP

(Application forms for other grades of membership are obtainable from the Institute)

To the Board of Directors
Gentlemen:

I hereby make application for Associate membership in the Institute of Radio Engineers on the basis of my training and professional experience given herewith, and refer to the members named below who are personally familiar with my work.

I certify that the statements made in the record of my training and professional experience are correct, and agree if elected, that I will be governed by the constitution of the Institute as long as I continue a member. Furthermore I agree to promote the objects of the Institute so far as shall be in my power, and if my membership shall be discontinued will return my membership badge.

.....
(Sign with pen)

.....
(Address for mail)

..... (Date) (City and State)

Sponsors:
(Signature of references not required here)

Mr. Mr.

Address Address

City and State City and State

Mr.

Address

City and State

The following extracts from the Constitution govern applications for admission to the Institute in the Associate grade:

ARTICLE II—MEMBERSHIP

Sec. 1: The membership of the Institute shall consist of: * * * (c) Associates, who shall be entitled to all the rights and privileges of the Institute except the right to hold any elective office specified in Article V. * * *

Sec. 4. An Associate shall be not less than twenty-one years of age and shall be a person who is interested in and connected with the study or application of radio science or the radio arts.

ARTICLE III—ADMISSION AND EXPULSIONS

Sec. 2: * * * Applicants shall give references to members of the Institute as follows: * * * for the grade of Associate, to three Fellows, Members, or Associates; * * * Each application for admission * * * shall embody a full record of the general technical education of the applicant and of his professional career.

ARTICLE IV—ENTRANCE FEE AND DUES

Sec. 1: * * * Entrance fee for the Associate grade of membership is \$3.00 and annual dues are \$6.00.

ENTRANCE FEE SHOULD ACCOMPANY APPLICATION

Isolantite

APPROVED FOR A DECADE

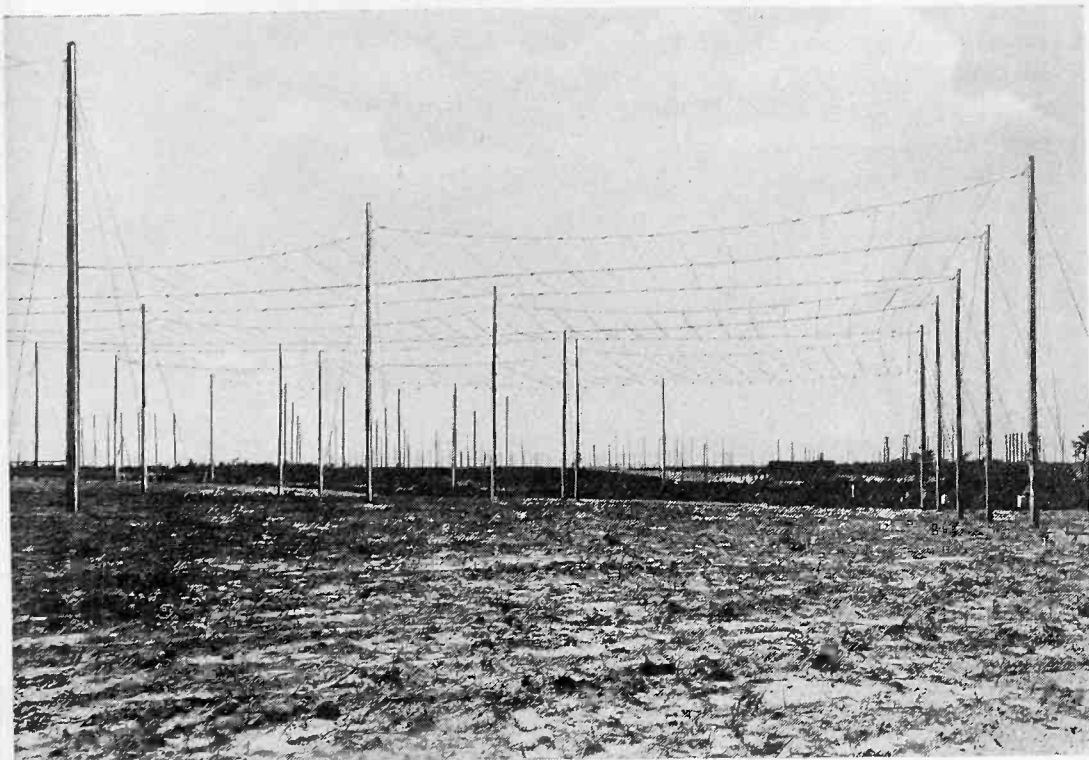

Central Receiving Station
RCA Communications, Inc., Riverhead, L.I.

ISOLANTITE insulates the antennas of the world's greatest Radio Communication System.

What more obvious indorsement could be desired than to be specified by engineers who know.

Write for Bulletin 100-F

Isolantite Inc.

BELLEVILLE, N.J.

New York Sales Office, Woolworth Building, 233 Broadway, New York

When writing to advertisers mention of the PROCEEDINGS will be mutually helpful.

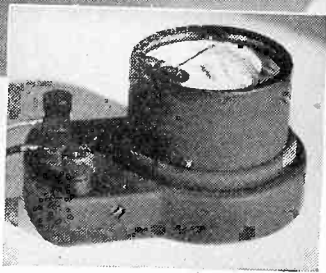
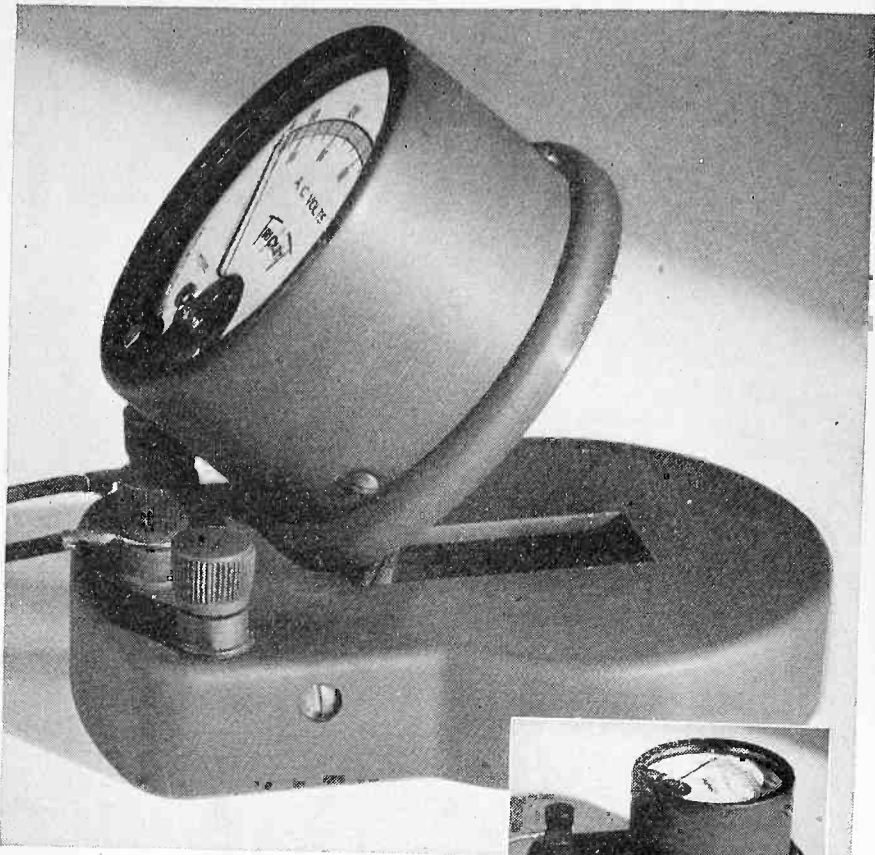

Check

Your

Experiments With Advanced

TRIPLET INSTRUMENTS!

IF YOU want the most precise, easy-to-read equipment, select Triplet Portable Instruments. A sturdy hinged arrangement makes it easy to raise or lower the meter until the desired reading angle is secured. In this way, the scale is always in direct alignment with the line of vision. This feature facilitates the making of curves and the carrying out of laboratory experiments.

The exacting engineer prefers a Triplet Portable Instrument because it serves a double purpose. It can be used either as a regular portable instrument, or, as the new adjustable type. Before starting a chart, he can adjust the meter until he can readily see the dial . . . regardless of where he places it! A single glance at the upraised easy-to-read dial gives him the information he desires . . . and enables him to continue with his experiment without moving from his position and without loss of time.

Triplet Portable Instruments are advanced in design, precision built, compactly constructed, and absolutely dependable. Widely regarded for their

superiority, they are extensively used in many leading laboratories, schools and universities. Single range meters are equipped with binding posts or jacks. Tipped cable leads are supplied with a pin jack at one end and spade terminals on the other.

Your Jobber Can Supply You!

See these Triplet Instruments *before* you make up your mind. They pay for themselves many times in service and complete satisfaction.

THE TRIPLET ELECTRICAL INSTRUMENT COMPANY
 63 Main Street Bluffton, Ohio



SEND COUPON FOR QUICK FACTS!

The Triplet Electrical Instrument Co.
 63 Main Street, Bluffton, Ohio.
 Gentlemen: Send me catalog on Triplet Portable Instruments . . . and complete line of radio servicing instruments.

Name

Street Address

City State

When writing to advertisers mention of the PROCEEDINGS will be mutually helpful.

RCA VICTOR

PRECISION LABORATORY EQUIPMENT

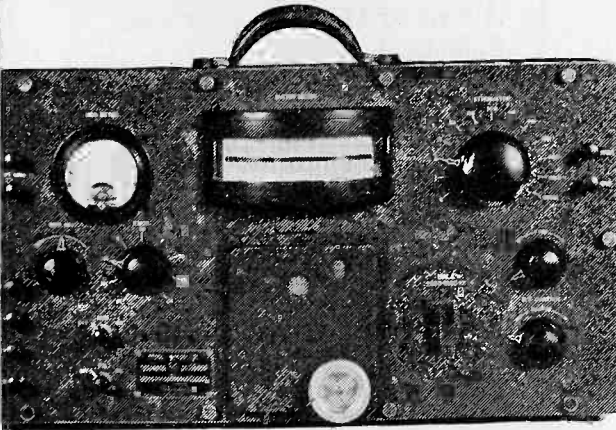

← STANDARD SIGNAL GENERATOR
TYPE TMV-18-D

Standard range 100 kc to 10,000 kc. Extra coils for 25 kc to 25,000 kc. R-F voltage output 0.25 microvolts to 2 volts. Internal 400 cycle modulator. Accurate frequency calibration. Improved precision dial with worm driven vernier. Minimum stray field.

FIELD INTENSITY METER TYPE TMV-75-B →
Frequency range 500 kc to 20,000 kc. Field intensity range 20 microvolts/meter to 6 volts/meter.

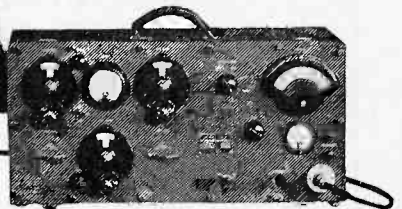

← BEAT FREQUENCY OSCILLATOR TYPE TMV-52-E
Range 20 to 17,000 cycles. Constant output. Low harmonic content. Open circuit output 25 volts. Vibrating reed calibration indicator.

← UNIVERSAL CURVE RECORDER TMV-36-B
Semi-automatic. Provides rapid and easy means of recording characteristic curves. (Instrument shown attached to Beat Frequency Oscillator.)

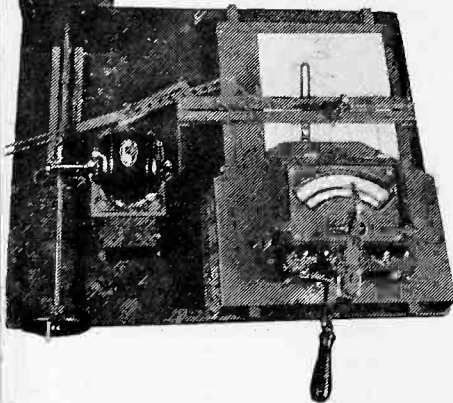

← ALSO HIGH FREQUENCY MULTI-SIGNAL
SYSTEM TMV-107-A

For generating, transmitting, selecting and attenuating modulated or unmodulated signals in range of 2,000 kc to 20,000 kc. Employs single transmission line free from leakage. May be mounted on rack with crystal controlled temperature regulated Master Oscillator Amplifier units and power supply.

Bulletins and prices on application



Industrial
Products
Section

RCA VICTOR CO., INC.

CAMDEN, NEW JERSEY

When writing to advertisers mention of the PROCEEDINGS will be mutually helpful.

PROFESSIONAL ENGINEERING DIRECTORY

BLILEY PIEZO-ELECTRIC CO.

*Designers and Manufacturers
of
QUARTZ CRYSTALS
for
Standard or Special Requirements*

226A Union Station Bldg.
ERIE, PENNA.

Cathode Ray Tubes and Associated Equipment For All Purposes

*Write for Complete
Technical Data*

ALLEN B. DUMONT
LABORATORIES
UPPER MONTCLAIR, N.J.

PRACTICAL RADIO ENGINEERING

One year Residence Course
Advanced Home Study Course
Combined Home Study-Residence
Course

Write for details

Capitol Radio Engineering
Institute
Washington, D.C.

FOR MANY YEARS

the Professional Engineering Directory
has helped consulting engineers, design-
ers, and laboratory men make the right
contacts in the radio industry. Perhaps we
can help you with your problems too. For
further information write to

Advertising Department
INSTITUTE OF RADIO
ENGINEERS
33 West 39th St.
NEW YORK CITY, N.Y.

Alphabetical Index to Advertisements

	A	
Allen-Bradley Co.		VII
American Tel. & Tel. Co.		IX
	C	
Central Radio Laboratories		XXII
Cornell-Dubilier Corp.		XX
	E	
Erie Resistor Corp.		XXI
	G	
General Radio Co.		Outside Back Cover
	H	
Hygrade Sylvania Corp.		VIII
	I	
Iliffe and Sons, Ltd.		X
I.R.E.		XI, XII, XIX, Inside Back Cover
Isolantite, Inc.		XIII
	P	
Professional Eng. Directory		XVI
	R	
Raytheon Production Corp.		XVIII
RCA Victor Company, Inc.		XV
	S	
Stackpole Carbon Co.		XVII
	T	
Triplett Elec. Inst. Co.		XIV

When writing to advertisers mention of the PROCEEDINGS will be mutually helpful.

Eliminate

IGNITION INTERFERENCE

with radio reception on ANY car



(A)

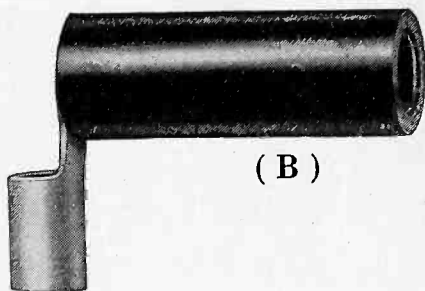

(B)



(C)

STACKPOLE CARBON AUTO SPARK SUPPRESSORS

NOW—perfect reception on sensitive modern automobile radios, undisturbed by high voltage discharges from the ignition system. The solid, long-lived, trouble-free structure of Stackpole Spark Suppressors—molded in bakelite, and containing no troublesome steel wool or springs—cannot be affected by heat, high humidity, vibration or rough usage.

(A) and (B) above show the standard Spark Plug Types, with screw-in connection for cable and snap-on connection for spark plug, straight or at right angles. (C) shows the Distributor Type, with double screw-in connection for use in the main distributor lead wire.

Write for descriptive catalogue

STACKPOLE CARBON COMPANY
ST. MARYS PENNSYLVANIA

VARIABLE
RESISTORS

FIXED
RESISTORS

SPARK
SUPPRESSORS

When writing to advertisers mention of the PROCEEDINGS will be mutually helpful.

THE SKY-WAYS—AND RADIO

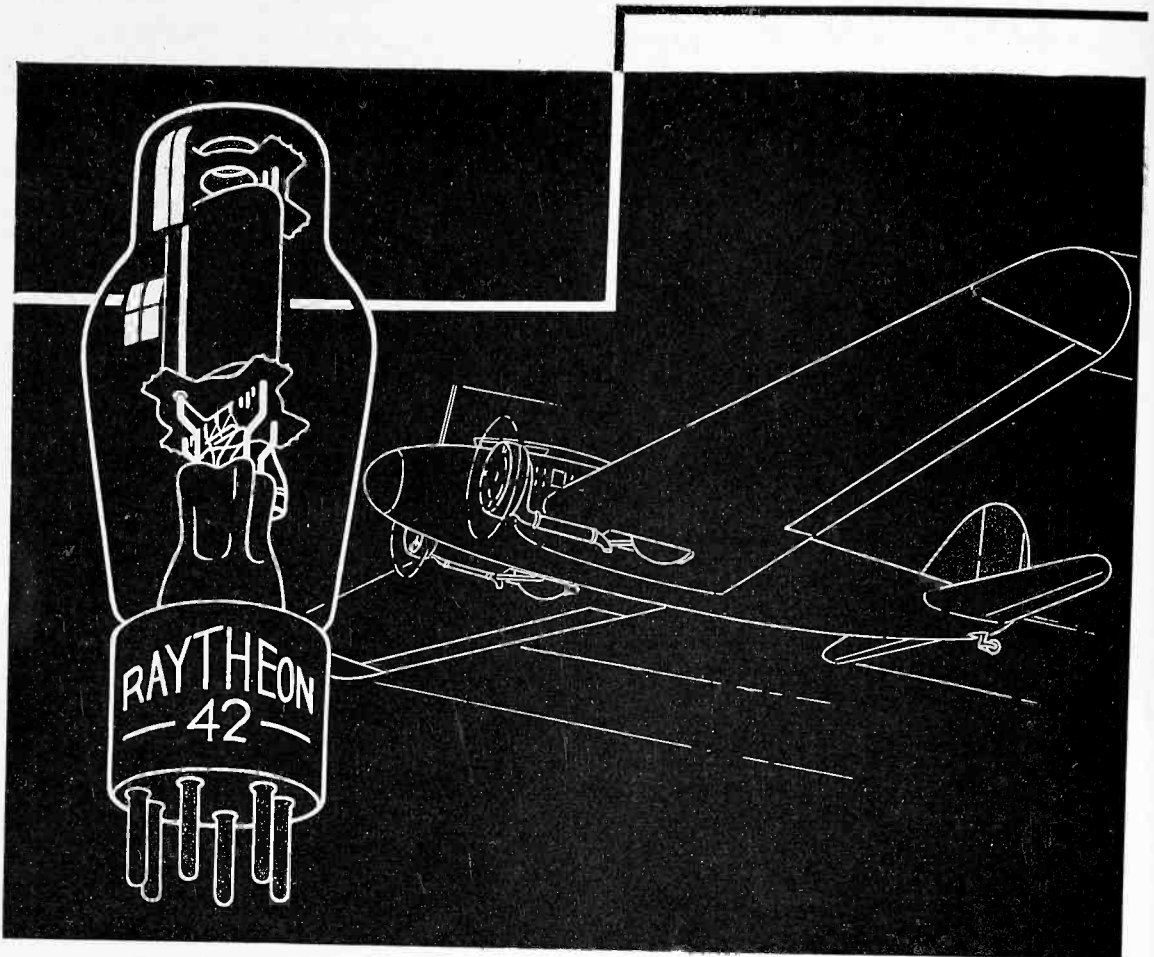

AS YOU KNOW, the country's greatest air-lines depend on radio to guide their planes safely through the sky-ways.

Weather reports of sudden storm movements ahead—poor visibility, low ceiling, etc., are vital information which must be flashed to the pilot, with utmost assurance of his receiving it clearly and without fail, in order to insure maximum safety.

Because of these requirements, air transport companies demand the very finest of radio equipment. And the majority of them are now using Raytheon 4-pillar Tubes because they have found, through exhaustive tests, that these tubes give maximum efficient performance.

Such characteristics involve fundamental mechanical and electrical designs, based on an intimate knowledge of the rigid requirements and severe operating conditions of aircraft receivers. And they obviously must be built into the tube in the first place.

And yet the Raytheon 4-pillar Tubes, selected for use in aircraft receivers, are the very same tubes used by police departments throughout the country, by polar expeditions, in auto radios and by millions of set owners everywhere.

The interested engineer may obtain further technical information, by writing direct to the New York Office as listed below.

RAYTHEON 4-PILLAR RADIO TUBES

RAYTHEON PRODUCTION CORPORATION

30 East 42nd St., New York City
445 Lake Shore Drive, Chicago



55 Chapel St., Newton, Mass.
555 Howard St., San Francisco

When writing to advertisers mention of the PROCEEDINGS will be mutually helpful.

CHANGE IN MAILING ADDRESS OR BUSINESS TITLE

Members of the Institute are asked to use this form for notifying the Institute office of a change in their mailing address or the listing of their company affiliation or title in the Year Book.

The Secretary,
THE INSTITUTE OF RADIO ENGINEERS,
33 West 39th Street,
New York, N.Y.

Dear Sir:

Effective please note change in my address
(date)
for mail as follows:

FROM

.....
(Name)

.....
(Street Address)

.....
(City and State)

TO NEW ADDRESS

.....
(Street Address)

.....
(City and State)

Please note following change in my Year Book listing.

.....
(Title)

.....
(Company Name)

.....
(Company Address)

Constant Capacity

C-D
condensers

Small, even compact, exceptionally neat, yes, but built for real, heavy-duty, *constant capacity* work—that's the story of the C-D mica capacitor Type No. 6.

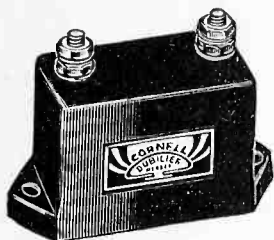

THE Standard of Comparison.

Mica dielectric capacitor sealed in molded bakelite.

Patented series-connected stack allowing unusually high r.f. voltages.

Capacities from .1 at 500 test volts to .0001 mfd. at 5,000 test volts.

Built like high-power units for handling heavy currents in comparison to size.

Screw and nut terminals, high-voltage insulated.

This capacitor is now available with a special stack to hold a constant capacity within a wide range of temperatures. Such a unit is applicable as a *constant capacity* condenser to replace the usual oscillating crystal. Also ideal in ultra-short-wave applications, where constants must be rigidly maintained.

A popular unit, Type 6 C-D capacitor is found in large and small transmitters, in electronic equipment, in laboratory work, where constant capacity, high-voltage standards, minimum dielectric losses, and long service life are prerequisites.

Just one of many types of C-D mica capacitors for every radio, electronic and electrical requirement, made in the world's largest factory devoted exclusively to condenser engineering and production.

Write for the new 1934 catalog No. 127 containing description, dimensions and complete listing of the capacities and working voltages obtainable in Type 6, as well as other mica, sulfinate, paper, oil, electrolytic and molded capacitors.



**CORNELL-DUBILIER
CORPORATION**

4379 Bronx Boulevard - - - New York City

When writing to advertisers mention of the PROCEEDINGS will be mutually helpful.



THE fundamental expression of Ohm's Law . . . $E=RI$. . . underlies all electrical theory. Without it, progress in the electronic industry would have been greatly retarded.

Fundamental research resulting in constant improvement of Erie Moulded Carbon Resistors and Erie Suppressors makes possible continued electronic progress.

A well equipped research laboratory, competent engineering staff and automatic manufacturing equipment keep Erie high resistance products more than abreast of the industry's requirements.

Precision-made Erie Resistors and Erie Suppressors have been the solution to many resistance problems. A letter to us will bring you complete technical data and samples to test in your own laboratory.

Daily continuous laboratory checks are made on the various steps in the manufacturing process of Erie Resistors and Erie Suppressors. Their acceptance by over 75% of the country's leading radio manufacturers is proof of their superiority.

ERIE RESISTOR CORPORATION

ERIE, PA.

Factories in ERIE, PA.-TORONTO, CANADA-LONDON, ENG.

When writing to advertisers mention of the PROCEEDINGS will be mutually helpful.

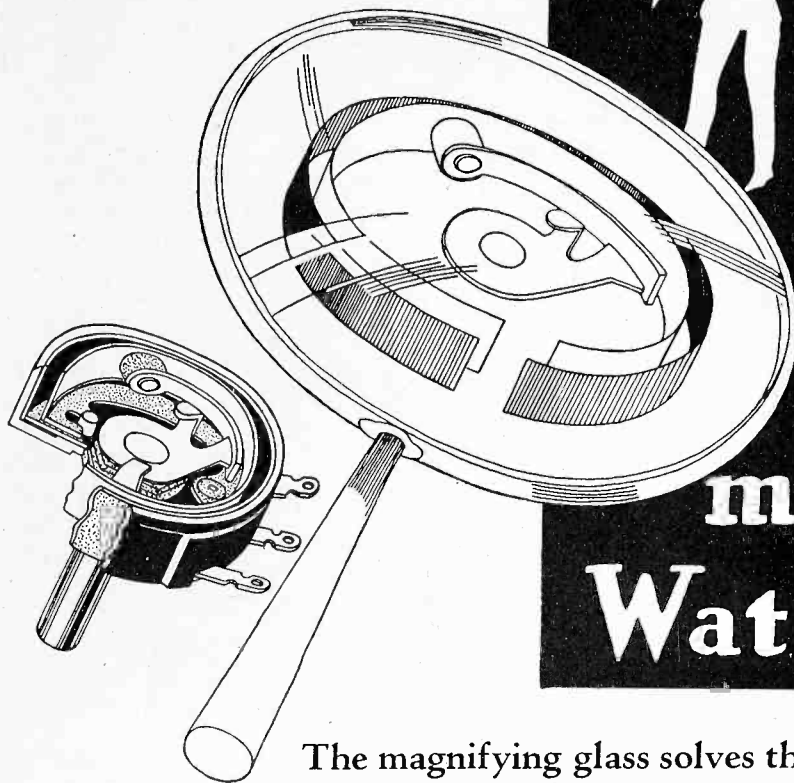

“Ah,
my dear
Watson,~”

The magnifying glass solves the mystery of its perfection . . . note the rocker arm . . . see how it gently presses on the contact band, which in turn presses evenly upon the resistor strip. . . .”

“Yes, yes, Holmes,” . . . “it’s as clear as day to me now.”

Centralab, pioneers in smooth volume control, climax their efforts in this new RADIOHM. Greater effective resistance area, plus the patented frictionless contact, makes the new RADIOHM the ultimate in volume Controls.

Central Radio Laboratories, Milwaukee

Centralab

RADIOHM

When writing to advertisers mention of the PROCEEDINGS will be mutually helpful.

Institute of Radio Engineers Forthcoming Meetings

NINTH ANNUAL CONVENTION

Philadelphia, Pennsylvania

May 28, 29, and 30, 1934

LOS ANGELES SECTION

May 15, 1934

NEW YORK MEETING

May 2, 1934

PHILADELPHIA SECTION

May 3, 1934

WASHINGTON SECTION

May 14, 1934

WHAT WILL IT DO AT R.F.?

Tests on circuits and materials made at audio frequency may give data which is valid at radio frequencies—and they may not. Certainly some samples should be tested at the frequency which will be employed in practice. Such measurements are now scarcely more difficult than those made at audio frequencies.

The Type 484 Modulated Oscillator provides the power source needed for such measurements. Especially suited to the newly developed Type 516 Radio-Frequency Bridge, it is adapted to all types of radio-frequency testing when the voltage accuracy of a signal generator is not required.

Features:

Wide frequency range—
490 KC to 40 MC (five
coils.)

Small external field

Price: Oscillator \$145.00
Inductors \$8.00 each

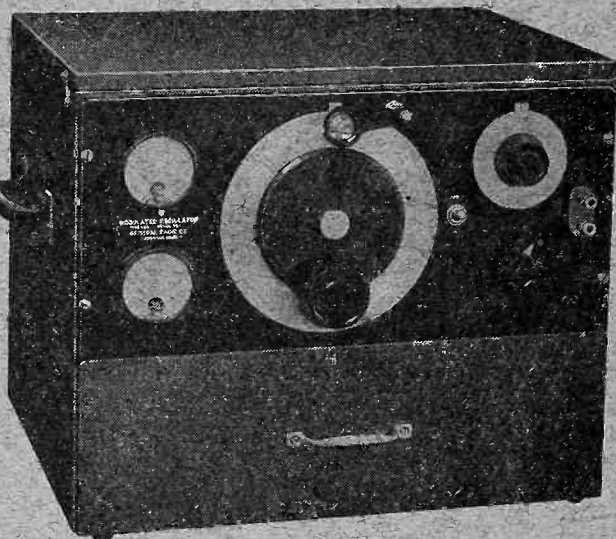

Described in Catalog G 2 R

GENERAL RADIO COMPANY
CAMBRIDGE MASSACHUSETTS