

VOLUME 21

DECEMBER, 1933

NUMBER 12

PROCEEDINGS
of
**The Institute of Radio
Engineers**



Form for Change of Mailing or Business Title on Page X

Institute of Radio Engineers Forthcoming Meetings

BOSTON SECTION
December 15, 1933

NEW YORK MEETING
January 3, 1934
February 7, 1934

WASHINGTON SECTION
December 14, 1933

PROCEEDINGS OF

The Institute of Radio Engineers

Volume 21

December, 1933

Number 12

Board of Editors

ALFRED N. GOLDSMITH, *Chairman*

R. R. BATCHER
H. H. BEVERAGE
F. W. GROVER
G. W. PICKARD

L. P. WHEELER
L. E. WHITTEMORE
WILLIAM WILSON
K. S. VAN DYKE

CONTENTS

PART I

| | |
|---|------|
| Institute News and Radio Notes..... | 1621 |
| November Meeting of the Board of Directors..... | 1621 |
| Committee Work..... | 1622 |
| Radio Transmission of Standard Frequencies..... | 1622 |
| Institute Meetings..... | 1624 |
| Personal Mention..... | 1629 |

Part II

Technical Papers

| | | |
|---|------------------------------------|------|
| A Study of Television Image Characteristics..... | E. W. ENGSTROM | 1631 |
| An Experimental Television System..... | E. W. ENGSTROM | 1652 |
| Description of an Experimental Television System and the Kinescope .. | V. K. ZWORYKIN | 1655 |
| Description of Experimental Television Transmitting Apparatus..... | R. D. KELL | 1674 |
| Description of Experimental Television Receivers..... | G. L. BEERS | 1692 |
| Vacuum Tubes of Small Dimensions for Use at Extremely High Frequen- | B. J. THOMPSON AND G. M. ROSE, Jr. | 1707 |
| cies..... | | |
| Operation of Tube Oscillators on a Common Load..... | S. I. MODEL | 1722 |
| Some Earth Potential Measurements Being Made in Connection with the | G. C. SOUTHWORTH | 1740 |
| International Polar Year..... | | |
| Note on the Theory of the Magnetron Oscillator..... | E. C. S. MEGAW | 1749 |
| Book Reviews: "Die Kathodenstrahlröhre und ihre Anwendung in der | L. P. WHEELER | 1752 |
| Schwachstromtechnik," by Manfred von Ardenne .. | | |
| Booklets, Catalogs, and Pamphlets Received..... | | 1753 |
| Radio Abstracts and References..... | | 1754 |
| Contributors to this Issue..... | | 1763 |

The Institute of Radio Engineers

GENERAL INFORMATION

INSTITUTE. The Institute of Radio Engineers was formed in 1912 through the amalgamation of the Society of Wireless Telegraph Engineers and the Wireless Institute. Its headquarters were established in New York City and the membership has grown from less than fifty members at the start to several thousand.

AIMS AND OBJECTS. The Institute functions solely to advance the theory and practice of radio and allied branches of engineering and of the related arts and sciences, their application to human needs, and the maintenance of a high professional standing among its members. Among the methods of accomplishing this need is the publication of papers, discussions, and communications of interest to the membership.

PROCEEDINGS. The PROCEEDINGS is the official publication of the Institute and in it are published all of the papers, discussions, and communications received from the membership which are accepted for publication by the Board of Editors. Copies are sent without additional charge to all members of the Institute. The subscription price to nonmembers is \$10.00 per year, with an additional charge for postage where such is necessary.

RESPONSIBILITY. It is understood that the statements and opinions given in the PROCEEDINGS are views of the individual members to whom they are credited, and are not binding on the membership of the Institute as a whole. Papers submitted to the Institute for publication shall be regarded as no longer confidential.

REPRINTING PROCEEDINGS MATERIAL. The right to reprint portions or abstracts of the papers, discussions, or editorial notes in the PROCEEDINGS is granted on the express condition that specific reference shall be made to the source of such material. Diagrams and photographs published in the PROCEEDINGS may not be reproduced without making specific arrangements with the Institute through the Secretary.

MANUSCRIPTS. All manuscripts should be addressed to the Institute of Radio Engineers, 33 West 39th Street, New York City. They will be examined by the Papers Committee and the Board of Editors to determine their suitability for publication in the PROCEEDINGS. Authors are advised as promptly as possible of the action taken, usually within two or three months. Manuscripts and illustrations will be destroyed immediately after publication of the paper unless the author requests their return. Information on the mechanical form in which manuscripts should be prepared may be obtained by addressing the secretary.

MAILING. Entered as second-class matter at the post office at Menasha, Wisconsin. Acceptance for mailing at special rate of postage is provided for in the act of February 28, 1925, embodied in Paragraph 4, Section 412, P. L. and R., and authorization was granted on October 26, 1927.

Published monthly by

THE INSTITUTE OF RADIO ENGINEERS, INC.

Publication office, 450-454 Ahnaip St., Menasha, Wis.

BUSINESS, EDITORIAL, AND ADVERTISING OFFICES

Harold P. Westman, *Secretary*

33 West 39th Street, New York, N. Y.

INSTITUTE SECTIONS

- ATLANTA—Chairman, H. L. Wills; Secretary, Philip C. Bangs, 23 Kensington Road, Avondale Estates, Ga.
- BOSTON—Chairman, E. L. Chaffee; Secretary, G. W. Kenrick, Tufts College, Mass.
- BUFFALO-NIAGARA—Chairman, L. Grant Hector; Secretary, E. C. Waud, 235 Huntington Avenue, Buffalo, N. Y.
- CHICAGO—Chairman, R. M. Arnold; Secretary, Donald H. Miller, McGraw-Hill Publishing Company, 520 N. Michigan Ave., Chicago, Ill.
- CINCINNATI—Chairman, W. C. Osterbrock; Secretary, Helen Klein, Crosley Radio Corporation, Cincinnati, Ohio.
- CLEVELAND—Chairman, P. A. Marsal; Secretary, R. P. Worden, 1629 Cordova Ave., Lakewood, Ohio.
- CONNECTICUT VALLEY—Chairman, H. W. Holt; Secretary, C. B. De Soto American Radio Relay League, 38 La Salle Rd., W. Hartford, Conn.
- DETROIT—Chairman, G. W. Carter; Secretary, E. C. Denstaedt, Detroit Police Department, Detroit, Mich.
- LOS ANGELES—Chairman, J. K. Hilliard; Secretary, N. B. Neely, 1569 Munson Ave., Los Angeles, Calif.
- NEW ORLEANS—Chairman, J. A. Courtenay; Secretary, C. B. Reynolds, Radiomarine Corporation, 512 St. Peter St., New Orleans, La.
- PHILADELPHIA—Chairman, W. F. Diehl; Secretary, G. C. Blackwood, 243 E. Upsal St., Mt. Airy, Philadelphia, Pa.
- PITTSBURGH—Chairman, Lee Sutherlin; Secretary, A. P. Sunnergren, West Penn Power Company, 14 Wood St., Pittsburgh, Pa.
- ROCHESTER—Chairman, A. E. Soderholm; Secretary, John J. Long, Radio Station WHAM, Sagamore Hotel, Rochester, N. Y.
- SAN FRANCISCO—Chairman, G. T. Royden; Secretary, R. C. Shermund, 2300-16th Ave., San Francisco, Calif.
- SEATTLE—Chairman, H. H. Bouson; Secretary, Howard Mason, 2709-4th West, Seattle, Wash.
- TORONTO—Chairman, W. F. Choat; Secretary, G. E. Pipe, Rogers-Majestic Corporation, Toronto, Ont., Canada.
- WASHINGTON—Chairman, H. G. Dorsey; Secretary, C. L. Davis, Washington Building, 15th and G Sts., Washington, D. C.

GEOGRAPHICAL LOCATION OF MEMBERS ELECTED NOVEMBER 8, 1933

Transferred to the Fellow Grade

| | | |
|------------|---|---------------|
| California | San Francisco, c/o Mackay Radio & Telegraph Co., 22 Battery St. | Royden, G. T. |
|------------|---|---------------|

Transferred to the Member Grade

| | | |
|-----------|---|-----------------|
| New York | New York City, c/o Bell Telephone Labs., 180 Varick St. | McIntosh, F. H. |
| | New York City, Radio Inventions, Inc., 41 Park Row | Miller, H. G. |
| Australia | Sydney, N.S.W., Box 3765, G.P.O. | Mingay, O. F. |

Elected to the Member Grade

| | | |
|-------------------|---|---------------|
| Dist. of Columbia | Washington, 4817-36 St. N.W., Apt. 210 | Davies, G. L. |
| | Washington, McLachlen Bldg. | Orton, W. H. |
| England | Liverpool, 18, 52 Brodie Ave., Mossley Hill | Taylor, R. H. |
| | Paddox, Rugby, "Kelvin," Shenstone Ave. | Hulme, F. H. |

Elected to the Associate Grade

| | | |
|--------------------|---|---------------------|
| Alabama | Escatawpa | Sporna, J. |
| California | Altadena, 2185 Mar Vista Ave. | Hull, R. W. |
| | Half Moon Bay | Triplett, W. R. |
| | Los Angeles, 1475 Alvira St. | Hidy, J. H. |
| | Los Angeles, 1474 S. Canfield | Sunde, H. R. |
| | Los Angeles, 2033 Victoria Ave. | Wamil, P. L. |
| | San Diego, 3443 Richmond St. | McBride, A. C., Jr. |
| | San Francisco, 311 California St., Rm. 606 | Spiegel, L. |
| | San Jose, 371 Florence Ave. | Gordon, R. H. |
| Illinois | Wheaton, 225 W. Wesley St. | Reber, G. |
| Massachusetts | Springfield, 174 Northampton Ave. | Benson, S. E. |
| Michigan | Ann Arbor, Lawyers Club | Albertson, F. W. |
| Minnesota | Anoka, 116 Gray St. | Melloh, A. W. |
| New Jersey | Haddonfield, 110 Avondale Ave. | Fernsler, G. L. |
| New York | Brooklyn, 741-57th St. | Birkeland, O. |
| | Brooklyn, 616 Nostrand Ave. | Schreiber, R. G. |
| | New York City, 3031 N. Holland Ave. | Smith, A. |
| | New York City, 413 City Island Ave. | Switzer, R. C. |
| Ohio | Toledo, 116 Boody St. | Heaton, R. W. |
| Rhode Island | Providence, 433 Friendship St. | Provost, G. O. |
| Washington | Bremerton, U.S.S. Lexington, Navy Yard | Bowers, R. W. |
| Australia | Casino, N.S.W., P.O. Box 27 | Cradick, S. T. |
| | Melbourne, C.1, Victoria, P.M.G.'s Research Labs., 59 Lt. Collins St. | Badenach, R. M. |
| Brazil | S. Paulo, Rua Augusta 89 | Jones, E. Y., Jr. |
| Canada | Toronto, Ont., 1590 Bathurst St. | Isserstedt, S. G. |
| | Montreal, P.Q., 2353 St. Antoine St. | Truesdell, E. |
| England | Cheltenham, Gloucester, "Whitfield," Harp Hill | Webb, C. B. N. |
| | Crumpsall, Manchester, 56 Kearsley Rd. | Simpson, G. |
| | Leeds, Yorkshire, 29 Cliff Mount, Hyde Park | Booth, A. E. |
| | Norwich, Norfolk, 132 Trafford Rd. | Rudd, G. A. |
| France | Nanterre (Seine), 49 Rue du Chemin de Fer | Maget, R. |
| Holland | Rotterdam, 91 Kralingscheplaslaan | Blom, P. |
| Norway | Oslo, Prinsengate 2 | Hielm, J. A. |
| Philippine Islands | Manila, 418 Santa Mesa St. | Palenzuela, V. V. |

Elected to the Juuioir Grade

| | | |
|------------|------------------------------------|-------------------|
| California | Huntington Park, 3113 Broadway St. | Von Werner, W. K. |
|------------|------------------------------------|-------------------|

Elected to the Student Grade

| | | |
|------------|--|--------------------|
| California | Berkeley, Bowles Hall, University of Calif. Campus | Thorne, B. W., Jr. |
| | San Francisco, 4141-24th St. | Kusich, E. A. |



APPLICATIONS FOR MEMBERSHIP

Applications for transfer or election to the various grades of membership have been received from the persons listed below, and have been approved by the Admissions Committee. Members objecting to transfer or election of any of these applicants should communicate with the Secretary on or before December 30, 1933. These applications will be considered by the Board of Directors at its meeting on January 3, 1934.

For Election to the Associate Grade

| | | |
|----------------------|--|-------------------|
| California | Berkeley, 205 The Uplands | Tonjes, V. |
| | Palo Alto, R.F.D. 1, Box 586 M | Klipsch, P. W. |
| | San Pedro, NC Division, USS Chicago, c/o P.M. | Waldron, G. R. |
| Connecticut | Middletown, Box 369 Wesleyan Station | Walstrom, J. E. |
| District of Columbia | Washington, 1112 Connecticut Ave. | Seccombe, W. T. |
| Massachusetts | Leominster, 9 Prescott St. | Cialdea, G. M. |
| | North Quincy, 37 Webster St. | Thomas, W. D. |
| Minnesota | Northfield, Radio Station WCAL | Jensen, M. |
| New Jersey | Cranford, 19 Adams Ave. | Fulmer, J. W. |
| | Short Hills, 100 Hobart Ave. | Abel, W. K. |
| New York | Brooklyn, 798 Myrtle Ave. | D'Agostino, V. F. |
| | Brooklyn, 93 Monitor St. | Graham, W. A. |
| | New York City, 195 Broadway, Rm. 2006 | Campbell, R. D. |
| | New York City, 215 W. 101st St. | Hartley, J. D. |
| | New York City, 150 W. 104th St. | Ryden, N. G. |
| Ohio | Cincinnati, 579 Terrace Ave. | Adams, R. F. |
| Texas | Dallas, Radio Station KRLD | Peterson, D. A. |
| Australia | Sydney N.S.W. c/o R. W. Reynolds, Ltd., 200 Chalmers St. | Cohen, L. |
| China | Shanghai, c/o Anderson Meyer & Co., P.O. Box 265 | Chu, M. C. |
| England | Bristol, 6 Cotham Lawn Rd. | Pinto, C. |
| | Halifax, 7 Wade St. | Jackson, F. S. |
| | London N. W. 3, 39 Glenmore Rd., Belsize Park | Jayasekara, D. P. |
| | London S. W. 17, 30 High St., Tooting | Jones, S. L. |
| | Mayford, Woking, Mayford Villa | Anderson, C. A. |
| | Portsmouth, Hants., 149 Eastney Rd. | Thomas, W. J. |
| France | Viarmes (S & O) 36 rue aux Fees | Wybrands, K. |
| New Zealand | Kaitaia, North Auckland | Snelgar, I. J. |
| | New Brighton, Christchurch, 174 Baker St. | Watkins, E. K. C. |
| North Wales | Colwyn Bay, Plas Cadnant, Woodland Park | Parry, L. |
| Straits Settlements | Penang, 26 Kampong Kolam | Hoe, T. S. |
| Sweden | Lidingo 2 | Brigge, G. A. |

For Election to the Junior Grade

| | | |
|------------|---|-----------------|
| New Jersey | Wildwood, 113 E. Young Ave. | Jimerson, O. J. |
| New York | New York City, 615 W. 136th St. Apt. 17 | Zahn, K. W. |
| Utah | Salt Lake City, 177 E. 24th S. | Jones, R. F. |

For Election to the Student Grade

| | | |
|---------------|---|------------------|
| California | San Francisco, 3773—20th St. | O'Brien, M. P. |
| | Stanford University, P. O. Box 544 | Summerlin, W. T. |
| Georgia | Atlanta, 792 Techwood Dr. | Mohler, V. E. |
| Massachusetts | Cambridge, c/o Superintendent's Office, 69 Massachusetts Ave. | Maximoff, B. S. |
| Minnesota | Minneapolis, 3035—40th Ave. S. | Hauser, P. D. |
| | Minneapolis, 130 Arthur Ave. | Henrici, C. R. |
| | Minneapolis, 815—8th Ave. S. | Jacobs, M. |
| | Minneapolis, 3703 Washburn Ave. N. | Jensen, O. H. |
| | Minneapolis, 307—16th Ave. S. E. | Martin, C. A. |
| | Minneapolis, 516 Ontario St. S. E. | Newhouse, A. B. |
| | Minneapolis, 1219 University Ave. S. E. | Sather, O. J. |
| | Minneapolis, Pioneer Hall, Univ. of Minn. | Schott, O. A. |
| | Minneapolis, 2714—4th St. N. | Smith, M. R. |
| | Minneapolis, 621 Oak St. S. E. | Turnquist, A. G. |
| | St. Paul, 855 Edmund St. | Boese, W. C. |
| New York | Flushing, 4645—156th St. | McGirr, R. |
| Pennsylvania | Norwood, Del. Co., 308 Urban Ave. | Osterlund, J. A. |
| | Philadelphia, 6218 Catherine St. | Boghosian, W. H. |
| | Philadelphia, 2021 S. 7th St. | Hoffman, J. |

OFFICERS AND BOARD OF DIRECTORS, 1933

(Terms expire January 1, 1934, except as otherwise noted)

President

L. M. HULL

Vice President

JONATHAN ZENNECK

Treasurer

MELVILLE EASTHAM

Secretary

HAROLD P. WESTMAN

Editor

ALFRED N. GOLDSMITH

Directors

M. C. BATSEL

J. V. L. HOGAN

C. M. JANSKY, JR.

R. H. MANSON, *Junior Past President*

E. R. SHUTE

A. F. VAN DYCK

WILLIAM WILSON

Serving until January 1, 1935

W. G. CADY, *Junior Past President*

O. H. CALDWELL

C. W. HORN

E. L. NELSON

Serving until January 1, 1936

R. A. HEISING

H. M. TURNER

F. A. KOLSTER

INSTITUTE NEWS AND RADIO NOTES

November Meeting of the Board of Directors

The November meeting of the Board of Directors was held on the 8th at the Institute office in New York City, and was attended by L. M. Hull, president; Melville Eastham, treasurer; O. H. Caldwell, Alfred N. Goldsmith, R. A. Heising, J. V. L. Hogan, C. M. Jansky, Jr., F. A. Kolster, R. H. Manson, E. L. Nelson, H. M. Turner, A. F. Van Dyck, William Wilson, and H. P. Westman, secretary.

G. T. Royden was transferred to the Fellow grade, F. H. McIntosh, H. G. Miller, and O. F. Mingay were transferred to the Member grade and G. L. Davies, F. H. Hulme, W. H. Orton, and R. H. Taylor were admitted directly to the grade of Member. Thirty-four applications for Associate grade, one for the Junior grade, and two for the Student grade of membership were approved.

The report of the Tellers Committee was accepted, and the following declared elected:

| | |
|-------------------------|-------------------------|
| For President 1934 | C. M. Jansky, Jr. |
| For Vice President 1934 | Balth. van der Pol, Jr. |
| For Directors 1934-1936 | Arthur Batcheller |
| | Alfred N. Goldsmith |
| | William Wilson |

Dr. Goldsmith was reappointed the Institute's representative on the Standards Council of the American Standards Association and the secretary was appointed alternate representative thereon.

A gift of approximately \$2000 was presented to the Institute for such use as the Board of Directors may decide. This sum is the balance of an account which remained after the dissolution of "Associated Radio Manufacturers," an advisory group originally formed some years ago. The use to which this fund will be put will be determined later after the matter has been given careful consideration.

In a discussion of the operation of the Industrial Relations Committee, it was agreed that the membership of the committee should be expanded and a number of names of suitable members were discussed.

The Emergency Employment Service continues in operation and during the month of October located five permanent and ten temporary positions for members registered with it. Twenty-five additional members registered bringing the total registration to 668. Employers desiring engineers or technicians are urged to take advantage of this service which is maintained without charge to either employers or prospective employees. Members hearing of available positions will be

assisting the Institute and their fellow members by bringing such information to the attention of the secretary.

Committee Work

INDUSTRIAL RELATIONS COMMITTEE

A luncheon meeting of the Industrial Relations Committee was held at the Chemists Club, New York City, at 1:00 P.M. on November 8. Those present were: L. M. Hull, chairman; O. H. Caldwell, C. M. Jansky, Jr., and H. P. Westman, secretary.

The committee discussed its organization and considered in a preliminary fashion certain problems which are to be given its attention when the personnel of the committee has been expanded.

NEW YORK PROGRAM COMMITTEE

The New York Program Committee held a meeting on October 26 at the Institute office. Those present were C. W. Horn, chairman; H. H. Beverage, I. S. Coggeshall (representing E. R. Shute), H. C. Gawler, L. C. F. Horle, F. B. Llewellyn (representing R. A. Heising), and H. P. Westman, secretary.

The past several meetings in New York were reviewed and preparations made for meetings to be held in December and January.

MEMBERSHIP COMMITTEE

The Membership Committee held a meeting on November 8 at the Institute office. H. C. Gawler, chairman; Knox McIlwain of the Philadelphia Section, C. R. Rowe, E. W. Schaefer and Jack Yolles (representing David Grimes), were present.

Consideration was given to the drafting of a message to the membership to stimulate the obtaining of new members.

Radio Transmissions of Standard Frequencies

The Bureau of Standards transmits standard frequencies from its station WWV, Beltsville, Md., every Tuesday except legal holidays. The transmissions are on 5000 kilocycles per second. The transmissions are given continuously from 12 noon to 2 P.M., and from 10:00 P.M. to midnight, Eastern Standard Time. The service may be used by transmitting stations in adjusting their transmitters to exact frequency, and by the public in calibrating frequency standards, and transmitting and receiving apparatus. The transmissions can be heard and utilized by stations equipped for continuous-wave reception through the

United States, although not with certainty in some places. The accuracy of the frequency is at all times better than one cycle per second (one in five million).

From the 5000 kilocycles any frequency may be checked by the method of harmonics. Information on how to receive and utilize the signals is given in a pamphlet obtainable on request addressed to the Bureau of Standards, Washington, D.C.

The transmissions consist mainly of continuous, unkeyed carrier frequency, giving a continuous whistle in the phones when received with an oscillating receiving set. For the first five minutes the general call (CQ de WWV) and announcement of the frequency are transmitted. The frequency and the call letters of the station (WWV) are given every ten minutes thereafter.

Supplementary experimental transmissions are made at other times. Some of these are made at higher frequencies and some with modulated waves, probably modulated at 10 kilocycles. Information regarding proposed supplementary transmissions is given by radio during the regular transmissions.

The Bureau desires to receive reports on the transmissions, especially because radio transmission phenomena change with the season of the year. The data desired are approximate field intensity, fading characteristics, and the suitability of the transmissions for frequency measurements. It is suggested that in reporting on intensities, the following designations be used where field intensity measurement apparatus is not used: (1) hardly perceptible, unreadable; (2) weak, readable now and then; (3) fairly good, readable with difficulty; (4) good, readable; (5) very good, perfectly readable. A statement as to whether fading is present or not is desired, and if so, its characteristics, such as time between peaks of signal intensity. Statements as to type of receiving set and type of antenna used are also desired. The Bureau would also appreciate reports on the use of the transmissions for purposes of frequency measurement or control.

All reports and letters regarding the transmissions should be addressed to the Bureau of Standards, Washington, D.C.

Incorrect Addresses

On pages VII, VIII, and IX of the advertising section of this issue will be found the names of those members of the Institute whose correct addresses are not known. It will be appreciated if anyone having information concerning the present addresses of any of the persons listed will communicate with the Secretary of the Institute.

Proceedings Binders

Binders for the PROCEEDINGS, which may be used as permanent covers or for temporary transfer purposes, are available from the Institute office. These binders are of handsome Spanish grain fabrikoid, in blue and gold. Wire fasteners hold each copy in place, and permit removal of any issue from the binder in a few seconds. All issues lie flat when the binder is open. Each binder will accommodate a full year's supply of the PROCEEDINGS, and they are available at one dollar and seventy five cents (\$1.75) each. Your name, or PROCEEDINGS volume number, will be stamped in gold for fifty cents (50¢) additional.

1933 Index

Following page 1763 of this issue there will be found an Index for the year 1933. This is divided into three parts: First, there is a Chronological Index; second, an Authors Index; and third, a Subject Index.

Institute Meetings

BUFFALO-NIAGARA SECTION

A meeting of the Buffalo-Niagara Section was held at the University of Buffalo on October 26. L. Grant Hector, chairman, presided and the attendance totaled thirty-two.

A paper by H. E. West, district engineer of the American Telephone and Telegraph Company on the subject of "Relations of the Telephone Company to Network Broadcasting" was presented. The subject was treated from the standpoint of the character of the listener's interests and the facilities provided to fulfill or stimulate this interest. The telephone network used in broadcasting and the development and improvements to keep it technically in line with developments in broadcast transmission were described. The paper was closed with details of special lines, cables, and associated apparatus used for broadcast services. A general discussion followed.

CHICAGO SECTION

R. M. Arnold, chairman, presided at the October 27 meeting of the Chicago Section held in the auditorium of the Western Society of Engineers.

A paper on "Radio Circuits Applied to New Uses" was presented by Keith Henney of the publication staff of "*Electronics*." The paper

was based upon the application of typical radio circuits for such devices as amplifiers, oscillators, and rectifiers for application to non-radio uses such as production testing, industrial control, electrical, and physical measurements. A number of examples of the use of radio circuits for industrial and commercial purposes were presented. It was pointed out that radio engineers should not ignore these new services which are being required as they are in particularly advantageous positions to supply the necessary technical services in the adaptation of electronic tubes for other than the communications industry.

Messrs. Arnold, Hoag, Mathias, and Rodriguez participated in the discussion of the paper. The attendance at the meeting totaled 100.

CINCINNATI SECTION

A meeting of the Cincinnati Section was held on September 26 at the University of Cincinnati. W. C. Osterbrock, chairman, presided and the attendance totaled seventy-five.

A paper on "Loud Speaker Theory, with Comments on Phases of Hearing" was presented by F. W. Kranz of the Magnavox Company.

Dr. Kranz devoted most of his paper to the relation between the electrical and mechanical systems of a loud speaker. He showed the mathematical equivalents used to determine electrically the mechanical action of a speaker and to treat the mechanical system as an equivalent electrical system to determine its performance. He closed his paper with a brief historical sketch of various theories of hearing and their plausibility.

The October meeting of the Cincinnati Section was held on the 17th for the presentation of a paper on "WLW's New 500,000-Watt Transmitter" by J. A. Chambers, technical director of WLW and WSAI. The meeting was held jointly with the Cincinnati Section of the American Institute of Electrical Engineers and was presided over by L. C. Nowland, chairman of that organization.

The first portion of the meeting was an inspection trip to the new WLW transmitter located at Mason, Ohio. Small groups were formed and supplied with guides who conducted them through the building explaining the various items of interest. The new 830-foot vertical antenna which is now being used attracted considerable attention.

After visiting the station, the meeting was adjourned to the studios of WLW in Cincinnati where Mr. Chambers presented a paper on the technical side of radio broadcasting. Starting with the program as it originates in the program committee, he traced its course through artist selection, continuity department, rehearsals, and the final per-

formance. He then outlined the present studio set-up and the new transmitter which is being installed.

Approximately 200 were present at both the transmitter and the studio.

CONNECTICUT VALLEY SECTION

A meeting of the Connecticut Valley Section was held at the Hotel Charles in Springfield, Mass., on October 26. H. W. Holt, chairman, presided and thirty-six members and guests were in attendance.

The first speaker at the meeting was L. F. Curtis, chief engineer of the United American Bosch Corporation, who reported on the national convention held in Chicago in June. He discussed not only the number of technical papers which were presented but covered certain committee meetings which were held.

A paper on "Electron-Coupled Oscillators" was then presented by M. R. Briggs of the Westinghouse Electric and Manufacturing Company. The author discussed first the use of master oscillator arrangements in general, and pointed out their utility and applicability. The cause of frequency instability with changes in load or operating voltages was analyzed mathematically, and the superiority of the electron-coupled type of oscillator treated. Examples cited showed frequency changes of less than 0.0025 per cent with twenty per cent changes in operational voltages easily realized; the equivalent factor for the usual master oscillator is 0.025 to 0.04 per cent. There was then considered the performance of different types of tubes in electron coupled circuits ranging from the 24A through the 865 and the 850 to the 860. This latter tube seems to be ideal, combining high power output with excellent frequency stability. The paper was concluded with the description of a special triode Colpitts circuit comparable in frequency stability as regards changes in operating voltages but which is inferior to the electron coupled oscillator in respect to a changing load.

In the discussion which followed, J. J. Lamb described an oscillator combining crystal control and electron coupling. B. V. K. French pointed out difficulties in connection with the operation of tube cathodes at radio-frequency voltages above the heater potential in electron-coupled circuits. Frequency shifts due to interchanging of tubes of the same type was discussed, and the maximum change was indicated as being of the order of 0.02 per cent.

DETROIT SECTION

The Detroit News Conference room was the place in which the October 20 meeting of the Detroit Section was held. In the absence of the chairman, A. B. Buchanan presided.

A paper on "Universal Radio Receivers" was presented by R. P. Wuerfel. The speaker presented a brief history of the development of receivers for home use and described the various developments which made possible the universal alternating—direct-current receiver. After a short discussion of the first universal receivers and their difficulties such as excessive heat and heater-cathode insulation breakdown, the limitations of the sets were considered. The public acceptance of this type of receiver was considered unusual and much beyond early expectations.

A number of the forty-five members and guests in attendance participated in the discussion which covered to a large extent a résumé of recent developments which will contribute to a more ideal broadcast receiver.

NEW YORK MEETING

The November New York meeting of the Institute was held on the 8th in the Engineering Societies Building, and was presided over by President Hull.

A paper on "High Quality Radio Broadcast Transmission and Reception" was presented by Stuart Ballantine, President of the Boonton Research Corporation of Boonton, N. J. The author presented the results of a detailed survey of the current American broadcast system from microphone to loud speaker, principally from the viewpoint of frequency and amplitude distortion. The main difficulties and sources of distortion in the system were pointed out and remedies suggested.

A special program was broadcast from WABC through the co-operation of the Columbia Broadcasting System and permitted the demonstration of high quality reception. The program as reproduced by the receiver was compared directly with the reproduction obtained from a high fidelity amplifier operated directly from a short telephone line between the station studio and the Engineering Societies building. The effects upon fidelity of transmitting a program over approximately 2000 miles of telephone circuits were shown. The time required for transmission over this long line was audibly demonstrated by reproducing a program originating in New York by means of a high quality receiver and comparing it with the output of the telephone circuit which was passed through a suitable amplifier and separate loud speaker. On speech, a very definite delay was apparent.

The attendance at the meeting was 650.

SAN FRANCISCO SECTION

A meeting of the San Francisco Section was held on October 18 at the Bellevue Hotel. A. H. Brolley, vice chairman, presided.

A paper on "Servicing of Broadcast Receivers" was presented by Charles Herbst, Jr. A general discussion followed the presentation of the paper and a special demonstration of new 16-millimeter sound film was given. The attendance at the meeting totaled forty-two, and eight were present at the informal dinner which preceded it.

SEATTLE SECTION

The Seattle Section held a meeting on September 30 at the University of Washington. H. H. Bouson, chairman, presided, and the attendance was seventy-five.

A paper on "Mercury-Vapor Tubes" was presented by A. V. Eastman of the University of Washington. The speaker first outlined the characteristics of various types of filaments and their suitability for use in high vacuum rectifier tubes as well as in low voltage gaseous rectifiers, commonly used in charging storage batteries. Other characteristics of these two types of rectifier tubes were covered and it was shown how a mercury-vapor tube retains the desirable features of each while avoiding their disadvantages.

Typical circuits for mercury-vapor rectifiers were given, and the relation of peak inverse to output voltage discussed. The development of the heat-shielded cathode and the importance of correct bulb temperature and its influence on gas pressure was then discussed.

The action of the grid in a mercury-vapor tube was described. An experimental set-up using a type 54 thyratron was used to demonstrate grid control with both alternating- and direct-current plate power. The control by shifting the phase of the grid voltage was also demonstrated. The meeting concluded with a general discussion chiefly concerned with the characteristics and applications of mercury-vapor tubes.

The October meeting of the Seattle Section was held on the 27th at the University of Washington with H. H. Bouson, chairman, presiding.

A paper on "The Government Monitoring Station at Portland, Oregon" was presented by R. H. Landsburg who has been in charge of this station since it was placed in operation a few years ago. A general schematic layout of the station was presented, and the method of checking the frequency of broadcast stations was described. A thirty-kilocycle crystal was used as a secondary standard, and multivibrators were driven from this source to give frequencies of 0.1, 1.0, and 100 kilocycles. By using multiples of these frequencies and a calibrated audio oscillator broadcast stations in the northwest and Alaska may be checked within an accuracy of a few cycles. In closing, the speaker

pointed out that commercial and amateur stations were checked periodically including short-wave stations as far East as New York.

The meeting was attended by forty-two members and guests.

WASHINGTON SECTION

A meeting of the Washington Section was held on October 12. H. G. Dorsey, chairman, presided, and the attendance was forty-two. Thirteen were present at the informal dinner held prior to the meeting.

"Sound Recording on Sixteen-Millimeter Film" was the subject of a paper by E. W. Kellogg of the RCA Victor Company. In it, the speaker outlined the development of sound moving pictures, the recording of sound of film, and the problems encountered in the design of satisfactory equipment for recording on sixteen-millimeter film. The quality of recording and reproduction on the smaller film was compared with that obtainable with thirty-five-millimeter film.

A sixteen-millimeter sound on film projector and a compact lightweight camera were then described. The camera was adapted for direct recording by the installation of a microphone in its back. No amplifying equipment was necessary. Another model of camera for use in recording sound other than the voice of the person operating it was also discussed. A demonstration was given to show the quality of reproduction obtainable when the original recording was on thirty-five-millimeter film and was reduced for sixteen-millimeter use as well as when the original recording was done directly on sixteen-millimeter film.

Personal Mention

Formerly with the Motorvox Company, A. C. Bernstein has become chief engineer for H. Wall of Paris, France.

H. W. Byler previously with the RCA Victor Company has become factory superintendent for the Philco Storage Battery Company in Philadelphia.

G. A. J. Glover is now chief engineer for Mobile Broadcasting Service of Melbourne, Australia, having formerly been connected with Firth Brothers.

C. J. Larsen formerly consulting engineer for the American Telephone and Telegraph Company has joined the Research Department of Associated Electric Laboratories of Chicago.

Formerly with the Jewell Electrical Instrument Company, J. Remde is now director of the Service Instruments Laboratories of Chicago, Ill.

H. M. Threlkeld previously with the Grigsby-Grunow Company left to join the engineering staff of General Household Utilities Company of Chicago, Ill.

W. H. Wenstrom, Lieutenant USA, has been transferred from Fort Monmouth to California Institute of Technology, Pasadena, Calif.

H. L. Byerlay formerly with the Michigan Bell Telephone Company has joined the faculty of Lawrence Institute of Technology at Highland Park, Mich.

H. L. Griffiths has left Marconi's Wireless Telegraph Company to join the staff of the British Broadcasting Corporation staff at Tatsfield, Kent, England.



TECHNICAL PAPERS

A STUDY OF TELEVISION IMAGE CHARACTERISTICS*

BY

E. W. ENGSTROM

(RCA Victor Company, Inc., Camden, New Jersey)

Summary—An investigation was carried out to obtain quantitative information on the several characteristics of television images, particularly those relating to image detail. The tests were conducted largely through the use of equivalents so as to provide sufficient range of measurement. Such data are of value in establishing operating standards, determining satisfactory performance, and in guiding development work. It was found possible to define satisfactory television image characteristics for those items studied. The results are given in such form as to be readily applicable to practical conditions.

INTRODUCTION

BECAUSE of the lack of quantitative measures of performance, expression of the degree of satisfaction provided by a television image has been bounded on one hand by the optimism or conservatism of the observer, and on the other hand by the practical limitations which prevent for the moment an increase of picture detail, picture steadiness, picture illumination, picture contrast, and frame repetition frequency. It is the purpose of this paper to describe investigations made regarding some of these picture properties.

Picture detail is determined by the quantity of information that the entire system can handle in a given time. Also, the communication band is proportional to the frame repetition frequency. (Frame repetition frequency determines steadiness of action and picture flicker.) Optical, sensitivity, and transformation problems are present in the pick-up gear and become apparent as attempts are made to go beyond present practical limits. Somewhat similar problems are present in the reproducing elements. These limits are contingent upon the particular state of the art, and, therefore, are constantly receding and yielding to development.

Since the frequency band required is proportional to the quantity of information to be transmitted, the limitations of the electrical channels must be considered. These problems include the ability to handle wide frequency bands and to provide space in the radio spectrum

* Decimal classification: R583. Original manuscript received by the Institute, February 20, 1933.

for television channels. This may be illustrated by the following table for certain conditions which are stated.

Aspect Ratio 1.33 (4×3).

Frame Repetition Frequency 24 per second.

Picture Frequency

It is assumed that the picture resolution along the scanning line is approximately the same as the width of the scanning line (square picture elements) and that each picture element (of maximum resolution) requires one-half cycle for transmission in elemental form. The maximum picture frequency, therefore, determines the steepness of wave front of change in contrast along the scanning line.

It is also assumed that pictures will be transmitted for ninety per cent of the total time, the remaining ten per cent being necessary for control functions.

| Scanning Lines | Picture Elements | Maximum Picture Frequency | Maximum Picture Communication Band |
|----------------|------------------|---------------------------|------------------------------------|
| 60 | 4,798 | 63,970 | 127,900 |
| 120 | 19,200 | 256,000 | 512,000 |
| 180 | 43,190 | 576,000 | 1,152,000 |
| 240 | 76,780 | 1,024,000 | 2,048,000 |
| 360 | 172,800 | 2,302,000 | 4,604,000 |
| 480 | 307,100 | 4,094,000 | 8,188,000 |

The limitations present in the electrical circuit are also determined by the state of the art at any particular time, and, therefore, are subject to advances as a result of development. It is probable that the ultimate limit may be the space available for television channels in the radio spectrum.

GENERAL CONSIDERATION OF IMAGE CHARACTERISTICS

Determination of satisfactory picture quality in television images is difficult because of the inadequacy of present television apparatus for such a study and because the reactions involved are largely psychological and physiological. During the growth of television detail, as the development work has progressed, improvement of picture quality has been noted, for example, through stages of a , $2a$, $3a$, and $4a$ scanning lines, where $4a$ represents the present practical limits. We are not in a position to work with and study $5a$, $6a$, etc., scanning lines in such a determination. Therefore, in studies of picture detail, picture size, and viewing distance, many subterfuges have been used.

Because of the wealth of detail, extreme ranges of brightness, and contrast in nature, the eye tends to demand image resolution up to the acuity and perception limits of the eye. We have, however, become accustomed to certain compromises in these image characteristics

through long association with paintings, photographs, projected transparencies, and other forms of reproduction, because of the limitations of these agencies of reproduction.

The perception of form or acuity of the eye is usually defined as the minimum angular separation which permits resolution of two point objects. For the average normal eye this approximates one minute of arc for that portion of the field which falls on the fovea of the retina. Other measures include minimum dimensions for seeing a point, line, or separation between two lines or groups of lines, change of contour, etc. Some of these become rather indefinite if the object is self-luminous. Other eye characteristics of interest in such a study include per-

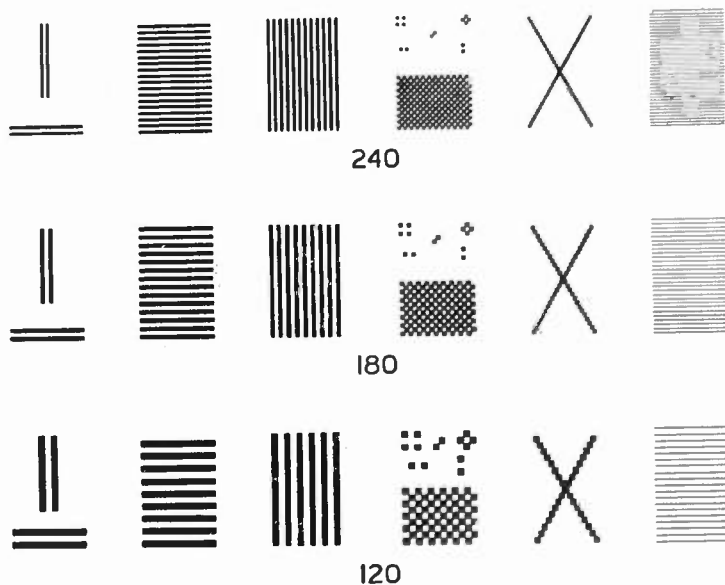

Fig. 1

ception of movement, perception of contrast, color vision, color sensitivity, perception of light, and effects of flicker.

Elementary studies of some properties of vision may be made through the use of the chart indicated by Fig. 1. This chart includes a group of patterns which may be obtained from the scanning system used in television. The numbers under each group indicate the total number of scanning lines for the height of the chart. This chart assumes equal horizontal and vertical resolution for the groups of five figures to the left of the chart. It also assumes that the scanning lines will coincide with the detail structure (of same width as scanning line) of the chart scanned, so as to provide the greatest possible detail in the chart reproduced for a given number of scanning lines. The fine grating to the right of the chart indicates the scanning line paths. No particu-

lar attempt was made to avoid optical illusions, but it is believed that the figures are sufficiently free to avoid mistakes in judgment.

Relationship of picture size, picture detail, and viewing distance, is of interest in studying television images. This relationship may be approached from theoretical considerations of providing sufficient detail to satisfy the acuity of the eye. We may start with the definition of acuity for the average normal eye (one minute of arc for that portion of the field which falls on the fovea of the retina). This is justified even though the image may be so large as not to be included within the relatively small field of most acute vision, since the eye naturally tends to explore the entire image, and the image is, therefore, subjected in all its parts to the finest resolution of the eye.

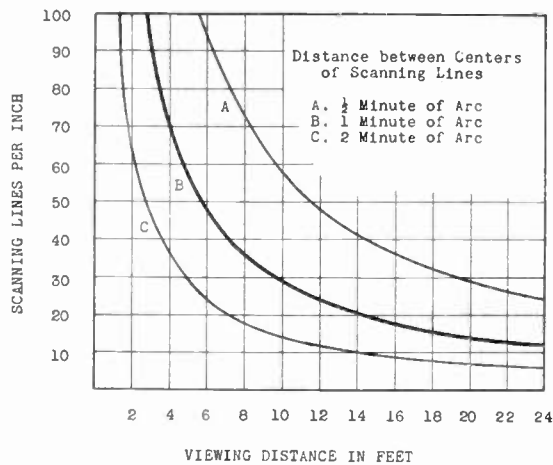

Fig. 2

Since the resolving properties of the eye are so definitely tied up with the type of detail to be analyzed, we shall choose for this theoretical consideration a very specific definition of acuity. For this example we shall use two black lines separated by a white space equivalent to the width of one of the lines, such as the pairs of lines in the groups to the left of the chart. If such lines, for a particular viewing point, are separated so that the distance between them subtends an angle to the eye of one minute, then the average eye will be able to see them as two lines. At greater viewing distances the two lines will blur into one. In order to keep our discussion in terms of scanning lines, the curve to follow will be plotted in terms of scanning lines against viewing distances. For the two horizontal lines it is necessary to have one scanning line for each line and one scanning line for the space between lines. Since, by definition, the space between lines must subtend an angle of one minute, then the width of each scanning line or, in other words, the distance between centers of scanning lines, also subtends an angle

of one minute. Fig. 2 includes a calculated curve indicating for various viewing distances the number of scanning lines per inch required for a one minute of arc separation between centers of scanning lines. For later reference, curves are also shown for one-half-minute and two-minute arc distances between centers of scanning lines.

In using these curves it is necessary to understand the span or variation of eye acuity for different people. For the type of detail we are considering, this span is probably from approximately one-half minute to approximately one and one-half minutes—one minute being used as the average. This is pointed out specifically because of this wide variation and the difficulty of dealing with a definite average value.

By inspection of this curve (the one-minute curve) we are able to determine (within the scope of our definition) the amount of detail in terms of scanning lines for still images at various viewing distances for the "average eye." If, for viewing distance X , the curve indicates that Y scanning lines should be provided, then the eye will be satisfied at this viewing distance for a detail of Y scanning lines. For closer viewing distances and Y scanning lines, the eye will not be satisfied since the picture structure will be pronounced, resulting in "lack of detail." For greater viewing distances and Y scanning lines, the eye will be satisfied from the standpoint of detail, but more detail is available than required by eye acuity.

In order to make some practical tests, a number of observations were made using charts of the type shown in Fig. 1. Three charts were used—one two and one-half inches high, the second five inches high, and the third twenty inches high—so as to provide an effective range of scanning lines of from 60 to 480. Tests were made by three people having good vision and having no known eye defects. The tests were conducted by placing the charts on a wall at eye level in a room having uniform daylight illumination (mainly sky light since the sun did not strike the windows). The illumination at the chart was between 20 and 40 foot candles. The contrast on the charts was the maximum possible in a normal photographic print.

The pairs of lines to the left of the chart were used to obtain data for the first curve. For each degree of "scanning line detail" a viewing distance was chosen at which the two lines could just be resolved; at greater distances the two lines blurred into one. At this same viewing distance the group of horizontal and the group of vertical lines (the second and third groups of figures from the left) could just be resolved into lines; at greater distances they blurred into a uniform gray. The curve plotted in Fig. 3 is the average for the three observers. A curve

was plotted for resolving the two squares, a part of the fourth group from the left (the two squares at the left, just above the checkerboard pattern). A curve was plotted for resolving the checkerboard pattern, in the lower half of the fourth figure from the left. A curve was also plotted for the crossed lines, the fifth figure from the left. In this case the viewing distance chosen was the point at which the line structure could just be seen; at greater viewing distances the line structure was missing, and the cross appeared to be made up of two straight lines of constant width. All of the curves were plotted using the average viewing distance for the three observers. An interesting point noted from the observations was the consistency of the viewing distances chosen. Two of the observers picked viewing distances very nearly the same.

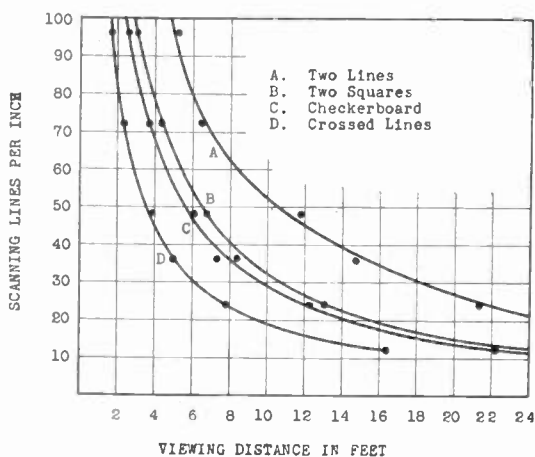

Fig. 3

The third observer picked viewing distances slightly greater (10 to 20 per cent). In the case of the third observer, this difference was consistent for all of the tests. These curves indicate the range of satisfactory viewing distances for the types of detail chosen. In general, the detail types probably do not cover the extremes, but do cover at least the average range encountered in scanned television images. Some interesting deductions may be made by comparing these data with the theoretical curves for one-half, one, and two minutes of arc separations between center lines of scanning paths. For convenience these curves are shown in Fig. 4, superimposed. The data from the observations are indicated by a dark band including the span between the test for the two lines and the test for the crossed lines of the previous curves. The one-half-, one-, and two-minute arc curves are shown as solid lines. The data presented in Fig. 4 indicate that the types of detail on which the tests were made require, for any chosen viewing distance, a range of from a little over one-half minute to a little less than two minutes of

arc separation between centers of scanning lines. It is also indicated that the average acuity of the three observers is above that of the "average eye"—near the upper limit of acuity. From the standpoint of these tests and the tests to follow, this is a safe condition because, for any viewing distance, detail satisfactory to this group of three observers will certainly be satisfactory to the average observer.

In viewing reproductions the observer tends to position himself so that he is satisfied regarding the information and the effect he wishes to obtain. (The position or viewing distance for greatest resolution is about eight to ten inches for the average person.) Because of habit and experience we have learned to temper our acuity demands. The following generalizations are of interest, and are given in terms of

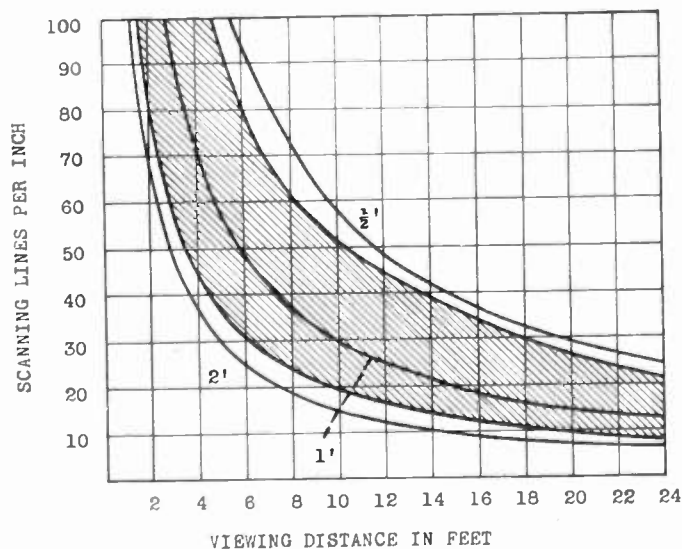

Fig. 4

general experience rather than technical knowledge. When viewing a painting we rather unconsciously choose a position where the brush stroke detail becomes unnoticeable, and where we obtain the effect the artist wished to convey. We have learned that a newspaper illustration contains only a certain amount of detail, and that such illustrations will not bear close inspection. We also know in general what to expect from motion pictures of the theater and home types. We, further, know that good photographs go beyond the acuity limits of the eye, and that the field may be optically enlarged to improve the resolution. Other examples could be given, but the above are sufficient to illustrate the effect of experience on the average person.

The value of the above curves is to indicate the maximum useful detail from the standpoint of eye acuity, assuming favorable conditions for all other related factors. For a particular viewing distance, the

amount of detail required in a reproduction (still image) is dependent upon the type of information to be conveyed by the picture. Since this varies, it is safe to assume that, for limiting conditions, detail corresponding to that indicated by the curves should be provided. For average conditions and for general use it is also safe to assume that sufficient satisfaction can be provided by considerably less detail than that indicated. This is verified by the various types of printed reproductions.

DETERMINATION OF SCANNING LINES, PICTURE SIZE, AND VIEWING DISTANCE FOR TELEVISION IMAGES

It is difficult to interpret television image quality in terms of the relationships discussed. The first reason for this is that television images are the result of scanning at the pick-up end which introduces an aperture effect, and at the reproducing end the aperture effect is introduced for the second time. This results in a definite and peculiar line and detail structure. Detail along each line is dependent upon the ability of the system to reproduce changes in contrast. The second reason is that television images are made up of rapidly superimposed, individual pictures much the same as motion pictures. The third reason is that television images usually include motion having certain continuity. The effects of motion will be taken up more in detail later in the paper.

Photographs have been made which consist of scanned reproductions of an ordinary photograph or scene. These, therefore, have picture structures which correspond to television images and are useful in studies of the character outlined by this paper. Such scanned reproductions are usually limited in the number of scanning lines possible by much the same reasons that a television system is limited in the number of scanning lines unless elaborate apparatus is specially constructed. Other forms of reproductions have been used to simulate television picture structures. Such methods of comparison are, naturally, limited to inspection of one picture frame and, as such, a still image.

In television we are concerned with moving images and with a succession of movements or scenes which have certain continuity. Also, the vision is aided by sound accompanying the picture. Because of the wide gap between a still picture of certain detail and a television reproduction having the same equivalent detail, it is difficult to draw any definite information regarding the number of scanning lines desired for a particular condition from any of the methods of study which have been discussed. These methods are helpful in preliminary studies, but fall short when an attempt is made to draw general conclusions.

Motion in a picture directs the observer's interest to the object or objects in motion. Under these conditions the eye requires less detail than for a still picture, assuming that the detail is sufficient so that the purpose of the movements may be understood. Proper use of this may be made in television in the choice of "story action" and choice of background for the action. Also, in an image which is the result of scanning at the pick-up end, motion of the objects being scanned positions these objects for particular frames in favorable relation to be analyzed and reproduced when these objects are small and approach in at least one dimension the size of the scanning beam.

For a more complete study of television image, it seems necessary to have available the ability to produce image reproductions which have picture structures equivalent to television, controllable illumination, controllable size, flicker frequency equivalent to television, and capacities for subjects which will be used in television. It is also desirable to cover a range of picture detail equivalent to television images of 60, 120, 180, 240, and even larger numbers of scanning lines. These equivalents should be so made that they represent nearly perfect picture structures for the detail included. This seems desirable so as to avoid mistakes in judgment. Also, it will permit study with images equivalent to the more advanced stages of television which will later be attained as a result of continued development. Such an experimental set-up will allow reasonable determination of several related picture properties—picture detail, picture size, and viewing distance.

As has been pointed out, it is impracticable to make use of television systems for this study. This is because of limitations in our ability at present to produce television images with sufficient detail, illumination, and size for this investigation and to have these characteristics variable. We must, therefore, resort to suitable equivalents. A motion picture film having a picture structure equivalent to a television image provides a very flexible means for carrying out this work. Such a method was chosen, and the procedure used will be described. There are numerous ways in which such a film may be made, but the method used for this investigation is flexible and presents only a reasonable amount of preparatory work.

In the system of television that we are considering, the scanning paths are horizontal and the beam progresses from left to right (when facing the object or reproduction) and from top to bottom. The scanning beam is usually round or square in cross section. Since the scanning beam has width in the direction of the scanning path, a certain form of distortion is introduced. This is known as aperture distortion, and has been adequately treated in the general television literature.

This much has been indicated about the image characteristics because we shall later make comparisons between the structure of a television image and the motion picture equivalents we are to use.

The equipment used in making sixteen-millimeter motion pictures with detail structure equivalent to television images consisted essentially of a thirty-five-millimeter to sixteen-millimeter optical reduction printer. A system of optics was interposed between the two picture gates for the purpose of breaking up the picture image into small areas, each of which was uniformly illuminated, and which transmitted the same total quantity of light as a corresponding area in the picture image. A diagram of the optical system is shown in Fig. 5. The filament of an incandescent lamp 1 is focused by means of condenser lenses 2 upon a corrected lens 4. Lens 4 in turn forms an image of the thirty-five-millimeter picture aperture 3 on the plane surface of condenser lens 7. The equivalent of thousands of tiny spherical lenses 6 are placed directly in front of lens 7. Each of the tiny lenses forms an image of aperture 5. The plane containing the many images of aperture 5 is brought to focus upon the sixteen-millimeter aperture 9 by means of a corrected lens 8. Condenser lens 7 makes it possible for lens 8 to collect an equal quantity of light from each of the images formed by lenses 6. The horizontal dimension of the rectangular aperture 5 is such that the sides of the images formed by lenses 6 just touch, thereby forming continuous bands of light in the horizontal direction. The dimension of aperture 5 in the vertical direction is narrower, thereby producing narrow dark spaces between the horizontal lines formed. This was done to simulate television image lines. The image at aperture 9 of a motion picture film at aperture 3 is broken up by this optical system into as many elementary areas as there are lenses or equivalent lenses in 6, each of which contains no detail within itself. By adjusting the reduction ratios of lenses 4 and 8, and by having sufficient equivalent lenses at 6, it is possible to vary the number of picture elements.

Since it would have been quite difficult actually to obtain the thousands of minute spherical lenses, an approximate but more practical scheme was resorted to. It is known that two crossed cylindrical lenses are very nearly equivalent to a single spherical lens. Thus, it would be quite possible to approximate the required condition by crossing two layers of fine glass rods, the rods being in actual contact with each other. Fortunately, an even simpler solution was found. Kodacolor film is embossed with minute cylindrical lenses having focal lengths of about 6 mils. By crossing two pieces of Kodacolor film with the embossed surfaces in contact, very satisfactory results were obtained. The focal lengths of the equivalent spherical lenses formed by

crossed Kodacolor film were so short that the size of aperture 5 would have had to be larger than the diameter of lens 4. This condition was corrected by forming a cell made up of two pieces of Kodacolor film crossed, and filling the space between the embossings with a transparent solution having an index of refraction greater than air and less than the index of the film base. By varying the index of refraction of this transparent solution, it is possible to make the lenses have any desired focal length from 6 mils to infinity.

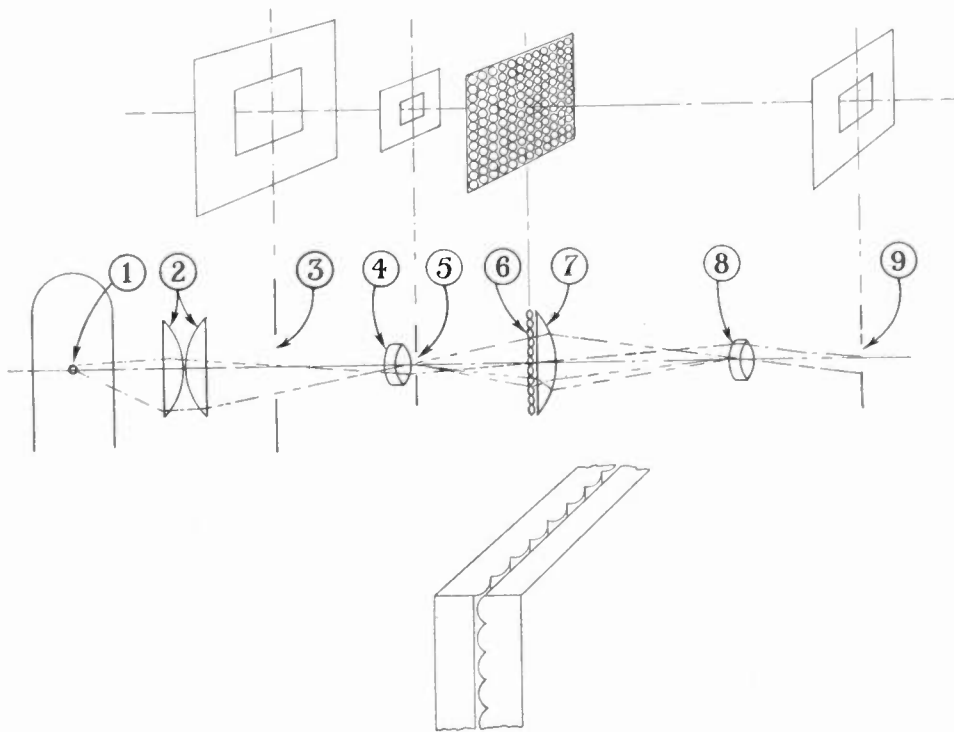

Fig. 5

The Kodacolor cell and lenses 4 and 8 were arranged in a suitable mounting and mounted on the reduction printer between the thirty-five-millimeter aperture and the sixteen-millimeter aperture. Arrangements were provided for adjustment of these various lenses. The subject matter was taken from a thirty-five-millimeter positive print. The first printing operation gave a sixteen-millimeter negative having the desired picture structure. A sixteen-millimeter positive was then made by printing from the negative in a sixteen-millimeter contact printer. The sound was transferred in the usual manner.

Films were made up for a variety of scenes and subjects. These, in general, included:

- Head and shoulders of girls modeling hats,
- Close-up, medium, and distant shots of a baseball game,

Medium and semiclose-up shots of a scene in a zoo,
Medium and distant shots of a football game,
Animated cartoons,
Titles.

These were assembled for one group with all scenes of the same detail (line structure) on the same run of film. For another group these were assembled with each scene progressing from 60- to 240-line structure. The pictures made included :

60-line structure,
120-line structure,
180-line structure,
240-line structure,
Normal projection print.

It was planned at the start to produce pictures having detail structures greater than 240 lines, but it was found that limitations, mainly in film resolution, prevented this. The resolution of the sixteen-millimeter film used was naturally considerably greater than a 360-line structure, but, with the averaging process used in producing each small section of the picture, the resolution was not sufficient to prevent merging of one section into the next. Later determinations made from viewing these films indicated that the 240-line structure pictures were sufficient for the purposes of the investigation since the results were of such a nature that the relationship could be extended to higher numbers of scanning lines.

Samples of three picture frames are given as Figs. 6, 7, and 8. These are all enlargements from the sixteen-millimeter negatives and include structures of 60, 120, 180, and 240 lines, and, also, a normal photographic enlargement. It is interesting to note how near the 240-line structure approaches the normal enlargement in picture quality.

An RCA Photophone sixteen-millimeter sound projector equipment was used in projecting these films. The light cutter in the projector was modified so as to interrupt the light only during the time that the film was being moved from one frame to the next by the intermittent movement. This modification consisted in removing one blade from the light cutter. The light was, therefore, cut off once per frame, giving for these tests a flicker frequency of 24 per second. The films were shown to several groups of people, using projected picture sizes 6, 12, and 24 inches high. The major reaction from these showings was the expression of satisfaction obtained from viewing pictures 12 inches high and larger in comparison to smaller pictures.

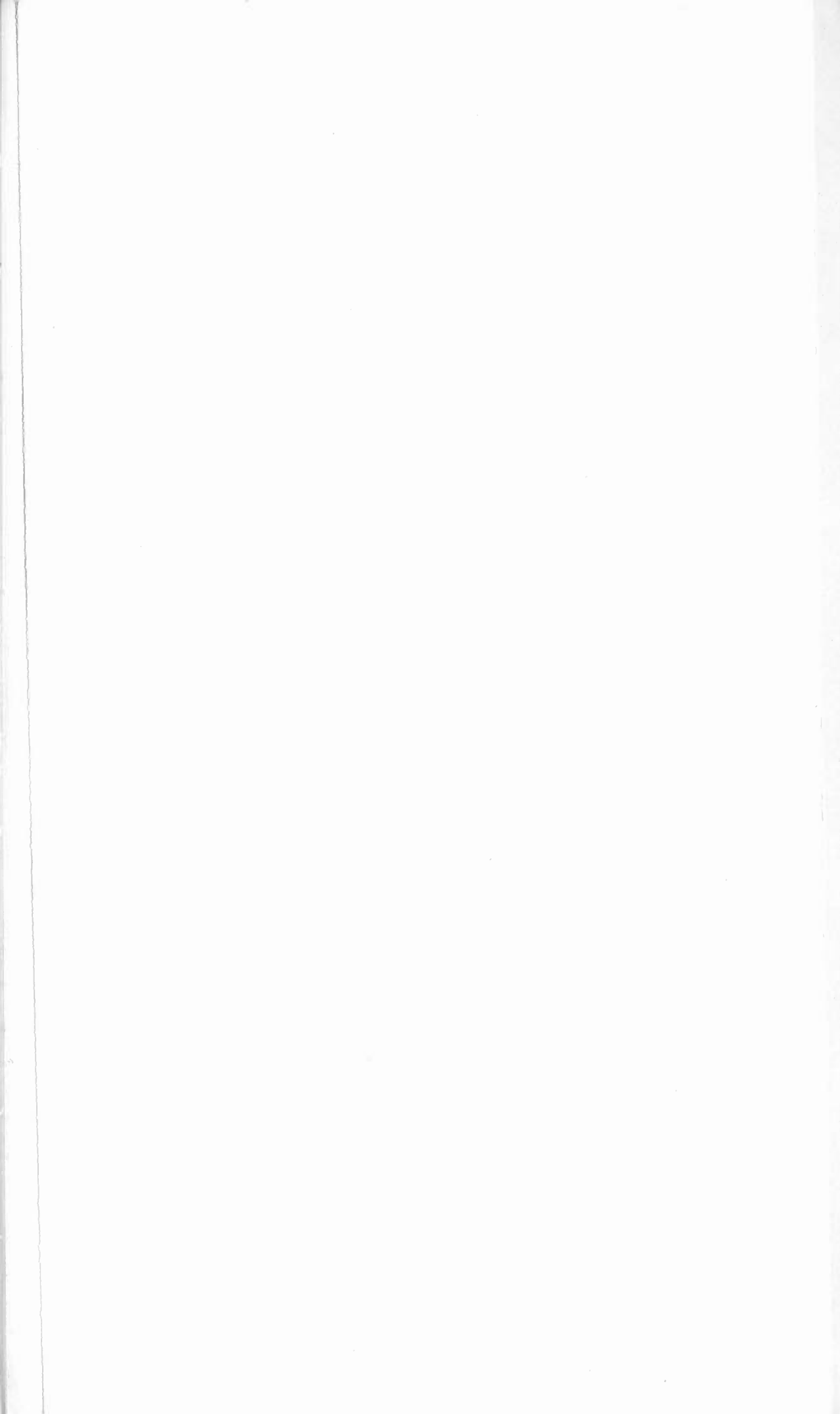

Medium and semiclose-up shots of a scene in a zoo,
Medium and distant shots of a football game,
Animated cartoons,
Titles.

These were assembled for one group with all scenes of the same detail (line structure) on the same run of film. For another group these were assembled with each scene progressing from 60- to 240-line structure. The pictures made included:

60-line structure,
120-line structure,
180-line structure,
240-line structure,
Normal projection print.

It was planned at the start to produce pictures having detail structures greater than 240 lines, but it was found that limitations, mainly in film resolution, prevented this. The resolution of the sixteen-millimeter film used was naturally considerably greater than a 360-line structure, but, with the averaging process used in producing each small section of the picture, the resolution was not sufficient to prevent merging of one section into the next. Later determinations made from viewing these films indicated that the 240-line structure pictures were sufficient for the purposes of the investigation since the results were of such a nature that the relationship could be extended to higher numbers of scanning lines.

Samples of three picture frames are given as Figs. 6, 7, and 8. These are all enlargements from the sixteen-millimeter negatives and include structures of 60, 120, 180, and 240 lines, and, also, a normal photographic enlargement. It is interesting to note how near the 240-line structure approaches the normal enlargement in picture quality.

An RCA Photophone sixteen-millimeter sound projector equipment was used in projecting these films. The light cutter in the projector was modified so as to interrupt the light only during the time that the film was being moved from one frame to the next by the intermittent movement. This modification consisted in removing one blade from the light cutter. The light was, therefore, cut off once per frame, giving for these tests a flicker frequency of 24 per second. The films were shown to several groups of people, using projected picture sizes 6, 12, and 24 inches high. The major reaction from these showings was the expression of satisfaction obtained from viewing pictures 12 inches high and larger in comparison to smaller pictures.

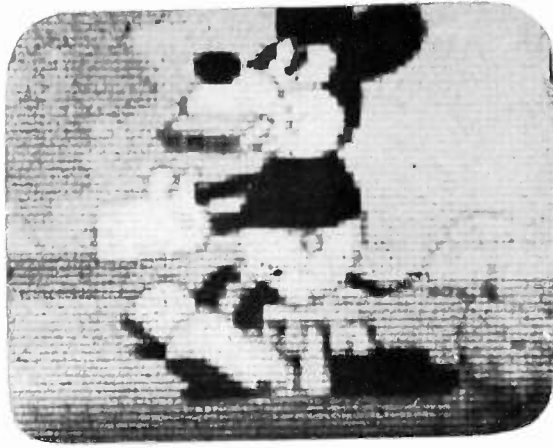

60 Scanning Lines
(a)

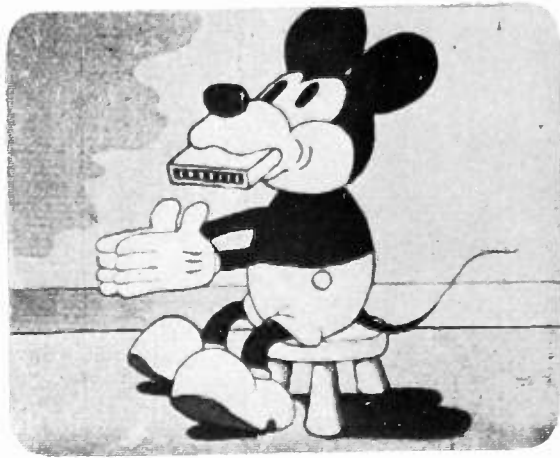

180 Scanning Lines
(c)

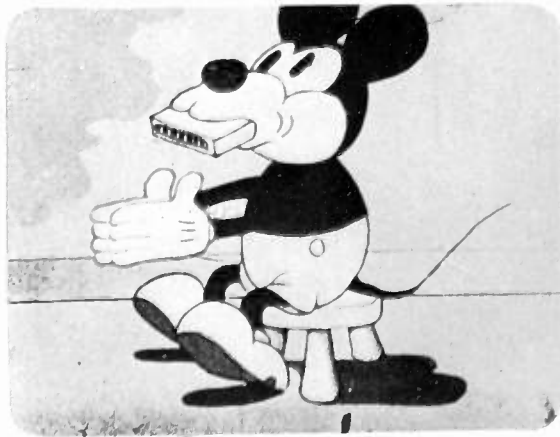

Enlargement
(e)

Medium and semiclose-up shots of a scene in a zoo,
Medium and distant shots of a football game,
Animated cartoons,
Titles.

These were assembled for one group with all scenes of the same detail (line structure) on the same run of film. For another group these were assembled with each scene progressing from 60- to 240-line structure. The pictures made included:

60-line structure,
120-line structure,
180-line structure,
240-line structure,
Normal projection print.

It was planned at the start to produce pictures having detail structures greater than 240 lines, but it was found that limitations, mainly in film resolution, prevented this. The resolution of the sixteen-millimeter film used was naturally considerably greater than a 360-line structure, but, with the averaging process used in producing each small section of the picture, the resolution was not sufficient to prevent merging of one section into the next. Later determinations made from viewing these films indicated that the 240-line structure pictures were sufficient for the purposes of the investigation since the results were of such a nature that the relationship could be extended to higher numbers of scanning lines.

Samples of three picture frames are given as Figs. 6, 7, and 8. These are all enlargements from the sixteen-millimeter negatives and include structures of 60, 120, 180, and 240 lines, and, also, a normal photographic enlargement. It is interesting to note how near the 240-line structure approaches the normal enlargement in picture quality.

An RCA Photophone sixteen-millimeter sound projector equipment was used in projecting these films. The light cutter in the projector was modified so as to interrupt the light only during the time that the film was being moved from one frame to the next by the intermittent movement. This modification consisted in removing one blade from the light cutter. The light was, therefore, cut off once per frame, giving for these tests a flicker frequency of 24 per second. The films were shown to several groups of people, using projected picture sizes 6, 12, and 24 inches high. The major reaction from these showings was the expression of satisfaction obtained from viewing pictures 12 inches high and larger in comparison to smaller pictures.

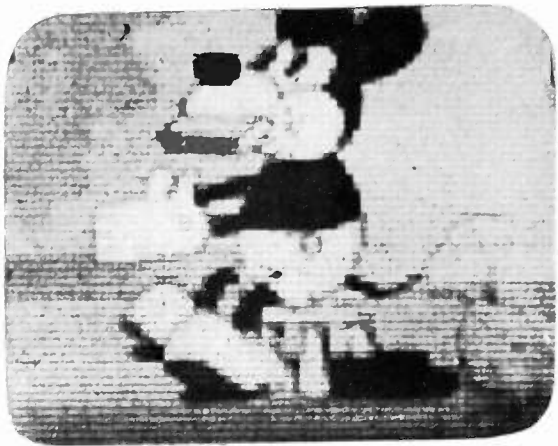

60 Scanning Lines
(a)

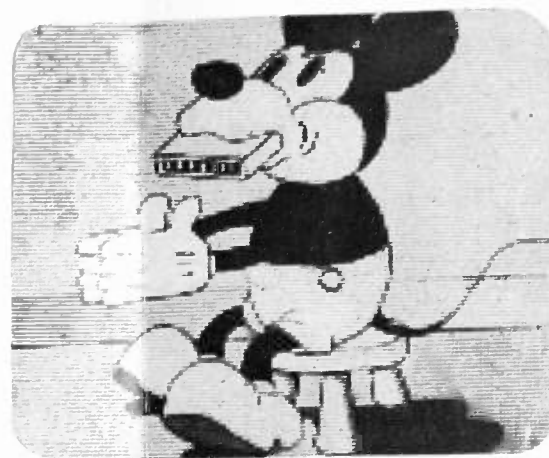

120 Scanning Lines
(b)

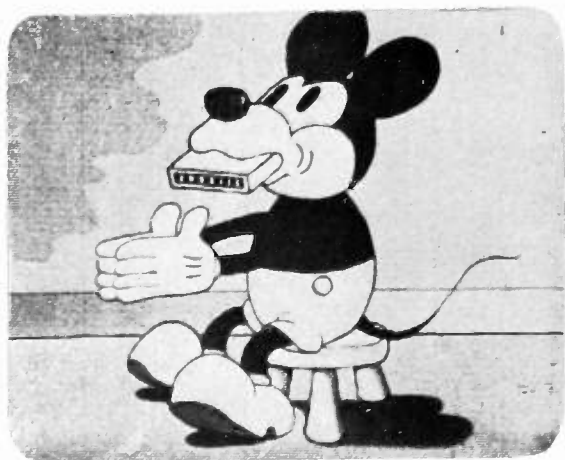

180 Scanning Lines
(c)

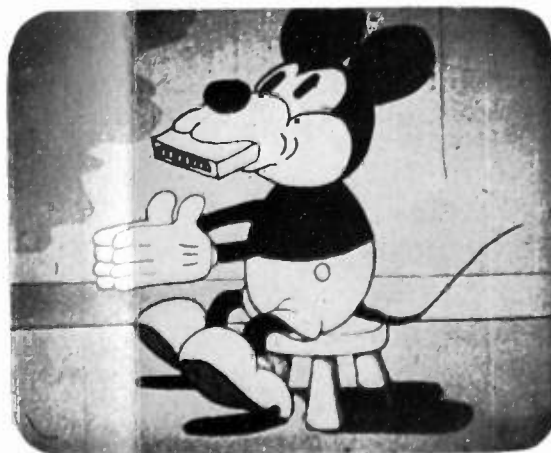

240 Scanning Lines
(d)

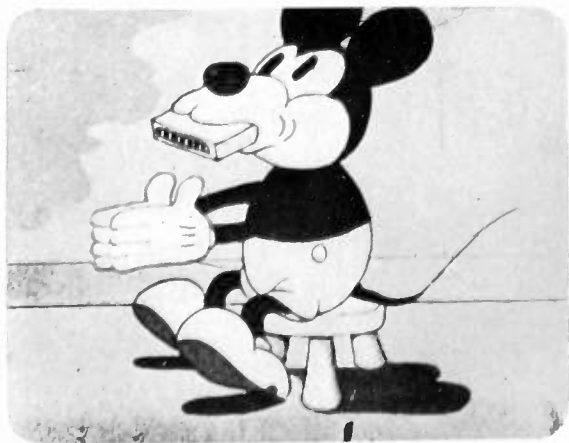

Enlargement
(e)



60 Scanning
(a)



180 Scanning
(c)



Enlargement
(e)

Medium and semiclose-up shots of a scene in a zoo,
Medium and distant shots of a football game,
Animated cartoons,
Titles.

These were assembled for one group with all scenes of the same detail (line structure) on the same run of film. For another group these were assembled with each scene progressing from 60- to 240-line structure. The pictures made included:

60-line structure,
120-line structure,
180-line structure,
240-line structure,
Normal projection print.

It was planned at the start to produce pictures having detail structures greater than 240 lines, but it was found that limitations, mainly in film resolution, prevented this. The resolution of the sixteen-millimeter film used was naturally considerably greater than a 360-line structure, but, with the averaging process used in producing each small section of the picture, the resolution was not sufficient to prevent merging of one section into the next. Later determinations made from viewing these films indicated that the 240-line structure pictures were sufficient for the purposes of the investigation since the results were of such a nature that the relationship could be extended to higher numbers of scanning lines.

Samples of three picture frames are given as Figs. 6, 7, and 8. These are all enlargements from the sixteen-millimeter negatives and include structures of 60, 120, 180, and 240 lines, and, also, a normal photographic enlargement. It is interesting to note how near the 240-line structure approaches the normal enlargement in picture quality.

An RCA Photophone sixteen-millimeter sound projector equipment was used in projecting these films. The light cutter in the projector was modified so as to interrupt the light only during the time that the film was being moved from one frame to the next by the intermittent movement. This modification consisted in removing one blade from the light cutter. The light was, therefore, cut off once per frame, giving for these tests a flicker frequency of 24 per second. The films were shown to several groups of people, using projected picture sizes 6, 12, and 24 inches high. The major reaction from these showings was the expression of satisfaction obtained from viewing pictures 12 inches high and larger in comparison to smaller pictures.

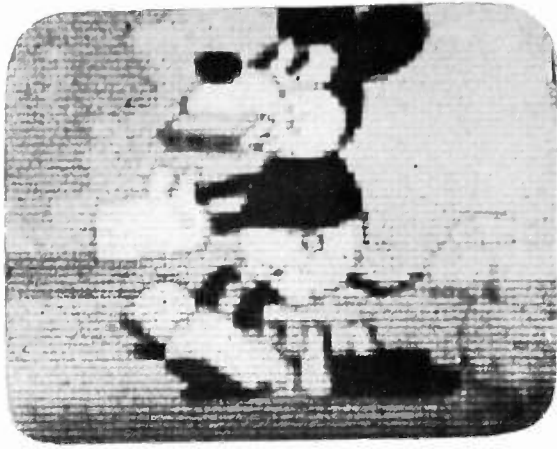

60 Scanning Lines
(a)

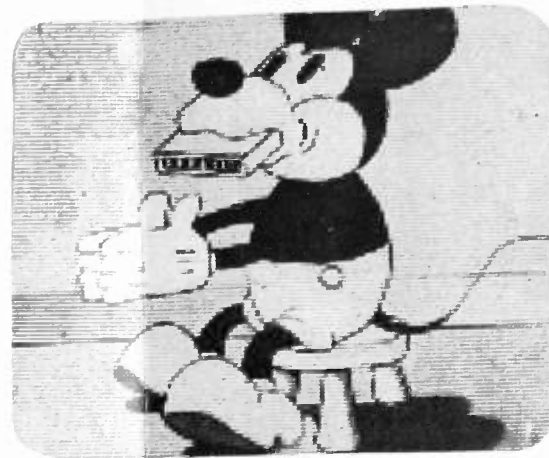

120 Scanning Lines
(b)

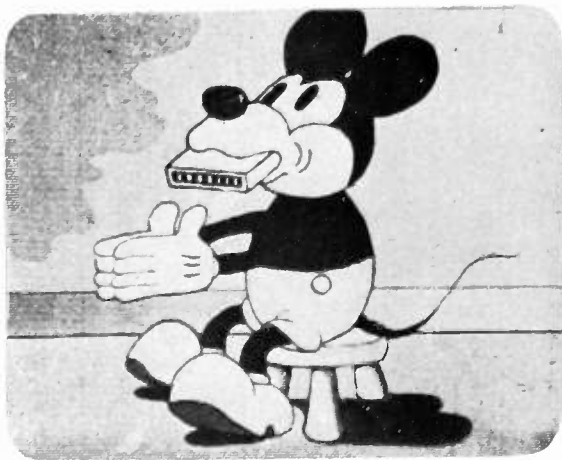

180 Scanning Lines
(c)

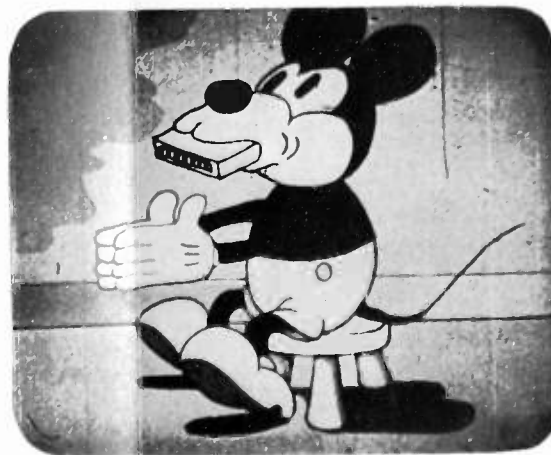

240 Scanning Lines
(d)

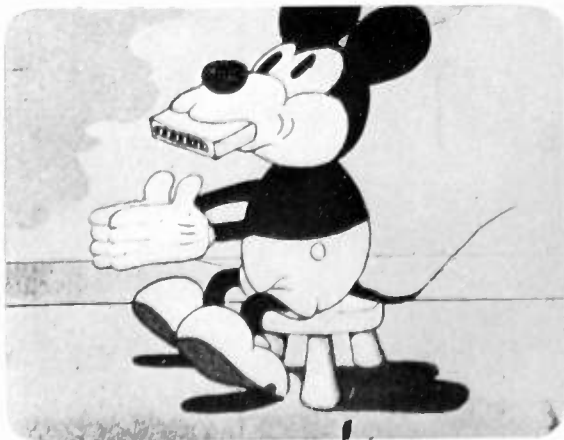

Enlargement
(e)



60 Scanning
(a)



180 Scanning
(c)



Enlargeme
(e)



Scanning Lines
(b)



Scanning Lines
(d)

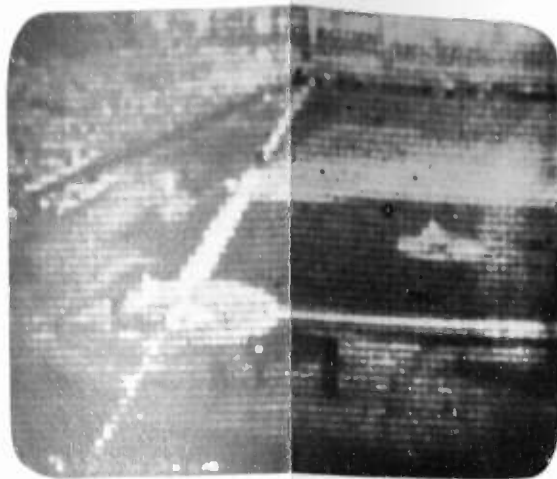

60 Scanning Lines
(a)

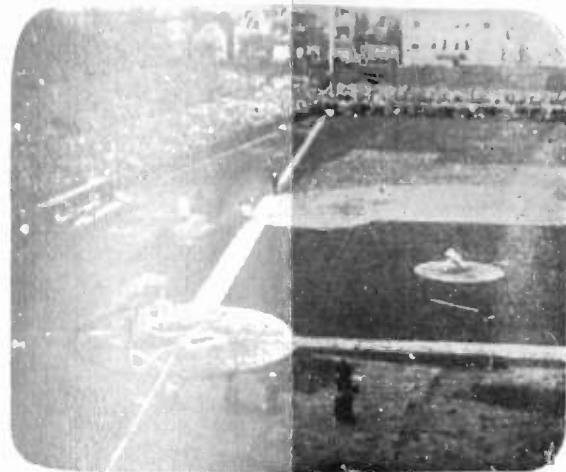

180 Scanning Lines
(c)

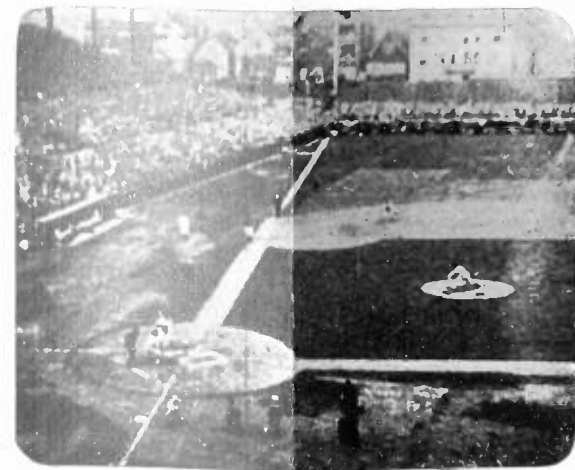

Enlargement
(e)

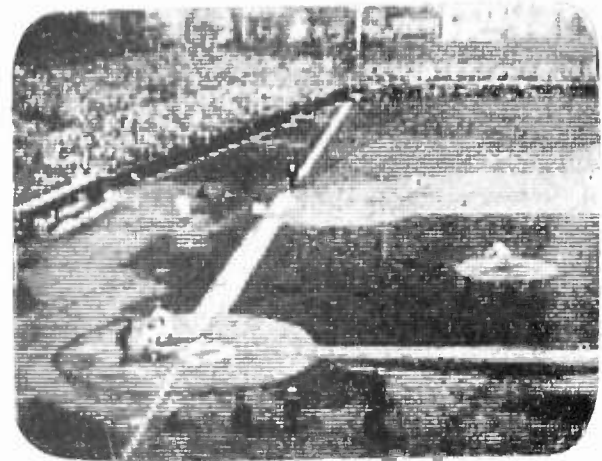

120 Scanning Lines
(b)

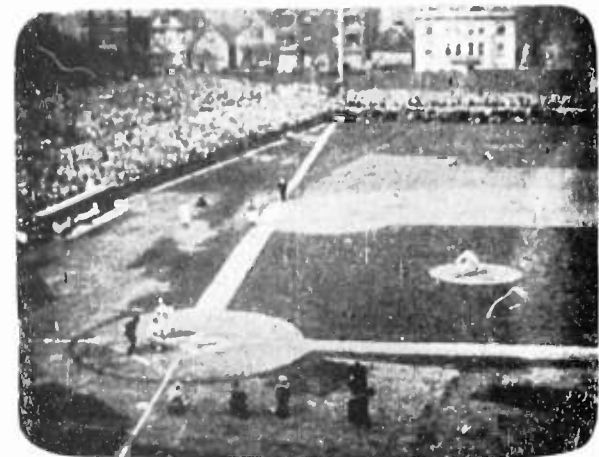

240 Scanning Lines
(d)

It will be of interest at this point to record some of the reactions on how well these films form equivalents of television images. These reactions were formed as a result of observations and tests made with the films. The horizontal-line structure was so clearly equivalent that we may pass by this without comment. The changes of contrast along the horizontal "scanning" lines for the 60-line structures appeared somewhat "mosaic" in arrangement. This was because the boundaries of the individual picture arrangements were determined by the multiple lens arrangement used to produce the image. This effect was not noticed in 120-line structure or in those of higher detail. The 120-, 180-, and 240-line structures, and also the 60-line structure, except for the effect explained above, were well suited for study of image detail. In general a particular line structure on the film was considerably better than a television image (as we are at present able to produce them) of the same number of scanning lines. This is a desirable condition because the results of the tests will then be in terms of television of an advanced stage rather than in terms of present capabilities.

In order to obtain some quantitative information, a number of practical viewing tests were made. These tests were made by the same three observers who made the tests covered earlier in this paper. For these observations the same projector equipment as described in a paragraph above was used (one light interruption per frame). The projection lamp was operated at rated voltage (normal brilliancy) and the projection lens was stopped down to give the desired screen illumination. A screen illumination of five to six foot candles was chosen. This was measured at the screen, looking toward the projection lens, and with the projector running, but without film in the picture aperture. This value of screen illumination, though less than for theatre or home movies, was chosen because it gives a fairly bright picture and because it falls within a range to be reasonably expected for television. For the pictures of various sizes the foot candles of illumination (surface density) was kept the same, varying the total luminous flux in proportion. The stray room illumination was of the general order of one-tenth foot candle.

Viewing tests were made with projected pictures of various heights, using the film subjects listed earlier. For pictures of given height and line structure, observations were made for each type of subject matter on the film. These data were averaged, and the information used in the curves to be plotted includes this in terms of an over-all average for the three observers. In taking the observations, viewing distances were chosen at which the lines and detail structure became noticeable. At closer viewing distances the picture structure became increasingly

It will be of interest at this point to record some of the reactions on how well these films form equivalents of television images. These reactions were formed as a result of observations and tests made with the films. The horizontal-line structure was so clearly equivalent that we may pass by this without comment. The changes of contrast along the horizontal "scanning" lines for the 60-line structures appeared somewhat "mosaic" in arrangement. This was because the boundaries of the individual picture arrangements were determined by the multiple lens arrangement used to produce the image. This effect was not noticed in 120-line structure or in those of higher detail. The 120-, 180-, and 240-line structures, and also the 60-line structure, except for the effect explained above, were well suited for study of image detail. In general a particular line structure on the film was considerably better than a television image (as we are at present able to produce them) of the same number of scanning lines. This is a desirable condition because the results of the tests will then be in terms of television of an advanced stage rather than in terms of present capabilities.

In order to obtain some quantitative information, a number of practical viewing tests were made. These tests were made by the same three observers who made the tests covered earlier in this paper. For these observations the same projector equipment as described in a paragraph above was used (one light interruption per frame). The projection lamp was operated at rated voltage (normal brilliancy) and the projection lens was stopped down to give the desired screen illumination. A screen illumination of five to six foot candles was chosen. This was measured at the screen, looking toward the projection lens, and with the projector running, but without film in the picture aperture. This value of screen illumination, though less than for theatre or home movies, was chosen because it gives a fairly bright picture and because it falls within a range to be reasonably expected for television. For the pictures of various sizes the foot candles of illumination (surface density) was kept the same, varying the total luminous flux in proportion. The stray room illumination was of the general order of one-tenth foot candle.

Viewing tests were made with projected pictures of various heights, using the film subjects listed earlier. For pictures of given height and line structure, observations were made for each type of subject matter on the film. These data were averaged, and the information used in the curves to be plotted includes this in terms of an over-all average for the three observers. In taking the observations, viewing distances were chosen at which the lines and detail structure became noticeable. At closer viewing distances the picture structure became increasingly

objectionable. At the viewing distances chosen the picture detail was just satisfactory. At greater viewing distances the picture detail was, naturally, sufficient. It was noted that the type of picture subject did not influence the viewing distance chosen by more than ten per cent. This is explainable on the basis that we are determining minimum con-

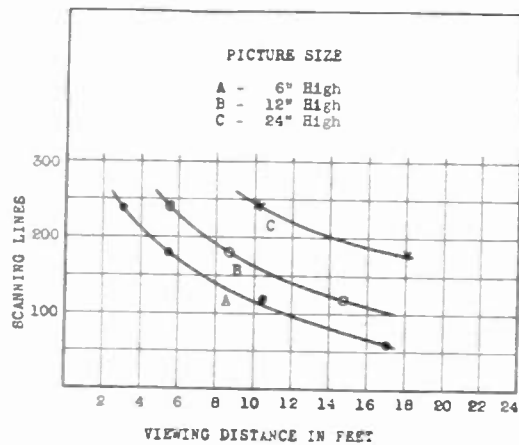

Fig. 9

ditions in terms of line and detail structure. Data were taken for pictures 6, 12, and 24 inches high, and for picture structures of 60, 120, 180, and 240 lines, and also for a normal projection print. This information is given in curve form in Fig. 9.

In order to present these observed data in more general form, the above curves are shown, in Fig. 10, replotted in terms of scanning lines

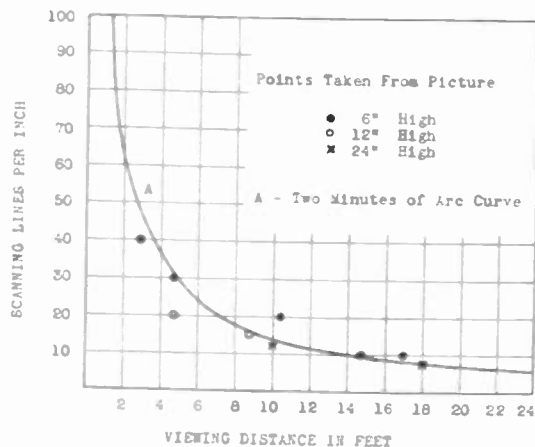

Fig. 10

per inch. The curve drawn through the observed points is the two minutes of arc curve from Fig. 2. This, as explained earlier in the paper, is a curve between scanning lines per inch and viewing distance where the dimension between centers of scanning lines subtends an angle to the eye of two minutes. Because of the correspondence between the

plotted points and the two minutes of arc curve, we shall use this two minutes of arc curve in our discussion as representing the average results (for the three observers) for practical viewing conditions.

It is of interest to compare these observed results from viewing the films of several detail structures, with the observed results of viewing the chart, Fig. 1, the curves of which are shown in Fig. 4. In the case of the still chart observations, the average falls on the one minute of arc curve; in the case of the observed motion picture television equivalents, the average falls on the two minutes of arc curve.

In order to indicate the relative viewing distances for a normal projection print, the data taken are shown in another graphical form. The plotted points for picture structures of 60, 120, 180, and 240 lines are

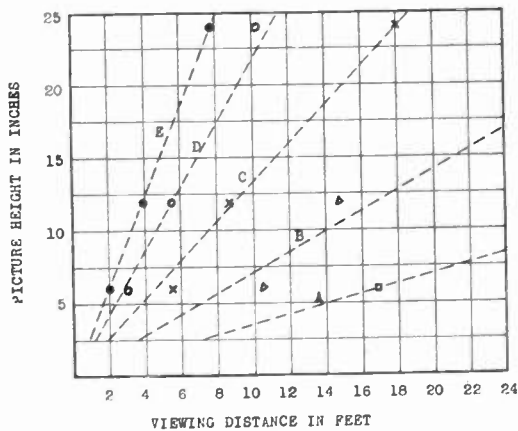

Fig. 11 A— 60 scanning lines
 B—120 scanning lines
 C—180 scanning lines
 D—240 scanning lines
 E—projection print

the same as for the curves in Fig. 9. The plotted points for a normal projection print were taken in the same manner as for the other films. In this instance the viewing distance chosen was where the picture just began to show loss of detail. Thus Fig. 11 indicates in a general measure the relative merits of the several picture structures. It also shows how near the 240-line structure approaches a normal sixteen-millimeter projection print. In inspecting this chart it will be noted that the observed data do not entirely check the theoretical acuity conditions. This is also to be noted by the variation of the points from the theoretical curve in Fig. 10. An example of this for the chart, Fig. 11, is that curve *D* for 240 lines should indicate viewing distances one half that for curve *B* of 120 lines. Curve *B* for 120 lines and curve *A* for 60 lines show the proper one-to-two relationship for viewing distances. It is probable

that for the higher number of lines the observed data err on the side of being too "good."

With a screen illumination of the order used in these tests (5 to 6 foot candles) an increase in apparent detail can be obtained with higher values of illumination, thereby providing a greater range of contrast. To determine the general order of this increase, several tests were made with a screen illumination of 20 foot candles. With this value the apparent picture detail was improved, but also the picture structure was more pronounced, requiring a choice of viewing distance from thirty to forty per cent greater than for an illumination of 5 to 6 foot candles. Since 5 to 6 foot candles is more in keeping with television possibilities for the next several years, and since the difference in ap-

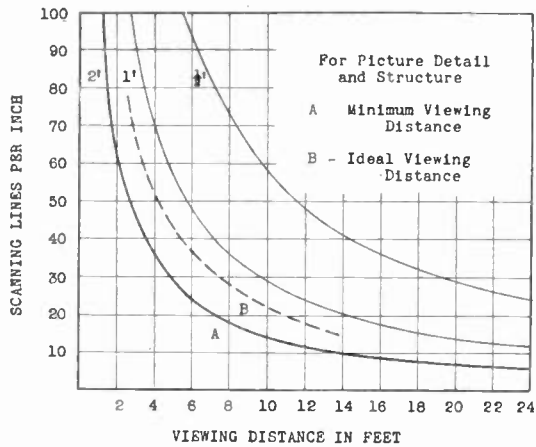

Fig. 12

parent detail and viewing distance is within the accuracy tolerances of the generalizations to be drawn, this particular condition will not be taken into account.

Some interesting data were obtained from direct comparisons of these projected television equivalents with the same subjects having "perfect detail." Two similar projectors were set up so that the projected images were side by side on the screen and the illumination of each the same. One projector was used to project the film having television line structure; and the other projector, the same film subjects but a normal projection print. Observations were made using pictures of several heights and using the films having picture structures of 120, 180, and 240 lines. Viewing distances were chosen at which the two screen images had the same apparent detail. At these viewing distances the image from the normal projection print had a detail structure beyond eye acuity in fineness, and in this sense "perfect." These viewing distances might, therefore, be termed "ideal viewing distances" from

the standpoint of picture detail and structure for the television equivalents. The data taken indicate that this "ideal viewing distance" is approximately fifty per cent greater than the "minimum viewing distances" shown by the curves in Figs. 9 and 10. This information is shown in graphical form by Fig. 12.

We have determined from these observations two viewing distances in terms of picture detail and structure. The first is a minimum viewing distance, and the second an ideal viewing distance. If the total picture size were limited, we would, in viewing this picture, tend to approach it until the picture detail and structure became unsatisfactory. We would for this condition choose the minimum viewing distance referred to above. If the total picture size were ample, we would tend to position ourselves so that we would view it at the ideal viewing distance. This relationship will be covered more fully later in the paper.

The tests we have made on picture detail are rigorous. We have set as standards the ability of the eye to see the elements of detail and picture structure. Another less exacting standard would be the "ability" of images having various degrees of detail to "tell the desired story." In this case the detail required is dependent upon the kind of story and information to be presented. The detail requirements would increase as the scenes became more intricate. During the early stages of development such a standard is useful, but, for obvious reasons, it is not of a lasting type since it is the eye and the reactions of vision that must be satisfied. The standards we have used are definite and of a character which will not become obsolete as the development of television progresses.

If we qualify and limit "the ability to tell a desired story" to specific conditions, the experience we have had with television and these tests allows us to make some interesting approximate generalizations. If we take as a standard the information and entertainment capabilities of sixteen-millimeter home movie film and equipment, we may estimate the television images in comparison.

| | | |
|-------------------|-----|-------------------------------------|
| 60 scanning lines | | entirely inadequate |
| 120 | " " | hardly passable |
| 180 | " " | minimum acceptable |
| 240 | " " | satisfactory |
| 360 | " " | excellent |
| 480 | " " | equivalent for practical conditions |

This comparison assumes advanced stages of development for each of the line structures. It relates to the ability of observers to understand and follow the action and story. It does not relate to the ability to reproduce titles and small objects.

We stated earlier in this paper that motion in a picture has an effect on the apparent detail. There are several reasons for this. The observer's interest is directed to the object or objects in motion. The eye then does not tend to explore the picture step by step, examining each section critically. Under these conditions the eye requires less detail than for a still picture, assuming that the detail is sufficient so that the purpose of the movements may be understood. Objects made up of too few picture elements to recognize while still, may be recognizable and realistic while in motion. A portion of this improvement is due to experience on the part of the observer in associating the motion with things and processes he understands. A portion of the improvement is due to more favorable conditions for scanning while the object is in motion. Another portion of the improvement, as already stated, is due to concentration of interest around the motion. This effect is very important in dealing with crude television images, but becomes minor in images having sufficient detail to satisfy eye acuity. An image made up of 30 scanning lines, though inadequate for almost any subject, provides much more satisfactory results for objects in motion than for still scenes. On the other extreme, a normal sixteen-millimeter projected image of a scene including motion is not, in any large measure, superior to a scene containing no motion. There is, of course, a decided difference in the center or centers of interest.

Reference to Figs. 6, 7, and 8 will illustrate this. In particular, in the 60-line print of the baseball scene, the players are about five picture elements high, and considerable imagination must be used to locate them. With the same scene in motion the observers can pick out the players, roughly determine their action, and, in a general sense, follow the game. In other words, the condition has changed from a reproduction of a scene containing no motion, and which gives practically no information except that it is a baseball field, to a reproduction of the same scene in which the players move, and which in general allows the observers to follow the action roughly. It is apparent from examining the other prints, particularly as the amount of detail increases, that reproductions with motion would naturally improve the satisfaction obtained, but the difference would not be as great and would decrease as the picture detail improved. Summarizing the effects of motion in a television image, we may conclude that the major improvement is that of observer interest. This is true because, to be generally satisfactory, the image must contain sufficient detail to satisfy eye acuity. This same condition holds in the case of motion pictures. We are, therefore, justified (and safe from the standpoint of results) in discounting the effects of motion in the generalizations to be drawn from this analysis.

Thus far in our investigation we have considered picture detail and structure and have arrived at certain relationships between number of scanning lines and viewing distances. We have not taken into consideration the picture size. By reference to the curve in Fig. 10, and by knowing the total number of scanning lines available for the system we are considering, we may readily determine the size of the picture in terms of height. This does not, however, tell us, at the viewing distance we have chosen, that the picture will be of a size pleasant to view. If the picture is too small it will be unsatisfactory because too fixed an attention will be required for viewing. If the picture is too large it will be unsatisfactory because too large movements of eyes or head will be required for viewing. In television, because of the practical limitations in detail (scanning lines), we are confronted in general with too small rather than too large pictures.

In television we use the same ratios of picture width to picture height (aspect ratio) as in motion pictures (6 to 5, or 4 to 3). In moderately large theaters the distance from the back row of the orchestra section to the screen does not usually exceed six to seven times the screen height. The front row of seats may be as close as one and one-half to two times the screen height. The choice position is probably at four times the screen height from the screen. In home movies (where less detail is available because of the smaller size film) the desired viewing distances cover a span of from four to eight times the picture height. Since television, of the type we are considering, is for home entertainment, we shall in this consideration of television picture size use the accepted ratio of picture height to viewing distance for home movies (span of one to four—one to eight) in our comparisons. To make this more specific we shall follow through an example. For this illustration we shall use a picture one foot high. The desired viewing distance range is from four to eight feet. Going beyond eight feet, viewing conditions become decreasingly satisfactory and at twelve feet and beyond become quite unsatisfactory. This is based on the assumption that the same general run of subject matter will be used as for motion pictures.

We have now accumulated data which allow preparing a chart including relationships between scanning lines, picture size, viewing distance, and desired ratios of picture height to viewing distance. The information on this chart, which is given as Fig. 13, is based on the observed data recorded in curve form in Fig. 10. Using this "minimum viewing distance" relation between scanning lines per inch and viewing distance, the chart in Fig. 13 shows for a number of viewing distances the picture size—total scanning line relationship. Superimposed on

this are horizontal broken lines for picture height to viewing distance ratios of one to four, one to eight, one to twelve, and one to sixteen. In using this chart we must take into consideration the fact that between the one-to-four and one-to-eight picture height to viewing distance lines, the viewing conditions will be satisfactory. As we drop below the one-to-eight ratio line the viewing conditions become less satisfactory, and below the one-to-twelve ratio line, generally unsatisfactory.

This chart (Fig. 13) includes all the necessary information to determine scanning lines required if viewing distance and picture height have been decided upon; or picture size, if a certain number of scan-

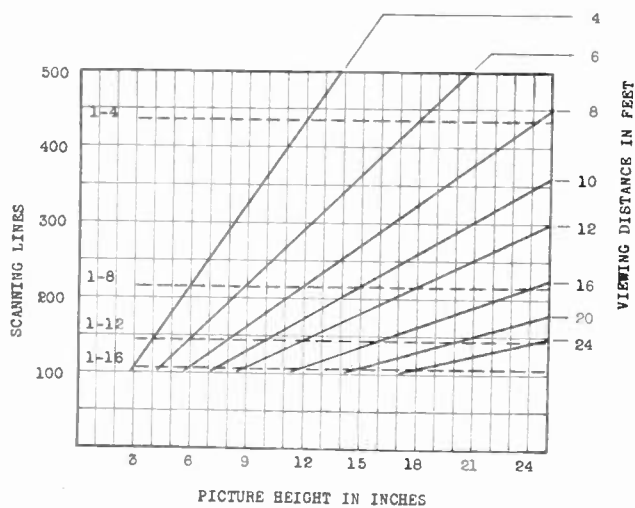

Fig. 13—Relationship between scanning lines and picture size for several viewing distances. Broken lines indicate picture height to viewing distance ratios.

ning lines are possible and a certain viewing distance is desired. The chart also provides a guide for the desired picture sizes for general viewing conditions. To illustrate, we might decide that we wish to view a television image at eight feet. Starting down the eight-foot viewing distance line, we find that with 360 scanning lines we may have a picture twenty inches high. We also learn that the picture height to viewing distance ratio is a very desirable one. With 240 scanning lines we find that we may have a picture thirteen and one-half inches high. Here the picture height to viewing distance is above the one-to-eight ratio line and, therefore, satisfactory. With 180 scanning lines we may have a picture ten inches high. We note that we have dropped below the one-to-eight ratio line, a less desirable viewing condition. At this point the picture will, in general, be satisfactory for viewing but probably the minimum desirable for an eight-foot viewing distance.

The viewing distance lines on this chart mean, in accordance with the explanation given a few paragraphs previously, that, at this par-

ticular distance and for the number of scanning lines and picture height indicated at any point along the line, this is the minimum viewing distance for a picture of this number of scanning lines and height. Since this information is based on tests made by three observers who have, as previously pointed out, acuity above average, this is a safe condition for average use. Suppose, as in the above illustration, we have chosen an eight-foot viewing distance and, with 240 scanning lines available, a picture height of thirteen and one-half inches. The nearest an observer should view this image is, then, at eight feet. Observers more distant will naturally find satisfactory detail conditions. To determine if the general viewing conditions at more distant points are satisfactory because of the picture size, we may start at the eight-foot viewing distance line and the thirteen and one-half inch picture size and drop down along the thirteen and one-half inch ordinate. At a ten-foot viewing distance we are just a little under the one-to-eight ratio. At a twelve-foot viewing distance we are nearing the one-to-twelve ratio and approaching unsatisfactory viewing conditions. Therefore, a picture of 240 scanning lines and thirteen and one-half inches high may be viewed from eight feet to about twelve feet.

ACKNOWLEDGMENT

The author expresses appreciation for the assistance of Messrs. W. L. Carlson and T. V. DeHaven who together with the author were the three observers referred to in the paper, for the assistance of Mr. T. V. DeHaven in preparing some of the test set-ups, and for the assistance of Mr. G. L. Dimmick in preparing the films having the special detail structures.



AN EXPERIMENTAL TELEVISION SYSTEM*

BY

E. W. ENGSTROM

(RCA Victor Company, Inc., Camden, New Jersey)

Summary—This forms the introduction to a group of papers describing the apparatus used in making practical tests on an experimental television system.

DURING the early part of 1931 it was decided to make practical tests on a cathode ray television system of the type being developed by the research organization of RCA Victor. This project was entirely experimental in nature, but was so directed as to obtain operating conditions as nearly as possible in keeping with probable television broadcast service. The location chosen for these tests was the metropolitan area of New York. The studio and transmitter equipment was located in the Empire State Building with the antenna structures at the very top. Apparatus for this project was completed and installed during the second half of the year. Operation tests followed, continuing through the first half of 1932.

The equipment used for these experimental field tests was in keeping with the status of television development at that time. Two radio transmitters were used, one for picture and the other for sound. These were operated in the experimental television band, 40 to 80 megacycles. The picture and sound transmitters were widely separated in frequency to simplify the apparatus requirements. One hundred and twenty line scanning was used. The limit of 120 lines was established mostly by the signal-to-noise ratio for direct studio pick-up. The picture repetition frequency was 24 per second. This was chosen so as to provide adequate continuity of action for objects in motion for studio programs and to enable the use of standard sound motion picture film for film subject material. Synchronization was automatically maintained at the receiver by transmitted synchronizing impulses, one impulse for each line and one impulse for each picture frame. The line and frame impulses differed in character. "Mechanical" scanning equipment was used for both studio and film subjects.

The television receiver consisted essentially of two channels, one a receiver for picture with its cathode ray tube and associated circuits and the other a receiver for sound with its usual loud speaker. Independent tuning arrangements were provided for each channel. The

* Decimal classification: R583. Original manuscript received by the Institute, July 10, 1933.

cathode ray tube was mounted in a vertical position and the reproduced image viewed in a mirror mounted on the inside of an adjustable top lid of the cabinet.

After the apparatus had been installed and placed in operating condition, practical tests followed. These tests were varied in nature and were intended to be as comprehensive as possible. A propagation study was made of the metropolitan area of New York. An analysis was made of electrical "noise" disturbances, sources of this "noise", and the resulting effect on television performance. Experience was obtained in the use of the terminal and radio transmitter apparatus which indicated limitations and measures to permit greatest usefulness. Receivers were placed in many locations and the installation and operating problems were studied. Reactions of many observers were obtained.

Much valuable engineering information was obtained as a result of this project. An opportunity was available to design and construct apparatus for a complete experimental television system. Indications were obtained regarding the possibilities and limitations of the apparatus. Extensive operating data were accumulated. The project provided further insight and it broadened the perspective on that rather intangible factor "satisfactory television performance." An analysis of the experience and engineering information provided concrete objectives for continued research on television.

Some of the major conclusions and indications are of general interest. The frequency range of 40 to 80 megacycles was found well suited for the transmission of television programs. The greatest source of interference was from ignition systems of automobiles and airplanes, electrical commutators and contactors, etc. It was sometimes necessary to locate the receiving antenna in a favorable location as regards signal and sources of interference. For an image of 120 lines the motion picture scanner gave satisfactory performance. The studio scanner was adequate for only small areas of coverage. In general the studio scanner was the item which most seriously limited the program material. Study indicated that an image of 120 lines was not adequate unless the subject material from film and certainly from studio was carefully prepared and limited in accordance with the image resolution and pick-up performance of the system. To be satisfactory, a television system should provide an image of more than 120 lines. A more general discussion of the image detail requirements for television has been given in a previous paper.¹ The operating tests indicated that the fundamentals of the method of synchronizing used were satisfactory. The

¹ E. W. Engstrom, "A study of television image characteristics," *Proc. I.R.E.*, this issue, pp. 1631-1651.

superiority of the cathode ray tube for image reproduction was definitely indicated. With the levels of useful illumination possible through the use of the cathode ray tube, the image flicker was considered objectionable with a repetition frequency of 24 per second. The receiver performance and operating characteristics were in keeping with the design objectives.

Information has been presented on the results of the propagation study made as a part of this project.² It is the purpose of the following papers to describe the system and the experimental apparatus used. The description of the entire system is covered by three papers: a description of the system, the cathode ray tube, and associated circuits; a description of the transmitting equipment; and a description of the receiving equipment. Each paper has been prepared by the engineer responsible for that portion of the project.

Acknowledgement is made to all the members of the RCA Victor organization who participated in the work, and for the assistance of others in associated companies of the RCA group.

² L. F. Jones, "A study of the propagation of wavelengths between three and eight meters," *PROC. I.R.E.*, vol. 21, pp. 349-386; March, (1933).



DESCRIPTION OF AN EXPERIMENTAL TELEVISION SYSTEM AND THE KINESCOPE*

By

V. K. ZWORYKIN

(RCA Victor Company, Inc., Camden, New Jersey)

Summary—A general description is given of an experimental television system using a cathode ray tube (kinescope) as the image reproducing element in the receiver. The fundamental considerations underlying the design and use of the kinescope for television are outlined. A description of the circuits associated with the kinescope and an explanation of the application to an experimental receiver are included.

INTRODUCTION

THE experimental television system placed in operation by RCA Victor in New York late in 1931, and on which practical tests were made during the first half of 1932, was based on the use of a cathode ray tube as the image reproducing element in the receiver. This allowed the use of a system with 120 scanning lines and a frame

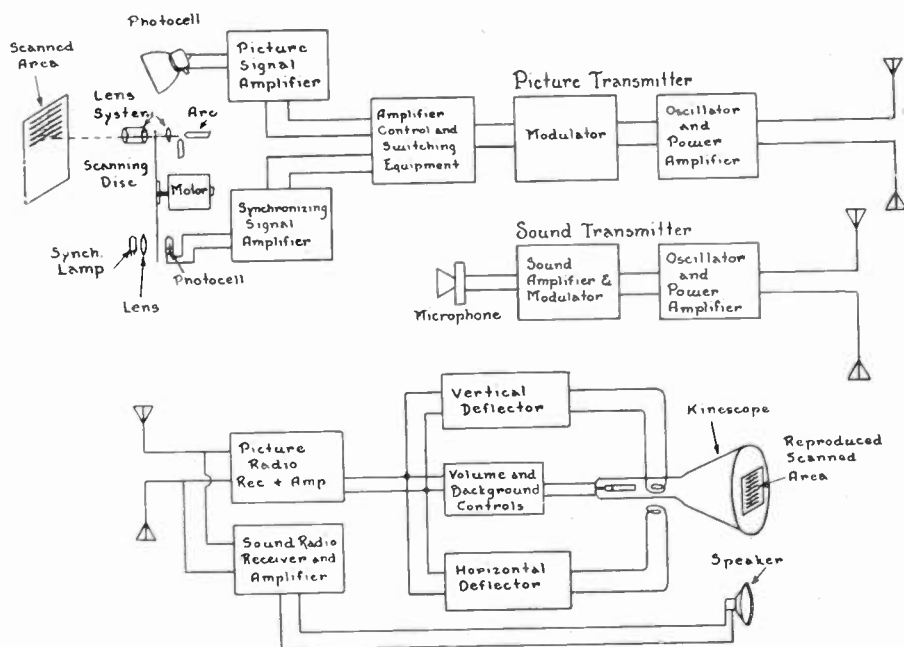

Fig. 1

repetition frequency of 24 per second with adequate illumination for the reproduced image.

A block diagram of the system is shown in Fig. 1, where the components and their location in the system are indicated. Naming the

* Decimal classification: R583. Original manuscript received by the Institute, July 10, 1933.

units in order, we have for television from the studio: The photoelectric tubes, the flying spot scanning equipment, the picture signal and synchronizing signal amplifiers, the control and switching equipment, and the modulating and radio transmitter equipment. The units comprising the television receiver are: An antenna system feeding two radio receivers, one for sight, including the cathode ray unit with its associated horizontal and vertical deflecting equipment, and the other for sound, including the usual loud speaker.

THE KINESCOPE

The name "kinescope" has been applied to the cathode ray tube used in the television receiver to distinguish it from ordinary cathode

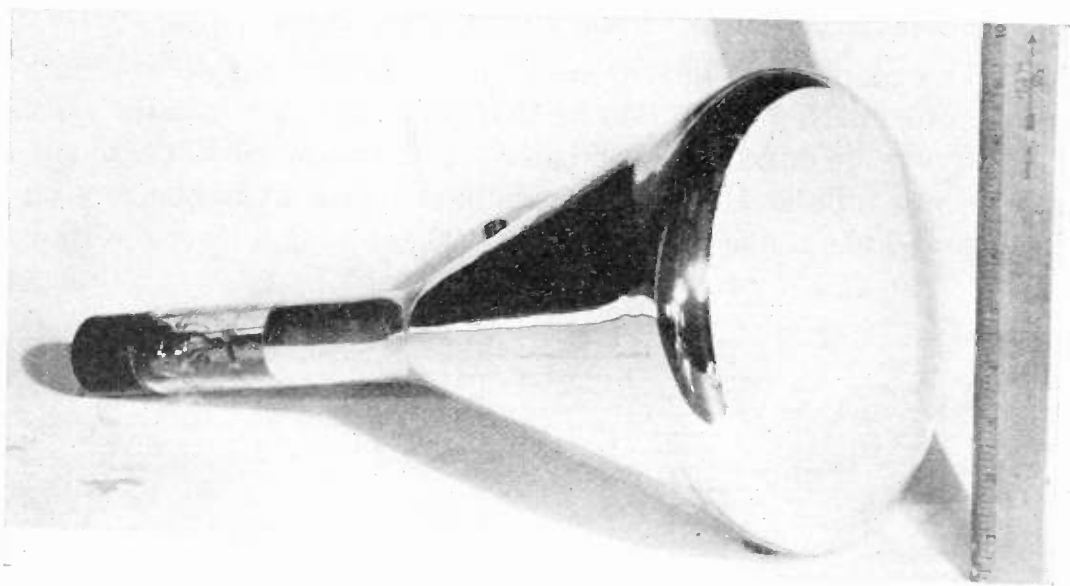

Fig. 2

ray oscilloscopes because it has several important points of difference; for instance, an added element to control the intensity of the beam. Fig. 2 gives the general appearance of the tube which has a diameter of 9 inches, permitting a reproduced image of approximately $5\frac{1}{2} \times 6\frac{1}{2}$ inches. Fig. 3 is a cross-section view of one of these tubes, showing the relative position of the electrodes, especially the cathode and its surrounding assembly, which is usually referred to as the "electron gun." The indirectly heated cathode, *C*, operates on alternating current. Its emitting area is located at the tip of the cathode sleeve and is formed by coating with the usual barium and strontium oxides. The control electrode, corresponding to the grid in the ordinary triode, is shown at *G*. It has an aperture, *O*, directly in front of the cathode emitting surface, and besides functioning as the control element it also serves as a shield for the cathode.

The first anode, A_1 , has suitable apertures which limit the angle of the emerging electron beam. The electron gun is situated in the long, narrow neck attached to the large cone-shaped end of the kinescope, the inner surface of the cone being silvered or otherwise metallized, and serves as the second anode. The purpose of the second anode, A_2 , is to accelerate the electrons emerging from the electron gun and to form the electrostatic field to focus them into a very small, thread-like beam. The first anode usually operates at a fraction of the second anode voltage.

The focusing is accomplished by an electrostatic field set up by potential differences applied between elements of the electron gun and the gun itself and the metallized portion of the neck of the kinescope.

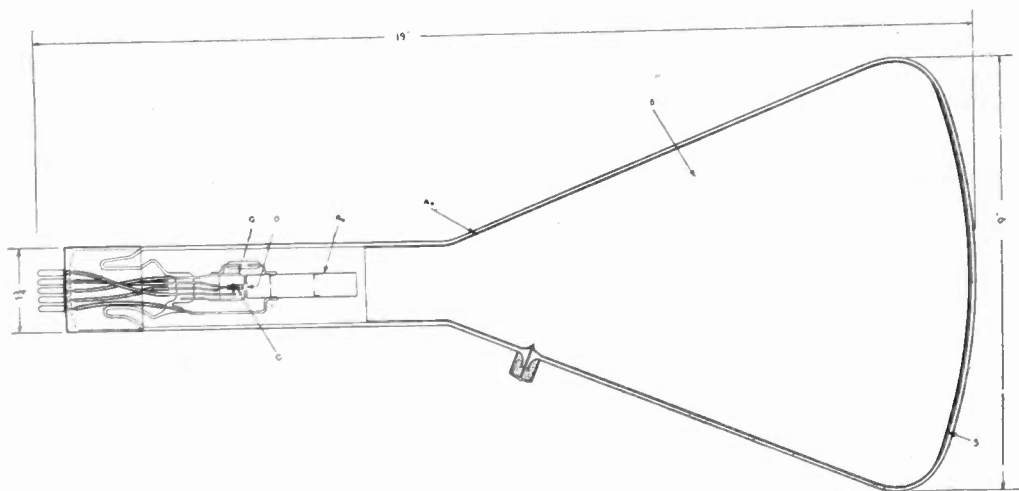

Fig. 3

The theory of the electrostatic focusing is described in detail in a recent paper by the writer.¹ The lines of force of the electrostatic field, between properly shaped electrodes, force the electrons of the beam to move toward the axis, overcoming the natural tendency of electrons to repel each other. This action is analogous to the focusing of light rays by means of optical lenses. The electrostatic lenses, however, have a peculiarity in that their index of refraction for electrons is not confined to the boundary between the optical media, as in optics, but varies throughout all the length of the electrostatic field. Also, it is almost impossible to produce a simple single electron lens; the field always forms a combination of positive and negative lenses. However, by proper arrangement of electrodes and potentials, it is always possible to produce a complex electrostatic lens which will be equivalent to either positive or negative optical lenses.

¹ V. K. Zworykin, *Jour. Frank. Inst.*, pp. 535-555, May, (1933).

The distribution of electrostatic fields in the electron gun of the kinescope is shown on Fig. 4. In this particular case, the total action of fields on electrons is equivalent to a combination of four lenses, as is shown in the same figure.

The first two lenses force the electrons through the apertures of the first anode and assure the desired control of the beam by the control element G . The final focusing of the beam on the screen is accomplished by the second pair of lenses created by the field between the end of the gun and the neck of the bulb. Thus, the final size of the

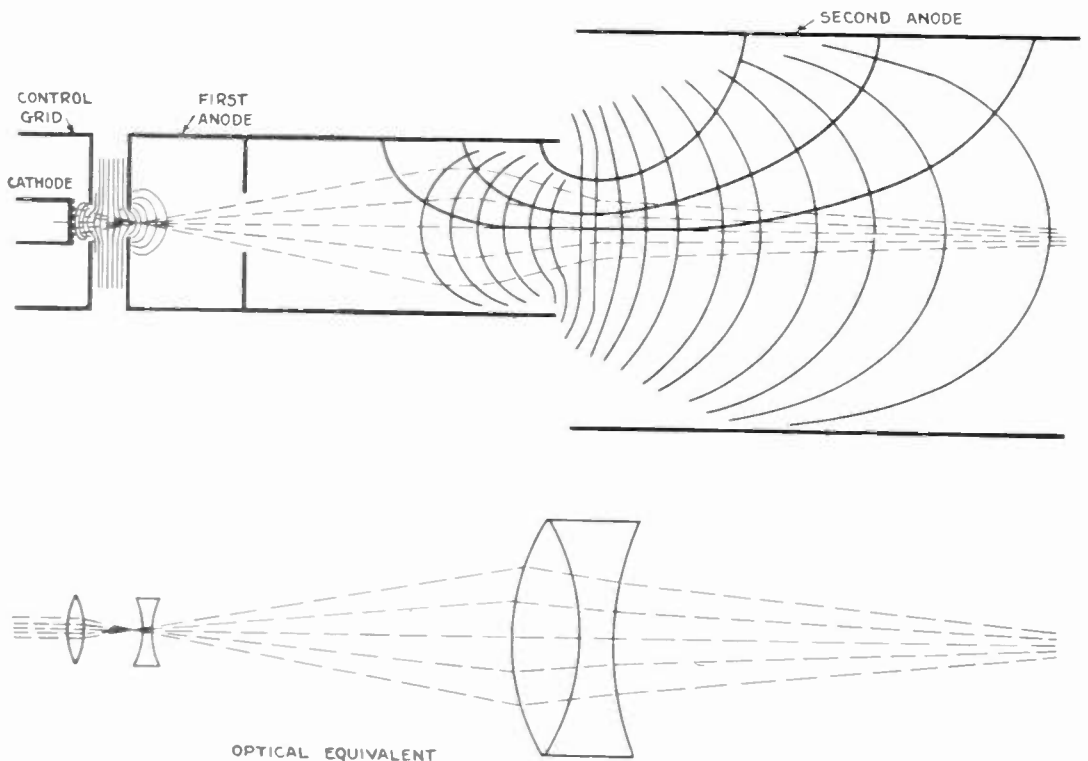

Fig. 4

spot on the screen, as in its optical analogue, depends chiefly on the size of the active area of the cathode and the optical distances between the cathode, lenses, and the fluorescent screen.

The velocity of the beam is expressed by the equation

$$v = 5.95 \times 10^7 \sqrt{V}$$

where v = beam velocity in centimeters per second and V is the second anode voltage. For $V = 4500$ volts, as used in kinescopes, the beam velocity is somewhat greater than one tenth that of light.

After leaving the first anode, the focused, accelerated beam impinges upon the fluorescent screen deposited upon the flat end of the conical portion of the kinescope. The fluorescent screen serves as a

transducer, absorbing electrical energy and emitting light. Thus there is produced a small bright spot on the screen, approximately equal in area to the cross section of the beam. The fluorescent screen is very thin, so a large portion of the emitted light is transmitted outside of the tube as useful illumination.

In order to reproduce the light intensity variations of the original picture, it is necessary to vary the intensity of the spot of light upon the fluorescent screen. This is accomplished by means of the control element, G , of the electron gun. For satisfactory reproduction, the

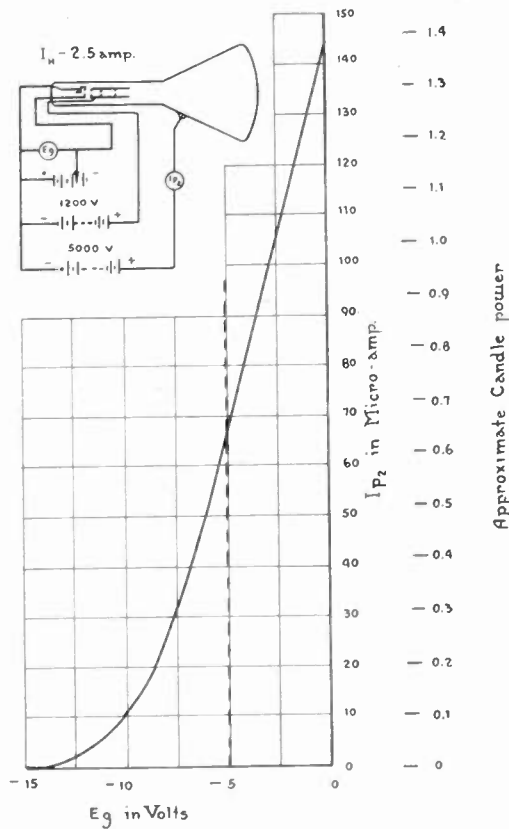

Fig. 5

control of the electron beam intensity should be a linear function of the input signal voltage. Furthermore, it is very essential that during the exercising of this control the sharp focusing of the spot shall not be destroyed. Still another requirement is that this control will not affect the velocity of the electron beam because the deflection of the beam is inversely proportional to its velocity and, therefore, a slight change due to picture modulation would disturb the image, making the bright lines shorter and the darker lines longer. As a result of careful design, the variation of velocity of the beam (from complete cut-off to full

brilliancy) in the kinescope is so small as to be unnoticeable to the observer of the picture.

The characteristic curve of the kinescope is shown in Fig. 5. From this it will be seen that an input of 10 volts alternating current will give practically complete modulation (i.e., a change from maximum to minimum brilliancy) of the cathode ray beam. The shape of this curve gives the proportionality between input voltage and second anode current and corresponding brightness of the spot. (It is to be noted that the values of current, voltage, illumination, etc., given on Fig. 5, and all figures in this report, are illustrative rather than specific values for a particular type of cathode ray kinescope tube.) By referring to Fig. 6,

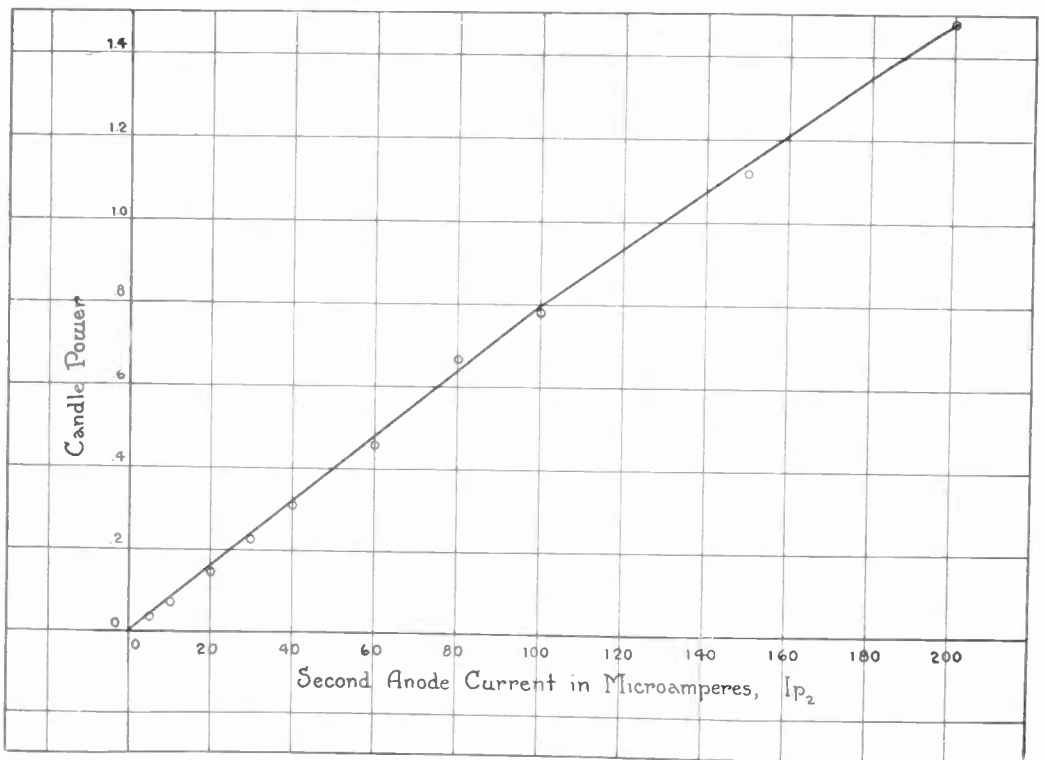

Fig. 6

which shows a graph of the relation of second anode current to the light emitted from the fluorescent screen, it will be noted that a linear proportionality exists. Therefore, we can draw the conclusion that a television picture, varying in shade from black to white, will have accurately reproduced all the intermediate shadings necessary for good half-tone pictures.

If we inspect the fluorescent spot by means of an enlarged photograph, we find that the light intensity is not uniform. When measured for a stationary spot, enlarged fifty times, the curve obtained from densitometer observations (see Fig. 7) shows that the light intensity

increases toward the center of the spot. The actual diameter of the spot was 2 millimeters. During the scanning of a picture, when the spot is in motion, the light intensity per square unit of screen decreases proportionately to the scanned area. Therefore the edges of the spot, being less luminous, disappear and the apparent size of the spot decreases. This explains the fact that the diameter of the static spot is larger than the value calculated by dividing the picture height by the number of scanning lines. The photograph of the spot also shows why black spaces between the scanning lines of the received picture may be noticed upon close observation. This is caused by the differences in light intensity between the center and the edges of the spot.

The material used for the fluorescent screen is a synthetic zinc orthosilicate phosphor almost identical with natural willemite. Zinc

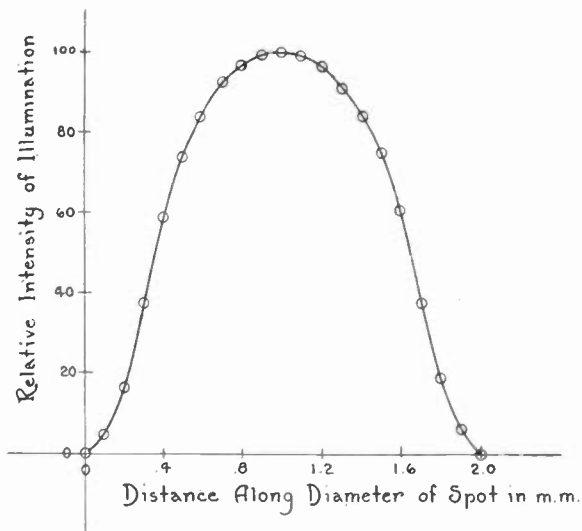

Fig. 7

orthosilicate phosphor was chosen because of its luminous efficiency, its short time lag, its comparative stability and its resistance to "burning" by the electron beam. The good luminous efficiency is due to the fact that the light, green in color, emitted by the zinc orthosilicate phosphor lies in the visible spectrum in a narrow band peaked at 5230A, close to the wavelength of maximum sensitivity of the eye (5560A) as shown in Fig. 8. The luminous efficiency of incandescent tungsten lamps ranges from 2.5–4.0 per cent² whereas the zinc orthosilicate phosphor has an efficiency of 1.8–2.7 per cent when expressed on the basis of lumens per watt, assuming 690 lumens per watt as the maximum theoretical efficiency.³ Fig. 9 shows candle power plotted

² Forsythe and Watson, *Jour. Frank. Inst.*, vol. 213, no. 6; June, (1932).

³ A. Schloemer, "Kathodenszillograph und Leuchtmasse," *Zeit. für Tech. Physik*, vol. 13, no.5, (1932).

against second anode voltage, and Fig. 6 shows candle power plotted against current carried by the electron beam for the cathode excitation of zinc orthosilicate phosphor. The general relation between candle power, applied voltage, and current intensity for phosphors excited by cathode rays is given by the equation:⁴

$$I = AQ(V - V_0)$$

I = the intensity of emitted light in candle power.

A = a constant characteristic of the phosphor.

Q = the current intensity in the beam in amperes per cm.²

V = the applied voltage (in volts).

V_0 = the extrapolated minimum exciting voltage (in volts) (a constant for each phosphor).

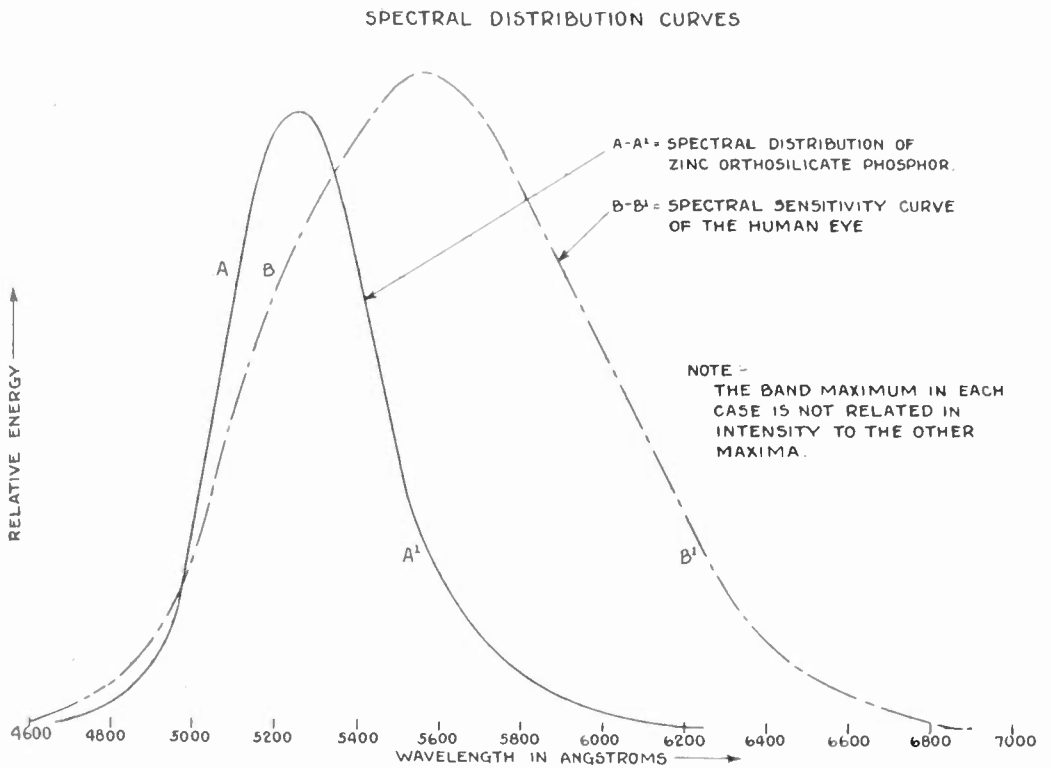

Fig. 8

Fig. 10 shows the time decay curve of the zinc orthosilicate phosphor luminescence. The decay curve shows that at the end of approximately 0.06 second practically all visible luminescence has ceased. For reproducing 24 pictures per second, the decay curve of the ideal phosphor should be long enough so that the phosphor just loses its effective brilliancy at the end of 1/24th of a second. If the time of decay is too

⁴ Wien-Harms, "Handbuch der Experimentalphysik," part 1, ch. 23, p. 158.

long, the moving portions of the picture will "trail," as, for instance, the path of a moving baseball would be marked by a comet-like tail. If the time of decay is too short, flicker is noticeable because of the space of comparative total darkness between the times when the fluorescent material is excited between successive pictures.

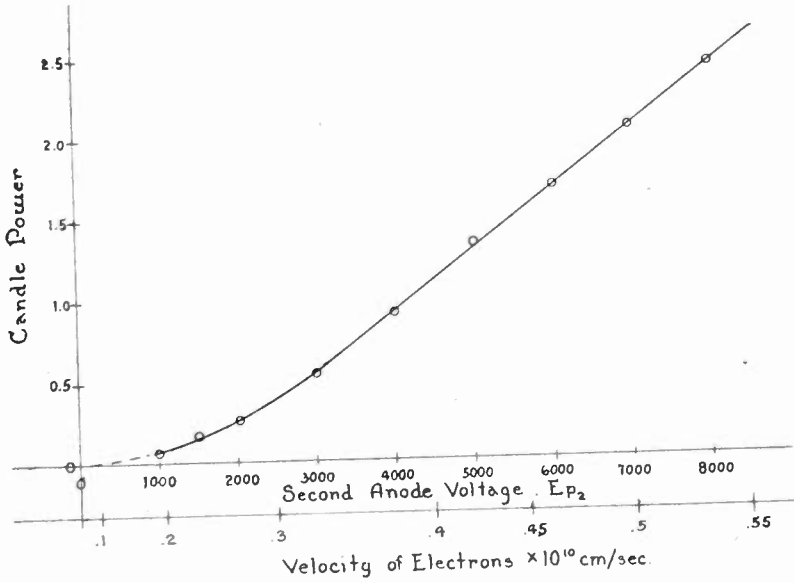

Fig. 9

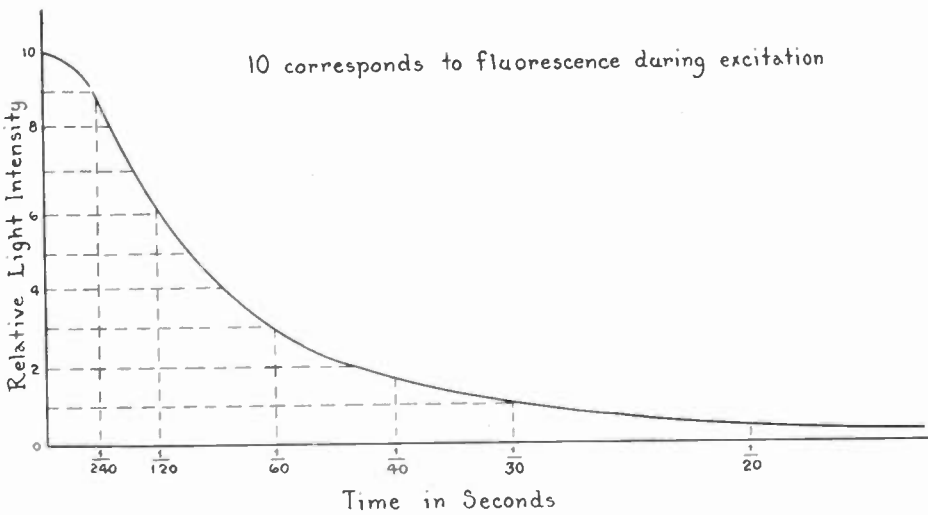

Fig. 10

When the electron beam strikes the fluorescent screen, the screen would acquire a negative charge, which, because of the good dielectric properties of the phosphor, would remain on the surface and act as a repulsive force upon the electron beam and may completely repulse the beam from the screen, thus stopping the light emission. To remove

this charge, we used to have a half-transparent, metallic film between the end of the kinescope tube and the fluorescent screen. Later, we found that a properly prepared phosphor emits a sufficient ratio of secondary to primary electrons to remove the accumulated charges. The secondary electrons are attracted to the high, positively-charged, metallized inner surface of the kinescope and thus the negative charge is carried away. Consequently, the kinescopes used in this equipment do not have transparent metallic film under the fluorescent screen.

The advantages of the kinescope in television over other means for reassembling the picture at the receiver are: the use of an inertialess beam, easily deflected and synchronized at speeds far greater than required for television; a sufficiently brilliant fluorescent spot which may be viewed directly on the end of the tube eliminating the restricted viewing angle usually present in mechanical scanners; noiseless operation; and the outstanding feature of the flexibility of the cathode ray tube itself.

SCANNING

The problem of picture transmission is essentially three-dimensional, two dimensions being required for expression of area, while a third is required to indicate intensity. Since a single radio channel is ordinarily capable of transmitting only two-dimensional intelligence, namely, intensity of signal and duration of time, it is evident that the concept of area in a picture must somehow be effectively reduced to a succession of unidimensional signals. This requirement introduces the necessity of scanning; that is, exploring the picture area, element by element, in some logical order in an interval of time so brief as not to be detectable by the human eye due to its persistence of vision.

One of the simplest methods of scanning a picture is to cause a spot of light to sweep across it in a succession of parallel horizontal lines. The motion of the spot across the picture may be either unidirectional or sinusoidal. An example of the latter type of scanning is employed with motion picture film in the system described in an earlier paper.⁵ At the transmitter this was accomplished by means of a galvanometer mirror which reflected the scanning beam onto the continuously moving film. In the cathode ray receiver this kind of motion is easily duplicated by deflecting the beam by a magnetic field produced by a sinusoidal current identical with the one energizing the galvanometer. This was superseded by unidirectional scanning. An example of unidirectional motion in scanning is that produced by the Nipkow disk widely used

⁵ V. K. Zworykin, "Television with cathode ray tube for receiver," *Radio Eng.*, vol. 9, no. 12, pp. 38-41; December, (1929).

in television. The disk contains a single row of holes equally spaced around the circumference, successively spaced at smaller distances from the center.

The general arrangement of the transmitter used in the present system is illustrated in Fig. 11. The components of this will be explained in an accompanying paper. Light from the source, *A*, is concentrated on the disk and images of the moving holes are projected through the lens, *L*, on to the object, *O*, to be televised. By means of the mask, *M*, only one hole is imaged at a time and, therefore, the flying spot covers the object completely with a series of parallel lines during each revolution of the disk. It is evident that the motion of spot across the object is uniform and in one direction only.

Light from the flying spot, reflected by the object, is gathered into a system of photo-electric cells and thus transformed into electrical

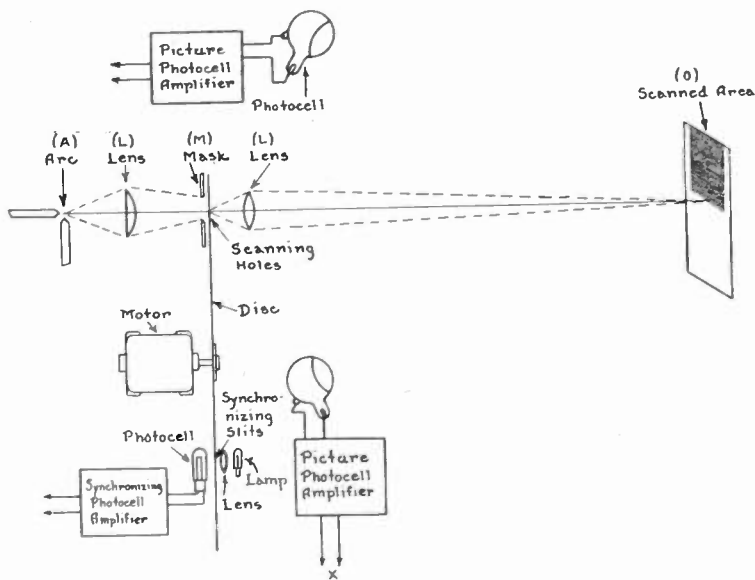

Fig. 11

impulses. These impulses, amplified, serve to modulate the output of the radio transmitter.

In televising moving picture film, the spiral row of scanning holes is replaced by a circular row, the vertical component of scanning being supplied by motion of the film, itself, passing the scanning line with a constant velocity. Here, as before, the flying spot explores the entire picture in a series of parallel lines, the light being transmitted directly through the object into a photocell situated behind the film.

In the experimental system described, the picture is made up of 120 lines and is transmitted at the rate of 24 per second. The picture has a 5-to-6 ratio of vertical to horizontal dimensions, and, therefore, the

horizontal detail is equal to 144 lines. The beam traces a succession of equally spaced horizontal lines across the fluorescent screen, constructing the television picture in the identical manner that the flying spot at the transmitter has scanned it, beginning from the top downward and after the last, or 120th line, jumping back to the position at the start of a new picture.

In order to scan with a cathode ray beam in this manner, two variable magnetic fields are applied to the beam just as it emerges from the electron gun; a vertical one, pulsating 24 times per second, and a horizontal one, pulsating 2880 times per second.

When an electron beam passes through a magnetic field it is deflected in a direction normal to the magnetic lines of force according to the well-known equation⁶

$$\delta_1 = \frac{evB}{2m} \frac{l^2}{v^2}$$

δ_1 = the displacement from the initial straight line.

e = the charge on the electron.

m = the mass of the electron.

B = the intensity of the magnetic field.

l = the length of path in the magnetic field.

v = the velocity of the electron.

(All quantities expressed in electromagnetic and c.g.s. units.)

δ_2 , the further displacement, during the time necessary to traverse the path from the magnetic field to the screen = $evBL/mv^2$. The total displacement is given by

$$\delta = \delta_1 + \delta_2 = \frac{e}{m} \frac{Bl}{v} \left(\frac{l}{2} + L \right) \text{ cm}$$

L = the distance from the deflecting magnetic field to the fluorescent screen.

In order that the cathode beam at the receiver follow the unidirectional scanning at the transmitter, the variation of intensity of both horizontal and vertical deflecting fields plotted against time is of a "saw-tooth" shape, as shown in Fig. 12. Each cycle consists of two parts; the first, linear with respect to time and lasting practically the whole cycle, and the second, or return period, lasting only a small fraction of the cycle. The picture is reproduced during the first part of the scanning period by varying the bias of the control element ac-

⁶ J. T. Irwin, "Oscillographs," Isaac Pitman and Sons, Ltd., London, (1925.)

ording to the light intensities of the transmitted picture, as described above.

There are a number of methods that will produce "saw-tooth"-shaped electrical impulses. A simple one has been described in an earlier paper,⁵ consisting of charging a condenser through a current

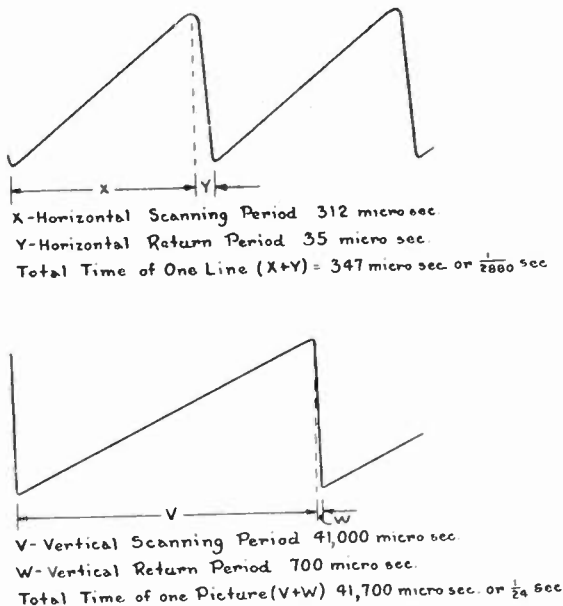

Fig. 12

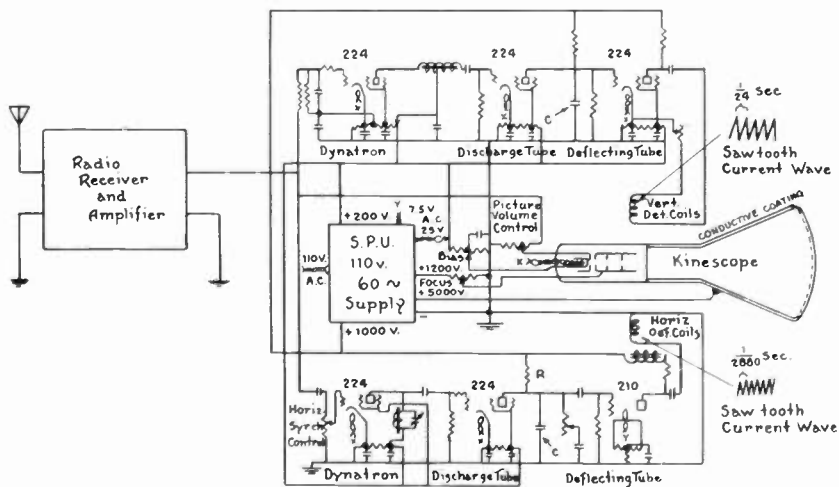

Fig. 13

limiting device such as a saturated two-electrode vacuum valve and then discharging the condenser through a thermionic or gas-discharge tube. The practical limitation of this "saw-tooth" generator lies in the fact that there is no such thing as a completely saturated thermionic tube. Therefore, the condenser cannot be charged exactly linearly with

time, and, consequently, the line reproduced on the fluorescent screen will be not exactly straight.

In order to straighten the scanning lines and improve the quality of the reproduced picture, a more complicated circuit was used, involving one dynatron oscillator and two amplifying tubes, as shown in Fig. 13. The condenser, *C*, in the horizontal deflecting circuit is charged continuously through the resistance, *R*. Periodically, at the end of predetermined intervals, the condenser is discharged. During these intervals, the accumulated charge does not reach saturation value, for the time ($1/2880$ of a second) is insufficient. The vacuum tube through which the discharge takes place is controlled by impulses supplied from a dynatron oscillator having a distorted wave shape. The frequency of oscillation of the dynatron (which can be made to vary over a fairly wide range) is initially adjusted to approximately 2880 cycles per second, so that received synchronizing signals will have no difficulty in pulling the dynatron into step with the synchronizing impulses generated by the transmitter scanning disk, as explained later. The charging and discharging of condenser, *C*, represent saw-tooth variations of potential, which, when applied to the grid of an amplifying tube, produce saw-tooth current impulses in deflecting coils connected in the plate of the amplifier.

The vertical deflecting circuit is similar to the horizontal circuit just described. Both vertical and horizontal deflecting systems operate on the beam by the magnetic fields generated by coils placed about the neck of the cathode ray tube.

The choice of electromagnetic deflection in preference to electrostatic was made more as a result of economical consideration than mechanical choice. The kinescope for electromagnetic deflection is much cheaper to make than the one equipped with inside deflecting plates for electrostatic deflection. On the other hand, the electromagnetic deflecting unit itself requires more power and is more costly to build than the electrostatic one. The predominance of one or more factors depends chiefly upon the frequency of deflection and velocity of the beam.

The constants of the electrical circuits for vertical and horizontal deflection are, of course; entirely different, due to the great difference in the operating frequencies of the two deflection circuits.

SYNCHRONIZATION

When both deflecting circuits are properly adjusted and synchronized with the transmitter, a pattern consisting of 120 parallel lines is seen on the fluorescent screen. The sharpness of the pattern and

perfection of its synchronization with the transmitter determines to a large extent the quality of the reproduced picture. This pattern is transformed into the picture by applying the picture signal impulses from the transmitter to the control element of the kinescope, so as momentarily to vary the brilliancy of the spot.

For sending synchronizing impulses, the transmitting scanning disk has an auxiliary row of slits, one for each scanning aperture. (See Fig. 14.) These slits, together with a separate illuminating lamp and

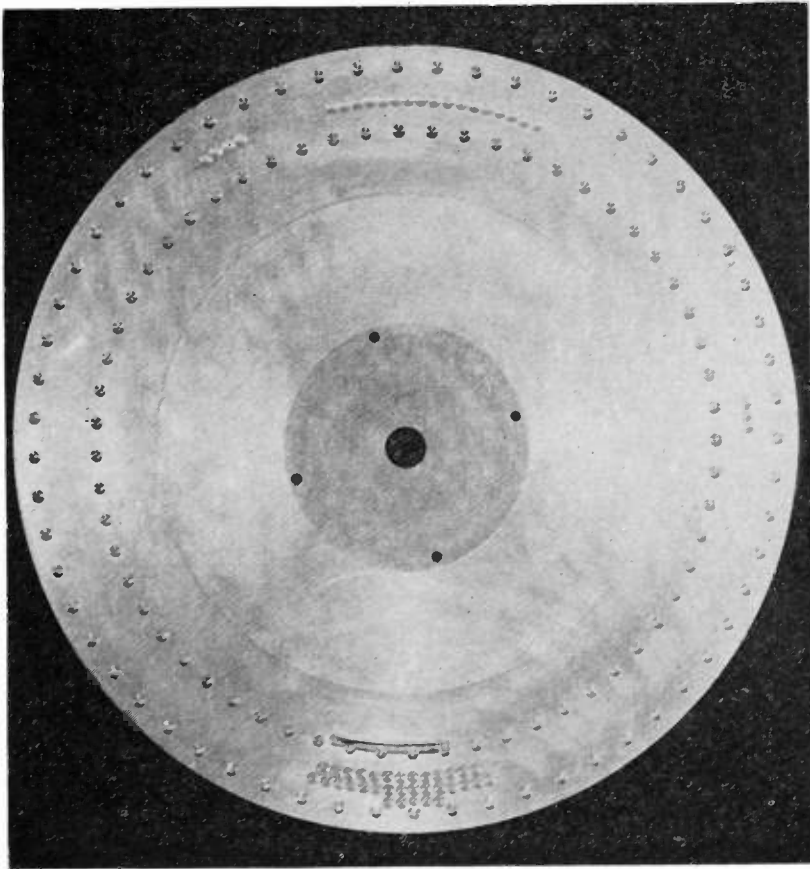

Fig. 14

photocell, produce impulses, one at the end of each line and at the end of each picture frame. The synchronizing impulses are transmitted over the picture signal channel. They do not interfere with the picture signals, because they occur at an instant when the picture actually is not being transmitted.

To allow the transmission of horizontal synchronizing signals at a time when the beam at the receiver is returning to start a new horizontal trace, the generation of picture signals is cut off for ten per cent of the scanning time. This is done by simply spacing the scanning disk apertures ten per cent farther apart than the width of the scanned

frame. Vertical synchronization is carried out in the same manner, synchronizing impulses for this purpose being transmitted at the completion of each frame.

There is considerable advantage gained from using a synchronizing system in which the beam at the receiver is brought into step with the

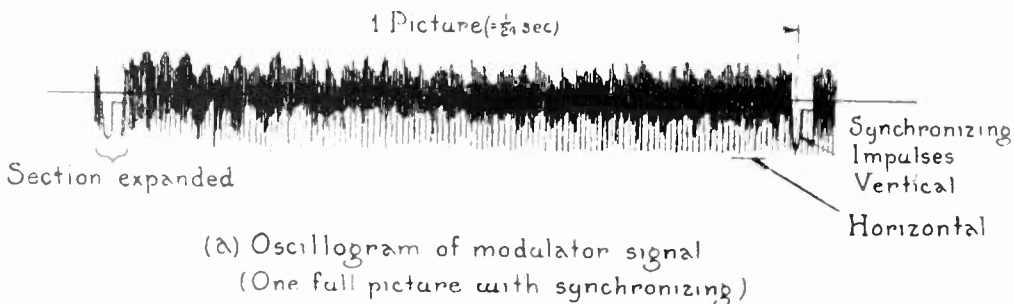

Fig. 15

transmitter at the end of each horizontal line because momentary disturbances of the nature of static do not appreciably affect the picture.

It will be seen that the transmitter is modulated by picture, horizontal synchronizing, and vertical synchronizing signals. The resulting composite signal which is fed to the modulator grid, therefore, ap-

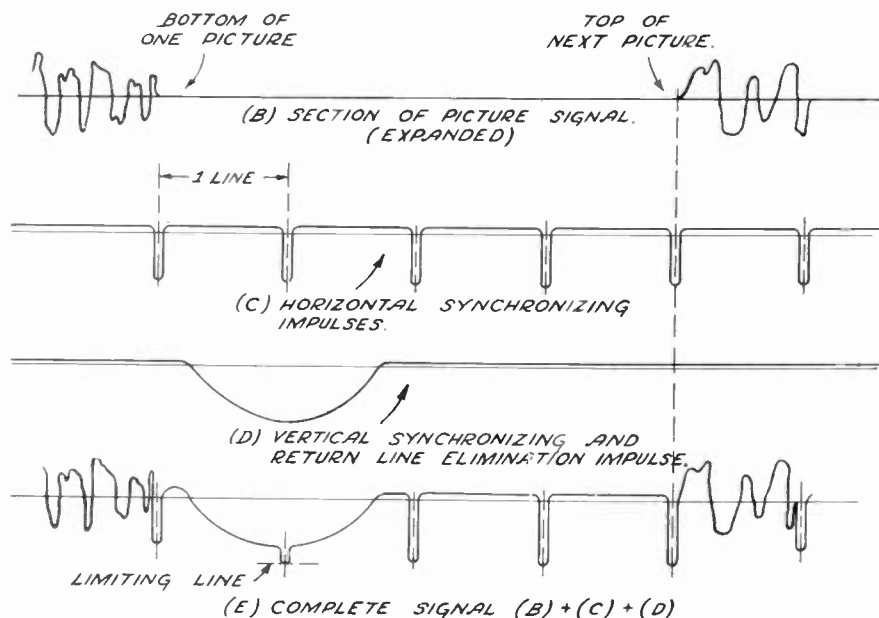

Fig. 16

pears as shown in Fig. 15. A clearer view of the components of this composite signal can be gathered from Fig. 16, the top curve of which represents the irregular-shaped picture signals which are often unsymmetrical about the axis, usually more positive than negative. Both synchronizing signals are arranged to have their peaks on the negative

side of the axis. The difference in shape of the horizontal and vertical impulses, of course, is due to the shape of the corresponding openings in the scanning disk, and this difference in wave shape is utilized at the receiver for the purpose of separating these two synchronizing impulses. The three signals mentioned above differ in frequency and in amplitude, since the horizontal synchronizing impulses occur at a rate of 2880 per second, the vertical impulses 24 times a second and the picture sig-

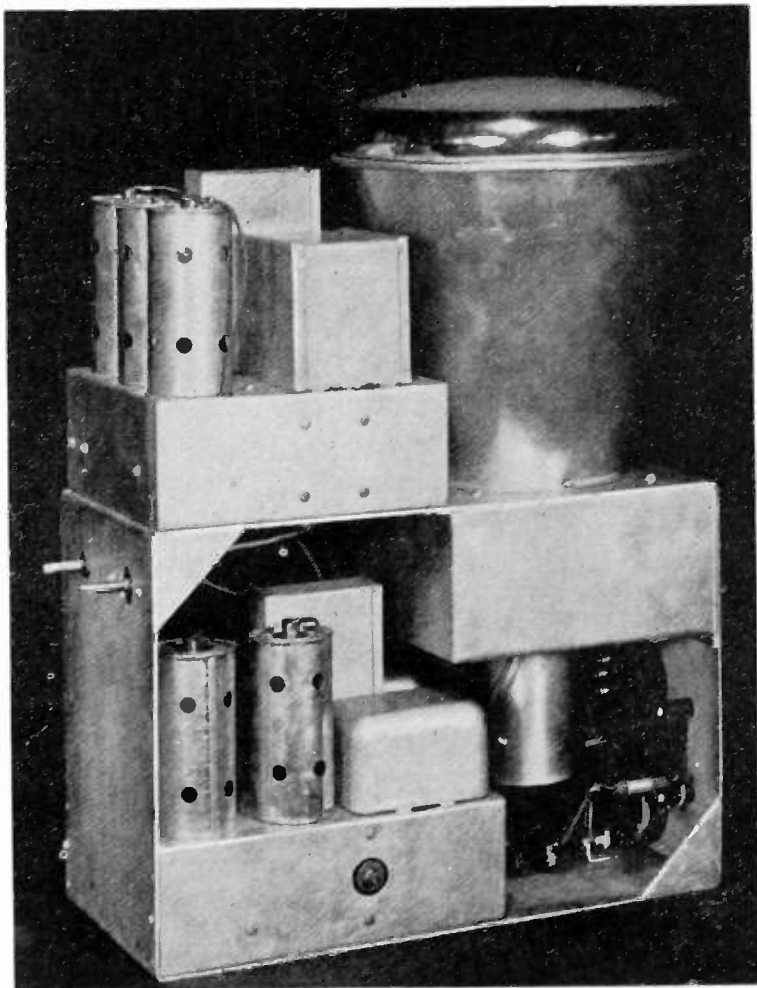

Fig. 17

nals at a widely varying rate. The peak picture signal amplitude is carefully adjusted to be always less than the horizontal and vertical impulses, the amplitude of the latter being approximately equal.

The separation of the three signals at the receiver is accomplished by a very simple means which is described in detail in an accompanying paper, so that the fundamentals only will be mentioned here. If we trace the signals at the receiver from the antenna through the radio

receiver and amplifier, shown in Fig. 13, we find that they are applied to three independent units, the vertical deflecting system, the horizontal deflecting system, and the input to the kinescope. The synchronizing impulses do not affect the picture on the kinescope because they are transmitted at a time when the cathode ray beam is extinguished, that is, during its return period. The picture signals do not affect the deflecting circuits because amplitude selection is utilized; that is, the amplitude of the picture signals is never sufficient to affect the input

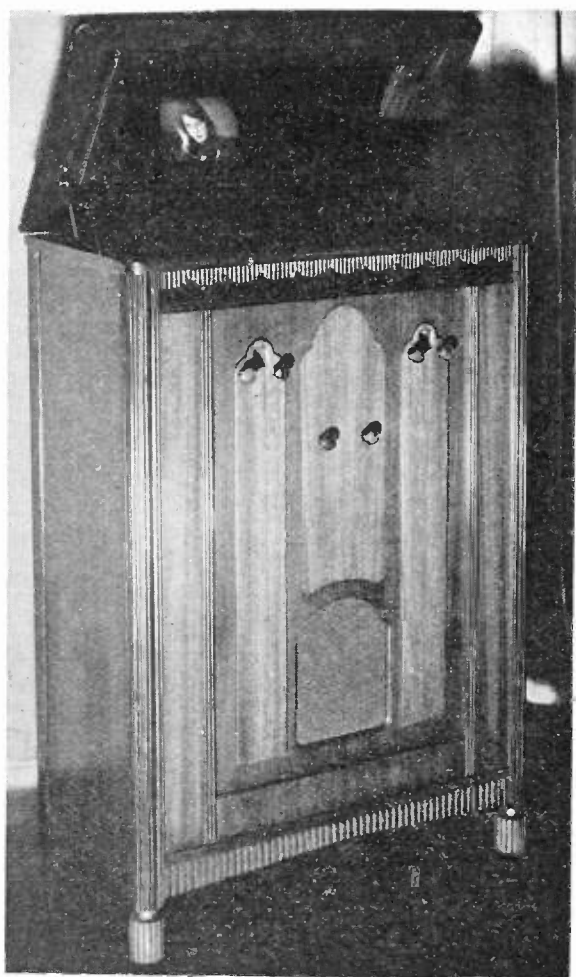

Fig. 18

tubes of either deflecting system. The selection between vertical and horizontal synchronizing impulses is made on the basis of wave shape selection. A simple filter in each of the input circuits of the two deflecting units gives satisfactory discrimination against undesired synchronizing impulses. The plate circuits of both dynatron input tubes contain circuits approximately resonant to the operating periods of their respective deflecting circuits, thus aiding in the matter of selectivity.

When the electron beam returns to the position from which it starts to trace a new line, and particularly when it returns from the bottom of the picture to start a new frame, an undesirable light trace, called the return line, is visible in the picture. To eliminate this the synchronizing impulses which are in the negative direction are applied to the control electrode of the kinescope, so as to bias it negatively and thus eliminate the return line by extinguishing the beam during its return.

To produce a picture, the intensity of light on a fluorescent screen is varied by impressing the picture signal on the kinescope control element. If the bias adjustment on the kinescope is set so that the picture signals have the maximum swing on the characteristic curve of the kinescope (shown in Fig. 5) a picture with optimum contrast is produced. The picture background, or the average illumination of the picture, can be controlled by the operator by adjusting the kinescope bias.

REPRODUCING EQUIPMENT

The arrangement of the television receiver built for these tests is shown in Figs. 17 and 18. The former is a photograph of the chassis containing the deflecting unit and kinescope. This chassis slides as a unit into the cabinet. Fig. 18 is a photograph of the complete receiver which contains a power unit, kinescope unit, two radio receivers—one for picture and one for sound signals—and a loud speaker.

The reproduced image is viewed in a mirror mounted on the inside lid of the cabinet. In this way the lid shields the picture from overhead illumination. This method also affords a greater and more convenient viewing angle. The brilliancy of the picture is sufficient to permit observation without the necessity of completely darkening the room. Since this type of television receiver has no moving mechanical parts it is quiet in operation.

The operations to be performed in tuning such a receiver are as follows: After the power switch is turned on, the picture and sound receivers are tuned to their respective signals in the ordinary manner. Next, the picture "volume" control (radio sensitivity control) is increased to that point at which the picture locks into synchronism. Then the signal voltage (picture-frequency amplification) to the kinescope is adjusted to the best operating point determined by observation. The background control is adjusted to the desired value depending upon the type of picture being transmitted.

DESCRIPTION OF EXPERIMENTAL TELEVISION TRANSMITTING APPARATUS

BY

R. D. KELL

(RCA Victor Company, Inc., Camden, New Jersey)

Summary—A description is given of an experimental television transmitter. This equipment was installed in the *Empire State Building* and was used in making practical tests on an experimental television system. The installation included facilities for radiating sound and picture signals from studio and from motion picture film. The general considerations underlying the design and performance of television terminal and transmitting apparatus for this experimental system are reviewed.

THEORETICAL CONSIDERATIONS

THE utilization of that part of the radio-frequency spectrum in the vicinity of 50 megacycles has removed from television the limitations of a narrow communication channel. The remaining question to be answered before an experimental system could be decided upon was how great a resolution of the picture would be practicable with the available terminal equipment. In the resolution of the picture, the limiting factor was found to be in the quantity of light available for scanning in the studio. In other words, as the picture resolution is increased with a corresponding decrease in the scanning spot size, the signal-to-noise ratio reaches a value beyond which the television signals are unusable. A ratio of ten to one has been found by experience to be about the limit of usefulness. From measurements on 48-, 60-, and 80-line television studio pick-up equipment, it was determined that with a light source of the highest intrinsic brilliancy available, the ratio of signal to noise would approach the limiting ratio of ten to one with 120-line mechanical scanning.

The terminal equipment developed for use at the transmitter consists of the usual photo-electric tubes with their associated amplifiers and scanning disk, using modified forms of the conventional type. At the receiver, a special cathode ray tube replaces the well-known scanning disk with its associated neon lamp. The scanning beam is made to move across the fluorescent screen of the receiving tube in synchronism with the scanning spot at the transmitter by means of special deflecting circuits. The scanning spot produced at the transmitter moves with constant velocity across the object being scanned. To produce

* Decimal classification: R583. Original manuscript received by the Institute, July 10, 1933.

an undistorted image of the object on the cathode ray tube, the scanning spot at the receiver must also move at constant velocity. After tracing a line across the screen, the beam must return before it can start the scanning of the next horizontal line. The scanning beam is often spoken of as being inertialess, which should allow its return across the screen in zero time. This is practically true, but the inertia of the deflecting circuits is such that approximately one tenth of the scanning time is required for the return of the scanning beam across the screen. To allow for this at the transmitter, the spacing of the apertures in the scanning disk is such that for ten per cent of the time there is no scanning spot on the object. Fig. 1 shows the useful picture

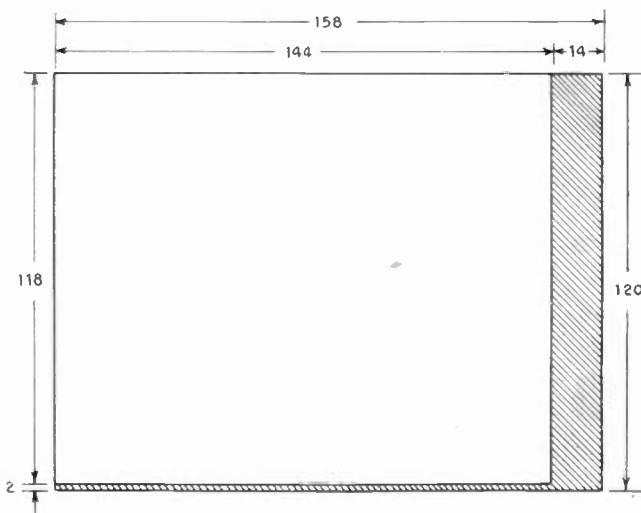

Fig. 1

area plus the shaded area which is that lost due to the time required for the return of the scanning beam. The dimensions shown are in picture elements, which in the vertical direction corresponds with the number of horizontal scanning lines.

The theoretical elements shown in the shaded area at the side of the useful picture area are to allow sufficient time for the horizontal return. The two lines at the bottom of the picture, likewise, allow sufficient time for the vertical return. The total theoretical number of elements which must be transmitted for the production of a picture of 144×118 or 16,992 elements, is found to be 120×158 or 18,960, which is a loss of 1968 elements due to the time required for the horizontal and vertical return of the scanning beam. The highest theoretical frequency required of the system may be simply arrived at by assuming that the maximum frequency is produced when alternate elements are black. This produces $18,960 \div 2 = 9480$ cycles per picture. At 24 pictures per second, the top frequency is then $9480 \times 24 = 227,520$ cycles.

The lowest frequency that may be produced in the scanning of a stationary object is produced when the scanning field is half black and half white about a horizontal axis. For a scanning speed of 24 pictures per second, this lowest frequency is 24 cycles per second. These frequencies, 24 and 227,520 cycles, define the frequency band required for the production of a 120-line picture.

The synchronizing signals, to be sufficiently accurate for a picture having as many as 17,000 elements, must be supplied to the receiver directly from the transmitter. The use of even a common power supply for synchronizing the transmitter and receiver introduces difficulties

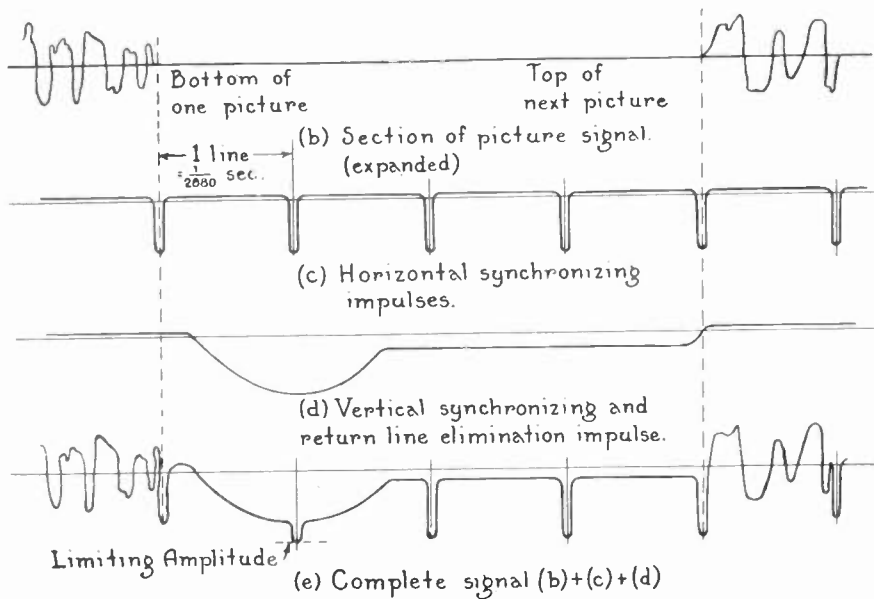

Fig. 2

when such a great number of picture elements are used. The horizontal synchronizing signals must have a frequency at least equal to the line frequency of the picture if the synchronizing is to be sufficiently accurate in a horizontal direction. A second frequency is required to frame the picture properly in the vertical direction. This also must be supplied from the transmitter.

Because of the time required for the scanning beam to return across the screen at the receiver, a loss of 1968 picture elements per picture is unavoidable. The use of this lost time for transmitting the synchronizing signals seemed, if possible, to be the most desirable solution of the problem. The system developed makes use of this time during which no picture is transmitted for the transmission of both horizontal and vertical synchronizing signals. The first advantage of this is that it is possible to mix the synchronizing and the picture signals at the transmitter, and utilize them for their distinctive pur-

poses at the receiver without the use of filters. The second advantage is that no additional width of frequency band is required for the synchronization of the picture.

At 24 pictures per second, the vertical synchronizing signal is 24 impulses per second and the line frequency of a 120-line picture repeated 24 times per second is $120 \times 24 = 2880$ impulses per second. These then are the two impulse rates that must be transmitted to the receiver for the proper synchronizing and framing of the picture. The term "impulse" is used here instead of cycles, because the synchronizing signals are square-topped waves having a duration of approximately one fiftieth of their repetition rate. Fig. 2 shows the general

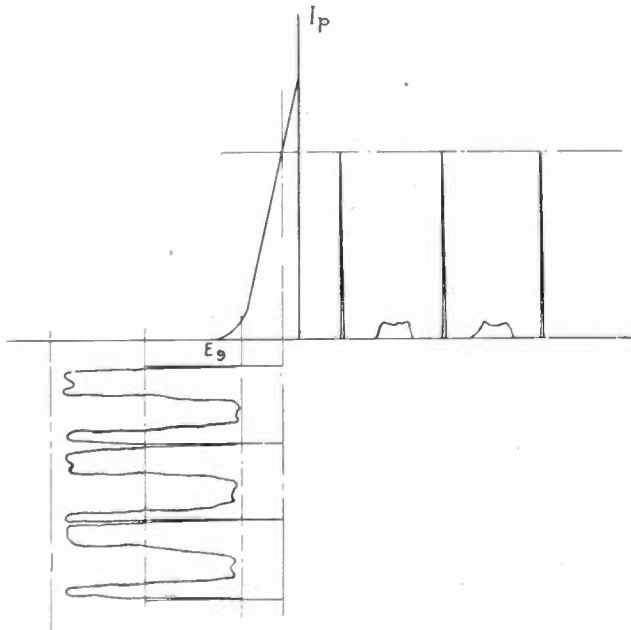

Fig. 3

shape of the impulses and their relation to the picture signal. These impulses are generated at the end of each scanning line and last for 10 microseconds. They are produced by means of an auxiliary set of slits in the scanning disk at the transmitter through which light is directed into a photo-electric tube. At the end of each scanning of the picture, or every 24th of a second, a vertical synchronizing impulse, lasting for 350 microseconds, is produced by means of a longer slit passing between the same lamp and photo-electric tube as used for the production of the horizontal synchronizing impulses. These synchronizing impulses are mixed with the picture in such a phase that all synchronizing signals are in the same direction as picture signals produced by the scanning of black, that is, all synchronizing impulses extinguish the scanning beam at the receiver. The vertical synchronizing impulse causes the scanning

beam at the receiver to start its return to the top of the picture for the next vertical scanning. The beam moves from bottom to top across the scanning area on its return path, and would produce a bright diagonal line across the picture if some means of extinguishing the scanning beam during its return path were not employed. The signal produced by light passing through the low amplitude end of the vertical synchronizing slot serves this purpose, that is, it extinguishes the scanning beam until it has reached the top of the scanning area. During the horizontal return of the scanning beam it is extinguished, as no light falls into the picture photo-electric tube during the scanning of the ten per cent area at the side of the picture during which time the receiving beam is returning. The horizontal and vertical impulses are

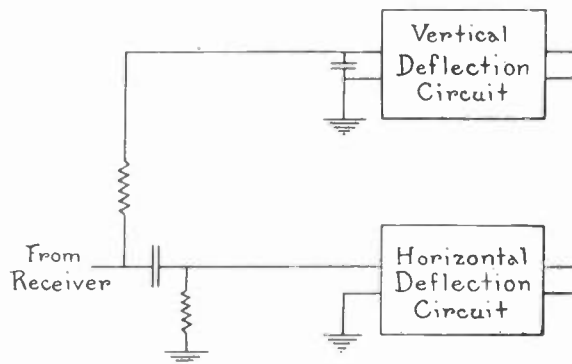

Fig. 4

so adjusted as to have the same amplitude. Also, the picture signal level is maintained at such a value that it never exceeds the synchronizing impulses in amplitude. This allows the use of "amplitude selection" in the receivers to separate the synchronizing from the picture. Fig. 3 shows the condition of operation of the final synchronizing amplifier tube in the receiver, for selecting between the picture and synchronizing signals by amplitude selection. The grid bias is adjusted to such a value that the picture signal causes practically no change in plate current, and only the synchronizing impulses are amplified. The selection between the horizontal and vertical synchronizing impulses depends upon the difference in steepness of the wave front of the two impulses. We have termed this method of separating the impulses "wave front selection." Fig. 4 shows the arrangement of the synchronizing circuits for making the selection between the horizontal and vertical synchronizing signals. In selecting the vertical impulse, the voltage across the condenser which is in series with a resistor is used. The values of condenser and resistor are such that the impedance presented by the condenser to the steep wave front of the horizontal synchronizing impulses is low, while its impedance is high to the gradual slope of the vertical

synchronizing impulse. As a result, in the output of the network, the vertical impulses as applied to the vertical deflecting unit have approximately ten times the amplitude of the horizontal synchronizing impulses in the same circuit. It is important that the horizontal synchronizing impulses after passing through the selecting circuit be of such low amplitude that they do not affect the vertical synchronizing. If they are not sufficiently low, the picture may be improperly framed on any horizontal impulses. The principle of the action in the network for the horizontal selection is the same. But in this case the voltage across the resistor is used to operate the deflecting circuit. No serious harm is done if the horizontal and vertical impulses are mixed in the input to the horizontal deflecting unit, because during the vertical synchronizing impulse there is no picture on the receiving screen.

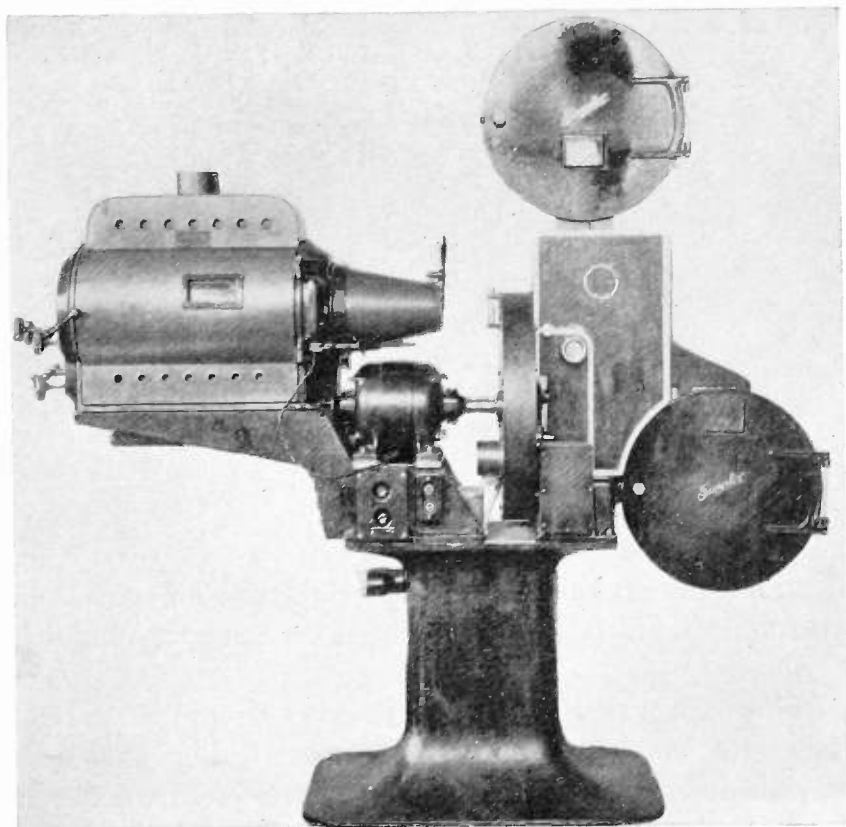

Fig. 5

MECHANICAL DESIGN OF FILM SCANNER

Fig. 5 is a photograph of the motion picture film scanner designed and constructed for our television experiments. This scanner consists of the conventional scanning disk having apertures equally spaced around its periphery and on equal radii. The apertures in the disk are

illuminated by a standard motion picture projection arc. Fig. 6 shows the optical system employed. The image of the scanning aperture is focused on the film by means of a projection lens placed at twice its focal length from the disk, so that its dimensions will be the same as the aperture in the disk. Ordinarily, when a photo-electric tube is placed behind the film, the scanning spot which moves across the film also moves across the cathode of the photo-electric tube. The result is undesirable variations in the photo-electric current due to the nonuniform sensitivity of portions of the cathode. To overcome this difficulty, a second lens was placed behind the film in such a position as to image

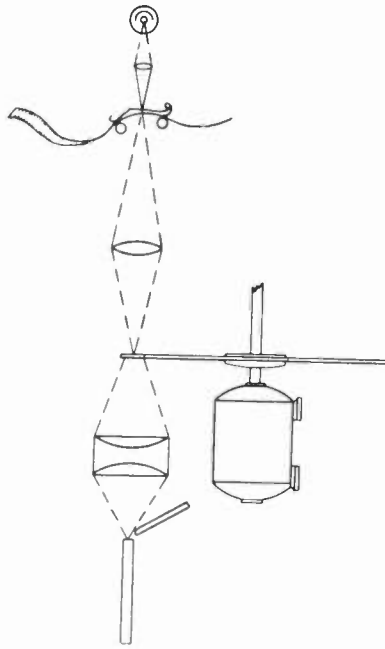

Fig. 6

the projection lens on the photo-electric tube. This causes the light passing through the film to fall in a small stationary spot on the cathode.

Fig. 7 is a photograph showing the arrangement of the gates and sprockets in the motion picture scanner head. The path of the film is over a pull-down sprocket and through the picture gate. In order to insure an absolutely constant speed of film through the picture gate, it is necessary that some form of mechanical filter be provided to eliminate slight variations in speed introduced by gear backlash, mechanical vibration, and the jerky feed inherent with sprocket-tooth drive. In this mechanism a device known as an impedance roller is used for this purpose. The impedance roller consists of a flywheel attached to a roller about the size of a sprocket wheel. The roller is driven by the film passing around it and is not connected to the drive mechanism in any other

way. The film after leaving the picture gate passes over the roller to the constant speed sprocket. The inertia of the roller serves to prevent any variations in the linear speed of the film, and causes the film to be drawn through the gate at an absolutely constant speed. The vertical framing of the picture is accomplished by manually adjusting the posi-

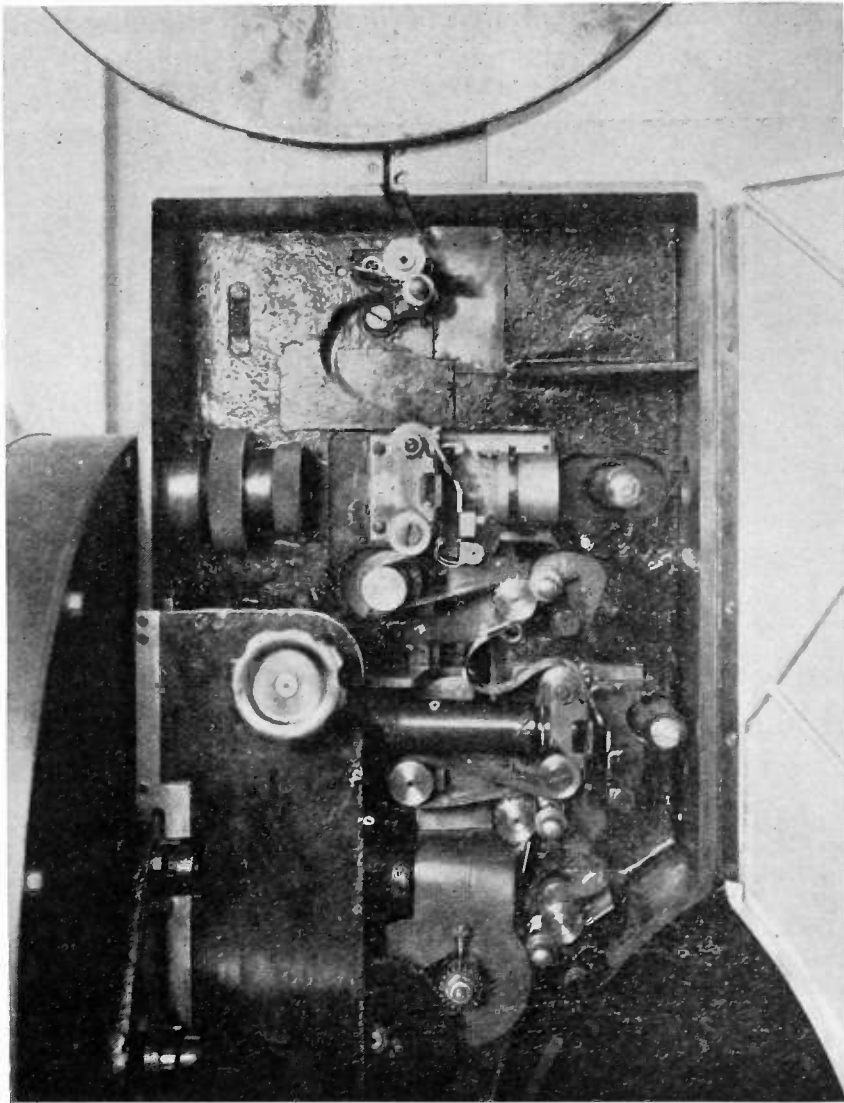

Fig. 7

tion of the film in the picture gate with respect to the vertical synchronizing aperture so that the vertical synchronizing impulse comes just as the scanning of a picture frame is completed. To make this adjustment, the impedance roller next to the picture gate is moved by means of the framing knob so as to vary the length of the film between the pull-down sprocket and the picture gate.

Tests with the ordinary 120-line scanning disk proved it to be large and unwieldy. As a result a disk was used having half the required number of apertures and driven at double speed. Fig. 8 is a photograph of the scanning disk. Each of the 60 square apertures measures 0.006 inch on a side. The chordal distance between apertures is 0.926 inch. This dimension is the width of the picture (0.875 inch) plus ten per cent. The additional ten per cent is to allow the scanning beam to return across the screen at the receiver as already described.

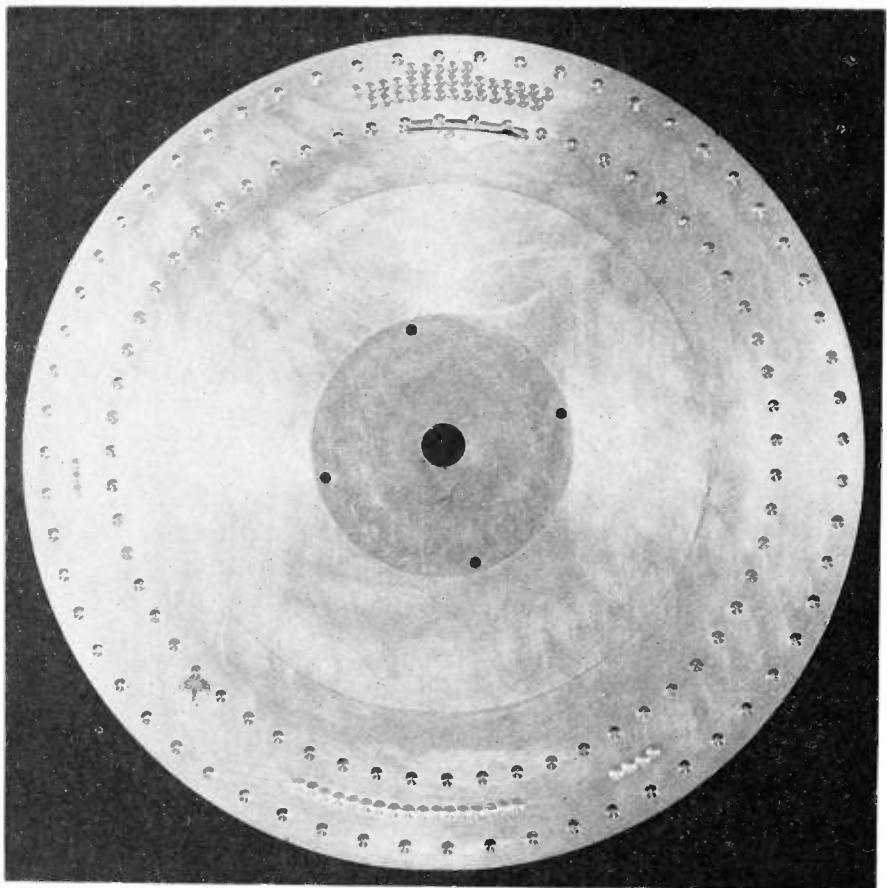

Fig. 8

Fig. 9 is a photograph showing the arrangement of the incandescent lamp and photo-electric tube used for obtaining the synchronizing signals from a second set of apertures in the disk having the same angular spacing as the picture scanning apertures, but on a shorter radius. The horizontal synchronizing apertures are 0.100 inch in length and 0.010 inch in width, while the vertical synchronizing slot is 2.8 inches in length and 0.100 inch in width at its widest part. The shapes of these two types of synchronizing apertures are shown in Fig. 10. An exciter lamp is used with a lens system arranged to place an image of the filament on the synchronizing apertures.

The position of the synchronizing lamp is such that the light passes through the horizontal synchronizing apertures and into the photo-electric tube just as the corresponding picture aperture moves from the edge of the picture into the ten per cent area in which no light falls on the picture photo-electric tube.

Fig. 11 shows the arrangement for securing the vertical synchronizing signal. A rotating shutter containing a slot is driven through a gear

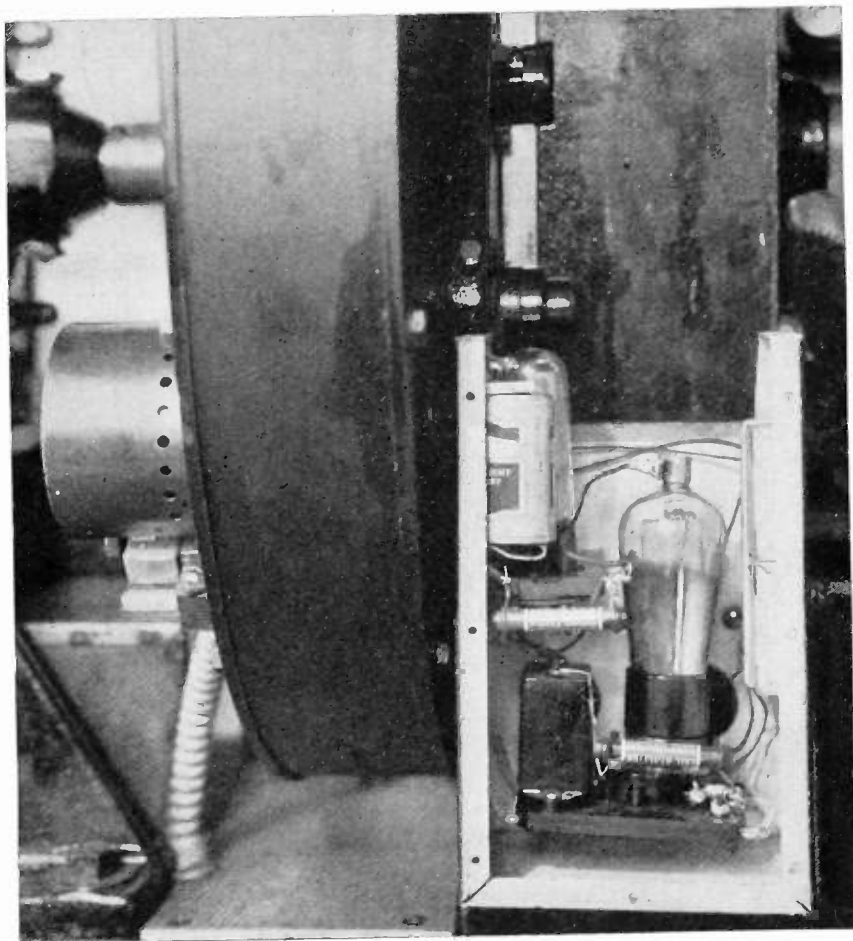
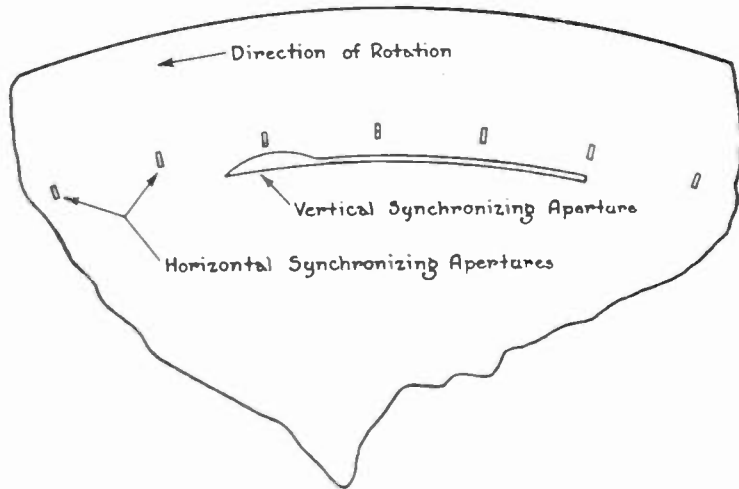

Fig. 9

train so that at the completion of each picture the aperture for producing the vertical synchronizing impulse is uncovered. The gearing between the scanning disk and the film drive sprockets is so arranged that two revolutions of the scanning disk (the passing of 120 apertures across the film) occur while the film moves one frame. With the disk running at 2880 revolutions per minute, the film runs at 24 frames per second, the standard sound film projection speed. A four-pole synchronous motor operating from a 96-cycle power supply gives the required

disk speed (2880 r.p.m.) without the use of gears between the disk and driving motor.

Any fairly constant speed drive would be suitable because receiver synchronization depends directly upon the scanning disk speed; there-



Broken Section of disc.

Fig. 10

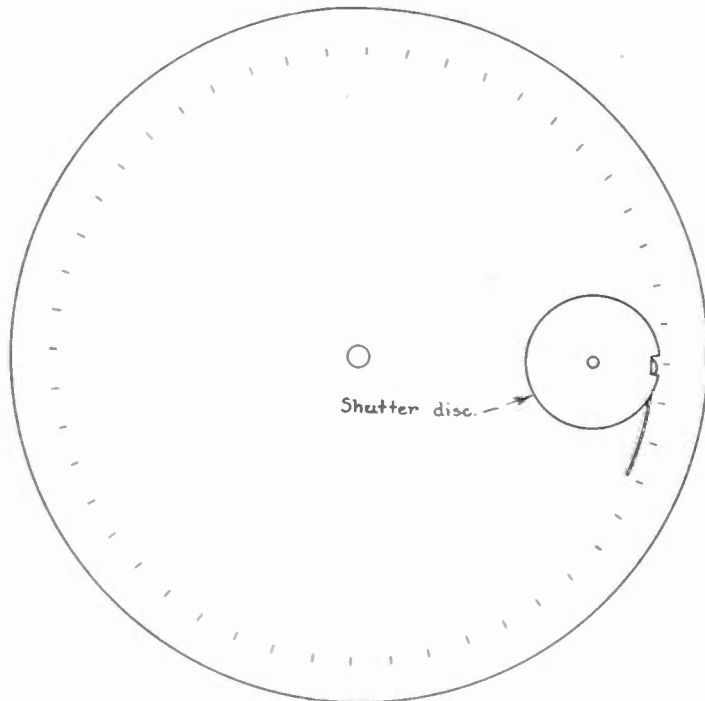

Fig. 11

fore, any change in speed or hunting of the scanning disk produces no displacement of the received picture. This is in contrast with the synchronizing of two mechanical scanning devices, where for a picture of 10,000 elements or more it is very difficult to obtain a speed control at

the receiver sufficiently accurate to prevent appreciable shifting of the received image, due to hunting.

MECHANICAL DESIGN OF THE STUDIO SCANNER

Fig. 12 is a photograph of the studio scanner. A high intensity arc with a condensing lens system is used to illuminate the rectangular pic-

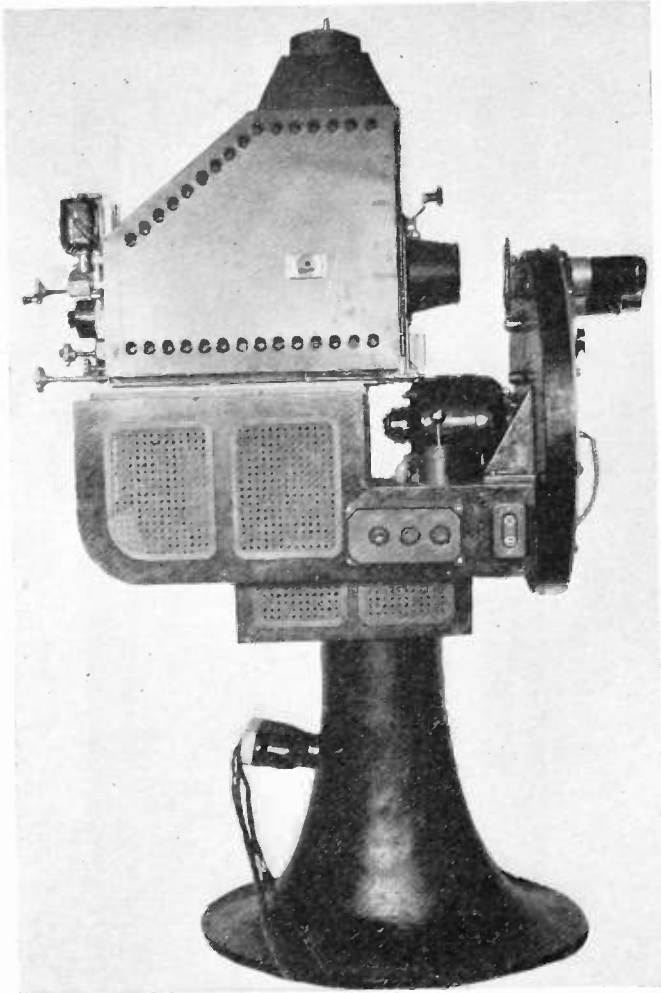

Fig. 12

ture aperture. Three lenses of different focal lengths are mounted on the disk housing in such a way that they may be changed back and forth with little effort or delay during a program, so that a quick change in the size of the scanning field in the studio for the transmission of either close-ups or of scenes containing several persons may be secured. The complete scanner is mounted on pivots so that it may be rotated and at the same time tilted upward or downward, to follow action in the studio. Two motors supply the tilting and rotating forces through

reduction gears. These motors are both controlled by a special four-position toggle switch located near the monitor, so that the monitoring operator can easily keep the scanning field in the desired position in the studio. A duplicate toggle switch is placed in the studio, enabling the studio director also to control the position of the scanning field if desired.

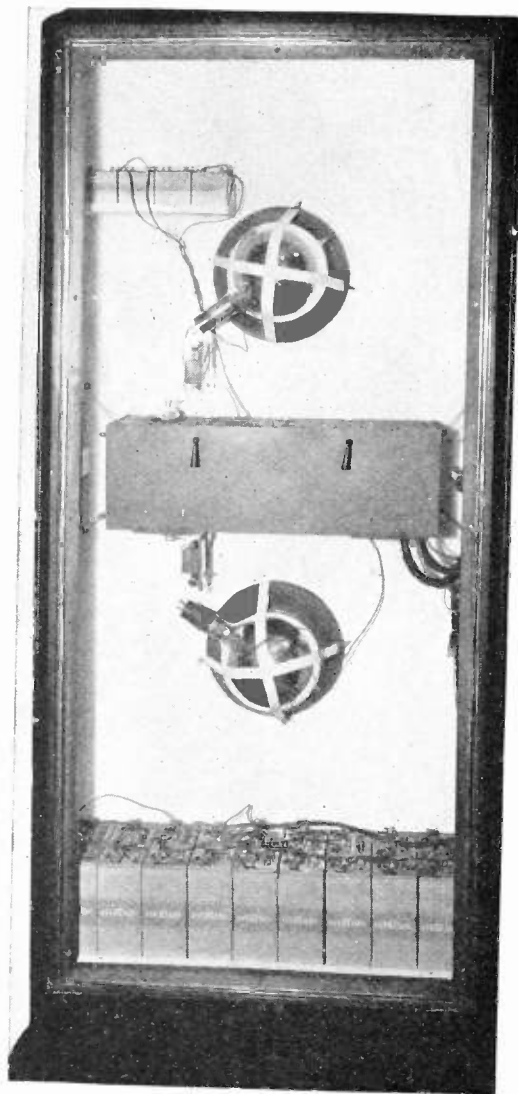

Fig. 13

STUDIO PICK-UP EQUIPMENT

When a picture of 17,000 elements is to be transmitted from a studio, the photo-electric pick-up equipment must be capable of: (a) As great a ratio of picture signal to noise as possible; (b) uniform response to light variation up to 225,000 per second; and (c) arrangement permitting satisfactory close-ups and long-distance views.

For studio work spherical photo-electric tubes of caesium oxide, gas-filled type are used, two tubes forming a pick-up unit. Between each pair of photo-electric tubes is placed a shielded amplifier which may be seen in Fig. 13, a photograph showing the rear view of one of the

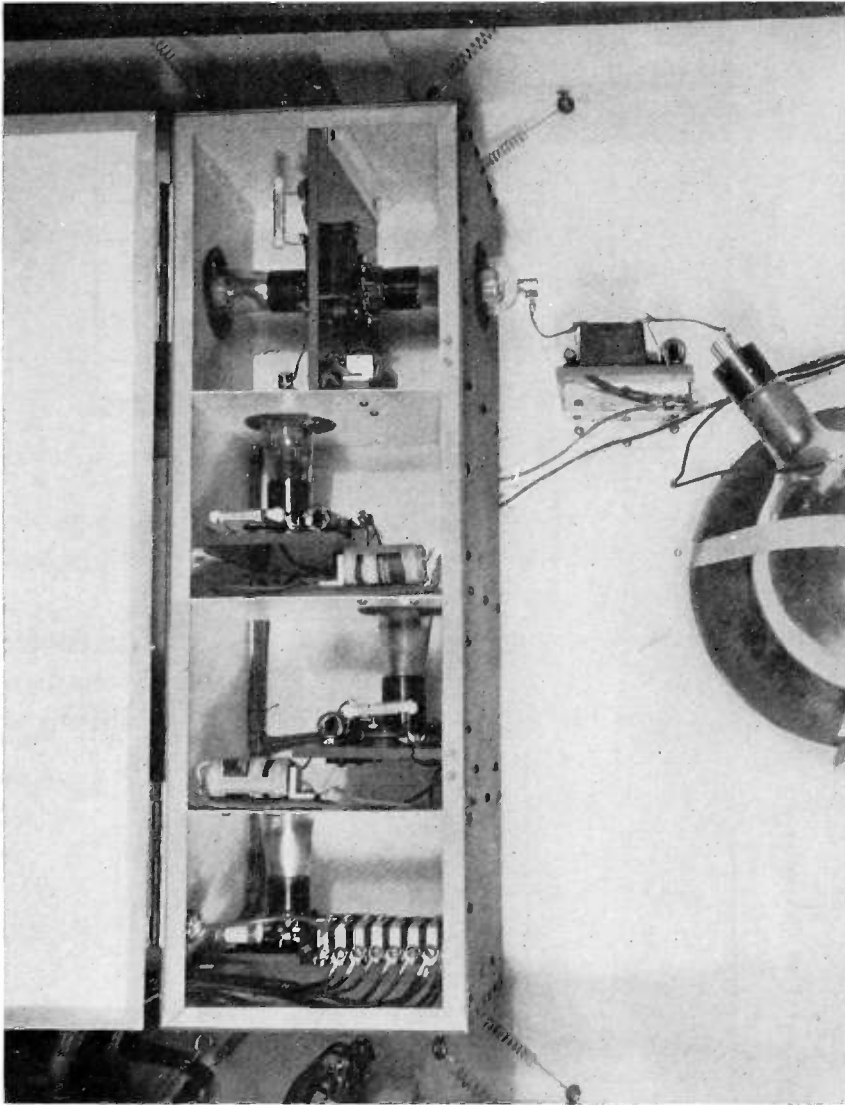

Fig. 14

units with the back removed. Fig. 14 shows the arrangement of the picture amplifier.

THE PRODUCTION OF THE TELEVISION SIGNALS

The photo-electric tubes used in the studio and in the film scanner are gas-filled and have appreciable time lag. Fig. 15 shows a typical frequency response curve of the tubes with different polarizing voltages.

The response is seen to increase quite rapidly with increased polarizing voltage at the lower frequencies, but above 60 kilocycles only a small increase in response is secured by increasing the polarizing voltage. The maximum polarizing voltage that is practicable with this type of tube when working at frequencies above 200 kilocycles is 45 volts.

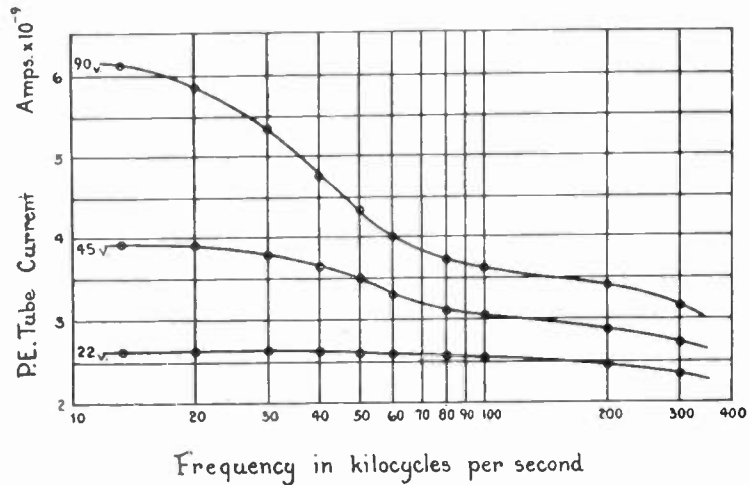

Fig. 15

When sufficient light is available to secure satisfactory signal-to-noise ratio, an operating voltage of 22 is preferable.

The capacity across the load resistance at the input to each amplifier stage is very important in determining the frequency characteristic of the system, and must be kept as low as possible if the output voltage

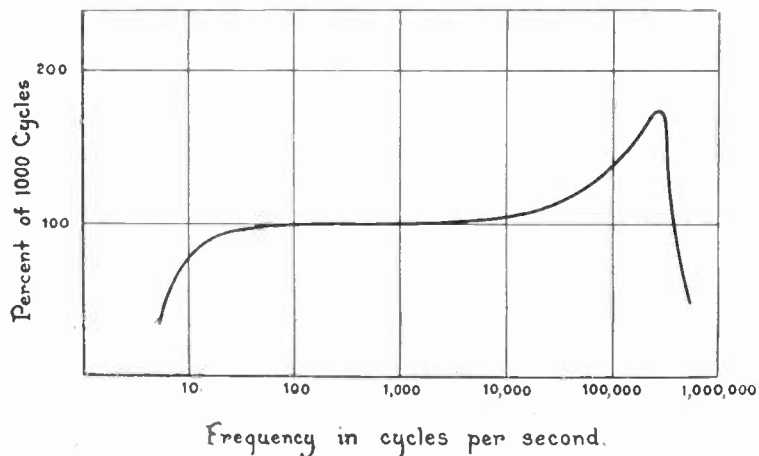

Fig. 16

to the amplifier is to remain practically constant up to 225 kilocycles. At this frequency 10 micromicrofarads have an impedance of only 70,000 ohms. The photo-electric tubes in the studio pick-up units are connected directly to the grids of special screen-grid tubes, with the shortest possible connections. The photo-electric tube in the film scanner is also connected directly to the grid of its amplifier tube.

The amplifiers make use of special coupling circuits to produce the desired frequency characteristic. The plate circuit of each voltage amplifier contains an inductance having a value such that the tube and stray capacity across the coil produce a parallel resonant circuit having a natural period well above the working range of the amplifier. This method of coupling between stages makes possible an amplifier having

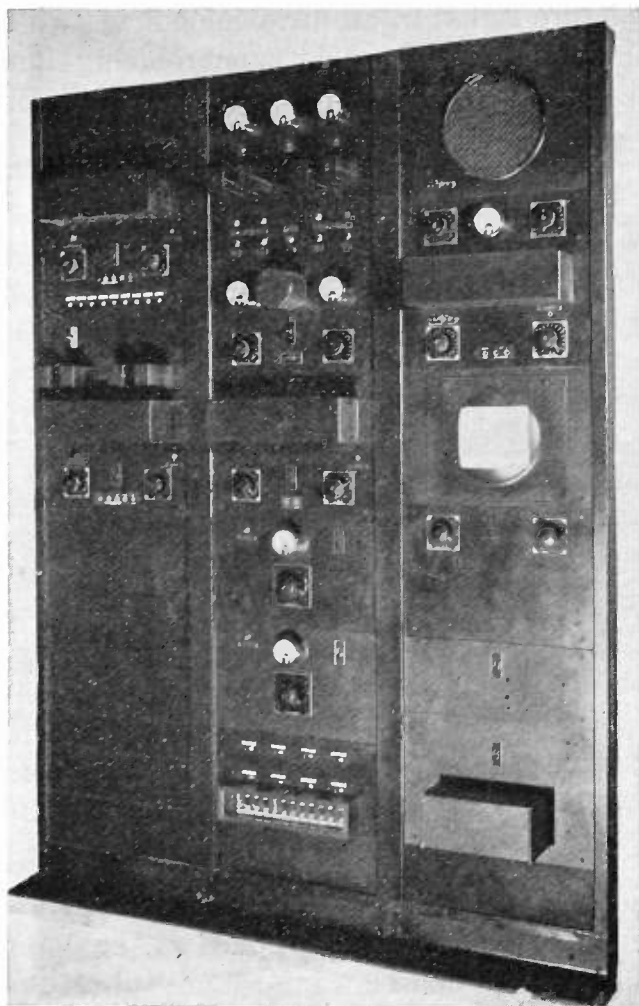

Fig. 17

practically any desired characteristic over a wide band of frequencies. Actually the amplifiers are designed to have a rising characteristic such that the response at 200 kilocycles is approximately twice that at 1000 cycles as shown in Fig. 16. This rising characteristic compensates electrically for the decrease in light change at both the transmitter and receiver when the width of the detail being scanned approaches the width of the scanning spot.

The amplifiers in the film scanner and in the studio pick-up units have an output impedance sufficiently low to allow the transmission of the signal over special low capacity cable to the control room. The output from the synchronizing amplifiers on both the studio scanner and the film scanner are transmitted to the control room over low capacity cable in the same manner as the picture signal.

In the control room the synchronizing signal is mixed with the accompanying picture signal in an arrangement of two amplifier tubes having a common plate resistor. The synchronizing signal is applied to the grid of one and the picture signal to the grid of the other. The com-

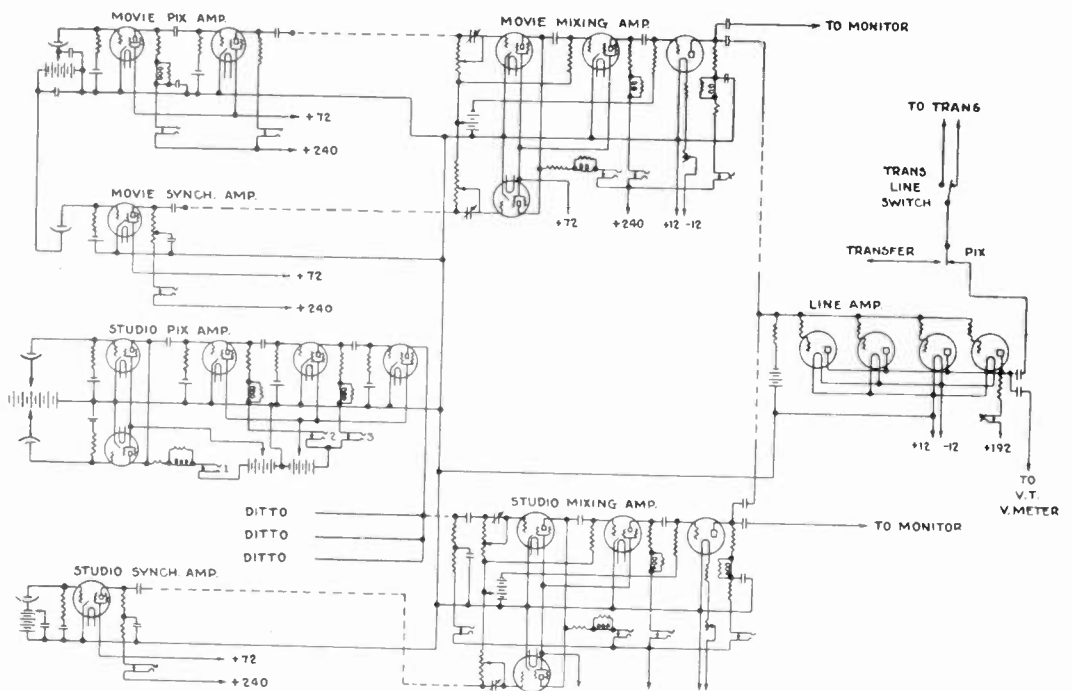

Fig. 18

bined signal is then amplified to give approximately 2 volts (peak) across 1000 ohms, after which it is applied to the line amplifier. This amplifier consists of a group of low impedance tubes in parallel and has a voltage amplification of unity. Its output impedance is sufficiently low to allow the transmission of the television signals over special low capacity cable to the radio transmitter without objectionable attenuation of the high frequencies. Fig. 17 is a photograph showing the general arrangement of the amplifier racks. Fig. 18 is a schematic diagram showing the complete amplifier layout of the installation in the Empire State Building. The switching is so arranged that the signals from the film scanner or the studio may be passed through the line amplifier to the radio transmitter. The picture monitor may be connected to either the output of the picture amplifier or to a radio receiver, which

makes possible the monitoring of the radiated signals. All speech equipment is arranged to be switched simultaneously with the picture signals so that the picture with its accompanying sound are always together.

THE RADIO TRANSMITTERS

Both the picture and sound transmitters utilize quartz crystal oscillators driving power amplifiers through frequency doubler and tripler stages. The sound transmitter was modulated in its power amplifier stage by a class "B" modulator of conventional design.

The picture transmitter was also modulated in its power amplifier but the requirements were unusual in that the transmitter had to be capable of being modulated uniformly by frequencies from 24 cycles to 225,000 cycles. To accomplish this, the power stage was modulated by means of two UV-848 modulator tubes. The modulation reactors were of special design having very low distributed capacity. The voltage amplifiers preceding the UV-848 tubes have circuit constants such that practically constant response is obtained over the desired frequency range. The adjustment of the modulation at the transmitter is unusual in that amplitude distortion of the synchronizing signals is purposely permitted in order that these signals produce over one hundred per cent modulation. The polarity of modulation is such that the synchronizing impulses drive the plate current of the modulator practically to zero, causing the radio-frequency output to increase. So far as the radiated picture signals are concerned, this means the black portions of the picture correspond to an increase in amplitude of the radio-frequency carrier. The advantage of this method of operation is that the carrier may be driven to one hundred and twenty-five per cent modulation on the synchronizing impulses, thus permitting one hundred per cent modulation for the picture signals.



DESCRIPTION OF EXPERIMENTAL TELEVISION RECEIVERS*

BY

G. L. BEERS

(RCA Victor Company, Inc., Camden, New Jersey)

Summary—Several television and sound receivers were constructed for use in an experimental system. The major considerations involved in the design of these receivers are outlined. Curves are shown which illustrate the receiver performance characteristics. A brief discussion of some of the observations which were made during the field tests of the receivers is included.

INTRODUCTION

THE necessity for a wide communication band to realize even limited picture detail has brought about a consideration of frequencies above 30 megacycles per second for the dissemination of television programs. One of the major factors in determining the desirability of these frequencies for television applications is the possibility of designing suitable receivers for such frequencies. Experimental television and sound receivers have been built for these ultra-high frequencies and have given satisfactory results in the reception of both sound and television programs. It is the purpose of this paper to describe the design of these receivers and report some of the observations which were obtained through their use. These receivers were used in the general television field tests and survey work referred to in the first paper of this series.

GENERAL

When the problem of providing experimental ultra-high frequency receiving equipment capable of receiving both picture and sound programs was first considered, it was decided to use separate receivers for the sound and picture communication bands. The use of two receivers would provide considerably greater flexibility in the choice of the picture and sound carrier frequencies than would have been possible if a combination picture and sound receiver had been used. The general performance requirements for the two receivers were as follows:

1. The sensitivity should be sufficient under normal receiving conditions to reach the level where noise and interference becomes objectionable.

* Decimal classification: R583×R361. Original manuscript received by the Institute, July 10, 1933.

2. The selectivity of the receivers should be as great as consistent with the use of a reasonable number of tuned circuits designed to pass the necessary communication bands.
3. The fidelity of the sound receiver should be comparable with the fidelity of the modern broadcast radio receiver. The fidelity of the picture receiver should be such as to provide the faithful reproduction of the transmitted image. The maximum frequency required to reproduce the picture and synchronizing impulses with the television system in use was approximately 227,500 cycles per second.

After a brief consideration of these specifications, it was evident that the superheterodyne type of receiver was best suited to provide

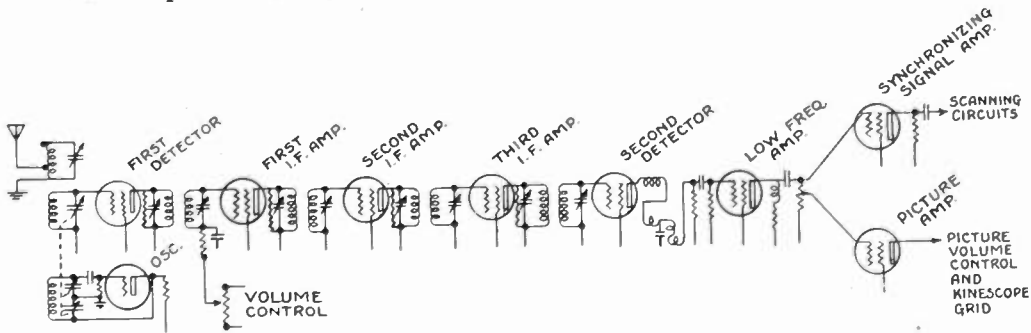

Fig. 1

the desired performance. Since both the sound and picture receivers were to operate in the same cabinet, the tuning range of the picture receiver was limited to 35 to 55 megacycles per second, and the sound receiver from 55 to 75 megacycles per second. These limitations on the tuning range of the two receivers were imposed in order to prevent the

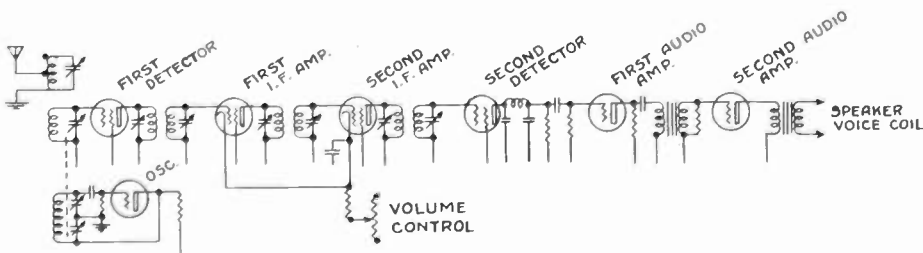

Fig. 2

interference which might result from the oscillator frequency of the one receiver being adjusted to a frequency in the tuning range of the other receiver.

The schematic circuit diagrams of the picture and sound receivers are shown in Figs. 1 and 2. The same general design was employed in both the sound and picture receivers. The main differences between the

two receivers were in the intermediate-frequency and low-frequency amplifiers. These differences will be discussed in detail in the sections of the paper devoted to these amplifiers.

ANTENNAS

Several types of ultra-high-frequency antennas were tested to determine the most suitable type for installation in the average home. Directional antennas were the most efficient of the types tested, but these would be unsatisfactory for receiving signals from television broadcast stations located in different directions unless some means for rotating the antenna structure were provided. A vertical half-wave antenna connected directly to the receiver was found to be the most satisfactory in the majority of locations. An antenna of this type will

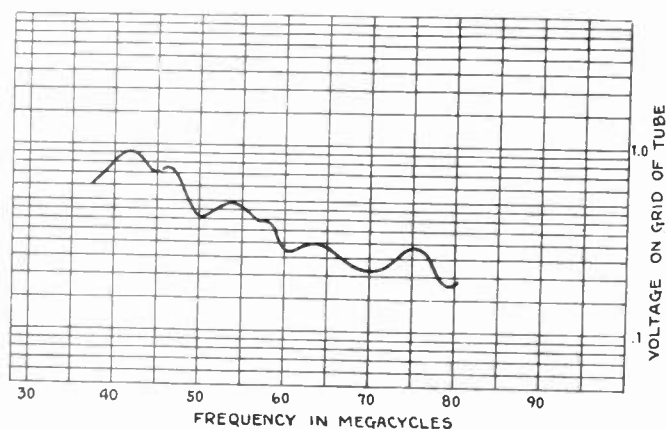

Fig. 3

function satisfactorily over a fairly wide frequency range, as indicated by the curve in Fig. 3. This curve shows the voltage developed across a tuned circuit directly connected to a half-wave vertical antenna 96 inches long.

A small number of homes were found where the indoor half-wave antenna did not intercept signals of sufficient strength to permit satisfactory reproduction of the television programs. At these locations it was necessary to erect the antenna in an unshielded location, such as above the roof of the building, and connect it to the receiver through a transmission line.

The field strength interference patterns encountered in the frequency range from 40 to 80 megacycles made it necessary to determine experimentally the antenna location which would provide the greatest signal strength. An indication of these variations in field strength is given by the contours in Fig. 4, which show the relation between received signal strength and antenna location on the ground floor of a

house. A vertical half-wave antenna directly connected to a tuned circuit and vacuum tube voltmeter was used to determine the signal strength. From the contours in this figure it is evident that moving the receiving antenna a distance of but one or two feet may change the strength of the received signals by several hundred per cent. These interference patterns are functions of both the frequency on which the transmitter is operating and its geographical location. More than one antenna might, therefore, be necessary to obtain satisfactory results in

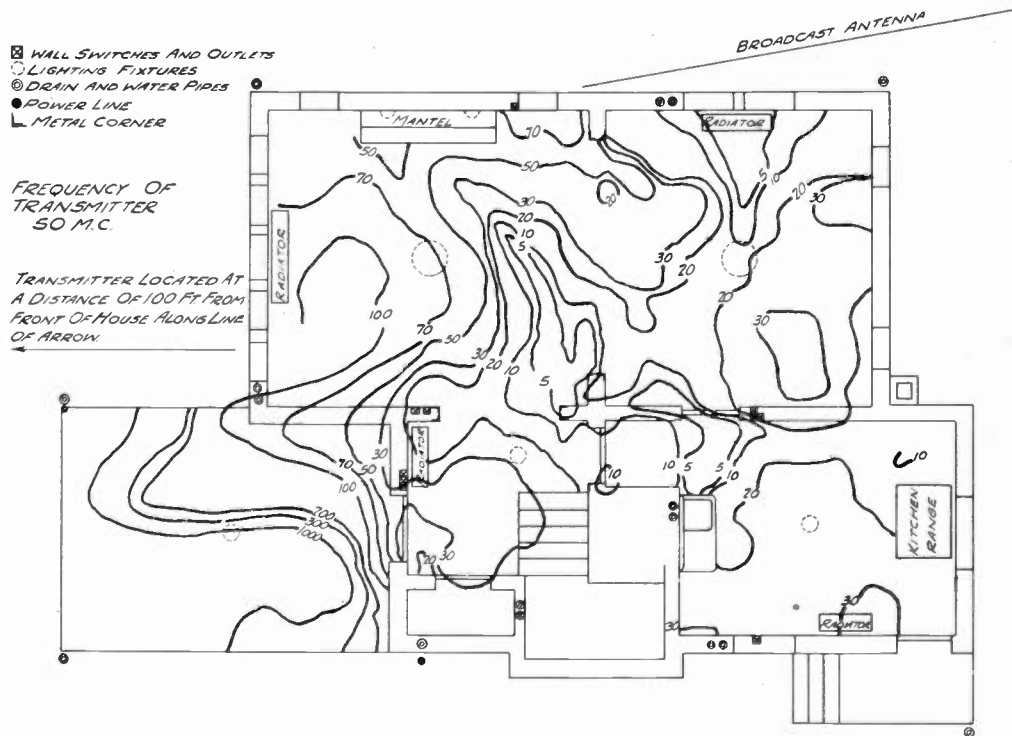

Fig. 4

receiving signals from a number of television transmitters. This requirement is not as serious as it would seem at first thought, since a half-wave antenna for frequencies above 30 megacycles is small and easily erected.

RADIO-FREQUENCY CIRCUITS

Two coupled tuned circuits were used in both receivers to transfer the received signals from the antenna to the grid of the first detector. The first tuned circuit was provided with suitable terminals so that the antenna might be connected across either a part or all of the tuned circuit. This tuned circuit was also provided with a separate tuning control so that experiments with various antenna arrangements might be conducted. The coupling between the two tuned circuits was so adjusted as to provide a flat-topped selectivity characteristic. The self-

supporting coils used in these tuned circuits were one inch in diameter, wound with No. 10 B. & S. copper wire. The radio-frequency resistance of the coils was as low as permissible on the basis of the communication band which the radio-frequency circuits must pass. The $\omega L/R$ ratio for the individual tuned circuits was approximately 125. Curve (a)

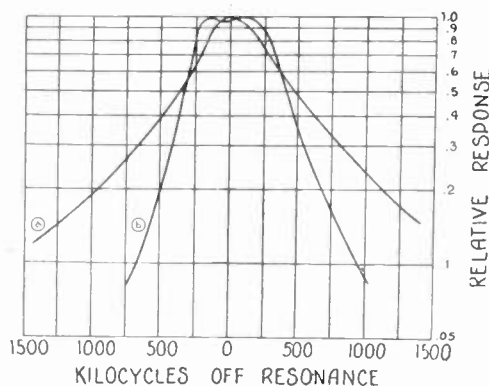

Fig. 5

in Fig. 5 shows the selectivity characteristic of a single tuned circuit at 50 megacycles. The selectivity characteristic of the two coupled tuned circuits is shown in curve (b) of the same figure.

OSCILLATOR AND FIRST DETECTOR

The oscillator circuit used in both the sound and picture receivers is shown in Fig. 6. A UY-227 tube functioned satisfactorily in this circuit up to 80 megacycles. Electromagnetic coupling between the oscillator and first detector tuned circuits was used to apply the desired oscillator

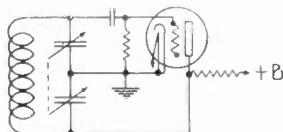

Fig. 6

voltage to the grid of the first detector which was a negatively biased UY-224 tube. Fig. 7 shows the radio-frequency coil and tuning condenser arrangement.

In order to prevent the necessity of frequent retuning of a superheterodyne receiver, it is essential that the width of the frequency band which the intermediate-frequency amplifier is designed to pass be greater than the frequency deviations of the oscillator. The fulfillment of this requirement may make it necessary to design the intermediate-frequency amplifier to pass a frequency band which is several times the width of the communication band it is intended to amplify. This condi-

tion was encountered in the design of the sound receiver. The maximum frequency variation of the oscillator, due to temperature changes of the oscillator tuned circuit elements and variations in line voltage, was approximately 0.1 per cent. With the oscillator tuned to 60 megacycles, this degree of oscillator frequency instability might result in a frequency deviation as great as four times the width of the communication band which the sound receiver was required to amplify. The communication band required for the reception of the picture signals,

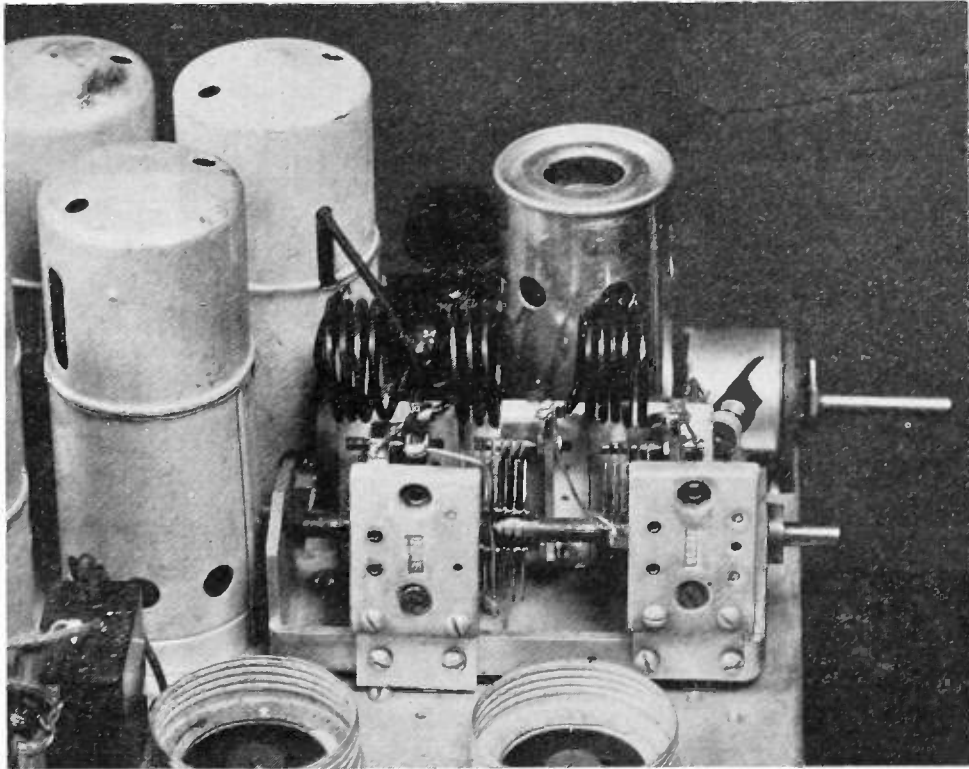

Fig. 7

however, was several hundred kilocycles, making it unnecessary to consider the oscillator frequency variations in the design of the intermediate-frequency amplifier for the picture receiver.

PICTURE RECEIVER INTERMEDIATE-FREQUENCY AMPLIFIER

The wide communication band necessary to provide satisfactory reproduction of the television program required the use of a comparatively high intermediate frequency to obtain the desired amplification and selectivity characteristics. A high intermediate frequency was also desirable to minimize the interference due to a transmitter separated in frequency by twice the intermediate frequency from the transmitter

whose signals it was desired to receive. A consideration of both these factors led to the choice of 6 megacycles as the intermediate frequency for the picture receiver. The complete intermediate-frequency amplifier used four transformers, each having two tuned circuits so coupled as to give a selectivity characteristic of the desired band width. A damping resistor was used across the primary of each transformer to flatten the top of the selectivity characteristic. The two resonant circuits in each transformer were tuned by means of small adjustable condensers.

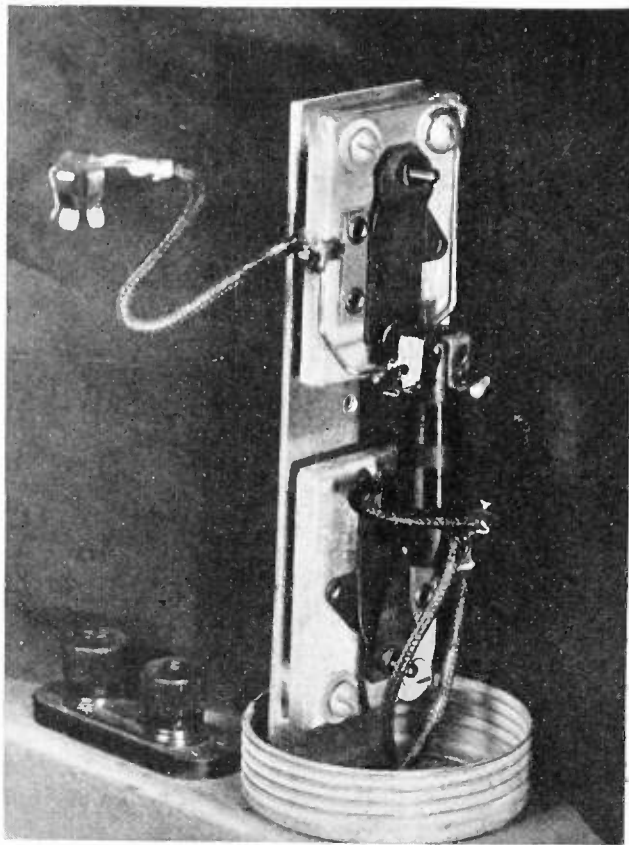

Fig. 8

The arrangement of the coils and condensers in an individual transformer is shown in the photograph in Fig. 8. The long, narrow transformer construction permitted the location of a tuned circuit at the top and bottom of each transformer, thus making possible the use of very short leads to the grid and plate of the associated tubes. The same type of metal shield was used for both the transformer and amplifier tube.

The selectivity characteristic obtained from a single intermediate-frequency stage of the picture receiver is shown by curve (a) in Fig. 9. The over-all selectivity characteristic of the three-stage amplifier is shown in curve (b) of the same figure. The voltage gain of this amplifier

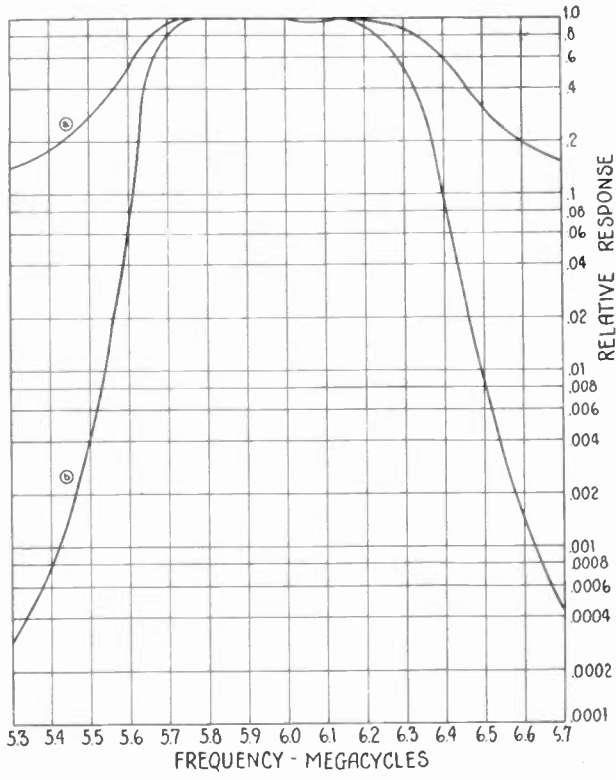

Fig. 9

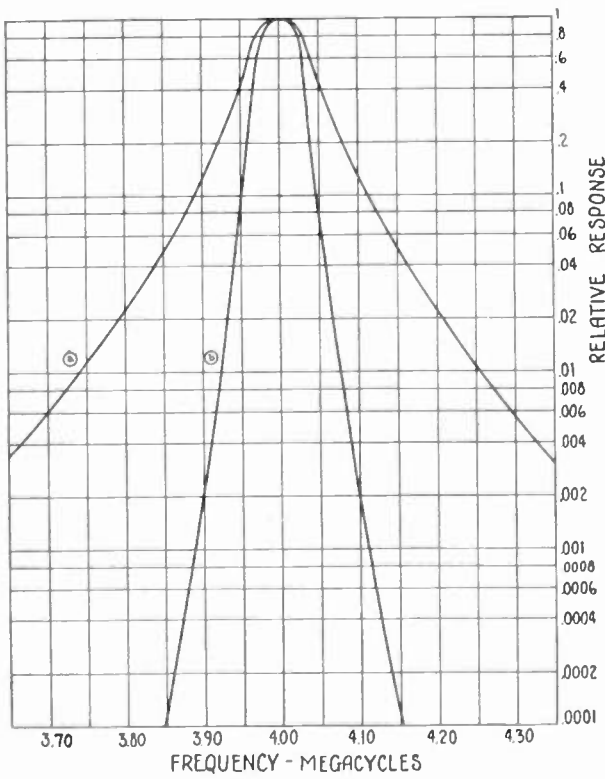

Fig. 10

as measured from the grid of the first detector to the grid of the second detector was approximately 7000.

SOUND RECEIVER INTERMEDIATE-FREQUENCY AMPLIFIER

Both the sound and picture receivers were to operate in the same cabinet, and it was therefore undesirable to use the same intermediate frequency in both receivers because of the possibility of coupling between the two amplifiers causing interference. Four megacycles was chosen as the intermediate frequency for the sound receivers. The in-

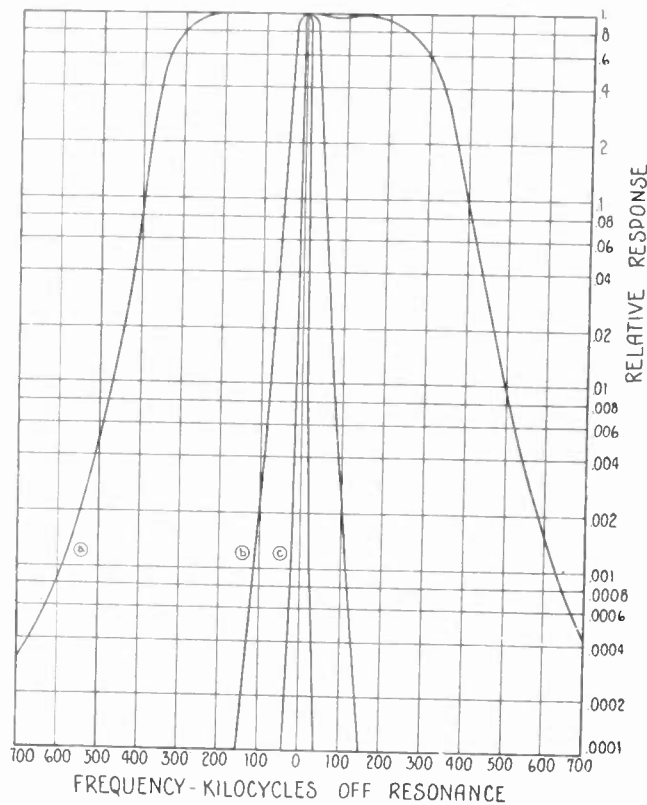

Fig. 11

termediate-frequency amplifier was designed to pass a band of 50 kilocycles in order to minimize the effects of the oscillator-frequency variations. The sound receiver intermediate-frequency transformers were similar in design to those used in the picture receiver. Three transformers were used in the complete amplifier. The selectivity characteristic of an individual transformer is shown in curve (a) in Fig. 10. Curve (b) in the same figure shows the over-all selectivity characteristic of the complete amplifier. The voltage gain, as measured from the grid of the first detector to the grid of the second detector, was 8000. Fig. 11 shows a comparison between the intermediate-frequency amplifier selectivity characteristics of the picture receiver, the sound receiver, and a typical

broadcast receiver. These characteristics are shown in curves (a), (b), and (c), respectively.

PICTURE-FREQUENCY AMPLIFIER AND DETECTOR

The picture-frequency system of the television receiver consisted of a negatively-biased detector and a two-stage resistance-coupled amplifier. The television system for which the receivers were designed made use of a carrier wave which was modulated with both picture and synchronizing impulses. The synchronizing impulses were slightly larger in amplitude than the picture impulses. In order that this difference in amplitude between the picture and synchronizing impulses might be accentuated in the receiver, two separate output tubes were provided. One of these tubes was used to supply the picture impulses to the grid of the kinescope, while the other was used to impress the synchronizing impulses on the vertical and horizontal deflection circuits in the kinescope unit. The bias on the synchronizing output tube was made sufficiently negative to distort the impulses supplied to its grid, and thereby accentuate the difference in their amplitudes. The high negative bias used on the synchronizing output tube caused a decided reduction in amplification. In order that sufficient output might be obtained from the synchronizing output tube without overloading the picture output tube, the grids of these two tubes were connected to a tapped resistor which was coupled to the plate of the first low-frequency amplifier tube through the usual coupling condenser. The grids of the two output tubes were connected to the tapped resistor so that the impulses applied to the grid of the synchronizing output tube had twice the amplitude of those applied to the picture output tube. A potentiometer connected in the plate circuit of the picture output tube was used to control the amplitude of the signals applied to the grid of the kinescope. A potential variation of only ten volts on the grid of the kinescope was sufficient to provide full modulation of this type of light source. This voltage could readily be obtained from a UY-224 tube, even though a comparatively low value of load resistance was used to obtain the desired frequency response characteristic. UY-224 tubes were likewise used for the synchronizing output tube, the first low-frequency amplifier and the negatively-biased detector. The over-all frequency response characteristic of the complete amplifier is shown in curve (a) Fig. 12.

AUDIO-FREQUENCY AMPLIFIER AND DETECTOR

The audio-frequency system of the sound receiver was similar to that employed in conventional broadcast receivers. The negatively-biased UY-224 detector was followed by a resistance-coupled audio-

frequency stage using a UY-227 tube. This tube, in turn, was coupled through a transformer to the UX-210 output tube. The UX-210 tube was used because it minimized the power required from the combined socket power unit since the high plate potential used with this tube was also required for the synchronizing circuits. The frequency-response characteristic of the complete audio-frequency amplifier is shown in curve (b) of Fig. 12. A comparison between curves (a) and (b) in this figure shows the relative frequency characteristics of both the picture and sound low-frequency amplifiers.

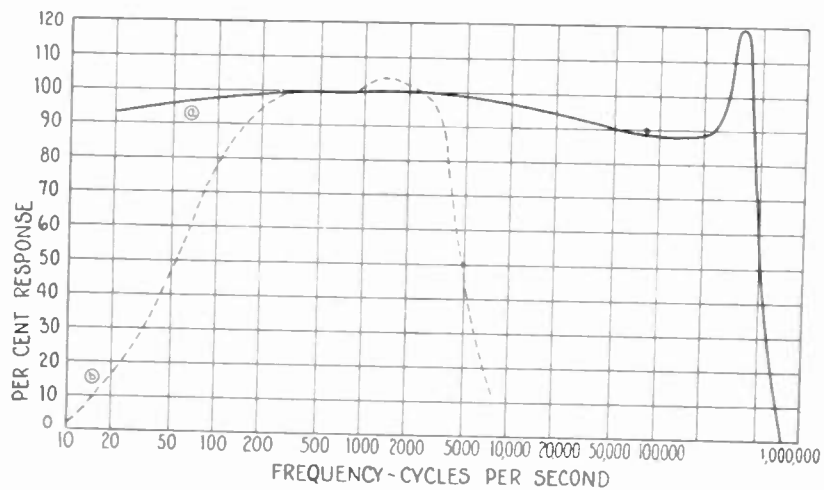

Fig. 12

COMPLETE RECEIVERS

The general chassis arrangement of the picture receiver is shown in Fig. 13. The four metal shields in the middle of the chassis contain the intermediate-frequency transformers. The tubes are enclosed in the other shields. Fig. 14 is a photograph showing the bottom view of the chassis. The arrangement of the by-pass condensers and coupling resistors is illustrated in this figure. Fig. 15 shows the general arrangement of the sound receiver chassis. Three of the shields on this chassis contain intermediate-frequency transformers; the remainder are tube shields. Both receivers were mounted in the cabinet on blocks of sponge rubber to prevent the vibrations from the loud speaker being transmitted to the receiver chassis. The plate, grid, and filament potentials for both receivers were supplied from the common socket power unit.

At the time the receivers were designed and built, a reliable attenuator for ultra-high frequencies was not available for use in measuring the absolute sensitivity of the receivers. Field tests of the receivers at various locations, however, indicated that the sensitivity of both the sound and picture receivers was sufficient to reach the normal noise or

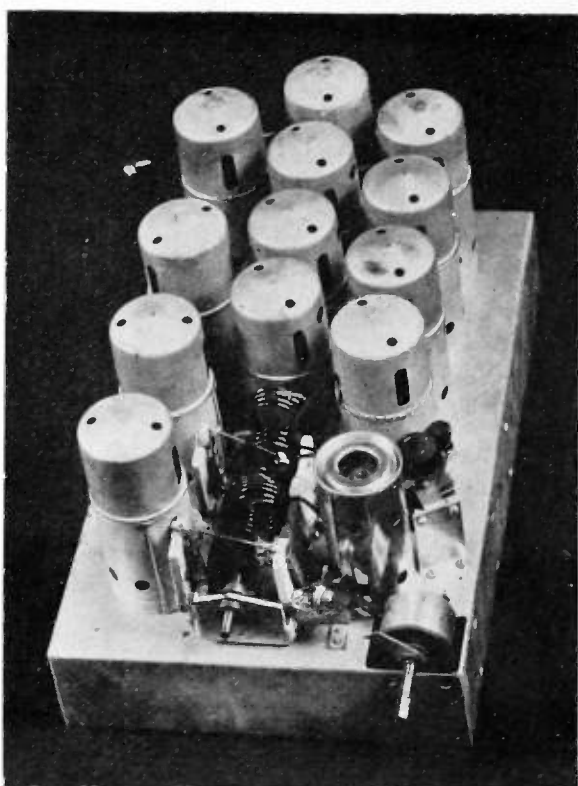

Fig. 13

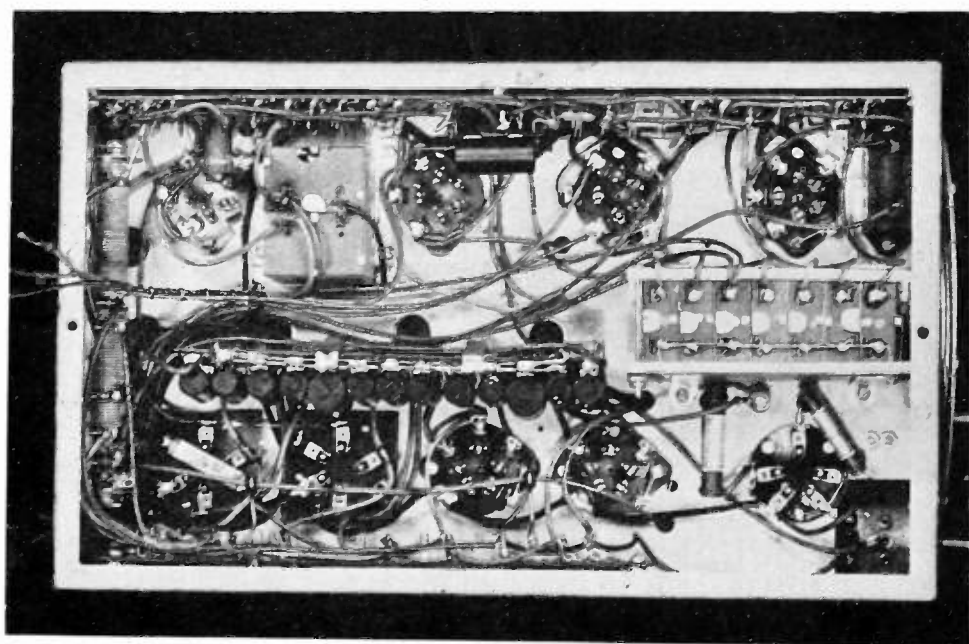

Fig. 14

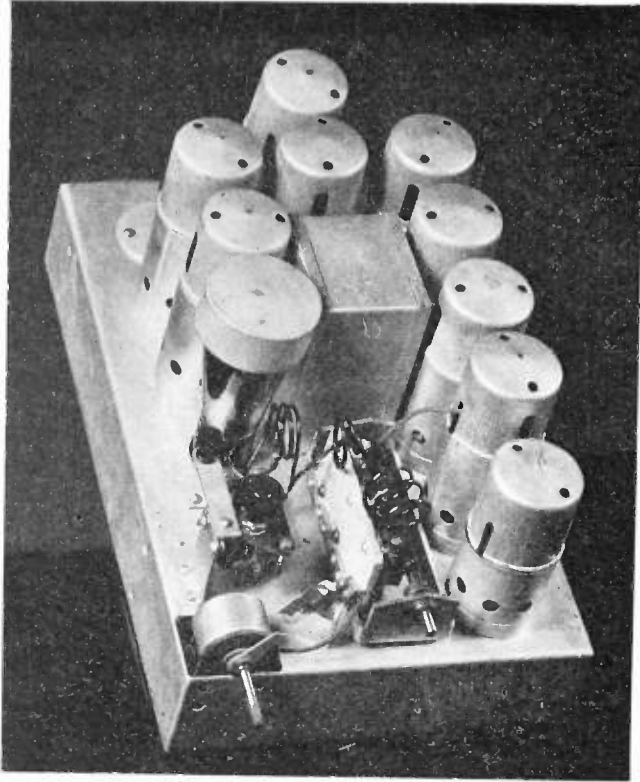

Fig. 15

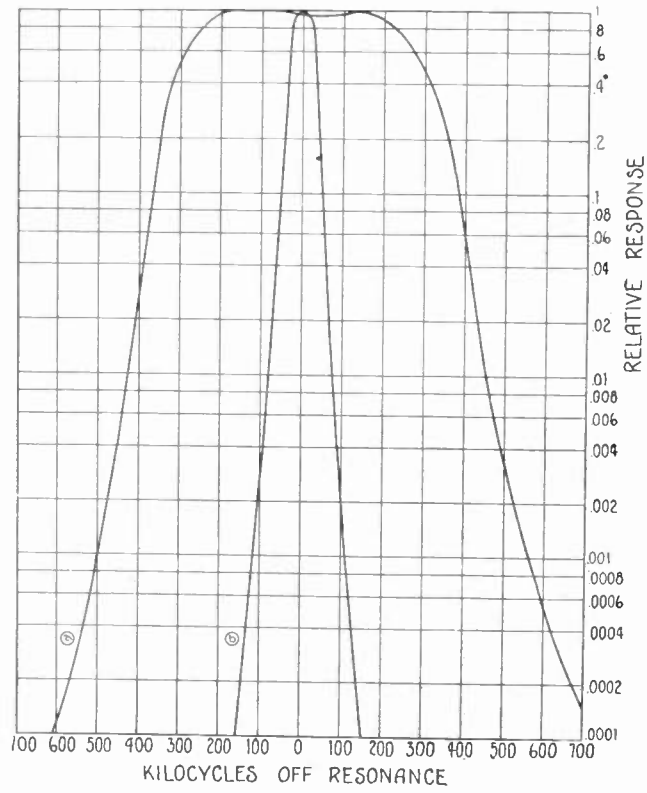

Fig. 16

interference level. The over-all selectivity curves of the sound and picture receivers are shown in Fig. 16. Curve (a) is the selectivity characteristic of the picture receiver, and curve (b) the corresponding characteristic of the sound receiver. The over-all fidelity characteristics of the two receivers are substantially the same as the characteristics of their low-frequency amplifiers, as shown in Fig. 12. The fidelity of the picture receiver was such that the reproduced pictures were practically identical in detail with those obtained on the monitor unit at the transmitter.

OBSERVATIONS ON THE RECEPTION OF TELEVISION AND SOUND PROGRAMS

These experimental ultra-high-frequency picture and sound receivers were in use for some time, and a number of interesting observations were made.

The only evidence of static which was encountered during the field tests was an occasional click from the loud speaker at the time of a lightning flash in the vicinity. No evidence of multiple images or fading was found. The only fluctuations in the strength of the received signals which were noted were due to the motion of objects near the receiving antenna. An automatic volume control could compensate for these fluctuations satisfactorily if the minimum signal strength were sufficient to give the required signal-to-noise ratio. The chief source of man-made interference which was observed was the ignition systems of airplanes and automobiles. Tests which were made indicated that this type of interference can be greatly reduced by the use of resistors in the spark plug and distributor loads. At those locations where the field strength is weak and the receiver is located near a street on which there is considerable traffic, it may be desirable to erect the receiving antenna as far from the street as possible and connect it to the receiver through a shielded transmission line.

The psychological effect of interference in the picture and sound programs is very interesting. Prior to the tests it was felt that for a given interference the field strength necessary to give a satisfactory signal-to-noise ratio would be much greater for the picture signals than for the sound signals, because of the wider communication band required for the picture signals. The conclusion reached by a number of observers, however, indicate that the effect of interference, such as that due to the ignition systems of automobiles, on the picture programs was not as serious as expected on the basis of the above assumption. In several instances such interference produced a more objectionable effect on the sound program than it did on the picture program. Whenever

the interference was of sufficient amplitude to destroy the picture synchronization, it likewise prevented the satisfactory reception of the sound program. The effect of interference of a temporary nature on the picture program could easily be avoided by glancing away from the picture. With the sound program, however, the only means of obtaining relief from such interference was either to turn off the set or turn down the volume control.

In the case of the usual sound broadcast program, the listener can obtain some measure of enjoyment while reading or engaged in some other diversion. To derive any degree of pleasure from a television program requires the entire attention of the observer.



VACUUM TUBES OF SMALL DIMENSIONS FOR USE AT EXTREMELY HIGH FREQUENCIES*

By

B. J. THOMPSON and G. M. ROSE, JR.

(Research and Development Laboratory, RCA Radiotron Company, Inc., Harrison, New Jersey)

Summary—*This paper describes the construction and operation of very small triodes and screen-grid tubes intended for reception at wavelengths down to 60 centimeters with conventional circuits.*

The tubes represent nearly a tenfold reduction in dimensions as compared with conventional receiving tubes, but compare favorably with them in transconductance and amplification factor. The interelectrode capacitances are only a fraction of those obtained in the larger tubes.

The triodes have been operated in a conventional feed-back oscillator circuit at a wavelength of 30 centimeters with a plate voltage of 115 volts and a plate current of 3 milliamperes.

Receivers have been constructed using the screen-grid tubes which afford tuned radio-frequency amplification at 100 centimeters and 75 centimeters, a gain of approximately four per stage being obtained at the longer wavelength.

INTRODUCTION

IN recent years interest in the possibilities of radio communication at wavelengths of less than three meters has been greatly increased, because of the imminent saturation of the spectrum of greater wavelengths and of the peculiar properties expected of these short waves. As a study of radio transmission requires transmitting and receiving apparatus, much effort has been devoted to the development of equipment suitable for such wavelengths, the types of tubes and circuits used at longer wavelengths having proved unsatisfactory. It is the purpose of this paper to describe a study of the possibilities of vacuum tubes of very small physical dimensions for use in radio reception at wavelengths as short as 60 centimeters.

As the minimum wavelength of commercial radio communication has been reduced, refinements of the previously existing types of receiving apparatus have been made, until it is now possible to use either tuned radio-frequency amplification or superheterodyne amplification followed by a triode type detector at wavelengths as short as five meters. It had been found that the vacuum tubes constituted the limiting factors at about ten meters, and subsequent reduction in wavelength has been made possible by improvements in tube design. In

* Decimal classification: R331. Original manuscript received by the Institute, May 15, 1933. Presented before Eighth Annual Convention, Chicago, Illinois, June 26, 1933. Presented before New York Meeting, October 4, 1933.

all of this work the apparatus in use differs from the conventional long-wave apparatus only in refinement. The limit of the improvements by this method seems definitely to have been reached at about three to five meters wavelength, due to various characteristics of the tubes.

As what appeared to be a wall was reached in this refinement of conventional long-wave apparatus, it was natural that investigators should seek other and radically different means for reception. By far the greatest amount of attention has been devoted to the study of Barkhausen-Kurz¹ or Gill-Morrell² oscillations, which may readily be obtained at wavelengths as short as thirty centimeters. Many schemes for the use of these oscillations in reception have been described, some of the circuits resembling the well-known superregenerative detector, others being used as heterodyne detectors, but the majority being more obscure in their principles of operation.³ In general, all use only one tube—or one stage—at the ultra-high frequency, the amplification being carried out at an intermediate or low frequency. Other schemes have been proposed, using oscillating magnetrons, for example.

It is the authors' experience that these methods all suffer from one or more serious faults when considered from the standpoint of practical use. Nearly all of the methods are wasteful of plate power. Many are insensitive in the extreme. The more sensitive are unstable, in general. Tuning is broad. The most serious faults shared by all are limitation of sensitivity, due to the fact that no amplification may be had ahead of the detector, and radiation from the oscillator which is coupled directly to the antenna.

The purpose of the work described in this paper was to reduce the lower wavelength limit of the conventional types of tubes and circuits in order to obtain their advantages of simplicity at wavelengths below one meter.

THEORETICAL CONSIDERATIONS

The limitations imposed on tuned radio-frequency reception at the present lower wavelength limit are due to a number of factors. These are:

(1) The interelectrode capacitances of the tube are so great that, with the addition of the tuning capacitance, the L/C ratio is too low for a value of impedance sufficient to afford appreciable amplification.

¹ H. Barkhausen and K. Kurz, *Phys. Zeit.*, vol. 21, no. 1; January, (1920).

² E. W. B. Gill and J. H. Morrell, *Phil. Mag.*, vol. 44, no. 161; July, (1922).

³ A considerable bibliography on this subject is given by W. H. Wenstrom, *Proc. I.R.E.*, vol. 20, no. 1, pp. 95-112; January, (1932). The papers by Hollmann, Uda, Okabe, and Beauvais, in particular, discuss receiving circuits.

(2) The lead inductances of the tube are so great that much of the output voltage of the tube appears inside the bulb, where it is unavailable.

(3) The interelectrode capacitances and lead inductances form a tuned circuit at a wavelength well above the limit desired.

(4) The time of transit of the electrons across the space between electrodes becomes an appreciable part of a period which results in a reduction in the effective amplification of the tube.

(5) As the wavelength is reduced the radio-frequency resistance of the circuit is increased with a consequent reduction in resonant impedance.

It will be seen that most of these limitations are associated with too large a ratio of some fixed characteristic of the tube to those characteristics of the circuit which vary with frequency. These characteristics of the tube are fixed only for a given design; however, any change in design which results in lower transconductance, as would be the case with increased interelectrode spacing to reduce capacitance, cannot be considered a genuine improvement.

In a vacuum tube, if all linear physical dimensions are kept in a fixed ratio to each other there will be no change in transconductance, plate current, or amplification factor at fixed operating voltages, no matter what changes are made in the actual magnitude of the linear dimensions. On the other hand, the values of interelectrode capacitance, lead inductance, and time of electron transit are in direct proportion to the magnitude of the linear dimensions.⁴

These considerations lead directly to the principle on which this work is based: for optimum design at any wavelength, all tube and circuit linear dimensions should be in proportion to the wavelength. This principle is modified in practice since, at longer wavelengths, there is no advantage in making the tube of large size and it becomes inconvenient to make the tuned circuit of optimum dimensions.

Unfortunately, it is not to be expected that this proportionality of dimension will result in constant amplification, since the resonant impedance, L/RC , is reduced as the wavelength becomes shorter. However, on the basis of Butterworth's formulas for high-frequency resistance⁵ and Coffin's formula for inductance, with Rosa's correction,⁶ a coil having the following dimensions:

⁴ A statement and proof of part of this may be found in that remarkable paper by Langmuir and Compton, "Electrical discharges in gases", Part II, *Rev. Mod. Phys.*, vol. 3, no. 2, p. 252; April, (1931).

⁵ S. Butterworth, *Exp. W. & W. Eng.*, vol. 3, nos. 31, 32, and 34, pp. 203-210; 309-316; 417-424; April, May, and July, (1926).

⁶ E. B. Rosa and F. W. Grover, Scientific Paper of the Bureau of Standards No. 169, third edition, pp. 117-122, December, (1916).

length = $1/8$ in.
diameter = $1/8$ in.
turns = 5
wire diameter = 0.020 in.

should have a resistance of 0.37 ohm and an inductance of 5.87×10^{-8} henry at 50 centimeters wavelength. A capacitance of 1.2×10^{-12} farad would be required for resonance, giving an impedance, L/RC , of 132,000 ohms. This high value in comparison to those obtained at longer wavelengths may be accounted for in part by the fact that the coil is of much more nearly optimum design than those used at the longer wavelengths.

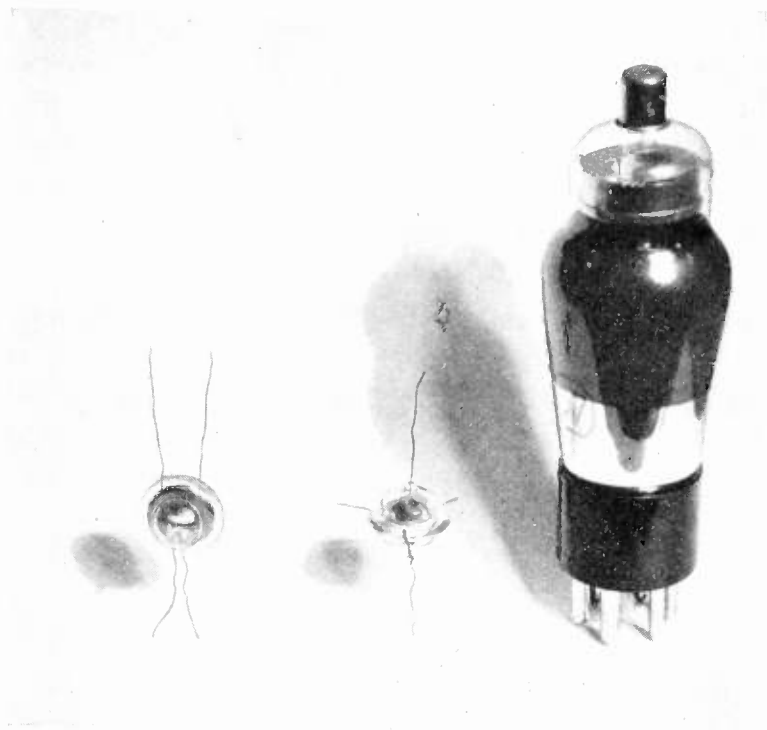

Fig. 1—Small triode and screen-grid tube compared with a conventional size 57 type tube. The triode is shown at the left.

Since tubes of conventional size have been found to have a lower wavelength limit of about five meters, the principle of proportionality requires a tenfold reduction of linear dimension to produce a tube capable of amplification at a wavelength of 50 centimeters.

Both screen-grid tubes and triodes representing such reductions have been constructed and studied in operation.

TUBE STRUCTURE

A photograph of these tubes is shown in Fig. 1. A conventional size type 57 tube serves as a standard of comparison. The largest dimension

of either of these small tubes is less than three quarters of an inch, and the elements themselves are correspondingly small.

Both types of tubes are of parallel plane construction and have indirectly heated cathodes.

In the triode the parts are sufficiently light in weight to permit supporting them on their lead wires alone. This has resulted in the elimination of capacitances which would otherwise be present between the various elements and the support structure. Both plate and cathode are of the same shape, consisting of two small metal cups placed back to back with the grid interposed between them. The cathode cup has within it a small heater; its outer surface is coated with the emitting material. The grid is of mesh fastened on a support ring. The inter-

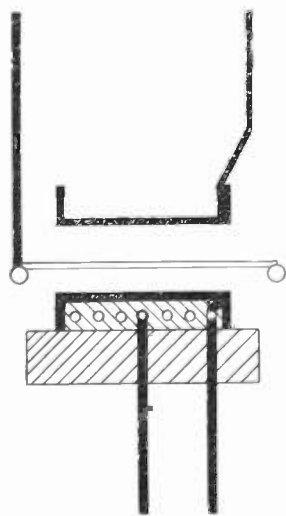

Fig. 2—Cross-section view showing the structure of the small triode.

electrode spacings are only a few thousandths of an inch. Fig. 2 shows the general construction.

The assembly scheme of the triode cannot be satisfactorily applied to the screen-grid tube because of mechanical complications arising from the presence of the second grid. A different method is used which is productive of a stronger and more rigid assembly. The tetrode parts, however, are of the same size and shape as those of the triode, with the addition of the screen grid which is similar to the control grid though somewhat larger.

A small ceramic disk serves as a foundation upon which the tube parts, with the exception of the plate, are assembled. It, therefore, acts as a common supporting insulator. The correct spacings between the grids and the cathode are obtained by adjusting their individual distances from this insulator. As the distance from the plate to the screen grid is not so critical, the plate is supported by its lead wire from the

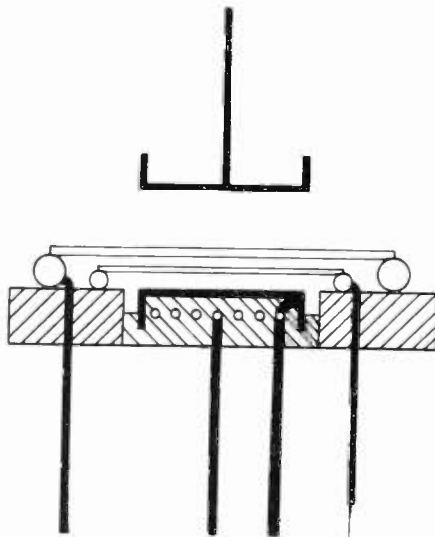

Fig. 3—Cross-section view showing the structure of the small screen-grid tube.

glass bulb. The spacings between the other parts is again only a few thousandths of an inch. The general construction is shown in Fig. 3.

The bulbs used to enclose both types of tubes are in two parts which are more or less hemispherical in shape. These two parts are placed together with the mount inside, and a seal is made between them. All of the triode leads pass through this seal, thereby eliminating the need for a stem as ordinarily used. In the tetrode separate seals

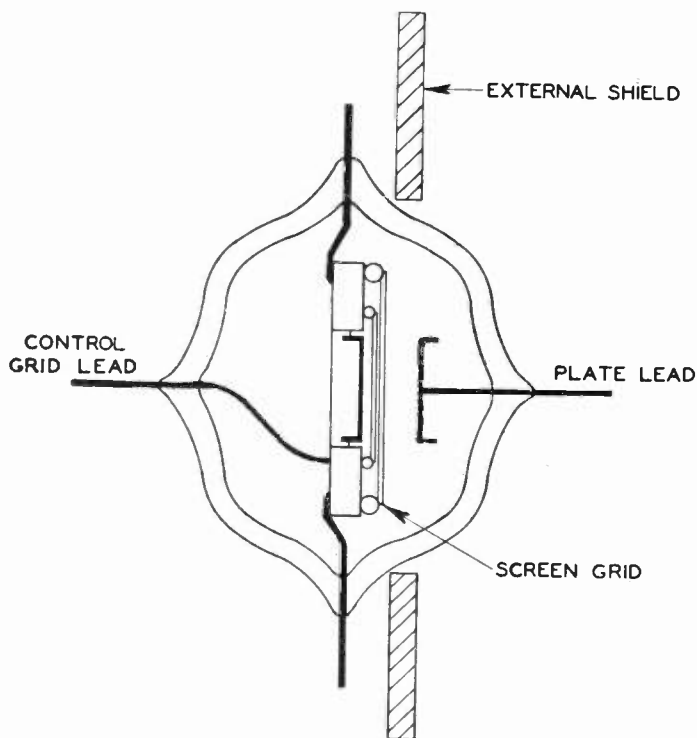

Fig. 4—View showing the screening arrangement used with the small screen-grid tube.

are made at opposite ends of the bulb for the plate and control-grid leads while all of the remaining leads come out through the main seal.

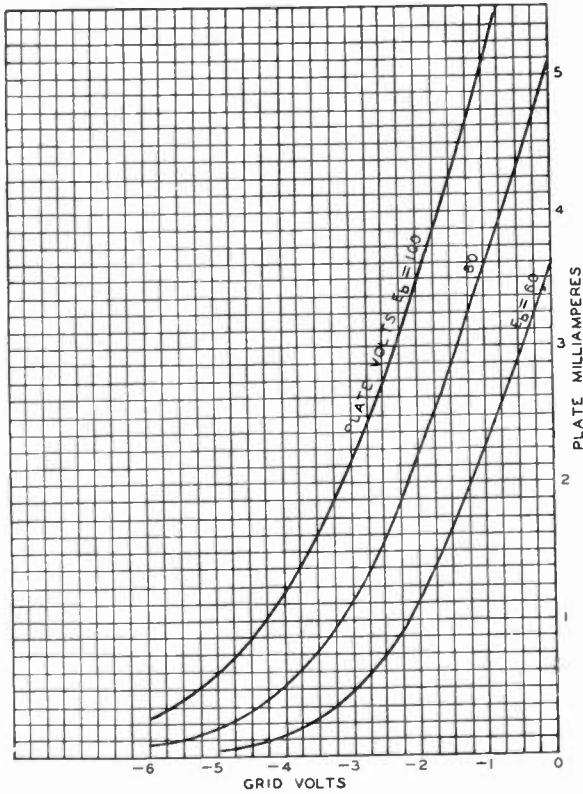

Fig. 5—Mutual characteristics of the small triode.

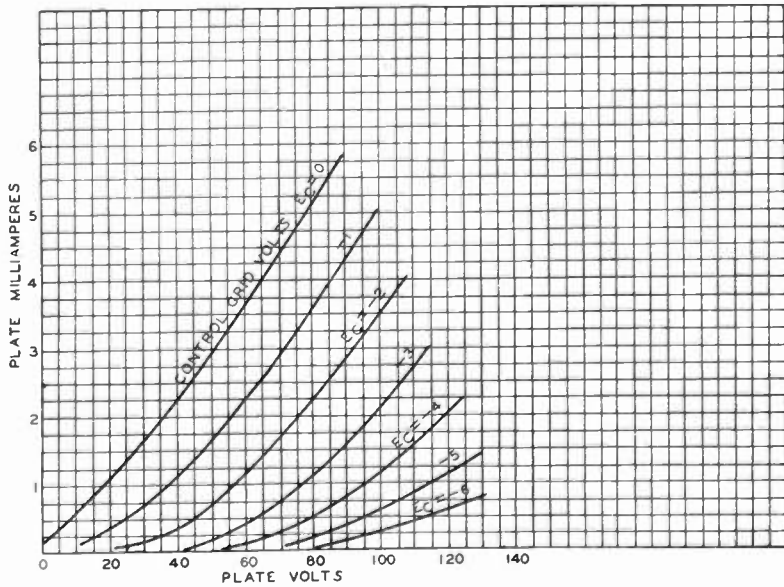

Fig. 6—Plate characteristics of the small triode.

In the case of the tetrode this general arrangement has advantages from the standpoint of screening. The mount is so placed in the bulb

that its screen grid lies just above the plane of the seal and extends almost to the glass. It is readily seen from Fig. 4 that when the external shield is placed as indicated the plate is effectively isolated from the control grid. The screen-grid lead is quite short and comes out adjacent to the external shield where it can be readily grounded, thus minimizing screen-lead impedance. This holds true for the heater and cathode leads likewise.

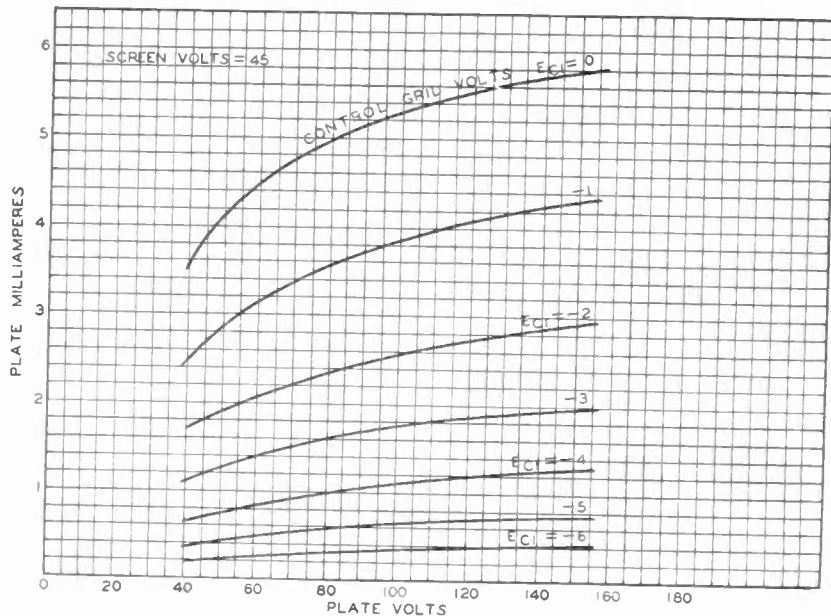

Fig. 7—Plate characteristics of the small screen-grid tube.

ELECTRICAL CHARACTERISTICS

From an examination of the static characteristics of the triode, which are shown in Figs. 5 and 6, it is readily seen that these characteristics are directly comparable both as to magnitude and shape with those of an ordinary triode. Under the operating conditions, plate voltage = 67.5 volts and grid voltage = -2 volts, the values of the various parameters are as follows:

Plate current = 4 ma

Plate resistance = 9,500 ohms

Transconductance = 1550 $\mu\text{a}/\text{v}$

Amplification factor = 14.7.

The interelectrode capacitances for these tubes have been measured as follows:

Grid-cathode capacitance = 0.7 μmf

Plate-cathode capacitance = 0.07 μmf

Plate-grid capacitance = 0.8 μmf .

As might be predicted from the results of the measurements on the triode, the tetrode characteristics are likewise similar to those of the

larger tubes of this sort. A family of plate-current—plate-voltage curves is shown in Fig. 7. Points were not taken for the lower values of plate voltage because of the excessive values of screen-grid current. The mutual family of curves is given in Fig. 8. Under the operating conditions, control-grid voltage = -0.5 volt, screen-grid voltage = 67.5 volts, and plate voltage = 135 volts,

Plate current = 4.0 ma

Transconductance = $1100 \mu\text{a/v}$

Plate resistance = $360,000$ ohms

Amplification factor = 400 .

The values of the interelectrode capacitances are:

Input capacitance = $2.5 \mu\text{mf}$

Output capacitance = $0.5 \mu\text{mf}$

Plate-grid capacitance = $0.015 \mu\text{mf}$.

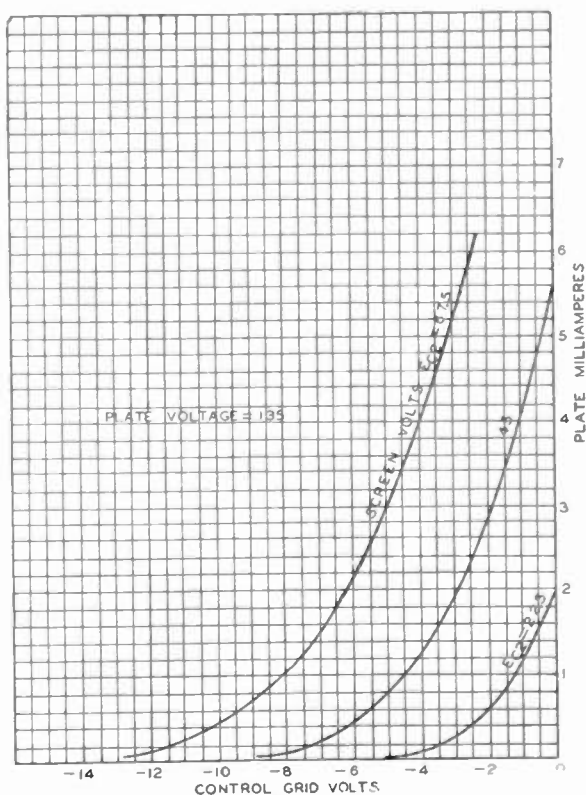

Fig. 8—Mutual characteristics of the small screen-grid tube.

OPERATION

Tests have been made upon both the triodes and the screen-grid tubes to determine how well they will perform in conventional circuits at wavelengths much lower than the minimum at which ordinary tubes will function.

The minimum wavelength at which a triode will generate oscillations offers a means for comparing it with ordinary tubes. The value of this minimum wavelength of oscillation is of particular interest here because it shows how closely a normal feed-back oscillator can approach those wavelengths generated almost solely by Barkhausen tubes and circuits.

An inductive feed-back oscillator was set up whose inductance consisted of several turns of small copper wire wound in a solenoid about one eighth of an inch in diameter tuned only by the tube interelectrode

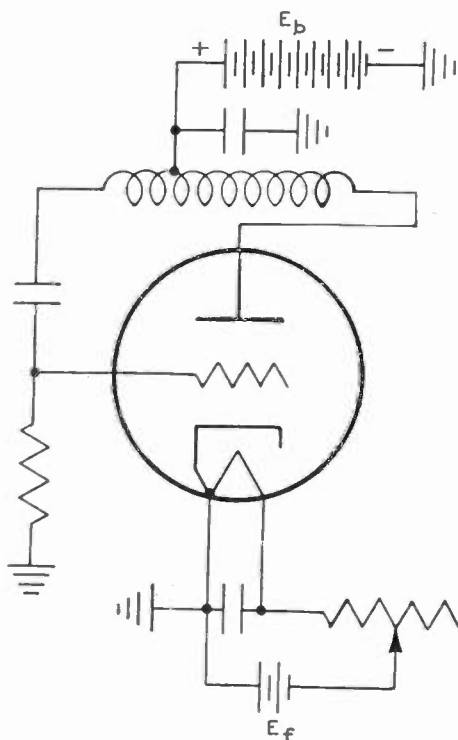

Fig. 9—Circuit diagram of the ultra-high-frequency oscillator using the small triode.

capacitances. The circuit is given in Fig. 9, while a photograph of the oscillator is shown in Fig. 10. With a coil of six turns very stable 65-centimeter oscillations were produced with as low as 45 volts on the plate of the tube. Smaller coils gave shorter wavelengths with continued stability until a minimum wavelength of slightly below 30 centimeters was reached with a coil of only one turn. Oscillations at this wavelength could be sustained with as low as 115 volts on the plate of the tube and with a plate current of approximately 3 milliamperes.

Owing to the difficulty of making quantitative measurements of radio-frequency amplification at wavelengths of one meter and less, the gain realizable by the use of the screen-grid tubes was determined

by their operation in actual receiving sets. The first set consisted of two stages of tuned radio-frequency amplification, a detector, and one stage of audio-frequency amplification. The screen-grid tubes were used in the radio-frequency amplifier stages and the small triodes as the detector and audio amplifier. The whole set, of which photographs are shown in Figs. 11 and 12, was enclosed in a brass box seven inches long, three inches high, and three inches wide. Small coils such as those used in the oscillator tuned by almost equally small variable condensers constituted the tuned circuits. In order to prevent any signal pick-up except through the antenna, the batteries and all external leads were

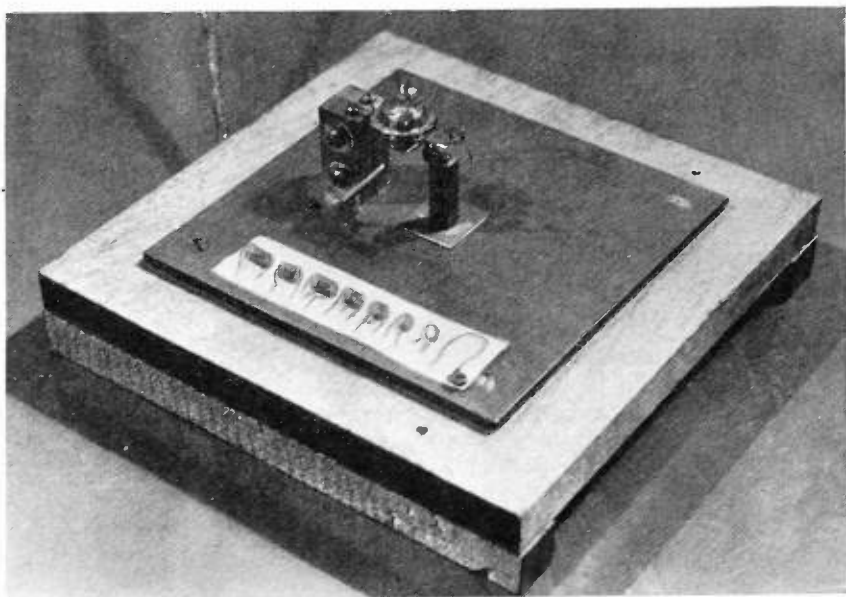

Fig. 10—Photograph of the ultra-high-frequency oscillator. Several tuning coils for different wavelengths are shown.

enclosed in metal shielding. With the set so shielded there was no trace of oscillation in any of the circuits. The tuning range of the receiver was from about 95 to about 110 centimeters.

An oscillator operating at a wavelength of 100 centimeters, consisting of one of the small triodes modulated by a broadcast receiver and loosely coupled to a half-wave radiator, was set up in an open area. The total plate power supplied to the oscillator was 68 milliwatts. Photographs of this transmitter are shown in Figs. 13 and 14.

With the receiver located about 200 feet from the transmitter, signals of good strength were received with the half-wave receiving antenna coupled to the input of the first radio-frequency stage but none could be heard with the antenna coupled directly to the detector. From other listening tests it was estimated that the gain per stage was of the order of four.

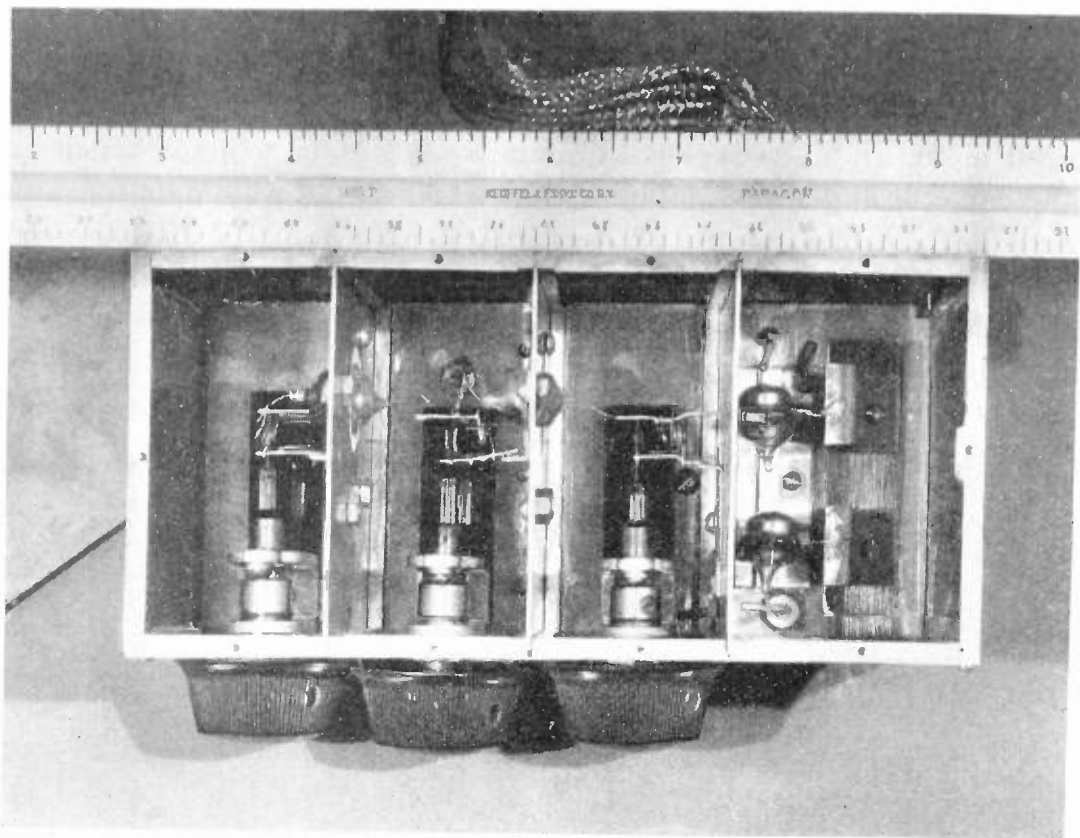

Fig. 11—Photograph of a tuned radio-frequency receiver for a wavelength of 100 centimeters. The scale is marked in inches.

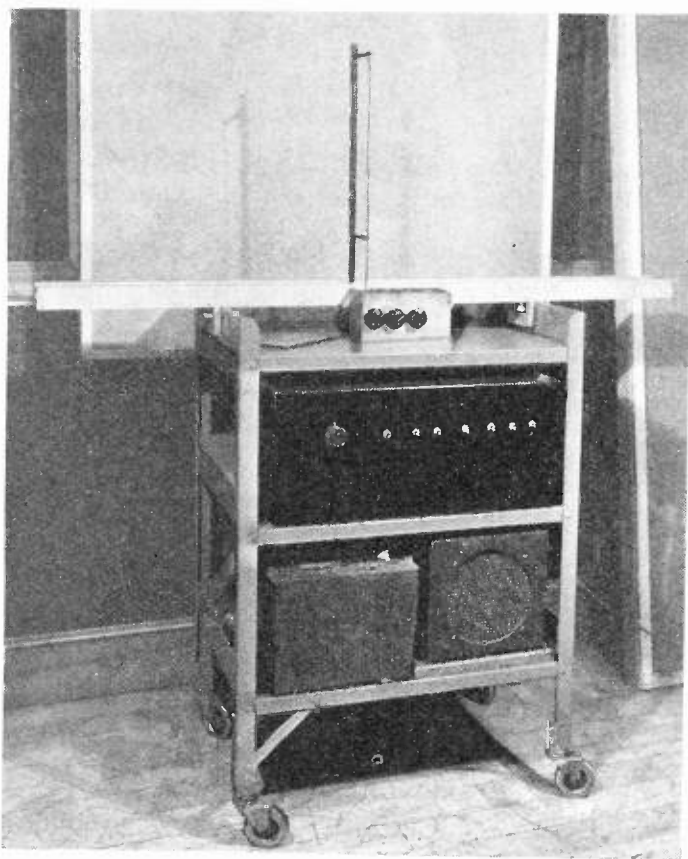

Fig. 12—Photograph of the complete 100-centimeter receiver arrangement.

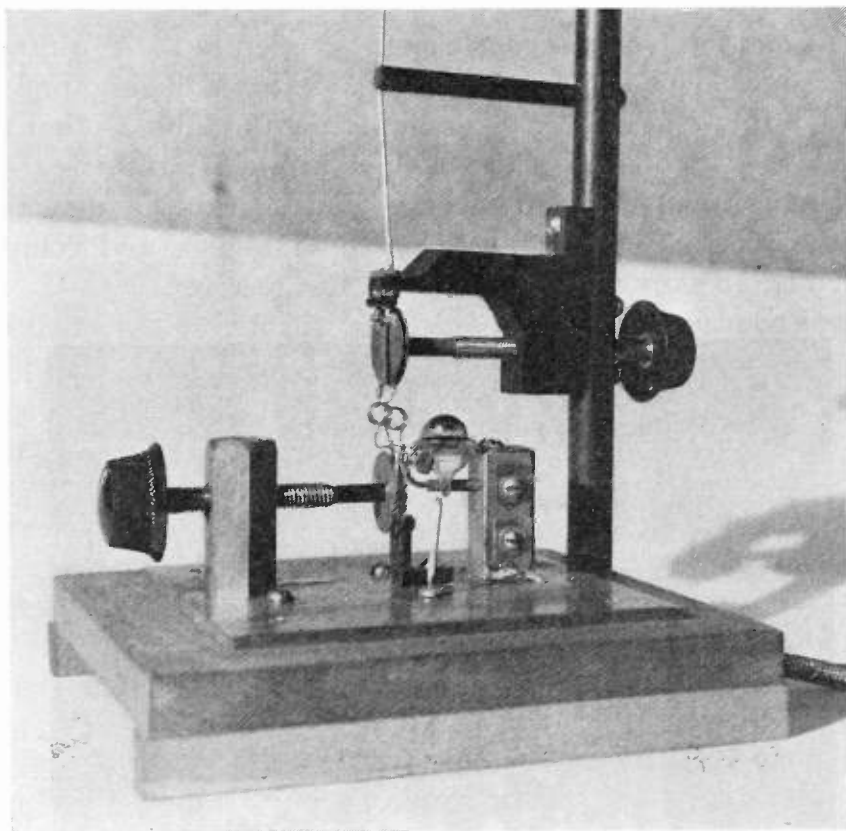

Fig. 13—Photograph of the 100-centimeter oscillator.

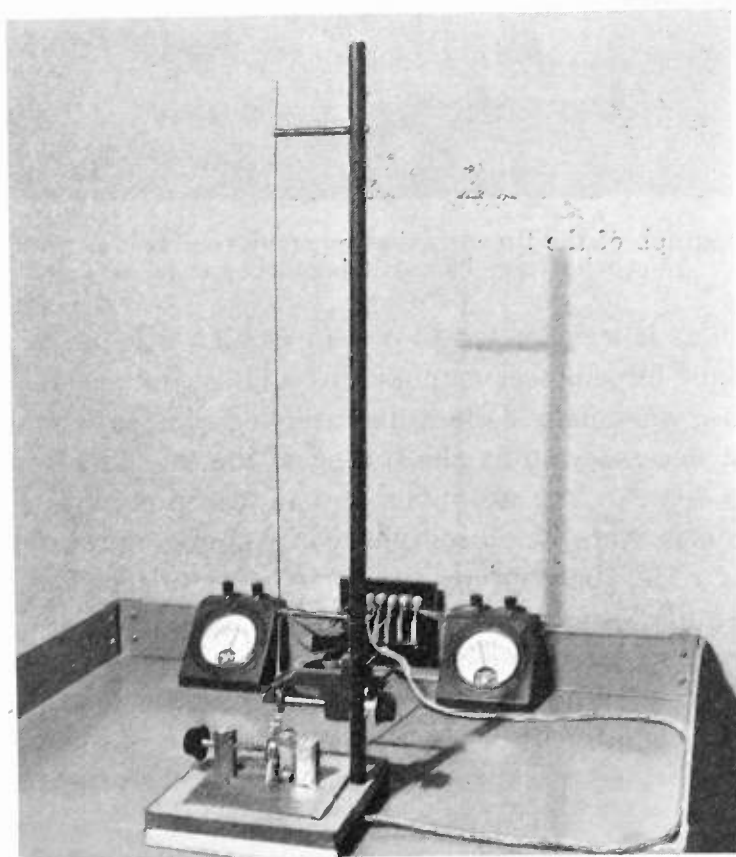

Fig. 14—Photograph of the 100-centimeter transmitter.

The second receiver was constructed to operate at 75 centimeters or thereabouts. This set was not so elaborate as the one previously described, but more care was taken in placing the tubes so that all circuit connections would be shorter than before. It consisted of one stage of radio-frequency amplification and a grid-leak detector. As before, the set was enclosed in a small brass box and completely shielded. Fig. 15 shows a photograph of this receiver.

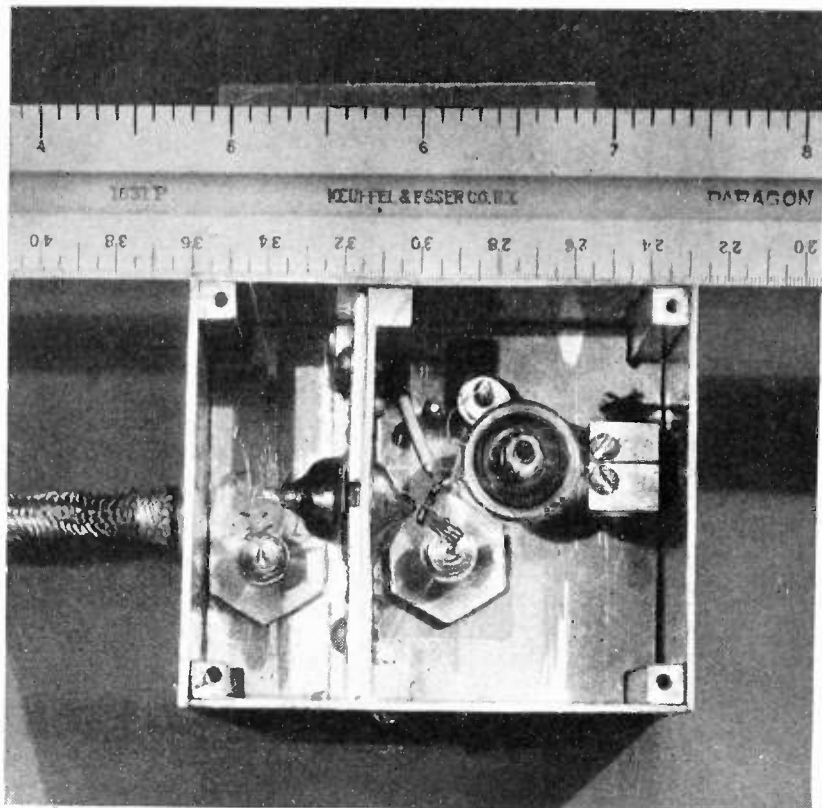

Fig. 15—Photograph of the tuned radio-frequency receiver for a wavelength of 75 centimeters. The scale is marked in inches.

Inasmuch as it was desired to obtain as high a value of input and coupling circuit impedances as possible, tuning condensers were eliminated and use was made of the tube interelectrode capacitances only. This made it necessary to fix the tuning of the set. The initial tuning necessary to line up the amplifier and detector circuits at approximately 75 centimeters was accomplished by changing the turn spacing of the tuning coils, thereby varying their inductances. The frequency of the transmitter was adjusted by means of a variable condenser to bring it into tune with the receiver.

Following much the same procedure as before, except that the distance from oscillator to receiver was less and the tests were carried out in a large shielded room, the receiver output when the antenna was

coupled to the radio-frequency stage was compared to its output when the antenna was coupled directly to the detector. Again these comparisons were qualitative rather than quantitative. While the contribution of the radio-frequency stage was found to be small, it did furnish some gain as evidenced by the increase in output when it was operating.

CONCLUSION

While no claim is made to optimum design of either tubes or circuits, it has been demonstrated that it is possible to produce tubes of small physical dimensions with characteristics which permit radio-frequency amplifiers, oscillators, and detectors to be used at wavelengths well below one meter in the conventional manner. It may be of interest to consider the significance of these results.

A sensitive, compact, and economical receiver should be only a problem of design in accordance with well-known principles. For example, a superheterodyne circuit might be used, with one stage of radio-frequency amplification to block the local oscillator from the antenna. The intermediate frequency might well be in the range from two to five meters, as these tubes should afford excellent amplification at such wavelengths.

In conclusion the authors wish to point out that the tubes which have been described were made in the laboratory with the object of demonstrating certain fundamental principles, rather than of producing a commercial tube design. However, it is hoped that these principles will be of value in the future development of special short-wave tubes.



OPERATION OF TUBE OSCILLATORS ON A COMMON LOAD*

BY

S. I. MODEL

(State Weak-Current Corporation, Radio Transmitter Research Institute, Leningrad, U.S.S.R.)

Summary — This paper presents the problem of obtaining high power by means of a great number of tube oscillators operated in parallel. The principal disadvantages of conventional parallel connection are listed, and the advantages of subdivision of tubes into groups (units) with their tank circuits coupled to a common load circuit are shown.

Two principal methods of connecting units, viz., series and parallel, are discussed. Their equivalence both with regard to power and to the possibility of connecting together various power and voltage units is proved. Theoretical analysis is illustrated by experimental data.

THE problem of obtaining high powers in radio-frequency circuits has usually been attacked in two ways, by increasing the power of vacuum tube generators and by connecting them in parallel. The increase in output of transmitting stations ordinarily overspeeds the growth of power of individual tubes, so that a large number of tubes had to be connected in parallel to supply the power required.

Until recently power stages of many transmitters were composed of push-pull connected tubes operated in parallel. The conventional parallel connection of large numbers of power tubes in 100-kilowatt broadcast transmitters of U.S.S.R. has proved to have no considerable operating difficulties. However, this conventional parallel connection method has some disadvantages; namely,

1. With shorter waves parallel connection of many tubes is not feasible due to the considerable parasitic capacities making the plate-circuit impedance too low. With longer waves the design of the transmitter becomes complicated due to the same parasitic capacities.

2. For long waves the problem of parallel operation of tubes may be considered as practically solved. The problem is confined to providing means for securing the continuity of operation of the transmitter in case of a failure with any one of the tubes. Even with various individual devices, it occurs sometimes that such a failure results in cutting off several other tubes or the entire stage, i.e. in shutting down the whole station.

* Decimal classification: R140. Original manuscript received by the Institute, July 28, 1933. In the original form printed in Russian in "Vestnik Radio," nos. 5-6, (1932).

3. A difficulty is encountered in connecting spare units during operation, which is desirable for maintaining constancy of power and operating conditions of the station.

4. At lower plate voltages the design of the tank circuit becomes complicated, because its impedance should be very low.

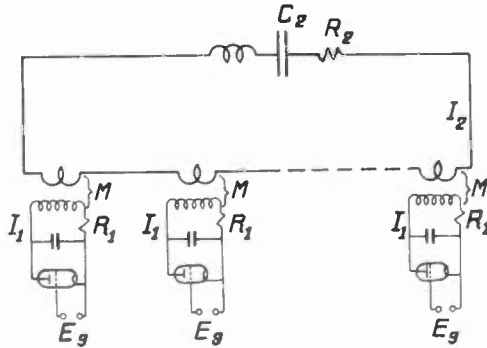

Fig. 1

All these difficulties are largely eliminated when the power stage of the transmitter is composed of units (or groups) instead of tubes in the conventional parallel connection. Each unit consists of a smaller number of tubes (depending upon the number of units) and an oscillat-

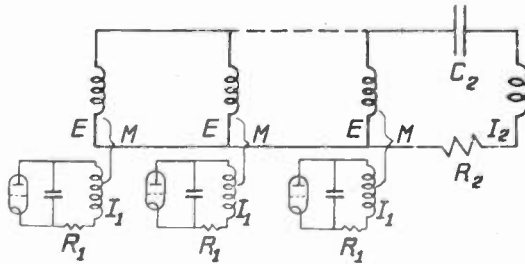

Fig. 2

ing tank circuit coupled to another circuit (or antenna) which loads all the units (Figs. 1 and 2). Apart from other advantages, such a system simplifies supplying power to the transmitter.

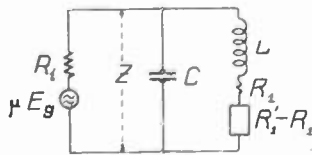

Fig. 3

In the present paper the principal methods of connecting and operating units are considered from the standpoint of the above considerations. Long waves are mainly kept in view. It is obvious that independently of the diagram of connections, any unit may be represented by the equivalent network shown in Fig. 3, wherein μE_g = the

electromotive force of the tube generator, R_i = its internal resistance (its value being dependent on the wave shape of the plate current), and $R_1' - R_1$ = the resistance of the common circuit reflected to a given unit.

There are two principal diagrams of connection of units, series (Fig. 1) and parallel (Fig. 2). All other diagrams are modifications of these two.

I. SERIES CONNECTION OF UNITS

Consider n series-connected units. Assuming that all unit circuits are in resonance and quite identical, that their electromotive forces of excitation are in phase and also that the units are similarly coupled to the common circuit, we can write, for the power in common circuit, the following expression:

$$W_2 = I_2^2 R_2 = n I_1^2 (R_1' - R_1),$$

wherein, R_1' = total resistance which consists of loss resistance (R_1) of the unit circuit and of reflected resistance from the common circuit. On the other hand,

$$I_2 = \frac{I_1 \omega M n}{R_2}$$

whence, solving for the resistance,

$$R_1' - R_1 = \left(\frac{I_2}{I_1} \right)^2 \frac{R_2}{n} = \frac{\omega^2 M^2 n}{R_2}. \quad (1)$$

In the case of a single unit and the same coupling M ,

$$R_1' - R_1 = \frac{\omega^2 M^2}{R_2}. \quad (2)$$

The comparison of (1) and (2) shows that, as far as any individual unit is concerned, the series connection of n units is equivalent to increasing the coupling between unit circuit and common circuit \sqrt{n} times, or else to decreasing the resistance R_2 of common circuit n times. Therefore, frequency characteristics and efficiencies of the unit circuits will in this case depend not only upon the degree of their coupling to the common circuit, but also upon the number of units being connected. It is obvious, that with a constant coupling factor between the unit circuits and the common circuit, the efficiency of the former will increase with the number of units. Moreover, the increase in the reflected resistance will lower the equivalent impedance Z of the unit circuits. Thus, a change in the number of units will vary the operating

conditions and output of each unit. In the case of a single unit, the equivalent impedance Z of the plate circuit will be a maximum, and oscillating power will be a minimum. Considering the modulation curve we can see that the position of the telephone (carrier) point in relation to that of maximum operating conditions will depend upon the number of units in service, and consequently, accurate adjustment to telephone (carrier) power is possible only when all the units are connected; if one unit is connected the coupling should be increased \sqrt{n} times.

All the above statements are true when there is no coupling between the common circuit and the circuits of idle units (or when their influence is somehow eliminated). Consider n units in operation each of them having impedance Z and circuit efficiency η which is determined as

$$\eta = \frac{R_1' - R_1}{R_1'}$$

Assume that the electromotive force of one of the units is switched off (Fig. 4). Then the resistance R_2 of the common circuit will increase by a considerable amount

$$\Delta R_2 = \frac{\omega^2 M^2}{R_1}$$

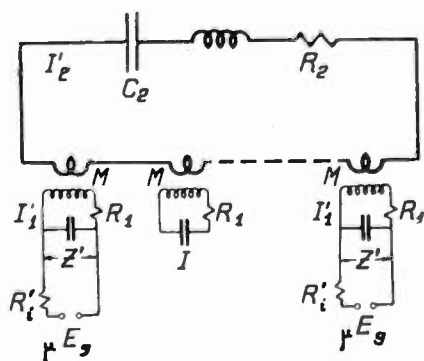

Fig. 4

due to the load of the idle unit; supposed to be tuned exactly to the frequency of transmitter.

This will result in a considerable change in operating conditions of the remaining $(n - 1)$ units; the current in the common circuit and power transmitted will both decrease. The variation of impedance of each of the $(n - 1)$ units may be determined by simple calculations,

$$Z' = \epsilon Z,$$

wherein,

$$\epsilon = \frac{n(1 - \eta) + \eta}{n(1 - \eta)};$$

the variation of current in the tank circuit of each of $(n-1)$ units is

$$\frac{I_1'}{I_1} = \frac{1 + \frac{Z}{R_i}}{\frac{\gamma}{\epsilon} + \frac{Z}{R_i}}.$$

Here γ is the coefficient of variation of internal resistance of unit oscillators which is caused mainly by overexcitation of the oscillators, producing a distorted plate current wave shape.

The variation of current in the common circuit,

$$\frac{I_2'}{I_2} = \frac{I_1' n - 1}{I_1 \epsilon n}.$$

Variation of output,

$$\frac{W_2'}{W_2} = \left(\frac{I_2'}{I_2}\right)^2.$$

Variation of current in idle unit,

$$\frac{I}{I_1} = \frac{I_2'}{I_2} n(\epsilon - 1).$$

Consider a radiotelephone transmitter consisting of six units. Under normal operating conditions $Z/R_i = 0.2$, (approximately).

Assuming $E_p = 0.45 E_b$ (wherein E_p is the tank circuit alternating-current voltage and E_b is the plate supply voltage), the change in operating conditions in the case of dropping out of one unit is illustrated by Table I. The respective efficiencies apply to the full number of units.

TABLE I

| η | ϵ | γ | $\frac{I_1'}{I_1}$ | $\frac{I_2'}{I_2}$ | $\frac{W_2'}{W_2}$ | $\frac{I}{I_1}$ |
|--------|------------|----------|--------------------|--------------------|--------------------|-----------------|
| 0.9 | 2.5 | 1 | 2 | 0.67 | 0.45 | 6 |
| 0.92 | 2.9 | 1.1 | 2.1 | 0.6 | 0.36 | 6.9 |
| 0.94 | 3.6 | 1.3 | 2.15 | 0.5 | 0.25 | 7.8 |
| 0.96 | 5 | 1.9 | 2.2 | 0.37 | 0.14 | 8.9 |
| 0.98 | 9.2 | 2.5 | 2.6 | 0.235 | 0.055 | 11.5 |

Apart from a considerable increase of current in the idle unit tank circuit and a sudden drop of power, the dropping of a unit will cause serious modulation distortion.

In a radio transmitter the current increase would be lower due to greater distortion of the plate current wave shape. Less serious consequences will result if the filament circuit of the idle unit is not broken, because in this case the idle unit circuit will load up the plate circuit of the tube oscillators. Moreover, the circuit of the idle unit may not be exactly tuned to the transmitter frequency, which is very likely in general, as the tuning is adjusted for a minimum direct-current component of plate current. Anyhow the influence of the idle unit upon the common circuit should be eliminated to avoid the undesirable effects in operation of the system.

As in the case of the conventional series connection of electromotive forces, this scheme permits, generally speaking, the operation of units of unequal power, to obtain the proper output from each. For example, consider n_a units with output W_a and ratings M_a , I_a , and R_a' , and n_b units with ratings W_b , M_b , I_b , and R_b' . Then the output of a unit of group a ,

$$W_a = I_a \omega M I_2.$$

Load on the unit is determined by the resistance reduced to its tank circuit

$$R_a' = \frac{W_a}{I_a^2} = \omega M_a \cdot \frac{I_2}{I_a}.$$

Current in the common circuit

$$I_2 = \frac{n_a I_a \omega M_a + n_b I_b \omega M_b}{R_2}$$

whence,

$$R_a' = \frac{\omega^2 M_a^2}{R_2} \left(n_a + n_b \frac{I_b \omega M_b}{I_a \omega M_a} \right) = \frac{\omega^2 M_a^2}{R_2} \left(n_a + n_b \frac{W_b}{W_a} \right). \quad (3)$$

The output of each unit can be determined from readings of circuit meters. Switching on each unit separately we have,

$$\omega M_a = \frac{I_2'}{I_a'} R_2.$$

With joint operation

$$W_a = I_a \omega M_a I_2 = I_2 I_2' R_2 \frac{I_a}{I_a'}. \quad (4)$$

Full oscillating power of unit

$$W \approx I_a^2 R_a + I_2 I_2' R_2 \frac{I_a}{I_a'}. \quad (4')$$

It should be kept in mind that dissimilar operating conditions of units may result in a number of them consuming power instead of delivering it. Assume that one of the units is operated under modified conditions as compared to the rest n' units, Fig. 5. Then with synchronous excitation all the units

$$J_a = \frac{E_a(R_1R_2 + \omega^2M_b^2) - E_b\omega^2M_aM_b}{R_1(R_1R_4 + n_1\omega^2M_a^2 + \omega^2M_b^2)} \quad (5)$$

$$J_b = \frac{E_b(R_1R_2 + n_1\omega^2M_a^2) - E_a n_1\omega^2M_aM_b}{R_1(R_1R_4 + n_1\omega^2M_a^2 + \omega^2M_b^2)} \quad (5')$$

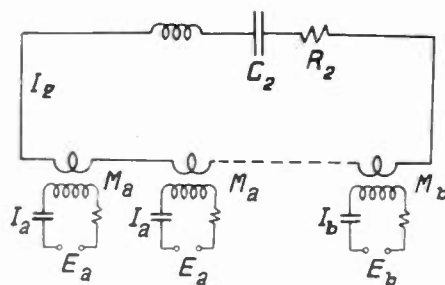

Fig. 5

Here E_a and E_b are equivalent electromotive forces of the tube oscillators.

As the numerators are represented by algebraic differences, the conditions may be created under which the current in the unit "b" will have the opposite phase in relation to its electromotive force; this fact indicates that the unit consumes power from outside. In extreme cases (when the numerator equals zero) the full power supplied to the unit will be dissipated on the plate.

In comparison with the conventional parallel connection of tubes, the unit system, apart from other advantages, adds to the flexibility of the system, permitting load adjustments during operation of the transmitter, by adjusting the coupling between units and tank circuit or by variation of plate supply voltage; by these means operating conditions of any of the units can be made lighter, if necessary. These methods cannot be recommended for a broadcast transmitter, because wide regulation may affect modulation and frequency characteristics of the transmitter. But the very possibility of such a regulation shows that a spare unit may be put in service during operation of the transmitter. By applying first filament voltage and grid bias and then low plate voltage with loose coupling to load circuit the unit is protected against overloads and overvoltages. The load on the unit may then be increased up to the normal value, by raising the plate voltage and

tightening the coupling with the common circuit. (Equation (5) shows that in bringing a spare unit into operation conditions may arise when the unit will consume power from the external common circuit.) Such introduction of a spare unit will not affect the normal operation of other units.

II. PARALLEL CONNECTION OF UNITS

The connection diagram is shown in Fig. 2. The electromotive force in each branch will be

$$E = jI_1\omega M.$$

By connecting equipotential points in case of equal electromotive forces we obtain the equivalent network (Fig. 6).

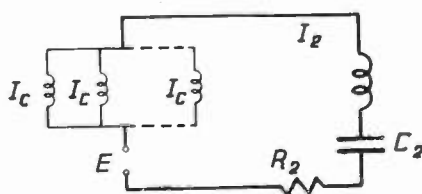

Fig. 6

Current in each coupling coil

$$I_c = \frac{I_2}{n}$$

At resonance conditions, when

$$\omega L_2 = \frac{1}{\omega C_2},$$

evidently,

$$I_2 = \frac{E}{R_2}, \quad I_c = \frac{E}{nR_2}$$

The external resistance reduced to each unit circuit will be

$$R_1' - R_1 = \frac{\omega^2 M^2}{nR_2} \tag{6}$$

In further analysis of operation of this system, the mathematics may be somewhat simplified if the assumption is made that the inductance of the common circuit consists only of those of coupling coils; i.e.,

$$L_2 = \frac{L_c}{n} \quad \text{or} \quad L_c = nL_2.$$

Thorough analysis shows that this assumption introduces no principal changes.

Suppose now that only n_1 units are operated out of all the n units. The currents in coils coupled to the operating units are designated by I_2' ; the currents in other coils, by I_2'' (Fig. 7).

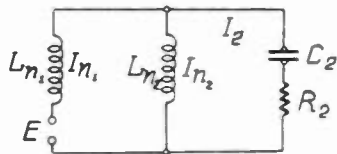

Fig. 7

Connecting equipotential points together, as before, the equivalent network will be obtained, where,

$$I_{n_1} = n_1 I_2', \quad I_{n_2} = n_2 I_2'',$$

$$\frac{n}{n_1} L_2 = L_{n_1}, \quad \frac{n}{n_2} L_2 = L_{n_2}.$$

The current in the common circuit

$$I_2 = E \frac{j\omega L_{n_1}}{\frac{L_{n_1} + L_{n_2}}{C_2} - \omega^2 L_{n_1} L_{n_2} + j\omega R_2 (L_{n_1} + L_{n_2})}$$

At resonance conditions, when,

$$L_2 = \frac{1}{\omega C_2}, \quad I_2 = \frac{L_{n_2}}{R_2 (L_{n_1} + L_{n_2})}$$

It is easy to see, that at resonance the current I_2 not only will be in phase with its electromotive force but it will reach its maximum value.

Currents in coupling coils

$$I_{n_1} = E \left[\frac{L_{n_2}^2}{R_2 (L_{n_1} + L_{n_2})^2} - j \frac{1}{\omega (L_{n_1} + L_{n_2})} \right],$$

$$I_{n_2} = E \left[\frac{L_{n_1} L_{n_2}}{R_2 (L_{n_1} + L_{n_2})^2} + j \frac{1}{\omega (L_{n_1} + L_{n_2})} \right].$$

Thus, at resonance the current in the common circuit

$$I_2 = E \frac{n_1}{n R_2}$$

Currents in coils coupled to the operating units

$$I_2' = E \left(\frac{n_1}{n^2 R_2} - j \frac{n_2}{\omega L_2 n^2} \right).$$

Currents in the idle units coupling coils

$$I_2'' = E \left(\frac{n_1}{n^2 R_2} + j \frac{n_2}{\omega L_2 n^2} \right).$$

Denote current in unit circuit by I_1 , impedance reduced to the unit circuit by Z_1' ; then the electromotive force in a coupling coil will be

$$E = j I_1 \omega M.$$

Reaction of the common circuit upon the unit circuit will be expressed by the counter electromotive force of mutual inductance.

$$- I_2' j \omega M = I_1 Z_1'$$

whence impedance reduced to the unit circuit

$$Z_1' = - \frac{I_2'}{I_1} j \omega M \quad \text{or} \quad Z_1' = \omega^2 M^2 \left(\frac{n_1}{n^2 R_2} - j \frac{n_2}{n^2 \omega L_2} \right). \quad (7)$$

Thus, in addition to the active inphase component

$$\frac{\omega^2 M^2}{R_2} \cdot \frac{n_1}{n^2},$$

the reduced impedance will have a reactive component,

$$- j \frac{\omega^2 M^2}{\omega L_2} \cdot \frac{n_2}{n^2}$$

or expressing it in terms of decrement of the common circuit,

$$- j \frac{\omega^2 M^2 n_2}{n^2 R_2} \cdot \delta_2,$$

because,

$$\omega L_2 = \frac{R_2}{\delta_2}.$$

Therefore,

$$Z_1' = \frac{\omega^2 M^2}{n R^2} \left(\frac{n_1}{n} - j \delta_2 \frac{n_2}{n} \right). \quad (8)$$

The reactive component decreases as the number of units in service increases; it is equal to zero when all the units are operated. This

shows that the accuracy of tuning units in resonance depends to some degree on the number of units in operation; maximum detuning occurs when only one unit out of n is in operation.

If all units are in operation

$$Z_1' = R_1' - R_1 = \frac{\omega^2 M^2}{nR_2}.$$

As under normal conditions the efficiency of a unit circuit is very high, we can assume,

$$R_1' \approx \frac{\omega^2 M^2}{nR_2}.$$

The inductance of a unit circuit is determined for normal operating conditions, when all the units are in operation. Thus, we have,

$$\omega L_1 = R_1' \delta_1',$$

wherein δ_1' is the equivalent decrement of a unit circuit when all the units are in service.

The equivalent resistance with n_1 connected units will be,

$$Z_1' \approx R_1' \left(\frac{n_1}{n} - j\delta_2 \frac{n_2}{n} \right).$$

The entering of the reactive component is equivalent to lowering unit-circuit inductance by ΔL_1 ,

$$\frac{\Delta L_1}{L_1} \approx \frac{\delta_1' \delta_2 \eta_2}{n}. \quad (9)$$

In this particular case, when only one unit is in operation (maximum detuning),

$$n_1 = 1; \quad I_2 = j \frac{I_1 \omega M}{n^2 R_2}. \quad (10)$$

$$Z_1' \approx R_1' \left(\frac{1}{n} - j\delta_2 \frac{n-1}{n} \right).$$

The relative decrease of inductance

$$\frac{\Delta L_1}{L_1} = \delta_1' \delta_2 \frac{n-1}{n}.$$

Let,

$$n = 6, \quad \delta_2 = 0.16, \quad \delta_1' = 0.13, \quad \frac{\Delta L_1}{L_1} \approx 1.7\%.$$

Maximum frequency detuning will be therefore of the order of 0.8 per cent—almost negligible under these conditions. The variation of the active component resembles that of the series connection; when the number of units in service is decreased the load on each unit is also decreased, because the reflected resistance is diminished. For that reason, the considerations of adjusting for telephone power, etc., hold true in the case of parallel connection as well.

When one of the units, as for example in Fig. 2, drops out its effect upon the rest of the system (due to coupling between its circuit and the common circuit) is different from that when the units are connected in series. If the tuning is accurate the circuit of the idle unit will insert a considerable resistance in that branch of the common circuit which is associated with the idle unit; this resistance will somewhat detune the common circuit and the circuits of operating units. The current in the idle unit circuit

$$I = I_1' \frac{1 - j \frac{1}{\delta_2}}{1 + j \frac{1}{\delta_2} \left[\frac{(1 - \eta)n + \eta}{\eta(n - 1)} \right]}$$

wherein,

I_1' —current in circuit of operating unit

η —unit circuit efficiency under normal conditions (before dropping out).

As the currents in unit circuits undergo but slight change, the modulus of current variation in the idle unit circuit is

$$\left| \frac{I}{I_1} \right| \approx \sqrt{\frac{1 + \frac{1}{\delta_2^2}}{1 + \frac{1}{\delta_2^2} \left[\frac{(1 - \eta)n + \eta}{\eta(n - 1)} \right]^2}}$$

Let $n = 6$. Then assuming $\eta = 0.9 \div 0.98$ and $1/\delta_2 = 5 \div 10$, the current rise will be $[I/I_1] = 2.5 \div 4$; i.e., less dangerous than in case of series connection of units. Tests have shown that with filament voltage not being removed the current in the circuit is then less than that under normal conditions, due to the valve nature of the load. Anyhow, the

effect of the idle unit is undesirable and should be in some way or other eliminated.

From the power standpoint parallel connection of units is equivalent to series connection; as the number of units in operation increases the load of each unit also increases; both circuits permit connecting units of different outputs and load them accordingly. If desired, the unit load may be decreased by loosening the coupling to the common circuit, by lowering the plate voltage, or by decreasing high-frequency grid swing, etc. Both circuit schemes permit putting into service a spare unit.

As compared to parallel connection of generators or transformers in heavy current engineering, the parallel connection of radio units permits greater freedom, because of the resonance tuning of the common circuit, the parallel connection of units is identical to the series connection of generators.

Using the same symbols as in the case of series connection, we can write

$$R_a' = \frac{\omega^2 M_a^2}{n^2 R_2'} \left(n_a + b_b \frac{W_b}{W_a} \right). \quad (11)$$

The oscillating power of the unit,

$$W = I_a^2 R_a + I_2 I_2' R_2 \frac{I_a}{I_a'},$$

can be determined from readings of high-frequency meters.

As compared to series connection of units, the parallel connection has the particular advantage that it permits more nearly comparable conditions of coupling to the common circuit.

The above inferences are based on the assumption of synchronous excitation of units. The synchronous condition may be easily checked by readings of instruments pertaining to individual unit circuits and to the common circuit during joint and individual operation.

Nonsynchronous operation of a unit is not to be allowed in either the parallel or series connection, as it causes detuning of the unit circuits and subsequent reduction of output.

Nonsynchronous operation of units may in general be compensated for by the proper tuning of tank circuits, as it is done, for example, in "dephasing" modulation. Such a compensation is, however, interfered with when the number of units operated or their coupling to the common circuit is changed, etc. It is therefore desirable to insure synchronous operation without resorting to artificial means.

In the case of long waves, the synchronous condition is easily maintained without special means; in the case of short waves it is attained by proper design of circuits and feeders.

III. EXPERIMENTAL CHECK

The above statements were first experimentally checked in an installation consisting of three high-frequency stages, a master oscillator, a buffer amplifier, and a last stage which comprised four units (each rated at 250 watts) operating on a common load. Some excerpts from the experimental data are given below.

A. Series Connection of Units

Tests have shown that in order to secure stable results screening is necessary not only for the first two stages but also for the units to eliminate parasitic interaction between them. The interaction of units without screening was easily detected when the common circuit was broken; a slight change in tuning of one unit affected the currents in other units so that it was hard to evaluate the accuracy of the tuning of circuits. The interaction was completely removed by insertion of screens between the units. The feed-back in various stages was in addition eliminated by careful neutralization of units and buffer amplifier; this was at times checked during tests.

The study of series connection of units was carried out at wavelengths of about 400 meters.

The following sequence was held in tuning the circuits of the last stage: First, the units were energized and their circuits tuned without the common circuit; then the common circuit was tuned, being loosely coupled to one of the units; and then the coupling was increased to normal. The common circuit was coupled to all the remaining units one after another, and the coupling was increased until the same current relation was obtained as in the unit tuned first. Thereupon all the units switched on together. The character of the change of operating conditions, as is shown in Table II, completely proves the above statements.

TABLE II

| n | I_0 | I_1 | I_2 | E_p/E_b | $\frac{W_2}{n}$ | $R_1' - R_1$ | η_t | η_k |
|-----|-------|-------|-------|-----------|-----------------|--------------|----------|----------|
| 1 | 40 | 3.7 | 2.3 | 1.04 | 21.6 | 1.6 | 0.6 | 0.45 |
| 2 | 55 | 3.56 | 4.6 | 1 | 43.5 | 3.5 | 0.62 | 0.64 |
| 3 | 58 | 3.05 | 5.8 | 0.86 | 46 | 5 | 0.56 | 0.71 |
| 4 | 68 | 2.77 | 7.1 | 0.78 | 51.5 | 6.7 | 0.49 | 0.77 |

Symbols used in Table II: n = number of operating units, I_0 = direct-current component of plate current of one unit in milliamperes,

I_1 = current in unit circuit, I_2 = current in common circuit, W_2 = power in common circuit, $R_1' - R_1$ = resistance, η_t = tube oscillator efficiency, and η_k = unit circuit efficiency.

Plate voltage E_B , grid bias e_g , and high-frequency peak voltage on the grid circuit E_g were maintained at constant values:

$$E_B = 2000 \text{ volts}, \quad e_g = -115 \text{ volts}, \quad E_g = 200 \text{ volts.}$$

Circuit resistances were

$$R_1 \approx 2 \text{ ohms}, \quad R_2 = 4.1 \text{ ohms.}$$

The table shows that units were operated under synchronous conditions. In effect, the current ratio I_2/I_1 is proportional to the number of units (n) in service.

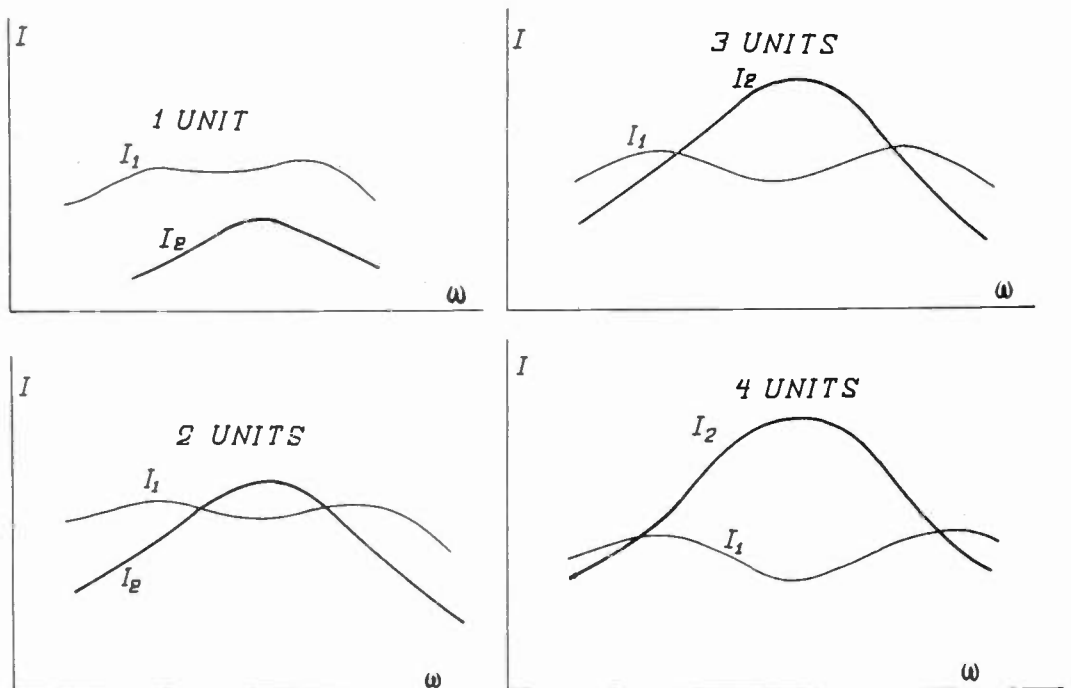

Fig. 8

The number of units in service affects not only the operating conditions of a unit and the efficiency of its circuit, but also the frequency transmission characteristic of the common circuit. This is fully proved by resonance curves taken with various number of units (Figs. 10 and 11). In obtaining resonance curves the frequency of the master oscillator was varied with a corresponding adjustment of the circuit of the buffer amplifier. The tuning of the circuits of the last stage (those of the units and that of the common) was kept unchanged. High-frequency voltage applied to the grids of the units was maintained constant.

Fig. 10 shows that the sharpest resonance curve in the secondary circuit I_2 is obtained when one unit is in service. As the number of units is increased the secondary current curve becomes flatter. The curves in Fig. 11 were taken with closer coupling and less overexcitation: one unit gives a single-humped curve of I_2 ; two units, a flatter curve resembling double-humped; three units, a double-humped curve with closely spaced peaks; four units, a very pronounced double-humped curve with far spaced peaks.

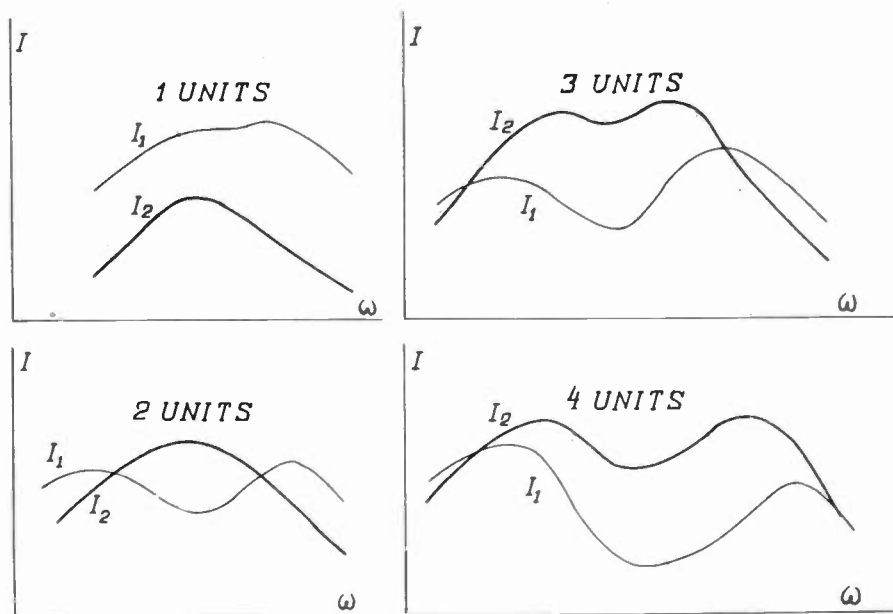

Fig. 9

As was pointed out above, the connecting of several similarly loaded units is equivalent to an increase of the coupling factor of each unit with the common circuit in the ratio of the square root of the number of units; i.e.,

$$M_e = M\sqrt{n}.$$

This was fully proved by actual tests.

All the above statements regarding unequal loading of units were experimentally confirmed.

The connection of two units with equal but phase opposing electromotive forces gave the same effect as no-load connection of units; as if the common circuit were broken. It is interesting to note, that in this case both units could easily be fully loaded by detuning their circuits in opposite directions (increasing capacity in one and decreasing it in another).

In all tests with an incomplete number of units, the circuits of idle units either were broken or detuned, after which their coupling to the common circuit was loosened. Retaining of close coupling between an idle unit and the common circuit has the very strong effect of decreasing the current in the common circuit. A special circuit was used for studying the methods of eliminating the influence of idle units. A. L. Minz suggested the following method (Fig. 12).

The coupling coil of the common intermediary circuit consists of two coils L' and L'' (more exactly L' is the coupling coil as coils L_{coup} and L'' are not coupled).

A movable screen is arranged parallel to coils L' and L'' .

When a unit is in service the screen is located against coil L'' . When the unit comes out of operation the screen is shifted over to coil L' and demagnetizes it to the same degree as the coil L'' when the unit

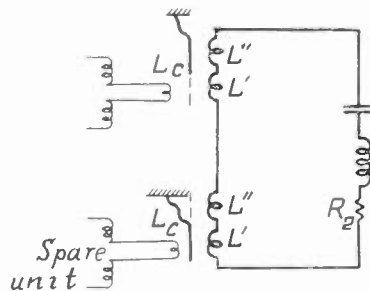

Fig. 10

was operating. Thus, with stationary coupling coils the taking of a unit out of operation is not accompanied by detuning of the common circuit. Meanwhile the screen between coils L' and L_{coup} eliminates the coupling between them and causes detuning of the unit circuit. When a spare unit is brought into action the screen is shifted in the opposite direction.

This method not only eliminates the effect of an idle unit upon the common circuit but also permits making repairs on the idle unit during operation of the transmitter.

B. Parallel Connection of Units

Tests with parallel connection of units were carried out in the same installation which was used for series connection.

The sequence of tuning of various circuits of the last stage was similar to that in the case of the series connection. The nature of the load variations on units, changes in operating conditions of their oscillators, etc., completely justified the theoretical analysis and was similar to the case of the series circuit.

The shape of the resonance curves is changed with the number of units connected, according to the same law as in the case of the series connection, the most peaked curve corresponds to one unit. The effect of idle units is less pronounced than in the case of series connection. Nevertheless, this effect was eliminated in all tests.

In tests of unequal loading of the units, the plate voltage and the coupling to the common circuit were varied in one of the units; the regulation covered a wide range when the whole system was operated and was not accompanied by any complications. Thus, for example, with two units jointly operated

| | |
|----------------------------|----------------------------------|
| $I_2 = 15.2$ amperes, | $W_2 = 162$ watts |
| Unit No. 1. | Unit No. 2. |
| $E_0 = 3500$ volts, | $E_0 = 2500$ volts |
| $I_1 = 2.22$ amperes | $I_1 = 1.05$ amperes |
| $W_1 = I_1^2 R = 22$ watts | $W_1 = 5$ watts |
| | $I_{\text{coup}} = 3.2$ amperes. |

Here I_c is the current in that branch of the common circuit which is coupled to unit No. 2.

With separate connection of units and the same coupling

| | |
|------------------------------------|----------------------------------|
| Unit No. 1. | Unit No. 2. |
| $E_0 = 3500$ volts, | $E_0 = 2500$ volts |
| $I_1' = 2.37$ amperes, | $I_1' = 1.2$ amperes |
| $I_2' = 10.65$ amperes, | $I_2' = 6.4$ amperes |
| $I'_{\text{coup}} = 2.18$ amperes, | $I'_{\text{coup}} = 1.2$ amperes |
| $W_2' = 80$ watts | $W_2' = 29$ watts. |

Determining the power delivered by each unit during joint operation, using formula (11),

$$(W_2)_{N_1} = I_2 I_2' R \frac{I_1}{I_1'} = 106 \text{ watts,}$$

$$(W_2)_{N_2} = 59 \text{ watts.}$$

Similar results were obtained in tests with a greater number of units.

Further operation with telephone high-frequency power of some hundred kilowatts completely proved all the theoretical inferences and the above results of experimental checks.

ACKNOWLEDGMENT

I wish to express my thanks to those fellow-workers who participated in the experimental part of the work as well as to Mr. G. S. Shulman for having kindly checked this translation.

SOME EARTH POTENTIAL MEASUREMENTS BEING MADE IN CONNECTION WITH THE INTERNATIONAL POLAR YEAR*

BY

G. C. SOUTHWORTH

(American Telephone and Telegraph Company, New York City)

FOR several years the Bell System has been studying the relation between radio transmission and earth potential disturbances. A paper dealing with this subject was published in 1931.¹ Prompted by the needs of the International Polar Year, together with the prospect that further work would throw additional light on the nature of radio transmission, the work was extended somewhat in 1932.

It is expected that useful correlation will be found between the normal earth potential effects which occur day after day during undisturbed periods and the corresponding diurnal and seasonal variation of radio transmission. It seems entirely probable, for instance, that earth potentials are but the terrestrial manifestations of certain changes taking place in the Kennelly-Heaviside layer which may not be found by other methods.

This paper is intended to serve mainly as a progress report outlining briefly the methods and scope of the work and showing the type of data being obtained. It leaves to a later date most of their correlation and their interpretation. The data here presented are in a conventional form used by other investigators for many years. Their value lies mainly in their extent and in the rather wide range of circumstances under which they were obtained.

It is interesting to note that the study of earth potentials is relatively young. It began soon after the telegraph came into general use, but ceased soon after the advent of trolleys and other commercial applications of electric power. During this period valuable data were obtained, particularly at Greenwich. There were also other points of observation near Paris and Berlin and later in Sweden. Of the experimental lines now in use the best known are those of the Ebro Observatory in Tortosa, Spain, dating from 1910, and those of the Carnegie Institution of Washington, located respectively at Watheroo (Western Australia) and Huancayo (Peru) and dating from 1923 and 1926, re-

* Decimal classification: R113.5. Original manuscript received by the Institute, June 16, 1933. Presented before U.R.S.I., Washington, D.C., April, 27, 1933.

¹ Isabel S. Bemis, *PROC. I.R.E.*, vol. 19, pp. 1931-1947; November, (1931).

spectively. The latter points were supplemented in 1931 by the Tucson (Arizona) observatory of the Coast and Geodetic Survey.

The locations of the observation points covered by this paper are shown in Fig. 1. These points were chosen largely from consideration of available wire lines and the feasibility of operation. However, some regard was also given to their latitudes and the geological formation of the earth in that vicinity. The stations at Tucson and Boston are observing points of the Carnegie Institution of Washington and Tufts College, respectively. Similar work is in progress at these points.

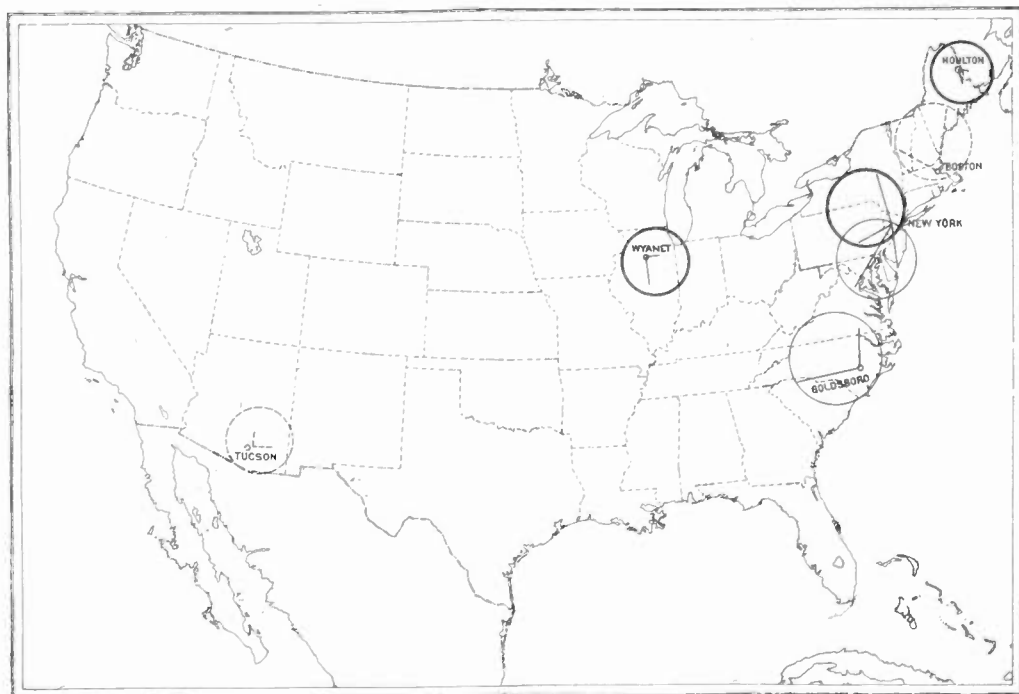
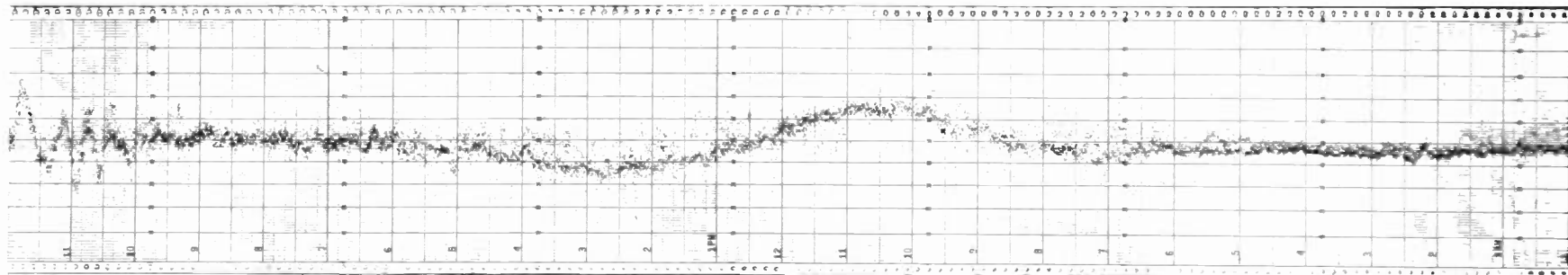

Fig. 1—Stations at which earth potentials are recorded.

The technique of measuring earth potentials is essentially that of connecting a recording voltmeter into the crust of the earth at two points and measuring the prevailing voltages. If the interfering effects of commercial origin are small, these lines may be short; otherwise it is desirable that they be of considerable length, say, 75 kilometers or more. Observations made on two lines disposed roughly at right angles to each other permit of the magnitude and general direction of this gradient being determined.

One type of record being obtained is shown by Fig. 2. In the course of analysis hourly averages are transcribed to a data sheet where they are averaged over monthly periods for the study of diurnal and seasonal variations. The principal characteristics of the more pronounced disturbances are also recorded. A study of these latter data is planned

RECORDS OF EARTH POTENTIALS



MENDHAM, N. J.-CAPE MAY, N. J. —————
 MENDHAM, N. J.-FAIRFAX, VA. —————

RECORD OF JAN. 21, 1933.
 SHOWING NORMAL DIURNAL VARIATION

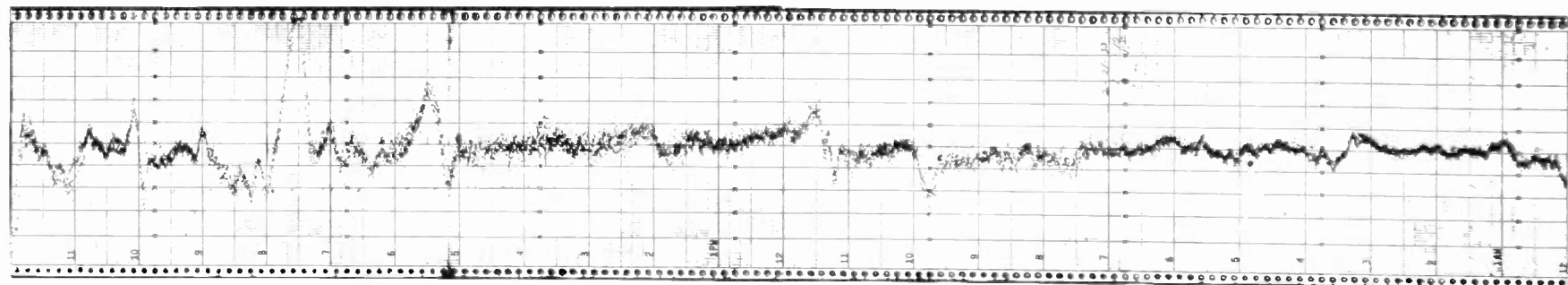

MENDHAM, N. J.-FONDA, N. Y. —————
 MENDHAM, N. J.-LEBANON, PA. —————

RECORD OF FEB. 21, 1933.
 SHOWING EARTH POTENTIAL DISTURBANCE

Fig. 2

which should bring out the time and direction of arrival of each disturbance as well as statistics regarding their average behavior.

Fig. 3 shows the average diurnal variation measured at Houlton, Maine, for the month of November, 1932, resolved into north-south and east-west components. Near the bottom of the figure are shown the magnitudes and directions of the prevailing voltages for each hour. It will be observed that the magnitudes are greatest during daylight hours and that the successive vectors seem to rotate clockwise through 720 degrees in the twenty-four-hour period. Similar data taken in the

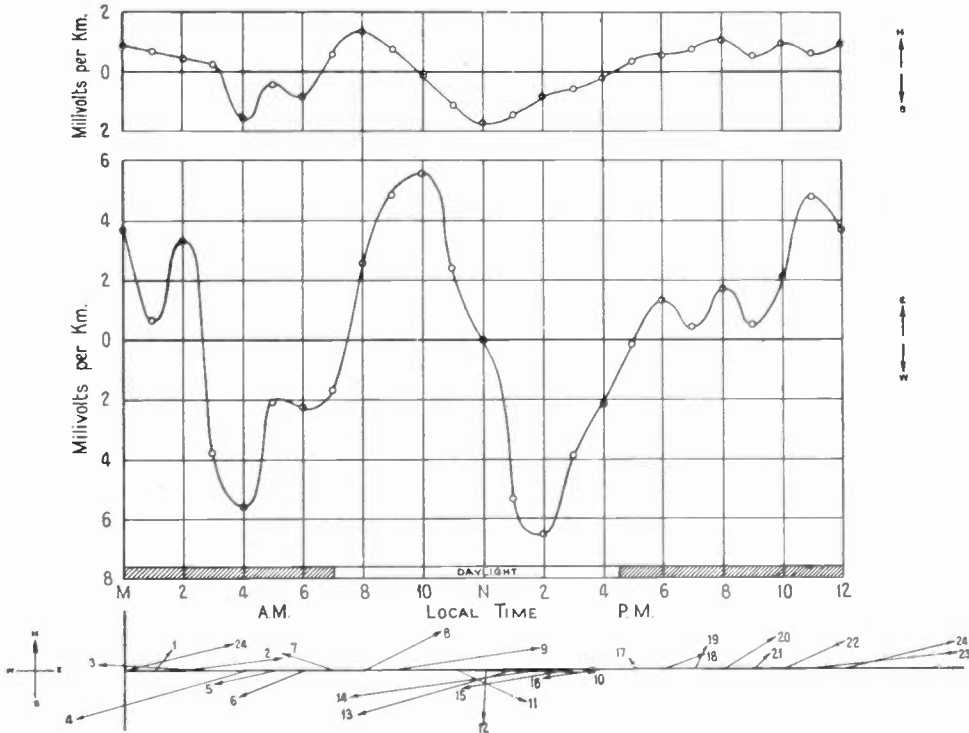

Fig. 3—Diurnal variation of earth potentials. Houlton, Maine, November, 1932.

southern hemisphere indicate a counterclockwise rotation. The conspicuous twelve-hour component is found generally in the diurnal variation of earth potentials at other places and has been known for many years. A harmonic analysis of the diurnal variation is in progress which shows not only the predominance of this second harmonic but also the existence of several rather high frequency components.

The vector representation above may be shown as a hodograph as has been done in Fig. 4. The successive termini corresponding to hourly magnitudes and directions are numbered successively. The seasonal trend for the six months under consideration is apparent. It will, of course, be necessary to wait until the end of the year to confirm this trend more definitely.

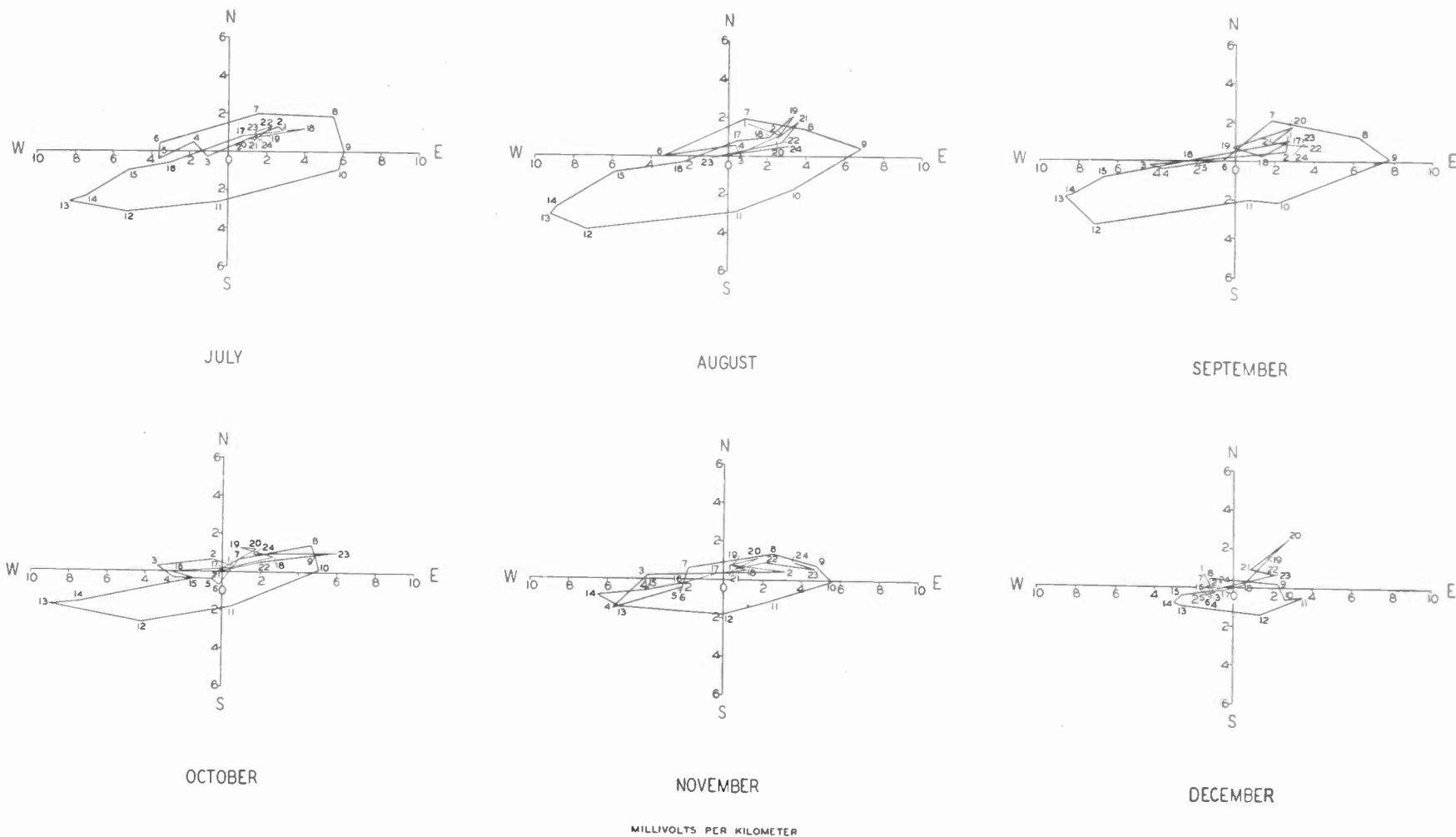

Fig. 4—Diurnal variation of earth potential. Houlton, Maine, July to December, 1932. Seasonal effect.

Fig. 5 makes evident the extreme differences that exist between the magnitudes and directions of voltages prevailing at different locations. These diagrams are all drawn to the same scale except that of the large figure for Wyanet, Illinois, which has been magnified by a factor of four to make its detail more readily comparable with the neighboring diagram for Houlton, Maine. The small Wyanet diagram shown in the lower right corner of the figure retains the original scale.

It will be noted that the smallest diurnal variations shown are measured in Illinois where the soil is deep and the geological formation is homogeneous, and the largest in the region between eastern Pennsylvania and Virginia where the conditions are generally the reverse. These voltages are in the same order as the prevailing resistivities of the earth as measured in these regions and as reported by one of the author's colleagues.² It should be pointed out, however, that these differences are not as great as those of the corresponding resistivities. It will also be noted that the diagrams for Wyanet, Illinois, and Houlton, Maine, are very similar in form and are only moderately elongated, whereas those for New York, N. Y. (North) and New York, N. Y. (South) are very much elongated, suggesting that, although similar outside influences may be present at all places, there is some distinctly local influence present near the latter points which restricts the voltages to the northwest and southeast directions. This prevailing direction is almost at right angles to the direction of the mountain ranges in this region. Other measurements made in these ranges but further south show this same effect. Potential gradients measured nearer the shore are less directed. The relation between these directions and geological formation is being given further study.

We might conclude, tentatively at least, from the data above, that the eastern mountain ranges exhibit higher conductivity longitudinally than transversely. We might, consequently, expect less attenuation to broadcast transmission in a northeast-southwest direction than along its perpendicular. It would be interesting to know whether such a difference has ever been observed.

The study of earth potential disturbances as contrasted with the normal effects reveals certain interesting characteristics that are shown in Fig. 6. This represents the magnitude and direction of the prevailing voltages at Houlton, at Wyanet, and also at the two points near New York during a particular earth potential disturbance which took place on January 15, 1933. It will be noted that the tendency near New York for the voltage to be directed along a northwest-southeast line,

² R. H. Card, Paper read before Washington Meeting, American Geophysical Union, April 27, 1933.

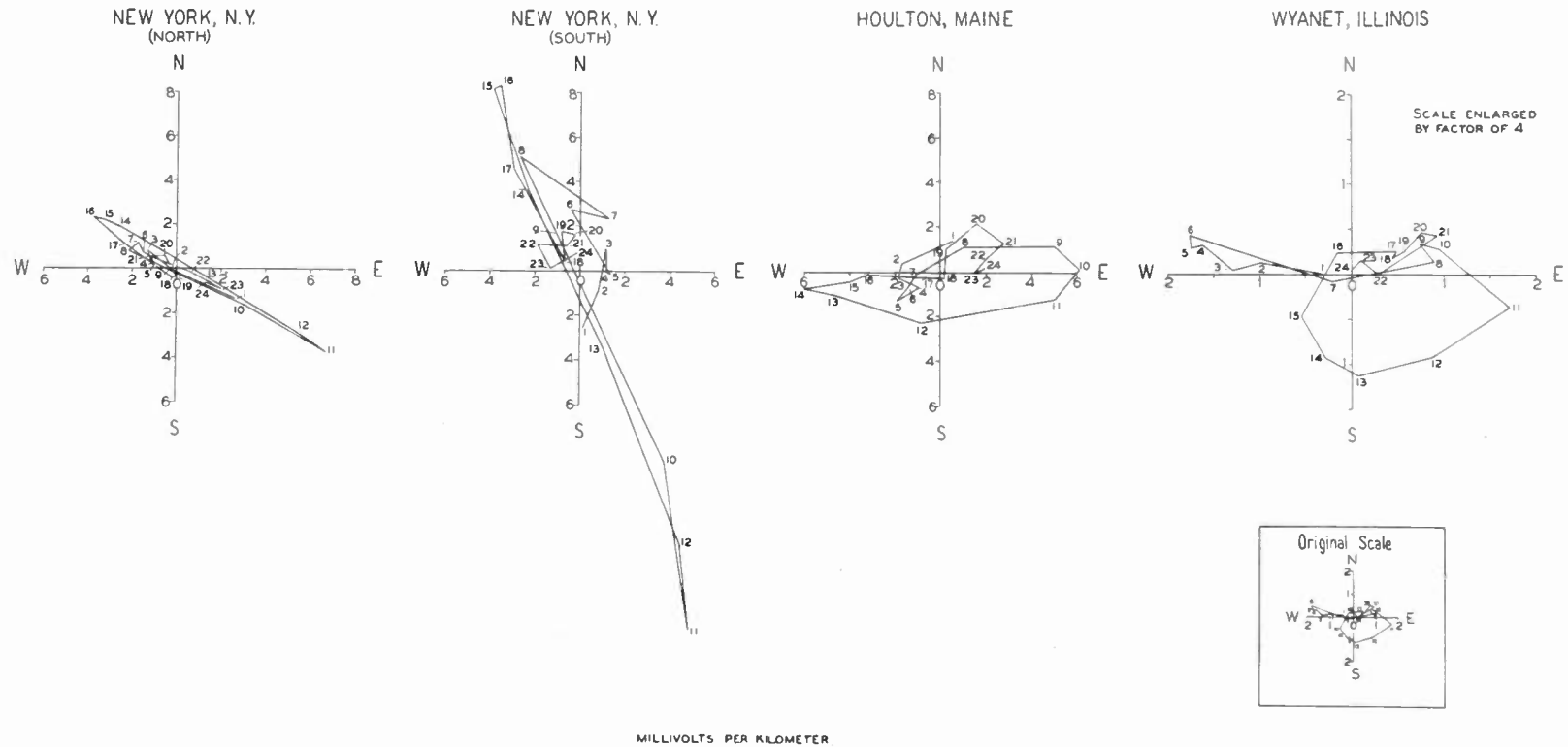

Fig 5—Diurnal variation of earth potential. January, 1933. Effect of station location.

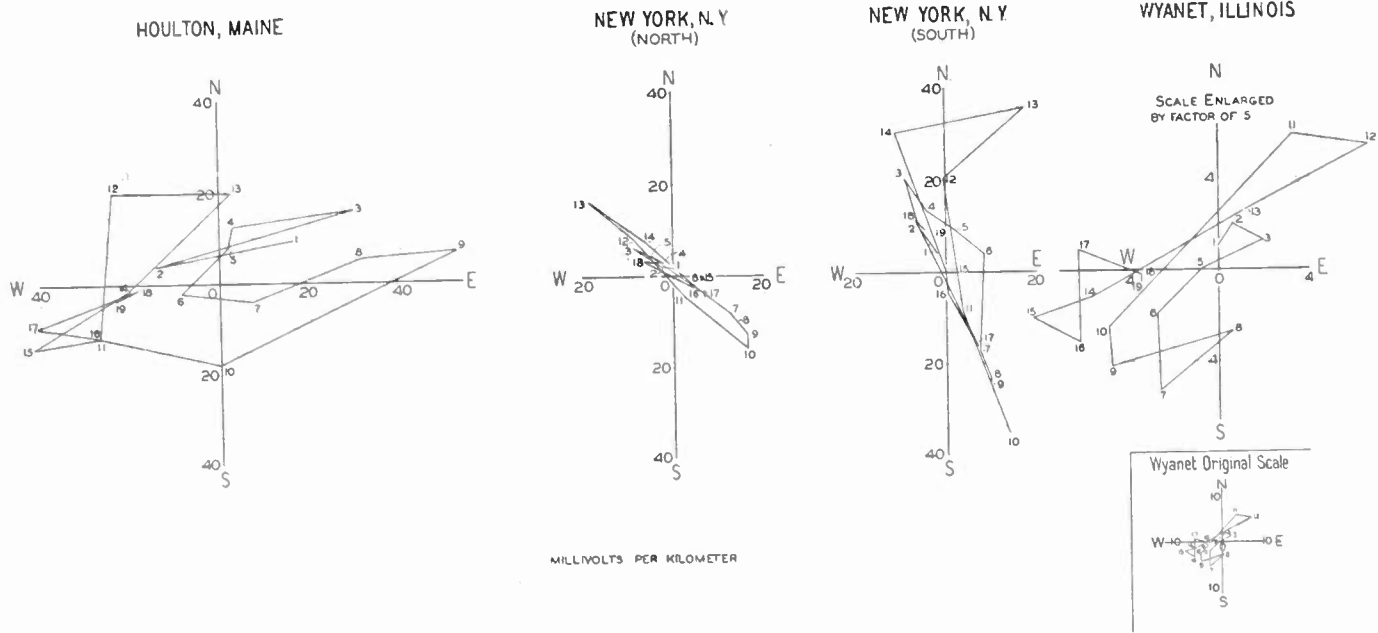

Fig. 6—Directional characteristics. Earth potential disturbance of January 15, 1933. 2 A.M.—5 A.M., E.S.T.

so conspicuous above for the normal diurnal variation, holds also for this abnormal or disturbed period. It would also appear that the relative magnitudes measured at these various points are related to local conditions in much the same manner as for the normal effect.

ACKNOWLEDGMENT

This work has been made possible through the kind coöperation of a rather large number of people in both the operating and research groups of the Bell System. On account of their number and also the diverse nature of their contributions, it is not feasible to give them the recognition which they may individually deserve.



NOTE ON THE THEORY OF THE MAGNETRON OSCILLATOR*

By

E. C. S. MEGAW

(Communication from the Research Staff of the M.O. Valve Company, Ltd., Wembley, England)

IN A recent note¹ J. B. Hoag has given a simple argument to show that the relations

$$\lambda H = 10,650$$

and

$$\lambda H = 13,100$$

between the magnetic field strength H and oscillation wavelength λ , should hold approximately in a cylindrical magnetron for the cases of no space charge and saturated space charge, respectively. It was assumed that the half period of the oscillation is equal to the time of transit of an electron from filament to anode and that the anode voltage had the critical value for which the electrons just touch the anode surface. The additional assumption was introduced that the electrons attain their maximum velocity within a negligible distance from the filament.

It has been shown elsewhere² that when the critical relation holds between anode voltage and field strength, the time of transit of an electron in a cylindrical magnetron is given by

$$T = \left(2 \frac{e}{m} E_a \right)^{-1/2} \int_{r_0}^{r_a} \left[f(r) - \frac{r^2}{r_a^2} \left(1 - \frac{r_0^2}{r^2} \right)^2 \right]^{-1/2} dr$$

where,

E_a = anode voltage

r = radial distance from electrode axis

r_0 = filament radius

r_a = anode radius

and,

$f(r)$ is defined by

$$E_r = f(r) \cdot E_a$$

Okabe's relation³ between λ and H , which is identical with Hoag's first result, was obtained by assuming r_0 infinitely small and putting

* Decimal classification: R133. Original manuscript received by the Institute, September 8, 1933.

¹ Proc. I.R.E., vol. 21, p. 1132; August, (1933).

² Megaw, *Jour. I.R.E.* (London), vol. 72, p. 330; April, (1933).

³ Okabe, Proc. I.R.E., vol. 17, p. 652; April, (1929).

$f(r) = 1$. Now $f(r) = 1$ means that the whole of the interelectrode space is at anode potential so that the electrons will attain their maximum velocity immediately they leave the filament. This is the additional assumption made by Hoag in obtaining his first figure for λH , which should therefore evidently agree with Okabe's result.

By giving $f(r)$ the forms appropriate to zero and saturated space charge the relations

$$\lambda H = 12,300 \text{ (zero space charge)}$$

and

$$\lambda H = 16,700 \text{ (saturated space charge)}$$

have been obtained,² for values of r_a/r_o of the order of 100, by graphical integration of the equation for transit time. These relations agree quite well with the observed minimum and maximum wavelengths when the oscillation amplitude is small.

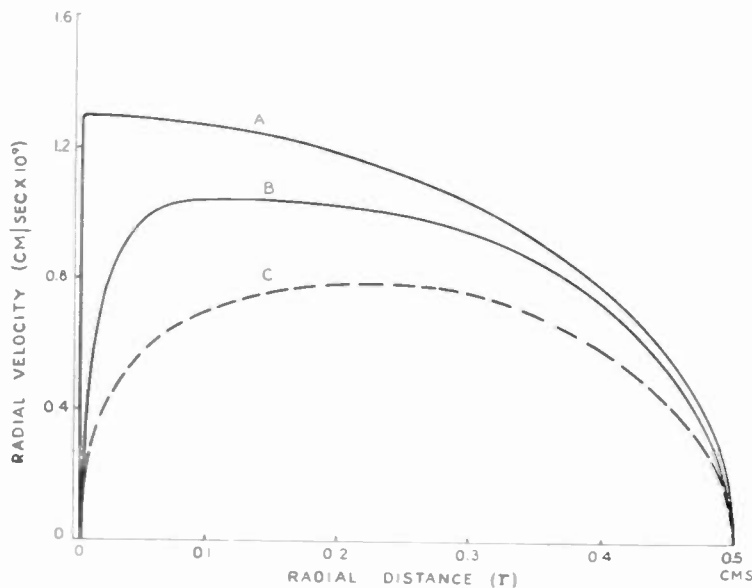

Fig. 1. Radial velocity as a function of radial distance from electrode axis.

Curve A. $f(r) = 1$ (constant total velocity)

Curve B. $f(r) = \left(\log \frac{r}{r_0} \right) / \left(\log \frac{r_a}{r_0} \right)$
(actual potential distribution with no space charge)

Curve C. $f(r) = \left(\frac{r \beta_a^2}{r_a \beta_a^2} \right)^{2/3}$
(saturated space charge).

In obtaining the relation for saturated space charge it has been assumed that the potential distribution is not appreciably changed by the presence of the magnetic field. There is experimental evidence⁴

⁴ Hull, *Phys. Rev.*, vol. 18, p. 31; July, (1921).

that this is not far from the truth. The last two equations are at least more accurate than those obtained on the assumption of constant total velocity. The curves shown in Fig. 1 indicate the magnitude of the error introduced by this assumption in a typical case.

It is found that the observed wavelengths tend to be slightly lower than those given by the theory outlined above, particularly when the magnetic field is inclined to the electrode axis so as to obtain a maximum output.² In this case it appears that the electrons providing the output energy describe several loops, with successively decreasing amplitude, before reaching the anode. The average "transit time" for such electrons would probably be smaller than that for electrons which touch the anode on their first outward journey.

These curves apply to a magnetron with a 1.0-centimeter diameter anode and a 0.01-centimeter filament when the anode voltage is 400 and the magnetic field strength is adjusted to the critical value.

ACKNOWLEDGMENT

The author desires to tender his acknowledgment to the General Electric Company and the Marconi Company on whose behalf the work leading to this publication was done.



BOOK REVIEW

Die Kathodenstrahlröhre und ihre Anwendung in der Schwachstromtechnik, by Manfred von Ardenne with assistance of Dr.-Ing. Henning Knoblauch. Published by Julius Springer, Berlin, 398 pp., 432 figures. Price, RM36.

Recent years have seen a very great increase in the use of the low voltage Braun tube as a necessary laboratory tool accompanied by an equally large extension of the number of purposes to which it is applicable. Hence the appearance of this book by one who has been largely responsible for these developments will be welcomed by a considerable army of laboratory workers.

Both author and publisher are to be congratulated on producing a work which is worthy of the best traditions of German scientific and technical book-making. The subject matter is comprehensively and clearly covered, while the letter-press and illustrations are unusually well done. The photographs of discharge phenomena within the tube, those of structural details taken through the glass envelope, and the reproductions of certain oscillograms are the finest things of the kind the reviewer has ever seen.

The text is in four main parts. The first deals with the theory and construction of the cathode ray tube; the second with the accessories required for its use; the third with its applications as a laboratory tool; while the fourth treats of its industrial uses and possibilities. The parts of the first section dealing with the production of the electronic pencil, its concentration and modulation, and the various methods of deflection are adequately done and constitute about fifteen per cent of the whole text. The part on tube construction and manufacturing methods and practices is quite full and contributes another fifteen per cent to the total. The section on accessory apparatus discusses such matters as supply voltages (direct-current and alternating-current); amplifiers for increasing sensitivity; means of obtaining the deflecting voltages from the phenomena or equipment to be studied (electric, magnetic, optical or mechanical); methods of producing a time axis; and equipment for producing oscillograms photographically. This second section constitutes about thirty-five per cent of the book.

The third section details methods of using the oscillograph in the study of transient and periodic processes; in testing condensers, electron tubes, rectifiers, amplifiers, loud speakers, radio transmitters and receivers; in the determination radio wave field strengths and direction; and in studies of the ionosphere. There are also chapters on specialized applications in telegraphy, telephony, high voltage research, acoustics, ballistics, internal combustion engine research, and medical research (electrocardiograph). This section comprises some twenty per cent of the material in the book. The last section comprises two chapters, the first of which is devoted to a description of installations for sound recording on movie films, and the second to television equipment. No apparatus other than that of German manufacture is described. The material presented in this section forms about ten per cent of the whole.

The remaining five per cent of the book consists of an admirably arranged bibliography and adequate indices. Altogether this is a very valuable reference work and in addition an outstanding example of the printer's art.

*L. P. WHEELER.

* Naval Research Laboratory, Bellevue, Anacostia, D. C.

BOOKLETS, CATALOGS, AND PAMPHLETS RECEIVED

Copies of the publications listed on this page may be obtained gratis by addressing the manufacturer or publisher.

The frequency measuring service offered by the Phelps Precision Laboratory of 3612-22nd Avenue, S., Minneapolis, Minnesota, is described in a leaflet issued by that organization.

"The Use of Colloidal Graphite in the Manufacture of Electrical Resistance" is the title of Technical Bulletin No. 11.4 issued by the Acheson Oildag Company of Port Huron, Mich.

The Allen B. DuMont Laboratories of Upper Montclair, N. J., have issued leaflets covering their cathode ray oscillograph tubes and accessory equipment.

Leaflets outlining special courses in radio mathematics, radio transmitter engineering, and elements of electrical engineering offered by RCA Institutes are available from that organization which may be addressed at 75 Varick Street, New York.

The RCA Radiotron-Cunningham Radio Tube chart giving data on several dozen standard vacuum tubes is available from the commercial engineering sections of RCA Radiotron and E. T. Cunningham at Harrison, N. J. In addition, an erratum notice on application Note No. 17 on special applications of the Type 53 tube has been published. Additional Application Notes issued are as follows: Note No. 19 on operating conditions for the 1A6 as an oscillator-mixer, No. 20 on an increase in the maximum allowable grid resistor for Types 38, 41, 42, 89, and 2A5, No. 21 on operating characteristics of the Type 1-V and the Type 12Z3, No. 22 on the operation of the 2A6, 2B7, 6B7, 55, 75, 77, and 85 as resistance coupled audio-frequency amplifiers, No. 23 on the operating characteristics of the type 84 tube, No. 24 on the 1A6 as a half-wave diode tetrode, No. 25 on the influence of circuit constants on receiver output noise, No. 26 on the 37, 56, 57, and 77 tubes as resistance coupled high voltage amplifiers, No. 27 on the use of pentagrid converter tubes in multirange receivers, and No. 28 on special applications of the type 79 tube.

"For the Inspector" is the name of a booklet issued by the Electrical Cord Manufacturers of the National Electrical Manufacturers Association, 155 East 44th Street, New York City, to encourage the use of approved electrical materials.

The Brush Development Company of 3715 Euclid Avenue, Cleveland, Ohio, has released a folder describing their grille type of microphones.

Bulletin No. 220 has been released by the National Company of 61 Sherman Street, Malden, Mass. It describes various high-frequency receivers as well as components for both receivers and transmitters.

Bulletin No. 10 of the Central Scientific Company of Chicago covers CENCO high vacuum pumps, gauges, and accessories.

Carrier Systems for Telephony and Telegraphy is the title of a catalog recently issued by Telefonaktiebolaget, L. M. Ericsson, Stockholm, Sweden.

RADIO ABSTRACTS AND REFERENCES

THIS is prepared monthly by the Bureau of Standards,* and is intended to cover the more important papers of interest to the professional radio engineer which have recently appeared in periodicals, books, etc. The number at the left of each reference classifies the reference by subject, in accordance with the "Classification of Radio Subjects: An Extension of the Dewey Decimal System," Bureau of Standards Circular No. 385, obtainable from the Superintendent of Documents, Government Printing Office, Washington, D. C., for 10 cents a copy. The classification also appeared in full on pp. 1433-1456 of the August, 1930, issue of the PROCEEDINGS of the Institute of Radio Engineers.

The articles listed are not obtainable from the Government or the Institute of Radio Engineers, except when publications thereof. The various periodicals can be secured from their publishers and can be consulted at large public libraries.

R000. RADIO (GENERAL)

- R070 S. Kaufman. Radio and its present relation to education. *Radio News*, vol. 15, pp. 265-266, 312; November, (1933).

Some of the educational programs now being presented, are reviewed and the advantages of educational broadcasts are pointed out.

R100. RADIO PRINCIPLES

- R113.55 S. K. Mitra; H. Rakshit; P. Syam; B. N. Ghose. Effect of the solar eclipse on the ionosphere. *Nature* (London), vol. 132, pp. 442-443; September 30, (1933).

From observations taken on the eclipse of August 21, 1933, it is concluded that ultraviolet light is at least one of the agencies producing ionization of the E layer and that corpuscular rays have little or no effect.

- R113.61 T. Minohara and Y. Ito. Measurements of heights of the Kennelly-Heaviside layer in Japan. *Report of Radio Research in Japan*, vol. 3, L1-31; June, (1933).

A large amount of data is given on measurements of the Kennelly-Heaviside layer in Japan from August, 1932 to January, 1933.

- R113.61 Meeting for discussion on the ionosphere. *Proc. Roy. Soc.* (London), vol. 141, pp. 697-722; September, (1933).

This is a kind of round table discussion on the above subject. Prof. E. V. Appleton, Messrs. S. Chapman, C. T. R. Wilson, T. L. Eckersley, R. A. Watson-Watt, J. A. Ratcliffe, and Prof. F. A. Lindemann, took part in the discussion which constitutes a comprehensive survey of the present status of the ionosphere.

- R113.61 T. R. Gilliland. Continuous measurements of the virtual heights of the ionosphere. *Bureau of Standards Journal of Research*, vol. 11, pp. 141-146; July, (1933). Research Paper No. 582. *Proc. I.R.E.*, vol. 21, pp. 1463-1475; October, (1933).

Abstract of this paper appeared in the reference list in the October, 1933, *Proc. I.R.E.*

- R113.7 C. N. Anderson. Attenuation of overland radio transmission in the

* This list compiled by Mr. A. H. Hodge and Miss E. M. Zandonini.

- ×R270 frequency range 1.5 to 3.5 megacycles per second. *PROC. I.R.E.*, vol. 21, pp. 1447-1462; October, (1933).
 These data are for the general frequency range 1.5 to 3.5 megacycles per second and for various combinations of overwater and overland transmission as well as entirely overland. The generalizations in this paper are chiefly in the form of curves which enable one to make approximations of field strengths to be expected under the conditions noted above. The relation of these data to transmission in the broadcast frequency range is shown.
- R113.7 Report of Committee on radio propagation data. *PROC. I.R.E.*, vol. 21, pp. 1419-1438; October, (1933).
 The report of the U. S. A. group which was prepared for the North American Radio conference, Mexico City, July 10, 1933 is given. Radio wave propagation data for the frequency range 150 to 1700 kilocycles, and distances up to 5000 kilometers are given in the form of graphs. The data are presented in a concise and usable form.
- R114 E. T. Burton and E. M. Boardman. Audio-frequency atmospherics. *PROC. I.R.E.*, vol. 21, pp. 1476-1494; October, (1933).
 Musical and nonmusical atmospherics occurring within the frequency range lying between 150 and 4000 cycles have been studied. Attention is directed to two types of the former, one a short damped oscillation, apparently a multiple reflection phenomenon, and the other a varying tone of comparatively long duration. Dependence of atmospheric variations on diurnal, seasonal and meteorological effects are discussed. Characteristics of audio-frequency atmospherics are shown in oscillograms and graphs.
- R114 K. G. Jansky. Electrical disturbances apparently of extraterrestrial origin. *PROC. I.R.E.*, vol. 21, pp. 1387-1398; October, (1933).
 From data obtained over a period of more than a year, it is concluded that the direction of arrival of high-frequency atmospherics is fixed in space. The source is outside the solar system. Coordinates of the region from which the waves seem to come are given as right ascension 18 hours and declination -10 degrees.
- R115 T. L. Eckersley. Experimental and theoretical study of the polar distribution of energy in a beam at great distance from the sender. *Marconi Rev.*, no. 43, pp. 1-11; July-August, (1933).
 This article discusses the question of the difference between theoretical and observed values of energy concentration from a beam aerial array as revealed by recent experiments made by the Marconi Company in conjunction with the British Post Office on the transmission from the Marconi beam station at Klipheval, South Africa.
- ×R125.1 W. Ochmann and M. Rein. Theorie und praktische Anwendung der gerichteten Strahlung. (The theory and practical use of directed radiation.) *Hochfrequenz. und Elektroakustik*, vol. 42, pp. 68-72; August, (1933).
 This is the conclusion of a survey the first part of which has been abstracted previously. The practical use of technical antenna systems is described. The method of operation of reflectors as well as the influence of the earth on the configuration of the directional characteristic is treated.
- R125.1 K. Tani. Theory of the complex antenna. *Report of Radio Research in Japan*, vol. 3, pp. 19-88; June, (1933).
 "In this paper is proposed a general theory of the beam antenna of straight wires, based on the views as set forth by Leon Brillouin and developed by A. A. Pistolokors. Useful tables for the design of beam antennas are added. The paper consists of the following eleven sections: introduction, radiation coupling between two straight-wire antennas parallel to each other, radiation coupling between n parallel straight-wire antennas, distribution of electromotive force and current on the radiation-coupled antenna, effects of radiation reactance and some related experiments, applications of the theory of beam antennas, tables of radiation impedance, comparison of the transversal and the longitudinal plane antenna, free resonant antenna in a radiation field, antenna system of a large number of oscillators and resonators, antenna system including elements not in tune."
- R131 S. Ballantine. Fluctuations noise due to collision ionization in electronic amplifier tubes. *Physics*, vol. 4, pp. 294-306; September, (1933).
 Ions formed by collision in electronic amplifier tubes move toward the cathode and control grid and produce momentary increases in the space-charge limited current. An approximate theory is presented, applicable to cathodes of large diameter. Both the noise and the increase in the average value of the electron current due to the presence of

ionization are calculated. The production of noise in tubes with oxide cathodes containing mercury vapor, argon and the gases naturally evolved from the electrodes and tube walls is investigated experimentally as affected by pressure and electron current density.

- R132 O. E. Keall. Noise as a limiting factor in amplifier design. *Marconi Rev.*, no. 43, pp. 18-26; July-August, (1933).
The case of a combined photo cell and amplifier is considered in relation to noise. The following factors which contribute toward the total noise are considered: shot effect in photo cell, thermal effect in photo-cell load, shot effect across first anode load, thermal effect across first anode load, photoelectric effect in vacuum tubes, flicker effect.
- R133 W. D. Hershberger; H. A. Zahl; M. J. E. Volay. Luminous discharge between Lecher wires in a partially evacuated tube. *Physics*, vol. 4, pp. 291-293; September, (1933).
This paper gives results of experiments with a Gill-Morrell oscillator generating undamped waves less than a meter in length. A study was made of the potential difference between the Lecher wires coupled to the oscillator by enclosing these wires in an evacuated glass tube several wave lengths long. The use of this tube made possible a visual study of the changes in potential distribution as various circuit adjustments were made.
- R133 J. S. McPetrie. The determination of the inter-electrode times of transit of electrons in triode valves with positive grid potentials. *Phil. Mag.* (London), vol. 16, pp. 544-553; September, (1933).
The performance of electrical circuits incorporating three-electrode vacuum tubes is affected seriously at very high frequencies by the times of transit of the electrons between the various electrodes. In this paper it is shown how these times may be determined for any vacuum tube with a positive potential on the grid and any potential on the anode. It is also shown how the velocity of emission of the electrons from the cathode may be taken into account.
- R134 C. B. Fisher. S.-G. Valve as superhet detector. *Wireless Engineer & Experimental Wireless* (London), vol. 10, pp. 541-542; October, (1933).
Some notes intended as an amplification of an article by E. C. L. White, "The screen-grid valve as a frequency changer in the superhet," which appeared in *Wireless Engineer*, November, (1932).
- R134 J. Kammerloher. Hochfrequenzschrimgitter-Röhre als Anodengleichrichter. (The high-frequency screen grid vacuum tube as an anode rectifier.) *Elek.-Nach. Tech.*, vol. 10, pp. 345-352; August, (1933).
The theory of the screen-grid anode rectifier is presented. It is shown that for high frequencies the static characteristic curve is effective. Experimental results are given and are found to be in good agreement with the theory.
- R140 H. Subra. Étude de la synchronisation d'un auto-oscillateur et de son fonctionnement au voisinage de la synchronisation. (The study of synchronization of an oscillator and of its operation in the neighborhood of synchronization.) *L'Onde Electrique*, vol. 12, pp. 353-384; July, (1933).
This article treats the phenomena which occur when two oscillators have their frequencies brought very close to the same value. The classical theory of beats does not hold in this case where there is coupling between the oscillators. The article describes these phenomena and explains the operation of one oscillator disturbed by a second oscillator whose frequency is very near that of the first.
- R142 K. Clough. Band-pass effect obtained in new I.F. design. *Radio News*,
×R361.2 vol. 15, pp. 285-286; November, (1933).
Design data are given on intermediate frequency coupling unit which permit high intermediate-frequency selectivity without side band cutting.
- R146 D. C. Espley. The calculation of harmonic production in thermionic valves with resistive loads. *Proc. I.R.E.*, vol. 21, pp. 1439-1446; October, (1933).
"Formulas are obtained for the amplitudes of harmonic components and the direct-current change in the anode current of thermionic valves operating with resistive loads:

These expressions for components up to the sixth harmonic are given in terms of points taken from the load line on the anode-voltage—anode-current characteristics at equally spaced intervals of grid voltage."

- R148
×R116 S. O. Pearson. How the signal reaches your set. *Wireless World* (London), vol. 33, pp. 250–252; September 22, (1933).
Modulation and the purpose of the carrier wave are explained.
- R149 L. A. Richards. The use of triode vacuum tube rectifiers to supply constant voltage. *Rev. Sci. Instr.*, vol. 4, pp. 479–482; September, (1933).
When triode vacuum tubes are used as rectifiers approximately constant direct-current voltage can be obtained from a rectifier-filter circuit by having changes in the alternating-current line voltage control the grid bias of the triode rectifiers. Circuit arrangements and results obtained are given.
- R165 M. V. Scroggie. The electrostatic loud speaker. *Wireless World* (London), vol. 33, pp. 226–227, September 15; pp. 248–249, September 22; pp. 272–274, September 29, (1933).
These three articles explain how the electrostatic loud speaker works, how it behaves as a load in a vacuum tube circuit and how it can best be combined with a moving-coil unit.
- R200. RADIO MEASUREMENTS AND STANDARDIZATION
- R214
×R381 G. F. Lampkin. Automatic temperature compensation for the frequency meter. *QST*, vol. 17, pp. 16–19, 58; October, (1933).
A condenser is described whose capacity varies with temperature in such a manner as to partially compensate for change of frequency of a piezo oscillator due to temperature changes.
- R214 S. Matsumara and S. Ishikawa. On tourmaline oscillators. *Report of Radio Research in Japan*, vol. 3, pp. 1–5; June, (1933).
The frequency characteristics of tourmaline-controlled oscillators were investigated, and it was found that these oscillators have practically the same characteristics as those in which quartz crystals were used.
- R214 A. Scheibe and U. Adelsberger. Frequenz und Gang der Quarzuhren der Physikalisch-Technischen Reichsanstalt. (Frequency and operation of the quartz frequency standard of the Physikalisch-Technischen Reichsanstalt.) *Ann. der Physik*, vol. 18, pp. 1–25; September, (1933).
Results obtained with a quartz-driven clock or frequency standard are given. The methods of measurement of the average value and of the instantaneous value of frequency are given. It is stated that the instantaneous value can be measured to an accuracy of $\pm 1 \times 10^{-9}$. The absolute frequency is accurate to 1 to 2×10^{-8} .
- R214 E. H. Rietzke. Notes on crystals. *Radio Eng.*, vol. 13, pp. 23–24; September, (1933).
A brief discussion of the piezo-electric effect and its application to frequency control.
- R241 W. A. Barclay. Measuring resistances. *Wireless Engineer & Experimental Wireless* (London), vol. 10, pp. 552–555; October, (1933).
A "four-variable" alignment chart which expedites the calculation of resistance from measurements made with a galvanometer type instrument is described.
- R265.2 H. S. Knowles. Loud speaker cost vs. quality. *Electronics*, vol. 6, pp. 240–242, 256; September, (1933).
Comparative data of a number of 5-inch and 12-inch speakers are given in the form of graphs. These criteria of performance are considered: (1) loudness efficiency, (2) type of response, and (3) power handling capacity.
- R270 T. Nakai. Field strength measurements and directional observations of short waves. *Report of Radio Research in Japan*, vol. 3, pp. 89–98; June, (1933).

A brief account is given of a field intensity measuring apparatus. The calibration of the over-all gain by the vertical aerial and its tuning circuit was made by comparing it with a loop. The apparatus was compared with a Western Electric high-frequency field-strength measuring set. Directional observations were also conducted by using a high-frequency direction finder of a new goniometer type. Its working is satisfactory and free from the error due to wave polarization.

- R270 T. Nakai. Field strength measurements and directional observations of high-frequency radio waves at the Electrotechnical Laboratory, Ministry of Communications. *Report of Radio Research in Japan*, vol. 3, F, pp. 1-24; June, (1933).

This consists of a large number of graphs showing field intensity data obtained from September to December, 1932.

- R270 K. A. Norton and S. E. Reymer. A continuous recorder of radio field intensities. *Bureau of Standards Journal of Research*, vol. 11, pp. 373-378; September, (1933). Research Paper No. 597.

A recorder of received radio intensities is described. A bridge arrangement makes feasible the operation of the recorder from a commercial alternating-current supply. Sample records of received field intensities from several American broadcast stations are shown. These illustrate the flexibility of the recorder and also some properties of broadcast transmissions.

- R280 D. W. Randolph; O. S. Duffendack; R. A. Wolfe. Electron emitting alloys of nickel and barium. *Electronics*, vol. 6, pp. 244-246; September, (1933).

This article gives the characteristics of nickel and barium alloys that are of interest in vacuum tube work.

- R280 H. C. Todd. Svea metal—Its application and use. *Radio Eng.*, vol. 13, pp. 26-28; September, (1933).

- R281 W. A. Yager. Electrical leakage over glass surfaces. *Bell Lab. Record*, vol. 12, pp. 40-44; October, (1933).

Results of a study of leakage over glass surfaces under conditions of different humidity and for different glasses are given. The previous history and treatment of the glass is found to affect the leakage greatly.

R300. RADIO APPARATUS AND EQUIPMENT

- R320 Some new types of broadcast transmitting aerials (editorial). *Wireless Engineer & Experimental Wireless* (London), vol. 10, pp. 525-526; October, (1933).

Two types of antennas are described. A single self-supporting wooden tower 140 meters high having a bronze ring of 10 meters diameter at the top and a vertically hanging wire down the center of the tower serves as antenna for a 60-kilowatt station, wavelength 325 meters, at Breslau. The service area is said to be doubled. The second type of antenna described is a steel lattice mast formed of two square pyramids placed base to base. The mast serves as antenna.

- R331 P. L. Copeland. Surface conditions and stability of characteristics in screened-grid tubes. *Jour. Franklin Inst.*, vol. 216, pp. 417-426; October, (1933).

"The characteristics of screened-grid tubes are discussed and the influence of secondary emission is emphasized. The marked change in secondary emission with surface contamination causes instability of characteristics. Experiments with carefully evacuated '24 tubes indicate that the evaporation of active material from the cathode considerably increases the secondary emission from the plate and that the liberation of 'getter' in a completed tube limits the stability attainable."

- R355.21 G. F. Van Dissel. La station radioélectrique de la Société des Nations. (The radio station of the Society of Nations.) *L'Onde Electrique*, vol. 12, pp. 329-352; July, (1933).

The radio facilities of the Society of Nations are described. These consist of several transmitting and receiving stations.

- R355.5 G. G. Blake. Ultra-short waves. *Electrician* (London), vol. 111, pp. 279-280; September 8, (1933).
A "zero-shunt" method of measurement of 60-centimeter waves is described. Radio-metric inductances and condensers are discussed. "If a few turns of thermostatic bimetal strip, connected to two short aerials . . . are arranged parallel to the oscillating antennae, either so close as to be within its electrostatic field or at one of the antinodes, when heat radiations are allowed to fall on the inductance it gradually unwinds and comes into resonance."
- R355.5 J. J. Lamb. Tritet multi-band crystal control. *QST*, vol. 17, pp. 9-15; October, (1933).
A transmitter exciter unit is described which by using plug-in coils provides transmitter excitation on four bands with crystal control and on five bands with electron-coupled self-control.
- R355.5 C. C. Anderson. Inexpensive individual-band transmitters. *QST*, vol. 17, pp. 21-22, 24; October, (1933).
A combination of low-power transmitters for "four-band" operation.
- R355.8 G. Wataghin and R. Deaglio. Note on new methods to modulate light. *Proc. I.R.E.*, vol. 21, pp. 1495-1496; October, (1933).
This note describes some methods for modulating light, which have been investigated by the authors.
- R355.9 M. G. Scroggie. Applications of the dynatron. *Wireless Engineer & Experimental Wireless* (London), vol. 10, pp. 527-540; October, (1933).
The characteristics and operating conditions of the screen-grid vacuum tube used as a dynatron are reviewed from a practical point of view. The precautions to be observed in obtaining the maximum advantage from the special features of the dynatron are detailed, and it is shown how it may be applied to receivers, wavemeters, standard signal generators, beat-frequency oscillators, and apparatus for measuring the radio-frequency resistance of oscillatory circuits, the power factor of dielectrics, and the admittance of chokes and similar components.
- R355.9 S. Bagno and S. S. Egert. A practical signal generator. *Radio News*, vol. 15, pp. 273-274, 303; November, (1933).
Constructional data for a signal generator for service men and experimenters are given.
- R357 S. S. Egert and S. Bagno. A new and practical multivibrator. *Radio Eng.*, vol. 13, pp. 20-21; September, (1933).
A relaxation type of multivibrator which uses 78-type tubes is described.
- R361 W. C. Dorf. The International Nine. *Radio News*, vol. 15, pp. 277, 299; November, (1933).
Constructional data for a high-frequency receiver are given.
- R361.2 F. H. Jones. A crystal-controlled short-wave super. *Radio News*, vol. 15, pp. 280, 310; November, (1933).
This article, the second of a series, provides data on directional and diversity antenna arrays, and proceeds with the constructional data on the receiver.
- R362.2 F. R. W. Strafford. Design of the detector-oscillator. *Wireless World* (London), vol. 33, pp. 229-230; September 15, (1933).
Some difficulties involved in the frequency changing device of the superheterodyne receiver are pointed out and methods of overcoming these are given.
- R365.2 S. Ballantine. A piezo-electric loud speaker for the higher audio frequencies. *Proc. I. R. E.*, vol. 21, pp. 1399-1408; October, (1933).
This paper is a description of an electrophone unit adapted for the reproduction of the higher audible frequencies and suitable for use as a component of a composite reproducing system. This instrument is of the horn type and is driven by a piezo-electrically active diaphragm built up of crystals of Rochelle salt.

- R365.2 B. S. Trott. The external loudspeaker and the miniature receiver. *Radio Eng.*, vol. 13, pp. 16-17; September, (1933).
Notes on the use of a quality loud speaker with a miniature receiver.
- R365.21 W. T. Cocking. Delayed amplified A.V.C. *Wireless World* (London), vol. 33, pp. 244-246; September 22, (1933).
In this article the design of amplified automatic volume controlled circuits is considered in a practical manner.
- R366.3 J. L. Potter. Rectifier for modulation measurements. *Electronics*, vol. 6, p. 247; September, (1933).
A rectifier using a type 280 tube for modulation measurements is described.
- R381 By-pass condensers for 5-meter work. *Wireless World* (London), vol. 33, pp. 266-267; September 29, (1933).
A measuring apparatus for determining the impedance of condensers at 5 meters is described.
- R383 L. H. Bainbridge-Bell. A continuously variable rheostat dispensing with sliding contacts. *Jour. Sci. Instr.* (London), vol. 10, pp. 295-296; September, (1933).
Description of apparatus.
- R388 M. Knoll. The electronic microscope. *Electronics*, vol. 6, p. 243; September, (1933).
The use of the cathode-ray tube as a magnifying device is discussed.
- R388 F. Helgans. Über statische Licht- und Stromspannungs-Kennlinien als Grundlage der Helligkeitssteuerung von Elektronenstrahlröhren. (On the static light- and current voltage-characteristic lines as the foundation for brightness control for electron radiation tubes.) *Hochfrequenz. und Elektroakustik*, vol. 42, pp. 45-53; August, (1933).
Results of a study of the static characteristics of cathode-ray tubes are given.
- R388 J. M. Hollywood and M. P. Wilder. Cathode-ray tubes. *Radio News*, vol. 15, pp. 268-270, 313; November, (1933).
Constructional data on cathode-ray equipment.

R400. RADIO COMMUNICATION SYSTEMS

- R410 C. J. W. Hill and H. Page. A long wave single sideband telephony receiver for transatlantic working. *Marconi Rev.*, no. 43, pp. 12-17; July-August, (1933).
This is the concluding part of a paper dealing with the receiver recently constructed by Marconi Company for the Post Office and installed at Baldock.
- R410 A. H. Reeves. The single side-band system applied to short-wave telephone links. *Jour. I. E. E.* (London), vol. 73, pp. 245-279; September, (1933).
The possibility of single side-band radiotelephony as a commercial project and the various problems encountered in such a system are discussed. It is shown that in the absence of selective fading the question of synchronizing is fairly simple. Some experimental results are given.
- R423.5
× R214 T. Nakai; R. Kimura; and S. Ueno. Experiments in ultra-high-frequency communication. *Report of Radio Research in Japan*, vol. 3, pp. 7-17; June, (1933).
This paper presents in outline, experiments in ultra-high-frequency communication that were carried out during the summer of 1932, together with a brief account of experimental investigations made by the authors. A transmitter controlled by a tourmaline

crystal was constructed and set up at the Meteorological Observatory on the summit of Mt. Fuji, 3780 meters above sea level. Receiving measurements were carried out on a large scale at a number of laboratories and stations, on ships and on running passenger trains.

- R430 E. H. Scott. Radio noise. *Radio News*, vol. 15, pp. 278-279; November, (1933).

This article discusses the cause, prevention and suggested remedies for radio noise.

- R430 C. V. Aggers and W. E. Pakala. Reducing radio interference from commutating machines. *Electric Jour.*, vol. 30, pp. 423-427; October, (1933).

An analysis of the several interference voltages produced by commutation shows what preventative measures will be effective.

- R440 W. L. Black. A compact, alternating-current operated speech input equipment. *Proc. I.R.E.*, vol. 21, pp. 1409-1418; October, (1933).

This paper describes an alternating-current operated, speech input equipment primarily intended for installation as studio equipment for local channel broadcast stations or for permanent installation at outside pick-up points frequently used by large broadcast stations. The features of this equipment are the use of moving coil microphones, the inclusion of high quality, high gain, all alternating-current operated amplifiers capable of delivering a high output level. Mechanically, the principal component is a single factory-assembled and -wired metal cabinet.

- R480 Radio relay systems. *Electrical Rev.*, vol. 113, pp. 414-415; September 29, (1933).

A brief discussion of radio relay systems for program distribution.

R500. APPLICATIONS OF RADIO

- R512.3 C. E. Horton and C. Crampton. A radio compass developed in H. M. Signal School. *Jour. I. E. E.*, (London), vol. 73, pp. 284-294; September, (1933).

This article describes a wireless direction finder free from ambiguity which has been developed for use in ships as well as on shore. The direction and sense are determined by a single operation. The principle involved is a combination of a figure-of-eight reception characteristic with a cardioid.

- R526 F. W. Dunmore. A method of providing course and quadrant identification with the radio range-beacon system. *Bureau of Standards Journal of Research*, vol. 11, pp. 309-325; September, (1933). Research Paper No. 593.

This paper describes a method of obviating the difficulty of determining which quadrant an aviator is in with respect to the radio beacon. The method uses a directive signal composed of one dot transmitted in a westerly direction, two dots in an easterly direction, three dots north and four dots south. Depending upon which set of signals is the loudest, a pilot may determine his direction from the beacon. Methods of transmitting these signals are described.

- R583 A. Church. Recent developments in television. *Nature* (London), vol. 132, pp. 502-505; September 30, (1933).

A brief historical survey of the developments in television.

- R590 G. E. Fleming. Mixing circuits for public address systems. *Radio News*, vol. 15, pp. 271-272, 309; November, (1933).

Design data including volume control, mixing, impedance matching and sound sources for public address systems are given.

R600. RADIO STATIONS

- R600 P. S. Gates. A complete broadcast studio installation for alternating-current operation. *Radio Eng.*, vol. 13, pp. 18-19; September, (1933).

Description of a studio installation.

R800. NONRADIO SUBJECTS

- 535.38 M. J. Kelly. The Caesium-oxide-silver photo-electric cell. *Bell Lab. Record*, vol. 12, pp. 34-39; October, (1933).
The construction and use of photo-electric cells are discussed.
- 537.7 F. Eisner. Ein neues Verfahren zur Frequenzanalyse und seine Anwendung zur Untersuchung von Flugzeuggeräuschen. (A new method of frequency analysis and its use for the investigation of airplane noises.) *Hochfrequenz. und. Elektroakustik*, vol. 42, pp. 53-64; August, (1933).
A method is described for analyzing a periodic alternating voltage. The method consists in using a search tone of variable frequency which is used to generate a beat frequency between the noise and itself. The difference tone is impressed on a constant frequency tone and the second difference tone is very quickly damped out in a resonant circuit of very narrow frequency range. Oscillograms of various motor noises are shown. Several references are given.
- 538.11 I. J. Saxl. Magnetostriction oscillators. *Radio News*, vol. 15, pp. 275-276, 312; November, (1933).
A description of the principles and applications of magnetostriction.
- 621.313.7 D. D. Knowles and C. E. Haller. The phantom tester. *Electronics*, vol. 6, pp. 248-249; September, 1933.
A method of testing high power mercury vapor tubes is given.
- 621.375.1 F. L. Arnot. The measurement of critical potentials with a screened-grid valve. *Jour. Sci. Instr.* (London), 10, pp. 294-295; September, (1933).
Apparatus is described in which a screened-grid vacuum tube is used to determine critical potentials.
- 621.382.8 E. W. Smith. The characteristics of submarine telephone cables at carrier frequencies. *Jour. I. E. E.*, (London), vol. 73, pp. 213-232; September, (1933).
This article deals with the electrical characteristics of submarine cables designed to transmit carrier frequencies. The sphere of this branch of communication is outlined, and the general principles of operation and cable design are stated. The use of bridge networks to determine the characteristics of short lengths of cable, and of a completed laid cable, is described.



CONTRIBUTORS TO THIS ISSUE

Beers, G. L.: Born 1899 at Indiana, Pennsylvania. Received B.S. degree, Gettysburg College, 1921. Westinghouse graduate student course and engineering school, 1921-1922; radio engineering department, Westinghouse Electric and Manufacturing Company, in charge of superheterodyne receiver development, 1922-1930; research department, RCA Victor Company, 1930 to date. Associate member, Institute of Radio Engineers, 1927; Member, 1929.

Engstrom, E. W.: Born August 25, 1901, at Minneapolis, Minnesota. Received B.S. degree in electrical engineering, University of Minnesota, 1923. Radio engineering department, General Electric Company, 1923-1930; engineering department, RCA Victor Company, 1930 to date. Associate member, Institute of Radio Engineers, 1925.

Kell, R. D.: Born June 7, 1904, at Kell, Illinois. Received B.S. degree in electrical engineering, University of Illinois, 1926; postgraduate work, University of Illinois, 1926-1927. Assistant in Alexanderson's radio laboratory, Schenectady, 1927-1930; RCA Victor Company, 1930 to date. Nonmember, Institute of Radio Engineers.

Megaw, E. C. S.: Born January 19, 1908, at Dublin, Ireland. Received B.Sc. degree in electrical engineering, Queen's University, Belfast, 1928; Beit Scientific Research Fellow at City and Guilds (engineering) College, London, 1928-1930. Amateur radio, 1924-1930; transmitting valve group, research laboratories, General Electric Company, Wembley, England, 1930 to date. Associate member, Institute of Radio Engineers, 1929.

Model, S. I.: See PROCEEDINGS for January, 1933.

Rose, George M., Jr.: Born November 22, 1907, at Nashville, Tennessee. Received B.S. degree in electrical engineering, University of North Carolina, 1928. Research laboratory, General Electric Company, 1929-1930; vacuum tube engineering department, 1930-1931; research and development laboratory, RCA Radiotron Company, 1930 to date. Associate member, Institute of Radio Engineers, 1931.

Southworth, George C.: Born August 24, 1890, at Little Cooley, Pennsylvania. Received B.S. degree, 1914; M.S. degree, 1916, Grove City College; Ph.D. degree, Yale University, 1923. Assistant physicist, Bureau of Standards, 1917-1918. Instructor, Yale University, 1918-1923; research on radio communication, American Telephone and Telegraph Company, 1923 to date; De Forest (radio) lecturer, Yale University, 1927-1930. Member, American Physical Society, Washington Philosophical Society. Member, Institute of Radio Engineers, 1926.

Thompson, B. J.: See PROCEEDINGS for April, 1933.

Zworykin, Vladimir K.: Born 1889 in Russia. Received E.E. degree, Petrograd Institute of Technology. In 1912 entered the laboratory of the College de France, Paris, research in X-rays, working under Professor P. Langevin. During World War served in Russian Army as officer in Radio Corps. Research laboratory, Westinghouse Electric and Manufacturing Company, 1920 to date. Received Ph.D. degree, University of Pittsburgh, 1926. Since 1929 connected with research laboratory, RCA Victor Company, working on television, electron optics, photoelectric cells, and allied problems. Member, Institute of Radio Engineers, 1930.

R800. NONRADIO SUBJECTS

- 535.38 M. J. Kelly. The Caesium-oxide-silver photo-electric cell. *Bell Lab. Record*, vol. 12, pp. 34-39; October, (1933).
The construction and use of photo-electric cells are discussed.
- 537.7 F. Eisner. Ein neues Verfahren zur Frequenzanalyse und seine Anwendung zur Untersuchung von Flugzeuggeräuschen. (A new method of frequency analysis and its use for the investigation of airplane noises.) *Hochfrequenz. und. Elektroakustik*, vol. 42, pp. 53-64; August, (1933).
A method is described for analyzing a periodic alternating voltage. The method consists in using a search tone of variable frequency which is used to generate a beat frequency between the noise and itself. The difference tone is impressed on a constant frequency tone and the second difference tone is very quickly damped out in a resonant circuit of very narrow frequency range. Oscillograms of various motor noises are shown. Several references are given.
- 538.11 I. J. Saxl. Magnetostriction oscillators. *Radio News*, vol. 15, pp. 275-276, 312; November, (1933).
A description of the principles and applications of magnetostriction.
- 621.313.7 D. D. Knowles and C. E. Haller. The phantom tester. *Electronics*, vol. 6, pp. 248-249; September, 1933.
A method of testing high power mercury vapor tubes is given.
- 621.375.1 F. L. Arnot. The measurement of critical potentials with a screened-grid valve. *Jour. Sci. Instr.* (London), 10, pp. 294-295; September, (1933).
Apparatus is described in which a screened-grid vacuum tube is used to determine critical potentials.
- 621.382.8 E. W. Smith. The characteristics of submarine telephone cables at carrier frequencies. *Jour. I. E. E.*, (London), vol. 73, pp. 213-232; September, (1933).
This article deals with the electrical characteristics of submarine cables designed to transmit carrier frequencies. The sphere of this branch of communication is outlined, and the general principles of operation and cable design are stated. The use of bridge networks to determine the characteristics of short lengths of cable, and of a completed laid cable, is described.



CONTRIBUTORS TO THIS ISSUE

Beers, G. L.: Born 1899 at Indiana, Pennsylvania. Received B.S. degree, Gettysburg College, 1921. Westinghouse graduate student course and engineering school, 1921-1922; radio engineering department, Westinghouse Electric and Manufacturing Company, in charge of superheterodyne receiver development, 1922-1930; research department, RCA Victor Company, 1930 to date. Associate member, Institute of Radio Engineers, 1927; Member, 1929.

Engstrom, E. W.: Born August 25, 1901, at Minneapolis, Minnesota. Received B.S. degree in electrical engineering, University of Minnesota, 1923. Radio engineering department, General Electric Company, 1923-1930; engineering department, RCA Victor Company, 1930 to date. Associate member, Institute of Radio Engineers, 1925.

Kell, R. D.: Born June 7, 1904, at Kell, Illinois. Received B.S. degree in electrical engineering, University of Illinois, 1926; postgraduate work, University of Illinois, 1926-1927. Assistant in Alexanderson's radio laboratory, Schenectady, 1927-1930; RCA Victor Company, 1930 to date. Nonmember, Institute of Radio Engineers.

Megaw, E. C. S.: Born January 19, 1908, at Dublin, Ireland. Received B.Sc. degree in electrical engineering, Queen's University, Belfast, 1928; Beit Scientific Research Fellow at City and Guilds (engineering) College, London, 1928-1930. Amateur radio, 1924-1930; transmitting valve group, research laboratories, General Electric Company, Wembley, England, 1930 to date. Associate member, Institute of Radio Engineers, 1929.

Model, S. I.: See PROCEEDINGS for January, 1933.

Rose, George M., Jr.: Born November 22, 1907, at Nashville, Tennessee. Received B.S. degree in electrical engineering, University of North Carolina, 1928. Research laboratory, General Electric Company, 1929-1930; vacuum tube engineering department, 1930-1931; research and development laboratory, RCA Radiotron Company, 1930 to date. Associate member, Institute of Radio Engineers, 1931.

Southworth, George C.: Born August 24, 1890, at Little Cooley, Pennsylvania. Received B.S. degree, 1914; M.S. degree, 1916, Grove City College; Ph.D. degree, Yale University, 1923. Assistant physicist, Bureau of Standards, 1917-1918. Instructor, Yale University, 1918-1923; research on radio communication, American Telephone and Telegraph Company, 1923 to date; De Forest (radio) lecturer, Yale University, 1927-1930. Member, American Physical Society, Washington Philosophical Society. Member, Institute of Radio Engineers, 1926.

Thompson, B. J.: See PROCEEDINGS for April, 1933.

Zworykin, Vladimir K.: Born 1889 in Russia. Received E.E. degree, Petrograd Institute of Technology. In 1912 entered the laboratory of the College de France, Paris, research in X-rays, working under Professor P. Langevin. During World War served in Russian Army as officer in Radio Corps. Research laboratory, Westinghouse Electric and Manufacturing Company, 1920 to date. Received Ph.D. degree, University of Pittsburgh, 1926. Since 1929 connected with research laboratory, RCA Victor Company, working on television, electron optics, photoelectric cells, and allied problems. Member, Institute of Radio Engineers, 1930.

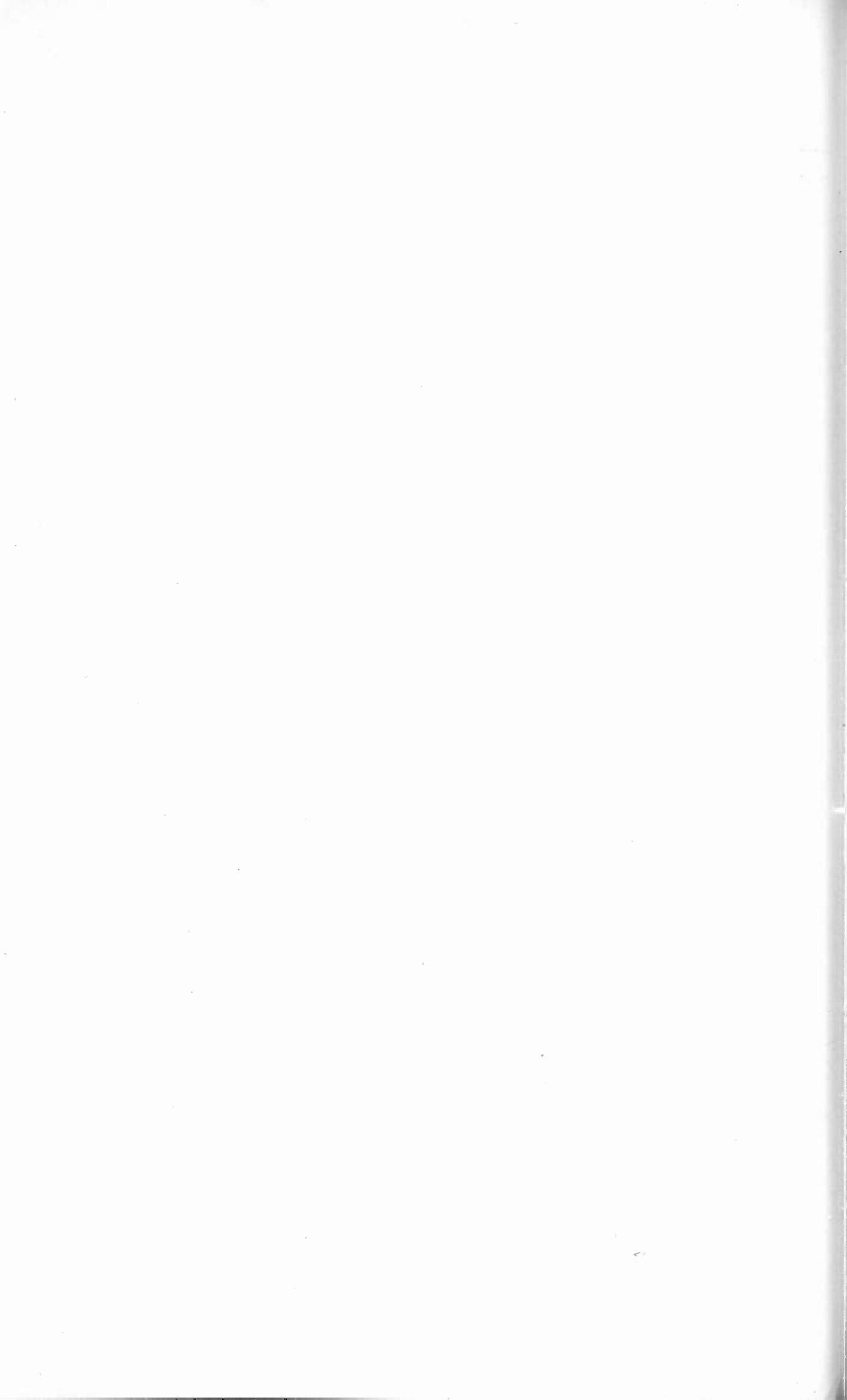

PROCEEDINGS
OF
THE INSTITUTE OF RADIO
ENGINEERS
(INCORPORATED)

VOLUME 21

1933



PUBLISHED MONTHLY BY
THE INSTITUTE OF RADIO ENGINEERS
(INC.)
33 WEST 39TH STREET, NEW YORK, N. Y.



CONTENTS OF VOLUME 21

1933

An Index covering the years 1909 through 1930 is available in pamphlet form, and may be obtained from the Institute at \$1.00 per copy. A very few copies of the 1931 Index, which was published in pamphlet form as a supplement to the January, 1932, issue of the PROCEEDINGS, are offered for distribution. The Index for 1932 is to be found in the December, 1932, issue of the PROCEEDINGS, following page 1986.

The Index for 1933 is a continuation of the previous ones. It is numbered chronologically, and the numbers at the left of the titles are keys for use in referring to it from the Authors Index and the Cross Index.

NUMBER 1; JANUARY, 1933

PART I

| | <i>Page</i> |
|---|-------------|
| Frontispiece, Officers of Cincinnati Section, 1932..... | 2 |
| Institute News and Radio Notes..... | 3 |
| December Meeting of the Board of Directors..... | 3 |
| Rochester Fall Meeting..... | 3 |
| Radio Transmissions of Standard Frequencies..... | 4 |
| Committee Work..... | 5 |
| Institute Meetings..... | 6 |
| Personal Mention..... | 11 |

PART II

Technical Papers

| | <i>Year</i> | <i>Page</i> |
|--|-------------|-------------|
| 1043. An Oscillator Having a Linear Operating Characteristic.... | 1933 | 14 |
| L. B. Arguimbau (Jan.) | | |
| 1044. Measurement of the Frequency of Ultra-Radio Waves.... | 1933 | 29 |
| J. Barton Hoag (Jan.) | | |
| 1045. Frequency Doubling in a Triode Vacuum Tube Circuit.... | 1933 | 37 |
| Carl E. Smith (Jan.) | | |
| 1046. Modulation Frequencies in Visual Transmission..... | 1933 | 51 |
| Edwin Lee White (Jan.) | | |
| 1047. An Improvement in Vacuum Tube Voltmeters..... | 1933 | 56 |
| R. M. Somers (Jan.) | | |
| 1047. Transoceanic Reception of High-Frequency Telephone Sig- nals..... | 1933 | 63 |
| R. M. Morris and W. A. R. Brown (Jan.) | | |
| 1049. North Atlantic Ship-Shore Radiotelephone Transmission During 1930 and 1931..... | 1933 | 81 |
| Clifford N. Anderson (Jan.) | | |
| 1050. Short-Wave Transmission to South America..... | 1933 | 102 |
| C. R. Burrows and E. J. Howard (Jan.) | | |
| 1051. Transmission Curves of High-Frequency Networks..... | 1933 | 114 |
| S. J. Model (Jan.) | | |
| 1052. Equivalent Circuits of an Active Network..... | 1933 | 144 |
| J. G. Brainerd (Jan.) | | |
| 1053. Mutual Impedance of Two Skew Antenna Wires..... | 1933 | 154 |
| F. H. Murray (Jan.) | | |
| 1054. Book Review: Communication Engineering..... | 1933 | 159 |
| W. L. Everitt | | |
| Reviewed by F. W. Grover (Jan.) | | |
| 1055. Book Review: Radio Engineering..... | 1933 | 159 |
| F. E. Terman | | |
| Reviewed by H. M. Turner (Jan.) | | |

| | | | |
|-------|--|------|-----|
| 1056. | Book Review: Photocells and Their Applications (Second Edition)..... | 1933 | 160 |
| | V. K. Zworykin and E. D. Wilson Reviewed by W. C. White (Jan.) | | |
| 1057. | Book Review: Handbook of Chemistry and Physics, (Seventeenth Edition)..... | 1933 | 160 |
| | Reviewed by R. R. Ramsey (Jan.) | | |
| 1058. | Book Review: High Selectivity Tone-Corrected Receiving Circuits..... | 1933 | 161 |
| | F. M. Colebrook Reviewed by Harold A. Wheeler (Jan.) | | |
| | Booklets, Catalogs, and Pamphlets Received..... | 1933 | 161 |
| | Radio Abstracts and References..... | 1933 | 163 |
| | Contributors to this Issue..... | 1933 | 170 |

NUMBER 2; FEBRUARY, 1933

PART I

| | |
|--|-------------|
| | <i>Page</i> |
| Frontispiece..... | 174 |
| Institute News and Radio Notes..... | 175 |
| January Meeting of the Board of Directors..... | 175 |
| Institute Meetings..... | 177 |
| Personal Mention..... | 187 |

PART II

Technical Papers

| | | |
|--|-------------|-------------|
| | <i>Year</i> | <i>Page</i> |
| 1059. The Required Minimum Frequency Separation Between Carrier Waves of Broadcast Stations..... | 1933 | 193 |
| P. P. Eckersley (Feb.) | | |
| 1060. Low Power Radio Transmitters for Broadcasting..... | 1933 | 212 |
| A. W. Kishpaugh and R. E. Coram (Feb.) | | |
| 1061. Supervisory and Control Equipment for Audio-Frequency Amplifiers..... | 1933 | 228 |
| Harry Sohon (Feb.) | | |
| Discussion by A. F. Rose and H. Sohon (October, 1933)... | 1933 | 1497 |
| 1062. General Theory on the Propagation of Radio Waves in the Ionized Layer of the Upper Atmosphere..... | 1933 | 238 |
| Shogo Namba (Feb.) | | |
| 1063. Some Long-Distance Transmission Phenomena of Low-Frequency Waves..... | 1933 | 263 |
| Eitaro Yokoyama and Isao Tanimura (Feb.) | | |
| 1064. A practical Analysis of Parallel Resonance..... | 1933 | 271 |
| Reuben Lee (Feb.) | | |
| Discussion by W. J. Seeley and Reuben Lee (June, 1933)... | 1933 | 875 |
| 1065. Relations Between the Parameters of Coupled-Circuit Theory and Transducer Theory with Some Applications..... | 1933 | 282 |
| J. G. Brainerd (Feb.) | | |
| 1066. Graphical Methods for Problems Involving Radio-Frequency Transmission Lines..... | 1933 | 290 |
| Hans Roder (Feb.) | | |
| 1067. Ellipse Diagram of a Lecher Wire System..... | 1933 | 303 |
| Ataka Hikosaburo (Feb.) | | |
| 830. Discussion on "On the Amplitude of Driven Loud Speaker Cones," by M. J. O. Strutt (May, 1931)..... | 1933 | 312 |
| N. W. McLachlan and M. J. O. Strutt (Feb.) | | |
| 923. Discussion on "Historical Review of Ultra-Short-Wave Progress," by William H. Wenstrom (Jan. 1932)..... | 1933 | 315 |
| H. M. Dowsett and William H. Wenstrom (Feb.) | | |
| 860. Book Review: Thermionic Vacuum Tubes..... | 1933 | 317 |
| E. V. Appleton | | |
| Reviewed by B. E. Shackelford (Feb.) | | |

| | | | |
|-------|--|------|-----|
| 1069. | Book Review: Servicing Receivers by Means of Resistance Measurement..... | 1933 | 317 |
| | John F. Rider | | |
| | Reviewed by S. S. Kirby (Feb.) | | |
| | Booklets, Catalogs, and Pamphlets Received..... | 1933 | 318 |
| | Radio Abstracts and References..... | 1933 | 319 |
| | Contributors to this Issue..... | 1933 | 326 |

NUMBER 3; MARCH, 1933

PART I

| | <i>Page</i> |
|---|-------------|
| Frontispiece, Hubert M. Turner, Director, 1933..... | 330 |
| Institute News and Radio Notes..... | 331 |
| February Meeting of the Board of Directors..... | 331 |
| Radio Transmissions of Standard Frequencies..... | 337 |
| Committee Work..... | 339 |
| Institute Meetings..... | 339 |
| Personal Mention..... | 346 |

PART II

Technical Papers

| | <i>Year</i> | <i>Page</i> |
|---|-------------|-------------|
| 1070. A Study of the Propagation of Wavelengths Between Three and Eight Meters..... | 1933 | 349 |
| L. F. Jones (March) | | |
| 1071. Notes on Propagation of Waves Below Ten Meters in Length..... | 1933 | 387 |
| Bertram Trevor and P. S. Carter (March) | | |
| 1072. Ultra-Short-Wave Propagation..... | 1933 | 427 |
| J. C. Schelleng, C. R. Burrows and E. B. Ferrel (March) | | |
| 1073. Some Results of a Study of Ultra-Short-Wave Transmission Phenomena..... | 1933 | 464 |
| C. R. Englund, A. B. Crawford, and W. M. Mumford (March) | | |
| 1074. Book Review: The True Road to Radio..... | 1933 | 493 |
| Albert Hall | | |
| Reviewed by S. S. Kirby (March) | | |
| Booklets, Catalogs, and Pamphlets Received..... | 1933 | 494 |
| Radio Abstracts and References..... | 1933 | 495 |
| Contributors to this Issue..... | 1933 | 502 |

NUMBER 4; APRIL, 1933

PART I

| | <i>Page</i> |
|--|-------------|
| Frontispiece, F. A. Kolster, Director, 1933..... | 506 |
| Institute News and Radio Notes..... | 507 |
| March Meeting of the Board of Directors..... | 507 |
| Report of the Secretary for 1932..... | 508 |
| Radio Transmissions of Standard Frequencies..... | 516 |
| Annual Meeting of the U.R.S.I..... | 517 |
| Committee Work..... | 517 |
| Institute Meetings..... | 519 |
| Personal Mention..... | 527 |

PART II

Technical Papers

| | <i>Year</i> | <i>Page</i> |
|---|-------------|-------------|
| 1075. Continuous Kennelly-Heaviside Layer Records of a Solar Eclipse..... | 1933 | 529 |
| H. R. Mimno and P. H. Wang (April) | | |

| | | | |
|-------|---|------|-----|
| 1076. | Observations of the Effective Height of the Kennelly-Heaviside Layer and Field Intensity During the Solar Eclipse of August 31, 1932..... | 1933 | 546 |
| | G. W. Kenrick and G. W. Pickard (April) | | |
| 1077. | Observations in Transmission During the Solar Eclipse of August 31, 1932..... | 1933 | 567 |
| | John R. Martin and S. W. McCuskey (April) | | |
| 1078. | Experiments on Electromagnetic Shielding at Frequencies Between One and Thirty Kilocycles..... | 1933 | 574 |
| | Walter Lyons (April) | | |
| 1079. | Graphical Determination of Performance of Push-Pull Audio Amplifiers..... | 1933 | 591 |
| | B. J. Thompson (April) | | |
| 1080. | Theory of the Detection of Two Modulated Waves by a Linear Rectifier..... | 1933 | 601 |
| | Charles B. Aiken (April) | | |
| 978. | Discussion on "Some Notes on Grid Circuit and Diode Rectification," by F. E. Terman and J. R. Nelson (June, 1932; Dec., 1932)..... | 1933 | 630 |
| | Fred G. Kelly (April) | | |
| 1081. | Book Review: Radio Engineering Handbook..... | 1933 | 631 |
| | Keith Henney and Twenty-Two Collaborators Reviewed by R. R. Batcher (April) | | |
| 1082. | Book Review: Report of the Radio Research Board for the Year 1931..... | 1933 | 631 |
| | Reviewed by S. S. Kirby (April) | | |
| 1083. | Book Review: Acoustics and Architecture..... | 1933 | 632 |
| | Paul E. Sabine Reviewed by Frank Massa (April) | | |
| | Radio Abstracts and References..... | 1933 | 634 |
| | Contributors to this Issue..... | 1933 | 640 |

NUMBER 5; MAY, 1933

PART I

| | <i>Page</i> |
|---|-------------|
| Frontispiece, Electrical Group at Chicago Exposition..... | 644 |
| Institute News and Radio Notes..... | 645 |
| April Meeting of the Board of Directors..... | 645 |
| 1933 Standards Report Notice..... | 645 |
| Committee Work..... | 645 |
| Institute Meetings..... | 646 |
| Personal Mention..... | 653 |

PART II

Technical Papers

| | <i>Year</i> | <i>Page</i> |
|--|-------------|-------------|
| 1084. On the Collection of Sound in Reverberant Rooms, with Special Reference to the Application of the Ribbon Microphone..... | 1933 | 655 |
| Harry F. Olson (May) | | |
| 1085. A High-Quality Ribbon Receiver..... | 1933 | 673 |
| Harry F. Olson and Frank Massa (May) | | |
| 1086. Permissible Amplitude Distortion of Speech in an Audio Reproducing System..... | 1933 | 682 |
| Frank Massa (May) | | |
| 1087. Ferro-Inductors and Permeability Tuning..... | 1933 | 690 |
| W. J. Polydoroff (May) | | |
| 1088. The Spray Shield Tube..... | 1933 | 710 |
| H. W. Parker and F. J. Fox (May) | | |
| 1089. Cyclones, Anticyclones, and the Kennelly-Heaviside Layer..... | 1933 | 721 |
| Robert Cameron Colwell (May) | | |

| | | | |
|-------|--|------|-----|
| 1016. | Discussion on "A Fourier Analysis of Radio-Frequency Power Amplifier Wave Forms," by L. B. Hallman, Jr. (Oct. 1932)..... | 1933 | 726 |
| | F. E. Terman and L. B. Hallman, Jr. (May) | | |
| | Booklets, Catalogs, and Pamphlets Received..... | 1933 | 732 |
| | Radio Abstracts and References..... | 1933 | 733 |
| | Contributors to this Issue..... | 1933 | 740 |

NUMBER 6; JUNE, 1933

PART I

| | <i>Page</i> |
|--|-------------|
| Condensed Program of Eighth Annual Convention..... | Cover II |
| Frontispiece, Bal Tabarin..... | 742 |
| Institute News and Radio Notes..... | 743 |
| Eighth Annual Convention..... | 743 |
| May Meeting of the Board of Directors..... | 761 |
| Election Notice..... | 762 |

PART II

Technical Papers

| | <i>Year</i> | <i>Page</i> |
|--|-------------|-------------|
| 1090. The Optical Behavior of the Ground for Short Radio Waves. C. B. Feldman (June) | 1933 | 764 |
| 1091. A Radio Range Beacon Free From Night Effects..... H. A. Chinn (June) | 1933 | 802 |
| 1092. On the Solution of the Problem of Night Effects with the Radio Range Beacon System..... H. Diamond (June) | 1933 | 808 |
| 1093. Theoretical Notes on Certain Features of Television Re- ceiving Circuits..... G. D. Robinson (June) | 1933 | 833 |
| 1094. Dynamic Measurement of Electron Tube Coefficients.... W. N. Tuttle (June) | 1933 | 844 |
| 1095. Class B Amplifiers Considered from the Conventional Class A Standpoint..... J. R. Nelson (June) | 1933 | 858 |
| 1064. Discussion on "A Practical Analysis of Parallel Resonance," by Reuben Lee (Feb., 1933)..... W. J. Seeley and Reuben Lee (June) | 1933 | 875 |
| 1096. Book Review: Handbook 17. Code for Protection Against Lightning..... U. S. Department of Commerce Reviewed by H. H. Beverage (June) | 1933 | 877 |
| 1097. Book Review: Modern Connectors for Timber Construc- tion..... U. S. Department of Commerce Reviewed by T. A. M. Craven (June) | 1933 | 877 |
| Radio Abstracts and References..... | 1933 | 878 |
| Contributors to this Issue..... | 1933 | 883 |

NUMBER 7; JULY, 1933

PART I

| | <i>Page</i> |
|--|-------------|
| Frontispiece, E. R. Shute, Director, 1933..... | 886 |
| Institute News and Radio Notes..... | 887 |
| June Meeting of the Board of Directors..... | 887 |
| Radio Transmissions of Standard Frequencies..... | 888 |
| Committee Work..... | 889 |
| Institute Meetings..... | 890 |
| Personal Mention..... | 905 |

PART II

Technical Papers

| | <i>Year</i> | <i>Page</i> |
|---|-------------|-------------|
| 1098. A Theory of Available Output and Optimum Operating Conditions for Triode Valves..... | 1933 | 909 |
| M. V. Callendar (July) | | |
| 1099. Diode Detection Analysis..... | 1933 | 930 |
| C. E. Kilgour and J. M. Glessner (July) | | |
| 1100. Application of Transformer Coupled Modulators..... | 1933 | 944 |
| J. A. Hutcheson (July) | | |
| 1101. The Interdependence of Frequency Variation and Harmonic Content, and the Problem of Constant-Frequency Oscillators..... | 1933 | 958 |
| Janusz Groszkowski (July) | | |
| 1102. A Simplified Frequency Dividing Circuit..... | 1933 | 982 |
| Victor J. Andrew (July) | | |
| 1103. An Analysis of Power Detection..... | 1933 | 984 |
| Rinaldo De Cola (July) | | |
| 1104. Modes of Vibration of Piezo-Electric Crystals..... | 1933 | 990 |
| N. H. Williams (July) | | |
| 1105. Propagation of Waves of 150 to 2000 Kilocycles per Second (2000 to 150 Meters) at Distances Between 50 and 2000 Kilometers..... | 1933 | 996 |
| Balth. van der Pol, T. L. Eckersley, J. H. Dellinger and P. le Corbeiller (July) | | |
| 1106. A Method of Calculation of Field Strengths in High-Frequency Radio Transmission..... | 1933 | 1003 |
| Shogo Namba and Taro Tsukada (July) | | |
| 1107. A Note on Nonlinearity in Transducers Used in Communication..... | 1933 | 1029 |
| Peter Caporale (July) | | |
| 1108. Tables for the Calculation of the Mutual Inductance of Any Two Coaxial Single-Layer Coils..... | 1933 | 1039 |
| Frederick W. Grover (July) | | |
| 1109. Some General Resonance Relations and a Discussion of Thevenin's Theorem..... | 1933 | 1050 |
| 1110. Book Review: Short-Wave Wireless Communication..... | 1933 | 1055 |
| A. W. Ladner and C. R. Stoner Reviewed by Isabel S. Bemis (July) | | |
| J. G. Brainerd (July) | | |
| 1111. Book Review: Annual Tables of Constants and Numerical Data..... | 1933 | 1057 |
| R. Mesny Reviewed by L. E. Whittemore (July) | | |
| 1112. Book Review: Standards Year Book, 1933..... | 1933 | 1056 |
| U. S. Department of Commerce, Bureau of Standards Reviewed by L. E. Whittemore (July) | | |
| Booklets, Catalogs, and Pamphlets Received..... | 1933 | 1056 |
| Radio Abstracts and References..... | 1933 | 1058 |
| Contributors to this Issue..... | 1933 | 1064 |

NUMBER 8; AUGUST, 1933

PART I

| | <i>Page</i> |
|--|-------------|
| Frontispiece, Harold De Forest Arnold..... | 1068 |
| Institute News and Radio Notes..... | 1069 |
| Eighth Annual Convention..... | 1069 |
| Radio Transmissions of Standard Frequencies..... | 1069 |
| Institute Meetings..... | 1071 |

PART II

Technical Papers

| | <i>Year</i> | <i>Page</i> |
|---|-------------|-------------|
| 1113. The Application of Graphite as an Anode Material to High Vacuum Transmitting Tubes..... E. E. Spitzer (August) | 1933 | 1075 |
| 1114. Vacuum Tube Characteristics in the Positive Grid Region by an Oscillographic Method..... H. N. Kozanowski and I. E. Mouromtseff (August) | 1933 | 1082 |
| 1115. A Life Power Supply Utilizing Thyration Rectifiers..... H. W. Lord (August) | 1933 | 1097 |
| 1116. The Limiting Polarization of Downcoming Radio Waves Traveling Obliquely to the Earth's Magnetic Field... W. G. Baker and A. L. Green (August) | 1933 | 1103 |
| 1117. A Note on the Theory of the Magnetron Oscillator..... J. Barton Hoag (August) | 1933 | 1132 |
| 1118. Determination of Grid Driving Power in Radio-Frequency Power Amplifiers..... H. P. Thomas (August) | 1933 | 1134 |
| 1119. Amplitude Characteristics of Coupled Circuits Having Distributed Constants..... Ronold King (August) | 1933 | 1142 |
| 1120. Frequency Modulation and the Effects of a Periodic Capacity Variation in a Nondissipative Oscillatory Circuit..... W. L. Barrow (August) | 1933 | 1182 |
| 1121. Modulation Products in a Power Law Modulator..... A. G. Tynan (August) | 1933 | 1203 |
| 1122. A Method for Calculating Transmission Properties of Electrical Networks Consisting of a Number of Sections... A. Alford (August) | 1933 | 1210 |
| 1123. Book Review: Theory of Thermionic Vacuum Tubes..... E. L. Chaffee Reviewed by J. C. Warner (August) | 1933 | 1221 |
| 1124. Book Review: Radio International..... Ernst A. Pariser Reviewed by J. A. Sohon (August) | 1933 | 1222 |
| 1125. Book Review: An Appraisal of Radio Broadcasting in the Land-Grant Colleges and State Universities..... Tracy Ferris Tyler Reviewed by W. G. Cady (August) | 1933 | 1222 |
| Booklets, Catalogs, and Pamphlets Received..... | 1933 | 1224 |
| Radio Abstracts and References..... | 1933 | 1225 |
| Contributors to this Issue..... | 1933 | 1230 |

NUMBER 9; SEPTEMBER, 1933

PART I

| | <i>Page</i> |
|---|-------------|
| Institute News and Radio Notes..... | 1233 |
| The Relation of Engineering to the Radio Industrial Code..... | 1233 |
| Institute Meetings..... | 1234 |
| Personal Mention..... | 1236 |
| 1051. Errata to "Transmission Curves of High-Frequency Networks," by S. J. Model (Jan., 1933)..... | 1238 |

PART II

Technical Papers

| | <i>Year</i> | <i>Page</i> |
|--|-------------|-------------|
| 1126. The Radio Patrol System of the City of New York..... F. W. Cunningham and T. W. Rochester (Sept.) | 1933 | 1239 |

| | | | |
|-------|---|------|------|
| 1127. | An Outline of the Action of a Tone Corrected Highly Selective Receiver | 1933 | 1252 |
| | E. B. Moullin (Sept.) | | |
| 1128. | A Study of Reception from Synchronized Broadcast Stations | 1933 | 1265 |
| | Charles B. Aiken (Sept.) | | |
| 1129. | Some Characteristics of Ultra-High-Frequency Transmission | 1933 | 1302 |
| | Henry Muyskens and John D. Kraus (Sept.) | | |
| 1130. | Notes on Television Definition | 1933 | 1317 |
| | William H. Wenstrom (Sept.) | | |
| 1131. | A Magnetostriction Filter | 1933 | 1328 |
| | Harry H. Hall (Sept.) | | |
| 1132. | Properties of Mycalex | 1933 | 1339 |
| | W. W. Brown (Sept.) | | |
| 1133. | Radiation Resistance of Concentric Conductor Transmission Lines | 1933 | 1343 |
| | Robert Whitmer (Sept.) | | |
| 1134. | Low-Frequency Radio Receiving Measurements at the Bureau of Standards in 1931 and 1932 | 1933 | 1354 |
| | E. B. Judson (Sept.) | | |
| 1135. | Note on a Modified Reactance-Frequency Chart | 1933 | 1364 |
| | J. R. Tolmie (Sept.) | | |
| 1031. | Discussion of "Pittsburgh's Contributions to Radio," by S. M. Kintner (Dec., 1932) | 1933 | 1367 |
| | H. S. Gowan (Sept.) | | |
| 869. | Correction to "On the Calculation of Radiation Resistance of Antennas and Antenna Combinations," by Rudolf Bechmann (Aug. 1931) | 1933 | 1367 |
| 1136. | Book Review: Elements of Engineering Acoustics | 1933 | 1368 |
| | L. E. C. Hughes Reviewed by Benjamin Olney (Sept.) | | |
| 1137. | Book Review: Vector Analysis | 1933 | 1368 |
| | H. B. Phillips Reviewed by F. W. Grover (Sept.) | | |
| 1138. | Book Review: Wireless Receivers | 1933 | 1369 |
| | C. E. Oatley Reviewed by Harold A. Wheeler (Sept.) | | |
| 1139. | Book Review: Mesures Radio-Electriques Elementaries, | 1933 | 1369 |
| | F. Dacos and M. Rousseau Reviewed by L. P. Wheeler (Sept.) | | |
| | Booklets, Catalogs, and Pamphlets Received | 1933 | 1371 |
| | Radio Abstracts and References | 1933 | 1372 |
| | Contributors to this Issue | 1933 | 1381 |

NUMBER 10; OCTOBER, 1933

PART I

| | |
|---|-------------|
| | <i>Page</i> |
| Institute News and Radio Notes | 1383 |
| September Meeting of the Board of Directors | 1383 |
| Radio Transmissions of Standard Frequencies | 1384 |
| Committee Work | 1385 |
| Personal Mention | 1386 |

PART II

Technical Papers

| | | |
|---|-------------|-------------|
| | <i>Year</i> | <i>Page</i> |
| 1140. Electrical Disturbances Apparently of Extraterrestrial Origin | 1933 | 1387 |
| Karl G. Jansky (Oct.) | | |

| | | | |
|-------|--|------|------|
| 1141. | A Piezo-Electric Loud Speaker for the Higher Audio Frequencies..... | 1933 | 1399 |
| | Stuart Ballantine (Oct.) | | |
| 1142. | A Compact, Alternating-Current Operated Speech Input Equipment..... | 1933 | 1409 |
| | W. L. Black (Oct.) | | |
| 1143. | Report of Committee on Radio Propagation Data..... | 1933 | 1419 |
| 1144. | The Calculation of Harmonic Production in Thermionic Valves with Resistive Loads..... | 1933 | 1439 |
| | D. C. Espley (Oct.) | | |
| 1145. | Attenuation of Overland Radio Transmission in the Frequency Range 1.5 to 3.5 Megacycles per Second..... | 1933 | 1447 |
| | C. N. Anderson (Oct.) | | |
| 1146. | Continuous Measurements of the Virtual Heights of the Ionosphere..... | 1933 | 1463 |
| | T. R. Gilliland (Oct.) | | |
| 1147. | Audio-Frequency Atmosphericics..... | 1933 | 1476 |
| | E. T. Burton and E. M. Boardman (Oct.) | | |
| 1148. | Note on New Methods to Modulate Light..... | 1933 | 1495 |
| | G. Wataghin and R. Deaglio (Oct.) | | |
| 1061. | Discussion on "Supervisory and Control Equipment for Audio-Frequency Amplifiers," by Harry Sohon (Feb., 1933)..... | 1933 | 1497 |
| | A. F. Rose and H. Sohon (Oct.) | | |
| 1149. | Book Review: Network Synthesis..... | 1933 | 1498 |
| | Charles M. Son Gewertz Reviewed by F. W. Grover (Oct.) | | |
| 1150. | Book Review: Télévision et Transmission des Images..... | 1933 | 1498 |
| | René Mesny Reviewed by Madison Cawein (Oct.) | | |
| | Radio Abstracts and References..... | 1933 | 1500 |
| | Contributors to this Issue..... | 1933 | 1511 |

NUMBER 11; NOVEMBER, 1933

PART I

| | |
|--|-------------|
| | <i>Page</i> |
| Institute News and Radio Notes..... | 1513 |
| October Meeting of The Board of Directors..... | 1513 |
| Rochester Fall Meeting..... | 1513 |
| Committee Work..... | 1514 |
| Institute Meetings..... | 1515 |

PART II

Technical Papers

| | | |
|-------|---|-------------|
| | <i>Year</i> | <i>Page</i> |
| 1151. | A New Field of Application for Ultra-Short Waves..... | 1933 1519 |
| | Ernst Kramer (Nov.) | |
| 1152. | Vacuum Tube Electronics at Ultra-High Frequencies.... | 1933 1532 |
| | F. B. Llewellyn (Nov.) | |
| 1153. | Some Aspects of Radio Law..... | 1933 1574 |
| | J. Warren Wright (Nov.) | |
| 1154. | Radiation and Induction..... | 1933 1585 |
| | R. R. Ramsey (Nov.) | |
| 1155. | Superregenerative Wave Meter for Ultra-Short Waves... | 1933 1590 |
| | H. Ataka (Nov.) | |
| 1156. | On the Production of Ultra-Short-Wave Oscillation with Cold-Cathode Discharge Tube..... | 1933 1593 |
| | Kinjiro Okabe (Nov.) | |
| 1157. | A Projector Type Light Flux Generator for Testing Light Sensitive Devices..... | 1933 1599 |
| | E. B. Kurtz and J. L. Potter (Nov.) | |

| | | | |
|-------|---|------|------|
| 1158. | A Note on the Simple Two-Element Low-Pass Filter of Two and Three Sections..... | 1933 | 1603 |
| | L. B. Hallman, Jr. (Nov.) | | |
| 1029. | Discussion on "Linearly Tapered Loaded Transmission Lines," by J. W. Arnold and R. C. Taylor (Nov., 1932) | 1933 | 1609 |
| | A. T. Starr (Nov.) | | |
| | Radio Abstracts and References..... | 1933 | 1610 |
| | Contributors to this Issue..... | 1933 | 1619 |

NUMBER 12; DECEMBER, 1933

PART I

| | | |
|---|--|-------------|
| | | <i>Page</i> |
| Institute News and Radio Notes..... | | 1621 |
| November Meeting of the Board of Directors..... | | 1621 |
| Committee Work..... | | 1622 |
| Radio Transmission of Standard Frequencies..... | | 1622 |
| Institute meetings..... | | 1624 |
| Personal Mention..... | | 1626 |

PART II

Technical Papers

| | | | |
|-------|---|------|------|
| 1159. | A Study of Television Image Characteristics..... | 1933 | 1631 |
| | E. W. Engstrom (Dec.) | | |
| 1160. | An Experimental Television System..... | 1933 | 1652 |
| | E. W. Engstrom (Dec.) | | |
| 1161. | Description of an Experimental Television System and the Kinescope..... | 1933 | 1655 |
| | V. K. Zworykin (Dec.) | | |
| 1162. | Description of Experimental Television Transmitting Apparatus..... | 1933 | 1674 |
| | R. D. Kell (Dec.) | | |
| 1163. | Description of Experimental Television Receivers..... | 1933 | 1692 |
| | G. L. Beers (Dec.) | | |
| 1164. | Vacuum Tubes of Small Dimensions for Use at Extremely High Frequencies..... | 1933 | 1707 |
| | B. J. Thompson and G. M. Rose, Jr. (Dec.) | | |
| 1165. | Operation of Tube Oscillators on a Common Load..... | 1933 | 1722 |
| | S. I. Model (Dec.) | | |
| 1166. | Some Earth Potential Measurements Being Made in Connection with the International Polar Year..... | 1933 | 1740 |
| | G. C. Southworth (Dec.) | | |
| 1167. | Note on the Theory of the Magnetron Oscillator..... | 1933 | 1749 |
| | E. C. S. Megaw (Dec.) | | |
| 1168. | Book Review: Die Kathodenstrahlröhre und ihre Anwendung in der Schwachstromtechnik..... | 1933 | 1752 |
| | Manfred von Ardenne | | |
| | Reviewed by L. P. Wheeler (Dec.) | | |
| | Booklets, Catalogs, and Pamphlets Received..... | 1933 | 1753 |
| | Radio Abstracts and References..... | 1933 | 1754 |
| | Contributors to this Issue..... | 1933 | 1763 |

AUTHOR INDEX

Numbers refer to the chronological list. Bold-face type indicates papers, light-face type indicates discussions, and italics refer to book reviews.

A

Aiken, Charles B., 1080, 1128
Alford, Andrew, 1122
Anderson, Clifford N., 1049, 1145
Andrew, Victor J., 1102
Arguimbau, L. B., 1043
Ataka, Hikosaburo, 1067, 1155

B

Baker, W. G., 1116
Ballantine, Stuart, 1141
Barrow, W. L., 1120
Batcher, R. R., 1081
Bechmann, Rudolf, 869
Beers, G. L., 1163
Bemis, Isabel S., 1110
Beverage, H. H., 1096
Black, W. L., 1142
Boardman, E. M., 1147
Brainerd, J. G., 1052, 1065, 1109
Brown, W. A. R., 1048
Brown, W. W., 1132
Burrows, C. R., 1050, 1072
Burton, E. T., 1147

C

Cady, W. G., 1125
Callendar, M. V., 1098
Caporale, Peter, 1107
Carter, P. S., 1071
Cawein, Madison, 1150
Chinn, H. A., 1091
Colwell, Robert C., 1089
Coram, R. E., 1060
Craven, T. A. M., 1097
Crawford, A. B., 1073
Cunningham, F. W., 1126

D

Deaglio, R., 1148
De Cola, Rinaldo, 1103
Dellinger, J. H., 1105
Diamond, Harry, 1092
Dowsett, H. M., 923

E

Eckersley, P. P., 1059
Eckersley, T. L., 1105
Englund, C. R., 1073
Engstrom, E. W., 1159, 1160
Espley, D. C., 1144

F

Feldman, C. B., 1090
Ferrell, E. B., 1072
Fox, F. J., 1088

G

Gilliland, T. R., 1146
Glessner, J. M., 1099
Gowan, H. S., 1031
Green, A. L., 1116
Groszkowski, Janusz, 1101
Grover, F. W., 1054, 1108, 1137, 1149

H

Hall, Harry H., 1131
Hallman, L. B., Jr., 1016, 1158
Hikosaburo, Ataka, 1067, 1155
Hoag, J. B., 1044, 1117
Howard, E. J., 1050
Hutcheson, J. A., 1100

J

Jansky, Karl G., 1140
Jones, L. F., 1070
Judson, E. B., 1134

K

Kell, R. D., 1162
Kelly, Fred G., 978
Kenrick, G. W., 1076
Kilgour, C. E., 1099
King, Ronold, 1119
Kirby, S. S., 1069, 1074, 1082
Kispaugh, A. W., 1060
Kozanowski, H. N., 1114
Kramer, Ernst, 1151
Kraus, John D., 1129
Kurtz, E. B., 1157

L

Le Corbieller, P., 1105
Lee, Reuben, 1064
Llewellyn, F. B., 1152
Lord, H. W., 1115
Lyons, Walter, 1078

M

Martin, John R., 1077
Massa, Frank, 1083, 1085, 1086
McCuskey, S. W., 1077
McLachlan, N. W., 830
Megaw, E. C. S., 1167
Minmo, H. R., 1075
Model, S. J., 1051, 1065
Morris, R. M., 1048
Moullin, E. B., 1127
Mouromtseff, I. E., 1114
Mumford, W. M., 1073
Murray, F. H., 1053
Muyskens, Henry, 1129

N

Namba, Shogo, 1062, 1106
Nelson, J. R., 1095

O

Okabe, Kinjiro, 1156
Olney, Benjamin, 1136
Olson, Harry F., 1084, 1085

P

Parker, H. W., 1088
Pickard, G. W., 1076
Polydoroff, W. J., 1087
Potter, J. L., 1157

R

Ramsey, R. R., 1057, 1154
Robinson, G. D., 1093
Rochester, T. W., 1126
Roder, Hans, 1066
Rose, A. F., 1061
Rose, G. M., Jr., 1164

S

Schelleng, J. C., 1072
Seeley, W. J., 1064
Shackleford, B. E., 1068
Smith, Carl E., 1045
Sohon, Harry, 1061
Sohon, J. A., 1124
Somers, R. M., 1047
Southworth, G. C., 1166
Spitzer, E. E., 1113
Starr, A. T., 1029
Strutt, M. J. O., 830

T

Tanimura, Isao, 1063
Terman, F. E., 1016
Thomas, H. P., 1118
Thompson, B. J., 1079, 1164
Tolmie, J. R., 1135
Trevor, Bertram, 1071
Tsukada, Taro, 1106
Turner, H. M., 1055
Tuttle, W. N., 1094
Tynan, A. G., 1121

V

van der Pol, Balth., 1105

W

Wang, P. H., 1075
Warner, J. C., 1123
Wataghin, G., 1148
Wenstrom, W. H., 923, 1130
Wheeler, H. A., 1058, 1138
Wheeler, L. P., 1139, 1168
White, E. L., 1046
White, W. C., 1056
Whitmer, Robert, 1133
Whittemore, L. E., 1111, 1112
Williams, N. H., 1104
Wright, J. Warren, 1153

Y

Yokoyama, Eitaro, 1063

Z

Zworykin, V. K., 1161

SUBJECT INDEX

A

- Aircraft Radio:
Range Beacon Free from Night Effects: 1091, 1092
- Amplifier:
Class B from Class A Standpoint: 1095
Discussion on Analysis Radio-Frequency Power, Wave Forms: 1016
Discussion on Supervisory and Control Equipment for Audio-Frequency: 1061
Grid Driving Power for Radio-Frequency: 1118
Performance of Push-Pull Audio: 1079
Supervisory and Control Equipment for Audio: 1061
- Amplitude Characteristics of Coupled Circuits Having Distributed Constants: 1119
- Amplitude Distortion:
Audio Reproducing Systems: 1086
- Antenna:
Mutual Impedance of Wires: 1053
- Antenna Resistance Calculation, Correction: 869
- Anticyclones and Kennelly-Heaviside Layer: 1089
- Atmospherics:
Audio-Frequency: 1147
- Attenuation:
Transmission on 1.5 to 3.5 Mc: 1145
- Audio-Frequency:
Piezo-Electric Loud Speaker for Higher: 1141
- Audio-Frequency Amplifiers:
Class B from Class A Standpoint: 1095
Performance of Push-Pull: 1079
Supervisory and Control Equipment for: 1061
- Audio-Frequency Atmospherics: 1147

B

- Book Reviews:
Acoustics and Architecture, by P. E. Sabine, (reviewed by Frank Massa): 1083
An Appraisal of Radio Broadcasting in the Land-Grant Colleges and State Universities, by T. F. Tyler, (reviewed by W. G. Cady): 1125
Annual Table of Constants and Numerical Data, by R. Mesny, (reviewed by L. E. Whittemore): 1111

- Communication Engineering, by W. L. Everitt, (reviewed by F. W. Grover): 1054
- Die Kathodenstrahlröhre und ihre Anwendung in der Schwachstromtechnik, by Manfred von Ardenne, (reviewed by L. P. Wheeler): 1168
- Elements of Engineering Acoustics, by L. E. C. Hughes, (reviewed by Benjamin Olney): 1136
- Handbook 16. Code for Protection Against Lightning, by U. S. Department of Commerce, (reviewed by H. H. Beverage): 1096
- Handbook of Chemistry and Physics (Seventeenth Edition), (reviewed by R. R. Ramsey): 1057
- High Selectivity Tone-Corrected Receiving Circuits, by F. M. Colebrook, (reviewed by H. A. Wheeler): 1058
- Mesures Radio-Electrique Elementaries, by F. Dacos and M. Rousseau, (reviewed by L. P. Wheeler): 1139
- Modern Connectors for Timber Construction, by U. S. Department of Commerce, (reviewed by T. A. M. Craven): 1097
- Network Synthesis, by C. M. Son Gewertz, (reviewed by F. W. Grover): 1149
- Photocells and Their Applications (Second Edition), by V. K. Zworykin and E. D. Wilson, (reviewed by W. C. White): 1056
- Radio Engineering, by F. E. Terman, (reviewed by H. M. Turner): 1055
- Radio Engineering Handbook, by Keith Henney, (reviewed by R. R. Batcher): 1081
- Radio International, by E. A. Pariser, (reviewed by J. A. Sohon): 1124
- Report of the Radio Research Board for the Year 1931, (reviewed by S. S. Kirby): 1082
- Servicing Receivers by Means of Resistance Measurement, by J. H. Rider, (reviewed by S. S. Kirby): 1069
- Short Wave Wireless Communication, by A. W. Ladner and C. R. Stoner, (reviewed by I. S. Bemis): 1110
- Standard Year Book, 1933, by U. S. Department of Commerce, (re-

viewed by L. E. Whittemore):
1112
Television et Transmission des
Images, by Rene Mesny, (re-
viewed by Madison Cawein):
1150
The True Road to Radio, by Albert
Hall, (reviewed by S. S. Kirby):
1074
Theory of Thermionic Vacuum
Tubes, by E. L. Chaffee, (re-
viewed by J. C. Warner): 1123
Thermionic Vacuum Tubes, by E.
V. Appleton, (reviewed by B. E.
Shackelford): 1068
Vector Analysis, by H. B. Phillips,
(reviewed by F. W. Grover): 1137
Wireless Receivers, by C. E. Oatley,
(reviewed by H. A. Wheeler):
1138
Broadcast Frequency Allocation:
Required Minimum Separation:
1059
Broadcasting:
Low Power Transmitters: 1060
Reception of Synchronized: 1128
Required Frequency Separation:
1059

C

Calculation of Radiation Resistance of
Antennas, Correction to: 869
Capacity Variation and Frequency
Modulation: 1120
Characteristics of Ultra High Fre-
quency Transmission: 1129
Circuit Analysis:
Calculating Transmission Proper-
ties of Electrical Networks: 1122
Coupled Circuits Having Distrib-
uted Constants: 1119
Diode Detection: 1099
Discussion on Parallel Resonance:
1064
Ellipse Diagram for Lecher Wire
System: 1066
Equivalent Circuit of Active Net-
work: 1052
Errata on Transmission Curves of
High Frequency Networks: 1051
Parallel Resonance: 1064
Resonance Relations and Thevenin's
Theorem: 1109
Circuit Theory:
Relations of Coupled, and Trans-
ducer Theory: 1065
Coil:
Calculation of Mutual Inductance:
1108
Concentric Conductor Transmission
Line: 1133
Coupled Circuits Having Distributed
Constants: 1119

Crystal Oscillators:
Modes of Vibration: 1104
Cyclones and Kennelly-Heaviside
Layer: 1089

D

Definition:
Television: 1130
Detection:
Diode Analysis: 1099
Power: 1103
Two Modulated Waves: 1080
Diode Detection Analysis: 1099
Diode Rectification:
Discussion on Grid and: 978
Distortion:
Audio Reproducing Systems: 1086
Disturbances:
Electrical of Extraterrestrial Origin:
1140
Dynamic Measurements of Tube Co-
efficients: 1094

E

Earth Potential Measurements: 1166
Eclipse:
Kennelly-Heaviside Layer Records
During Solar: 1075, 1076
Electrical Disturbances of Extrater-
restrial Origin: 1140
Electromagnetic Shielding:
For Frequencies Between one and
Thirty Kilocycles: 1078
Electronics:
Tube, at Ultra High Frequencies:
1152
Ellipse Diagram of Lecher Wire Sys-
tem: 1067

F

Ferro-Inductors and Permeability
Tuning: 1087
Field Intensity:
Calculation of High Frequency:
1106
During Solar Eclipse: 1076, 1077
Field Strength:
Calculation of High Frequency:
1106
Filter:
Calculation of Properties of Trans-
mission Networks: 1122
Magnetostriction: 1131
Two Elements Low Pass: 1158
Frequency:
Measurement: 1044
Simplified, Dividing Circuit: 1102
Variation, Harmonic Content and
Constant Frequency Oscillators:
1101
Frequency Changers:
Doubling in Triodes: 1045

Frequency Divider:
Simplified Circuit: 1102
Frequency Doubling:
In Triodes: 1045
Frequency Modulation:
and Effects of Capacity Variation:
1120
In Visual Transmission: 1046
Frequency-Reactance Chart: 1135
Frequency Separation:
Required Minimum for Broadcast-
ing: 1059

G

Generator:
Light, for Testing Light Sensitive
Devices: 1157
Graphite Anodes for Tubes: 1113
Grid Rectification:
Discussion on Diode and: 978

H

Harmonics:
Frequency Variation, and Constant
Frequency Oscillators: 1101
In Tubes With Resistive Loads:
1144

I

Impedance:
Mutual of Antenna Wires: 1053
Inductance:
Calculation of Mutual: 1108
Ferro-Inductor: 1087
Induction and Radiation: 1154
Insulators:
Mycalex: 1132
International Polar Year Measure-
ments: 1166
Ionized Layer:
During Solar Eclipse: 1075, 1076
Propagation of Waves in, 1062
Ionosphere:
Continuous Measurements: 1146

K

Kennelly-Heaviside Layer:
Continuous Measurements: 1146
Cyclones and Anticyclones: 1089
During Solar Eclipse: 1075: 1076
Propagation of Waves in: 1062
Kinescope: 1161

L

Law:
Aspects of Radio: 1153
Lecher Wire:
Ellipse Diagram for: 1066
Life Test:
Power Supply Utilizing Thyratrons:
1115

Light:
Flux Generator for Testing Light
Sensitive Devices: 1157
Methods of Modulating: 1148
Linear Rectifier:
Detecting Two Modulated Waves:
1080
Linearly Tapered Loaded Transmis-
sion Lines, Discussion: 1029
Loud Speaker:
Discussion on Amplitude of Cones:
830
Piezo-Electric: 1141
Low-Pass Filter:
Two Element: 1158

M

Magnetrostriction Filter: 1131
Magnetron:
Theory on: 1117, 1167
Measurement:
Continuous Ionosphere: 1146
Low Frequency Receiving: 1134
Simplified Frequency Dividing Cir-
cuit: 1102
Tube Characteristics in Positive
Grid Region: 1114
Tube Coefficient Dynamic: 1094
Ultra-Radio Wave: 1044
Vacuum Tube Voltmeter: 1047
Microphones:
Sound and Ribbon: 1084
Modulation:
Frequencies in Visual Transmission:
1046
Frequency, and Effects of Capacity
Variation: 1120
Methods for Light: 1148
Products in Power Law Modulator:
1121
Transformer Coupled Modulators:
1100
Modulator:
Modulation Products in Power Law:
1121
Transformer Coupled: 1100
Mutual Inductance:
Calculation: 1108
Mycalex: 1132

N

Network Analysis:
(See Circuit Analysis)
Coupled-Circuit and Transducer
Theory: 1065
Diode Detection: 1099
Networks:
Equivalent Circuits of Active: 1052
Transmission of High-Frequency:
1051
Night Effects:
Range Beacon Free From: 1091,
1092

O

- Optical Behavior of Ground for Short Radio Waves: 1090
- Oscillations:
 - Ultra Short Wave, With Cold Cathode Tubes: 1156
- Oscillator:
 - Constant Frequency, and Frequency Variation and Harmonic Content: 1101
 - Effect of Capacity Variation: 1120
 - Frequency Modulation: 1120
 - Having Linear Operating Characteristic: 1049
 - Operation on Common Load: 1165
 - Theory on Magnetron: 1117, 1167
 - Vibration of Crystal: 1104
- Oscillographic Measurements:
 - Tube Characteristics in Positive Grid Region: 1114
- Output:
 - Operating Conditions and, for Triodes: 1098
- Overland Transmission:
 - Attenuation at 1.5 to 3.5 Mc: 1145

P

- Permeability Tuning and Ferro-Inductors: 1087
- Photocells:
 - Generator for Testing: 1157
- Piezo-Electric Crystal Oscillator:
 - Vibration of: 1104
- Piezo-Electric Loud Speaker: 1141
- Pittsburgh's Contribution to Radio, Discussion: 1031
- Polar Year Measurements: 1166
- Polarization:
 - Waves Traveling Obliquely to Earth's Magnetic Field: 1116
- Police Radio:
 - System for New York City: 1126
- Power:
 - Grid Driving for Radio-Frequency Amplifiers: 1118
- Power Detection:
 - Analysis: 1103
- Power Law Modulator: 1121
- Power Supply:
 - Life Test Using Thyratons: 1115
 - Oscillators Operated from Common: 1165
- Propagation:
 - Attenuation Between 1.5 and 3.5 Mc: 1145
 - Cyclones and Anticyclones: 1089
 - During Solar Eclipse: 1075, 1077
 - In Ionized Layer: 1062
 - Low-Frequency Waves: 1063
 - Optical Behavior of Ground: 1090
 - Polarization of Waves Traveling

- Obliquely to Earth's Magnetic Field: 1116
- Report of Committee: 1143
- Study of Waves Between Three and Eight Meters: 1070
- Ultra Short Waves: 1072, 1073
- Waves Below Ten Meters: 1071
- Waves Between 150 and 2000 Kilocycles: 1105
- Waves for Distances of 50 to 2000 Kilometers: 1105
- Push-Pull Amplifiers:
 - Performance of Audio: 1079

R

- Radiation and Induction: 1154
- Radiation Resistance:
 - Concentric Conductor Line: 1133
- Radio-Frequency Amplifiers:
 - Grid Driving Power: 1118
- Radio-Frequency Transmission Lines:
 - Graphical Method for Problems: 1066
- Radio Law:
 - Aspects: 1153
- Radio Patrol System for City of New York: 1126
- Radio Range Beacon Free From Night Effects: 1091, 1092
- Radio Systems:
 - Police: 1126
- Radiotelephone:
 - Ship-Shore Transmission: 1049
 - Transoceanic Reception: 1048
- Range Beacon:
 - Radio, Free From Night Effects: 1091, 1092
- Reactance-Frequency Chart: 1135
- Receiving Measurements:
 - Low Frequency: 1134
- Receiver:
 - Ribbon Telephone: 1085
 - Television: 1093, 1163
 - Tone Corrected Highly Selective: 1127
- Reception:
 - Synchronized Broadcast Stations: 1128
 - Transoceanic, High-Frequency Telephone: 1048
- Rectification:
 - Discussion on Grid and Diode: 978
- Rectifier:
 - Detecting Two Modulated Waves With Linear: 1080
 - Thyratrons, in Life Test Power Supply: 1115
- Resonance:
 - Analysis of Parallel: 1064
 - Discussion on Parallel: 1064
 - Some Relations and Thevenin's Theorem: 1109

Reverberance:
Sound and, Ribbon Microphone: 1084
Ribbon Telephone Receiver: 1085
Ribbon Microphone, Sound and: 1084

S

Shielding:
Electromagnetic, Between One and Thirty Kilocycles: 1078
Spray, Tubes: 1088
Ship-Shore Radiotelephone Transmission: 1049
Solar Eclipse:
Kennelly-Heaviside Layer Records: 1075, 1076
Sound:
Collection of, and Ribbon Microphone: 1084
Speech:
Distortion in Audio Systems: 1086
Speech Input Equipment:
A-C Operated: 1142
Spray-Shield Tube: 1088
Static:
Audio-Frequency: 1147
Disturbances of Extraterrestrial Origin: 1140
Superregeneration:
Wave Meter for Ultra Short Waves: 1155
Synchronized Broadcasting:
Reception of: 1128

T

Telephone:
Transoceanic Reception: 1048
Telephone Receiver:
Ribbon: 1085
Television:
Definition: 1130
Image Characteristics: 1159
Modulation Frequencies: 1046
Receiving Circuits: 1093, 1163
System: 1160, 1161
Transmitter: 1162
Testing:
Light Generator for Light Sensitive Devices: 1157
Thevenin's Theorem: 1109
Thyratrons:
Life Test Power Supply Utilizing: 1115
Tone Correction:
Action of, Highly Selective Receivers: 1027
Transducers:
Nonlinearity in: 1107
Transducer Theory and Coupled Circuits: 1065
Transformers:
Modulators Coupled by: 1100

Transmitter:
A-C Operated Speech Input Equipment: 1142
Low Power Broadcast: 1060
Television: 1162

Transmission:
Attenuation for, of 1.5 to 3.5 Mc: 1145
Calculation of Properties in Electrical Networks: 1122
Cyclones and Anticyclones: 1089
During Solar Eclipse: 1076, 1077
Field Strength Calculation for High-Frequency: 1106
In Ionized Layer: 1062
Low-Frequency Waves: 1063
Modulation Frequencies in Visual: 1046
of High-Frequency Networks: 1051
Optical Behavior of Ground: 1090
Polarization of Waves Traveling Obliquely to Earth's Magnetic Field: 1116
Report of Committee: 1143
Ship-Shore Radiotelephone: 1049
Short-Wave to South America: 1050
Study of Three to Eight Meter: 1070
Ultra High Frequency: 1129
Ultra Short Waves: 1072, 1073
Waves Below Ten Meters: 1071
Waves Between 150 and 2000 Kilocycles: 1105
Waves for Distances of 50 to 2000 Kilometers: 1105

Transmission Line:
Graphical Methods for Problems: 1066
Radiation Resistance of Concentric Conductor: 1133

Triodes:
Output and Operating Conditions for: 1098

Tube:
Analysis of Power Detection: 1103
Characteristics in Positive Grid Region: 1114
Cold Cathode for Ultra Short Wave Oscillations: 1156
Diode Detection Analysis: 1099
Electronics at Ultra High Frequencies: 1152
Frequency Doubling in Triode: 1045
Graphite Anodes: 1113
Harmonic Production With Resistive Loads: 1144
High Frequency: 1164
Improvement in Vacuum, Voltmeter: 1047
Measurement Dynamic Coefficients: 1094
Operation on Common Load: 1165
Output and Operating Conditions of Triodes: 1098

O

- Optical Behavior of Ground for Short Radio Waves: 1090
- Oscillations:
 - Ultra Short Wave, With Cold Cathode Tubes: 1156
- Oscillator:
 - Constant Frequency, and Frequency Variation and Harmonic Content: 1101
 - Effect of Capacity Variation: 1120
 - Frequency Modulation: 1120
 - Having Linear Operating Characteristic: 1049
 - Operation on Common Load: 1165
 - Theory on Magnetron: 1117, 1167
 - Vibration of Crystal: 1104
- Oscillographic Measurements:
 - Tube Characteristics in Positive Grid Region: 1114
- Output:
 - Operating Conditions and, for Triodes: 1098
- Overland Transmission:
 - Attenuation at 1.5 to 3.5 Mc: 1145

P

- Permeability Tuning and Ferro-Inductors: 1087
- Photocells:
 - Generator for Testing: 1157
- Piezo-Electric Crystal Oscillator:
 - Vibration of: 1104
- Piezo-Electric Loud Speaker: 1141
- Pittsburgh's Contribution to Radio, Discussion: 1031
- Polar Year Measurements: 1166
- Polarization:
 - Waves Traveling Obliquely to Earth's Magnetic Field: 1116
- Police Radio:
 - System for New York City: 1126
- Power:
 - Grid Driving for Radio-Frequency Amplifiers: 1118
- Power Detection:
 - Analysis: 1103
- Power Law Modulator: 1121
- Power Supply:
 - Life Test Using Thyratons: 1115
 - Oscillators Operated from Common: 1165
- Propagation:
 - Attenuation Between 1.5 and 3.5 Mc: 1145
 - Cyclones and Anticyclones: 1089
 - During Solar Eclipse: 1075, 1077
 - In Ionized Layer: 1062
 - Low-Frequency Waves: 1063
 - Optical Behavior of Ground: 1090
 - Polarization of Waves Traveling

- Obliquely to Earth's Magnetic Field: 1116
- Report of Committee: 1143
- Study of Waves Between Three and Eight Meters: 1070
- Ultra Short Waves: 1072, 1073
- Waves Below Ten Meters: 1071
- Waves Between 150 and 2000 Kilocycles: 1105
- Waves for Distances of 50 to 2000 Kilometers: 1105
- Push-Pull Amplifiers:
 - Performance of Audio: 1079

R

- Radiation and Induction: 1154
- Radiation Resistance:
 - Concentric Conductor Line: 1133
- Radio-Frequency Amplifiers:
 - Grid Driving Power: 1118
- Radio-Frequency Transmission Lines:
 - Graphical Method for Problems: 1066
- Radio Law:
 - Aspects: 1153
- Radio Patrol System for City of New York: 1126
- Radio Range Beacon Free From Night Effects: 1091, 1092
- Radio Systems:
 - Police: 1126
- Radiotelephone:
 - Ship-Shore Transmission: 1049
 - Transoceanic Reception: 1048
- Range Beacon:
 - Radio, Free From Night Effects: 1091, 1092
- Reactance-Frequency Chart: 1135
- Receiving Measurements:
 - Low Frequency: 1134
- Receiver:
 - Ribbon Telephone: 1085
 - Television: 1093, 1163
 - Tone Corrected Highly Selective: 1127
- Reception:
 - Synchronized Broadcast Stations: 1128
 - Transoceanic, High-Frequency Telephone: 1048
- Rectification:
 - Discussion on Grid and Diode: 978
- Rectifier:
 - Detecting Two Modulated Waves With Linear: 1080
 - Thyratrons, in Life Test Power Supply: 1115
- Resonance:
 - Analysis of Parallel: 1064
 - Discussion on Parallel: 1064
 - Some Relations and Thevenin's Theorem: 1109

Reverberance:
Sound and, Ribbon Microphone: 1084
Ribbon Telephone Receiver: 1085
Ribbon Microphone, Sound and: 1084

S

Shielding:
Electromagnetic, Between One and Thirty Kilocycles: 1078
Spray, Tubes: 1088
Ship-Shore Radiotelephone Transmission: 1049
Solar Eclipse:
Kennelly-Heaviside Layer Records: 1075, 1076
Sound:
Collection of, and Ribbon Microphone: 1084
Speech:
Distortion in Audio Systems: 1086
Speech Input Equipment:
A-C Operated: 1142
Spray-Shield Tube: 1088
Static:
Audio-Frequency: 1147
Disturbances of Extraterrestrial Origin: 1140
Superregeneration:
Wave Meter for Ultra Short Waves: 1155
Synchronized Broadcasting:
Reception of: 1128

T

Telephone:
Transoceanic Reception: 1048
Telephone Receiver:
Ribbon: 1085
Television:
Definition: 1130
Image Characteristics: 1159
Modulation Frequencies: 1046
Receiving Circuits: 1093, 1163
System: 1160, 1161
Transmitter: 1162
Testing:
Light Generator for Light Sensitive Devices: 1157
Thevenin's Theorem: 1109
Thyratrons:
Life Test Power Supply Utilizing: 1115
Tone Correction:
Action of, Highly Selective Receivers: 1027
Transducers:
Nonlinearity in: 1107
Transducer Theory and Coupled Circuits: 1065
Transformers:
Modulators Coupled by: 1100

Transmitter:
A-C Operated Speech Input Equipment: 1142
Low Power Broadcast: 1060
Television: 1162

Transmission:
Attenuation for, of 1.5 to 3.5 Mc: 1145
Calculation of Properties in Electrical Networks: 1122
Cyclones and Anticyclones: 1089
During Solar Eclipse: 1076, 1077
Field Strength Calculation for High-Frequency: 1106
In Ionized Layer: 1062
Low-Frequency Waves: 1063
Modulation Frequencies in Visual: 1046
of High-Frequency Networks: 1051
Optical Behavior of Ground: 1090
Polarization of Waves Traveling Obliquely to Earth's Magnetic Field: 1116
Report of Committee: 1143
Ship-Shore Radiotelephone: 1049
Short-Wave to South America: 1050
Study of Three to Eight Meter: 1070
Ultra High Frequency: 1129
Ultra Short Waves: 1072, 1073
Waves Below Ten Meters: 1071
Waves Between 150 and 2000 Kilocycles: 1105
Waves for Distances of 50 to 2000 Kilometers: 1105

Transmission Line:
Graphical Methods for Problems: 1066
Radiation Resistance of Concentric Conductor: 1133

Triodes:
Output and Operating Conditions for: 1098

Tube:
Analysis of Power Detection: 1103
Characteristics in Positive Grid Region: 1114
Cold Cathode for Ultra Short Wave Oscillations: 1156
Diode Detection Analysis: 1099
Electronics at Ultra High Frequencies: 1152
Frequency Doubling in Triode: 1045
Graphite Anodes: 1113
Harmonic Production With Resistive Loads: 1144
High Frequency: 1164
Improvement in Vacuum, Voltmeter: 1047
Measurement Dynamic Coefficients: 1094
Operation on Common Load: 1165
Output and Operating Conditions of Triodes: 1098

Small Dimensions: 1164
Spray Shield: 1088
Tuning:
Permeability: 1087

U

Ultra Short Radio Waves:
Characteristics of: 1129
Discussion on Review of: 923
Frequency Measurement: 1044
New Field For: 1151
Oscillations With Cold Cathode
Tube: 1156
Propagation: 1072
Propagation Below Ten Meters:
1071
Study of Propagation: 1070

Superregenerative Wave Meter For:
1155
Transmission: 1073

V

Vacuum Tube Voltmeter:
Improvement in: 1047
Vibration of Crystal Oscillators: 1104
Visual Transmission:
Modulation Frequencies: 1046
Voltmeter:
Improvement in Vacuum Tube:
1047

W

Wave:
Measurement, Ultra-Radio: 1044
Wave Meter:
Superregenerative: 1155

INCORRECT ADDRESSES

Listed below are the names and last known addresses of one hundred and eighty-five members of the Institute whose correct addresses are not known. It will be appreciated if anyone having information concerning the present addresses of any of the persons listed will communicate with the Secretary of the Institute.

- | | |
|---------------------------|--|
| Ackerman, E. K. | Amplivox Engineering, 7113 Euclid Ave., Cleveland, Ohio. |
| Adams, Frank S. | 27 Avon View, Devizes, Wiltshire, Eng. |
| Aldrich, Gordon H. | 1 Balmoral Mansions, St. Andrews, Bristol, Eng. |
| Alexander, Robert L. | Kinemas, Ltd., Johannesburg, Transvaal, S. Africa. |
| Allen, Otis T. | Station WZG, Fort Bragg, N. C. |
| Archer, C. | 138 Yeo Street, Bellevue East, Johannesburg, S. Africa. |
| Baldwin, Preston De G. | Radio Station WALR, Zanesville, Ohio. |
| Bargamian, John | 214 West 50th St., New York, N. Y. |
| Barker, Howard J. | Post Office Box 742, Atlanta, Ga. |
| Barnette, Allen F. | 314 West 94th St., Los Angeles, Calif. |
| Berman, Henry O. | 836 N. Howard St., Baltimore, Md. |
| Berry, James L. | 114 Remsen St., Brooklyn, N. Y. |
| Bohn, William C. | 139 Sagamore Rd., Maplewood, N. J. |
| Borek, John J. | 1334 N. Marshall St., Milwaukee, Wisc. |
| Boylan, E. Brandt | 2205 Monroe St., Wilmington, Del. |
| Brewster, O. H. | 800 Frederica Street, Owensboro, Ky. |
| Brickson, H. O. | 208 Center Ave., Stevens Point, Wisc. |
| Brown, J. Kenneth | 3762 Ninth St., Riverside, Calif. |
| Bucher, E. E. | R. C. A. Photophone, Inc., 411-5th Ave., New York City. |
| Burghard, Ensign G. E. | 22 East 88th St., New York, N. Y. |
| Cann, John O. G. | 87 Columbia Ave., Westmount, Quebec, Can. |
| Cartwright, Randle V. | 1137 Pleasant St., Boulder, Colo. |
| Castanie, William Francis | 5331 Devonshire Ave., St. Louis, Mo. |
| Cherne, Leo J. | 1539 N. Irving Ave., Chicago, Ill. |
| Clark, Joseph S. | Polymet Mfg. Co., 829 East 134th St., New York, N. Y. |
| Clark, Roland R. | 114 East 19th St., Marion, Ind. |
| Cosandey, Charles J. | 1313 North 56th Avenue W., Duluth, Minn. |
| Cox, Alfred | 46 Hinrich's Place, Bloomfield, N. J. |
| Crapp, George L. | Shirley Court, Stonehurst, Pa. |
| Cruikshank, John M. | Medical Services, British Government Hospital, Nassau, Bahama Islands. |
| Culley, Pawson | 116 Ralph Ave., Brooklyn, N. Y. |
| Dewey, Carlyle S. | Box 607 Yale Station, New Haven, Conn. |
| Doan, Robert O. | 906 Edgecomb Pl., Apt. 3-B, Chicago, Ill. |
| Donovan, Arthur C., Jr. | 34 Manchester Rd., Brookline, Mass. |
| D'Adrian, A. L. Duval | 1124 Washington St., Alton, Ill. |
| Edwards, David A. | 117 Chestnut Street, Binghamton, N. Y. |
| Edwards, Lyman M. | 1914 West Cherokee St., Enid, Oklahoma. |
| Ehlers, Paul | P. O. Box 584, Davenport, Iowa. |
| Ellinwood, Carl W. | 1933 Hillcrest Ave., Merchantville, N. J. |
| Falconer, John L. | 13 Pinewood Ave., Toronto, Ont., Can. |
| Falknor, Frank B. | 7730 Colfax Ave., Chicago, Ill. |
| Fenton, Kenneth G. | 201 Locust St., Valparaiso, Ind. |
| Fisher, Frank E. | 1750 No. Springfield Ave., Chicago, Ill. |
| Fitzsimons, Frank | 1953 Finsman Ave., Pennsauken, 1 WSP, N. J. |
| Frederick, Paul E. | 2600 Mayfield Rd., Cleveland Heights, Ohio. |
| Gady, John W. | P. O. Box 404, Hamilton, Bermuda. |
| Gebhart, Bernard R. | 1318 N. Van Buren St., Milwaukee, Wis. |
| Gibbon, Quincy D. | Gibbon Radio Shop, Cleveland, Miss. |
| Giovanini, Frank | 114 William St., East Orange, N. J. |
| Glaze, John C. | 5083 Westminster Place, St. Louis, Mo. |
| Goddard, Fredk, M. | 668 77th St., Brooklyn, N. Y. |
| Gowan, Hubert S. | 62 St. George St., Kitchener, Ont., Can. |
| Gray, De Wayne R. | 626 Benson St., Camden, N. J. |
| Grey, Charles C. | 41 Crescent Place, Yonkers, N. Y. |
| Griva, John | 13943 Mayfield, Detroit, Mich. |
| Grumman, F. W. | 20 Irving Place, New York, N. Y. |
| Gunther, W. J. | 424 Washington St., Gary, Ind. |
| Haire, A. F. | c/o R. C. A. Photophone, Inc., 529 West Congress St., Detroit, Michigan. |
| Hale, Walter S. | California & Hawaiian Sugar Refining Co., Crockett, Calif. |
| Hansen, John C. | Radio Victor Corporation of Am., Building 5—2nd Floor, Camden, N. J. |
| Harness, Sam A. | 463 West St., New York, N. Y. |
| Heather, Harold | 2214 S. La Brea Ave., Los Angeles, Calif. |
| Hecht, R. H. | c/o Elec. Research Products, Inc., 910 S. Michigan, Chicago, Ill. |
| Heeder, M. E. | 3895-18th St., San Francisco, Calif. |
| Helt, Scott | P. O. Box 1462, Mobile, Alabama. |

- Hetzel, Ralph E. 6047 Carlton Way, Hollywood, Calif.
Hicks, H. J. 5571 Chamberlain Ave., St. Louis, Mo.
Holst, P. F. G. 1115 White Horse, Oaklyn, N. J.
Hopper, C. L. Box 543, Frankfort, Mich.
Hughes, William P., Jr. 5013-8th Ave., Brooklyn, N. Y.
Hurvitz, Hyman 604½ Park Road, Washington, D. C.
Hutcheson, John A. 47 Florence St., Springfield, Mass.
- Ivanko, John G. 199 Ann St., Bridgeport, Conn.
- Jelen, M. J. 4830 Barry Ave., Chicago, Ill.
John, Raymond 4430 S. Grand Blvd., St. Louis, Mo.
Johnson, Carl C. 1909-19th St., So., St. Petersburg, Fla.
Johnson, R. Stanley 192 Park Place, Brooklyn, N. Y.
Jones, A. B. 1-A Glenlyon Rd., Eltham S. E. 9, London, England.
Jorgenson, Harold Janis Hotel, South Haven, Mich.
- Kacourine, Serge N. Stankevitch St. N. 11 Apt. 6, Moscow, U. S. S. R.
Keogh, R. J. 5216 W. Adams St., Chicago, Ill.
Kerrison, Harland R. 15 Dutchess Drive, Scotswood on Tyne, Northumberland, England
Kilheffer, Lawrence D. 3255 Wayne Ave., Dayton, Ohio.
King, Frank Rm. 300, 91 Seventh Ave., New York, N. Y.
Klein, Norman E. National Air Transport, Municipal Airport, Chicago, Ill.
Kruise, Charles C. 226 W. Meinecke Ave., Milwaukee, Wis.
- Lee, Donald C. Westinghouse Elec. & Mfg. Co., Chicopee Falls, Mass.
Lee, Fat Chang 557 W. 124th St., Apt. 26, New York, N. Y.
Le Viness, J. E. 9318 Ave. L., Brooklyn, N. Y.
Lewis, Evan J. 611 S. Birch, Santa Ana, Calif.
Lumb, Frank J. 10½ Pleasant St., Auburn, N. Y.
- Macy, Spencer A. U. S. M. C. Radio Station G3L, 2nd Brigade, Campo De Marte Managua, Nic., Central America.
- Manchester, R. M. 1171 Bush St., San Francisco, Calif.
Mann, Hayward K. 66 Bay State Road, Boston, Mass.
Mareek, Albert J. U. S. Navy, 1233 Appleton, Long Beach, Calif.
Martlieu, C. H. O. 4 Blowers Street, Halifax, N. S., Canada.
McKinney, Francis M. General Delivery, Victor, Colo.
Meacham, J. F. B. 86-04—117th Street, Richmond Hill, L. I., N. Y.
Menard, J. L. 7818 St. Denis St., Montreal, Que., Can.
Miller, S. S. Research Products, Engineering Dept., Northern Electric Co., Montreal, Que., Canada.
- Minnikin, Sidney J. 1237 West 4th St., Los Angeles, Calif.
Minton, John Box 175, White Plains, N. Y.
Moore, Thomas H. P. O. Box 491, Charleston, W. Va.
Morris, William J. 232 Newport Road, Roath, Cardiff, Wales.
- Nauth, G. Raymond 145 Clendenan Ave., Toronto, Ont., Can.
Nelson, Ivar 616 East 5th St., Yankton, S. D.
Nichols, F. A. 1115-15th Street, Greeley, Colo.
Noyes, Atherton, Jr. 3 C Gibson Terrace, Cambridge, Mass.
- Ostrander, R. S. 2337 Grandview Ave., Cleveland Heights, Ohio.
Oxner, Edwin K. 40 W. Milwaukee Ave., Detroit, Mich.
- Palmer, Edward D. 1217 Willard St., Ann Arbor, Mich.
Palmer, James 7233 Phillips Ave., Chicago, Ill.
Parker, Ray H. 5355 Poinsette Ave., Richmond, Calif.
Payne, Charles C. 8 West 40th St., New York, N. Y.
Pelikan, B. Z. 51 W. Frambes Ave., Columbus, Ohio.
Penn, William D. B-12 Adams House, Cambridge, Mass.
Percy, Faye W. P. O. Box 4475, University of Arizona Station, Tucson, Arizona.
Perkins, Laurence M. c/o Erie Resistor Corp., Erie, Pa.
Pfeiff, Fred J. 101 Terrace Ave., Hasbrouck Heights, N. J.
Pickett, C. E. 5217 Ellis Ave., Chicago, Ill.
Pitts, Henry L. U.S. Navy, U.S.S. Wright, c/o Postmaster, San Diego, Calif.
Potter, George E. NC Division, U.S.S. Chicago, c/o P. M., San Francisco, Calif.
- Rasmussen, Robert P. O. Box 318, Oil City, Pa.
Read, George T. 4159 East 138th St., Cleveland, Ohio.
Reynolds, F. T. 364 Eddy St., San Francisco, Calif.
Royal, James E. P. O. Box 543, Daytona Beach, Fla.
Rush, Floyd M. c/o Radio Station KMED, Sparta Bldg., Medford, Oregon.
Ryall, Henry 67 Bradley St., Portland, Maine.
- St. James, Robert T. 1135 No. Cicero Ave., Chicago, Ill.
Sampson, John C. 4707 Wilcox, St. Louis, Mo.
Sandifer, Norwood H. Cain Radio Distr., Jacksonville, Fla.
Sattgast, J. Kenneth 2315 Gaebler Ave., Overland, Mo.
Scheffer, Roy J. 717 Greenwood St., New Orleans, La.
Schenke, Kurtiss P. 60 Midwood St., Brooklyn, N. Y.
Seymour, Fred M. Seymour Radio Co., 3645 Nottingham Road, Detroit, Michigan.
Sharp, James M., Jr. Box 2145, Stanford University Calif.

- Sheppard, Walter A.
 Sherwood, Leslie F.
 Shomler, H. B.
 Shortland, James W.
 Shotwell, Harold H.
 Simpson, Leroy C.
 Siovic, John E.
 Sklar, H. Lee
 Smith, F. E.
 Smith, Herbert H.
 Smith, K. R.
 Smith, Robert T.
 Somersalo, George A.
 Sprague, Robert M.
 Starner, Charles J.
 Starr, Alfred R.
 Strachan, George H.
 Straw, Fred D.
 Sturtevant, J. W.
 Sutton, Robert B.
 Sweighert, D. V.
 Swift, William C. G.
- Tagart, Sam W.
 Tanaka, Yoshio
 Tasker, Joseph M.
 Tatreault, Leon E.
 Thorsen, Orville T.
 Traugott, Paul
- Vaill, Edward W.
 Van Doeren, C. A.
 Vogel, Erwin William
- Walker, C. L.
 Wallace, L. E.
 Watson, J. E.
 Watts, Harley M.
 Wayland, Russell J.
 Weiss, Earl
 Wells, M. M.
 White, Joseph P.
 Wilcox, Nathan
 Wild, Sydney J.
 Wilkinson, L. G.
 Willers, Theodore H.
 Wilm, Carl F.
 Wisegarver, Orton H.
 Worst, J. S.
 Wynne, William A.
- Yates, Raymond F.
- Zeigler, T. W.
- Mt. Royal Hotel, Montreal, Que., Can.
 c/o Radio Station WIOD, Miami Beach, Fla.
 721 No. Brand, Glendale, Calif.
 221 Stratford Road, Brooklyn, N. Y.
 32 N. Worth Ave., Elgin, Ill.
 8 Mynderse St., Schenectady, N. Y.
 7436 Kimbark Ave., Chicago, Ill.
 Micamold Radio Corp., 1087 Flushing Ave., Brooklyn, N. Y.
 630 Cochran Ave., Apt. 8, Los Angeles, Calif.
 1360 Sir Francis Blvd., San Francisco, Calif.
 Brunswick Radio Corp., 120 West 42nd St., New York, N. Y.
 University of Tennessee, 1409 Highland Ave., Knoxville, Tenn.
 4674 Manor Ave., Chicago, Ill.
 c/o Federal Telegraph Co., 200 Mt. Pleasant Ave., Newark, N. J.
 Stanford University, 1033 Guinda St., Palo Alto, Calif.
 216 West 102nd St., New York, N. Y.
 920 So. Baldwin Ave., Arcadia, Calif.
 222 West 53rd St., Ashtabula, Ohio.
 15220 Hilliard Road, Lakewood, Ohio.
 632 West 20th Ave., Spokane, Washington.
 Royal Hotel, Bucyrus, Ohio.
 37-20—81st St., Jackson Heights, L. I., N. Y.
- 1428 No. Marshall St., Apt. 25, Milwaukee, Wisc.
 Jojk Nonoichi Sending Station, Nonoichi-Machi, Ishikawa-Ken, Japan.
 64 Rowe Ave., Hartford, Conn.
 2210 Glendon Ave., W. Los Angeles, Calif.
 3547 Pierce Ave., Chicago, Ill.
 2134 W. Erie Ave., Philadelphia, Pa.
- 80 Maiden Lane, New York, N. Y.
 3323 E. 8th St., Tulsa Okla.
 4606 Clarendon Road, Brooklyn, N. Y.
- 68 Federal Street, Springfield, Mass.
 1521 South West 7th St., Miami, Fla.
 57 Sherwood Ave., Toronto, Ont., Can.
 820 E. Wells St., Milwaukee, Wisc.
 U.S. Navy, U.S.S. Texas, c/o Postmaster, San Pedro, Calif.
 79 East Depew Ave., Buffalo, N. Y.
 c/o Radio Stations WLW & WSAI, Mason, Ohio.
 Dept. of Hospitals, Seaview Hospital, Staten Island, N. Y.
 Control Room, Station KSO, Des Moines, Iowa.
 1609 Grand Ave., Oakland, Calif.
 3111 Grove Ave., Berwyn, Ill.
 P. O. Box 338, Auburn, N. Y.
 4542 N. Kenneth Ave., Chicago, Ill.
 Hotel Mayfair, Kansas City, Mo.
 7113 Euclid Ave., Cleveland, Ohio.
 Apt. 106, 70 Van Reypen St., Jersey City, N. J.
- 419 Grider St., Buffalo, N. Y.
- 1535 P St., N. W. Washington, D. C.

CHANGE IN MAILING ADDRESS OR BUSINESS TITLE

Members of the Institute are asked to use this form for notifying the Institute office of a change in their mailing address or the listing of their company affiliation or title in the Year Book.

The Secretary,
THE INSTITUTE OF RADIO ENGINEERS,
33 West 39th Street,
New York, N.Y.

Dear Sir:

Effective please note change in my address
(date)
for mail as follows:

FROM

.....
(Name)

.....
(Street Address)

.....
(City and State)

TO NEW ADDRESS

.....
(Street Address)

.....
(City and State)

Please note following change in my Year Book listing.

.....
(Title)

.....
(Company Name)

.....
(Company Address)

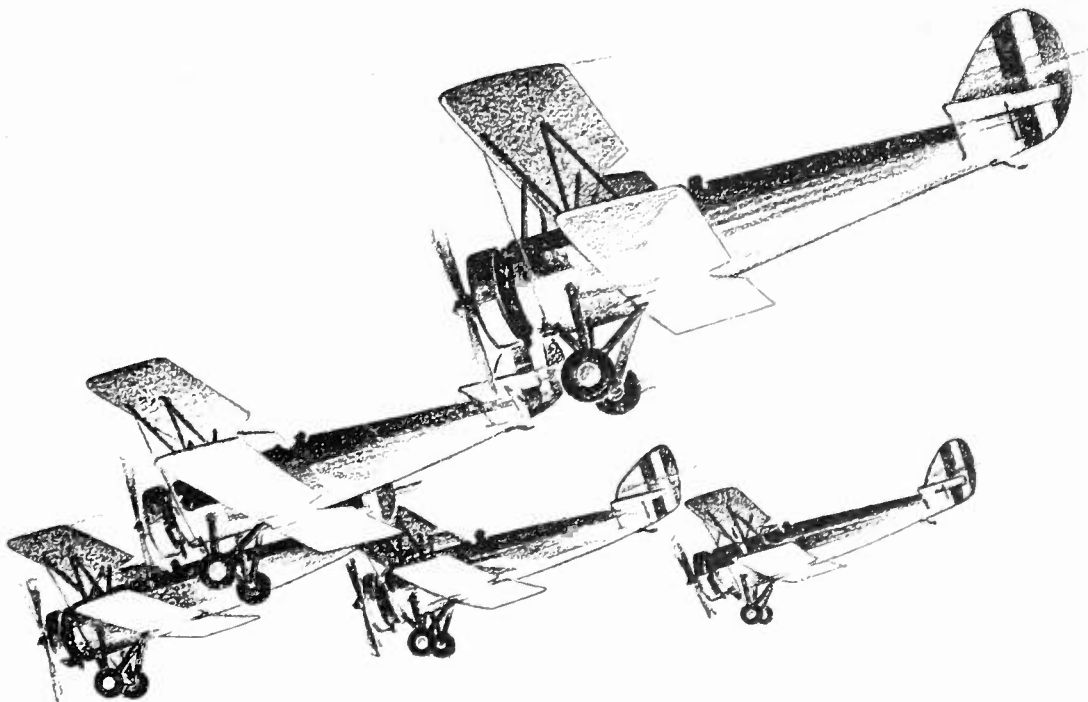

TEAMWORK

The activities of the Hygrade Sylvania Corporation have always been marked by cooperation from start to finish. The men who actively manage the business own the major portion of the company's stock. They work shoulder to shoulder with the experimental and production departments of the company.

In the laboratories, Sylvania's skilled scientists conduct the company's extensive research work . . . and collaborate with production engineers in the practical application of their discoveries.

A striking example of the effectiveness of such team work was Hygrade Sylvania's part in the pioneering and development of the revolutionary 6.3 volt group of tubes . . . and its application to automobile sets and general use.

These engineers have cooperated with leading set manufacturers in solving circuit and design problems. Requests for service of this type are welcome. Write for consultation . . . no obligation incurred. Acquaint yourself with our activities . . . send for Sylvania's new weekly house organ, "Flashes." Hygrade Sylvania Corporation, Emporium, Penna.

Sylvania

(Reg. U. S. Pat. Off.)



THE SET-TESTED RADIO TUBE

© 1931. H. S. C.

When writing to advertisers mention of the PROCEEDINGS will be mutually helpful.

Back Numbers of the Proceedings, Indexes, and Year Books Available

MEMBERS of the Institute will find that back issues of the Proceedings are becoming increasingly valuable, and scarce. For the benefit of those desiring to complete their file of back numbers there is printed below a list of all complete volumes (bound and unbound) and miscellaneous copies on hand for sale by the Institute.

The contents of each issue can be found in the 1909-1930 Index, the 1931 Year Book and in the December, 1932, Proceedings.

BLUE BUCKRAM BOUND VOLUMES:

- Vol. 10 (1922), \$8.75 to members.
- Vol. 18 (1930), \$9.50 to members
- Vol. 19 (1931), \$9.50 to members
- Vol. 20 (1932), \$9.50 to members

LEATHER BOUND VOLUME:

- Vol. 14 (1926), \$10.25 to members

UNBOUND VOLUMES:

- Vols. 5, 6, 8, 9, 10, 11, 13, 14, 18, and 19 (1917-1918-1920-1921-1922-1923-1925-1926-1930-1931), \$6.75 per volume (1917-1926) and \$7.50 per volume (1927-1931) to members

MISCELLANEOUS COPIES:

- Vol. 1 (1913) July and December
- Vol. 2 (1914) June
- Vol. 3 (1915) December
- Vol. 4 (1916) June and August
- Vol. 7 (1919) February, April, August, and December
- Vol. 12 (1924) April, June, August, October, and December
- Vol. 15 (1927) January, April, May, June, July, October, November, and December
- Vol. 16 (1928) February, March, April, May, June, July, August, September, October, November, and December
- Vol. 17 (1929) January, March, April, May, June, July, August, September, November, and December
- Vol. 20 (1932) January, March, April, May, June, July, August, September, October, November, and December

These single copies are priced at \$1.13 each to members to the January, 1927, issue. Subsequent to that number the price is \$0.75 each. Prior to January, 1927, the Proceedings was published bimonthly, beginning with the February issue and ending with the December issue. Since January, 1927, it has been published monthly.

MEMBERS will also find that our index and Year Book supplies are becoming limited. The following are now available:

INDEX

The Proceedings Index for the years 1909-1930 inclusive is available to members at \$1.00 per copy. This index is extensively cross indexed.

YEAR BOOK

The 1932 Year Book is now available to members at \$1.00 per copy. This Year Book includes a current alphabetical catalogue of the I.R.E. membership, in which the mailing address and business affiliation of each member is listed, as well as current information on standard measurements for tubes and sockets and standard requirements for radio receivers.

Make remittances payable to the Institute of Radio Engineers and send orders to:

THE INSTITUTE OF RADIO ENGINEERS

33 West 39th Street
NEW YORK CITY, N.Y.

A *Friend* in the house

"It would be a hardship for me to be without a telephone. Each evening, you see, my son calls up to chat with me. That is the brightest spot in my day."

"Mother, wouldn't it be awful without a telephone? That ice cream would never have come for the party if we hadn't called up about it."

"... then Jim grabbed the telephone and called the doctor. If it hadn't been for that, I don't know what would have happened to Doris."



THERE are many fine things in life that we take almost for granted. Health, water, sunlight, green fields, loyal friends, a home to live in. . . . Not until some mischance deprives us of these priceless possessions do we learn to esteem them at their true value.

It is in much the same manner that most people regard the telephone. Each day, each week, each year, they use it freely, casually, as a matter of course.

To keep friend in constant

touch with friend, to help manage a household smoothly and efficiently, to give larger scope and opportunity to business of every kind, to protect loved ones in time of unexpected danger . . . this is the task of the telephone.

It stands ever ready to serve you—to carry your voice to any one of millions of other telephones in this country or in foreign lands. You are in touch with everything and everybody when you have a telephone.

AMERICAN TELEPHONE AND TELEGRAPH COMPANY



When writing to advertisers mention of the PROCEEDINGS will be mutually helpful.

"WE CANCELED OUR FACTORY INSPECTION AND RELY ON ERIE'S OWN TESTS"

BECAUSE resistors furnished by us over a period of years have so consistently been well within their specified resistance tolerances, several leading radio manufacturers have eliminated their factory inspection of Erie Resistors.

Modern manufacturing methods on machinery of our own design, plus triple inspection of each resistor guarantees a finished product that satisfies the most rigid specification.

Every radio manufacturer can cut production costs by specifying Erie Resistors and eliminating factory tests. Why not take advantage of this large saving through the use of precision-tested Erie Resistors?

Top: An automatic machine of our own design that electrically tests and sorts Erie Resistors according to their tolerances.

Above: Finished resistors being checked by a skilled operator.



ERIE RESISTOR CORPORATION

ERIE, PA.

Factories in ERIE, PA. - TORONTO, CANADA - LONDON, ENG.

When writing to advertisers mention of the PROCEEDINGS will be mutually helpful.

The Institute of Radio Engineers Incorporated

33 West 39th Street, New York, N. Y.

APPLICATION FOR ASSOCIATE MEMBERSHIP

(Application forms for other grades of membership are obtainable from the Institute)

To the Board of Directors

Gentlemen:

I hereby make application for Associate membership in the Institute of Radio Engineers on the basis of my training and professional experience given herewith, and refer to the members named below who are personally familiar with my work.

I certify that the statements made in the record of my training and professional experience are correct, and agree if elected, that I will be governed by the constitution of the Institute as long as I continue a member. Furthermore I agree to promote the objects of the Institute so far as shall be in my power, and if my membership shall be discontinued will return my membership badge.

.....
(Sign with pen)

.....
(Address for mail)

.....
(Date)

.....
(City and State)

Sponsors:

(Signature of references not required here)

Mr. Mr.

Address Address

City and State City and State

Mr.

Address

City and State

The following extracts from the Constitution govern applications for admission to the Institute in the Associate grade:

ARTICLE II—MEMBERSHIP

Sec. 1: The membership of the Institute shall consist of: * * * (c) Associates, who shall be entitled to all the rights and privileges of the Institute except the right to hold any elective office specified in Article V. * * *

Sec. 4: An Associate shall be not less than twenty-one years of age and shall be a person who is interested in and connected with the study or application of radio science or the radio arts.

ARTICLE III—ADMISSION AND EXPULSIONS

Sec. 2: * * * Applicants shall give references to members of the Institute as follows: * * * for the grade of Associate, to three Fellows, Members, or Associates; * * * Each application for admission * * * shall embody a full record of the general technical education of the applicant and of his professional career.

ENTRANCE FEE SHOULD ACCOMPANY APPLICATION



A NEW Member of An OLD Family

Here is a capacitor which fills in the gap between the small mica condensers and the larger tubular or stacking units. You can, with every assurance of complete satisfaction, specify C-D Type 59 for low-power stages of r.f. amplification, for output stages of small transmitters, and for grid condensers and plate blocking condensers up to 5000 volts.



Lending itself to stacking for series or for multiple connections, this handy capacitor can be used in groups to meet a wide range of capacity and working voltage requirements. Its outstanding features are:

- All the advantages of the tubular type. No bushings. No insulating troubles. Large conducting surfaces for terminals.
- Smaller dimensions than former cast-aluminum Type 40 which it replaces, having height of only $2\frac{1}{2}$ inches as against $4\frac{3}{4}$.
- Because of reduced height, more units can be used in stack of given height.
- Mounting centers interchangeable with Type 40.
- Available in all capacities between .000050 mfd. at 5000V and .1 mfd. at 1000V.

Typical of the Cornell-Dubilier *complete* line of capacitors for every conceivable transmitting and receiving function.

WRITE for further data on this handy capacitor, as well as for our 1933-34 catalog covering the combined Cornell and Dubilier lines.



CORNELL-DUBILIER CORPORATION

4377 Bronx Boulevard - - - New York City

When writing to advertisers mention of the PROCEEDINGS will be mutually helpful.

PROFESSIONAL ENGINEERING DIRECTORY

TO

CONSULTANTS

DESIGNERS

PATENT

ATTORNEYS

**Cathode Ray Tubes
and Associated
Equipment For All
Purposes**

*Write for Complete
Technical Data*

**ALLEN B. DUMONT
LABORATORIES
UPPER MONTCLAIR, N.J.**

**FOR ADVANCED
TRAINING**

in:

Practical Radio Engineering
Practical Television Engineering

write to

**CAPITOL RADIO ENGI-
NEERING INSTITUTE**

Riggs Bank Bldg.
Washington, D.C.

We

suggest

the use

of the

Professional

Engineering Directory

Alphabetical Index to Advertisements

| | | |
|-----------------------------------|------------------------------------|-------|
| A | | |
| American Tel. & Tel. Co. | | XIII |
| C | | |
| Central Radio Laboratories | | XX |
| Cornell-Dubilier Corp. | | XVII |
| E | | |
| Electrophone Corp. | | XIX |
| Erie Resistor Corp. | | XIV |
| G | | |
| General Radio Co. | Outside Back Cover | |
| H | | |
| Hygrade Sylvania Corp. | | XI |
| I | | |
| I.R.E. | X, XII, XV, XVI, Inside Back Cover | |
| P | | |
| Professional Eng. Directory | | XVIII |

High - Fidelity Sound Reproduction

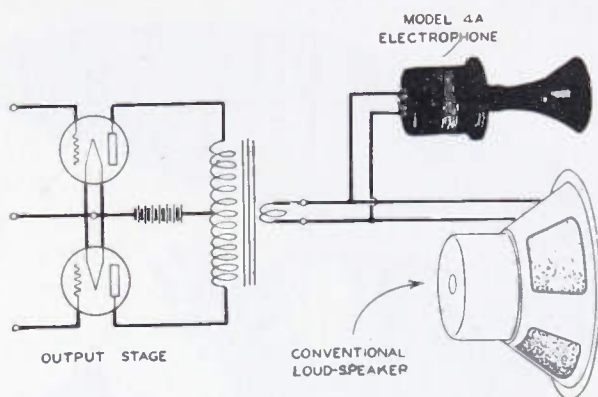

NOW SIMPLY OBTAINED BY ADDING THE NEW MODEL 4A HIGH-FREQUENCY ELECTROPHONE TO EXISTING EQUIPMENT

● The range of sound reproduction may be considerably extended at the high frequency end by connecting a model 4A Electrophone unit across your present loud speaker as shown by the diagram. This unit is of the piezoelectric type and is scientifically designed for the efficient and distortionless reproduction of the higher audio frequencies. Its frequency response characteristic complements that of the average loud-speaker.

NO FILTERS OR FIELD SUPPLY REQUIRED

● Due to the parallel combination of capacitive reactance of the piezoelectric diaphragm employed in this unit and the inductive reactance of the low-frequency speaker the power divides naturally between the two units. This connection also improves the power-factor of the output circuit. No field excitation required. This results in a simplicity and saving of cost not possible with other types.

Send for free Technical Bulletin IF.

ELECTROPHONE CORPORATION

2019 F Rittenhouse Square

Philadelphia

Licensed under patents and applications of
Boonton Research Corporation and Brush Development Company.

When writing to advertisers mention of the PROCEEDINGS will be mutually helpful.

NEW

Adjustable Voltage Transformer

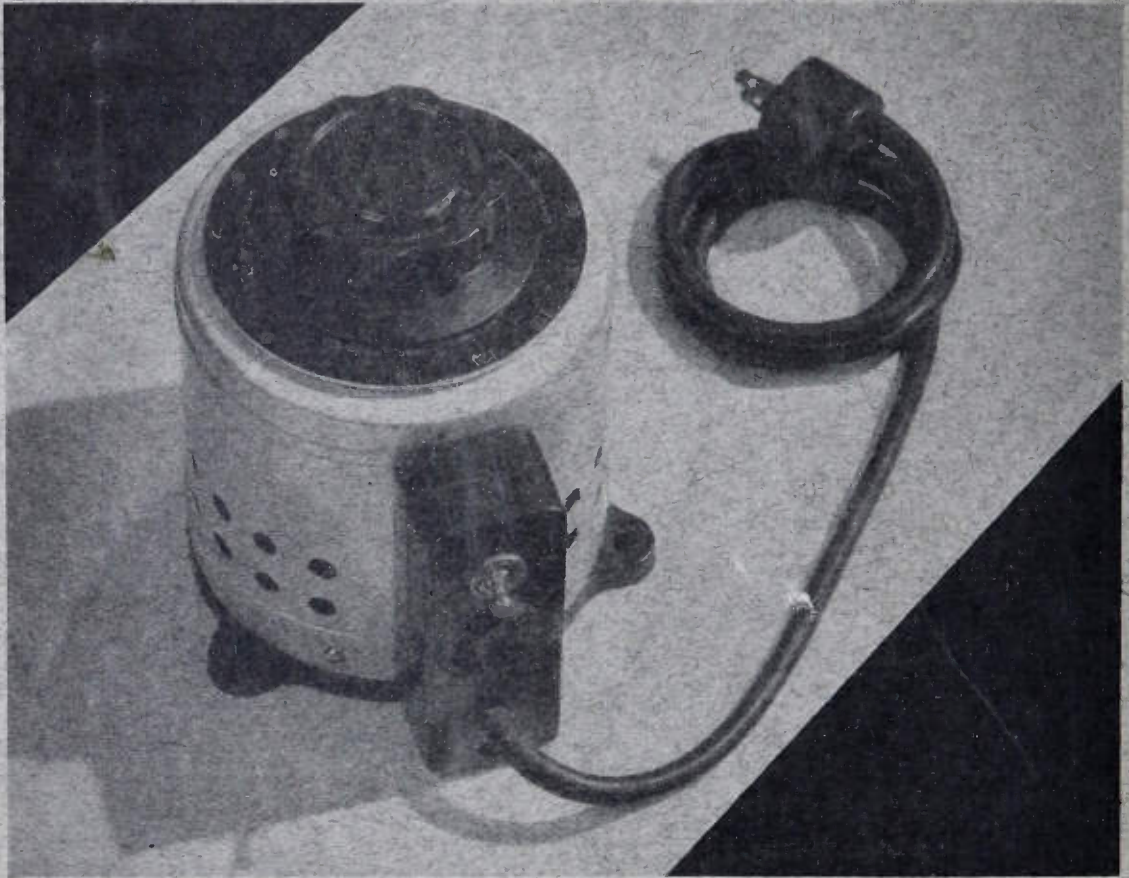

HERE is an adjustable transformer that does all that a rheostat does—with greater efficiency and better regulation. Connect a VARIAC* to the 115-volt, 60 cycle line and obtain any voltage between 0 and 135 volts by turning the knob. The control is uniform and continuous, yet

short-circuited turns cause no heating trouble.

The VARIAC* is ideal for speed adjustment on voltage-sensitive motors, for brilliancy control on sign and theatre lights, for over-voltage and under-voltage testing on socket-power devices of all kinds. Its price is \$16.50.

**VARIAC is pronounced "Vary-ack." Trade mark registered. Patent applied for.*

Write for complete specifications on the VARIAC. Ask for Bulletin EX-3307-R.

GENERAL RADIO COMPANY, CAMBRIDGE, MASSACHUSETTS

GEORGE BANTA PUBLISHING COMPANY, MENASHA, WISCONSIN